

fa



UNITED STATES PATENT AND TRADEMARK OFFICE

UNITED STATES DEPARTMENT OF COMMERCE
United States Patent and Trademark Office
Address: COMMISSIONER FOR PATENTS
P.O. Box 1450
Alexandria, Virginia 22313-1450
www.uspto.gov

APPLICATION NO.	FILING DATE	FIRST NAMED INVENTOR	ATTORNEY DOCKET NO.	CONFIRMATION NO.
09/419,175	10/15/1999	GREGORY T. OSTERHOUT	11032RR	9870
35527	7590	09/23/2005	EXAMINER	
DUKE W. YEE YEE & ASSOCIATES, P.C. P.O. BOX 802333 DALLAS, TX 75380			TRAN, PABLO N	
			ART UNIT	PAPER NUMBER
			2685	

DATE MAILED: 09/23/2005

Please find below and/or attached an Office communication concerning this application or proceeding.

Notice of Abandonment	Application No.	Applicant(s)	
	09/419,175	OSTERHOUT ET AL.	
	Examiner	Art Unit	
	Pablo N. Tran	2685	

-- The MAILING DATE of this communication appears on the cover sheet with the correspondence address--

This application is abandoned in view of:

1. Applicant's failure to timely file a proper reply to the Office letter mailed on 23 February 2005.
 - (a) A reply was received on _____ (with a Certificate of Mailing or Transmission dated _____), which is after the expiration of the period for reply (including a total extension of time of _____ month(s)) which expired on _____.
 - (b) A proposed reply was received on _____, but it does not constitute a proper reply under 37 CFR 1.113 (a) to the final rejection.
(A proper reply under 37 CFR 1.113 to a final rejection consists only of: (1) a timely filed amendment which places the application in condition for allowance; (2) a timely filed Notice of Appeal (with appeal fee); or (3) a timely filed Request for Continued Examination (RCE) in compliance with 37 CFR 1.114).
 - (c) A reply was received on _____ but it does not constitute a proper reply, or a bona fide attempt at a proper reply, to the non-final rejection. See 37 CFR 1.85(a) and 1.111. (See explanation in box 7 below).
 - (d) No reply has been received.
2. Applicant's failure to timely pay the required issue fee and publication fee, if applicable, within the statutory period of three months from the mailing date of the Notice of Allowance (PTOL-85).
 - (a) The issue fee and publication fee, if applicable, was received on _____ (with a Certificate of Mailing or Transmission dated _____), which is after the expiration of the statutory period for payment of the issue fee (and publication fee) set in the Notice of Allowance (PTOL-85).
 - (b) The submitted fee of \$_____ is insufficient. A balance of \$_____ is due.
The issue fee required by 37 CFR 1.18 is \$_____. The publication fee, if required by 37 CFR 1.18(d), is \$_____.
 - (c) The issue fee and publication fee, if applicable, has not been received.
3. Applicant's failure to timely file corrected drawings as required by, and within the three-month period set in, the Notice of Allowability (PTO-37).
 - (a) Proposed corrected drawings were received on _____ (with a Certificate of Mailing or Transmission dated _____), which is after the expiration of the period for reply.
 - (b) No corrected drawings have been received.
4. The letter of express abandonment which is signed by the attorney or agent of record, the assignee of the entire interest, or all of the applicants.
5. The letter of express abandonment which is signed by an attorney or agent (acting in a representative capacity under 37 CFR 1.34(a)) upon the filing of a continuing application.
6. The decision by the Board of Patent Appeals and Interference rendered on _____ and because the period for seeking court review of the decision has expired and there are no allowed claims.
7. The reason(s) below:

Per direction of attorney Duke Yee (Reg. 34,285), based on the telephone communication on 09/14/05, the Application is abandon.

PABLO N. TRAN
PRIMARY EXAMINER

PT
AJ2655

Petitions to revive under 37 CFR 1.137(a) or (b), or requests to withdraw the holding of abandonment under 37 CFR 1.181, should be promptly filed to minimize any negative effects on patent term.



UNITED STATES PATENT AND TRADEMARK OFFICE

UNITED STATES DEPARTMENT OF COMMERCE
United States Patent and Trademark Office
Address: COMMISSIONER FOR PATENTS
P.O. Box 1450
Alexandria, Virginia 22313-1450
www.uspto.gov

APPLICATION NO.	FILING DATE	FIRST NAMED INVENTOR	ATTORNEY DOCKET NO.	CONFIRMATION NO.
09/419,175	10/15/1999	GREGORY T. OSTERHOUT	11032RR	9870
35527	7590	02/23/2005	EXAMINER	
DUKE W. YEE YEE & ASSOCIATES, P.C. P.O. BOX 802333 DALLAS, TX 75380			TRAN, PABLO N	
			ART UNIT	PAPER NUMBER
			2685	

DATE MAILED: 02/23/2005

Please find below and/or attached an Office communication concerning this application or proceeding.

Office Action Summary

Application No.

09/419,175

Applicant(s)

OSTERHOUT ET AL.

Examiner

Pablo N Tran

Art Unit

2685

-- The MAILING DATE of this communication appears on the cover sheet with the correspondence address --

Period for Reply

A SHORTENED STATUTORY PERIOD FOR REPLY IS SET TO EXPIRE 3 MONTH(S) FROM THE MAILING DATE OF THIS COMMUNICATION.

- Extensions of time may be available under the provisions of 37 CFR 1.136(a). In no event, however, may a reply be timely filed after SIX (6) MONTHS from the mailing date of this communication.
- If the period for reply specified above is less than thirty (30) days, a reply within the statutory minimum of thirty (30) days will be considered timely.
- If NO period for reply is specified above, the maximum statutory period will apply and will expire SIX (6) MONTHS from the mailing date of this communication.
- Failure to reply within the set or extended period for reply will, by statute, cause the application to become ABANDONED (35 U.S.C. § 133). Any reply received by the Office later than three months after the mailing date of this communication, even if timely filed, may reduce any earned patent term adjustment. See 37 CFR 1.704(b).

Status

- 1) Responsive to communication(s) filed on 28 January 2004.
- 2a) This action is FINAL. 2b) This action is non-final.
- 3) Since this application is in condition for allowance except for formal matters, prosecution as to the merits is closed in accordance with the practice under *Ex parte Quayle*, 1935 C.D. 11, 453 O.G. 213.

Disposition of Claims

- 4) Claim(s) 1-81 is/are pending in the application.
4a) Of the above claim(s) 9-16,34-42 and 52-69 is/are withdrawn from consideration.
- 5) Claim(s) _____ is/are allowed.
- 6) Claim(s) 1-8,17-33,43-51 and 70-81 is/are rejected.
- 7) Claim(s) _____ is/are objected to.
- 8) Claim(s) _____ are subject to restriction and/or election requirement.

Application Papers

- 9) The specification is objected to by the Examiner.
- 10) The drawing(s) filed on _____ is/are: a) accepted or b) objected to by the Examiner.
Applicant may not request that any objection to the drawing(s) be held in abeyance. See 37 CFR 1.85(a).
Replacement drawing sheet(s) including the correction is required if the drawing(s) is objected to. See 37 CFR 1.121(d).
- 11) The oath or declaration is objected to by the Examiner. Note the attached Office Action or form PTO-152.

Priority under 35 U.S.C. § 119

- 12) Acknowledgment is made of a claim for foreign priority under 35 U.S.C. § 119(a)-(d) or (f).
a) All b) Some * c) None of:
1. Certified copies of the priority documents have been received.
2. Certified copies of the priority documents have been received in Application No. _____.
3. Copies of the certified copies of the priority documents have been received in this National Stage application from the International Bureau (PCT Rule 17.2(a)).

* See the attached detailed Office action for a list of the certified copies not received.

Attachment(s)

- 1) Notice of References Cited (PTO-892)
- 2) Notice of Draftsperson's Patent Drawing Review (PTO-948)
- 3) Information Disclosure Statement(s) (PTO-1449 or PTO/SB/08)
Paper No(s)/Mail Date _____
- 4) Interview Summary (PTO-413)
Paper No(s)/Mail Date. _____
- 5) Notice of Informal Patent Application (PTO-152)
- 6) Other: _____

DETAILED ACTION

Claim Rejections - 35 USC § 112

1. The following is a quotation of the second paragraph of 35 U.S.C. 112:

The specification shall conclude with one or more claims particularly pointing out and distinctly claiming the subject matter which the applicant regards as his invention.

2. Claims 1-8, 17-33, 43-51, and 70-81 are rejected under 35 U.S.C. 112, second paragraph, as being indefinite for failing to particularly point out and distinctly claim the subject matter which applicant regards as the invention.

Regarding claims 1 and 17, the claimed limitation "transmitting the new address to which the incoming call is to be redirected" rendered the claim indefinite. Is the new address is being transmitted to a location. If it is than where does this new address being transmitted to or is it that the incoming call will be transmitted to the new address. The examiner will interpret as that the incoming call will be transmitted to the new address of another device. Appropriated correction is required.

Regarding claims 25 and 43, the claimed limitation "wherein the sending of the registration notification causes the called party to be provided with an option to redirect routing of the call to another address" rendered the claim indefinite. Is "another address" the same as the new address? Appropriated correction is required.

Claim Rejections - 35 USC § 102

3. The following is a quotation of the appropriate paragraphs of 35 U.S.C. 102 that form the basis for the rejections under this section made in this Office action:

A person shall be entitled to a patent unless –

(b) the invention was patented or described in a printed publication in this or a foreign country or in public use or on sale in this country, more than one year prior to the date of application for patent in the United States.

4. Claims 1-5, 8, 17-21, 24-26, 28, 30-33, 43-44, 46, 48-51, and 70-81 are rejected under 35 U.S.C. 102(b) as being anticipated by *Pepe et al.* (5,742,905).

As per claims 1, 17, 25, 43, 70, 72-73, 75-76, 78-79, and 81, *Pepe et al.* disclosed a method for redirecting a call from a data processing apparatus to another device wherein receiving at the data processing apparatus (fig. 24/no. 30, col. 30/ln. 40-42) a registration notice of an incoming call from a server (fig. 24/no. 48), responsive to the registration notice-providing a user with an option to redirect the routing of the call prior to establishing a communication connection between an originator of the incoming call and the data processing apparatus, receiving user input in response to providing the option to redirect the routing of the incoming call-wherein the user input identifies a new address of another device to which the incoming call is to be routed, and responsive to receiving the user input-the incoming call will be transmitted to the new address of another device (col. 30/ln. 40-66).

As per claims 2-5, 8, 18-21, 24, 28, 33, 46, and 51, *Pepe et al.* disclosed such that the data processing apparatus is of a PDA, laptop computer, portable computing device, wireless device, or a wire-line device (fig. 1-3).

As per claims 30-31, 48-49, 71, 74, 77, and 80, *Pepe et al.* disclosed such that the user has the option to place the incoming on hold or redirect to a voice mailbox (col.

30/ln. 40-col. 31/ln. 13, wherein it is clear that the user can type in a message and request that the caller stay on the phone and the user will answer the call momentarily).

As per claims 32, 50, *Pepe et al.* disclosed utilizing wireless application protocol (col. 7/ln. 21-col. 8/ln. 53, col. 16/ln. 1-23)

As per claims 26 and 44, *Pepe et al.* disclosed prior to said sending step-receiving a request to initiate a call with a called party and determining a preferred location of the called party (col. 30/ln. 28-56).

Claim Rejections - 35 USC § 103

5. The following is a quotation of 35 U.S.C. 103(a) which forms the basis for all obviousness rejections set forth in this Office action:

(a) A patent may not be obtained though the invention is not identically disclosed or described as set forth in section 102 of this title, if the differences between the subject matter sought to be patented and the prior art are such that the subject matter as a whole would have been obvious at the time the invention was made to a person having ordinary skill in the art to which said subject matter pertains. Patentability shall not be negated by the manner in which the invention was made.

6. Claims 6, 22, 27, 29, 45, and 47 are rejected under 35 U.S.C. 103(a) as being unpatentable over by *Pepe et al.* (5,742,905).

As per claims 6, 22, 27, and 45, *Pepe et al.* disclosed various protocols are being utilized but not explicitly SIP. However, such is notoriously well known in the art that the examiner takes Official Notice of such. Therefore, it would have been obvious to one of ordinary skill in the art to provide such parlay protocol to the personal communication internetworking system of *Pepe et al.* in order to effectively provide notification of such events as incoming calls to the user.

As per claims 29 and 47, *Pepe et al.* disclosed various portable devices such as a PDA but not explicitly a Palm VII utilized a device. However, such is notoriously well known in the art that the examiner takes Official Notice of such. Therefore, it would have been obvious to one of ordinary skill in the art to provide such device to be utilized in the personal communication internetworking system of *Pepe et al.* in order to expand functionality of the device and provide flexibility and portability to the user.

7. Claims 7 and 23 are rejected under 35 U.S.C. 103(a) as being unpatentable over by *Pepe et al.* (5,742,905) in view of *French-St. George et al.* (6,122,348).

As per claims 7 and 23, *Pepe et al.* disclosed the incoming call is of various media formats but not explicitly video and select the appropriate video device. However, such is notoriously well known in the art, as disclosed by *French-St. George et al.* (col. 4/ln. 6-41). Therefore, it would have been obvious to one of ordinary skill in the art to provide such media format to be utilized in the personal communication internetworking system of *Pepe et al.* in order to provide such signaling structure that enables a user to manage the receipt of the incoming signaling messages.

Conclusion

8. The prior art made of record and not relied upon is considered pertinent to applicant's disclosure.

Titmuss et al. (6,167,122), Pepper et al. (5,930,700), and Shaffer et al. (5,911,123) disclose such call forwarding method in a radiotelephone communication system.

Application/Control Number: 09/419,175
Art Unit: 2685

Page 6

9. Any inquiry concerning this communication or earlier communications from the examiner should be directed to Pablo Tran whose telephone number is (703)308-7941. The examiner normal hours are 9:30 -5:00 (Monday-Friday). If attempts to reach the examiner by telephone are unsuccessful, the examiner's supervisor, Edward Urban, can be reached at (703)305-4385.

Any response to this action should be mailed to:

Commissioner of Patents and Trademarks
Washington, D.C. 20231

or faxed to:

(703) 872-9314 (for Technology Center 2600 only)

Hand-delivered responses should be brought to Crystal Park II, 2121 Crystal Drive, Arlington, VA, Sixth Floor (Receptionist).

Any inquiry of a general nature or relating to the status of this application or proceeding should be directed to the Technology Center 2600 Customer Service Office whose telephone number is (703) 306-0377.

**PABLO N. TRAN
PRIMARY EXAMINER**

February 18, 2005



AU2685

Notice of References Cited

Application/Control No.
09/419,175

Applicant(s)/Patent Under
Reexamination
OSTERHOUT ET AL.

Examiner
Pablo N Tran

Art Unit
2685

Page 1 of 1

U.S. PATENT DOCUMENTS

*		Document Number Country Code-Number-Kind Code	Date MM-YYYY	Name	Classification
	A	US-5,742,905	04-1998	Pepe et al.	455/461
	B	US-6,122,348	09-2000	French-St. George et al.	379/88.23
	C	US-5,930,700	07-1999	Pepper et al.	455/435.3
	D	US-5,911,123	06-1999	Shaffer et al.	455/554.1
	E	US-6,167,122	12-2000	Titmuss et al.	379/93.15
	F	US-			
	G	US-			
	H	US-			
	I	US-			
	J	US-			
	K	US-			
	L	US-			
	M	US-			

FOREIGN PATENT DOCUMENTS

*		Document Number Country Code-Number-Kind Code	Date MM-YYYY	Country	Name	Classification
	N					
	O					
	P					
	Q					
	R					
	S					
	T					

NON-PATENT DOCUMENTS

*		Include as applicable: Author, Title Date, Publisher, Edition or Volume, Pertinent Pages)
	U	
	V	
	W	
	X	

*A copy of this reference is not being furnished with this Office action. (See MPEP § 707.05(a).)
Dates in MM-YYYY format are publication dates. Classifications may be US or foreign.



UNITED STATES PATENT AND TRADEMARK OFFICE

COMMISSIONER FOR PATENTS
UNITED STATES PATENT AND TRADEMARK OFFICE
P.O. BOX 1450
ALEXANDRIA, VA 22313-1450
www.uspto.gov

DUKE W. YEE
YEE & ASSOCIATES, P.C.
P.O. BOX 802333
DALLAS TX 75380

MAILED

#21

JAN 18 2005

DIRECTOR'S OFFICE
TECHNOLOGY CENTER 2600

In Re Application:	:
OSTERHOUT, GREGORY T., et al	:
Appl No. 09/419,175	: WITHDRAW FROM ISSUE
Filed: October 15, 1999	: FEE PAID
Title: PORTABLE CALL MANAGEMENT	:
SYSTEM	:

The above-identified application is withdrawn from issue after payment of the issue fee due unpatentability of one or more claims. See 37 CFR 1.313(b)(1).

The above-identified application is hereby withdrawn from issue.

The issue fee is refundable upon written request. If, however, the application is again found allowable, the issue fee can be applied toward payment of the issue fee in the amount identified on the new Notice of Allowance and Issue Fee Due upon written request. This request and any balance due must be received on or before the due date noted in the new Notice of Allowance in order to prevent abandonment of the application.

Telephone inquiries should be directed to Edward Urban, 703-305-4385.

The above-identified application is being forwarded to the examiner for prompt appropriate action, including notifying applicant of the new status of this application.

 Reinhard Eisenzopf
 Acting, Director TC 2600
 Communications



UNITED STATES PATENT AND TRADEMARK OFFICE

COMMISSIONER FOR PATENTS
UNITED STATES PATENT AND TRADEMARK OFFICE
P.O. BOX 1450
ALEXANDRIA, VA 22313-1450

#20

DATE: January 11, 2005
TO: Director, Office of Publication
PK3- 910
FROM: Edward Urban
SPE, Art Unit 2684
SUBJECT: WITHDRAWAL FROM ISSUE

Applicant: OSTERHOUT, GREGORY T., et al
Serial No.: 09/419,175
Filed: October 15, 1999
For: **PORTABLE CALL MANAGEMENT SYSTEM**
Notice of Allowance Mailed: April 21, 2004
Issue Fee Paid Date: June 29, 2004

It is requested that the above-identified application be withdrawn from issue for the following purpose:

Reopen Prosecution

The issue fee has been paid. It is directed that this application be withdrawn from issue under 37 CFR 1.313 and returned to the jurisdiction of examining Workgroup 2680.

The Examiner is authorized and directed to take prompt appropriate action on this case including notifying applicants of the new status of this application. Return this application promptly to the Office of the Director Workgroup 2680.

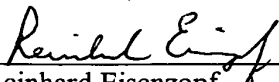

Reinhard Eisenzopf
Acting, Director Technology Center 2600
Communications

PART B - FEE(S) TRANSMITTAL

Complete and send this form, together with applicable fee(s), to: **Mail**

**Mail Stop ISSUE FEE
Commissioner for Patents
P.O. Box 1450
Alexandria, Virginia 22313-1450
or Fax (703) 746-4000**

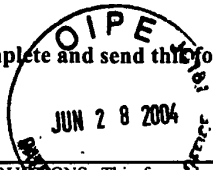

[Handwritten mark]

INSTRUCTIONS: This form should be used for transmitting the ISSUE FEE and PUBLICATION FEE (if required). Blocks 1 through 4 should be completed where appropriate. **(a)** further correspondence including the Patent, advance orders and notification of maintenance fees will be mailed to the current correspondence address as indicated unless **(b)** indicated below or directed otherwise in Block 1, by (a) specifying a new correspondence address; and/or (b) indicating a separate "FEE ADDRESS" for maintenance fee notifications.

CURRENT CORRESPONDENCE ADDRESS (Note: Legibly mark-up with any corrections or use Block 1)

Note: A certificate of mailing can only be used for domestic mailings of the Fee(s) Transmittal. This certificate cannot be used for any other accompanying papers. Each additional paper, such as an assignment or formal drawing, must have its own certificate of mailing or transmission.

35527 7590 04/21/2004
**DUKE W. YEE
CARSTENS, YEE & CAHOON, L.L.P.
P.O. BOX 802334
DALLAS, TX 75380**

Certificate of Mailing or Transmission
I hereby certify that this Fee(s) Transmittal is being deposited with the United States Postal Service with sufficient postage for first class mail in an envelope addressed to the Mail Stop ISSUE FEE address above, or being facsimile transmitted to the USPTO, on the date indicated below.

<i>Nell Whitton</i>	(Depositor's name)
<i>Nell Whitton</i>	(Signature)
<i>06-23-04</i>	(Date)

APPLICATION NO.	FILING DATE	FIRST NAMED INVENTOR	ATTORNEY DOCKET NO.	CONFIRMATION NO.
09/419,175	10/15/1999	GREGORY T. OSTERHOUT	11032RR	9870

TITLE OF INVENTION: PORTABLE CALL MANAGEMENT SYSTEM

APPLN. TYPE	SMALL ENTITY	ISSUE FEE	PUBLICATION FEE	TOTAL FEE(S) DUE	DATE DUE
nonprovisional	NO	\$1330	\$0	\$1330	07/21/2004

EXAMINER	ART UNIT	CLASS-SUBCLASS
NGUYEN, THUAN T	2685	455-422100

1. Change of correspondence address or indication of "Fee Address" (37 CFR 1.363).
 Change of correspondence address (or Change of Correspondence Address form PTO/SB/122) attached.
 "Fee Address" indication (or "Fee Address" Indication form PTO/SB/47; Rev 03-02 or more recent) attached. Use of a Customer Number is required.

2. For printing on the patent front page, list (1) the names of up to 3 registered patent attorneys or agents OR, alternatively, (2) the name of a single firm (having as a member a registered attorney or agent) and the names of up to 2 registered patent attorneys or agents. If no name is listed, no name will be printed.

1 _____
2 _____
3 _____

3. ASSIGNEE NAME AND RESIDENCE DATA TO BE PRINTED ON THE PATENT (print or type)

PLEASE NOTE: Unless an assignee is identified below, no assignee data will appear on the patent. Inclusion of assignee data is only appropriate when an assignment has been previously submitted to the USPTO or is being submitted under separate cover. Completion of this form is NOT a substitute for filing an assignment.

(A) NAME OF ASSIGNEE

(B) RESIDENCE: (CITY AND STATE OR COUNTRY)

Nortel Networks Limited

St. Laurent, Quebec H4S 2A9 Canada

Please check the appropriate assignee category or categories (will not be printed on the patent); individual corporation or other private group entity government

4a. The following fee(s) are enclosed:

- Issue Fee
- Publication Fee
- Advance Order - # of Copies _____

4b. Payment of Fee(s):

- A check in the amount of the fee(s) is enclosed.
- Payment by credit card. Form PTO-2038 is attached.
- The Director is hereby authorized by charge the required fee(s), or credit any overpayment, to Deposit Account Number 50-3157 (enclose an extra copy of this form).

Director for Patents is requested to apply the Issue Fee and Publication Fee (if any) or to re-apply any previously paid issue fee to the application identified above.

(Authorized Signature) *[Signature]* (Date) *06/23/04*

NOTE: The Issue Fee and Publication Fee (if required) will not be accepted from anyone other than the applicant; a registered attorney or agent; or the assignee or other party in interest as shown by the records of the United States Patent and Trademark Office.

This collection of information is required by 37 CFR 1.311. The information is required to obtain or retain a benefit by the public which is to file (and by the USPTO to process) an application. Confidentiality is governed by 35 U.S.C. 122 and 37 CFR 1.14. This collection is estimated to take 12 minutes to complete, including gathering, preparing, and submitting the completed application form to the USPTO. Time will vary depending upon the individual case. Any comments on the amount of time you require to complete this form and/or suggestions for reducing this burden, should be sent to the Chief Information Officer, U.S. Patent and Trademark Office, U.S. Department of Commerce, Alexandria, Virginia 22313-1450. DO NOT SEND FEES OR COMPLETED FORMS TO THIS ADDRESS. SEND TO: Commissioner for Patents, Alexandria, Virginia 22313-1450.

Under the Paperwork Reduction Act of 1995, no persons are required to respond to a collection of information unless it displays a valid OMB control number.

06/29/2004 HGUTEMAR 00000049 09419175
01 FC:1501 1330.00 DP

TRANSMIT THIS FORM WITH FEE(S)



UNITED STATES PATENT AND TRADEMARK OFFICE

UNITED STATES DEPARTMENT OF COMMERCE
United States Patent and Trademark Office
Address: COMMISSIONER FOR PATENTS
P.O. Box 1450
Alexandria, Virginia 22313-1450
www.uspto.gov

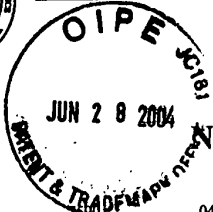

NOTICE OF ALLOWANCE AND FEE(S) DUE

35527

04/21/2004

DUKE W. YEE
CARSTENS, YEE & CAHOON, L.L.P.
P.O. BOX 802334
DALLAS, TX 75380

EXAMINER

NGUYEN, THUAN T

ART UNIT PAPER NUMBER

2685

19

DATE MAILED: 04/21/2004

Table with 5 columns: APPLICATION NO., FILING DATE, FIRST NAMED INVENTOR, ATTORNEY DOCKET NO., CONFIRMATION NO.

TITLE OF INVENTION: PORTABLE CALL MANAGEMENT SYSTEM

Table with 6 columns: APPLN. TYPE, SMALL ENTITY, ISSUE FEE, PUBLICATION FEE, TOTAL FEE(S) DUE, DATE DUE

THE APPLICATION IDENTIFIED ABOVE HAS BEEN EXAMINED AND IS ALLOWED FOR ISSUANCE AS A PATENT. PROSECUTION ON THE MERITS IS CLOSED. THIS NOTICE OF ALLOWANCE IS NOT A GRANT OF PATENT RIGHTS. THIS APPLICATION IS SUBJECT TO WITHDRAWAL FROM ISSUE AT THE INITIATIVE OF THE OFFICE OR UPON PETITION BY THE APPLICANT. SEE 37 CFR 1.313 AND MPEP 1308.

THE ISSUE FEE AND PUBLICATION FEE (IF REQUIRED) MUST BE PAID WITHIN THREE MONTHS FROM THE MAILING DATE OF THIS NOTICE OR THIS APPLICATION SHALL BE REGARDED AS ABANDONED. THIS STATUTORY PERIOD CANNOT BE EXTENDED. SEE 35 U.S.C. 151. THE ISSUE FEE DUE INDICATED ABOVE REFLECTS A CREDIT FOR ANY PREVIOUSLY PAID ISSUE FEE APPLIED IN THIS APPLICATION. THE PTOL-85B (OR AN EQUIVALENT) MUST BE RETURNED WITHIN THIS PERIOD EVEN IF NO FEE IS DUE OR THE APPLICATION WILL BE REGARDED AS ABANDONED.

HOW TO REPLY TO THIS NOTICE:

I. Review the SMALL ENTITY status shown above.

If the SMALL ENTITY is shown as YES, verify your current SMALL ENTITY status:

- A. If the status is the same, pay the TOTAL FEE(S) DUE shown above.
B. If the status is changed, pay the PUBLICATION FEE (if required) and twice the amount of the ISSUE FEE shown above and notify the United States Patent and Trademark Office of the change in status, or

If the SMALL ENTITY is shown as NO:

- A. Pay TOTAL FEE(S) DUE shown above, or
B. If applicant claimed SMALL ENTITY status before, or is now claiming SMALL ENTITY status, check the box below and enclose the PUBLICATION FEE and 1/2 the ISSUE FEE shown above.
[] Applicant claims SMALL ENTITY status. See 37 CFR 1.27.

II. PART B - FEE(S) TRANSMITTAL should be completed and returned to the United States Patent and Trademark Office (USPTO) with your ISSUE FEE and PUBLICATION FEE (if required). Even if the fee(s) have already been paid, Part B - Fee(s) Transmittal should be completed and returned. If you are charging the fee(s) to your deposit account, section "4b" of Part B - Fee(s) Transmittal should be completed and an extra copy of the form should be submitted.

III. All communications regarding this application must give the application number. Please direct all communications prior to issuance to Mail Stop ISSUE FEE unless advised to the contrary.

IMPORTANT REMINDER: Utility patents issuing on applications filed on or after Dec. 12, 1980 may require payment of maintenance fees. It is patentee's responsibility to ensure timely payment of maintenance fees when due.



IN THE UNITED STATES PATENT AND TRADEMARK OFFICE

In re application of: Osterhout et al.	§	Group Art Unit: 2685
	§	
Serial No.: 09/419,175	§	Examiner: Nguyen, Thuan T.
	§	
Filed: October 15, 1999	§	Attorney Docket No.: 11032RR
	§	
For: Portable Call Management System	§	
	§	

LETTER TO THE OFFICIAL DRAFTSMAN

Mail Stop Issue Fee
Commissioner for Patents
P.O. Box 1450
Alexandria, VA 22313-1450

Sir:

Submitted herewith are formal drawings (6 sheets) for the above-identified application.

Respectfully submitted,

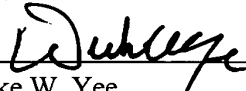

 Duke W. Yee
 Registration No. 34,285
Yee & Associates, P.C.
 P.O. Box 802333
 Dallas, Texas 75380
 (972) 367-2001
 ATTORNEY FOR APPLICANTS

I hereby certify this correspondence is being deposited with the United States Postal service as First Class mail in an envelope addressed to: Mail Stop Issue Fee, Commissioner for Patents, P.O. Box 1450, Alexandria, VA 22313-1450

on 06/23/04 by Dell Whetton



Received in the U.S. Patent & Trademark Office
 In Re Application of
 INVENTOR: Osterhout et al.
 TITLE: Portable Call Management System
 Enclosed:
 1. Transmittal Letter;
 2. Letter to the Official Draftsman; and
 3. 6 sheets of drawings.

Client: Nortel Networks Corporation
 Serial No. 09/419,175 Date Mailed: 12/14/99
 Docket No. 11032RR
 DWY/jbw

Received in the U.S. Patent & Trademark Office
 In Re Application of
 INVENTOR: Osterhout et al.
 TITLE: Portable Call Management System
 Enclosed:
 1. Transmittal Letter;
 2. Letter to the Official Draftsman; and
 3. 6 sheets of drawings.

Client: Nortel Networks Corporation
 Serial No. 09/419,175 Date Mailed: 12/14/99
 Docket No. 11032RR
 DWY/jbw





IN THE UNITED STATES PATENT AND TRADEMARK OFFICE

In re application of: Osterhout et al.

Serial No.: 09/419,175

Filed: 10/15/99

For: PORTABLE CALL
MANAGEMENT SYSTEM

§ Group Art Unit: 2745

§

§ Examiner: Unknown

§

§ Attorney Docket No.: 11032RR

§

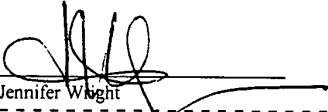
Certificate of Mailing Under 37 C.F.R. § 1.8(a)
I hereby certify this correspondence is being deposited with the United States Postal Service as First Class mail in an envelope addressed to: Assistant Commissioner of Patents, Washington, D.C. 20231 on December 14, 1999.
By: 
Jennifer Wright

TRANSMITTAL DOCUMENT

Assistant Commissioner of Patents
Washington, D.C. 20231

Sir:

ENCLOSED HEREWITH:

- Letter to Official Draftsman;
- 6 sheets of drawings; and
- Our return postcard.

No fees are believed to be necessary. If, however, any fees are required, I authorize the Commissioner to charge these fees which may be required to Deposit Account No. 50-0392. No extension of time is believed to be necessary. If, however, any fees are required, I authorize the Commissioner to charge these fees which may be required to Deposit Account No. 50-0392.

Respectfully submitted,

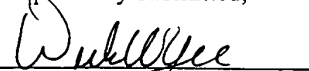

Duke W. Yee
Registration No. 34,285
CARSTENS YEE & CAHOON, LLP
P.O. Box 802334
Dallas, Texas 75380
(972) 367-2001
ATTORNEY FOR APPLICANT



FIG. 1

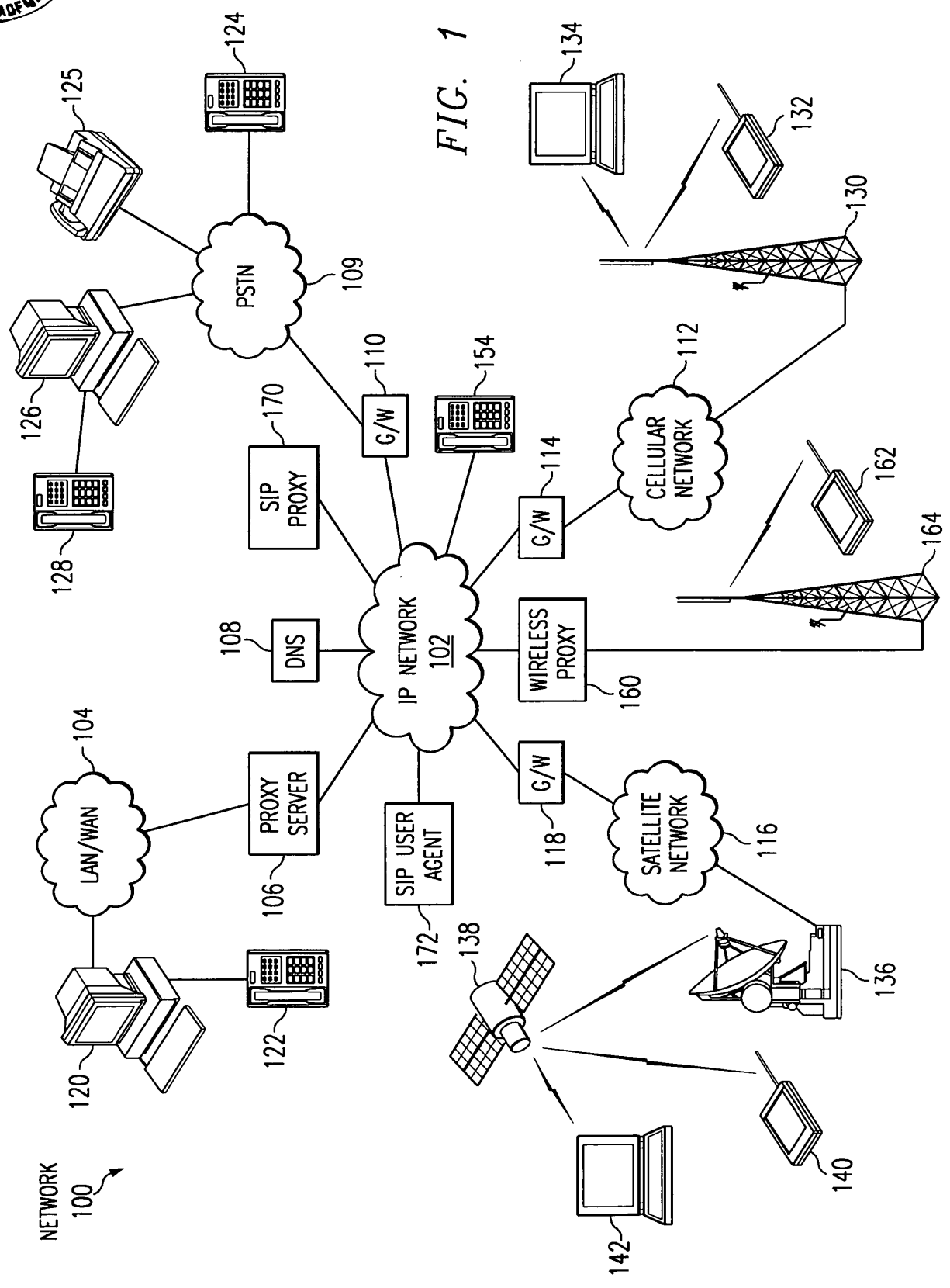

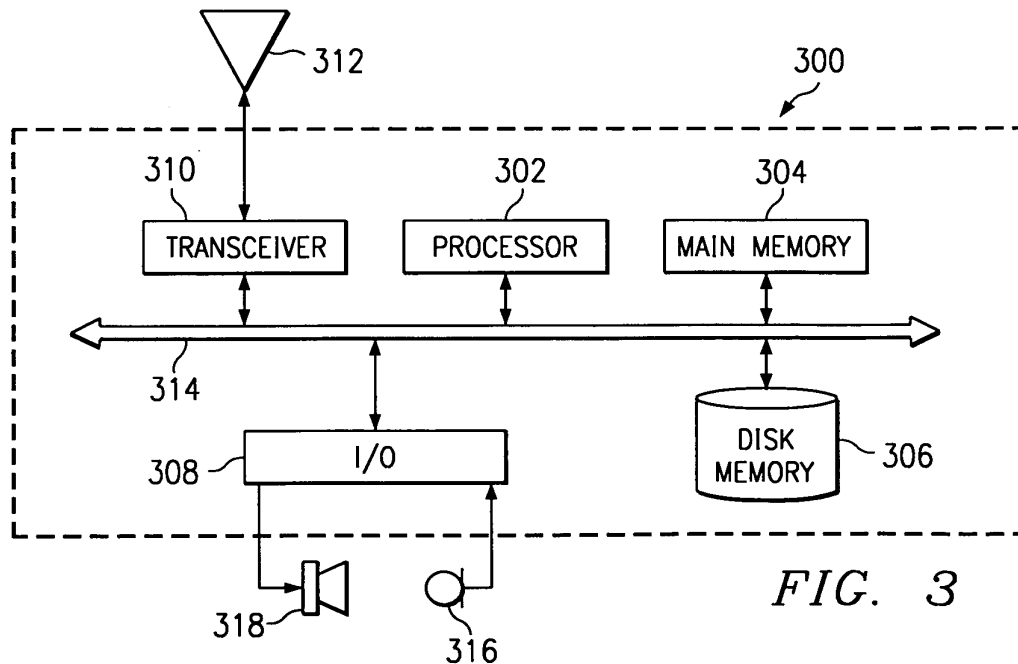
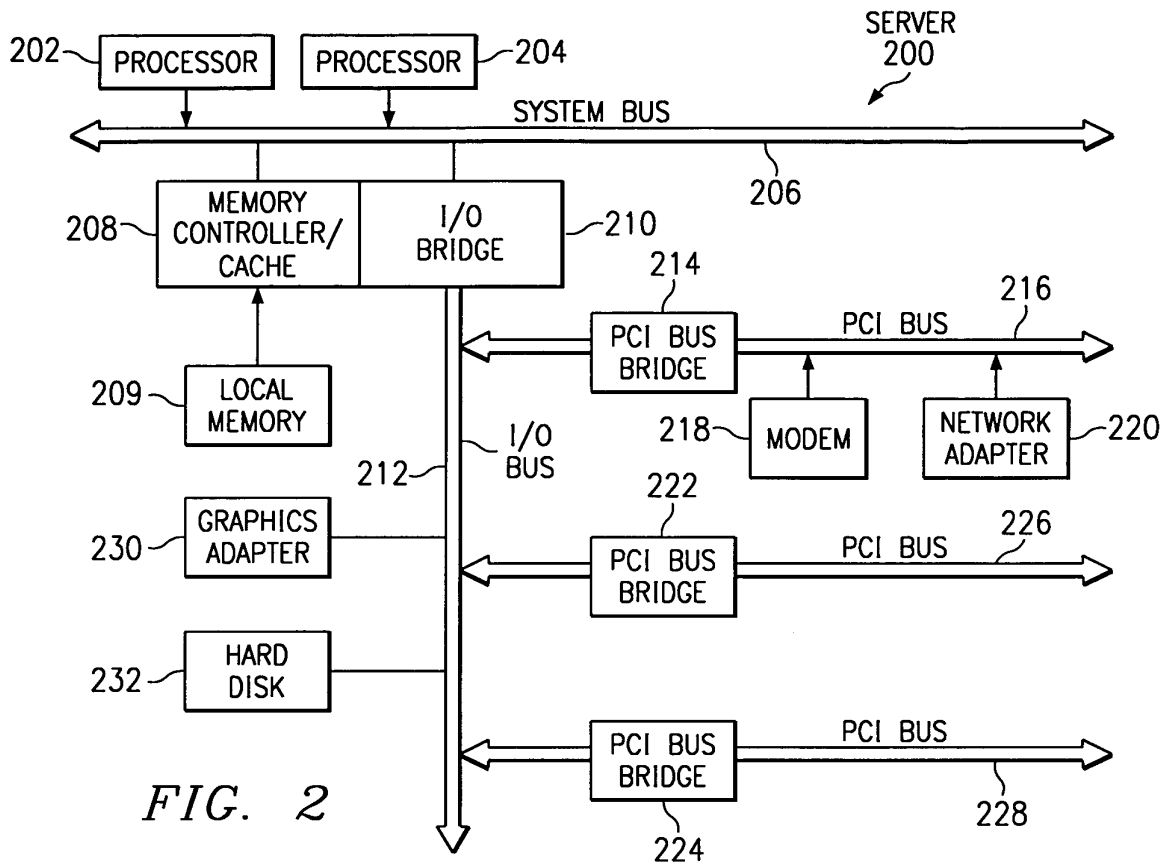

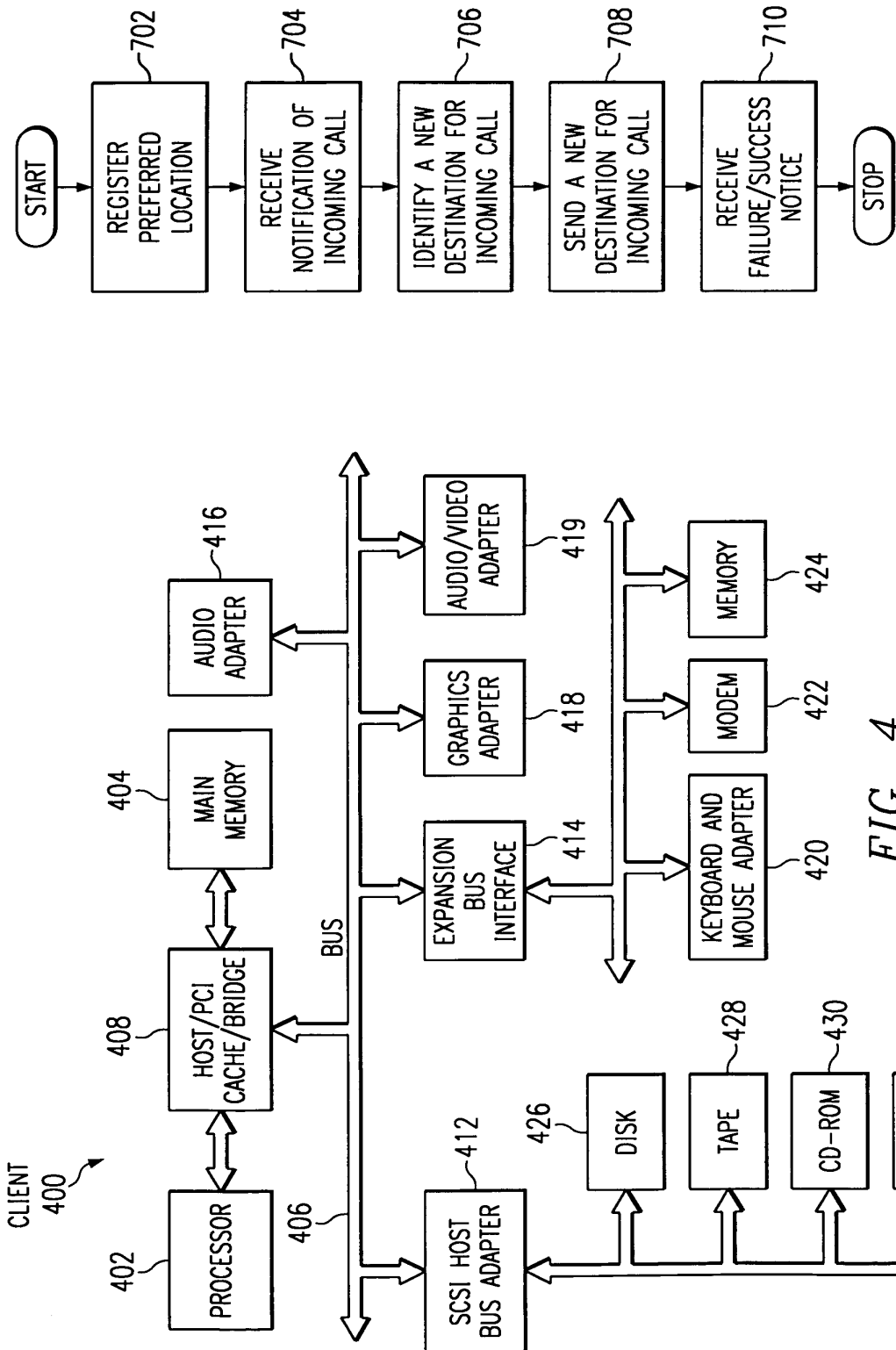

FIG. 4

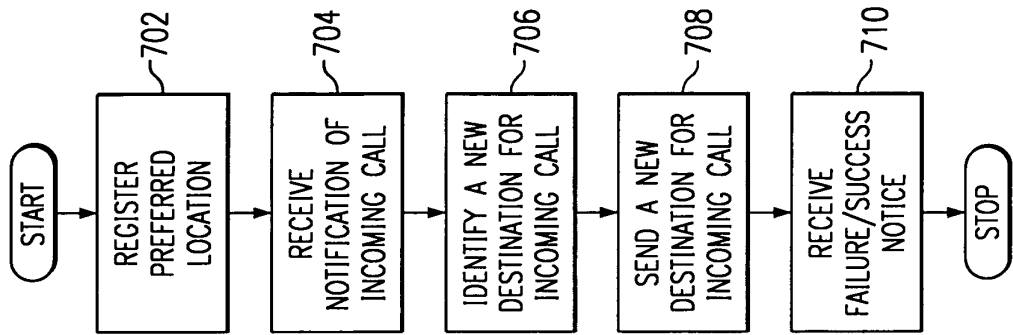

FIG. 7

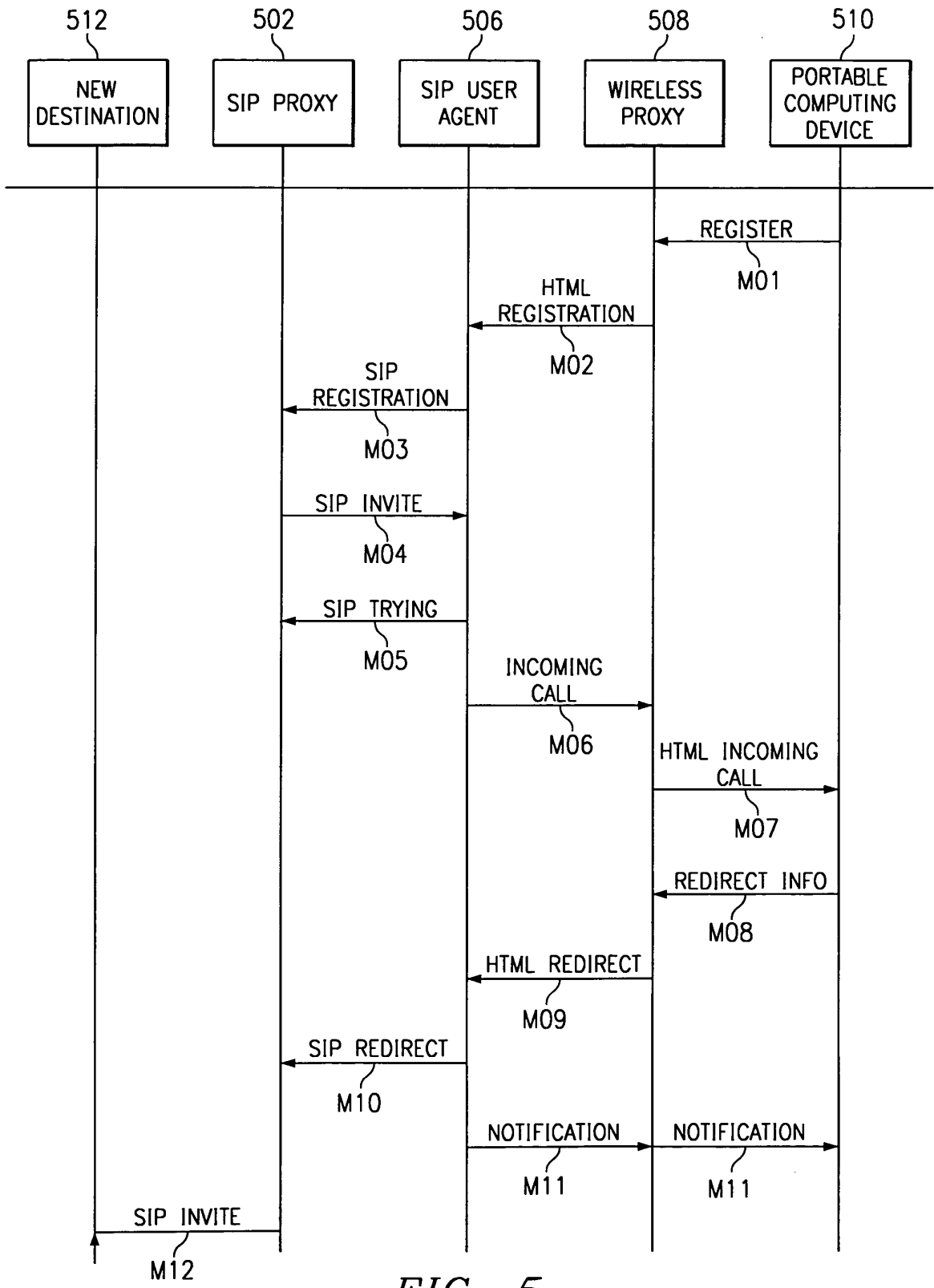

FIG. 5



NORTEL NETWORKS

601
REGISTER

FIG. 6A

NORTEL NETWORKS

ENTER THE FOLLOWING INFORMATION:

USER: 602

PROXY ID: 604

PROXY PORT: 606

FIG. 6B

NORTEL NETWORKS

YOU HAVE AN INCOMING CALL FROM:

PARTY INFORMATION

608	<input type="button" value="REDIRECT"/>	<input type="button" value="VOICE MAIL"/>	618
614	<input type="button" value="HOLD"/>	<input type="button" value="TRASH"/>	616

FIG. 6C

NORTEL NETWORKS

ENTER THE NEW DESTINATION:

610

612

FIG. 6D

NORTEL NETWORKS

THE CALL HAS BEEN REDIRECTED

FIG. 6E

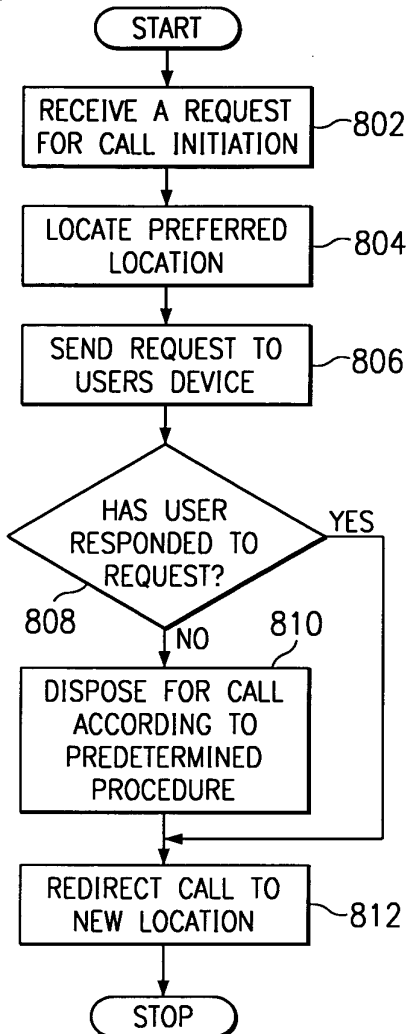

FIG. 8

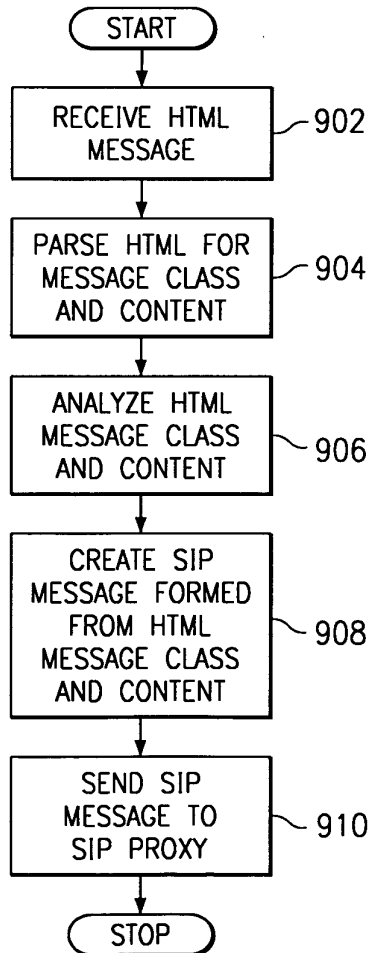

FIG. 9

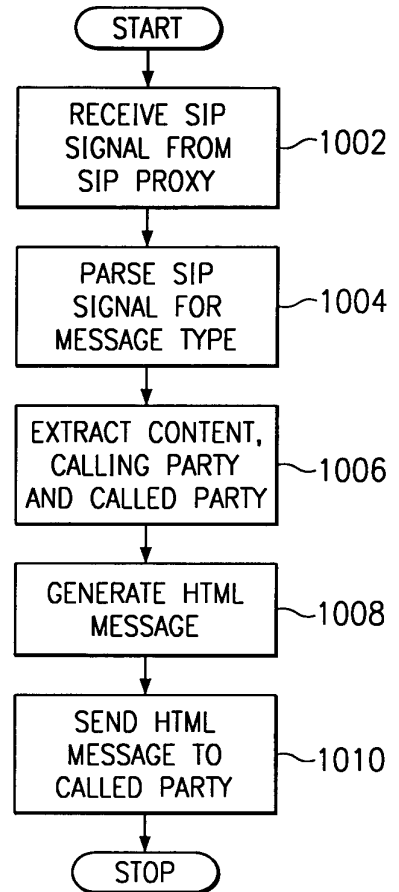

FIG. 10



PH

22 LPO

IN THE UNITED STATES PATENT AND TRADEMARK OFFICE

In re application of: Osterhout et al.

§
§
§
§
§
§
§

Group Art Unit: 2685

Serial No.: 09/419,175*

Examiner: Nguyen, Thuan T.

Filed: October 15, 1999

Attorney Docket No.: 11032RR

For: Portable Call Management System

LETTER TO THE OFFICIAL DRAFTER

Mail Stop Issue Fee
Commissioner for Patents
P.O. Box 1450
Alexandria, VA 22313-1450

Sir:

Submitted herewith are formal drawings (6 sheets) for the above-identified application.

Respectfully submitted,



Duke W. Yee
Registration No. 34,285
Yee & Associates, P.C.
P.O. Box 802333
Dallas, Texas 75380
(972) 367-2001
ATTORNEY FOR APPLICANTS

I hereby certify this correspondence is being deposited with the United States Postal service as First Class mail in an envelope addressed to: Mail Stop Issue Fee, Commissioner for Patents, P.O. Box 1450, Alexandria, VA 22313-1450

on 06/23/04 by Dell Whetton



Received in the U.S. Patent & Trademark Office
 In Re Application of
 INVENTOR: Osterhout et al.
 TITLE: Probable Call Management System
 Enclosed:
 1. Transmittal Letter;
 2. Letter to the Official Draftsman; and
 3. 6 sheets of drawings.

Client: Nortel Networks Corporation
 Serial No. 09/419,175 Date Mailed: 12/14/99
 Docket No. 11032RR DWY/jbw

Received in the U.S. Patent & Trademark Office
 In Re Application of
 INVENTOR: Osterhout et al.
 TITLE: Probable Call Management System
 Enclosed:
 1. Transmittal Letter;
 2. Letter to the Official Draftsman; and
 3. 6 sheets of drawings.

Client: Nortel Networks Corporation
 Serial No. 09/419,175 Date Mailed: 12/14/99
 Docket No. 11032RR DWY/jbw

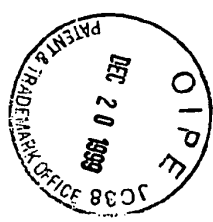



IN THE UNITED STATES PATENT AND TRADEMARK OFFICE

Application of: Osterhout et al.

Serial No.: 09/419,175

Filed: 10/15/99

For: **PORTABLE CALL
MANAGEMENT SYSTEM**

§ Group Art Unit: 2745

§

§ Examiner: **Unknown**

§

§ Attorney Docket No.: 11032RR

§

Certificate of Mailing Under 37 C.F.R. § 1.8(a)

I hereby certify this correspondence is being deposited with the United States Postal Service as First Class mail in an envelope addressed to: Assistant Commissioner of Patents, Washington, D.C. 20231 on December 14, 1999.

By: _____

Jennifer Wright

TRANSMITTAL DOCUMENT

Assistant Commissioner of Patents
Washington, D.C. 20231

Sir:

ENCLOSED HEREWITH:

- Letter to Official Draftsman;
- 6 sheets of drawings; and
- Our return postcard.

No fees are believed to be necessary. If, however, any fees are required, I authorize the Commissioner to charge these fees which may be required to Deposit Account No. 50-0392. No extension of time is believed to be necessary. If, however, any fees are required, I authorize the Commissioner to charge these fees which may be required to Deposit Account No. 50-0392.

Respectfully submitted,



Duke W. Yee

Registration No. 34,285
CARSTENS YEE & CAHOON, LLP
P.O. Box 802334
Dallas, Texas 75380
(972) 367-2001
ATTORNEY FOR APPLICANT



09/419,175

R#

1/6

FIG. 1

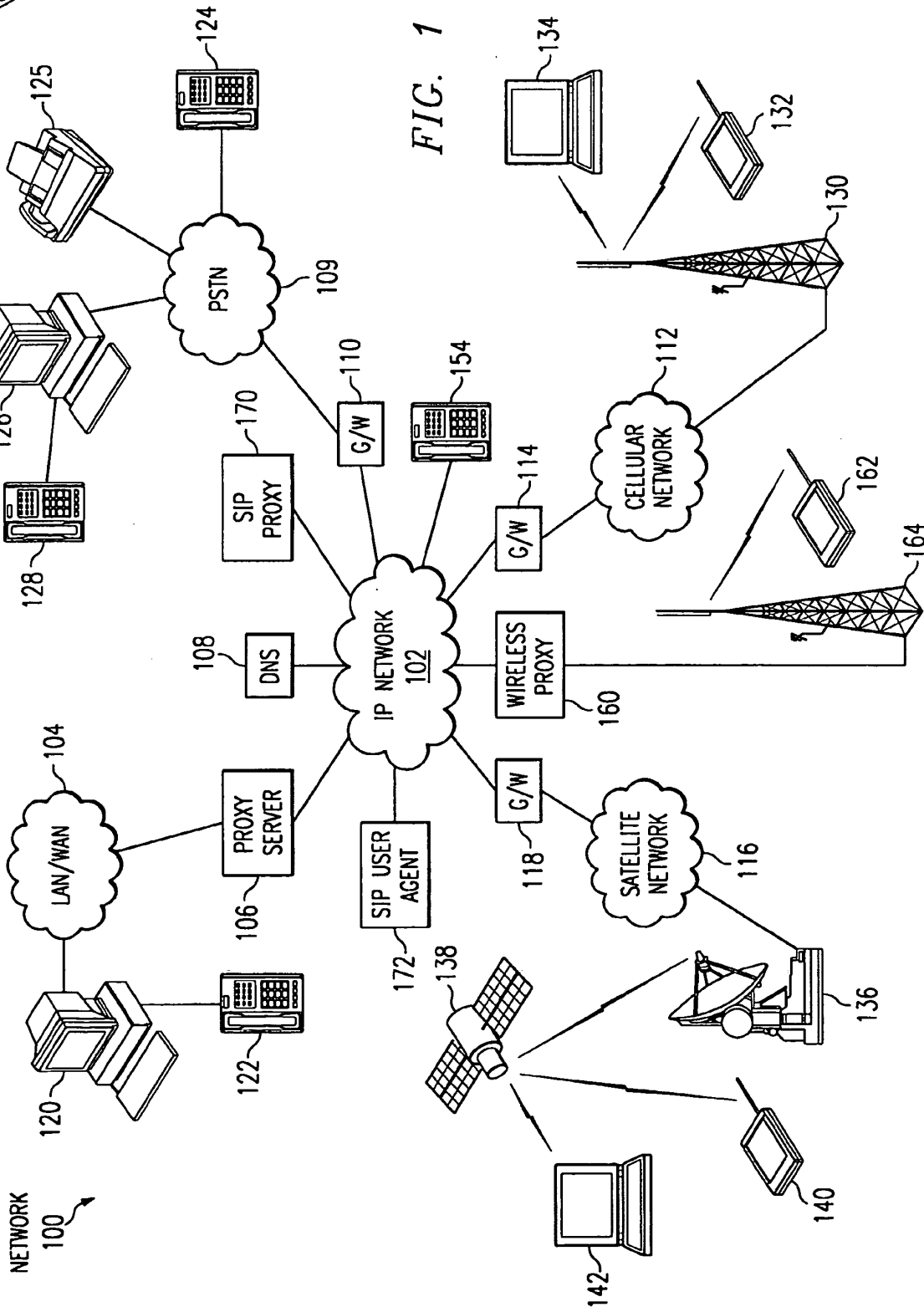

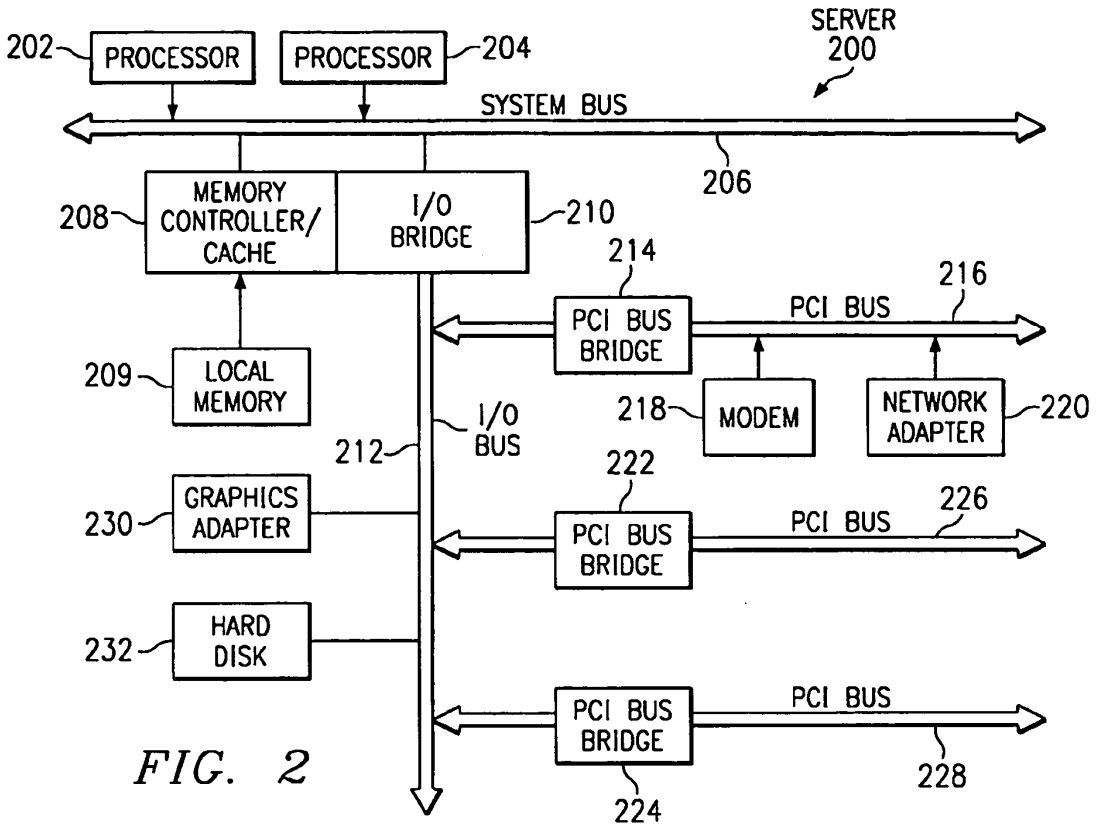

FIG. 2

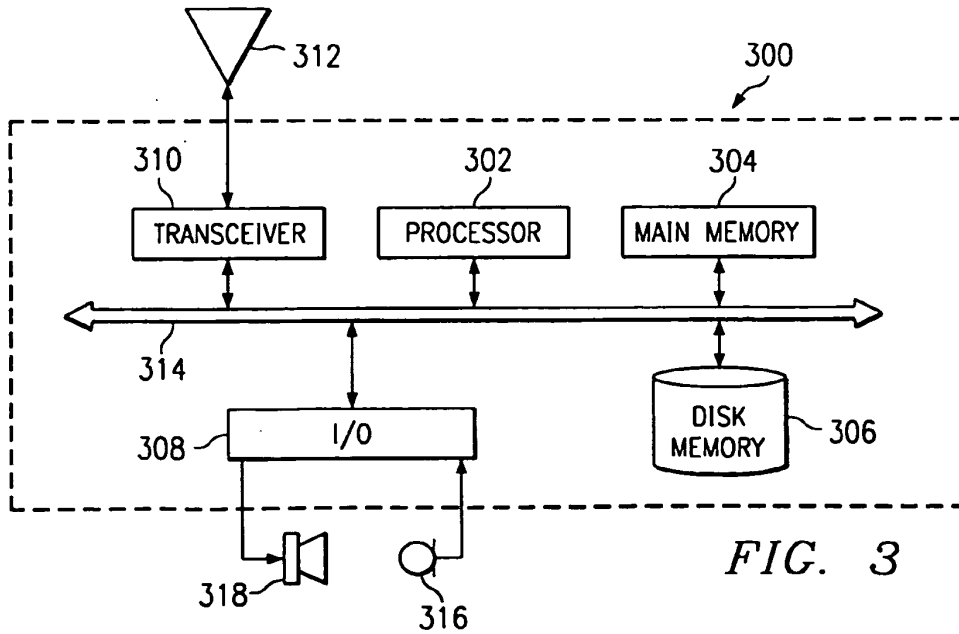

FIG. 3

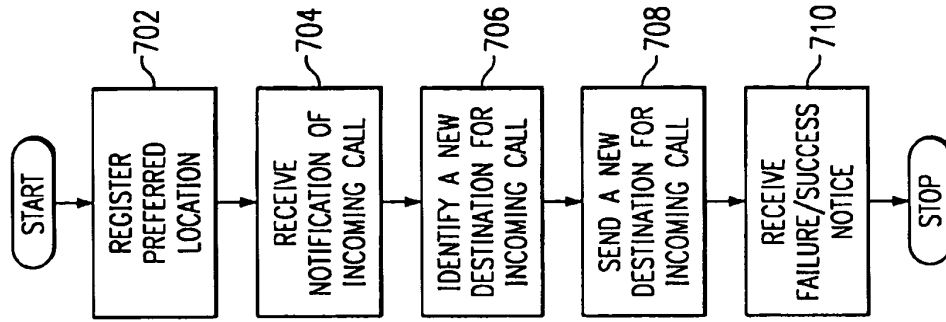

FIG. 7

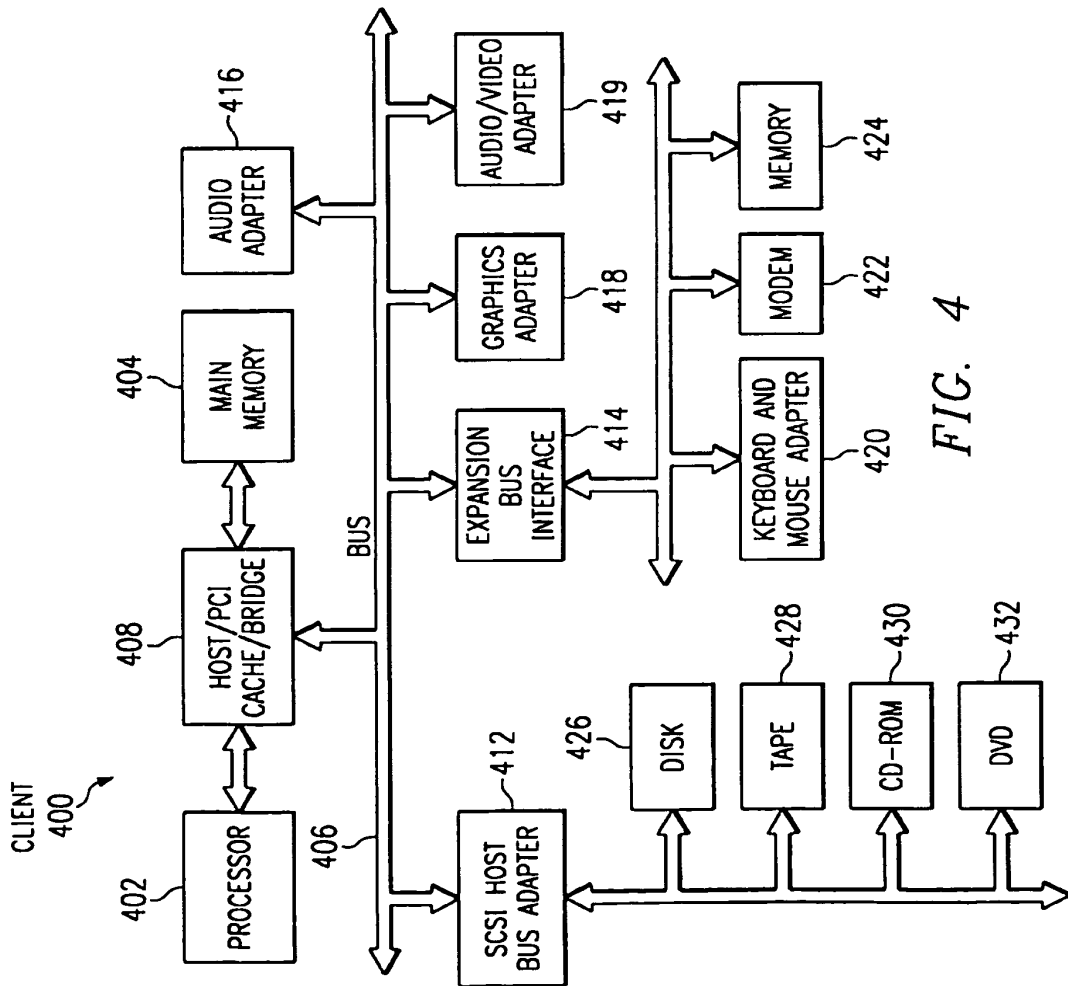

FIG. 4

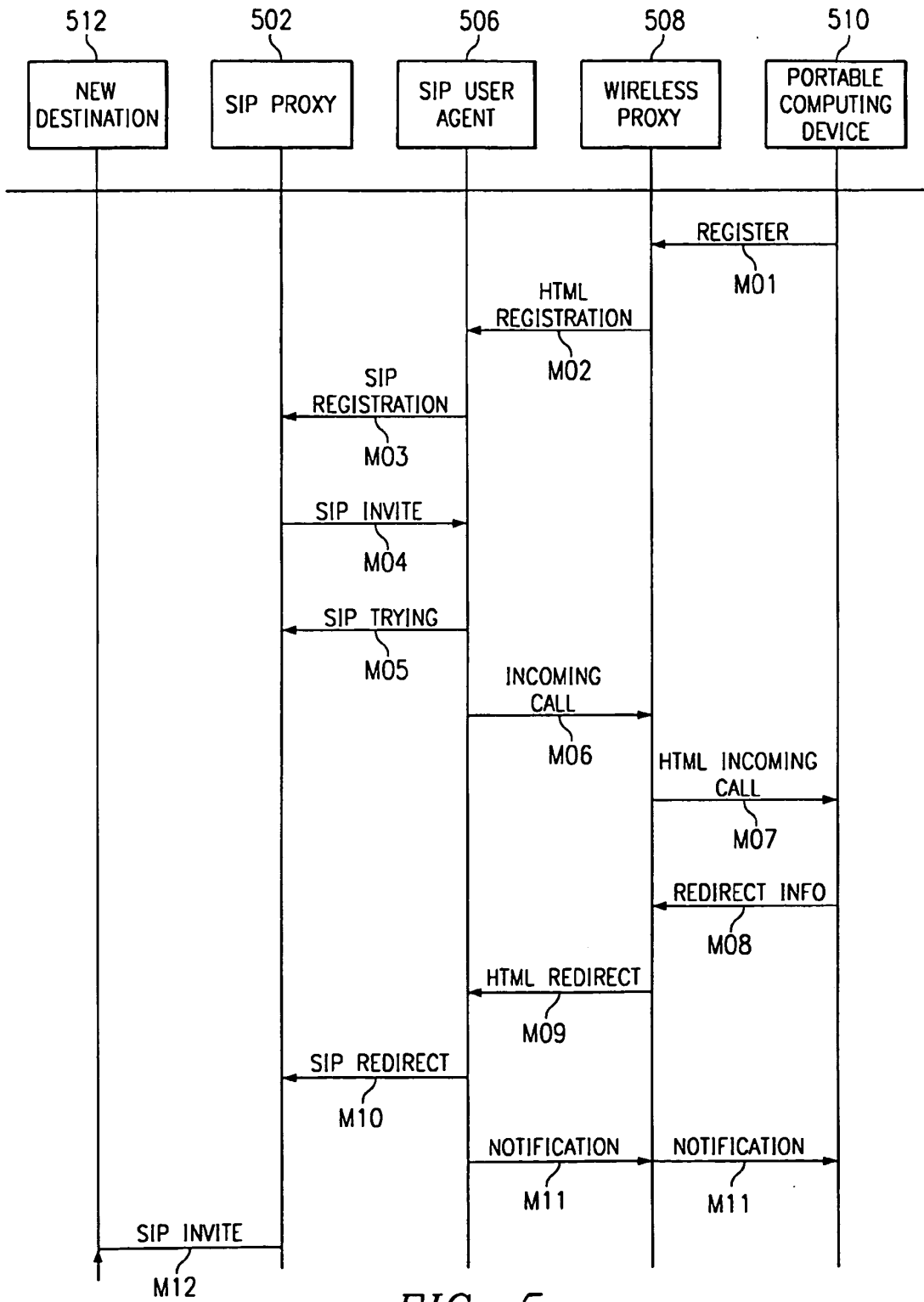

FIG. 5



NORTEL NETWORKS

601
REGISTER

FIG. 6A

NORTEL NETWORKS

ENTER THE FOLLOWING INFORMATION:

USER: 602

PROXY ID: 604

PROXY PORT: 606

FIG. 6B

NORTEL NETWORKS

YOU HAVE AN INCOMING CALL FROM:

PARTY INFORMATION

608	<input type="button" value="REDIRECT"/>	<input type="button" value="VOICE MAIL"/>	618
614	<input type="button" value="HOLD"/>	<input type="button" value="TRASH"/>	616

FIG. 6C

NORTEL NETWORKS

ENTER THE NEW DESTINATION:

610

612

FIG. 6D

NORTEL NETWORKS

THE CALL HAS BEEN REDIRECTED

FIG. 6E

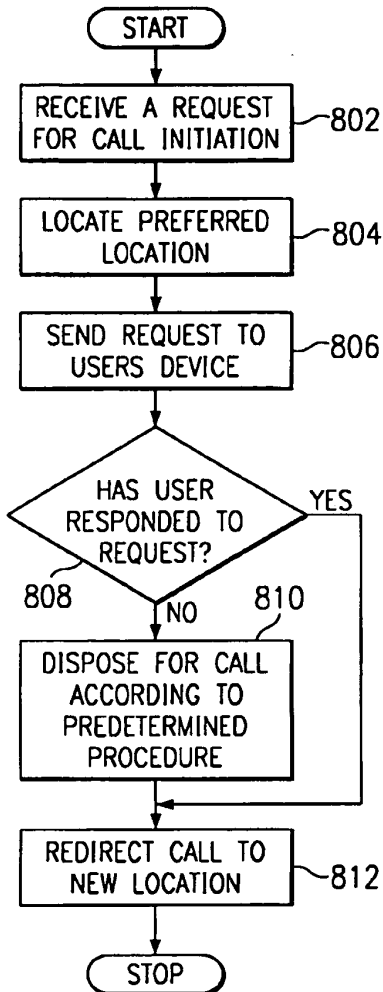

FIG. 8

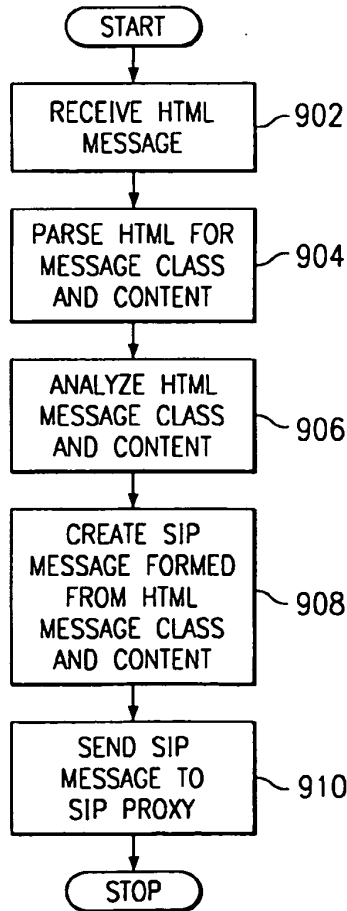

FIG. 9

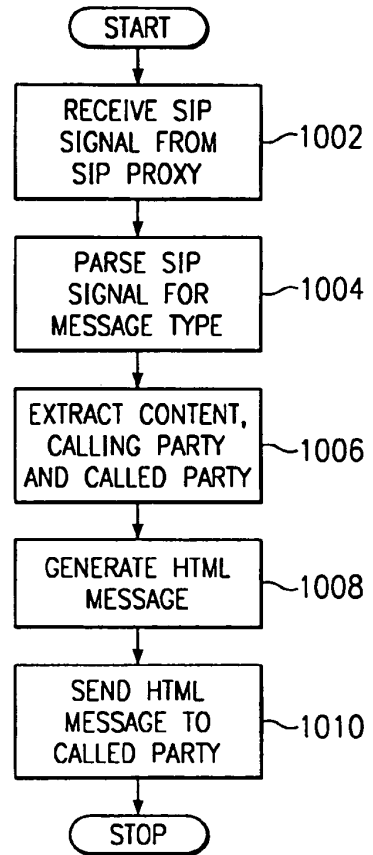

FIG. 10



UNITED STATES PATENT AND TRADEMARK OFFICE

UNITED STATES DEPARTMENT OF COMMERCE
United States Patent and Trademark Office
Address: COMMISSIONER FOR PATENTS
P.O. Box 1450
Alexandria, Virginia 22313-1450
www.uspto.gov



NOTICE OF ALLOWANCE AND FEE(S) DUE

35527 04/21/2004
DUKE W. YEE
CARSTENS, YEE & CAHOON, L.L.P.
P.O. BOX 802334
DALLAS, TX 75380

EXAMINER

NGUYEN, THUAN T

ART UNIT PAPER NUMBER

2685

19

DATE MAILED: 04/21/2004

Table with 5 columns: APPLICATION NO., FILING DATE, FIRST NAMED INVENTOR, ATTORNEY DOCKET NO., CONFIRMATION NO.
09/419,175 10/15/1999 GREGORY T. OSTERHOUT 11032RR 9870

TITLE OF INVENTION: PORTABLE CALL MANAGEMENT SYSTEM

Table with 6 columns: APPLN. TYPE, SMALL ENTITY, ISSUE FEE, PUBLICATION FEE, TOTAL FEE(S) DUE, DATE DUE
nonprovisional NO \$1330 \$0 \$1330 07/21/2004

THE APPLICATION IDENTIFIED ABOVE HAS BEEN EXAMINED AND IS ALLOWED FOR ISSUANCE AS A PATENT. PROSECUTION ON THE MERITS IS CLOSED. THIS NOTICE OF ALLOWANCE IS NOT A GRANT OF PATENT RIGHTS. THIS APPLICATION IS SUBJECT TO WITHDRAWAL FROM ISSUE AT THE INITIATIVE OF THE OFFICE OR UPON PETITION BY THE APPLICANT. SEE 37 CFR 1.313 AND MPEP 1308.

THE ISSUE FEE AND PUBLICATION FEE (IF REQUIRED) MUST BE PAID WITHIN THREE MONTHS FROM THE MAILING DATE OF THIS NOTICE OR THIS APPLICATION SHALL BE REGARDED AS ABANDONED. THIS STATUTORY PERIOD CANNOT BE EXTENDED. SEE 35 U.S.C. 151. THE ISSUE FEE DUE INDICATED ABOVE REFLECTS A CREDIT FOR ANY PREVIOUSLY PAID ISSUE FEE APPLIED IN THIS APPLICATION. THE PTOL-85B (OR AN EQUIVALENT) MUST BE RETURNED WITHIN THIS PERIOD EVEN IF NO FEE IS DUE OR THE APPLICATION WILL BE REGARDED AS ABANDONED.

HOW TO REPLY TO THIS NOTICE:

I. Review the SMALL ENTITY status shown above.

If the SMALL ENTITY is shown as YES, verify your current SMALL ENTITY status:

A. If the status is the same, pay the TOTAL FEE(S) DUE shown above.

B. If the status is changed, pay the PUBLICATION FEE (if required) and twice the amount of the ISSUE FEE shown above and notify the United States Patent and Trademark Office of the change in status, or

If the SMALL ENTITY is shown as NO:

A. Pay TOTAL FEE(S) DUE shown above, or

B. If applicant claimed SMALL ENTITY status before, or is now claiming SMALL ENTITY status, check the box below and enclose the PUBLICATION FEE and 1/2 the ISSUE FEE shown above.

[] Applicant claims SMALL ENTITY status. See 37 CFR 1.27.

II. PART B - FEE(S) TRANSMITTAL should be completed and returned to the United States Patent and Trademark Office (USPTO) with your ISSUE FEE and PUBLICATION FEE (if required). Even if the fee(s) have already been paid, Part B - Fee(s) Transmittal should be completed and returned. If you are charging the fee(s) to your deposit account, section "4b" of Part B - Fee(s) Transmittal should be completed and an extra copy of the form should be submitted.

III. All communications regarding this application must give the application number. Please direct all communications prior to issuance to Mail Stop ISSUE FEE unless advised to the contrary.

IMPORTANT REMINDER: Utility patents issuing on applications filed on or after Dec. 12, 1980 may require payment of maintenance fees. It is patentee's responsibility to ensure timely payment of maintenance fees when due.

PH

PART B - FEE(S) TRANSMITTAL

Complete and send this form, together with applicable fee(s), to: Mail

Mail Stop ISSUE FEE
Commissioner for Patents
P.O. Box 1450
Alexandria, Virginia 22313-1450
or Fax (703) 746-4000

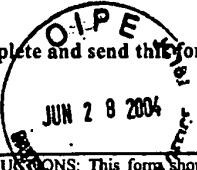

[Handwritten mark]

INSTRUCTIONS: This form should be used for transmitting the ISSUE FEE and PUBLICATION FEE (if required). Blocks 1 through 4 should be completed where appropriate. Further correspondence including the Patent, advance orders and notification of maintenance fees will be mailed to the current correspondence address as indicated unless directed below or directed otherwise in Block 1, by (a) specifying a new correspondence address; and/or (b) indicating a separate "FEE ADDRESS" for maintenance fee notifications.

CURRENT CORRESPONDENCE ADDRESS (Note: Legibly mark-up with any corrections or use Block 1)

35527 7590 04/21/2004

DUKE W. YEE
CARSTENS, YEE & CAHOON, L.L.P.
P.O. BOX 802334
DALLAS, TX 75380

Note: A certificate of mailing can only be used for domestic mailings of the Fee(s) Transmittal. This certificate cannot be used for any other accompanying papers. Each additional paper, such as an assignment or formal drawing, must have its own certificate of mailing or transmission.

Certificate of Mailing or Transmission
I hereby certify that this Fee(s) Transmittal is being deposited with the United States Postal Service with sufficient postage for first class mail in an envelope addressed to the Mail Stop ISSUE FEE address above, or being facsimile transmitted to the USPTO, on the date indicated below.

<i>Nell Whittom</i>	(Depositor's name)
<i>Nell Whittom</i>	(Signature)
<i>06-23-04</i>	(Date)

APPLICATION NO.	FILING DATE	FIRST NAMED INVENTOR	ATTORNEY DOCKET NO.	CONFIRMATION NO.
09/419,175	10/15/1999	GREGORY T. OSTERHOUT	11032RR	9870

TITLE OF INVENTION: PORTABLE CALL MANAGEMENT SYSTEM

APPLN. TYPE	SMALL ENTITY	ISSUE FEE	PUBLICATION FEE	TOTAL FEE(S) DUE	DATE DUE
nonprovisional	NO	\$1330	\$0	\$1330	07/21/2004

EXAMINER	ART UNIT	CLASS-SUBCLASS
NGUYEN, THUAN T	2685	455-422100

1. Change of correspondence address or indication of "Fee Address" (37 CFR 1.363).
 Change of correspondence address (or Change of Correspondence Address form PTO/SB/122) attached.
 "Fee Address" indication (or "Fee Address" Indication form PTO/SB/47; Rev 03-02 or more recent) attached. Use of a Customer Number is required.
2. For printing on the patent front page, list (1) the names of up to 3 registered patent attorneys or agents OR, alternatively, (2) the name of a single firm (having as a member a registered attorney or agent) and the names of up to 2 registered patent attorneys or agents. If no name is listed, no name will be printed.

3. ASSIGNEE NAME AND RESIDENCE DATA TO BE PRINTED ON THE PATENT (print or type)
PLEASE NOTE: Unless an assignee is identified below, no assignee data will appear on the patent. Inclusion of assignee data is only appropriate when an assignment has been previously submitted to the USPTO or is being submitted under separate cover. Completion of this form is NOT a substitute for filing an assignment.

(A) NAME OF ASSIGNEE: *Nortel Networks Limited*
(B) RESIDENCE: (CITY AND STATE OR COUNTRY) *St. Laurent, Quebec H4S 2A9 Canada*

Please check the appropriate assignee category or categories (will not be printed on the patent): individual corporation or other private group entity government

- 4a. The following fee(s) are enclosed:
 Issue Fee
 Publication Fee
 Advance Order - # of Copies _____
- 4b. Payment of Fee(s):
 A check in the amount of the fee(s) is enclosed.
 Payment by credit card. Form PTO-2038 is attached.
 The Director is hereby authorized by charge the required fee(s), or credit any overpayment, to Deposit Account Number *50-3157* (enclose an extra copy of this form).

Director for Patents is requested to apply the Issue Fee and Publication Fee (if any) or to re-apply any previously paid issue fee to the application identified above.

(Authorized Signature) *[Signature]* (Date) *06/23/04*

NOTE: The Issue Fee and Publication Fee (if required) will not be accepted from anyone other than the applicant; a registered attorney or agent; or the assignee or other party in interest as shown by the records of the United States Patent and Trademark Office.
This collection of information is required by 37 CFR 1.311. The information is required to obtain or retain a benefit by the public which is to file (and by the USPTO to process) an application. Confidentiality is governed by 35 U.S.C. 122 and 37 CFR 1.14. This collection is estimated to take 12 minutes to complete, including gathering, preparing, and submitting the completed application form to the USPTO. Time will vary depending upon the individual case. Any comments on the amount of time you require to complete this form and/or suggestions for reducing this burden, should be sent to the Chief Information Officer, U.S. Patent and Trademark Office, U.S. Department of Commerce, Alexandria, Virginia 22313-1450. DO NOT SEND FEES OR COMPLETED FORMS TO THIS ADDRESS. SEND TO: Commissioner for Patents, Alexandria, Virginia 22313-1450.
Under the Paperwork Reduction Act of 1995, no persons are required to respond to a collection of information unless it displays a valid OMB control number.

06/29/2004 HGUTEMAR2 00000049 09419175
01 FC:1501 1330.00 00

TRANSMIT THIS FORM WITH FEE(S)



UNITED STATES PATENT AND TRADEMARK OFFICE

UNITED STATES DEPARTMENT OF COMMERCE
United States Patent and Trademark Office
Address: COMMISSIONER FOR PATENTS
P.O. Box 1450
Alexandria, Virginia 22313-1450
www.uspto.gov

NOTICE OF ALLOWANCE AND FEE(S) DUE

35527 7590 04/21/2004
DUKE W. YEE
CARSTENS, YEE & CAHOON, L.L.P.
P.O. BOX 802334
DALLAS, TX 75380

EXAMINER

NGUYEN, THUAN T

ART UNIT PAPER NUMBER

2685

19

DATE MAILED: 04/21/2004

Table with 5 columns: APPLICATION NO., FILING DATE, FIRST NAMED INVENTOR, ATTORNEY DOCKET NO., CONFIRMATION NO.
09/419,175 10/15/1999 GREGORY T. OSTERHOUT 11032RR 9870

TITLE OF INVENTION: PORTABLE CALL MANAGEMENT SYSTEM

Table with 6 columns: APPLN. TYPE, SMALL ENTITY, ISSUE FEE, PUBLICATION FEE, TOTAL FEE(S) DUE, DATE DUE
nonprovisional NO \$1330 \$0 \$1330 07/21/2004

THE APPLICATION IDENTIFIED ABOVE HAS BEEN EXAMINED AND IS ALLOWED FOR ISSUANCE AS A PATENT. PROSECUTION ON THE MERITS IS CLOSED. THIS NOTICE OF ALLOWANCE IS NOT A GRANT OF PATENT RIGHTS. THIS APPLICATION IS SUBJECT TO WITHDRAWAL FROM ISSUE AT THE INITIATIVE OF THE OFFICE OR UPON PETITION BY THE APPLICANT. SEE 37 CFR 1.313 AND MPEP 1308.

THE ISSUE FEE AND PUBLICATION FEE (IF REQUIRED) MUST BE PAID WITHIN THREE MONTHS FROM THE MAILING DATE OF THIS NOTICE OR THIS APPLICATION SHALL BE REGARDED AS ABANDONED. THIS STATUTORY PERIOD CANNOT BE EXTENDED. SEE 35 U.S.C. 151. THE ISSUE FEE DUE INDICATED ABOVE REFLECTS A CREDIT FOR ANY PREVIOUSLY PAID ISSUE FEE APPLIED IN THIS APPLICATION. THE PTOL-85B (OR AN EQUIVALENT) MUST BE RETURNED WITHIN THIS PERIOD EVEN IF NO FEE IS DUE OR THE APPLICATION WILL BE REGARDED AS ABANDONED.

HOW TO REPLY TO THIS NOTICE:

I. Review the SMALL ENTITY status shown above.

If the SMALL ENTITY is shown as YES, verify your current SMALL ENTITY status:

A. If the status is the same, pay the TOTAL FEE(S) DUE shown above.

B. If the status is changed, pay the PUBLICATION FEE (if required) and twice the amount of the ISSUE FEE shown above and notify the United States Patent and Trademark Office of the change in status, or

If the SMALL ENTITY is shown as NO:

A. Pay TOTAL FEE(S) DUE shown above, or

B. If applicant claimed SMALL ENTITY status before, or is now claiming SMALL ENTITY status, check the box below and enclose the PUBLICATION FEE and 1/2 the ISSUE FEE shown above.

Applicant claims SMALL ENTITY status. See 37 CFR 1.27.

II. PART B - FEE(S) TRANSMITTAL should be completed and returned to the United States Patent and Trademark Office (USPTO) with your ISSUE FEE and PUBLICATION FEE (if required). Even if the fee(s) have already been paid, Part B - Fee(s) Transmittal should be completed and returned. If you are charging the fee(s) to your deposit account, section "4b" of Part B - Fee(s) Transmittal should be completed and an extra copy of the form should be submitted.

III. All communications regarding this application must give the application number. Please direct all communications prior to issuance to Mail Stop ISSUE FEE unless advised to the contrary.

IMPORTANT REMINDER: Utility patents issuing on applications filed on or after Dec. 12, 1980 may require payment of maintenance fees. It is patentee's responsibility to ensure timely payment of maintenance fees when due.

PART B - FEE(S) TRANSMITTAL

Complete and send this form, together with applicable fee(s), to: **Mail** **Mail Stop ISSUE FEE**
Commissioner for Patents
P.O. Box 1450
Alexandria, Virginia 22313-1450
 or **Fax** **(703) 746-4000**

INSTRUCTIONS: This form should be used for transmitting the ISSUE FEE and PUBLICATION FEE (if required). Blocks 1 through 4 should be completed where appropriate. All further correspondence including the Patent, advance orders and notification of maintenance fees will be mailed to the current correspondence address as indicated unless corrected below or directed otherwise in Block 1, by (a) specifying a new correspondence address; and/or (b) indicating a separate "FEE ADDRESS" for maintenance fee notifications.

CURRENT CORRESPONDENCE ADDRESS (Note: Legibly mark-up with any corrections or use Block 1)

35527 7590 04/21/2004

DUKE W. YEE
CARSTENS, YEE & CAHOON, L.L.P.
P.O. BOX 802334
DALLAS, TX 75380

Note: A certificate of mailing can only be used for domestic mailings of the Fee(s) Transmittal. This certificate cannot be used for any other accompanying papers. Each additional paper, such as an assignment or formal drawing, must have its own certificate of mailing or transmission.

Certificate of Mailing or Transmission

I hereby certify that this Fee(s) Transmittal is being deposited with the United States Postal Service with sufficient postage for first class mail in an envelope addressed to the Mail Stop ISSUE FEE address above, or being facsimile transmitted to the USPTO, on the date indicated below.

(Depositor's name)
(Signature)
(Date)

APPLICATION NO.	FILING DATE	FIRST NAMED INVENTOR	ATTORNEY DOCKET NO.	CONFIRMATION NO.
09/419,175	10/15/1999	GREGORY T. OSTERHOUT	11032RR	9870

TITLE OF INVENTION: PORTABLE CALL MANAGEMENT SYSTEM

APPLN. TYPE	SMALL ENTITY	ISSUE FEE	PUBLICATION FEE	TOTAL FEE(S) DUE	DATE DUE
nonprovisional	NO	\$1330	\$0	\$1330	07/21/2004

EXAMINER	ART UNIT	CLASS-SUBCLASS
NGUYEN, THUAN T	2685	455-422100

<p>1. Change of correspondence address or indication of "Fee Address" (37 CFR 1.363).</p> <p><input type="checkbox"/> Change of correspondence address (or Change of Correspondence Address form PTO/SB/122) attached.</p> <p><input type="checkbox"/> "Fee Address" indication (or "Fee Address" Indication form PTO/SB/47; Rev 03-02 or more recent) attached. Use of a Customer Number is required.</p>	<p>2. For printing on the patent front page, list (1) the names of up to 3 registered patent attorneys or agents OR, alternatively, (2) the name of a single firm (having as a member a registered attorney or agent) and the names of up to 2 registered patent attorneys or agents. If no name is listed, no name will be printed.</p> <p>1 _____</p> <p>2 _____</p> <p>3 _____</p>
--	---

3. ASSIGNEE NAME AND RESIDENCE DATA TO BE PRINTED ON THE PATENT (print or type)

PLEASE NOTE: Unless an assignee is identified below, no assignee data will appear on the patent. Inclusion of assignee data is only appropriate when an assignment has been previously submitted to the USPTO or is being submitted under separate cover. Completion of this form is NOT a substitute for filing an assignment.

(A) NAME OF ASSIGNEE _____ (B) RESIDENCE: (CITY and STATE OR COUNTRY) _____

Please check the appropriate assignee category or categories (will not be printed on the patent); individual corporation or other private group entity government

<p>4a. The following fee(s) are enclosed:</p> <p><input type="checkbox"/> Issue Fee</p> <p><input type="checkbox"/> Publication Fee</p> <p><input type="checkbox"/> Advance Order - # of Copies _____</p>	<p>4b. Payment of Fee(s):</p> <p><input type="checkbox"/> A check in the amount of the fee(s) is enclosed.</p> <p><input type="checkbox"/> Payment by credit card. Form PTO-2038 is attached.</p> <p><input type="checkbox"/> The Director is hereby authorized by charge the required fee(s), or credit any overpayment, to Deposit Account Number _____ (enclose an extra copy of this form).</p>
---	---

Director for Patents is requested to apply the Issue Fee and Publication Fee (if any) or to re-apply any previously paid issue fee to the application identified above.

(Authorized Signature)	(Date)
------------------------	--------

NOTE: The Issue Fee and Publication Fee (if required) will not be accepted from anyone other than the applicant; a registered attorney or agent; or the assignee or other party in interest as shown by the records of the United States Patent and Trademark Office.

This collection of information is required by 37 CFR 1.311. The information is required to obtain or retain a benefit by the public which is to file (and by the USPTO to process) an application. Confidentiality is governed by 35 U.S.C. 122 and 37 CFR 1.14. This collection is estimated to take 12 minutes to complete, including gathering, preparing, and submitting the completed application form to the USPTO. Time will vary depending upon the individual case. Any comments on the amount of time you require to complete this form and/or suggestions for reducing this burden, should be sent to the Chief Information Officer, U.S. Patent and Trademark Office, U.S. Department of Commerce, Alexandria, Virginia 22313-1450. **DO NOT SEND FEES OR COMPLETED FORMS TO THIS ADDRESS. SEND TO: Commissioner for Patents, Alexandria, Virginia 22313-1450.**

Under the Paperwork Reduction Act of 1995, no persons are required to respond to a collection of information unless it displays a valid OMB control number.

TRANSMIT THIS FORM WITH FEE(S)



UNITED STATES PATENT AND TRADEMARK OFFICE

UNITED STATES DEPARTMENT OF COMMERCE
United States Patent and Trademark Office
Address: COMMISSIONER FOR PATENTS
P.O. Box 1450
Alexandria, Virginia 22313-1450
www.uspto.gov

Table with 5 columns: APPLICATION NO., FILING DATE, FIRST NAMED INVENTOR, ATTORNEY DOCKET NO., CONFIRMATION NO.
Row 1: 09/419,175, 10/15/1999, GREGORY T. OSTERHOUT, 11032RR, 9870
Row 2: 35527, 7590, 04/21/2004, [EXAMINER], []
Row 3: [DUKE W. YEE], [CARSTENS, YEE & CAHOON, L.L.P.], [P.O. BOX 802334], [DALLAS, TX 75380], [NGUYEN, THUAN T]
Row 4: [ART UNIT], [PAPER NUMBER]
Row 5: [2685]

DATE MAILED: 04/21/2004

Determination of Patent Term Extension under 35 U.S.C. 154 (b)
(application filed after June 7, 1995 but prior to May 29, 2000)

The Patent Term Extension is 0 day(s). Any patent to issue from the above-identified application will include an indication of the 0 day extension on the front page.

If a Continued Prosecution Application (CPA) was filed in the above-identified application, the filing date that determines Patent Term Extension is the filing date of the most recent CPA.

Applicant will be able to obtain more detailed information by accessing the Patent Application Information Retrieval (PAIR) system (http://pair.uspto.gov).

Any questions regarding the Patent Term Extension or Adjustment determination should be directed to the Office of Patent Legal Administration at (703) 305-1383. Questions relating to issue and publication fee payments should be directed to the Customer Service Center of the Office of Patent Publication at (703) 305-8283.

Notice of Allowability

Application No.

09/419,175

Examiner

THUAN T. NGUYEN

Applicant(s)

OSTERHOUT ET AL.

Art Unit

2685

-- The MAILING DATE of this communication appears on the cover sheet with the correspondence address--

All claims being allowable, PROSECUTION ON THE MERITS IS (OR REMAINS) CLOSED in this application. If not included herewith (or previously mailed), a Notice of Allowance (PTOL-85) or other appropriate communication will be mailed in due course. **THIS NOTICE OF ALLOWABILITY IS NOT A GRANT OF PATENT RIGHTS.** This application is subject to withdrawal from issue at the initiative of the Office or upon petition by the applicant. See 37 CFR 1.313 and MPEP 1308.

- 1. This communication is responsive to _____.
- 2. The allowed claim(s) is/are 1-8,17-33,43-51 and 70-81.
- 3. The drawings filed on _____ are accepted by the Examiner.
- 4. Acknowledgment is made of a claim for foreign priority under 35 U.S.C. § 119(a)-(d) or (f).
 - a) All b) Some* c) None of the:
 - 1. Certified copies of the priority documents have been received.
 - 2. Certified copies of the priority documents have been received in Application No. _____.
 - 3. Copies of the certified copies of the priority documents have been received in this national stage application from the International Bureau (PCT Rule 17.2(a)).

* Certified copies not received: _____.

Applicant has THREE MONTHS FROM THE "MAILING DATE" of this communication to file a reply complying with the requirements noted below. Failure to timely comply will result in ABANDONMENT of this application. **THIS THREE-MONTH PERIOD IS NOT EXTENDABLE.**

- 5. A SUBSTITUTE OATH OR DECLARATION must be submitted. Note the attached EXAMINER'S AMENDMENT or NOTICE OF INFORMAL PATENT APPLICATION (PTO-152) which gives reason(s) why the oath or declaration is deficient.
 - 6. CORRECTED DRAWINGS (as "replacement sheets") must be submitted.
 - (a) including changes required by the Notice of Draftsperson's Patent Drawing Review (PTO-948) attached
 - 1) hereto or 2) to Paper No./Mail Date _____.
 - (b) including changes required by the attached Examiner's Amendment / Comment or in the Office action of Paper No./Mail Date _____.
- Identifying indicia such as the application number (see 37 CFR 1.84(c)) should be written on the drawings in the front (not the back) of each sheet. Replacement sheet(s) should be labeled as such in the header according to 37 CFR 1.121(d).
- 7. DEPOSIT OF and/or INFORMATION about the deposit of BIOLOGICAL MATERIAL must be submitted. Note the attached Examiner's comment regarding REQUIREMENT FOR THE DEPOSIT OF BIOLOGICAL MATERIAL.

Attachment(s)

- 1. Notice of References Cited (PTO-892)
- 2. Notice of Draftsperson's Patent Drawing Review (PTO-948)
- 3. Information Disclosure Statements (PTO-1449 or PTO/SB/08), Paper No./Mail Date _____
- 4. Examiner's Comment Regarding Requirement for Deposit of Biological Material
- 5. Notice of Informal Patent Application (PTO-152)
- 6. Interview Summary (PTO-413), Paper No./Mail Date _____
- 7. Examiner's Amendment/Comment
- 8. Examiner's Statement of Reasons for Allowance
- 9. Other _____

DETAILED ACTION

Allowable Subject Matter

1. Claims 1-8, 17-33, 43-51, and 70-81 are allowed.

Drawings

2. Claims are allowed. Formal drawings are required in response to this action.

Reasons for Allowance

3. The following is an examiner's statement of reasons for allowance:

The closest prior art of record issued to Jain and Wang fails to teach or suggest *a system and a method for redirecting an incoming call prior to establishing a communication connection between an originator of the incoming call and the data processing system with an option for the user or the received party of the incoming call to redirect it instead of the system as cited in claims 1, 17, 25, and 43*. Jain discloses a multicasting system with a conventional forwarding technique of messages using pre-stored numbers or alternate numbers as normally used in a personal location service; and Wang shows a closer technique of giving the users options to redirect the call. However, Wang requires that call transferring can only be performed with already established communication connections between an originator of the call and the palm-size device (Figs. 18-19, col. 36/line 10 to col. 37/line 11). The present invention discloses the amended languages that “responsive to receiving the registration notice, providing a user with an option to redirect the routing of the call prior to establishing a communication connection between an originator of the incoming call and the data processing system” and wherein the user

Art Unit: 2685

input identifies a new address of another device, instead of the data processing system, to which the incoming call is forwarding to.

Any comments considered necessary by applicant must be submitted no later than the payment of the issue fee and, to avoid processing delays, should preferably accompany the issue fee. Such submissions should be clearly labeled "Comments on Statement of Reasons for Allowance."

Conclusion

4. Any response to this action should be mailed to:

Commissioner of Patents and Trademarks

Washington, D.C. 20231

or faxed to:

(703) 872-9306, (for Technology Center 2600 only)

Hand-delivered responses should be brought to Crystal Park II,

2121 Crystal Drive, Arlington, VA., Sixth Floor (Receptionist).

5. Any inquiry concerning this communication or earlier communications from the examiner should be directed to Tony Thuan Nguyen whose telephone number is (703) 308-5860. The examiner can normally be reached on Monday-Friday from 9:30 AM to 7:00 PM, with alternate Fridays off.

Art Unit: 2685

If attempts to reach the examiner by telephone are unsuccessful, the examiner's supervisor, Edward Urban, can be reached at (703) 305-4385.

Any inquiry of a general nature or relating to the status of this application or proceeding should be directed to the **Technology Center 2600 Customer Service Office** whose telephone number is **(703) 306-0377**.

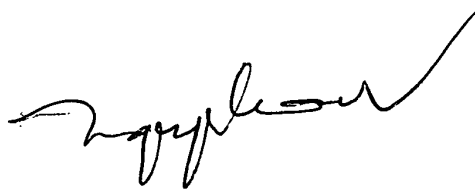

TONY T. NGUYEN
PATENT EXAMINER (750)

Tony T. Nguyen
Art Unit 2685
April 16, 2004

**RECEIVED
CENTRAL FAX CENTER**

JAN 28 2004

**Carstens,
Yee &
Cahoon, L.L.P.**

13760 Noel Road
Suite 900
Dallas, Texas 75240

Main No. (972) 367-2001
Facsimile (972) 367-2002

OFFICIAL

Facsimile Cover Sheet

To: Commissioner for Patents for Examiner Thuan T. Nguyen Group Art Unit 2685	Facsimile No.: 703/872-9306
From: Rebecca Clayton Legal Assistant to Stephen J. Walder, Jr.	No. of Pages Including Cover Sheet: 16
Message: Enclosed herewith: <ul style="list-style-type: none"> • Transmittal Document; and • Response to Office Action. 	
Re: Application No. 09/419,175 Attorney Docket No: 11032RR	
Date: Wednesday, January 28, 2004	
Please contact us at (972) 367-2001 if you do not receive all pages indicated above or experience any difficulty in receiving this facsimile.	<i>This Facsimile is intended only for the use of the addressee and, if the addressee is a client or their agent, contains privileged and confidential information. If you are not the intended recipient of this facsimile, you have received this facsimile inadvertently and in error. Any review, dissemination, distribution, or copying is strictly prohibited. If you received this facsimile in error, please notify us by telephone and return the facsimile to us immediately.</i>

**PLEASE CONFIRM RECEIPT OF THIS TRANSMISSION
BY FAXING A CONFIRMATION TO 972-367-2002.**

E

IN THE UNITED STATES PATENT AND TRADEMARK OFFICE

In re application of: Osterhout et al.

Serial No.: 09/419,175

Filed: October 15, 1999

For: Portable Call Management System

35527
PATENT TRADEMARK OFFICE
CUSTOMER NUMBER

§
§
§
§
§
§

Group Art Unit: 2685

Examiner: Nguyen, Thuan T.

Attorney Docket No.: 1.1032RR

Certificate of Transmission Under 37 C.F.R. § 1.8(a)
I hereby certify this correspondence is being transmitted via facsimile to the Commissioner for Patents, P.O. Box 1450, Alexandria, VA 22313-1450, facsimile number (703) 872-9306, on January 28, 2004.
By: Rebecca Clayton
Rebecca Clayton

TRANSMITTAL DOCUMENT

Commissioner for Patents
P.O. Box 1450
Alexandria, VA 22313-1450

Sir:
ENCLOSED HEREWITH:

- Response to Office Action.

No fees are believed to be required. If, however, any fees are required, I authorize the Commissioner to charge these fees which may be required to Deposit Account No. 50-0392. No extension of time is believed to be necessary. If, however, an extension of time is required, the extension is requested, and I authorize the Commissioner to charge any fees for this extension to Deposit Account No. 50-0392.

Respectfully submitted,

Duke W. Yee
Duke W. Yee
Registration No. 34,285
CARSTENS, YEE & CAHOON, LLP
P.O. Box 802334
Dallas, Texas 75380
(972) 367-2001
ATTORNEY FOR APPLICANTS

RECEIVED
CENTRAL FAX CENTER

IN THE UNITED STATES PATENT AND TRADEMARK OFFICE

JAN 28 2004

In re application: Osterhout et al.

Serial No.: 09/419,175

Filed: October 15, 1999

For: Portable Call Management System

§
§
§
§
§
§
§
§
§
§

Group Art Unit: 2685

Examiner: Nguyen, Thuan T.

Attorney Docket No.: 11032RR

OFFICIAL

18/E
2/4/04
OK

Certificate of Transmission Under 37 C.F.R. § 1.8(a)
I hereby certify this correspondence is being transmitted via facsimile to the Commissioner for Patents, P.O. Box 1450, Alexandria, VA 22313-1450, facsimile number (703) 872-9306, on January 28, 2004.
By: Rebecca Clayton
Rebecca Clayton

RESPONSE TO OFFICE ACTION

Commissioner for Patents
P.O. Box 1450
Alexandria, VA 22313-1450

Sir:

No fees are believed to be required. If, however, any fees are required, I authorize the Commissioner to charge these fees which may be required to Deposit Account No. 50-0392. No extension of time is believed to be necessary. If, however, an extension of time is required, the extension is requested, and I authorize the Commissioner to charge any fees for this extension to Deposit Account No. 50-0392.

In response to the Office Action dated October 28, 2003, please amend the above-identified application as follows:

Listing of Claims begins on page 2 of this paper.

Remarks begin on page 9 of this paper.

E

IN THE CLAIMS:

1. (Currently amended) A method of redirecting a call from a data processing system having a first address to another device having another address, comprising the steps of:
- receiving at the data processing system, a registration notice of an incoming call from a server;
 - responsive to receiving the registration notice, providing a user with an option to redirect the routing of the call prior to establishing a communication connection between an originator of the incoming call and the data processing system;
 - receiving user input in response to providing the option to redirect the routing of the incoming call, wherein the user input identifies a new address of another device, other than the data processing system, to which the incoming call is to be routed; and
 - responsive to receiving the user input, transmitting the new address to which the incoming call is to be redirected.
2. (Original) The method as recited in claim 1, wherein said data processing system is a personal digital assistant.
3. (Original) The method as recited in claim 1, wherein said data processing system is a laptop computer.
4. (Original) The method as recited in claim 1, wherein said data processing system is a portable computing device.
5. (Original) The method as recited in claim 1, wherein said data processing system is a wireless device.
6. (Original) The method as recited in claim 1, wherein the registration notice is a session initiation protocol registration notice.

7. (Original) The method as recited in claim 1, wherein the incoming call comprises video and the new address corresponds to a video display terminal.

8. (Original) The method as recited in claim 1, wherein said data processing system is a wire-line connected device.

9-16. (Canceled)

12
17. (Currently amended) A system of redirecting a call from a data processing system having a first address to another device having another address, comprising:
means for receiving at a data processing system a registration notice of an incoming call from a server;

means, responsive to receiving the registration notice, for providing a user with an option to redirect the routing of the call prior to establishing a communication connection between an originator of the incoming call and the data processing system;

means for receiving user input in response to providing the option to redirect the routing of the incoming call, wherein the user input identifies a new address of another device, other than the data processing system, to which the incoming call is to be routed; and

means, responsive to receiving the user input, for transmitting the new address to which the incoming call is to be redirected.

13
18. (Original) The system as recited in claim 17, wherein said data processing system is a personal digital assistant.

14
19. (Original) The system as recited in claim 17, wherein said data processing system is a laptop computer.

15
20. (Original) The system as recited in claim 17, wherein said data processing system is a portable computing device.

¹⁶ 21. (Original) The system as recited in claim ¹² 17, wherein said data processing system is a wireless device.

¹⁷ 22. (Original) The system as recited in claim ¹² 17, wherein the registration notice is a session initiation protocol registration notice.

¹⁸ 23. (Original) The system as recited in claim ¹² 17, wherein the incoming call comprises video and the new address corresponds to a video display terminal.

21

¹⁹ 24. (Original) The system as recited in claim ¹² 17, wherein said data processing system is a wire-line connected device.

²³ 25. (Currently amended) A method for redirecting calls to a data processing system at a first location to another device at a second location; comprising the steps of:
 sending a registration notification to a called party's preferred location, the registration notification identifying an incoming call;
 receiving a response from the called party's preferred location, prior to establishing a communication connection between an originator of the incoming call and the data processing system, the response including a new address identified from user input received at the called party's preferred location in response to receiving the registration notification at the called party's preferred location; and
 responsive to receipt of the new address from the called party, redirecting the incoming call to the new address, wherein the sending of the registration notification causes the called party to be provided with an option to redirect routing of the call to another address, and wherein the response is generated based on user input indicating that the option to redirect routing of the call is to be utilized.

²⁴ 26. (Original) The method as recited in claim ²³ 25, further comprising:
 prior to said sending step, receiving a request to initiate a call with a called party;
 and
 determining a preferred location of the called party.

28

E

²⁵
27. (Original) The method as recited in claim ²³25, wherein the registration notification is a session initiation protocol registration.

²⁶
28. (Original) The method as recited in claim ²³25, wherein the preferred location is a personal digital assistant.

²⁷
29. (Original) The method as recited in claim ²⁶28, wherein the personal digital assistant is a Palm VII utilizing a Palm Query Application to provide a user interface.

²⁸
30. (Original) The method as recited in claim ²³25, wherein the new address corresponds to a voice mailbox.

²⁹
31. (Original) The method as recited in claim ²³25, wherein the new address corresponds to placing the incoming call on hold.

³⁰
32. (Original) The method as recited in claim ²³25, wherein communication with the preferred device is provided utilizing a wireless application protocol.

³¹
33. (Original) The method as recited in claim ²³25, wherein the new address corresponds to a wire-line device.

[34-42. (Canceled)

³⁵
43. (Currently amended) A system for redirecting calls to a data processing system at a first location to another device at a second location; comprising:

means for sending a registration notification to a called party's preferred location, the registration notification identifying an incoming call;

means for receiving a response from the called party's preferred location prior to establishing a communication connection between an originator of the incoming call and the data processing system, the response including a new address identified from user

29

E

input received at the called party's preferred location in response to receiving the registration notification at the called party's preferred location; and

means, responsive to receipt of the new address from the called party, for redirecting the incoming call to the new address, wherein the sending of the registration notification causes the called party to be provided with an option to redirect routing of the incoming call to another address, and wherein the response is generated based on user input indicating that the option to redirect routing of the call is to be utilized.

Handwritten mark resembling a stylized 'E' or '1'.

³⁶ 44. (Original) The system as recited in claim ³⁵ 43, further comprising:
prior to said sending step, means for receiving a request to initiate a call with a called party; and
means for determining a preferred location of the called party.

³⁷ 45. (Original) The system as recited in claim ³⁵ 43, wherein the registration notification is a session initiation protocol registration.

³⁸ 46. (Original) The system as recited in claim ³⁵ 43, wherein the preferred location is a personal digital assistant.

³⁹ 47. (Original) The system as recited in claim ³⁸ 46, wherein the personal digital assistant is a Palm VII utilizing a Palm Query Application to provide a user interface.

⁴⁰ 48. (Original) The system as recited in claim ³⁵ 43, wherein the new address corresponds to a voice mailbox.

⁴¹ 49. (Original) The system as recited in claim ³⁵ 43, wherein the new address corresponds to placing the incoming call on hold.

⁴² 50. (Original) The system as recited in claim ³⁵ 43, wherein communication with the preferred device is provided utilizing a wireless application protocol.

¹³
~~51~~. (Original) The system as recited in claim ~~43~~³⁵, wherein the new address corresponds to a wire-line device.

52-69. (Canceled)

⁹
~~70~~. (Previously presented) The method of claim 1, wherein providing a user with an option to redirect the routing of the call includes providing, on the data processing device, a user interface through which the new address may be entered by the user.

E

¹⁰
~~71~~. (Previously presented) The method of claim ~~70~~⁹, wherein the user interface includes an option to redirect the call, an option to place the call on hold, and an option to redirect the call to a voicemail system.

¹¹
~~72~~. (Previously presented) The method of claim ~~71~~¹⁰, wherein if the option to redirect the call is selected, a further user interface is provided for entry of the new address.

²⁰
~~73~~. (Previously presented) The system of claim ~~72~~¹², wherein the means for providing a user with an option to redirect the routing of the call includes means for providing, on the data processing device, a user interface through which the new address may be entered by the user.

²¹
~~74~~. (Previously presented) The system of claim ~~73~~²⁰, wherein the user interface includes an option to redirect the call, an option to place the call on hold, and an option to redirect the call to a voicemail system.

²²
~~75~~. (Previously presented) The system of claim ~~74~~²¹, wherein if the option to redirect the call is selected, a further user interface is provided for entry of the new address.

³²
~~76~~. (Previously presented) The method of claim ~~25~~²³, wherein the called party is provided with an option to redirect the routing of the call by providing, on the data

31

E

processing device, a user interface through which the new address may be entered by the user.

³³
~~77~~. (Previously presented) The method of claim ³²~~76~~, wherein the user interface includes an option to redirect the call, an option to place the call on hold, and an option to redirect the call to a voicemail system.

³⁴
~~78~~. (Previously presented) The method of claim ³³~~77~~, wherein if the option to redirect the call is selected, a further user interface is provided for entry of the new address.

77

⁴⁴
~~79~~. (Previously presented) The system of claim ³⁵~~43~~, wherein the option provided to the called party to redirect the routing of the call includes a user interface through which the new address may be entered by the user.

⁴⁵
~~80~~. (Previously presented) The system of claim ⁴⁴~~79~~, wherein the user interface includes an option to redirect the call, an option to place the call on hold, and an option to redirect the call to a voicemail system.

⁴⁴
~~81~~. (Previously presented) The system of claim ⁴⁵~~80~~, wherein if the option to redirect the call is selected, a further user interface is provided for entry of the new address.

REMARKS

Claims 1-8, 17-33, 43-51 and 70-81 are pending in the present application. By this Response, claims 1, 17, 25 and 43 are amended to recite that the user is provided with the option to redirect the routing of the call prior to establishing a communication connection between an originator of the incoming call and the data processing system. Reconsideration of the claims is respectfully requested in view of the above amendments and the following remarks.

I. 35 U.S.C. § 103, Obviousness

The Office Action rejects claims 1-8, 17-33, 43-51, and 70-81 under 35 U.S.C. § 103(a) as being unpatentable over Jain et al. (U.S. Patent No. 6,085,101) in view of Wang et al. (U.S. Patent No. 6,161,134/ or "Wang"). This rejection is respectfully traversed.

As to claims 1-8, 17-33, 43-51, and 70-81, the Office Action states:

Regarding claims 1, 17, 25, and 43, Jain discloses a system and its corresponding method of "redirecting or re-routing a call from a data processing system having a first address to another device having another address, comprising the step of receiving at the data processing system a registration notice of an incoming call from a server, responsive to receiving the user input (see below), transmitting the new address to which the incoming call is to be redirected", i.e., call management is disclosed wherein new address or new location of the intended recipient can be recognized, and the call or message from the user at a data processing system can be forwarding to or re-directing to the new location using personal locating services and/or personal communication internetworking (see Figs. 2, 4, 6, 8 7 13; col. 1/lines 10-37 for a plurality of data processing systems, col. 2/lines 12-26 for registration notification using HLR and call forwarding, col. 6/lines 47-67 for forwarding addresses and col. 13/line 50 to col. 14/line 34 for personal location services).

Jain does not disclose the step of "responsive to receiving the registration notice, providing a user with an option to redirect the routing of the call; receiving user input in response to providing the option to redirect the routing of the call, wherein the user input identifies a new address of another device, other than the data processing system, to which the call is to be routed" as pre-amended; however, Wang teaches an exact same technique in using individual user profile and the user can further designate his or her preferences, using an option to redirect or rerouting a call by entering a new address of another device, to a new address of

another device that he would like to communicate (see Wang, Fig. 8, Figs. 17-19 & 21-22 as the user has an option to choose to transfer a call to line 1 or 2 or he can enter a new address or a new number on line 1720 of Fig. 17, and col. 36/line 10 to col. 37/line 11 for call forwarding, col. 38/line 15 to col. 40/line 32 for user interaction with the option to transfer a call, and col. 39/line 58 to col. 40/line 32 for transfer procedure whereas the user can input a new address of another device that the user specifies for the call to be routed to.) Therefore, it would have been obvious to one of ordinary skill in the art at the time the invention was made to modify Jain's system with Wang's teaching technique of providing the user an opportunity or an option to specify a new address to his or her intended destination for another device, and based on user profile and preferences (user settings (as illustrated in Figs. 26 & 27), the system easily routes the call to a desired location as taught by Wang. The motivation for doing this is to offer to the users an interaction manner for directly receiving their inputs in controlling and modifying their intended destinations as the user prefers.

Office Action dated October 28, 2003, pages 3-4.

Claim 1, which is representative of claims 17, 25 and 43 with regard to similarly recited subject matter, reads as follows:

- I. A method of redirecting a call from a data processing system having a first address to another device having another address, comprising the steps of:
 - receiving at the data processing system, a registration notice of an incoming call from a server;
 - responsive to receiving the registration notice, providing a user with an option to redirect the routing of the call prior to establishing a communication connection between an originator of the incoming call and the data processing system;
 - receiving user input in response to providing the option to redirect the routing of the incoming call, wherein the user input identifies a new address of another device, other than the data processing system, to which the incoming call is to be routed; and
 - responsive to receiving the user input, transmitting the new address to which the incoming call is to be redirected. (emphasis added)

One of the principle advantages of the present invention is the ability to provide a notification of an incoming call to a user of a data processing device prior to the user having to establish communication with the originator of the call, and providing an option for the user to input an address for another device to which the call may be redirected. In

E

this way, the user need not ever accept the incoming call at his data processing device and may decide where to redirect the call so that proper communication can be provided. Thus, a key feature of the invention is to be able to prompt the user for a forwarding address before a connection is established and thereby redirect the call to another device before a connection is established. This feature has been clarified and emphasized by the above amendments to the independent claims.

Neither of the Jain nor Wang references teach or suggest these features. Specifically, neither Jain nor Wang teach or suggest "responsive to receiving the registration notice, providing a user with an option to redirect the routing of the call prior to establishing a communication connection between an originator of the incoming call and the data processing system" and "receiving user input in response to providing the option to redirect the routing of the incoming call, wherein the user input identifies a new address of another device, other than the data processing system, to which the incoming call is to be routed", as recited in claim 1 and similar features found in claims 17, 25 and 43.

Jain is directed to a system for multicasting a single message to a plurality of recipients. With the system of Jain, a message provider calls a multicast service, the network server queries the message provider and obtains the message and recipient addresses, the network server then contacts some or all of the recipients and transmits the message to those recipients that were contacted (see column 3, lines 48-68). Jain further teaches that the multicasting functionality of the Jain system may be used in conjunction with known communication network services such as personal location service and call forwarding. Call forwarding, as is described in the Jain reference (column 2, lines 24-26), involves receiving a call with a designation of a destination telephone number and automatically consulting stored information to identify an alternate number to which calls to the destination telephone number are to be forwarded. Personal location service is a known service of cellular telephone systems in which a cell or registration area in which a mobile terminal is currently located is identified from existing information in the wireless communication infrastructure (column 13, lines 59-61).

The Office Action admits, and Applicants agree, that Jain does not teach "responsive to receiving the registration notice, providing a user with an option to

redirect the routing of the call; receiving user input in response to providing the option to redirect the routing of the call, wherein the user input identifies a new address of another device, other than the data processing system, to which the call is to be routed" (see Office Action, page 3). However, the Office Action alleges that Wang teaches these features in Figures 8, 17-19 and 21-22, column 36, line 10 to column 37, line 11, and column 38, line 15 to column 40, line 32. Applicants respectfully disagree.

The cited Figures and sections of the Wang reference refer to transferring and forwarding of calls. With regard to forwarding of calls, Wang teaches that the interfaces shown in Figures 21 and 22 may be used to designate an alternative address to which incoming calls may be forwarded. However, the entry of the call forwarding alternative address is performed prior to the call being received. That is, the alternative address must be established prior to any notification of an incoming call being received. This is similar to the call forwarding discussed in Jain, i.e. using already stored alternative address information to determine where to forward the call. While Figure 22 shows an interface through which the call forwarding alternative address may be changed, this is not an interface that is provided in response to receiving a notification of a call. To the contrary, any calls that are received after the alternative address has been changed will be forwarded to the new alternative address rather than the previously used alternative address.

This is clear from the description of Figures 21 and 22 in column 36 and the graphical user interface in column 40. At column 36, lines 35-37, Wang clearly states that call forwarding of all calls to the alternative address is clearly performed after the entry of the call forwarding alternative address. In column 40, lines 55-60, Wang teaches that the user inputs a number such as "9876" as the number of the forwarded to network device and a call forwarding features is then established with the gateway server. Thus, call forwarding of incoming calls will then be performed. The call forwarding of Wang does not involve a user receiving a notification of an incoming call, being provided with an option for entering an address to which the call is to be forwarded, prior to establishing a communication connection between the originator of the call and a data processing system, and then receiving input from a user of the data processing device identifying the address to which the call is to be forwarded. To the contrary, Wang

requires that the alternative address be established prior to call forwarding occurring and the call forwarding is then performed automatically by the gateway server until disabled.

With regard to transferring of calls, Wang teaches that calls may be transferred between two lines and graphical user interfaces are provided for facilitating this operation, as shown in Figures 18 and 19. The call transferring of Wang involves a connecting a call on a first line, i.e. line 01, establishing a connection of another call on a second line, i.e. line 02, and then transferring the call on line 01 to the line on 02. Wang specifically states "As indicated in FIG. 9, line 01 is already connected when the user starts the transfer program 902" (column 36, lines 51-52) and "The palm-sized computer 343 then sends a dial (A1) "5432" message 910 formatted according to FIG. 5D to the Ethernet telephone 310. The Ethernet telephone 310 then connects line 02 to the "5432" device 912..." (column 36, lines 61-67). The call on the first line 01 is then connected to the "5432" device on line 02 (column 37, lines 7-10).

Thus, with regard to call transferring, Wang requires that two communications be established with the palm-sized device prior to being able to perform the transfer, one of which must already be established prior to entry of the device id for the other line. The call transferring can only be performed with already established communication connections between an originator of the call and the palm-sized device and a call from the palm-sized device and a destination device, i.e. the "5432" device. Therefore, the call transfer option of Wang does not teach or suggest "responsive to receiving the registration notice, providing a user with an option to redirect the routing of the call prior to establishing a communication connection between an originator of the incoming call and the data processing system" and does not teach or suggest "receiving user input in response to providing the option to redirect the routing of the incoming call, wherein the user input identifies a new address of another device, other than the data processing system, to which the incoming call is to be route" (emphasis added). Neither call forwarding nor call transferring in Wang teaches or suggests these features.

Therefore, neither Jain nor Wang, either alone or in combination, teach or suggest all of the features of claim 1 as detailed above. Claims 17, 25 and 43 recite similar features and thus, are allowable over the alleged combination of Jain and Wang for similar reasons. At least by virtue of their dependency on claims 17, 25 and 43, Jain and

Wang, either alone or in combination, teach or suggest the features of dependent claims 2-8, 18-24, 26-33, 44-51 and 70-81. Accordingly, Applicants respectfully request that the rejection of claims 1-8, 17-33, 43-51, and 70-81 under 35 U.S.C. § 103(a) be withdrawn.

II. Conclusion

It is respectfully urged that the subject application is patentable over Jain and Wang and is now in condition for allowance. The Examiner is invited to call the undersigned at the below-listed telephone number if in the opinion of the Examiner such a telephone conference would expedite or aid the prosecution and examination of this application.

Respectfully submitted,

DATE: January 28, 2004

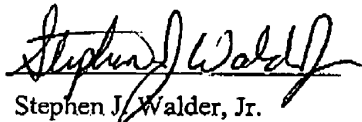

Stephen J. Walder, Jr.
Reg. No. 41,534
Carstens, Yec & Cahoon, LLP
P.O. Box 802334
Dallas, TX 75380
(972) 367-2001
Attorney for Applicants

E

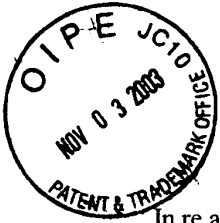

IN THE UNITED STATES PATENT AND TRADEMARK OFFICE

2685

17
Jd
11/13/03

In re application of: **Osterhout et al.**

§
§
§
§
§
§

Group Art Unit: **2685**

Serial No.: **09/419,175**

Examiner: **Nguyen, Thuan T.**

Filed: **October 15, 1999**

Attorney Docket No.: **11032RR**

For: **Portable Call Management System**

Certificate of Mailing Under 37 C.F.R. § 1.8(a)
 I hereby certify this correspondence is being deposited with the United States Postal Service as First Class mail in an envelope addressed to: Commissioner for Patents, P.O. Box 1450, Alexandria, VA 22313-1450 on 10-28-03
 By: Dell Whitton
 Dell Whitton

TRANSMITTAL DOCUMENT

Commissioner for Patents
P.O. Box 1450
Alexandria, VA 22313-1450

RECEIVED

NOV 06 2003

Technology Center 2600

Sir:
ENCLOSED HEREWITH:

- Supplemental Information Disclosure Statement;
- Form PTO-1449;
- Check in the amount of \$180.00; and
- Our return postcard.

A fee in the amount of \$180.00 is required. A check for this amount is enclosed. No extension of time is believed to be necessary. If, however, an extension of time is required, the extension is requested, and I authorize the Commissioner to charge any fees for this extension to Deposit Account No. 50-0392.

Respectfully submitted,

Duke W. Yee
Duke W. Yee

Registration No. 34,285
CARSTENS, YEE & CAHOON, LLP
P.O. Box 802334
Dallas, Texas 75380
(972) 367-2001
ATTORNEY FOR APPLICANTS

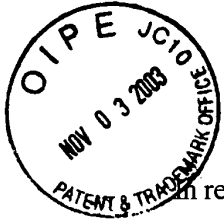

IN THE UNITED STATES PATENT AND TRADEMARK OFFICE

In re application of: **Osterhout et al.**

Serial No.: **09/419,175**

Filed: **October 15, 1999**

For: **Portable Call Management System**

§
§
§
§
§
§
§

Group Art Unit: **2685**

Examiner: **Nguyen, Thuan T.**

Attorney Docket No.: **11032RR**

**SUPPLEMENTAL INFORMATION DISCLOSURE STATEMENT
UNDER 37 C.F.R. 1.97**

RECEIVED

Commissioner for Patents
P.O. Box 1450
Alexandria, VA 22313-1450

**NOV 06 2003
Technology Center 2600**

Sir:

Applicants request that the information listed on the attached Form PTO-1449 be considered by the Office during the pendency of the above entitled application, pursuant to 37 C.F.R. 1.97.

Please charge any fees necessary for prosecution of the present application to Deposit Account No. 50-0392. If any extension of time is required, such extension is hereby requested. Please charge any additional required fee for extension of time to Deposit Account No. 50-0392.

In accordance with 37 C.F.R. 1.97(h), the filing of this Supplemental Information Disclosure Statement shall not constitute an admission that any information cited therein is, or is considered to be, material to patentability as defined in 37 C.F.R. 1.56(b). In the interest of full and complete disclosure to the Office, some or all of the art cited herein may not be considered by Applicant(s) or the Undersigned to be material under the new standards of materiality defined in 37 C.F.R. 1.56(b), enacted March 16, 1992, but may be material under the old standard of materiality defined in 37 C.F.R. 1.56(a), last amended on November 28, 1988, or may merely be technical background which may be of interest to the Examiner. In accordance with 37 C.F.R. 1.97(g), the

11/05/2003 CNGUYEN 00000035 09419175

01 FC:1806

180.00 0P

Osterhout et al. - 09/419,175
Page 1 of 2

filing of this Supplemental Information Disclosure Statement shall not be construed to mean that a search has been made.

This Supplemental Information Disclosure Statement is being filed before the mailing date of a final action or a notice of allowance. A check is enclosed for the required fee of \$180.00 as set forth in § 1.17(p).

Respectfully submitted,

Date: 10/27/05

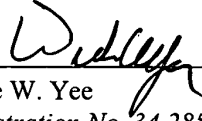

Duke W. Yee
Registration No. 34,285
CARSTENS, YEE & CAHOON, LLP
P.O. Box 802334
Dallas, Texas 75380
(972) 367-2001



Form PTO-1449 LIST OF PRIOR ART CITED BY APPLICANT <i>(Use several sheets if necessary)</i>	ATTORNEY DOCKET NO. 11032RR	SERIAL NO. 09/419	RECEIVED NOV. 06 2003
	APPLICANT Osterhout et al.		
	FILING DATE October 15, 1999	GROUP ART UNIT 2685	

U.S. PATENT DOCUMENTS

EXAMINER INITIAL	DOCUMENT NO.	PUBLICATION DATE	INVENTOR NAME	CLASS/SUBCLASS	FILING DATE
<i>CB</i>	AA 6,161,134	Dec. 12, 2000	Wang et al.	709/220	Oct. 30, 1998
<i>GM</i>	AB 6,421,536 B1	Jul. 16, 2002	Uranaka et al.	455/417	Apr. 7, 1999
<i>ST</i>	AC 2002/0118800	Aug. 29, 2002	Martinez et al.	379/67.1	Jul. 12, 2001

FOREIGN PATENT DOCUMENTS

EXAMINER INITIAL	DOCUMENT NO.	PUBLICATION DATE	COUNTRY	CLASS/SUBCLASS	TRANSLATION	
					YES	NO

OTHER PRIOR ART (including author, title, date, pertinent page, etc.)

--	--	--	--

RELATED PATENT APPLICATIONS

EXAMINER INITIAL	APPLICATION NO./ ATTY. DOCKET NO.	APPLICANT	TITLE	FILING DATE

DATE CONSIDERED

4/12/04

EXAMINER

[Signature]

EXAMINER: Initial if reference considered, whether or not citation is in conformance with MPEP § 609; draw line through citation if not in conformance and not considered. Include copy of this form with next communication to applicant.



UNITED STATES PATENT AND TRADEMARK OFFICE

UNITED STATES DEPARTMENT OF COMMERCE
United States Patent and Trademark Office
Address: COMMISSIONER FOR PATENTS
P.O. Box 1450
Alexandria, Virginia 22313-1450
www.uspto.gov

APPLICATION NO.	FILING DATE	FIRST NAMED INVENTOR	ATTORNEY DOCKET NO.	CONFIRMATION NO.
09/419,175	10/15/1999	GREGORY T. OSTERHOUT	11032RR	9870
35527	7590	10/28/2003	EXAMINER	
DUKE W. LEE CARSTENS, YEE & CAHOON, L.L.P. P.O. BOX 802334 DALLAS, TX 75380			NGUYEN, THUAN T	
			ART UNIT	PAPER NUMBER
			2685	

DATE MAILED: 10/28/2003

Please find below and/or attached an Office communication concerning this application or proceeding.

Office Action Summary

Application No. 09/419,175	Applicant(s) OSTERHOUT ET AL.
Examiner THUAN T. NGUYEN	Art Unit 2685

-- The MAILING DATE of this communication appears on the cover sheet with the correspondence address --

Period for Reply

A SHORTENED STATUTORY PERIOD FOR REPLY IS SET TO EXPIRE 3 MONTH(S) FROM THE MAILING DATE OF THIS COMMUNICATION.

- Extensions of time may be available under the provisions of 37 CFR 1.136(a). In no event, however, may a reply be timely filed after SIX (6) MONTHS from the mailing date of this communication.
- If the period for reply specified above is less than thirty (30) days, a reply within the statutory minimum of thirty (30) days will be considered timely.
- If NO period for reply is specified above, the maximum statutory period will apply and will expire SIX (6) MONTHS from the mailing date of this communication.
- Failure to reply within the set or extended period for reply will, by statute, cause the application to become ABANDONED (35 U.S.C. § 133).
- Any reply received by the Office later than three months after the mailing date of this communication, even if timely filed, may reduce any earned patent term adjustment. See 37 CFR 1.704(b).

Status

- 1) Responsive to communication(s) filed on _____.
- 2a) This action is **FINAL**.
- 2b) This action is non-final.
- 3) Since this application is in condition for allowance except for formal matters, prosecution as to the merits is closed in accordance with the practice under *Ex parte Quayle*, 1935 C.D. 11, 453 O.G. 213.

Disposition of Claims

- 4) Claim(s) 1-8, 17-33, 43-51 and 70-81 is/are pending in the application.
 - 4a) Of the above claim(s) _____ is/are withdrawn from consideration.
- 5) Claim(s) _____ is/are allowed.
- 6) Claim(s) 1-8, 17-33, 43-51 and 70-81 is/are rejected.
- 7) Claim(s) _____ is/are objected to.
- 8) Claim(s) _____ are subject to restriction and/or election requirement.

Application Papers

- 9) The specification is objected to by the Examiner.
- 10) The drawing(s) filed on _____ is/are: a) accepted or b) objected to by the Examiner.
Applicant may not request that any objection to the drawing(s) be held in abeyance. See 37 CFR 1.85(a).
- 11) The proposed drawing correction filed on _____ is: a) approved b) disapproved by the Examiner.
If approved, corrected drawings are required in reply to this Office action.
- 12) The oath or declaration is objected to by the Examiner.

Priority under 35 U.S.C. §§ 119 and 120

- 13) Acknowledgment is made of a claim for foreign priority under 35 U.S.C. § 119(a)-(d) or (f).
 - a) All b) Some * c) None of:
 - 1. Certified copies of the priority documents have been received.
 - 2. Certified copies of the priority documents have been received in Application No. _____.
 - 3. Copies of the certified copies of the priority documents have been received in this National Stage application from the International Bureau (PCT Rule 17.2(a)).* See the attached detailed Office action for a list of the certified copies not received.
- 14) Acknowledgment is made of a claim for domestic priority under 35 U.S.C. § 119(e) (to a provisional application).
 - a) The translation of the foreign language provisional application has been received.
- 15) Acknowledgment is made of a claim for domestic priority under 35 U.S.C. §§ 120 and/or 121.

Attachment(s)

- 1) Notice of References Cited (PTO-892)
- 2) Notice of Draftsperson's Patent Drawing Review (PTO-948)
- 3) Information Disclosure Statement(s) (PTO-1449) Paper No(s) _____
- 4) Interview Summary (PTO-413) Paper No(s). _____
- 5) Notice of Informal Patent Application (PTO-152)
- 6) Other: _____

Art Unit: 2685

DETAILED ACTION

Continued Examination Under 37 CFR 1.114

1. A request for continued examination under 37 CFR 1.114, including the fee set forth in 37 CFR 1.17(e), was filed in this application after final rejection. Since this application is eligible for continued examination under 37 CFR 1.114, and the fee set forth in 37 CFR 1.17(e) has been timely paid, the finality of the previous Office action has been withdrawn pursuant to 37 CFR 1.114. Applicant's submission filed on 9/9/03 has been entered.

Remarks

2. Claims 63-65 were canceled without prejudice (Paper no. 9). Pending claims are now 1-8, 17-33, 43-51, and new claims 70-81.

Response to Arguments

3. Applicant's arguments with respect to claims 1-8, 17-33, and 43-51 have been considered but are moot in view of the new ground(s) of rejection.

Claim Rejections - 35 USC § 103

4. The following is a quotation of 35 U.S.C. 103(a) which forms the basis for all obviousness rejections set forth in this Office action:

(a) A patent may not be obtained though the invention is not identically disclosed or described as set forth in section 102 of this title, if the differences between the subject matter sought to be patented and the prior art are such that the subject matter as a whole would have been obvious at the time the invention was made to a person having ordinary skill in the art to which said subject matter pertains. Patentability shall not be negated by the manner in which the invention was made.

Art Unit: 2685

5. Claims 1-8, 17-33, 43-51, and 70-81 are rejected under 35 U.S.C. 103(a) as being unpatentable over Jain et al. (U.S. Patent No. 6,085,101) in view of Wang et al. (U.S. Patent No. 6,161,134/ or "Wang").

Regarding claims 1, 17, 25, and 43, Jain discloses a system and its corresponding method of "redirecting or re-routing a call from a data processing system having a first address to another device having another address, comprising the step of receiving at the data processing system a registration notice of an incoming call from a server, responsive to receiving the user input (see below), transmitting the new address to which the incoming call is to be redirected", i.e., call management is disclosed wherein new address or new location of the intended recipient can be recognized, and the call or message from the user at a data processing system can be forwarding to or re-directing to the new location using personal locating services and/or personal communication internetworking (see Figs. 2, 4, 6, 8 7 13; col. 1/lines 10-37 for a plurality of data processing systems, col. 2/lines 12-26 for registration notification using HLR and call forwarding, col. 6/lines 47-67 for forwarding addresses and col. 13/line 50 to col. 14/line 34 for personal location services).

Jain does not disclose the step of "responsive to receiving the registration notice, providing a user with an option to redirect the routing of the call; receiving user input in response to providing the option to redirect the routing of the call, wherein the user input identifies a new address of another device, other than the data processing system, to which the call is to be routed" as pre-amended; however, Wang teaches an exact same technique in using individual user

Art Unit: 2685

profile and the user can further designate his or her preferences, using an option to redirect or rerouting a call by entering a new address of another device, to a new address of another device that he would like to communicate (see Wang, Fig. 8, Figs. 17-19 & 21-22 as the user has an option to choose to transfer a call to line 1 or 2 or he can enter a new address or a new number on line 1720 of Fig. 17, and col. 36/line 10 to col. 37/line 11 for call forwarding, col. 38/line 15 to col. 40/line 32 for user interaction with the option to transfer a call, and col. 39/line 58 to col. 40/line 32 for transfer procedure whereas the user can input a new address of another device that the user specifies for the call to be routed to). Therefore, it would have been obvious to one of ordinary skill in the art at the time the invention was made to modify Jain's system with Wang's teaching technique of providing the user an opportunity or an option to specify a new address to his or her intended destination for another device, and based on user profile and preferences (user settings (as illustrated in Figs. 26 & 27), the system easily routes the call to a desired location as taught by Wang. The motivation for doing this is to offer to the users an interaction manner for directly receiving their inputs in controlling and modifying their intended destinations as the user prefers.

As for claims 2-5 and 8, Jain further discloses "wherein the data processing system is a personal digital assistant, a laptop computer, a portable computing device, a wireless device, and a wire-line connected device" (see Figs. 1 & 2, and col. 1/lines 10-37).

As for claim 6, Jain further reveals the step of "wherein the registration notice is a session initiation protocol registration notice", i.e., SS7 protocol is addressed in handling the transmission

Art Unit: 2685

and delivering of call/messages over the network including a call registration (Fig. 2, col. 1/line 55 to col. 2/line 26, and col. 9/lines 20-34).

As for claim 7, Jain further discloses “wherein the incoming call comprises video and the new address corresponds to video display terminal”, i.e., a video display terminal such as a video screen of a laptop or a computing terminal is addressed (Fig. 2) wherein the new address or new location of that terminal can be provided by a recipient list database 1302 (as illustrated in Fig. 13, and col. 12/lines 53-66).

As for claims 30-31, and 48-49, Jain further discloses to include voice mail service and the step of placing the incoming call on-hold (col. 15/lines 1-14).

As for claims 18-24, 26-29, 32-33, 44-47, 50-51, and 70-81, these claims with the modifying step for providing a user with an option to redirect the routing of a call includes providing, on the data processing device, a user interface through which the new address may be entered by the user are rejected for the reasons given in the scope of claims 1-8 as already disclosed in details above.

Conclusion

6. **Any response to this action should be mailed to:**
Commissioner of Patents and Trademarks
Washington, D.C. 20231

or faxed to:
(703) 872-9314, (for Technology Center 2600 only)

*Hand-delivered responses should be brought to Crystal Park II,
2121 Crystal Drive, Arlington, VA., Sixth Floor (Receptionist).*

Art Unit: 2685

7. Any inquiry concerning this communication or earlier communications from the examiner should be directed to Tony Thuan Nguyen whose telephone number is (703) 308-5860. The examiner can normally be reached on Monday-Friday from 9:00 AM to 6:00 PM, with alternate Fridays off.

If attempts to reach the examiner by telephone are unsuccessful, the examiner's supervisor, Edward Urban, can be reached at (703) 305-4385.

Any inquiry of a general nature or relating to the status of this application or proceeding should be directed to the **Technology Center 2600 Customer Service Office** whose telephone number is **(703) 306-0377**.



TONY T. NGUYEN
PATENT EXAMINER

Tony T. Nguyen
Art Unit 2685
October 15, 2003

Notice of References Cited	Application/Control No. 09/419,175	Applicant(s)/Patent Under Reexamination OSTERHOUT ET AL.	
	Examiner THUAN T. NGUYEN	Art Unit 2685	Page 1 of 1

U.S. PATENT DOCUMENTS

*	Document Number Country Code-Number-Kind Code	Date MM-YYYY	Name	Classification
A	US-6,161,134	12-2000	Wang et al.	709/220
B	US-			
C	US-			
D	US-			
E	US-			
F	US-			
G	US-			
H	US-			
I	US-			
J	US-			
K	US-			
L	US-			
M	US-			

FOREIGN PATENT DOCUMENTS

*	Document Number Country Code-Number-Kind Code	Date MM-YYYY	Country	Name	Classification
N					
O					
P					
Q					
R					
S					
T					

NON-PATENT DOCUMENTS

*	Include as applicable: Author, Title Date, Publisher, Edition or Volume, Pertinent Pages)
U	
V	
W	
X	

*A copy of this reference is not being furnished with this Office action. (See MPEP § 707.05(a).)
Dates in MM-YYYY format are publication dates. Classifications may be US or foreign.



#15D
10/15/03
OH

IN THE UNITED STATES PATENT AND TRADEMARK OFFICE

In re application: **Osterhout et al.**

§
§
§
§
§
§
§
§
§
§

Serial No.: **09/419,175**

Group Art Unit: **2685**

RECEIVED

SEP 16 2003

Filed: **October 15, 1999**

Examiner: **Nguyen, Thuan T** Technology Center 2600

For: **Portable Call Management System**

Attorney Docket No.: **11032RR**

35527

PATENT TRADEMARK OFFICE
CUSTOMER NUMBER

Certificate of Mailing Under 37 C.F.R. § 1.8(a)
I hereby certify this correspondence is deposited with the United States Postal Service as First Class mail in an envelope addressed to: Commissioner for Patents, P.O. Box 1450, Alexandria, VA 22313-1450 on September 9, 2003.
By: Rebecca Clayton
Rebecca Clayton

PRELIMINARY AMENDMENT TO RCE

Commissioner for Patents
P.O. Box 1450
Alexandria, VA 22313-1450

Sir:

A fee of \$750.00 is required for filing of the Request for Continued Examination. A check in this amount is enclosed. No additional fees are believed to be necessary. If, however, any additional fees are required, I authorize the Commissioner to charge these fees which may be required to Deposit Account No. 50-0392. No extension of time is believed to be necessary. If, however, an extension of time is required, the extension is requested, and I authorize the Commissioner to charge any fees for this extension to Deposit Account No. 50-0392.

In response to the Final Office Action dated April 9, 2003, the telephone interview conducted July 21, 2003, and in addition to the filing of a Request for Continued Examination (RCE) herewith, please amend the claims of the present application as follows:

IN THE CLAIMS:

- E
1. (Currently amended) A method of redirecting a call from a data processing system having a first address to another device having another address, comprising the steps of:
- receiving at the data processing system, a registration notice of an incoming call from a server;
 - responsive to receiving the registration notice, providing a user with an option to redirect the routing of the call;
 - receiving user input for identifying in response to providing the option to redirect the routing of the call, wherein the user input identifies a new address of another device, other than the data processing system, to which the call is to be routed; and
 - responsive to receiving the user input, transmitting the new address to which the call is to be redirected.
- D
2. (Original) The method as recited in claim 1, wherein said data processing system is a personal digital assistant.
3. (Original) The method as recited in claim 1, wherein said data processing system is a laptop computer.
4. (Original) The method as recited in claim 1, wherein said data processing system is a portable computing device.
5. (Original) The method as recited in claim 1, wherein said data processing system is a wireless device.
6. (Original) The method as recited in claim 1, wherein the registration notice is a session initiation protocol registration notice.

7. (Original) The method as recited in claim 1, wherein the incoming call comprises video and the new address corresponds to a video display terminal.

8. (Original) The method as recited in claim 1, wherein said data processing system is a wire-line connected device.

9-16. (Canceled)

17. (Currently amended) A system of redirecting a call from a data processing system having a first address to another device having another address, comprising:

means for receiving at a data processing system a registration notice of an incoming call from a server;

means, responsive to receiving the registration notice, for providing a user with an option to redirect the routing of the call;

means for receiving user input for identifying in response to providing the option to redirect the routing of the call, wherein the user input identifies a new address of another device, other than the data processing system, to which the call is to be routed;
and

means, responsive to receiving the user input, for transmitting the new address to which the call is to be redirected.

18. (Original) The system as recited in claim 17, wherein said data processing system is a personal digital assistant.

19. (Original) The system as recited in claim 17, wherein said data processing system is a laptop computer.

20. (Original) The system as recited in claim 17, wherein said data processing system is a portable computing device.

21. (Original) The system as recited in claim 17, wherein said data processing system is a wireless device.

22. (Original) The system as recited in claim 17, wherein the registration notice is a session initiation protocol registration notice.

23. (Original) The system as recited in claim 17, wherein the incoming call comprises video and the new address corresponds to a video display terminal.

24. (Original) The system as recited in claim 17, wherein said data processing system is a wire-line connected device.

25. (Currently amended) A method for redirecting calls to a data processing system at a first location to a another device at a second location; comprising the steps of:
sending a registration notification to a called party's preferred location;
receiving a response from the called party's preferred location, the response including a new address identified from user input received at the called party's preferred location in response to receiving the registration notification at the called party's preferred location; and
responsive to receipt of the new address from the called party, redirecting the incoming call to the new address, wherein the sending of the registration notification causes the called party to be provided with an option to redirect routing of the call to another address, and wherein the response is generated based on user input indicating that the option to redirect routing of the call is to be utilized.

26. (Original) The method as recited in claim 25, further comprising:
prior to said sending step, receiving a request to initiate a call with a called party;
and
determining a preferred location of the called party.

27. (Original) The method as recited in claim 25, wherein the registration notification is a session initiation protocol registration.

28. (Original) The method as recited in claim 25, wherein the preferred location is a personal digital assistant.

29. (Original) The method as recited in claim 28, wherein the personal digital assistant is a Palm VII utilizing a Palm Query Application to provide a user interface.

30. (Original) The method as recited in claim 25, wherein the new address corresponds to a voice mailbox.

31. (Original) The method as recited in claim 25, wherein the new address corresponds to placing the incoming call on hold.

32. (Original) The method as recited in claim 25, wherein communication with the preferred device is provided utilizing a wireless application protocol.

33. (Original) The method as recited in claim 25, wherein the new address corresponds to a wire-line device.

34-42. (Canceled)

43. (Currently amended) A system for redirecting calls to a data processing system at a first location to another device at a second location; comprising:

means for sending a registration notification to a called party's preferred location;

means for receiving a response from the called party's preferred location, the response including a new address identified from user input received at the called party's preferred location in response to receiving the registration notification at the called party's preferred location; and

means, responsive to receipt of the new address from the called party, for redirecting the incoming call to the new address, wherein the sending of the registration notification causes the called party to be provided with an option to redirect routing of the call to another address, and wherein the response is generated based on user input indicating that the option to redirect routing of the call is to be utilized.

- E
44. (Original) The system as recited in claim 43, further comprising:
prior to said sending step, means for receiving a request to initiate a call with a called party; and
means for determining a preferred location of the called party.
- D
45. (Original) The system as recited in claim 43, wherein the registration notification is a session initiation protocol registration.
46. (Original) The system as recited in claim 43, wherein the preferred location is a personal digital assistant.
47. (Original) The system as recited in claim 46, wherein the personal digital assistant is a Palm VII utilizing a Palm Query Application to provide a user interface.
48. (Original) The system as recited in claim 43, wherein the new address corresponds to a voice mailbox.
49. (Original) The system as recited in claim 43, wherein the new address corresponds to placing the incoming call on hold.
50. (Original) The system as recited in claim 43, wherein communication with the preferred device is provided utilizing a wireless application protocol.
51. (Original) The system as recited in claim 43, wherein the new address corresponds to a wire-line device.

52-69. (Canceled)

70. (New) The method of claim 1, wherein providing a user with an option to redirect the routing of the call includes providing, on the data processing device, a user interface through which the new address may be entered by the user.

71. (New) The method of claim 70, wherein the user interface includes an option to redirect the call, an option to place the call on hold, and an option to redirect the call to a voicemail system.

72. (New) The method of claim 71, wherein if the option to redirect the call is selected, a further user interface is provided for entry of the new address.

73. (New) The system of claim 17, wherein the means for providing a user with an option to redirect the routing of the call includes means for providing, on the data processing device, a user interface through which the new address may be entered by the user.

74. (New) The system of claim 73, wherein the user interface includes an option to redirect the call, an option to place the call on hold, and an option to redirect the call to a voicemail system.

75. (New) The system of claim 74, wherein if the option to redirect the call is selected, a further user interface is provided for entry of the new address.

76. (New) The method of claim 25, wherein the called party is provided with an option to redirect the routing of the call by providing, on the data processing device, a user interface through which the new address may be entered by the user.

77. (New) The method of claim 76, wherein the user interface includes an option to redirect the call, an option to place the call on hold, and an option to redirect the call to a voicemail system.

78. (New) The method of claim 77, wherein if the option to redirect the call is selected, a further user interface is provided for entry of the new address.

79. (New) The system of claim 43, wherein the option provided to the called party to redirect the routing of the call includes a user interface through which the new address may be entered by the user.

80. (New) The system of claim 79, wherein the user interface includes an option to redirect the call, an option to place the call on hold, and an option to redirect the call to a voicemail system.

81. (New) The system of claim 80, wherein if the option to redirect the call is selected, a further user interface is provided for entry of the new address.

REMARKS

Claims 1-8, 17-33, 43-51 and 70-81 are pending in the present application. By this Preliminary Amendment, claims 1, 17, 25 and 43 are amended and claims 70-81 are added. Claims 1, 17, 25 and 43, are amended, in view of the results of the July 21, 2003 telephone interview with Examiner Nguyen, to clarify the preamble and exemplify the aspect of receiving user input by reciting providing a user with an option to redirect the routing of a call. Claims 70-81 are added to recite additional features of one exemplary manner by which the option to redirect a call is provided to a user. Support for the amendments and the additional claims may be found at least in Figures 6A-6D. No new matter has been added by this Preliminary Amendment.

In addition to the reasons set forth in the previously filed Response to Final Office Action, neither the Jain reference nor the Lee reference cited in the Final Office Action teach or suggest the features of providing a user with an option to redirect the routing of a call in response to receiving a registration notice of an incoming call, as recited in the independent claims 1, 17, 25 and 43. Moreover, neither Jain nor Lee, either alone or in combination, teach or suggest the user interface recited in claims 70, 73, 76 and 79. Neither Jain nor Lee, either alone or in combination, teach or suggest a user interface that includes an option to redirect a call, an option to place the call on hold, and an option to redirect the call to a voicemail system, as recited in claims 71, 74, 77 and 80. Additionally, neither Jain nor Lee, either alone or in combination, teach or suggest that when a redirect option of the user interface is selected, a further user interface is provided for entry of a new address, as recited in claims 72, 75, 78 and 81. Accordingly, Applicants respectfully request withdrawal of the rejections of claims 1-8, 17-33, 43-51 and allowance of all of the pending claims.

It is respectfully urged that the subject application is patentable over the Jain and Lee references cited in the Final Office Action and is now in condition for allowance. The Examiner is invited to call the undersigned at the below-listed telephone number if in the opinion of the Examiner such a telephone conference would expedite or aid the prosecution and examination of this application.

Respectfully submitted,

DATE:

September 5, 2003

Stephen J. Walder, Jr.

Stephen J. Walder, Jr.

Reg. No. 41,534

Carstens, Yee & Cahoon, LLP

P.O. Box 802334

Dallas, TX 75380

(972) 367-2001

Attorney for Applicants



PTO/SB/17 (05-03)

Approved for use through 04/30/2003. OMB 0651-0032
U.S. Patent and Trademark Office; U.S. DEPARTMENT OF COMMERCE

Under the Paperwork Reduction Act of 1995, no persons are required to respond to a collection of information unless it displays a valid OMB control number.

FEE TRANSMITTAL for FY 2003

Effective 01/01/2003. Patent fees are subject to annual revision.

Applicant claims small entity status. See 37 CFR 1.27

TOTAL AMOUNT OF PAYMENT (\$) 750.00

Complete if Known

Application Number: 09/419,175
 Filing Date: October 15, 1999
 First Named Inventor: Osterhout et al.
 Examiner Name: Nguyen, Thuan T.
 Art Unit: 2685
 Attorney Docket No.: 11032RR

RECEIVED
SEP 16 2003
Technology Center 2600

METHOD OF PAYMENT (check all that apply)

Check Credit card Money Order Other None

Deposit Account:
 Deposit Account Number: 50-0392
 Deposit Account Name: Carstens, Yee & Cahoon

The Director is authorized to: (check all that apply)
 Charge fee(s) indicated below Credit any overpayments
 Charge any additional fee(s) during the pendency of this application
 Charge fee(s) indicated below, except for the filing fee to the above-identified deposit account.

FEE CALCULATION (continued)

1. BASIC FILING FEE

Large Entity Fee Code (\$)	Large Entity Fee (\$)	Small Entity Fee Code (\$)	Small Entity Fee (\$)	Fee Description	Fee Paid
1001	750	2001	375	Utility filing fee	
1002	330	2002	165	Design filing fee	
1003	520	2003	260	Plant filing fee	
1004	750	2004	375	Reissue filing fee	
1005	160	2005	80	Provisional filing fee	
SUBTOTAL (1)					(\$) 0.00

3. ADDITIONAL FEES

Large Entity Fee Code (\$)	Large Entity Fee (\$)	Small Entity Fee Code (\$)	Small Entity Fee (\$)	Fee Description	Fee Paid
1051	130	2051	65	Surcharge - late filing fee or oath	
1052	50	2052	25	Surcharge - late provisional filing fee or cover sheet	
1053	130	1053	130	Non-English specification	
1812	2,520	1812	2,520	For filing a request for ex parte reexamination	
1804	920*	1804	920*	Requesting publication of SIR prior to Examiner action	
1805	1,840*	1805	1,840*	Requesting publication of SIR after Examiner action	
1251	110	2251	55	Extension for reply within first month	
1252	410	2252	205	Extension for reply within second month	
1253	930	2253	465	Extension for reply within third month	
1254	1,450	2254	725	Extension for reply within fourth month	
1255	1,970	2255	985	Extension for reply within fifth month	
1401	320	2401	160	Notice of Appeal	
1402	320	2402	160	Filing a brief in support of an appeal	
1403	280	2403	140	Request for oral hearing	
1451	1,510	1451	1,510	Petition to institute a public use proceeding	
1452	110	2452	55	Petition to revive - unavoidable	
1453	1,300	2453	650	Petition to revive - unintentional	
1501	1,300	2501	650	Utility issue fee (or reissue)	
1502	470	2502	235	Design issue fee	
1503	630	2503	315	Plant issue fee	
1460	130	1460	130	Petitions to the Commissioner	
1807	50	1807	50	Processing fee under 37 CFR 1.17(q)	
1806	180	1806	180	Submission of Information Disclosure Stmt	
8021	40	8021	40	Recording each patent assignment per property (times number of properties)	
1809	750	2809	375	Filing a submission after final rejection (37 CFR 1.129(a))	
1810	750	2810	375	For each additional invention to be examined (37 CFR 1.129(b))	
1801	750	2801	375	Request for Continued Examination (RCE)	750.00
1802	900	1802	900	Request for expedited examination of a design application	
Other fee (specify)					
*Reduced by Basic Filing Fee Paid					
SUBTOTAL (3)					(\$) 750.00

2. EXTRA CLAIM FEES FOR UTILITY AND REISSUE

Total Claims: - 20** = X =

Independent Claims: - 3** = X =

Multiple Dependent: =

Fee from below:

Fee Paid:

Large Entity Fee Code (\$)	Large Entity Fee (\$)	Small Entity Fee Code (\$)	Small Entity Fee (\$)	Fee Description	Fee Paid
1202	18	2202	9	Claims in excess of 20	
1201	84	2201	42	Independent claims in excess of 3	
1203	280	2203	140	Multiple dependent claim, if not paid	
1204	84	2204	42	** Reissue independent claims over original patent	
1205	18	2205	9	** Reissue claims in excess of 20 and over original patent	
SUBTOTAL (2)					(\$) 0.00

**or number previously paid, if greater; For Reissues, see above

SUBMITTED BY (Complete if applicable)

Name (Print/Type): Duke W. Yee
 Registration No. (Attorney/Agent): 34,285
 Telephone: 972-367-2001
 Signature: *Duke W. Yee*
 Date: 09/09/03

WARNING: Information on this form may become public. Credit card information should not be included on this form. Provide credit card information and authorization on PTO-2038.

This collection of information is required by 37 CFR 1.17 and 1.27. The information is required to obtain or retain a benefit by the public which is to file (and by the USPTO to process) an application. Confidentiality is governed by 35 U.S.C. 122 and 37 CFR 1.14. This collection is estimated to take 12 minutes to complete, including gathering, preparing, and submitting the completed application form to the USPTO. Time will vary depending upon the individual case. Any comments on the amount of time you require to complete this form and/or suggestions for reducing this burden, should be sent to the Chief Information Officer, U.S. Patent and Trademark Office, U.S. Department of Commerce, P.O. Box 1450, Alexandria, VA 22313-1450. DO NOT SEND FEES OR COMPLETED FORMS TO THIS ADDRESS. SEND TO: Commissioner for Patents, P.O. Box 1450, Alexandria, VA 22313-1450.

If you need assistance in completing the form, call 1-800-PTO-9199 and select option 2.



RCE/2700
#14
P1/S1/S3
04

Approved for use through 04/30/2003. OMB 0651-0031
U.S. Patent and Trademark Office; U.S. DEPARTMENT OF COMMERCE
Under the Paperwork Reduction Act of 1995, no persons are required to respond to a collection of information unless it contains a valid OMB control number.

**Request
For
Continued Examination (RCE)
Transmittal**

Address to:
Mail Stop RCE
Commissioner for Patents
P.O. Box 1450
Alexandria, VA 22313-1450

Application Number	09/419,175
Filing Date	10/15/1999
First Named Inventor	Osterhout et al.
Art Unit	2685
Examiner Name	Nguyen, Thuan T.
Attorney Docket Number	11032RR

This is a Request for Continued Examination (RCE) under 37 CFR 1.114 of the above-identified application.
Request for Continued Examination (RCE) practice under 37 CFR 1.114 does not apply to any utility or plant application filed prior to June 8, 1995, or to any design application. See Instruction Sheet for RCEs (not to be submitted to the USPTO) on page 2.

1. **Submission required under 37 CFR 1.114** Note: If the RCE is proper, any previously filed unentered amendments and amendments enclosed with the RCE will be entered in the order in which they were filed unless applicant instructs otherwise. If applicant does not wish to have any previously filed unentered amendment(s) entered, applicant must request non-entry of such amendment(s).

- a. Previously submitted. If a final Office action is outstanding, any amendments filed after the final Office action may be considered as a submission even if this box is not checked.
- i. Consider the arguments in the Appeal Brief or Rely Brief previously filed on SEP 16 2003
- ii. Other _____
- b. Enclosed
- i. Amendment/Reply
- ii. Affidavit(s)/ Declaration(s)
- iii. Information Disclosure Statement (IDS)
- iv. Other _____

RECEIVED
SEP 16 2003
Technology Center 2600

2. **Miscellaneous**

- a. Suspension of action on the above-identified application is requested under 37 CFR 1.103(c) for a period of _____ months. (Period of suspension shall not exceed 3 months; Fee under 37 CFR 1.17(i) required)
- b. Other _____

3. **Fees**

- The RCE fee under 37 CFR 1.17(e) is required by 37 CFR 1.114 when the RCE is filed.
The Director is hereby authorized to charge the following fees, or credit any overpayments, to
- a. Deposit Account No. 50-0392
- i. RCE fee required under 37 CFR 1.17(e)
- ii. Extension of time fee (37 CFR 1.136 and 1.17) 09/15/2003 RMEBRAHT 00000095 09419175
- iii. Other 01 FC:1801 750.00 0P
- b. Check in the amount of \$ 750.00 enclosed
- c. Payment by credit card (Form PTO-2038 enclosed)

WARNING: Information on this form may become public. Credit card information should not be included on this form. Provide credit card information and authorization on PTO-2038.

SIGNATURE OF APPLICANT, ATTORNEY, OR AGENT REQUIRED

Name (Print/Type)	Duke W. Yee	Registration No. (Attorney/Agent)	34,285
Signature	<i>Duke W. Yee</i>	Date	September 9, 2003

CERTIFICATE OF MAILING OR TRANSMISSION

I hereby certify that this correspondence is being deposited with the United States Postal Service with sufficient postage as first class mail in an envelope addressed to: Mail Stop RCE, Commissioner for Patents, P. O. Box 1450, Alexandria, VA 22313-1450 or facsimile transmitted to the U.S. Patent and Trademark Office on the date shown below.

Name (Print/Type)	Rebecca Clayton	Date	September 9, 2003
Signature	<i>Rebecca Clayton</i>		

This collection of information is required by 37 CFR 1.114. The information is required to obtain or retain a benefit by the public which is to file (and by the USPTO to process) an application. Confidentiality is governed by 35 U.S.C. 122 and 37 CFR 1.14. This collection is estimated to take 12 minutes to complete, including gathering, preparing, and submitting the completed application form to the USPTO. Time will vary depending upon the individual case. Any comments on the amount of time you require to complete this form and/or suggestions for reducing this burden, should be sent to the Chief Information Officer, U.S. Patent and Trademark Office, U.S. Department of Commerce, P.O. Box 1450, Alexandria, VA 22313-1450. DO NOT SEND FEES OR COMPLETED FORMS TO THIS ADDRESS. SEND TO: Mail Stop RCE, Commissioner for Patents, P.O. Box 1450, Alexandria, VA 22313-1450.

If you need assistance in completing the form, call 1-800-PTO-9199 and select option 2.



UNITED STATES DEPARTMENT OF COMMERCE
Patent and Trademark Office
 Address: COMMISSIONER OF PATENTS AND TRADEMARKS
 Washington, D.C. 20231

APPLICATION NUMBER	FILING DATE	FIRST NAMED APPLICANT	ATTORNEY DOCKET NO.
--------------------	-------------	-----------------------	---------------------

EXAMINER

ART UNIT	PAPER NUMBER
----------	--------------

13

DATE MAILED:

INTERVIEW SUMMARY

All participants (applicant, applicant's representative, PTO personnel):

- (1) STEPHEN WALDER (3) _____
 (2) TONY T. NGUYEN (4) _____

Date of Interview 08/12/03

Type: Telephonic Personal (copy is given to applicant applicant's representative).

Exhibit shown or demonstration conducted: Yes No If yes, brief description: _____

Agreement was reached. was not reached.

Claim(s) discussed: 1, 17, 25 & 43

Identification of prior art discussed: JAIN and LEE of record

INFORMALITIES SUCH AS

Description of the general nature of what was agreed to if an agreement was reached, or any other comments: 112-21 SHOULD BE FIXED. THE APPLICANTS WOULD CONSIDER TO HAVE RCE AND REWRITE THE CLAIM LANGUAGES OF IND. CLAIMS 1, 17, 25 & 43 WITH THE POINT OUT OF THE STEP FOR "USER INPUT" INTERACTION WHETHER TO ACCEPT OR FORWARD A CALL TO ANOTHER ADDRESS OF ANOTHER DEVICE; IF CLAIMS AMENDED AS DISCUSSED, THEY WOULD OVERCOME LEE'S.

(A fuller description, if necessary, and a copy of the amendments, if available, which the examiner agreed would render the claims allowable must be attached. Also, where no copy of the amendments which would render the claims allowable is available, a summary thereof must be attached.)

1. It is not necessary for applicant to provide a separate record of the substance of the interview.

Unless the paragraph above has been checked to indicate to the contrary. A FORMAL WRITTEN RESPONSE TO THE LAST OFFICE ACTION IS NOT WAIVED AND MUST INCLUDE THE SUBSTANCE OF THE INTERVIEW. (See MPEP Section 713.04). If a response to the last Office action has are ready been filed, APPLICANT IS GIVEN ONE MONTH FROM THIS INTERVIEW DATE TO FILE A STATEMENT OF THE SUBSTANCE OF THE INTERVIEW.

2. Since the Examiner's interview summary above (including any attachments) reflects a complete response to each of the objections, rejections and requirements that may be present in the last Office action, and since the claims are now allowable, this completed form is considered to fulfill the response requirements of the last Office action. Applicant is not relieved from providing a separate record of the interview unless box 1 above is also checked.

Examiner Note: You must sign this form unless it is an attachment to another form.

FORM PTOL-413 (REV.1-98)

A. U. 2685

 NGUYEN, T.



UNITED STATES PATENT AND TRADEMARK OFFICE

UNITED STATES DEPARTMENT OF COMMERCE
United States Patent and Trademark Office
Address: COMMISSIONER FOR PATENTS
P.O. Box 1450
Alexandria, Virginia 22313-1450
www.uspto.gov

APPLICATION NO.	FILING DATE	FIRST NAMED INVENTOR	ATTORNEY DOCKET NO.	CONFIRMATION NO.
09/419,175	10/15/1999	GREGORY T. OSTERHOUT	11032RR	9870

35527 7590 07/30/2003

DUKE W. LEE
CARSTENS, YEE & CAHOON, L.L.P.
P.O. BOX 802334
DALLAS, TX 75380

EXAMINER

NGUYEN, THUAN T

ART UNIT	PAPER NUMBER
2685	

DATE MAILED: 07/30/2003

12

Please find below and/or attached an Office communication concerning this application or proceeding.



UNITED STATES DEPARTMENT OF COMMERCE
Patent and Trademark Office
 Address: COMMISSIONER OF PATENTS AND TRADEMARKS
 Washington, D.C. 20231

APPLICATION NUMBER	FILING DATE	FIRST NAMED APPLICANT	ATTORNEY DOCKET NO.
--------------------	-------------	-----------------------	---------------------

EXAMINER

ART UNIT PAPER NUMBER

12

DATE MAILED:

INTERVIEW SUMMARY

All participants (applicant, applicant's representative, PTO personnel):

- (1) Tony Nguyen (3) _____
- (2) Duke Lee's Representative (4) _____

Date of Interview 7/21/03

Type: Telephonic Personal (copy is given to applicant applicant's representative).

Exhibit shown or demonstration conducted: Yes No If yes, brief description: _____

Agreement was reached. was not reached.

Claim(s) discussed: NONE

Identification of prior art discussed: NONE

Description of the general nature of what was agreed to if an agreement was reached, or any other comments:

This application has been scheduled for an interview for 08/12/03 after a Notice of Appeal submitted in (07/09/03) before the applicants or the Examiner could take any further action on this case. Case is now in After Final status.

(A fuller description, if necessary, and a copy of the amendments, if available, which the examiner agreed would render the claims allowable must be attached: Also, where no copy of the amendments which would render the claims allowable is available, a summary thereof must be attached.)

1. It is not necessary for applicant to provide a separate record of the substance of the interview.

Unless the paragraph above has been checked to indicate to the contrary, A FORMAL WRITTEN RESPONSE TO THE LAST OFFICE ACTION IS NOT WAIVED AND MUST INCLUDE THE SUBSTANCE OF THE INTERVIEW. (See MPEP Section 713.04). If a response to the last Office action has already been filed, APPLICANT IS GIVEN ONE MONTH FROM THIS INTERVIEW DATE TO FILE A STATEMENT OF THE SUBSTANCE OF THE INTERVIEW.

2. Since the Examiner's interview summary above (including any attachments) reflects a complete response to each of the objections, rejections and requirements that may be present in the last Office action, and since the claims are now allowable, this completed form is considered to fulfill the response requirements of the last Office action. Applicant is not relieved from providing a separate record of the interview unless box 1 above is also checked.

Examiner Note: You must sign this form unless it is an attachment to another form.

FORM PTOL-413 (REV.1-96)

A.U. 2685

 TONY T. NGUYEN
 PATENT EXAMINER

**Carstens,
Yee &
Cahoon, L.L.P.**

13760 Noel Road
Suite 900
Dallas, Texas 75240

Main No. (972) 367-2001
Facsimile (972) 367-2002

Facsimile Cover Sheet

To: Commissioner for Patents for Examiner Thuan T. Nguyen Group Art Unit 2685	Facsimile No.: 703/872-9315
From: Krista Douthitt Paralegal to Duke Yee	No. of Pages Including Cover Sheet: 3
<p>Message:</p> <p>Enclosed herewith:</p> <ul style="list-style-type: none"> • Transmittal Document; and • Notice of Appeal. 	
<p>Re: Application No. 09/419,175 Attorney Docket No: 11032RR</p>	
<p>Date: Wednesday, July 09, 2003</p>	
<p>Please contact us at (972) 367-2001 if you do not receive all pages indicated above or experience any difficulty in receiving this facsimile.</p>	<p><i>This Facsimile is intended only for the use of the addressee and, if the addressee is a client or their agent, contains privileged and confidential information. If you are not the intended recipient of this facsimile, you have received this facsimile inadvertently and in error. Any review, dissemination, distribution, or copying is strictly prohibited. If you received this facsimile in error, please notify us by telephone and return the facsimile to us immediately.</i></p>

**PLEASE CONFIRM RECEIPT OF THIS TRANSMISSION
BY FAXING A CONFIRMATION TO 972-367-2002.**

Official

IN THE UNITED STATES PATENT AND TRADEMARK OFFICE

In re application of: Osterhout et al.

Serial No.: 09/419,175

Filed: October 15, 1999

For: Portable Call Management System

§
§
§
§
§
§

Group Art Unit: 2685

Examiner: Nguyen, Thuan T.

Attorney Docket No.: 11032RR

Certificate of Transmission Under 37 C.F.R. § 1.8(a)
 I hereby certify this correspondence is being transmitted via facsimile to the Assistant Commissioner for Patents, P.O. Box 1450, Alexandria, VA 22313-1450, facsimile number (703) 872-9315 on July 9, 2003.
 By: K Douthitt
 Krista Douthitt

TRANSMITTAL DOCUMENT

Commissioner for Patents
P.O. Box 1450
Alexandria, VA 22313-1450

Sir:
ENCLOSED HERewith:



35527

- Notice of Appeal

A fee of \$320.00 is believed to be necessary. Please charge this fee to Deposit Account No. 50-0392. No additional fees are believed to be required. In the event that any additional fees are required for the prosecution of this application, please charge the additional fees to Deposit Account No. 50-0392. No extension of time is believed to be necessary. If, however, an extension of time is needed, the extension is requested and the fee for this extension should be charged to Deposit Account No. 50-0392.

Respectfully submitted,

Duke W. Yee
 Duke W. Yee
 Registration No. 34,285
 CARSTENS, YEE & CAHOON, LLP
 P.O. Box 802334
 Dallas, Texas 75380
 (972) 367-2001
 ATTORNEY FOR APPLICANTS

IN THE UNITED STATES PATENT AND TRADEMARK OFFICE

In re application of: **Osterhout et al.**
Serial No.: 09/419,175
Filed: **October 15, 1999**
For: **Portable Call Management System**

§
§
§
§
§
§

Group Art Unit: 2685
Examiner: **Nguyen, Thuan T.**
Attorney Docket No.: 11032RR

RECEIVED
7-9-03
Official

Certificate of Transmission Under 37 C.F.R. § 1.8(a)
I hereby certify this correspondence is being transmitted via facsimile to the Commissioner for Patents, P.O. Box 1450, Alexandria, VA 22313-1450, facsimile number (703) 872-9315 on July 9, 2003.
By: K Douthitt
Krista Douthitt

NOTICE OF APPEAL

Commissioner for Patents
P.O. Box 1450
Alexandria, VA 22313-1450

Sir:

Applicant hereby appeals to the Board of Patent Appeals and Interferences from the office action dated April 9, 2003 finally rejecting claims 1-8, 17-33, and 43-51.

A fee of \$320.00 is believed to be necessary. Please charge this fee to Deposit Account No. 50-0392. No additional fees are believed to be required. In the event that any additional fees are required for the prosecution of this application, please charge the additional fees to Deposit Account No. 50-0392. No extension of time is believed to be necessary. If, however, an extension of time is needed, the extension is requested and the fee for this extension should be charged to Deposit Account No. 50-0392.

Respectfully submitted,

Duke W. Yee
Duke W. Yee
Reg. No. 34,285
CARSTENS YEE & CAHOON, LLP
P.O. Box 802334
Dallas, Texas 75380
(972) 367-2001
ATTORNEY FOR APPLICANTS

#1116
P. 02
07/10/03
(N-E)

IN THE UNITED STATES PATENT AND TRADEMARK OFFICE

Official

In re application of: Osterhout et al.

§
§
§
§
§
§

Group Art Unit: 2685

Serial No.: 09/419,175

Examiner: Nguyen, Thuan T.

Filed: October 15, 1999

Attorney Docket No.: 11032RR

For: Portable Call Management System

Certificate of Transmission Under 37 C.F.R. § 1.8(a)
I hereby certify this correspondence is being transmitted via facsimile to the Commissioner for Patents, P.O. Box 1450, Alexandria, VA 22313-1450, facsimile number (703) 872-9315, on June 9, 2003.
By: Rebecca Clayton
Rebecca Clayton



35527

PATENT TRADEMARK OFFICE

TRANSMITTAL DOCUMENT

Commissioner for Patents
P.O. Box 1450
Alexandria, VA 22313-1450

Sir:

ENCLOSED HERewith:

- Response to Final Office Action

No fees are believed to be required. If, however, any fees are required, I authorize the Commissioner to charge these fees which may be required to Deposit Account No. 50-0392. No extension of time is believed to be necessary. If, however, an extension of time is required, the extension is requested, and I authorize the Commissioner to charge any fees for this extension to Deposit Account No. 50-0392.

Respectfully submitted,

Stephen J. Walder, Jr.
Stephen J. Walder, Jr.
Registration No. 41,534

Duke W. Yee
Registration No. 34,285
CARSTENS, YEE & CAHOON, LLP
P.O. Box 802334
Dallas, Texas 75380
(972) 367-2001
ATTORNEYS FOR APPLICANTS

Official

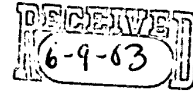

76

IN THE UNITED STATES PATENT AND TRADEMARK OFFICE

In re application: Osterhout et al.

Serial No.: 09/419,175

Filed: October 15, 1999

For: Portable Call Management System

§
§
§
§
§
§
§
§
§
§
§

Group Art Unit: 2685

Examiner: Nguyen, Thuan T.

Attorney Docket No.: 11032RR

Certificate of Transmission Under 37 C.F.R. § 1.8(a)
I hereby certify this correspondence is being transmitted via facsimile to Commissioner for Patents, P.O. Box 1450, Alexandria, VA 22313-1450, facsimile number (703) 872-9315, on June 9, 2003.
By: Rebecca Clayton
Rebecca Clayton

RESPONSE TO FINAL OFFICE ACTION

Commissioner for Patents
P.O. Box 1450
Alexandria, VA 22313-1450

Sir:

No fees are believed to be required. If, however, any fees are required, I authorize the Commissioner to charge these fees which may be required to Deposit Account No. 50-0392. No extension of time is believed to be necessary. If, however, an extension of time is required, the extension is requested, and I authorize the Commissioner to charge any fees for this extension to Deposit Account No. 50-0392.

In response to the Final Office Action dated April 9, 2003, reconsideration of the claims in view of the following remarks is respectfully requested.

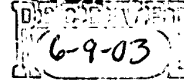
Official**IN THE CLAIMS:**

1. (Previously amended) A method of redirecting a call from a data processing system to another address, comprising the steps of:
 - receiving at a data processing system a registration notice of an incoming call from a server;
 - responsive to receiving the registration notice, receiving user input for identifying a new address of another device, other than the data processing system, to which the call is to be routed; and
 - responsive to receiving the user input, transmitting the new address to which the call is to be redirected.
2. (Original) The method as recited in claim 1, wherein said data processing system is a personal digital assistant.
3. (Original) The method as recited in claim 1, wherein said data processing system is a laptop computer.
4. (Original) The method as recited in claim 1, wherein said data processing system is a portable computing device.
5. (Original) The method as recited in claim 1, wherein said data processing system is a wireless device.
6. (Original) The method as recited in claim 1, wherein the registration notice is a session initiation protocol registration notice.
7. (Original) The method as recited in claim 1, wherein the incoming call comprises video and the new address corresponds to a video display terminal.

8. (Original) The method as recited in claim 1, wherein said data processing system is a wire-line connected device.

9-16. (Canceled)

17. (Previously amended) A system of redirecting a call from a data processing system to another address, comprising:

means for receiving at a data processing system a registration notice of an incoming call from a server;

means, responsive to receiving the registration notice, for receiving user input for identifying a new address of another device, other than the data processing system, to which the call is to be routed; and

means, responsive to receiving the user input, for transmitting the new address to which the call is to be redirected.

18. (Original) The system as recited in claim 17, wherein said data processing system is a personal digital assistant.

19. (Original) The system as recited in claim 17, wherein said data processing system is a laptop computer.

20. (Original) The system as recited in claim 17, wherein said data processing system is a portable computing device.

21. (Original) The system as recited in claim 17, wherein said data processing system is a wireless device.

22. (Original) The system as recited in claim 17, wherein the registration notice is a session initiation protocol registration notice.

23. (Original) The system as recited in claim 17, wherein the incoming call comprises video and the new address corresponds to a video display terminal.
24. (Original) The system as recited in claim 17, wherein said data processing system is a wire-line connected device.
25. (Previously amended) A method for redirecting calls to a data processing system to a second location; comprising the steps of:
 sending a registration notification to a called party's preferred location;
 receiving a response from the called party's preferred location, the response including a new address identified from user input received at the called party's preferred location in response to receiving the registration notification at the called party's preferred location; and
 responsive to receipt of the new address from the called party, redirecting the incoming call to the new address.
26. (Original) The method as recited in claim 25, further comprising:
 prior to said sending step, receiving a request to initiate a call with a called party;
 and
 determining a preferred location of the called party.
27. (Original) The method as recited in claim 25, wherein the registration notification is a session initiation protocol registration.
28. (Original) The method as recited in claim 25, wherein the preferred location is a personal digital assistant.
29. (Original) The method as recited in claim 28, wherein the personal digital assistant is a Palm VII utilizing a Palm Query Application to provide a user interface.

30. (Original) The method as recited in claim 25, wherein the new address corresponds to a voice mailbox.

31. (Original) The method as recited in claim 25, wherein the new address corresponds to placing the incoming call on hold.

32. (Original) The method as recited in claim 25, wherein communication with the preferred device is provided utilizing a wireless application protocol.

33. (Original) The method as recited in claim 25, wherein the new address corresponds to a wire-line device.

34-42. (Canceled)

43. (Previously amended) A system for redirecting calls to a data processing system to a second location; comprising:

means for sending a registration notification to a called party's preferred location;

means for receiving a response from the called party's preferred location, the response including a new address identified from user input received at the called party's preferred location in response to receiving the registration notification at the called party's preferred location; and

means, responsive to receipt of the new address from the called party, for redirecting the incoming call to the new address.

44. (Original) The system as recited in claim 43, further comprising:

prior to said sending step, means for receiving a request to initiate a call with a called party; and

means for determining a preferred location of the called party.

45. (Original) The system as recited in claim 43, wherein the registration notification is a session initiation protocol registration.

46. (Original) The system as recited in claim 43, wherein the preferred location is a personal digital assistant.

47. (Original) The system as recited in claim 46, wherein the personal digital assistant is a Palm VII utilizing a Palm Query Application to provide a user interface.

48. (Original) The system as recited in claim 43, wherein the new address corresponds to a voice mailbox.

49. (Original) The system as recited in claim 43, wherein the new address corresponds to placing the incoming call on hold.

50. (Original) The system as recited in claim 43, wherein communication with the preferred device is provided utilizing a wireless application protocol.

51. (Original) The system as recited in claim 43, wherein the new address corresponds to a wire-line device.

52-69. (Canceled)

REMARKS

Claims 1-8, 17-33 and 43-51 are pending in the present application. No amendments to the claims have been made by this Response. Reconsideration of the claims is respectfully requested.

I. 35 U.S.C. § 103, Alleged Obviousness

The Office Action rejects claims 1-8, 17-33 and 43-51 under 35 U.S.C. § 103(a) as being unpatentable over Jain et al. (U.S. Patent No. 6,085,101) in view of Lee et al. (U.S. Patent No. 6,161,008). This rejection is respectfully traversed.

Claim 1, which is representative of the other rejected independent claims 17, 25 and 43, with regard to similarly recited subject matter, reads as follows:

1. A method of redirecting a call from a data processing system to another address, comprising the steps of:
 - receiving at a data processing system a registration notice of an incoming call from a server;
 - responsive to receiving the registration notice, receiving user input for identifying a new address of another device, other than the data processing system, to which the call is to be routed; and
 - responsive to receiving the user input, transmitting the new address to which the call is to be redirected. (emphasis added)

Neither Jain nor Lee, either alone or in combination, teach or suggest receiving user input for identifying a new address of another device in response to receiving a registration notice or transmitting a new address to which the call is to be redirected in response to receiving the user input, as recited in claim 1 and similar features in claims 17, 25 and 43.

Jain is directed to a system for multicasting a single message to a plurality of recipients. With the system of Jain, a message provider calls a multicast service, the network server queries the message provider and obtains the message and recipient addresses, the network server then contacts some or all of the recipients and transmits the message to those recipients that were contacted (see column 3, lines 48-68). Jain further

teaches that the multicasting functionality of the Jain system may be used in conjunction with known communication network services such as personal location service and call forwarding. Call forwarding, as is described in the Jain reference (column 2, lines 24-26), involves receiving a call with a designation of a destination telephone number and automatically consulting stored information to identify an alternate number to which calls to the destination telephone number are to be forwarded. Personal location service is a known service of cellular telephone systems in which a cell or registration area in which a mobile terminal is currently located is identified from existing information in the wireless communication infrastructure (column 13, lines 59-61).

The Office Action admits, however, that Jain does not teach user input for identifying a new address of another device other than the data processing system to which the call is to be routed, as recited in independent claim 1 and similar features in the other independent claims 17, 25 and 43 (see Final Office Action, page 3). But, the Office Action alleges that Lee teaches this feature at column 2, line 65 to column 3, line 6, Figure 4, and column 11, line 33 to column 12, line 48. Applicants respectfully disagree.

Lee is directed to a personal mobility service for identifying a terminal to which a communication should be routed. With the personal mobility service of Lee, four sources of information are used to determine to which of a plurality of terminals registered as being associated with a user, a communication should be sent. The system of Lee uses a user profile created by a user, a terminal network usage profile, last activity information, and terminal capability information to identify a terminal to which a communication should be sent (see column 8, line 45 to column 9, line 30). The user profile is a set of preferences entered by the user indicating which terminal identifier (TID) to provide at what time of the day (see column 11, line 65 to column 12, line 2).

Thus, the information used by Lee is information that is pre-set in the system. That is, the user must establish the user profile prior to the communication being sent to the system of Lee in order for the user profile to be used as a mechanism for determining which terminal to send the communication to. Similarly, other information, i.e. network usage information, terminal capability information, and last activity information, is information that is established prior to when the communication comes into the system of Lee.

Contrary to the teachings of Lee, the claimed invention allows a user, at the time that a registration notice is received, to provide user input to indicate a new address to which the incoming call or communication is to be redirected. Thus, the user may decide at the time the registration notice is received for an incoming call, which other device to send the call to. With the system of Lee, the user must establish where calls are to be routed a priori, i.e. beforehand and the routing of the call is performed automatically based on this prior existing user profile, network usage information, last activity information, and terminal capability information.

To illustrate this point further, take the example provided in Applicant's disclosure on page 12 of the present specification. Assume that a husband receives a notification of an incoming call to his wireless telephone. The husband can look at the display of his wireless telephone to see the notification and determine that the call is for his wife. The husband may then supply user input, e.g., the telephone number for his wife's work, to thereby redirect the call to his wife's work phone, her wireless phone, or the like.

Since Lee performs all of its functionality based on pre-existing information, there is no ability to receive user input to redirect a call to another device in response to receiving a registration notice of an incoming call, there is no ability to transmit the address to which the call is to be redirected in response to receiving the user input. Also, Lee does not transmit any redirection information after the call has been routed to a terminal. Moreover, even if the system of Lee could be used to redirect calls, such redirection would not be based on a user's input being received in response to receiving a registration notice of an incoming call but would rather be based on pre-existing information as with the initial routing of the call.

Thus, in summary, the Office Action admits that Jain does not teach receiving user input for identifying a new address of another device in response to receiving a registration notice of an incoming call or transmitting the new address to which the call is to be redirected in response to receiving the user input.

Similar distinctions over Jain exist in the other independent claims 17, 25 and 43. For example, claim 17 recites "means, responsive to receiving the registration notice, for receiving user input for identifying a new address of another device, other than the data

processing system, to which the call is to be routed" (emphasis added). Claim 25 recites "receiving a response from the called party's preferred location, the response including a new address identified from user input received at the called party's preferred location in response to receiving the registration notification at the called party's preferred location" (emphasis added). Similarly, claim 43 recites "means for receiving a response from the called party's preferred location, the response including a new address identified from user input received at the called party's preferred location in response to receiving the registration notification at the called party's preferred location" (emphasis added).

In view of the above, Applicants respectfully submit that neither Jain nor Lee, either alone or in combination, teach or suggest the features of independent claims 1, 17, 25 and 43. At least by virtue of their dependency on claims 1, 17, 25 and 43, respectively, neither Jain nor Lee, either alone or in combination, teach or suggest the features of dependent claims 2-8, 18-24, 26-33, and 44-51. Accordingly, Applicants respectfully request withdrawal of the rejection of claims 1-8, 17-33, and 43-51 under 35 U.S.C. § 103(a).

II. Conclusion

It is respectfully urged that the subject application is patentable over Jain and Lee and is now in condition for allowance. The Examiner is invited to call the undersigned at the below-listed telephone number if in the opinion of the Examiner such a telephone conference would expedite or aid the prosecution and examination of this application.

Respectfully submitted,

DATE: June 9, 2003

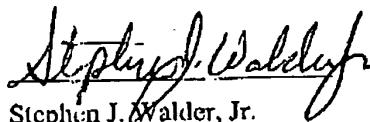

Stephen J. Waldler, Jr.
Reg. No. 41,534
Carstens, Yee & Cahoon, LLP
P.O. Box 802334
Dallas, TX 75380
(972) 367-2001
Attorney for Applicants



UNITED STATES PATENT AND TRADEMARK OFFICE

UNITED STATES DEPARTMENT OF COMMERCE
United States Patent and Trademark Office
Address: COMMISSIONER OF PATENTS AND TRADEMARKS
Washington, D.C. 20231
www.uspto.gov

APPLICATION NO.	FILING DATE	FIRST NAMED INVENTOR	ATTORNEY DOCKET NO.	CONFIRMATION NO.
09/419,175	10/15/1999	GREGORY T. OSTERHOUT	11032RR	9870

35527 7590 04/09/2003

DUKE W. LEE
CARSTENS, YEE & CAHOON, L.L.P.
P.O. BOX 802334
DALLAS, TX 75380

EXAMINER

NGUYEN, THUAN T

ART UNIT PAPER NUMBER

2685

DATE MAILED: 04/09/2003

Please find below and/or attached an Office communication concerning this application or proceeding.

Office Action Summary

Application No.
09/419,175

Applicant(s)
Osterhout

Examiner
Thuan Nguyen

Art Unit
2685



-- The MAILING DATE of this communication appears on the cover sheet with the correspondence address --

Period for Reply

A SHORTENED STATUTORY PERIOD FOR REPLY IS SET TO EXPIRE 3 MONTH(S) FROM THE MAILING DATE OF THIS COMMUNICATION.

- Extensions of time may be available under the provisions of 37 CFR 1.136 (a). In no event, however, may a reply be timely filed after SIX (6) MONTHS from the mailing date of this communication.
- If the period for reply specified above is less than thirty (30) days, a reply within the statutory minimum of thirty (30) days will be considered timely.
- If NO period for reply is specified above, the maximum statutory period will apply and will expire SIX (6) MONTHS from the mailing date of this communication.
- Failure to reply within the set or extended period for reply will, by statute, cause the application to become ABANDONED (35 U.S.C. § 133).
- Any reply received by the Office later than three months after the mailing date of this communication, even if timely filed, may reduce any earned patent term adjustment. See 37 CFR 1.704(b).

Status

- 1) Responsive to communication(s) filed on _____.
- 2a) This action is FINAL. 2b) This action is non-final.
- 3) Since this application is in condition for allowance except for formal matters, prosecution as to the merits is closed in accordance with the practice under *Ex parte Quayle*, 1935 C.D. 11; 453 O.G. 213.

Disposition of Claims

- 4) Claim(s) 1-8, 17-33, and 43-51 is/are pending in the application.
4a) Of the above, claim(s) _____ is/are withdrawn from consideration.
- 5) Claim(s) _____ is/are allowed.
- 6) Claim(s) 1-8, 17-33, and 43-51 is/are rejected.
- 7) Claim(s) _____ is/are objected to.
- 8) Claims _____ are subject to restriction and/or election requirement.

Application Papers

- 9) The specification is objected to by the Examiner.
- 10) The drawing(s) filed on _____ is/are a) accepted or b) objected to by the Examiner.
Applicant may not request that any objection to the drawing(s) be held in abeyance. See 37 CFR 1.85(a).
- 11) The proposed drawing correction filed on _____ is: a) approved b) disapproved by the Examiner.
If approved, corrected drawings are required in reply to this Office action.
- 12) The oath or declaration is objected to by the Examiner.

Priority under 35 U.S.C. §§ 119 and 120

- 13) Acknowledgement is made of a claim for foreign priority under 35 U.S.C. § 119(a)-(d) or (f).
a) All b) Some* c) None of:
1. Certified copies of the priority documents have been received.
2. Certified copies of the priority documents have been received in Application No. _____.
3. Copies of the certified copies of the priority documents have been received in this National Stage application from the International Bureau (PCT Rule 17.2(a)).
*See the attached detailed Office action for a list of the certified copies not received.
- 14) Acknowledgement is made of a claim for domestic priority under 35 U.S.C. § 119(e).
a) The translation of the foreign language provisional application has been received.
- 15) Acknowledgement is made of a claim for domestic priority under 35 U.S.C. §§ 120 and/or 121.

Attachment(s)

- 1) Notice of References Cited (PTO-892)
- 2) Notice of Draftsperson's Patent Drawing Review (PTO-948)
- 3) Information Disclosure Statement(s) (PTO-1449) Paper No(s). _____
- 4) Interview Summary (PTO-413) Paper No(s). _____
- 5) Notice of Informal Patent Application (PTO-152)
- 6) Other:

Art Unit: 2685

DETAILED ACTION

Remarks

1. Claims 63-65 were canceled without prejudice (Paper no. 9). Pending claims are now 1-8, 17-33, and 43-51.

Response to Arguments

2. Applicant's arguments with respect to claims 1-8, 17-33, and 43-51 have been considered but are moot in view of the new ground(s) of rejection.

Claim Rejections - 35 USC § 103

3. The following is a quotation of 35 U.S.C. 103(a) which forms the basis for all obviousness rejections set forth in this Office action:

(a) A patent may not be obtained though the invention is not identically disclosed or described as set forth in section 102 of this title, if the differences between the subject matter sought to be patented and the prior art are such that the subject matter as a whole would have been obvious at the time the invention was made to a person having ordinary skill in the art to which said subject matter pertains. Patentability shall not be negatived by the manner in which the invention was made.

4. Claims 1-8, 17-33, and 43-51 are rejected under 35 U.S.C. 103(a) as being unpatentable over Jain et al. (U.S. Patent No. 6,085,101) in view of Lee et al. (U.S. Patent No. 6,161,008/ or "Lee").

Regarding claims 1, 17, 25, and 43, Jain discloses a system and its corresponding method of "redirecting or re-routing a call from a data processing system to another address, comprising

Art Unit: 2685

the step of receiving at the data processing system a registration notice of an incoming call from a server, and responsive to receiving the user input (see below), transmitting the new address to which the incoming call is to be redirected”, i.e., call management is disclosed wherein new address or new location of the intended recipient can be recognized, and the call or message from the user at a data processing system can be forwarding to or re-directing to the new location using personal locating services and/or personal communication internetworking (see Figs. 2, 4, 6, 8 7 13; col. 1/lines 10-37 for a plurality of data processing systems, col. 2/lines 12-26 for registration notification using HLR and call forwarding, col. 6/lines 47-67 for forwarding addresses and col. 13/line 50 to col. 14/line 34 for personal location services).

Jain does not disclose the step of “responsive to receiving the registration notice, receiving user input for identifying a new address of another device, other than the data processing system, to which the call is to be routed” as amended; however, Lee teaches an exact same technique in using individual user profile and the user can designate his or her preferences to the address of another device that he would like to communicate (see Lee, col. 2/line 65 to col. 3/line 6; and Fig. 4, and col. 11/line 33 to col. 12/line 48 for PID and the address 408 is the address of concerned of another device that the user specifies for the call to be routed. Therefore, it would have been obvious to one of ordinary skill in the art at the time the invention was made to modify Jain’s system with Lee’s teaching technique of providing the user an opportunity to address his or her intended destination for another device, and based on user profile and preferences, the system easily routes the call to a desired location as taught by Lee. The motivation for doing this is to

Art Unit: 2685

offer to the users an interaction method for directly receiving their inputs in controlling and modifying their intended destinations from their user profiles.

As for claims 2-5 and 8, Jain further discloses “wherein the data processing system is a personal digital assistant, a laptop computer, a portable computing device, a wireless device, and a wire-line connected device” (see Figs. 1 & 2, and col. 1/lines 10-37).

As for claim 6, Jain further reveals the step of “wherein the registration notice is a session initiation protocol registration notice”, i.e., SS7 protocol is addressed in handling the transmission and delivering of call/messages over the network including a call registration (Fig. 2, col. 1/line 55 to col. 2/line 26, and col. 9/lines 20-34).

As for claim 7, Jain further discloses “wherein the incoming call comprises video and the new address corresponds to video display terminal”, i.e., a video display terminal such as a video screen of a laptop or a computing terminal is addressed (Fig. 2) wherein the new address or new location of that terminal can be provided by a recipient list database 1302 (as illustrated in Fig. 13, and col. 12/lines 53-66).

As for claims 30-31, and 48-49, Jain further discloses to include voice mail service and the step of placing the incoming call on-hold (col. 15/lines 1-14).

As for claims 18-24, 26-29, 32-33, 44-47, 50-51, these claims are rejected for the reasons given in the scope of claims 2-8 as already disclosed in details above.

Art Unit: 2685

Conclusion

5. Applicant's amendment necessitated the new ground(s) of rejection presented in this Office action. Accordingly, **THIS ACTION IS MADE FINAL**. See MPEP § 706.07(a). Applicant is reminded of the extension of time policy as set forth in 37 CFR 1.136(a).

A shortened statutory period for reply to this final action is set to expire **THREE MONTHS** from the mailing date of this action. In the event a first reply is filed within **TWO MONTHS** of the mailing date of this final action and the advisory action is not mailed until after the end of the **THREE-MONTH** shortened statutory period, then the shortened statutory period will expire on the date the advisory action is mailed, and any extension fee pursuant to 37 CFR 1.136(a) will be calculated from the mailing date of the advisory action. In no event, however, will the statutory period for reply expire later than **SIX MONTHS** from the date of this final action.

6. **Any response to this action should be mailed to:**

Commissioner of Patents and Trademarks

Washington, D.C. 20231

or faxed to:

(703) 872-9314, (for Technology Center 2600 only)

Hand-delivered responses should be brought to Crystal Park II,

2121 Crystal Drive, Arlington, VA., Sixth Floor (Receptionist).

Art Unit: 2685

7. Any inquiry concerning this communication or earlier communications from the examiner should be directed to Tony Thuan Nguyen whose telephone number is (703) 308-5860. The examiner can normally be reached on Monday-Friday from 9:00 AM to 6:00 PM, with alternate Fridays off.

If attempts to reach the examiner by telephone are unsuccessful, the examiner's supervisor, Edward Urban, can be reached at (703) 305-4385.

Any inquiry of a general nature or relating to the status of this application or proceeding should be directed to the **Technology Center 2600 Customer Service Office** whose telephone number is **(703) 306-0377**.

Tony T. Nguyen
Art Unit 2685
April 4, 2003

EDWARD F. URBAN
SUPERVISORY PATENT EXAMINER
TECHNOLOGY CENTER 2600

IN THE UNITED STATES PATENT AND TRADEMARK OFFICE

In re application of: Osterhout et al.

Serial No.: 09/419,175

Filed: October 15, 1999

For: Portable Call Management System

§
§
§
§
§
§

Group Art Unit: 2684

Examiner: Nguyen, Thuan T.

Attorney Docket No.: 11032RR

Certificate of Transmission Under 37 C.F.R. § 1.8(a)
 I hereby certify this correspondence is being transmitted via facsimile to the Assistant Commissioner of Patents, Washington, D.C. 20231, facsimile number (703) 872-9314, on January 22, 2003
 By: Rebecca Clayton
 Rebecca Clayton



35527

PATENT TRADEMARK OFFICE

TRANSMITTAL DOCUMENT

Assistant Commissioner of Patents
Washington, D.C. 20231

Sir:
ENCLOSED HEREWITH:

- Response to Office Action; and
- Change of Attorney's Address in Application.

No fees are believed to be required. If, however, any fees are required, I authorize the Commissioner to charge these fees which may be required to Deposit Account No. 50-0392. No extension of time is believed to be necessary. If, however, an extension of time is required, the extension is requested, and I authorize the Commissioner to charge any fees for this extension to Deposit Account No. 50-0392.

Respectfully submitted,

Duke W. Yee
Registration No. 34,285
CARSTENS, YEE & CAHOON, LLP
P.O. Box 802334
Dallas, Texas 75380
(972) 367-2001
ATTORNEY FOR APPLICANTS

**Carstens,
Yee &
Cahoon, L.L.P.**

13760 Noel Road
Suite 900
Dallas, Texas 75240

Main No. (972) 367-2001
Facsimile (972) 367-2002

Facsimile Cover Sheet

<p>To: Assistant Commissioner of Patents for Examiner Thuan T. Nguyen Group Art Unit 2684</p>	<p>Facsimile No.: 703/872-9314</p>
<p>From: Rebecca Clayton Legal Assistant to Stephen J. Walder, Jr.</p>	<p>No. of Pages Including Cover Sheet: 15</p>
<p>Message:</p> <p>Enclosed herewith:</p> <ul style="list-style-type: none"> • Transmittal Document; • Response to Office Action; and • Change of Attorney's Address in Application. 	
<p>Re: Application No. 09/419,175 Attorney Docket No: 11032RR</p>	
<p>Date: Wednesday, January 22, 2003</p>	
<p>Please contact us at (972) 367-2001 if you do not receive all pages indicated above or experience any difficulty in receiving this facsimile.</p>	<p><i>This Facsimile is intended only for the use of the addressee and, if the addressee is a client or their agent, contains privileged and confidential information. If you are not the intended recipient of this facsimile, you have received this facsimile inadvertently and in error. Any review, dissemination, distribution, or copying is strictly prohibited. If you received this facsimile in error, please notify us by telephone and return the facsimile to us immediately.</i></p>

**PLEASE CONFIRM RECEIPT OF THIS TRANSMISSION
BY FAXING A CONFIRMATION TO 972-367-2002.**

#9/B
m
29-03
Official

IN THE UNITED STATES PATENT AND TRADEMARK OFFICE

In re application: **Osterhout et al.**

Serial No.: **09/419,175**

Filed: **October 15, 1999**

For: **Portable Call Management System**

§
§
§
§
§
§
§
§
§
§

Group Art Unit: **2684**

Examiner: **Nguyen, Thuan T.**

Attorney Docket No.: **11032RR**

RECEIVED
1/22/03
7C

Certificate of Transmission Under 37 C.F.R. § 1.8(a)
I hereby certify this correspondence is being transmitted via facsimile to the Assistant Commissioner of Patents, Washington, D.C. 20231, facsimile number (703) 872-9314, on January 21, 2003.
By: Rebecca Clayton
Rebecca Clayton

RESPONSE TO OFFICE ACTION

Assistant Commissioner of Patents
Washington, D.C. 20231

Sir:

No fees are believed to be required. If, however, any fees are required, I authorize the Commissioner to charge those fees which may be required to Deposit Account No. 50-0392. No extension of time is believed to be necessary. If, however, an extension of time is required, the extension is requested, and I authorize the Commissioner to charge any fees for this extension to Deposit Account No. 50-0392.

In response to the Office Action dated October 24, 2002, please amend the above-identified application as follows:

Official
RECEIVED
1-22-03

IN THE CLAIMS:

A clean version of the entire set of pending claims is as follows:

1. A method of redirecting a call from a data processing system to another address, comprising the steps of:

receiving at a data processing system a registration notice of an incoming call from a server;

responsive to receiving the registration notice, receiving user input for identifying a new address of another device, other than the data processing system, to which the call is to be routed; and

responsive to receiving the user input, transmitting the new address to which the call is to be redirected.

B

2. The method as recited in claim 1, wherein said data processing system is a personal digital assistant.

3. The method as recited in claim 1, wherein said data processing system is a laptop computer.

4. The method as recited in claim 1, wherein said data processing system is a portable computing device.

5. The method as recited in claim 1, wherein said data processing system is a wireless device.

6. The method as recited in claim 1, wherein the registration notice is a session initiation protocol registration notice.

7. The method as recited in claim 1, wherein the incoming call comprises video and the new address corresponds to a video display terminal.

8. The method as recited in claim 1, wherein said data processing system is a wire-line connected device.

17. A system of redirecting a call from a data processing system to another address, comprising:

means for receiving at a data processing system a registration notice of an incoming call from a server;

means, responsive to receiving the registration notice, for receiving user input for identifying a new address of another device, other than the data processing system, to which the call is to be routed; and

means, responsive to receiving the user input, for transmitting the new address to which the call is to be redirected.

B2

18. The system as recited in claim 17, wherein said data processing system is a personal digital assistant.

19. The system as recited in claim 17, wherein said data processing system is a laptop computer.

20. The system as recited in claim 17, wherein said data processing system is a portable computing device.

21. The system as recited in claim 17, wherein said data processing system is a wireless device.

22. The system as recited in claim 17, wherein the registration notice is a session initiation protocol registration notice.

23. The system as recited in claim 17, wherein the incoming call comprises video and the new address corresponds to a video display terminal.

24. The system as recited in claim 17, wherein said data processing system is a wire-line connected device.

25. A method for redirecting calls to a data processing system to a second location; comprising the steps of:

3
2
sending a registration notification to a called party's preferred location;

receiving a response from the called party's preferred location, the response

including a new address identified from user input received at the called party's preferred location in response to receiving the registration notification at the called party's preferred location; and

responsive to receipt of the new address from the called party, redirecting the incoming call to the new address.

26. The method as recited in claim 25, further comprising:

prior to said sending step, receiving a request to initiate a call with a called party;

and

determining a preferred location of the called party.

27. The method as recited in claim 25, wherein the registration notification is a session initiation protocol registration.

28. The method as recited in claim 25, wherein the preferred location is a personal digital assistant.

29. The method as recited in claim 28, wherein the personal digital assistant is a Palm VII utilizing a Palm Query Application to provide a user interface.

30. The method as recited in claim 25, wherein the new address corresponds to a voice mailbox.

31. The method as recited in claim 25, wherein the new address corresponds to placing the incoming call on hold.

32. The method as recited in claim 25, wherein communication with the preferred device is provided utilizing a wireless application protocol.

33. The method as recited in claim 25, wherein the new address corresponds to a wire-line device.

43. A system for redirecting calls to a data processing system to a second location; comprising:

means for sending a registration notification to a called party's preferred location;

means for receiving a response from the called party's preferred location, the response including a new address identified from user input received at the called party's preferred location in response to receiving the registration notification at the called party's preferred location; and

means, responsive to receipt of the new address from the called party, for redirecting the incoming call to the new address.

BY

44. The system as recited in claim 43, further comprising:

prior to said sending step, means for receiving a request to initiate a call with a called party; and

means for determining a preferred location of the called party.

45. The system as recited in claim 43, wherein the registration notification is a session initiation protocol registration.

46. The system as recited in claim 43, wherein the preferred location is a personal digital assistant.

47. The system as recited in claim 46, wherein the personal digital assistant is a Palm VII utilizing a Palm Query Application to provide a user interface.

48. The system as recited in claim 43, wherein the new address corresponds to a voice mailbox.

49. The system as recited in claim 43, wherein the new address corresponds to placing the incoming call on hold.

50. The system as recited in claim 43, wherein communication with the preferred device is provided utilizing a wireless application protocol.

51. The system as recited in claim 43, wherein the new address corresponds to a wire-line device.

REMARKS

Claims 1-8, 17-33 and 43-51 are pending in the present application. By this Response, claims 63-65 are canceled and claims 1, 17, 25 and 43 are amended. Reconsideration of the claims is respectfully requested in view of the above amendments and the following remarks.

I. 35 U.S.C. § 102, Alleged Anticipation Based on Jain

The Office Action rejects claims 1-8, 17-33, and 43-51 under 35 U.S.C. § 102(c) as being anticipated by Jain et al. (U.S. Patent No. 6,085,101). This rejection is respectfully traversed.

As to independent claims 1, 17, 25 and 43, the Office Action states:

Regarding claims 1, 17, 25, and 43, Jain discloses a system and its corresponding method of "redirecting or re-routing a call from a data processing system to another address, comprising the step of receiving at the data processing system a registration notice of an incoming call from a server, and responsive to determination of a new address, transmitting a new address to which the incoming

call is to be redirected", i.e., call management is disclosed wherein new address or new location of the intended recipient can be recognized, and the call or message from the user at a data processing system can be forwarding to or re-directing to the new location using personal locating services and/or personal communication internetworking (see Figs. 2, 4, 6, 8 7 13; col. 1/lines 10-37 for a plurality of data processing systems, col.2/lines 12-26 for registration notification using HLR and call forwarding, col. 6/lines 47-67 for forwarding addresses and col. 13/line 50 to col. 14/line 34 for personal location services).

Claim 1, which is representative of the other independent claims 17, 25 and 43 with regard to similarly recited subject matter, reads as follows:

1. A method of redirecting a call from a data processing system to another address, comprising the steps of:
receiving at a data processing system a registration notice of an incoming call from a server;
responsive to receiving the registration notice, receiving user input for identifying a new address of another device, other than the data processing system, to which the call is to be routed; and
responsive to receiving the user input, transmitting the new address to which the call is to be redirected. (emphasis added)

Jain does not teach user input for identifying a new address of another device other than the data processing system to which the call is to be routed, and similar features in the other independent claims 17, 25 and 43.

Jain is directed to a system for multicasting a single message to a plurality of recipients. With the system of Jain, a message provider calls a multicast service, the network server queries the message provider and obtains the message and recipient addresses, the network server then contacts some or all of the recipients and transmits the message to those recipients that were contacted (see column 3, lines 48-68). Jain further teaches that the multicasting functionality of the Jain system may be used in conjunction with known communication network services such as personal location service and call forwarding. Call forwarding, as is described in the Jain reference (column 2, lines 24-26) and generally known in the art, involves receiving a call with a designation of a destination telephone number and automatically consulting stored information to identify an alternate number to which calls to the destination telephone number are to be forwarded. Personal location service is a known service of cellular telephone systems in

which a cell or registration area in which a mobile terminal is currently located is identified from existing information in the wireless communication infrastructure (column 13, lines 59-61).

Neither the multicasting system of Jain or the known network services of call forwarding or personal location service teach "responsive to receiving the registration notice, receiving user input for identifying a new address of another device, other than the data processing system, to which the call is to be routed" as recited in claim 1. Jain only teaches multicasting a message to a plurality of recipients identified in a recipient list and possible integration of such multicasting into existing call forwarding and personal location services. In none of these systems is a users input ever received in response to a notification of a call, the users input being used for identifying a new address to which the call is routed.

While Jain does teach that user input may be received to generate responses to multicast messages (column 12, lines 24-41), these responses are for receiving a user's acceptance or declining of invitations provided in the multicast message or other similar specific response to the content of the multicast message. These responses are not used to identify a new address of another device to which the call is to be routed.

Similar distinctions over Jain exist in the other independent claims 17, 25 and 43. For example, claim 17 recites "means, responsive to receiving the registration notice, for receiving user input for identifying a new address of another device, other than the data processing system, to which the call is to be routed" (emphasis added). Claim 25 recites "receiving a response from the called party's preferred location, the response including a new address identified from user input received at the called party's preferred location in response to receiving the registration notification at the called party's preferred location" (emphasis added). Similarly, claim 43 recites "means for receiving a response from the called party's preferred location, the response including a new address identified from user input received at the called party's preferred location in response to receiving the registration notification at the called party's preferred location" (emphasis added).

In view of the above, Applicants respectfully submit that Jain does not teach each and every feature of independent claims 1, 17, 25 and 43 as is required under 35 U.S.C. § 102(e). At least by virtue of their dependency on claims 1, 17, 25 and 43, respectively,

Jain does not teach each and every feature of dependent claims 2-8, 18-24, 26-33, and 44-51. Accordingly, Applicants respectfully request withdrawal of the rejection of claims 1-8, 17-33, and 43-51 under 35 U.S.C. § 102(e).

Furthermore, Jain does not teach, suggest, or give any incentive to make the needed changes to reach the presently claimed invention. Jain does not provide any teaching, suggestion, or incentive to make these changes because Jain is not directed to solving the same problem as the present invention. To the contrary, Jain is directed to a multicasting system for sending a single message to a plurality of recipients whereas the present invention is directed to redirection of calls based on user input in response to receiving a registration notification.

Absent the Examiner pointing out some teaching or incentive, with sufficient evidence to satisfy the MPFP requirements, to implement Jain to redirect calls based on user input in response to receiving a registration notification, one of ordinary skill in the art would not be led to modify Jain to reach the present invention when the reference is examined as a whole. Absent some teaching, suggestion, or incentive to modify Jain in this manner, the presently claimed invention can be reached only through an improper use of hindsight using the Applicants' disclosure as a template to make the necessary changes to reach the claimed invention.

II. 35 U.S.C. § 103, Obviousness

The Office Action rejects claims 63-65 under 35 U.S.C. § 103(a) as being unpatentable over Jain et al. (U.S. Patent No. 6,085,101) in view of Lee et al. (U.S. Patent No. 6,161,008/ or "Lee"). This rejection is moot in view of the cancellation of claims 63-65.

III. Conclusion

It is respectfully urged that the subject application is patentable over Jain and Lee and is now in condition for allowance. The Examiner is invited to call the undersigned at the below-listed telephone number if in the opinion of the Examiner such a telephone conference would expedite or aid the prosecution and examination of this application.

Respectfully submitted,

DATE: January 22, 2003

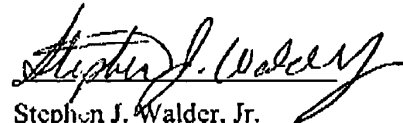

Stephen J. Walder, Jr.
Reg. No. 41,534
Carstens, Yee & Cahoon, LLP
P.O. Box 802334
Dallas, TX 75380
(972) 367-2001
Attorney for Applicants

APPENDIX OF CLAIM AMENDMENTS

Please cancel claims 63-65 without prejudice or disclaimer.

Please amend claims 1, 17, 25 and 43 as follows:

1. A method of redirecting a call from a data processing system to another address, comprising the steps of:
 - receiving at a data processing system a registration notice of an incoming call from a server;
 - ~~responsive to receiving the registration notice, receiving user input for identifying a new address of another device, other than the data processing system, to which the call is to be routed;~~ and
 - responsive to [determination of a new address;] ~~receiving the user input,~~ transmitting [a] ~~the~~ new address to which the [incoming] call is to be redirected.

17. A system of redirecting a call from a data processing system to another address, comprising:
 - means for receiving at a data processing system a registration notice of an incoming call from a server;
 - ~~means, responsive to receiving the registration notice, for receiving user input for identifying a new address of another device, other than the data processing system, to which the call is to be routed;~~ and
 - means, responsive to [determination of a new address;] ~~receiving the user input,~~ for transmitting [a] ~~the~~ new address to which the [incoming] call is to be redirected.

25. A method for redirecting calls to a data processing system to a second location; comprising the steps of:
 - sending a registration notification to a called party's preferred location;
 - ~~receiving a response from the called party's preferred location, the response including a new address identified from user input received at the called party's preferred~~

location in response to receiving the registration notification at the called party's preferred location; and

responsive to receipt of [a] the new address from the called party, redirecting the incoming call to the new address.

43. A system for redirecting calls to a data processing system to a second location; comprising:

means for sending a registration notification to a called party's preferred location;

means for receiving a response from the called party's preferred location, the response including a new address identified from user input received at the called party's preferred location in response to receiving the registration notification at the called party's preferred location; and

means, responsive to receipt of [a] the new address from the called party, for redirecting the incoming call to the new address.

Official

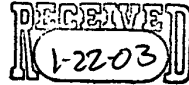

#8
m
1-29-03

IN THE UNITED STATES PATENT AND TRADEMARK OFFICE

In re application of: Osterhout et al.	§	Group Art Unit: 2684
Serial No.: 09/419,175	§	Examiner: Nguyen, Thuan T.
Filed: October 15, 1999	§	Attorney Docket No.: 11032RR
For: Portable Call Management System	§	

CHANGE OF ATTORNEY'S ADDRESS IN APPLICATION

Please send all correspondence for this application to customer number 35527, which should correspond to the following address:

Duke W. Yee
Carstens Yee & Cahoon, LLP
P.O. Box 802334
Dallas, TX 75380

Please direct telephone calls to:

(972) 367-2001

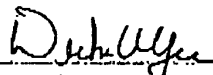

 Duke W. Yee
 Reg. No. 34,285
 Carstens, Yee & Cahoon, L.L.P.
 P.O. Box 802334
 Dallas, TX 75380
 Tel. No.: (972) 367-2001

I hereby certify this correspondence is being transmitted via facsimile to the Assistant Commissioner of Patents, Washington, D.C. 20231, facsimile number (703) 872-9314,

on January 22, 2003 by Drew Clayton

g



UNITED STATES PATENT AND TRADEMARK OFFICE

UNITED STATES DEPARTMENT OF COMMERCE
United States Patent and Trademark Office
Address: COMMISSIONER OF PATENTS AND TRADEMARKS
Washington, D.C. 20231
www.uspto.gov

APPLICATION NO.	FILING DATE	FIRST NAMED INVENTOR	ATTORNEY DOCKET NO.	CONFIRMATION NO.
09/419,175	10/15/1999	GREGORY T. OSTERHOUT	11032RR	9870

7590 10/24/2002

JOHN D CRANE
NORTEL NETWORKS INTELLECTUAL PROP LAW
21 LAKESIDE BOULEVARD
MS 468/05/B10
RICHARDSON, TX 75240

EXAMINER

NGUYEN, THUAN T

ART UNIT	PAPER NUMBER
----------	--------------

2684

DATE MAILED: 10/24/2002

Please find below and/or attached an Office communication concerning this application or proceeding.

g

g

Office Action Summary

Application No. 09/419,175	Applicant(s) Osterhout
Examiner Thuan Nguyen	Art Unit 2684

-- The MAILING DATE of this communication appears on the cover sheet with the correspondence address --

Period for Reply

A SHORTENED STATUTORY PERIOD FOR REPLY IS SET TO EXPIRE 3 MONTH(S) FROM THE MAILING DATE OF THIS COMMUNICATION.

- Extensions of time may be available under the provisions of 37 CFR 1.136 (a). In no event, however, may a reply be timely filed after SIX (6) MONTHS from the mailing date of this communication.
- If the period for reply specified above is less than thirty (30) days, a reply within the statutory minimum of thirty (30) days will be considered timely.
- If NO period for reply is specified above, the maximum statutory period will apply and will expire SIX (6) MONTHS from the mailing date of this communication.
- Failure to reply within the set or extended period for reply will, by statute, cause the application to become ABANDONED (35 U.S.C. § 133).
- Any reply received by the Office later than three months after the mailing date of this communication, even if timely filed, may reduce any earned patent term adjustment. See 37 CFR 1.704(b).

Status

- 1) Responsive to communication(s) filed on _____.
- 2a) This action is FINAL. 2b) This action is non-final.
- 3) Since this application is in condition for allowance except for formal matters, prosecution as to the merits is closed in accordance with the practice under *Ex parte Quayle*, 1935 C.D. 11; 453 O.G. 213.

Disposition of Claims

- 4) Claim(s) 1-8, 17-33, 43-51, and 63-65 is/are pending in the application.
- 4a) Of the above, claim(s) _____ is/are withdrawn from consideration.
- 5) Claim(s) _____ is/are allowed.
- 6) Claim(s) 1-8, 17-33, 43-51, and 63-65 is/are rejected.
- 7) Claim(s) _____ is/are objected to.
- 8) Claims _____ are subject to restriction and/or election requirement.

Application Papers

- 9) The specification is objected to by the Examiner.
- 10) The drawing(s) filed on _____ is/are a) accepted or b) objected to by the Examiner.
Applicant may not request that any objection to the drawing(s) be held in abeyance. See 37 CFR 1.85(a).
- 11) The proposed drawing correction filed on _____ is: a) approved b) disapproved by the Examiner.
If approved, corrected drawings are required in reply to this Office action.
- 12) The oath or declaration is objected to by the Examiner.

Priority under 35 U.S.C. §§ 119 and 120

- 13) Acknowledgement is made of a claim for foreign priority under 35 U.S.C. § 119(a)-(d) or (f).
a) All b) Some* c) None of:
- Certified copies of the priority documents have been received.
 - Certified copies of the priority documents have been received in Application No. _____.
 - Copies of the certified copies of the priority documents have been received in this National Stage application from the International Bureau (PCT Rule 17.2(a)).

*See the attached detailed Office action for a list of the certified copies not received.

- 14) Acknowledgement is made of a claim for domestic priority under 35 U.S.C. § 119(e).
a) The translation of the foreign language provisional application has been received.
- 15) Acknowledgement is made of a claim for domestic priority under 35 U.S.C. §§ 120 and/or 121.

Attachment(s)

- 1) Notice of References Cited (PTO-892) 4) Interview Summary (PTO-413) Paper No(s). _____
- 2) Notice of Draftsperson's Patent Drawing Review (PTO-948) 5) Notice of Informal Patent Application (PTO-152)
- 3) Information Disclosure Statement(s) (PTO-1449) Paper No(s). 4 6) Other:

Art Unit: 2684

DETAILED ACTION

Remarks

1. Claims 9-16, 34-42, 52-62, and 66-69 were canceled without prejudice (Paper no. 6).

Claim Rejections - 35 USC § 102

2. The following is a quotation of the appropriate paragraphs of 35 U.S.C. 102 that form the basis for the rejections under this section made in this Office action:

A person shall be entitled to a patent unless --

(e) the invention was described in a patent granted on an application for patent by another filed in the United States before the invention thereof by the applicant for patent, or on an international application by another who has fulfilled the requirements of paragraphs (1), (2), and (4) of section 371© of this title before the invention thereof by the applicant for patent.

The changes made to 35 U.S.C. 102(e) by the American Inventors Protection Act of 1999 (AIPA) do not apply to the examination of this application as the application being examined was not (1) filed on or after November 29, 2000, or (2) voluntarily published under 35 U.S.C. 122(b). Therefore, this application is examined under 35 U.S.C. 102(e) prior to the amendment by the AIPA (pre-AIPA 35 U.S.C. 102(e)).

3. Claims 1-8, 17-33, and 43-51 are rejected under 35 U.S.C. 102(e) as being anticipated by Jain et al. (U.S. Patent No. 6,085,101/ or "Jain" hereinafter).

Regarding claims 1, 17, 25, and 43, Jain discloses a system and its corresponding method of "redirecting or re-routing a call from a data processing system to another address, comprising the step of receiving at the data processing system a registration notice of an incoming call from a server, and responsive to determination of a new address, transmitting a new address to which the

Art Unit: 2684

incoming call is to be redirected”, i.e., call management is disclosed wherein new address or new location of the intended recipient can be recognized, and the call or message from the user at a data processing system can be forwarding to or re-directing to the new location using personal locating services and/or personal communication internetworking (see Figs. 2, 4, 6, 8 7 13; col. 1/lines 10-37 for a plurality of data processing systems, col. 2/lines 12-26 for registration notification using HLR and call forwarding, col. 6/lines 47-67 for forwarding addresses and col. 13/line 50 to col. 14/line 34 for personal location services).

As for claims 2-5 and 8, Jain further discloses “wherein the data processing system is a personal digital assistant, a laptop computer, a portable computing device, a wireless device, and a wire-line connected device” (see Figs. 1 & 2, and col. 1/lines 10-37).

As for claim 6, Jain further reveals the step of “wherein the registration notice is a session initiation protocol registration notice”, i.e., SS7 protocol is addressed in handling the transmission and delivering of call/messages over the network including a call registration (Fig. 2, col. 1/line 55 to col. 2/line 26, and col. 9/lines 20-34).

As for claim 7, Jain further discloses “wherein the incoming call comprises video and the new address corresponds to video display terminal”, i.e., a video display terminal such as a video screen of a laptop or a computing terminal is addressed (Fig. 2) wherein the new address or new location of that terminal can be provided by a recipient list database 1302 (as illustrated in Fig. 13, and col. 12/lines 53-66).

Art Unit: 2684

As for claims 30-31, and 48-49, Jain further discloses to include voice mail service and the step of placing the incoming call on-hold (col. 15/lines 1-14).

As for claims 18-24, 26-29, 32-33, 44-47, 50-51, these claims are rejected for the reasons given in the scope of claims 2-8 as already disclosed in details above.

Claim Rejections - 35 USC § 103

4. The following is a quotation of 35 U.S.C. 103(a) which forms the basis for all obviousness rejections set forth in this Office action:

(a) A patent may not be obtained though the invention is not identically disclosed or described as set forth in section 102 of this title, if the differences between the subject matter sought to be patented and the prior art are such that the subject matter as a whole would have been obvious at the time the invention was made to a person having ordinary skill in the art to which said subject matter pertains. Patentability shall not be negatived by the manner in which the invention was made.

5. Claims 63-65 are rejected under 35 U.S.C. 103(a) as being unpatentable over Jain et al. (U.S. Patent No. 6,085,101) in view of Lee et al. (U.S. Patent No. 6,161,008/ or “Lee”).

Regarding claims 63-65, in further view of claim 1 above, Jain does not further address to include “a proxy server for performing address lookup and directing calls with a user agent to aid the translation between a protocol recognized by the proxy server and recognized by a terminal unit” and “HTML protocol” as claimed; however, in the same field of endeavor, Lee includes a proxy server for routing data between networks and Internet Protocol technology with IP addresses based on URL or HTML (col. 3/line 63-col. 4/line 9) with gatekeeper acts as user agent

Art Unit: 2684

in aiding the proxy server in routing (Fig. 1, and col. 4/lines 10-35). Therefore, it would have been obvious to one of ordinary skill in the art at the time the invention was made to modify Jain's system with Lee's technique of using a proxy server and its associated technique in order to performing address lookup and directing calls based on the URL or HTML protocol and PIDs of user profiles (col. 13/line 35 to col. 14/line 39) as suggested by Lee.

Conclusion

6. The prior art made of record and not relied upon is considered pertinent to applicant's disclosure:

Dynarski et al (US Patent 6,466,571 B1), Chang et al (US Patent 6,463,270 B1), Ladd et al (US Patent 6,385,583 B1) and Shaffer et al. (US Patent 5,901,214) disclose communications systems with routing techniques in IP networks.

7. **Any response to this action should be mailed to:**

Commissioner of Patents and Trademarks

Washington, D.C. 20231

or faxed to:

(703) 872-9314, (for Technology Center 2600 only)

*Hand-delivered responses should be brought to Crystal Park II,
2121 Crystal Drive, Arlington, VA., Sixth Floor (Receptionist).*

Art Unit: 2684

8. Any inquiry concerning this communication or earlier communications from the examiner should be directed to Tony Thuan Nguyen whose telephone number is (703) 308-5860. The examiner can normally be reached on Monday-Friday from 9:00 AM to 6:00 PM, with alternate Fridays off.

If attempts to reach the examiner by telephone are unsuccessful, the examiner's supervisor, Daniel Hunter, can be reached at (703) 308-6732.

Any inquiry of a general nature or relating to the status of this application or proceeding should be directed to the **Technology Center 2600 Customer Service Office** whose telephone number is (703) 306-0377.

10/21/02
702600

Tony T. Nguyen
Art Unit 2684
October 15, 2002

Notice of References Cited

Application/Control No. 09/419,175	Applicant(s)/Patent Under Reexam Osterhout	
Examiner Thuan Nguyen	Art Unit 2684	Page 1 of 1

U.S. PATENT DOCUMENTS

	Document Number Country Code-Number-Kind Code	Date MM-YYYY ¹	Name	Classification ²	
A	6,085,101	7/2000	Jain et al.	455	500
B	6,161,008	12/2000	Lee et al.	455	445
C	6,466,571 B1	10/2002	Dynarski et al.	455	567
D	6,463,270 B1	10/2002	Chang et al.	455	403
E	6,385,583 B1	5/2002	Ladd et al.	379	88
F	5,901,214	5/1999	Shaffer et al.	379	220
G					
H					
I					
J					
K					
L					
M					

FOREIGN PATENT DOCUMENTS

	Document Number Country Code-Number-Kind Code	Date MM-YYYY ¹	Country	Name	Classification ²	
N						
O						
P						
Q						
R						
S						
T						

NON-PATENT DOCUMENTS

	Include, as applicable: Author, Title, Date, Publisher, Edition or Volume, Pertinent Pages
U	
V	
W	
X	

* A copy of this reference is not being furnished with this Office action. See MPEP § 707.05(a). ¹ Dates in MM-YYYY format are publication dates. ² Classifications may be U.S. or foreign.

Form PTO-1449 LIST OF PRIOR ART CITED BY APPLICANT <i>(Use several sheets if necessary)</i>	ATTORNEY DOCKET NO. 11032RR	SERIAL NO. 09/419,175
	APPLICANT Osterhout	
	FILING DATE October 15, 1999	GROUP ART UNIT Unknown-2684

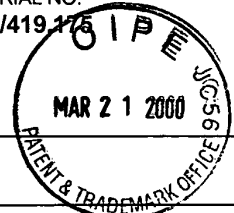

U.S. PATENT DOCUMENTS					
EXAMINER INITIAL	DOCUMENT NO.	PUBLICATION DATE	INVENTOR NAME	CLASS/SUBCLASS	FILING DATE

RECEIVED
 MAR 23 2000
 TC 2700 MAIL ROOM

FOREIGN PATENT DOCUMENTS					
EXAMINER INITIAL	DOCUMENT NO.	PUBLICATION DATE	COUNTRY	CLASS/SUBCLASS	TRANSLATION YES NO

OTHER PRIOR ART (including author, title, date, pertinent page, etc.)

<i>812</i>	AA	Handley, et al.; SIP: Session Initiation Protocol; March 1999; pp. 1-134
<i>813</i>	AB	3Com Corporation; Web Clipping Developer's Guide; Document Number 3009-001; Print Date 8/7/99;

DATE CONSIDERED *10/10/02* EXAMINER *[Signature]*

EXAMINER: Initial if reference considered, whether or not citation is in conformance with MPEP § 609; draw line through citation if not in conformance and not considered. Include copy of this form with next communication to applicant.



#6/Election/Amdt A
7/30/02
w.b.
COPY OF PAPERS
ORIGINALLY FILED

THE UNITED STATES PATENT AND TRADEMARK OFFICE

In re application: **Osterhout et al.**

§
§
§
§
§
§
§
§
§
§
§

Serial No.: 09/419,175

Group Art Unit: 2684

RECEIVED

JUL 26 2002

Filed: **October 15, 1999**

Examiner: **Nguyen, Thuan** Technology Center 2600

For: **Portable Call Management System**

Attorney Docket No.: 11032RR

Certificate of Mailing Under 37 C.F.R. § 1.8(a)
I hereby certify this correspondence is being deposited with the United States Postal Service as First Class mail in an envelope addressed to: Assistant Commissioner of Patents, Washington, D.C. 20231 on July 18, 2002.
By: Krista Douthitt
Krista Douthitt

RESPONSE TO RESTRICTION REQUIREMENT

Assistant Commissioner of Patents
Washington, D.C. 20231

Sir:

No fees are believed to be required. If, however, any fees are required, I authorize the Commissioner to charge these fees which may be required to Deposit Account No. 50-0392. No extension of time is believed to be necessary. If, however, an extension of time is required, the extension is requested, and I authorize the Commissioner to charge any fees for this extension to Deposit Account No. 50-0392.

In response to the Restriction Requirement dated June 18, 2002, please amend the above-identified application as follows:

IN THE CLAIMS:

✓ ✓ ✓ ✓

Please cancel claims 9-16, 34-42, 52-62, and 66-69 without prejudice.

REMARKS

Claims 1-8, 17-33, 43-51 and 63-65 are pending in the present application. Claims 9-16, 34-42, 52-62, and 66-69 have been cancelled. The examiner has stated that a restriction to one of three sets of claims is required under 35 U.S.C § 121. The examiner has grouped the claims as follows:

- I. Claims 1-8, 17-33, 43-51 and 63-65, drawn to a method and a system for redirecting a call(s) from a data processing system to another address, classified in class 455, subclass 445.
- II. Claims 9-16 and 34-42, drawn to a computer program product in computer readable media for use in a data processing system, classified in class 712, subclass 200+.
- III. Claims 52-62 and 66-69, drawn to a communication system and its method for processing and/or initiating a call including registration processes, classified in class 455, subclass 435.

Office Action dated June 18, 2002, page 2. After reviewing the claims and the groups identified by the examiner, applicants elect group I, which contains claims 1-8, 17-33, 43-51 and 63-65, without traverse.

The examiner is invited to call the undersigned at the below-listed telephone number if in the opinion of the examiner such a telephone conference would expedite or aid the prosecution and examination of this application.

DATE: 7/18/02

Respectfully submitted,



Duke W. Yee
Reg. No. 34,285
Carstens, Yee & Cahoon, LLP
P.O. Box 802334
Dallas, TX 75380
(972) 367-2001
Agent for Applicants



2684
COPY OF PAPERS
ORIGINALLY FILED

IN THE UNITED STATES PATENT AND TRADEMARK OFFICE

RECEIVED

JUL 26 2002

Technology Center 2600

Application of: Osterhout et al.

Serial No.: 09/419,175

Filed: October 15, 1999

For: Portable Call Management System

§ Group Art Unit: 2684
§
§ Examiner: Nguyen, Thuan T.
§
§ Attorney Docket No.: 11032RR
§

Certificate of Mailing Under 37 C.F.R. § 1.8(a)
I hereby certify this correspondence is being deposited with the United States Postal Service as First Class mail in an envelope addressed to: Assistant Commissioner of Patents, Washington, D.C. 20231 on July 18, 2002.
By: K. Douthitt
Krista Douthitt

TRANSMITTAL DOCUMENT

Assistant Commissioner of Patents
Washington, D.C. 20231

Sir:
ENCLOSED HEREWITH:

- Response to Restriction Requirement; and
- Our return postcard.

No fees are believed to be required. If, however, any fees are required, I authorize the Commissioner to charge these fees which may be required to Deposit Account No. 50-0392. No extension of time is believed to be necessary. If, however, an extension of time is required, the extension is requested, and I authorize the Commissioner to charge any fees for this extension to Deposit Account No. 50-0392.

Respectfully submitted,

Duke W. Yee
Duke W. Yee
Registration No. 34,285
CARSTENS, YEE & CAHOON, LLP
P.O. Box 802334
Dallas, Texas 75380
(972) 367-2001
ATTORNEY FOR APPLICANT



UNITED STATES PATENT AND TRADEMARK OFFICE

UNITED STATES DEPARTMENT OF COMMERCE
United States Patent and Trademark Office
Address: COMMISSIONER OF PATENTS AND TRADEMARKS
Washington, D.C. 20231
www.uspto.gov

APPLICATION NO.	FILING DATE	FIRST NAMED INVENTOR	ATTORNEY DOCKET NO.	CONFIRMATION NO.
09/419,175	10/15/1999	GREGORY T. OSTERHOUT	11032RR	9870

7590 06/18/2002

JOHN D CRANE
NORTEL NETWORKS INTELLECTUAL PROP LAW
21 LAKESIDE BOULEVARD
MS 468/05/B10
RICHARDSON, TX 75240

EXAMINER

NGUYEN, THUAN T

ART UNIT PAPER NUMBER

2684

DATE MAILED: 06/18/2002

Please find below and/or attached an Office communication concerning this application or proceeding.

Office Action Summary

Application No.
09/419,175

Applicant(s)
Osterhout

Examiner
Thuan Nguyen

Art Unit
2684



-- The MAILING DATE of this communication appears on the cover sheet with the correspondence address --

Period for Reply

A SHORTENED STATUTORY PERIOD FOR REPLY IS SET TO EXPIRE 3 MONTH(S) FROM THE MAILING DATE OF THIS COMMUNICATION.

- Extensions of time may be available under the provisions of 37 CFR 1.136 (a). In no event, however, may a reply be timely filed after SIX (6) MONTHS from the mailing date of this communication.
- If the period for reply specified above is less than thirty (30) days, a reply within the statutory minimum of thirty (30) days will be considered timely.
- If NO period for reply is specified above, the maximum statutory period will apply and will expire SIX (6) MONTHS from the mailing date of this communication.
- Failure to reply within the set or extended period for reply will, by statute, cause the application to become ABANDONED (35 U.S.C. § 133).
- Any reply received by the Office later than three months after the mailing date of this communication, even if timely filed, may reduce any earned patent term adjustment. See 37 CFR 1.704(b).

Status

- 1) Responsive to communication(s) filed on _____
- 2a) This action is FINAL. 2b) This action is non-final.
- 3) Since this application is in condition for allowance except for formal matters, prosecution as to the merits is closed in accordance with the practice under *Ex parte Quayle*, 1935 C.D. 11; 453 O.G. 213.

Disposition of Claims

- 4) Claim(s) 1-69 is/are pending in the application.
4a) Of the above, claim(s) _____ is/are withdrawn from consideration.
- 5) Claim(s) _____ is/are allowed.
- 6) Claim(s) _____ is/are rejected.
- 7) Claim(s) _____ is/are objected to.
- 8) Claims 1-69 are subject to restriction and/or election requirement.

Application Papers

- 9) The specification is objected to by the Examiner.
- 10) The drawing(s) filed on _____ is/are a) accepted or b) objected to by the Examiner.
Applicant may not request that any objection to the drawing(s) be held in abeyance. See 37 CFR 1.85(a).
- 11) The proposed drawing correction filed on _____ is: a) approved b) disapproved by the Examiner.
If approved, corrected drawings are required in reply to this Office action.
- 12) The oath or declaration is objected to by the Examiner.

Priority under 35 U.S.C. §§ 119 and 120

- 13) Acknowledgement is made of a claim for foreign priority under 35 U.S.C. § 119(a)-(d) or (f).
a) All b) Some* c) None of:
1. Certified copies of the priority documents have been received.
2. Certified copies of the priority documents have been received in Application No. _____
3. Copies of the certified copies of the priority documents have been received in this National Stage application from the International Bureau (PCT Rule 17.2(a)).

*See the attached detailed Office action for a list of the certified copies not received.

- 14) Acknowledgement is made of a claim for domestic priority under 35 U.S.C. § 119(e).
a) The translation of the foreign language provisional application has been received.
- 15) Acknowledgement is made of a claim for domestic priority under 35 U.S.C. §§ 120 and/or 121.

Attachment(s)

- 1) Notice of References Cited (PTO-892)
- 2) Notice of Draftsperson's Patent Drawing Review (PTO-948)
- 3) Information Disclosure Statement(s) (PTO-1449) Paper No(s). _____
- 4) Interview Summary (PTO-413) Paper No(s). _____
- 5) Notice of Informal Patent Application (PTO-152)
- 6) Other:

Art Unit: 2684

DETAILED ACTION

Election/Restriction

1. Restriction to one of the following inventions is required under 35 U.S.C. 121:
 - I. Claims 1-8, 17-33, 43-51 and 63-65, drawn to a method and a system for redirecting a call(s) from a data processing system to another address, classified in class 455, subclass 445.
 - II. Claims 9-16, and 34-42, drawn to a computer program product in computer readable media for use in a data processing system, classified in class 712, subclass 200+.
 - III. Claims 52-62, and 66-69, drawn to a communication system and its method for processing and/or initiating a call including registration processes, classified in class 455, subclass 435.
2. The inventions are distinct, each from the other because of the following reasons:
3. Inventions I, II and III are related as combination and subcombinations. Inventions in this relationship are distinct if it can be shown that (1) the combination as claimed does not require the particulars of the subcombination as claimed for patentability, and (2) that the subcombination has utility by itself or in other combinations (MPEP § 806.05(c)). In the instant case, the combination as claimed does not require the particulars of the subcombination as claimed because invention I refers to a method and a system for redirecting a call(s) from a data processing system to another

Art Unit: 2684

address for routing calls. The subcombination has separate utility whereas invention II is about a computer program product in computer readable media for use in a data processing system for redirecting a call(s) from a data processing system to another address; and invention III is different from invention I & II for a communication system and its method for processing and/or initiating a call including registration processes. See MPEP § 806.05(d).

4. Because these inventions are distinct for the reasons given above and have acquired a separate status in the art as shown by their different classification, restriction for examination purposes as indicated is proper.

5. Because these inventions are distinct for the reasons given above and the search required for Group I is not required for Group II & III, restriction for examination purposes as indicated is proper.

6. Because these inventions are distinct for the reasons given above and have acquired a separate status in the art because of their recognized divergent subject matter, restriction for examination purposes as indicated is proper.

Conclusion

7. **Any response to this action should be mailed to:**
Commissioner of Patents and Trademarks
Washington, D.C. 20231

or faxed to:
(703) 872-9314, (for Technology Center 2600 only)

*Hand-delivered responses should be brought to Crystal Park II,
2121 Crystal Drive, Arlington, VA., Sixth Floor (Receptionist).*

Art Unit: 2684

8. Any inquiry concerning this communication or earlier communications from the examiner should be directed to Tony Thuan Nguyen whose telephone number is (703) 308-5860. The examiner can normally be reached on Monday-Friday from 9:00 AM to 6:00 PM, with alternate Fridays off.

If attempts to reach the examiner by telephone are unsuccessful, the examiner's supervisor, Daniel Hunter, can be reached at (703) 308-6732.

Any inquiry of a general nature or relating to the status of this application or proceeding should be directed to the **Technology Center 2600 Customer Service Office** whose telephone number is **(703) 306-0377**.



TONY T. NGUYEN
PATENT EXAMINER

Tony T. Nguyen
Art Unit 2684
June 12, 2002

GP 2743

RECEIVED
MAR 23 2000
TC 2700 MAIL ROOM

IN THE UNITED STATES PATENT AND TRADEMARK OFFICE

In re application of: **Osterhout et al.**

§ Group Art Unit: **Unknown**

Serial No.: **09/419,175**

§ Examiner: **Unknown**

Filed: **October 15, 1999**

§ Attorney Docket No.: **11032RR**

For: **Portable Call Management System**



Certificate of Mailing Under 37 C.F.R. § 1.8(a)
I hereby certify this correspondence is being deposited with the United States Postal Service as First Class mail in an envelope addressed to: Assistant Commissioner of Patents, Washington, D.C. 20231 on 3/15/00
By: Jennifer Wright
Jennifer Wright

TRANSMITTAL DOCUMENT

Assistant Commissioner of Patents
Washington, D.C. 20231

Sir:

ENCLOSED HEREWITH:

- Information Disclosure Statement;
- Form PTO-1449;
- Reference AA-AB; and
- Our return postcard.

No fees are believed to be necessary. If, however, any fees are required, I authorize the Commissioner to charge these fees which may be required to Deposit Account No. 50-0392.

Respectfully submitted,

Duke W. Yee
Duke W. Yee

Registration No. 34,285
CARSTENS, YEE & CAHOON, LLP
P.O. Box 802334
Dallas, Texas 75380
(972) 367-2001
ATTORNEY FOR APPLICANT

IN THE UNITED STATES PATENT AND TRADEMARK OFFICE

In re application of: **Osterhout**

Serial No.: 09/419,175

Filed: **October 15, 1999**

For: **Portable Call Management System**

§
§ Group Art Unit: **Unknown**
§
§ Examiner: **Unknown**
§
§ Attorney Docket No.: **11032RR**
§

TC 2700 MAIL ROOM

MAR 23 2000

RECEIVED

K. Ward
3/30/00
#4
Rain Art
W. Allich



Certificate of Mailing Under 37 C.F.R. § 1.8(a)
I hereby certify this correspondence is being deposited with the United States Postal Service as First Class mail in an envelope addressed to: Assistant Commissioner of Patents, Washington, D.C. 20231 on 3/15/00
By: *Jennifer Wright*
Jennifer Wright

INFORMATION DISCLOSURE STATEMENT UNDER 37 C.F.R. 1.97

Hon. Assistant Commissioner of Patents
Washington, D.C. 20231

Sir:

Applicants request that the information listed on the attached Form PTO-1449 be considered by the Office during the pendency of the above entitled application, pursuant to 37 C.F.R. 1.97.

Please charge any fees necessary for prosecution of the present application to Deposit Account No. 50-0392. If any extension of time is required, such extension is hereby requested. Please charge any additional required fee for extension of time to Deposit Account No. 50-0392. A duplicate copy of this document is enclosed.

In accordance with 37 C.F.R. 1.97(h), the filing of this Information Disclosure Statement shall not constitute an admission that any information cited therein is, or is considered to be, material to patentability as defined in 37 C.F.R. 1.56(b). In the interest of full and complete

disclosure to the Office, some or all of the art cited herein may not be considered by Applicant(s) or the Undersigned to be material under the new standards of materiality defined in 37 C.F.R. 1.56(b), enacted March 16, 1992, but may be material under the old standard of materiality defined in 37 C.F.R. 1.56(a), last amended on November 28, 1988, or may merely be technical background which may be of interest to the Examiner. In accordance with 37 C.F.R. 1.97(g), the filing of this Information Disclosure Statement shall not be construed to mean that a search has been made.

This Information Disclosure Statement is being filed under 37 C.F.R. § 1.97(b) within three months of the filing date of the application, or before the mailing date of a first office action on the merits. No fee or certification is required.

Respectfully submitted,

Date: 3/15/00

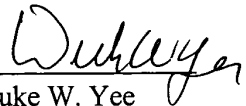
Duke W. Yee
Reg. No. 34,285
Carstens, Yee & Cahoon, LLP
P.O. Box 802334
Dallas, Texas 75380
(972) 367-2000

Attorney for Applicant



GAU 2745

IN THE UNITED STATES PATENT AND TRADEMARK OFFICE

In re application of:
OSTERHOUT ET AL.

Serial No.: 09/419,175

Filed: 10/15/99

For: **PORTABLE
MANAGEMENT SYSTEM**

CALL

§ Group Art Unit: 2745

§
§ Examiner: UNKNOWN

§
§ Attorney Docket No.: 11032RR

§

RECEIVED
MAR-9 2000
TC 2700 MAIL ROOM

Certificate of Mailing Under 37 C.F.R. § 1.8(a)
 I hereby certify this correspondence is being deposited with the United States Postal Service as First Class mail in an envelope addressed to: Assistant Commissioner of Patents, Washington, D.C. 20231 on 2/21/00
 By: 
 Jennifer Wright

TRANSMITTAL DOCUMENT

Assistant Commissioner of Patents
Washington, D.C. 20231

Sir:

ENCLOSED HEREWITH:

- Change of Attorney's Address Form; and
- Our return postcard.

No fees are believed to be necessary. If, however, any fees are required, I authorize the Commissioner to charge these fees which may be required to Deposit Account No. 50-0392. No extension of time is believed to be necessary. If, however, any fees are required, I authorize the Commissioner to charge these fees which may be required to Deposit Account No. 50-0392.

Respectfully submitted,



Duke W. Yee
Registration No. 34,285
CARSTENS, YEE & CAHOON, LLP
P.O. Box 802334
Dallas, Texas 75380
(972) 367-2001
ATTORNEY FOR APPLICANT

Docket No. 11032RR*



PATENT

IN THE UNITED STATES PATENT AND TRADEMARK OFFICE

In re application of: **OSTERHOUT ET AL.**
Serial No.: 09/419,175
Filed: 10/15/99
For: **PORTABLE CALL MANAGEMENT SYSTEM**

Group No.: 2745
Examiner: UNKNOWN

Assistant Commissioner for Patents
Washington, D.C. 20231

RECEIVED
MAR -9 2000
TC 2700 MAIL ROOM

CHANGE OF ATTORNEY'S ADDRESS IN APPLICATION

Please send all correspondence for this application as follows:

Duke W. Yee
Carstens Yee & Cahoon, LLP
P.O. Box 802334
Dallas, TX 75380

Please direct telephone calls to:

(972) 367-2001

Duke W. Yee

Duke W. Yee
Reg. No. 34,285
Tel. No.: (972) 367-2001
P.O. Box 802334
Dallas, TX 75380

CERTIFICATE OF MAILING/TRANSMISSION (37 C.F.R. 1.8(a))

I hereby certify that, on the date shown below, this correspondence is being:

MAILING

deposited with the United States Postal Service with sufficient postage as first class mail in an envelope addressed to the Assistant Commissioner for Patents, Washington, D.C. 20231.

FACSIMILE

transmitted by facsimile to the Patent and Trademark Office.

Date: 2/28/00

Signature *Jennifer Wright*
(type or print name of person certifying)

09/419175

NOTICE OF DRAFTSPERSON'S PATENT DRAWING REVIEW

The drawing(s) filed (insert date) 10/15/99 are:

- A. [] approved by the Draftsperson under 37 CFR 1.84 or 1.152.
B. [X] objected to by the Draftsperson under 37 CFR 1.84 or 1.152 for the reasons indicated below. The Examiner will require submission of new, corrected drawings when necessary.

1. DRAWINGS. 37 CFR 1.84(a): Acceptable categories of drawings: Black ink. Color. Fig(s)
2. PHOTOGRAPHS. 37 CFR 1.84 (b) Fig(s)
3. TYPE OF PAPER. 37 CFR 1.84(c) Fig(s)
4. SIZE OF PAPER. 37 CFR 1.84(f): Acceptable sizes: Fig(s)
5. MARGINS. 37 CFR 1.84(g): Acceptable margins: Fig(s)
6. VIEWS. 37 CFR 1.84(h) Fig(s)
7. SECTIONAL VIEWS. 37 CFR 1.84 (h)(3) Fig(s)
8. ARRANGEMENT OF VIEWS. 37 CFR 1.84(i) Fig(s)
9. SCALE. 37 CFR 1.84(k) Fig(s)
10. CHARACTER OF LINES, NUMBERS, & LETTERS. 37 CFR 1.84(j) Fig(s)
11. SHADING. 37 CFR 1.84(m) Fig(s)
12. NUMBERS, LETTERS, & REFERENCE CHARACTERS. 37 CFR 1.84(p) Fig(s)
13. LEAD LINES. 37 CFR 1.84(q) Fig(s)
14. NUMBERING OF SHEETS OF DRAWINGS. 37 CFR 1.84(t) Fig(s)
15. NUMBERING OF VIEWS. 37 CFR 1.84(u) Fig(s)
16. CORRECTIONS. 37 CFR 1.84(w) Fig(s)
17. DESIGN DRAWINGS. 37 CFR 1.152 Fig(s)

REVIEWER [Signature] DATE 1/5/00 TELEPHONE NO.

ATTACHMENT TO PAPER NO.

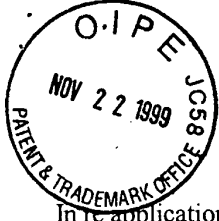

Sector #

IN THE UNITED STATES PATENT AND TRADEMARK OFFICE

In re application of: **Osterhout et al.**

Serial No.: **09/419,175**

Filed: **10/15/99**

For: **Portable Call Management System**

§ Group Art Unit: **2745**

§

§ Examiner: **Unknown**

§

§ Attorney Docket No.: **11032RR**

§

Certificate of Mailing Under 37 C.F.R. § 1.8(a)

I hereby certify this correspondence is being deposited with the United States Postal Service as First Class mail in an envelope addressed to: Assistant Commissioner of Patents, Washington, D.C. 20231 on

November 19, 1999.

By: Stacy Bachmann
Stacy Bachmann

TRANSMITTAL DOCUMENT

Assistant Commissioner of Patents
Washington, D.C. 20231

Sir:

ENCLOSED HEREWITH:

- Change of Attorney's Address in Application;
- Notice to File Missing Parts of Application;
- Declaration and Power of Attorney for Patent Application;
- Recordation;
- 2 Assignments;
- Check in the sum of \$40.00; and
- Our return postcard.

No fees are believed to be necessary. If, however, any additional fees are required, I authorize the Commissioner to charge these fees which may be required to Deposit Account No. 50-0392. No extension of time is believed to be necessary. If, however, an extension of time is required, the extension is requested, and I authorize the Commissioner to charge any fees for this extension to Deposit Account No. 50-0392.

Respectfully submitted,

Duke W. Yee

Duke W. Yee
Registration No. 34,285
CARSTENS, YEE & CAHOON, LLP
P.O. Box 802334
Dallas, Texas 75380
(972) 367-2001
ATTORNEY FOR APPLICANT

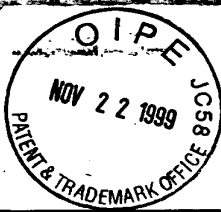

UNITED STATES DEPARTMENT OF COMMERCE
Patent and Trademark Office
 Address: COMMISSIONER OF PATENTS AND TRADEMARKS
 Washington, D.C. 20231

APPLICATION NUMBER	FILING/RECEIPT DATE	FIRST NAMED APPLICANT	ATTORNEY DOCKET NO./TITLE
--------------------	---------------------	-----------------------	---------------------------

09/419,175	10/15/99	OSTERHOUT	G 11032RR
------------	----------	-----------	-----------

0232/1104

STEPHEN R LOE
 CARSTENS YEE & CAHOON LLP
 P O BOX 802334
 DALLAS TX 75380

NOT ASSIGNED

2745

DATE MAILED:

11/04/99

NOTICE TO FILE MISSING PARTS OF APPLICATION

Filing Date Granted:

An Application Number and Filing Date have been assigned to this application. The items indicated below, however, are missing. Applicant is given TWO MONTHS FROM THE DATE OF THIS NOTICE within which to file all required items and pay any fees required below to avoid abandonment. Extensions of time may be obtained by filing a petition accompanied by the extension fee under the provisions of 37-CFR 1.136(a). If any of items 1 or 3 through 5 are indicated as missing, the SURCHARGE set forth in 37 CFR 1.16(e) of \$65.00 for a small entity in compliance with 37 CFR 1.27, or \$130.00 for a non-small entity, must also be timely submitted in reply to this NOTICE to avoid abandonment.

If all required items on this form are filed within the period set above, the total amount owed by applicant as a small entity (statement filed) non-small entity is \$ 200

- 1. The statutory basic filing fee is:
 - missing.
 - insufficient.
 Applicant must submit \$ _____ to complete the basic filing fee and/or file a small entity statement claiming such status (37 CFR 1.27).
- 2. The following additional claims fees are due:
 - \$ _____ for _____ total claims over 20.
 - \$ _____ for _____ independent claims over 3.
 - \$ _____ for multiple dependent claim surcharge.
 Applicant must either submit the additional claim fees or cancel additional claims for which fees are due.
- 3. The oath or declaration:
 - is missing or unsigned.
 - does not cover the newly submitted items.
 An oath or declaration in compliance with 37 CFR 1.63, including residence information and identifying the application by the above Application Number and Filing Date is required.
- 4. The signature(s) to the oath or declaration is/are by a person other than inventor or person qualified under 37 CFR 1.42, 1.43 or 1.47.

A properly signed oath or declaration in compliance with 37 CFR 1.63, identifying the application by the above Application Number and Filing Date, is required.
- 5. The signature of the following joint inventor(s) is missing from the oath or declaration:

An oath or declaration in compliance with 37 CFR 1.63 listing the names of all inventors and signed by the omitted inventor(s), identifying this application by the above Application Number and Filing Date, is required.
- 6. A \$50.00 processing fee is required since your check was returned without payment (37 CFR 1.21(m)).
- 7. Your filing receipt was mailed in error because your check was returned without payment.
- 8. The application was filed in a language other than English.

Applicant must file a verified English translation of the application, the \$130.00 set forth in 37 CFR 1.17(k), unless previously submitted, and a statement that the translation is accurate (37 CFR 1.52(d)).
- 9. OTHER:

09419175
 00000049 500392
 130.00 CH
 11/23/1999 CCEITN
 02 FC:105

Direct the reply and any questions about this notice to "Attention: Box Missing Parts."

A copy of this notice MUST be returned with the reply.

[Signature]

Customer Service Center
 Initial Patent Examination Division (703) 308-1202



Docket No. 11032RR

PATENT

IN THE UNITED STATES PATENT AND TRADEMARK OFFICE

In re application of: Osterhout et al.
Serial No.: 09/419,175
Filed: October 15, 1999
For: Portable Call Management System

Group No.: 2745
Examiner: Unknown

Assistant Commissioner for Patents
Washington, D.C. 20231

CHANGE OF ATTORNEY'S ADDRESS IN APPLICATION

Please send all correspondence for this application as follows:

John D. Crane
Nortel Networks
Intellectual Property Law Group
21 Lakeside Boulevard
MS 468/05/B10
Richardson, Texas 75082

Please direct telephone calls to:

(972) 685-8442

Stephen R. Loe
Reg. No. 43,757
Tel. No.: (972) 367-2001
13760 Noel Road, Suite 900
Dallas, Texas 75240

CERTIFICATE OF MAILING/TRANSMISSION (37 C.F.R. 1.8(a))

I hereby certify that, on the date shown below, this correspondence is being:

MAILING



deposited with the United States Postal Service with sufficient postage as first class mail in an envelope addressed to the Assistant Commissioner for Patents, Washington, D.C. 20231.

FACSIMILE



transmitted by facsimile to the Patent and Trademark Office.

Date: November 19, 1999

Signature

Stacey Bachmann
(type or print name of person certifying)



**DECLARATION AND POWER OF ATTORNEY FOR
PATENT APPLICATION**

As below named inventor, I hereby declare that:

My residence, post office address and citizenship is as stated below next to my name;

I believe that I am the original, first and sole inventor (if only one name is listed below) or an original, first and joint inventor (if plural names are listed below) of the subject matter which is claimed and for which a patent is sought on the invention entitled as set forth below, which is described in the specification of which: (check one)

was filed on October 15, 1999, under Attorney's Docket Number 11032RR as Application No. 09/419,175

PORTABLE CALL MANAGEMENT SYSTEM

I hereby state that I have reviewed and understand the contents of the above identified specification, including the claims, as amended by any amendment referred to above.

I acknowledge the duty to disclose information which is material to the patentability of this application in accordance with 37 CFR 1.56.

I hereby claim the benefit under Title 35 United States Code section 120 of the provisional application filed under 111b of this title as listed below:

I hereby declare that all statements made herein of my own knowledge are true and that all statements made on information and belief are believed to be true; and further that these statements were made with the knowledge that willful false statements and the like so made are punishable by fine of imprisonment, or both, under 18 USC 1001 and that such willful false statements may jeopardize the validity of the application or any patent issued thereon.

POWER OF ATTORNEY: As a named inventor, I hereby appoint the following attorneys and/or agents to prosecute this application and transact all business in the Patent and Trademark Office connected therewith.

John D. Crane, Reg. No. 25,231;
Christopher O. Edwards, Reg. No. 36,127; Robert C. Klinger, Reg. No. 34,365;
James A. Harrison, Reg. No. 40,401; W. Glen Johnson, Reg. No. 39,525; Duke W. Yee, Reg. No. 34,285;
Rudolph J. Buchel, Reg. No. 43,448, Joseph R. Burwell, Reg. No. 44,468, Stephen R. Loe, Reg. No. 43,757.

Send correspondence to John D. Crane, Nortel Networks Corporation, Patent Department; P.O. Box 833858, Mail Stop 468/05/B10; Richardson, Texas 75083-3858 and direct all telephone calls to John D. Crane, telephone: (972) 695-8442.

=====

(1) FULL NAME OF INVENTOR: **Gregory T. Osterhout**

INVENTOR'S SIGNATURE: _____

DATE:

RESIDENCE: 313 Falcon Court, Coppell, TX 75019

COUNTY: Dallas

CITIZENSHIP: United States

POST OFFICE ADDRESS: Same As Above

(2) FULL NAME OF INVENTOR: **Kim B. Holmes**

INVENTOR'S SIGNATURE: 

DATE: 11/17/99.

RESIDENCE: 5409 Scenic Drive, Rowlett, TX 75088

COUNTY: Rockwall

CITIZENSHIP: Canada

POST OFFICE ADDRESS: Same As Above

(3) FULL NAME OF INVENTOR: Mark Sosebee

INVENTOR'S SIGNATURE: Mark Sosebee

DATE: 11/17/99

RESIDENCE: 920 Goodwin Drive, Plano, TX 75023

COUNTY: Collin

CITIZENSHIP: United States

POST OFFICE ADDRESS: Same As Above



**UNITED STATES DEPARTMENT OF COMMERCE
Patent and Trademark Office**

Address: COMMISSIONER OF PATENTS AND TRADEMARKS
Washington, D.C. 20231

APPLICATION NUMBER	FILING/RECEIPT DATE	FIRST NAMED APPLICANT	ATTORNEY DOCKET NO./TITLE
09/419,175	10/15/99	OSTERHOUT	G 11032RR

0232/1104

STEPHEN R LOE
CARSTENS YEE & CAHOON LLP
P O BOX 802334
DALLAS TX 75380

NOT ASSIGNED

2745

DATE MAILED:

11/04/99

**NOTICE TO FILE MISSING PARTS OF APPLICATION
Filing Date Granted**

An Application Number and Filing Date have been assigned to this application. The items indicated below, however, are missing. Applicant is given **TWO MONTHS FROM THE DATE OF THIS NOTICE** within which to file all required items and pay any fees required below to avoid abandonment. Extensions of time may be obtained by filing a petition accompanied by the extension fee under the provisions of 37 CFR 1.136(a). **If any of items 1 or 3 through 5 are indicated as missing, the SURCHARGE set forth in 37 CFR 1.16(e) of \$65.00 for a small entity in compliance with 37 CFR 1.27, or \$130.00 for a non-small entity, must also be timely submitted in reply to this NOTICE to avoid abandonment.**

If all required items on this form are filed within the period set above, the total amount owed by applicant as a small entity (statement filed) non-small entity is \$ 130.

1. The statutory basic filing fee is:
 missing.
 insufficient.
Applicant must submit \$ _____ to complete the basic filing fee and/or file a small entity statement claiming such status (37 CFR 1.27).

2. The following additional claims fees are due:
\$ _____ for _____ total claims over 20.
\$ _____ for _____ independent claims over 3.
\$ _____ for multiple dependent claim surcharge.
Applicant must either submit the additional claim fees or cancel additional claims for which fees are due.

3. The oath or declaration:
 is missing or unsigned.
 does not cover the newly submitted items.
An oath or declaration in compliance with 37 CFR 1.63, including residence information and identifying the application by the above Application Number and Filing Date is required.

4. The signature(s) to the oath or declaration is/are by a person other than inventor or person qualified under 37 CFR 1.42, 1.43 or 1.47.
A properly signed oath or declaration in compliance with 37 CFR 1.63, identifying the application by the above Application Number and Filing Date, is required.

5. The signature of the following joint inventor(s) is missing from the oath or declaration:

An oath or declaration in compliance with 37 CFR 1.63 listing the names of all inventors and signed by the omitted inventor(s), identifying this application by the above Application Number and Filing Date, is required.

6. A \$50.00 processing fee is required since your check was returned without payment (37 CFR 1.21(m)).
 7. Your filing receipt was mailed in error because your check was returned without payment.
 8. The application was filed in a language other than English.
Applicant must file a verified English translation of the application, the \$130.00 set forth in 37 CFR 1.17(k), unless previously submitted, and a statement that the translation is accurate (37 CFR 1.52(d)).
 9. OTHER: _____

Direct the reply and any questions about this notice to "Attention: Box Missing Parts."

A copy of this notice MUST be returned with the reply.

Customer Service Center
Initial Patent Examination Division (703) 308-1202



10/15/99

Express Mail No.: EL356872801US

A

IN THE UNITED STATES PATENT AND TRADEMARK OFFICE

Docket No. 11032RR
Assistant Commissioner for Patents
Washington, D.C. 20231

JC503 U.S. PTO
09/419175
10/15/99

Sir:
Transmitted herewith for filing is the patent application of Inventor(s):

For: PORTABLE CALL MANAGEMENT SYSTEM

Enclosed are also:

- X 24 Pages of Specification including an Abstract
X 14 Pages of Claims
X 10 Sheet(s) of Drawings
X A Declaration and Power of Attorney

CLAIMS AS FILED

Table with columns: FOR, Number Filed, Number Extra, Rate, Basic Fee (\$760). Rows include Total Claims, Independent Claims, Multiple Dependent Claims, and Total Filing Fee.

- X A check in the amount of \$2,188.00 is enclosed for the filing.
X The Commissioner is hereby authorized to charge payment of the following fees associated with the communication or credit any over payment to Carstens, Yee & Cahoon, Deposit Account No. 50-0392. A duplicate copy of this sheet is enclosed.
X Any additional filing fees required under 37CFR § 1.16.
X Any patent application processing fees under 37CFR § 1.17.

Respectfully,

Signature of Stephen R. Loe
Stephen R. Loe
Registration No. 43,757
CARSTENS YEE & CAHOON, LLP
P.O. Box 802334
Dallas, Texas 75380
(972) 367-2001
ATTORNEY FOR APPLICANT

Vertical text on the left margin: 10/15/99

Docket No. 11032RR

PORTABLE CALL MANAGEMENT SYSTEM5 **1. Field of the Invention:**

The present invention relates to telecommunications systems and, more specifically, to methods of transferring calls real time from one device to another.

2. Background of the Invention:

10 Historically, when a caller telephoned a party, if the party to which the caller wished to speak with did not answer the phone or if the line was busy, the caller had to hang up and redial at a later time hoping that the second call would reach the intended party. Often times, the caller would need to attempt to contact the party multiple times in order to reach that party. If the caller had urgent
15 information in which time was of the essence, this method was unsatisfactory and often resulted in the intended party missing important business or other opportunities.

Some of these problems were alleviated with the introduction of answering machines and voice mail systems. However, even these solutions were not
20 completely satisfactory. For instance, utilizing answering machines and voice mail systems required the called party to actively retrieve their messages. Thus, either many important messages were still not received in a timely manner if the called party did not retrieve their messages frequently or the called party was required to check their voice mail or answering machine quite frequently when the
25 party was out of the office or home in order to insure that messages were retrieved quickly. Thus, this results in the same problem as having the caller repeatedly call the intended party, except that in this case it is the called party that must waste its time insuring that no messages are missed.

A more recent solution to this problem is the introduction of subscriber's
30 static reach list. A static reach list enabled a subscriber (i.e., called party) to enter a list of telephone numbers (or IP addresses, etc.) where the subscriber might be reached. The subscriber would enter these numbers in the order of preference in

Docket No. 11032RR

which the subscriber wished the telecommunications system to try to reach the subscriber. Therefore, if the subscriber were going to be away from the location of the subscriber's normal telephone number, if a call were received for the subscriber, the telecommunications system would redirect the subscriber's calls to

5 the next number on the static reach list until the subscriber were reached or until the list of numbers was exhausted.

However, this method required the subscriber to know in advance the telephone number or other communications address at which the subscriber would be while traveling. Many times such information is unknowable either because

10 the person does not know a number at the location to which they are travelling or because the person does not know sufficiently in advance where they will be in order to update the static reach list with the appropriate number. Therefore, it would be beneficial to have a method of to prevent a called party from missing calls without being required to know the number of a phone at which they will be

15 in advance.

SECRET

Docket No. 11032RR

SUMMARY OF THE INVENTION

The present invention solves the problem of preventing a called party from missing calls without having to know in advance the number at which they will be by providing a method and apparatus for redirecting a call from a data processing system to another address. In a preferred embodiment, a notice of an incoming call received from a server at a data processing system. This notice may include caller identification information as well. The user of the data processing system is prompted for an address to which the user wishes the call to be redirected. The user then identifies and sends to the server a new address to which the incoming call is to be redirected.

In another aspect of the present invention, an SIP server receives a notice of a call and forwards the notice to a SIP user agent. The SIP proxy server then identifies the address to which the called party wishes the call sent from a database of preferred locations. The called party has previously registered their preferred location to this database. The SIP user agent then sends a message to the called party that they have an incoming call. The called party then identifies a phone number or IP address to which the called party wishes the call to be redirected. Thus, the called party can have their calls originally directed to their handheld personal digital assistant or other data processing device. Thus, when a call is received, the called party can determine at that time how to dispose of the call.

Other aspects and features of the present invention will become apparent to those ordinarily skilled in the art upon review of the following description of specific embodiments of the invention in conjunction with the accompanying figures.

Docket No. 11032RR

BRIEF DESCRIPTION OF THE DRAWINGS

5 The novel features believed characteristic of the invention are set forth in the appended claims. The invention itself, however, as well as a preferred mode of use, further objectives and advantages thereof, will best be understood by reference to the following detailed description of an illustrative embodiment when read in conjunction with the accompanying drawings, wherein:

10 **Figure 1** depicts a block diagram illustrating a communications network in which the present invention may be implemented;

Figure 2 depicts a block diagram of a data processing system which may be implemented as a server in accordance with the present invention;

15 **Figure 3** depicts a block diagram of a portable device such as a personal digital assistant (PDA) in which the present invention may be implemented;

Figure 4 depicts a block diagram of a data processing system in which the present invention may be implemented;

Figure 5 depicts a message flow chart illustrating the processes of redirecting a call in real time from according to the present invention;

20 **Figures 6A-6E** illustrate examples of sample HTML or web pages displayed to a user of a portable computing device;

Figure 7 depicts a flowchart illustrating the methods executed on a portable computing device in accordance with a preferred embodiment of the present invention;

25 **Figure 8** depicts a flowchart illustrating the processes of redirecting a call which are implemented on a server within the communications network in accordance with the present invention;

Figure 9 depicts a flowchart illustrating a method of converting HTML to SIP as performed by a SIP User Agent in accordance with the present invention;

30 and

Express Mail No.: EL356872801US

Docket No. 11032RR

Figure 10 depicts a flowchart illustrating a method of converting an SIP signal into an HTML message in accordance with the present invention.

Patent Application No. 11/032,222

Docket No. 11032RR

DETAILED DESCRIPTION OF THE PREFERRED EMBODIMENT

5

With reference now to the figures, and in particular with reference to **Figure 1**, a system diagram illustrating a plurality of interconnected heterogeneous networks in which the present invention may be implemented is depicted. As illustrated, an Internet Protocol (IP) network **102**, a Local Area Network (LAN) / Wide Area Network (WAN) **104**, the Public Switched Telephone Network (PSTN) **109**, a cellular wireless network **112**, and a satellite communication network **116** make up the plurality of heterogeneous networks serviced by the personal mobility system of the present invention.

IP network **102** may be the publicly available IP network, a private IP network, or a combination of public and private IP networks. In any case, IP network **102** operates according to the Internet Protocol and routes packets among its many switches and through its many transmission paths. IP networks are generally known in the art to be expandable, fairly easy to use and heavily supported. Coupled to IP network **102** is a Domain Name Server (DNS) **108** to which queries may be sent, such queries each requesting an IP address based upon a Uniform Resource Locator (URL). IP network **102** supports 32 bit IP addresses as well as 128 bit IP addresses, which are currently in the planning stage.

LAN/WAN **104** couples to IP network **102** via a proxy server **106** (or another connection). LAN/WAN **104** may operate according to various communication protocols, such as the Internet Protocol, the Asynchronous Transfer Mode (ATM) protocol, or other known packet switched protocols. Proxy server **106** serves to route data between IP network **102** and LAN/WAN **104**. A firewall that precludes unwanted communications from entering LAN/WAN **104** may also be located at the location of proxy server **106**.

Computer **120** couples to LAN/WAN **104** and supports communications with LAN/WAN **104**. Computer **120** may employ the LAN/WAN and proxy

Docket No. 11032RR

server **106** to communicate with other devices across IP network **102**. Such communications are generally known in the art and will not be further described herein except to expand upon the teachings of the present invention. As is also shown, phone **122** couples to computer **120** and may be employed to initiate IP
5 Telephony communications with another phone or voice terminal using IP Telephony. In such an IP telephony system, a gatekeeper **152** is deployed by a service provider to manage IP telephony for its users. An IP phone **154** connected to IP network **102** (or other phone, e.g., phone **124**) may communicate with phone **122** using IP telephony.

10 PSTN **109** is a circuit switched network that is primarily employed for voice communications, such as those enabled by a standard phone **124**. However, PSTN **109** also supports the transmission of data. Data transmissions may be supported to a tone based terminal, such as a FAX machine **125**, to a tone based modem contained in computer **126**, or to another device that couples to PSTN **109**
15 via a digital connection, such as an Integrated Services Digital Network (ISDN) line, an Asynchronous Digital Subscriber Line (ADSL), or another digital connection to a terminal that supports such a connection. As illustrated, a voice terminal, such as phone **128**, may couple to PSTN **109** via computer **126** rather than being supported directly by PSTN **109**, as is the case with phone **124**. Thus,
20 computer **126** may support IP telephony with voice terminal **128**, for example.

Cellular network **112** supports wireless communications with terminals operating in its service area (which may cover a city, county, state, country, etc.). As is known, cellular network **112** includes a plurality of towers, e.g., **130**, that each service communications within a respective cell. Wireless terminals that
25 may operate in conjunction with cellular network **112** include wireless handsets **132** and wirelessly enabled laptop computers **134**, for example. Wireless handsets **132** could be, for example, personal digital assistants, wireless or cellular telephones, or two-way pagers. Cellular network **112** couples to IP network **102** via gateway **114**.

30 Wireless handsets **132** and wirelessly enabled laptop computers **134** may communicate with cellular network **112** using a wireless application protocol

Docket No. 11032RR

(WAP). WAP is an open, global specification that allows mobile users with wireless devices, such as, for example, mobile phones, pagers, two-way radios, smartphones, communicators, personal digital assistants, and portable laptop computers, to easily access and interact with information and services almost
5 instantly. WAP is a communications protocol and application environment and can be built on any operating system including, for example, Palm OS, EPOC, Windows CE, FLEXOS, OS/9, and JavaOS. WAP provides interoperability even between different device families.

WAP is the wireless equivalent of Hypertext Transfer Protocol (HTTP)
10 and Hypertext Markup Language (HTML). The HTTP-like component defines the communication protocol between the handheld device and a server or gateway. This component addresses characteristics that are unique to wireless devices, such as data rate and round-trip response time. The HTML-like component, Wireless Markup Language (WML), defines new markup and scripting languages for
15 displaying information to and interacting with the user. This component is highly focused on the limited display size and limited input devices available on small, handheld devices. For example, a typical cell phone may have only a 4x10-character display with 16-gray levels and only a numeric keypad plus up/down volume keys.

20 Cellular network **112** operates according to an operating standard, which may be the Advanced Mobile Phone System (AMPS) standard, the Code Division Multiple Access (CDMA) standard, the Time Division Multiple Access (TDMA) standard, or the Global System for Mobile Communications or Groupe Speciale Mobile (GSM), for example. Independent of the standard(s) supported by cellular
25 network **112**, cellular network **112** supports voice and data communications with terminal units, e.g., **132** and **134**.

Satellite network **116** includes at least one satellite dish **136** that operates in conjunction with a satellite **138** to provide satellite communications with a plurality of terminals, e.g., laptop computer **142** and satellite handset **140**.
30 Satellite handset **140** could also be a two-way pager. Satellite network **116** may be serviced by one or more geosynchronous orbiting satellites, a plurality of

Docket No. 11032RR

medium earth orbit satellites, or a plurality of low earth orbit satellites. In any case, satellite network **116** services voice and data communications and couples to IP network **102** via gateway **118**.

Wireless Proxy **160** is coupled to IP network **102** and is coupled to a plurality of towers, e.g., **162**, which each provide wireless communications with wireless devices such as wireless device **164**. Wireless Proxy **160** provides access to IP network **102** to wireless device **164**, such as personal digital assistants (PDAs), that may require proprietary or other special protocols in order to communicate with IP network **102**. For example, wireless proxy server **160** may be a 3Com server utilizing 3Com protocols for communicating with a Palm VII, a handheld portable computing device available from 3Com Corporation in Santa Clara, California.

In a preferred embodiment of the present invention, wireless proxy **160** is a 3Com proxy server supporting communications with Palm VII personal organizer and portable computing device **164** is a Palm VII personal organizer. In this embodiment, communications between wireless proxy server **160** and portable computing device **164** is facilitated by the use of Palm Query Applications (PQAs). A PQA is like a mini-Web site that resides on portable computing device **164**. That is, a PQA is a special kind of record database. A typical PQA contains an HTML form or a list of hyperlinks that request additional information either locally — on personal computing device **164** — or remotely — on the Internet.

Much of the content on the Internet is designed to take advantage of the power of Pentium/RISC-class computers with large, high resolution color monitors and fast and cheap Internet access. In these circumstances, there is little reason to economize on the abundant connect time and large file size that make Web browsing such a rich, multimedia experience from a desktop or notebook computer.

However, this model is not the best model for a small, low-power computer like the Palm VII organizer with its tiny screen, battery powered operation, and relatively slow and expensive wireless connection to the Internet.

Docket No. 11032RR

Rather than duplicate the Web browsing model on a handheld computer, PQAs are developed that access targeted bits of Internet information — like clippings from a newspaper. Typically, a handheld computer user does not focus on following hyperlinks to the Internet (although this is available), but instead, they
5 compose a simple query in the PQA (for example a request for a stock quote) and then send that query over the air.

Also included in network **100** is a Session Initiation Protocol (SIP) proxy **170**. SIP proxy **170** is connected to IP network **102** and provides switching and routing for communication over IP network **102**. SIP proxy **170** also maintains a
10 static list of preferred locations to which a user wishes telephone calls or other communication types sent. When a request to initiate a communications session is received, SIP proxy **170** retrieves the static list of the called party and routes the call to the top address in the static list. If the communications session is not established with the top address in the static list, then SIP proxy **170** may attempt
15 to access the next address in the list and so on until the called party is reached or until the addresses in the static list are exhausted.

SIP is a textual based signaling protocol for creating, modifying and terminating sessions. These sessions can be multimedia conferences, Internet telephone calls and similar applications consisting of one or more media types
20 such as, for example, audio, video, or whiteboard. SIP invitations are used to create sessions and carry session descriptions, which allow participants to agree on a set of compatible media types. SIP requests can be sent either over TCP or UDP.

SIP User Agent **172** is also connected with IP Network **102**. SIP User
25 Agent **172** translates between SIP communications and Hypertext Transfer Protocol (HTTP) and other extensible markup language (XML) based protocols such as Voice XML (VOXML) and Wireless Application Protocol (WAP).

Figure 1 is intended as an example and not as an architectural limitation for the processes of the present invention.

30 In a preferred embodiment, a user registers an address to which they wish their voice calls or other communications to be sent. The address can be an IP

Docket No. 11032RR

address, a PSTN address or other type of address for locating an electronic device such as a data processing system or telephone. As an example, consider a user of portable device **164** wishing to have all of their calls routed to the portable device. The user of portable device **164** sends an HTML registration request to Wireless
5 Proxy **160**, which then forwards the HTML registration request to SIP User Agent **172**. SIP User Agent **172** translates the HTML registration request from HTML into an SIP registration statement and sends the SIP registration statement to SIP Proxy **170**. SIP Proxy **170** then updates the user's static list and inserts the newly received address into the top of the static list as the first address to attempt
10 to establish a connection with if a request to initiate communications with that user is received. If the user does not have a static list, SIP Proxy **170** can create one and then place the received address in the newly created static list. The registration request does not have to initiate from a portable wireless device such as portable device **164** but may initiate with a LAN based data processing system
15 such as client **120** or with some other type of wireless device.

When SIP Proxy **170** receives a request to initiate communications, such as a voice telephone call, with a user, SIP Proxy **170** retrieves the static list for the called party and determines the first address to contact. SIP Proxy **170** then sends an SIP Invite message to SIP User Agent **172**. SIP User Agent **172** translates the
20 SIP Invite message into an HTML message and sends the HTML message to Wireless Proxy **160** which then forwards the HTML message to portable device **164**.

Once the HTML invite message is received at portable device **164**, the user may then determine how to dispose of the call. If portable device **164** is a
25 telephone (or supports voice communications), the user may choose to take the call if it is someone to which the user wishes to speak. The user may also redirect the call elsewhere to a nearby PSTN address, to a voice mailbox, or to an IP address. Portable device **164** may even suggest options as to disposal of the incoming communication. For example, if the incoming communication is video,
30 rather than a voice call, portable device **164** may suggest routing the

Docket No. 11032RR

communication to client **120** on LAN/WAN **104**, which may be the nearest device capable of receiving such communication.

If the user decides to redirect the call to some other device, then redirection information in HTML format indicating the address of the new device is sent from portable device **164** to wireless proxy **160**. Wireless proxy **160** then forwards the HTML redirect information to SIP User Agent **172**, which converts the HTML redirect information into an SIP redirect and send the SIP redirect to SIP proxy **170**. SIP User Agent **172** also sends an HTML notification to portable device **164** via wireless proxy **160** indicating that the communication is being redirected. SIP proxy **170** then redirects the communication to the new address and takes down the connection with portable device **164**. If SIP proxy **170** is unable to make a connection with the new address (e.g., incorrect address, device off-line, etc.), then the communication must be terminated or the next address in the user's static list contacted. This is because the connection to portable device **164** has already been taken down thus preventing an attempt to request a new address to which to redirect the communication.

As an example of uses of such redirection methods and systems according to the present invention, consider a family consisting of a husband, wife, and children. Perhaps the husband has registered his wireless telephone as the device to which incoming calls to his home telephone should be delivered. If notification of an incoming call is received by the husband on his wireless telephone, he can look at the display to see who the caller is. If the husband determines that the call is for his wife, he can redirect the call to her work phone or to her wireless phone. If the call is for one of the children, the call can be redirected to the home phone. However, if the call is for the husband, he can choose to take the call on his wireless telephone. Alternatively, if the call is for the husband, but he does not wish to speak with the caller, the call can be forwarded to his voice mailbox.

As another example of the use of redirection methods and systems according to the present invention, consider a person travelling on business and away from the office. The business person can register a personal digital assistant (PDA) as the device to which incoming calls are directed. Thus, wherever the

Docket No. 11032RR

business person is, no calls will be misses because of being away from the office. If notification of a call is received, the business person can have the call redirected to a phone near where the business person is presently located. Such phone could be the room phone of the hotel where the person is currently staying or it could be
5 the office phone of the person with which the business person is meeting.

Referring now to **Figure 2**, a block diagram of a data processing system which may be implemented as a server, such as server **106, 108, 160, or 170** in **Figure 1**, is depicted in accordance with the present invention. Data processing system **200** may be a symmetric multiprocessor (SMP) system including a
10 plurality of processors **202** and **204** connected to system bus **206**. Alternatively, a single processor system may be employed. Also connected to system bus **206** is memory controller/cache **208**, which provides an interface to local memory **209**. I/O bus bridge **210** is connected to system bus **206** and provides an interface to I/O bus **212**. Memory controller/cache **208** and I/O bus bridge **210** may be
15 integrated as depicted.

Peripheral component interconnect (PCI) bus bridge **214** connected to I/O bus **212** provides an interface to PCI local bus **216**. A number of modems **218-220** may be connected to PCI bus **216**. Typical PCI bus implementations will support four PCI expansion slots or add-in connectors. Communications links to
20 network computers **120, 126, 134, and 142** in **Figure 1** may be provided through modem **218** and network adapter **220** connected to PCI local bus **216** through add-in boards.

Additional PCI bus bridges **222** and **224** provide interfaces for additional PCI buses **226** and **228**, from which additional modems or network adapters may
25 be supported. In this manner, server **200** allows connections to multiple network computers. A memory mapped graphics adapter **230** and hard disk **232** may also be connected to I/O bus **212** as depicted, either directly or indirectly.

Those of ordinary skill in the art will appreciate that the hardware depicted in **Figure 2** may vary. For example, other peripheral devices, such as optical disk
30 drives and the like, also may be used in addition to or in place of the hardware

Docket No. 11032RR

depicted. The depicted example is not meant to imply architectural limitations with respect to the present invention.

The data processing system depicted in **Figure 2** may be, for example, an IBM RS/6000, a product of International Business Machines Corporation in Armonk, New York, running the Advanced Interactive Executive (AIX) operating system.

Turning now to **Figure 3**, a block diagram of a personal digital assistant (PDA), such as portable device **164** in **Figure 1**, is illustrated in which the present invention may be implemented. The PDA is typically a palmtop computer, such as, for example, a Palm VII, a product of 3Com Corporation in Santa Clara, California, connected to a wireless communications network and which may provide voice, fax, e-mail, and/or other types of communication. The PDA **300** may have one or more processors **302**, such as a microprocessor, a main memory **304**, a disk memory **306**, and an I/O **308** such as a mouse, keyboard, or pen-type input, and a screen or monitor. The PDA **300** may also have a wireless transceiver **310** connected to an antenna **312** configured to transmit and receive wireless communications. The processor **302**, memories **304**, **306**, I/O **308**, and transceiver are connected to a bus **304**. The bus transfers data, i.e., instructions and information, between each of the devices connected to it. The I/O **308** may permit faxes, e-mail, or optical images to be displayed on a monitor or printed out by a printer. The I/O **308** may be connected to a microphone **316** and a speaker **318** so that voice or sound information may be sent and received.

With reference now to **Figure 4**, a block diagram of a data processing system in which the present invention may be implemented is illustrated. Data processing system **400** is an example of a client computer such as client **120**, **126**, **134**, or **142** in **Figure 1**. Data processing system **400** employs a peripheral component interconnect (PCI) local bus architecture. Although the depicted example employs a PCI bus, other bus architectures, such as Micro Channel and ISA, may be used. Processor **402** and main memory **404** are connected to PCI local bus **406** through PCI bridge **408**. PCI bridge **408** may also include an integrated memory controller and cache memory for processor **402**. Additional

Docket No. 11032RR

connections to PCI local bus 406 may be made through direct component interconnection or through add-in boards. In the depicted example, SCSI host bus adapter 412 and expansion bus interface 414 are connected to PCI local bus 406 by direct component connection. In contrast, audio adapter 416, graphics adapter 418, and audio/video adapter (A/V) 419 are connected to PCI local bus 406 by add-in boards inserted into expansion slots. Expansion bus interface 414 provides a connection for a keyboard and mouse adapter 420, modem 422, and additional memory 424. In the depicted example, SCSI host bus adapter 412 provides a connection for hard disk drive 426, tape drive 428, CD-ROM drive 430, and digital video disc read only memory drive (DVD-ROM) 432. Typical PCI local bus implementations will support three or four PCI expansion slots or add-in connectors.

An operating system runs on processor 402 and is used to coordinate and provide control of various components within data processing system 400 in **Figure 4**. The operating system may be a commercially available operating system, such as OS/2, which is available from International Business Machines Corporation. "OS/2" is a trademark of International Business Machines Corporation. An object oriented programming system, such as Java, may run in conjunction with the operating system, providing calls to the operating system from Java programs or applications executing on data processing system 400. Instructions for the operating system, the object-oriented operating system, and applications or programs are located on a storage device, such as hard disk drive 426, and may be loaded into main memory 404 for execution by processor 402.

Those of ordinary skill in the art will appreciate that the hardware in **Figure 4** may vary depending on the implementation. For example, other peripheral devices, such as optical disk drives and the like, may be used in addition to or in place of the hardware depicted in **Figure 4**. The depicted example is not meant to imply architectural limitations with respect to the present invention. For example, the processes of the present invention may be applied to multiprocessor data processing systems.

Docket No. 11032RR

Turning now to **Figure 5**, a message flow chart is depicted illustrating the processes of redirecting a call in real time from a wireless device according to the present invention. In this example, a redirect from a wireless device utilizing a wireless proxy is illustrated. A similar flow would result if the redirect were being sent from a LAN/WAN connected device except for the omission of wireless proxy 508.

A user of a portable computing device such as a PDA or laptop computer initiates a registration by entering a proxy ID, a proxy port, and an address, such as, for example, a PSTN number or an IP address, and sending this information to wireless proxy **508** (step **M01**). **Figures 6A** illustrates an example of a sample HTML screen displayed to a user to initiate registration. The user may pull up the registration page by selecting the word "register" **601** on the page. **Figure 6B** illustrates an example of a sample HTML screen allowing a user to register by providing prompts to enter an user name **602**, a proxy identification **604**, and a proxy port **606**.

Wireless Proxy **508** receives the HTML registration web page and forwards it to SIP user agent **506** (step **M02**). User agent **506** receives the HTML page and sends a SIP registration to SIP proxy **502** (step **M03**). SIP proxy **502** updates its destination list for the user with the address for portable computing device **510**. Next, an SIP invite signal is sent to user agent **506** (step **M04**).

User agent **506** then sends an SIP 100-trying signal back to SIP proxy **502** (step **M05**). When a call for the user at portable computing device **510** is received by user agent **506**, user agent **506** sends an HTML page to 3Com proxy **508** to indicate an incoming call for the user at portable computing device **510** (step **M06**). 3Com proxy **508** forwards the HTML page to portable computing device **510** (step **M07**). The HTML page is displayed the user of portable computing device **510** to indicate that the user has an incoming call. An example of such an HTML page is illustrated in **Figure 6C**. A hot button **608** is supplied which the user may select to redirect the incoming call. Other hot buttons **614**, **616**, and **618** allow the user to place the call on hold, terminate the call without answering, or send the call to voice mail respectively. If redirection is chosen, the user of the

Docket No. 11032RR

portable computing device **510** then redirects the call to another destination by entering and sending a PSTN, IP, or other address as the new destination (step **M08**). **Figure 6D** illustrates an example of a sample HTML page in which the user may enter the new destination for the incoming phone call in destination box **610** and then send the new destination by selecting the “submit” hot button **612**.

Wireless proxy **508** receives the HTML page containing the new destination and this page is forwarded to user agent **506** (step **M09**). User agent **506** sends a SIP 300 signal to SIP proxy **502** containing the new destination (step **M10**). User agent **506** also sends an HTML page to portable computing device **510** via 3Com proxy **508** indicating that the call was redirected (step **M11**). A message is displayed to the user of portable computing device **510** indicating that the call was redirected. An example of such a HTML page is illustrated in **Figure 6E**. SIP proxy **502** receives the 300 signal and sends out an invite to the new destination (step **M12**).

If portable computing device **510** does not respond to the message indicating that the user has an incoming call (step **M07**), then a SIP 480 Temporarily not available signal is sent from user agent **506** back to SIP proxy server **502**. SIP proxy **502** can then decide how to process the call. For example, for calls to which the portable computing device does not respond, SIP proxy **502** could forward the call to a predefined destination or take the call down.

Turning now to **Figure 7**, a flowchart illustrating the methods executed on a portable computing device in accordance with a preferred embodiment of the present invention is depicted. To start, a user of a data processing device registers the address of their data processing device that they wish their calls to be delivered to (step **702**). Typically, when the data processing device is activated, it performs an SIP registration with a SIP registration server, effectively causing all future calls to route to this device as the first selection. On deactivation of the device, the shutdown processing unregisters with the SIP registration server thereby restoring the defaults on how the called party is to be reached (i.e., the subscriber’s static reach list). Next, when a call is made to the user, a notification of the incoming call is received at their data processing device (step **704**).

Docket No. 11032RR

Included in the notification may be caller identification information such as PSTN or IP address from where the call originated. The user then identifies a new destination for the incoming call to be sent (step 706). For example, if the user has traveled to a hotel, the user may enter the phone number of the room at the hotel. As another example, if the user is near a pay phone, the user may enter the phone number of the pay phone. Once the user has identified a new destination for the incoming call to be redirected to, this new destination is sent back to a SIP proxy via a SIP User Agent (step 708). Once the SIP User Agent receives the redirect request, the user will receive a notice indicating the call is being redirected (step 710).

Turning now to **Figure 8**, a flowchart illustrating the processes of redirecting a call which are implemented on a server within the communications network is depicted in accordance with the present invention. To start, a server within the communications network receives a request for call initiation from a PSTN (step 802). The server accesses a database to which the called party has registered the current device to which they wish their calls directed (step 804). The current device is registered at the top of a static reach list of numbers to try in order to reach the called party. Once the current device is identified, a notice is sent to the called parties current location indicating that the party has an incoming call and requesting information about where to direct the call (step 806). Next, a determination is made as to whether the user has responded to the request (step 808). If the user does not respond after a given period of time, then the call is disposed of according to a predetermined procedure (step 810). For example, if the user does not respond to the request, then the server may redirect the call to the next address in the called party's static reach list of preferred locations or if there are no more preferred locations stored in a database, the server may end the call. If the user does respond to the request, then the call is redirected to the new location and a confirmation is sent to the user indicating such (step 812). The call may be redirected to a cell phone, to a nearby wire-line device, to the called party's voice mailbox, or the party initiating the call may be placed on temporary hold. If the party initiating the call is placed on hold, a standard greeting will be

Docket No. 11032RR

sent to the calling party to make them aware that the called party is attempting to find an appropriate method to receive the call or is on another call and to stay on the call because the called party will answer momentarily.

Turning now to **Figure 9**, a flowchart illustrating a method of converting HTML to SIP as performed by a SIP User Agent is depicted in accordance with the present invention. To start, a SIP User Agent receives an HTML message (step **902**). The SIP User Agent then parses the HTML message for class and content (step **904**). The SIP User Agent then analyzes the message class and content (step **906**) to create an SIP signal from the HTML message (step **908**). The newly formed SIP signal is then sent to an SIP Proxy (step **910**) and the process stops.

Turning now to **Figure 10**, a flowchart illustrating a method of converting an SIP signal into an HTML message is depicted in accordance with the present invention. First, the SIP User Agent receives an SIP signal from the SIP Proxy (step **1002**). The SIP signal is then parsed for message type (step **1004**) and the content, calling party, and called party are extracted from the SIP signal (step **1006**). Using the extracted information, the SIP User Agent generates an appropriate HTML page (step **1008**) and sends the HTML message to the called party (step **1010**) ending the process.

Although the present invention has been described primarily with reference to redirecting telephony communications. Other forms of media streams may be redirected as well. For example, a client such as client **120** or portable device **164**, that has previously performed an SIP registration, receives a notification of incoming data streams. The notification will include information about what types of data streams are included. This will be encoded into the notification at either SIP Proxy **170** or at User Agent **172**. The notice displayed to the user will inform the user of whether there are multiple types of data streams and what types of data streams are in the incoming communication. Once the notification is displayed to the user of the client, the client may then decide how to dispose of the incoming data streams. If the user selects one device, such as telephone **124** to send the data stream to, then the name or address of telephone

Docket No. 11032RR

124 will be sent back to SIP Proxy 170, which will then redirect the call to telephone 124. The user may select more than one device to send the data streams to as well. If the data stream consists of multiple data types, the user may instruct SIP Proxy 170 to send each data stream to a different type of device.

5 Furthermore, the user may instruct SIP Proxy 170 to send all of the data streams to several locations (forking) such that multiple parties may be connected (such as for a conference call) or to several locations, but have only the first to “pick up” or “answer” be connected. This last alternative might be useful if the user wished to redirect the data stream to another person, but was unsure of that person’s location
10 but did know of several possible locations of that person.

To help illustrate the present invention, consider the following example of a user’s device receiving multiple types of data streams at a single device. For example, a user might have registered their personal digital assistant as the device to which to have incoming data streams routed. The SIP Proxy 170 receives an
15 incoming data stream intended for this user and generates and routes a message to the user indicating the types of message streams and from what party. The types of message streams include audio, video (in MPEG format), text and a JPEG picture. The user of the personal digital assistant might decide to route the audio to speakers or to a telephone such as telephone 124, route the video to a desktop
20 computer such as client 120 or to a television attached to a set top box, the text routed to a printer (perhaps connected to client 120), and the JPEG picture routed to a second computer such as client 126 or to a device dedicated to generating and displaying still pictures. Thus, each of the data streams were directed to a device which was best able to utilize and present the information to the user.

25 To illustrate “forking”, consider a person receiving a data stream (perhaps a phone call, but not necessarily). The person after determining what the data stream is and/or who it is from, decides that other people within an organization should participate as well. The person would then enter several names or addresses for the SIP Proxy 170 to use to redirect the data stream. This list of
30 several names could include the user originally receiving the notification. In that way several people could participate, such as on a conference call.

Docket No. 11032RR

In yet another example of forking, the user could receive notification of an incoming call and determine that that call was for another person. However, the user does not know the exact location of the other person, but does know of several locations where that person might be. The user in this case would enter several location names and instruct the proxy to redirect the call to each of them and connect the location which "picked up" first. In that manner the call is forwarded to the correct party even though the user receiving the notification knew no more than several possibilities of locations.

Although the present invention has been described primarily with reference to presenting call notification information to the called party through means of a display, other methods are also possible. Such methods include, but are not limited to, notifying the called party of an incoming call through the use of sounds or through a voice synthesizer if the portable device supported such options. Furthermore, as another option, the portable computing device could vibrate to indicate that the user had an incoming call. The use of sounds and vibrations could also be used to alert the called party of an incoming call such that they could direct their attention to a visual display which would indicate the nature and origin of the call.

Although described primarily with reference to SIP, an SIP proxy and an SIP user agent, other communications initiation and routing protocols, such as H.323 Protocol, can be utilized as well. Furthermore, other text based or XML based protocols may be utilized rather than HTTP and HTML. Examples of other protocols include, but are not limited to, Voice XML (VOXML), Speech Markup Language (SML), WAP, and XHTML. In such cases the SIP user agent would be replaced with a user agent which translated between the appropriate protocols.

It should be noted that although the present invention has been described with reference to utilizing a SIP proxy, a proxy of any kind is not necessary if the complete IP address of the device to which the call is to be directed is known and used. Furthermore, the SIP user agent is not necessary if all of the terminal devices (e.g., portable data processing systems, personal digital assistants, phones, desk top computers, cell phones) involved in a calling process utilize SIP such that

Docket No. 11032RR

communications with the SIP proxy does not need to be facilitated with a translating user agent. In this case, the SIP proxy becomes the agent. Furthermore, the SIP proxy does not have to be a proxy. Any device or software which can perform the functionality of the SIP proxy will suffice, wherein the
5 primary functions performed by the SIP proxy are address lookup (determining the IP or other type address based on information received, i.e., converting john@nortel.com into an IP address) and redirecting calls.

It should also be noted that although the present invention has been described primarily with reference to voice calls, it applies to other types of
10 communication as well, including, but not limited to for example, video conferencing or text messages. For example, a portable computing device could receive a notification of an incoming video call or video message and a user could redirect that incoming video message to a laptop or desktop computer, a television, or other video display terminal such that the video could be viewed by
15 the called party. The device receiving the request could even suggest alternative destinations to redirect the call to based on the type of call (e.g. video, voice, text) the request corresponds to.

It is important to note that while the present invention has been described in the context of a fully functioning data processing system, those of ordinary skill
20 in the art will appreciate that the processes of the present invention are capable of being distributed in the form of a computer readable medium of instructions and a variety of forms and that the present invention applies equally regardless of the particular type of signal bearing media actually used to carry out the distribution. Examples of computer readable media include recordable-type media such a
25 floppy disc, a hard disk drive, a RAM, and CD-ROMs and transmission-type media such as digital and analog communications links.

The description of the present invention has been presented for purposes of illustration and description, but is not intended to be exhaustive or limited to the invention in the form disclosed. Many modifications and variations will be
30 apparent to those of ordinary skill in the art. For example, the present invention is not limited to SIP and Palm VII's. Other types of call initiation protocols other

Docket No. 11032RR

- 1 8. The method as recited in claim 1, wherein said data processing system is a
- 2 wire-line connected device.

RECEIVED

Docket No. 11032RR

- 1 9. A computer program product in computer readable media for use in a data
2 processing system for redirecting a call from a data processing system to another
3 address, the computer program product comprising:
4 first instructions for receiving at a data processing system a registration notice
5 of an incoming call from a server; and
6 second instructions, responsive to determination of a new address; for
7 transmitting a new address to which the incoming call is to be redirected.
- 1 10. The computer program product as recited in claim 9, wherein said data
2 processing system is a personal digital assistant.
- 1 11. The computer program product as recited in claim 9, wherein said data
2 processing system is a laptop computer.
- 1 12. The computer program product as recited in claim 9, wherein said data
2 processing system is a portable computing device.
- 1 13. The computer program product as recited in claim 9, wherein said data
2 processing system is a wireless device.
- 1 14. The computer program product as recited in claim 9, wherein the registration
2 notice is a session initiation protocol registration notice.
- 1 15. The computer program product as recited in claim 9, wherein the incoming
2 call comprises video and the new address corresponds to a video display terminal.
- 1 16. The computer program product as recited in claim 9, wherein said data
2 processing system is a wire-line connected device.

2025 RELEASE UNDER E.O. 14176

Docket No. 11032RR

- 1 17. A system of redirecting a call from a data processing system to another
2 address, comprising:
3 means for receiving at a data processing system a registration notice of an
4 incoming call from a server; and
5 means, responsive to determination of a new address; for transmitting a new
6 address to which the incoming call is to be redirected.
- 1 18. The system as recited in claim 17, wherein said data processing system is a
2 personal digital assistant.
- 1 19. The system as recited in claim 17, wherein said data processing system is a
2 laptop computer.
- 1 20. The system as recited in claim 17, wherein said data processing system is a
2 portable computing device.
- 1 21. The system as recited in claim 17, wherein said data processing system is a
2 wireless device.
- 1 22. The system as recited in claim 17, wherein the registration notice is a session
2 initiation protocol registration notice.
- 1 23. The system as recited in claim 17, wherein the incoming call comprises video
2 and the new address corresponds to a video display terminal.
- 1 24. The system as recited in claim 17, wherein said data processing system is a
2 wire-line connected device.

Docket No. 11032RR

- 1 25. A method for redirecting calls to a data processing system to a second
2 location; comprising the steps of:
3 sending a registration notification to a called party's preferred location; and
4 responsive to receipt of a new address from the called party, redirecting the
5 incoming call to the new address.
- 1 26. The method as recited in claim 25, further comprising:
2 prior to said sending step, receiving a request to initiate a call with a called
3 party; and
4 determining a preferred location of the called party.
- 1 27. The method as recited in claim 25, wherein the registration notification is a
2 session initiation protocol registration.
- 1 28. The method as recited in claim 25, wherein the preferred location is a personal
2 digital assistant.
- 1 29. The method as recited in claim 28, wherein the personal digital assistant is a
2 Palm VII utilizing a Palm Query Application to provide a user interface.
- 1 30. The method as recited in claim 25, wherein the new address corresponds to a
2 voice mailbox.
- 1 31. The method as recited in claim 25, wherein the new address corresponds to
2 placing the incoming call on hold.
- 1 32. The method as recited in claim 25, wherein communication with the preferred
2 device is provided utilizing a wireless application protocol.

Express Mail No.: EL356872801US

Docket No. 11032RR

- 1 33. The method as recited in claim 25, wherein the new address corresponds to a
- 2 wire-line device.

2025 RELEASE UNDER E.O. 14176

Docket No. 11032RR

- 1 43. A system for redirecting calls to a data processing system to a second
2 location; comprising:
3 means for sending a registration notification to a called party's preferred
4 location; and
5 means, responsive to receipt of a new address from the called party, for
6 redirecting the incoming call to the new address.
- 1 44. The system as recited in claim 43, further comprising:
2 prior to said sending step, means for receiving a request to initiate a call with a
3 called party; and
4 means for determining a preferred location of the called party.
- 1 45. The system as recited in claim 43, wherein the registration notification is a
2 session initiation protocol registration.
- 1 46. The system as recited in claim 43, wherein the preferred location is a personal
2 digital assistant.
- 1 47. The system as recited in claim 46, wherein the personal digital assistant is a
2 Palm VII utilizing a Palm Query Application to provide a user interface.
- 1 48. The system as recited in claim 43, wherein the new address corresponds to a
2 voice mailbox.
- 1 49. The system as recited in claim 43, wherein the new address corresponds to
2 placing the incoming call on hold.
- 1 50. The system as recited in claim 43, wherein communication with the preferred
2 device is provided utilizing a wireless application protocol.

66504-526760

Docket No. 11032RR

66. A method for initiating calls, comprising the steps of:
receiving registration notice of an incoming call, wherein said registration notice is formatted in a first protocol;
translating said registration notice from the first protocol into a second
5 protocol; and
transmitting a modified registration notice to a terminating device; wherein the modified registration notice is formatted in the second protocol.
67. The method as recited in claim 66, further comprising:
receiving a location data with which to redirect the incoming call from the
10 terminating device; wherein the location data is formatted in the second protocol; and
translating the location data to a second location data; and
transmitting the second location data, wherein the second location data is formatted in the second protocol.
68. The method as recited in claim 66, wherein the first protocol is a session
15 initiation protocol.
69. The method as recited in claim 66, wherein the second protocol is a hypertext markup language.

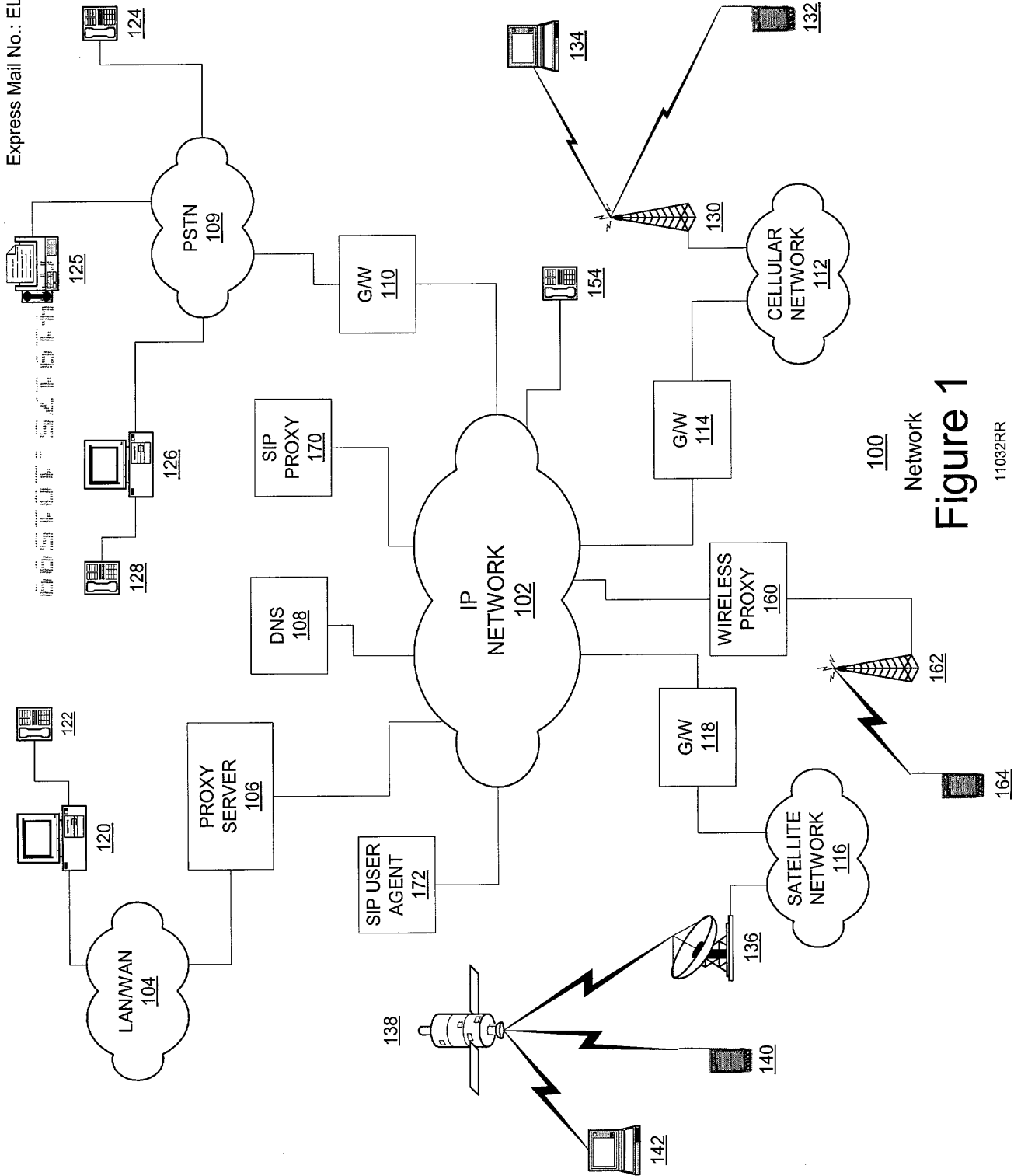

100 Network
Figure 1

11032RR

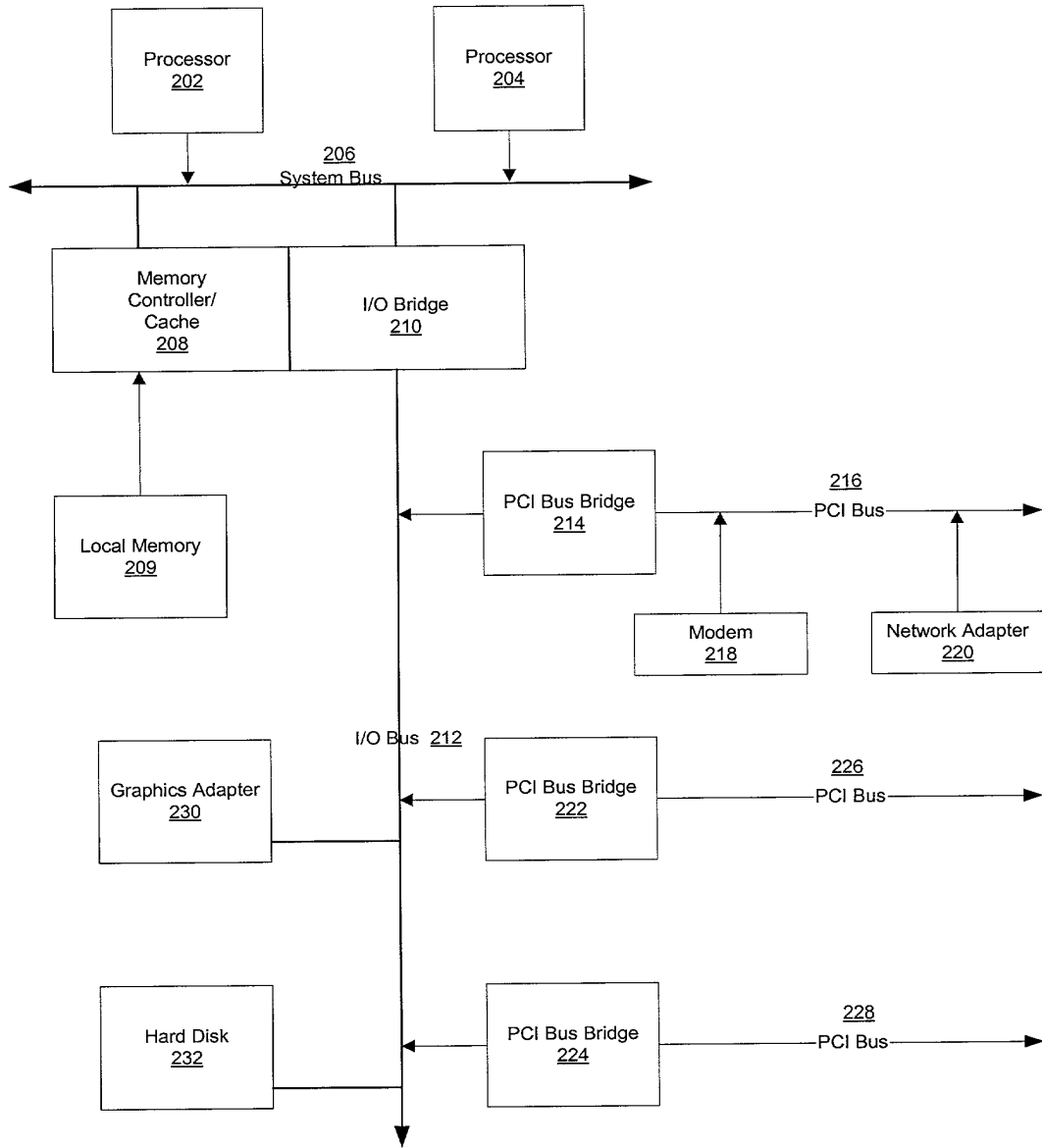

200
Server

Figure 2

11032RR

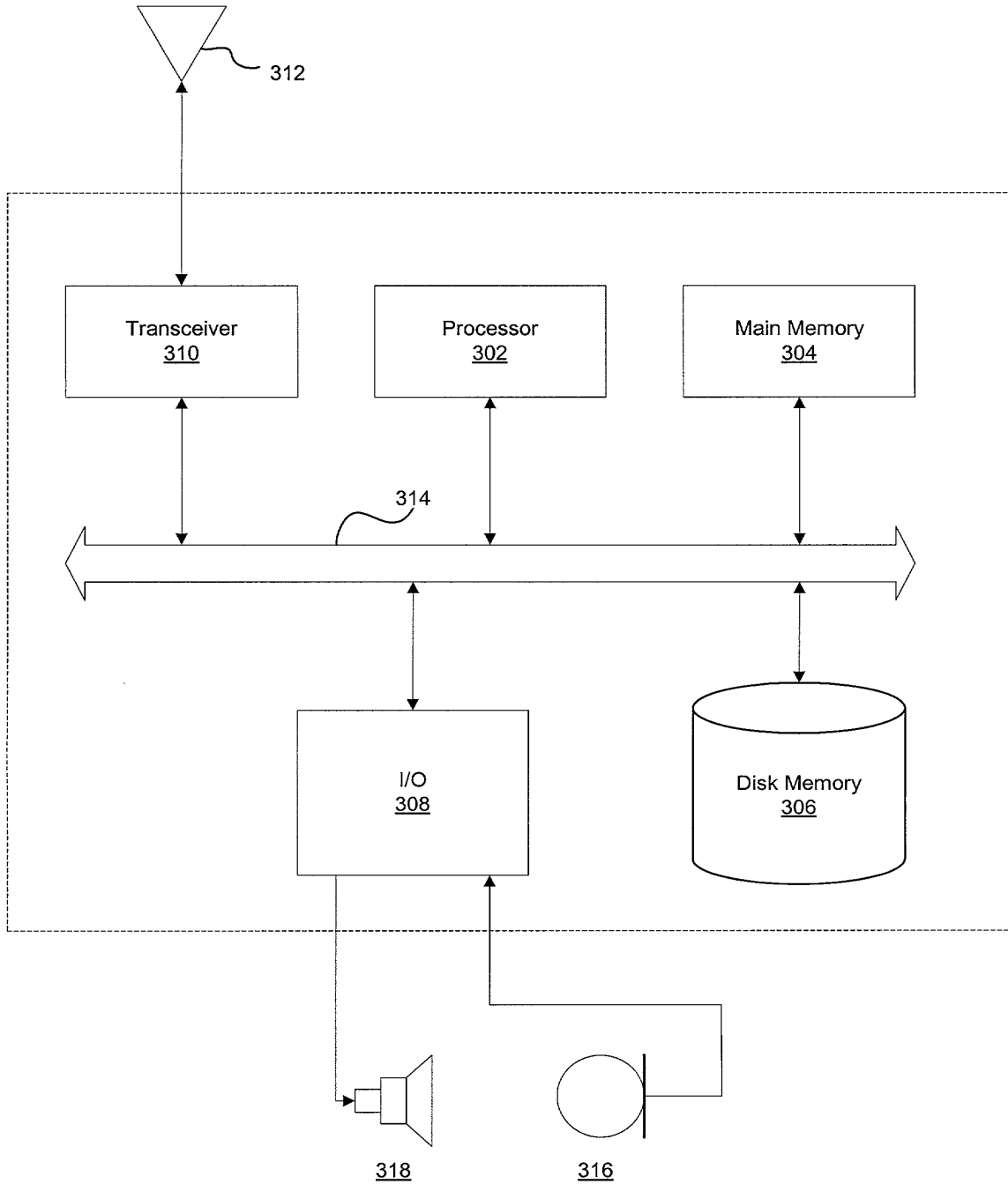

300

Figure 3

11032RR

Patent Pending

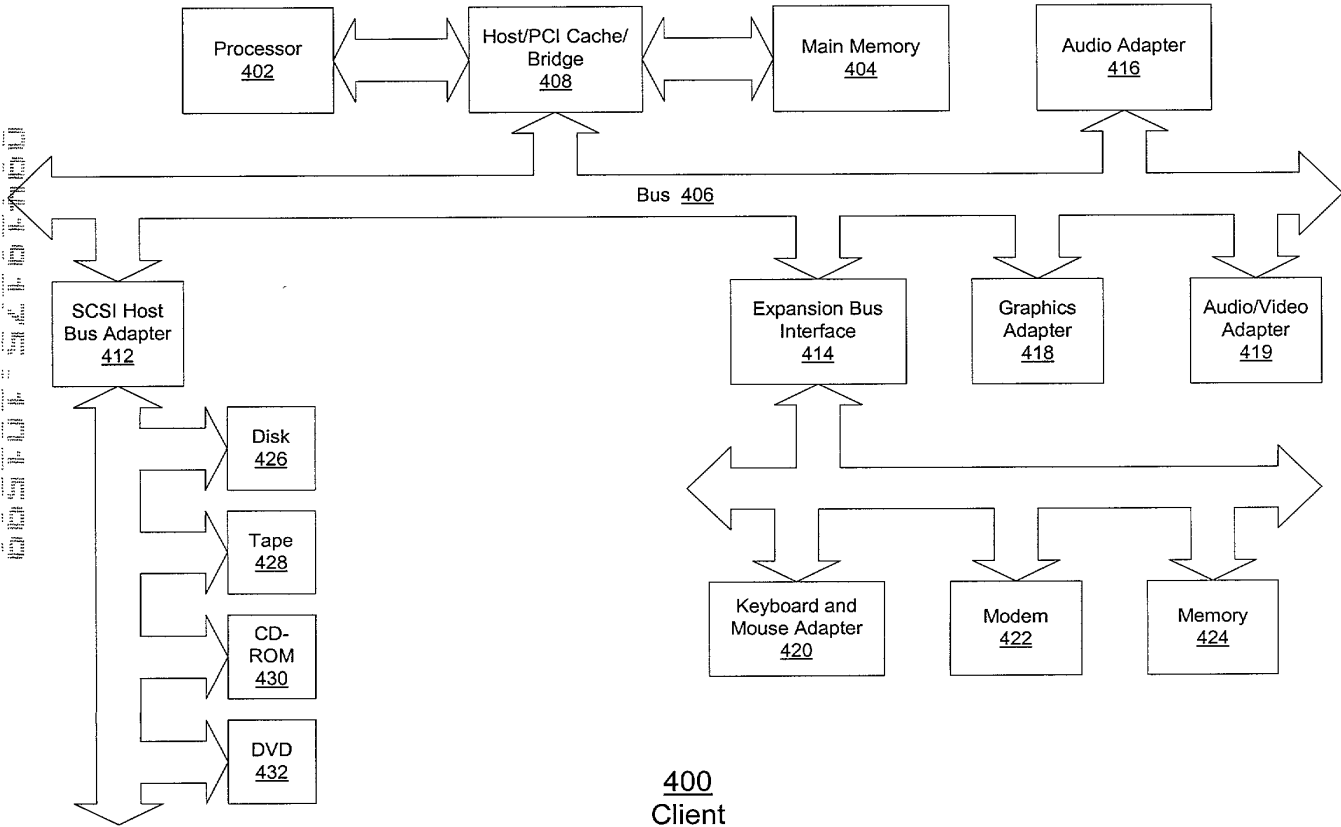

400
Client
Figure 4
11032RR

CONFIDENTIAL

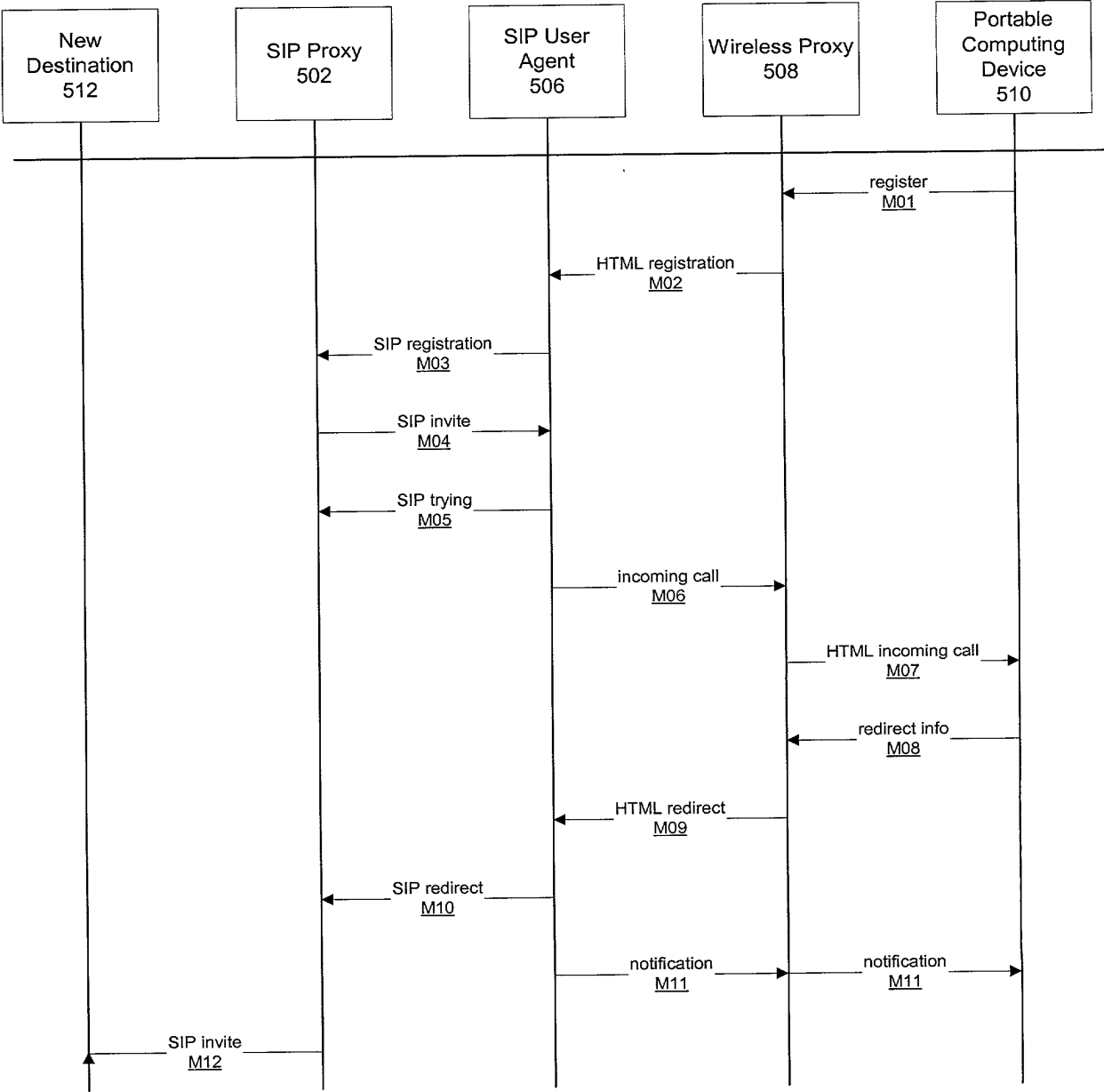

Figure 5

11032RR

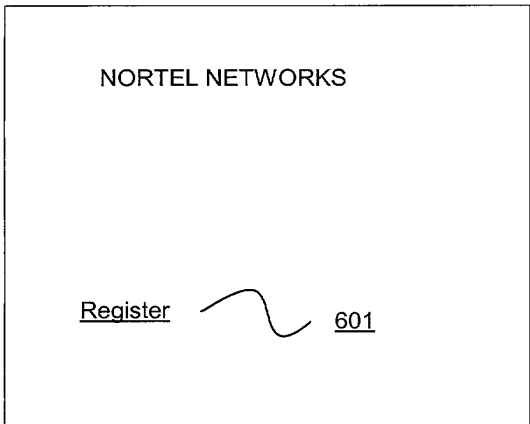

Figure 6A

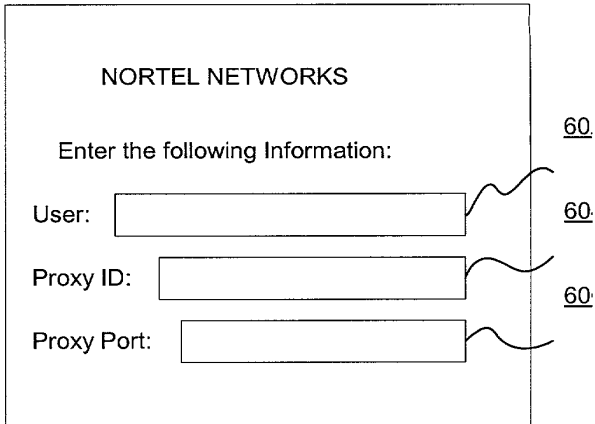

Figure 6B

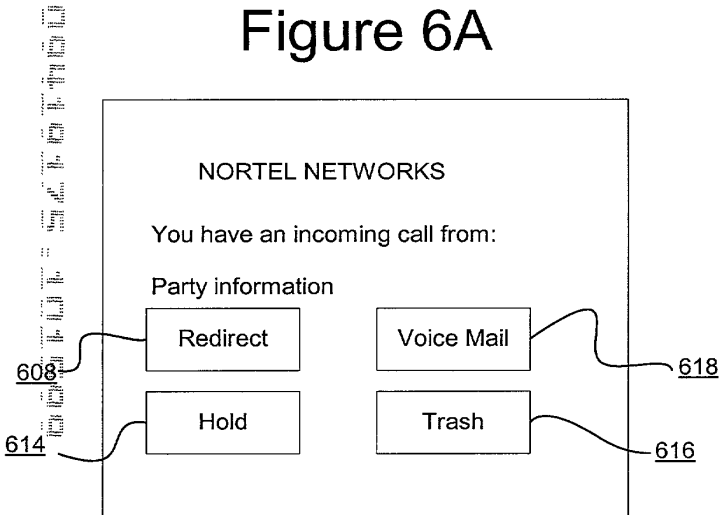

Figure 6C

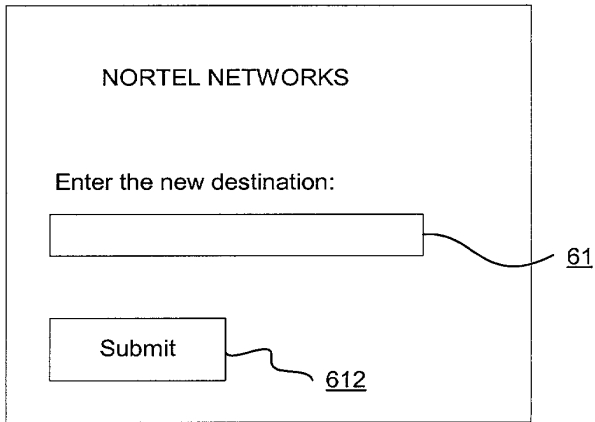

Figure 6D

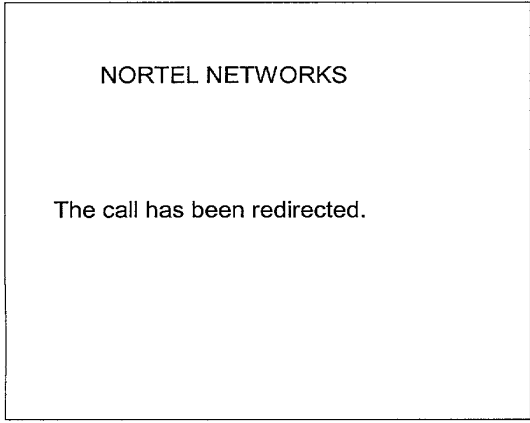

Figure 6E

11032RR

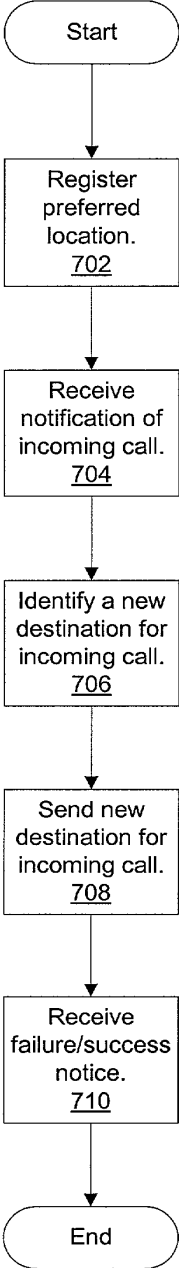

Figure 7

11032RR

11032RR

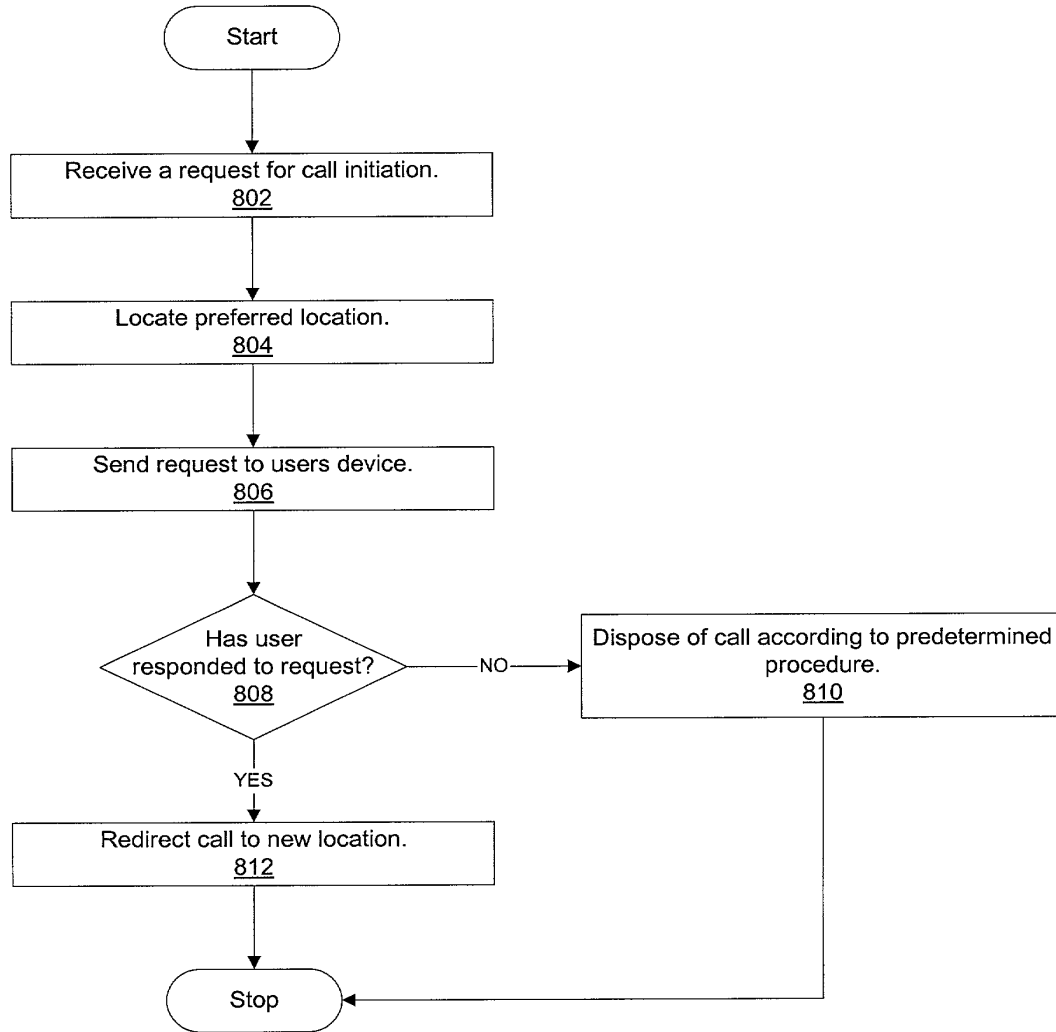

Figure 8

11032RR

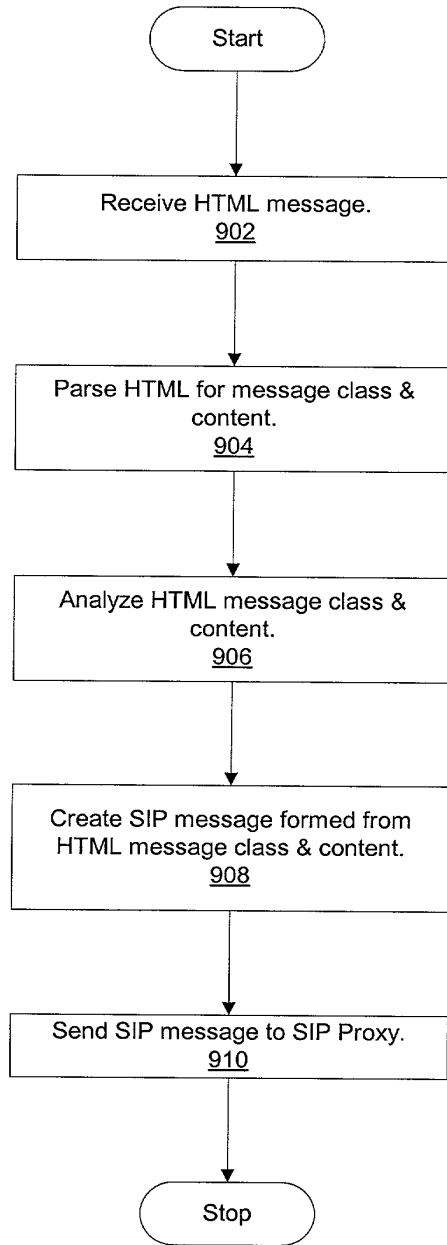

Figure 9

11032RR

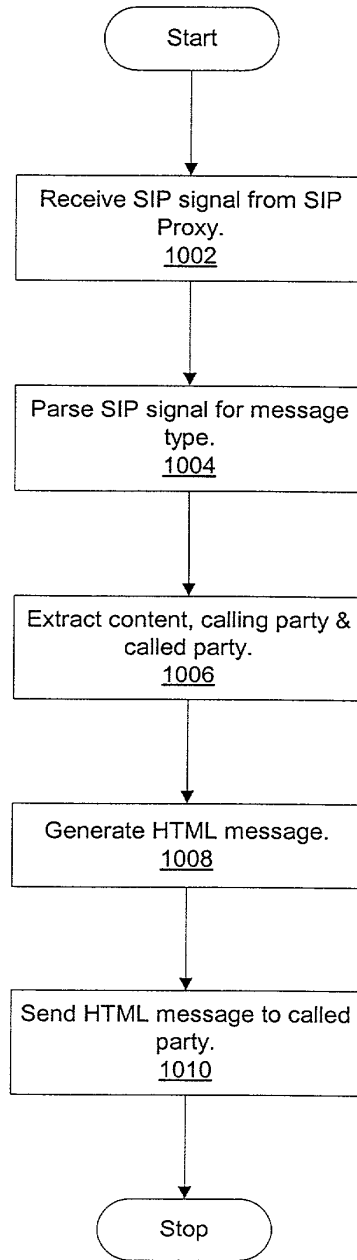

Figure 10

11032RR

Docket Number: **11032RR**
Page 1 of 3

**DECLARATION AND POWER OF ATTORNEY FOR
PATENT APPLICATION**

As below named inventor, I hereby declare that:

My residence, post office address and citizenship is as stated below next to my name;

I believe that I am the original, first and sole inventor (if only one name is listed below) or an original, first and joint inventor (if plural names are listed below) of the subject matter which is claimed and for which a patent is sought on the invention entitled as set forth below, which is described in the specification of which: (check one)

filed herewith under Attorney's Docket Number 11032RR

PORTABLE CALL MANAGEMENT SYSTEM

I hereby state that I have reviewed and understand the contents of the above identified specification, including the claims, as amended by any amendment referred to above.

I acknowledge the duty to disclose information which is material to the patentability of this application in accordance with 37 CFR 1.56.

I hereby claim the benefit under Title 35 United States Code section 120 of the provisional application filed under 111b of this title as listed below:

I hereby declare that all statements made herein of my own knowledge are true and that all statements made on information and belief are believed to be true; and further that these statements were made with the knowledge that willful false statements and the like so made are punishable by fine of imprisonment, or both, under 18 USC 1001 and that such willful false statements may jeopardize the validity of the application or any patent issued thereon.

DECLARATION

Docket Number: **11032RR**
Page 2 of 3

POWER OF ATTORNEY. As a named inventor, I hereby appoint the following attorneys and/or agents to prosecute this application and transact all business in the Patent and Trademark Office connected therewith.

John D. Crane, Reg. No. 25,231;
Christopher O. Edwards, Reg. No. 36,127; Robert C. Klinger, Reg. No. 34,365;
James A. Harrison, Reg. No. 40,401; W. Glen Johnson, Reg. No. 39,525; Duke W. Yee, Reg. No. 34,285;
Rudolph J. Buchel, Reg. No. 43,448. Joseph R. Burwell, Reg. No. 44,468, Stephen R. Loe, Reg. No. 43,757.

Send correspondence to John D. Crane, Nortel Networks Corporation, Patent Department; P.O. Box 833858, Mail Stop 468/05/B10; Richardson, Texas 75083-3858 and direct all telephone calls to John D. Crane, telephone: (972) 695-8442.

=====

(1) FULL NAME OF INVENTOR: Gregory T. Osterhout

INVENTOR'S SIGNATURE: *Gregory T. Osterhout*

DATE: 10/15/99

RESIDENCE: 313 Falcon Court, Coppell, TX 75019

COUNTY: Dallas

CITIZENSHIP: United States

POST OFFICE ADDRESS: Same As Above

(2) FULL NAME OF INVENTOR: Kim B. Holmes

INVENTOR'S SIGNATURE: _____

DATE:

RESIDENCE: 5408 Scenic Drive, Rowlett, TX 75088

COUNTY: Dallas

CITIZENSHIP: Canada

POST OFFICE ADDRESS: Same As Above

15803 U.S. PTO

09/419175



455	422.1
Class	Subclass
ISSUE CLASSIFICATION	

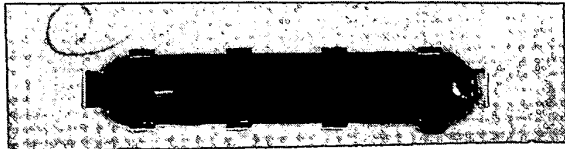

PATENT NUMBER

U.S. UTILITY PATENT APPLICATION

<input checked="" type="checkbox"/> O.I.P.E.	PATENT DATE
SCANNED <i>CK3 O.A. D.M.W.</i>	

SECTOR	CLASS <i>379</i>	SUBCLASS <i>4</i>	ART UNIT <i>2655</i>	EXAMINER <i>FRANK, R</i>
--------	------------------	-------------------	----------------------	--------------------------

FILED WITH: DISK (CRF) FICHE
(Attached in pocket on right inside flap)

PREPARED AND APPROVED FOR ISSUE

ORIGINAL		CROSS REFERENCE(S)					
CLASS	SUBCLASS	CLASS	SUBCLASS (ONE SUBCLASS PER BLOCK)				
455	422.1	455	426.1	445			
INTERNATIONAL CLASSIFICATION							
H04B	7/00						

Continued on Issue Slip Inside File Jacket

2-14-05 Formal Drawings (*6* sheets) set *L* *6-28-04*

<input type="checkbox"/> TERMINAL DISCLAIMER	DRAWINGS			CLAIMS ALLOWED	
	Sheets Drwg. <i>10</i>	Figs. Drwg. <i>14</i>	Print Fig. <i>8</i>	Total Claims <i>46</i>	Print Claim for O.G. <i>1</i>
<input type="checkbox"/> a) The term of this patent subsequent to _____ (date) has been disclaimed.	_____ (Assistant Examiner)			NOTICE OF ALLOWANCE MAILED	
<input type="checkbox"/> b) The term of this patent shall not extend beyond the expiration date of U.S. Patent. No. _____	<i>Tony T. Nguyen</i> TONY T. NGUYEN PATENT EXAMINER, FSA <i>Nguyen, T</i> <i>4/15/04</i> (Primary Examiner) (Date)			<i>4-21-04</i> ISSUE FEE Amount Due <i>11330</i> Date Paid <i>6-28-04</i>	
<input type="checkbox"/> c) The terminal _____ months of this patent have been disclaimed.	<i>Denise H. Davis</i> <i>1/14/04</i> (Legal Instruments Examiner) (Date)			ISSUE BATCH NUMBER	

WARNING:

The information disclosed herein may be restricted. Unauthorized disclosure may be prohibited by the United States Code Title 35, Sections 122, 181 and 368. Possession outside the U.S. Patent & Trademark Office is restricted to authorized employees and contractors only.

Form PTO-436A (Rev. 10/97)

ISSUE FEE IN FILE

(LABEL AREA)

BEST AVAILABLE COPY

(FACE)

SEARCHED

Class	Sub.	Date	Exmr.
455	422	10/7/02	800
	414		
	415		
	417		
	433		
	435		
	445		
	459		
	461		
↓			
	Updated above		10/7/03 800
	Updated searches		4/12/04 800
455	435.1		800
	422.1		
	445		
	446		
	451		
	426.1		
↓			

SEARCH NOTES (INCLUDING SEARCH STRATEGY)

	Date	Exmr.
Fast Searching	10/7/02	800
to	10/10/02	800
Comp. To	10/10/02	800
Fast updated	10/9/03	800
Nguyen Vs	10/9/03	800
Ed Urban	04/07/03	800
Fast updated	4/12/04	800

INTERFERENCE SEARCHED

Class	Sub.	Date	Exmr.
455	422.1	4/13/04	800
	445		
	426.1		
↓			

BEST AVAILABLE COPY

(RIGHT OUTSIDE)

JC714 U.S. PTO



10/15/99

Express Mail No.: EL356872801US

A

IN THE UNITED STATES PATENT AND TRADEMARK OFFICE

Docket No. 11032RR
Assistant Commissioner for Patents
Washington, D.C. 20231

Sir:
Transmitted herewith for filing is the patent application of Inventor(s):

For: **PORTABLE CALL MANAGEMENT SYSTEM**

Jc503 U.S. PTO
09/419175
10/15/99

Enclosed are also:

- 24 Pages of Specification including an Abstract
- 14 Pages of Claims
- 10 Sheet(s) of Drawings
- A Declaration and Power of Attorney

CLAIMS AS FILED

FOR	Number Filed		Number Extra		Rate		Basic Fee (\$760)	
Total Claims	69	-20 =	49	X	\$ 18	=	\$882.00	
Independent Claims	10	-3 =	7	X	\$ 78	=	\$546.00	
Multiple Dependent Claims	0			X	\$260	=	\$0	
Total Filing Fee							=	\$2,188.00

- A check in the amount of \$2,188.00 is enclosed for the filing.
- The Commissioner is hereby authorized to charge payment of the following fees associated with the communication or credit any over payment to Carstens, Yee & Cahoon, Deposit Account No. 50-0392. A duplicate copy of this sheet is enclosed.
- Any additional filing fees required under 37CFR § 1.16.
- Any patent application processing fees under 37CFR § 1.17.

Respectfully,

Stephen R. Loe
Registration No. 43,757
CARSTENS YEE & CAHOON, LLP
P.O. Box 802334
Dallas, Texas 75380
(972) 367-2001
ATTORNEY FOR APPLICANT

ENCLOSURE

JC714 U.S. PTO



10/15/99

Express Mail No.: EL356872801US

A

IN THE UNITED STATES PATENT AND TRADEMARK OFFICE

Docket No. 11032RR
Assistant Commissioner for Patents
Washington, D.C. 20231

Sir:
Transmitted herewith for filing is the patent application of Inventor(s):

For: **PORTABLE CALL MANAGEMENT SYSTEM**



Enclosed are also:

- 24 Pages of Specification including an Abstract
- 14 Pages of Claims
- 10 Sheet(s) of Drawings
- A Declaration and Power of Attorney

CLAIMS AS FILED

FOR	Number Filed		Number Extra		Rate		Basic Fee (\$760)
Total Claims	69	-20 =	49	X	\$ 18	=	\$882.00
Independent Claims	10	-3 =	7	X	\$ 78	=	\$546.00
Multiple Dependent Claims	0			X	\$260	=	\$0
Total Filing Fee							= \$2,188.00

- A check in the amount of \$2,188.00 is enclosed for the filing.
- The Commissioner is hereby authorized to charge payment of the following fees associated with the communication or credit any over payment to Carstens, Yee & Cahoon, Deposit Account No. 50-0392. A duplicate copy of this sheet is enclosed.
- Any additional filing fees required under 37CFR § 1.16.
- Any patent application processing fees under 37CFR § 1.17.

Respectfully,

Stephen R. Loe
Registration No. 43,757
CARSTENS YEE & CAHOON, LLP
P.O. Box 802334
Dallas, Texas 75380
(972) 367-2001
ATTORNEY FOR APPLICANT

ENCLOSURE

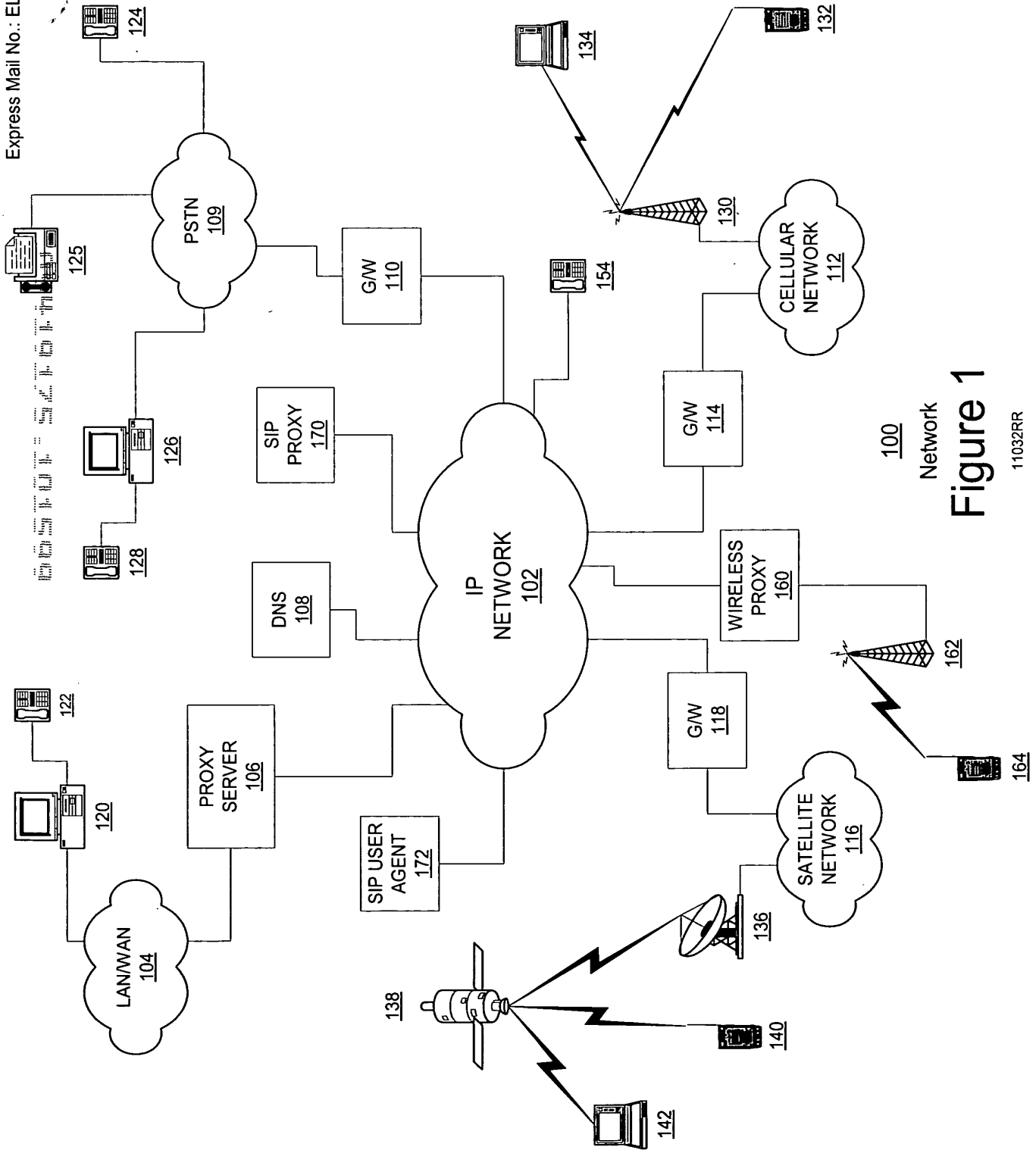

100 Network
Figure 1
11032RR

CONFIDENTIAL

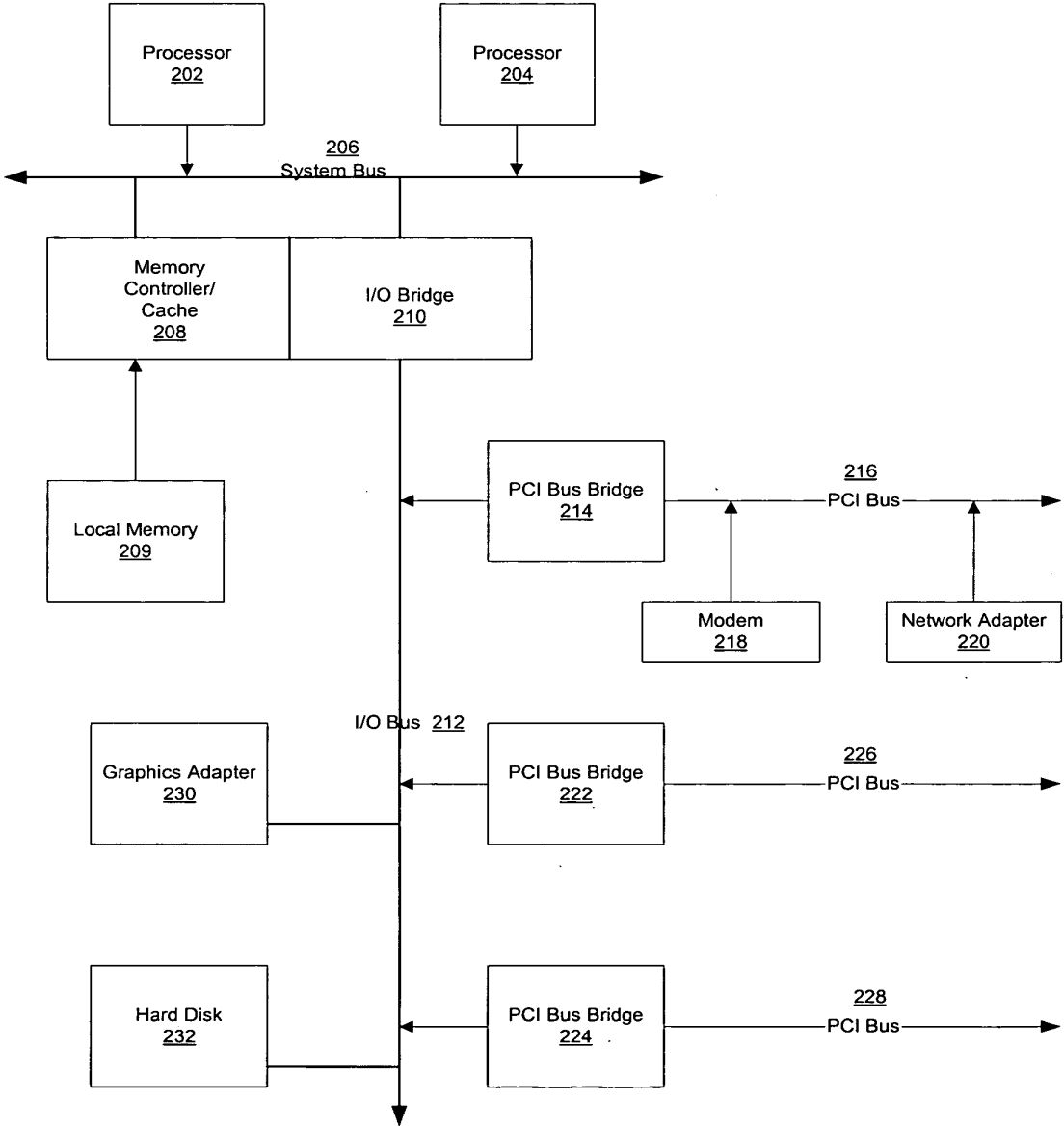

200
Server
Figure 2
11032RR

U.S. PAT. & TRADE OFF. DES. OFF.

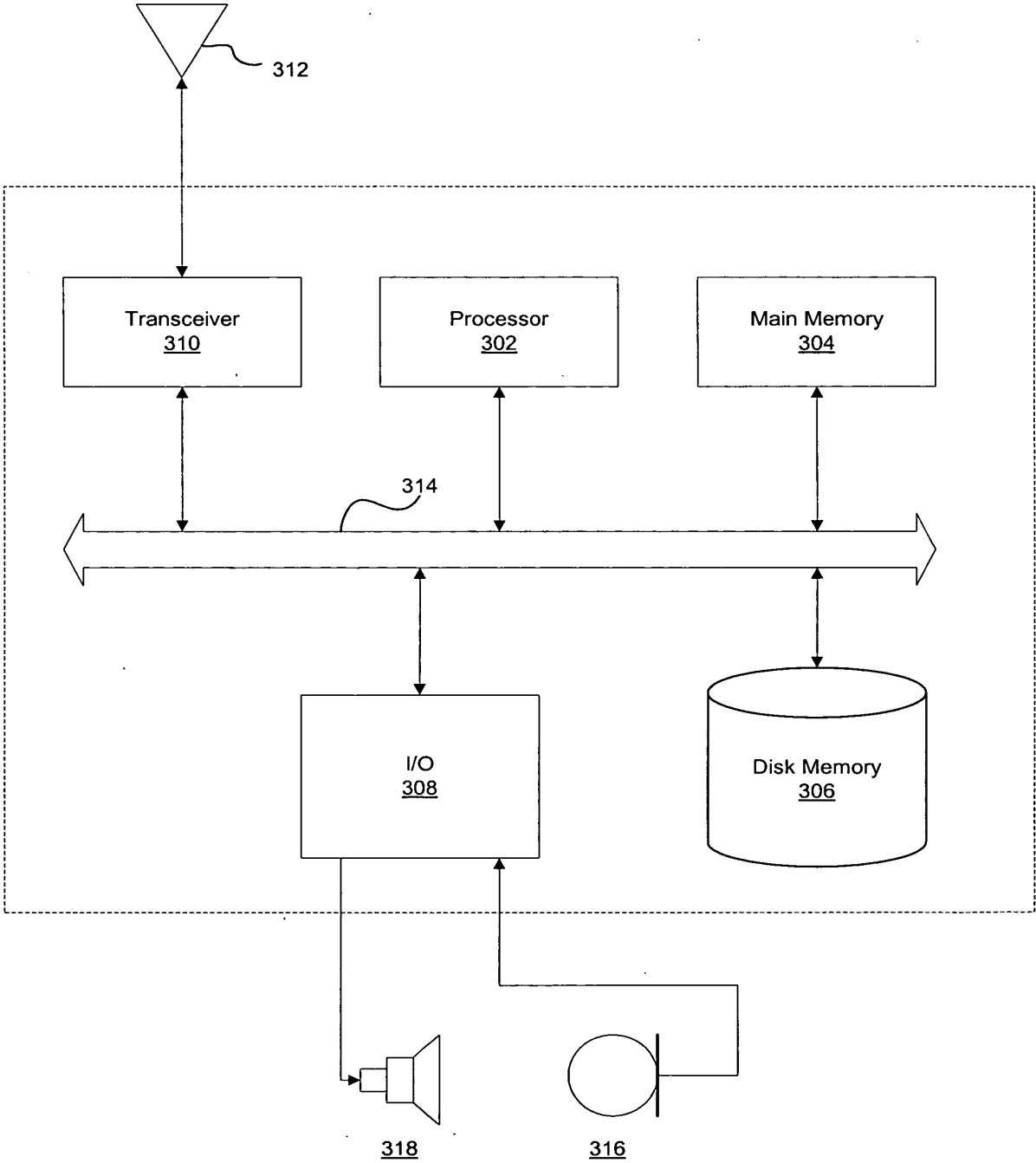

300
Figure 3
11032RR

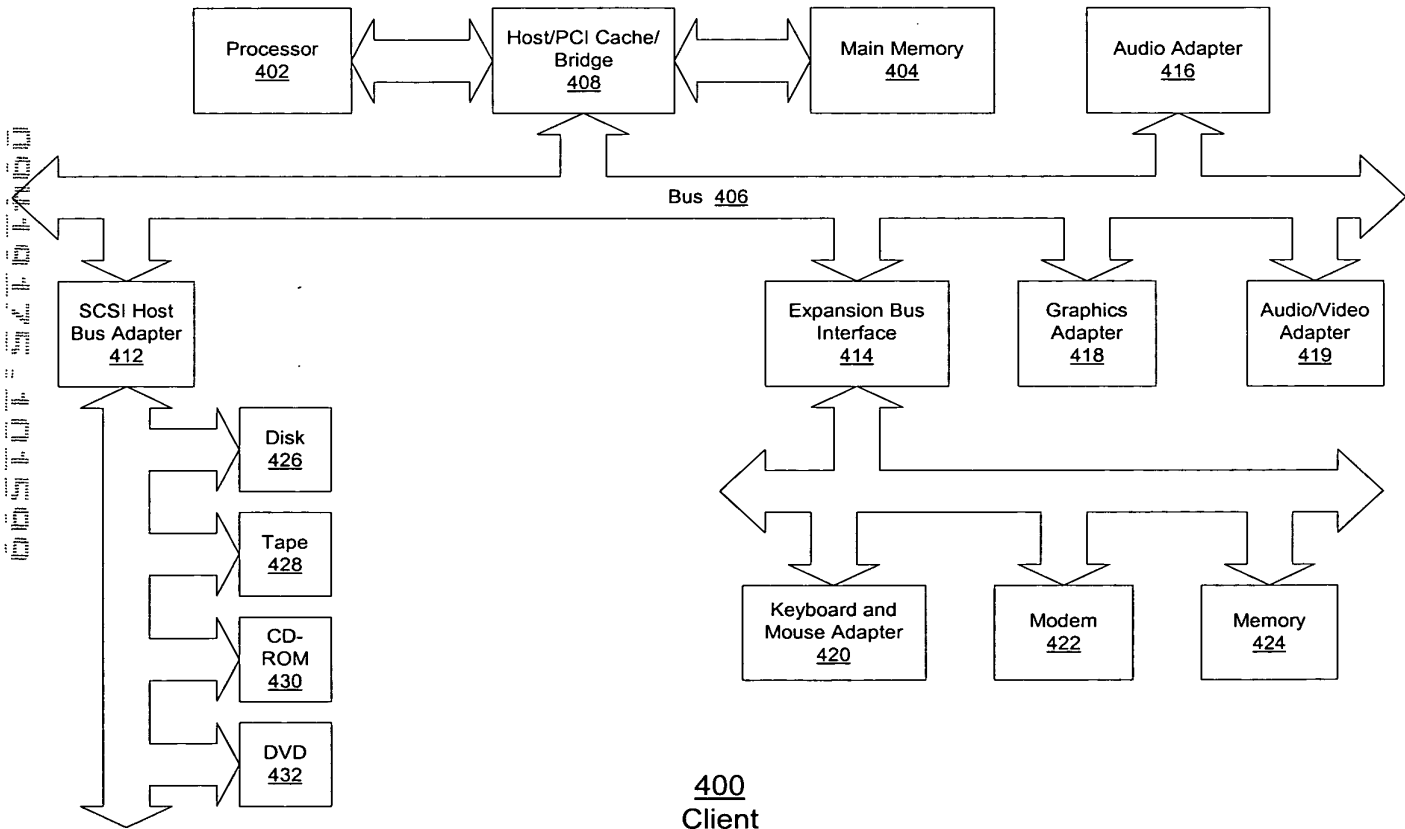

400
Client
Figure 4
11032RR

CONFIDENTIAL

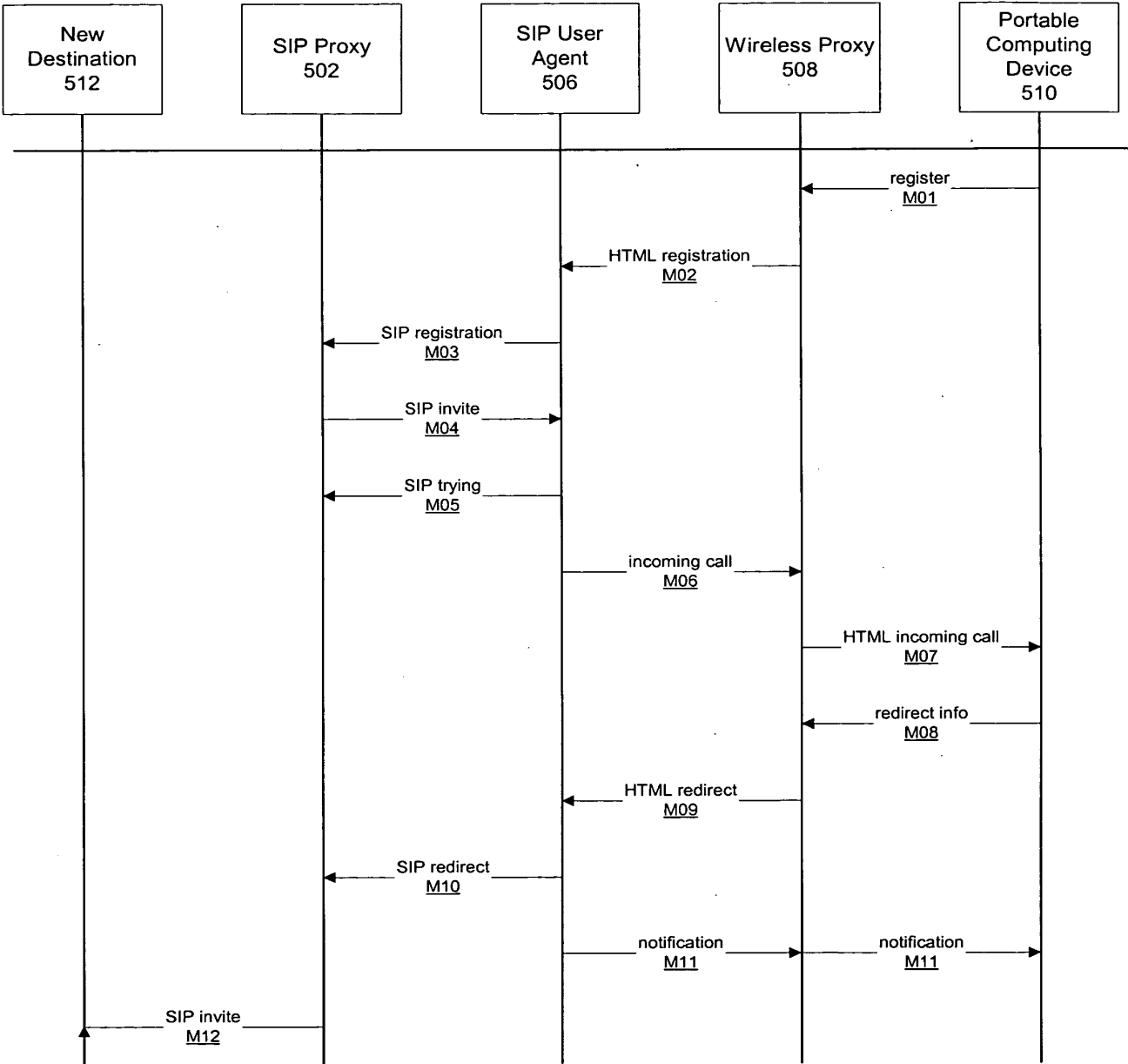

Figure 5
11032RR

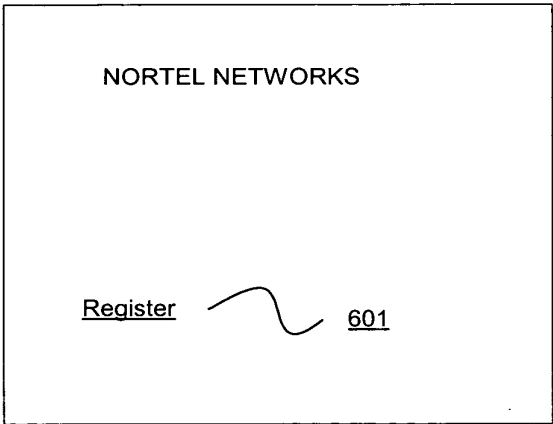

Figure 6A

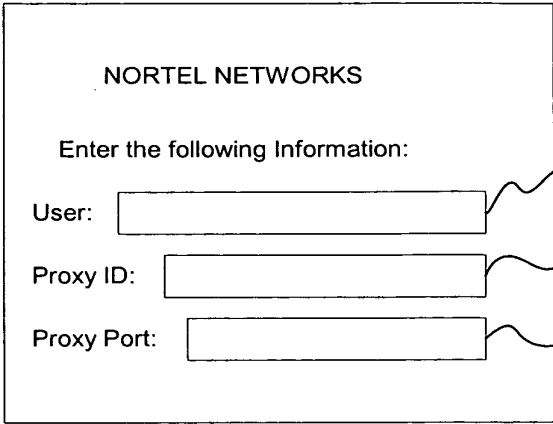

Figure 6B

608
614

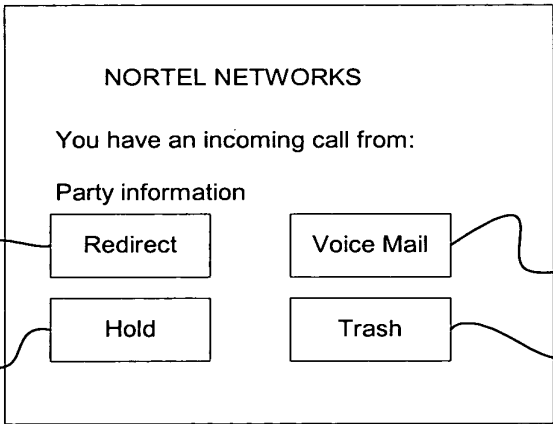

Figure 6C

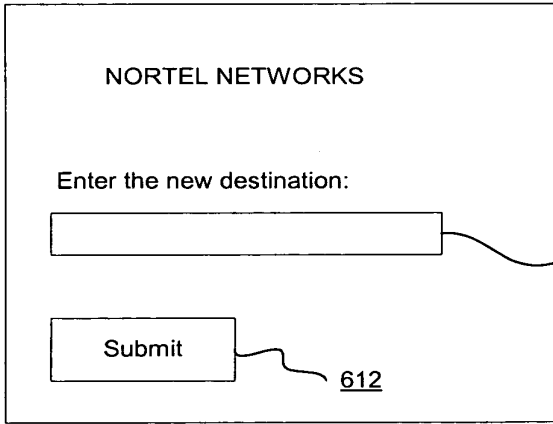

Figure 6D

11032RR

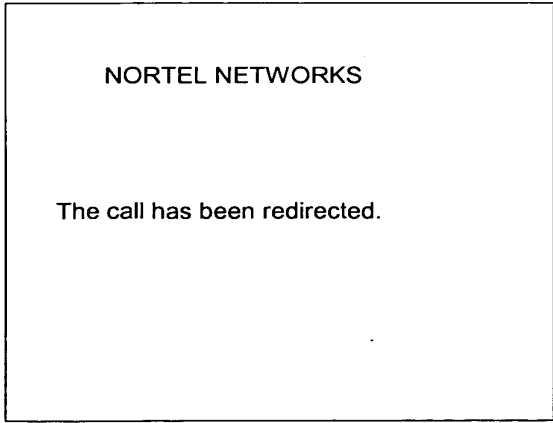

Figure 6E

11032RR

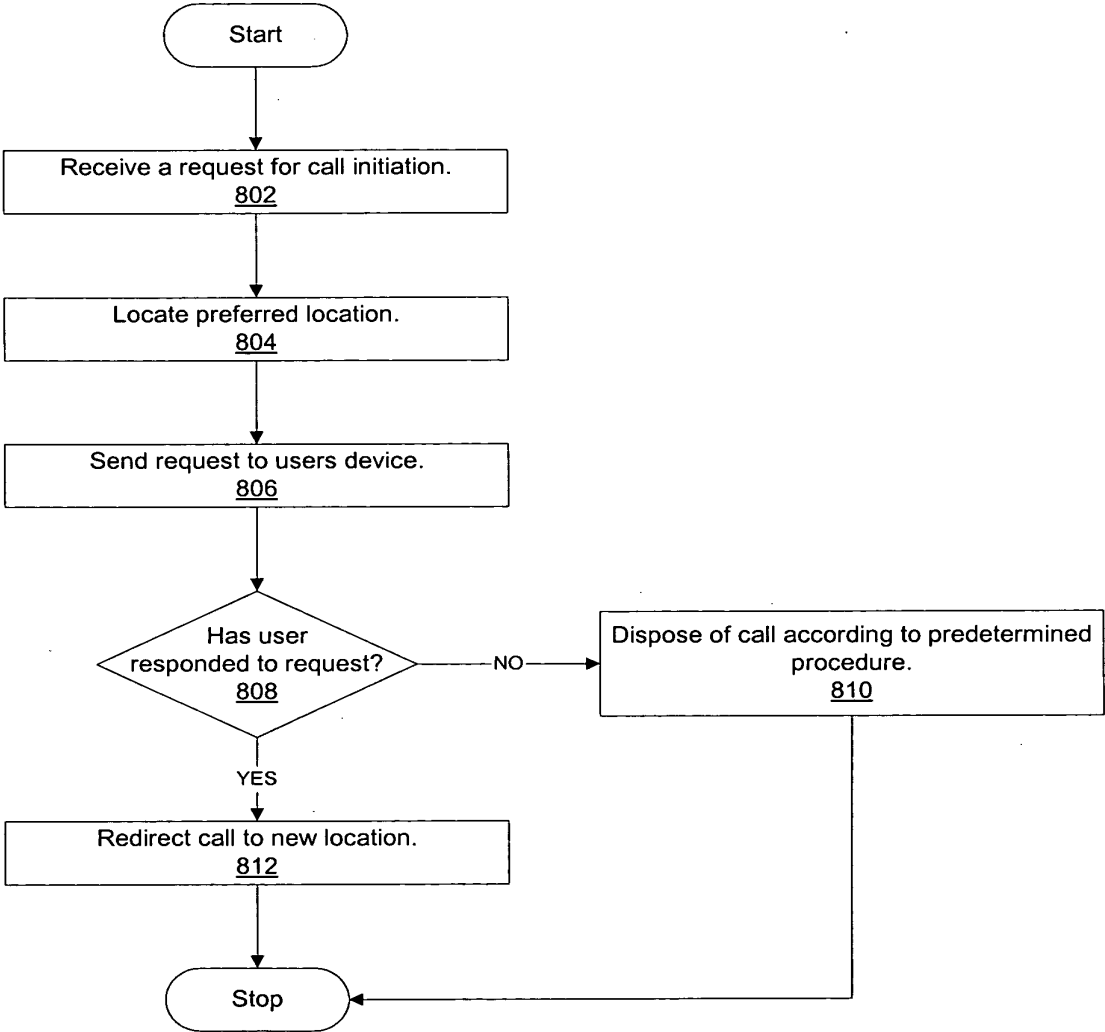

Figure 8
11032RR

CONFIDENTIAL

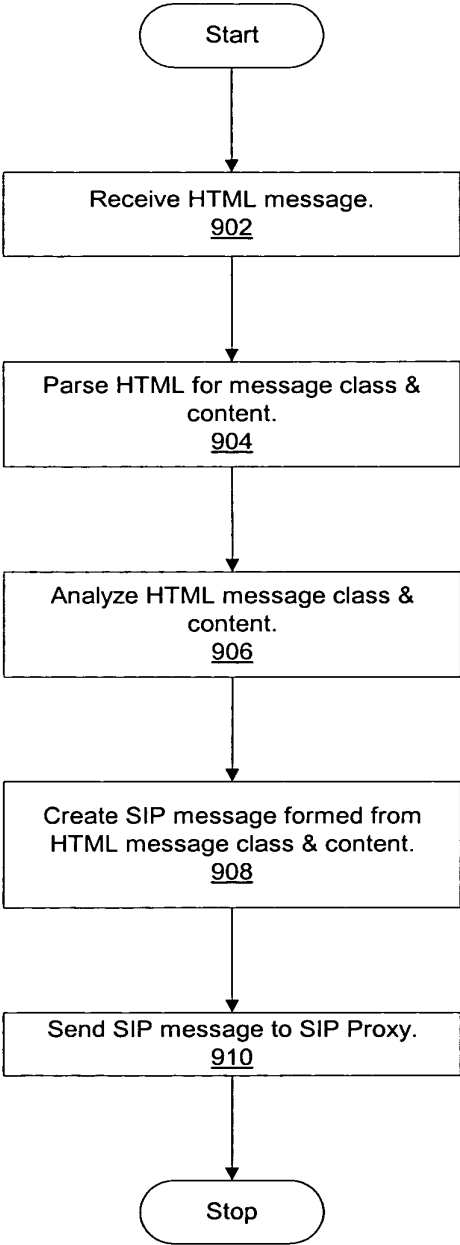

Figure 9
11032RR

11032RR

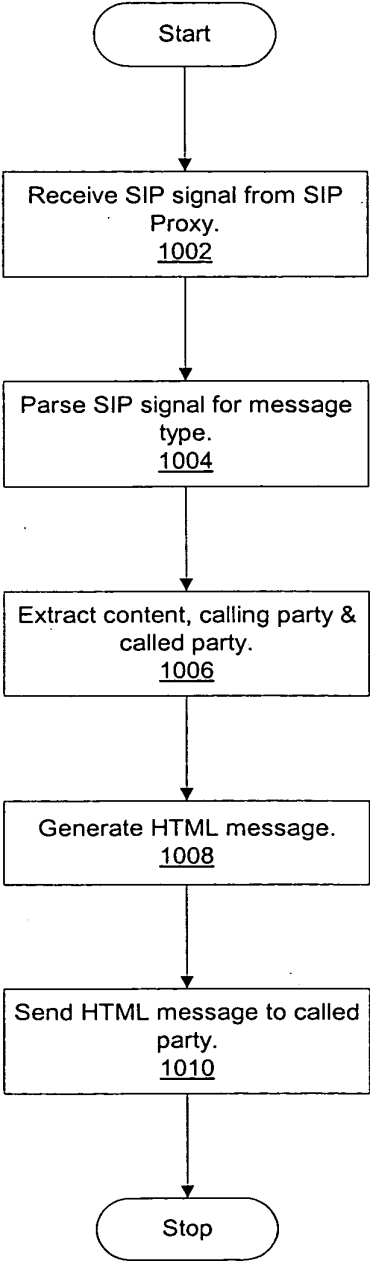

Figure 10

11032RR

Docket No. 11032RR

PORTABLE CALL MANAGEMENT SYSTEM

5 **1. Field of the Invention:**

The present invention relates to telecommunications systems and, more specifically, to methods of transferring calls real time from one device to another.

2. Background of the Invention:

10 Historically, when a caller telephoned a party, if the party to which the caller wished to speak with did not answer the phone or if the line was busy, the caller had to hang up and redial at a later time hoping that the second call would reach the intended party. Often times, the caller would need to attempt to contact the party multiple times in order to reach that party. If the caller had urgent
15 information in which time was of the essence, this method was unsatisfactory and often resulted in the intended party missing important business or other opportunities.

Some of these problems were alleviated with the introduction of answering machines and voice mail systems. However, even these solutions were not
20 completely satisfactory. For instance, utilizing answering machines and voice mail systems required the called party to actively retrieve their messages. Thus, either many important messages were still not received in a timely manner if the called party did not retrieve their messages frequently or the called party was
25 required to check their voice mail or answering machine quite frequently when the party was out of the office or home in order to insure that messages were retrieved quickly. Thus, this results in the same problem as having the caller repeatedly call the intended party, except that in this case it is the called party that must waste its time insuring that no messages are missed.

A more recent solution to this problem is the introduction of subscriber's
30 static reach list. A static reach list enabled a subscriber (i.e., called party) to enter a list of telephone numbers (or IP addresses, etc.) where the subscriber might be reached. The subscriber would enter these numbers in the order of preference in

RECEIVED

Docket No. 11032RR

SUMMARY OF THE INVENTION

5 The present invention solves the problem of preventing a called party from missing calls without having to know in advance the number at which they will be by providing a method and apparatus for redirecting a call from a data processing system to another address. In a preferred embodiment, a notice of an incoming call received from a server at a data processing system. This notice may include caller identification information as well. The user of the data processing system is prompted for an address to which the user wishes the call to be redirected. The user then identifies and sends to the server a new address to which the incoming call is to be redirected.

10 In another aspect of the present invention, an SIP server receives a notice of a call and forwards the notice to a SIP user agent. The SIP proxy server then identifies the address to which the called party wishes the call sent from a database of preferred locations. The called party has previously registered their preferred location to this database. The SIP user agent then sends a message to the called party that they have an incoming call. The called party then identifies a phone number or IP address to which the called party wishes the call to be redirected. Thus, the called party can have their calls originally directed to their handheld personal digital assistant or other data processing device. Thus, when a call is received, the called party can determine at that time how to dispose of the call.

15 Other aspects and features of the present invention will become apparent to those ordinarily skilled in the art upon review of the following description of specific embodiments of the invention in conjunction with the accompanying figures.

Docket No. 11032RR

BRIEF DESCRIPTION OF THE DRAWINGS

5 The novel features believed characteristic of the invention are set forth in the appended claims. The invention itself, however, as well as a preferred mode of use, further objectives and advantages thereof, will best be understood by reference to the following detailed description of an illustrative embodiment when read in conjunction with the accompanying drawings, wherein:

10 **Figure 1** depicts a block diagram illustrating a communications network in which the present invention may be implemented;

Figure 2 depicts a block diagram of a data processing system which may be implemented as a server in accordance with the present invention;

15 **Figure 3** depicts a block diagram of a portable device such as a personal digital assistant (PDA) in which the present invention may be implemented;

Figure 4 depicts a block diagram of a data processing system in which the present invention may be implemented;

Figure 5 depicts a message flow chart illustrating the processes of redirecting a call in real time from according to the present invention;

20 **Figures 6A-6E** illustrate examples of sample HTML or web pages displayed to a user of a portable computing device;

Figure 7 depicts a flowchart illustrating the methods executed on a portable computing device in accordance with a preferred embodiment of the present invention;

25 **Figure 8** depicts a flowchart illustrating the processes of redirecting a call which are implemented on a server within the communications network in accordance with the present invention;

Figure 9 depicts a flowchart illustrating a method of converting HTML to SIP as performed by a SIP User Agent in accordance with the present invention;

30 and

Docket No. 11032RR

Figure 10 depicts a flowchart illustrating a method of converting an SIP signal into an HTML message in accordance with the present invention.

CONFIDENTIAL

Docket No. 11032RR

DETAILED DESCRIPTION OF THE PREFERRED EMBODIMENT

5

With reference now to the figures, and in particular with reference to **Figure 1**, a system diagram illustrating a plurality of interconnected heterogeneous networks in which the present invention may be implemented is depicted. As illustrated, an Internet Protocol (IP) network **102**, a Local Area Network (LAN) / Wide Area Network (WAN) **104**, the Public Switched Telephone Network (PSTN) **109**, a cellular wireless network **112**, and a satellite communication network **116** make up the plurality of heterogeneous networks serviced by the personal mobility system of the present invention.

IP network **102** may be the publicly available IP network, a private IP network, or a combination of public and private IP networks. In any case, IP network **102** operates according to the Internet Protocol and routes packets among its many switches and through its many transmission paths. IP networks are generally known in the art to be expandable, fairly easy to use and heavily supported. Coupled to IP network **102** is a Domain Name Server (DNS) **108** to which queries may be sent, such queries each requesting an IP address based upon a Uniform Resource Locator (URL). IP network **102** supports 32 bit IP addresses as well as 128 bit IP addresses, which are currently in the planning stage.

LAN/WAN **104** couples to IP network **102** via a proxy server **106** (or another connection). LAN/WAN **104** may operate according to various communication protocols, such as the Internet Protocol, the Asynchronous Transfer Mode (ATM) protocol, or other known packet switched protocols. Proxy server **106** serves to route data between IP network **102** and LAN/WAN **104**. A firewall that precludes unwanted communications from entering LAN/WAN **104** may also be located at the location of proxy server **106**.

Computer **120** couples to LAN/WAN **104** and supports communications with LAN/WAN **104**. Computer **120** may employ the LAN/WAN and proxy

Docket No. 11032RR

server 106 to communicate with other devices across IP network 102. Such communications are generally known in the art and will not be further described herein except to expand upon the teachings of the present invention. As is also shown, phone 122 couples to computer 120 and may be employed to initiate IP
5 Telephony communications with another phone or voice terminal using IP Telephony. In such an IP telephony system, a gatekeeper 152 is deployed by a service provider to manage IP telephony for its users. An IP phone 154 connected to IP network 102 (or other phone, e.g., phone 124) may communicate with phone 122 using IP telephony.

10 PSTN 109 is a circuit switched network that is primarily employed for voice communications, such as those enabled by a standard phone 124. However, PSTN 109 also supports the transmission of data. Data transmissions may be supported to a tone based terminal, such as a FAX machine 125, to a tone based modem contained in computer 126, or to another device that couples to PSTN 109
15 via a digital connection, such as an Integrated Services Digital Network (ISDN) line, an Asynchronous Digital Subscriber Line (ADSL), or another digital connection to a terminal that supports such a connection. As illustrated, a voice terminal, such as phone 128, may couple to PSTN 109 via computer 126 rather than being supported directly by PSTN 109, as is the case with phone 124. Thus,
20 computer 126 may support IP telephony with voice terminal 128, for example.

Cellular network 112 supports wireless communications with terminals operating in its service area (which may cover a city, county, state, country, etc.). As is known, cellular network 112 includes a plurality of towers, e.g., 130, that each service communications within a respective cell. Wireless terminals that
25 may operate in conjunction with cellular network 112 include wireless handsets 132 and wirelessly enabled laptop computers 134, for example. Wireless handsets 132 could be, for example, personal digital assistants, wireless or cellular telephones, or two-way pagers. Cellular network 112 couples to IP network 102 via gateway 114.

30 Wireless handsets 132 and wirelessly enabled laptop computers 134 may communicate with cellular network 112 using a wireless application protocol

8

Docket No. 11032RR

(WAP). WAP is an open, global specification that allows mobile users with wireless devices, such as, for example, mobile phones, pagers, two-way radios, smartphones, communicators, personal digital assistants, and portable laptop computers, to easily access and interact with information and services almost
 5 instantly. WAP is a communications protocol and application environment and can be built on any operating system including, for example, Palm OS, EPOC, Windows CE, FLEXOS, OS/9, and JavaOS. WAP provides interoperability even between different device families.

WAP is the wireless equivalent of Hypertext Transfer Protocol (HTTP)
 10 and Hypertext Markup Language (HTML). The HTTP-like component defines the communication protocol between the handheld device and a server or gateway. This component addresses characteristics that are unique to wireless devices, such as data rate and round-trip response time. The HTML-like component, Wireless Markup Language (WML), defines new markup and scripting languages for
 15 displaying information to and interacting with the user. This component is highly focused on the limited display size and limited input devices available on small, handheld devices. For example, a typical cell phone may have only a 4x10-character display with 16-gray levels and only a numeric keypad plus up/down volume keys.

20 Cellular network **112** operates according to an operating standard, which may be the Advanced Mobile Phone System (AMPS) standard, the Code Division Multiple Access (CDMA) standard, the Time Division Multiple Access (TDMA) standard, or the Global System for Mobile Communications or Groupe Speciale Mobile (GSM), for example. Independent of the standard(s) supported by cellular
 25 network **112**, cellular network **112** supports voice and data communications with terminal units, e.g., **132** and **134**.

Satellite network **116** includes at least one satellite dish **136** that operates in conjunction with a satellite **138** to provide satellite communications with a plurality of terminals, e.g., laptop computer **142** and satellite handset **140**.
 30 Satellite handset **140** could also be a two-way pager. Satellite network **116** may be serviced by one or more geosynchronous orbiting satellites, a plurality of

Docket No. 11032RR

medium earth orbit satellites, or a plurality of low earth orbit satellites. In any case, satellite network 116 services voice and data communications and couples to IP network 102 via gateway 118.

Wireless Proxy 160 is coupled to IP network 102 and is coupled to a plurality of towers, e.g., 162, which each provide wireless communications with wireless devices such as wireless device 164. Wireless Proxy 160 provides access to IP network 102 to wireless device 164, such as personal digital assistants (PDAs), that may require proprietary or other special protocols in order to communicate with IP network 102. For example, wireless proxy server 160 may be a 3Com server utilizing 3Com protocols for communicating with a Palm VII, a handheld portable computing device available from 3Com Corporation in Santa Clara, California.

In a preferred embodiment of the present invention, wireless proxy 160 is a 3Com proxy server supporting communications with Palm VII personal organizer and portable computing device 164 is a Palm VII personal organizer. In this embodiment, communications between wireless proxy server 160 and portable computing device 164 is facilitated by the use of Palm Query Applications (PQAs). A PQA is like a mini-Web site that resides on portable computing device 164. That is, a PQA is a special kind of record database. A typical PQA contains an HTML form or a list of hyperlinks that request additional information either locally — on personal computing device 164 — or remotely — on the Internet.

Much of the content on the Internet is designed to take advantage of the power of Pentium/RISC-class computers with large, high resolution color monitors and fast and cheap Internet access. In these circumstances, there is little reason to economize on the abundant connect time and large file size that make Web browsing such a rich, multimedia experience from a desktop or notebook computer.

However, this model is not the best model for a small, low-power computer like the Palm VII organizer with its tiny screen, battery powered operation, and relatively slow and expensive wireless connection to the Internet.

Docket No. 11032RR

Rather than duplicate the Web browsing model on a handheld computer, PQAs are developed that access targeted bits of Internet information — like clippings from a newspaper. Typically, a handheld computer user does not focus on following hyperlinks to the Internet (although this is available), but instead, they
5 compose a simple query in the PQA (for example a request for a stock quote) and then send that query over the air.

Also included in network 100 is a Session Initiation Protocol (SIP) proxy 170. SIP proxy 170 is connected to IP network 102 and provides switching and routing for communication over IP network 102. SIP proxy 170 also maintains a static list of preferred locations to which a user wishes telephone calls or other communication types sent. When a request to initiate a communications session is received, SIP proxy 170 retrieves the static list of the called party and routes the call to the top address in the static list. If the communications session is not established with the top address in the static list, then SIP proxy 170 may attempt
15 to access the next address in the list and so on until the called party is reached or until the addresses in the static list are exhausted.

SIP is a textual based signaling protocol for creating, modifying and terminating sessions. These sessions can be multimedia conferences, Internet telephone calls and similar applications consisting of one or more media types
20 such as, for example, audio, video, or whiteboard. SIP invitations are used to create sessions and carry session descriptions, which allow participants to agree on a set of compatible media types. SIP requests can be sent either over TCP or UDP.

SIP User Agent 172 is also connected with IP Network 102. SIP User
25 Agent 172 translates between SIP communications and Hypertext Transfer Protocol (HTTP) and other extensible markup language (XML) based protocols such as Voice XML (VOXML) and Wireless Application Protocol (WAP).

Figure 1 is intended as an example and not as an architectural limitation for the processes of the present invention.

30 In a preferred embodiment, a user registers an address to which they wish their voice calls or other communications to be sent. The address can be an IP

Docket No. 11032RR

address, a PSTN address or other type of address for locating an electronic device such as a data processing system or telephone. As an example, consider a user of portable device 164 wishing to have all of their calls routed to the portable device. The user of portable device 164 sends an HTML registration request to Wireless
5 Proxy 160, which then forwards the HTML registration request to SIP User Agent 172. SIP User Agent SIP 172 translates the HTML registration request from HTML into an SIP registration statement and sends the SIP registration statement to SIP Proxy 170. SIP Proxy 170 then updates the user's static list and inserts the newly received address into the top of the static list as the first address to attempt
10 to establish a connection with if a request to initiate communications with that user is received. If the user does not have a static list, SIP Proxy 170 can create one and then place the received address in the newly created static list. The registration request does not have to initiate from a portable wireless device such as portable device 164 but may initiate with a LAN based data processing system
15 such as client 120 or with some other type of wireless device.

When SIP Proxy 170 receives a request to initiate communications, such as a voice telephone call, with a user, SIP Proxy 170 retrieves the static list for the called party and determines the first address to contact. SIP Proxy 170 then sends an SIP Invite message to SIP User Agent 172. SIP User Agent 172 translates the
20 SIP Invite message into an HTML message and sends the HTML message to Wireless Proxy 160 which then forwards the HTML message to portable device 164.

Once the HTML invite message is received at portable device 164, the user may then determine how to dispose of the call. If portable device 164 is a
25 telephone (or supports voice communications), the user may choose to take the call if it is someone to which the user wishes to speak. The user may also redirect the call elsewhere to a nearby PSTN address, to a voice mailbox, or to an IP address. Portable device 164 may even suggest options as to disposal of the incoming communication. For example, if the incoming communication is video,
30 rather than a voice call, portable device 164 may suggest routing the

12

Docket No. 11032RR

communication to client **120** on LAN/WAN **104**, which may be the nearest device capable of receiving such communication.

If the user decides to redirect the call to some other device, then redirection information in HTML format indicating the address of the new device is sent from portable device **164** to wireless proxy **160**. Wireless proxy **160** then forwards the HTML redirect information to SIP User Agent **172**, which converts the HTML redirect information into an SIP redirect and send the SIP redirect to SIP proxy **170**. SIP User Agent **172** also sends an HTML notification to portable device **164** via wireless proxy **160** indicating that the communication is being redirected. SIP proxy **170** then redirects the communication to the new address and takes down the connection with portable device **164**. If SIP proxy **170** is unable to make a connection with the new address (e.g., incorrect address, device off-line, etc.), then the communication must be terminated or the next address in the user's static list contacted. This is because the connection to portable device **164** has already been taken down thus preventing an attempt to request a new address to which to redirect the communication.

As an example of uses of such redirection methods and systems according to the present invention, consider a family consisting of a husband, wife, and children. Perhaps the husband has registered his wireless telephone as the device to which incoming calls to his home telephone should be delivered. If notification of an incoming call is received by the husband on his wireless telephone, he can look at the display to see who the caller is. If the husband determines that the call is for his wife, he can redirect the call to her work phone or to her wireless phone. If the call is for one of the children, the call can be redirected to the home phone. However, if the call is for the husband, he can choose to take the call on his wireless telephone. Alternatively, if the call is for the husband, but he does not wish to speak with the caller, the call can be forwarded to his voice mailbox.

As another example of the use of redirection methods and systems according to the present invention, consider a person travelling on business and away from the office. The business person can register a personal digital assistant (PDA) as the device to which incoming calls are directed. Thus, wherever the

Docket No. 11032RR

business person is, no calls will be misses because of being away from the office. If notification of a call is received, the business person can have the call redirected to a phone near where the business person is presently located. Such phone could be the room phone of the hotel where the person is currently staying or it could be
5 the office phone of the person with which the business person is meeting.

Referring now to **Figure 2**, a block diagram of a data processing system which may be implemented as a server, such as server **106, 108, 160, or 170** in **Figure 1**, is depicted in accordance with the present invention. Data processing system **200** may be a symmetric multiprocessor (SMP) system including a
10 plurality of processors **202** and **204** connected to system bus **206**. Alternatively, a single processor system may be employed. Also connected to system bus **206** is memory controller/cache **208**, which provides an interface to local memory **209**. I/O bus bridge **210** is connected to system bus **206** and provides an interface to I/O bus **212**. Memory controller/cache **208** and I/O bus bridge **210** may be
15 integrated as depicted.

Peripheral component interconnect (PCI) bus bridge **214** connected to I/O bus **212** provides an interface to PCI local bus **216**. A number of modems **218-220** may be connected to PCI bus **216**. Typical PCI bus implementations will support four PCI expansion slots or add-in connectors. Communications links to
20 network computers **120, 126, 134, and 142** in **Figure 1** may be provided through modem **218** and network adapter **220** connected to PCI local bus **216** through add-in boards.

Additional PCI bus bridges **222** and **224** provide interfaces for additional PCI buses **226** and **228**, from which additional modems or network adapters may
25 be supported. In this manner, server **200** allows connections to multiple network computers. A memory mapped graphics adapter **230** and hard disk **232** may also be connected to I/O bus **212** as depicted, either directly or indirectly.

Those of ordinary skill in the art will appreciate that the hardware depicted in **Figure 2** may vary. For example, other peripheral devices, such as optical disk
30 drives and the like, also may be used in addition to or in place of the hardware

144

Docket No. 11032RR

depicted. The depicted example is not meant to imply architectural limitations with respect to the present invention.

The data processing system depicted in **Figure 2** may be, for example, an IBM RS/6000, a product of International Business Machines Corporation in Armonk, New York, running the Advanced Interactive Executive (AIX) operating system.

Turning now to **Figure 3**, a block diagram of a personal digital assistant (PDA), such as portable device **164** in **Figure 1**, is illustrated in which the present invention may be implemented. The PDA is typically a palmtop computer, such as, for example, a Palm VII, a product of 3Com Corporation in Santa Clara, California, connected to a wireless communications network and which may provide voice, fax, e-mail, and/or other types of communication. The PDA **300** may have one or more processors **302**, such as a microprocessor, a main memory **304**, a disk memory **306**, and an I/O **308** such as a mouse, keyboard, or pen-type input, and a screen or monitor. The PDA **300** may also have a wireless transceiver **310** connected to an antenna **312** configured to transmit and receive wireless communications. The processor **302**, memories **304**, **306**, I/O **308**, and transceiver are connected to a bus **304**. The bus transfers data, i.e., instructions and information, between each of the devices connected to it. The I/O **308** may permit faxes, e-mail, or optical images to be displayed on a monitor or printed out by a printer. The I/O **308** may be connected to a microphone **316** and a speaker **318** so that voice or sound information may be sent and received.

With reference now to **Figure 4**, a block diagram of a data processing system in which the present invention may be implemented is illustrated. Data processing system **400** is an example of a client computer such as client **120**, **126**, **134**, or **142** in **Figure 1**. Data processing system **400** employs a peripheral component interconnect (PCI) local bus architecture. Although the depicted example employs a PCI bus, other bus architectures, such as Micro Channel and ISA, may be used. Processor **402** and main memory **404** are connected to PCI local bus **406** through PCI bridge **408**. PCI bridge **408** may also include an integrated memory controller and cache memory for processor **402**. Additional

Docket No. 11032RR

connections to PCI local bus 406 may be made through direct component interconnection or through add-in boards. In the depicted example, SCSI host bus adapter 412 and expansion bus interface 414 are connected to PCI local bus 406 by direct component connection. In contrast, audio adapter 416, graphics adapter 5 418, and audio/video adapter (A/V) 419 are connected to PCI local bus 406 by add-in boards inserted into expansion slots. Expansion bus interface 414 provides a connection for a keyboard and mouse adapter 420, modem 422, and additional memory 424. In the depicted example, SCSI host bus adapter 412 provides a connection for hard disk drive 426, tape drive 428, CD-ROM drive 430, and 10 digital video disc read only memory drive (DVD-ROM) 432. Typical PCI local bus implementations will support three or four PCI expansion slots or add-in connectors.

An operating system runs on processor 402 and is used to coordinate and provide control of various components within data processing system 400 in 15 **Figure 4**. The operating system may be a commercially available operating system, such as OS/2, which is available from International Business Machines Corporation. "OS/2" is a trademark of International Business Machines Corporation. An object oriented programming system, such as Java, may run in conjunction with the operating system, providing calls to the operating system 20 from Java programs or applications executing on data processing system 400. Instructions for the operating system, the object-oriented operating system, and applications or programs are located on a storage device, such as hard disk drive 426, and may be loaded into main memory 404 for execution by processor 402.

Those of ordinary skill in the art will appreciate that the hardware in 25 **Figure 4** may vary depending on the implementation. For example, other peripheral devices, such as optical disk drives and the like, may be used in addition to or in place of the hardware depicted in **Figure 4**. The depicted example is not meant to imply architectural limitations with respect to the present invention. For example, the processes of the present invention may be applied to 30 multiprocessor data processing systems.

Docket No. 11032RR

Turning now to **Figure 5**, a message flow chart is depicted illustrating the processes of redirecting a call in real time from a wireless device according to the present invention. In this example, a redirect from a wireless device utilizing a wireless proxy is illustrated. A similar flow would result if the redirect were being sent from a LAN/WAN connected device except for the omission of wireless proxy 508.

A user of a portable computing device such as a PDA or laptop computer initiates a registration by entering a proxy ID, a proxy port, and an address, such as, for example, a PSTN number or an IP address, and sending this information to wireless proxy 508 (step **M01**). **Figures 6A** illustrates an example of a sample HTML screen displayed to a user to initiate registration. The user may pull up the registration page by selecting the word "register" 601 on the page. **Figure 6B** illustrates an example of a sample HTML screen allowing a user to register by providing prompts to enter an user name 602, a proxy identification 604, and a proxy port 606.

Wireless Proxy 508 receives the HTML registration web page and forwards it to SIP user agent 506 (step **M02**). User agent 506 receives the HTML page and sends a SIP registration to SIP proxy 502 (step **M03**). SIP proxy 502 updates its destination list for the user with the address for portable computing device 510. Next, an SIP invite signal is sent to user agent 506 (step **M04**).

User agent 506 then sends an SIP 100-trying signal back to SIP proxy 502 (step **M05**). When a call for the user at portable computing device 510 is received by user agent 506, user agent 506 sends an HTML page to 3Com proxy 508 to indicate an incoming call for the user at portable computing device 510 (step **M06**). 3Com proxy 508 forwards the HTML page to portable computing device 510 (step **M07**). The HTML page is displayed the user of portable computing device 510 to indicate that the user has an incoming call. An example of such an HTML page is illustrated in **Figure 6C**. A hot button 608 is supplied which the user may select to redirect the incoming call. Other hot buttons 614, 616, and 618 allow the user to place the call on hold, terminate the call without answering, or send the call to voice mail respectively. If redirection is chosen, the user of the

Docket No. 11032RR

portable computing device **510** then redirects the call to another destination by entering and sending a PSTN, IP, or other address as the new destination (step **M08**). **Figure 6D** illustrates an example of a sample HTML page in which the user may enter the new destination for the incoming phone call in destination box **610** and then send the new destination by selecting the "submit" hot button **612**.

Wireless proxy **508** receives the HTML page containing the new destination and this page is forwarded to user agent **506** (step **M09**). User agent **506** sends a SIP 300 signal to SIP proxy **502** containing the new destination (step **M10**). User agent **506** also sends an HTML page to portable computing device **510** via 3Com proxy **508** indicating that the call was redirected (step **M11**). A message is displayed to the user of portable computing device **510** indicating that the call was redirected. An example of such a HTML page is illustrated in **Figure 6E**. SIP proxy **502** receives the 300 signal and sends out an invite to the new destination (step **M12**).

If portable computing device **510** does not respond to the message indicating that the user has an incoming call (step **M07**), then a SIP 480 Temporarily not available signal is sent from user agent **506** back to SIP proxy server **502**. SIP proxy **502** can then decide how to process the call. For example, for calls to which the portable computing device does not respond, SIP proxy **502** could forward the call to a predefined destination or take the call down.

Turning now to **Figure 7**, a flowchart illustrating the methods executed on a portable computing device in accordance with a preferred embodiment of the present invention is depicted. To start, a user of a data processing device registers the address of their data processing device that they wish their calls to be delivered to (step **702**). Typically, when the data processing device is activated, it performs an SIP registration with a SIP registration server, effectively causing all future calls to route to this device as the first selection. On deactivation of the device, the shutdown processing unregisters with the SIP registration server thereby restoring the defaults on how the called party is to be reached (i.e., the subscriber's static reach list). Next, when a call is made to the user, a notification of the incoming call is received at their data processing device (step **704**).

Docket No. 11032RR

Included in the notification may be caller identification information such as PSTN or IP address from where the call originated. The user then identifies a new destination for the incoming call to be sent (step 706). For example, if the user has traveled to a hotel, the user may enter the phone number of the room at the hotel. As another example, if the user is near a pay phone, the user may enter the phone number of the pay phone. Once the user has identified a new destination for the incoming call to be redirected to, this new destination is sent back to a SIP proxy via a SIP User Agent (step 708). Once the SIP User Agent receives the redirect request, the user will receive a notice indicating the call is being redirected (step 710).

Turning now to **Figure 8**, a flowchart illustrating the processes of redirecting a call which are implemented on a server within the communications network is depicted in accordance with the present invention. To start, a server within the communications network receives a request for call initiation from a PSTN (step 802). The server accesses a database to which the called party has registered the current device to which they wish their calls directed (step 804). The current device is registered at the top of a static reach list of numbers to try in order to reach the called party. Once the current device is identified, a notice is sent to the called parties current location indicating that the party has an incoming call and requesting information about where to direct the call (step 806). Next, a determination is made as to whether the user has responded to the request (step 808). If the user does not respond after a given period of time, then the call is disposed of according to a predetermined procedure (step 810). For example, if the user does not respond to the request, then the server may redirect the call to the next address in the called party's static reach list of preferred locations or if there are no more preferred locations stored in a database, the server may end the call. If the user does respond to the request, then the call is redirected to the new location and a confirmation is sent to the user indicating such (step 812). The call may be redirected to a cell phone, to a nearby wire-line device, to the called party's voice mailbox, or the party initiating the call may be placed on temporary hold. If the party initiating the call is placed on hold, a standard greeting will be

Docket No. 11032RR

sent to the calling party to make them aware that the called party is attempting to find an appropriate method to receive the call or is on another call and to stay on the call because the called party will answer momentarily.

Turning now to **Figure 9**, a flowchart illustrating a method of converting HTML to SIP as performed by a SIP User Agent is depicted in accordance with the present invention. To start, a SIP User Agent receives an HTML message (step 902). The SIP User Agent then parses the HTML message for class and content (step 904). The SIP User Agent then analyzes the message class and content (step 906) to create an SIP signal from the HTML message (step 908). The newly formed SIP signal is then sent to an SIP Proxy (step 910) and the process stops.

Turning now to **Figure 10**, a flowchart illustrating a method of converting an SIP signal into an HTML message is depicted in accordance with the present invention. First, the SIP User Agent receives an SIP signal from the SIP Proxy (step 1002). The SIP signal is then parsed for message type (step 1004) and the content, calling party, and called party are extracted from the SIP signal (step 1006). Using the extracted information, the SIP User Agent generates an appropriate HTML page (step 1008) and sends the HTML message to the called party (step 1010) ending the process.

Although the present invention has been described primarily with reference to redirecting telephony communications. Other forms of media streams may be redirected as well. For example, a client such as client 120 or portable device 164, that has previously performed an SIP registration, receives a notification of incoming data streams. The notification will include information about what types of data streams are included. This will be encoded into the notification at either SIP Proxy 170 or at User Agent 172. The notice displayed to the user will inform the user of whether there are multiple types of data streams and what types of data streams are in the incoming communication. Once the notification is displayed to the user of the client, the client may then decide how to dispose of the incoming data streams. If the user selects one device, such as telephone 124 to send the data stream to, then the name or address of telephone

Docket No. 11032RR

124 will be sent back to SIP Proxy 170, which will then redirect the call to telephone 124. The user may select more than one device to send the data streams to as well. If the data stream consists of multiple data types, the user may instruct SIP Proxy 170 to send each data stream to a different type of device.

5 Furthermore, the user may instruct SIP Proxy 170 to send all of the data streams to several locations (forking) such that multiple parties may be connected (such as for a conference call) or to several locations, but have only the first to “pick up” or “answer” be connected. This last alternative might be useful if the user wished to redirect the data stream to another person, but was unsure of that person’s location
10 but did know of several possible locations of that person.

To help illustrate the present invention, consider the following example of a user’s device receiving multiple types of data streams at a single device. For example, a user might have registered their personal digital assistant as the device to which to have incoming data streams routed. The SIP Proxy 170 receives an
15 incoming data stream intended for this user and generates and routes a message to the user indicating the types of message streams and from what party. The types of message streams include audio, video (in MPEG format), text and a JPEG picture. The user of the personal digital assistant might decide to route the audio to speakers or to a telephone such as telephone 124, route the video to a desktop
20 computer such as client 120 or to a television attached to a set top box, the text routed to a printer (perhaps connected to client 120), and the JPEG picture routed to a second computer such as client 126 or to a device dedicated to generating and displaying still pictures. Thus, each of the data streams were directed to a device which was best able to utilize and present the information to the user.

25 To illustrate “forking”, consider a person receiving a data stream (perhaps a phone call, but not necessarily). The person after determining what the data stream is and/or who it is from, decides that other people within an organization should participate as well. The person would then enter several names or addresses for the SIP Proxy 170 to use to redirect the data stream. This list of
30 several names could include the user originally receiving the notification. In that way several people could participate, such as on a conference call.

21

Docket No. 11032RR

In yet another example of forking, the user could receive notification of an incoming call and determine that that call was for another person. However, the user does not know the exact location of the other person, but does know of several locations where that person might be. The user in this case would enter several location names and instruct the proxy to redirect the call to each of them and connect the location which "picked up" first. In that manner the call is forwarded to the correct party even though the user receiving the notification knew no more than several possibilities of locations.

Although the present invention has been described primarily with reference to presenting call notification information to the called party through means of a display, other methods are also possible. Such methods include, but are not limited to, notifying the called party of an incoming call through the use of sounds or through a voice synthesizer if the portable device supported such options. Furthermore, as another option, the portable computing device could vibrate to indicate that the user had an incoming call. The use of sounds and vibrations could also be used to alert the called party of an incoming call such that they could direct their attention to a visual display which would indicate the nature and origin of the call.

Although described primarily with reference to SIP, an SIP proxy and an SIP user agent, other communications initiation and routing protocols, such as H.323 Protocol, can be utilized as well. Furthermore, other text based or XML based protocols may be utilized rather than HTTP and HTML. Examples of other protocols include, but are not limited to, Voice XML (VOXML), Speech Markup Language (SML), WAP, and XHTML. In such cases the SIP user agent would be replaced with a user agent which translated between the appropriate protocols.

It should be noted that although the present invention has been described with reference to utilizing a SIP proxy, a proxy of any kind is not necessary if the complete IP address of the device to which the call is to be directed is known and used. Furthermore, the SIP user agent is not necessary if all of the terminal devices (e.g., portable data processing systems, personal digital assistants, phones, desk top computers, cell phones) involved in a calling process utilize SIP such that

Docket No. 11032RR

communications with the SIP proxy does not need to be facilitated with a translating user agent. In this case, the SIP proxy becomes the agent.

Furthermore, the SIP proxy does not have to be a proxy. Any device or software which can perform the functionality of the SIP proxy will suffice, wherein the
5 primary functions performed by the SIP proxy are address lookup (determining the IP or other type address based on information received, i.e., converting john@nortel.com into an IP address) and redirecting calls.

It should also be noted that although the present invention has been described primarily with reference to voice calls, it applies to other types of
10 communication as well, including, but not limited to for example, video conferencing or text messages. For example, a portable computing device could receive a notification of an incoming video call or video message and a user could redirect that incoming video message to a laptop or desktop computer, a television, or other video display terminal such that the video could be viewed by
15 the called party. The device receiving the request could even suggest alternative destinations to redirect the call to based on the type of call (e.g. video, voice, text) the request corresponds to.

It is important to note that while the present invention has been described in the context of a fully functioning data processing system, those of ordinary skill
20 in the art will appreciate that the processes of the present invention are capable of being distributed in the form of a computer readable medium of instructions and a variety of forms and that the present invention applies equally regardless of the particular type of signal bearing media actually used to carry out the distribution. Examples of computer readable media include recordable-type media such a
25 floppy disc, a hard disk drive, a RAM, and CD-ROMs and transmission-type media such as digital and analog communications links.

The description of the present invention has been presented for purposes of illustration and description, but is not intended to be exhaustive or limited to the invention in the form disclosed. Many modifications and variations will be
30 apparent to those of ordinary skill in the art. For example, the present invention is not limited to SIP and Palm VII's. Other types of call initiation protocols other

Docket No. 11032RR

than SIP may be utilized. Furthermore, other types of portable devices other than Palm VII's may be utilized including, but not limited to, portable computers, laptop computers, other types of personal digital assistants (PDAs), and other handheld data processing systems. The embodiment was chosen and described in
5 order to best explain the principles of the invention, the practical application, and to enable others of ordinary skill in the art to understand the invention for various embodiments with various modifications as are suited to the particular use contemplated.

005075407000

Docket No. 11032RR

1
2
3

CLAIMS:

What is claimed is:

SB
BI

1
2
3
4
5
6

1. A method of redirecting a call from a data processing system to another address, comprising the steps of:
receiving at a data processing system a registration notice of an incoming call from a server; and
responsive to determination of a new address; transmitting a new address to which the incoming call is to be redirected.

1
2

2. The method as recited in claim 1, wherein said data processing system is a personal digital assistant.

1
2

3. The method as recited in claim 1, wherein said data processing system is a laptop computer.

1
2

4. The method as recited in claim 1, wherein said data processing system is a portable computing device.

1
2

5. The method as recited in claim 1, wherein said data processing system is a wireless device.

1
2

6. The method as recited in claim 1, wherein the registration notice is a session initiation protocol registration notice.

1
2

7. The method as recited in claim 1, wherein the incoming call comprises video and the new address corresponds to a video display terminal.

25

Docket No. 11032RR

- 1 8. The method as recited in claim 1, wherein said data processing system is a
- 2 wire-line connected device.

WESTER SAFETY

3

Docket No. 11032RR

- 1 9. A computer program product in computer readable media for use in a data
2 processing system for redirecting a call from a data processing system to another
3 address, the computer program product comprising:
4 first instructions for receiving at a data processing system a registration notice
5 of an incoming call from a server; and
6 second instructions, responsive to determination of a new address; for
7 transmitting a new address to which the incoming call is to be redirected.
- 1 10. The computer program product as recited in claim 9, wherein said data
2 processing system is a personal digital assistant.
- 1 11. The computer program product as recited in claim 9, wherein said data
2 processing system is a laptop computer.
- 1 12. The computer program product as recited in claim 9, wherein said data
2 processing system is a portable computing device.
- 1 13. The computer program product as recited in claim 9, wherein said data
2 processing system is a wireless device.
- 1 14. The computer program product as recited in claim 9, wherein the registration
2 notice is a session initiation protocol registration notice.
- 1 15. The computer program product as recited in claim 9, wherein the incoming
2 call comprises video and the new address corresponds to a video display terminal.
- 1 16. The computer program product as recited in claim 9, wherein said data
2 processing system is a wire-line connected device.

030707 0400

Docket No. 11032RR

56
B2

1 17. A system of redirecting a call from a data processing system to another
 2 address, comprising:
 3 means for receiving at a data processing system a registration notice of an
 4 incoming call from a server; and
 5 means, responsive to determination of a new address; for transmitting a new
 6 address to which the incoming call is to be redirected.

1 18. The system as recited in claim 17, wherein said data processing system is a
 2 personal digital assistant.

1 19. The system as recited in claim 17, wherein said data processing system is a
 2 laptop computer.

1 20. The system as recited in claim 17, wherein said data processing system is a
 2 portable computing device.

1 21. The system as recited in claim 17, wherein said data processing system is a
 2 wireless device.

1 22. The system as recited in claim 17, wherein the registration notice is a session
 2 initiation protocol registration notice.

1 23. The system as recited in claim 17, wherein the incoming call comprises video
 2 and the new address corresponds to a video display terminal.

1 24. The system as recited in claim 17, wherein said data processing system is a
 2 wire-line connected device.

11032RR-56-B2

Docket No. 11032RR

Handwritten initials "SAB" and a signature.

1 25. A method for redirecting calls to a data processing system to a second
 2 location; comprising the steps of:
 3 sending a registration notification to a called party's preferred location; and
 4 responsive to receipt of a new address from the called party, redirecting the
 5 incoming call to the new address.

1 26. The method as recited in claim 25, further comprising:
 2 prior to said sending step, receiving a request to initiate a call with a called
 3 party; and
 4 determining a preferred location of the called party.

1 27. The method as recited in claim 25, wherein the registration notification is a
 2 session initiation protocol registration.

1 28. The method as recited in claim 25, wherein the preferred location is a personal
 2 digital assistant.

1 29. The method as recited in claim 28, wherein the personal digital assistant is a
 2 Palm VII utilizing a Palm Query Application to provide a user interface.

1 30. The method as recited in claim 25, wherein the new address corresponds to a
 2 voice mailbox.

1 31. The method as recited in claim 25, wherein the new address corresponds to
 2 placing the incoming call on hold.

1 32. The method as recited in claim 25, wherein communication with the preferred
 2 device is provided utilizing a wireless application protocol.

WEST OF S.E. 10TH

Express Mail No.: EL356872801US

Docket No. 11032RR

- 1 33. The method as recited in claim 25, wherein the new address corresponds to a
- 2 wire-line device.

RECEIVED

Docket No. 11032RR

RECEIVED

1 34. A computer program product in computer readable media for use in a data
2 processing system for redirecting calls to a data processing system to a second
3 location; the computer program product comprising:

4 first instructions for sending a registration notification to a called party's
5 preferred location; and

6 second instructions, responsive to receipt of a new address from the called
7 party, for redirecting the incoming call to the new address.

1 35. The computer program product as recited in claim 34, further comprising:
2 prior to said sending step, third instructions for receiving a request to initiate a
3 call with a called party; and

4 fourth instructions for determining a preferred location of the called party.

1 36. The computer program product as recited in claim 34, wherein the registration
2 notification is a session initiation protocol registration.

1 37. The computer program product as recited in claim 34, wherein the preferred
2 location is a personal digital assistant.

1 38. The computer program product as recited in claim 37, wherein the personal
2 digital assistant is a Palm VII utilizing a Palm Query Application to provide a user
3 interface.

1 39. The computer program product as recited in claim 34, wherein the new
2 address corresponds to a voice mailbox.

1 40. The computer program product as recited in claim 34, wherein the new
2 address corresponds to placing the incoming call on hold.

Docket No. 11032RR

1 41. The computer program product as recited in claim 34, wherein
2 communication with the preferred device is provided utilizing a wireless application
3 protocol.

1 42. The computer program product as recited in claim 34, wherein the new
2 address corresponds to a wire-line device.

030507 5257160

Docket No. 11032RR

Sub
B

1 43. A system for redirecting calls to a data processing system to a second
 2 location; comprising:
 3 means for sending a registration notification to a called party's preferred
 4 location; and
 5 means, responsive to receipt of a new address from the called party, for
 6 redirecting the incoming call to the new address.

1 44. The system as recited in claim 43, further comprising:
 2 prior to said sending step, means for receiving a request to initiate a call with a
 3 called party; and
 4 means for determining a preferred location of the called party.

1 45. The system as recited in claim 43, wherein the registration notification is a
 2 session initiation protocol registration.

1 46. The system as recited in claim 43, wherein the preferred location is a personal
 2 digital assistant.

1 47. The system as recited in claim 46, wherein the personal digital assistant is a
 2 Palm VII utilizing a Palm Query Application to provide a user interface.

1 48. The system as recited in claim 43, wherein the new address corresponds to a
 2 voice mailbox.

1 49. The system as recited in claim 43, wherein the new address corresponds to
 2 placing the incoming call on hold.

1 50. The system as recited in claim 43, wherein communication with the preferred
 2 device is provided utilizing a wireless application protocol.

W O R L D S E C R E T A R I A T

Docket No. 11032RR .

- 1 51. The system as recited in claim 43, wherein the new address corresponds to a
- 2 wire-line device.

COPIES SENT

Docket No. 11032RR

- 1 52. A method in a communications system for processing a call, the method
2 comprising:
3 receiving at a mobile data processing system a call for a user;
4 sending a first request to setup the call to the mobile data processing system
5 associated with a user, wherein the mobile data processing system has a wireless
6 communications capability;
7 receiving a response to the request, wherein the response includes an address
8 for the call; and
9 sending a second request to setup the call to the user using the address.
- 1 53. The method as recited in claim 52, wherein the data processing system is a
2 personal digital assistant.
- 1 54. The method as recited in claim 52, wherein the personal digital assistant is a
2 Palm VII.
- 1 55. The method as recited in claim 52, wherein the request and the response are
2 session initiation protocol messages.

ELECTRONIC

Docket No. 11032RR

025101521010

1 56. A method for processing a call at a data processing system the method
 2 comprising:
 3 receiving a request to establish a call;
 4 presenting caller information at the data processing system; and
 5 responsive to an identification of an address for the call, returning a response
 6 including the address.

1 57. The method as recited in claim 56, wherein the step of presenting caller
 2 information comprises displaying the caller information.

1 58. The method as recited in claim 56, wherein the step of presenting caller
 2 information comprises presenting the caller information audibly.

1 59. The method as recited in claim 56, wherein the request and the response are
 2 session initiation protocol messages.

1 60. The method as recited in claim 56, wherein the data processing system is a
 2 wireless device.

1 61. The method as recited in claim 56, wherein the step of presenting caller
 2 information comprises a vibrating alert.

1 62. The method as recited in claim 56, wherein the data processing system is a
 2 two-way pager.

Docket No. 11032RR

63. A communications network for redirecting communications; comprising:
a proxy server for performing address lookup and directing calls;
a user agent functionally connected to the aid proxy server to provide protocol
translation between a protocol recognized by the proxy server and a protocol
5 recognized by a terminal unit and to provide a communication link between the proxy
server and the terminal unit; wherein

the proxy server, responsive to an indication from the terminal unit to redirect
a call, redirects calls to a new location.

64. The network as recited in claim 63, wherein the proxy server is a session
10 initiation protocol proxy server and the user agent is a session initiation protocol user
agent for translating between session initiation protocol and a second protocol.

65. The network as recited in claim 64, wherein the second protocol is HTML.

20050928 10:54:40

Docket No. 11032RR

66. A method for initiating calls, comprising the steps of:
receiving registration notice of an incoming call, wherein said registration
notice is formatted in a first protocol,
translating said registration notice from the first protocol into a second
5 protocol; and
transmitting a modified registration notice to a terminating device; wherein
the modified registration notice is formatted in the second protocol.

67. The method as recited in claim 66, further comprising:
receiving a location data with which to redirect the incoming call from the
10 terminating device; wherein the location data is formatted in the second protocol; and
translating the location data to a second location data; and
transmitting the second location data, wherein the second location data is
formatted in the second protocol.

68. The method as recited in claim 66, wherein the first protocol is a session
15 initiation protocol.

69. The method as recited in claim 66, wherein the second protocol is a hypertext
markup language.

OFFICE OF THE CLERK

Docket Number: **11032RR**
Page 1 of 3

**DECLARATION AND POWER OF ATTORNEY FOR
PATENT APPLICATION**

As below named inventor, I hereby declare that:

My residence, post office address and citizenship is as stated below next to my name;

I believe that I am the original, first and sole inventor (if only one name is listed below) or an original, first and joint inventor (if plural names are listed below) of the subject matter which is claimed and for which a patent is sought on the invention entitled as set forth below, which is described in the specification of which: (check one)

filed herewith under Attorney's Docket Number 11032RR

PORTABLE CALL MANAGEMENT SYSTEM

I hereby state that I have reviewed and understand the contents of the above identified specification, including the claims, as amended by any amendment referred to above.

I acknowledge the duty to disclose information which is material to the patentability of this application in accordance with 37 CFR 1.56.

I hereby claim the benefit under Title 35 United States Code section 120 of the provisional application filed under 111b of this title as listed below:

I hereby declare that all statements made herein of my own knowledge are true and that all statements made on information and belief are believed to be true; and further that these statements were made with the knowledge that willful false statements and the like so made are punishable by fine of imprisonment, or both, under 18 USC 1001 and that such willful false statements may jeopardize the validity of the application or any patent issued thereon.

001-107-1000 10-00

Docket Number: **11032RR**
Page 2 of 3

POWER OF ATTORNEY: As a named inventor, I hereby appoint the following attorneys and/or agents to prosecute this application and transact all business in the Patent and Trademark Office connected therewith.

John D. Crane, Reg. No. 25,231;
Christopher O. Edwards, Reg. No. 36,127; Robert C. Klinger, Reg. No. 34,365;
James A. Harrison, Reg. No. 40,401; W. Glen Johnson, Reg. No. 39,525; Duke W. Yee, Reg. No. 34,286;
Rudolph J. Buchel, Reg. No. 43,448; Joseph R. Burwell, Reg. No. 44,468; Stephen R. Loe, Reg. No. 43,757.

Send correspondence to John D. Crane, Nortel Networks Corporation, Patent Department; P.O. Box 833858, Mail Stop 468/05/B10; Richardson, Texas 75083-3858 and direct all telephone calls to John D. Crane, telephone: (972) 695-8442.

=====

(1) FULL NAME OF INVENTOR: Gregory T. Osterhout

INVENTOR'S SIGNATURE: _____

Gregory T. Osterhout

DATE: 10/15/99

RESIDENCE: 313 Falcon Court, Coppell, TX 75019

COUNTY: Dallas

CITIZENSHIP: United States

POST OFFICE ADDRESS: Same As Above

(2) FULL NAME OF INVENTOR: Kim B. Holmes

INVENTOR'S SIGNATURE: _____

DATE:

RESIDENCE: 5408 Scenic Drive, Rowlett, TX 75088

COUNTY: Dallas

CITIZENSHIP: Canada

POST OFFICE ADDRESS: Same As Above

20051015 5:16:10 PM

SERIAL NUMBER 09/419,175	FILING DATE 10/15/99	CLASS 455	GROUP ART UNIT 2745 2684	ATTORNEY DOCKET NO. 11032RR
-----------------------------	-------------------------	--------------	---	--------------------------------

APPLICANT

GREGORY T. OSTERHOUT, COPPELL, TX; KIM B. HOLMES, ROWLETT, TX; MARK SOSEBEE, PLANO, TX.

CONTINUING DOMESTIC DATA***
VERIFIED

No (3/96)

371 (NAT'L STAGE) DATA***
VERIFIED

No (3/96)

FOREIGN APPLICATIONS***
VERIFIED

No (3/96)

IF REQUIRED, FOREIGN FILING LICENSE GRANTED 11/04/99

Foreign Priority claimed 35 USC 119 (a-d) conditions met	<input type="checkbox"/> yes <input checked="" type="checkbox"/> no <input type="checkbox"/> yes <input type="checkbox"/> no <input type="checkbox"/> Met after Allowance	STATE OR COUNTRY TX	SHEETS DRAWING 10	TOTAL CLAIMS 69	INDEPENDENT CLAIMS 10
Verified and Acknowledged	Examiner's Initials <u>JYC</u> Initials _____				

ADDRESS

JOHN D CRANE
NORTEL NETWORKS INTELLECTUAL PROP LAW
21 LAKESIDE BOULEVARD
MS 468/05/B10
RICHARDSON TX 75240

TITLE

PORTABLE CALL MANAGEMENT SYSTEM

FILING FEE RECEIVED \$2,318	FEES: Authority has been given in Paper No. _____ to charge/credit DEPOSIT ACCOUNT NO. _____ for the following:	<input type="checkbox"/> All Fees <input type="checkbox"/> 1.16 Fees (Filing) <input type="checkbox"/> 1.17 Fees (Processing Ext. of time) <input type="checkbox"/> 1.18 Fees (Issue) <input type="checkbox"/> Other _____ <input type="checkbox"/> Credit
--------------------------------	---	---

PATENT APPLICATION FEE DETERMINATION RECORD
Effective November 10, 1998

Application or Docket Number

CLAIMS AS FILED - PART I

(Column 1) (Column 2)

FOR	NUMBER FILED	NUMBER EXTRA
BASIC FEE		
TOTAL CLAIMS	69 minus 20 = *	49
INDEPENDENT CLAIMS	10 minus 3 = *	7
MULTIPLE DEPENDENT CLAIM PRESENT		

* If the difference in column 1 is less than zero, enter "0" in column 2

CLAIMS AS AMENDED - PART II

(Column 1) (Column 2) (Column 3)

AMENDMENT A	CLAIMS REMAINING AFTER AMENDMENT	HIGHEST NUMBER PREVIOUSLY PAID FOR	PRESENT EXTRA
Total	* 37	** 69	= 0
Independent	* 5	*** 10	= 0
FIRST PRESENTATION OF MULTIPLE DEPENDENT CLAIM			

(Column 1) (Column 2) (Column 3)

AMENDMENT B	CLAIMS REMAINING AFTER AMENDMENT	HIGHEST NUMBER PREVIOUSLY PAID FOR	PRESENT EXTRA
Total	* 33	** 69	=
Independent	* 4	*** 10	=
FIRST PRESENTATION OF MULTIPLE DEPENDENT CLAIM			

(Column 1) (Column 2) (Column 3)

AMENDMENT C	CLAIMS REMAINING AFTER AMENDMENT	HIGHEST NUMBER PREVIOUSLY PAID FOR	PRESENT EXTRA
Total	* 45	**	=
Independent	* 4	***	=
FIRST PRESENTATION OF MULTIPLE DEPENDENT CLAIM			

* If the entry in column 1 is less than the entry in column 2, write "0" in column 3.
 ** If the "Highest Number Previously Paid For" IN THIS SPACE is less than 20, enter "20."
 *** If the "Highest Number Previously Paid For" IN THIS SPACE is less than 3, enter "3."
 The "Highest Number Previously Paid For" (Total or Independent) is the highest number found in the appropriate box in column 1.

SMALL ENTITY TYPE OR

OTHER THAN SMALL ENTITY

RATE	FEE
	380.00
X\$ 9=	
X39=	
+130=	
TOTAL	

RATE	FEE
	760.00
X\$18=	882.7
X78=	546.7
+260=	
TOTAL	2188.

SMALL ENTITY OR

OTHER THAN SMALL ENTITY

RATE	ADDITIONAL FEE
X\$ 9=	
X39=	
+130=	
TOTAL ADDIT. FEE	

RATE	ADDITIONAL FEE
X\$18=	
X78=	
+260=	
TOTAL ADDIT. FEE	

RATE	ADDITIONAL FEE
X\$ 9=	
X39=	
+130=	
TOTAL ADDIT. FEE	

RATE	ADDITIONAL FEE
X\$18=	
X78=	
+260=	
TOTAL ADDIT. FEE	

RATE	ADDITIONAL FEE
X\$ 9=	
X39=	
+130=	
TOTAL ADDIT. FEE	

RATE	ADDITIONAL FEE
X\$18=	
X78=	
+260=	
TOTAL ADDIT. FEE	

PATENT APPLICATION SERIAL NO. _____

U.S. DEPARTMENT OF COMMERCE
PATENT AND TRADEMARK OFFICE
FEE RECORD SHEET

10/25/1999 GDUCKETT 00000003 09419175

01 FC:101	760.00 OP
02 FC:102	546.00 OP
03 FC:103	882.00 OP

PTO-1556
(5/87)

*U.S. GPO: 1998-433-214/80404