

(12) **United States Patent**
Stubbs et al.

(10) **Patent No.:** **US 6,736,759 B1**
(45) **Date of Patent:** **May 18, 2004**

- (54) **EXERCISE MONITORING SYSTEM AND METHODS**
- (75) Inventors: **Jack B. Stubbs**, Waynesville, OH (US);
Kevin L. Schwieger, Lebanon, OH (US)
- (73) Assignee: **Paragon Solutions, LLC**, Waynesville, OH (US)
- (*) Notice: Subject to any disclaimer, the term of this patent is extended or adjusted under 35 U.S.C. 154(b) by 0 days.

5,622,180 A	4/1997	Tammi et al.	
5,627,548 A	5/1997	Woo et al.	
5,632,279 A	5/1997	Heikkilä	
5,690,119 A	11/1997	Rytky et al.	
5,731,757 A	3/1998	Layson, Jr.	
5,779,631 A	7/1998	Chance	
5,781,155 A	7/1998	Woo et al.	
5,810,722 A	9/1998	Heikkilä	
5,840,039 A	11/1998	Heikkilä	
5,852,401 A	12/1998	Kita	
5,884,198 A	3/1999	Kese et al.	
5,889,493 A	3/1999	Endo	
5,891,042 A	4/1999	Sham et al.	
5,905,460 A	5/1999	Odagiri et al.	
5,919,133 A	7/1999	Taylor et al.	
6,002,982 A	12/1999	Fry	
6,013,007 A	* 1/2000	Roots et al.	482/8
6,032,108 A	* 2/2000	Seiple et al.	702/97
6,083,248 A	7/2000	Thompson	
6,148,262 A	11/2000	Fry	
6,148,280 A	* 11/2000	Kramer	703/153
6,152,856 A	11/2000	Studor et al.	
6,199,550 B1	3/2001	Wiesmann et al.	
6,285,314 B1	* 9/2001	Nagatsuma et al.	482/8

(21) Appl. No.: **09/436,515**

(22) Filed: **Nov. 9, 1999**

- (51) **Int. Cl.⁷** **A63B 21/00**
- (52) **U.S. Cl.** **482/8; 482/900; 482/5**
- (58) **Field of Search** 482/1-9, 900-902; 702/127, 141, 142, 150, 153, 97; 701/213-216, 207

(56) **References Cited**

U.S. PATENT DOCUMENTS

4,566,461 A	1/1986	Lubell et al.
5,081,991 A	1/1992	Chance
5,148,002 A	9/1992	Kuo et al.
5,167,230 A	12/1992	Chance
5,318,487 A	6/1994	Golen et al.
5,345,244 A	9/1994	Gildea et al.
5,408,444 A	4/1995	Kita et al.
5,456,262 A	10/1995	Birnbaum
5,458,548 A	10/1995	Crossing et al.
5,464,021 A	11/1995	Birnbaum
5,486,818 A	1/1996	Loponen
5,491,474 A	2/1996	Suni et al.
5,564,417 A	10/1996	Chance
5,575,284 A	11/1996	Athan et al.
5,589,835 A	12/1996	Gildea et al.
5,611,346 A	3/1997	Heikkilä et al.

FOREIGN PATENT DOCUMENTS

WO	WO9812599	3/1998
WO	WO9923524	5/1999
WO	WO9923525	5/1999
WO	WO0141879	6/2001

* cited by examiner

Primary Examiner—Glenn E. Richman
(74) *Attorney, Agent, or Firm*—Dinsmore & Shohl LLP

(57) **ABSTRACT**

An exercise monitoring system which includes an electronic positioning device; a physiological monitor; and a display unit configured for displaying data provided by the electronic positioning device and the physiological monitor.

32 Claims, 12 Drawing Sheets

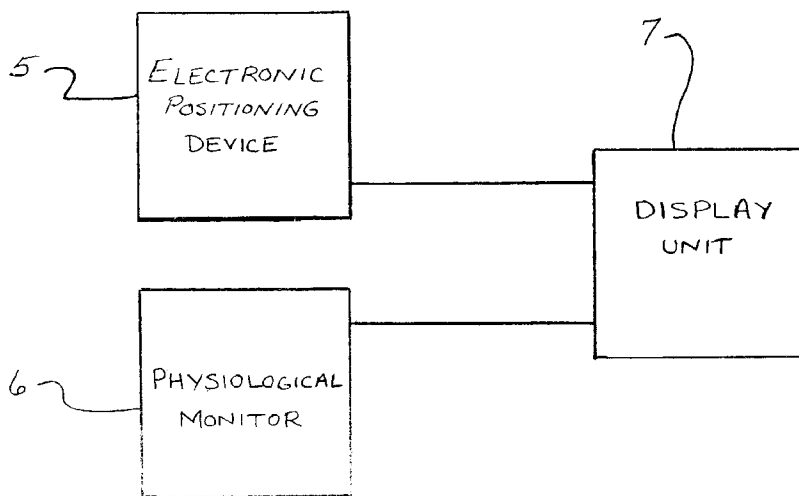

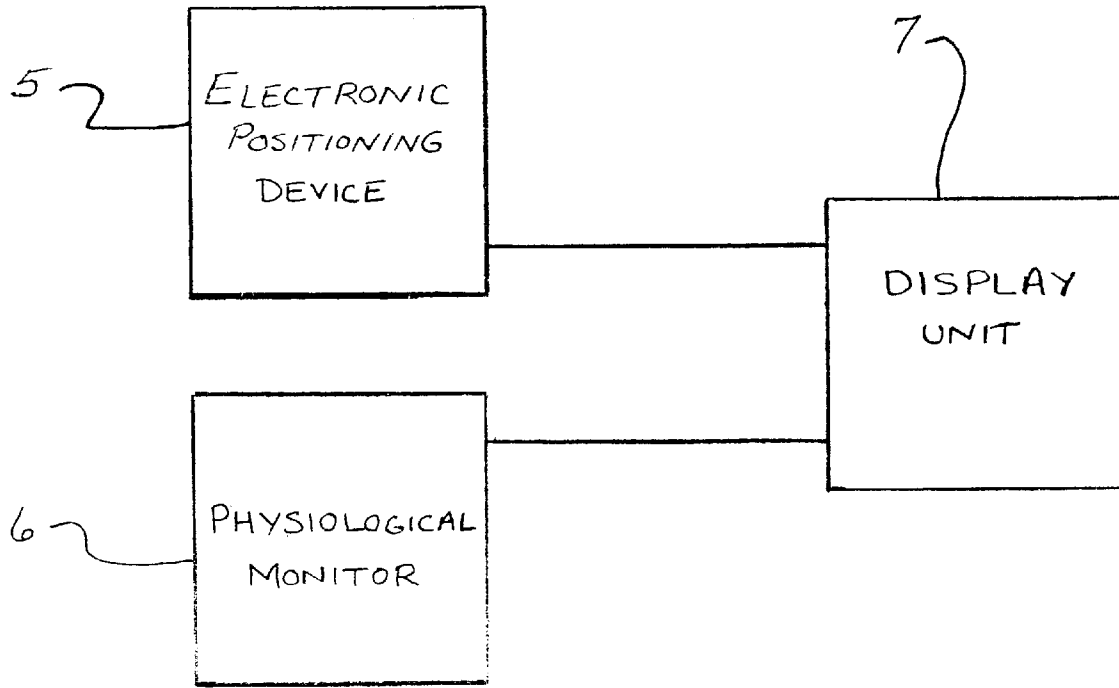

FIG. 1

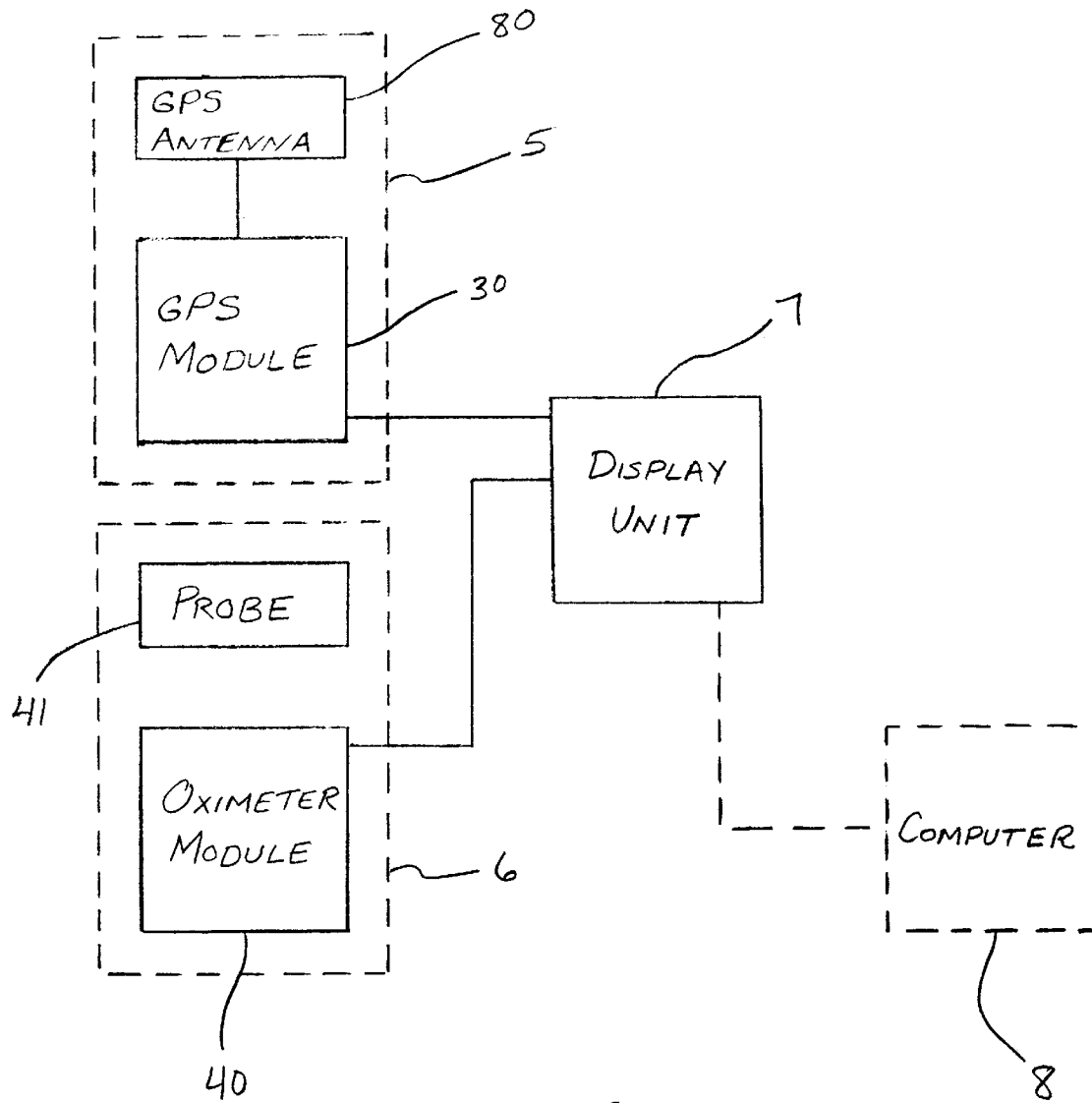

FIG. 2

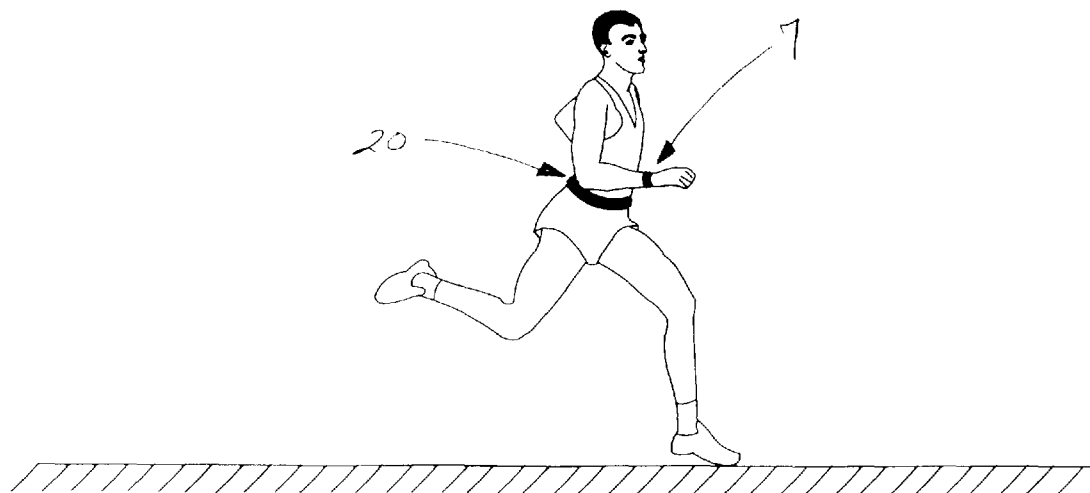
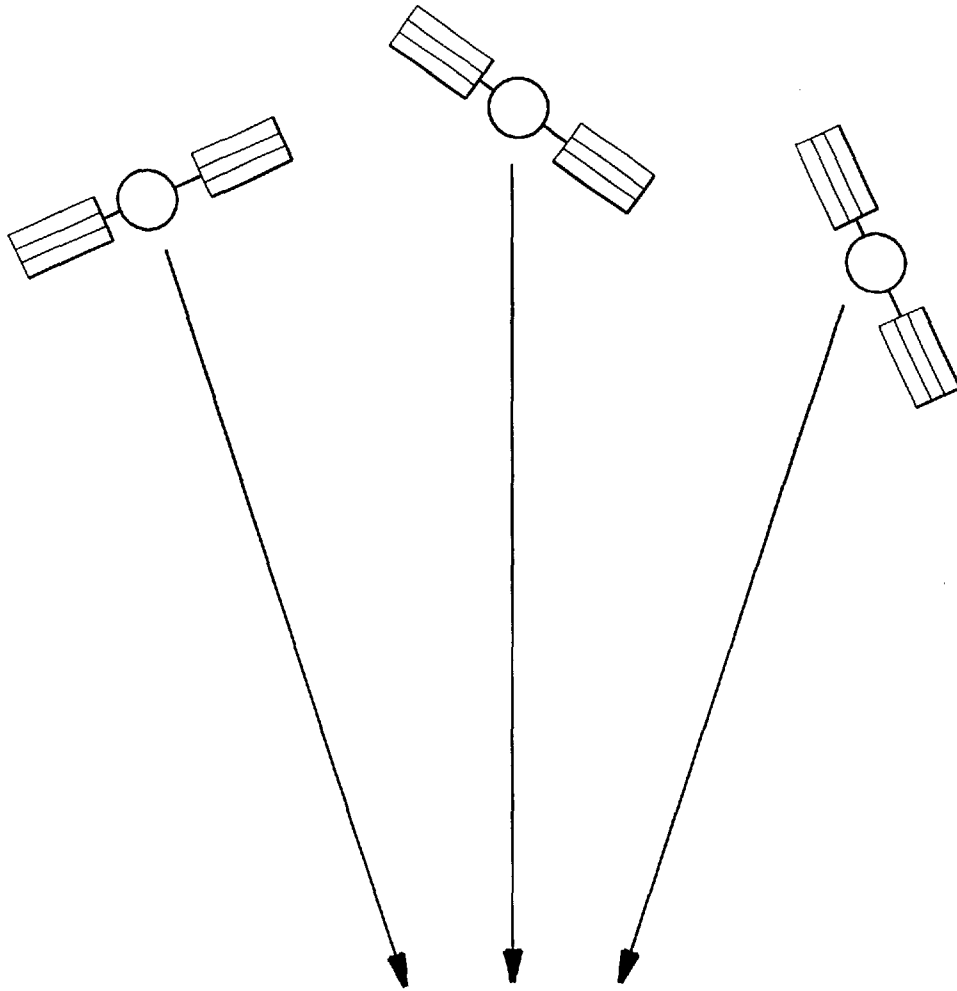

FIG. 3

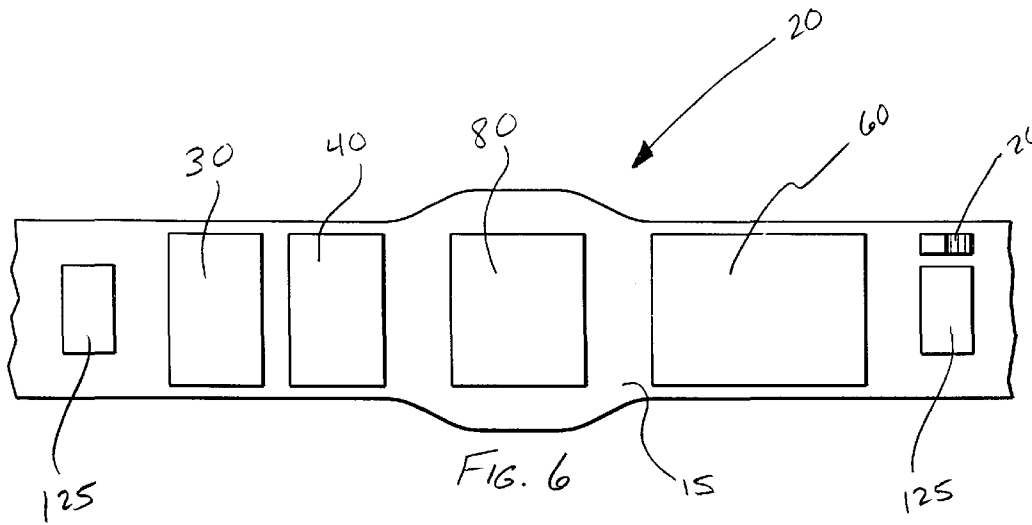

FIG. 6

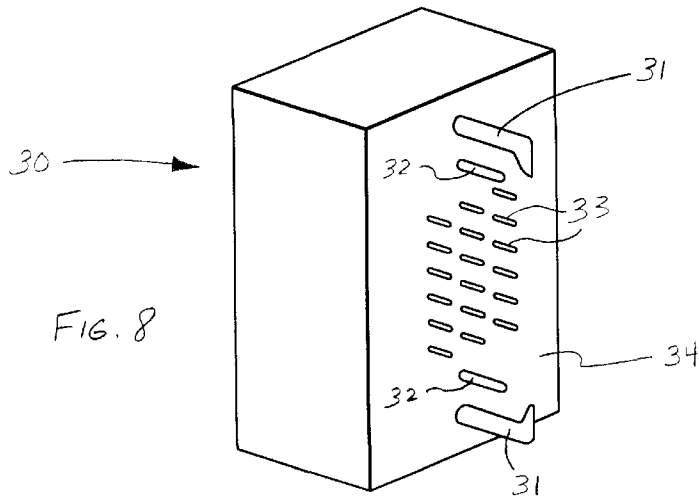

FIG. 8

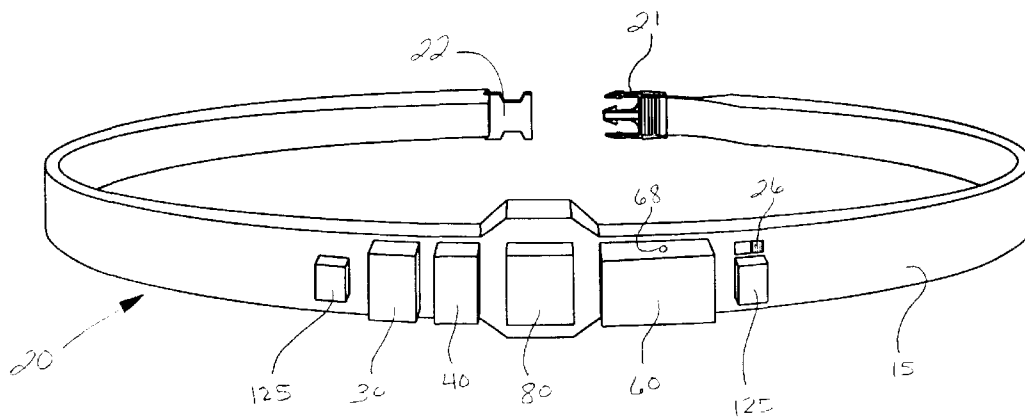

FIG. 4

Explore Litigation Insights

Docket Alarm provides insights to develop a more informed litigation strategy and the peace of mind of knowing you're on top of things.

Real-Time Litigation Alerts



Keep your litigation team up-to-date with **real-time alerts** and advanced team management tools built for the enterprise, all while greatly reducing PACER spend.

Our comprehensive service means we can handle Federal, State, and Administrative courts across the country.

Advanced Docket Research



With over 230 million records, Docket Alarm's cloud-native docket research platform finds what other services can't. Coverage includes Federal, State, plus PTAB, TTAB, ITC and NLRB decisions, all in one place.

Identify arguments that have been successful in the past with full text, pinpoint searching. Link to case law cited within any court document via Fastcase.

Analytics At Your Fingertips



Learn what happened the last time a particular judge, opposing counsel or company faced cases similar to yours.

Advanced out-of-the-box PTAB and TTAB analytics are always at your fingertips.

API

Docket Alarm offers a powerful API (application programming interface) to developers that want to integrate case filings into their apps.

LAW FIRMS

Build custom dashboards for your attorneys and clients with live data direct from the court.

Automate many repetitive legal tasks like conflict checks, document management, and marketing.

FINANCIAL INSTITUTIONS

Litigation and bankruptcy checks for companies and debtors.

E-DISCOVERY AND LEGAL VENDORS

Sync your system to PACER to automate legal marketing.