

[54] **PORTABLE AEROBIC FITNESS MONITOR FOR WALKING AND RUNNING**

[75] Inventors: **J. Jeffrey Richardson**, Boulder; **Ted D. Wade**, Littleton, both of Colo.

[73] Assignee: **Living Systems, Inc.**, Boulder, Colo.

[21] Appl. No.: **08/902,748**

[22] Filed: **Jul. 30, 1997**

[51] **Int. Cl.⁶** **A61B 5/02**

[52] **U.S. Cl.** **600/300; 600/481; 600/587; 482/8; 482/901**

[58] **Field of Search** 600/500, 502, 600/520, 587, 592, 595; 482/3, 4, 8, 9, 900, 901, 300, 481

[56] **References Cited**

U.S. PATENT DOCUMENTS

4,192,000	3/1980	Lipsey	482/8
4,434,801	3/1984	Jiminez et al.	600/502
4,566,461	1/1986	Lubell et al.	600/481
4,757,453	7/1988	Nasiff	364/415
4,771,394	9/1988	Cavanagh	364/561
4,830,021	5/1989	Thornton	600/520
4,867,442	9/1989	Matthews	482/8
5,117,444	5/1992	Sutton et al.	377/24.2
5,314,389	5/1994	Dotan	482/3
5,435,315	7/1995	McPhee et al.	600/502
5,485,402	1/1996	Smith et al.	364/566
5,524,637	6/1996	Erickson	600/592

Primary Examiner—Cary O'Connor
Assistant Examiner—Charles Marmer, II
Attorney, Agent, or Firm—Jay R Beyer; Stephen C Sheer

[57] **ABSTRACT**

A personal fitness monitoring device and a method for assessing the fitness of an individual as the individual exercises includes using a pedometer to determine and output data representing the locomotion of the individual. A heart rate monitor determines and outputs data representing the heart rate of the individual. A determination arrangement calculates the fitness of the individual as the individual exercises using personal data provided by the individual in combination with the data outputs of the pedometer and the heart rate without requiring a predetermined exercise regime. In one embodiment, the pedometer calculates a distance traveled by the individual using personal data provided by the individual. The personal fitness monitoring device may further include a user interface for communicating with the user. The user interface uses a single user controlled selecting mechanism to select a desired one of various user selectable options. The single user controlled selecting mechanism is arranged such that the user selects the desired option by actuating the selecting mechanism during or immediately following the time during which the desired option is being presented by the user interface. The personal fitness monitoring device may also include a predicting arrangement for tracking and predicting the fitness of the individual.

23 Claims, 14 Drawing Sheets

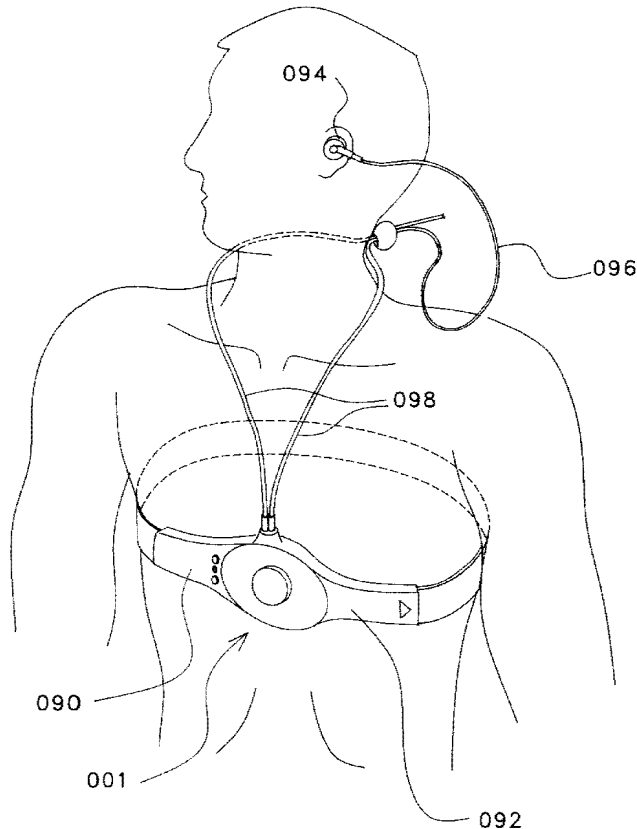

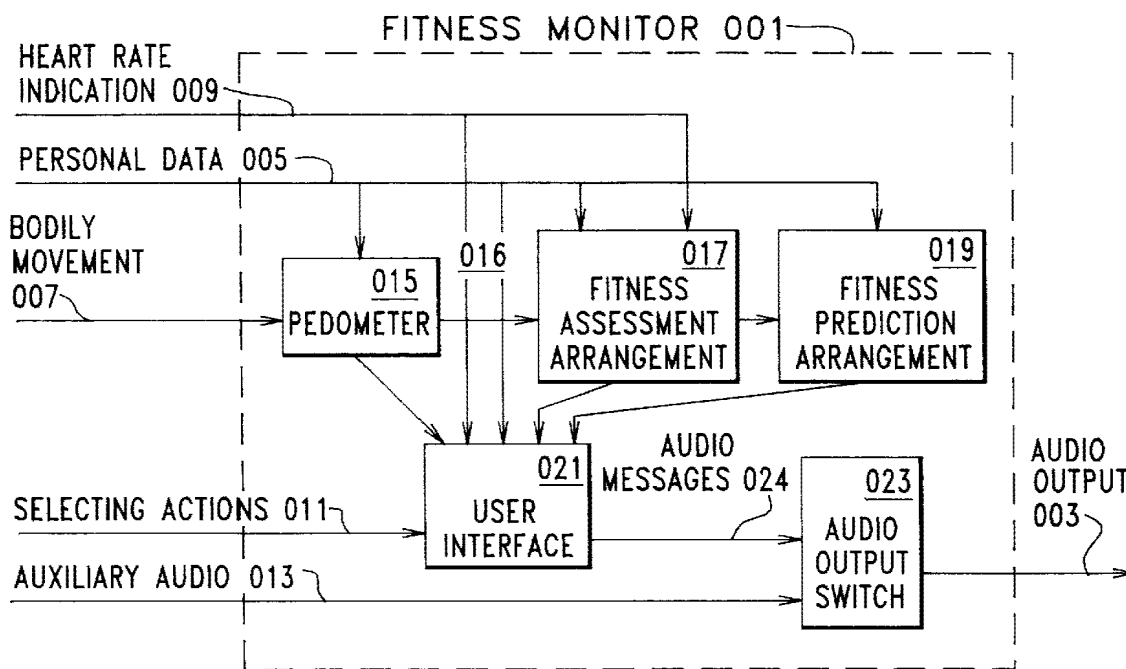

FIG. 1

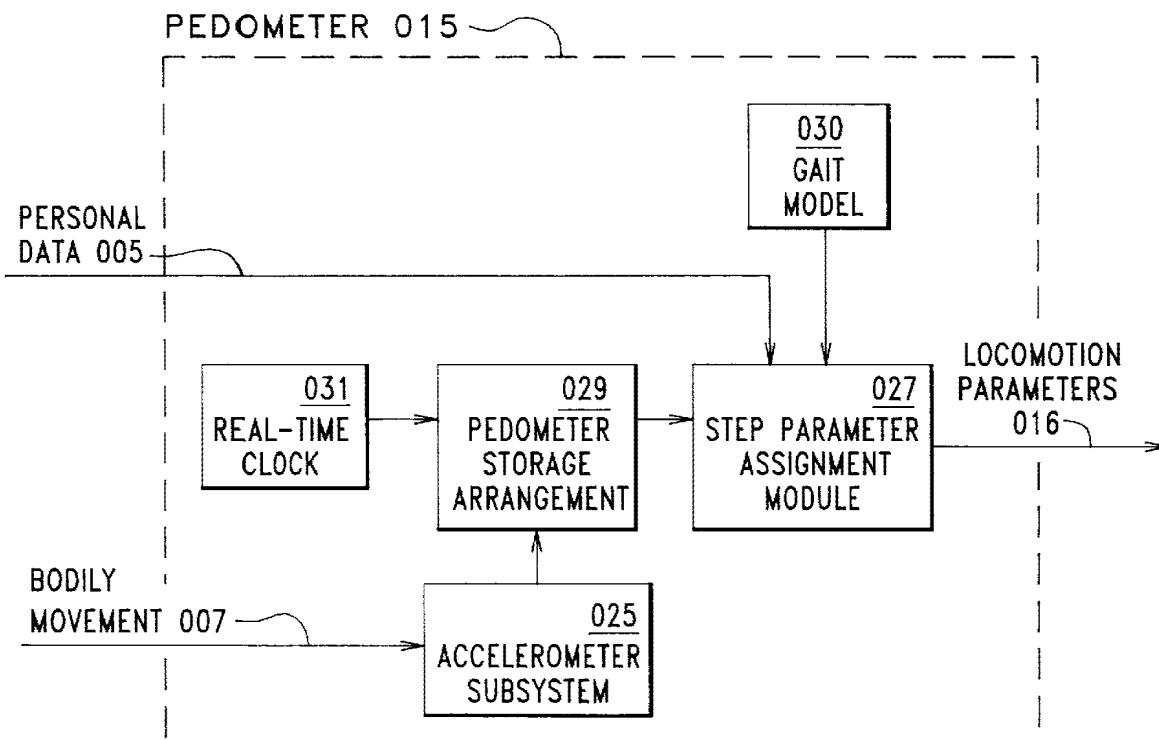

FIG. 2

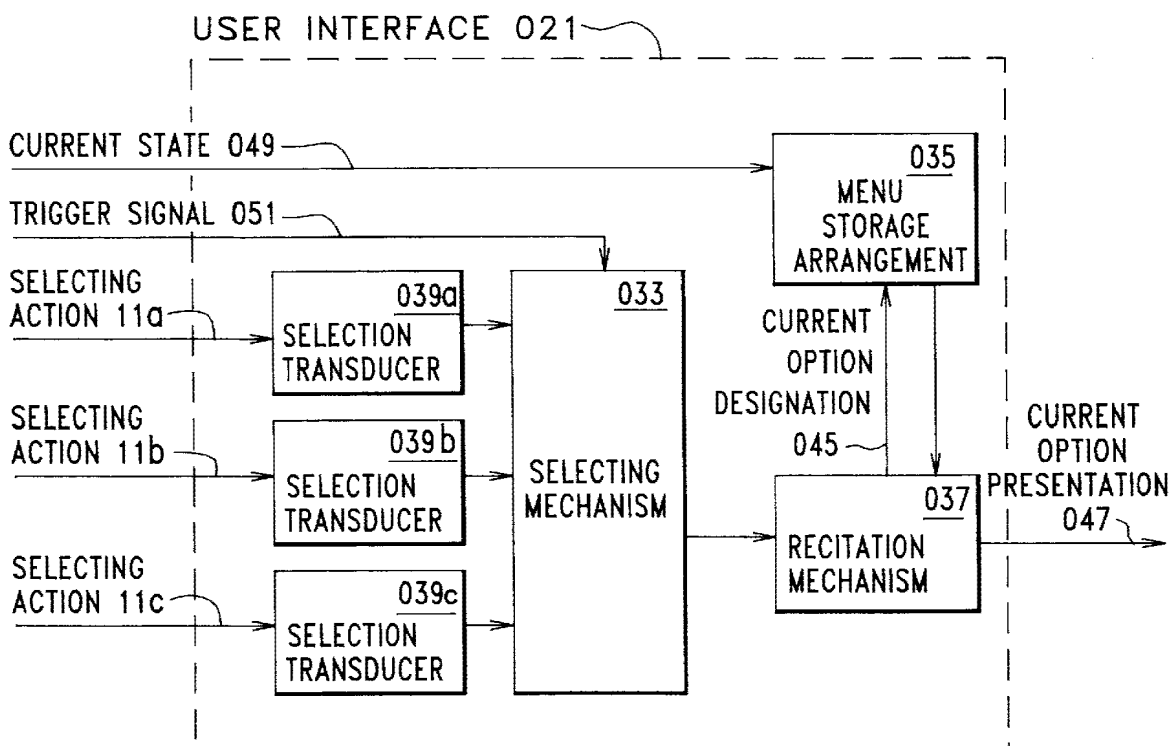

FIG. 3

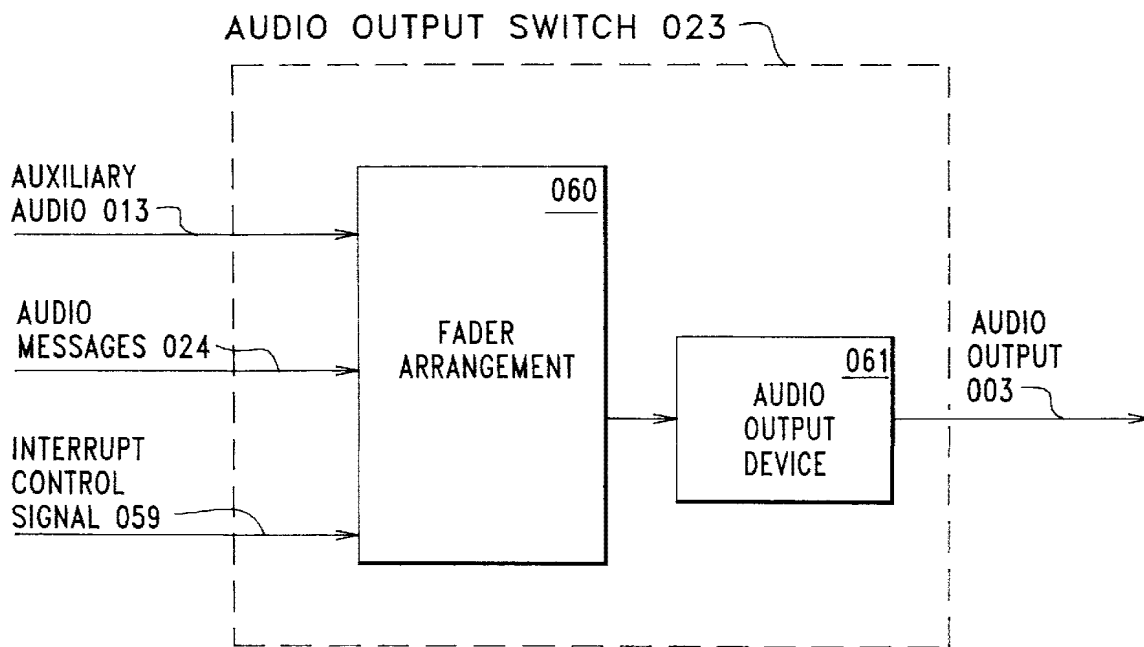

FIG. 4

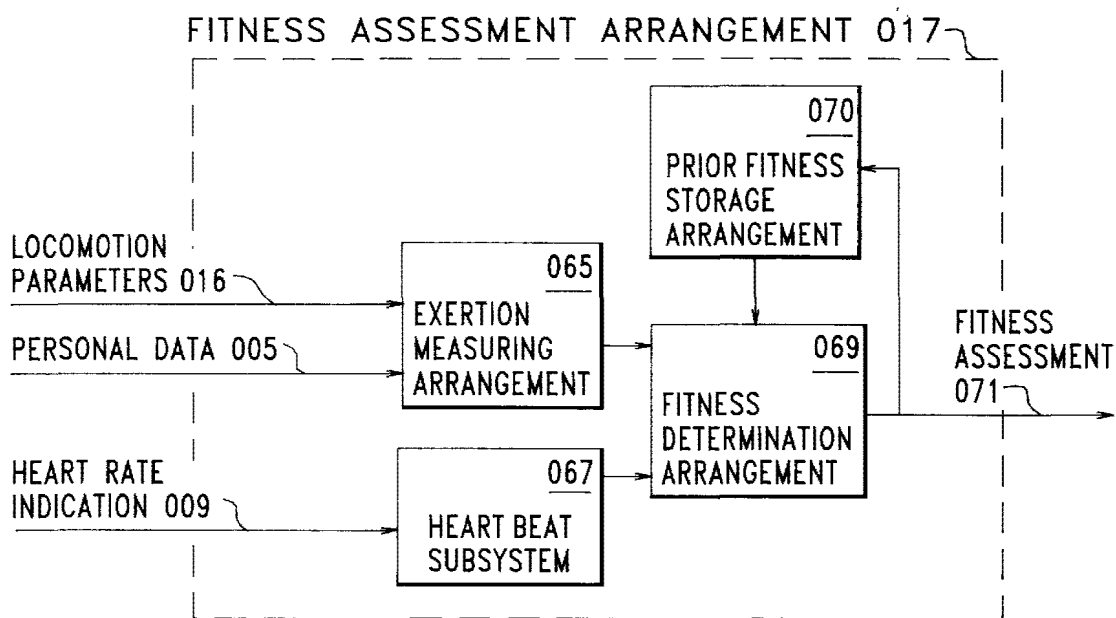

FIG. 5

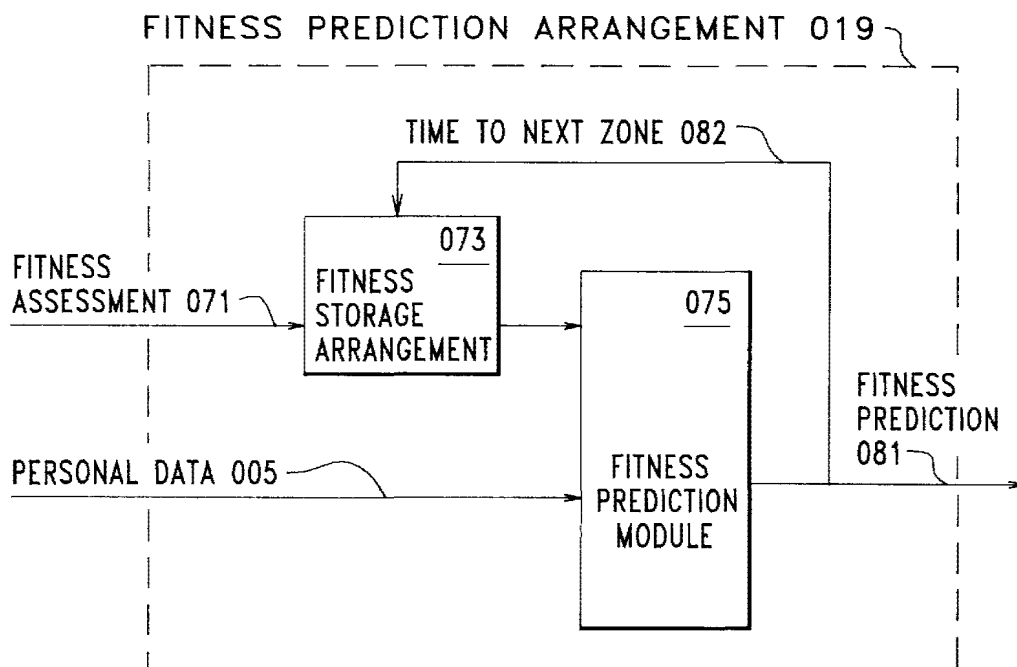

FIG. 6

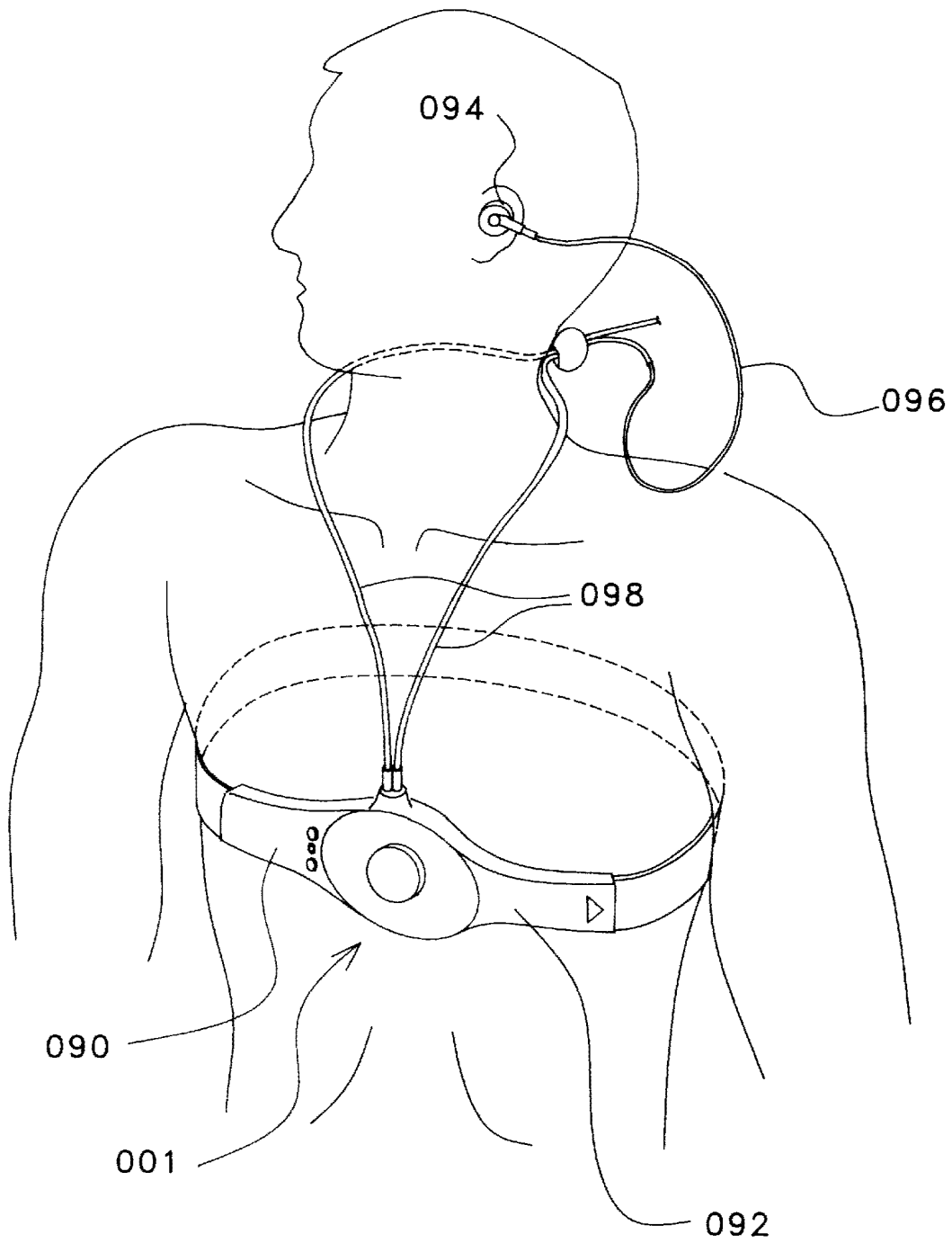

FIG. 7

Explore Litigation Insights

Docket Alarm provides insights to develop a more informed litigation strategy and the peace of mind of knowing you're on top of things.

Real-Time Litigation Alerts



Keep your litigation team up-to-date with **real-time alerts** and advanced team management tools built for the enterprise, all while greatly reducing PACER spend.

Our comprehensive service means we can handle Federal, State, and Administrative courts across the country.

Advanced Docket Research



With over 230 million records, Docket Alarm's cloud-native docket research platform finds what other services can't. Coverage includes Federal, State, plus PTAB, TTAB, ITC and NLRB decisions, all in one place.

Identify arguments that have been successful in the past with full text, pinpoint searching. Link to case law cited within any court document via Fastcase.

Analytics At Your Fingertips



Learn what happened the last time a particular judge, opposing counsel or company faced cases similar to yours.

Advanced out-of-the-box PTAB and TTAB analytics are always at your fingertips.

API

Docket Alarm offers a powerful API (application programming interface) to developers that want to integrate case filings into their apps.

LAW FIRMS

Build custom dashboards for your attorneys and clients with live data direct from the court.

Automate many repetitive legal tasks like conflict checks, document management, and marketing.

FINANCIAL INSTITUTIONS

Litigation and bankruptcy checks for companies and debtors.

E-DISCOVERY AND LEGAL VENDORS

Sync your system to PACER to automate legal marketing.