

United States Patent [19]

Shimizu et al.

[11] Patent Number: **4,807,639**

[45] Date of Patent: **Feb. 28, 1989**

[54] **PULSE DETECTION APPARATUS**

[75] Inventors: **Atsuko Shimizu; Hiroshi Fujii; Shinichi Ohki**, all of Tokyo, Japan

[73] Assignee: **Casio Computer Co., Ltd.**, Tokyo, Japan

[21] Appl. No.: **901,783**

[22] Filed: **Aug. 28, 1986**

[30] **Foreign Application Priority Data**

Aug. 31, 1985 [JP] Japan 60-192632
Aug. 31, 1985 [JP] Japan 60-192633

[51] Int. Cl.⁴ **A61B 5/02**

[52] U.S. Cl. **128/690; 128/706**

[58] Field of Search **128/690, 707, 706**

[56] **References Cited**

U.S. PATENT DOCUMENTS

3,937,004 2/1976 Natori et al. 128/690
3,978,849 9/1976 Geneen 128/690
4,009,708 3/1977 Fay, Jr. 128/690
4,086,916 5/1978 Freeman et al. 128/690

4,101,071 7/1978 Brejnik et al. 128/690
4,202,350 5/1980 Walton 128/690
4,278,095 7/1981 Lapeyre 128/707
4,281,663 8/1981 Pringle 128/707
4,305,401 12/1981 Reissmueller et al. 128/690
4,425,921 1/1984 Fujisaki et al. 128/690
4,450,843 5/1984 Barney et al. 128/690
4,489,731 12/1984 Baumberg 128/690
4,566,461 1/1986 Lubell et al. 128/689

Primary Examiner—Francis Jaworski

Assistant Examiner—George Manuel

Attorney, Agent, or Firm—Frishauf, Holtz, Goodman & Woodward

[57] **ABSTRACT**

A pulse detection apparatus includes a memory for storing the normal pulse count of a user. After taking some exercise such as jogging, the percentage of the pulse count, detected by a pulse sensor, with respect to the normal pulse count, is calculated, and the results are displayed, to allow the user to determine the recovery rate of his physical strength.

21 Claims, 19 Drawing Sheets

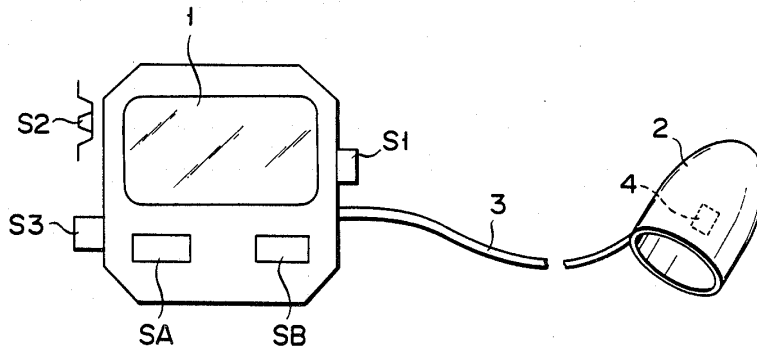

FIG. 1

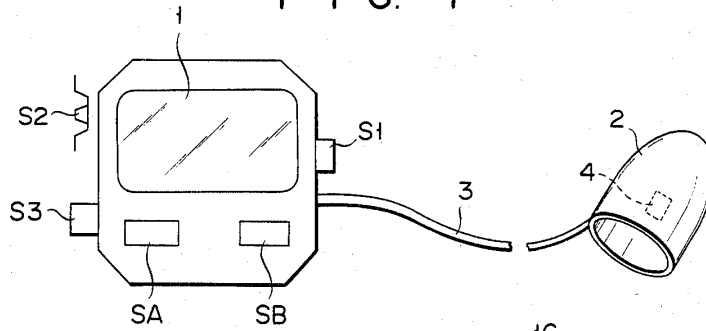

FIG. 2

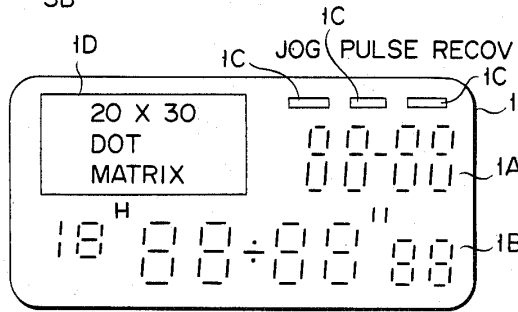

FIG. 9A

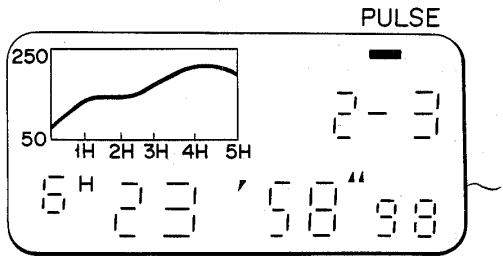
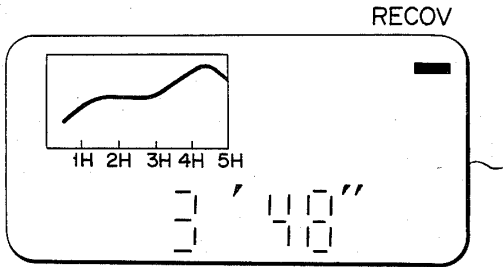
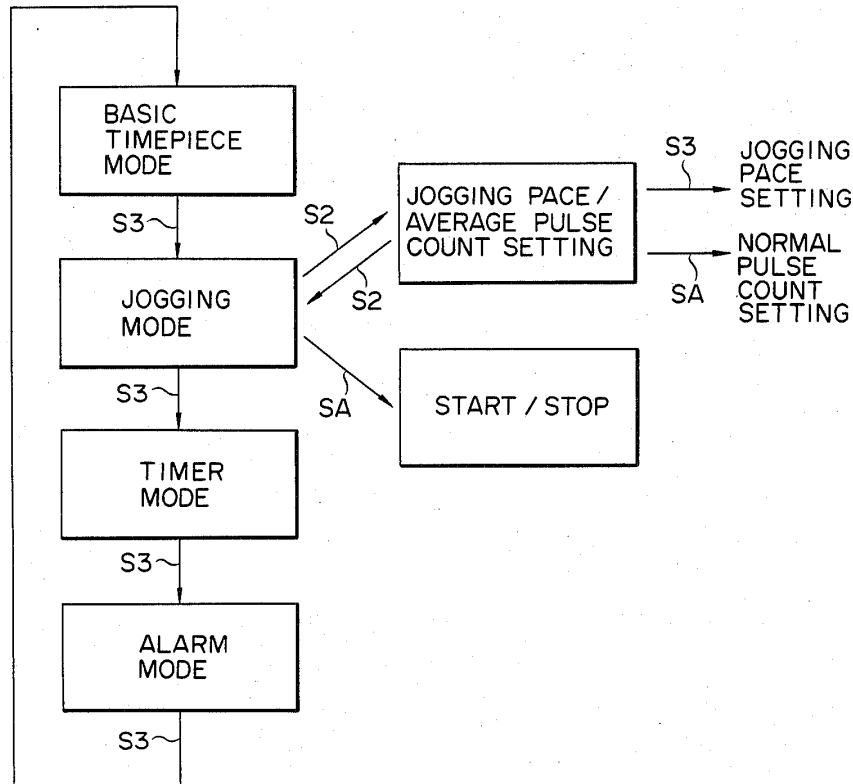

FIG. 9B



F I G. 3



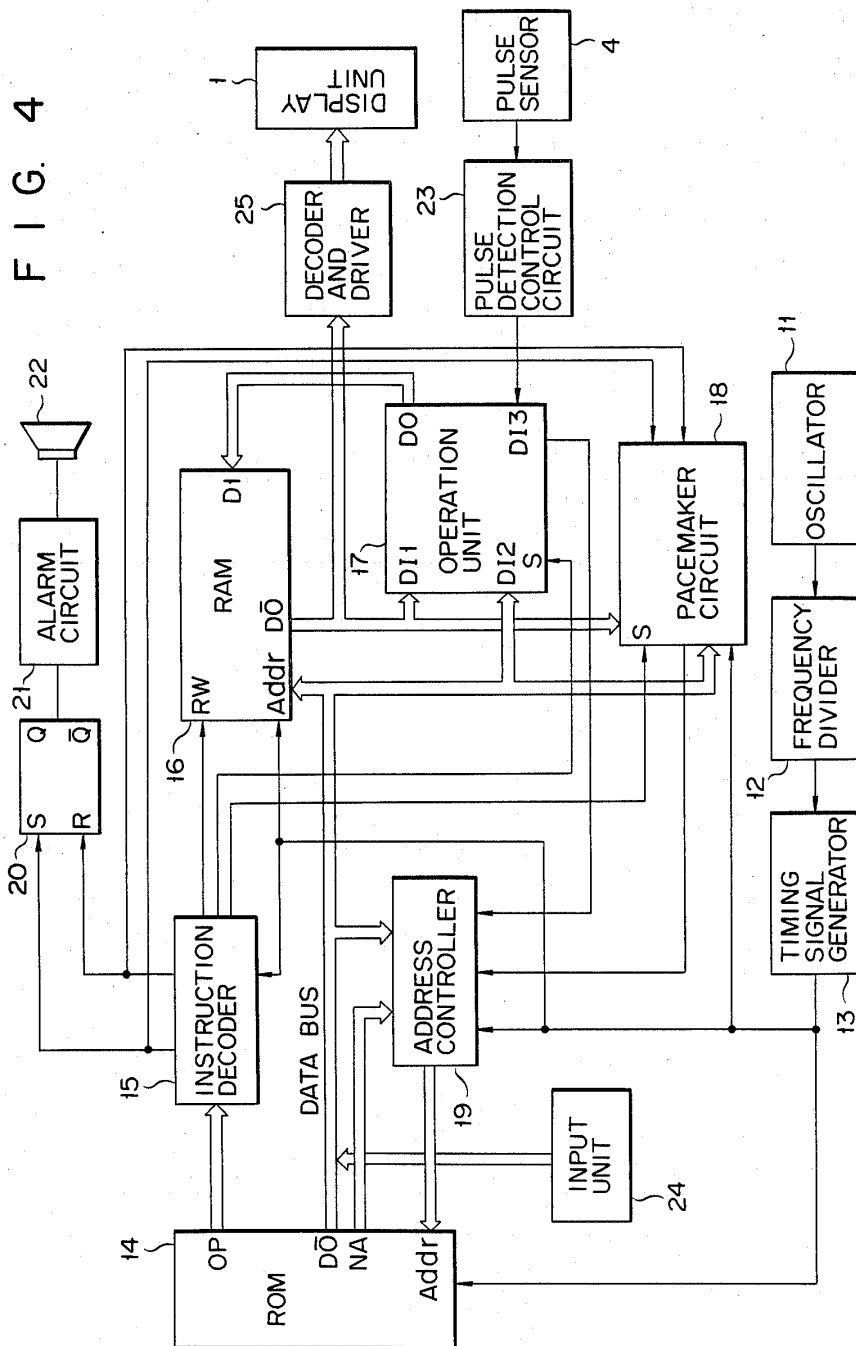
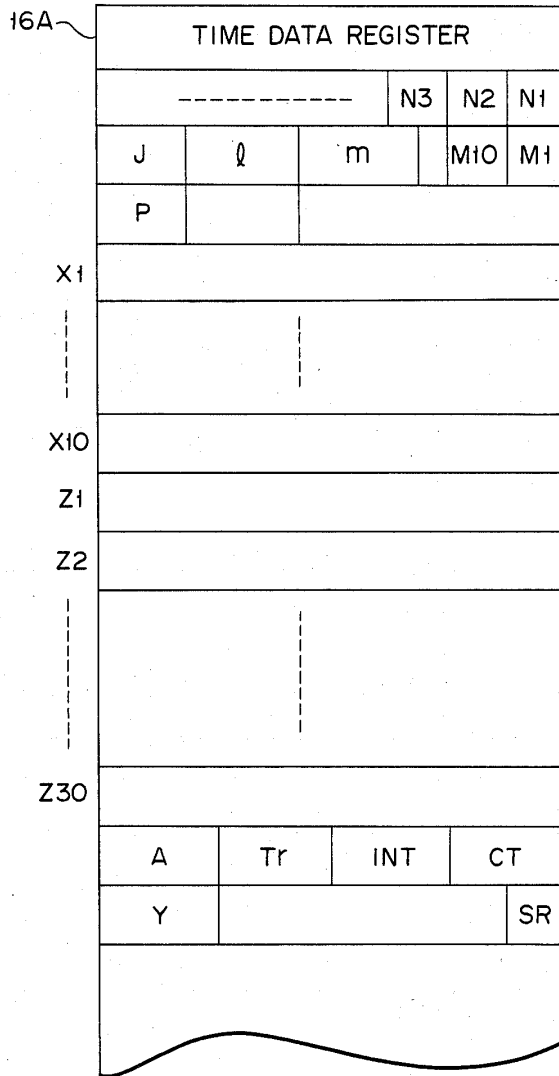

FIG. 5



Explore Litigation Insights

Docket Alarm provides insights to develop a more informed litigation strategy and the peace of mind of knowing you're on top of things.

Real-Time Litigation Alerts



Keep your litigation team up-to-date with **real-time alerts** and advanced team management tools built for the enterprise, all while greatly reducing PACER spend.

Our comprehensive service means we can handle Federal, State, and Administrative courts across the country.

Advanced Docket Research



With over 230 million records, Docket Alarm's cloud-native docket research platform finds what other services can't. Coverage includes Federal, State, plus PTAB, TTAB, ITC and NLRB decisions, all in one place.

Identify arguments that have been successful in the past with full text, pinpoint searching. Link to case law cited within any court document via Fastcase.

Analytics At Your Fingertips



Learn what happened the last time a particular judge, opposing counsel or company faced cases similar to yours.

Advanced out-of-the-box PTAB and TTAB analytics are always at your fingertips.

API

Docket Alarm offers a powerful API (application programming interface) to developers that want to integrate case filings into their apps.

LAW FIRMS

Build custom dashboards for your attorneys and clients with live data direct from the court.

Automate many repetitive legal tasks like conflict checks, document management, and marketing.

FINANCIAL INSTITUTIONS

Litigation and bankruptcy checks for companies and debtors.

E-DISCOVERY AND LEGAL VENDORS

Sync your system to PACER to automate legal marketing.