



US006556564B2

(12) **United States Patent
Rogers**

(10) **Patent No.: US 6,556,564 B2**
(45) **Date of Patent: Apr. 29, 2003**

(54) **SCHEDULED INTERNET PROTOCOL
TELEPHONE INSTRUMENT SYSTEM**

(75) Inventor: **Steven A. Rogers**, Alton, NH (US)

(73) Assignee: **Cetacean Networks, Inc.**, Portsmouth, NH (US)

(*) Notice: Subject to any disclaimer, the term of this patent is extended or adjusted under 35 U.S.C. 154(b) by 66 days.

(21) Appl. No.: **09/780,685**

(22) Filed: **Feb. 8, 2001**

(65) **Prior Publication Data**

US 2001/0033565 A1 Oct. 25, 2001

Related U.S. Application Data

(60) Provisional application No. 60/181,099, filed on Feb. 8, 2000.

(51) **Int. Cl.⁷ H04L 12/66**

(52) **U.S. Cl. 370/352; 370/443; 370/498; 379/88.17**

(58) **Field of Search 370/352, 353, 370/354, 355, 356, 389, 419, 474, 476, 442, 443, 444, 498; 709/88.17**

(56) **References Cited**

U.S. PATENT DOCUMENTS

5,526,353 A	6/1996	Henley et al.	370/60.1
5,610,920 A	3/1997	Doll et al.	370/389
5,825,873 A	10/1998	Duncan et al.	379/419
5,832,275 A	11/1998	Olds	395/712
6,185,184 B1	2/2001	Mattaway et al.	370/230

Primary Examiner—Douglas Olms

Assistant Examiner—Bob A. Phunkulh

(74) *Attorney, Agent, or Firm*—Weingarten, Schurgin, Gagnebin & Lebovici LLP

(57) **ABSTRACT**

A LAN telephone which makes voice telephone calls over a local area network (LAN) data network. Acoustic voice sounds are digitally encoded and transmitted as data, over the LAN. The disclosed telephone simultaneously receives LAN data packets and decodes them, translating the data into acoustic audio voice sounds. All communications with the network occur through the use of the LAN, including data for call control and for voice signals. The disclosed LAN telephone uses a packet scheduling technique to prevent packet collision, delay or loss. The scheduling technique relies on time of transmission and arrival to switch packets. Additionally, the disclosed LAN telephone is operable to receive power from a data switch, using LAN wiring. The instrument further includes a means for attaching peripheral devices through an electronic interface system, as well as an internal system for allowing the telephone to be moved, from one connection to another, without changing the telephone number. The instrument also provides a system for automatically changing the internal control software of the instrument, or of any connected peripheral. A system for connecting an external "speaker-phone" system is also disclosed, which gives the instrument's user the ability to place the voice audio source and pickup in a location that is convenient to the user and not necessarily co-located with the instrument itself.

21 Claims, 14 Drawing Sheets

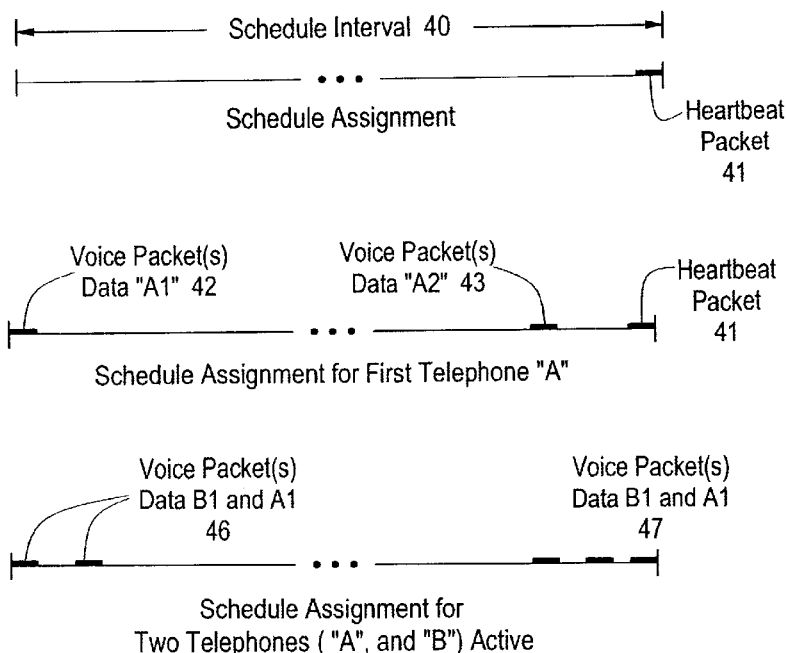

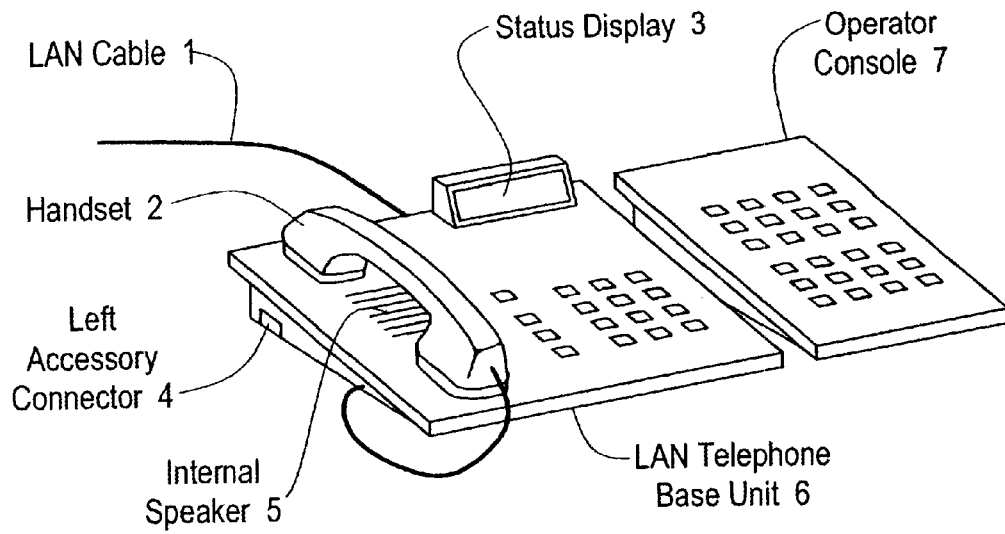

FIG. 1

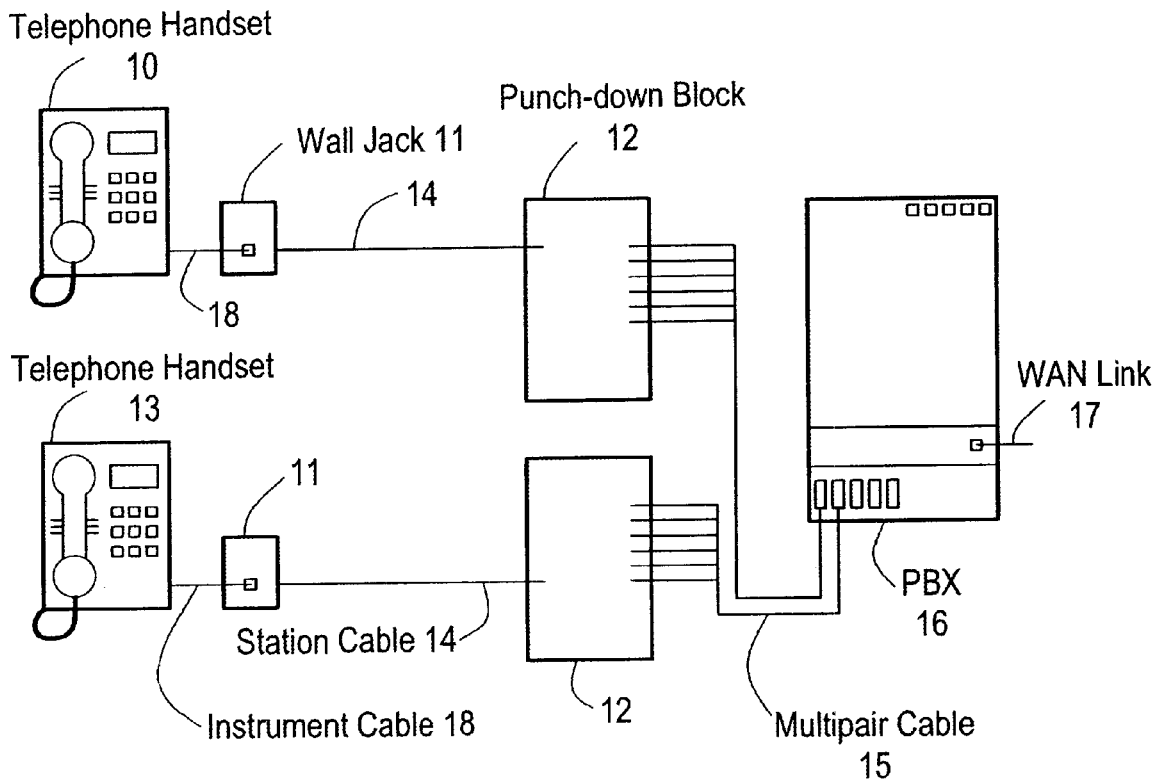

FIG. 2

Prior Art

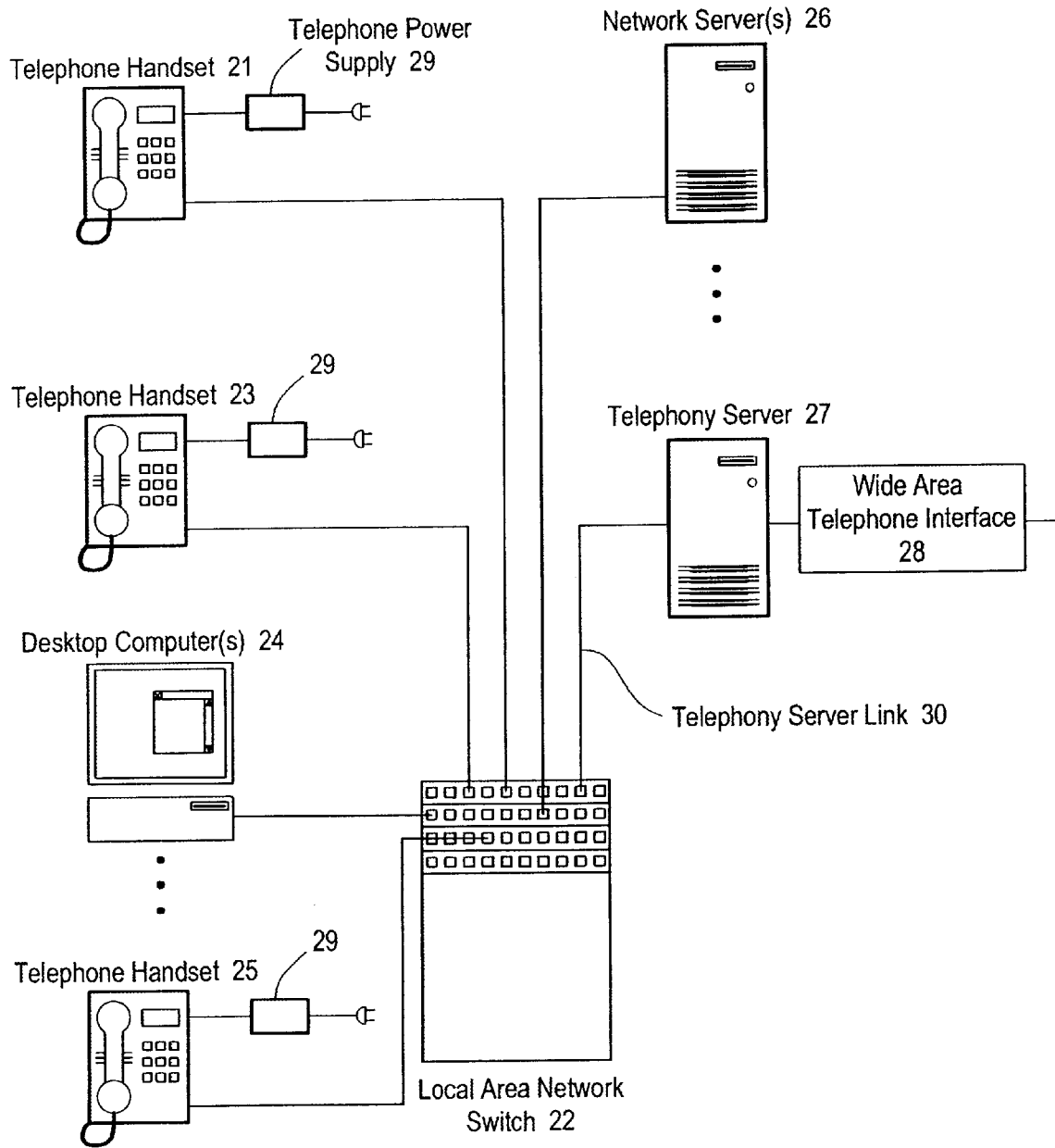
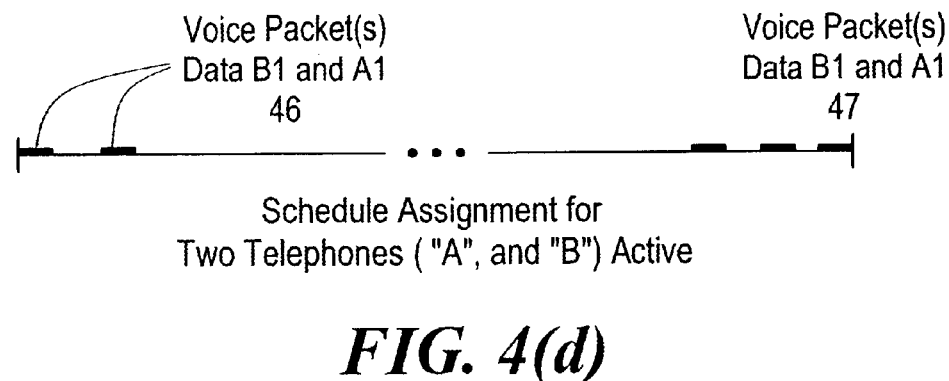
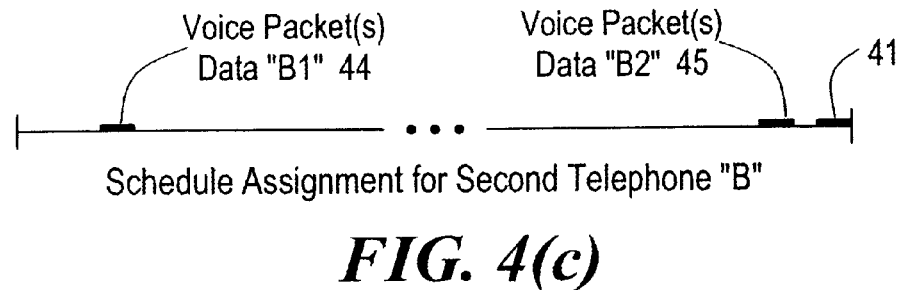
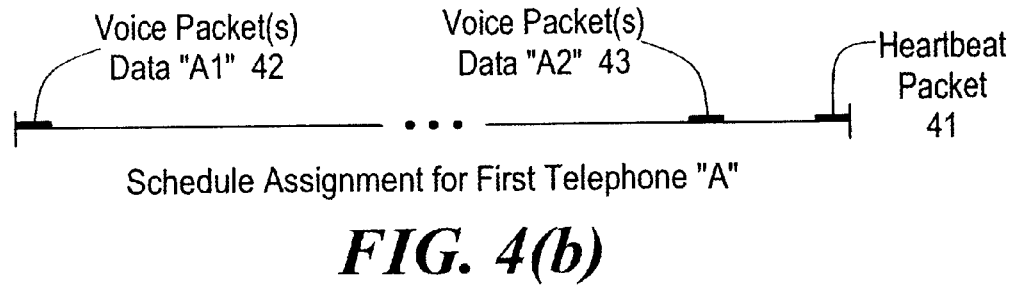
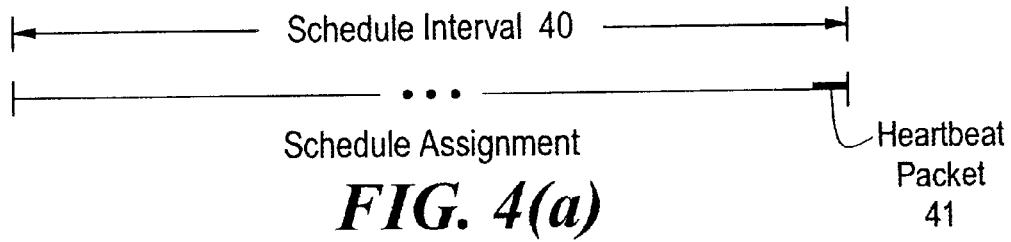

FIG. 3

Prior Art



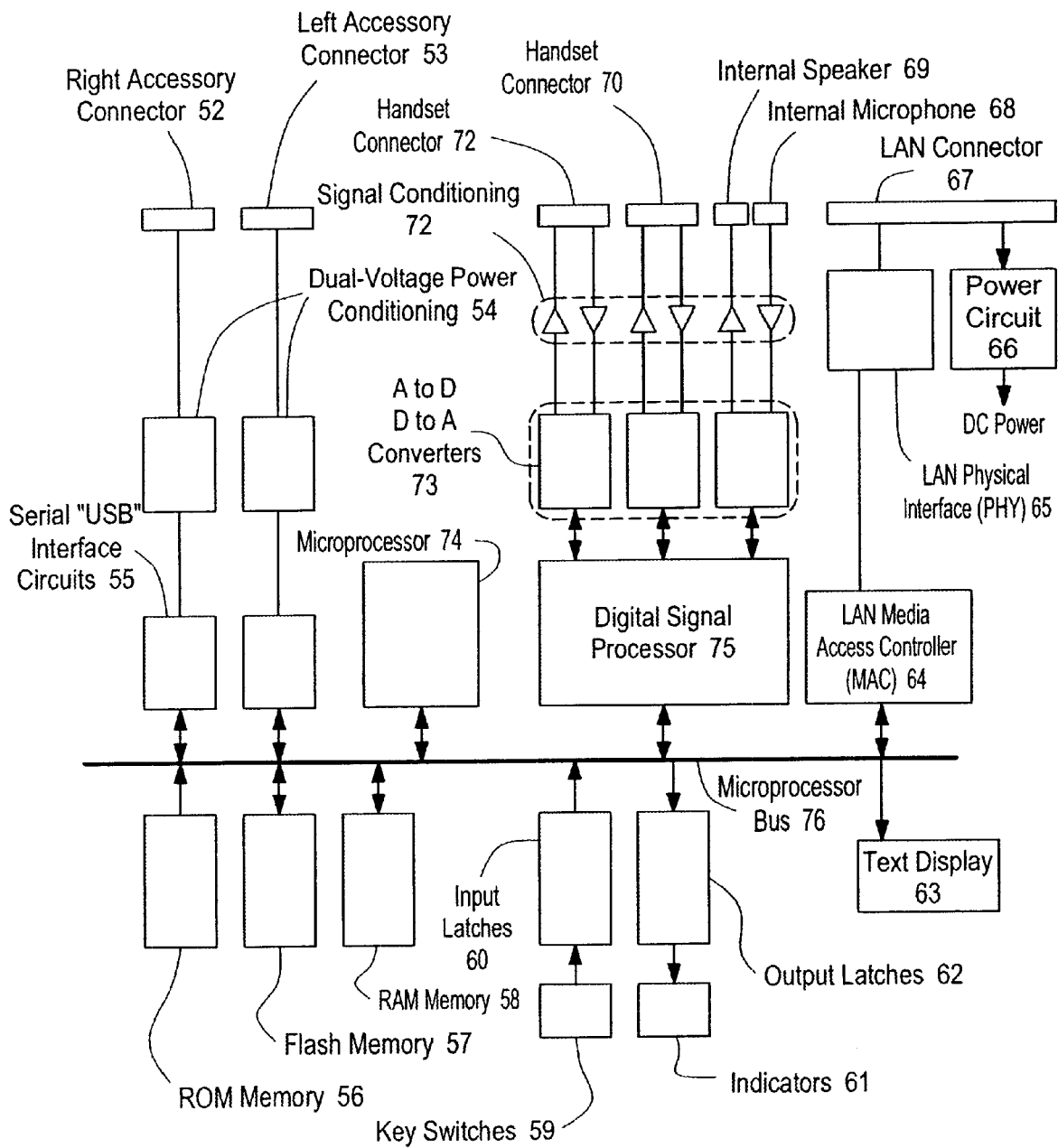

FIG. 5

Explore Litigation Insights

Docket Alarm provides insights to develop a more informed litigation strategy and the peace of mind of knowing you're on top of things.

Real-Time Litigation Alerts



Keep your litigation team up-to-date with **real-time alerts** and advanced team management tools built for the enterprise, all while greatly reducing PACER spend.

Our comprehensive service means we can handle Federal, State, and Administrative courts across the country.

Advanced Docket Research



With over 230 million records, Docket Alarm's cloud-native docket research platform finds what other services can't. Coverage includes Federal, State, plus PTAB, TTAB, ITC and NLRB decisions, all in one place.

Identify arguments that have been successful in the past with full text, pinpoint searching. Link to case law cited within any court document via Fastcase.

Analytics At Your Fingertips



Learn what happened the last time a particular judge, opposing counsel or company faced cases similar to yours.

Advanced out-of-the-box PTAB and TTAB analytics are always at your fingertips.

API

Docket Alarm offers a powerful API (application programming interface) to developers that want to integrate case filings into their apps.

LAW FIRMS

Build custom dashboards for your attorneys and clients with live data direct from the court.

Automate many repetitive legal tasks like conflict checks, document management, and marketing.

FINANCIAL INSTITUTIONS

Litigation and bankruptcy checks for companies and debtors.

E-DISCOVERY AND LEGAL VENDORS

Sync your system to PACER to automate legal marketing.