

Continuation from U.S. Patent Application No.: 12/144,729

Attorney Docket No.: 1028.4

**IN THE UNITED STATES PATENT AND TRADEMARK OFFICE**

In re Application of:	:	Art Unit: 2615
C. Earl Woolfork	:	
	:	
	:	
For: WIRELESS DIGITAL AUDIO SYSTEM	:	Customer No.: 68533
	:	
	:	

**COVER LETTER FOR TRANSMITTAL OF CONTINUATION APPLICATION**

Dear Sir:

The Applicant respectfully submits this continuation application that claims benefit of U.S. Patent Application No.: 12/144,729, filed June 24, 2009, that claimed benefit of U.S. Patent Application No.: 10/648,012, filed August 26, 2003 which claimed benefit of U.S. Patent Application No. 10/027,391, filed December 21, 2001, now abandoned. Transmitted herewith please find the specification; claims; drawings; application data sheet; a copy of the previously filed declaration in Application No. 10/648,012; and the required fees. Any overpayment or underpayment of fees associated with this filing are authorized to be charged to Deposit Acct. No. 50-4576.

Best Regards,



Megan Lyman, Reg. No. 57,054

Under the Paperwork Reduction Act of 1995, no persons are required to respond to a collection of information unless it contains a valid OMB control number.

<b>Application Data Sheet 37 CFR 1.76</b>		<b>Attorney Docket Number</b>	1028.4
		<b>Application Number</b>	
<b>Title of Invention</b>	Wireless Digital Audio System		
The application data sheet is part of the provisional or nonprovisional application for which it is being submitted. The following form contains the bibliographic data arranged in a format specified by the United States Patent and Trademark Office as outlined in 37 CFR 1.76. This document may be completed electronically and submitted to the Office in electronic format using the Electronic Filing System (EFS) or the document may be printed and included in a paper filed application.			

**Secrecy Order 37 CFR 5.2**

Portions or all of the application associated with this Application Data Sheet may fall under a Secrecy Order pursuant to 37 CFR 5.2 (Paper filers only. Applications that fall under Secrecy Order may not be filed electronically.)

**Applicant Information:**

<b>Applicant 1</b>					<input type="button" value="Remove"/>
<b>Applicant Authority</b>		<input checked="" type="radio"/> Inventor		<input type="radio"/> Legal Representative under 35 U.S.C. 117	
				<input type="radio"/> Party of Interest under 35 U.S.C. 118	
<b>Prefix</b>	<b>Given Name</b>	<b>Middle Name</b>	<b>Family Name</b>	<b>Suffix</b>	
Mr.	C.	Earl	Woolfork		
<b>Residence Information (Select One)</b> <input checked="" type="radio"/> US Residency <input type="radio"/> Non US Residency <input type="radio"/> Active US Military Service					
<b>City</b>	Pasadena	<b>State/Province</b>	CA	<b>Country of Residence i</b>	US
<b>Citizenship under 37 CFR 1.41(b) i</b>		US			
<b>Mailing Address of Applicant:</b>					
<b>Address 1</b>	500 Santa Paula Ave.				
<b>Address 2</b>					
<b>City</b>	Pasadena	<b>State/Province</b>	CA		
<b>Postal Code</b>	91107	<b>Country<sup>i</sup></b>	US		
All Inventors Must Be Listed - Additional Inventor Information blocks may be generated within this form by selecting the <b>Add</b> button.					
<input type="button" value="Add"/>					

**Correspondence Information:**

Enter either Customer Number or complete the Correspondence Information section below. For further information see 37 CFR 1.33(a).			
<input type="checkbox"/> An Address is being provided for the correspondence information of this application.			
<b>Customer Number</b>	68533		
<b>Email Address</b>		<input type="button" value="Add Email"/>	<input type="button" value="Remove Email"/>

**Application Information:**

<b>Title of the Invention</b>	Wireless Digital Audio System		
<b>Attorney Docket Number</b>	1028.4	<b>Small Entity Status Claimed</b>	<input checked="" type="checkbox"/>
<b>Application Type</b>	Nonprovisional		
<b>Subject Matter</b>	Utility		
<b>Suggested Class (if any)</b>		<b>Sub Class (if any)</b>	
<b>Suggested Technology Center (if any)</b>	2614		
<b>Total Number of Drawing Sheets (if any)</b>	3	<b>Suggested Figure for Publication (if any)</b>	1

<b>Application Data Sheet 37 CFR 1.76</b>		Attorney Docket Number	1028.4
		Application Number	
Title of Invention	Wireless Digital Audio System		

**Publication Information:**

Request Early Publication (Fee required at time of Request 37 CFR 1.219)

**Request Not to Publish.** I hereby request that the attached application not be published under 35 U.S.C. 122(b) and certify that the invention disclosed in the attached application **has not and will not** be the subject of an application filed in another country, or under a multilateral international agreement, that requires publication at eighteen months after filing.

**Representative Information:**

Representative information should be provided for all practitioners having a power of attorney in the application. Providing this information in the Application Data Sheet does not constitute a power of attorney in the application (see 37 CFR 1.32). Enter either Customer Number or complete the Representative Name section below. If both sections are completed the Customer Number will be used for the Representative Information during processing.

Please Select One:  Customer Number  US Patent Practitioner  Limited Recognition (37 CFR 11.9)

Customer Number 68533

**Domestic Benefit/National Stage Information:**

This section allows for the applicant to either claim benefit under 35 U.S.C. 119(e), 120, 121, or 365(c) or indicate National Stage entry from a PCT application. Providing this information in the application data sheet constitutes the specific reference required by 35 U.S.C. 119(e) or 120, and 37 CFR 1.78(a)(2) or CFR 1.78(a)(4), and need not otherwise be made part of the specification.

Prior Application Status	Pending	<input type="button" value="Remove"/>	
Application Number	Continuity Type	Prior Application Number	Filing Date (YYYY-MM-DD)
12144729	Continuation of	10648012	2003-08-26

Additional Domestic Benefit/National Stage Data may be generated within this form by selecting the **Add** button.

**Foreign Priority Information:**

This section allows for the applicant to claim benefit of foreign priority and to identify any prior foreign application for which priority is not claimed. Providing this information in the application data sheet constitutes the claim for priority as required by 35 U.S.C. 119(b) and 37 CFR 1.55(a).

<input type="button" value="Remove"/>			
Application Number	Country <sup>i</sup>	Parent Filing Date (YYYY-MM-DD)	Priority Claimed
			<input checked="" type="radio"/> Yes <input type="radio"/> No

Additional Foreign Priority Data may be generated within this form by selecting the **Add** button.

**Assignee Information:**

Providing this information in the application data sheet does not substitute for compliance with any requirement of part 3 of Title 37 of the CFR to have an assignment recorded in the Office.

Assignee 1

Under the Paperwork Reduction Act of 1995, no persons are required to respond to a collection of information unless it contains a valid OMB control number.

<b>Application Data Sheet 37 CFR 1.76</b>		Attorney Docket Number	1028.4	
		Application Number		
Title of Invention	Wireless Digital Audio System			
If the Assignee is an Organization check here. <input checked="" type="checkbox"/>				
Organization Name	One-E-Way			
<b>Mailing Address Information:</b>				
Address 1	P.O. Box 70848			
Address 2				
City	Pasadena	State/Province	CA	
Country <sup>i</sup>	US	Postal Code	91107-9998	
Phone Number		Fax Number		
Email Address				
Additional Assignee Data may be generated within this form by selecting the <b>Add</b> button. <span style="float: right;"><input type="button" value="Add"/></span>				

**Signature:**

A signature of the applicant or representative is required in accordance with 37 CFR 1.33 and 10.18. Please see 37 CFR 1.4(d) for the form of the signature.					
Signature	/Megan Lyman/		Date (YYYY-MM-DD)	2009-09-30	
First Name	Megan	Last Name	Lyman	Registration Number	57054

This collection of information is required by 37 CFR 1.76. The information is required to obtain or retain a benefit by the public which is to file (and by the USPTO to process) an application. Confidentiality is governed by 35 U.S.C. 122 and 37 CFR 1.14. This collection is estimated to take 23 minutes to complete, including gathering, preparing, and submitting the completed application data sheet form to the USPTO. Time will vary depending upon the individual case. Any comments on the amount of time you require to complete this form and/or suggestions for reducing this burden, should be sent to the Chief Information Officer, U.S. Patent and Trademark Office, U.S. Department of Commerce, P.O. Box 1450, Alexandria, VA 22313-1450. DO NOT SEND FEES OR COMPLETED FORMS TO THIS ADDRESS. **SEND TO: Commissioner for Patents, P.O. Box 1450, Alexandria, VA 22313-1450.**

## Privacy Act Statement

The Privacy Act of 1974 (P.L. 93-579) requires that you be given certain information in connection with your submission of the attached form related to a patent application or patent. Accordingly, pursuant to the requirements of the Act, please be advised that: (1) the general authority for the collection of this information is 35 U.S.C. 2(b)(2); (2) furnishing of the information solicited is voluntary; and (3) the principal purpose for which the information is used by the U.S. Patent and Trademark Office is to process and/or examine your submission related to a patent application or patent. If you do not furnish the requested information, the U.S. Patent and Trademark Office may not be able to process and/or examine your submission, which may result in termination of proceedings or abandonment of the application or expiration of the patent.

The information provided by you in this form will be subject to the following routine uses:

1. The information on this form will be treated confidentially to the extent allowed under the Freedom of Information Act (5 U.S.C. 552) and the Privacy Act (5 U.S.C. 552a). Records from this system of records may be disclosed to the Department of Justice to determine whether the Freedom of Information Act requires disclosure of these records.
2. A record from this system of records may be disclosed, as a routine use, in the course of presenting evidence to a court, magistrate, or administrative tribunal, including disclosures to opposing counsel in the course of settlement negotiations.
3. A record in this system of records may be disclosed, as a routine use, to a Member of Congress submitting a request involving an individual, to whom the record pertains, when the individual has requested assistance from the Member with respect to the subject matter of the record.
4. A record in this system of records may be disclosed, as a routine use, to a contractor of the Agency having need for the information in order to perform a contract. Recipients of information shall be required to comply with the requirements of the Privacy Act of 1974, as amended, pursuant to 5 U.S.C. 552a(m).
5. A record related to an International Application filed under the Patent Cooperation Treaty in this system of records may be disclosed, as a routine use, to the International Bureau of the World Intellectual Property Organization, pursuant to the Patent Cooperation Treaty.
6. A record in this system of records may be disclosed, as a routine use, to another federal agency for purposes of National Security review (35 U.S.C. 181) and for review pursuant to the Atomic Energy Act (42 U.S.C. 218(c)).
7. A record from this system of records may be disclosed, as a routine use, to the Administrator, General Services, or his/her designee, during an inspection of records conducted by GSA as part of that agency's responsibility to recommend improvements in records management practices and programs, under authority of 44 U.S.C. 2904 and 2906. Such disclosure shall be made in accordance with the GSA regulations governing inspection of records for this purpose, and any other relevant (i.e., GSA or Commerce) directive. Such disclosure shall not be used to make determinations about individuals.
8. A record from this system of records may be disclosed, as a routine use, to the public after either publication of the application pursuant to 35 U.S.C. 122(b) or issuance of a patent pursuant to 35 U.S.C. 151. Further, a record may be disclosed, subject to the limitations of 37 CFR 1.14, as a routine use, to the public if the record was filed in an application which became abandoned or in which the proceedings were terminated and which application is referenced by either a published application, an application open to public inspections or an issued patent.
9. A record from this system of records may be disclosed, as a routine use, to a Federal, State, or local law enforcement agency, if the USPTO becomes aware of a violation or potential violation of law or regulation.

## WIRELESS DIGITAL AUDIO MUSIC SYSTEM

This continuation application claims the benefit of U.S. Patent Application Serial No. 12/144,729 filed July 12, 2008, which claimed benefit of U.S. Patent Application Serial No. 10/648,012 filed August 26, 2003, which claimed benefit from U.S. Patent Application Serial No. 10/027,391, filed December 21, 2001, for "Wireless Digital Audio System," published under US 2003/0118196 A1 on June 26, 2003, now abandoned, both of which are incorporated herein in their entirety by reference.

### BACKGROUND OF THE INVENTION

[0001] This invention relates to audio player devices and more particularly to systems that include headphone listening devices. The new audio system uses an existing headphone jack (i.e., this is the standard analog headphone jack that connects to wired headphones) of a music audio player (i.e., portable CD player, portable cassette player, portable A.M./F.M. radio, laptop/desktop computer, portable MP3 player, and the like) to connect a battery powered transmitter for wireless transmission of a signal to a set of battery powered receiving headphones.

[0002] Use of audio headphones with audio player devices such as portable CD players, portable cassette players, portable A.M./F.M. radios, laptop/desktop computers, portable MP3 players and the like have been in use for many years. These systems incorporate an audio source having an analog headphone jack to which headphones may be connected by wire.

[0003] There are also known wireless headphones that may receive A.M. and F.M. radio transmissions. However, they do not allow use of a simple plug in (i.e., plug in to the existing analog audio headphone jack) battery powered transmitter for connection to any music audio player device jack, such as the above mentioned music audio player devices, for coded wireless transmission and reception by headphones of audio music for private listening without interference where multiple users occupying the same space are operating wireless transmission devices. Existing audio systems make use of electrical wire connections between the audio source and the headphones to accomplish private listening to multiple users.

[0004] There is a need for a battery powered simple connection system for existing music audio player devices (i.e., the previously mentioned music devices), to allow coded digital wireless transmission (using a battery powered transmitter) to a headphone receiver (using a battery powered receiver headphones) that accomplishes private listening to multiple users occupying the same space without the use of wires.

#### SUMMARY OF THE INVENTION

[0005] The present invention is generally directed to a wireless digital audio system for coded digital transmission of an audio signal from any audio player with an analog headphone jack to a receiver headphone located away from the audio player. Fuzzy logic technology may be utilized by the system to enhance bit detection. A battery-powered digital transmitter may include a headphone plug in communication with any suitable music audio source. For reception, a battery-powered headphone receiver may use embedded fuzzy logic to enhance user code bit detection. Fuzzy logic detection may be used to enhance user code bit detection during decoding of the transmitted audio signal. The wireless digital audio music system provides private listening without interference from other users or wireless devices and without the use of conventional cable connections.

[0006] These and other features, aspects and advantages of the present invention will become better understood with reference to the following drawings, description and claims.

#### BRIEF DESCRIPTION OF THE DRAWINGS

[0007] Some aspects of the present invention are generally shown by way of reference to the accompanying drawings in which:

Figure 1 schematically illustrates a wireless digital audio system in accordance with the present invention;

Figure 2 is a block diagram of an audio transmitter portion of the wireless digital audio system of Fig. 1.;

Figure 3 is a block diagram of an audio receiver portion of the wireless digital audio system of Fig. 1; and

Figure 4 is an exemplary graph showing the utilization of an embedded fuzzy logic coding algorithm according to one embodiment of the present invention.

#### DETAILED DESCRIPTION

[0008] The following detailed description is the best currently contemplated modes for carrying out the invention. The description is not to be taken in a limiting sense, but is made merely for the purpose of illustrating the general principles of the invention.

[0009] Referring to Figures 1 through 3, a wireless digital audio music system 10 may include a battery powered transmitter 20 connected to a portable music audio player or music audio source 80. The battery powered wireless digital audio music transmitter 20 utilizes an analog to digital converter or ADC 32 and may be connected to the music audio source 80 analog headphone jack 82 using a headphone plug 22. The battery powered transmitter 20 may have a transmitting antenna 24 that may be omni-directional for transmitting a spread spectrum modulated signal to a receiving antenna 52 of a battery powered headphone receiver 50. The battery powered receiver 50 may have headphone speakers 75 in headphones 55 for listening to the spread spectrum demodulated and decoded communication signal. In the headphone receiver 50, fuzzy logic detection may be used to optimize reception of the received user code. The transmitter 20 may digitize the audio signal using ADC 32. The digitized signal may be processed downstream by an encoder 36. After digital conversion, the digital signal may be processed by a digital low pass filter. To reduce the effects of channel noise, the battery powered transmitter 20 may use a channel encoder 38. A modulator 42 modulates the digital signal to be transmitted. For further noise immunity, a spread spectrum DPSK (differential phase shift key) transmitter or module 48, is utilized. The battery powered transmitter 20 may



contain a code generator 44 that may be used to create a unique user code. The unique user code generated is specifically associated with one wireless digital audio system user, and it is the only code recognized by the battery powered headphone receiver 50 operated by a particular user. The radio frequency (RF) spectrum utilized (as taken from the Industrial, Scientific and Medical (ISM) band) may be approximately 2.4 GHz. The power radiated by the transmitter adheres to the ISM standard.

[0010] Particularly, the received spread spectrum signal may be communicated to a 2.4 GHz direct conversion receiver or module 56. Referring to Figures 1 through 4, the spread spectrum modulated signal from transmit antenna 24 may be received by receiving antenna 52 and then processed by spread spectrum direct conversion receiver or module 56 with a receiver code generator 60 that contains the same transmitted unique code, in the battery powered receiver 50 headphones. The transmitted signal from antenna 24 may be received by receiving antenna 52 and communicated to a wideband bandpass filter (BPF). The battery powered receiver 50 may utilize embedded fuzzy logic 61 (as graphically depicted in Figures 1, 4) to optimize the bit detection of the received user code. The down converted output signal of direct conversion receiver or module 56 may be summed by receiver summing element 58 with a receiver code generator 60 signal. The receiver code generator 60 may contain the same unique wireless transmission of a signal code word that was transmitted by audio transmitter 20 specific to a particular user. Other code words from wireless digital audio systems 10 may appear as noise to audio receiver 50. This may also be true for other device transmitted wireless signals operating in the wireless digital audio spectrum of digital audio system 10. This code division multiple access (CDMA) may be used to provide each user independent audible enjoyment. The resulting summed digital signal from receiving summary element 58 and direct conversion receiver or module 56 may be processed by a 64-Ary demodulator 62 to demodulate the signal elements modulated in the audio transmitter 20. A block de-interleaver 64 may then decode the bits of the digital signal encoded in the block interleaver 40. Following such, a Viterbi decoder 66 may be used to decode the bits encoded by the channel encoder 38 in audio transmitter 20. A source decoder 68 may further decode the coding applied by encoder 36.

[0011] Each receiver headphone 50 user may be able to listen (privately) to high fidelity audio music, using any of the audio devices listed previously, without the use of wires, and without interference from any other receiver headphone 50 user, even when operated within a shared space. The fuzzy logic detection technique 61 used in the receiver 50 could provide greater user separation through optimizing code division in the headphone receiver.

[0012] The battery powered transmitter 20 sends the audio music information to the battery powered receiver 50 in digital packet format. These packets may flow to create a digital bit stream rate less than or equal to 1.0 Mbps.

[0013] The user code bits in each packet may be received and detected by a fuzzy logic detection sub-system 61 (as an option) embedded in the headphone receiver 50 to optimize audio receiver performance. For each consecutive packet received, the fuzzy logic detection sub-system 61 may compute a conditional density with respect to the context and fuzziness of the user code vector, i.e., the received code bits in each packet. Fuzziness may describe the ambiguity of the high (1)/low (0 or -1) event in the received user code within the packet. The fuzzy logic detection sub-system 61 may measure the degree to which a high/low bit occurs in the user code vector, which produces a low probability of bit error in the presence of noise. The fuzzy logic detection sub-system 61 may use a set of if-then rules to map the user code bit inputs to validation outputs. These rules may be developed as if-then statements.

[0014] Fuzzy logic detection sub-system 61 in battery-powered headphone receiver 50 utilizes the if-then fuzzy set to map the received user code bits into two values: a low (0 or -1) and a high (1). Thus, as the user code bits are received, the "if" rules map the signal bit energy to the fuzzy set low value to some degree and to the fuzzy set high value to some degree. Figure 4 graphically shows that x-value -1 equals the maximum low bit energy representation and x-value 1 equals the maximum high bit energy representation. Due to additive noise, the user code bit energy may have some membership to a low and high as represented in Figure 4. The if-part fuzzy set may determine if each bit in the user code, for every received packet, has a greater membership to a high bit representation or a low bit representation. The more a user code bit energy fits into the

high or low representation, the closer its subsethood, i.e., a measure of the membership degree to which a set may be a subset of another set, may be to one.

[0015] The if-then rule parts that make up the fuzzy logic detection sub-system 61 must be followed by a defuzzifying operation. This operation reduces the aforementioned fuzzy set to a bit energy representation (i.e., -1 or 1) that is received by the transmitted packet. Fuzzy logic detection sub-system 61 may be used in battery-powered headphone receiver 50 to enhance overall system performance.

[0016] The next step may process the digital signal to return the signal to analog or base band format for use in powering speaker(s) 75. A digital-to-analog converter 70 (DAC) may be used to transform the digital signal to an analog audio signal. An analog low pass filter 72 may be used to filter the analog audio music signal to pass a signal in the approximate 20 Hz to 20 kHz frequency range and filter other frequencies. The analog audio music signal may then be processed by a power amplifier 74 that may be optimized for powering headphone speakers 75 to provide a high quality, low distortion audio music for audible enjoyment by a user wearing headphones 55. A person skilled in the art would appreciate that some of the embodiments described hereinabove are merely illustrative of the general principles of the present invention. Other modifications or variations may be employed that are within the scope of the invention. Thus, by way of example, but not of limitation, alternative configurations may be utilized in accordance with the teachings herein. Accordingly, the drawings and description are illustrative and not meant to be a limitation thereof.

[0017] Moreover, all terms should be interpreted in the broadest possible manner consistent with the context. In particular, the terms “comprises” and “comprising” should be interpreted as referring to elements, components, or steps in a non-exclusive manner, indicating that the referenced elements, components, or steps may be present, or utilized, or combined with other elements, components, or steps that are not expressly referenced. Thus, it is intended that the invention cover all embodiments and variations thereof as long as such embodiments and variations come within the scope of the appended claims and their equivalents.

ABSTRACT

[0018] A wireless digital audio system includes a portable audio source with a digital audio transmitter operatively coupled thereto and an audio receiver operatively coupled to a headphone set. The audio receiver is configured for digital wireless communication with the audio transmitter. The digital audio receiver utilizes fuzzy logic to optimize digital signal processing. Each of the digital audio transmitter and receiver is configured for code division multiple access (CDMA) communication. The wireless digital audio system allows private audio enjoyment without interference from other users of independent wireless digital transmitters and receivers sharing the same space.

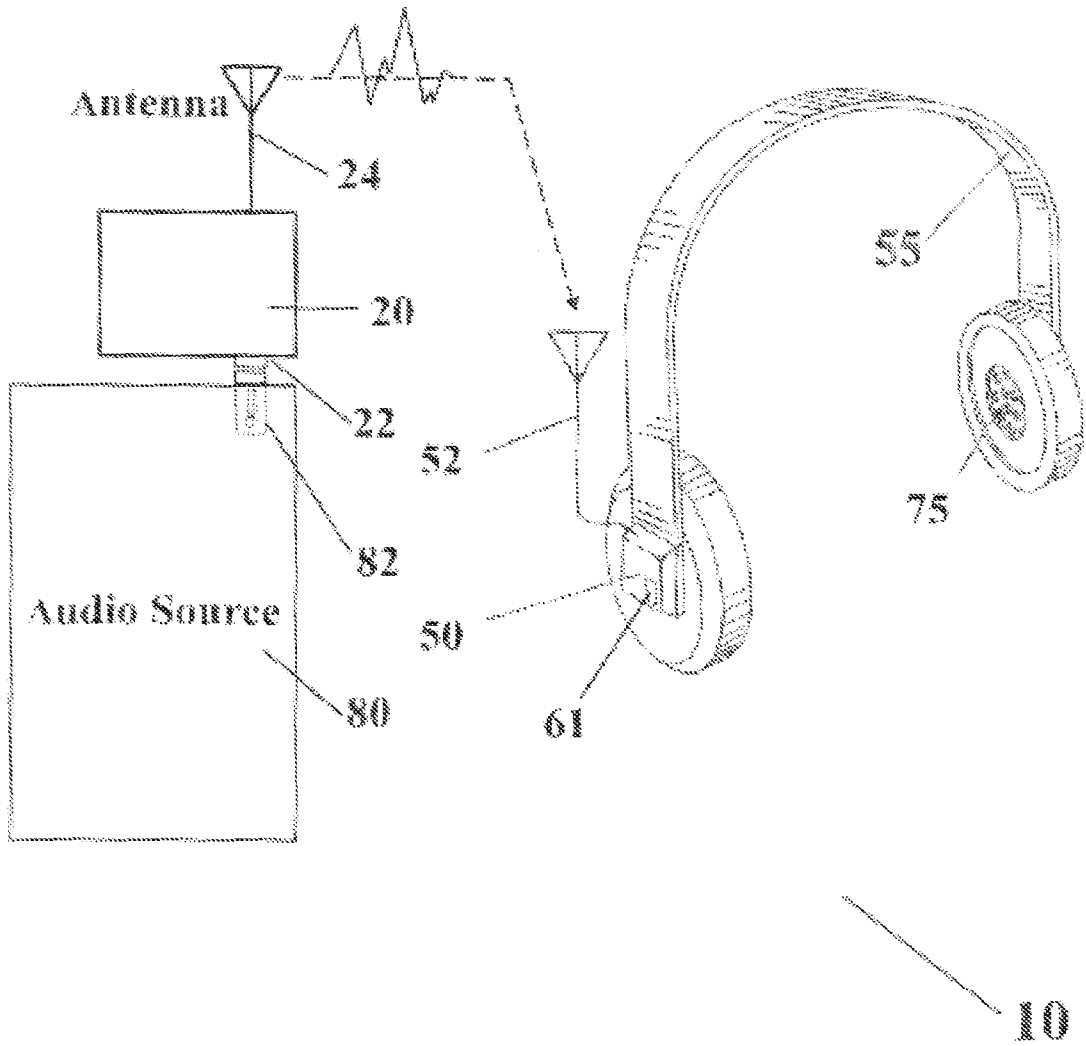

**FIG.1**

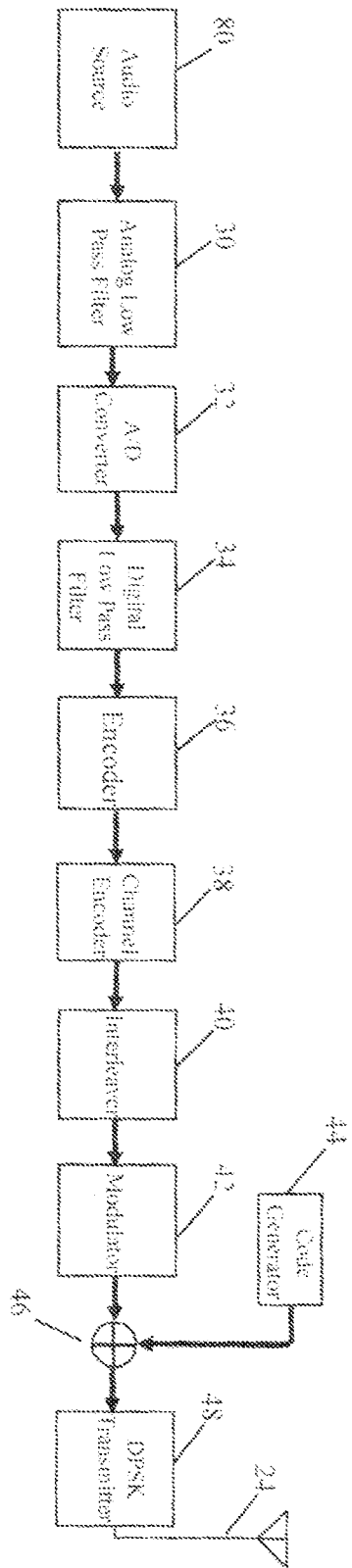

FIG. 2

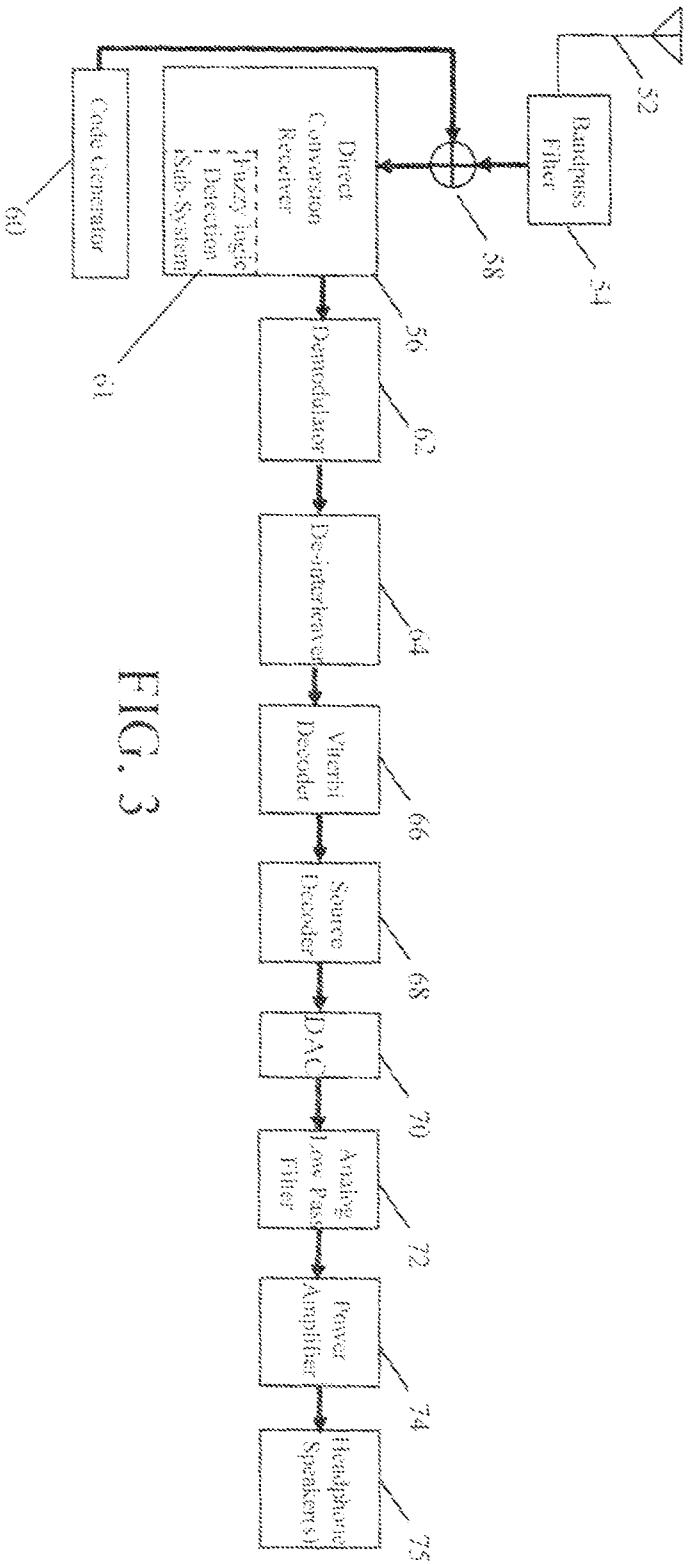

FIG. 3

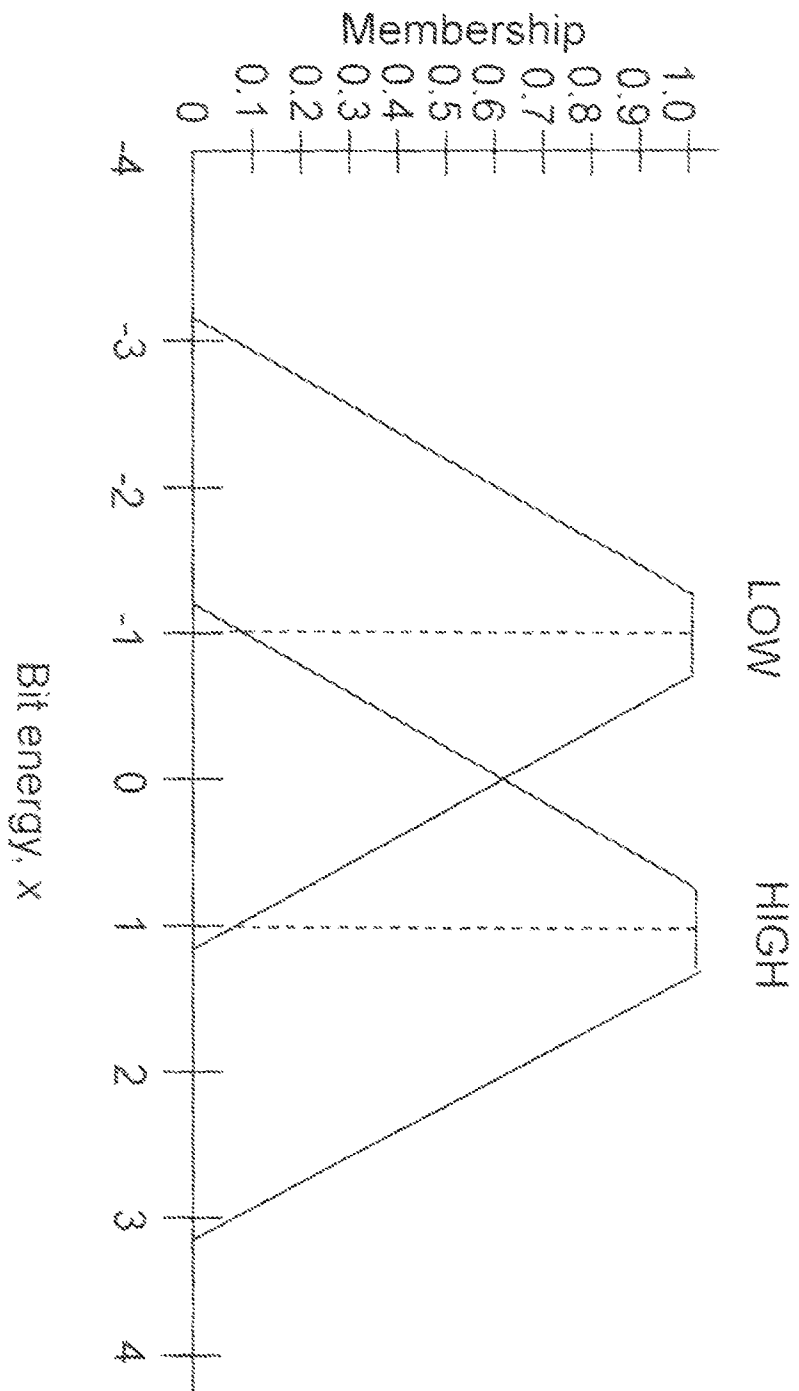

Fig. 4

Continuation of U.S. Patent Application No.: 12/144,729

Attorney Docket No.: 1028.4

**IN THE UNITED STATES PATENT AND TRADEMARK OFFICE**

In re Application of:	:	Art Unit: 2615
C. Earl Woolfork	:	
	:	
	:	
For: WIRELESS DIGITAL AUDIO SYSTEM	:	Customer No.: 68533
	:	
	:	

**COVER LETTER FOR PREVIOUSLY FILED DECLARATION**

Dear Sir:

The Applicant respectfully submits this previously filed copy of a declaration in U.S. Patent Application No.: 10/648,012, filed August 26, 2003 which claimed benefit of U.S. Patent Application No. 10/027,391, filed December 21, 2001, not abandoned. This previously filed copy of a declaration satisfies the requirements of a declaration under 37 C.F.R. 163(d)(1)(iv) as part of the presently filed continuation application of U.S. Patent Application No.: 12/144,729. Any overpayment or underpayment of fees associated with this filing are authorized to be charged to Deposit Acct. No. 50-4576.

Best Regards,

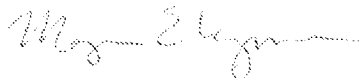

Megan Lyman, Reg. No. 57,054



## COMBINATION DECLARATION AND POWER OF ATTORNEY

As the below named inventor, I hereby declare that this declaration is an original.

### INVENTORSHIP IDENTIFICATION

My residence, post office address and citizenship are as stated below next to my name, I believe I am the original, first and sole inventor of the subject matter which is claimed and for which a patent is sought on the invention entitled: **FUZZY AUDIO WIRELESS MUSIC SYSTEM**.

### SPECIFICATION IDENTIFICATION

The specification is attached hereto.

### ACKNOWLEDGEMENT OF REVIEW OF PAPERS AND DUTY OF CANDOR

I hereby state that I have reviewed and understand the contents of the above identified specification, including the claims, as amended by any amendment referred to above. I acknowledge the duty to disclose information which is material to the examination of this application in accordance with Title 37, Code of Federal Regulations, Section 1.56(a), including information that occurred between the filing date of the prior application and the national filing date of the continuation-in-part application.

### PRIORITY CLAIM

I hereby claim foreign priority benefits under Title 35, United States Code, Section 119 of any foreign application(s) for patent or inventor's certificate or of any PCT international application(s) designating at least one country other than the United States of America listed below and have also identified below any foreign application(s) for patent or inventor's certificate or any PCT international application(s) designating at least one country other than the United States of America filed by me on the same subject matter having a filing date before that of the application(s) of which priority is claimed.

No such applications have been filed.

Dated: 8/20/03

  
C. EARL WOOLFORK

CLAIMS

I claim:

1. A wireless digital audio system, comprising:
  - at least one digital audio transmitter operatively coupled to at least one audio source, said at least one digital audio transmitter comprising:
    - a digital modulator configured for code division multiple access (CDMA) communication;
    - said digital audio transmitter configured for digital wireless communication with at least one digital audio receiver, said digital audio receiver comprising:
      - a digital demodulator configured for CDMA communication;
      - a digital-to-analog converter (DAC) generating an audio output; and
  - at least one module adapted to reproduce said generated audio output, said audio having been wirelessly transmitted from said at least one audio source virtually free from interference from multiple CDMA wireless digital audio system transmitters operating in the wireless digital audio system spectrum to a user providing a particular audio receiver user with independent audio in a shared space with other wireless digital audio system users, wherein each of said wireless digital audio system users utilize their own independent audio source, and their own independent digital transmitter that associates only with their own independent receiver.
  
2. A wireless digital audio headphone comprising:
  - at least one audio receiver configured for digital wireless communication with at least one digital audio transmitter, said at least one digital audio transmitter comprising:
    - a digital modulator configured for code division multiple access (CDMA) communication; and adding a unique user code bit sequence;
    - said at least one audio receiver comprising:
      - a digital demodulator configured for CDMA communication;
      - a digital-to-analog converter (DAC) generating an audio output; and

at least one module adapted to reproduce said generated audio output, when the unique user code bit sequence is recognized, said audio having been wirelessly transmitted from at least one audio source virtually free from interference from multiple CDMA wireless digital audio system transmitters operating in the wireless digital audio system spectrum to a user and providing a particular audio receiver user with independent audio in a shared space with other wireless digital audio system users, wherein each of said wireless digital audio system users utilize their own independent audio source, and their own independent digital transmitter that associates only with their own independent receiver.

3. A portable wireless digital audio transmitter, configured to couple to an audio player, and wirelessly transmit a code division multiple access (CDMA) communication signal and a unique user code bit sequence to at least one digital audio receiver;

said portable wireless digital audio transmitter comprising:

a digital modulator module configured for CDMA communication;

said at least one digital audio receiver comprising:

a digital demodulator configured for CDMA communication;

a digital-to-analog converter (DAC) generating an audio output; and

at least one module adapted to reproduce audio output generated by said audio player, when the unique user code bit sequence is recognized, said audio output having been wirelessly transmitted from said audio player virtually free from interference from multiple CDMA wireless digital audio system transmitters operating in the wireless digital audio system spectrum to a user and providing a particular audio receiver user with independent audio in a shared space with other wireless digital audio system users, wherein each of said wireless digital audio system users utilize their own independent audio player, and their own independent digital audio transmitter that associates only with their own independent digital audio receiver.

4. A wireless digital audio system, comprising:

a portable digital audio transmitter configured to couple to an audio source and operative to transmit a code division multiple access (CDMA) communication signal of

said audio source output and adding a unique user code to maintain fidelity of said audio source output, said audio source to provide an audio signal representative of music; and

said portable digital audio transmitter configured for digital wireless communication with at least one digital audio receiver, said digital audio receiver comprising:

an audio receiver operative to receive the CDMA communication signal wherein when the unique user code is recognized, the transmitted audio source signal is reproduced, said audio source output virtually free from interference from multiple CDMA wireless digital audio system transmitters operating in the wireless digital audio system spectrum to a user and providing a particular audio receiver user with independent audio in a shared space with other wireless digital audio system users, wherein each of said wireless digital audio system users utilize their own independent audio source, and their own independent digital transmitter that associates only with their own independent headphone receiver.

5. A method for listening to an audio output with a wireless digital audio system while running comprising the steps of:

activating said wireless digital audio system while running, said wireless digital audio system, comprising:

a digital audio transmitter operatively coupled to an audio source and operative to transmit a code division multiple access (CDMA) communication signal of said audio source output and adding a unique user code to maintain fidelity of said audio source output; and

said digital audio transmitter configured for digital wireless communication with at least one digital audio receiver, said digital audio receiver comprising:

an audio receiver operative to receive the CDMA communication signal wherein if the unique user code is recognized, the transmitted audio source signal is reproduced,

said audio source output having been wirelessly transmitted from said audio source virtually free from interference from multiple CDMA wireless digital audio system transmitters operating in the wireless digital audio system spectrum to a user and providing a particular audio receiver user with independent audio in a shared space with other wireless digital audio system users, wherein each of said wireless digital audio system users utilize their own independent audio source, and their own independent digital audio transmitter that associates only with their own independent digital audio receiver.

6. A method for listening to an audio output with a wireless digital audio system while running comprising the steps of:

activating said wireless digital audio system while running, said wireless digital audio system, comprising:

a portable digital audio transmitter configured to couple to an audio player and operative to transmit a code division multiple access (CDMA) communication of the audio output of said audio player and adding a unique user code to maintain fidelity of said audio output; and

said portable digital audio transmitter configured for digital wireless communication with at least one digital audio receiver, said digital audio receiver comprising:

an audio receiver operative to receive the CDMA communication signal wherein if the unique user code is recognized, the transmitted audio signal is reproduced, said audio output having been wirelessly transmitted from said audio player virtually free from interference from multiple CDMA wireless digital audio system transmitters operating in the wireless digital audio system spectrum to a user and providing a particular audio receiver user with independent audio in a shared space with other wireless digital audio system users, wherein each of said wireless digital audio system users utilize their own independent audio player, and their own independent digital audio

transmitter that associates only with their own independent digital audio receiver.

7. A method for listening to an audio output with a wireless digital audio system by a user in motion resulting primarily from physical force initiated by said user, comprising the steps of:

activating said wireless digital audio system during individual independent motion from exercise, said wireless digital audio system, comprising:

a digital audio transmitter operatively coupled to an audio source and operative to transmit a code division multiple access (CDMA) communication signal of the audio source output and adding a unique user code to maintain fidelity of said audio source output; and

said digital audio transmitter configured for digital wireless communication with at least one digital audio receiver, said digital audio receiver comprising:

an audio receiver operative to receive the CDMA communication signal wherein if the unique user code is recognized, the transmitted audio signal is reproduced, said audio source output having been wirelessly transmitted from said audio source virtually free from interference from multiple CDMA wireless digital audio system transmitters operating in the wireless digital audio system spectrum to a user and providing a particular audio receiver user with independent audio in a shared space with other wireless digital audio system users, wherein each of said wireless digital audio system users utilize their own independent audio source, and their own independent digital audio transmitter that associates only with their own independent digital audio receiver.

8. A wireless digital audio system, comprising:

at least one digital audio transmitter operatively coupled to at least one audio source, said at least one digital audio transmitter comprising:

a digital modulator configured for code division multiple access (CDMA) communication;

at least one audio receiver configured for digital wireless communication

with said at least one digital audio transmitter, said at least one audio receiver comprising:

a digital demodulator configured for CDMA communication;

a digital-to-analog converter (DAC) generating an audio output; and

at least one module adapted to reproduce said generated audio output, said audio having been wirelessly transmitted from said at least one audio source free from interference from multiple CDMA wireless digital audio system transmitters operating in the wireless digital audio system spectrum to a user providing a particular audio receiver user with independent audio in a shared space with other wireless digital audio system users, wherein each of said wireless digital audio system users utilize their own independent audio source, and their own independent digital transmitter that associates only with their own independent receiver.

9. A wireless digital audio system, comprising:

a portable digital audio transmitter configured to couple to an audio player and operative to transmit a code division multiple access (CDMA) communication signal of an audio output and adding a unique user code to maintain fidelity of said audio output; and

an audio receiver operative to receive said CDMA communication signal wherein if the unique user code is recognized, the transmitted audio signal is reproduced, said audio free from interference from multiple CDMA wireless digital audio system transmitters operating in the wireless digital audio system spectrum to a user providing a particular audio receiver user with independent audio in a shared space with other wireless digital audio system users, wherein each of said wireless digital audio system users utilize their own independent audio player, and their own independent portable transmitter that associates only with their own independent headphone receiver.

10. A wireless digital audio system, comprising:

a portable audio source to provide a signal representative of music;

a digital audio transmitter operatively coupled to said portable audio source, said digital audio transmitter comprising:

a digital modulator module configured for code division multiple access (CDMA) communication and utilizing a unique user code bit sequence;

said digital audio transmitter configured for digital wireless communication with at least one digital audio receiver, said digital audio receiver comprising:

a digital demodulator module configured for code division multiple access (CDMA) communication; and

a digital-to-analog converter (DAC) generating an audio output; and

at least one module adapted to reproduce said generated audio output, when the unique user code bit sequence is recognized, said audio having been wirelessly transmitted from said portable audio source free from interference from multiple CDMA wireless digital audio system transmitters operating in the wireless digital audio system spectrum to a user providing a particular digital audio receiver user with independent audio in a shared space with other wireless digital audio system users, wherein each of said wireless digital audio system users utilize their own independent audio source, and their own independent digital audio transmitter that associates only with their own independent receiver.

11. A wireless digital audio system, comprising:

a portable digital audio transmitter configured to couple to an audio source and operative to transmit a code division multiple access (CDMA) communication signal of said audio source output and adding a unique user code to maintain fidelity of said audio source output, said audio source to provide an audio signal representative of music; and

an audio receiver operative to receive the CDMA communication signal wherein when the unique user code is recognized, the transmitted audio source signal is reproduced, said audio source output free from interference from multiple CDMA wireless digital audio system transmitters operating in the wireless digital audio system spectrum to a user providing a particular audio receiver user with independent audio in a shared space with other wireless digital audio system users, wherein each of said wireless digital audio system users utilize their own independent audio source, and their own independent digital audio transmitter that associates only with their own independent headphone



receiver.

12. A wireless digital audio receiver comprising:

an embedded fuzzy logic detector wherein the fuzzy logic detector activates fuzzy logic rules and performs a defuzzification operation in response to a received unique user code to enhance detection of the unique user code;

a direct conversion module being configured to capture the correct unique user code bit sequence embedded in the received CDMA signal;

a digital demodulator adapted to process output from said direct conversion module;

a digital-to-analog converter (DAC) generating an audio output wherein if the unique user code bit sequence corresponding to the decoded and converted digital signal is recognized, said audio output having been wirelessly transmitted, said audio output reproduced virtually without interference when operated in a shared space containing at least one other user of a wireless device utilizing code division multiple access (CDMA) communication.

## Electronic Patent Application Fee Transmittal

<b>Application Number:</b>				
<b>Filing Date:</b>				
<b>Title of Invention:</b>	Wireless Digital Audio Music System			
<b>First Named Inventor/Applicant Name:</b>	C. Earl Woolfork			
<b>Filer:</b>	Megan Elizabeth Lyman			
<b>Attorney Docket Number:</b>	1028.4			
Filed as Small Entity				
<b>Utility under 35 USC 111(a) Filing Fees</b>				
<b>Description</b>	<b>Fee Code</b>	<b>Quantity</b>	<b>Amount</b>	<b>Sub-Total in USD(\$)</b>
<b>Basic Filing:</b>				
Utility filing Fee (Electronic filing)	4011	1	82	82
Utility Search Fee	2111	1	270	270
Utility Examination Fee	2311	1	110	110
<b>Pages:</b>				
<b>Claims:</b>				
Independent claims in excess of 3	2201	9	110	990
<b>Miscellaneous-Filing:</b>				
<b>Petition:</b>				

Description	Fee Code	Quantity	Amount	Sub-Total in USD(\$)
<b>Patent-Appeals-and-Interference:</b>				
<b>Post-Allowance-and-Post-Issuance:</b>				
<b>Extension-of-Time:</b>				
<b>Miscellaneous:</b>				
<b>Total in USD (\$)</b>				<b>1452</b>

## Electronic Acknowledgement Receipt

<b>EFS ID:</b>	6175799
<b>Application Number:</b>	12570343
<b>International Application Number:</b>	
<b>Confirmation Number:</b>	9973
<b>Title of Invention:</b>	Wireless Digital Audio Music System
<b>First Named Inventor/Applicant Name:</b>	C. Earl Woolfork
<b>Customer Number:</b>	68533
<b>Filer:</b>	Megan Elizabeth Lyman
<b>Filer Authorized By:</b>	
<b>Attorney Docket Number:</b>	1028.4
<b>Receipt Date:</b>	30-SEP-2009
<b>Filing Date:</b>	
<b>Time Stamp:</b>	14:29:31
<b>Application Type:</b>	Utility under 35 USC 111(a)

### Payment information:

Submitted with Payment	yes
Payment Type	Credit Card
Payment was successfully received in RAM	\$1452
RAM confirmation Number	3255
Deposit Account	504576
Authorized User	WOOLFORK,C. EARL

The Director of the USPTO is hereby authorized to charge indicated fees and credit any overpayment as follows:

Charge any Additional Fees required under 37 C.F.R. Section 1.16 (National application filing, search, and examination fees)

Charge any Additional Fees required under 37 C.F.R. Section 1.17 (Patent application and reexamination processing fees)

Charge any Additional Fees required under 37 C.F.R. Section 1.19 (Document supply fees)

Charge any Additional Fees required under 37 C.F.R. Section 1.21 (Miscellaneous fees and charges)

**File Listing:**

Document Number	Document Description	File Name	File Size(Bytes)/ Message Digest	Multi Part /.zip	Pages (if appl.)
1	Transmittal of New Application	TransmittalSheet.pdf	73438 897cebffe6c1033d8285f0b5a616baf0815f0a04	no	1
<b>Warnings:</b>					
<b>Information:</b>					
2	Application Data Sheet	ADS.pdf	1315069 62e5616013b1cae396f4d11b88f3825362b65c11	no	4
<b>Warnings:</b>					
<b>Information:</b>					
3	Specification	Specification.pdf	67276 1bc3a9e2f006b6356897826ee0b3163b2a835a32	no	7
<b>Warnings:</b>					
<b>Information:</b>					
4	Drawings-only black and white line drawings	Figures.pdf	3282322 59f9c71f247007761df703d35358cac0b01b2501	no	3
<b>Warnings:</b>					
<b>Information:</b>					
5	Transmittal of New Application	CoverSheetForDeclaration.pdf	73559 811253d453176007e8d61c874192fa27c3e79586	no	1
<b>Warnings:</b>					
<b>Information:</b>					
6	Oath or Declaration filed	Declaration.pdf	550340 4b842beab0a38d06c88e932c985e4fcbdb84c7741	no	1
<b>Warnings:</b>					
<b>Information:</b>					
7	Claims	Claims.pdf	61467 307dc5dc6d7f585a9094731705584baa878a9f2d	no	8
<b>Warnings:</b>					
<b>Information:</b>					
8	Fee Worksheet (PTO-875)	fee-info.pdf	36130 d6170d09068c74af407e1e3d595ef2823aa33b5f	no	2
<b>Warnings:</b>					

<b>Information:</b>	
<b>Total Files Size (in bytes):</b>	5459601
<p><b>This Acknowledgement Receipt evidences receipt on the noted date by the USPTO of the indicated documents, characterized by the applicant, and including page counts, where applicable. It serves as evidence of receipt similar to a Post Card, as described in MPEP 503.</b></p> <p><b><u>New Applications Under 35 U.S.C. 111</u></b>  <b>If a new application is being filed and the application includes the necessary components for a filing date (see 37 CFR 1.53(b)-(d) and MPEP 506), a Filing Receipt (37 CFR 1.54) will be issued in due course and the date shown on this Acknowledgement Receipt will establish the filing date of the application.</b></p> <p><b><u>National Stage of an International Application under 35 U.S.C. 371</u></b>  <b>If a timely submission to enter the national stage of an international application is compliant with the conditions of 35 U.S.C. 371 and other applicable requirements a Form PCT/DO/EO/903 indicating acceptance of the application as a national stage submission under 35 U.S.C. 371 will be issued in addition to the Filing Receipt, in due course.</b></p> <p><b><u>New International Application Filed with the USPTO as a Receiving Office</u></b>  <b>If a new international application is being filed and the international application includes the necessary components for an international filing date (see PCT Article 11 and MPEP 1810), a Notification of the International Application Number and of the International Filing Date (Form PCT/RO/105) will be issued in due course, subject to prescriptions concerning national security, and the date shown on this Acknowledgement Receipt will establish the international filing date of the application.</b></p>	

## SCORE Placeholder Sheet for IFW Content

Application Number: 12570343 Document Date: 9/30/2009

The presence of this form in the IFW record indicates that the following document type was received in electronic format on the date identified above. This content is stored in the SCORE database.

- Drawings – Other than Black and White Line Drawings

Since this was an electronic submission, there is no physical artifact folder, no artifact folder is recorded in PALM, and no paper documents or physical media exist. The TIFF images in the IFW record were created from the original documents that are stored in SCORE.

To access the documents in the SCORE database, refer to instructions developed by SIRA.

At the time of document entry (noted above):

- Examiners may access SCORE content via the eDAN interface.
- Other USPTO employees can bookmark the current SCORE URL (<http://es/ScoreAccessWeb/>).
- External customers may access SCORE content via the Public and Private PAIR interfaces.

Form Revision Date: February 8, 2006

Filing Date: 09/30/09

Approved for use through 7/31/2006. OMB 0651-0032  
U.S. Patent and Trademark Office; U.S. DEPARTMENT OF COMMERCE

Under the Paperwork Reduction Act of 1995, no persons are required to respond to a collection of information unless it displays a valid OMB control number.

PATENT APPLICATION FEE DETERMINATION RECORD Substitute for Form PTO-875					Application or Docket Number <b>12/570,343</b>						
<b>APPLICATION AS FILED – PART I</b>					SMALL ENTITY		OR		OTHER THAN SMALL ENTITY		
(Column 1)		(Column 2)			RATE (\$)	FEE (\$)			RATE (\$)	FEE (\$)	
FOR	NUMBER FILED	NUMBER EXTRA			N/A	82			N/A		
BASIC FEE (37 CFR 1.16(a), (b), or (c))	N/A	N/A			N/A	270			N/A		
SEARCH FEE (37 CFR 1.16(k), (l), or (m))	N/A	N/A			N/A	110			N/A		
EXAMINATION FEE (37 CFR 1.16(o), (p), or (q))	N/A	N/A			x\$26				x\$52		
TOTAL CLAIMS (37 CFR 1.16(i))	12	minus 20 =			x\$110	990			x\$220		
INDEPENDENT CLAIMS (37 CFR 1.16(h))	12	minus 3 =									
INDEPENDENT CLAIMS (37 CFR 1.16(h))	12	minus 3 =									
INDEPENDENT CLAIMS (37 CFR 1.16(h))	12	minus 3 =									
INDEPENDENT CLAIMS (37 CFR 1.16(h))	12	minus 3 =									
APPLICATION SIZE FEE (37 CFR 1.16(s))	If the specification and drawings exceed 100 sheets of paper, the application size fee due is \$270 (\$135 for small entity) for each additional 50 sheets or fraction thereof. See 35 U.S.C. 41(a)(1)(G) and 37 CFR										
MULTIPLE DEPENDENT CLAIM PRESENT (37 CFR 1.16(j))					195				390		
					TOTAL	1452			TOTAL		
* If the difference in column 1 is less than zero, enter "0" in column 2.											
<b>APPLICATION AS AMENDED – PART II</b>					SMALL ENTITY		OR		OTHER THAN SMALL ENTITY		
(Column 1)		(Column 2)		(Column 3)		RATE (\$)	ADDITIONAL FEE (\$)			RATE (\$)	ADDITIONAL FEE (\$)
AMENDMENT A	CLAIMS REMAINING AFTER AMENDMENT		HIGHEST NUMBER PREVIOUSLY PAID FOR	PRESENT EXTRA		X =				X =	
	Total (37 CFR 1.16(i))	*	Minus	**	=	X =				X =	
	Independent (37 CFR 1.16(h))	*	Minus	***	=						
	Application Size Fee (37 CFR 1.16(s))					N/A				N/A	
	FIRST PRESENTATION OF MULTIPLE DEPENDENT CLAIM (37 CFR 1.16(j))										
					TOTAL ADD'T FEE				TOTAL ADD'T FEE		
(Column 1)		(Column 2)		(Column 3)		RATE (\$)	ADDITIONAL FEE (\$)			RATE (\$)	ADDITIONAL FEE (\$)
AMENDMENT B	CLAIMS REMAINING AFTER AMENDMENT		HIGHEST NUMBER PREVIOUSLY PAID FOR	PRESENT EXTRA		X =				X =	
	Total (37 CFR 1.16(i))	*	Minus	**	=	X =				X =	
	Independent (37 CFR 1.16(h))	*	Minus	***	=						
	Application Size Fee (37 CFR 1.16(s))					N/A				N/A	
	FIRST PRESENTATION OF MULTIPLE DEPENDENT CLAIM (37 CFR 1.16(j))										
					TOTAL ADD'T FEE				TOTAL ADD'T FEE		
* If the entry in column 1 is less than the entry in column 2, write "0" in column 3.											
** If the "Highest Number Previously Paid For" IN THIS SPACE is less than 20, enter "20".											
*** If the "Highest Number Previously Paid For" IN THIS SPACE is less than 3, enter "3".											
The "Highest Number Previously Paid For" (Total or Independent) is the highest number found in the appropriate box in column 1.											

This collection of information is required by 37 CFR 1.16. The information is required to obtain or retain a benefit by the public which is to file (and by the USPTO to process) an application. Confidentiality is governed by 35 U.S.C. 122 and 37 CFR 1.14. This collection is estimated to take 12 minutes to complete, including gathering, preparing, and submitting the completed application form to the USPTO. Time will vary depending upon the individual case. Any comments on the amount of time you require to complete this form and/or suggestions for reducing this burden, should be sent to the Chief Information Officer, U.S. Patent and Trademark Office, U.S. Department of Commerce, P.O. Box 1450, Alexandria, VA 22313-1450. DO NOT SEND FEES OR COMPLETED FORMS TO THIS ADDRESS. SEND TO: Commissioner for Patents, P.O. Box 1450, Alexandria, VA 22313-1450.

If you need assistance in completing the form, call 1-800-PTO-9199 and select option 2.





UNITED STATES PATENT AND TRADEMARK OFFICE

UNITED STATES DEPARTMENT OF COMMERCE
United States Patent and Trademark Office
Address: COMMISSIONER FOR PATENTS
P.O. Box 1459
Alexandria, Virginia 22313-1450
www.uspto.gov

Table with 7 columns: APPLICATION NUMBER, FILING or 371(c) DATE, GRP ART UNIT, FIL FEE REC'D, ATTY. DOCKET NO, TOT CLAIMS, IND CLAIMS. Row 1: 12/570,343, 09/30/2009, 2617, 1452, 1028.4, 12, 12

CONFIRMATION NO. 9973

68533
MEGAN LYMAN
1816 SILVER MIST CT.
RALEIGH, NC 27613

FILING RECEIPT



Date Mailed: 10/16/2009

Receipt is acknowledged of this non-provisional patent application. The application will be taken up for examination in due course. Applicant will be notified as to the results of the examination. Any correspondence concerning the application must include the following identification information: the U.S. APPLICATION NUMBER, FILING DATE, NAME OF APPLICANT, and TITLE OF INVENTION. Fees transmitted by check or draft are subject to collection. Please verify the accuracy of the data presented on this receipt. If an error is noted on this Filing Receipt, please submit a written request for a Filing Receipt Correction. Please provide a copy of this Filing Receipt with the changes noted thereon. If you received a "Notice to File Missing Parts" for this application, please submit any corrections to this Filing Receipt with your reply to the Notice. When the USPTO processes the reply to the Notice, the USPTO will generate another Filing Receipt incorporating the requested corrections

Applicant(s)

C. Earl Woolfork, Pasadena, CA;

Assignment For Published Patent Application

ONE-E-WAY, Pasadena, CA

Power of Attorney: None

Domestic Priority data as claimed by applicant

This application is a CON of 12/144,729 07/12/2008
which is a CON of 10/648,012 08/26/2003 PAT 7,412,294

Foreign Applications

If Required, Foreign Filing License Granted: 10/13/2009

The country code and number of your priority application, to be used for filing abroad under the Paris Convention, is US 12/570,343

Projected Publication Date: 01/21/2010

Non-Publication Request: No

Early Publication Request: No

\*\* SMALL ENTITY \*\*

**Title**

Wireless Digital Audio System

**Preliminary Class**

455

**PROTECTING YOUR INVENTION OUTSIDE THE UNITED STATES**

Since the rights granted by a U.S. patent extend only throughout the territory of the United States and have no effect in a foreign country, an inventor who wishes patent protection in another country must apply for a patent in a specific country or in regional patent offices. Applicants may wish to consider the filing of an international application under the Patent Cooperation Treaty (PCT). An international (PCT) application generally has the same effect as a regular national patent application in each PCT-member country. The PCT process **simplifies** the filing of patent applications on the same invention in member countries, but **does not result** in a grant of "an international patent" and does not eliminate the need of applicants to file additional documents and fees in countries where patent protection is desired.

Almost every country has its own patent law, and a person desiring a patent in a particular country must make an application for patent in that country in accordance with its particular laws. Since the laws of many countries differ in various respects from the patent law of the United States, applicants are advised to seek guidance from specific foreign countries to ensure that patent rights are not lost prematurely.

Applicants also are advised that in the case of inventions made in the United States, the Director of the USPTO must issue a license before applicants can apply for a patent in a foreign country. The filing of a U.S. patent application serves as a request for a foreign filing license. The application's filing receipt contains further information and guidance as to the status of applicant's license for foreign filing.

Applicants may wish to consult the USPTO booklet, "General Information Concerning Patents" (specifically, the section entitled "Treaties and Foreign Patents") for more information on timeframes and deadlines for filing foreign patent applications. The guide is available either by contacting the USPTO Contact Center at 800-786-9199, or it can be viewed on the USPTO website at <http://www.uspto.gov/web/offices/pac/doc/general/index.html>.

For information on preventing theft of your intellectual property (patents, trademarks and copyrights), you may wish to consult the U.S. Government website, <http://www.stopfakes.gov>. Part of a Department of Commerce initiative, this website includes self-help "toolkits" giving innovators guidance on how to protect intellectual property in specific countries such as China, Korea and Mexico. For questions regarding patent enforcement issues, applicants may call the U.S. Government hotline at 1-866-999-HALT (1-866-999-4158).

**LICENSE FOR FOREIGN FILING UNDER**

**Title 35, United States Code, Section 184**

**Title 37, Code of Federal Regulations, 5.11 & 5.15**

**GRANTED**

The applicant has been granted a license under 35 U.S.C. 184, if the phrase "IF REQUIRED, FOREIGN FILING LICENSE GRANTED" followed by a date appears on this form. Such licenses are issued in all applications where the conditions for issuance of a license have been met, regardless of whether or not a license may be required as

set forth in 37 CFR 5.15. The scope and limitations of this license are set forth in 37 CFR 5.15(a) unless an earlier license has been issued under 37 CFR 5.15(b). The license is subject to revocation upon written notification. The date indicated is the effective date of the license, unless an earlier license of similar scope has been granted under 37 CFR 5.13 or 5.14.

This license is to be retained by the licensee and may be used at any time on or after the effective date thereof unless it is revoked. This license is automatically transferred to any related applications(s) filed under 37 CFR 1.53(d). This license is not retroactive.

The grant of a license does not in any way lessen the responsibility of a licensee for the security of the subject matter as imposed by any Government contract or the provisions of existing laws relating to espionage and the national security or the export of technical data. Licensees should apprise themselves of current regulations especially with respect to certain countries, of other agencies, particularly the Office of Defense Trade Controls, Department of State (with respect to Arms, Munitions and Implements of War (22 CFR 121-128)); the Bureau of Industry and Security, Department of Commerce (15 CFR parts 730-774); the Office of Foreign Assets Control, Department of Treasury (31 CFR Parts 500+) and the Department of Energy.

**NOT GRANTED**

No license under 35 U.S.C. 184 has been granted at this time, if the phrase "IF REQUIRED, FOREIGN FILING LICENSE GRANTED" DOES NOT appear on this form. Applicant may still petition for a license under 37 CFR 5.12, if a license is desired before the expiration of 6 months from the filing date of the application. If 6 months has lapsed from the filing date of this application and the licensee has not received any indication of a secrecy order under 35 U.S.C. 181, the licensee may foreign file the application pursuant to 37 CFR 5.15(b).



UNITED STATES PATENT AND TRADEMARK OFFICE

UNITED STATES DEPARTMENT OF COMMERCE  
United States Patent and Trademark Office  
Address: COMMISSIONER FOR PATENTS  
P.O. Box 1450  
Alexandria, Virginia 22313-1450  
www.uspto.gov

APPLICATION NO.	FILING DATE	FIRST NAMED INVENTOR	ATTORNEY DOCKET NO.	CONFIRMATION NO.
12/570,343	09/30/2009	C. Earl Woolfork	1028.4	9973
68533	7590	01/13/2010	EXAMINER FLANDERS, ANDREW C	
MEGAN LYMAN 1816 SILVER MIST CT. RALEIGH, NC 27613			ART UNIT	PAPER NUMBER
			2614	
			MAIL DATE	DELIVERY MODE
			01/13/2010	PAPER

**Please find below and/or attached an Office communication concerning this application or proceeding.**

The time period for reply, if any, is set in the attached communication.



**DETAILED ACTION**

***Claim Rejections - 35 USC § 103***

The following is a quotation of 35 U.S.C. 103(a) which forms the basis for all obviousness rejections set forth in this Office action:

(a) A patent may not be obtained though the invention is not identically disclosed or described as set forth in section 102 of this title, if the differences between the subject matter sought to be patented and the prior art are such that the subject matter as a whole would have been obvious at the time the invention was made to a person having ordinary skill in the art to which said subject matter pertains. Patentability shall not be negated by the manner in which the invention was made.

The factual inquiries set forth in *Graham v. John Deere Co.*, 383 U.S. 1, 148 USPQ 459 (1966), that are applied for establishing a background for determining obviousness under 35 U.S.C. 103(a) are summarized as follows:

1. Determining the scope and contents of the prior art.
2. Ascertaining the differences between the prior art and the claims at issue.
3. Resolving the level of ordinary skill in the pertinent art.
4. Considering objective evidence present in the application indicating obviousness or nonobviousness.

**Claims 1 – 11** are rejected under 35 U.S.C. 103(a) as being unpatentable over Alstatt (U.S. Patent 5,771,441) in view of Li (U.S. Patent 6,781,977).

Regarding **Claim 1**, Alstatt discloses:

A wireless digital audio system (Fig. 1), comprising:

at least one audio transmitter operatively coupled to at least one audio source  
(14),

said audio transmitter configured for wireless communication with at least one  
audio receiver (24), said audio receiver comprising:

at least one module adapted to reproduce said generated audio output (26), said audio having been wirelessly transmitted from said at least one audio source (transmission from 14 to 24 shown in fig. 1) virtually free from interference from multiple wireless digital audio system transmitters operating in the wireless digital audio system spectrum to a user providing a particular audio receiver user with independent audio in a shared space with other wireless digital audio system users (it is obvious that there can be multiple users of the Alstatt system in the same area; user can adjust the frequency to avoid interference; col. 7 lines 1 - 12), wherein each of said wireless digital audio system users utilize their own independent audio source (i.e. two users in the same area using Fig. 1, each would have their own portable player 10), and their own independent digital transmitter that associates with their own independent receiver. (each receiver will receive the data from the frequency tuned to).

Alstatt fails to disclose  
the system as a digital system;  
said at least one digital audio transmitter comprising:  
a digital modulator configured for code division multiple access (CDMA) communication;  
a digital demodulator configured for CDMA communication;  
a digital-to-analog converter (DAC) generating an audio output; and  
only associating with their own independent receiver.

However, digital CDMA transmissions of audio sources to headphones in devices was notoriously well known in the art. For Example, Li teaches a system providing CDMA communication of digital audio to headphone devices; col. 3 lines 20 – 33.

Replacing the FM transmitter/receiver implementation of Alstatt to use the digital CDMA communication discloses:

the system as a digital system (i.e. digital audio; col. 2 lines 48 – 51); also A/D conversion; col. 3 line 7);

said at least one digital audio transmitter (sending unit 100) comprising:

a digital modulator configured for code division multiple access (CDMA) communication (105);

said at least one audio receiver comprising:

a digital demodulator configured for CDMA communication (202);

a digital-to-analog converter (DAC) generating an audio output (204); and

only associating with their own independent receiver (i.e. CDMA code channel; cols. 5 and 6 in place of the FM frequency).

It would have been obvious to one of ordinary skill in the art at the time the invention was made to apply the digital CDMA wireless communication of Li to replace the FM modulation communication as taught by Alstatt. Li clearly teaches the device for use in portable implementations such as music and headphone audio reproductions. Li also teaches the outputs/inputs as standard audio jacks. Furthermore, doing so would be simple substitution of one known element (i.e. digital CDMA transmitter/receiver) for another (i.e. analog FM transmitter) to obtain predictable results (i.e. Alstatt w/ a digital



transmitter). Additionally, Li discloses a number of advantages of using digital communication in col. 6.

Regarding **Claims 2, 3, 9, 10 and 11**, in addition to the elements stated above regarding claim 1, the combination of Alstatt in view of Li further discloses;

adding a unique user code bit sequence (inherent in CDMA communication; see attached definition of CDMA).

**Claims 4 and 8** are rejected under the same grounds as claim 1 above.

Regarding **Claim 5**, in addition to the elements stated above regarding claim 1, the combination further discloses:

listening while running and activating said digital audio system while running (col. 5 lines 30 – 50).

Regarding **Claim 6**, in addition to the elements stated above regarding claim 2, the combination further discloses:

listening while running and activating said digital audio system while running (col. 5 lines 30 – 50).

**Claim 7** is rejected under the same grounds as claim 6 above.

### ***Double Patenting***

The nonstatutory double patenting rejection is based on a judicially created doctrine grounded in public policy (a policy reflected in the statute) so as to prevent the unjustified or improper timewise extension of the "right to exclude" granted by a patent and to prevent possible harassment by multiple assignees. A nonstatutory obviousness-type double patenting rejection is appropriate where the conflicting claims are not identical, but at least one examined application claim is not patentably distinct from the reference claim(s) because the examined application claim is either anticipated by, or would have been obvious over, the reference claim(s). See, e.g., *In re Berg*, 140 F.3d 1428, 46 USPQ2d 1226 (Fed. Cir. 1998); *In re Goodman*, 11 F.3d 1046, 29 USPQ2d 2010 (Fed. Cir. 1993); *In re Longi*, 759 F.2d 887, 225 USPQ 645 (Fed. Cir. 1985); *In re Van Ornum*, 686 F.2d 937, 214 USPQ 761 (CCPA 1982); *In re Vogel*, 422 F.2d 438, 164 USPQ 619 (CCPA 1970); and *In re Thorington*, 418 F.2d 528, 163 USPQ 644 (CCPA 1969).

A timely filed terminal disclaimer in compliance with 37 CFR 1.321(c) or 1.321(d) may be used to overcome an actual or provisional rejection based on a nonstatutory double patenting ground provided the conflicting application or patent either is shown to be commonly owned with this application, or claims an invention made as a result of activities undertaken within the scope of a joint research agreement.

Effective January 1, 1994, a registered attorney or agent of record may sign a terminal disclaimer. A terminal disclaimer signed by the assignee must fully comply with 37 CFR 3.73(b).

Claims 1 – 12 are provisionally rejected on the ground of nonstatutory obviousness-type double patenting as being unpatentable over claims 11 – 16, 18 and 21 – 23 of copending Application No. 12/144,729. Although the conflicting claims are not identical, they are not patentably distinct from each other because the claims of the '729 application anticipate the claims of the instant application..

This is a provisional obviousness-type double patenting rejection because the conflicting claims have not in fact been patented.

Claims 1- 15 are rejected on the ground of nonstatutory obviousness-type double patenting as being unpatentable over claims 1 – 19 of U.S. Patent No. 7,412,294.

Although the conflicting claims are not identical, they are not patentably distinct from each other because the '294 Patent anticipates the claims of the instant application.

### ***Conclusion***

Any inquiry concerning this communication or earlier communications from the examiner should be directed to ANDREW C. FLANDERS whose telephone number is (571)272-7516. The examiner can normally be reached on M-F 8:30 - 5:00.

If attempts to reach the examiner by telephone are unsuccessful, the examiner's supervisor, Curtis Kuntz can be reached on (571) 272-7499. The fax phone number for the organization where this application or proceeding is assigned is 571-273-8300.

Information regarding the status of an application may be obtained from the Patent Application Information Retrieval (PAIR) system. Status information for published applications may be obtained from either Private PAIR or Public PAIR. Status information for unpublished applications is available through Private PAIR only. For more information about the PAIR system, see <http://pair-direct.uspto.gov>. Should you have questions on access to the Private PAIR system, contact the Electronic Business Center (EBC) at 866-217-9197 (toll-free). If you would like assistance from a USPTO Customer Service Representative or access to the automated information system, call 800-786-9199 (IN USA OR CANADA) or 571-272-1000.

/Andrew C Flanders/  
Primary Examiner, Art Unit 2614

Application/Control Number: 12/570,343  
Art Unit: 2614

Page 8

<b>Notice of References Cited</b>	Application/Control No. 12/570,343	Applicant(s)/Patent Under Reexamination WOOLFORK, C. EARL	
	Examiner ANDREW C. FLANDERS	Art Unit 2614	Page 1 of 1

**U.S. PATENT DOCUMENTS**

*	Document Number Country Code-Number-Kind Code	Date MM-YYYY	Name	Classification
*	A US-5,771,441	06-1998	Altstatt, John E.	455/66.1
*	B US-6,781,977	08-2004	Li, Yingtao	370/335
	C US-			
	D US-			
	E US-			
	F US-			
	G US-			
	H US-			
	I US-			
	J US-			
	K US-			
	L US-			
	M US-			

**FOREIGN PATENT DOCUMENTS**

*	Document Number Country Code-Number-Kind Code	Date MM-YYYY	Country	Name	Classification
	N				
	O				
	P				
	Q				
	R				
	S				
	T				

**NON-PATENT DOCUMENTS**

*	Include as applicable: Author, Title Date, Publisher, Edition or Volume, Pertinent Pages)
U	Microsoft Computer Dictionary definition for Code Division Multiplex Access, copyright 2002
V	
W	
X	

\*A copy of this reference is not being furnished with this Office action. (See MPEP § 707.05(a).)  
Dates in MM-YYYY format are publication dates. Classifications may be US or foreign.

<b><i>Index of Claims</i></b> 	<b>Application/Control No.</b> 12570343	<b>Applicant(s)/Patent Under Reexamination</b> WOOLFORK, C. EARL
	<b>Examiner</b> ANDREW C FLANDERS	<b>Art Unit</b> 2614

✓	<b>Rejected</b>	-	<b>Cancelled</b>	N	<b>Non-Elected</b>	A	<b>Appeal</b>
=	<b>Allowed</b>	÷	<b>Restricted</b>	I	<b>Interference</b>	O	<b>Objected</b>

Claims renumbered in the same order as presented by applicant
  CPA
  T.D.
  R.1.47

CLAIM		DATE								
Final	Original	01/11/2010								
	1	✓								
	2	✓								
	3	✓								
	4	✓								
	5	✓								
	6	✓								
	7	✓								
	8	✓								
	9	✓								
	10	✓								
	11	✓								
	12	✓								

<b>Search Notes</b>  	<b>Application/Control No.</b>  12570343	<b>Applicant(s)/Patent Under Reexamination</b>  WOOLFORK, C. EARL
	<b>Examiner</b>  ANDREW C FLANDERS	<b>Art Unit</b>  2614

<b>SEARCHED</b>			
<b>Class</b>	<b>Subclass</b>	<b>Date</b>	<b>Examiner</b>

<b>SEARCH NOTES</b>		
<b>Search Notes</b>	<b>Date</b>	<b>Examiner</b>
Reviewed and repeated search history (including class search) of Parent Application 12/144,729	1/11/10	acf
eDan EAST and PALM inventor search for double patenting	1/11/10	acf

<b>INTERFERENCE SEARCH</b>			
<b>Class</b>	<b>Subclass</b>	<b>Date</b>	<b>Examiner</b>

	/ANDREW C FLANDERS/ Primary Examiner.Art Unit 2614
--	---

## EAST Search History

## EAST Search History (Prior Art)

Ref #	Hits	Search Query	DBs	Default Operator	Plurals	Time Stamp
L1	1	("7412294").PN.	US-PGPUB; USPAT	OR	OFF	2010/01/11 12:21
S1	9	FHSS with unique with user	US-PGPUB; USPAT	OR	OFF	2007/03/20 09:30
S2	6	S1 and @ad<"20011221"	US-PGPUB; USPAT	OR	OFF	2006/05/02 17:45
S3	0	FHSS with unique adj hop	US-PGPUB; USPAT	OR	OFF	2006/05/02 17:46
S4	0	FHSS with each adj user	US-PGPUB; USPAT	OR	OFF	2006/05/02 17:46
S5	0	FHSS with individual adj user	US-PGPUB; USPAT	OR	OFF	2006/05/02 17:47
S6	0	(FHSS or "frequency hopping spread spectrum") with individual adj user	US-PGPUB; USPAT	OR	OFF	2006/05/02 17:47
S7	0	(FHSS or "frequency hopping spread spectrum") near user same unique	US-PGPUB; USPAT	OR	OFF	2006/05/02 17:47
S8	9	(FHSS or "frequency hopping spread spectrum") with user same unique	US-PGPUB; USPAT	OR	OFF	2006/05/02 17:48
S9	17	(FHSS or "frequency hopping spread spectrum") same unique same user	US-PGPUB; USPAT	OR	OFF	2006/05/02 17:48
S10	6	S9 and @ad<"20011221"	US-PGPUB; USPAT	OR	OFF	2006/05/02 17:48
S11	9	(FHSS or "frequency hopping spread spectrum") same multiple adj user!	US-PGPUB; USPAT	OR	OFF	2006/05/03 10:32



S12	91	(FHSS or "frequency hopping spread spectrum") same (pn or "hopping code")	US-PGPUB; USPAT	OR	OFF	2006/05/02 17:50
S13	13	(FHSS or "frequency hopping spread spectrum") with ("hopping code")	US-PGPUB; USPAT	OR	OFF	2006/05/02 17:50
S14	3	S13 and @ad<"20011221"	US-PGPUB; USPAT	OR	OFF	2006/05/02 17:51
S15	1	("5946343").PN.	US-PGPUB; USPAT	OR	OFF	2006/05/03 11:46
S16	1	("6342844").PN.	US-PGPUB; USPAT	OR	OFF	2006/05/03 11:46
S17	1	("5771441").PN.	US-PGPUB; USPAT	OR	OFF	2006/08/28 15:55
S18	10725	"rechargeable battery" and @ad<"20011220"	US-PGPUB; USPAT	OR	OFF	2006/08/28 15:55
S19	376	"rechargeable battery".ti. and @ad<"20011220"	US-PGPUB; USPAT	OR	OFF	2006/08/28 15:55
S20	17	("rechargeable battery" and portable).ti. and @ad<"20011220"	US-PGPUB; USPAT	OR	OFF	2006/08/28 15:57
S21	3623043	("rechargeable battery" and portable) with mah andd @ad<"20011220"	US-PGPUB; USPAT	OR	OFF	2006/08/28 15:57
S22	0	("rechargeable battery" and portable) with mah and @ad<"20011220"	US-PGPUB; USPAT	OR	OFF	2006/08/28 15:57
S23	3623041	("rechargeable battery" and portable) with mah andd @ad<"20011220"	US-PGPUB; USPAT	OR	OFF	2006/08/28 15:57
S24	3623041	("rechargeable battery" and portable) with "ma-h" andd @ad<"20011220"	US-PGPUB; USPAT	OR	OFF	2006/08/28 15:57
S25	0	("rechargeable battery" and portable) with "ma-h" and @ad<"20011220"	US-PGPUB; USPAT	OR	OFF	2006/08/28 15:57
S26	640693	("rechargeable battery" and portable) with milliamp hours and @ad<"20011220"	US-PGPUB; USPAT	OR	OFF	2006/08/28 15:57

S27	18	("rechargeable battery" and portable) and "milliamp hours" and @ad<"20011220"	US-PGPUB; USPAT	OR	OFF	2006/08/31 12:17
S28	29	"5491839"	US-PGPUB; USPAT	OR	OFF	2006/08/30 12:56
S29	1	("5491839").PN.	US-PGPUB; USPAT	OR	OFF	2006/08/30 12:56
S30	1	("5771441").PN.	US-PGPUB; USPAT	OR	OFF	2006/08/30 12:56
S31	1	("6,107,147").PN.	US-PGPUB; USPAT	OR	OFF	2006/08/31 12:17
S32	0	(10/648012).APP.	US-PGPUB; USPAT	OR	OFF	2006/09/25 09:26
S33	1	("5946343").PN.	US-PGPUB; USPAT	OR	OFF	2006/09/25 09:50
S34	422	(455/564.1,412,413).CCLS.	US-PGPUB; USPAT	OR	OFF	2006/09/25 09:50
S35	5294	(375/219,295-297,346,348).CCLS.	US-PGPUB; USPAT	OR	OFF	2006/09/25 10:02
S36	1	("20040223622").PN.	US-PGPUB; USPAT	OR	OFF	2006/09/25 10:04
S37	1	("5946343").PN.	US-PGPUB; USPAT	OR	OFF	2006/09/25 10:05
S38	1	("7,050,419").PN.	US-PGPUB; USPAT	OR	OFF	2007/03/20 09:32
S39	1	("20010025358").PN.	US-PGPUB; USPAT	OR	OFF	2007/03/20 09:37
S40	2618	(375/341,140,147).CCLS.	US-PGPUB; USPAT	OR	OFF	2007/03/20 09:37
S41	1807	S40 and @ad<"20011220"	US-PGPUB; USPAT	OR	OFF	2007/03/20 09:38

S42	8	("2001/0025358").URPN.	USPAT	OR	OFF	2007/03/20 09:51
S43	0	("2002/0025009").URPN.	USPAT	OR	OFF	2007/03/20 09:59
S44	0	("2002/0025009").URPN.	USPAT	OR	OFF	2007/03/20 10:01
S45	12	("20020159543"   "5434623"   "5867532"   "5973642"   "6243423"   "6327314"   "6339612"   "6459728"   "6477210"   "6480554"   "6654429"   "6671338").PN. OR ("7099413").URPN.	US-PGPUB; USPAT; USOCR	OR	OFF	2007/03/20 10:08
S46	74	"band pass" and demodulator and interleaver and "viterbi decoder"	US-PGPUB; USPAT; USOCR	OR	OFF	2007/03/20 10:08
S47	59	S46 and @ad<"20011220"	US-PGPUB; USPAT; USOCR	OR	OFF	2007/03/20 10:08
S48	17	("4278978"   "4635063"   "5175558"   "5493307").PN. OR ("6130643").URPN.	US-PGPUB; USPAT; USOCR	OR	OFF	2007/03/20 10:15
S49	1	("5175558").PN.	US-PGPUB; USPAT	OR	OFF	2007/03/20 10:16
S50	13	("4651155"   "4931977").PN. OR ("5175558"). URPN.	US-PGPUB; USPAT; USOCR	OR	OFF	2007/03/20 10:34
S51	1	("5946343").PN.	US-PGPUB; USPAT	OR	OFF	2007/03/20 11:40
S52	7186	(375/295,146,130,340,316,148).CCLS.	US-PGPUB; USPAT	OR	OFF	2007/03/20 11:41
S53	4473	S52 and @ad<"20011220"	US-PGPUB; USPAT	OR	OFF	2007/03/20 11:41
S54	1	("20040223622").PN.	US-PGPUB; USPAT	OR	OFF	2007/03/21 12:11
S55	5	"reed solomon" with "intersymbol interference"	US-PGPUB; USPAT	OR	OFF	2007/03/21 12:13

S56	30	"reed solomon" same "intersymbol interference"	US-PGPUB; USPAT	OR	OFF	2007/03/21 12:13
S57	21	S56 and @ad<"20011220"	US-PGPUB; USPAT	OR	OFF	2007/03/21 12:27
S58	1	("20030045235").PN.	US-PGPUB; USPAT	OR	OFF	2007/03/21 12:37
S59	1	("5790595").PN.	US-PGPUB; USPAT	OR	OFF	2007/03/21 12:37
S60	2435	((375/262,265,341) or (714/794,795)).CCLS.	US-PGPUB; USPAT	OR	OFF	2007/03/24 09:15
S62	56	"375".clas. and "fuzzy logic"	US-PGPUB; USPAT	OR	OFF	2007/03/26 11:04
S64	1	("4970637").PN.	US-PGPUB; USPAT	OR	OFF	2007/03/28 13:46
S65	755	(audio sound music voice) same (a/d "analog to digital") same (lpf "low pass")	US-PGPUB; USPAT	OR	OFF	2007/03/28 13:46
S66	282	(audio sound music voice) with (a/d "analog to digital") with ((lpf "low pass") and "digital")	US-PGPUB; USPAT	OR	OFF	2007/03/28 13:47
S67	227	(audio sound music voice) with (a/d "analog to digital") with ((lpf "low pass") and "digital") and @ad<"20011221"	US-PGPUB; USPAT	OR	OFF	2007/03/28 15:33
S68	34712	"band pass filter" bpf with "direct conversion receiver"	US-PGPUB; USPAT	OR	OFF	2007/03/28 15:33
S69	35	("band pass filter" bpf) with "direct conversion receiver"	US-PGPUB; USPAT	OR	OFF	2007/03/28 15:33
S70	8	S69 and @ad<"20011221"	US-PGPUB; USPAT	OR	OFF	2007/03/28 15:55
S71	1	("20030045235").PN.	US-PGPUB; USPAT	OR	OFF	2007/03/28 16:16
S72	1	("20040223622").PN.	US-PGPUB; USPAT	OR	OFF	2007/03/28 16:20

S73	1	("5946343").PN.	US-PGPUB; USPAT	OR	OFF	2007/03/28 16:27
S74	364	"64-ary"	US-PGPUB; USPAT	OR	OFF	2007/03/28 16:27
S75	74	"64-ary" near modulat\$4	US-PGPUB; USPAT	OR	OFF	2007/03/28 16:27
S76	46	S75 and @ad<"20011120"	US-PGPUB; USPAT	OR	OFF	2007/03/28 16:27
S77	2	((("4970637") or ("5790595")).PN.	US-PGPUB; USPAT	OR	OFF	2007/07/16 09:58
S78	3	((("4970637") or ("5790595") or ("20040223622")).PN.	US-PGPUB; USPAT	OR	OFF	2007/07/16 09:58
S79	3	("2004/0223622").URPN.	USPAT	OR	OFF	2007/07/16 11:25
S80	1	("5771441").PN.	US-PGPUB; USPAT	OR	OFF	2007/07/16 11:25
S81	60	("2236946"   "2828413"   "2840694"   "3080785"   "3085460"   "3087117"   "3296916"   "3579211"   "3743751"   "3781451"   "3825666"   "3863157"   "3901118"   "3906160"   "4004228"   "4229826"   "4335930"   "4344184"   "4369521"   "4430757"   "4453269"   "4464792"   "4471493"   "4612688"   "4647135"   "4721926"   "4794622"   "4845751"   "4899388"   "4988957"   "5025704"   "5214568").PN. OR ("5771441"). URPN.	US-PGPUB; USPAT; USOCR	OR	OFF	2007/07/16 11:26
S82	2	S81 and cdma	US-PGPUB; USPAT; USOCR	OR	OFF	2007/07/16 11:26
S83	1	("6678892").PN.	US-PGPUB; USPAT	OR	OFF	2008/05/20 11:41

S84	1	("20020072816").PN.	US-PGPUB; USPAT	OR	OFF	2008/05/20 14:24
S85	22	"fuzzy logic" and modulat\$5 and filter and (dpsk "phase shift key")	US-PGPUB; USPAT	OR	OFF	2008/06/06 09:20
S86	0	"455".clas. and "375".clas. and S85	US-PGPUB; USPAT	OR	OFF	2008/06/06 09:21
S87	1	"10100351"	US-PGPUB; USPAT	OR	OFF	2008/06/06 11:49
S88	1	("6,678,892").PN.	US-PGPUB; USPAT	OR	OFF	2008/06/06 12:38
S89	3	("20030021429"   "20030076346"   "6867820").PN.	US-PGPUB; USPAT	OR	OFF	2008/06/06 12:42
S90	13	("4589134"   "4626892"   "5042070"   "5541638"   "5581621"   "5631850"   "5775939"   "6100936"   "6195438").PN. OR ("6867820").URPN.	US-PGPUB; USPAT; USOCR	OR	OFF	2008/06/06 12:43
S91	2	"10648012"	US-PGPUB; USPAT	OR	OFF	2009/02/14 10:23
S92	1	"12144729"	US-PGPUB; USPAT	OR	OFF	2009/02/14 10:31
S93	1	("5790595").PN.	US-PGPUB; USPAT	OR	OFF	2009/02/14 12:36
S94	1	("6678892").PN.	US-PGPUB; USPAT	OR	OFF	2009/02/14 12:37
S95	1	("6678892").PN.	US-PGPUB; USPAT	OR	OFF	2009/05/26 07:51
S96	1680	portable and music and CDMA and transmitter and receiver	US-PGPUB; USPAT	OR	OFF	2009/09/01 11:35
S97	527	portable and music and CDMA and transmitter and receiver and private	US-PGPUB; USPAT	OR	OFF	2009/09/01 11:35

S98	57	portable and music and CDMA and transmitter and receiver and private and "fuzzy logic"	US-PGPUB; USPAT	OR	OFF	2009/09/01 11:35
S99	0	S98 and @ad<"20011221"	US-PGPUB; USPAT	OR	OFF	2009/09/01 11:36
S100	41	S97 and @ad<"20011221"	US-PGPUB; USPAT	OR	OFF	2009/09/01 11:36
S101	1	("6678692").PN.	US-PGPUB; USPAT	OR	OFF	2009/09/01 11:39
S102	1	("6678892").PN.	US-PGPUB; USPAT	OR	OFF	2009/09/01 11:39
S103	25	("5555466"   "5771441"   "6058288"   "6243645"   "6266815"   "6300880"   "6317039").PN. OR ("6678892").URPN.	US-PGPUB; USPAT; USOCR	OR	OFF	2009/09/01 11:39
S104	63	("2236946"   "2828413"   "2840694"   "3080785"   "3085460"   "3087117"   "3296916"   "3579211"   "3743751"   "3781451"   "3825666"   "3863157"   "3901118"   "3906160"   "4004228"   "4229826"   "4335930"   "4344184"   "4369521"   "4430757"   "4453269"   "4464792"   "4471493"   "4612688"   "4647135"   "4721926"   "4794622"   "4845751"   "4899388"   "4988957"   "5025704"   "5214568").PN. OR ("5771441").URPN.	US-PGPUB; USPAT; USOCR	OR	OFF	2009/09/01 11:42
S105	10	("20030045235"   "20040223622"   "5491839"   "5771441"   "5790595"   "5946343"   "6342844"   "6418558"   "6678892"   "6982132").PN.	US-PGPUB; USPAT; USOCR	OR	OFF	2009/09/01 11:42
S106	4453	"fuzzy logic" and @ad<"20011221"	US-PGPUB; USPAT; USOCR	OR	OFF	2009/09/01 11:48
S107	659	S106 and transmitter	US-PGPUB; USPAT; USOCR	OR	OFF	2009/09/01 11:48

S108	591	S106 and portable	US-PGPUB; USPAT; USOCR	OR	OFF	2009/09/01 11:48
S109	4	S106 and portable adj player	US-PGPUB; USPAT; USOCR	OR	OFF	2009/09/01 11:49
S110	0	"fuzzy logic" with reciever	US-PGPUB; USPAT; USOCR	OR	OFF	2009/09/01 11:50
S111	49	"fuzzy logic" with receiver	US-PGPUB; USPAT; USOCR	OR	OFF	2009/09/01 11:50
S112	27	S111 and @ad<"20011221"	US-PGPUB; USPAT	OR	OFF	2009/09/01 11:50
S113	192	"fuzzy logic" same receiver	US-PGPUB; USPAT; USOCR	OR	OFF	2009/09/01 11:51
S114	72	S113 and @ad<"20011221"	US-PGPUB; USPAT	OR	OFF	2009/09/01 11:52
S115	71	("4019141"   "4229829"   "5264795"   "5404577"   "5437057"   "5568516"   "5694467"   "5771438"   "5771441"   "5867223"   "5978689"   "6006115").PN. OR ("6424820").URPN.	US-PGPUB; USPAT; USOCR	OR	OFF	2009/09/02 11:27
S116	34	S115 and @ad<"20011221"	US-PGPUB; USPAT	OR	OFF	2009/09/02 11:28
S117	31	bluetooth with (headphone headset earphone "head phone" "head set" "ear phone") with cdma	US-PGPUB; USPAT	OR	OFF	2009/09/02 11:32
S118	2	S117 and @ad<"20011221"	US-PGPUB; USPAT	OR	OFF	2009/09/02 11:32
S119	32	wireless with (headphone headset earphone "head phone" "head set" "ear phone") with cdma	US-PGPUB; USPAT	OR	OFF	2009/09/02 11:33
S120	3	S119 and @ad<"20011221"	US-PGPUB; USPAT	OR	OFF	2009/09/02 11:33



S121	57	(headphone headset earphone "head phone" "head set" "ear phone") with cdma	US-PGPUB; USPAT	OR	OFF	2009/09/02 11:34
S122	10	S121 and @ad<"20011221"	US-PGPUB; USPAT	OR	OFF	2009/09/02 11:34
S123	0	WO0056093	US-PGPUB; USPAT	OR	OFF	2009/09/02 11:36
S124	0	WO0056093	US-PGPUB; USPAT; USOCR; FPRS; EPO; JPO; DERWENT; IBM_TDB	OR	OFF	2009/09/02 11:37
S125	0	WO/0056093	US-PGPUB; USPAT; USOCR; FPRS; EPO; JPO; DERWENT; IBM_TDB	OR	OFF	2009/09/02 11:37
S126	2	((("5781542") or ("5799005")).PN.	US-PGPUB; USPAT	OR	OFF	2009/09/02 11:42
S127	1	("6199076").PN.	US-PGPUB; USPAT	OR	OFF	2009/09/02 13:51
S128	0	woolfork-earl.in.	US-PGPUB; USPAT	OR	OFF	2009/11/23 11:44
S129	3	woolfork-c-\$.in.	US-PGPUB; USPAT	OR	OFF	2009/11/23 11:44

## EAST Search History (Interference)

Ref #	Hits	Search Query	DBs	Default Operator	Plurals	Time Stamp
S130	0	woolfork-earl.in.	USPAT; UPAD	OR	OFF	2009/11/23 11:44

S131	1	woolfork-c-\$.in.	USPAT; UPAD	OR	OFF	2009/11/23 11:44
S132	195	(700/94).CCLS.	UPAD	OR	OFF	2009/11/23 11:59
S133	225	((700/94) or (455/3.06)).CCLS.	UPAD	OR	OFF	2010/01/11 11:18

1/ 11/ 2010 12:27:04 PM

C:\Documents and Settings\aflanders\My Documents\EAST\Workspaces\12570343.wsp



UNITED STATES PATENT AND TRADEMARK OFFICE

UNITED STATES DEPARTMENT OF COMMERCE  
United States Patent and Trademark Office  
Address: COMMISSIONER FOR PATENTS  
P.O. Box 1459  
Alexandria, Virginia 22313-1450  
www.uspto.gov

APPLICATION NUMBER	FILING OR 371(C) DATE	FIRST NAMED APPLICANT	ATTY. DOCKET NO./TITLE
12/570,343	09/30/2009	C. Earl Woolfork	1028.4

**CONFIRMATION NO. 9973**

68533  
MEGAN LYMAN  
1816 SILVER MIST CT.  
RALEIGH, NC 27613

**PUBLICATION NOTICE**



**Title:**Wireless Digital Audio System  
**Publication No.**US-2010-0014698-A1  
**Publication Date:**01/21/2010

**NOTICE OF PUBLICATION OF APPLICATION**

The above-identified application will be electronically published as a patent application publication pursuant to 37 CFR 1.211, et seq. The patent application publication number and publication date are set forth above.

The publication may be accessed through the USPTO's publically available Searchable Databases via the Internet at [www.uspto.gov](http://www.uspto.gov). The direct link to access the publication is currently <http://www.uspto.gov/patft/>.

The publication process established by the Office does not provide for mailing a copy of the publication to applicant. A copy of the publication may be obtained from the Office upon payment of the appropriate fee set forth in 37 CFR 1.19(a)(1). Orders for copies of patent application publications are handled by the USPTO's Office of Public Records. The Office of Public Records can be reached by telephone at (703) 308-9726 or (800) 972-6382, by facsimile at (703) 305-8759, by mail addressed to the United States Patent and Trademark Office, Office of Public Records, Alexandria, VA 22313-1450 or via the Internet.

In addition, information on the status of the application, including the mailing date of Office actions and the dates of receipt of correspondence filed in the Office, may also be accessed via the Internet through the Patent Electronic Business Center at [www.uspto.gov](http://www.uspto.gov) using the public side of the Patent Application Information and Retrieval (PAIR) system. The direct link to access this status information is currently <http://pair.uspto.gov/>. Prior to publication, such status information is confidential and may only be obtained by applicant using the private side of PAIR.

Further assistance in electronically accessing the publication, or about PAIR, is available by calling the Patent Electronic Business Center at 1-866-217-9197.

Office of Data Management, Application Assistance Unit (571) 272-4000, or (571) 272-4200, or 1-888-786-0101

Under the Paperwork Reduction Act of 1995, no persons are required to respond to a collection of information unless it displays a valid OMB control number.

<b>POWER OF ATTORNEY OR REVOCAION OF POWER OF ATTORNEY WITH A NEW POWER OF ATTORNEY AND CHANGE OF CORRESPONDENCE ADDRESS</b>	Application Number	12/570,343
	Filing Date	09/30/2009
	First Named Inventor	C. Earl Woolfork
	Title	Wireless Digital Audio Music
	Art Unit	2614
	Examiner Name	Andrew Flanders
	Attorney Docket Number	1028.4

I hereby revoke all previous powers of attorney given in the above-identified application.

A Power of Attorney is submitted herewith.

OR

I hereby appoint Practitioner(s) associated with the following Customer Number as my/our attorney(s) or agent(s) to prosecute the application identified above, and to transact all business in the United States Patent and Trademark Office connected therewith:

68533

OR

I hereby appoint Practitioner(s) named below as my/our attorney(s) or agent(s) to prosecute the application identified above, and to transact all business in the United States Patent and Trademark Office connected therewith:

Practitioner(s) Name	Registration Number

Please recognize or change the correspondence address for the above-identified application to:

The address associated with the above-mentioned Customer Number.

OR

The address associated with Customer Number:

68533

OR

<input type="checkbox"/> Firm or Individual Name			
Address			
City	State	Zip	
Country			
Telephone	Email		

I am the:

Applicant/Inventor.

OR

Assignee of record of the entire interest. See 37 CFR 3.71.  
Statement under 37 CFR 3.73(b) (Form PTO/SB/96) submitted herewith or filed on \_\_\_\_\_

**SIGNATURE of Applicant or Assignee of Record**

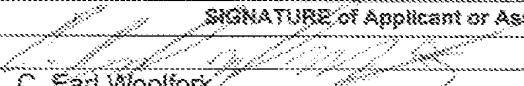
Signature		Date	1/20/10
Name	C. Earl Woolfork	Telephone	
Title and Company			

NOTE: Signatures of all the inventors or assignees of record of the entire interest or their representative(s) are required. Submit multiple forms if more than one signature is required, see below.

\*Total of 1 forms are submitted.

This collection of information is required by 37 CFR 1.31, 1.32 and 1.33. The information is required to obtain or retain a benefit by the public which is to file (and by the USPTO to process) an application. Confidentiality is governed by 35 U.S.C. 122 and 37 CFR 1.11 and 1.14. This collection is estimated to take 2 minutes to complete, including gathering, preparing, and submitting the completed application form to the USPTO. Time will vary depending upon the individual case. Any comments on the amount of time you require to complete this form and/or suggestions for reducing this burden, should be sent to the Chief Information Officer, U.S. Patent and Trademark Office, U.S. Department of Commerce, P.O. Box 1480, Alexandria, VA 22313-1480. DO NOT SEND FEES OR COMPLETED FORMS TO THIS ADDRESS. SEND TO: Commissioner for Patents, P.O. Box 1480, Alexandria, VA 22313-1480.

If you need assistance in completing the form, call 1-800-PTO-9199 and select option 2.

## Privacy Act Statement

The Privacy Act of 1974 (P.L. 93-579) requires that you be given certain information in connection with your submission of the attached form related to a patent application or patent. Accordingly, pursuant to the requirements of the Act, please be advised that: (1) the general authority for the collection of this information is 35 U.S.C. 2(b)(2); (2) furnishing of the information solicited is voluntary; and (3) the principal purpose for which the information is used by the U.S. Patent and Trademark Office is to process and/or examine your submission related to a patent application or patent. If you do not furnish the requested information, the U.S. Patent and Trademark Office may not be able to process and/or examine your submission, which may result in termination of proceedings or abandonment of the application or expiration of the patent.

The information provided by you in this form will be subject to the following routine uses:

1. The information on this form will be treated confidentially to the extent allowed under the Freedom of Information Act (5 U.S.C. 552) and the Privacy Act (5 U.S.C. 552a). Records from this system of records may be disclosed to the Department of Justice to determine whether disclosure of these records is required by the Freedom of Information Act.
2. A record from this system of records may be disclosed, as a routine use, in the course of presenting evidence to a court, magistrate, or administrative tribunal, including disclosures to opposing counsel in the course of settlement negotiations.
3. A record in this system of records may be disclosed, as a routine use, to a Member of Congress submitting a request involving an individual, to whom the record pertains, when the individual has requested assistance from the Member with respect to the subject matter of the record.
4. A record in this system of records may be disclosed, as a routine use, to a contractor of the Agency having need for the information in order to perform a contract. Recipients of information shall be required to comply with the requirements of the Privacy Act of 1974, as amended, pursuant to 5 U.S.C. 552a(m).
5. A record related to an International Application filed under the Patent Cooperation Treaty in this system of records may be disclosed, as a routine use, to the International Bureau of the World Intellectual Property Organization, pursuant to the Patent Cooperation Treaty.
6. A record in this system of records may be disclosed, as a routine use, to another federal agency for purposes of National Security review (35 U.S.C. 181) and for review pursuant to the Atomic Energy Act (42 U.S.C. 218(c)).
7. A record from this system of records may be disclosed, as a routine use, to the Administrator, General Services, or his/her designee, during an inspection of records conducted by GSA as part of that agency's responsibility to recommend improvements in records management practices and programs, under authority of 44 U.S.C. 2904 and 2906. Such disclosure shall be made in accordance with the GSA regulations governing inspection of records for this purpose, and any other relevant (i.e., GSA or Commerce) directive. Such disclosure shall not be used to make determinations about individuals.
8. A record from this system of records may be disclosed, as a routine use, to the public after either publication of the application pursuant to 35 U.S.C. 122(b) or issuance of a patent pursuant to 35 U.S.C. 151. Further, a record may be disclosed, subject to the limitations of 37 CFR 1.14, as a routine use, to the public if the record was filed in an application which became abandoned or in which the proceedings were terminated and which application is referenced by either a published application, an application open to public inspection or an issued patent.
9. A record from this system of records may be disclosed, as a routine use, to a Federal, State, or local law enforcement agency, if the USPTO becomes aware of a violation or potential violation of law or regulation.

## Electronic Acknowledgement Receipt

<b>EFS ID:</b>	6927158
<b>Application Number:</b>	12570343
<b>International Application Number:</b>	
<b>Confirmation Number:</b>	9973
<b>Title of Invention:</b>	Wireless Digital Audio System
<b>First Named Inventor/Applicant Name:</b>	C. Earl Woolfork
<b>Customer Number:</b>	68533
<b>Filer:</b>	Megan Elizabeth Lyman
<b>Filer Authorized By:</b>	
<b>Attorney Docket Number:</b>	1028.4
<b>Receipt Date:</b>	02-FEB-2010
<b>Filing Date:</b>	30-SEP-2009
<b>Time Stamp:</b>	09:29:24
<b>Application Type:</b>	Utility under 35 USC 111(a)

### Payment information:

Submitted with Payment	no
------------------------	----

### File Listing:

Document Number	Document Description	File Name	File Size(Bytes)/ Message Digest	Multi Part /.zip	Pages (if appl.)
1	Power of Attorney	POASigned.pdf	1079848 <small>3a9a8445:449264ba02cea96103a41584c381b5e1</small>	no	2

### Warnings:

### Information:

Total Files Size (in bytes):

1079848

This Acknowledgement Receipt evidences receipt on the noted date by the USPTO of the indicated documents, characterized by the applicant, and including page counts, where applicable. It serves as evidence of receipt similar to a Post Card, as described in MPEP 503.

**New Applications Under 35 U.S.C. 111**

If a new application is being filed and the application includes the necessary components for a filing date (see 37 CFR 1.53(b)-(d) and MPEP 506), a Filing Receipt (37 CFR 1.54) will be issued in due course and the date shown on this Acknowledgement Receipt will establish the filing date of the application.

**National Stage of an International Application under 35 U.S.C. 371**

If a timely submission to enter the national stage of an international application is compliant with the conditions of 35 U.S.C. 371 and other applicable requirements a Form PCT/DO/EO/903 indicating acceptance of the application as a national stage submission under 35 U.S.C. 371 will be issued in addition to the Filing Receipt, in due course.

**New International Application Filed with the USPTO as a Receiving Office**

If a new international application is being filed and the international application includes the necessary components for an international filing date (see PCT Article 11 and MPEP 1810), a Notification of the International Application Number and of the International Filing Date (Form PCT/RO/105) will be issued in due course, subject to prescriptions concerning national security, and the date shown on this Acknowledgement Receipt will establish the international filing date of the application.

**TERMINAL DISCLAIMER TO OBTAIN A DOUBLE PATENTING  
REJECTION OVER A "PRIOR" PATENT**

Docket Number (Optional)

1028.4

In re Application of: C. Earl Woolfork

Application No.: 12/570,343

Filed: 09/30/2009

For: Wireless Digital Audio System

The owner\*, C. Earl Woolfork, of 100 percent interest in the instant application hereby disclaims, except as provided below, the terminal part of the statutory term of any patent granted on the instant application which would extend beyond the expiration date of the full statutory term **prior patent** No. 7,412,294 as the term of said prior patent is defined in 35 U.S.C. 154 and 173, and as the term of said **prior patent** is presently shortened by any terminal disclaimer. The owner hereby agrees that any patent so granted on the instant application shall be enforceable only for and during such period that it and the **prior patent** are commonly owned. This agreement runs with any patent granted on the instant application and is binding upon the grantee, its successors or assigns.

In making the above disclaimer, the owner does not disclaim the terminal part of the term of any patent granted on the instant application that would extend to the expiration date of the full statutory term as defined in 35 U.S.C. 154 and 173 of the **prior patent**, "as the term of said **prior patent** is presently shortened by any terminal disclaimer," in the event that said **prior patent** later:

- expires for failure to pay a maintenance fee;
- is held unenforceable;
- is found invalid by a court of competent jurisdiction;
- is statutorily disclaimed in whole or terminally disclaimed under 37 CFR 1.321;
- has all claims canceled by a reexamination certificate;
- is reissued; or
- is in any manner terminated prior to the expiration of its full statutory term as presently shortened by any terminal disclaimer.

Check either box 1 or 2 below, if appropriate.

1.  For submissions on behalf of a business/organization (e.g., corporation, partnership, university, government agency, etc.), the undersigned is empowered to act on behalf of the business/organization.

I hereby declare that all statements made herein of my own knowledge are true and that all statements made on information and belief are believed to be true; and further that these statements were made with the knowledge that willful false statements and the like so made are punishable by fine or imprisonment, or both, under Section 1001 of Title 18 of the United States Code and that such willful false statements may jeopardize the validity of the application or any patent issued thereon.

2.  The undersigned is an attorney or agent of record. Reg. No. 57,054

/Megan Lyman/  
Signature

02/02/2010  
Date

Megan Lyman  
Typed or printed name

(919) 341-4023  
Telephone Number

- Terminal disclaimer fee under 37 CFR 1.20(d) included.

**WARNING: Information on this form may become public. Credit card information should not be included on this form. Provide credit card information and authorization on PTO-2038.**

\*Statement under 37 CFR 3.73(b) is required if terminal disclaimer is signed by the assignee (owner).  
Form PTO/SB/96 may be used for making this certification. See MPEP § 324.

This collection of information is required by 37 CFR 1.321. The information is required to obtain or retain a benefit by the public which is to file (and by the USPTO to process) an application. Confidentiality is governed by 35 U.S.C. 122 and 37 CFR 1.11 and 1.14. This collection is estimated to take 12 minutes to complete, including gathering, preparing, and submitting the completed application form to the USPTO. Time will vary depending upon the individual case. Any comments on the amount of time you require to complete this form and/or suggestions for reducing this burden, should be sent to the Chief Information Officer, U.S. Patent and Trademark Office, U.S. Department of Commerce, P.O. Box 1450, Alexandria, VA 22313-1450. DO NOT SEND FEES OR COMPLETED FORMS TO THIS ADDRESS. **SEND TO: Commissioner for Patents, P.O. Box 1450, Alexandria, VA 22313-1450.**

If you need assistance in completing the form, call 1-800-PTO-9199 and select option 2.



## Privacy Act Statement

The **Privacy Act of 1974 (P.L. 93-579)** requires that you be given certain information in connection with your submission of the attached form related to a patent application or patent. Accordingly, pursuant to the requirements of the Act, please be advised that: (1) the general authority for the collection of this information is 35 U.S.C. 2(b)(2); (2) furnishing of the information solicited is voluntary; and (3) the principal purpose for which the information is used by the U.S. Patent and Trademark Office is to process and/or examine your submission related to a patent application or patent. If you do not furnish the requested information, the U.S. Patent and Trademark Office may not be able to process and/or examine your submission, which may result in termination of proceedings or abandonment of the application or expiration of the patent.

The information provided by you in this form will be subject to the following routine uses:

1. The information on this form will be treated confidentially to the extent allowed under the Freedom of Information Act (5 U.S.C. 552) and the Privacy Act (5 U.S.C. 552a). Records from this system of records may be disclosed to the Department of Justice to determine whether disclosure of these records is required by the Freedom of Information Act.
2. A record from this system of records may be disclosed, as a routine use, in the course of presenting evidence to a court, magistrate, or administrative tribunal, including disclosures to opposing counsel in the course of settlement negotiations.
3. A record in this system of records may be disclosed, as a routine use, to a Member of Congress submitting a request involving an individual, to whom the record pertains, when the individual has requested assistance from the Member with respect to the subject matter of the record.
4. A record in this system of records may be disclosed, as a routine use, to a contractor of the Agency having need for the information in order to perform a contract. Recipients of information shall be required to comply with the requirements of the Privacy Act of 1974, as amended, pursuant to 5 U.S.C. 552a(m).
5. A record related to an International Application filed under the Patent Cooperation Treaty in this system of records may be disclosed, as a routine use, to the International Bureau of the World Intellectual Property Organization, pursuant to the Patent Cooperation Treaty.
6. A record in this system of records may be disclosed, as a routine use, to another federal agency for purposes of National Security review (35 U.S.C. 181) and for review pursuant to the Atomic Energy Act (42 U.S.C. 218(c)).
7. A record from this system of records may be disclosed, as a routine use, to the Administrator, General Services, or his/her designee, during an inspection of records conducted by GSA as part of that agency's responsibility to recommend improvements in records management practices and programs, under authority of 44 U.S.C. 2904 and 2906. Such disclosure shall be made in accordance with the GSA regulations governing inspection of records for this purpose, and any other relevant (*i.e.*, GSA or Commerce) directive. Such disclosure shall not be used to make determinations about individuals.
8. A record from this system of records may be disclosed, as a routine use, to the public after either publication of the application pursuant to 35 U.S.C. 122(b) or issuance of a patent pursuant to 35 U.S.C. 151. Further, a record may be disclosed, subject to the limitations of 37 CFR 1.14, as a routine use, to the public if the record was filed in an application which became abandoned or in which the proceedings were terminated and which application is referenced by either a published application, an application open to public inspection or an issued patent.
9. A record from this system of records may be disclosed, as a routine use, to a Federal, State, or local law enforcement agency, if the USPTO becomes aware of a violation or potential violation of law or regulation.

## Electronic Patent Application Fee Transmittal

<b>Application Number:</b>	12570343			
<b>Filing Date:</b>	30-Sep-2009			
<b>Title of Invention:</b>	Wireless Digital Audio System			
<b>First Named Inventor/Applicant Name:</b>	C. Earl Woolfork			
<b>Filer:</b>	Megan Elizabeth Lyman			
<b>Attorney Docket Number:</b>	1028.4			
Filed as Small Entity				
<b>Utility under 35 USC 111(a) Filing Fees</b>				
<b>Description</b>	<b>Fee Code</b>	<b>Quantity</b>	<b>Amount</b>	<b>Sub-Total in USD(\$)</b>
<b>Basic Filing:</b>				
<b>Pages:</b>				
<b>Claims:</b>				
Claims in excess of 20	2202	6	26	156
Independent claims in excess of 3	2201	7	110	770
<b>Miscellaneous-Filing:</b>				
<b>Petition:</b>				
<b>Patent-Appeals-and-Interference:</b>				
<b>Post-Allowance-and-Post-Issuance:</b>				

Description	Fee Code	Quantity	Amount	Sub-Total in USD(\$)
<b>Extension-of-Time:</b>				
<b>Miscellaneous:</b>				
Statutory disclaimer	2814	2	70	140
<b>Total in USD (\$)</b>				<b>1066</b>

## Electronic Acknowledgement Receipt

<b>EFS ID:</b>	6950353
<b>Application Number:</b>	12570343
<b>International Application Number:</b>	
<b>Confirmation Number:</b>	9973
<b>Title of Invention:</b>	Wireless Digital Audio System
<b>First Named Inventor/Applicant Name:</b>	C. Earl Woolfork
<b>Customer Number:</b>	68533
<b>Filer:</b>	Megan Elizabeth Lyman
<b>Filer Authorized By:</b>	
<b>Attorney Docket Number:</b>	1028.4
<b>Receipt Date:</b>	04-FEB-2010
<b>Filing Date:</b>	30-SEP-2009
<b>Time Stamp:</b>	15:02:56
<b>Application Type:</b>	Utility under 35 USC 111(a)

### Payment information:

Submitted with Payment	yes
Payment Type	Deposit Account
Payment was successfully received in RAM	\$1066
RAM confirmation Number	1284
Deposit Account	504576
Authorized User	

The Director of the USPTO is hereby authorized to charge indicated fees and credit any overpayment as follows:

Charge any Additional Fees required under 37 C.F.R. Section 1.17 (Patent application and reexamination processing fees)

Charge any Additional Fees required under 37 C.F.R. Section 1.19 (Document supply fees)

Charge any Additional Fees required under 37 C.F.R. Section 1.20 (Post Issuance fees)

Charge any Additional Fees required under 37 C.F.R. Section 1.21 (Miscellaneous fees and charges)

**File Listing:**

Document Number	Document Description	File Name	File Size(Bytes)/ Message Digest	Multi Part /.zip	Pages (if appl.)
1	Applicant Arguments/Remarks Made in an Amendment	Response.pdf	150190 07062237f51b19d5d5cd8c515519b85378354d1	no	8
<b>Warnings:</b>					
<b>Information:</b>					
2	Claims	Claims12570343.pdf	77580 8b85ce6fc089d03867b715888c6137de4bf2f1bc	no	13
<b>Warnings:</b>					
<b>Information:</b>					
3	Terminal Disclaimer Filed	TDastoApp729.pdf	205734 3e4341c95915b5e475a90ae196a6d0009a560e97	no	2
<b>Warnings:</b>					
<b>Information:</b>					
4	Terminal Disclaimer Filed	TDastoPatent294.pdf	210235 7616d10b96c707ab8d0f0cb9f3775472146e15e	no	2
<b>Warnings:</b>					
<b>Information:</b>					
5	Fee Worksheet (PTO-875)	fee-info.pdf	33101 b1638f5db928c8e8084d3c96f9c1388f77690254	no	2
<b>Warnings:</b>					
<b>Information:</b>					
<b>Total Files Size (in bytes):</b>			676840		

**This Acknowledgement Receipt evidences receipt on the noted date by the USPTO of the indicated documents, characterized by the applicant, and including page counts, where applicable. It serves as evidence of receipt similar to a Post Card, as described in MPEP 503.**

**New Applications Under 35 U.S.C. 111**

**If a new application is being filed and the application includes the necessary components for a filing date (see 37 CFR 1.53(b)-(d) and MPEP 506), a Filing Receipt (37 CFR 1.54) will be issued in due course and the date shown on this Acknowledgement Receipt will establish the filing date of the application.**

**National Stage of an International Application under 35 U.S.C. 371**

**If a timely submission to enter the national stage of an international application is compliant with the conditions of 35 U.S.C. 371 and other applicable requirements a Form PCT/DO/EO/903 indicating acceptance of the application as a national stage submission under 35 U.S.C. 371 will be issued in addition to the Filing Receipt, in due course.**

**New International Application Filed with the USPTO as a Receiving Office**

**If a new international application is being filed and the international application includes the necessary components for an international filing date (see PCT Article 11 and MPEP 1810), a Notification of the International Application Number and of the International Filing Date (Form PCT/RO/105) will be issued in due course, subject to prescriptions concerning national security, and the date shown on this Acknowledgement Receipt will establish the international filing date of the application.**

**RESPONSE TO OFFICE ACTION DATED 1/13/10**

**CLAIM ADDITIONS 13-26**

Claims 13-26 have been added to this application. These claims contain no new matter. The claims are added to better describe the detail of the present invention and are narrower in scope than the previously presented claims. It is respectfully requested that the new claims 13-26 be entered.

**RESPONSE TO REJECTION OF CLAIMS 1 -11 UNDER 35 U.S.C. 103**

A finding of obviousness requires that "the differences between the subject matter sought to be patented and the prior art are such that the subject matter as a whole would have been obvious at the time the invention was made to a person having ordinary skill in the art to which the subject matter pertains." 35 U.S.C. §103(a). In *KSR Int'l Co. v. Teleflex, Inc.*, 127 S. Ct. 1727, 82 USPQ2d 1385 (2007), the Supreme Court stated that the following factors set forth in *Graham v. John Deere Co.*, 383 U.S. 1, 148 USPQ 459 (1966) control an obviousness inquiry: (1) the scope and content of the prior art; (2) the differences between the prior art and the claimed invention; (3) the level of ordinary skill in the art; and (4) objective evidence of nonobviousness. *KSR*, 127 S. Ct. at 1734, 82 USPQ2d at 1388 (quoting *Graham*, 383 U.S. at 17-18, 14 USPQ at 467).

The *KSR* Court rejected a rigid application of the "teaching, suggestion, or motivation [TSM]" test previously applied by the Court of Appeals for the Federal Circuit. *KSR*, 127 S. Ct. at 1739 USPQ2d at 1395. However, the Supreme Court affirmed that it is "important to identify a reason that would have prompted a person of ordinary skill in the relevant field to combine the elements in the way the claimed new invention does...because inventions in most, if not all, instances rely upon building blocks long since uncovered, and claimed discoveries almost of necessity will be combinations of what, in some sense, is already known." *KSR*, 127 S. Ct. at 1741, 82 USPQ2d at 1396. Once the *Graham* factors have been addressed, the Examiner may apply the TSM test, asking whether (1) a teaching, suggestion or motivation exists in the prior art to combine the references cited, and (2) one skilled in the art would have a reasonable expectation of success. See USPTO Guidelines at 57534.

Further, in order to establish *prima facie* obviousness of a claimed invention, all the claim limitations must be taught or suggested by the prior art. *In re Royka*, 490 F.2d 981, 180 USPQ 580 (CCPA 1974). Additionally, in considering a prior art reference, the reference must be considered in its entirety, *i.e.*, as a whole, including portions that would lead away from the claimed invention. *WL Gore & Associates, Inc. v. Garlock, Inc.*, 721 F.2d 1540, 220 USPQ 303 (Fed. Cir. 1983), cert. denied, 469 U.S. 851 (1984). Moreover, it is improper to combine references where the references teach away from their combination. *In re Grasselli*, 713 F.2d 731, 743, 218 USPQ 769, 779 (Fed. Cir. 1983). Indeed, "an applicant may rebut a *prima facie* case of obviousness by showing that the prior art teaches away from the claimed invention *in any material respect*." *In re Peterson*, 315 F.3d 1325, 1331 (Fed. Cir. 2003). (Emphasis added.)

Moreover, a prior art reference is only appropriate where the "invention as a whole would be obvious to a person of ordinary skill in the field." *In re Kumar*, 418 F.3d 1361, 76 USPQ2d 1048, 1053 (Fed. Cir. 2005). Thus, to render an invention unpatentable for obviousness, the prior art must enable the invention. *Id.*

The rejections are predicated on applying the digital CDMA wireless communication of Li to replace the FM modulation communication taught in Altstatt (OA, pg.4, 1/13/10). Li is further cited for teaching portability and outputs/inputs. It is posited that the present invention could be created by the "substitution of one known element . . . for another . . . to obtain predictable results." *Id.*

*Altstatt, alone or in combination, is not appropriate prior art for use under 103*

**Altstatt has been consistently, and properly, removed as prior art**

Firstly, Altstatt has been reviewed during the prosecution of co-pending application 12/144,729 and issued patent 7,412,294. In each case, rejections predicated either primarily, or otherwise, on this reference have been removed. Altstatt has been combined with a variety of references during the prosecution of both applications (Schotz ('343), Rozin, Mooney, Benthin, Schotz ('839)). All rejections containing reference to Altstatt have been overcome.

The use of Altstatt during the prosecution of application no. 10/638,012 is very similar to the use of Altstatt in the present Office Action. For example, in the Final



Rejection mailed December 30, 2005 in application no. 10/638,012, Altstatt is used in conjunction with Schotz as a wireless audio system to be combined with Schotz's digital transmission and reception (page 10). Additionally, in the Office Action mailed May 17, 2006 in the same application, the Examiner makes the statement on page 10: "However, the system of Altstatt an analog transmission system that, operation lacks the benefits digitally encoded and transmitted audio signal." The last use of Altstatt as prior art for a 103 rejection in the '012 application is in the Final Rejection mailed on October 2, 2006 where it is again used as the wireless component and other references are used to teach the digital component. Altstatt was removed as prior art in each instance.

Since it has already been agreed that this reference cannot support a rejection under 103 in combination with any other reference, and the reference is not being used in any new way to reject any new element of the claims in the instant application, Altstatt is not an appropriate reference. The rejection should be removed.

**Altstatt, alone, and in combination, does not suggest the current invention and would render the current invention inoperable**

Altstatt's inappropriateness as prior art, alone and especially in combination, for the present invention has been shown. Neither the specification nor claims of the present invention disclose the use of a CDMA centralized base station. Furthermore, Altstatt does not suggest the limitations of the claim language (either alone or in combination). Altstatt states in column 6 lines 64 – 65 "center frequency of the RF carrier generated by the transmitter is set" and column 7 lines 1 – 12 (as referenced on page 3 of the current OA) "In the preferred embodiment, the frequency is set before shipment." Thus, the center frequency transmission of one Altstatt user will certainly overlap (due to the limited spectrum of 88 – 108 MHz disclosed by Altstatt in column 6 line 58) with the center frequency transmission being used by many other users of Altstatt's design (i.e., interference occurrence).

Altstatt teaches a receiver designed to receive all frequencies within the 88 – 108 MHz frequency band (Altstatt column 9 lines 1 – 19). Altstatt is silent about a receiver that is tuned to receive only *one* unique frequency; it does not teach a user tunable receiver (Altstatt column 7 lines 6 – 8 "This allows the user to move the frequency of his

or her transmitter in case a strong local station is causing interference” is directed only to a transmitter, not a receiver).

The current OA states on page 3 that “it is obvious that there can be multiple users of the Alstatt system in the same area; user can adjust the frequency to avoid interference; col. 7 lines 1 – 12” and “each receiver will receive the data from the frequency tuned to.” This is incorrect. Because only the transmitter of Altstatt’s system is user adjustable, any user of Altstatt’s system may, at anytime, set their transmitter frequency to the transmitter frequency of another user.

As a result, the following scenario can exist. User 1 and user 2 share the same space, wherein user 1 is listening to audio selection A at a tuned transmitter frequency of 95 MHz and user 2 is listening to audio selection B at a tuned transmitter frequency of 104 MHz. The receiver of user 1 can receive transmitted frequency 104 MHz (obviously this is not the expected frequency of reception), thus incorrectly receiving user 2’s audio selection. This results because Altstatt does not teach a receiver that the user can tune, but instead, teaches a receiver that only rejects interfering signals *from adjacent frequencies* (Altsatt column 3 lines 63 – 64 “rejecting interfering signals from adjacent frequencies to the transmitter frequency and column 8 lines 52 – 55 “headphone receiver ... rejection of interfering signals from adjacent frequencies”). Clearly, 95 MHz and 104MHz are not adjacent frequencies.

Additionally, if the transmitter “frequency is set before shipment,” (Altstatt column 7 lines 1 – 3) then the following scenario can exist. User 1 and user 2 share the same space and the same factory shipped transmitter frequency, wherein user 1 is attempting to listen to audio selection A at 95 MHz and user 2 is listening to audio selection B at 95 MHz. The receiver of user 2 can incorrectly receive user 1’s audio selection. If user 2 changes his or her transmitter FM frequency to any frequency other than 94 or 96 MHz (the adjacent frequencies that Alstatt teaches will be rejected by the receiver), then the previous scenario will exist.

These are simple examples involving just two users of Altstatt’s system, clearly scenarios that involve more than two users would significantly increase the interference issues. The addition of Li does not limit these interference issues, nor suggest a way to

create the present invention. Nor does the addition of Li lead to the “predictable result” of the high-fidelity, low-distortion system of the present invention.

As stated previously, the present invention discloses: “The unique user code generated is specifically associated with one wireless digital audio system user, and it is the only code recognized by the ... headphone receiver,” column 2 lines 47 – 50 and “The receiver code generator 60 may contain the same unique wireless transmission of a signal code word that was transmitted by audio transmitter 20 specific to a particular user” column 3 lines 5 – 8. The “FM frequency” stated on page 4 of the current OA does not equate to a “unique user code” as defined within the specification because it cannot provide each user with a unique code.

Therefore, the present invention’s claim limitation “a *unique user code* ... audio having been wirelessly transmitted from said at least one audio source *free from interference from multiple CDMA wireless digital audio system transmitters operating in the wireless digital audio system spectrum*” (emphasis added) is not met, suggested, or predicted by Altstatt. The interjection of Li does not alleviate these deficiencies.

Moreover, Altstatt, alone or in combination with Li or other prior art, does not suggest the claim limitation “*providing a particular audio receiver user with independent audio* in a shared space with other wireless digital audio system users, wherein *each of said wireless digital audio system users utilize their own independent audio source, and their own independent digital audio transmitter that associates only with their own independent receiver*” (emphasis added). Neither Li nor Altstatt alone or in combination meet the above claim limitations. The properties defined in the present invention cannot be predicted from Altstatt and Li.

Because Altstatt cannot provide even remotely interference free listening in a one-to-one transmitter to receiver design with multiple users, even with the interjection of Li’s technology, the combination does not teach, suggest, or motivate the present invention. The rejection should be removed.

*The addition of Li to Altstatt does not result in appropriate prior art for use under 103*

**The combination of Li and Altstatt essentially creates Lavelle, which has been consistently removed as prior art**

It can be shown that the combination of Li (6,781,977) with Altstatt (5,771,441) creates the centralized base station design of Lavelle's invention (6,678,892), which has been overcome in the prosecution of co-pending application 12/144,729 and issued patent 7,412,294. If Li and Altstatt create Lavelle, and Lavelle cannot obviate the present invention, then the application of Li and Altstatt is not appropriate prior art and cannot obviate the present invention.

Moreover, the withdrawal of the prior art reference of Lavelle (page 2 of the OA mailed on 09/16/2009 "Applicant's arguments with respect to the claims have been considered but are moot in view of the new ground(s) of rejection.") and the above discussion showing that Li with Altstatt basically create Lavelle, necessitates the removal of this rejection.

**The combination of Li and Altstatt do not provide a high quality, low distortion audio output to a singular user as required by the present invention**

Regardless of Altstatt's inability to show obviousness in the present invention, both previously and currently, it is clear that the prior art references Li and Altstatt cannot be combined to render the present invention obvious under 103.

Li clearly discloses that the "subscribers" (i.e., users) of his digital CDMA wireless communication system utilize the CDMA base station to access music (Li column 7 lines 9 – 17 "The exchange or the service-providing unit of the mobile net can store various multichannel sounds needed by users, e.g. a great amount of MP3 music data. On request of users, the exchange or the service-providing unit of the mobile net sends the suitable data to the wideband CDMA base station, by which the multichannel data, e.g. MP3 music data, is transmitted to the multichannel mobile equipment through the radio interface of the wideband CDMA. Then subscribers can enjoy the MP3 music in real-time mode by choice."). Further, column 7 lines 43 – 45 of Li, states "users can enjoy the music ... at the same time." Li clearly discloses the use of a single code (column 5 lines 62 – 67 & column 6 line 1 "modulated to a single CDMA code channel ... music ... modulated to another CDMA code channel") to transmit the music for all subscribers to access. This is not commensurate with the operation of the present invention.

By contrast, the present invention discloses: “The unique user code generated is specifically associated with one wireless digital audio system user” (column 2 lines 47 – 49). The invention discloses a one-to-one transmitter to receiver correlation (Parent Application 10/027,391, paragraph 0011 “The audio transmitter ... transmitting ... to a receiving antenna 52 of an audio receiver 50 that may be a headphone receiver”) that suppresses interference (Parent Application 10/027,391, paragraph 0015 “The direct conversion receiver 56 may provide a method for down converting the received signal while utilizing timing and synchronization to capture the correct bit sequence embedded in the received spread spectrum signal” and Parent Application 10/027,391, paragraph 0016 “Other code words from wireless digital audio systems 10 may appear as noise to a particular audio receiver 50”) without the need of a CDMA base station for centralized control.

Therefore, applying Li’s digital CDMA wireless communication to replace the FM modulation communication of Altstatt, as suggested in the current Office Action, creates a CDMA communication device that interfaces with a CDMA base station that will transmit music data to be accessed (using the headphones) by any subscriber at the same time. This cannot predict the attributes of the present invention.

Moreover, the Office Action relies on Li’s technology applied to Altstatt’s hardware. This combination does not yield or suggest a satisfactory listening system for high quality, low distortion audio. Because the combination of Li and Altstatt results in a system that is not always operable, it cannot predict or suggest the present invention. It cannot be used to obviate the present invention. A rejection is inappropriate where the combination cannot yield a product unsatisfactory for its intended purpose. To do so negates any suggestion or motivation to make the modification of the references required (i.e., changing the frequency that Altstatt works in and removing the required CDMA centralized control base station of Li to somehow create the present invention). *In re Gordon*, 733 F.2d 900, 221 USPQ 1125 (Fed. Cir. 1984). Because Li necessitates centralized control of a base station through the use of a cell phone network (i.e., “IMT2000,” “CDMA2000” and “IS-95”), the combination is inoperable when cell phone signal is unavailable (e.g., subway tunnels, basements, elevators, mountain areas, etc.).

The present invention solves a myriad of design and technical problems that arise from a combination of Li and Altstatt and is thus worthy of patenting. The rejection creates an unsatisfactory product, one which would require inventive capabilities to create the present invention, it should be removed.

**PROVISIONAL OBVIOUSNESS-TYPE DOUBLE PATENTING  
REJECTIONS TO CLAIMS 1-12**

Without assenting to the argument in the present Office Action, a terminal disclaimer is filed concurrently with this response, limiting the life of this patent to the same term as U.S. Patent Application No. 12/144,729.

**DOUBLE PATENTING REJECTIONS TO CLAIMS 1-19**

Without assenting to the argument in the present Office Action, a terminal disclaimer is filed concurrently with this response, limiting the life of this patent to the same term as U.S. Patent No. 7,412,294.

February 4<sup>th</sup>, 2010

Respectfully Submitted,

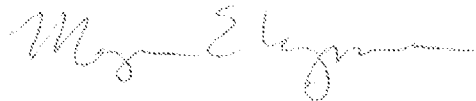

Megan E. Lyman, Registration No. 57,054  
1816 Silver Mist Ct.  
Raleigh, NC 27613  
(919) 341-4023

CLAIMS

I claim:

1. (Previously Presented) A wireless digital audio system, comprising:
  - at least one digital audio transmitter operatively coupled to at least one audio source, said at least one digital audio transmitter comprising:
    - a digital modulator configured for code division multiple access (CDMA) communication;
    - said digital audio transmitter configured for digital wireless communication with at least one digital audio receiver, said digital audio receiver comprising:
      - a digital demodulator configured for CDMA communication;
      - a digital-to-analog converter (DAC) generating an audio output; and
  - at least one module adapted to reproduce said generated audio output, said audio having been wirelessly transmitted from said at least one audio source virtually free from interference from multiple CDMA wireless digital audio system transmitters operating in the wireless digital audio system spectrum to a user providing a particular audio receiver user with independent audio in a shared space with other wireless digital audio system users, wherein each of said wireless digital audio system users utilize their own independent audio source, and their own independent digital transmitter that associates only with their own independent receiver.
  
2. (Previously Presented) A wireless digital audio headphone comprising:
  - at least one audio receiver configured for digital wireless communication with at least one digital audio transmitter, said at least one digital audio transmitter comprising:
    - a digital modulator configured for code division multiple access (CDMA) communication; and adding a unique user code bit sequence;
  - said at least one audio receiver comprising:
    - a digital demodulator configured for CDMA communication;
    - a digital-to-analog converter (DAC) generating an audio output; and
  - at least one module adapted to reproduce said generated audio output, when the unique user code bit sequence is recognized, said audio having been wirelessly

transmitted from at least one audio source virtually free from interference from multiple CDMA wireless digital audio system transmitters operating in the wireless digital audio system spectrum to a user and providing a particular audio receiver user with independent audio in a shared space with other wireless digital audio system users, wherein each of said wireless digital audio system users utilize their own independent audio source, and their own independent digital transmitter that associates only with their own independent receiver.

3. (Previously Presented) A portable wireless digital audio transmitter, configured to couple to an audio player, and wirelessly transmit a code division multiple access (CDMA) communication signal and a unique user code bit sequence to at least one digital audio receiver;

said portable wireless digital audio transmitter comprising:

a digital modulator module configured for CDMA communication;

said at least one digital audio receiver comprising:

a digital demodulator configured for CDMA communication;

a digital-to-analog converter (DAC) generating an audio output; and

at least one module adapted to reproduce audio output generated by said audio player, when the unique user code bit sequence is recognized, said audio output having been wirelessly transmitted from said audio player virtually free from interference from multiple CDMA wireless digital audio system transmitters operating in the wireless digital audio system spectrum to a user and providing a particular audio receiver user with independent audio in a shared space with other wireless digital audio system users, wherein each of said wireless digital audio system users utilize their own independent audio player, and their own independent digital audio transmitter that associates only with their own independent digital audio receiver.

4. (Previously Presented) A wireless digital audio system, comprising:

a portable digital audio transmitter configured to couple to an audio source and operative to transmit a code division multiple access (CDMA) communication signal of said audio source output and adding a unique user code to maintain fidelity of said audio



source output, said audio source to provide an audio signal representative of music; and

said portable digital audio transmitter configured for digital wireless communication with at least one digital audio receiver, said digital audio receiver comprising:

an audio receiver operative to receive the CDMA communication signal wherein when the unique user code is recognized, the transmitted audio source signal is reproduced, said audio source output virtually free from interference from multiple CDMA wireless digital audio system transmitters operating in the wireless digital audio system spectrum to a user and providing a particular audio receiver user with independent audio in a shared space with other wireless digital audio system users, wherein each of said wireless digital audio system users utilize their own independent audio source, and their own independent digital transmitter that associates only with their own independent headphone receiver.

5. (Previously Presented) A method for listening to an audio output with a wireless digital audio system while running comprising the steps of:

activating said wireless digital audio system while running, said wireless digital audio system, comprising:

a digital audio transmitter operatively coupled to an audio source and operative to transmit a code division multiple access (CDMA) communication signal of said audio source output and adding a unique user code to maintain fidelity of said audio source output; and

said digital audio transmitter configured for digital wireless communication with at least one digital audio receiver, said digital audio receiver comprising:

an audio receiver operative to receive the CDMA communication signal wherein if the unique user code is recognized, the transmitted audio source signal is reproduced, said audio source output having been wirelessly transmitted from said audio source virtually free from interference from multiple CDMA wireless digital audio system

transmitters operating in the wireless digital audio system spectrum to a user and providing a particular audio receiver user with independent audio in a shared space with other wireless digital audio system users, wherein each of said wireless digital audio system users utilize their own independent audio source, and their own independent digital audio transmitter that associates only with their own independent digital audio receiver.

6. (Previously Presented) A method for listening to an audio output with a wireless digital audio system while running comprising the steps of:

activating said wireless digital audio system while running, said wireless digital audio system, comprising:

a portable digital audio transmitter configured to couple to an audio player and operative to transmit a code division multiple access (CDMA) communication of the audio output of said audio player and adding a unique user code to maintain fidelity of said audio output; and

said portable digital audio transmitter configured for digital wireless communication with at least one digital audio receiver, said digital audio receiver comprising:

an audio receiver operative to receive the CDMA communication signal wherein if the unique user code is recognized, the transmitted audio signal is reproduced, said audio output having been wirelessly transmitted from said audio player virtually free from interference from multiple CDMA wireless digital audio system transmitters operating in the wireless digital audio system spectrum to a user and providing a particular audio receiver user with independent audio in a shared space with other wireless digital audio system users, wherein each of said wireless digital audio system users utilize their own independent audio player, and their own independent digital audio transmitter that associates only with their own independent digital audio receiver.

7. (Previously Presented) A method for listening to an audio output with a wireless digital audio system by a user in motion resulting primarily from physical force initiated by said user, comprising the steps of:
- activating said wireless digital audio system during individual independent motion from exercise, said wireless digital audio system, comprising:
    - a digital audio transmitter operatively coupled to an audio source and operative to transmit a code division multiple access (CDMA) communication signal of the audio source output and adding a unique user code to maintain fidelity of said audio source output; and
    - said digital audio transmitter configured for digital wireless communication with at least one digital audio receiver, said digital audio receiver comprising:
      - an audio receiver operative to receive the CDMA communication signal wherein if the unique user code is recognized, the transmitted audio signal is reproduced, said audio source output having been wirelessly transmitted from said audio source virtually free from interference from multiple CDMA wireless digital audio system transmitters operating in the wireless digital audio system spectrum to a user and providing a particular audio receiver user with independent audio in a shared space with other wireless digital audio system users, wherein each of said wireless digital audio system users utilize their own independent audio source, and their own independent digital audio transmitter that associates only with their own independent digital audio receiver.
8. (Previously Presented) A wireless digital audio system, comprising:
- at least one digital audio transmitter operatively coupled to at least one audio source, said at least one digital audio transmitter comprising:
    - a digital modulator configured for code division multiple access (CDMA) communication;
    - at least one audio receiver configured for digital wireless communication with said at least one digital audio transmitter, said at least one audio receiver comprising:
      - a digital demodulator configured for CDMA communication;
      - a digital-to-analog converter (DAC) generating an audio output; and

at least one module adapted to reproduce said generated audio output, said audio having been wirelessly transmitted from said at least one audio source free from interference from multiple CDMA wireless digital audio system transmitters operating in the wireless digital audio system spectrum to a user providing a particular audio receiver user with independent audio in a shared space with other wireless digital audio system users, wherein each of said wireless digital audio system users utilize their own independent audio source, and their own independent digital transmitter that associates only with their own independent receiver.

9. (Previously Presented) A wireless digital audio system, comprising:  
a portable digital audio transmitter configured to couple to an audio player and operative to transmit a code division multiple access (CDMA) communication signal of an audio output and adding a unique user code to maintain fidelity of said audio output; and  
an audio receiver operative to receive said CDMA communication signal wherein if the unique user code is recognized, the transmitted audio signal is reproduced, said audio free from interference from multiple CDMA wireless digital audio system transmitters operating in the wireless digital audio system spectrum to a user providing a particular audio receiver user with independent audio in a shared space with other wireless digital audio system users, wherein each of said wireless digital audio system users utilize their own independent audio player, and their own independent portable transmitter that associates only with their own independent headphone receiver.

10. (Previously Presented) A wireless digital audio system, comprising:  
a portable audio source to provide a signal representative of music;  
a digital audio transmitter operatively coupled to said portable audio source, said digital audio transmitter comprising:  
a digital modulator module configured for code division multiple access (CDMA) communication and utilizing a unique user code bit sequence;  
said digital audio transmitter configured for digital wireless communication with at least one digital audio receiver, said digital audio receiver comprising:

a digital demodulator module configured for code division multiple access (CDMA) communication; and

a digital-to-analog converter (DAC) generating an audio output; and

at least one module adapted to reproduce said generated audio output, when the unique user code bit sequence is recognized, said audio having been wirelessly transmitted from said portable audio source free from interference from multiple CDMA wireless digital audio system transmitters operating in the wireless digital audio system spectrum to a user providing a particular digital audio receiver user with independent audio in a shared space with other wireless digital audio system users, wherein each of said wireless digital audio system users utilize their own independent audio source, and their own independent digital audio transmitter that associates only with their own independent receiver.

11. (Previously Presented) A wireless digital audio system, comprising:

a portable digital audio transmitter configured to couple to an audio source and operative to transmit a code division multiple access (CDMA) communication signal of said audio source output and adding a unique user code to maintain fidelity of said audio source output, said audio source to provide an audio signal representative of music; and

an audio receiver operative to receive the CDMA communication signal wherein when the unique user code is recognized, the transmitted audio source signal is reproduced, said audio source output free from interference from multiple CDMA wireless digital audio system transmitters operating in the wireless digital audio system spectrum to a user providing a particular audio receiver user with independent audio in a shared space with other wireless digital audio system users, wherein each of said wireless digital audio system users utilize their own independent audio source, and their own independent digital audio transmitter that associates only with their own independent headphone receiver.

12. (Previously Presented) A wireless digital audio receiver comprising:

an embedded fuzzy logic detector wherein the fuzzy logic detector activates fuzzy

logic rules and performs a defuzzification operation in response to a received unique user code to enhance detection of the unique user code;

a direct conversion module being configured to capture the correct unique user code bit sequence embedded in the received CDMA signal;

a digital demodulator adapted to process output from said direct conversion module;

a digital-to-analog converter (DAC) generating an audio output wherein if the unique user code bit sequence corresponding to the decoded and converted digital signal is recognized, said audio output having been wirelessly transmitted, said audio output reproduced virtually without interference when operated in a shared space containing at least one other user of a wireless device utilizing code division multiple access (CDMA) communication.

13. (New) A wireless digital audio system, comprising:

at least one digital audio transmitter operatively coupled to at least one audio source, said at least one digital audio transmitter comprising:

a differential phase shift keying (DPSK) module modulating signal of said audio source output and a unique user code bit sequence being configured for code division multiple access (CDMA) communication;

said digital audio transmitter configured for digital wireless communication with at least one digital audio receiver, said digital audio receiver comprising:

a direct conversion module configured to capture the correct unique user code bit sequence embedded in the received spread spectrum signal;

a digital demodulator configured for CDMA communication;

a digital-to-analog converter (DAC) generating an audio output; and

at least one module adapted to reproduce said generated audio output, said audio having been wirelessly transmitted from said at least one audio source virtually free from interference from multiple CDMA wireless digital audio system transmitters operating in the wireless digital audio system spectrum to a user and providing a particular audio

receiver user with independent audio in a shared space with other wireless digital audio system users, wherein each of said wireless digital audio system users utilize their own independent audio source, and their own independent digital transmitter that associates only with their own independent receiver.

14. (New) The digital audio receiver of claim 13, wherein said digital demodulator is operatively coupled to a Viterbi decoder.

15. (New) A wireless digital audio headphone comprising:  
at least one audio receiver configured for digital wireless communication with at least one digital audio transmitter, said at least one digital audio transmitter comprising:  
a differential phase shift keying (DPSK) module configured for code division multiple access (CDMA) communication and adding a unique user code bit sequence;  
said at least one audio receiver comprising:  
a direct conversion module configured to capture the correct unique user code bit sequence embedded in the received spread spectrum signal;  
a digital demodulator configured for CDMA communication;  
a digital-to-analog converter (DAC) generating an audio output; and  
at least one module adapted to reproduce said generated audio output, when the unique user code bit sequence is recognized, said audio having been wirelessly transmitted from at least one audio source virtually free from interference from multiple CDMA wireless digital audio system transmitters operating in the wireless digital audio system spectrum to a user and providing a particular audio receiver user with independent audio in a shared space with other wireless digital audio system users, wherein each of said wireless digital audio system users utilize their own independent audio source, and their own independent digital transmitter that associates only with their own independent receiver.

16. (New) The digital audio receiver of claim 15, wherein said digital demodulator is operatively coupled to a Viterbi decoder.

17. (New) A portable wireless digital audio transmitter, configured to couple to an audio player and wirelessly transmit a code division multiple access (CDMA) communication signal having a differential phase shift keying (DPSK) modulated signal of said audio player output and a unique user code bit sequence to at least one digital audio receiver, said portable wireless digital audio transmitter comprising:

a digital modulator module configured for CDMA communication;

said at least one digital audio receiver comprising:

a direct conversion module configured to capture the correct unique user code bit sequence embedded in the received spread spectrum signal;

a digital demodulator configured for CDMA communication;

a digital-to-analog converter (DAC) generating an audio output; and

at least one module adapted to reproduce audio output generated by said audio player when the unique user code bit sequence is recognized, said audio output having been wirelessly transmitted from said audio player virtually free from interference from multiple CDMA wireless digital audio system transmitters operating in the wireless digital audio system spectrum to a user and providing a particular audio receiver user with independent audio in a shared space with other wireless digital audio system users, wherein each of said wireless digital audio system users utilize their own independent audio player, and their own independent digital audio transmitter that associates only with their own independent digital audio receiver.

18. (New) The digital audio receiver of claim 17, wherein said digital demodulator is operatively coupled to a Viterbi decoder.

19. (New) A wireless digital audio system, comprising:

a portable digital audio transmitter configured to couple to an audio player and operative to transmit a code division multiple access (CDMA) communication signal having a differential phase shift keying (DPSK) modulated signal of said audio player output and adding a unique user code bit sequence to maintain fidelity of said audio player output;



said portable digital audio transmitter configured for digital wireless communication with at least one digital audio receiver; and

said digital audio receiver operative to receive said CDMA communication signal wherein if the unique user code bit sequence is recognized, the transmitted audio signal is reproduced, said digital audio receiver comprising:

a direct conversion module configured to capture the correct unique user code bit sequence embedded in the received spread spectrum signal;

said audio signal virtually free from interference from multiple CDMA wireless digital audio system transmitters operating in the wireless digital audio system spectrum to a user providing a particular audio receiver user with independent audio in a shared space with other wireless digital audio system users, wherein each of said wireless digital audio system users utilize their own independent audio player, and their own independent transmitter that associates only with their own independent headphone receiver.

20. (New) The digital audio receiver of claim 19, wherein said digital demodulator is operatively coupled to a Viterbi decoder.

21. (New) A wireless digital audio system, comprising:

at least one digital audio transmitter operatively coupled to at least one audio source, said at least one digital audio transmitter comprising:

a digital modulator configured for direct sequence spread spectrum (DSSS) code division multiple access (CDMA) communication and adding a unique user code bit sequence;

said digital audio transmitter configured for digital wireless communication with at least one digital audio receiver, said digital audio receiver comprising:

a direct conversion module configured to capture the correct unique user code bit sequence embedded in the received spread spectrum signal;

a digital demodulator configured for DSSS CDMA communication;

a digital-to-analog converter (DAC) generating an audio output; and

at least one module adapted to reproduce said generated audio output, said audio having been wirelessly transmitted from said at least one audio source virtually free from

interference from multiple CDMA wireless digital audio system transmitters operating in the wireless digital audio system spectrum to a user and providing a particular audio receiver user with independent audio in a shared space with other wireless digital audio system users, wherein each of said wireless digital audio system users utilize their own independent audio source, and their own independent digital transmitter that associates only with their own independent receiver.

22. (New) The digital audio receiver of claim 21, wherein said digital demodulator is operatively coupled to a Viterbi decoder.

23. (New) A wireless digital audio headphone comprising:  
at least one audio receiver configured for digital wireless communication with at least one digital audio transmitter, said at least one digital audio transmitter comprising:  
a direct sequence spread spectrum (DSSS) code division multiple access (CDMA) modulator; and adding a unique user code bit sequence;  
said at least one audio receiver comprising:  
a direct conversion module configured to capture the correct unique user code bit sequence embedded in the received spread spectrum signal;  
a digital demodulator configured for DSSS CDMA communication;  
a digital-to-analog converter (DAC) generating an audio output; and  
at least one module adapted to reproduce said generated audio output, when the unique user code bit sequence is recognized, said audio having been wirelessly transmitted from at least one audio source virtually free from interference from multiple CDMA wireless digital audio system transmitters operating in the wireless digital audio system spectrum to a user and providing a particular audio receiver user with independent audio in a shared space with other wireless digital audio system users, wherein each of said wireless digital audio system users utilize their own independent audio source, and their own independent digital transmitter that associates only with their own independent receiver.

24. (New) The digital audio receiver of claim 23, wherein said digital demodulator is operatively coupled to a Viterbi decoder.

25. (New) A wireless digital audio system, comprising:  
a portable digital audio transmitter configured to couple to an audio player and operative to transmit a direct sequence spread spectrum (DSSS) code division multiple access (CDMA) communication signal of said audio player output and adding a unique user code bit sequence to maintain fidelity of said audio player output;

said portable digital audio transmitter configured for digital wireless communication with at least one digital audio receiver; and

said digital audio receiver operative to receive said DSSS CDMA communication signal wherein if the unique user code bit sequence is recognized, the transmitted audio signal is reproduced, said digital audio receiver comprising:

a direct conversion module configured to capture the correct unique user code bit sequence embedded in the received spread spectrum signal, said audio signal virtually free from interference from multiple CDMA wireless digital audio system transmitters operating in the wireless digital audio system spectrum to a user providing a particular audio receiver user with independent audio in a shared space with other wireless digital audio system users, wherein each of said wireless digital audio system users utilize their own independent audio player, and their own independent transmitter that associates only with their own independent headphone receiver.

26. (New) The digital audio receiver of claim 25, wherein said digital demodulator is operatively coupled to a Viterbi decoder.

Under the Paperwork Reduction Act of 1995, no persons are required to respond to a collection of information unless it displays a valid OMB control number.

<b>TERMINAL DISCLAIMER TO OBTAIN A PROVISIONAL DOUBLE PATENTING REJECTION OVER A PENDING "REFERENCE" APPLICATION</b>	Docket Number (Optional) 1028.4												
<p>In re Application of:</p> <p>Application No.:</p> <p>Filed:</p> <p>For:</p> <p>The owner*, <u>C. Earl Woolfork</u>, of <u>100</u> percent interest in the instant application hereby disclaims, except as provided below, the terminal part of the statutory term of any patent granted on the instant application which would extend beyond the expiration date of the full statutory term of any patent granted on pending <b>reference</b> Application Number <u>12/144,729</u>, filed on <u>7/12/2009</u>, as such term is defined in 35 U.S.C. 154 and 173, and as the term of any patent granted on said <b>reference</b> application may be shortened by any terminal disclaimer filed prior to the grant of any patent on the pending <b>reference</b> application. The owner hereby agrees that any patent so granted on the instant application shall be enforceable only for and during such period that it and any patent granted on the <b>reference</b> application are commonly owned. This agreement runs with any patent granted on the instant application and is binding upon the grantee, its successors or assigns.</p> <p>In making the above disclaimer, the owner does not disclaim the terminal part of any patent granted on the instant application that would extend to the expiration date of the full statutory term as defined in 35 U.S.C. 154 and 173 of any patent granted on said <b>reference</b> application, "as the term of any patent granted on said <b>reference</b> application may be shortened by any terminal disclaimer filed prior to the grant of any patent on the pending <b>reference</b> application," in the event that: any such patent: granted on the pending <b>reference</b> application: expires for failure to pay a maintenance fee, is held unenforceable, is found invalid by a court of competent jurisdiction, is statutorily disclaimed in whole or terminally disclaimed under 37 CFR 1.321, has all claims canceled by a reexamination certificate, is reissued, or is in any manner terminated prior to the expiration of its full statutory term as shortened by any terminal disclaimer filed prior to its grant.</p> <p>Check either box 1 or 2 below, if appropriate.</p> <p>1. <input type="checkbox"/> For submissions on behalf of a business/organization (e.g., corporation, partnership, university, government agency, etc.), the undersigned is empowered to act on behalf of the business/organization.</p> <p style="padding-left: 40px;">I hereby declare that all statements made herein of my own knowledge are true and that all statements made on information and belief are believed to be true; and further that these statements were made with the knowledge that willful false statements and the like so made are punishable by fine or imprisonment, or both, under Section 1001 of Title 18 of the United States Code and that such willful false statements may jeopardize the validity of the application or any patent issued thereon.</p> <p>2. <input checked="" type="checkbox"/> The undersigned is an attorney or agent of record. Reg. No. <u>57,054</u></p> <div style="text-align: center; margin-top: 20px;"> <table style="width: 100%; border: none;"> <tr> <td style="width: 60%; border-bottom: 1px solid black; text-align: center;">/Megan Lyman/</td> <td style="width: 40%; border-bottom: 1px solid black; text-align: center;">2/2/2010</td> </tr> <tr> <td style="text-align: center;">Signature</td> <td style="text-align: center;">Date</td> </tr> <tr> <td colspan="2" style="border-top: 1px solid black; text-align: center; padding-top: 5px;">Megan Lyman</td> </tr> <tr> <td colspan="2" style="text-align: center;">Typed or printed name</td> </tr> <tr> <td colspan="2" style="border-top: 1px solid black; text-align: center; padding-top: 5px;">(919) 341-4023</td> </tr> <tr> <td colspan="2" style="text-align: center;">Telephone Number</td> </tr> </table> </div> <p><input checked="" type="checkbox"/> Terminal disclaimer fee under 37 CFR 1.20(d) is included.</p> <p style="text-align: center; font-weight: bold; margin-top: 20px;">WARNING: Information on this form may become public. Credit card information should not be included on this form. Provide credit card information and authorization on PTO-2038.</p> <p style="font-size: small; margin-top: 20px;">*Statement under 37 CFR 3.73(b) is required if terminal disclaimer is signed by the assignee (owner).                  Form PTO/SB/96 may be used for making this statement. See MPEP § 324.</p>		/Megan Lyman/	2/2/2010	Signature	Date	Megan Lyman		Typed or printed name		(919) 341-4023		Telephone Number	
/Megan Lyman/	2/2/2010												
Signature	Date												
Megan Lyman													
Typed or printed name													
(919) 341-4023													
Telephone Number													

This collection of information is required by 37 CFR 1.321. The information is required to obtain or retain a benefit by the public which is to file (and by the USPTO to process) an application. Confidentiality is governed by 35 U.S.C. 122 and 37 CFR 1.11 and 1.14. This collection is estimated to take 12 minutes to complete, including gathering, preparing, and submitting the completed application form to the USPTO. Time will vary depending upon the individual case. Any comments on the amount of time you require to complete this form and/or suggestions for reducing this burden, should be sent to the Chief Information Officer, U.S. Patent and Trademark Office, U.S. Department of Commerce, P.O. Box 1450, Alexandria, VA 22313-1450. DO NOT SEND FEES OR COMPLETED FORMS TO THIS ADDRESS. **SEND TO: Commissioner for Patents, P.O. Box 1450, Alexandria, VA 22313-1450.**

If you need assistance in completing the form, call 1-800-PTO-9199 and select option 2.

## Privacy Act Statement

The **Privacy Act of 1974 (P.L. 93-579)** requires that you be given certain information in connection with your submission of the attached form related to a patent application or patent. Accordingly, pursuant to the requirements of the Act, please be advised that: (1) the general authority for the collection of this information is 35 U.S.C. 2(b)(2); (2) furnishing of the information solicited is voluntary; and (3) the principal purpose for which the information is used by the U.S. Patent and Trademark Office is to process and/or examine your submission related to a patent application or patent. If you do not furnish the requested information, the U.S. Patent and Trademark Office may not be able to process and/or examine your submission, which may result in termination of proceedings or abandonment of the application or expiration of the patent.

The information provided by you in this form will be subject to the following routine uses:

1. The information on this form will be treated confidentially to the extent allowed under the Freedom of Information Act (5 U.S.C. 552) and the Privacy Act (5 U.S.C. 552a). Records from this system of records may be disclosed to the Department of Justice to determine whether disclosure of these records is required by the Freedom of Information Act.
2. A record from this system of records may be disclosed, as a routine use, in the course of presenting evidence to a court, magistrate, or administrative tribunal, including disclosures to opposing counsel in the course of settlement negotiations.
3. A record in this system of records may be disclosed, as a routine use, to a Member of Congress submitting a request involving an individual, to whom the record pertains, when the individual has requested assistance from the Member with respect to the subject matter of the record.
4. A record in this system of records may be disclosed, as a routine use, to a contractor of the Agency having need for the information in order to perform a contract. Recipients of information shall be required to comply with the requirements of the Privacy Act of 1974, as amended, pursuant to 5 U.S.C. 552a(m).
5. A record related to an International Application filed under the Patent Cooperation Treaty in this system of records may be disclosed, as a routine use, to the International Bureau of the World Intellectual Property Organization, pursuant to the Patent Cooperation Treaty.
6. A record in this system of records may be disclosed, as a routine use, to another federal agency for purposes of National Security review (35 U.S.C. 181) and for review pursuant to the Atomic Energy Act (42 U.S.C. 218(c)).
7. A record from this system of records may be disclosed, as a routine use, to the Administrator, General Services, or his/her designee, during an inspection of records conducted by GSA as part of that agency's responsibility to recommend improvements in records management practices and programs, under authority of 44 U.S.C. 2904 and 2906. Such disclosure shall be made in accordance with the GSA regulations governing inspection of records for this purpose, and any other relevant (*i.e.*, GSA or Commerce) directive. Such disclosure shall not be used to make determinations about individuals.
8. A record from this system of records may be disclosed, as a routine use, to the public after either publication of the application pursuant to 35 U.S.C. 122(b) or issuance of a patent pursuant to 35 U.S.C. 151. Further, a record may be disclosed, subject to the limitations of 37 CFR 1.14, as a routine use, to the public if the record was filed in an application which became abandoned or in which the proceedings were terminated and which application is referenced by either a published application, an application open to public inspection or an issued patent.
9. A record from this system of records may be disclosed, as a routine use, to a Federal, State, or local law enforcement agency, if the USPTO becomes aware of a violation or potential violation of law or regulation.



UNITED STATES PATENT AND TRADEMARK OFFICE

UNITED STATES DEPARTMENT OF COMMERCE  
United States Patent and Trademark Office  
Address: COMMISSIONER FOR PATENTS  
P.O. Box 1450  
Alexandria, Virginia 22313-1450  
www.uspto.gov

APPLICATION NUMBER	FILING OR 371(C) DATE	FIRST NAMED APPLICANT	ATTY. DOCKET NO./TITLE
12/570,343	09/30/2009	C. Earl Woolfork	1028.4

68533  
MEGAN LYMAN  
1816 SILVER MIST CT.  
RALEIGH, NC 27613

**CONFIRMATION NO. 9973**  
**POA ACCEPTANCE LETTER**



Date Mailed: 02/18/2010

**NOTICE OF ACCEPTANCE OF POWER OF ATTORNEY**

This is in response to the Power of Attorney filed 02/02/2010.

The Power of Attorney in this application is accepted. Correspondence in this application will be mailed to the above address as provided by 37 CFR 1.33.

/tkim/

Office of Data Management, Application Assistance Unit (571) 272-4000, or (571) 272-4200, or 1-888-786-0101

<b>Application Number</b> 	<b>Application/Control No.</b> 12/570,343	<b>Applicant(s)/Patent under Reexamination</b> WOOLFORK, C. EARL

<b>Document Code - DISQ</b>	<b>Internal Document – DO NOT MAIL</b>
-----------------------------	--

<b>TERMINAL DISCLAIMER</b>	<input checked="" type="checkbox"/> <b>APPROVED</b>	<input type="checkbox"/> <b>DISAPPROVED</b>
Date Filed : 2/04/10	<b>This patent is subject to a Terminal Disclaimer</b>	

<b>Approved/Disapproved by:</b>
j.proctor

U.S. Patent and Trademark Office



UNITED STATES PATENT AND TRADEMARK OFFICE

UNITED STATES DEPARTMENT OF COMMERCE  
United States Patent and Trademark Office  
Address: COMMISSIONER FOR PATENTS  
P.O. Box 1450  
Alexandria, Virginia 22313-1450  
www.uspto.gov

APPLICATION NO.	FILING DATE	FIRST NAMED INVENTOR	ATTORNEY DOCKET NO.	CONFIRMATION NO.
12/570,343	09/30/2009	C. Earl Woolfork	1028.4	9973
68533	7590	06/07/2010	EXAMINER	
MEGAN LYMAN 1816 SILVER MIST CT. RALEIGH, NC 27613			FLANDERS, ANDREW C	
			ART UNIT	PAPER NUMBER
			2614	
			NOTIFICATION DATE	DELIVERY MODE
			06/07/2010	ELECTRONIC

**Please find below and/or attached an Office communication concerning this application or proceeding.**

The time period for reply, if any, is set in the attached communication.

Notice of the Office communication was sent electronically on above-indicated "Notification Date" to the following e-mail address(es):

MELYMAN@LYMANPATENTS.COM





## DETAILED ACTION

### *Response to Arguments*

Applicant's arguments filed 04 February 2010 have been fully considered but they are not persuasive.

Applicant alleges:

Since it has already been agreed that this reference cannot support a rejection under 103 in combination with any other reference, and the reference is not being used in any new way to reject any new element of the claims in the instant application, Alstatt is not an appropriate reference. The rejection should be removed.

The Examiner disagrees. First, it has never been agreed that Alstatt cannot support a rejection under a 103 combination. Secondly, the prosecution history of the '012 application in regards to the Alstatt reference is irrelevant due to the different limitations presented in the claims in the '012 application.

Applicant further alleges:

Alstatt, alone, and in combination, does not suggest the current invention and would render the current invention inoperable

Examiner disagrees. In this section of arguments, namely pages 3 – 5, Applicant argues Alstatt alone, and does not consider the nature of the combination of Alstatt and Li. Specifically, Applicant attacks Alstatt as a singular reference and as a result, the arguments are not persuasive.

Applicant further alleges:

The combination of Li and Altstatt essentially creates Lavelle, which has been consistently removed as prior art.

Examiner disagrees. There are a number of reasons, unrelated to the current presentation of the claims, why Lavelle was removed as prior art. Additionally, the combination does not essentially create Lavelle as the Lavelle prior art had issues w/ portability.

Applicant further alleges:

The combination of Li and Altstatt do not provide a high quality, low distortion audio output to a singular user as required by the present invention.

Examiner disagrees. These features are clearly met by the combination of Altstatt in view of Li as shown in the prior action as well as the current action.

***Claim Rejections - 35 USC § 103***

The following is a quotation of 35 U.S.C. 103(a) which forms the basis for all obviousness rejections set forth in this Office action:

(a) A patent may not be obtained though the invention is not identically disclosed or described as set forth in section 102 of this title, if the differences between the subject matter sought to be patented and the prior art are such that the subject matter as a whole would have been obvious at the time the invention was made to a person having ordinary skill in the art to which said subject matter pertains. Patentability shall not be negated by the manner in which the invention was made.

The factual inquiries set forth in *Graham v. John Deere Co.*, 383 U.S. 1, 148 USPQ 459 (1966), that are applied for establishing a background for determining obviousness under 35 U.S.C. 103(a) are summarized as follows:

1. Determining the scope and contents of the prior art.
2. Ascertaining the differences between the prior art and the claims at issue.
3. Resolving the level of ordinary skill in the pertinent art.
4. Considering objective evidence present in the application indicating obviousness or nonobviousness.

**Claims 1 – 11, 13, 15, 17, 19, 21, 23 and 25** are rejected under 35 U.S.C. 103(a) as being unpatentable over Alstatt (U.S. Patent 5,771,441) in view of Li (U.S. Patent 6,781,977).

Regarding **Claim 1**, Alstatt discloses:

A wireless digital audio system (Fig. 1), comprising:

at least one audio transmitter operatively coupled to at least one audio source (14),

said audio transmitter configured for wireless communication with at least one audio receiver (24), said audio receiver comprising:

at least one module adapted to reproduce said generated audio output (26), said audio having been wirelessly transmitted from said at least one audio source (transmission from 14 to 24 shown in fig. 1) virtually free from interference from multiple wireless digital audio system transmitters operating in the wireless digital audio system spectrum to a user providing a particular audio receiver user with independent audio in

a shared space with other wireless digital audio system users (it is obvious that there can be multiple users of the Alstatt system in the same area; user can adjust the frequency to avoid interference; col. 7 lines 1 - 12), wherein each of said wireless digital audio system users utilize their own independent audio source (i.e. two users in the same area using Fig. 1, each would have their own portable player 10), and their own independent digital transmitter that associates with their own independent receiver. (each receiver will receive the data from the frequency tuned to).

Alstatt fails to disclose  
the system as a digital system;  
said at least one digital audio transmitter comprising:  
a digital modulator configured for code division multiple access (CDMA)  
communication;  
a digital demodulator configured for CDMA communication;  
a digital-to-analog converter (DAC) generating an audio output; and  
only associating with their own independent receiver.

However, digital CDMA transmissions of audio sources to headphones in devices was notoriously well known in the art. For Example, Li teaches a system providing CDMA communication of digital audio to headphone devices; col. 3 lines 20 – 33.

Replacing the FM transmitter/receiver implementation of Alstatt to use the digital CDMA communication discloses:

the system as a digital system (i.e. digital audio; col. 2 lines 48 – 51); also A/D conversion; col. 3 line 7);

said at least one digital audio transmitter (sending unit 100) comprising:  
a digital modulator configured for code division multiple access (CDMA) communication (105);

said at least one audio receiver comprising:  
a digital demodulator configured for CDMA communication (202);  
a digital-to-analog converter (DAC) generating an audio output (204); and  
only associating with their own independent receiver (i.e. CDMA code channel; cols. 5 and 6 in place of the FM frequency).

It would have been obvious to one of ordinary skill in the art at the time the invention was made to apply the digital CDMA wireless communication of Li to replace the FM modulation communication as taught by Alstatt. Li clearly teaches the device for use in portable implementations such as music and headphone audio reproductions. Li also teaches the outputs/inputs as standard audio jacks. Furthermore, doing so would be simple substitution of one known element (i.e. digital CDMA transmitter/receiver) for another (i.e. analog FM transmitter) to obtain predictable results (i.e. Alstatt w/ a digital transmitter). Additionally, Li discloses a number of advantages of using digital communication in col. 6.

Regarding **Claims 2, 3, 9, 10 and 11**, in addition to the elements stated above regarding claim 1, the combination of Alstatt in view of Li further discloses;

adding a unique user code bit sequence (inherent in CDMA communication; see attached definition of CDMA).

**Claims 4 and 8** are rejected under the same grounds as claim 1 above.

Regarding **Claim 5**, in addition to the elements stated above regarding claim 1, the combination further discloses:

listening while running and activating said digital audio system while running (col. 5 lines 30 – 50).

Regarding **Claim 6**, in addition to the elements stated above regarding claim 2, the combination further discloses:

listening while running and activating said digital audio system while running (col. 5 lines 30 – 50).

**Claim 7** is rejected under the same grounds as claim 6 above.

Regarding **Claim 13**, Alstatt discloses:

A wireless audio system (Fig. 1), comprising:  
at least one audio transmitter operatively coupled to at least one audio source  
(14),

said audio transmitter configured for wireless communication with at least one  
audio receiver (24), said audio receiver comprising:

at least one module adapted to reproduce said generated audio output (26), said audio having been wirelessly transmitted from said at least one audio source (transmission from 14 to 24 shown in fig. 1) virtually free from interference from multiple wireless audio system transmitters operating in the wireless audio system spectrum to a user providing a particular audio receiver user with independent audio in a shared space with other wireless digital audio system users (it is obvious that there can be multiple users of the Alstatt system in the same area; user can adjust the frequency to avoid interference; col. 7 lines 1 - 12), wherein each of said wireless digital audio system users utilize their own independent audio source (i.e. two users in the same area using Fig. 1, each would have their own portable player 10), and their own independent digital transmitter that associates with their own independent receiver. (each receiver will receive the data from the frequency tuned to).

Alstatt fails to disclose

the system as a digital system;

said at least one digital audio transmitter comprising:

a differential phase shift keying (DPSK) module modulating signal of said audio source output and a unique user code bit sequence being configured for code division multiple access (CDMA) communication;

said digital audio receiver comprising:

a direct conversion module configured to capture the correct unique user code bit sequence embedded in the received spread spectrum signal;

a digital demodulator configured for CDMA communication;



a digital-to-analog converter (DAC) generating an audio output; and  
only associating with their own independent receiver.

However, digital CDMA transmissions of audio sources to headphones in devices was notoriously well known in the art. For Example, Li teaches a system providing CDMA communication of digital audio to headphone devices; col. 3 lines 20 – 33.

Replacing the FM transmitter/receiver implementation of Alstatt to use the digital CDMA communication discloses:

the system as a digital system (i.e. digital audio; col. 2 lines 48 – 51); also A/D conversion; col. 3 line 7);

said at least one digital audio transmitter (sending unit 100) comprising:

a module configured for code division multiple access (CDMA) communication and adding a unique user code bit sequence (105, unique user code bit sequence inherent in CDMA);

said at least one audio receiver comprising:

a direct conversion module configured to capture the correct unique user code bit sequence embedded in the received spread spectrum signal (202);

a digital-to-analog converter (DAC) generating an audio output (204); and

only associating with their own independent receiver (i.e. CDMA code channel; cols. 5 and 6 in place of the FM frequency).

It would have been obvious to one of ordinary skill in the art at the time the invention was made to apply the digital CDMA wireless communication of Li to replace the FM modulation communication as taught by Alstatt. Li clearly teaches the device for

use in portable implementations such as music and headphone audio reproductions. Li also teaches the outputs/inputs as standard audio jacks. Furthermore, doing so would be simple substitution of one known element (i.e. digital CDMA transmitter/receiver) for another (i.e. analog FM transmitter) to obtain predictable results (i.e. Alstatt w/ a digital transmitter). Additionally, Li discloses a number of advantages of using digital communication in col. 6.

Additionally, the combination fails to disclose the module as a differential phase shift keying (DPSK) module. However, DPSK modulation is notoriously well known to be used in CDMA communication. It would have been obvious to one of ordinary skill in the art at the time of the invention to apply the DPSK modulation to the CDMA implementation of the combination. One would have been motivated to do so to apply a known technique (i.e. DPSK) to a known device (CDMA transmitter) to yield predictable results (i.e. DPSK in CDMA, Li is silent as to the type of modulation used and it would have been provided predictable results to use any number of known and obvious techniques).

**Claims 15, 17 and 19** are rejected under the same grounds as claim 13 above.

Regarding **Claim 21**, the combination of Alstatt in view of Li discloses all of the claimed elements as shown in the rejection of claim 13.

The combination fails to explicitly disclose:

the modulator as a direct sequence spread spectrum modulator as well as the demodulator configured for DSSS CDMA communication. However, DSSS modulation is notoriously well known to be used in CDMA communication. It would have been obvious to one of ordinary skill in the art at the time of the invention to apply the DSSS modulation to the CDMA implementation of the combination. One would have been motivated to do so to apply a known technique (i.e. DSSS) to a known device (CDMA transmitter) to yield predictable results (i.e. DSSS in CDMA, Li is silent as to the type of modulation used and it would have been provided predictable results to use any number of known and obvious techniques).

**Claims 23 and 25** are rejected under the same grounds as claim 13 above.

**Claims 14, 16, 18, 20, 22, 24, and 26** are rejected under 35 U.S.C. 103(a) as being unpatentable over Alstatt (U.S. Patent 5,771,441) in view of Li (U.S. Patent 6,781,977) and in further view of Lindemann (U.S. Patent Application Publication 2004/0223622).

Regarding **Claim 14, 16, 18, 20, 22, 24 and 26**, in addition to the elements stated above regarding claim 13, 15, 17, 19, 21, 23 and 25, the combination fails to explicitly disclose:

wherein said digital demodulator is operatively coupled to a Viterbi decoder. However, it is notoriously well known in the digital audio/wireless transmission art to use a Viterbi decoder to perform error detection and correction; See Fig. 1 of Lindemann as well as para 59. Applying this teaching to the combination would have been nothing more than applying a known technique (i.e. viterbi decoding) to a known device (wireless digital audio device) ready for improvement to yield predictable results (now the combination has a viterbi decoder to provide some level of error correction).

***Allowable Subject Matter***

Claim 12 is allowed.

***Conclusion***

Applicant's amendment necessitated the new ground(s) of rejection presented in this Office action. Accordingly, **THIS ACTION IS MADE FINAL**. See MPEP § 706.07(a). Applicant is reminded of the extension of time policy as set forth in 37 CFR 1.136(a).

A shortened statutory period for reply to this final action is set to expire **THREE MONTHS** from the mailing date of this action. In the event a first reply is filed within **TWO MONTHS** of the mailing date of this final action and the advisory action is not mailed until after the end of the **THREE-MONTH** shortened statutory period, then the shortened statutory period will expire on the date the advisory action is mailed, and any

extension fee pursuant to 37 CFR 1.136(a) will be calculated from the mailing date of the advisory action. In no event, however, will the statutory period for reply expire later than SIX MONTHS from the date of this final action.

Any inquiry concerning this communication or earlier communications from the examiner should be directed to ANDREW C. FLANDERS whose telephone number is (571)272-7516. The examiner can normally be reached on M-F 8:30 - 5:00.

If attempts to reach the examiner by telephone are unsuccessful, the examiner's supervisor, Curtis Kuntz can be reached on (571) 272-7499. The fax phone number for the organization where this application or proceeding is assigned is 571-273-8300.

Information regarding the status of an application may be obtained from the Patent Application Information Retrieval (PAIR) system. Status information for published applications may be obtained from either Private PAIR or Public PAIR. Status information for unpublished applications is available through Private PAIR only. For more information about the PAIR system, see <http://pair-direct.uspto.gov>. Should you have questions on access to the Private PAIR system, contact the Electronic Business Center (EBC) at 866-217-9197 (toll-free). If you would like assistance from a USPTO Customer Service Representative or access to the automated information system, call 800-786-9199 (IN USA OR CANADA) or 571-272-1000.

/Andrew C Flanders/  
Primary Examiner, Art Unit 2614

<b>Index of Claims</b> 	<b>Application/Control No.</b> 12570343	<b>Applicant(s)/Patent Under Reexamination</b> WOOLFORK, C. EARL
	<b>Examiner</b> ANDREW C FLANDERS	<b>Art Unit</b> 2614

✓	<b>Rejected</b>	-	<b>Cancelled</b>	N	<b>Non-Elected</b>	A	<b>Appeal</b>
=	<b>Allowed</b>	÷	<b>Restricted</b>	I	<b>Interference</b>	O	<b>Objected</b>

Claims renumbered in the same order as presented by applicant
  CPA
  T.D.
  R.1.47

CLAIM		DATE							
Final	Original	01/11/2010	06/01/2010						
	1	✓	✓						
	2	✓	✓						
	3	✓	✓						
	4	✓	✓						
	5	✓	✓						
	6	✓	✓						
	7	✓	✓						
	8	✓	✓						
	9	✓	✓						
	10	✓	✓						
	11	✓	✓						
	12	✓	=						
	13		✓						
	14		✓						
	15		✓						
	16		✓						
	17		✓						
	18		✓						
	19		✓						
	20		✓						
	21		✓						
	22		✓						
	23		✓						
	24		✓						
	25		✓						
	26		✓						

## EAST Search History

## EAST Search History (Prior Art)

Ref #	Hits	Search Query	DBs	Default Operator	Plurals	Time Stamp
L3	1	("7412294").PN.	US-PGPUB; USPAT	OR	OFF	2010/06/01 09:29
L4	3	"12144729"	US-PGPUB; USPAT	OR	OFF	2010/06/01 09:34
S1	9	FHSS with unique with user	US-PGPUB; USPAT	OR	OFF	2007/03/20 09:30
S2	6	S1 and @ad<"20011221"	US-PGPUB; USPAT	OR	OFF	2006/05/02 17:45
S3	0	FHSS with unique adj hop	US-PGPUB; USPAT	OR	OFF	2006/05/02 17:46
S4	0	FHSS with each adj user	US-PGPUB; USPAT	OR	OFF	2006/05/02 17:46
S5	0	FHSS with individual adj user	US-PGPUB; USPAT	OR	OFF	2006/05/02 17:47
S6	0	(FHSS or "frequency hopping spread spectrum") with individual adj user	US-PGPUB; USPAT	OR	OFF	2006/05/02 17:47
S7	0	(FHSS or "frequency hopping spread spectrum") near user same unique	US-PGPUB; USPAT	OR	OFF	2006/05/02 17:47
S8	9	(FHSS or "frequency hopping spread spectrum") with user same unique	US-PGPUB; USPAT	OR	OFF	2006/05/02 17:48
S9	17	(FHSS or "frequency hopping spread spectrum") same unique same user	US-PGPUB; USPAT	OR	OFF	2006/05/02 17:48
S10	6	S9 and @ad<"20011221"	US-PGPUB; USPAT	OR	OFF	2006/05/02 17:48

S11	9	(FHSS or "frequency hopping spread spectrum") same multiple adj user!	US-PGPUB; USPAT	OR	OFF	2006/05/03 10:32
S12	91	(FHSS or "frequency hopping spread spectrum") same (pn or "hopping code")	US-PGPUB; USPAT	OR	OFF	2006/05/02 17:50
S13	13	(FHSS or "frequency hopping spread spectrum") with ("hopping code")	US-PGPUB; USPAT	OR	OFF	2006/05/02 17:50
S14	3	S13 and @ad<"20011221"	US-PGPUB; USPAT	OR	OFF	2006/05/02 17:51
S15	1	("5946343").PN.	US-PGPUB; USPAT	OR	OFF	2006/05/03 11:46
S16	1	("6342844").PN.	US-PGPUB; USPAT	OR	OFF	2006/05/03 11:46
S17	1	("5771441").PN.	US-PGPUB; USPAT	OR	OFF	2006/08/28 15:55
S18	10725	"rechargeable battery" and @ad<"20011220"	US-PGPUB; USPAT	OR	OFF	2006/08/28 15:55
S19	376	"rechargeable battery".ti. and @ad<"20011220"	US-PGPUB; USPAT	OR	OFF	2006/08/28 15:55
S20	17	("rechargeable battery" and portable).ti. and @ad<"20011220"	US-PGPUB; USPAT	OR	OFF	2006/08/28 15:57
S21	3623043	("rechargeable battery" and portable) with mah andd @ad<"20011220"	US-PGPUB; USPAT	OR	OFF	2006/08/28 15:57
S22	0	("rechargeable battery" and portable) with mah and @ad<"20011220"	US-PGPUB; USPAT	OR	OFF	2006/08/28 15:57
S23	3623041	("rechargeable battery" and portable) with ma-h andd @ad<"20011220"	US-PGPUB; USPAT	OR	OFF	2006/08/28 15:57
S24	3623041	("rechargeable battery" and portable) with "ma-h" andd @ad<"20011220"	US-PGPUB; USPAT	OR	OFF	2006/08/28 15:57
S25	0	("rechargeable battery" and portable) with "ma-h" and @ad<"20011220"	US-PGPUB; USPAT	OR	OFF	2006/08/28 15:57



S26	640693	("rechargeable battery" and portable) with milliamp hours and @ad<"20011220"	US-PGPUB; USPAT	OR	OFF	2006/08/28 15:57
S27	18	("rechargeable battery" and portable) and "milliamp hours" and @ad<"20011220"	US-PGPUB; USPAT	OR	OFF	2006/08/31 12:17
S28	29	"5491839"	US-PGPUB; USPAT	OR	OFF	2006/08/30 12:56
S29	1	("5491839").PN.	US-PGPUB; USPAT	OR	OFF	2006/08/30 12:56
S30	1	("5771441").PN.	US-PGPUB; USPAT	OR	OFF	2006/08/30 12:56
S31	1	("6,107,147").PN.	US-PGPUB; USPAT	OR	OFF	2006/08/31 12:17
S32	0	(10/648012).APP.	US-PGPUB; USPAT	OR	OFF	2006/09/25 09:26
S33	1	("5946343").PN.	US-PGPUB; USPAT	OR	OFF	2006/09/25 09:50
S34	422	(455/564.1,412,413).CCLS.	US-PGPUB; USPAT	OR	OFF	2006/09/25 09:50
S35	5294	(375/219,295-297,346,348).CCLS.	US-PGPUB; USPAT	OR	OFF	2006/09/25 10:02
S36	1	("20040223622").PN.	US-PGPUB; USPAT	OR	OFF	2006/09/25 10:04
S37	1	("5946343").PN.	US-PGPUB; USPAT	OR	OFF	2006/09/25 10:05
S38	1	("7,050,419").PN.	US-PGPUB; USPAT	OR	OFF	2007/03/20 09:32
S39	1	("20010025358").PN.	US-PGPUB; USPAT	OR	OFF	2007/03/20 09:37
S40	2618	(375/341,140,147).CCLS.	US-PGPUB; USPAT	OR	OFF	2007/03/20 09:37

S41	1807	S40 and @ad<"20011220"	US-PGPUB; USPAT	OR	OFF	2007/03/20 09:38
S42	8	("2001/0025358").URPN.	USPAT	OR	OFF	2007/03/20 09:51
S43	0	("2002/0025009").URPN.	USPAT	OR	OFF	2007/03/20 09:59
S44	0	("2002/0025009").URPN.	USPAT	OR	OFF	2007/03/20 10:01
S45	12	("20020159543"   "5434623"   "5867532"   "5973642"   "6243423"   "6327314"   "6339612"   "6459728"   "6477210"   "6480554"   "6654429"   "6671338").PN. OR ("7099413").URPN.	US-PGPUB; USPAT; USOCR	OR	OFF	2007/03/20 10:08
S46	74	"band pass" and demodulator and interleaver and "viterbi decoder"	US-PGPUB; USPAT; USOCR	OR	OFF	2007/03/20 10:08
S47	59	S46 and @ad<"20011220"	US-PGPUB; USPAT; USOCR	OR	OFF	2007/03/20 10:08
S48	17	("4278978"   "4635063"   "5175558"   "5493307").PN. OR ("6130643").URPN.	US-PGPUB; USPAT; USOCR	OR	OFF	2007/03/20 10:15
S49	1	("5175558").PN.	US-PGPUB; USPAT	OR	OFF	2007/03/20 10:16
S50	13	("4651155"   "4931977").PN. OR ("5175558"). URPN.	US-PGPUB; USPAT; USOCR	OR	OFF	2007/03/20 10:34
S51	1	("5946343").PN.	US-PGPUB; USPAT	OR	OFF	2007/03/20 11:40
S52	7186	(375/295,146,130,340,316,148).CCLS.	US-PGPUB; USPAT	OR	OFF	2007/03/20 11:41
S53	4473	S52 and @ad<"20011220"	US-PGPUB; USPAT	OR	OFF	2007/03/20 11:41
S54	1	("20040223622").PN.	US-PGPUB; USPAT	OR	OFF	2007/03/21 12:11

S55	5	"reed solomon" with "intersymbol interference"	US-PGPUB; USPAT	OR	OFF	2007/03/21 12:13
S56	30	"reed solomon" same "intersymbol interference"	US-PGPUB; USPAT	OR	OFF	2007/03/21 12:13
S57	21	S56 and @ad<"20011220"	US-PGPUB; USPAT	OR	OFF	2007/03/21 12:27
S58	1	("20030045235").PN.	US-PGPUB; USPAT	OR	OFF	2007/03/21 12:37
S59	1	("5790595").PN.	US-PGPUB; USPAT	OR	OFF	2007/03/21 12:37
S60	2435	((375/262,265,341) or (714/794,795)).CCLS.	US-PGPUB; USPAT	OR	OFF	2007/03/24 09:15
S62	56	"375".clas. and "fuzzy logic"	US-PGPUB; USPAT	OR	OFF	2007/03/26 11:04
S64	1	("4970637").PN.	US-PGPUB; USPAT	OR	OFF	2007/03/28 13:46
S65	755	(audio sound music voice) same (a/d "analog to digital") same (lpf "low pass")	US-PGPUB; USPAT	OR	OFF	2007/03/28 13:46
S66	282	(audio sound music voice) with (a/d "analog to digital") with ((lpf "low pass") and "digital")	US-PGPUB; USPAT	OR	OFF	2007/03/28 13:47
S67	227	(audio sound music voice) with (a/d "analog to digital") with ((lpf "low pass") and "digital") and @ad<"20011221"	US-PGPUB; USPAT	OR	OFF	2007/03/28 15:33
S68	34712	"band pass filter" bpf with "direct conversion receiver"	US-PGPUB; USPAT	OR	OFF	2007/03/28 15:33
S69	35	("band pass filter" bpf) with "direct conversion receiver"	US-PGPUB; USPAT	OR	OFF	2007/03/28 15:33
S70	8	S69 and @ad<"20011221"	US-PGPUB; USPAT	OR	OFF	2007/03/28 15:55
S71	1	("20030045235").PN.	US-PGPUB; USPAT	OR	OFF	2007/03/28 16:16

S72	1	("20040223622").PN.	US-PGPUB; USPAT	OR	OFF	2007/03/28 16:20
S73	1	("5946343").PN.	US-PGPUB; USPAT	OR	OFF	2007/03/28 16:27
S74	364	"64-ary"	US-PGPUB; USPAT	OR	OFF	2007/03/28 16:27
S75	74	"64-ary" near modulat\$4	US-PGPUB; USPAT	OR	OFF	2007/03/28 16:27
S76	46	S75 and @ad<"20011120"	US-PGPUB; USPAT	OR	OFF	2007/03/28 16:27
S77	2	((("4970637") or ("5790595")).PN.	US-PGPUB; USPAT	OR	OFF	2007/07/16 09:58
S78	3	((("4970637") or ("5790595") or ("20040223622")).PN.	US-PGPUB; USPAT	OR	OFF	2007/07/16 09:58
S79	3	("2004/0223622").URPN.	USPAT	OR	OFF	2007/07/16 11:25
S80	1	("5771441").PN.	US-PGPUB; USPAT	OR	OFF	2007/07/16 11:25
S81	60	("2236946"   "2828413"   "2840694"   "3080785"   "3085460"   "3087117"   "3296916"   "3579211"   "3743751"   "3781451"   "3825666"   "3863157"   "3901118"   "3906160"   "4004228"   "4229826"   "4335930"   "4344184"   "4369521"   "4430757"   "4453269"   "4464792"   "4471493"   "4612688"   "4647135"   "4721926"   "4794622"   "4845751"   "4899388"   "4988957"   "5025704"   "5214568").PN. OR ("5771441"). URPN.	US-PGPUB; USPAT; USOCR	OR	OFF	2007/07/16 11:26
S82	2	S81 and cdma	US-PGPUB; USPAT; USOCR	OR	OFF	2007/07/16 11:26

S83	1	("6678892").PN.	US-PGPUB; USPAT	OR	OFF	2008/05/20 11:41
S84	1	("20020072816").PN.	US-PGPUB; USPAT	OR	OFF	2008/05/20 14:24
S85	22	"fuzzy logic" and modulat\$5 and filter and (dpsk "phase shift key")	US-PGPUB; USPAT	OR	OFF	2008/06/06 09:20
S86	0	"455".clas. and "375".clas. and S85	US-PGPUB; USPAT	OR	OFF	2008/06/06 09:21
S87	1	"10100351"	US-PGPUB; USPAT	OR	OFF	2008/06/06 11:49
S88	1	("6,678,892").PN.	US-PGPUB; USPAT	OR	OFF	2008/06/06 12:38
S89	3	("20030021429"   "20030076346"   "6867820").PN.	US-PGPUB; USPAT	OR	OFF	2008/06/06 12:42
S90	13	("4589134"   "4626892"   "5042070"   "5541638"   "5581621"   "5631850"   "5775939"   "6100936"   "6195438").PN. OR ("6867820").URPN.	US-PGPUB; USPAT; USOCR	OR	OFF	2008/06/06 12:43
S91	2	"10648012"	US-PGPUB; USPAT	OR	OFF	2009/02/14 10:23
S92	1	"12144729"	US-PGPUB; USPAT	OR	OFF	2009/02/14 10:31
S93	1	("5790595").PN.	US-PGPUB; USPAT	OR	OFF	2009/02/14 12:36
S94	1	("6678892").PN.	US-PGPUB; USPAT	OR	OFF	2009/02/14 12:37
S95	1	("6678892").PN.	US-PGPUB; USPAT	OR	OFF	2009/05/26 07:51
S96	1680	portable and music and CDMA and transmitter and receiver	US-PGPUB; USPAT	OR	OFF	2009/09/01 11:35

S97	527	portable and music and CDMA and transmitter and receiver and private	US-PGPUB; USPAT	OR	OFF	2009/09/01 11:35
S98	57	portable and music and CDMA and transmitter and receiver and private and "fuzzy logic"	US-PGPUB; USPAT	OR	OFF	2009/09/01 11:35
S99	0	S98 and @ad<"20011221"	US-PGPUB; USPAT	OR	OFF	2009/09/01 11:36
S100	41	S97 and @ad<"20011221"	US-PGPUB; USPAT	OR	OFF	2009/09/01 11:36
S101	1	("6678692").PN.	US-PGPUB; USPAT	OR	OFF	2009/09/01 11:39
S102	1	("6678892").PN.	US-PGPUB; USPAT	OR	OFF	2009/09/01 11:39
S103	25	("5555466"   "5771441"   "6058288"   "6243645"   "6266815"   "6300880"   "6317039").PN. OR ("6678892").URPN.	US-PGPUB; USPAT; USOCR	OR	OFF	2009/09/01 11:39
S104	63	("2236946"   "2828413"   "2840694"   "3080785"   "3085460"   "3087117"   "3296916"   "3579211"   "3743751"   "3781451"   "3825666"   "3863157"   "3901118"   "3906160"   "4004228"   "4229826"   "4335930"   "4344184"   "4369521"   "4430757"   "4453269"   "4464792"   "4471493"   "4612688"   "4647135"   "4721926"   "4794622"   "4845751"   "4899388"   "4988957"   "5025704"   "5214568").PN. OR ("5771441").URPN.	US-PGPUB; USPAT; USOCR	OR	OFF	2009/09/01 11:42
S105	10	("20030045235"   "20040223622"   "5491839"   "5771441"   "5790595"   "5946343"   "6342844"   "6418558"   "6678892"   "6982132").PN.	US-PGPUB; USPAT; USOCR	OR	OFF	2009/09/01 11:42
S106	4453	"fuzzy logic" and @ad<"20011221"	US-PGPUB; USPAT; USOCR	OR	OFF	2009/09/01 11:48

S107	659	S106 and transmitter	US-PGPUB; USPAT; USOCR	OR	OFF	2009/09/01 11:48
S108	591	S106 and portable	US-PGPUB; USPAT; USOCR	OR	OFF	2009/09/01 11:48
S109	4	S106 and portable adj player	US-PGPUB; USPAT; USOCR	OR	OFF	2009/09/01 11:49
S110	0	"fuzzy logic" with reciever	US-PGPUB; USPAT; USOCR	OR	OFF	2009/09/01 11:50
S111	49	"fuzzy logic" with receiver	US-PGPUB; USPAT; USOCR	OR	OFF	2009/09/01 11:50
S112	27	S111 and @ad<"20011221"	US-PGPUB; USPAT	OR	OFF	2009/09/01 11:50
S113	192	"fuzzy logic" same receiver	US-PGPUB; USPAT; USOCR	OR	OFF	2009/09/01 11:51
S114	72	S113 and @ad<"20011221"	US-PGPUB; USPAT	OR	OFF	2009/09/01 11:52
S115	71	("4019141"   "4229829"   "5264795"   "5404577"   "5437057"   "5568516"   "5694467"   "5771438"   "5771441"   "5867223"   "5978689"   "6006115").PN. OR ("6424820").URPN.	US-PGPUB; USPAT; USOCR	OR	OFF	2009/09/02 11:27
S116	34	S115 and @ad<"20011221"	US-PGPUB; USPAT	OR	OFF	2009/09/02 11:28
S117	31	bluetooth with (headphone headset earphone "head phone" "head set" "ear phone") with cdma	US-PGPUB; USPAT	OR	OFF	2009/09/02 11:32
S118	2	S117 and @ad<"20011221"	US-PGPUB; USPAT	OR	OFF	2009/09/02 11:32
S119	32	wireless with (headphone headset earphone "head phone" "head set" "ear phone") with cdma	US-PGPUB; USPAT	OR	OFF	2009/09/02 11:33

S120	3	S119 and @ad<"20011221"	US-PGPUB; USPAT	OR	OFF	2009/09/02 11:33
S121	57	(headphone headset earphone "head phone" "head set" "ear phone") with cdma	US-PGPUB; USPAT	OR	OFF	2009/09/02 11:34
S122	10	S121 and @ad<"20011221"	US-PGPUB; USPAT	OR	OFF	2009/09/02 11:34
S123	0	WO0056093	US-PGPUB; USPAT	OR	OFF	2009/09/02 11:36
S124	0	WO0056093	US-PGPUB; USPAT; USOCR; FPRS; EPO; JPO; DERWENT; IBM_TDB	OR	OFF	2009/09/02 11:37
S125	0	WO/0056093	US-PGPUB; USPAT; USOCR; FPRS; EPO; JPO; DERWENT; IBM_TDB	OR	OFF	2009/09/02 11:37
S126	2	((("5781542") or ("5799005")).PN.	US-PGPUB; USPAT	OR	OFF	2009/09/02 11:42
S127	1	("6199076").PN.	US-PGPUB; USPAT	OR	OFF	2009/09/02 13:51
S128	0	woolfork-earl.in.	US-PGPUB; USPAT	OR	OFF	2009/11/23 11:44
S129	3	woolfork-c-\$.in.	US-PGPUB; USPAT	OR	OFF	2009/11/23 11:44
S139	1	("7412294").PN.	US-PGPUB; USPAT	OR	OFF	2010/01/11 12:21

## EAST Search History (Interference)



Ref #	Hits	Search Query	DBs	Default Operator	Plurals	Time Stamp
S130	0	woolfork-earl.in.	USPAT; UPAD	OR	OFF	2009/11/23 11:44
S131	1	woolfork-c-\$.in.	USPAT; UPAD	OR	OFF	2009/11/23 11:44
S132	195	(700/94).CCLS.	UPAD	OR	OFF	2009/11/23 11:59
S133	225	((700/94) or (455/3.06)).CCLS.	UPAD	OR	OFF	2010/01/11 11:18

6/ 1/ 2010 10:11:17 AM

C:\Documents and Settings\aflanders\My Documents\EAST\Workspaces\12570343.wsp

<b>Search Notes</b>  	<b>Application/Control No.</b>  12570343	<b>Applicant(s)/Patent Under Reexamination</b>  WOOLFORK, C. EARL
	<b>Examiner</b>  ANDREW C FLANDERS	<b>Art Unit</b>  2614

<b>SEARCHED</b>			
<b>Class</b>	<b>Subclass</b>	<b>Date</b>	<b>Examiner</b>

<b>SEARCH NOTES</b>		
<b>Search Notes</b>	<b>Date</b>	<b>Examiner</b>
Reviewed and repeated search history (including class search) of Parent Application 12/144,729	1/11/10	acf
eDan EAST and PALM inventor search for double patenting	1/11/10	acf
updated	6/1/10	acf

<b>INTERFERENCE SEARCH</b>			
<b>Class</b>	<b>Subclass</b>	<b>Date</b>	<b>Examiner</b>

	/ANDREW C FLANDERS/ Primary Examiner. Art Unit 2614
--	--

Doc code: RCEX

Doc description: Request for Continued Examination (RCE)

PTO/SB/30EFS (07-09)

Approved for use through 07/31/2012. OMB 0851-0031

U.S. Patent and Trademark Office; U.S. DEPARTMENT OF COMMERCE

Under the Paperwork Reduction Act of 1995, no persons are required to respond to a collection of information unless it contains a valid OMB control number.

### REQUEST FOR CONTINUED EXAMINATION(RCE)TRANSMITTAL (Submitted Only via EFS-Web)

Application Number	12570343	Filing Date	2009-09-30	Docket Number (if applicable)	1028.4	Art Unit	2614
First Named Inventor	C. Earl Woolfork			Examiner Name	Andrew C. Flanders		

**This is a Request for Continued Examination (RCE) under 37 CFR 1.114 of the above-identified application.**  
 Request for Continued Examination (RCE) practice under 37 CFR 1.114 does not apply to any utility or plant application filed prior to June 8, 1995, or to any design application. The Instruction Sheet for this form is located at WWW.USPTO.GOV

#### SUBMISSION REQUIRED UNDER 37 CFR 1.114

Note: If the RCE is proper, any previously filed unentered amendments and amendments enclosed with the RCE will be entered in the order in which they were filed unless applicant instructs otherwise. If applicant does not wish to have any previously filed unentered amendment(s) entered, applicant must request non-entry of such amendment(s).

Previously submitted. If a final Office action is outstanding, any amendments filed after the final Office action may be considered as a submission even if this box is not checked.

Consider the arguments in the Appeal Brief or Reply Brief previously filed on \_\_\_\_\_

Other \_\_\_\_\_

Enclosed

Amendment/Reply

Information Disclosure Statement (IDS)

Affidavit(s)/ Declaration(s)

Other \_\_\_\_\_

#### MISCELLANEOUS

Suspension of action on the above-identified application is requested under 37 CFR 1.103(c) for a period of months \_\_\_\_\_  
 (Period of suspension shall not exceed 3 months; Fee under 37 CFR 1.17(i) required)

Other \_\_\_\_\_

#### FEES

**The RCE fee under 37 CFR 1.17(e) is required by 37 CFR 1.114 when the RCE is filed.**

The Director is hereby authorized to charge any underpayment of fees, or credit any overpayments, to Deposit Account No 504576

#### SIGNATURE OF APPLICANT, ATTORNEY, OR AGENT REQUIRED

Patent Practitioner Signature

Applicant Signature

Doc code: RCEX

Doc description: Request for Continued Examination (RCE)

PTO/SB/30EFS (07-09)

Approved for use through 07/31/2012. OMB 0651-0031

U.S. Patent and Trademark Office; U.S. DEPARTMENT OF COMMERCE

Under the Paperwork Reduction Act of 1995, no persons are required to respond to a collection of information unless it contains a valid OMB control number.

Signature of Registered U.S. Patent Practitioner			
Signature	/Megan Lyman/	Date (YYYY-MM-DD)	2010-08-04
Name	Megan Lyman	Registration Number	57054

This collection of information is required by 37 CFR 1.114. The information is required to obtain or retain a benefit by the public which is to file (and by the USPTO to process) an application. Confidentiality is governed by 35 U.S.C. 122 and 37 CFR 1.11 and 1.14. This collection is estimated to take 12 minutes to complete, including gathering, preparing, and submitting the completed application form to the USPTO. Time will vary depending upon the individual case. Any comments on the amount of time you require to complete this form and/or suggestions for reducing this burden, should be sent to the Chief Information Officer, U.S. Patent and Trademark Office, U.S. Department of Commerce, P.O. Box 1450, Alexandria, VA 22313-1450.

*If you need assistance in completing the form, call 1-800-PTO-9199 and select option 2.*

## Privacy Act Statement

The Privacy Act of 1974 (P.L. 93-579) requires that you be given certain information in connection with your submission of the attached form related to a patent application or patent. Accordingly, pursuant to the requirements of the Act, please be advised that: (1) the general authority for the collection of this information is 35 U.S.C. 2(b)(2); (2) furnishing of the information solicited is voluntary; and (3) the principal purpose for which the information is used by the U.S. Patent and Trademark Office is to process and/or examine your submission related to a patent application or patent. If you do not furnish the requested information, the U.S. Patent and Trademark Office may not be able to process and/or examine your submission, which may result in termination of proceedings or abandonment of the application or expiration of the patent.

The information provided by you in this form will be subject to the following routine uses:

1. The information on this form will be treated confidentially to the extent allowed under the Freedom of Information Act (5 U.S.C. 552) and the Privacy Act (5 U.S.C. 552a). Records from this system of records may be disclosed to the Department of Justice to determine whether the Freedom of Information Act requires disclosure of these records.
2. A record from this system of records may be disclosed, as a routine use, in the course of presenting evidence to a court, magistrate, or administrative tribunal, including disclosures to opposing counsel in the course of settlement negotiations.
3. A record in this system of records may be disclosed, as a routine use, to a Member of Congress submitting a request involving an individual, to whom the record pertains, when the individual has requested assistance from the Member with respect to the subject matter of the record.
4. A record in this system of records may be disclosed, as a routine use, to a contractor of the Agency having need for the information in order to perform a contract. Recipients of information shall be required to comply with the requirements of the Privacy Act of 1974, as amended, pursuant to 5 U.S.C. 552a(m).
5. A record related to an International Application filed under the Patent Cooperation Treaty in this system of records may be disclosed, as a routine use, to the International Bureau of the World Intellectual Property Organization, pursuant to the Patent Cooperation Treaty.
6. A record in this system of records may be disclosed, as a routine use, to another federal agency for purposes of National Security review (35 U.S.C. 181) and for review pursuant to the Atomic Energy Act (42 U.S.C. 218(c)).
7. A record from this system of records may be disclosed, as a routine use, to the Administrator, General Services, or his/her designee, during an inspection of records conducted by GSA as part of that agency's responsibility to recommend improvements in records management practices and programs, under authority of 44 U.S.C. 2904 and 2906. Such disclosure shall be made in accordance with the GSA regulations governing inspection of records for this purpose, and any other relevant (i.e., GSA or Commerce) directive. Such disclosure shall not be used to make determinations about individuals.
8. A record from this system of records may be disclosed, as a routine use, to the public after either publication of the application pursuant to 35 U.S.C. 122(b) or issuance of a patent pursuant to 35 U.S.C. 151. Further, a record may be disclosed, subject to the limitations of 37 CFR 1.14, as a routine use, to the public if the record was filed in an application which became abandoned or in which the proceedings were terminated and which application is referenced by either a published application, an application open to public inspections or an issued patent.
9. A record from this system of records may be disclosed, as a routine use, to a Federal, State, or local law enforcement agency, if the USPTO becomes aware of a violation or potential violation of law or regulation.

**REQUEST FOR REEXAMINATION AND RESPONSE TO THE FINAL  
REJECTION DATED 06/07/10**

**RESPONSE TO REJECTION OF CLAIMS 1 -11, 13-26 UNDER 35 U.S.C. 103**

A finding of obviousness requires that “the differences between the subject matter sought to be patented and the prior art are such that the subject matter as a whole would have been obvious at the time the invention was made to a person having ordinary skill in the art to which the subject matter pertain.” 35 U.S.C. §103(a). In *KSR Int’l Co. v. Teleflex, Inc.*, 127 S. Ct. 1727, 82 USPQ2d 1385 (2007), the Supreme Court stated that the factors set forth in *Graham v. John Deere Co.*, 383 U.S. 1, 148 USPQ 459 (1966), control an obviousness inquiry: (1) the scope and content of the prior art; (2) the differences between the prior art and the claimed invention; (3) the level of ordinary skill in the art; and (4) objective evidence of nonobviousness. *KSR*, 127 S. Ct. at 1734, 82 USPQ2d at 1388 (quoting *Graham*, 383 U.S. at 17-18, 14 USPQ at 467).

The *KSR* Court rejected a rigid application of the "teaching, suggestion, or motivation [TSM]" test previously applied by the Court of Appeals for the Federal Circuit. *KSR*, 127 S. Ct. at 1739 USPQ2d at 1395. However, the Supreme Court affirmed that it is "important to identify a reason that would have prompted a person of ordinary skill in the relevant field to combine the elements in the way the claimed new invention does...because inventions in most, if not all, instances rely upon building blocks long since uncovered, and claimed discoveries almost of necessity will be combinations of what, in some sense, is already known." *KSR*, 127 S. Ct. at 1741, 82 USPQ2d at 1396. Once the *Graham* factors have been addressed, the Examiner may apply the TSM test, asking whether (1) a teaching, suggestion or motivation exists in the prior art to combine the references cited, and (2) one skilled in the art would have a reasonable expectation of success. *See* USPTO Guidelines at 57534.

Further, in order to establish *prima facie* obviousness of a claimed invention, all the claim limitations must be taught or suggested by the prior art. *In re Royka*, 490 F.2d 981, 180 USPQ 580 (CCPA 1974). Additionally, in considering a prior art reference, the reference must be considered in its entirety, *i.e.*, as a whole, including portions that would lead away from the claimed invention. *WL Gore & Associates, Inc. v. Garlock, Inc.*, 721 F.2d 1540, 220 USPQ 303 (Fed. Cir. 1983), cert. denied, 469 U.S. 851 (1984). Moreover,

it is improper to combine references where the references teach away from their combination. *In re Grasselli*, 713 F.2d 731,743,218 USPQ 769, 779 (Fed. Cir. 1983). Indeed, "an applicant may rebut a prima facie case of obviousness by showing that the prior art teaches away from the claimed invention *in any material respect.*" *In re Peterson*, 315 F.3d 1325, 1331 (Fed. Cir. 2003) (Emphasis added).

Moreover, a prior art reference is only appropriate where the "invention as a whole would be obvious to a person of ordinary skill in the field." *In re Kumar*, 418 F.3d 1361, 76 USPQ2d 1048, 1053 (Fed. Cir. 2005).

*Claims 1-11, 13, 15, 17, 19, 21, 23 and 25 rejected as unpatentable over Altstatt in view of Li*

The obviousness rejection is that the digital wireless communication of Li could be replaced by the FM modulation communication taught in Altstatt. Li is cited for teaching a device for use in portable implementations. It is stated that doing so is the substitution of one known element (i.e., the digital CDMA transmitter/receiver) for another (i.e., analog FM transmitter) to obtain predictable results. The Applicant respectfully disagrees.

Altstatt does not disclose a direct one-to-one digital transmitter-to-headphone communication link. Thus, Altstatt cannot realize the benefits of such a digital link as asserted (Examiner Office Action Mailed 08-09-2005, page 6: "However the system of Altstatt is an analog transmission system that, in operation, lacks the benefits of a digitally encoded and transmitted audio signal" and Office Action Mailed 05-17-2006, page 6 and Office Action Mailed 10-02-2006, page 10: "However, the system of Altstatt an analog transmission system that, operation lacks the benefits digitally encoded and transmitted audio signal."). Additionally, Li clearly discloses a cellular communication system (Li col. 1 lns. 57 – 63 "CDMA digital cellular communications system . . .," col. 6 lns. 55 – 62 "IMT 2000 . . . IS95 . . . CDMA 2000). IMT 2000, IS95 and CDMA 2000 are all cellular (i.e., cell phone) standards and each requires the centralized control of a base station for operation. Li's centralized control base station system does not disclose a direct one-to-one transmitter-to-headphone communication link.

Applying “the digital CDMA wireless communication of Li to replace the FM modulation communication as taught by Alstatt,” as stated on page 6 of the Final Rejection (FRJ) mailed 06/07/2010, *requires* the centralized control of the cellular base station taught by Li (Li col. 7 lns. 9 – 17 “The exchange or the service-providing unit of the mobile net can store various multichannel sounds needed by users, e.g. a great amount of MP3 music data. On request of users, the exchange or the service-providing unit of the mobile net sends the suitable data to the wideband CDMA base station, by which the multichannel data, e.g. MP3 music data, is transmitted to the multichannel mobile equipment through the radio interface of the wideband CDMA). Li teaches the cellular base station approach for “bi-directional” sound communication and interference suppression (Li col. 1 lns. 57 – 63 “CDMA digital cellular communications system can, with large system capacity only restricted by interference ... providing bi-directional ... sound.”). As a result, the Altstatt/Li combination stated in the FRJ requires the cellular base station to meet the interference mitigation claim language “virtually free from interference from device transmitted signals operating in the portable wireless digital audio system spectrum” as found in Claims 3-5, 9, 10, 13, 14, 21 and 23.

Regarding Claim 1, page 5 of the FRJ suggests the Altstatt/Li combination obviates the invention by “Replacing the FM transmitter/receiver implementation of Alstatt to use the digital CDMA communication,”. Page 6 of the FRJ continues with “sending unit 100”/receiving unit 200 representing the invention’s digital audio transmitter/receiver respectively. This Altstatt/Li combination fails to obviate the invention based on at least the following. The following explanation is applicable not only to Claim 1, but to the other remaining Claims (2-11, and 13, 15, 17, 21, and 23) that stand rejected under the Altstatt/Li combination.

Moreover, for Li’s sending unit 100 to communicate with receiving unit 200 without interference anomalies, the centralized control of a base station is required (Li col. 1 lns. 57 – 63, col. 6 lns. 55 – 62 and Li col. 7 lns. 9 – 17 as referenced above), especially when there exists at least one other “sending unit 100” in the vicinity. The Altstatt/Li combination does not suggest a portable audio system that includes a mobile transmitter and mobile receiver with a distributed architecture to one of ordinary skill.



Indeed there is no motivation for one of ordinary skill to combine Altstatt and Li as the end product would not suggest the present invention.

To further support this position, the Examiner is referred to the underlined portion of Exhibit I (herein attached) “From WPANs to Personal Networks Technologies and Applications” where it is stated: “A wireless network can be distributed or centralized. Distributed networks are those where each device accesses the medium individually and transmits the data without any central control . . . . Centralized network architecture has one network element, which controls the communication of various devices.” The claim language “configured for independent CDMA communication operation” (as seen in Claims 1, 3-9, 13, 15, 21, and 23) reflects the distributed architecture and is supported by the specification of 10/027,391 application in paragraph 0016. (“This ... (CDMA) may be used to provide each user independent operation.” (as well as other portions of the specification)).

Within the invention, the task of each receiver, among other things, is to mitigate interference in the vicinity in order to receive the correct transmission successfully. Thus, the direct conversion receiver (DCR) disclosed in the present invention (as recited in Claims 3-7, 9, 10, 13, 15, 17, 21, and 23) utilizes, among other things, “timing and synchronization to capture the correct bit sequence embedded in the received spread spectrum signal” (Parent Application 10/027,391 paragraph 0015). Further support for this language is contained in paragraph 0016 of the 10/027,391 application, where it states: “Other code words from wireless digital audio systems 10 may appear as noise to a particular audio receiver 50. This may also be true for other device transmitted signals operating in the wireless digital audio system 10 spectrum.” Moreover, Patent 7,412,294 col. 3 lns. 32-34 state: “The battery powered transmitter 20 sends the audio music information to the battery powered receiver 50 in digital packet format.”

When packets are communicated over a wireless link it may be referred to as packet radio. The underlined section of the text “Wireless Communications Principles & Practice” has been provided for clarification. (please see Exhibit II: “... called packet radio when used over a wireless link . . . . This benefit is valuable for the case of mobile services where the available bandwidth is limited. The packet radio approach supports intelligent protocols for data flow control and retransmission, which can provide highly

reliable transfer in degraded channel conditions.”). While other code words and/or other device transmitted signals are in the vicinity they can create associated noise channel conditions at the receiver that may prevent the capture of the packet with the correct bit sequence. Based on the above disclosures, it is clear that both intended and unintended spread spectrum packet signals can appear at the receiver, but only the packet with the correct bit sequence is captured by the DCR. Moreover, there exists several data delivery types (for clarification, please see section 16.2.1, of the book from Vijay Garg entitled Wireless Communications and Networking, (relative to the CDMA2000 cellular communication taught by Li) accessible on the following Google books website: [http://books.google.com/books?id=UE2wEc9NfB8C&pg=PA544&lpg=PA544&dq=cdma2000+isdn&source=bl&ots=pB26cq6oLc&sig=nzlcT7D4Q\\_P-KFMduSkb9b5015s&hl=en&ei=lZw8TKzcHZL4swOg0uDaCg&sa=X&oi=book\\_result&ct=result&resnum=2&ved=0CBoQ6AEwAQ#v=onepage&q=cdma2000%20isdn&f=false](http://books.google.com/books?id=UE2wEc9NfB8C&pg=PA544&lpg=PA544&dq=cdma2000+isdn&source=bl&ots=pB26cq6oLc&sig=nzlcT7D4Q_P-KFMduSkb9b5015s&hl=en&ei=lZw8TKzcHZL4swOg0uDaCg&sa=X&oi=book_result&ct=result&resnum=2&ved=0CBoQ6AEwAQ#v=onepage&q=cdma2000%20isdn&f=false)).

That source states: “End user data-bearing services. Services that deliver any form of data on behalf of the mobile end user, including packet data (e.g., IP service), circuit switched data services (e.g., B-ISDN emulation services), and SMS. Packet data services conform to industry standard connection-oriented and connectionless packet data including IP-based protocols (e.g., transmission control protocol (TCP) and user data protocol (UDP) and OSI connectionless interworking protocol (CLIP)). Circuit-switched data services that emulate international standards-defined, connection-oriented services such as asynchronous (async) dial-up access, fax, V.120 rate-adapted ISDN, and B-ISDN services.” Of these data delivery types available, the Altstatt/Li combination does not disclose or suggest a digital packet format for audio information as is included in the claim language and does not obviate the invention. The digital packet claim language is recited in Claims 1-7, 9, 10, 13, 15, 17, 21, and 23.

Moreover, within the scope of the invention (based on paragraphs 0015 and 0016 of the 10/027,391 application, as well as Patent 7,412,294 column 3 lines 32-34), the DCR accounts for, among other things, (1) relevant timing metrics to capture the packet with the correct bit sequence embedded in the received spread spectrum signal within a in-motion transmitter, in-motion receiver, distributed architecture and (2) relevant

synchronization metrics to capture the packet with the correct bit sequence embedded in the received spread spectrum signal within a in-motion transmitter, in-motion receiver, distributed architecture. Claims 3, 5, 9, 10, 13, 15, 21, and 23 recite the “direct conversion module configured to capture packets . . . .” It should be noted that synchronization includes forms of acquisition and tracking (please reference underlined section of Exhibit III taken from “Digital Communications Techniques Signal Design and Detection”). As a result, timing and synchronization, to capture the intended signal components, has been disclosed and broadly covers all types of timing and synchronization distributed architecture techniques to perform such a task.

Regarding Claim 13, the Altstatt/Li combination does not disclose a direct conversion receiver (DCR) as stated on page 9 in the FRJ where Li’s element “(202)” is referenced. There is no evidence that Li’s item 202 (“wideband CDMA demodulator”) is a DCR. The DCR disclosed in the present invention, among other things, performs direct down conversion from radio frequency (RF) to baseband (or very near baseband), thus, omitting intermediate frequency (IF) down conversion components that are often used. The invention utilizes the DCR for, among other things, down conversion from RF-to-baseband (or very near baseband), eliminating unnecessary IF components, which reduces the size and power consumption of the module. The Altstatt/Li combination does not disclose a DCR nor does it suggest the use of a DCR within the invention. Because one of ordinary skill would not look to Alstatt and Li to create the present invention with any reasonable expectation of success, the obviousness rejection should be removed.

In addition, the use of the DCR in the invention, suppresses aliasing noise effects by use of the anti-aliasing filters (typically low pass filters or some version thereof) located within the DCR, thus, aiding to preserve the fidelity of the transmitted high quality audio signal. The Altstatt/Li combination does not teach or suggest a DCR, thus, cannot realize the benefits of the claim language “a direct conversion module configured to capture the packet with the correct bit sequence embedded in the received spread spectrum signal.” (contained in Claims 3-7, 9, 10, 13, 15, 17, 21, and 23). Neither Li, Altstatt, Lindemann (Lindemann discloses in paragraph 0057 “In the RF receiver embodiment of FIG. 3, . . . , The RF Downconverter 302 modulates the RF signal, using a sinusoid generated by the RF VCO 310, *down to IF frequency*. The *IF signal is further*

*down modulated* by the IF Demodulator 303. The output of the IF Demodulator is a complex signal consisting of I and Q--real, imaginary--running at the Chip Rate”) nor any combination of the three teach, suggest, or disclose the DCR of the present invention. Claims 3-7, 9, 10, 13, 15, 17, 21, and 23 should be in allowance on the presence of the DCR alone.

Finally, intersymbol interference (ISI) distorts the audio signal content, causing a major obstacle to the transmission of high data rate audio from an in-motion transmitter to an in-motion receiver. Referring to the underlined sections of the Exhibit IV text “Adaptive Filter Theory,” Second Edition, by Simon Haykin, ISI “is caused by dispersion in the transmit filter, the transmission medium, and the receive filter ... we usually find that intersymbol interference is the chief determining factor in the design of high-data rate transmission systems ... intersymbol interference, if left unchecked, can result in erroneous decisions when the sampled signal at the channel output is compared with some preassigned threshold by means of a decision device.”

Within the present invention, both the digital audio transmitter and digital audio receiver may be in motion (see Claims 1, 3, 5, 6, 7, 8, 10, 15, 17, and 23), thus, the relative position and velocity of both the transmitter and receiver (both in-motion transmitter and in-motion receiver present spatial and temporal variations) will be constantly changing (e.g., a person running with the wireless digital audio system). Because ISI results when the in-motion digital audio transmitter attempts to communicate high symbol rate audio to the in-motion digital audio receiver, ISI must be suppressed. The present invention mitigates ISI to maintain fidelity of the high data rate audio signal while the in-motion transmitter is in communication with the in-motion receiver. The ISI mitigation is performed by, among other things, the claimed encoder (“an encoder with means to encode said original audio signal representation to reduce intersymbol interference”) and decoder (“a decoder with means to decode the applied reduced intersymbol interference coding of said original audio signal representation”) (Claims 3, 5, 6, 7,9-11, 13, and 21). The Altstatt/Li combination does not disclose or suggest an encoder/decoder pair for the reduction of ISI within an in-motion transmitter and in-motion receiver high symbol rate audio system. The claims should be in allowance on the presence of the encoder and decoder language alone.

These explanations and amendments remove the obviousness arguments for all remaining Claims 1-11, and 13, 15, 17, 21, and 23. Thus, for at least the reasons provided above, the prior art references are deficient in suggesting that their combination could produce the present invention, and the remaining Claims should be in allowance.

Without assenting to the rejections, the applicant has cancelled claims 14, 16, 18-20, 22, and 24-26.

August 3, 2010

Respectfully Submitted,

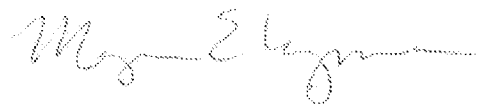
A handwritten signature in cursive script, appearing to read "Megan E. Lyman".

Megan E. Lyman, Registration No. 57,054  
1816 Silver Mist Ct.  
Raleigh, NC 27613  
(919) 341-4023

# EXHIBIT I

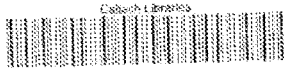

3 5047 01842 1966

universal personal communications

Ramjee Prasad  
Luc Deneire

From

**WPANs**

to

**Personal Networks**

Technologies and Applications

## 2.2 MAC in WLAN Standards

The MAC protocols form the basis of efficient use of a channel, be it wireline or wireless. When numerous users desire to transmit in a channel at the same time, conflicts occur, so there must be procedures on how the available channel capacity is allocated. These procedures constitute the MAC protocol rules each user has to follow in accessing the common channel [30]. The channel thus becomes a shared resource whose allocation is critical for proper functioning of the network. With the boom of WLANs, an efficient MAC has become a must.

Before designing an appropriate MAC protocol, one has to understand the wireless network under discussion [30–32]. The first thing that should be understood is the duplexing scheme used by a system and also the network architecture. A MAC protocol is dependent on these two issues.

Duplexing refers to mechanisms for wireless devices to send and receive. There are two duplexing methods, time based or frequency based. Sending and receiving data in the same frequency at different time periods is known as time division duplex (TDD), while sending and receiving data in same time and different frequency is known as frequency division duplex (FDD).

A wireless network can be distributed or centralized. Distributed networks are those where each device accesses the medium individually and transmits the data without any central control. Distributed network architecture requires the same frequency and thus makes use of TDD. IEEE 802.11 is an example of distributed network architecture. Centralized network architecture has one network element, which controls the communication of various devices. Such network architecture can make use of both TDD and FDD. HIPERLAN/2 is an example of centralized network architecture.

In the following sections the MAC protocols in IEEE 802.11 [33, 34] and HIPERLAN/2 [35, 36] are discussed. IEEE 802.11 is the most commonly used WLAN, and it is explained in more detail.

### 2.2.1 IEEE 802.11

Standardization of IEEE 802.11 was done to satisfy the needs of wireless data networking. CSMA/CA was the MAC protocol adopted by IEEE 802.11 [3, 10]. Wherein, the basic channel access method is random back-off CSMA with a MAC-level acknowledgment. A CSMA protocol requires the STA to listen before talk. In this protocol only one user can access the medium at a time while the system is mostly used for low data rate applications (Internet access, e-mail, and so forth). The IEEE 802.11 basic medium access behavior allows interoperability between compatible PHYs through the use of the CSMA/CA protocol and a random back-off time following a busy medium condition. In addition, all traffic uses immediate positive acknowledgment (ACK frame), where the sender

schedules a retransmission if no ACK protocol is designed to reduce the cost of accessing the medium at the point of collision. Collisions are most likely to occur (i.e., just after busy medium condition). A random back-off arrangement is used to reduce the probability of collision. IEEE 802.11 MAC also describes a CSMA protocol with regular intervals (like 100 ms) to enable stations to scan for other APs on any available channel. A station may decide on the best-suited channel based on special functional behavior for the first time. The MAC also gives a set of management frames via request-to-send/clear-to-send (RTS/CTS) for time-bounded service coordination (for time-bounded service).

The MAC sublayer is responsible for the protocol data unit (PDU) addressing, fragmentation and reassembly. The transmission mode exclusively, requiring contention mode, known as the contention period (CFP). During the CFP, each station may attempt to transmit, thereby eliminating the need for a central controller. IEEE 802.11 supports three different types of frames. The management frames are used for the AP, timing and synchronization. Control frames are used for handshaking and acknowledgments during the CFP and to ensure successful transmission of data during the CFP and to ensure successful acknowledgments during the CFP.

Since the contention-free mode of IEEE 802.11 is not discussed in this chapter, the MAC and not IEEE 802.11, respectively, are presented.

#### 2.2.1.1 Distributed Coordination Function (DCF)

The DCF is the fundamental MAC protocol for transfer on a best effort basis [10]. In this mode, all stations must be able to access the network, and it either



# EXHIBIT II

# WIRELESS

communications

Principles & Practice

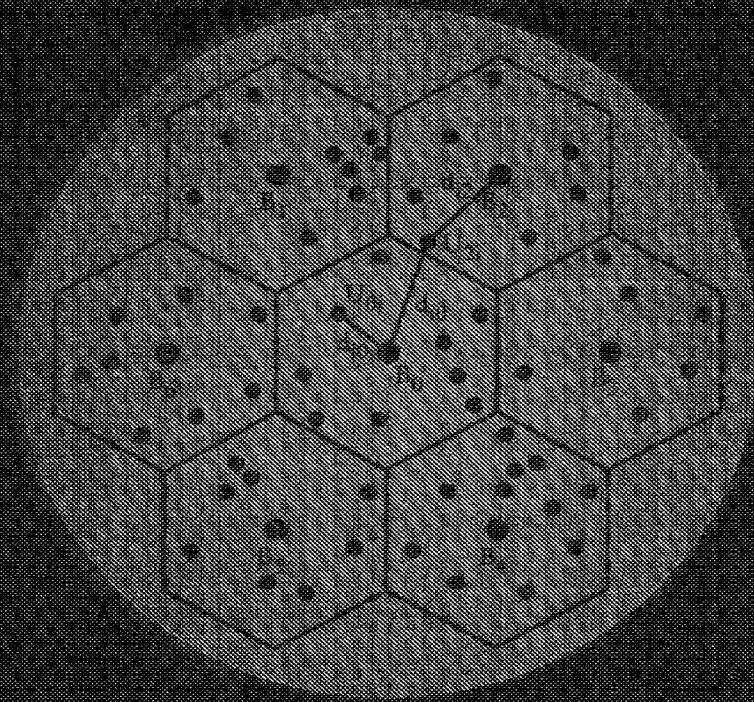

Theodore S. Rappaport

Figure 9.7 illustrates the sequential format of a packet transmission. The packet consists of header information, the user data, and a trailer. The header specifies the beginning of a new packet and contains the source address, destination address, packet sequence number, and other routing and billing information. The user data contains information which is generally protected with error control coding. The trailer contains a cyclic redundancy checksum which is used for error detection at the receiver.

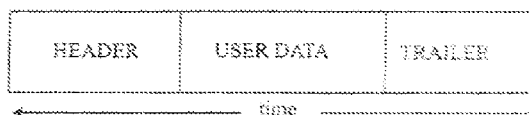

Figure 9.7  
Packet data format.

Figure 9.8 shows the structure of a transmitted packet, which typically consists of five fields: the flag bits, the address field, the control field, the information field, and the frame check sequence field. The flag bits are specific (or reserved) bit sequences that indicate the beginning and end of each packet. The address field contains the source and the destination address for transmitting messages and for receiving acknowledgments. The control field defines functions such as transfer of acknowledgments, automatic repeat requests (ARQ), and packet sequencing. The information field contains the user data and may have variable length. The final field is the frame check sequence field or the CRC (Cyclic Redundancy Check) that is used for error detection.

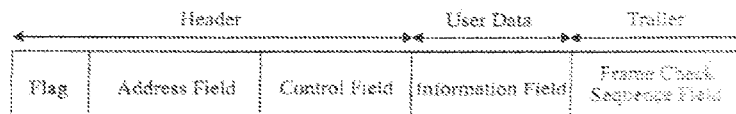

Figure 9.8  
Fields in a typical packet of data.

In contrast to circuit switching, packet switching (also called packet radio when used over a wireless link) provides excellent channel efficiency for bursty data transmissions of short length. An advantage of packet-switched data is that the channel is utilized only when sending or receiving bursts of information. This benefit is valuable for the case of mobile services where the available bandwidth is limited. The packet radio approach supports intelligent protocols for data flow control and retransmission, which can provide highly reliable transfer in degraded channel conditions. X.25 is a widely used packet radio protocol that defines a data interface for packet switching [Ber92], [Tan91].

# EXHIBIT III

# DIGITAL COMMUNICATION TECHNIQUES

## Signal Design and Detection

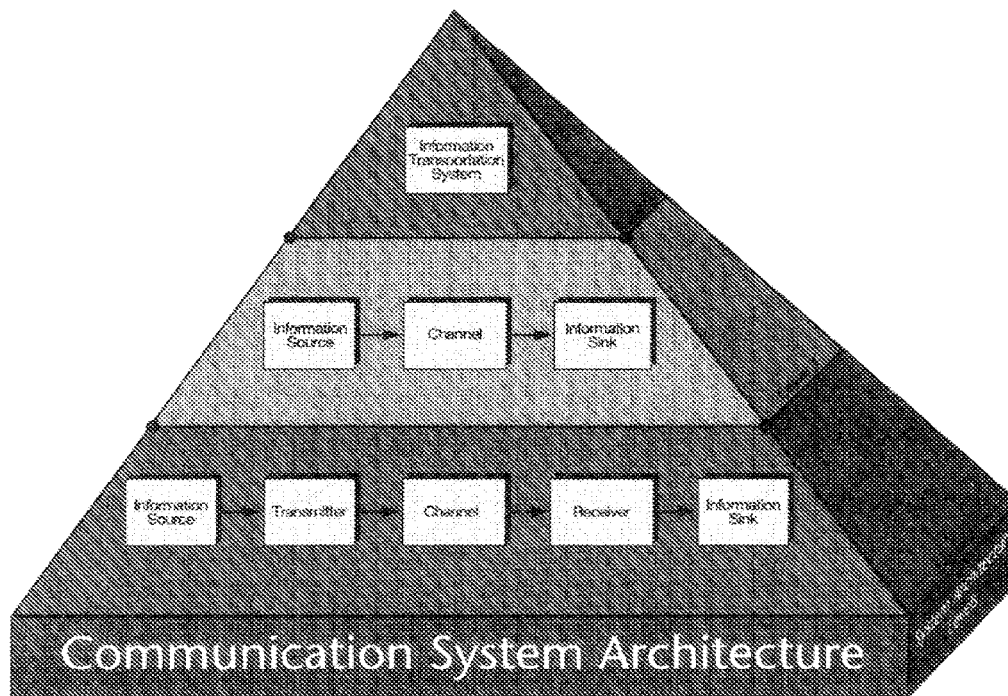

Marvin K. Simon • Sami M. Hinedi • William C. Lindsey

optimum receivers. The choice of the modulation scheme from the "simple" *binary phase shift keying* (BPSK) to the more "elaborate" *quadrature amplitude modulations* (QAM) is essential in trading channel bandwidth and achievable bit error rate for a given and fixed transmitted signal power. The *synchronization function* is fundamental in operating any communication link. At the receiving site, various timing and phase references are needed and are derived from the incoming noisy signal; these include carrier phase and frequency estimation, possibly subcarrier phase and frequency, and definitely symbol (bit) timing to recover the transmitted information bits. Synchronization precludes communication and includes these two functions: *acquisition and tracking*. Each of the carrier, subcarrier, and symbol acquisition processes consists of first frequency, then phase acquisition, and the total lock-up (or acquisition time) depends on the specific structures or algorithms employed. The transition from acquisition to tracking function is nonuniquely defined and is typically said to have occurred when the instantaneous phase error decreases and remains below a pre-determined threshold. Automatic gain control (AGC) circuitry is essential in maintaining reasonable received power levels in the receiver and in providing some protection against "large" intentional or accidental interferences. Finally, signal reference generators at both the transmitter and receiver require some degree of time and frequency stability to maintain a fixed reference throughout the system.

This chapter introduces the reader to the architecture of a digital communication system and introduces the various terms and key parameters used throughout the book. Section 1.2 presents practical "telecommunication networks" and discusses future networks. The various elements and key functions of an end-to-end communication link are discussed in Section 1.3. The key performance parameters such as signal-to-noise ratios, bandwidth, and so on, are defined along with the various losses that need to be accounted for in a link budget analysis. The "information" capacity of a communication channel as defined by Shannon is discussed in Section 1.4 and in Chapter 11. Communication with subcarriers and data formatting of various signals is the topic of Section 1.5.

## 1.1 DIGITAL COMMUNICATION SYSTEM FUNCTIONAL ARCHITECTURE

For the most part, the functional architecture of a digital communication system [3] has evolved over the past 35 years: with few exceptions, the functional architecture matches the physical structure. This evolution has been driven by two major forces, viz., the development of communication and information theory (communication sciences) and the development of communications, computer, and information technology. In presenting the functional architecture of a digital communication system, the top-down approach will be used. This approach takes advantage of the hierarchical nature of any system, in particular, an *information transportation system* which transports information using a *digital communication system*. In addition, the top-down approach fits well with the presentation and development of the digital communication techniques and theory presented in the chapters that follow.

Our top-down approach begins with the simplest architectural level, *Level 0: The Conceptual Level*, and proceeds downward until the bottom level, viz., the *Physical Level*, is reached. Figure 1.1 demonstrates that the basic building blocks of an *Information Transportation System (ITS)* in level one of the hierarchy are: (1) an information source to be transported, (2) a communication channel or information pipe, and (3) an information user or a sink. In order to connect the information source to the channel, a *transducer* is needed. In level 2 of the hierarchy in Fig. 1.1, this transducer is identified as the *communication*

tion on  
ing this  
Integrat  
T  
intergrat  
architec  
hierarch  
The tra  
Figure  
and the  
in Fig.  
a large  
upon to

### 1.1.1

We dev  
the con  
by our  
conven  
chapter  
4. 5, as  
as a po  
the IF  
Channel  
4. 5, a  
commu  
index of  
herence  
of the  
hierarch  
each of  
of the  
the arc

# **EXHIBIT IV**

SECOND EDITION

# ADAPTIVE FILTER THEORY

SIMON HAYKIN

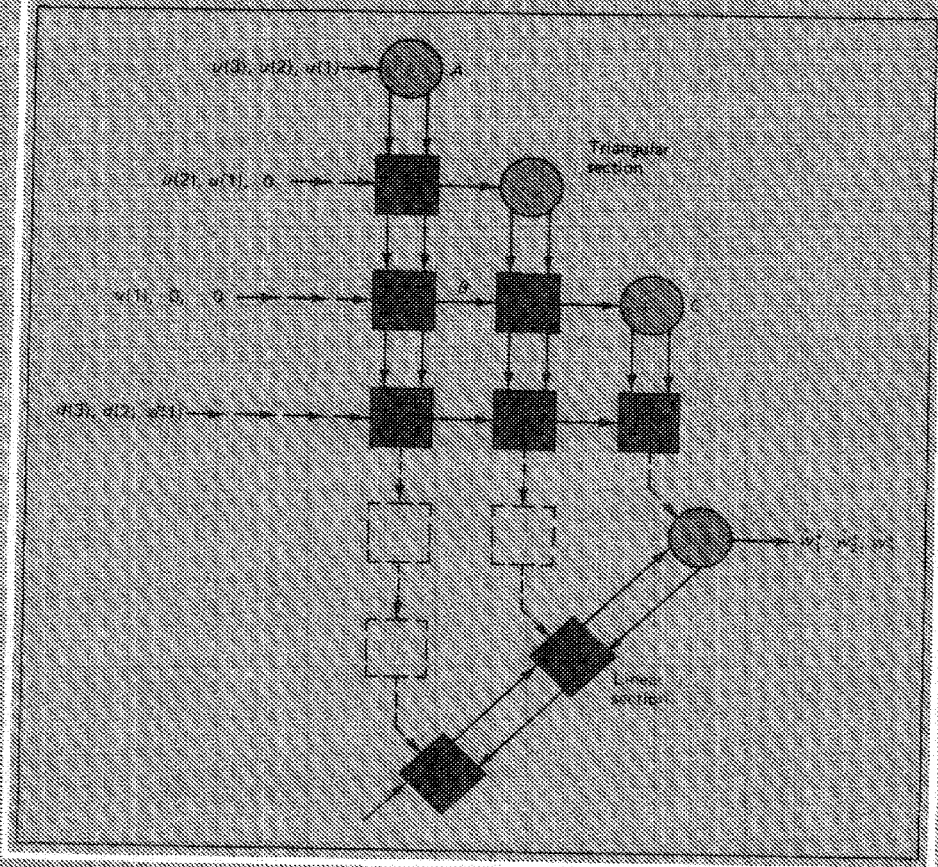

PRENTICE HALL INFORMATION AND SYSTEM SCIENCES SERIES  
Thomas Kailath, Series Editor



he present  
shown by

$$(1.37)$$

pole feed-  
be deter-

he proper-  
ced by the  
ords, the  
urion filter  
he transfer  
ans that if  
ansform of

$$(1.38)$$

itive noise  
ation filter

$$(1.39)$$

am illustrat-

on the aug-  
for details,  
as equations

$f(0)$ ,  $f(1)$ ,  
for varying  
the formula

$$(1.40)$$

s very large

n Chap. 1

2. A set of  $(M + 1)$  unknowns, made up of the feedback coefficients  $a_1, a_2, \dots, a_M$  and the variance  $\sigma^2$  of the white-noise process assumed to model  $w_n$ .

Given the seismogram  $u_0(n)$ , we may therefore uniquely determine the feedback coefficients  $a_1, a_2, \dots, a_M$  and the variance  $\sigma^2$  by solving this system of equations.

From Eq. (1.39), we see that the impulse response of the deconvolution filter consists of the sequence  $a_1, a_2, \dots, a_M$ . Accordingly, the convolution of this impulse response with  $u_0(n)$  yields the desired estimate  $\hat{w}_n$ , as shown by (see Fig. 1.14)

$$\hat{w}_n = \sum_{k=0}^M a_k u_0(n - k) \quad (1.41)$$

where  $a_0 = 1$ . Equation (1.41) is a description of the deconvolution process. Note, however, the wave  $d_0(n)$  generated by the source of seismic energy does not enter this description directly as in the idealized representation of Eq. (1.37). Rather, the physical nature of  $d_0(n)$  influences the deconvolution process by modeling  $d_0(n)$  as the impulse response of an all-pole feedback system.

An alternative procedure for constructing the deconvolution filter is to use an adaptive filtering algorithm, as illustrated in Fig. 1.15. In this application, the present value  $u_0(n)$  of the seismic output serves the purpose of a desired response for the algorithm, and the past values  $u_0(n - 1), u_0(n - 2), \dots, u_0(n - M)$  are used as elements of the input vector. The prediction error controls the adaptation of the  $M$  tap weights of the transversal filter component of the algorithm. When the algorithm has converged, the tap weights of the transversal filter provide estimates of the feedback coefficients  $a_1, a_2, \dots, a_M$ .

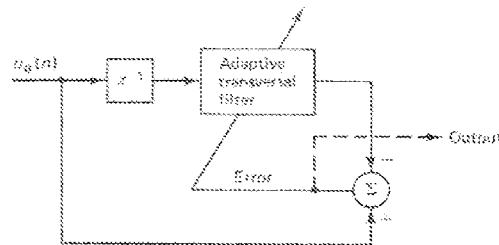

Figure 1.15 Adaptive filtering scheme for computing the impulse response of the deconvolution filter.

### Adaptive Equalization

During the past three decades, a considerable effort has been devoted to the study of data-transmission systems that utilize the available channel bandwidth efficiently. The objective here is to design the system so as to accommodate the highest possible rate of data transmission, subject to a specified reliability that is usually measured in terms of the error rate or average probability of symbol error. The transmission of digital data through a linear communication channel is limited by two factors:

1. Intersymbol Interference (ISI). This is caused by dispersion in the transmit filter, the transmission medium, and the receive filter.

2. Additive thermal noise. This is generated by the receiver at its front end.

For bandwidth-limited channels (e.g., voice-grade telephone channels), we usually find that intersymbol interference is the chief determining factor in the design of high-data-rate transmission systems.

Figure 1.16 shows the equivalent baseband model of a binary pulse-amplitude modulation (PAM) system. The signal applied to the input of the transmitter part of the system consists of a binary data sequence  $\{b_i\}$ , in which the binary symbol  $b_i$  consists of 1 or 0. This sequence is applied to a pulse generator, the output of which is filtered first in the transmitter, then by the medium, and finally in the receiver. Let  $u(k)$  denote the sampled output of the receive filter in Fig. 1.16; the sampling is performed in synchronism with the pulse generator in the transmitter. This output is compared to a threshold by means of a decision device. If the threshold is exceeded, the receiver makes a decision in favor of symbol 1. Otherwise, it decides in favor of symbol 0.

Let a scaling factor  $a_i$  be defined by

$$a_i = \begin{cases} +1, & \text{if the input bit } b_i \text{ consists of symbol 1} \\ -1, & \text{if the input bit } b_i \text{ consists of symbol 0} \end{cases} \quad (1.42)$$

Then, in the absence of noise, we may express  $u(k)$  as

$$\begin{aligned} u(k) &= \sum_n a_n p(k-n) \\ &= a_k p(0) + \sum_{n \neq k} a_n p(k-n) \end{aligned} \quad (1.43)$$

where  $p(n)$  is the sampled version of the impulse response of the cascade connection of the transmit filter, the transmission medium, and the receive filter. The first term on the right side of Eq. (1.43) defines the desired symbol, whereas the remaining series represents the intersymbol interference caused by the channel (i.e., the combination) of the transmit filter, the medium, and the receive filter). This intersymbol interference, if left unchecked, can result in erroneous decisions when the sampled signal at the channel output is compared with some preassigned threshold by means of a decision device.

To overcome the intersymbol interference problem, control of the time-sampled function  $p(n)$  is required. In principle, if the characteristics of the transmission medium are known precisely, then it is virtually always possible to design a pair of transmit and receive filters that will make the effect of intersymbol interference

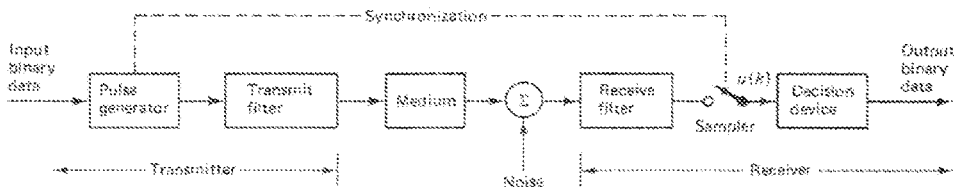

Figure 1.16 Block diagram of a baseband data transmission system (without equalization).

(at sampl  
all respon  
transmiss  
roll-off p  
impulse r  
sampling  
that the e  
makes it  
transmit  
may not  
adaptive  
real (Lack

An  
preequal  
mer techn  
at the re  
sampler  
ence mag  
itap way

As  
so as to i  
the trans  
sponse f  
located i  
ideal des  
desired r

1. Tr  
in  
we  
tes  
ma  
sec  
ref  
for  
or  
pri

2. De  
the  
de  
ses  
eq  
the  
19  
88

CLAIMS

I claim:

1. (Amended) A portable wireless digital audio system for digital transmission of an original audio signal representation from a portable audio source to a portable digital audio headphone receiver, said portable wireless digital audio system comprising:

~~at least one~~ a digital audio transmitter, capable of mobile operation, transmitting a unique user code with said original audio signal representation in packet format, wherein said digital audio transmitter is operatively coupled to ~~at least one~~ said portable audio source, said ~~at least one~~ digital audio transmitter comprising:

a digital modulator configured for independent code division multiple access (CDMA) communication operation;

said digital audio transmitter configured for direct digital wireless communication with ~~at least one~~ said portable digital audio headphone receiver, wherein said headphone receiver is configured to receive said unique user code with said original audio signal representation in packet format, said portable digital audio headphone receiver comprising:

an embedded fuzzy logic detector wherein the fuzzy logic detector activates fuzzy logic rules and performs a defuzzification operation to enhance detection of the unique user code;

a digital demodulator configured for independent CDMA communication operation;

a digital-to-analog converter (DAC) generating an audio output of said original audio signal representation; and

~~at least one~~ a module adapted to reproduce said generated audio output, ~~said audio having been wirelessly transmitted from said at least one audio source virtually free from interference from multiple CDMA wireless digital audio system transmitters operating in the wireless digital audio system spectrum, to a user providing a particular audio receiver user with independent audio in a shared space~~

~~with other wireless digital audio system users, wherein each of said wireless digital audio system users utilize their own independent audio source, and their own independent digital transmitter that associates only with their own independent receiver.~~

2. (Amended) A wireless digital audio headphone comprising:

~~at least one a digital audio receiver configured for digital wireless communication with at least one digital audio transmitter, said at least one digital audio transmitter to receive a unique user code bit sequence and a original audio signal representation in the form of packets;~~

~~a digital modulator configured for code division multiple access (CDMA) communication; and adding a unique user code bit sequence;~~

~~said at least one audio receiver comprising:~~

~~an embedded fuzzy logic detector wherein the fuzzy logic detector activates fuzzy logic rules and performs a defuzzification operation to enhance detection of the unique user code bit sequence;~~

~~a digital demodulator configured for CDMA communication;~~

~~a digital-to-analog converter (DAC) generating an audio output of the received original audio signal representation; and~~

~~at least one a module adapted to reproduce said generated audio output. when the unique user code bit sequence is recognized, said audio having been wirelessly transmitted from at least one audio source virtually free from interference from multiple CDMA wireless digital audio system transmitters operating in the wireless digital audio system spectrum to a user and providing a particular audio receiver user with independent audio in a shared space with other wireless digital audio system users, wherein each of said wireless digital audio system users utilize their own independent audio source, and their own independent digital transmitter that associates only with their own independent receiver.~~

3. (Amended) A portable wireless digital audio transmitter system for digital transmission of an original audio signal representation from a portable audio source to a portable digital audio headphone receiver, said portable wireless digital audio system comprising: configured to couple to an audio player, and wirelessly transmit a code division multiple access (CDMA) communication signal and a unique user code bit sequence to at least one digital audio receiver;

a digital audio transmitter operatively coupled to said portable audio source and transmitting a unique user code bit sequence with said original audio signal representation in packet format, wherein said digital audio transmitter operatively coupled to said audio source is capable of mobile operation, said digital audio transmitter comprising: said portable wireless digital audio transmitter comprising:

an encoder operative to encode said original audio signal representation to reduce intersymbol interference;

a digital modulator module configured for independent CDMA communication operation;

said digital audio transmitter configured for direct digital wireless communication with said portable digital audio headphone receiver, said portable digital audio headphone receiver comprising: at least one digital

audio receiver comprising:

a direct conversion module configured to capture packets embedded in the received spread spectrum signal, the captured packets corresponding to the unique user code bit sequence;

a digital demodulator configured for independent CDMA communication operation;

a decoder operative to decode the applied reduced intersymbol interference coding of said original audio signal representation;

a digital-to-analog converter (DAC) generating an audio output of said original audio signal representation; and

at least one a module adapted to reproduce said generated audio output, said audio having been wirelessly transmitted from said portable audio source and reproduced virtually free from interference, audio output generated by said audio

~~player, when the unique user code bit sequence is recognized, said audio output having been wirelessly transmitted from said audio player virtually free from interference from multiple CDMA wireless digital audio system transmitters operating in the wireless digital audio system spectrum to a user and providing a particular audio receiver user with independent audio in a shared space with other wireless digital audio system users, wherein each of said wireless digital audio system users utilize their own independent audio player, and their own independent digital audio transmitter that associates only with their own independent digital audio receiver.~~

4. (Amended) A wireless digital audio headphone system, comprising:
- a portable digital audio headphone receiver configured to receive a unique user code bit sequence and a original audio signal representation in the form of packets, said portable digital audio headphone receiver comprising:
    - a direct conversion module configured to capture said packets embedded in the received spread spectrum signal;
    - a digital demodulator configured for independent CDMA communication operation;
    - a decoder operative to decode reduced intersymbol interference coding of original audio signal representation;
    - a digital-to-analog converter (DAC) generating an audio output of said original audio signal representation; and
    - at least one a module adapted to reproduce said generated audio output in response to the unique user code bit sequence being recognized.
  - ~~a portable digital audio transmitter configured to couple to an audio source and operative to transmit a code division multiple access (CDMA) communication signal of said audio source output and adding a unique user code to maintain fidelity of said audio source output, said audio source to provide an audio signal representative of music; and~~
  - ~~said portable digital audio transmitter configured for digital wireless~~

~~communication with at least one digital audio receiver, said digital audio receiver comprising:~~

~~an audio receiver operative to receive the CDMA communication signal wherein when the unique user code is recognized, the transmitted audio source signal is reproduced, said audio source output virtually free from interference from multiple CDMA wireless digital audio system transmitters operating in the wireless digital audio system spectrum to a user and providing a particular audio receiver user with independent audio in a shared space with other wireless digital audio system users, wherein each of said wireless digital audio system users utilize their own independent audio source, and their own independent digital transmitter that associates only with their own independent headphone receiver.~~

5. (Amended) A portable wireless digital audio system for digital transmission of an original audio signal representation from a portable audio source to a portable digital audio headphone receiver, said portable wireless digital audio system comprising: A method for listening to an audio output with a wireless digital audio system while running comprising the steps of:

~~activating said wireless digital audio system while running, said wireless digital audio system, comprising:~~

a digital audio transmitter operatively coupled to said portable audio source and transmitting a unique user code bit sequence with said original audio signal representation in packet format, wherein said digital audio transmitter operatively coupled to said audio source is capable of mobile operation, said digital audio transmitter comprising:

an encoder operative to encode said original audio signal representation to reduce intersymbol interference;

a channel encoder and interleaver to reduce transmission errors;

a differential phase shift keying (DPSK) modulator being configured for

independent code division multiple access (CDMA) communication operation;

said digital audio transmitter configured for direct digital wireless communication with said portable digital audio headphone receiver, said portable digital audio headphone receiver comprising:

a direct conversion module configured to capture packets embedded in the received spread spectrum signal, the captured packets corresponding to the unique user code bit sequence;

a digital demodulator configured for independent CDMA communication operation;

a viterbi decoder and de-interleaver generating a corresponding digital output;

a decoder operative to decode the applied reduced intersymbol interference coding of said original audio signal representation;

a digital-to-analog converter (DAC) generating an audio output of said original audio signal representation; and

at least one a module adapted to reproduce said generated audio output, said audio having been wirelessly transmitted from said portable audio source virtually free from interference from device transmitted signals operating in the portable wireless digital audio system spectrum. audio transmitter operatively coupled to an audio source and operative to transmit a code division multiple access (CDMA) communication signal of said audio source output and adding a unique user code to maintain fidelity of said audio source output; and

said digital audio transmitter configured for digital wireless communication with at least one digital audio receiver, said digital audio receiver comprising:

an audio receiver operative to receive the CDMA communication signal



wherein if the unique user code is recognized, the transmitted audio source signal is reproduced, said audio source output having been wirelessly transmitted from said audio source virtually free from interference from multiple CDMA wireless digital audio system transmitters operating in the wireless digital audio system spectrum to a user and providing a particular audio receiver user with independent audio in a shared space with other wireless digital audio system users, wherein each of said wireless digital audio system users utilize their own independent audio source, and their own independent digital audio transmitter that associates only with their own independent digital audio receiver.

6. (Amended) A method for listening to an audio output with a portable wireless digital audio system while running comprising the steps of: for digital transmission of an original audio signal representation from a portable audio source to a portable digital audio headphone receiver, said portable wireless digital audio system comprising:

activating said wireless digital audio system while running, said wireless digital audio system, comprising:

a digital audio transmitter operatively coupled to said portable audio source and transmitting a unique user code with said original audio signal representation in packet format, wherein said digital audio transmitter coupled to said audio source is capable of mobile operation, said digital audio transmitter comprising: a portable digital audio transmitter configured to couple to an audio player and operative to transmit

a encoder operative to encode said original audio signal representation to reduce intersymbol interference;

a digital modulator configured for independent code division multiple access (CDMA) communication operation of the audio output of said audio player and adding a unique user code to maintain fidelity of said audio output and

~~said portable digital audio transmitter configured for digital wireless communication with at least one digital audio receiver, said digital audio receiver comprising: said digital audio transmitter configured for direct digital wireless communication with said portable digital audio headphone receiver, said portable digital audio headphone receiver comprising:~~

~~an embedded fuzzy logic detector wherein the fuzzy logic detector activates fuzzy logic rules and performs a defuzzification operation to enhance detection of the unique user code;~~

~~a direct conversion module configured to capture packets embedded in the received spread spectrum signal, the captured packets corresponding to the detected unique user code;~~

~~a digital demodulator configured for independent CDMA communication operation;~~

~~a decoder operative to decode the applied reduced intersymbol interference coding of said original audio signal representation;~~

~~at least one a module adapted to reproduce audio of said original audio signal representation. ~~an audio receiver operative to receive the CDMA communication signal wherein if the unique user code is recognized, the transmitted audio signal is reproduced, said audio output having been wirelessly transmitted from said audio player virtually free from interference from multiple CDMA wireless digital audio system transmitters operating in the wireless digital audio system spectrum to a user and providing a particular audio receiver user with independent audio in a shared space with other wireless digital audio system users, wherein each of said wireless digital audio system users utilize their own independent audio player, and their own independent digital audio transmitter that associates only with their own independent digital audio receiver.~~~~

7. (Amended) A method for listening to an audio output with a portable

wireless digital audio system for digital transmission of an original audio signal representation from a portable audio source to a digital audio headphone, said portable wireless digital audio system comprising: by a user in motion resulting primarily from physical force initiated by said user, comprising the steps of:

a digital audio transmitter operatively coupled to said portable audio source and transmitting a unique user code bit sequence with said original audio signal representation in packet format, wherein said digital audio transmitter coupled to said audio source is capable of mobile operation, said digital audio transmitter comprising: activating said wireless digital audio system during individual independent motion from exercise, said wireless digital audio system, comprising:

an encoder operative to encode said original audio signal representation to reduce intersymbol interference;

a differential phase shift keying (DPSK) modulator being configured for independent code division multiple access (CDMA) communication operation; a digital audio transmitter operatively coupled to an audio source and operative to transmit a code division multiple access (CDMA) communication; signal of the audio source output and adding a unique user code to maintain fidelity of said audio source output; and said digital audio transmitter configured for direct digital wireless communication with said portable digital audio headphone receiver, said portable digital audio headphone receiver comprising: said digital audio transmitter configured for digital wireless communication with at least one digital audio receiver, said digital audio receiver comprising:

an embedded fuzzy logic detector wherein the fuzzy logic detector activates fuzzy logic rules and performs a defuzzification operation to enhance detection of the unique user code bit sequence;

a direct conversion module configured to capture packets embedded in the received spread spectrum signal, the captured packets corresponding to the detected unique user code bit sequence;

a digital demodulator configured for independent CDMA communication operation;

a decoder operative to decode the applied reduced intersymbol interference coding of said original audio signal representation;

a digital-to-analog converter (DAC) generating an audio output of said original audio signal representation; and at least one a module adapted to reproduce said generated audio output. ~~an audio receiver operative to receive the CDMA communication signal wherein if the unique user code is recognized, the transmitted audio signal is reproduced, said audio source output having been wirelessly transmitted from said audio source virtually free from interference from multiple CDMA wireless digital audio system transmitters operating in the wireless digital audio system spectrum to a user and providing a particular audio receiver user with independent audio in a shared space with other wireless digital audio system users, wherein each of said wireless digital audio system users utilize their own independent audio source, and their own independent digital audio transmitter that associates only with their own independent digital audio receiver.~~

8. (Amended) A portable wireless digital audio system for digital transmission of an original audio representation from a portable audio source to a digital audio receiver, said portable wireless digital audio system comprising:

at least one a mobile digital audio transmitter operatively coupled to at least one said portable audio source, said at least one mobile digital audio transmitter configured to transmit a unique user code with the original audio representation;

a digital modulator configured for code division multiple access (CDMA) communication; and adding a unique user code;

at least one a mobile digital audio receiver configured for direct digital wireless communication with said at least one mobile digital audio transmitter, said at least one mobile audio receiver comprising:

an embedded fuzzy logic detector wherein the fuzzy logic detector activates fuzzy logic rules and performs a defuzzification operation to enhance detection of the unique user code;

a digital demodulator ~~configured for CDMA communication;~~  
a digital-to-analog converter (DAC) generating an audio output of said original audio representation; and  
at least one a module adapted to reproduce said generated audio output, ~~said audio having been wirelessly transmitted from said at least one audio source free from interference from multiple CDMA wireless digital audio system transmitters operating in the wireless digital audio system spectrum to a user providing a particular audio receiver user with independent audio in a shared space with other wireless digital audio system users, wherein each of said wireless digital audio system users utilize their own independent audio source, and their own independent digital transmitter that associates only with their own independent receiver.~~

9. (Amended) A portable wireless digital audio system for digital transmission of an original audio signal representation from a portable audio source to a digital audio headphone, said portable wireless digital audio system comprising:

a portable digital audio transmitter configured to couple to said portable audio source and transmitting a unique user code bit sequence with said original audio signal representation in packet format, said digital audio transmitter comprising:

an encoder operative to encode said original audio signal representation to reduce intersymbol interference; and

a digital modulator configured for independent code division multiple access (CDMA) communication operation; and a portable digital audio transmitter configured to couple to an audio player and operative to transmit a code division multiple access (CDMA) communication signal of an audio output and adding a unique user code to maintain fidelity of said audio output; and said portable digital audio transmitter configured for direct digital wireless communication with said digital audio headphone, said digital audio headphone comprising:

a direct conversion module configured to capture packets embedded in the received spread spectrum signal, the captured packets corresponding to the unique

user code bit sequence;

a digital demodulator configured for independent CDMA communication operation;

a decoder operative to decode the applied reduced intersymbol interference coding of said original audio signal representation;

a digital-to-analog converter (DAC) generating an audio output of said original audio signal representation; and

at least one a module adapted to reproduce said generated audio output, an audio receiver operative to receive said CDMA communication signal said audio having been wirelessly transmitted from said portable audio source virtually free from interference from device transmitted signals operating in the portable wireless digital audio system spectrum.

wherein if the unique user code is recognized, the transmitted audio signal is reproduced, said audio free from interference from multiple CDMA wireless digital audio system transmitters operating in the wireless digital audio system spectrum to a user providing a particular audio receiver user with independent audio in a shared space with other wireless digital audio system users, wherein each of said wireless digital audio system users utilize their own independent audio player, and their own independent portable transmitter that associates only with their own independent headphone receiver.

10. (Amended) A wireless digital audio headphone for receipt of a unique user code and a digital audio music representation signal in the form of a packet, said wireless digital audio headphone system, comprising:

a digital audio receiver, capable of mobile operation, configured for direct digital wireless communication with a mobile digital audio transmitter;

a portable audio source to provide a signal representative of music;

a digital audio transmitter operatively coupled to said portable audio source, said digital audio transmitter comprising:

a digital modulator module configured for code division multiple

access (CDMA) communication and utilizing a unique user code bit sequence;

~~said digital audio transmitter configured for digital wireless communication with at least one digital audio receiver, said digital audio receiver comprising:~~

~~a direct conversion module configured to capture packets embedded in the received spread spectrum signal, the captured packets corresponding to the unique user code;~~

~~a digital demodulator module configured for independent code division multiple access (CDMA) communication operation; and~~

~~a decoder operative to decode the applied reduced intersymbol interference coding of said audio music representation signal;~~

~~a digital-to-analog converter (DAC) generating an audio output of said digital audio music representation signal; and at least one a module adapted to reproduce said generated audio output, in response to the unique user code bit sequence is being recognized, said audio having been wirelessly transmitted from said portable audio source free from interference from multiple CDMA wireless digital audio system transmitters operating in the wireless digital audio system spectrum to a user providing a particular digital audio receiver user with independent audio in a shared space with other wireless digital audio system users, wherein each of said wireless digital audio system users utilize their own independent audio source, and their own independent digital audio transmitter that associates only with their own independent receiver.~~

11. (Amended) A wireless digital audio transmitter system operatively coupled to a portable audio source and configured to transmit a unique user code and an original audio signal representation in the form of packets, wherein said digital audio transmitter coupled to said audio source, and configured to be communicable with a mobile receiver, is capable of being moved in any direction during operation, said wireless digital audio transmitter comprising:

an encoder operative to encode said original audio signal representation to reduce intersymbol interference;

a channel encoder to reduce transmission errors; and

a digital modulator module configured for independent code division multiple access (CDMA) communication operation.

~~a portable digital audio transmitter configured to couple to an audio source and operative to transmit a code division multiple access (CDMA) communication signal of said audio source output and adding a unique user code to maintain fidelity of said audio source output, said audio source to provide an audio signal representative of music; and~~

~~an audio receiver operative to receive the CDMA communication signal wherein when the unique user code is recognized, the transmitted audio source signal is reproduced, said audio source output free from interference from multiple CDMA wireless digital audio system transmitters operating in the wireless digital audio system spectrum to a user providing a particular audio receiver user with independent audio in a shared space with other wireless digital audio system users, wherein each of said wireless digital audio system users utilize their own independent audio source, and their own independent digital audio transmitter that associates only with their own independent headphone receiver.~~

12. (Amended) A wireless digital audio receiver comprising:

an embedded fuzzy logic detector wherein the fuzzy logic detector activates fuzzy logic rules and performs a defuzzification operation in response to a received unique user code to enhance detection of the unique user code;

a direct conversion module being configured to capture the correct unique user code bit sequence embedded in ~~[[the]]~~ a received CDMA signal;

a digital demodulator adapted to process output from said direct conversion module;

a digital-to-analog converter (DAC) generating an audio output wherein if the unique user code bit sequence corresponding to the decoded and converted digital signal is recognized, said audio output having been wirelessly transmitted, said



audio output reproduced virtually without interference when operated in a shared space containing at least one other user of a wireless device utilizing code division multiple access (CDMA) communication.

13. (Amended) A portable wireless digital audio system for digital transmission of an original audio signal representation from a audio source to a digital audio receiver, said portable wireless digital audio system comprising:

a digital audio transmitter operatively coupled to said audio source and transmitting a unique user code with said original audio signal representation in packet format, wherein said digital audio transmitter coupled to said audio source and is capable of being moved in any direction during operation, said digital audio transmitter comprising:

an encoder operative to encode said original audio signal representation to reduce intersymbol interference;

an interleaver to reduce transmission errors;

a digital modulator module configured for independent CDMA communication operation;

said digital audio receiver capable of being moved in any direction during operation, is in direct communication with said digital audio transmitter, said digital audio receiver comprising:

a direct conversion module configured to capture packets embedded in the received spread spectrum signal, the captured packets corresponding to the unique user code;

a digital demodulator configured for independent CDMA communication operation;

an de-interleaver generating a corresponding digital output;

a decoder operative to decode the applied reduced intersymbol interference coding of said original audio signal representation;

a digital-to-analog converter (DAC) generating an audio output of said original audio signal representation; and

at least one a module adapted to reproduce said generated audio output, said

audio having been wirelessly transmitted from said audio source virtually free from interference from device transmitted signals operating in the portable wireless digital audio system spectrum.

~~at least one digital audio transmitter operatively coupled to at least one audio source, said at least one digital audio transmitter comprising:~~

~~a differential phase shift keying (DPSK) module modulating signal of said audio source output and a unique user code bit sequence and being configured for code division multiple access (CDMA) communication;~~

~~said digital audio transmitter configured for digital wireless communication with at least one digital audio receiver, said digital audio receiver comprising:~~

~~a direct conversion module configured to capture the correct unique user code bit sequence embedded in the received spread spectrum signal;~~

~~a digital demodulator configured for CDMA communication;~~

~~a digital-to-analog converter (DAC) generating an audio output; and~~

~~at least one module adapted to reproduce said generated audio output, said audio having been wirelessly transmitted from said at least one audio source virtually free from interference from multiple CDMA wireless digital audio system transmitters operating in the wireless digital audio system spectrum to a user providing a particular audio receiver user with independent audio in a shared space with other wireless digital audio system users, wherein each of said wireless digital audio system users utilize their own independent audio source, and their own independent digital transmitter that associates only with their own independent receiver.~~

14. (Canceled)

15. (Amended) A wireless digital audio headphone receiver, capable of mobile operation, configured to receive a unique user code and a original audio signal representation in the form of packets, the wireless digital audio receiver further configured to be communicable with a mobile digital audio transmitter, said wireless digital audio receiver comprising:

a direct conversion module configured to capture packets embedded in the received spread spectrum signal, the captured packets corresponding to the unique user code;

a digital demodulator configured for independent CDMA communication operation;

a decoder operative to decode reduced intersymbol interference coding of said original audio signal representation;

a digital-to-analog converter (DAC) generating an audio output of said original audio signal representation; and

at least one a module adapted to reproduce said generated audio output, said audio having been wirelessly transmitted from a portable audio source virtually free from interference from device transmitted signals operating in the digital wireless audio receiver spectrum.

~~at least one audio receiver configured for digital wireless communication with at least one digital audio transmitter, said at least one digital audio transmitter comprising:~~

~~a differential phase shift keying (DPSK) module configured for code division multiple access (CDMA) communication; and adding a unique user code bit sequence; said at least one audio receiver comprising:~~

~~a direct conversion module configured to capture the correct unique user code bit sequence embedded in the received spread spectrum signal;~~

~~a digital demodulator configured for CDMA communication;~~

~~a digital-to-analog converter (DAC) generating an audio output; and at least one module adapted to reproduce said generated audio output, when the unique user code bit sequence is recognized, said audio having been wirelessly transmitted from at least one audio source virtually free from interference from multiple CDMA wireless digital audio system transmitters operating in the wireless digital audio system spectrum to a user and providing a particular audio receiver user with independent audio in a shared space with other wireless digital audio system users, wherein each of said wireless digital audio system users utilize their own independent audio source, and their own independent digital transmitter that~~

associates only with their own independent receiver.

16. (Canceled)

17. (Amended) A portable wireless digital audio transmitter configured to couple to an audio player, operatively coupled to a portable audio source and configured to transmit a unique user code and an original audio signal representation in the form of packets, wherein said digital audio transmitter coupled to said audio source, and configured to be communicable with a mobile receiver, is capable of being moved in any direction during operation, said wireless digital audio transmitter and wirelessly transmit a code division multiple access (CDMA) communication signal having a differential phase shift keying (DPSK) modulated signal of said audio player output and a unique user code bit sequence to at least one digital audio receiver;

said portable wireless digital audio transmitter comprising:

an encoder operative to encode said original audio signal representation to reduce intersymbol interference;

an interleaver to reduce transmission errors;

a digital modulator module configured for CDMA communication; independent code division multiple access (CDMA) communication operation and utilizing differential phase shift keying (DPSK) to modulate said original audio signal representation.

said at least one digital audio receiver comprising:

a direct conversion module configured to capture the correct unique user code bit sequence embedded in the received spread spectrum signal;

a digital demodulator configured for CDMA communication; ;

a digital-to-analog converter (DAC) generating an audio output; and

at least one module adapted to reproduce audio output generated by said audio player, when the unique user code bit sequence is recognized, said audio output having been wirelessly transmitted from said audio player virtually free from interference from multiple CDMA wireless digital audio system transmitters

~~operating in the wireless digital audio system spectrum to a user and providing a particular audio receiver user with independent audio in a shared space with other wireless digital audio system users, wherein each of said wireless digital audio system users utilize their own independent audio player, and their own independent digital audio transmitter that associates only with their own independent digital audio receiver.~~

18. (Canceled)

19. (Canceled)

20. (Canceled)

21. (Amended)     A portable wireless digital audio system for digital transmission of an original audio signal representation from a audio source to a digital audio receiver, said portable wireless digital audio system comprising:

a digital audio transmitter operatively coupled to said audio source and transmitting a unique user code with said original audio signal representation in packet format, wherein said digital audio transmitter coupled to said audio source is capable of being moved in any direction during operation, said digital audio transmitter comprising:

an encoder operative to encode said original audio signal representation to reduce intersymbol interference;

a digital modulator module configured for independent code division multiple access (CDMA) communication operation and utilizing differential phase shift keying (DPSK) to modulate said original audio signal representation;

said digital audio receiver capable of being moved in any direction during operation and in direct communication with said digital audio transmitter, said digital audio receiver comprising:

a direct conversion module configured to capture packets embedded in the received spread spectrum signal, the captured packets corresponding to the unique user code;

a digital demodulator configured for independent CDMA communication operation;

a decoder operative to decode the applied reduced inter-symbol interference coding of said original audio signal representation;

a digital-to-analog converter (DAC) generating an audio output of said original audio signal representation; and

at least one a module adapted to reproduce said generated audio output, said audio having been wirelessly transmitted from said audio source virtually free from interference.

~~at least one digital audio transmitter operatively coupled to at least one audio source, said at least one digital audio transmitter comprising:~~

~~a digital modulator configured for direct sequence spread spectrum (DSSS) code division multiple access (CDMA) communication and adding a unique user code bit sequence;~~

~~said digital audio transmitter configured for digital wireless communication with at least one digital audio receiver, said digital audio receiver comprising:~~

~~a direct conversion module configured to capture the correct unique user code bit sequence embedded in the received spread spectrum signal;~~

~~a digital demodulator configured for DSSS CDMA communication;~~

~~a digital-to-analog converter (DAC) generating an audio output; and at least one module adapted to reproduce said generated audio output, said audio having been wirelessly transmitted from said at least one audio source virtually free from interference from multiple CDMA wireless digital audio system transmitters operating in the wireless digital audio system spectrum to a user providing a particular audio receiver user with independent audio in a shared space with other~~

~~wireless digital audio system users, wherein each of said wireless digital audio system users utilize their own independent audio source, and their own independent digital transmitter that associates only with their own independent receiver.~~

22. (Canceled)

23. (Amended) A wireless digital audio headphone receiver, capable of mobile operation, configured to receive a unique user code and a original audio signal representation in the form of packets, the wireless digital audio receiver further configured to be communicable with a mobile digital audio transmitter, said wireless digital audio receiver system, comprising:

a direct conversion module configured to capture packets embedded in the received spread spectrum signal, the captured packets corresponding to the unique user code;

a digital demodulator configured for independent CDMA communication operation;

an de-interleaver generating a corresponding digital output;

a decoder operative to decode reduced intersymbol interference coding of said original audio signal representation;

a digital-to-analog converter (DAC) generating an audio output of said original audio signal representation; and

at least one a module adapted to reproduce said generated audio output, said audio having been wirelessly transmitted from a portable audio source virtually free from interference from device transmitted signals operating in the digital wireless audio receiver spectrum.

~~at least one audio receiver configured for digital wireless communication with at least one digital audio transmitter, said at least one digital audio transmitter comprising;~~

~~a direct sequence spread spectrum (DSSS) code division multiple access (CDMA) modulator; and adding a unique user code bit sequence;~~

~~said at least one audio receiver comprising:~~  
~~a direct conversion module configured to capture the correct unique user code bit sequence embedded in the received spread spectrum signal;~~  
~~a digital demodulator configured for DSSS CDMA communication;~~  
~~a digital-to-analog converter (DAC) generating an audio output; and at least one module adapted to reproduce said generated audio output, when the unique user code bit sequence is recognized, said audio having been wirelessly transmitted from at least one audio source virtually free from interference from multiple CDMA wireless digital audio system transmitters operating in the wireless digital audio system spectrum to a user and providing a particular audio receiver user with independent audio in a shared space with other wireless digital audio system users, wherein each of said wireless digital audio system users utilize their own independent audio source, and their own independent digital transmitter that associates only with their own independent receiver.~~

24. (Canceled)

25. (Amended) A portable wireless digital audio system comprising:

~~a portable digital audio transmitter configured to couple to an audio player and operative to transmit a direct sequence spread spectrum (DSSS) code division multiple access (CDMA) communication signal of said audio player output and adding a unique user code bit sequence to maintain fidelity of said audio player output;~~

a digital audio transmitter operatively coupled to a portable audio source and configured to wirelessly transmit audio output from the portable audio source, the digital audio transmitter further configured to add a unique user code bit sequence to the audio output prior to the transmission;

~~said portable digital audio transmitter configured for digital wireless communication with at least one digital audio receiver;~~

~~and~~



a wireless digital audio headphone comprising:

a digital audio receiver configured to receive the unique user code bit sequence and the audio output;

an embedded fuzzy logic detector wherein the fuzzy logic detector activates fuzzy logic rules and performs a defuzzification operation to enhance detection of the unique user code bit sequence;

a digital-to-analog converter (DAC) generating an audio signal output of the received audio output; and

a module adapted to reproduce said generated audio signal output.

~~said digital audio receiver operative to receive said DSSS CDMA communication signal wherein if the unique user code bit sequence is recognized, the transmitted audio signal is reproduced, said digital audio receiver comprising:~~

~~a direct conversion module configured to capture the correct unique user code bit sequence embedded in the received spread spectrum signal;  
said audio signal virtually free from interference from multiple CDMA wireless digital audio system transmitters operating in the wireless digital audio system spectrum to a user providing a particular audio receiver user with independent audio in a shared space with other wireless digital audio system users, wherein each of said wireless digital audio system users utilize their own independent audio player, and their own independent transmitter that associates only with their own independent headphone receiver.~~

26. (Amended) The ~~digital audio receiver~~ portable wireless digital audio system of claim 25, wherein said ~~digital demodulator~~ audio transmitter is portable, ~~operatively coupled to a Viterbi decoder.~~

Doc code: IDS

Doc description: Information Disclosure Statement (IDS) Filed

PTO/SB/08a (01-10)

Approved for use through 07/31/2012. OMB 0651-0031

U.S. Patent and Trademark Office; U.S. DEPARTMENT OF COMMERCE

Under the Paperwork Reduction Act of 1995, no persons are required to respond to a collection of information unless it contains a valid OMB control number.

<b>INFORMATION DISCLOSURE STATEMENT BY APPLICANT ( Not for submission under 37 CFR 1.99)</b>	Application Number	12570343
	Filing Date	2009-09-30
	First Named Inventor	C. Earl Woolfork
	Art Unit	2614
	Examiner Name	Andrew Flanders
	Attorney Docket Number	1028.4

U.S. PATENTS <span style="float: right;">Remove</span>						
Examiner Initial*	Cite No	Patent Number	Kind Code <sup>1</sup>	Issue Date	Name of Patentee or Applicant of cited Document	Pages, Columns, Lines where Relevant Passages or Relevant Figures Appear
	1	5668880	A	1997-09-16	Alajajian, Philip	
	2	5721783	A	1998-02-24	Anderson, James	
	3	6115478	A	2000-09-05	dspfactory Ltd.	
	4	6236862	B1	2001-05-22	Intersignal LLC	
	5	7505823	B1	2009-03-17	Intrasonics Limited	
	6	5781542	A	1998-07-14	Tanaka	
	7	6678892	A	2004-08-13	Lavelle	
	8	5491839	A	1996-02-13	Schotz	

<b>INFORMATION DISCLOSURE STATEMENT BY APPLICANT</b> ( Not for submission under 37 CFR 1.99)	Application Number		12570343	
	Filing Date		2009-09-30	
	First Named Inventor	C. Earl Woolfork		
	Art Unit	2614		
	Examiner Name	Andrew Flanders		
	Attorney Docket Number	1028.4		

	9	5790595	A	1998-08-04	Benthin	
	10	5946343	A	1999-08-31	Schotz	
	11	6342844	B1	2002-01-29	Rozin	
	12	6418558	B1	2002-07-09	Roberts	
	13	6982132	B1	2006-01-03	Goldner	

If you wish to add additional U.S. Patent citation information please click the Add button.

**U.S.PATENT APPLICATION PUBLICATIONS**

Examiner Initial*	Cite No	Publication Number	Kind Code <sup>1</sup>	Publication Date	Name of Patentee or Applicant of cited Document	Pages, Columns, Lines where Relevant Passages or Relevant Figures Appear
	1	20030045235	A1	2003-03-06	Mooney	
	2	20040223622	A1	2004-11-11	Lindemann	

If you wish to add additional U.S. Published Application citation information please click the Add button.

**FOREIGN PATENT DOCUMENTS**

Examiner Initial*	Cite No	Foreign Document Number <sup>3</sup>	Country Code <sup>2</sup> j	Kind Code <sup>4</sup>	Publication Date	Name of Patentee or Applicant of cited Document	Pages, Columns, Lines where Relevant Passages or Relevant Figures Appear	T <sup>5</sup>

<b>INFORMATION DISCLOSURE STATEMENT BY APPLICANT ( Not for submission under 37 CFR 1.99)</b>	Application Number		12570343	
	Filing Date		2009-09-30	
	First Named Inventor	C. Earl Woolfork		
	Art Unit	2614		
	Examiner Name	Andrew Flanders		
	Attorney Docket Number	1028.4		

	1	GB2252013	GB	A	1992-07-22	Liu, Lu	<input type="checkbox"/>
	2	WO0133836	WO	A1	2001-05-10	Lockhart, Peter	<input type="checkbox"/>
	3	WO0076272	WO	A1	1998-03-12	Lindemann, Eric	<input type="checkbox"/>

If you wish to add additional Foreign Patent Document citation information please click the Add button

**NON-PATENT LITERATURE DOCUMENTS**

Examiner Initials*	Cite No	Include name of the author (in CAPITAL LETTERS), title of the article (when appropriate), title of the item (book, magazine, journal, serial, symposium, catalog, etc), date, pages(s), volume-issue number(s), publisher, city and/or country where published.	T <sup>5</sup>
	1	American National Standard for Methods of Measurement of Compatibility Between Wireless Communication Devices and Hearing Aids - ANSI C63. 19-2001	<input type="checkbox"/>
	2	A Conferencing Spread Spectrum Radio, KM LYE, TT TJHUNG, KC CHUA, TC PEK, WH YUNG, WP GOH, YP CHIA, WK LOH, FL MA, KM LOW	<input type="checkbox"/>
	3	Specification of the Bluetooth System, Version 1.0 B, pp 17-27, 4144, 81-86, 143-147	<input type="checkbox"/>

If you wish to add additional non-patent literature document citation information please click the Add button

**EXAMINER SIGNATURE**

Examiner Signature		Date Considered	
--------------------	--	-----------------	--

\*EXAMINER: Initial if reference considered, whether or not citation is in conformance with MPEP 609. Draw line through a citation if not in conformance and not considered. Include copy of this form with next communication to applicant.

<sup>1</sup> See Kind Codes of USPTO Patent Documents at [www.USPTO.GOV](http://www.USPTO.GOV) or MPEP 901.04. <sup>2</sup> Enter office that issued the document, by the two-letter code (WIPO Standard ST.3). <sup>3</sup> For Japanese patent documents, the indication of the year of the reign of the Emperor must precede the serial number of the patent document. <sup>4</sup> Kind of document by the appropriate symbols as indicated on the document under WIPO Standard ST.16 if possible. <sup>5</sup> Applicant is to place a check mark here if English language translation is attached.

<b>INFORMATION DISCLOSURE STATEMENT BY APPLICANT</b> ( Not for submission under 37 CFR 1.99)	Application Number	12570343
	Filing Date	2009-09-30
	First Named Inventor	C. Earl Woolfork
	Art Unit	2614
	Examiner Name	Andrew Flanders
	Attorney Docket Number	1028.4

**CERTIFICATION STATEMENT**

Please see 37 CFR 1.97 and 1.98 to make the appropriate selection(s):

That each item of information contained in the information disclosure statement was first cited in any communication from a foreign patent office in a counterpart foreign application not more than three months prior to the filing of the information disclosure statement. See 37 CFR 1.97(e)(1).

**OR**

That no item of information contained in the information disclosure statement was cited in a communication from a foreign patent office in a counterpart foreign application, and, to the knowledge of the person signing the certification after making reasonable inquiry, no item of information contained in the information disclosure statement was known to any individual designated in 37 CFR 1.56(c) more than three months prior to the filing of the information disclosure statement. See 37 CFR 1.97(e)(2).

See attached certification statement.

Fee set forth in 37 CFR 1.17 (p) has been submitted herewith.

None

**SIGNATURE**

A signature of the applicant or representative is required in accordance with CFR 1.33, 10.18. Please see CFR 1.4(d) for the form of the signature.

Signature	/Megan Lyman/	Date (YYYY-MM-DD)	2010-08-04
Name/Print	Megan Lyman	Registration Number	57054

This collection of information is required by 37 CFR 1.97 and 1.98. The information is required to obtain or retain a benefit by the public which is to file (and by the USPTO to process) an application. Confidentiality is governed by 35 U.S.C. 122 and 37 CFR 1.14. This collection is estimated to take 1 hour to complete, including gathering, preparing and submitting the completed application form to the USPTO. Time will vary depending upon the individual case. Any comments on the amount of time you require to complete this form and/or suggestions for reducing this burden, should be sent to the Chief Information Officer, U.S. Patent and Trademark Office, U.S. Department of Commerce, P.O. Box 1450, Alexandria, VA 22313-1450. **DO NOT SEND FEES OR COMPLETED FORMS TO THIS ADDRESS. SEND TO: Commissioner for Patents, P.O. Box 1450, Alexandria, VA 22313-1450.**

## Privacy Act Statement

The Privacy Act of 1974 (P.L. 93-579) requires that you be given certain information in connection with your submission of the attached form related to a patent application or patent. Accordingly, pursuant to the requirements of the Act, please be advised that: (1) the general authority for the collection of this information is 35 U.S.C. 2(b)(2); (2) furnishing of the information solicited is voluntary; and (3) the principal purpose for which the information is used by the U.S. Patent and Trademark Office is to process and/or examine your submission related to a patent application or patent. If you do not furnish the requested information, the U.S. Patent and Trademark Office may not be able to process and/or examine your submission, which may result in termination of proceedings or abandonment of the application or expiration of the patent.

The information provided by you in this form will be subject to the following routine uses:

1. The information on this form will be treated confidentially to the extent allowed under the Freedom of Information Act (5 U.S.C. 552) and the Privacy Act (5 U.S.C. 552a). Records from this system of records may be disclosed to the Department of Justice to determine whether the Freedom of Information Act requires disclosure of these records.
2. A record from this system of records may be disclosed, as a routine use, in the course of presenting evidence to a court, magistrate, or administrative tribunal, including disclosures to opposing counsel in the course of settlement negotiations.
3. A record in this system of records may be disclosed, as a routine use, to a Member of Congress submitting a request involving an individual, to whom the record pertains, when the individual has requested assistance from the Member with respect to the subject matter of the record.
4. A record in this system of records may be disclosed, as a routine use, to a contractor of the Agency having need for the information in order to perform a contract. Recipients of information shall be required to comply with the requirements of the Privacy Act of 1974, as amended, pursuant to 5 U.S.C. 552a(m).
5. A record related to an International Application filed under the Patent Cooperation Treaty in this system of records may be disclosed, as a routine use, to the International Bureau of the World Intellectual Property Organization, pursuant to the Patent Cooperation Treaty.
6. A record in this system of records may be disclosed, as a routine use, to another federal agency for purposes of National Security review (35 U.S.C. 181) and for review pursuant to the Atomic Energy Act (42 U.S.C. 218(c)).
7. A record from this system of records may be disclosed, as a routine use, to the Administrator, General Services, or his/her designee, during an inspection of records conducted by GSA as part of that agency's responsibility to recommend improvements in records management practices and programs, under authority of 44 U.S.C. 2904 and 2906. Such disclosure shall be made in accordance with the GSA regulations governing inspection of records for this purpose, and any other relevant (i.e., GSA or Commerce) directive. Such disclosure shall not be used to make determinations about individuals.
8. A record from this system of records may be disclosed, as a routine use, to the public after either publication of the application pursuant to 35 U.S.C. 122(b) or issuance of a patent pursuant to 35 U.S.C. 151. Further, a record may be disclosed, subject to the limitations of 37 CFR 1.14, as a routine use, to the public if the record was filed in an application which became abandoned or in which the proceedings were terminated and which application is referenced by either a published application, an application open to public inspections or an issued patent.
9. A record from this system of records may be disclosed, as a routine use, to a Federal, State, or local law enforcement agency, if the USPTO becomes aware of a violation or potential violation of law or regulation.

(12) UK Patent Application (19) GB (11) 2 252 013 A

(43) Date of A publication 22.07.1992

(21) Application No 9100844.1

(22) Date of filing 15.01.1991

(71) Applicant  
Lu Liu  
23, Lane 387, Hsin Shu Rd, Hsin Chuang City,  
Taipei Hsien, Taiwan

(72) Inventor  
Lu Liu

(74) Agent and/or Address for Service  
Langner Parry  
High Holborn House, 52-54 High Holborn, London,  
WC1V 6RR, United Kingdom

(51) INT CL<sup>5</sup>  
H04R 1/10

(52) UK CL (Edition K)  
H4J JDS J30F J30K

(56) Documents cited  
GB 2185364 A GB 1481483 A GB 0980850 A  
Tandy electronics catalogue item 32-2050  
page 42 pub. aug 1990 by intertan UK LTD

(58) Field of search  
UK CL (Edition K) H3Q QAH, H4J JA JDS  
INT CL<sup>5</sup> H02J 7/10, H04B 5/00 13/02, H04R 1/10

(54) Wireless television headphone set

(57) For receiving the audio frequency signal of a television set, a wireless television headphone set comprising an audio frequency signal oscillator and transmitter circuit connected in the internal circuit of a television set 2 to convert the audio frequency signal provided by said television set into a radio signal for transmitting through a transmitting antenna, and at least one headphone type radio receiver 3 for receiving said radio signal and converting it into a corresponding audio frequency signal. A volume control circuit can be provided in said at least one headphone type radio receiver for respective volume control.

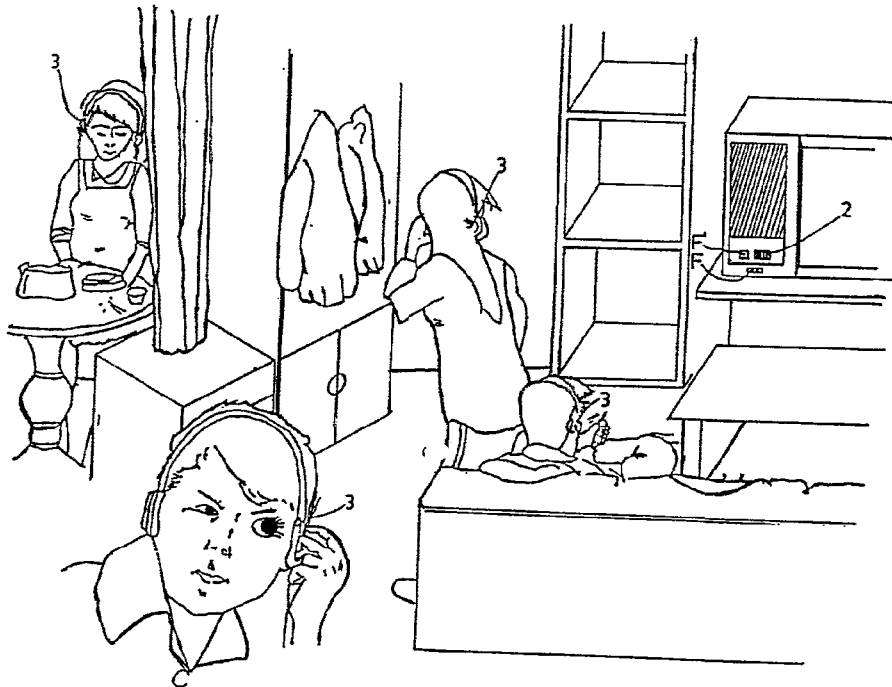
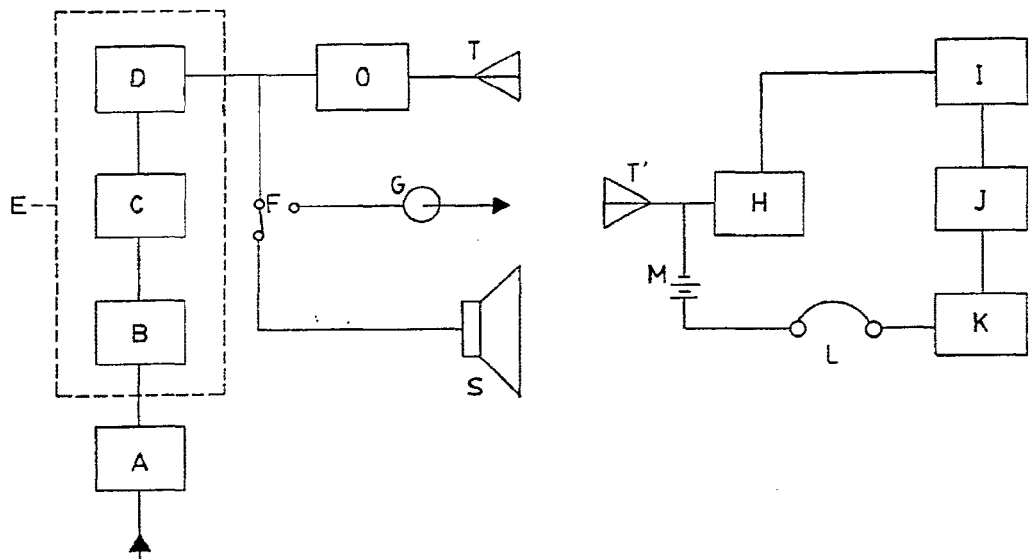
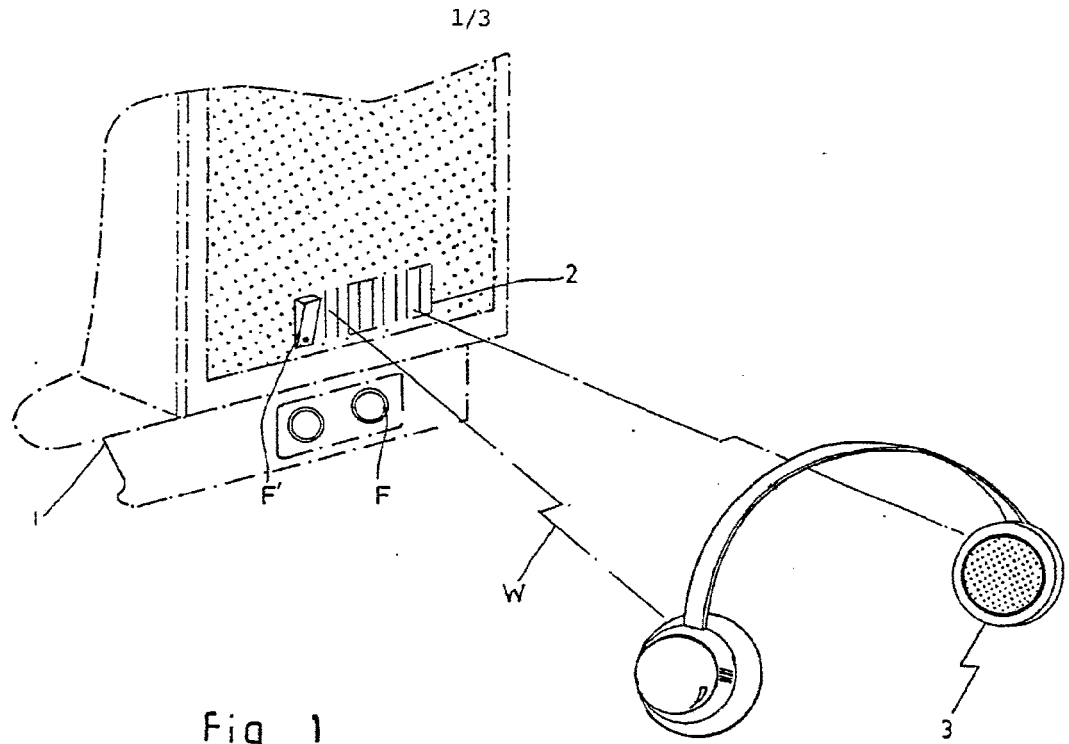

Fig. 4

GB 2 252 013 A





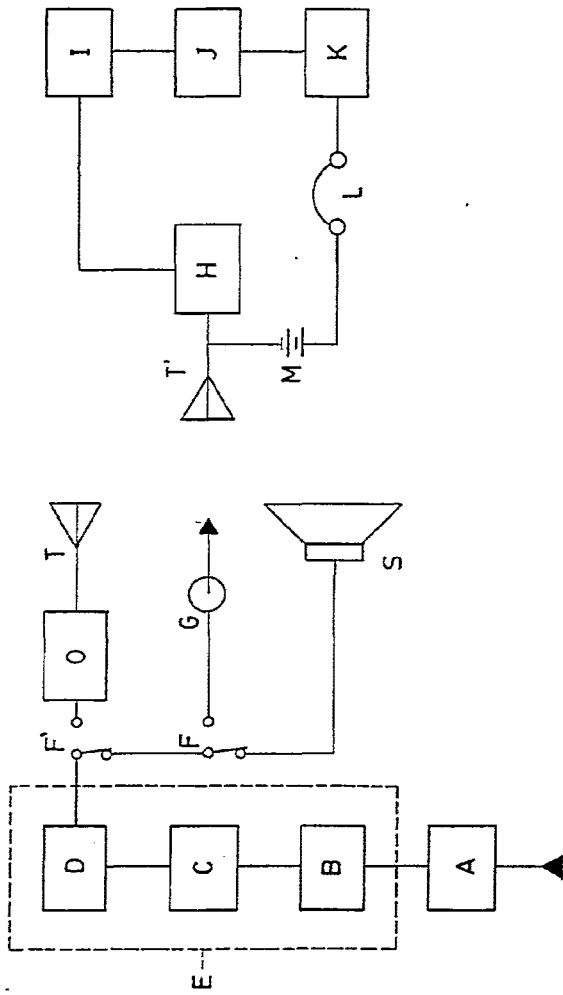

Fig. 3

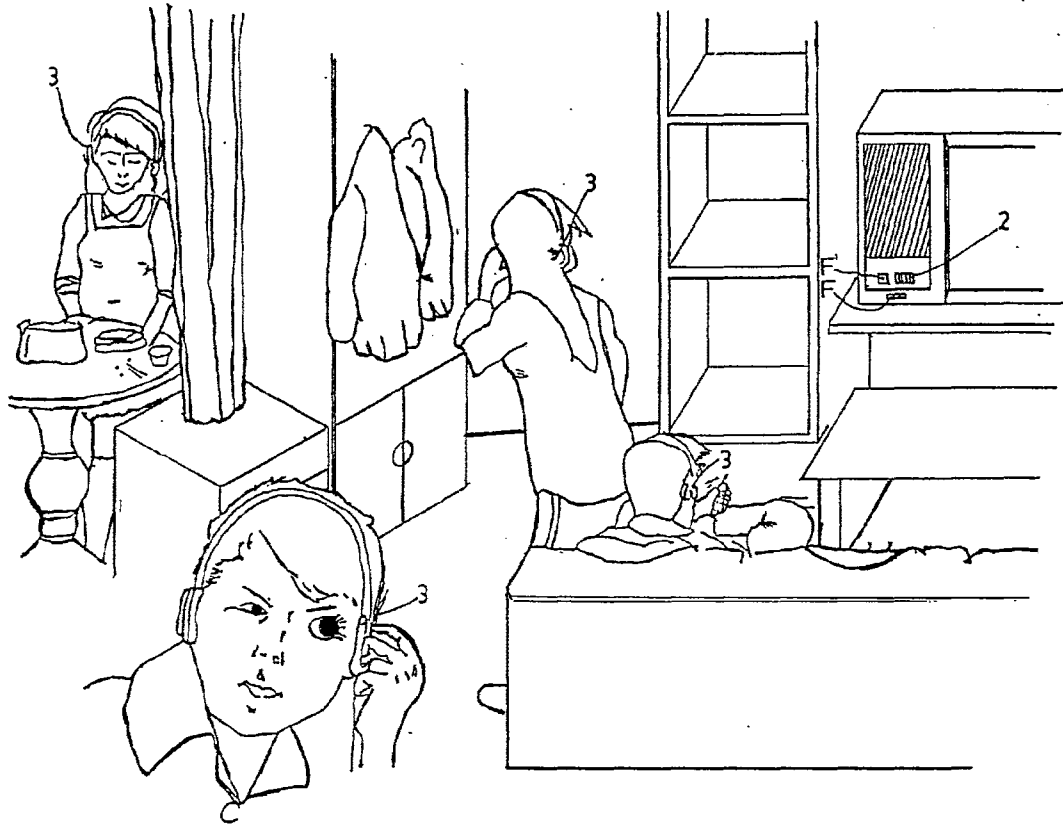

Fig. 4

WIRELESS TELEVISION HEADPHONE SET

The present invention relates to headphones, and more particularly relates to a wireless headphone for receiving the audio frequency signal transmitted through an audio frequency signal oscillator and transmitter circuit connected in the internal circuit of a television set.

A television set generally has an earphone jack for insertion therein of a earphone or headphone so that one can hear the voice from a television set clearly without interfering with the others while watching the TV program. However, an earphone or headphone is not practical for two or more persons to use at the same time. Further, because an earphone or headphone is to be connected to the earphone jack of a television set through a cable, one can not move away from a television set within the range confined by the cable when an earphone or headphone is put on the head. Because of the aforesaid disadvantages, few people would like to wear an earphone to receive the audio frequency signal provided by a television set while watching the TV program.

The present invention has been accomplished under

WIRELESS TELEVISION HEADPHONE SET

The present invention relates to headphones, and more particularly relates to a wireless headphone for receiving the audio frequency signal transmitted through an audio frequency signal oscillator and transmitter circuit connected in the internal circuit of a television set.

A television set generally has an earphone jack for insertion therein of a earphone or headphone so that one can hear the voice from a television set clearly without interfering with the others while watching the TV program. However, an earphone or headphone is not practical for two or more persons to use at the same time. Further, because an earphone or headphone is to be connected to the earphone jack of a television set through a cable, one can not move away from a television set within the range confined by the cable when an earphone or headphone is put on the head. Because of the aforesaid disadvantages, few people would like to wear an earphone to receive the audio frequency signal provided by a television set while watching the TV program.

The present invention has been accomplished under

Fig. 2 illustrates the block diagram of the transmitter and the headphone of the preferred embodiment of the present invention;

5 Fig. 3 illustrates an alternate form of the circuit block diagram of the present invention; and

Fig. 4 is a schematic drawing illustrating that various headphones are separately used for receiving the audio signal of the same television set.

10 Referring to the various drawings attached herewith, a detailed description of the structural features of "Wireless Television Headphone Set" of the present invention is as follows:-

15 Referring to Fig. 1, a wireless television headphone set in accordance with the present invention is generally comprised of an audio signal transmitting circuit 0 set inside a television set, and a plurality of headphone type radio receivers 3.

20 Referring to Fig. 2, output of the audio signal of a television set is sent to an audio signal output circuit E, which is connected in parallel with the internal circuit of said television set, for transmitting through an oscillator

and transmitter circuit O. The FM audio frequency carrier signal transmitted from the oscillator and transmitter circuit O is received by a receiving antenna T' for detection through a medium frequency amplifier circuit H and a detector I, to which the working voltage is supplied by a power supply M, from which the output signal is sent to an audio frequency amplifier J for amplification and for further output through a loudspeaker L via a volume control circuit K. As an alternate form of the present invention, a switch F' may be connected to the oscillator and transmitter circuit O at the front, to control the audio frequency signal output to the oscillator and transmitter circuit O or the speaker S of the television set. Therefore, the speaker S of the television set can be shut off while the present invention is used to hear the voice from the television set.

Referring to Fig. 4, several persons can respectively use a headphone type radio receiver 3 each to receive the audio frequency output signal of the television set while watching the screen of the television set or leaving away from the television set. Therefore each person can clearly hear the voice from the television set without interfering with the others.

## CLAIMS:

1. A wireless television headphone set, comprising an audio frequency signal oscillator and transmitter circuit connected in the internal circuit of a television set to convert the audio frequency signal provided by said television set into a radio signal for transmitting through a transmitting antenna; and at least a headphone type radio receiver for receiving said radio signal and converting it into corresponding audio frequency signal.

10

2. The wireless television headphone set of claim 1, wherein said headphone type radio receiver comprises a volume control for regulating the loudness of said audio frequency signal.

15

3. The wireless television headphone set of claim 1, which further comprises a switch connected between said audio frequency signal oscillator and transmitter and the speaker of said television set for controlling the audio frequency signal output of said television set to said oscillator and transmitter circuit or said speaker.

20

4. The wireless television headphone set substantially as herein before described with reference to, and as illustrated in, the accompanying drawings.

**Patents Act 1977**  
**Examiner's report to the Comptroller under**  
**Section 17 (The Search Report)**

- 6 -

Application number  
 9100844.1

**Relevant Technical fields**

(i) UK CI (Edition K ) H4J (JA), (JDS); H3Q (AH)

(ii) Int CI (Edition 5 ) H04R 1/10 H04 B 5/00,  
 13/02, H02J 7/10

**Databases (see over)**

(i) UK Patent Office

(ii)

**Search Examiner**

S J Cartwright

**Date of Search**

17.4.91

Documents considered relevant following a search in respect of claims 1-4

Category (see over)	Identity of document and relevant passages	Relevant to claim(s)
X	GB A 2185364 (LEATHER) whole document	1
Y	GB 1481483 (PALMAER) whole document	1
X	GB 980850 (BENDIX) whole document	1
X	<u>Tandy Electronics Catalogue</u> Item 32-2050 page 42 Pub. August 1990 by Intertan UK Ltd	1

SF2(p)



Category	Identity of document and relevant passages	Relevant to claim(s)

**Categories of documents**

**X:** Document indicating lack of novelty or of inventive step.

**Y:** Document indicating lack of inventive step if combined with one or more other documents of the same category.

**A:** Document indicating technological background and/or state of the art.

**P:** Document published on or after the declared priority date but before the filing date of the present application.

**E:** Patent document published on or after, but with priority date earlier than, the filing date of the present application.

**&:** Member of the same patent family, corresponding document.

**Databases:** The UK Patent Office database comprises classified collections of GB, EP, WO and US patent specifications as outlined periodically in the Official Journal (Patents). The on-line databases considered for search are also listed periodically in the Official Journal (Patents).

(12) INTERNATIONAL APPLICATION PUBLISHED UNDER THE PATENT COOPERATION TREATY (PCT)

(19) World Intellectual Property Organization  
International Bureau



(43) International Publication Date  
10 May 2001 (10.05.2001)

PCT

(10) International Publication Number  
WO 01/33836 A1

(51) International Patent Classification<sup>7</sup>: H04N 5/44, 7/08

[GB/GB]; 24 Grayling Mead, Romsey, Hampshire SO51 7RU (GB). ROWE, Stephen [GB/GB]; Hollybrook, Winchester Road, Crampmoor, Romsey, Hampshire SO51 9AL (GB). GIDLEY, William [GB/GB]; 15 Sycamore Close, Romsey, Hampshire SO51 5SB (GB).

(21) International Application Number: PCT/EP00/10408

(22) International Filing Date: 20 October 2000 (20.10.2000)

(25) Filing Language: English

(74) Agent: NEILL, Andrew; Siemens Shared Services Limited, Intellectual Property Department, Siemens House, Oldbury, Bracknell, Berkshire RG12 8FZ (GB).

(26) Publication Language: English

(81) Designated States (national): CA, JP, US.

(30) Priority Data:  
9925698.4 30 October 1999 (30.10.1999) GB  
0018329.3 27 July 2000 (27.07.2000) GB

(84) Designated States (regional): European patent (AT, BE, CH, CY, DE, DK, ES, FI, FR, GB, GR, IE, IT, LU, MC, NL, PT, SE).

(71) Applicant (for all designated States except US): ROKE MANOR RESEARCH LIMITED [GB/GB]; Roke Manor, Old Salisbury Lane, Romsey, Hants SO51 0ZN (GB).

Published:  
— With international search report.

(72) Inventors; and  
(75) Inventors/Applicants (for US only): LOCKHART, Peter

For two-letter codes and other abbreviations, refer to the "Guidance Notes on Codes and Abbreviations" appearing at the beginning of each regular issue of the PCT Gazette.

(54) Title: IMPROVED INTERACTIVE COMMUNICATIONS APPARATUS AND METHOD

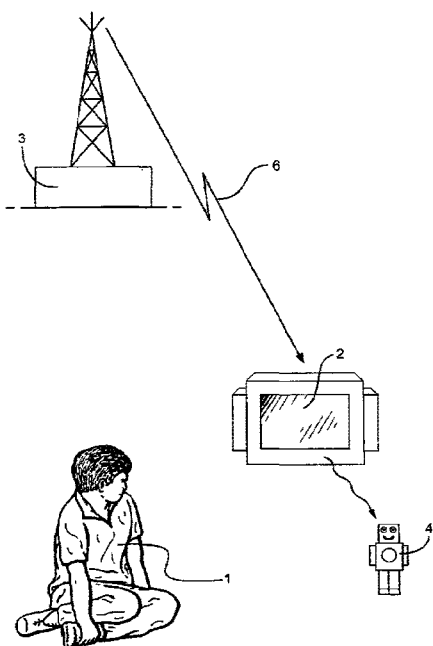

(57) Abstract: The present invention uses an acoustic data transmission system channel for communicating with remote items such as toys or other novelty devices. Control data is embedded in an acoustic which is broadcast to a toy. The data is received by the toy, which is in the vicinity of a receiver. Operation of the toy can be modified upon receipt of the embedded data. The receiver may be a television and the data broadcast with a television program.



WO 01/33836 A1

## IMPROVED INTERACTIVE COMMUNICATIONS APPARATUS AND METHOD

The present invention relates to an improved interactive communications apparatus and method. More specifically, the present invention relates to an apparatus and a method for interacting with remote items such as toys, domestic appliances, or novelty devices via the unwanted electromagnetic radiation emitted from an electronic devices.

Television (TV) screens and Video Display Units (VDUs) are known to emit unwanted electromagnetic (EM) radiation, often referred to as noise. The noise can be due to the electronic components used to create an image or sound. It is known to use this noise to try and reconstruct the original image or sound.

Presently toys can be pre-programmed to perform certain tasks in response to a predefined signal. This signal may be an electrical or acoustic signal, or a physical signal such as pressure. For example, a doll may cry when it is squeezed or dance in response to music being played.

However, these types of toys have a limited range of responses and are not readily re-programmable. Furthermore, these toys are not capable of interacting with signals, for example, from a television (TV) broadcast.

It is an object of the present invention to encode this unwanted EM radiation with information broadcast from, for example, a TV station, which could then be downloaded to a device, such as a toy.

It is a further object of the present invention that this information is used to program or modify the operation of the device.

According to the present invention there is provided apparatus for communicating with a remote item, said apparatus comprising: a broadcast

means arranged to transmit a signal, said signal having data embedded therein; a receiver arranged to receive said signal and encode unwanted electromagnetic radiation emitted from said receiver with said data; and a further receiver disposed proximate said remote item and arranged to detect said unwanted electromagnetic radiation and interpret said data upon which control of said remote item may be modified.

Preferably, the data is transmitted via a video component of the signal. The signal may be an analogue signal or a digital signal.

The data may be a modulated signal. The broadcast means may be a television broadcast or a webcast. The receiver may be a television, radio, or satellite decoder. The unwanted electromagnetic radiation may be caused by electronic components in the receiver. The receiver may include a video display unit, liquid crystal display, or plasma display.

The remote item may be a toy, domestic appliance, mobile phone, or other novelty device.

The remote item may be programmed and/or reprogrammed by the data to display or playback promotional messages.

The data may be encrypted to prevent misuse.

The signal may include data which is used to reprogram the remote item for advertising purposes.

Furthermore, according to the present invention there is provided a method for communicating with a remote item, said method comprising the steps of transmitting data, receiving said transmitted data, encoding said received data into an unwanted electromagnetic signal, transmitting said encoded unwanted electromagnetic signal, receiving said encoded unwanted electromagnetic signal,

and interpreting said data encoded within said unwanted electromagnetic signal, upon which operation of said remote item may be modified.

Advantageously, the present invention requires no additional hardware to be attached to the receiver. Furthermore, the present invention works independent of the broadcast system.

Advantageously, the present invention can be used to reinforce educational or promotional messages.

While the principle advantages and features of the present invention have been described above, a greater understanding and appreciation of the present invention may be obtained by referring to the drawings and detailed description of the preferred embodiments, presented by way of example only, in which; Figure 1 is a diagram of the basic system, Figure 2 is a diagram of the transmission system, and Figure 3 is a diagram of the receiver system.

In Figure 1, the basic concept of the invention is shown, in which a child 1, for example, is shown watching a TV programme on a monitor 2 while accompanied by a remote item, such as toy robot 4. A broadcast station 3 is arranged to transmit a signal 6, which contains the TV programme that the child is watching. The TV program is received by and displayed on the monitor 2. In addition to an audio and visual component, the signal 6 also includes a data burst which contains information for controlling the toy robot 4.

The monitor 2 emits unwanted electromagnetic radiation which has been encoded to include the data transmitted with the signal 6 from the broadcast station. The data can be encoded in the unwanted electromagnetic radiation or noise by modulation techniques. The noise is received by the toy and the data interpreted. The operation of the toy can be modified in response the interpreted

data. The toy could then appear to interact with the programme reinforcing educational or promotional messages. It is also intended that the toy may be updated by new software to add new features, behaviours, or vocabulary via the same data path. This could be a major incentive for the child to watch the broadcast in consort with the toy.

In Figure 2 the basic transmission process 20 for the broadcast system is shown. The broadcast is preferably an analogue broadcast. The term analogue broadcast includes all PAL, NTSC and SECAM type broadcasts, FM and AM radio broadcast in HF, VHF and UHF bands, as well analogue satellite and cable systems. The audio content 21 of a program to be broadcast is transmitted as part of the baseband audio signal. Digital control data 25 for controlling a remote item, such as the toy robot shown in Figure 1, is encrypted by encryption means 26. The control data may be encrypted using either an asymmetric or symmetric encryption scheme. The data is then modulated by modulation means 27 onto a carrier using, for example, angle modulation such as FSK, PSK, DPSK or CPSK, pulse position modulation, or multi-dimensional modulation schemes. The modulated data is then amplified by amplifier 28 and then combined with the audio content 21 of the program by summation means 23. The carrier can either be a simple tone or a spread spectrum carrier such as frequency hopped, chirped, or direct sequence spread spectrum. Broadcast means 24 then transmits a signal 6, which is the combination of audio content 21 and digital control data 25, via broadcast antenna 29. As will be appreciated, broadcast means 24 may be a VHF or UHF television broadcast or an AM or FM radiobroadcast.

Figure 3 shows a diagram of a receiving system 30 used for receiving signal 6 broadcast from the transmission systems shown in figure 2 and for transforming signal 6 into the encoded unwanted electromagnetic signal 36

containing the information or data for controlling the remote item 4. The receiving system 30 comprises a domestic receiver 31 and a remote device receiver 32. The remote device receiver 32 must be located proximate the source of the encoded unwanted electromagnetic signal 36, which is preferably located in the domestic receiver 31. The domestic receiver is preferably part of a TV or a radio. The remote device receiver 32 must be located proximate the remote item to be controlled, and is preferably disposed on or within the remote item.

Operation of the receiving system is as follows. The domestic receiver 31 receives signal 6 via domestic antenna 33, demodulates the video component of signal 6 via demodulation means 34 and then generates a display on display means 45. The display means is preferably a television screen. The unwanted electromagnetic radiation 36 emitted by the television is received by the antenna 37 located within the device receiver 32 and is then amplified by amplification means 38 and demodulated by demodulation means 39. The demodulation means then regenerates the digital control data 25. The control data is then applied to decryption means 40 which in turn generates the intended control data 41 for use by the remote device.

In the above embodiment the intended remote device is a toy robot. The digital control data 41 could be communicated to a microcontroller and used to update programs stored in a local memory of the toy robot. Alternatively, the digital control data could be used to generate control signals for use by actuators on the toy and/or a voice synthesiser connected to loudspeaker 58. Furthermore, if the toy robot contains a local feedback feature, a child playing with the robot can be requested to move the robot to an area in which there is improved reception of encoded unwanted electromagnetic signal 36.

As will be appreciated, in order to maximise signal reception, various configurations of transmission and receiver system previously described can be utilised.

As will also be appreciated, the data capacity of the broadcast channel is equal to the achievable data rate multiplied by the time available to transmit the data. Using relatively low amounts of transmitted data, such as four to eight bytes, the information can be used to trigger built-in responses, such as triggering a sequence of actions or phrases. As the amount of data increases to approximately ten one hundred bytes, the information can be used to modify the built-in responses, add new phrases or action sequences, or to download new data for field programmable devices and microcontrollers.

Furthermore, while encryption of the control data is not required, it does help to prevent misuse of the broadcast channel. The need for encryption becomes more critical as the amount of data transmitted to the device increases. For example, triggering a pre-defined response would not require the same level of protection as a complete downloading of new data.

In a further embodiment of the present invention, a facility is provided for the broadcaster to restore factory settings by transmission of a reset code. Furthermore, a reset button could be included on the toy, which when pressed resets the toy to the factory settings.

As will be appreciated by those skilled in the art, various modifications may be made to the embodiment hereinbefore described without departing from the scope of the present invention.



**CLAIMS**

1. Apparatus for communicating with a remote item, said apparatus comprising:
  - a broadcast means arranged to transmit a signal, said signal having data embedded therein;
  - a receiver arranged to receive said signal and encode unwanted electromagnetic radiation emitted from said receiver with said data; and
  - a further receiver disposed proximate said remote item and arranged to detect said unwanted electromagnetic radiation and interpret said data upon which control of said remote item may be modified.
2. Apparatus as claimed in Claim 1, wherein said data is transmitted via a video component of said signal.
3. Apparatus as claimed in any preceding claim, wherein said signal is an analogue signal.
4. Apparatus as claimed in any of Claims 1-2, wherein said signal is a digital signal.
5. Apparatus as claimed in any preceding claim, where said broadcast means includes means for encrypting said data.
6. Apparatus as claimed in Claim 5, wherein said further receiver includes means for decrypting said data.

7. Apparatus as claimed in any preceding claim, wherein said receiver is a television.

8. Apparatus as claimed in any preceding claim, wherein said data reprograms said remote item.

9. Apparatus as claimed in any preceding claim, wherein said data includes a code which upon reception by said remote item resets said remote item to a predefined program.

10. Apparatus as claimed in any preceding claim, wherein said remote item includes means for resetting said remote item to a predefined program.

11. Apparatus as claimed in any preceding claim, wherein said remote item is a toy.

12. Apparatus as claimed in any preceding Claim, wherein said data is a modulated signal

13. Apparatus as claimed in any preceding Claim, wherein said broadcast means is further arranged to modulate said data.

14. A method for communicating with a remote item, said method comprising the steps of:

transmitting data,

receiving said transmitted data,  
encoding said received data into an unwanted electromagnetic  
signal,  
transmitting said encoded unwanted electromagnetic signal,  
receiving said encoded unwanted electromagnetic signal, and  
interpreting said data encoded within said unwanted  
electromagnetic signal, upon which operation of said remote item  
may be modified.

15. A method as claimed in Claim 14, further comprising the step of  
encrypting said data prior to said step of transmitting data, and decrypting said  
data prior to said step of interpreting said data.

16. A method as claimed in Claims 14 or 15, wherein said data in  
transmitted via a video component of a broadcast.

17. A method as claimed in Claim 16, wherein said broadcast is a  
television broadcast

18. Apparatus for communicating with a remote item as hereinbefore  
described with reference to the accompanying figures.

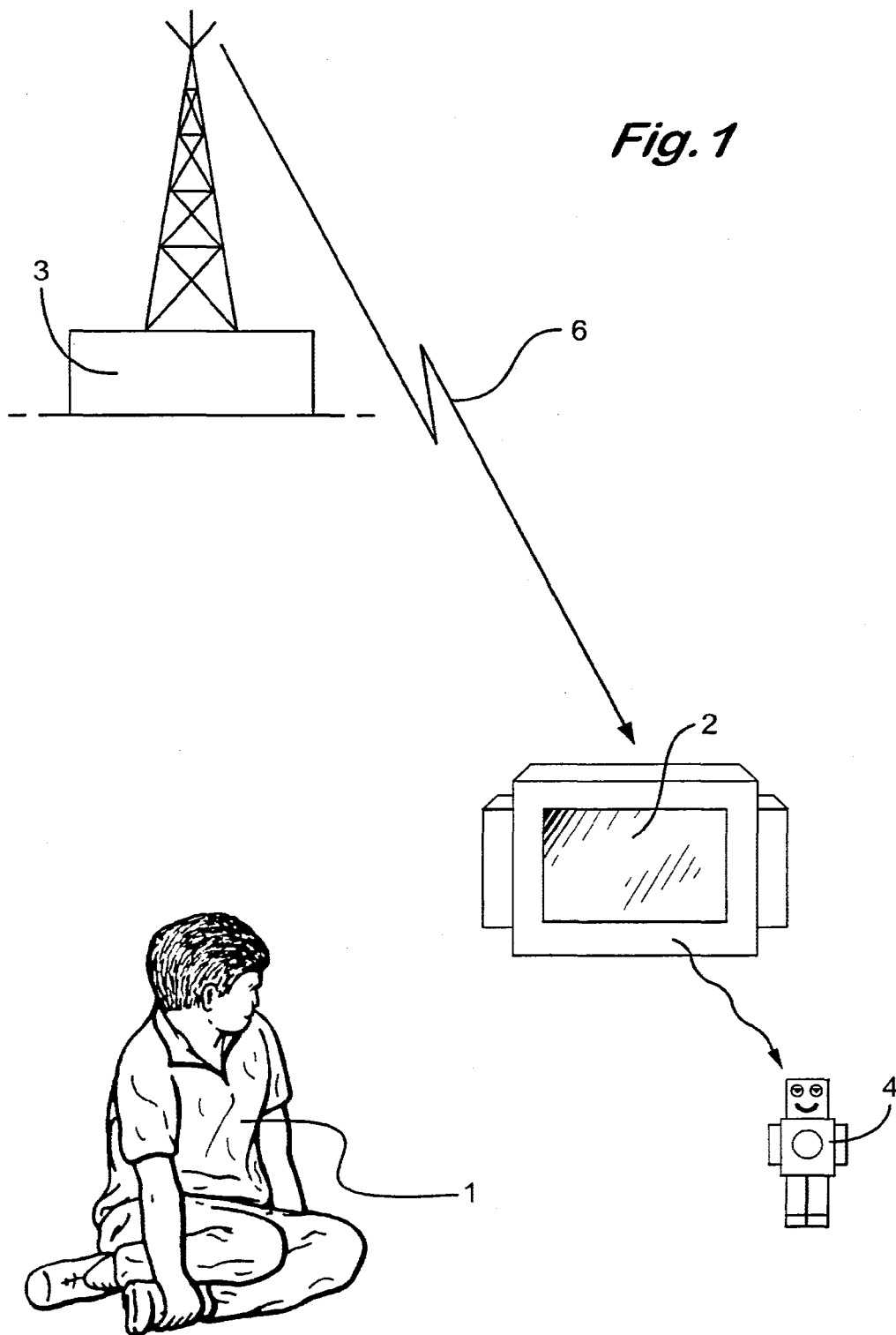

*Fig. 1*

Fig.2

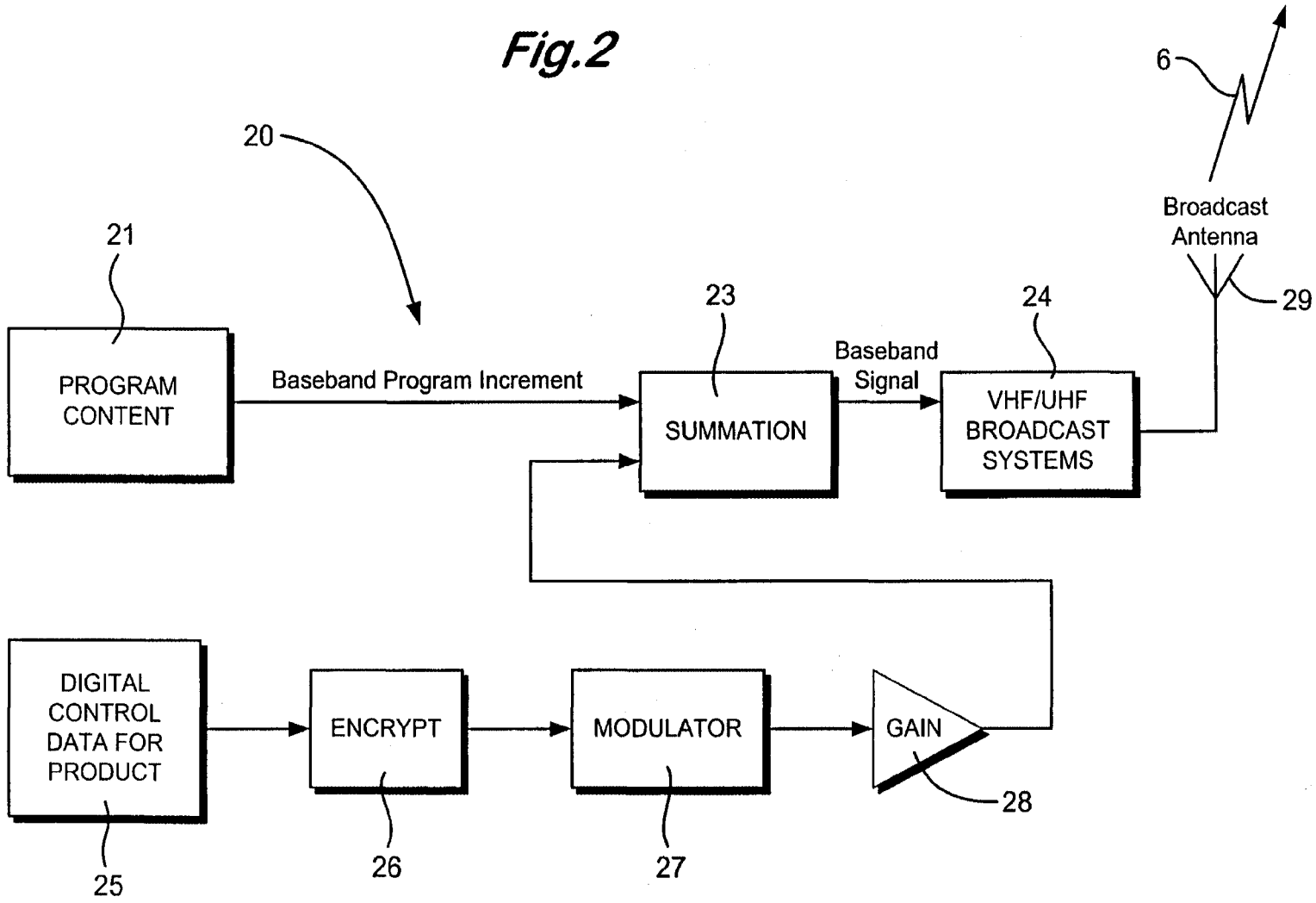

SUBSTITUTE SHEET (RULE 26)

**Fig.3**

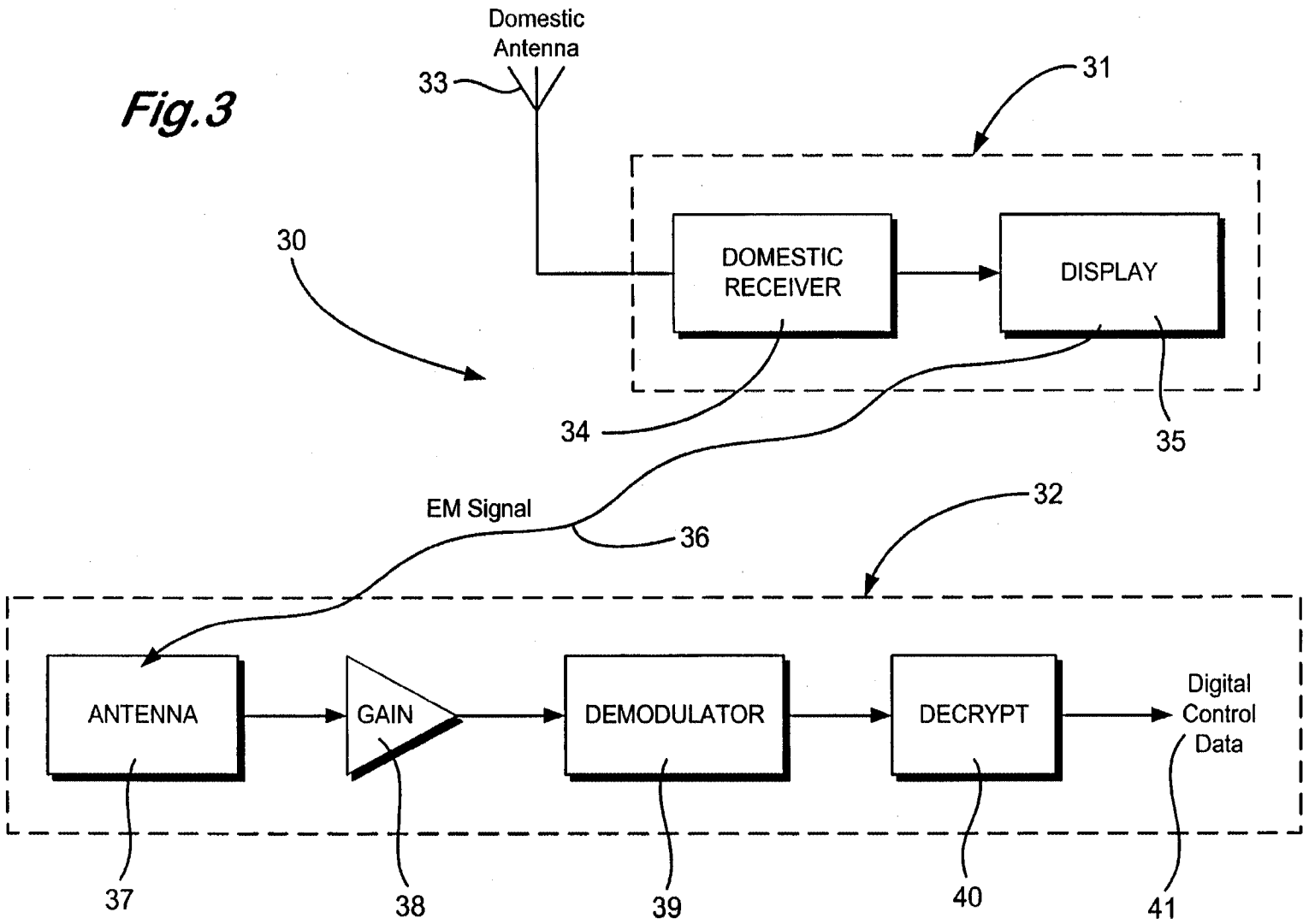

# INTERNATIONAL SEARCH REPORT

International Application No  
PCT/EP 00/10408

<b>A. CLASSIFICATION OF SUBJECT MATTER</b> IPC 7 H04N5/44 H04N7/08		
According to International Patent Classification (IPC) or to both national classification and IPC		
<b>B. FIELDS SEARCHED</b>		
Minimum documentation searched (classification system followed by classification symbols) IPC 7 H04N		
Documentation searched other than minimum documentation to the extent that such documents are included in the fields searched		
Electronic data base consulted during the international search (name of data base and, where practical, search terms used) EPO-Internal, WPI Data, PAJ		
<b>C. DOCUMENTS CONSIDERED TO BE RELEVANT</b>		
Category °	Citation of document, with indication, where appropriate, of the relevant passages	Relevant to claim No.
X	US 4 807 031 A (BROUGHTON ROBERT S ET AL) 21 February 1989 (1989-02-21)  column 1, line 7-12 column 2, line 37 - line 50 column 17, line 43 - line 52 -----	1-3,7,8, 11-14, 16-18
<input type="checkbox"/> Further documents are listed in the continuation of box C.		
<input checked="" type="checkbox"/> Patent family members are listed in annex.		
° Special categories of cited documents :		
*A* document defining the general state of the art which is not considered to be of particular relevance *E* earlier document but published on or after the international filing date *L* document which may throw doubts on priority claim(s) or which is cited to establish the publication date of another citation or other special reason (as specified) *O* document referring to an oral disclosure, use, exhibition or other means *P* document published prior to the international filing date but later than the priority date claimed	*T* later document published after the international filing date or priority date and not in conflict with the application but cited to understand the principle or theory underlying the invention *X* document of particular relevance; the claimed invention cannot be considered novel or cannot be considered to involve an inventive step when the document is taken alone *Y* document of particular relevance; the claimed invention cannot be considered to involve an inventive step when the document is combined with one or more other such documents, such combination being obvious to a person skilled in the art. *&* document member of the same patent family	
Date of the actual completion of the international search  <p style="text-align: center;">8 January 2001</p>	Date of mailing of the international search report  <p style="text-align: center;">24/01/2001</p>	
Name and mailing address of the ISA European Patent Office, P.B. 5818 Patentlaan 2 NL - 2280 HV Rijswijk Tel. (+31-70) 340-2040, Tx. 31 651 epo nl, Fax: (+31-70) 340-3016	Authorized officer  <p style="text-align: center;">Yvonne, J</p>	

# INTERNATIONAL SEARCH REPORT

Information on patent family members

International Application No

PCT/EP 00/10408

Patent document cited in search report	Publication date	Patent family member(s)	Publication date
US 4807031 A	21-02-1989	AT 99855 T	15-01-1994
		AU 615465 B	03-10-1991
		AU 2084288 A	23-05-1989
		BR 8807255 A	31-10-1989
		CA 1323688 A	26-10-1993
		CN 1036490 A, B	18-10-1989
		DE 3886929 D	17-02-1994
		DE 3886929 T	04-08-1994
		DK 303189 A	20-06-1989
		EP 0346402 A	20-12-1989
		ES 2009073 A	16-08-1989
		FI 893007 A, B,	19-06-1989
		GR 1000173 B	15-11-1991
		GR 1000595 B	26-08-1992
		IE 61641 B	16-11-1994
		IL 88089 A	27-02-1994
		IL 107233 A	24-06-1994
		IL 107234 A	31-07-1994
		JP 2545456 B	16-10-1996
		JP 2501881 T	21-06-1990
		KR 9702962 B	13-03-1997
		MC 2018 A	16-02-1990
		MW 3289 A	14-11-1990
		MX 165159 B	29-10-1992
		NO 176230 B	14-11-1994
		OA 9050 A	31-03-1991
		PH 24926 A	26-12-1990
		PT 88800 A, B	31-07-1989
		PT 100213 A	29-04-1994
		RU 2048709 C	20-11-1995
		WO 8904100 A	05-05-1989
		ZA 8807836 A	25-07-1990



(19) World Intellectual Property Organization  
International Bureau



(43) International Publication Date  
14 December 2000 (14.12.2000)

PCT

(10) International Publication Number  
WO 00/76272 A1

(51) International Patent Classification?: H04S 3/00

7973 Sagebrush Court, Boulder, CO 80301 (US). **CARLSON, Jason, Lee**; 8119 Kincross Way, Boulder, CO 80301 (US). **KATES, James, Mitchell**; 6796 Audobon Avenue, Niwot, CO 80503 (US).

(21) International Application Number: PCT/US99/28686

(22) International Filing Date: 3 December 1999 (03.12.1999)

(74) Agents: **BALES, Jennifer, L.** et al.; Macheledt Bales & Johnson LLP, Mountain View Plaza, 1520 Euclid Circle, Boulder, CO 80026-1250 (US).

(25) Filing Language: English

(26) Publication Language: English

(81) Designated States (national): AE, AL, AM, AT, AU, AZ, BA, BB, BG, BR, BY, CA, CH, CN, CU, CZ, DE, DK, EE, ES, FI, GB, GD, GE, GH, GM, HR, HU, ID, IL, IN, IS, JP, KE, KG, KP, KR, KZ, LC, LK, LR, LS, LT, LU, LV, MD, MG, MK, MN, MW, MX, NO, NZ, PL, PT, RO, RU, SD, SE, SG, SI, SK, SL, TJ, TM, TR, TT, UA, UG, UZ, VN, YU, ZA, ZW.

(30) Priority Data:  
60/110,705 3 December 1998 (03.12.1998) US

(71) Applicant: **AUDIOLOGIC, INCORPORATED**  
[US/US]; 4870 Sterling Drive, Boulder, CO 80301 (US).

(72) Inventors: **LINDEMANN, Eric**; 2975 18th Street, Boulder, CO 80304 (US). **MELANSON, John, Laurence**;

(84) Designated States (regional): ARIPO patent (GH, GM, KE, LS, MW, SD, SL, SZ, TZ, UG, ZW), Eurasian patent

[Continued on next page]

(54) Title: DIGITAL WIRELESS LOUDSPEAKER SYSTEM

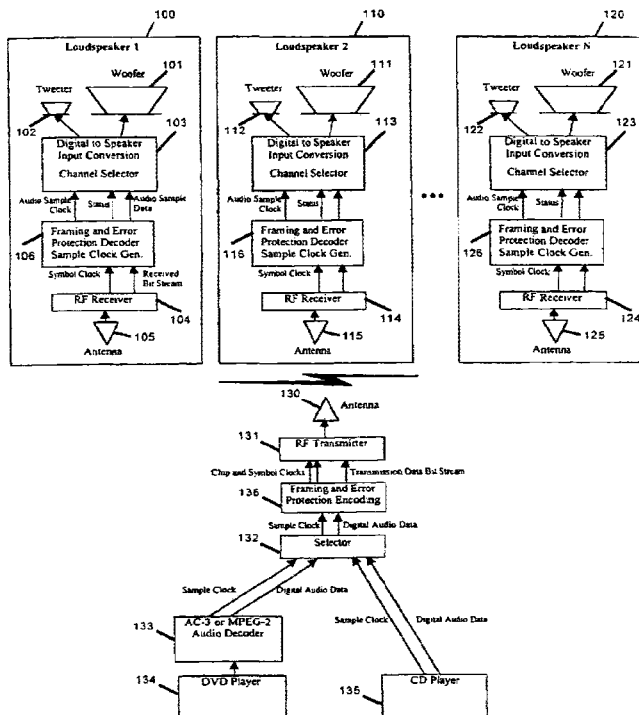

(57) Abstract: A digital wireless loudspeaker system includes an audio transmission device for selecting and transmitting digital audio data, and wireless speakers for receiving the data and broadcasting sound. The audio transmission device selects digital audio data together with a sample clock from a stereo compact disk, or decoded DVD data. The sample clock clocks an element that generates frames of data and adds error protection. Status messages are included in the transmission frames to control speaker attributes such as speaker group, enabling or disabling a sub-woofer, and volume of the loudspeaker digitally. These transmission frames are clocked into an RF transmitter and transmitted to the speakers. The received bit stream and symbol clock are output from the RF receiver in each speaker and input to a framing and error protection decoder and a sample clock generator. The recovered audio sample data and sample clock are input to a digital to speaker input conversion and channel selector.



WO 00/76272 A1



(AM, AZ, BY, KG, KZ, MD, RU, TJ, TM), European patent (AT, BE, CH, CY, DE, DK, ES, FI, FR, GB, GR, IE, IT, LU, MC, NL, PT, SE), OAPI patent (BF, BJ, CF, CG, CI, CM, GA, GN, GW, ML, MR, NE, SN, TD, TG).

— *Before the expiration of the time limit for amending the claims and to be republished in the event of receipt of amendments.*

**Published:**

— *With international search report.*

*For two-letter codes and other abbreviations, refer to the "Guidance Notes on Codes and Abbreviations" appearing at the beginning of each regular issue of the PCT Gazette.*

DIGITAL WIRELESS LOUDSPEAKER SYSTEM  
BACKGROUND OF INVENTION

This application claims the benefit of U.S. Provisional Application No. 60/110,705, filed December 3, 1998.

5     FIELD OF THE INVENTION

This invention relates to digital wireless loudspeaker systems.

DESCRIPTION OF THE PRIOR ART

10     Traditionally wires are required to connect an audio source, such as the output of a hi-fi power amplifier, to a set of loudspeakers. These wires are inconvenient, since they often need to be run under carpeting and floors, and through walls and ceilings. As home theater systems, often involving six surround sound loudspeakers, become increasingly popular, the wiring problem becomes a major annoyance. Wireless loudspeakers that communicate with the audio source via RF transmission remove the need for this web of wires.

15     Wireless loudspeakers have existed for some time [Recoton Patent Reference]. The analog FM transmission systems used in these speakers have resulted in relatively low-fidelity systems with signal to noise ratios on the order of 40dB to 60 dB. A need exists for a high fidelity wireless loudspeaker system with performance on a par with wired solutions.

20     The sampling rate of a compact disk is 44100 16 bit samples/ second. This results in a bit rate for stereo of  $44100 * 16 * 2 = 1411200$  bits/second. To achieve reliable wireless transmission, redundancy must be introduced in the transmitted bit stream. This redundancy supports a robust error detection and correction system. In addition, the wireless transmission system requires additional bits for framing and  
25     synchronization of data. In all, approximately three times the original bit rate, or  $3 * 1,411,200 = 4,233,600$  bits/second, is required to support wireless stereo. For a six channel surround sound home theater system, the bit rate triples to  $3 * 4,233,600 = 12,700,800$  bits/sec. Achieving these bit rates can be extremely difficult.

A wireless loudspeaker requires a power amplifier local to the loudspeaker. Local power amplifiers can provide an advantage in terms of audio fidelity. Most loudspeakers are either two-way or three-way systems. This means that the audio signal is divided into two or three frequency bands and these bands are sent to specialized speakers – woofer, tweeter, mid-range. The typical consumer audio loudspeaker divides the amplified audio signal into frequency bands using passive crossover circuits in the loudspeaker. These passive crossover circuits are made of inductors, resistors, and capacitors. The passive crossovers are difficult to design and are a major source of frequency distortion in a loudspeaker system.

An alternative to passive crossovers is active crossovers. With active crossovers, the line level unamplified audio signal is divided into frequency bands and then each frequency band signal is sent to a separate power amplifier. In a two-way system this is called bi-amplification. In a three-way system this is called tri-amplification. Active crossovers have traditionally been designed using analog electronics – op-amps etc. While active crossovers with multiple power amplifiers provide a clear benefit in terms of audio fidelity they can be a challenge to design cost effectively.

#### SUMMARY OF INVENTION

An digital wireless loudspeaker system includes an audio transmission device for selecting and transmitting digital audio data and wireless speakers for receiving the data and broadcasting sound. Digital audio data together with a digital audio sample clock that synchronizes the data, comes to the audio transmission device from either a stereo compact disk or an AC-3 or MPEG-2 Audio Decoder that decodes and uncompresses the multichannel compressed audio stream coming from the DVD motion picture disk. In the audio transmission device, a selector element selects the data and clock coming from either the CD Player or the Audio Decoder. The selected sample clock is used to clock the selected data into a framing and error protection encoding unit which generates frames of data and adds error protection. These transmission frames are clocked into an RF transmitter and transmitted to the speakers. For a stereo system there are two loudspeakers. For a typical surround sound home theater system there are six loudspeakers. Each loudspeaker contains an RF receive antenna and an RF receiver, and performs acquisition and tracking on the RF signal generated by the single RF transmitter in the audio transmission device. The received bit stream and symbol

clock are output from the RF receiver and input to a framing and error protection decoder and a sample clock generator. The recovered audio sample data and audio sample clock are input to a digital to speaker input conversion and channel selector. Status messages are included in the transmission frames to control speaker attributes  
5 such as speaker group, enabling or disabling a sub-woofer, and volume of the loudspeaker digitally.

Wireless transmission of digital audio is used in this invention to achieve hi-fidelity performance comparable to compact disk quality audio. One embodiment of the present invention solves this problem by using digital crossovers on the  
10 uncompressed digital audio signal and then employs novel Class D pulse width modulation (PWM) power amplifiers. These Class D PWM amplifiers are inexpensive and provide a convenient low cost path for generating an amplified speaker input signal directly from the digital audio stream.

When digital audio is transmitted to a wireless speaker the speaker needs to  
15 reliably recover the data as a stream of digital audio samples and needs to generate an accurate digital audio sample rate clock to output the data. When transmitting to several wireless loudspeakers simultaneously, as is the case with stereo or six channel surround sound, the sample rate clocks for the loudspeakers must be accurately  
20 synchronized to the data and with each other. Small delays from one speaker to the next would compromise the stereo or surround sound imaging of the sound. Even worse, variable delays would cause sounds to appear to move around in space. This invention solves the audio sample rate synchronization problem by generating the audio sample rate clock directly from the RF receiver symbol rate clock. For an RF system with continuously streaming data transmission, as is the case with digital audio in this  
25 invention, this clock is highly accurate and is guaranteed to be synchronized between RF receivers in multiple loudspeakers because it is generated at a single location in the RF transmitter.

One embodiment of the present invention meets the bit rate requirements by transmitting multichannel digitally compressed audio. Each loudspeaker receives the  
30 entire multichannel RF compressed audio stream, uncompresses it, and in the process selects the single channel intended for that loudspeaker.

BRIEF DESCRIPTION OF THE DRAWINGS

Figure 1 shows a block diagram of the audio part of a home theater system according to the present invention.

5 Figure 2 shows a block diagram of second embodiment of the present invention.

Figure 3 shows a detailed block diagram of the RF Receiver of Figure 1.

Figure 4 shows a detailed block diagram of the RF Transmitter of Figure 1.

Figure 5 shows a detailed block diagram of the Framing and Error Protection Encoding unit of Figure 1.

10 Figure 6 shows a block diagram of the Framing and Error Protection Encoding unit of Figure 2.

Figure 7 shows the diverse antenna of Figure 3 in more detail.

Figure 8 shows a block diagram of the Framing and Error Protection Decoder and Sample Clock Generator of Figure 1.

15 Figure 9 shows a block diagram of the Framing and Error Protection Decoder and Clock Generator of Figure 2.

Figure 10 shows a block diagram of one embodiment of the Speaker Input Conversion and Channel Selector of Figure 1.

20 Figure 11 shows another embodiment of the Digital to Speaker Input Conversion and Channel Selector of Figure 1

Figure 12 shows a block diagram of the Digital to Speaker Input Conversion and Compressed Audio Decoder and Channel Selector unit of Figure 2.

Figure 13 shows another embodiment of the Digital to Speaker Input Conversion and Compressed Audio Decoder and Channel Selector unit of Figure 2.

Figure 14 shows one embodiment of a single channel of the Stereo Digital Audio Encoder of Figure 2.

Figure 15 shows a third embodiment of the current invention.

5 Figure 16 shows one embodiment of the RF Receiver used in the embodiment of Figure 15.

Figure 17 shows another embodiment of the RF Receiver used in embodiment of Figure 15.

Figure 18 shows one embodiment of the Channel Selection Interface of Figure 15.

10 Figure 19 shows a second embodiment of the Channel Selector Interface of Figure 15.

#### DETAILED DESCRIPTION OF PREFERRED EMBODIMENTS

Figure 1 shows a block diagram of the audio part of a home theater system in which the present invention is used. Digital Audio Data together with a digital audio Sample Clock that synchronizes the data, comes from either a stereo compact disk 135, or the AC-3 or MPEG-2 Audio Decoder 133 that decodes and uncompresses the multichannel compressed audio stream coming from the DVD motion picture disk 134. Audio from the DVD disk is encoded in a compressed multichannel format – generally either AC-3 six channel or MPEG-2 multichannel formats. The Selector 132 selects the Digital Audio Data and Sample Clock coming from either the CD Player 135 or the AC-3 or MPEG—2 Audio Decoder 133. The selected Sample Clock is used to clock the selected Digital Audio Data into the Framing and Error Protection Encoding unit 136.

25 A detailed block diagram of the Framing and Error Protection Encoding unit is shown in Figure 5. The Framing unit 504 assembles Digital Audio Frames consisting of a fixed number of digital audio samples. Header and status information is added to each Digital Audio Frame 503. The function of the status information is to transmit

various loudspeaker settings and configurations to the loudspeaker systems. The Reed Solomon Encoder and Interleaver 502 divides the Digital Audio Frames into smaller Transmission Frames with a fixed number – e.g. 4 - of Transmission Frames per Digital Audio Frame. The interleaving function of the Reed Solomon Encoder and  
5 Interleaver 502 shuffles the bits in one digital audio frame so that adjacent digital audio bits appear in different Transmission Frames. Interleaving protects against burst errors in transmission. Each Transmission Frame is Reed Solomon Encoded 502 for error protection, and then a fixed bit sequence Frame Marker pattern is inserted in front of each Transmission Frame 501. The Frame Marker is used by the RF Receiver to  
10 recognize Transmission Frame boundaries. The Transmission Frame with inserted Frame Marker is then Convolutionally Encoded 500 for added error protection. The combination of Reed Solomon Encoding and Convolutional Encoding is called a concatenated encoder and represents a particularly robust form of encoding for error protection.

15 In Figure 1 the Transmission Frames from the Framing and Error Protection Encoding unit 136 are clocked into the RF Transmitter 131. Figure 4 shows a detailed block diagram of the RF Transmitter. In the embodiment of Figure 4, the Transmission Frames output from 136 form a bit stream that is input to the Modulator and Direct Sequence Spread Spectrum (DSSS) Spreader 405. The Modulator and DSSS Spreader  
20 405 takes the input bit stream  $M$  bits at a time and generates  $M$ -ary symbols. The symbols are generated at the Symbol Rate which is equal to the input bit rate divided by  $M$ .  $M$  is the number of bits per symbol and is typically in the range 2 to 16. The symbols are modulated by a spreading sequence. The spreading sequence is  $S$  bits long and the clock rate of the spreading sequence modulation, called the Chip Rate, is  $S$   
25 times the symbol rate.  $S$  is typically in the range 10 to 16.

The Modulator and Direct Sequence Spread Spectrum (DSSS) Spreader 405 relies on a Chip Clock and Symbol Clock. The Chip and Symbol Clocks are generated in the Framing and Error Protection Encoding unit 136, shown in detail in Figure 5. Each Digital Audio Frame, corresponds to a fixed number of multichannel audio  
30 samples. After header, status, and error bits are added to generate an extended digital audio frame, and after this extended frame is divided into transmission frames, each of which has error protection bits and a frame marker added to it, there are then a fixed number encoded transmission bits associated with each Digital Audio Frame. Since there are  $M$  transmission bits per transmission symbol we are able to derive a fixed ratio  
35 between the audio sample clock and the symbol and chip rate clocks.



$$F_c = S * F_s$$

$$F_s = F_a * S_f / A_f$$

where :

- 5  $F_c$  = frequency of chip rate clock  
 $S$  = number of chips per symbol  
 $F_s$  = frequency of symbol clock  
 $F_a$  = frequency of audio sample clock  
 $A_f$  = number of multichannel audio samples per digital audio frame  
 $S_f = (T_f * B_f / M)$  = number of symbols per digital audio frame  
10  $T_f$  = number of transmission frames per digital audio frame – a constant  
 $B_f$  = number of data bits per transmission frame – a constant  
 $M$  = number of data bits per symbol – a constant

15 The chip clock is then a fixed integer ratio  $F_c = F_a * (S * S_f / A_f)$  of the audio sample clock. The precise value of  $F_c$  is chosen so that  $(S * S_f / A_f)$  can be expressed as a ratio of relatively small integers  $R/Q$ . Taking the audio sample clock as input, and using frequency multipliers and clock dividers the Chip Clock and Symbol Clock Generator 505 in Figure 5 is generates a Chip and Symbol Clock, based on multiplying the audio sample clock by  $R/Q$ . These clocks are tightly synchronized with the audio Sample Clock. Frequency multipliers and clock dividers are well understood by those skilled in the art of digital circuit design. In Figure 1 the encoded frames from the Framing and Error Protection Encoding unit 136 are clocked into the RF Transmitter 131 using the Symbol Clock and Frame Clock.

25 In another embodiment both the Chip Clock and Symbol Clock and the Sample Clock are generated by frequency multiplication and clock division from the same Clock Oscillator running from the same crystal or. In general this oscillator run at a high frequency so that only clock dividers are required to generate both the Symbol Clock, Chip Clock, and audio Sample Clock.

30 The interleave function performed by the Reed Solomon Encoder and Interleaver with Frame Marker Insertion 407 protects against burst errors by scrambling adjacent bits across multiple Reed Solomon encoding blocks. This error protection system is a called a concatenated encoder with interleaving and is well known to those

skilled in the art of error protection system design [*Error Control Coding: Fundamental and Applications, Lin and Costello, Prentice Hall, 1983*].

5 Every digital RF modulation scheme, be it DSSS, FHSS, or another non-spread spectrum scheme, requires an accurate method of determining the symbol rate. A key element of the present invention is that the symbol rate is a fixed ratio  $R/Q$  of the audio Sample Clock. In other embodiments it may not be necessary to explicitly generate an actual Symbol Clock signal to accomplish the same goal of generating the symbol rate as a fixed ratio  $R/Q$  of the audio Sample Clock. In DSSS a chip clock is used which is  $S$  times the symbol rate. In FHSS no chip clock is used so only the  
10 symbol clock or symbol rate reference is generated.

Many DSSS modulation schemes exist and are well known to those skilled in the art of RF system design [*Digital Communications, Fundamentals and Applications, Benard Sklar, Prentice Hall, 1988*]. Also, many error encoding and modulation schemes can be implemented. In particular a Frequency Hopping Spread  
15 Spectrum (FHSS) modulation scheme [*Digital Communications, Fundamentals and Applications, Benard Sklar, Prentice Hall, 1988*] is a well known common alternative to a DSSS modulation scheme. In addition, it may be possible in certain situations to use a less complex error protection scheme consisting of a Convolutional Encoder alone, a Reed Solomon Encoder alone, or even no error protection scheme at  
20 all. In the absence of a Reed Solomon Encoder a separate Scrambler is often used to provide the same kind of protection against burst errors. Also, in the absence of a Reed Solomon Encoder a separate Frame Marker Insertion Unit inserts a Frame Marker every  $N$  audio samples. This allows the RF Receiver to recognize the beginning of a block of audio samples in an otherwise continuous bit stream. It is obvious to one skilled in the  
25 art of RF System design that the particular embodiment of RF Transmitter does not change the character of the present invention.

The output of the Modulator and DSSS Spreader 405 is a complex signal with  $I$  and  $Q$  – real and imaginary – components.  $I$  and  $Q$  are input to the IF Quadrature Modulator 404 where they are modulated by intermediate frequency (IF) – typically 50  
30 to 200 MHz – sine and cosine modulators. The sine and cosine modulators are derived from the IF VCO 409 output. The modulated  $I$  and  $Q$  are summed and this summed IF output is sent to the RF Upconverter 402. The RF Upconverter 402 modulates the IF output by a sinusoid at the RF carrier frequency – 915 MHz, 1.4 GHz, etc. – which is

generated by the RF VCO 408. The RF frequency signal is input to the Power Amplifier 401 and the amplified RF frequency signal is output to the air through the RF transmitter antenna 400. Some details such as band pass and low pass filters are left out of the block diagram of Figure 4. Those skilled in the art of RF System design will  
5 recognize this and understand that only the principle blocks of the RF transmitter design are shown in Figure 4.

Figure 1 shows Loudspeaker One 100, Loudspeaker Two 110 and Loudspeaker N 120. For a stereo system there are two loudspeakers. For a typical surround sound home theater system there are six loudspeakers. It is clear to one skilled in the art that  
10 the present invention can accommodate any reasonable number of loudspeakers with N typically equal to 2 through 8.

Each loudspeaker contains an RF receive antenna 105,115,125 and an RF receiver 104,114,124. One embodiment of the RF Antenna and RF receiver is shown in Figure 3. In this embodiment the receive antennae 300 found in each loudspeaker is  
15 comprised of multiple antennae of different sizes. This diverse antenna is shown in Figure 7. The multiple antennae of Figure 7 are housed in the speaker cabinet 700. 704 is the short antenna and 705 is a longer antenna. These antennae connect to the Electronics unit 703 which is also found inside the speaker cabinet 700 along with the Tweeter 701 and Woofer 702 speakers. The Electronics unit 703 contains all of the  
20 electronics for RF communications, audio signal processing, audio decoding, and amplification. The diverse antenna sizes allow for more robust RF reception, especially in the presence of multipath transmission due to reflections from walls, floors, ceilings, moving bodies, furniture, and other obstacles commonly found in indoor environments.

A detailed block diagram of the RF Receiver is shown in Figure 3. This  
25 embodiment implements a Direct Sequence Spread Spectrum (DSSS) demodulator and a concatenated error protection decoder corresponding to the RF transmitter embodiment of Figure 4. It is obvious to one skilled in the art of RF system design that the RF receiver design must mirror the RF transmitter design in its overall structure. In  
30 particular if an FHSS modulator is used in the transmitter an FHSS demodulator must be used in the receiver. Likewise, if an error protection encoder other than the concatenated encoder described in the RF transmitter embodiment of Figure 4 is used, then the corresponding error protection decoder must be used in the RF receiver. It is obvious to one skilled in the art of RF transmitter and receiver design that many

variations of modulation/demodulation and error protection encoding and decoding can be used without altering the character of the present invention.

In the RF receiver embodiment of Figure 3, the RF frequency signal from the antenna 300 is input to the RF Low Noise Amplifier 301 whose output is sent to the RF Downconverter 302. The RF Downconverter 302 modulates the RF signal, using a sinusoid generated by the RF VCO 310, down to IF frequency. Some details such as band pass and low pass filters are left out of the block diagram of Figure 3. Those skilled in the art of RF System design will recognize this and understand that only the principle blocks of the RF receiver design are shown in Figure 3. The IF signal is further down modulated by the IF Demodulator 303. The output of the IF Demodulator is a complex signal consisting of I and Q – real, imaginary – running at the Chip Rate. The I and Q components are input to an Analog to Digital Converter (ADC) 304 with sampling rate typically 1-2 times the Chip Rate. The ADC precision is typically 3 to 4 bits for I, and 3 to 4 bits for Q. In order to successfully decode the received I and Q signals, they must be despread. This is accomplished by again multiplying I and Q with the same spreading sequence used in the Modulator and DSSS Spreader 405 of the RF transmitter. This spreading sequence is known in advance. The spreading sequence must be correctly aligned in time with the received I and Q signals. This process is called symbol synchronization and is generally accomplished in two stages: a course synchronization stage called acquisition, and a fine tuning synchronization stage called tracking. Synchronization is implemented by the Correlator, DSSS Despreader and Demodulator with Acquisition and Tracking for Symbol Synchronization 305. Separate despreaders and correlators are used for the I and Q components. The correlators multiply the input I and Q signals with the spreading sequence. The multiply and sum operation of the correlators is done at a series of different delays with respect to the input I and Q signals. The intention is to find the delay with the maximum correlation value. At this delay the input I and Q signals are roughly synchronized with the Symbol Rate of the transmitter. This corresponds to the output of the acquisition stage of symbol synchronization. The symbol synchronization is further fine tuned by a tracking stage. Several techniques for tracking are known in the art. These include Delay-Locked Loop (DLL) and Tau-Dither Loop techniques. [*Digital Communications, Fundamentals and Applications, Bernard Sklar, Prentice Hall, 1988*]. Acquisition and tracking allow the start of the symbol period to be known with excellent sub-chip period resolution. At the start of each symbol period, as determined by the acquisition and tracking stages, the Correlator, DSSS Despreader and Demodulator with Acquisition and Tracking for Symbol Synchronization 305 outputs a

pulse. This stream of pulses, once per symbol, is the Symbol Clock. Similar acquisition and tracking techniques are used to perform Symbol Synchronization in FHSS systems and, in fact, in every other Digital RF Transmission system. Symbol synchronization techniques are well known to those skilled in the art of RF Receiver design and it is obvious to such a practitioner that the particular type of Symbol Synchronization employed will not change the character of the present invention.

In the present invention several loudspeakers each perform acquisition and tracking on the RF Signal generated by the single RF Transmitter. As a result the output of 305 in the RF Receiver of each loudspeaker is a Symbol Clock synchronized, to within sub-chip resolution, with the Symbol Clock in every other loudspeaker in the system. In the present invention, the transmitter transmits digital audio bits at a continuous and constant Symbol Rate derived directly from the digital audio Sample Clock that clocks audio samples into the RF Transmitter. This constant transmission rate results in a constant Symbol Clock output from 305.

In Figure 1 we see that the received bit stream and Symbol Clock are output from the RF Receiver and input to the Framing and Error Protection Decoder and Sample Clock Generator 106,116,126. A block diagram of the Framing and Error Protection Decoder and Sample Clock Generator is shown in Figure 8. The received bit stream is input to the Viterbi Decoder 800 which performs error detection and correction corresponding to the Convolutional Encoder 500 of Figure 5. The Viterbi decoded bit stream is input to the Frame Synchronizer 801.

Since the transmitted audio stream is continuous and constant the Frame Marker at the beginning of each Transmission Frame appears in the received bit stream at constant time intervals. The Frame Synchronizer 801 correlates the known Frame Marker sequence across many frame periods, and by so doing is able to determine the location of the Frame Marker and hence the start of each Transmission Frame. This is a convenient and economical method for frame synchronization. Another less economical method is sync word recognition at each frame boundary. Several techniques for frame synchronization are known in the art of RF Receiver Design [*Digital Communications, Fundamentals and Applications, Benard Sklar, Prentice Hall, 1988*]. It is obvious to one skilled in the art of RF Receiver design that the exact method of frame synchronization chosen does not effect the character of the present invention.

By reading the start each Transmission Frame the RF Receiver is able determine which Transmission Frame contains the Digital Audio Frame header, and as a result is able to identify the start of each Digital Audio Frame. The Frame Synchronizer 801 also strips off the Frame Marker and passes the Transmission Frames on to the Reed Solomon Decoder 802. Each transmission frame is Reed Solomon Decoded to generate fully error corrected Transmission Frames. The Transmission Frames are passed on to the Header and Status Stripper 803 which reads the head of each Transmission Frame looking for the header and status information that marks the beginning of each Digital Audio Frame. The Header and Status Stripper 803 removes the header and status information passing on the status information to the rest of the system. The digital audio data is passed on the Deinterleaver 804, which unshuffles the data in a single Digital Audio Data Frame to yield the original Digital Audio Data Frame. The Deinterleaver 804 also generates a pulse corresponding to the Digital Audio Frame Clock.

The Symbol Clock and the Digital Audio Frame Clock are input to the Audio Sample Clock Generator 805. Since we know that the ratio of transmission symbols to audio samples per Digital Audio frame is equal to  $R/Q$ , as described above, then by using frequency multipliers and clock dividers the Audio Sample Clock Generator is able to regenerate the Sample Clock by multiplying the Symbol Clock by  $Q/R$ . Since the Digital Audio Frame clock marks the beginning, with Symbol Clock accuracy, of a block of digital audio samples, it can be used to accurately set the phase of the regenerated Sample Clock. The Sample Clock is thus regenerated to within the synchronization limits of the Symbol Clock. This is approximately plus or minus one half the chip period. Given a symbol size of 2 bits, such as with DQPSK modulation, a factor of three redundancy in the data, stereo 16 bit samples, and a chip rate 11 times the symbol rate we have  $(16 \text{ bits/per sample} * 2 \text{ samples/per stereo sample} * 3 \text{ redundancy} / 2 \text{ bits per symbol} * 11 \text{ chips per symbol} = 528 \text{ chips per sample}$ . So the Sample Clock is synchronized across all loudspeakers at  $\pm 1/(2*528) = 1/1056$  of 1 sample for stereo. For a stereo 44,100 sampling rate this results in an audio Sample Clock synchronization between loudspeakers of  $\pm 21$  nanoseconds. For six channel the synchronization is even tighter.

As shown in Figure 1, the recovered Audio Sample Data and Audio Sample Clock are input to the Digital to Speaker Input Conversion and Channel Selector 103,113,123. A block diagram of one embodiment of the Speaker Input Conversion and Channel Selector is shown in Figure 10. The Digital Audio Sample Data input to

Figure 10 consists of all channels of audio.

The output of the Channel Selection Interface 1000 determines which audio channel the individual loudspeaker is assigned to in a surround sound or stereo system, which mix mode to use (described later), and digital crossover filter EQ information (also described later). Figure 18 shows one embodiment of the Channel Selection Interface. A Channel Selection Switch 1801 located on the speaker cabinet allows the user to specify what role an individual speaker is assigned to in a surround sound system: left front, center front, right front, left rear, right rear. In the case of a subwoofer the speaker itself is sufficiently distinctive that no switch is necessary. The output of the Channel Selection Switch is input to the Channel Selection Register and Status Decode Logic 1802. The output of the Channel Selection Register and Status Decode Logic 1802 is the output of the Channel Selection Interface 1000 and is sent to the remaining functional units of the Digital to Speaker Input Conversion and Channel Selector. A special NO\_CHANNEL output code from the Channel Selection Interface specifies that the speaker is disabled and should respond to no channel selection. Also comprised in the Channel Selection Interface is a Group Selection Switch 1800. Many homes and offices have multiple groups of loudspeakers - e.g. a group of loudspeakers in the living room and another group in the kitchen. The Group Selection Switch allows a loudspeaker to be assigned to one of many groups of loudspeakers.

Status information from the Framing and Error Protection Decoder and Sample Clock Generator 106,116,126 of Figure 1) is also received by the Channel Selection Interface 1000 and input to the Channel Selection Register and Status Decode Logic 1802. Among other messages, the status information contains commands to enable or disable a particular group of speakers. When the group to which the current loudspeaker is assigned is disabled, the Channel Selection Register and Status Decoder Logic 1802 is set to output the special NO\_CHANNEL output code.

Another status message determines enabling of different speaker modes according to speaker group. For example, "enable only left and right front channels for stereo speaker Group A". Another useful status message is "enable left and right front channels of speaker Group B to mix down the received six channel surround data to two channel stereo". This would be appropriate if there were only two stereo speakers in speaker Group B. This mix information appears at the output of the Channel Selection Register and Status Decode Logic 1802, and is input to the Channel Selector

and Mixer and Volume Control (1003 of Figure 10). At the same time another status message can be sent saying "enable full six channel decode on Group B". This would be appropriate if Speaker Group A consists of a full complement of six surround sound speakers. Again the mix information is used in this case.

5           Another status message involves enabling or disabling a sub-woofer in either a stereo or surround sound configuration. This is used to affect the frequency response of the crossover units as described below. The frequency response selection information is also available at the output of the Channel Selection Interface 1000.

          Another status message involves setting the volume of the loudspeaker digitally.  
10       This message is decoded by the Channel Selection Register and Status Decode Logic (1802 of Figure 18) and output by the Channel Selection Interface. The message includes the desired value of the volume control. The Channel Selector and Mixer and Volume Control unit 1003 receives the volume information and multiplies the incoming digital sample stream by the desired volume value. Implementing the volume control in  
15       the loudspeaker allows the RF communication link to function with a lower dynamic range equal to that coming from the media – e.g. Compact Disk or DVD. In another embodiment the Volume Control is implemented in the digital crossover filter. It  
20       obvious to one skilled in the art of digital signal processing that the volume control function can be implemented in any of the digital audio processing blocks of Figure 10 without changing the character of the invention. The key element of the present invention is that the volume control is implemented in the loudspeaker permitting a reduced dynamic range in the RF transmission system.

          It is obvious that minor changes can be made in the structure of the Channel Selection Interface, and that many variations are possible without changing the character  
25       of the current invention. A key element of the present invention is that status information is transmitted via the RF transmission system, and that this status information, possibly in conjunction with switch settings in the Channel Selection Interface, determines the enabling and disabling of a particular loudspeaker and the particular configuration of channel decoding, mixing and EQ for that loudspeaker.

30       The multichannel audio sample is input to the Channel Selector and Mixer and Volume Control 1003 which selects one channel from the multichannel Digital Audio Sample Data input, or mixes several channels of a surround sound signal to one channel, and outputs this to the Digital Crossover Filter 1004. In the embodiment



shown in Figure 1 a two way loudspeaker system is used, and so, the Digital Crossover 1004 divides the digital audio signal into a low and high frequency output. In another embodiment a three or four way system is used and the digital crossover divides the digital audio signal into three or four bands. There are a number of advantages to using digital filtering for implementing the crossover function. With digital filtering accurate linear phase filters can be designed. In addition the digital filters can be made to compensate for the non ideal phase and magnitude frequency characteristics of the speakers themselves. In addition the digital filter coefficients for the Digital Crossover 1004 can be downloaded to the loudspeaker using the status information which is decoded and output by the Channel Selection Interface 1000. These coefficients can be specially adjusted to compensate for acoustic differences in the room that the loudspeakers are placed in or can be adjusted according to whether or not a sub-woofer is present in the system. Different size and shapes of rooms and the locations of loudspeakers placed in them result in different, and often undesirable, changes in frequency response for a loudspeaker system. These can be almost eliminated using by using downloadable filter coefficients for the Digital Crossover 1004. The low and high frequency digital signals output from the Digital Crossover 1004 are input to two digital to analog converters (DACs) 1005,1006. The analog outputs of the DACs 1005,1006 are input to a Low Frequency Power Amplifier 1008 that drives the Woofer (101,111,121 in Figure 1), and a High Frequency Power Amplifier 1007 that drives the Tweeter (102,112,122 in Figure 1).

In addition to selecting the desired audio channel, the Channel Selector 1003 also determines the presence of the appropriate channel. The Channel Selector 1004 generates a power on/off binary signal in response to the presence or absence of the selected channel signal. The Auto Power On/Off unit 1014 conditions this signal and passes it on to the rest of the functions in the Speaker Input Conversion and Channel Selector of Figure 10. In this way, only in the presence of a desired signal are the important power consuming units, such as the power amplifiers in Loudspeaker, powered up. The RF Receiver in this embodiment is always powered up. In another embodiment, the RF Receiver also receives the signal from the Auto Power On/Off circuit. When power is off the Receiver turns on periodically – e.g. 2 times a second – and briefly samples the input RF stream to determine the presence of a desired signal. When the desired signal is present the Auto Power On/Off signal changes to the on state, and the RF Receiver switches to full on mode of operation. This embodiment is even more power efficient than when the RF Receiver is left permanently in full on mode. This is appropriate for very low powered battery operation where long standby times are needed. Generally, in the present invention it is assumed that the loudspeaker

is powered by plugging into a standard AC outlet, so the first Auto Power On/Off embodiment is simpler.

In another embodiment of the auto power on/off system the Channel Selector Interface generates the power on/off signal directly in response to special power on/off status messages.

Separate power amplifiers for high and low frequencies are very desirable from the point of view of audio fidelity but they add to the cost of the system. Figure 11 shows another embodiment of the Digital to Speaker Input Conversion and Channel Selector 103,113,123 of Figure 1. In this embodiment the DACs and Power Amplifiers have been replaced with Digital Input Class D Output amplifiers 1105,1106. These amplifiers convert the digital input stream directly to a Pulse Width Modulated (PWM) output stream that it fed directly to the speakers. This is an extremely cost effective solution. To help reduce distortion the high frequency and low frequency PWM streams are specifically adjusted for the Tweeter and Woofer they are intended to drive. The embodiment Figure 11 has the same channel selection interface, mixing, volume control, and power on/off functions as the embodiment of Figure 10.

Both the embodiments of Figure 10 and Figure 11 require a Sample Clock to synchronize the incoming audio sample data and subsequent units that operate on the data. The Sample Clock is generated by the Framing and Error Protection Decoder and Sample Clock Generator as shown in Figure 1.

In the embodiment of Figure 1, the function of channel selection is performed in the Digital to Speaker Input Conversion and Channel Selector unit 103,113,123. This corresponds to a Time Domain Multiple Access (TDMA) method of multiplexing the multiple audio channels onto a single RF frequency carrier. Figure 15 shows another embodiment of the current invention. In this embodiment the function of channel selection is performed in the RF Receiver 1504,1514,1524 rather than in the Digital to Speaker Input Conversion Unit 1503,1513,1523. Figure 16 shows one embodiment of the RF Receiver used in the embodiment of Figure 15. Here the output of the Channel Selection Register 1613, whose value is set by the Channel Selection Switch 1611 sets the RF carrier frequency for the current loudspeaker. In this embodiment all loudspeakers receive on a different carrier frequency and the RF Transmitter 1531 transmits each audio channel on a separate carrier frequency. This corresponds to a Frequency Domain Multiple Access (FDMA) method of multiplexing the multiple audio channels. As shown in the embodiment of Figure 16 the Channel Selection register sets the carrier frequency of both the RF Downconverter 1602 and IF Quadrature

Demodulators 1603. In another embodiment only the carrier frequency of the IF Quadrature Demodulator 1603. Figure 17 shows another embodiment of the RF Receiver used in embodiment of Figure 15. In this embodiment, the Channel Selection Register 1713 sets the spreading code for the RF Receiver. This corresponds to a Code  
5 Division Multiple Access (CDMA) method of multiplexing the multiple audio channels. Corresponding to the RF Receiver embodiment of Figure 17, the RF Transmitter 1531 transmits the multiple audio channels using different spreading codes.

In the embodiment of the present invention shown in Figure 15 the Channel Selection Switch 1611,1711 is moved into the RF Receiver so that it can set the RF  
10 carrier frequency and subcarrier frequencies or the spreading code. This results in a new embodiment of the Digital to Speaker Input Conversion unit 1503, 1513, 1523. This embodiment is identical to the embodiments of Digital to Speaker Input Conversion and Channel Selector described above for Figure 1, 103,113,123, except that a new embodiment of Channel Selector Interface is used. This Channel Selector  
15 Interface embodiment is shown in Figure 19. It is the same as that for Figure 18 except with no Channel Selection Switch. In this embodiment of the Channel Selector Interface no actual channel selection is performed, just status decoding and group selection switching, however the name is retained for continuity.

The block diagram of Figure 2 shows another embodiment of the present  
20 invention. In this embodiment the digital audio sample stream is digitally compressed before it is transmitted through the air. At the loudspeaker the compressed digital audio sample stream is uncompressed and a single channel of uncompressed audio is output to the speaker. By transmitting digitally compressed audio the bit rate required for RF transmission is reduced, greatly simplifying the RF design.

25 Audio from the Compact Disk Player 235 is uncompressed stereo at  $44100 \times 2 \times 16 = 1,411,200$  bits/sec. Audio from the DVD Player 234 is multichannel compressed audio – for example, six channel Dolby AC-3 compressed audio, or eight channel MPEG-2 compressed audio. The compressed six or eight channel audio from the DVD disk has a composite bit rate of approximately 500,000 bits/second. The  
30 uncompressed stereo audio from the CD player, with a bit rate of 1411200 bits/second, is input to a Stereo Digital Audio Encoder 233 that compresses the audio to generate a bit stream of approximately 500,000 bits/second. Although the compressed CD audio is only a two channel signal it has the same bit rate as the compressed DVD audio with six or eight channels. The Stereo Digital Audio Encoder 233 uses a smaller

compression factor than that used to generate the DVD compressed audio. This smaller compression factor allows for higher fidelity in the stereo audio stream and allows for simpler design in the Stereo Digital Audio Encoder 233.

5 High fidelity digital audio compression such as AC-3 or MPEG-2 is performed in blocks. One block of digital audio samples at a time is used to generate a block of Compressed Digital Audio Data bits. AC-3 and MPEG-2 are perceptual audio coders. Perceptual audio coders are well known to those skilled in the art of high fidelity digital audio data compression. The Stereo Digital Audio Encoder 233 is such a perceptual encoder. Figure 14 shows one embodiment of a single channel of the Stereo Digital  
10 Audio Encoder 233. The input stream of digital samples is taken in overlapping blocks. Each such block is multiplied by a tapered window 1400 such as a Hanning window. The windowed sample block is transformed to the frequency domain using a Discrete Cosine Transform 1401. The frequency scale is converted to a quasi-logarithmic critical band rate scale 1402. A psychoacoustic masked threshold curve is calculated for the frequency domain data 1403. It is well known that soft  
15 sounds with frequencies near those of louder sounds may be inaudible due to masking. The masked threshold curve is defines a frequency dependent level beneath which sounds are inaudible. The masked threshold curve is dependent on the frequency content of the input block. The number of compressed digital audio bits output for each digital audio input sample block is fixed. The input quasi-log spaced frequency bands  
20 of the input frequency domain block are arranged according to the relative audibility of their in-band energy. This audibility is determined with respect to the computed masked threshold curve. The fixed number of bits per compression block are allocated across the different frequencies 1404,1405 according to their relative audibility.  
25 Completely inaudible bands may receive zero allocated bits. Some bands may be encoded with 1-2 bits, others with 12 bits. The quantized frequency bands are backed into a single Compressed Digital Audio Frame 1406 for transmission to the loudspeaker.

30 Accompanying the blocks of Compressed Digital Audio Data are a bit clock and frame clock. The bit clock synchronizes individual bits in the compressed audio stream. The frame clock marks the boundaries between blocks of compressed audio. A fixed number of audio samples is specified as input to each compressed audio block and a fixed number of compressed audio bits is output each block. Therefore, there is a fixed frequency ratio between the input Digital Audio Sample Clock and the output  
35 Compressed Digital Audio Bit Clock and Compressed Digital Audio Frame Clock. For

some methods, there may be a dynamic selection between a small number of different block sizes, but it will be obvious to one skilled in the art of high fidelity digital audio compressor design that this does not change the character of the present invention.

5 The Selector 232 selects between the two 500,000 bits/second Compressed Audio Data Streams along with their accompanying bit and frame clocks. The selected stream is passed to the Framing and Error Protection Encoding unit 236. A block diagram of the Framing and Error Protection Encoding unit is shown in Figure 6. The functions in Figure 6 are almost identical to those of Figure 5 described earlier for the case of non-compressed audio. The differences are that the Compressed Digital Audio  
10 Bit Stream input to Figure 6 is already divided into Compressed Digital Audio Frames whose boundaries are marked by the Compressed Digital Audio Frame Clock also input to Figure 6. Since the frequency of the Compressed Digital Audio Bit Clock is a fixed ratio of the frequency of the Audio Sample Clock, and since the frequency Audio Sample Clock is a fixed ratio of the frequency of the Symbol and Chip Clocks, then the  
15 frequency of the Compressed Digital Audio Bit Clock is also a fixed ratio of the frequency of Symbol and Chip Clocks. This allows the Symbol and Chip Clocks in Figure 6 to be generated by frequency multiplication and clock division of the Compressed Digital Audio Bit Clock. This is accomplished by the Chip Clock and Symbol Clock Generator 605 in a manner similar to that described for 505 of Figure 5.  
20 The rest of the functions of Figure 6 are the same as those for Figure 5. The output of Figure 6 is input to the same RF Transmitter described as Figure 4.

Just as in Figure 1 each loudspeaker in 200,210,220 in has an Antenna  
205,215,225 and RF Receiver 204,214,223 which are identical with those of Figure 1. The output of the RF Receivers is input to the Framing and Error Protection Decoder  
25 and Clock Generator 206,216,226. A block diagram of the Framing and Error Protection Decoder and Clock Generator is shown in Figure 9. The functions of Figure 9 are mostly identical with the functions of Figure 8 described for the non-compressed audio case. The difference is that the output of the Deinterleaver 904 is a bit stream consisting of Compressed Digital Audio Frame Data whose boundaries are marked by  
30 the Compressed Digital Audio Frame Clock which is also output from the Deinterleaver 904. The Compressed Audio Bit Clock and Audio Sample Clock Generator 905 functions much like its counterpart 805 in Figure 8 except that in addition to regenerating the Audio Sample Clock it also regenerates the Compressed Digital Audio Bit Clock to synchronize the bits coming from the Deinterleaver. Figure 13 shows  
35 another embodiment of the Digital to Speaker Input Conversion and Compressed Audio

Decoder and Channel Selector unit.

In embodiment of Figure 2, the output of the Framing and Error Protection Decoder and Clock Generator 206,216,226, consisting of Compressed Audio Frame and Bit Clocks Audio Sample Clock and Compressed Audio bit stream, is input to the  
5 Digital to Speaker Input Conversion and Compressed Audio Decoder and Channel Selector unit 203,213,223.

Figure 12 shows a block diagram of the Digital to Speaker Input Conversion and Compressed Audio Decoder and Channel Selector unit. Each received frame of Compressed Digital Audio is input to the Bit Field Extraction and Channel Selection  
10 unit 1203. Here the quantized bit fields for each frequency band for each channel are identified. Only the bit fields for the selected channel or channels, according to the output of the Channel Selection Interface 1200, are selected. The Channel Selection Interface is identical to that shown in Figure 18. The bit fields are dequantized and rescaled to the original linear frequency in the Dequantize Frequency Band Bit Fields  
15 and Rescale to Linear Frequency Scale and Mixing and Volume Control unit 1204. If the mixing mode specified by the Channel Selection Interface 1200 indicates a mix down of multichannel surround sound to stereo, then the Dequantize Frequency Band Bit Fields and Rescale to Linear Frequency Scale and Mixing and Volume Control unit 1204 also performs this mixing function in the frequency domain. The volume control  
20 function is also implemented in the frequency domain in 1204 based on status information received by the Channel Selection Interface 1200. The output of 1204 is a linear frequency domain data block which is inverse transformed 1205 to return to the time domain. The inverse transformed block is a windowed time domain block, the first half of which is overlap added 1207 with the second half of the previous time  
25 domain block to generate a new half output block of uncompressed audio sample data. Just as in the uncompressed embodiment of Figure 11, the uncompressed time domain digital audio signal is split into high and low frequency bands by the digital crossover 1208, whose coefficient may be set by output from the Channel Selection Interface 1200, and the bands are sent to Class D digital input PWM amplifiers 1209, 1210  
30 which generate signals for the Woofer and Tweeter. In another embodiment the Class D digital amplifiers 1209,1210 are replaced by DACs and analog power amplifiers as in Figure 10.

Figure 13 shows another embodiment of the Digital to Speaker Input Conversion and Compressed Audio Decoder and Channel Selector unit. In this

embodiment the digital crossover function is implemented as a Frequency Domain Digital Crossover 1305 before the data is inverse transformed to the time domain. This is a particular economical implementation of the crossover function. Crossover coefficient, this time in the frequency domain, can be set by the Channel Selection  
5 Interface 1300. The frequency domain digital crossover results in separate frequency domain data blocks for the high frequency and low frequency bands. These blocks are separately inverse transformed 1306,1308 and overlap added 1307,1309 two generate the high and low frequency digital time domain signals which are input to the high and low frequency DACs 1310,1312 and then the high and low frequency power amplifiers  
10 1311,1313. The DACs and power amplifiers of Figure 13 can be replaced by Class D digital input amplifiers as in Figure 12.

The embodiments of Figure 12 and Figure 13 have the same auto power on/off embodiments as those of Figure 10 described earlier.

The embodiments of Figure 12 and Figure 13 require a Compressed Audio  
15 Frame Clock, a Compressed Audio Bit Clock, and an uncompressed Sample Clock to synchronize the incoming compressed audio sample data and later the uncompressed sampled data. These clocks are generated by the Framing and Error Protection Decoder and Clock Generator as shown in.

In the embodiments of Figure 12 and Figure 13 the volume control function is  
20 implemented in the Dequantize Frequency Band Bit Fields and Rescale to Linear Frequency Scale and Mixing and Volume Control unit. As with Figure 10 the volume control function can be moved to any of the digital audio processing blocks in Figure 12 and Figure 13 without changing the character of the present invention.

In both the uncompressed and compressed embodiments of Figure 1 and Figure  
25 2, the RF Receivers in each loudspeaker are designed to function in one of the unlicensed Instrumentation, Scientific, and Medical (ISM) frequency bands defined by the FCC in the U.S. These bands are centered around 900 MHz, 2.4 GHz, and 5.7 GHz. Internationally 900 MHz is not available for this type of product. Whatever transmission frequency band is used the important thing is that the bandwidth be  
30 sufficient to support the transmitted bit streams as described above. It is obvious to one skilled in the art that almost any transmission band can, in theory, be used for this purpose as long as the bandwidth is sufficient. In particular, embodiments for different countries will no doubt use different transmission bands.

In all of the embodiments of the present invention discussed above that use digital audio data compression, reference has been made to AC-3 and MPEG-2 perceptual audio encoding and decoding. AC-3 and MPEG-2 are two important embodiments of perceptual encoders, but it is obvious to one skilled in the art of perceptual encoder and decoder design that any perceptual audio coder can be used in the current invention without changing the character of the invention. What's more, it is not necessary to use a perceptual audio coder in the present invention. In some applications a simpler time domain audio coder, such as an ADPCM or linear predictive coder, might be used. With suitable framing for error correction and detection, these simpler coders may be used without changing the character of the present invention.

What is claimed is:



CLAIMS

1. A digital wireless loudspeaker system comprising:  
an audio transmission device including-  
means for receiving input digital audio data,  
means for obtaining an audio sample clock synchronized to the input digital  
5 audio data,  
means for generating transmission data based upon the input digital audio data,  
means for generating an RF transmission clock based upon the audio sample  
clock, and  
means for transmitting an RF signal based upon the transmission data and the  
10 transmission clock; and  
a wireless speaker for receiving the RF signal and broadcasting sound based upon the  
received RF signal, including-  
means for generating a derived sample clock based upon the transmission clock,  
means for generating output audio data based upon the transmission data, and  
15 means for broadcasting sound based upon the output audio data.
2. The system of claim 1, wherein the means for obtaining an audio sample clock  
comprises means for receiving a discrete input audio sample clock associated with the  
input audio data.
3. The system of claim 1, wherein the means for obtaining an audio sample clock  
comprises means for deriving the audio sample clock from the input audio data.
4. The system of claim 1, wherein the RF signal is transmitted continuously as a  
real time data stream.
5. The system of claim 1, wherein the RF signal includes status data.
6. The system of claim 5, wherein the status data includes a control signal for  
activating the wireless speaker.
7. The system of claim 5, wherein the status data includes a control signal for  
controlling volume of the broadcast sound.
8. The system of claim 5, wherein the speaker includes means for equalizing the

broadcast sound, and the status data includes a control signal for controlling equalization means.

9. The system of claim 1, wherein the RF signal includes two channels of audio data, and further including means for selecting a channel for the speaker to broadcast.

10. The system of claim 1, wherein the RF signal includes two channels of audio data, and a channel of status data.

11. The system of claim 10, wherein the means for transmitting transmits two RF signals at two different frequencies, each RF signal based upon one of the transmission data audio channels.

12. The system of claim 10, further including means for multiplexing the two channels of audio transmission data and the status channel prior to transmission, and means for demultiplexing the received RF signal,

13. The system of claim 1, further including means for assigning the speaker to a speaker group and means for selectively activating the speaker based on the speaker group assigned to it.

14. The system of claim 1, wherein the RF signal includes frame markers, and further including means for synchronizing the speaker based upon the frame marker.

15. A digital wireless loudspeaker system comprising:  
an audio transmission device including-  
means for receiving input digital audio data,  
means for generating two audio channels of transmission data based upon the  
input digital audio data, and  
5 means for transmitting an RF signal based upon the transmission data channels;  
and  
a wireless speaker for receiving the RF signal and broadcasting sound based upon the  
received RF signal, including-  
10 means for selecting one of the audio channels from the RF signal for broadcast,  
means for generating an output audio signal based upon the selected channel,  
and  
means for broadcasting sound based upon the output audio signal.
16. The system of claim 15, wherein the means for selecting comprises:  
a manual switch at the speaker for selecting which audio channel the speaker  
will broadcast; and  
means for choosing one of the audio channels based upon the manual switch.
17. The system of claim 15, further comprising:  
a manual switch for assigning the speaker to a speaker group; and  
means for selectively activating the speaker based on the speaker group assigned  
to it by the switch.
18. The system of claim 15, wherein the RF signal includes a control signal for  
controlling which audio channel the speaker will broadcast, comprising:  
means at the speaker for choosing which audio channel the speaker will  
broadcast based upon the control signal.
19. The system of claim 18, further comprising:  
means for assigning the speaker to a speaker group; and  
wherein the RF signal further includes a control signal for selectively activating  
the speaker based upon the speaker group assigned to it.
20. The system of claim 15, wherein the RF signal includes frame markers, and  
further including means for synchronizing the speaker based upon the frame markers.

21. The system of claim 15, wherein:  
the audio transmission device means for receiving further includes -  
means for receiving input digital audio data,  
means for obtaining an audio sample clock synchronized to the input  
5 digital audio data,  
means for generating an RF transmission clock based upon the audio  
sample clock,  
the means for transmitting transmits an RF signal based upon the  
transmission data and the transmission clock; and  
10 the wireless speaker further includes-  
means for generating a derived sample clock based upon the  
transmission clock, and  
the means for broadcasting broadcasts sound synchronized to the  
derived sample clock.
22. The system of claim 21, wherein the means for obtaining an audio sample clock  
comprises means for receiving a discrete input audio sample clock associated with the  
input audio data.
23. The system of claim 21, wherein the means for obtaining an audio sample clock  
comprises means for deriving the audio sample clock from the input audio data.
24. The system of claim 15, wherein the means for transmitting transmits two RF  
signals at two different frequencies, each RF signal based upon one of the transmission  
data audio channels, and wherein the means for selecting one of the channels comprises  
means for tuning in to the frequency associated with the appropriate RF signal.
25. The system of claim 15, further including means for multiplexing the two  
channels of audio transmission data prior to transmission, and means for  
demultiplexing the received RF signal prior to selecting the audio channel.

26. A digital wireless loudspeaker system comprising:  
an audio transmission device including-  
means for receiving input digital audio data,  
means for generating RF transmission data based upon the input digital audio  
data and including frame markers appearing at fixed intervals in the RF  
transmission data, and  
means for transmitting an RF signal based upon the RF transmission data; and  
at least two wireless speakers for receiving the RF signal and broadcasting sound based  
upon the received RF signal, each speaker including-  
means for generating an output audio signal based upon the received RF signal,  
means for synchronizing each output audio signal based upon the frame  
markers, and  
means for broadcasting sound based upon the synchronized output audio  
signals.

27. The system of claim 26, wherein the input digital audio data comprises digital  
audio samples in the form of a digital audio bit-stream, and wherein the frame markers  
are positioned within the bitstream with a temporal accuracy of at least one audio data  
sample.

28. The system of claim 27, wherein the frame markers are positioned within the  
bitstream with a temporal accuracy at least on the order of an audio data bit from said  
bit-stream.

29. The system of claim 28, wherein:  
the audio transmission device means for receiving further includes -  
means for receiving an input audio sample clock associated with the  
input digital audio data, and  
5 means for generating an RF transmission clock based upon the input  
audio sample clock,  
wherein the means for transmitting transmits an RF signal based upon  
the transmission data and the transmission clock;  
the wireless speaker further includes -  
10 means for generating a derived digital audio sample clock based upon  
the transmission clock,  
wherein the means for generating a derived digital audio sample clock is  
further responsive to the frame markers, such that the phase of

- 15                                   the derived sample clock is accurate to within at least on the  
  order of a data bit from the bit-stream; and  
  the means for broadcasting broadcasts sound synchronized to the derived  
  sample clock.
30.    The system of claim 27, wherein:  
          the audio transmission device means for receiving further includes -  
  means for receiving an input audio sample clock associated with the  
  input digital audio data, and  
5                                   means for generating an RF transmission clock based upon the input  
  audio sample clock,  
  wherein the means for transmitting transmits an RF signal based upon  
  the transmission data and the transmission clock; and  
          the wireless speaker further includes-  
10                                   means for generating a derived digital audio sample clock based upon  
  the transmission clock, wherein the means for generating a  
  derived digital audio sample clock is further responsive to the  
  frame markers, such that the phase of the digital audio sample  
  clock is accurate to within at least one audio sample, and  
15                                   wherein the means for broadcasting broadcasts sound synchronized to  
  the derived sample clock.
31.    The system of claim 26, wherein the RF signal further includes an RF  
transmission clock.
32.    The system of claim 31, wherein the input digital audio data further includes an  
input sample clock, and the RF transmission clock is based upon the input sample  
clock.
33.    The system of claim 32, wherein the frame markers are positioned within the  
bit-stream with a temporal accuracy at least on the order of one clock cycle from the RF  
transmission clock.
34.    The system of claim 26, wherein the RF signal includes at least two audio  
channels of data, the system further including means for selecting which audio channel  
each speaker will broadcast.

35. The system of claim 34 wherein the audio channel selecting means comprises a manual switch at each speaker.
36. The system of claim 35 further comprising:  
a manual switch at each speaker for assigning the associated speaker to a speaker group; and  
means for selectively activating each speaker based on the speaker group assigned to it by the associated switch.
- 5
37. The system of claim 34, wherein the RF signal includes a control signal for controlling which audio channel each speaker will broadcast, and further comprising:  
means at the speaker for choosing which audio channel the speaker will broadcast based upon the control signal.
38. The system of claim 37, further comprising:  
means for assigning the speaker to a speaker group; and  
wherein the RF signal further includes a control signal for selectively activating the speaker based upon the speaker group assigned to it.

39. A digital wireless loudspeaker system comprising:  
an audio transmission device including-  
means for receiving input digital audio data,  
means for generating two audio channels of transmission data based  
upon the input digital audio data,  
means for multiplexing the two audio channels; and  
means for transmitting an RF signal based upon the multiplexed  
transmission data channels, and  
a wireless speaker for receiving the RF signal and broadcasting sound based  
upon the received RF signal, including-  
means for demultiplexing the received RF signal;  
means for selecting one of the audio channels from the demultiplexed  
signal for broadcast,  
means for generating an output audio signal based upon the selected  
audio channel, and  
means for broadcasting sound based upon the output audio signal.
40. The system of claim 39, wherein the RF signal includes status data.
41. The system of claim 40, wherein the status data includes a control signal for activating the wireless speaker.
42. The system of claim 40, wherein the status data includes a control signal for controlling volume of the broadcast sound.
43. The system of claim 40, wherein the speaker includes means for equalizing the broadcast sound, and the status data includes a control signal for controlling the equalization means.
44. The system of claim 39 wherein the audio channel selecting means comprises a manual switch at each speaker.
45. The system of claim 44 further comprising:  
a manual switch at each speaker for assigning the associated speaker to a  
speaker group; and  
means for selectively activating each speaker based on the speaker group  
assigned to it by the associated switch.



46. The system of claim 39, wherein the RF signal includes a control signal for controlling which audio channel each speaker will broadcast, and further comprising:  
means at the speaker for choosing which audio channel the speaker will broadcast based upon the control signal.
47. The system of claim 46, further comprising:  
means for assigning the speaker to a speaker group; and  
wherein the RF signal further includes a control signal for selectively activating the speaker based upon the speaker group assigned to it.
48. The system of claim 39, further including means for assigning the speaker to a speaker group and means for selectively activating the speaker based on the speaker group assigned to it.

49. A digital wireless loudspeaker system comprising:  
an audio transmission device including-  
means for receiving input digital audio data,  
means for generating transmission data based upon the input digital  
audio data,  
5 means for generating speaker group data for selectively indicating  
speakers to be activated; and  
means for transmitting an RF signal based upon the transmission data  
and the speaker group data; and  
10 a wireless speaker for receiving the RF signal and broadcasting sound based  
upon the received RF signal, including-  
means for assigning the speaker to a speaker group,  
means for selectively activating the speaker according to the speaker  
group data,  
15 means for generating an output audio signal based upon the RF signal,  
and  
means for broadcasting sound based upon the output audio signal.
50. The system of claim 49 wherein the speaker group assigning means comprises a manual switch at the speaker.
51. The system of claim 49 wherein the RF signal further includes speaker group assigning data, and the speaker group assigning means comprises means for selectively activating the speaker based upon the speaker group assigning data.
52. The system of claim 49, wherein the RF signal includes frame markers, and further including means for synchronizing the speaker based upon the frame marker.
53. The system of claim 49, wherein:  
the audio transmission device means for receiving further includes -  
means for receiving an input audio sample clock associated with the  
input digital audio data, and  
5 means for generating an RF transmission clock based upon the input  
audio sample clock, and  
wherein the means for transmitting transmits an RF signal based upon  
the transmission data, the speaker group data, and the  
transmission clock; and

10           the wireless speaker further includes-  
                  means for generating a derived sample clock based upon the  
                                  transmission clock, and  
                  the means for broadcasting broadcasts sound synchronized to the  
                                  derived sample clock.

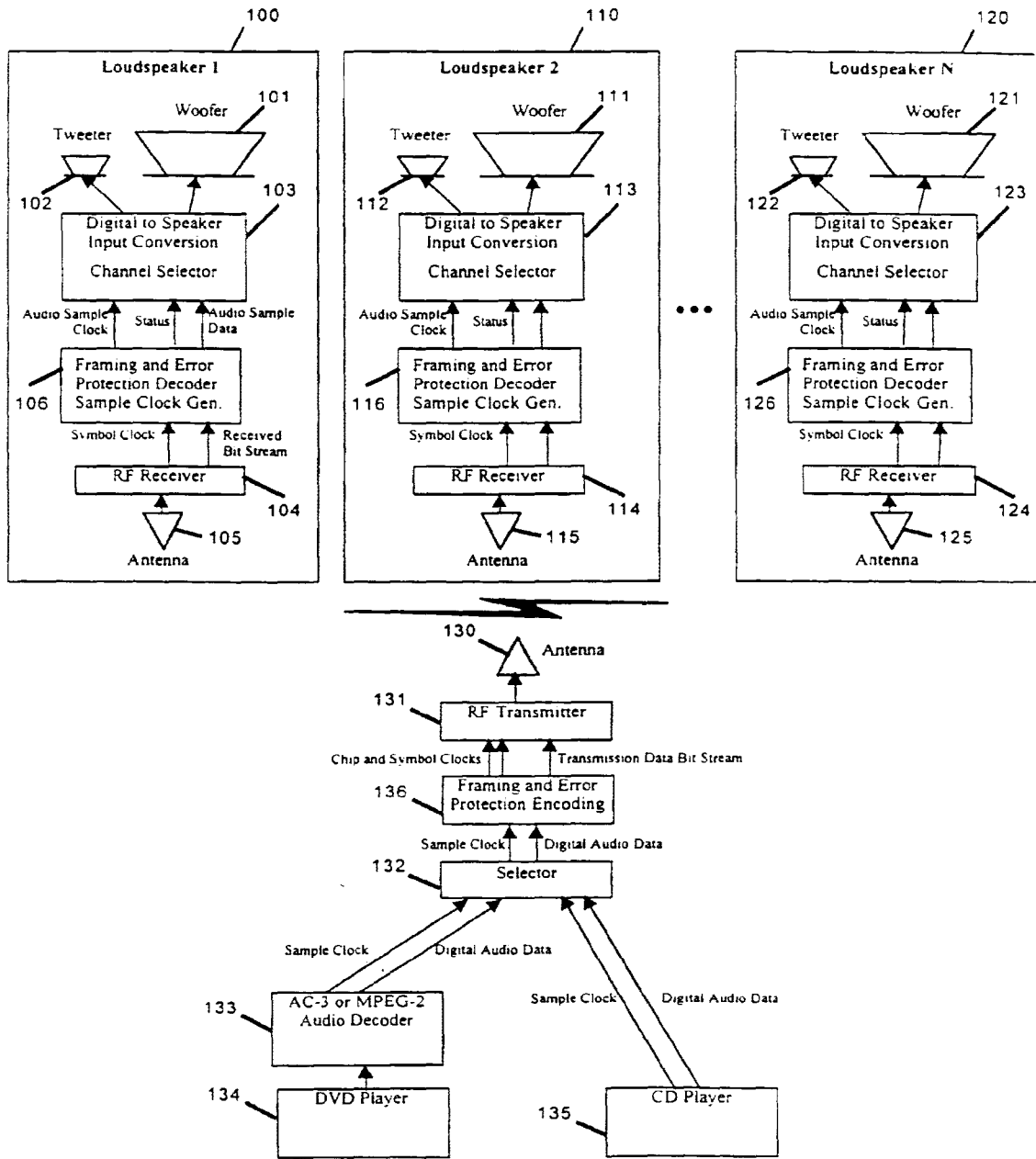

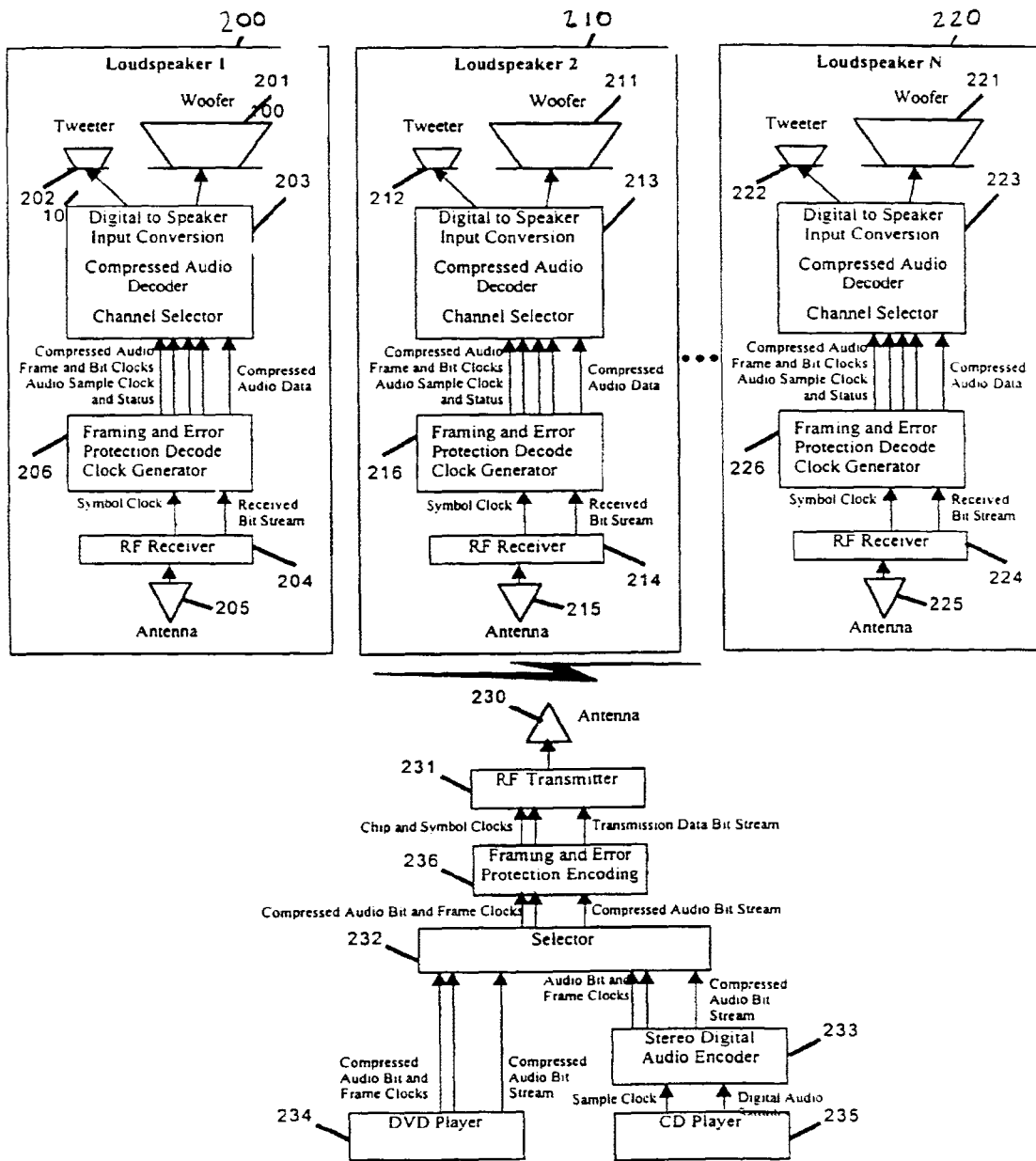

Figure 2

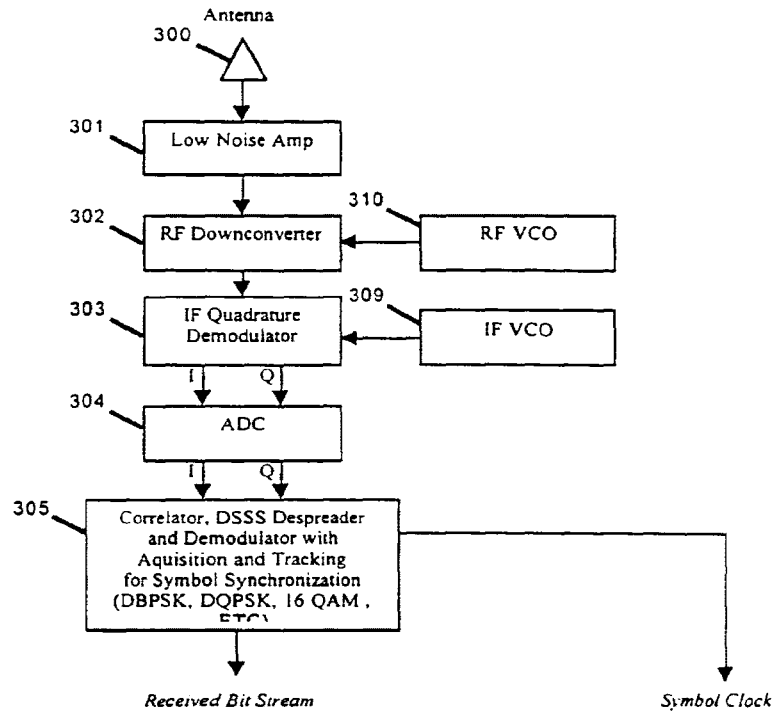

Figure 3

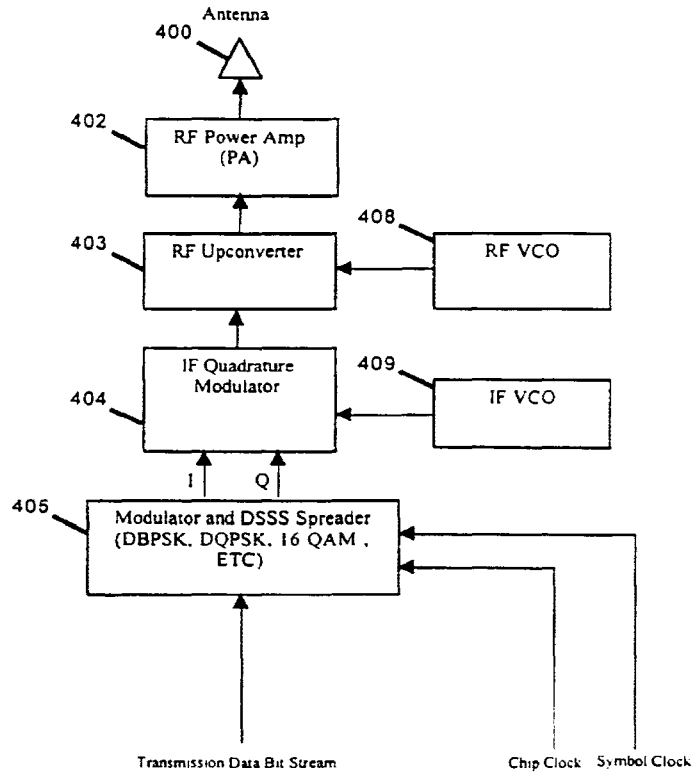

Figure 4

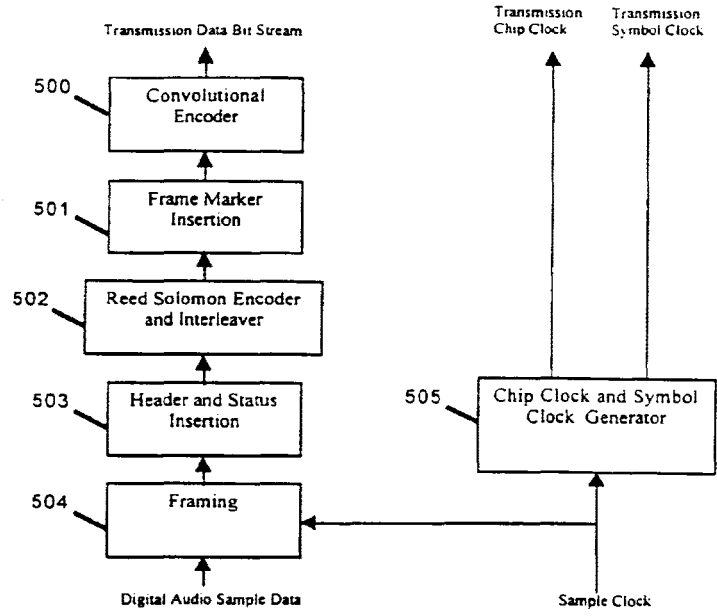

Figure 5



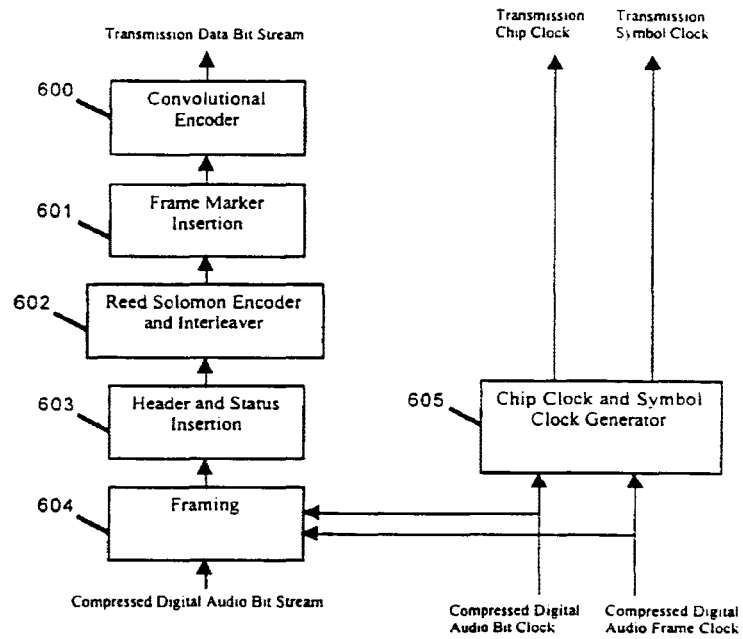

Figure 6

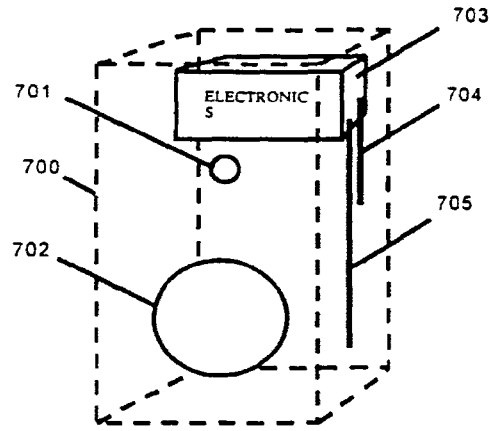

Figure 7

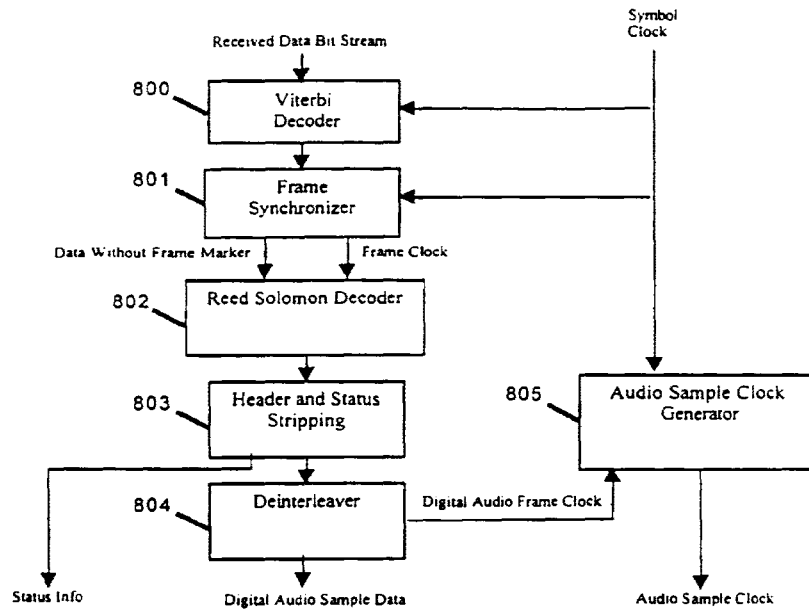

Figure 8

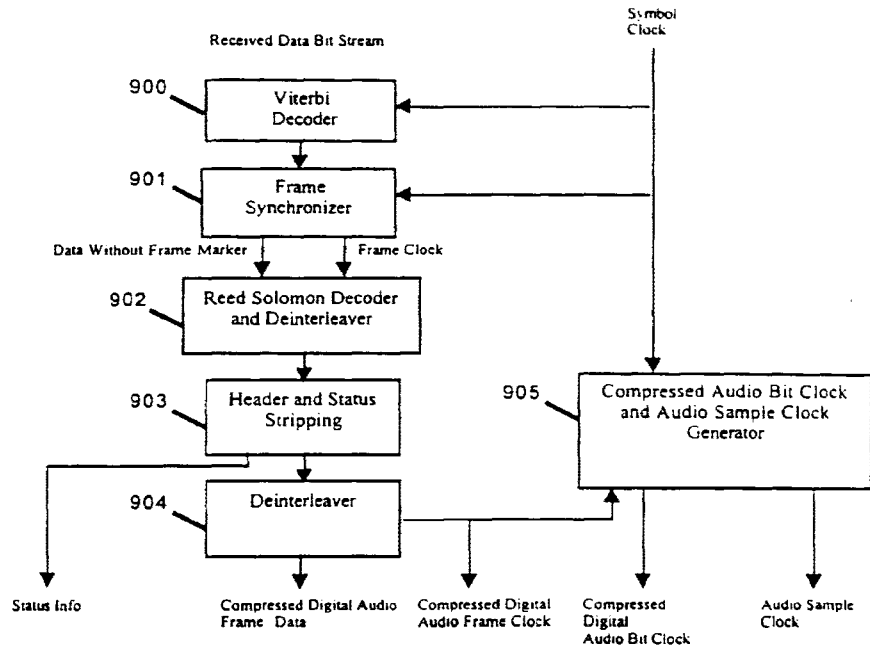

Figure 9

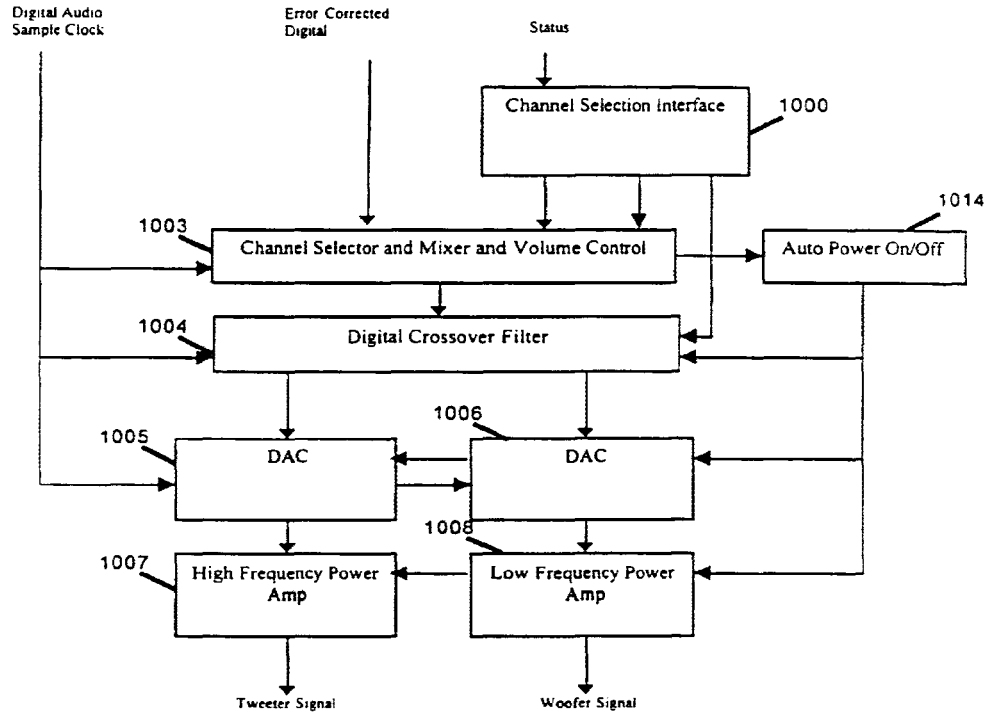

Figure 10

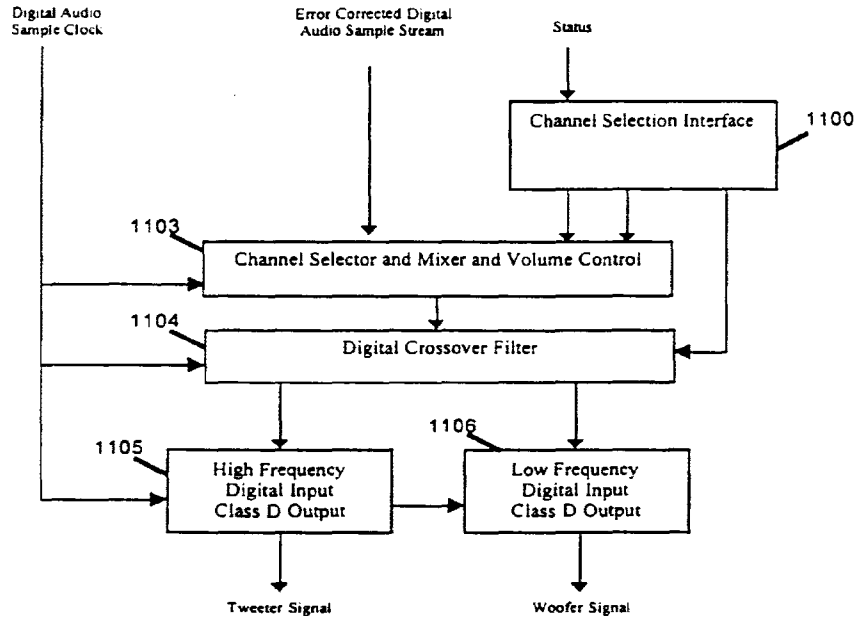
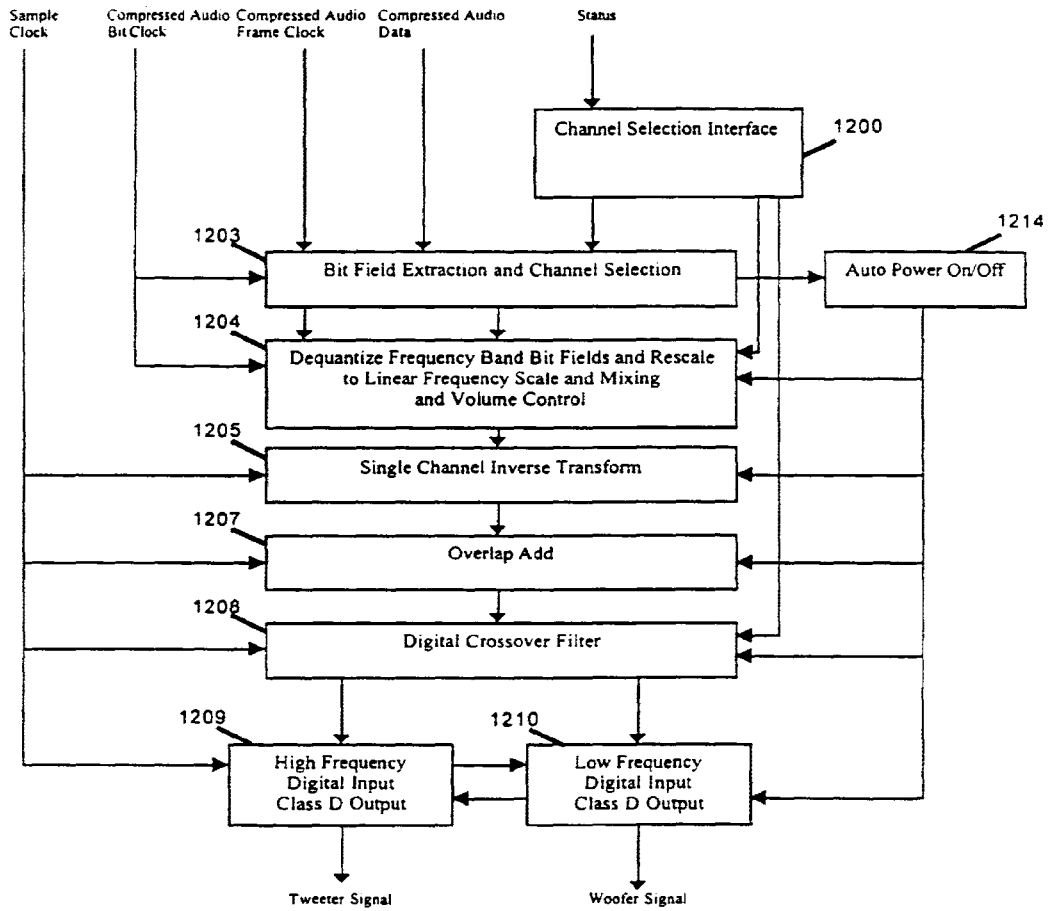

Figure 11

Figure 12



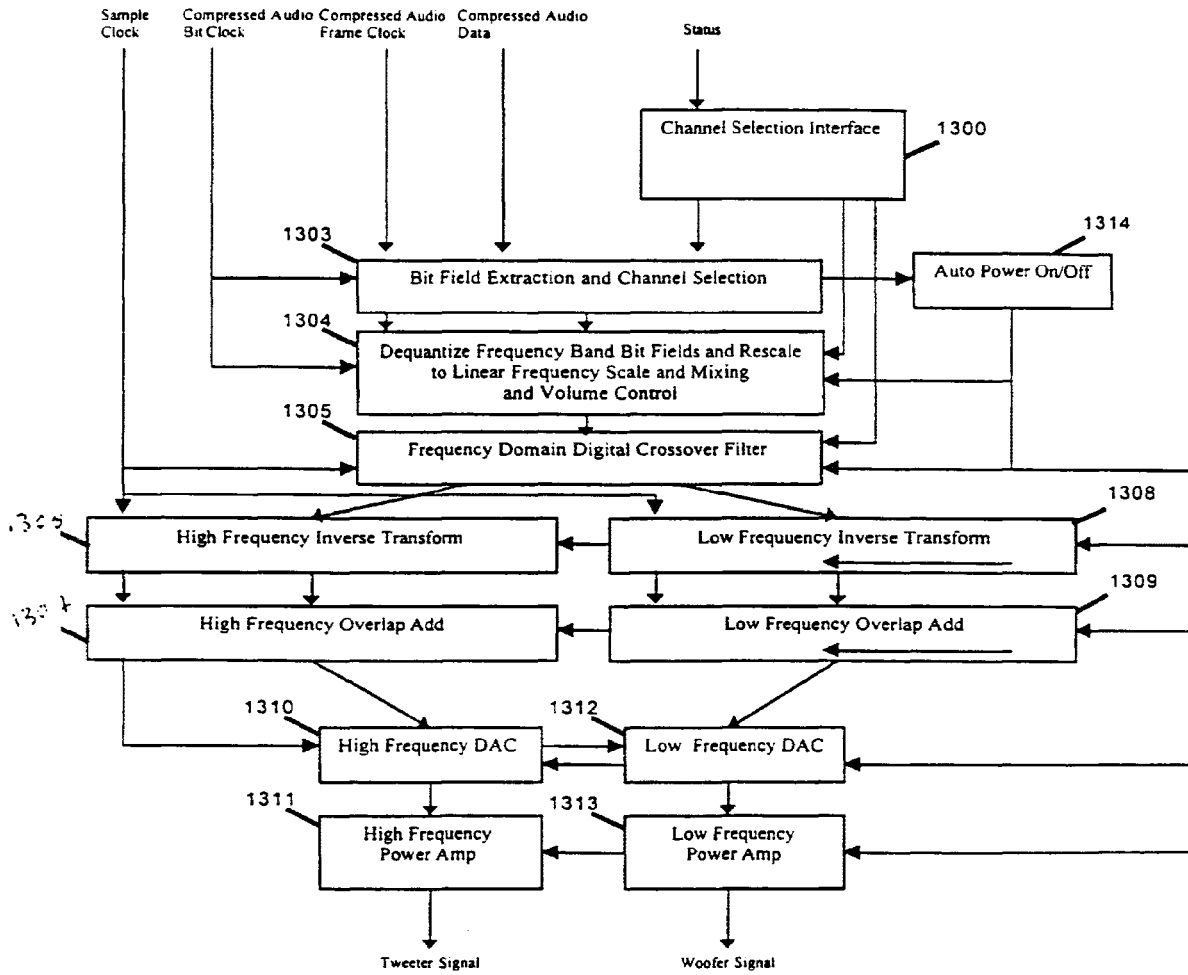

Figure 13



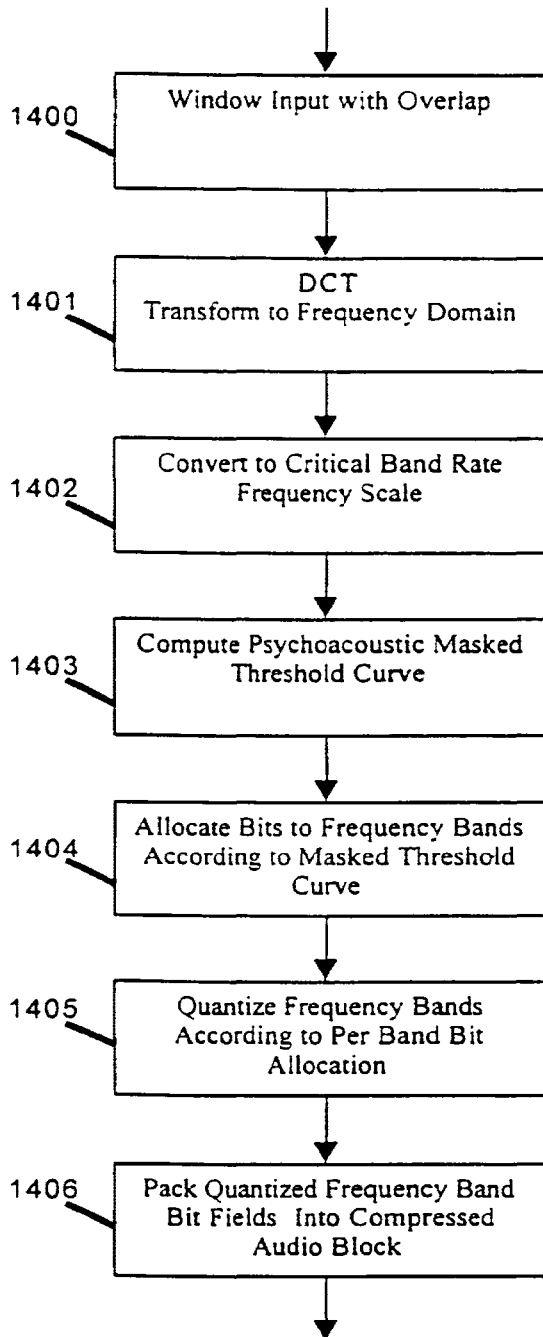

Figure 14

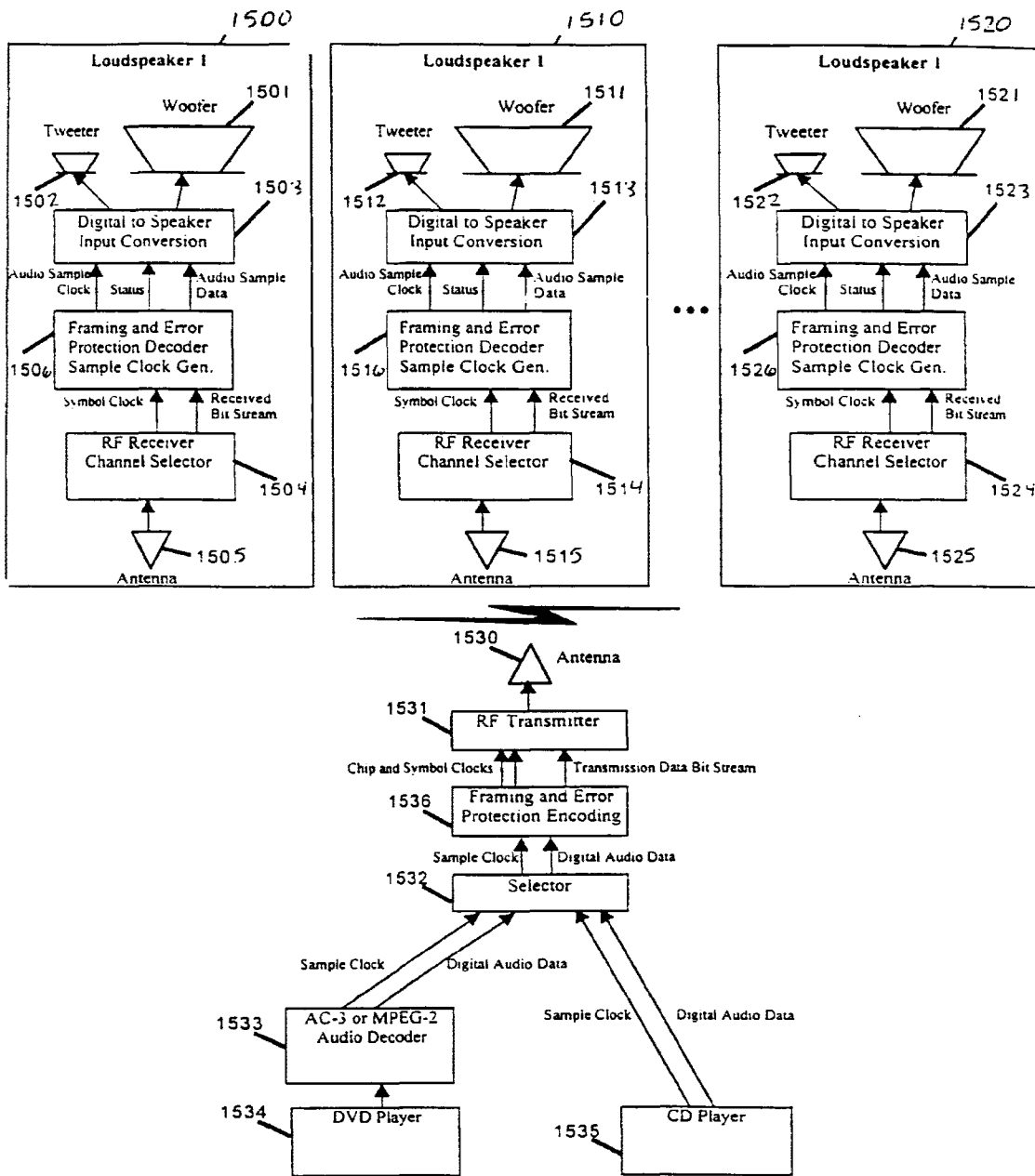

Figure 15

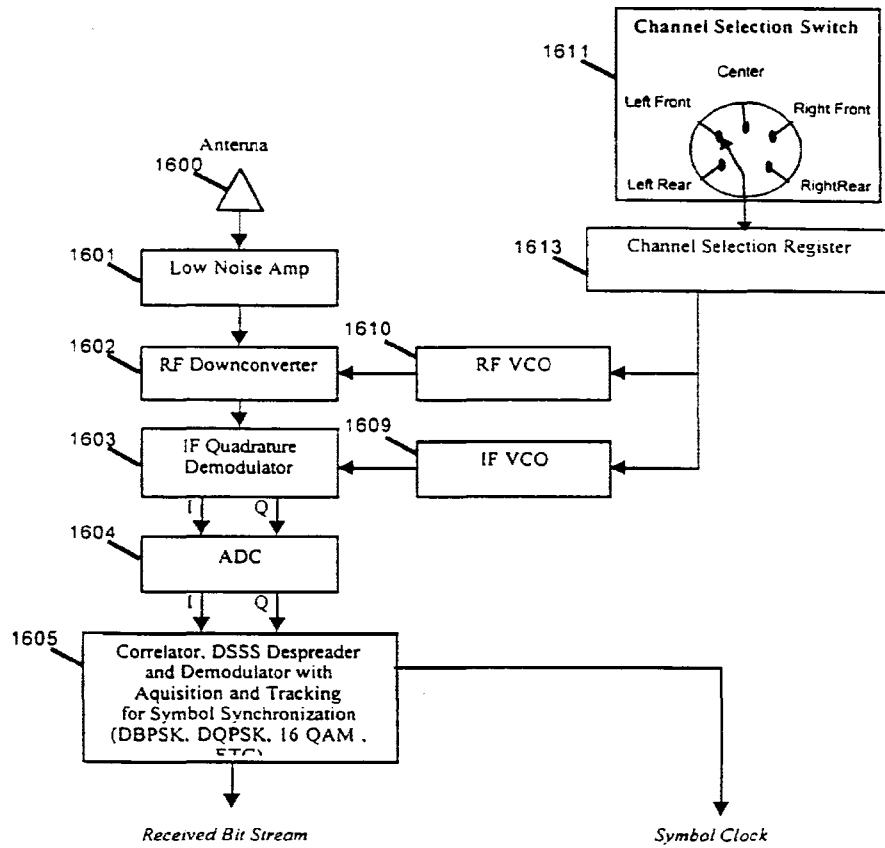

Figure 16

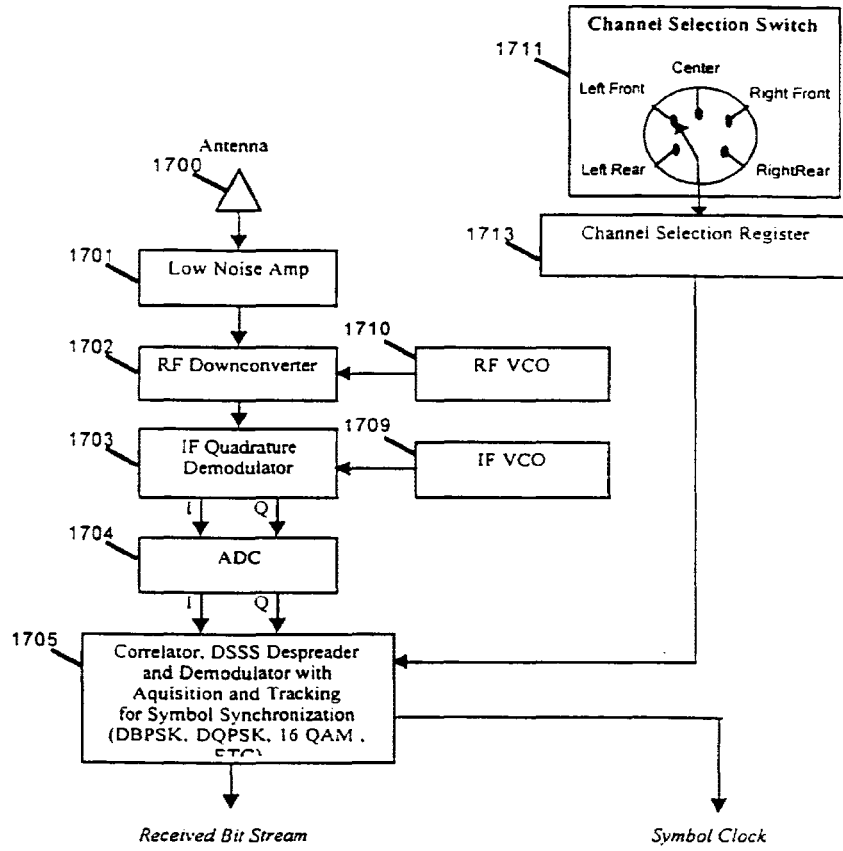

Figure 17

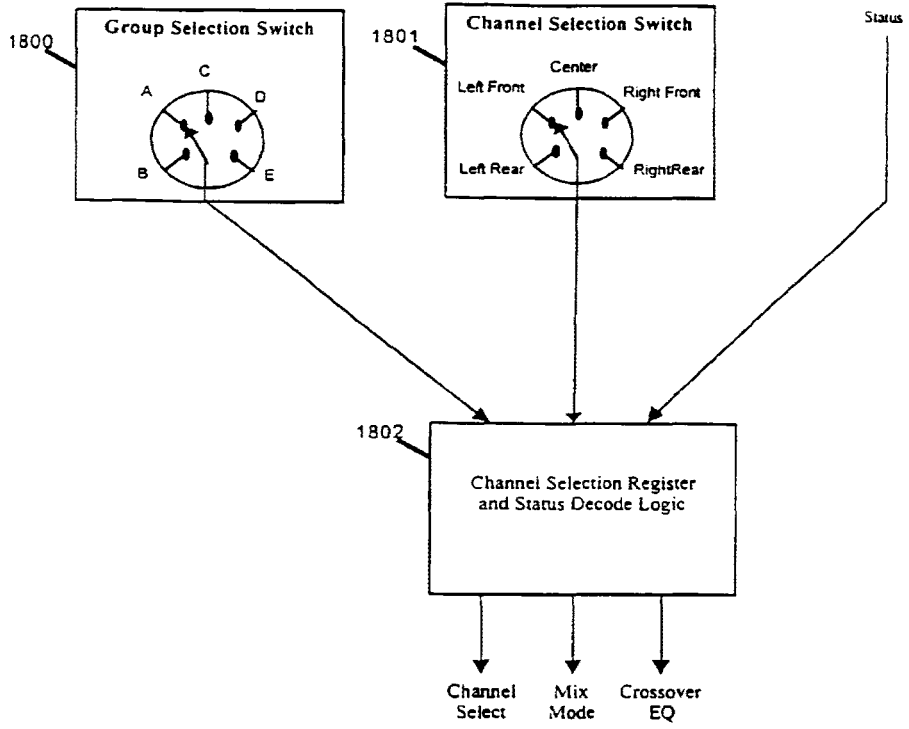

Figure 18

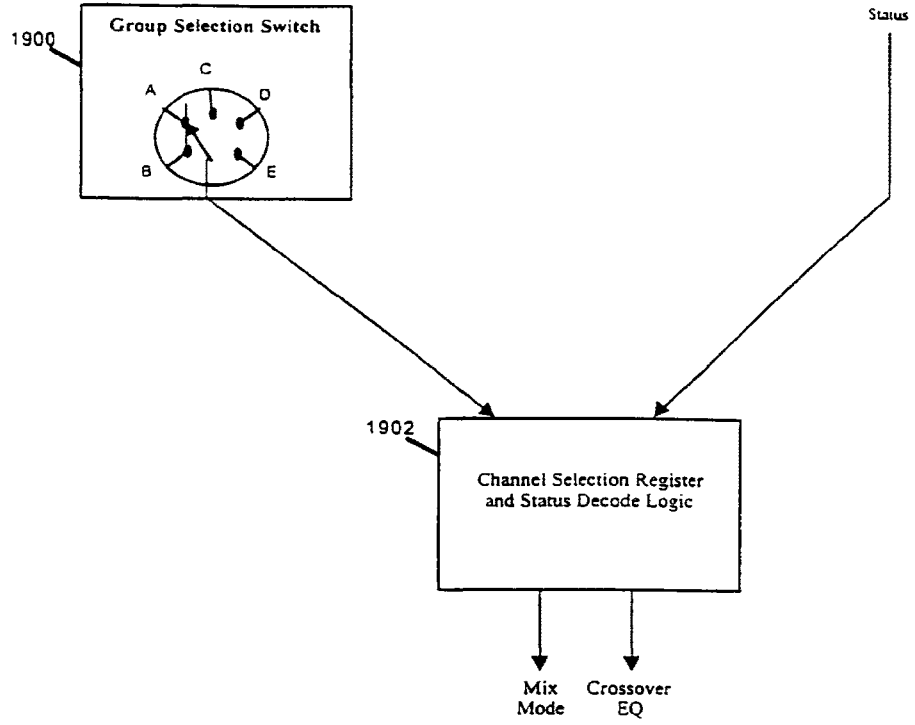

Figure 19

**INTERNATIONAL SEARCH REPORT**

Intern: al Application No  
PCT/US 99/28686

<b>A. CLASSIFICATION OF SUBJECT MATTER</b> IPC 7 H04S3/00		
According to International Patent Classification (IPC) or to both national classification and IPC		
<b>B. FIELDS SEARCHED</b>		
Minimum documentation searched (classification system followed by classification symbols) IPC 7 H04S H04B H04L H04R		
Documentation searched other than minimum documentation to the extent that such documents are included in the fields searched		
Electronic data base consulted during the international search (name of data base and, where practical, search terms used) WPI Data, PAJ		
<b>C. DOCUMENTS CONSIDERED TO BE RELEVANT</b>		
Category *	Citation of document, with indication, where appropriate, of the relevant passages	Relevant to claim No.
X	US 5 946 343 A (WOLSKI MARK R ET AL) 31 August 1999 (1999-08-31) column 4, line 26 -column 5, line 38 column 6, line 6 -column 19, line 2 ---	1-53
A	DE 299 08 045 U (VECCOM CO) 29 July 1999 (1999-07-29) page 1, line 3-35 page 2, line 4-6 page 2, line 20 -page 7, line 29 ---	1-53
A	WO 93 04540 A (LS RES INC) 4 March 1993 (1993-03-04) page 1, line 4-12 page 3, line 28 -page 5, line 32 page 7, line 29 -page 18, line 10 page 54, line 16 -page 55, line 11 -----	1-53
<input type="checkbox"/> Further documents are listed in the continuation of box C. <input checked="" type="checkbox"/> Patent family members are listed in annex.		
* Special categories of cited documents :		
"A" document defining the general state of the art which is not considered to be of particular relevance "E" earlier document but published on or after the international filing date "L" document which may throw doubts on priority claim(s) or which is cited to establish the publication date of another citation or other special reason (as specified) "O" document referring to an oral disclosure, use, exhibition or other means "P" document published prior to the international filing date but later than the priority date claimed		"T" later document published after the international filing date or priority date and not in conflict with the application but cited to understand the principle or theory underlying the invention "X" document of particular relevance; the claimed invention cannot be considered novel or cannot be considered to involve an inventive step when the document is taken alone "Y" document of particular relevance; the claimed invention cannot be considered to involve an inventive step when the document is combined with one or more other such documents, such combination being obvious to a person skilled in the art. "&" document member of the same patent family
Date of the actual completion of the international search <b>8 November 2000</b>		Date of mailing of the international search report <b>15/11/2000</b>
Name and mailing address of the ISA European Patent Office, P.B. 5818 Patentlaan 2 NL - 2280 HV Rijswijk Tel. (+31-70) 340-2040, Tx. 31 651 epo nt, Fax: (+31-70) 340-3016		Authorized officer <b>Zanti, P</b>

**INTERNATIONAL SEARCH REPORT**

International Application No  
PCT/US 99/28686

Patent document cited in search report	Publication date	Patent family member(s)	Publication date
US 5946343 A	31-08-1999	CA 2244191 A	14-08-1997
		US 5832024 A	03-11-1998
		WO 9729550 A	14-08-1997
		AU 4777096 A	28-08-1997
		EP 0880827 A	02-12-1998
-----			
DE 29908045 U	29-07-1999	NONE	
-----			
WO 9304540 A	04-03-1993	US 5299264 A	29-03-1994
		CA 2119264 A	04-03-1993
		EP 0600043 A	08-06-1994
		US 5491839 A	13-02-1996
		US 5581617 A	03-12-1996
-----			



## Electronic Patent Application Fee Transmittal

<b>Application Number:</b>	12570343			
<b>Filing Date:</b>	30-Sep-2009			
<b>Title of Invention:</b>	Wireless Digital Audio System			
<b>First Named Inventor/Applicant Name:</b>	C. Earl Woolfork			
<b>Filer:</b>	Megan Elizabeth Lyman			
<b>Attorney Docket Number:</b>	1028.4			
Filed as Small Entity				
<b>Utility under 35 USC 111(a) Filing Fees</b>				
Description	Fee Code	Quantity	Amount	Sub-Total in USD(\$)
<b>Basic Filing:</b>				
<b>Pages:</b>				
<b>Claims:</b>				
<b>Miscellaneous-Filing:</b>				
<b>Petition:</b>				
<b>Patent-Appeals-and-Interference:</b>				
<b>Post-Allowance-and-Post-Issuance:</b>				
<b>Extension-of-Time:</b>				

Description	Fee Code	Quantity	Amount	Sub-Total in USD(\$)
<b>Miscellaneous:</b>				
Request for continued examination	2801	1	405	405
Submission- Information Disclosure Stmt	1806	1	180	180
<b>Total in USD (\$)</b>				<b>585</b>

## Electronic Acknowledgement Receipt

<b>EFS ID:</b>	8153298
<b>Application Number:</b>	12570343
<b>International Application Number:</b>	
<b>Confirmation Number:</b>	9973
<b>Title of Invention:</b>	Wireless Digital Audio System
<b>First Named Inventor/Applicant Name:</b>	C. Earl Woolfork
<b>Customer Number:</b>	68533
<b>Filer:</b>	Megan Elizabeth Lyman
<b>Filer Authorized By:</b>	
<b>Attorney Docket Number:</b>	1028.4
<b>Receipt Date:</b>	04-AUG-2010
<b>Filing Date:</b>	30-SEP-2009
<b>Time Stamp:</b>	14:45:14
<b>Application Type:</b>	Utility under 35 USC 111(a)

### Payment information:

Submitted with Payment	yes
Payment Type	Credit Card
Payment was successfully received in RAM	\$585
RAM confirmation Number	946
Deposit Account	504576
Authorized User	WOOLFORK,C. EARL

The Director of the USPTO is hereby authorized to charge indicated fees and credit any overpayment as follows:

Charge any Additional Fees required under 37 C.F.R. Section 1.19 (Document supply fees)

Charge any Additional Fees required under 37 C.F.R. Section 1.20 (Post Issuance fees)

Charge any Additional Fees required under 37 C.F.R. Section 1.21 (Miscellaneous fees and charges)

**File Listing:**

Document Number	Document Description	File Name	File Size(Bytes)/ Message Digest	Multi Part /.zip	Pages (if appl.)
1	Request for Continued Examination (RCE)	RCEformfilled.pdf	797427	no	3
			22bbe42d9e2245cd0fbb0521139daf5bd2cd59c		
<b>Warnings:</b>					
<b>Information:</b>					
2	Applicant Arguments/Remarks Made in an Amendment	ResponsewithExhibits.pdf	6589612	no	21
			e81d4e0b3fe501f636cbf98fef99b299aafcf1b		
<b>Warnings:</b>					
<b>Information:</b>					
3	Amendment Submitted/Entered with Filing of CPA/RCE	Claims.pdf	118245	no	23
			7e6313bc2b3096314ec3f85e65144050dffe5ae65		
<b>Warnings:</b>					
<b>Information:</b>					
4	Information Disclosure Statement (IDS) Filed (SB/08)	IDS080410.pdf	612970	no	5
			9a210fca77222df38302442233dad051bc966f4		
<b>Warnings:</b>					
<b>Information:</b>					
5	Foreign Reference	ForeignLiterature.pdf	2775490	no	82
			04cb77f19919f036a5c16418439127b74bd e6100		
<b>Warnings:</b>					
<b>Information:</b>					
6	NPL Documents	NPLDocuments.pdf	9918374	no	134
			101563dde254f935773c58946c153b2a40a8b580		
<b>Warnings:</b>					
<b>Information:</b>					
7	Fee Worksheet (PTO-875)	fee-info.pdf	31664	no	2
			1b5ce07ede54286757eac95a7e1807b759c81129		
<b>Warnings:</b>					
<b>Information:</b>					
<b>Total Files Size (in bytes):</b>			20843782		

**This Acknowledgement Receipt evidences receipt on the noted date by the USPTO of the indicated documents, characterized by the applicant, and including page counts, where applicable. It serves as evidence of receipt similar to a Post Card, as described in MPEP 503.**

**New Applications Under 35 U.S.C. 111**

**If a new application is being filed and the application includes the necessary components for a filing date (see 37 CFR 1.53(b)-(d) and MPEP 506), a Filing Receipt (37 CFR 1.54) will be issued in due course and the date shown on this Acknowledgement Receipt will establish the filing date of the application.**

**National Stage of an International Application under 35 U.S.C. 371**

**If a timely submission to enter the national stage of an international application is compliant with the conditions of 35 U.S.C. 371 and other applicable requirements a Form PCT/DO/EO/903 indicating acceptance of the application as a national stage submission under 35 U.S.C. 371 will be issued in addition to the Filing Receipt, in due course.**

**New International Application Filed with the USPTO as a Receiving Office**

**If a new international application is being filed and the international application includes the necessary components for an international filing date (see PCT Article 11 and MPEP 1810), a Notification of the International Application Number and of the International Filing Date (Form PCT/RO/105) will be issued in due course, subject to prescriptions concerning national security, and the date shown on this Acknowledgement Receipt will establish the international filing date of the application.**

Under the Paperwork Reduction Act of 1995, no persons are required to respond to a collection of information unless it displays a valid OMB control number.

<b>PATENT APPLICATION FEE DETERMINATION RECORD</b> Substitute for Form PTO-875					Application or Docket Number <b>12/570,343</b>		Filing Date <b>09/30/2009</b>		<input type="checkbox"/> To be Mailed			
<b>APPLICATION AS FILED – PART I</b>												
(Column 1)			(Column 2)			SMALL ENTITY <input checked="" type="checkbox"/>		OR OTHER THAN SMALL ENTITY				
FOR		NUMBER FILED	NUMBER EXTRA		RATE (\$)	FEE (\$)	OR		RATE (\$)	FEE (\$)		
<input type="checkbox"/> BASIC FEE <small>(37 CFR 1.16(a), (b), or (c))</small>		N/A	N/A		N/A				N/A			
<input type="checkbox"/> SEARCH FEE <small>(37 CFR 1.16(k), (l), or (m))</small>		N/A	N/A		N/A				N/A			
<input type="checkbox"/> EXAMINATION FEE <small>(37 CFR 1.16(o), (p), or (q))</small>		N/A	N/A		N/A				N/A			
TOTAL CLAIMS <small>(37 CFR 1.16(i))</small>		minus 20 =	*		X \$ =		OR		X \$ =			
INDEPENDENT CLAIMS <small>(37 CFR 1.16(h))</small>		minus 3 =	*		X \$ =				X \$ =			
<input type="checkbox"/> APPLICATION SIZE FEE <small>(37 CFR 1.16(s))</small>		If the specification and drawings exceed 100 sheets of paper, the application size fee due is \$250 (\$125 for small entity) for each additional 50 sheets or fraction thereof. See 35 U.S.C. 41(a)(1)(G) and 37 CFR 1.16(s).										
<input type="checkbox"/> MULTIPLE DEPENDENT CLAIM PRESENT <small>(37 CFR 1.16(j))</small>												
* If the difference in column 1 is less than zero, enter "0" in column 2.												
<b>APPLICATION AS AMENDED – PART II</b>										TOTAL		
(Column 1)			(Column 2)			SMALL ENTITY		OR OTHER THAN SMALL ENTITY				
AMENDMENT	<b>08/04/2010</b>		CLAIMS REMAINING AFTER AMENDMENT		HIGHEST NUMBER PREVIOUSLY PAID FOR	PRESENT EXTRA	RATE (\$)	ADDITIONAL FEE (\$)	OR		RATE (\$)	ADDITIONAL FEE (\$)
	Total <small>(37 CFR 1.16(i))</small>		* 19	Minus	** 26	= 0	X \$26 =	0	OR		X \$ =	
	Independent <small>(37 CFR 1.16(h))</small>		* 18	Minus	*** 19	= 0	X \$110 =	0	OR		X \$ =	
	<input type="checkbox"/> Application Size Fee <small>(37 CFR 1.16(s))</small>											
	<input type="checkbox"/> FIRST PRESENTATION OF MULTIPLE DEPENDENT CLAIM <small>(37 CFR 1.16(j))</small>											
							TOTAL ADD'L FEE	<b>0</b>	OR		TOTAL ADD'L FEE	
AMENDMENT			CLAIMS REMAINING AFTER AMENDMENT		HIGHEST NUMBER PREVIOUSLY PAID FOR	PRESENT EXTRA	RATE (\$)	ADDITIONAL FEE (\$)	OR		RATE (\$)	ADDITIONAL FEE (\$)
	Total <small>(37 CFR 1.16(i))</small>		*	Minus	**	=	X \$ =		OR		X \$ =	
	Independent <small>(37 CFR 1.16(h))</small>		*	Minus	***	=	X \$ =		OR		X \$ =	
	<input type="checkbox"/> Application Size Fee <small>(37 CFR 1.16(s))</small>											
	<input type="checkbox"/> FIRST PRESENTATION OF MULTIPLE DEPENDENT CLAIM <small>(37 CFR 1.16(j))</small>											
							TOTAL ADD'L FEE		OR		TOTAL ADD'L FEE	
* If the entry in column 1 is less than the entry in column 2, write "0" in column 3.												
** If the "Highest Number Previously Paid For" IN THIS SPACE is less than 20, enter "20".												
*** If the "Highest Number Previously Paid For" IN THIS SPACE is less than 3, enter "3".												
The "Highest Number Previously Paid For" (Total or Independent) is the highest number found in the appropriate box in column 1.												
Legal Instrument Examiner: <b>/MARQUITA D. JONES/</b>												

This collection of information is required by 37 CFR 1.16. The information is required to obtain or retain a benefit by the public which is to file (and by the USPTO to process) an application. Confidentiality is governed by 35 U.S.C. 122 and 37 CFR 1.14. This collection is estimated to take 12 minutes to complete, including gathering, preparing, and submitting the completed application form to the USPTO. Time will vary depending upon the individual case. Any comments on the amount of time you require to complete this form and/or suggestions for reducing this burden, should be sent to the Chief Information Officer, U.S. Patent and Trademark Office, U.S. Department of Commerce, P.O. Box 1450, Alexandria, VA 22313-1450. DO NOT SEND FEES OR COMPLETED FORMS TO THIS ADDRESS. SEND TO: Commissioner for Patents, P.O. Box 1450, Alexandria, VA 22313-1450.

If you need assistance in completing the form, call 1-800-PTO-9199 and select option 2.



UNITED STATES PATENT AND TRADEMARK OFFICE

UNITED STATES DEPARTMENT OF COMMERCE
United States Patent and Trademark Office
Address: COMMISSIONER FOR PATENTS
P.O. Box 1450
Alexandria, Virginia 22313-1450
www.uspto.gov

NOTICE OF ALLOWANCE AND FEE(S) DUE

68533 7590 11/01/2010
MEGAN LYMAN
1816 SILVER MIST CT.
RALEIGH, NC 27613

EXAMINER

FLANDERS, ANDREW C

ART UNIT PAPER NUMBER

2614

DATE MAILED: 11/01/2010

Table with 5 columns: APPLICATION NO., FILING DATE, FIRST NAMED INVENTOR, ATTORNEY DOCKET NO., CONFIRMATION NO.
12/570,343 09/30/2009 C. Earl Woolfork 1028.4 9973

TITLE OF INVENTION: WIRELESS DIGITAL AUDIO SYSTEM

Table with 7 columns: APPLN. TYPE, SMALL ENTITY, ISSUE FEE DUE, PUBLICATION FEE DUE, PREV. PAID ISSUE FEE, TOTAL FEE(S) DUE, DATE DUE
nonprovisional YES \$755 \$300 \$0 \$1055 02/01/2011

THE APPLICATION IDENTIFIED ABOVE HAS BEEN EXAMINED AND IS ALLOWED FOR ISSUANCE AS A PATENT. PROSECUTION ON THE MERITS IS CLOSED. THIS NOTICE OF ALLOWANCE IS NOT A GRANT OF PATENT RIGHTS. THIS APPLICATION IS SUBJECT TO WITHDRAWAL FROM ISSUE AT THE INITIATIVE OF THE OFFICE OR UPON PETITION BY THE APPLICANT. SEE 37 CFR 1.313 AND MPEP 1308.

THE ISSUE FEE AND PUBLICATION FEE (IF REQUIRED) MUST BE PAID WITHIN THREE MONTHS FROM THE MAILING DATE OF THIS NOTICE OR THIS APPLICATION SHALL BE REGARDED AS ABANDONED. THIS STATUTORY PERIOD CANNOT BE EXTENDED. SEE 35 U.S.C. 151. THE ISSUE FEE DUE INDICATED ABOVE DOES NOT REFLECT A CREDIT FOR ANY PREVIOUSLY PAID ISSUE FEE IN THIS APPLICATION. IF AN ISSUE FEE HAS PREVIOUSLY BEEN PAID IN THIS APPLICATION (AS SHOWN ABOVE), THE RETURN OF PART B OF THIS FORM WILL BE CONSIDERED A REQUEST TO REAPPLY THE PREVIOUSLY PAID ISSUE FEE TOWARD THE ISSUE FEE NOW DUE.

HOW TO REPLY TO THIS NOTICE:

I. Review the SMALL ENTITY status shown above.

If the SMALL ENTITY is shown as YES, verify your current SMALL ENTITY status:

- A. If the status is the same, pay the TOTAL FEE(S) DUE shown above.
B. If the status above is to be removed, check box 5b on Part B - Fee(s) Transmittal and pay the PUBLICATION FEE (if required) and twice the amount of the ISSUE FEE shown above, or

If the SMALL ENTITY is shown as NO:

- A. Pay TOTAL FEE(S) DUE shown above, or
B. If applicant claimed SMALL ENTITY status before, or is now claiming SMALL ENTITY status, check box 5a on Part B - Fee(s) Transmittal and pay the PUBLICATION FEE (if required) and 1/2 the ISSUE FEE shown above.

II. PART B - FEE(S) TRANSMITTAL, or its equivalent, must be completed and returned to the United States Patent and Trademark Office (USPTO) with your ISSUE FEE and PUBLICATION FEE (if required). If you are charging the fee(s) to your deposit account, section "4b" of Part B - Fee(s) Transmittal should be completed and an extra copy of the form should be submitted. If an equivalent of Part B is filed, a request to reapply a previously paid issue fee must be clearly made, and delays in processing may occur due to the difficulty in recognizing the paper as an equivalent of Part B.

III. All communications regarding this application must give the application number. Please direct all communications prior to issuance to Mail Stop ISSUE FEE unless advised to the contrary.

IMPORTANT REMINDER: Utility patents issuing on applications filed on or after Dec. 12, 1980 may require payment of maintenance fees. It is patentee's responsibility to ensure timely payment of maintenance fees when due.

**PART B - FEE(S) TRANSMITTAL**

**Complete and send this form, together with applicable fee(s), to: Mail Mail Stop ISSUE FEE  
 Commissioner for Patents  
 P.O. Box 1450  
 Alexandria, Virginia 22313-1450  
 or Fax (571)-273-2885**

**INSTRUCTIONS:** This form should be used for transmitting the ISSUE FEE and PUBLICATION FEE (if required). Blocks 1 through 5 should be completed where appropriate. All further correspondence including the Patent, advance orders and notification of maintenance fees will be mailed to the current correspondence address as indicated unless corrected below or directed otherwise in Block 1, by (a) specifying a new correspondence address; and/or (b) indicating a separate "FEE ADDRESS" for maintenance fee notifications.

CURRENT CORRESPONDENCE ADDRESS (Note: Use Block 1 for any change of address)

68533                      7590                      11/01/2010

MEGAN LYMAN  
 1816 SILVER MIST CT.  
 RALEIGH, NC 27613

Note: A certificate of mailing can only be used for domestic mailings of the Fee(s) Transmittal. This certificate cannot be used for any other accompanying papers. Each additional paper, such as an assignment or formal drawing, must have its own certificate of mailing or transmission.

**Certificate of Mailing or Transmission**

I hereby certify that this Fee(s) Transmittal is being deposited with the United States Postal Service with sufficient postage for first class mail in an envelope addressed to the Mail Stop ISSUE FEE address above, or being facsimile transmitted to the USPTO (571) 273-2885, on the date indicated below.

(Depositor's name)
(Signature)
(Date)

APPLICATION NO.	FILING DATE	FIRST NAMED INVENTOR	ATTORNEY DOCKET NO.	CONFIRMATION NO.
12/570,343	09/30/2009	C. Earl Woolfork	1028.4	9973

TITLE OF INVENTION: WIRELESS DIGITAL AUDIO SYSTEM

APPLN. TYPE	SMALL ENTITY	ISSUE FEE DUE	PUBLICATION FEE DUE	PREV. PAID ISSUE FEE	TOTAL FEE(S) DUE	DATE DUE
nonprovisional	YES	\$755	\$300	\$0	\$1055	02/01/2011

EXAMINER	ART UNIT	CLASS-SUBCLASS
FLANDERS, ANDREW C	2614	700-094000

<p>1. Change of correspondence address or indication of "Fee Address" (37 CFR 1.363).</p> <p><input type="checkbox"/> Change of correspondence address (or Change of Correspondence Address form PTO/SB/122) attached.</p> <p><input type="checkbox"/> "Fee Address" indication (or "Fee Address" Indication form PTO/SB/47; Rev 03-02 or more recent) attached. <b>Use of a Customer Number is required.</b></p>	<p>2. For printing on the patent front page, list</p> <p>(1) the names of up to 3 registered patent attorneys or agents OR, alternatively, 1 _____</p> <p>(2) the name of a single firm (having as a member a registered attorney or agent) and the names of up to 2 registered patent attorneys or agents. If no name is listed, no name will be printed. 2 _____</p> <p>3 _____</p>
---	---

3. ASSIGNEE NAME AND RESIDENCE DATA TO BE PRINTED ON THE PATENT (print or type)

PLEASE NOTE: Unless an assignee is identified below, no assignee data will appear on the patent. If an assignee is identified below, the document has been filed for recordation as set forth in 37 CFR 3.11. Completion of this form is NOT a substitute for filing an assignment.

(A) NAME OF ASSIGNEE \_\_\_\_\_ (B) RESIDENCE: (CITY and STATE OR COUNTRY) \_\_\_\_\_

Please check the appropriate assignee category or categories (will not be printed on the patent):  Individual  Corporation or other private group entity  Government

<p>4a. The following fee(s) are submitted:</p> <p><input type="checkbox"/> Issue Fee</p> <p><input type="checkbox"/> Publication Fee (No small entity discount permitted)</p> <p><input type="checkbox"/> Advance Order - # of Copies _____</p>	<p>4b. Payment of Fee(s): (Please first reapply any previously paid issue fee shown above)</p> <p><input type="checkbox"/> A check is enclosed.</p> <p><input type="checkbox"/> Payment by credit card. Form PTO-2038 is attached.</p> <p><input type="checkbox"/> The Director is hereby authorized to charge the required fee(s), any deficiency, or credit any overpayment, to Deposit Account Number _____ (enclose an extra copy of this form).</p>
---	--

5. Change in Entity Status (from status indicated above)

a. Applicant claims SMALL ENTITY status. See 37 CFR 1.27.  b. Applicant is no longer claiming SMALL ENTITY status. See 37 CFR 1.27(g)(2).

NOTE: The Issue Fee and Publication Fee (if required) will not be accepted from anyone other than the applicant; a registered attorney or agent; or the assignee or other party in interest as shown by the records of the United States Patent and Trademark Office.

Authorized Signature \_\_\_\_\_ Date \_\_\_\_\_

Typed or printed name \_\_\_\_\_ Registration No. \_\_\_\_\_

This collection of information is required by 37 CFR 1.311. The information is required to obtain or retain a benefit by the public which is to file (and by the USPTO to process) an application. Confidentiality is governed by 35 U.S.C. 122 and 37 CFR 1.14. This collection is estimated to take 12 minutes to complete, including gathering, preparing, and submitting the completed application form to the USPTO. Time will vary depending upon the individual case. Any comments on the amount of time you require to complete this form and/or suggestions for reducing this burden, should be sent to the Chief Information Officer, U.S. Patent and Trademark Office, U.S. Department of Commerce, P.O. Box 1450, Alexandria, Virginia 22313-1450. DO NOT SEND FEES OR COMPLETED FORMS TO THIS ADDRESS. SEND TO: Commissioner for Patents, P.O. Box 1450, Alexandria, Virginia 22313-1450.

Under the Paperwork Reduction Act of 1995, no persons are required to respond to a collection of information unless it displays a valid OMB control number.





UNITED STATES PATENT AND TRADEMARK OFFICE

UNITED STATES DEPARTMENT OF COMMERCE
United States Patent and Trademark Office
Address: COMMISSIONER FOR PATENTS
P.O. Box 1450
Alexandria, Virginia 22313-1450
www.uspto.gov

Table with 5 columns: APPLICATION NO., FILING DATE, FIRST NAMED INVENTOR, ATTORNEY DOCKET NO., CONFIRMATION NO.
Row 1: 12/570,343, 09/30/2009, C. Earl Woolfork, 1028.4, 9973
Row 2: 68533, 7590, 11/01/2010, [EXAMINER], [FLANDERS, ANDREW C]
Row 3: [ART UNIT], [PAPER NUMBER]
Row 4: 2614, DATE MAILED: 11/01/2010

Determination of Patent Term Adjustment under 35 U.S.C. 154 (b)
(application filed on or after May 29, 2000)

The Patent Term Adjustment to date is 3 day(s). If the issue fee is paid on the date that is three months after the mailing date of this notice and the patent issues on the Tuesday before the date that is 28 weeks (six and a half months) after the mailing date of this notice, the Patent Term Adjustment will be 3 day(s).

If a Continued Prosecution Application (CPA) was filed in the above-identified application, the filing date that determines Patent Term Adjustment is the filing date of the most recent CPA.

Applicant will be able to obtain more detailed information by accessing the Patent Application Information Retrieval (PAIR) WEB site (http://pair.uspto.gov).

Any questions regarding the Patent Term Extension or Adjustment determination should be directed to the Office of Patent Legal Administration at (571)-272-7702. Questions relating to issue and publication fee payments should be directed to the Customer Service Center of the Office of Patent Publication at 1-(888)-786-0101 or (571)-272-4200.

<b>Notice of Allowability</b>	<b>Application No.</b>	<b>Applicant(s)</b>	
	12/570,343	WOOLFORK, C. EARL	
	<b>Examiner</b>	<b>Art Unit</b>	
	ANDREW C. FLANDERS	2614	

**-- The MAILING DATE of this communication appears on the cover sheet with the correspondence address--**

All claims being allowable, PROSECUTION ON THE MERITS IS (OR REMAINS) CLOSED in this application. If not included herewith (or previously mailed), a Notice of Allowance (PTOL-85) or other appropriate communication will be mailed in due course. **THIS NOTICE OF ALLOWABILITY IS NOT A GRANT OF PATENT RIGHTS.** This application is subject to withdrawal from issue at the initiative of the Office or upon petition by the applicant. See 37 CFR 1.313 and MPEP 1308.

1.  This communication is responsive to *the amendment filed 04 August 2010.*
2.  The allowed claim(s) is/are 1-3, 5-9, 12, 13, 21, 25, 26.
3.  Acknowledgment is made of a claim for foreign priority under 35 U.S.C. § 119(a)-(d) or (f).
  - a)  All    b)  Some\*    c)  None    of the:
    1.  Certified copies of the priority documents have been received.
    2.  Certified copies of the priority documents have been received in Application No. \_\_\_\_\_.
    3.  Copies of the certified copies of the priority documents have been received in this national stage application from the International Bureau (PCT Rule 17.2(a)).

\* Certified copies not received: \_\_\_\_\_.

Applicant has THREE MONTHS FROM THE "MAILING DATE" of this communication to file a reply complying with the requirements noted below. Failure to timely comply will result in ABANDONMENT of this application.  
**THIS THREE-MONTH PERIOD IS NOT EXTENDABLE.**

4.  A SUBSTITUTE OATH OR DECLARATION must be submitted. Note the attached EXAMINER'S AMENDMENT or NOTICE OF INFORMAL PATENT APPLICATION (PTO-152) which gives reason(s) why the oath or declaration is deficient.
5.  CORRECTED DRAWINGS ( as "replacement sheets") must be submitted.
  - (a)  including changes required by the Notice of Draftsperson's Patent Drawing Review ( PTO-948) attached
    - 1)  hereto or 2)  to Paper No./Mail Date \_\_\_\_\_.
  - (b)  including changes required by the attached Examiner's Amendment / Comment or in the Office action of Paper No./Mail Date \_\_\_\_\_.

**Identifying indicia such as the application number (see 37 CFR 1.84(c)) should be written on the drawings in the front (not the back) of each sheet. Replacement sheet(s) should be labeled as such in the header according to 37 CFR 1.121(d).**
6.  DEPOSIT OF and/or INFORMATION about the deposit of BIOLOGICAL MATERIAL must be submitted. Note the attached Examiner's comment regarding REQUIREMENT FOR THE DEPOSIT OF BIOLOGICAL MATERIAL.

**Attachment(s)**

- |  |  |
|--|--|
| 1. <input type="checkbox"/> Notice of References Cited (PTO-892)   | 5. <input type="checkbox"/> Notice of Informal Patent Application                      |
| 2. <input type="checkbox"/> Notice of Draftsperson's Patent Drawing Review (PTO-948)                               | 6. <input type="checkbox"/> Interview Summary (PTO-413),<br>Paper No./Mail Date _____. |
| 3. <input checked="" type="checkbox"/> Information Disclosure Statements (PTO/SB/08),<br>Paper No./Mail Date _____ | 7. <input checked="" type="checkbox"/> Examiner's Amendment/Comment                    |
| 4. <input type="checkbox"/> Examiner's Comment Regarding Requirement for Deposit<br>of Biological Material         | 8. <input type="checkbox"/> Examiner's Statement of Reasons for Allowance              |
|  | 9. <input type="checkbox"/> Other _____.   |

/Andrew C Flanders/  
 Primary Examiner, Art Unit 2614

**EXAMINER'S AMENDMENT**

An examiner's amendment to the record appears below. Should the changes and/or additions be unacceptable to applicant, an amendment may be filed as provided by 37 CFR 1.312. To ensure consideration of such an amendment, it MUST be submitted no later than the payment of the issue fee.

Authorization for this examiner's amendment was given in a telephone interview with Megan Lyman on 21 October 2010.

The application has been amended as follows:

Please cancel claims 4, 10, 11, 15, 17 and 23.

Any inquiry concerning this communication or earlier communications from the examiner should be directed to ANDREW C. FLANDERS whose telephone number is (571)272-7516. The examiner can normally be reached on M-F 8:30 - 5:00.

If attempts to reach the examiner by telephone are unsuccessful, the examiner's supervisor, Curtis Kuntz can be reached on (571) 272-7499. The fax phone number for the organization where this application or proceeding is assigned is 571-273-8300.

Art Unit: 2614

Information regarding the status of an application may be obtained from the Patent Application Information Retrieval (PAIR) system. Status information for published applications may be obtained from either Private PAIR or Public PAIR. Status information for unpublished applications is available through Private PAIR only. For more information about the PAIR system, see <http://pair-direct.uspto.gov>. Should you have questions on access to the Private PAIR system, contact the Electronic Business Center (EBC) at 866-217-9197 (toll-free). If you would like assistance from a USPTO Customer Service Representative or access to the automated information system, call 800-786-9199 (IN USA OR CANADA) or 571-272-1000.

/Andrew C Flanders/  
Primary Examiner, Art Unit 2614

<b>Index of Claims</b> 	<b>Application/Control No.</b> 12570343	<b>Applicant(s)/Patent Under Reexamination</b> WOOLFORK, C. EARL
	<b>Examiner</b> ANDREW C FLANDERS	<b>Art Unit</b> 2614

✓	<b>Rejected</b>	-	<b>Cancelled</b>	<b>N</b>	<b>Non-Elected</b>	<b>A</b>	<b>Appeal</b>
=	<b>Allowed</b>	÷	<b>Restricted</b>	<b>I</b>	<b>Interference</b>	<b>O</b>	<b>Objected</b>

Claims renumbered in the same order as presented by applicant
  CPA
  T.D.
  R.1.47

CLAIM		DATE							
Final	Original	01/11/2010	06/01/2010	10/21/2010					
1	1	✓	✓	=					
2	2	✓	✓	=					
3	3	✓	✓	=					
	4	✓	✓	-					
4	5	✓	✓	=					
5	6	✓	✓	=					
6	7	✓	✓	=					
7	8	✓	✓	=					
8	9	✓	✓	=					
	10	✓	✓	-					
	11	✓	✓	-					
9	12	✓	=	=					
10	13		✓	=					
	14		✓	-					
	15		✓	-					
	16		✓	-					
	17		✓	-					
	18		✓	-					
	19		✓	-					
	20		✓	-					
11	21		✓	=					
	22		✓	-					
	23		✓	-					
	24		✓	-					
12	25		✓	=					
13	26		✓	=					

<b>Issue Classification</b> 	<b>Application/Control No.</b> 12570343	<b>Applicant(s)/Patent Under Reexamination</b> WOOLFORK, C. EARL
	<b>Examiner</b> ANDREW C FLANDERS	<b>Art Unit</b> 2614

ORIGINAL						INTERNATIONAL CLASSIFICATION														
CLASS			SUBCLASS			CLAIMED					NON-CLAIMED									
700			94			G	0	6	F	17 / 00 (2006.01.01)										
<b>CROSS REFERENCE(S)</b>																				
CLASS	SUBCLASS (ONE SUBCLASS PER BLOCK)																			

<input type="checkbox"/> Claims renumbered in the same order as presented by applicant <input type="checkbox"/> CPA <input type="checkbox"/> T.D. <input type="checkbox"/> R.1.47															
Final	Original	Final	Original	Final	Original	Final	Original	Final	Original	Final	Original	Final	Original	Final	Original
1	1		17												
2	2		18												
3	3		19												
	4		20												
4	5	10	21												
5	6		22												
6	7	11	23												
7	8		24												
8	9	12	25												
	10	13	26												
	11														
8	12														
9	13														
	14														
	15														
	16														

NONE		<b>Total Claims Allowed:</b>	
		13	
(Assistant Examiner)	(Date)		
/ANDREW C FLANDERS/ Primary Examiner.Art Unit 2614	10/21/2010	O.G. Print Claim(s)	O.G. Print Figure
(Primary Examiner)	(Date)	1	1

<b>Search Notes</b>  	<b>Application/Control No.</b>  12570343	<b>Applicant(s)/Patent Under Reexamination</b>  WOOLFORK, C. EARL
	<b>Examiner</b>  ANDREW C FLANDERS	<b>Art Unit</b>  2614

<b>SEARCHED</b>			
<b>Class</b>	<b>Subclass</b>	<b>Date</b>	<b>Examiner</b>

<b>SEARCH NOTES</b>		
<b>Search Notes</b>	<b>Date</b>	<b>Examiner</b>
Reviewed and repeated search history (including class search) of Parent Application 12/144,729	1/11/10	acf
eDan EAST and PALM inventor search for double patenting	1/11/10	acf
updated	6/1/10	acf
Updated	10/21/10	acf

<b>INTERFERENCE SEARCH</b>			
<b>Class</b>	<b>Subclass</b>	<b>Date</b>	<b>Examiner</b>
700	94	10/21/10	acf

	/ANDREW C FLANDERS/ Primary Examiner.Art Unit 2614
--	---

## EAST Search History

## EAST Search History (Prior Art)

Ref #	Hits	Search Query	DBs	Default Operator	Plurals	Time Stamp
L1	2704	(700/94).CCLS.	US-PGPUB; USPAT	OR	OFF	2010/10/21 12:51
S1	9	FHSS with unique with user	US-PGPUB; USPAT	OR	OFF	2007/03/20 09:30
S2	6	S1 and @ad<"20011221"	US-PGPUB; USPAT	OR	OFF	2006/05/02 17:45
S3	0	FHSS with unique adj hop	US-PGPUB; USPAT	OR	OFF	2006/05/02 17:46
S4	0	FHSS with each adj user	US-PGPUB; USPAT	OR	OFF	2006/05/02 17:46
S5	0	FHSS with individual adj user	US-PGPUB; USPAT	OR	OFF	2006/05/02 17:47
S6	0	(FHSS or "frequency hopping spread spectrum") with individual adj user	US-PGPUB; USPAT	OR	OFF	2006/05/02 17:47
S7	0	(FHSS or "frequency hopping spread spectrum") near user same unique	US-PGPUB; USPAT	OR	OFF	2006/05/02 17:47
S8	9	(FHSS or "frequency hopping spread spectrum") with user same unique	US-PGPUB; USPAT	OR	OFF	2006/05/02 17:48
S9	17	(FHSS or "frequency hopping spread spectrum") same unique same user	US-PGPUB; USPAT	OR	OFF	2006/05/02 17:48
S10	6	S9 and @ad<"20011221"	US-PGPUB; USPAT	OR	OFF	2006/05/02 17:48
S11	9	(FHSS or "frequency hopping spread spectrum") same multiple adj user!	US-PGPUB; USPAT	OR	OFF	2006/05/03 10:32



S12	91	("FHSS or "frequency hopping spread spectrum") same (pn or "hopping code")	US-PGPUB; USPAT	OR	OFF	2006/05/02 17:50
S13	13	("FHSS or "frequency hopping spread spectrum") with ("hopping code")	US-PGPUB; USPAT	OR	OFF	2006/05/02 17:50
S14	3	S13 and @ad<"20011221"	US-PGPUB; USPAT	OR	OFF	2006/05/02 17:51
S15	1	("5946343").PN.	US-PGPUB; USPAT	OR	OFF	2006/05/03 11:46
S16	1	("6342844").PN.	US-PGPUB; USPAT	OR	OFF	2006/05/03 11:46
S17	1	("5771441").PN.	US-PGPUB; USPAT	OR	OFF	2006/08/28 15:55
S18	10725	"rechargeable battery" and @ad<"20011220"	US-PGPUB; USPAT	OR	OFF	2006/08/28 15:55
S19	376	"rechargeable battery".ti. and @ad<"20011220"	US-PGPUB; USPAT	OR	OFF	2006/08/28 15:55
S20	17	("rechargeable battery" and portable).ti. and @ad<"20011220"	US-PGPUB; USPAT	OR	OFF	2006/08/28 15:57
S21	3623043	("rechargeable battery" and portable) with mah andd @ad<"20011220"	US-PGPUB; USPAT	OR	OFF	2006/08/28 15:57
S22	0	("rechargeable battery" and portable) with mah and @ad<"20011220"	US-PGPUB; USPAT	OR	OFF	2006/08/28 15:57
S23	3623041	("rechargeable battery" and portable) with mah andd @ad<"20011220"	US-PGPUB; USPAT	OR	OFF	2006/08/28 15:57
S24	3623041	("rechargeable battery" and portable) with "ma-h" andd @ad<"20011220"	US-PGPUB; USPAT	OR	OFF	2006/08/28 15:57
S25	0	("rechargeable battery" and portable) with "ma-h" and @ad<"20011220"	US-PGPUB; USPAT	OR	OFF	2006/08/28 15:57
S26	640693	("rechargeable battery" and portable) with milliamp hours and @ad<"20011220"	US-PGPUB; USPAT	OR	OFF	2006/08/28 15:57

S27	18	("rechargeable battery" and portable) and "milliamp hours" and @ad<"20011220"	US-PGPUB; USPAT	OR	OFF	2006/08/31 12:17
S28	29	"5491839"	US-PGPUB; USPAT	OR	OFF	2006/08/30 12:56
S29	1	("5491839").PN.	US-PGPUB; USPAT	OR	OFF	2006/08/30 12:56
S30	1	("5771441").PN.	US-PGPUB; USPAT	OR	OFF	2006/08/30 12:56
S31	1	("6,107,147").PN.	US-PGPUB; USPAT	OR	OFF	2006/08/31 12:17
S32	0	(10/648012).APP.	US-PGPUB; USPAT	OR	OFF	2006/09/25 09:26
S33	1	("5946343").PN.	US-PGPUB; USPAT	OR	OFF	2006/09/25 09:50
S34	422	(455/564.1,412,413).CCLS.	US-PGPUB; USPAT	OR	OFF	2006/09/25 09:50
S35	5294	(375/219,295-297,346,348).CCLS.	US-PGPUB; USPAT	OR	OFF	2006/09/25 10:02
S36	1	("20040223622").PN.	US-PGPUB; USPAT	OR	OFF	2006/09/25 10:04
S37	1	("5946343").PN.	US-PGPUB; USPAT	OR	OFF	2006/09/25 10:05
S38	1	("7,050,419").PN.	US-PGPUB; USPAT	OR	OFF	2007/03/20 09:32
S39	1	("20010025358").PN.	US-PGPUB; USPAT	OR	OFF	2007/03/20 09:37
S40	2618	(375/341,140,147).CCLS.	US-PGPUB; USPAT	OR	OFF	2007/03/20 09:37
S41	1807	S40 and @ad<"20011220"	US-PGPUB; USPAT	OR	OFF	2007/03/20 09:38

S42	8	("2001/0025358").URPN.	USPAT	OR	OFF	2007/03/20 09:51
S43	0	("2002/0025009").URPN.	USPAT	OR	OFF	2007/03/20 09:59
S44	0	("2002/0025009").URPN.	USPAT	OR	OFF	2007/03/20 10:01
S45	12	("20020159543"   "5434623"   "5867532"   "5973642"   "6243423"   "6327314"   "6339612"   "6459728"   "6477210"   "6480554"   "6654429"   "6671338").PN. OR ("7099413").URPN.	US-PGPUB; USPAT; USOCR	OR	OFF	2007/03/20 10:08
S46	74	"band pass" and demodulator and interleaver and "viterbi decoder"	US-PGPUB; USPAT; USOCR	OR	OFF	2007/03/20 10:08
S47	59	S46 and @ad<"20011220"	US-PGPUB; USPAT; USOCR	OR	OFF	2007/03/20 10:08
S48	17	("4278978"   "4635063"   "5175558"   "5493307").PN. OR ("6130643").URPN.	US-PGPUB; USPAT; USOCR	OR	OFF	2007/03/20 10:15
S49	1	("5175558").PN.	US-PGPUB; USPAT	OR	OFF	2007/03/20 10:16
S50	13	("4651155"   "4931977").PN. OR ("5175558"). URPN.	US-PGPUB; USPAT; USOCR	OR	OFF	2007/03/20 10:34
S51	1	("5946343").PN.	US-PGPUB; USPAT	OR	OFF	2007/03/20 11:40
S52	7186	(375/295,146,130,340,316,148).CCLS.	US-PGPUB; USPAT	OR	OFF	2007/03/20 11:41
S53	4473	S52 and @ad<"20011220"	US-PGPUB; USPAT	OR	OFF	2007/03/20 11:41
S54	1	("20040223622").PN.	US-PGPUB; USPAT	OR	OFF	2007/03/21 12:11
S55	5	"reed solomon" with "intersymbol interference"	US-PGPUB; USPAT	OR	OFF	2007/03/21 12:13

S56	30	"reed solomon" same "intersymbol interference"	US-PGPUB; USPAT	OR	OFF	2007/03/21 12:13
S57	21	S56 and @ad<"20011220"	US-PGPUB; USPAT	OR	OFF	2007/03/21 12:27
S58	1	("20030045235").PN.	US-PGPUB; USPAT	OR	OFF	2007/03/21 12:37
S59	1	("5790595").PN.	US-PGPUB; USPAT	OR	OFF	2007/03/21 12:37
S60	2435	((375/262,265,341) or (714/794,795)).CCLS.	US-PGPUB; USPAT	OR	OFF	2007/03/24 09:15
S62	56	"375".clas. and "fuzzy logic"	US-PGPUB; USPAT	OR	OFF	2007/03/26 11:04
S64	1	("4970637").PN.	US-PGPUB; USPAT	OR	OFF	2007/03/28 13:46
S65	755	(audio sound music voice) same (a/d "analog to digital") same (lpf "low pass")	US-PGPUB; USPAT	OR	OFF	2007/03/28 13:46
S66	282	(audio sound music voice) with (a/d "analog to digital") with ((lpf "low pass") and "digital")	US-PGPUB; USPAT	OR	OFF	2007/03/28 13:47
S67	227	(audio sound music voice) with (a/d "analog to digital") with ((lpf "low pass") and "digital") and @ad<"20011221"	US-PGPUB; USPAT	OR	OFF	2007/03/28 15:33
S68	34712	"band pass filter" bpf with "direct conversion receiver"	US-PGPUB; USPAT	OR	OFF	2007/03/28 15:33
S69	35	("band pass filter" bpf) with "direct conversion receiver"	US-PGPUB; USPAT	OR	OFF	2007/03/28 15:33
S70	8	S69 and @ad<"20011221"	US-PGPUB; USPAT	OR	OFF	2007/03/28 15:55
S71	1	("20030045235").PN.	US-PGPUB; USPAT	OR	OFF	2007/03/28 16:16
S72	1	("20040223622").PN.	US-PGPUB; USPAT	OR	OFF	2007/03/28 16:20

S73	1	("5946343").PN.	US-PGPUB; USPAT	OR	OFF	2007/03/28 16:27
S74	364	"64-ary"	US-PGPUB; USPAT	OR	OFF	2007/03/28 16:27
S75	74	"64-ary" near modulat\$4	US-PGPUB; USPAT	OR	OFF	2007/03/28 16:27
S76	46	S75 and @ad<"20011120"	US-PGPUB; USPAT	OR	OFF	2007/03/28 16:27
S77	2	((("4970637") or ("5790595")).PN.	US-PGPUB; USPAT	OR	OFF	2007/07/16 09:58
S78	3	((("4970637") or ("5790595") or ("20040223622")).PN.	US-PGPUB; USPAT	OR	OFF	2007/07/16 09:58
S79	3	("2004/0223622").URPN.	USPAT	OR	OFF	2007/07/16 11:25
S80	1	("5771441").PN.	US-PGPUB; USPAT	OR	OFF	2007/07/16 11:25
S81	60	("2236946"   "2828413"   "2840694"   "3080785"   "3085460"   "3087117"   "3296916"   "3579211"   "3743751"   "3781451"   "3825666"   "3863157"   "3901118"   "3906160"   "4004228"   "4229826"   "4335930"   "4344184"   "4369521"   "4430757"   "4453269"   "4464792"   "4471493"   "4612688"   "4647135"   "4721926"   "4794622"   "4845751"   "4899388"   "4988957"   "5025704"   "5214568").PN. OR ("5771441"). URPN.	US-PGPUB; USPAT; USOCR	OR	OFF	2007/07/16 11:26
S82	2	S81 and cdma	US-PGPUB; USPAT; USOCR	OR	OFF	2007/07/16 11:26
S83	1	("6678892").PN.	US-PGPUB; USPAT	OR	OFF	2008/05/20 11:41

S84	1	("20020072816").PN.	US-PGPUB; USPAT	OR	OFF	2008/05/20 14:24
S85	22	"fuzzy logic" and modulat\$5 and filter and (dpsk "phase shift key")	US-PGPUB; USPAT	OR	OFF	2008/06/06 09:20
S86	0	"455".clas. and "375".clas. and S85	US-PGPUB; USPAT	OR	OFF	2008/06/06 09:21
S87	1	"10100351"	US-PGPUB; USPAT	OR	OFF	2008/06/06 11:49
S88	1	("6,678,892").PN.	US-PGPUB; USPAT	OR	OFF	2008/06/06 12:38
S89	3	("20030021429"   "20030076346"   "6867820").PN.	US-PGPUB; USPAT	OR	OFF	2008/06/06 12:42
S90	13	("4589134"   "4626892"   "5042070"   "5541638"   "5581621"   "5631850"   "5775939"   "6100936"   "6195438").PN. OR ("6867820").URPN.	US-PGPUB; USPAT; USOCR	OR	OFF	2008/06/06 12:43
S91	2	"10648012"	US-PGPUB; USPAT	OR	OFF	2009/02/14 10:23
S92	1	"12144729"	US-PGPUB; USPAT	OR	OFF	2009/02/14 10:31
S93	1	("5790595").PN.	US-PGPUB; USPAT	OR	OFF	2009/02/14 12:36
S94	1	("6678892").PN.	US-PGPUB; USPAT	OR	OFF	2009/02/14 12:37
S95	1	("6678892").PN.	US-PGPUB; USPAT	OR	OFF	2009/05/26 07:51
S96	1680	portable and music and CDMA and transmitter and receiver	US-PGPUB; USPAT	OR	OFF	2009/09/01 11:35
S97	527	portable and music and CDMA and transmitter and receiver and private	US-PGPUB; USPAT	OR	OFF	2009/09/01 11:35

S98	57	portable and music and CDMA and transmitter and receiver and private and "fuzzy logic"	US-PGPUB; USPAT	OR	OFF	2009/09/01 11:35
S99	0	S98 and @ad<"20011221"	US-PGPUB; USPAT	OR	OFF	2009/09/01 11:36
S100	41	S97 and @ad<"20011221"	US-PGPUB; USPAT	OR	OFF	2009/09/01 11:36
S101	1	("6678692").PN.	US-PGPUB; USPAT	OR	OFF	2009/09/01 11:39
S102	1	("6678892").PN.	US-PGPUB; USPAT	OR	OFF	2009/09/01 11:39
S103	25	("5555466"   "5771441"   "6058288"   "6243645"   "6266815"   "6300880"   "6317039").PN. OR ("6678892").URPN.	US-PGPUB; USPAT; USOCR	OR	OFF	2009/09/01 11:39
S104	63	("2236946"   "2828413"   "2840694"   "3080785"   "3085460"   "3087117"   "3296916"   "3579211"   "3743751"   "3781451"   "3825666"   "3863157"   "3901118"   "3906160"   "4004228"   "4229826"   "4335930"   "4344184"   "4369521"   "4430757"   "4453269"   "4464792"   "4471493"   "4612688"   "4647135"   "4721926"   "4794622"   "4845751"   "4899388"   "4988957"   "5025704"   "5214568").PN. OR ("5771441").URPN.	US-PGPUB; USPAT; USOCR	OR	OFF	2009/09/01 11:42
S105	10	("20030045235"   "20040223622"   "5491839"   "5771441"   "5790595"   "5946343"   "6342844"   "6418558"   "6678892"   "6982132").PN.	US-PGPUB; USPAT; USOCR	OR	OFF	2009/09/01 11:42
S106	4453	"fuzzy logic" and @ad<"20011221"	US-PGPUB; USPAT; USOCR	OR	OFF	2009/09/01 11:48
S107	659	S106 and transmitter	US-PGPUB; USPAT; USOCR	OR	OFF	2009/09/01 11:48

S108	591	S106 and portable	US-PGPUB; USPAT; USOCR	OR	OFF	2009/09/01 11:48
S109	4	S106 and portable adj player	US-PGPUB; USPAT; USOCR	OR	OFF	2009/09/01 11:49
S110	0	"fuzzy logic" with reciever	US-PGPUB; USPAT; USOCR	OR	OFF	2009/09/01 11:50
S111	49	"fuzzy logic" with receiver	US-PGPUB; USPAT; USOCR	OR	OFF	2009/09/01 11:50
S112	27	S111 and @ad<"20011221"	US-PGPUB; USPAT	OR	OFF	2009/09/01 11:50
S113	192	"fuzzy logic" same receiver	US-PGPUB; USPAT; USOCR	OR	OFF	2009/09/01 11:51
S114	72	S113 and @ad<"20011221"	US-PGPUB; USPAT	OR	OFF	2009/09/01 11:52
S115	71	("4019141"   "4229829"   "5264795"   "5404577"   "5437057"   "5568516"   "5694467"   "5771438"   "5771441"   "5867223"   "5978689"   "6006115").PN. OR ("6424820").URPN.	US-PGPUB; USPAT; USOCR	OR	OFF	2009/09/02 11:27
S116	34	S115 and @ad<"20011221"	US-PGPUB; USPAT	OR	OFF	2009/09/02 11:28
S117	31	bluetooth with (headphone headset earphone "head phone" "head set" "ear phone") with cdma	US-PGPUB; USPAT	OR	OFF	2009/09/02 11:32
S118	2	S117 and @ad<"20011221"	US-PGPUB; USPAT	OR	OFF	2009/09/02 11:32
S119	32	wireless with (headphone headset earphone "head phone" "head set" "ear phone") with cdma	US-PGPUB; USPAT	OR	OFF	2009/09/02 11:33
S120	3	S119 and @ad<"20011221"	US-PGPUB; USPAT	OR	OFF	2009/09/02 11:33



S121	57	(headphone headset earphone "head phone" "head set" "ear phone") with cdma	US-PGPUB; USPAT	OR	OFF	2009/09/02 11:34
S122	10	S121 and @ad<"20011221"	US-PGPUB; USPAT	OR	OFF	2009/09/02 11:34
S123	0	WO0056093	US-PGPUB; USPAT	OR	OFF	2009/09/02 11:36
S124	0	WO0056093	US-PGPUB; USPAT; USOCR; FPRS; EPO; JPO; DERWENT; IBM_TDB	OR	OFF	2009/09/02 11:37
S125	0	WO/0056093	US-PGPUB; USPAT; USOCR; FPRS; EPO; JPO; DERWENT; IBM_TDB	OR	OFF	2009/09/02 11:37
S126	2	((("5781542") or ("5799005"))).PN.	US-PGPUB; USPAT	OR	OFF	2009/09/02 11:42
S127	1	("6199076").PN.	US-PGPUB; USPAT	OR	OFF	2009/09/02 13:51
S128	0	woolfork-earl.in.	US-PGPUB; USPAT	OR	OFF	2009/11/23 11:44
S129	3	woolfork-c-\$.in.	US-PGPUB; USPAT	OR	OFF	2009/11/23 11:44
S139	1	("7412294").PN.	US-PGPUB; USPAT	OR	OFF	2010/01/11 12:21
S140	1	("7412294").PN.	US-PGPUB; USPAT	OR	OFF	2010/06/01 09:29
S141	3	"12144729"	US-PGPUB; USPAT	OR	OFF	2010/06/01 09:34

S142	843	cdma and "fuzzy logic"	US-PGPUB; USPAT	OR	OFF	2010/10/18 09:46
S143	66	S142 and @ad<"20011221"	US-PGPUB; USPAT	OR	OFF	2010/10/18 09:46
S144	14	cdma same "fuzzy logic"	US-PGPUB; USPAT	OR	OFF	2010/10/18 09:46
S145	5	S144 and @ad<"20011221"	US-PGPUB; USPAT	OR	OFF	2010/10/18 09:46
S146	11	code same wireless same "fuzzy logic"	US-PGPUB; USPAT	OR	OFF	2010/10/18 09:49
S147	2	S146 and @ad<"20011221"	US-PGPUB; USPAT	OR	OFF	2010/10/18 09:49

## EAST Search History (Interference)

Ref #	Hits	Search Query	DBs	Default Operator	Plurals	Time Stamp
S130	0	woolfork-earl.in.	USPAT; UPAD	OR	OFF	2009/11/23 11:44
S131	1	woolfork-c-\$.in.	USPAT; UPAD	OR	OFF	2009/11/23 11:44
S132	195	(700/94).CCLS.	UPAD	OR	OFF	2009/11/23 11:59
S133	225	((700/94) or (455/3.06)).CCLS.	UPAD	OR	OFF	2010/01/11 11:18

10/ 21/ 2010 12:51:47 PM

C:\Documents and Settings\aflanders\My Documents\EAST\Workspaces\12570343.wsp

<b>INFORMATION DISCLOSURE STATEMENT BY APPLICANT ( Not for submission under 37 CFR 1.99)</b>	Application Number		12570343
	Filing Date		2009-09-30
	First Named Inventor	C. Earl Woolfork	
	Art Unit	2614	
	Examiner Name	Andrew Flanders	
	Attorney Docket Number	1028.4	

U.S. PATENTS							Remove
Examiner Initial*	Cite No	Patent Number	Kind Code <sup>1</sup>	Issue Date	Name of Patentee or Applicant of cited Document	Pages, Columns, Lines where Relevant Passages or Relevant Figures Appear	
	1	5668880	A	1997-09-16	Alajajian, Philip		
	2	5721783	A	1998-02-24	Anderson, James		
	3	6115478	A	2000-09-05	dspfactory Ltd.		
	4	6236862	B1	2001-05-22	Intersignal LLC		
	5	7505823	B1	2009-03-17	Intrasonics Limited		
	6	5781542	A	1998-07-14	Tanaka		
	7	6678892	A	2004-08-13	Lavelle		
	8	5491839	A	1996-02-13	Schotz		

<b>INFORMATION DISCLOSURE STATEMENT BY APPLICANT</b> ( Not for submission under 37 CFR 1.99)	Application Number	12570343
	Filing Date	2009-09-30
	First Named Inventor	C. Earl Woolfork
	Art Unit	2614
	Examiner Name	Andrew Flanders
	Attorney Docket Number	1028.4

9	5790595	A	1998-08-04	Benthin	
10	5946343	A	1999-08-31	Schotz	
11	6342844	B1	2002-01-29	Rozin	
12	6418558	B1	2002-07-09	Roberts	
13	6982132	B1	2006-01-03	Goldner	

If you wish to add additional U.S. Patent citation information please click the Add button.

**U.S.PATENT APPLICATION PUBLICATIONS**

Examiner Initial*	Cite No	Publication Number	Kind Code <sup>1</sup>	Publication Date	Name of Patentee or Applicant of cited Document	Pages,Columns,Lines where Relevant Passages or Relevant Figures Appear
	1	20030045235	A1	2003-03-06	Mooney	
	2	20040223622	A1	2004-11-11	Lindemann	

If you wish to add additional U.S. Published Application citation information please click the Add button.

**FOREIGN PATENT DOCUMENTS**

Examiner Initial*	Cite No	Foreign Document Number <sup>3</sup>	Country Code <sup>2</sup> j	Kind Code <sup>4</sup>	Publication Date	Name of Patentee or Applicant of cited Document	Pages,Columns,Lines where Relevant Passages or Relevant Figures Appear	T <sup>5</sup>

<b>INFORMATION DISCLOSURE STATEMENT BY APPLICANT</b> ( Not for submission under 37 CFR 1.99)	Application Number	12570343
	Filing Date	2009-09-30
	First Named Inventor	C. Earl Woolfork
	Art Unit	2614
	Examiner Name	Andrew Flanders
	Attorney Docket Number	1028.4

1	GB2252013	GB	A	1992-07-22	Liu, Lu	<input type="checkbox"/>
2	WO0133836	WO	A1	2001-05-10	Lockhart, Peter	<input type="checkbox"/>
3	WO0076272	WO	A1	1998-03-12	Lindemann, Eric	<input type="checkbox"/>

If you wish to add additional Foreign Patent Document citation information please click the Add button

**NON-PATENT LITERATURE DOCUMENTS**

Examiner Initials*	Cite No	Include name of the author (in CAPITAL LETTERS), title of the article (when appropriate), title of the item (book, magazine, journal, serial, symposium, catalog, etc), date, pages(s), volume-issue number(s), publisher, city and/or country where published.	T <sup>5</sup>
	1	American National Standard for Methods of Measurement of Compatibility Between Wireless Communication Devices and Hearing Aids - ANSI C63. 19-2001	<input type="checkbox"/>
	2	A Conferencing Spread Spectrum Radio, KM LYE, TT TJHUNG, KC CHUA, TC PEK, WH YUNG, WP GOH, YP CHIA, WK LOH, FL MA, KM LOW 1994 /ACF/	<input type="checkbox"/>
	3	Specification of the Bluetooth System, Version 1.0 B, pp 17-27, 4144, 81-86, 143-147 11/20/99 /ACF/	<input type="checkbox"/>

If you wish to add additional non-patent literature document citation information please click the Add button

**EXAMINER SIGNATURE**

Examiner Signature	/Andrew Flanders/	Date Considered	10/25/2010
--------------------	-------------------	-----------------	------------

\*EXAMINER: Initial if reference considered, whether or not citation is in conformance with MPEP 609. Draw line through a citation if not in conformance and not considered. Include copy of this form with next communication to applicant.

<sup>1</sup> See Kind Codes of USPTO Patent Documents at [www.USPTO.GOV](http://www.USPTO.GOV) or MPEP 901.04. <sup>2</sup> Enter office that issued the document, by the two-letter code (WIPO Standard ST.3). <sup>3</sup> For Japanese patent documents, the indication of the year of the reign of the Emperor must precede the serial number of the patent document. <sup>4</sup> Kind of document by the appropriate symbols as indicated on the document under WIPO Standard ST.16 if possible. <sup>5</sup> Applicant is to place a check mark here if English language translation is attached.

**REQUEST FOR AMENDMENT AFTER ALLOWANCE UNDER 37 CFR 1.312**

The Applicant respectfully requests that the present application be amended as follows: the cancellation of claims 4, 10, 11, 15, 17, and 23 should read that they have been cancelled without prejudice. Claims 4, 10, 11, 15, 17, and 23 were cancelled via Examiner's Amendment, issued November 1, 2010 without the above language stating that claims are cancelled without prejudice.

It is noted with respect that the present amendment is filed before payment of the issue fee and can be entered on recommendation of the primary examiner, approved by the Director, without withdrawing the application from issue.

If there are any questions or concerns, or any information that may be provided to expedite this process, please do not hesitate to contact me.

November 5, 2010

Respectfully Submitted,

A handwritten signature in cursive script, appearing to read "Megan E. Lyman".

Megan E. Lyman, Registration No. 57,054  
1816 Silver Mist Ct.  
Raleigh, NC 27613  
(919) 341-4023

## Electronic Acknowledgement Receipt

<b>EFS ID:</b>	8782805
<b>Application Number:</b>	12570343
<b>International Application Number:</b>	
<b>Confirmation Number:</b>	9973
<b>Title of Invention:</b>	WIRELESS DIGITAL AUDIO SYSTEM
<b>First Named Inventor/Applicant Name:</b>	C. Earl Woolfork
<b>Customer Number:</b>	68533
<b>Filer:</b>	Megan Elizabeth Lyman
<b>Filer Authorized By:</b>	
<b>Attorney Docket Number:</b>	1028.4
<b>Receipt Date:</b>	05-NOV-2010
<b>Filing Date:</b>	30-SEP-2009
<b>Time Stamp:</b>	17:17:23
<b>Application Type:</b>	Utility under 35 USC 111(a)

### Payment information:

Submitted with Payment	no
------------------------	----

### File Listing:

Document Number	Document Description	File Name	File Size(Bytes)/ Message Digest	Multi Part /.zip	Pages (if appl.)
1	Amendment after Notice of Allowance (Rule 312)	AmendmentafterAllowance.pdf	90188 c280c286407010439525e01d90c3e3804cc8dec3	no	1

### Warnings:

### Information:

This Acknowledgement Receipt evidences receipt on the noted date by the USPTO of the indicated documents, characterized by the applicant, and including page counts, where applicable. It serves as evidence of receipt similar to a Post Card, as described in MPEP 503.

**New Applications Under 35 U.S.C. 111**

If a new application is being filed and the application includes the necessary components for a filing date (see 37 CFR 1.53(b)-(d) and MPEP 506), a Filing Receipt (37 CFR 1.54) will be issued in due course and the date shown on this Acknowledgement Receipt will establish the filing date of the application.

**National Stage of an International Application under 35 U.S.C. 371**

If a timely submission to enter the national stage of an international application is compliant with the conditions of 35 U.S.C. 371 and other applicable requirements a Form PCT/DO/EO/903 indicating acceptance of the application as a national stage submission under 35 U.S.C. 371 will be issued in addition to the Filing Receipt, in due course.

**New International Application Filed with the USPTO as a Receiving Office**

If a new international application is being filed and the international application includes the necessary components for an international filing date (see PCT Article 11 and MPEP 1810), a Notification of the International Application Number and of the International Filing Date (Form PCT/RO/105) will be issued in due course, subject to prescriptions concerning national security, and the date shown on this Acknowledgement Receipt will establish the international filing date of the application.





UNITED STATES PATENT AND TRADEMARK OFFICE

UNITED STATES DEPARTMENT OF COMMERCE  
United States Patent and Trademark Office  
Address: COMMISSIONER FOR PATENTS  
P.O. Box 1450  
Alexandria, Virginia 22313-1450  
www.uspto.gov

APPLICATION NO.	FILING DATE	FIRST NAMED INVENTOR	ATTORNEY DOCKET NO.	CONFIRMATION NO.
12/570,343	09/30/2009	C. Earl Woolfork	1028.4	9973
68533	7590	11/19/2010	EXAMINER FLANDERS, ANDREW C	
MEGAN LYMAN 1816 SILVER MIST CT. RALEIGH, NC 27613			ART UNIT	PAPER NUMBER
			2614	
			NOTIFICATION DATE	DELIVERY MODE
			11/19/2010	ELECTRONIC

**Please find below and/or attached an Office communication concerning this application or proceeding.**

The time period for reply, if any, is set in the attached communication.

Notice of the Office communication was sent electronically on above-indicated "Notification Date" to the following e-mail address(es):

MELYMAN@LYMANPATENTS.COM

<b>Response to Rule 312 Communication</b>	<b>Application No.</b>	<b>Applicant(s)</b>
	12/570,343	WOOLFORK, C. EARL
	<b>Examiner</b>	<b>Art Unit</b>
	ANDREW C. FLANDERS	2614

*-- The MAILING DATE of this communication appears on the cover sheet with the correspondence address --*

1.  The amendment filed on 05 November 2010 under 37 CFR 1.312 has been considered, and has been:
- a)  entered.
  - b)  entered as directed to matters of form not affecting the scope of the invention.
  - c)  disapproved because the amendment was filed after the payment of the issue fee.  
Any amendment filed after the date the issue fee is paid must be accompanied by a petition under 37 CFR 1.313(c)(1) and the required fee to withdraw the application from issue.
  - d)  disapproved. See explanation below.
  - e)  entered in part. See explanation below.

/Andrew C Flanders/  
Primary Examiner, Art Unit 2614



11/19/2010 15:54

9193410271

LYMAN

PAGE 01/02

PART B - FEE(S) TRANSMITTAL

Complete and return this form, together with applicable fee(s), to: Mail Stop 16516 FEE Commissioner for Patents P.O. Box 1450 Alexandria, Virginia 22313-1450 or Fax (571)-273-2885

INSTRUCTIONS: This form should be used for transmitting the ISSUE FEE and PUBLICATION FEE (if required). Blocks 1 through 5 should be completed where appropriate. All further correspondence including the Patent, advance orders and notification of maintenance fees will be mailed to the current correspondence address as indicated unless corrected below or directed otherwise in Block 1, by (a) specifying a new correspondence address; and/or (b) indicating a separate "FEE ADDRESS" for maintenance fee notifications.

CURRENT CORRESPONDENCE ADDRESS (Note: Use Block 1 for any change of address)

MEGAN LYMAN 1816 SILVER MIST CT. RALEIGH, NC 27613

11/22/2010 HUONG2 00000071 12570343 01 FC:2501 02 FC:1504 755.00 DP 300.00 DP

Note: A certificate of mailing can only be used for domestic mailings of the Fee(s) Transmittal. This certificate cannot be used for any other accompanying document. Each address accompanying an assignment of formal drawings must be a physical address.

I hereby certify that this Fee(s) Transmittal is being deposited with the United States Postal Service with sufficient postage for first class mail in an envelope addressed to the Mail Stop ISSUE FEE address above, or being facsimile transmitted to the USPTO (571) 273-2885, on the date indicated below.

Table with 3 rows: Depositor's name, Signature, Date

Table with 5 columns: APPLICATION NO., FILING DATE, FIRST NAMED INVENTOR, ATTORNEY DOCKET NO., CONFIRMATION NO.

TITLE OF INVENTION: WIRELESS DIGITAL AUDIO SYSTEM

Table with 7 columns: FEE TYPE, FEE STATUS, FEE AMOUNT, FEE INCREMENT, FEE TO INCREMENT, FEE TOTAL, FEE DATE

Table with 3 columns: EXAMINER, ART UNIT, CLASS-SUBCLASS

1. Change of correspondence address or indication of "Fee Address" (37 CFR 1.263). Change of correspondence address (or Change of Correspondence Address Form PTO/SB/122) attached. USE ADDRESS INDICATED FOR FEE ADDRESS INDICATED FORM PTO/SB/43; Rev 03-02 or more recent) attached. Use of a Customer Number is required.

2. For printing on the patent front page, list (1) the names of up to 3 registered patent attorneys or agents OR, alternatively, (2) the name of a single firm (having as a member a registered attorney or agent) and the names of up to 2 registered patent attorneys or agents. If no name is listed, no name will be printed. Megan E. Lyman

3. ASSIGNEE NAME AND RESIDENCE DATA TO BE PRINTED ON THE PATENT (print or type) PLEASE NOTE: Unless an assignee is identified below, no assignee data will appear on the patent. If an assignee is identified below, the document has been filed for recordation as set forth in 37 CFR 3.11. Completion of this form is NOT a substitute for filing an assignment. (A) NAME OF ASSIGNEE (B) RESIDENCE: (CITY AND STATE OR COUNTRY)

Please check the appropriate assignee category or categories (will not be printed on the patent): Individual, Corporation or other private entity, Government

4a. The following fee(s) are submitted: Publication Fee, Advance Order. 4b. Payment of Fee(s): Payment by credit card. Form PTO-2038 is attached. The Director is hereby authorized to charge the required fee(s), any deficiency, or credit any overpayment to the fee account of this form.

5. Change in Entity Status (from status indicated above) a. Applicant claims SMALL ENTITY status. See 37 CFR 1.27. b. Applicant is no longer claiming SMALL ENTITY status. See 37 CFR 1.27(g)(2).

NOTE: The Issue Fee and Publication Fee (if required) will not be accepted from anyone other than the applicant; a registered attorney or agent; or the assignee or other party in interest as shown by the records of the United States Patent and Trademark Office.

Authorized Signature: Megan E. Lyman, Date: 11/19/2010, Typed or printed name: Megan E. Lyman, Registration No.: 57054

This collection of information is required by 37 CFR 1.211. The information is required to obtain an exhibit in a patent which is to file (and by the USPTO to process) an application. Confidentiality is covered by 35 U.S.C. 122 and 37 CFR 1.14. This collection is estimated to take 12 minutes to complete, including gathering, preparing, and submitting the completed application form to the USPTO. Time will vary depending upon the individual case. Any comments on the amount of time you require to complete this form and/or suggestions for reducing this burden, should be sent to the Chief Information Officer, U.S. Patent and Trademark Office, U.S. Department of Commerce, P.O. Box 1450, Alexandria, Virginia 22313-1450. DO NOT SEND FEES OR COMPLETED FORMS TO THIS ADDRESS. SEND TO: Commissioner for Patents, P.O. Box 1450, Alexandria, Virginia 22313-1450.

Under the Paperwork Reduction Act of 1995, no persons are required to respond to a collection of information unless it displays a valid OMB control number.



Commissioner for Patents  
P.O. Box 1450  
Alexandria, Virginia 22313-1450  
or Fax (571)-273-2885

DATE 11/19/2010

INSTRUCTIONS: This form should be used for transmitting the ISSUE FEE and PUBLICATION FEE (if required). Blocks 1 through 5 should be completed where appropriate. Further correspondence including the Patent Application and notification of maintenance fees will be mailed to the current correspondence address as corrected below or directed otherwise in Block 1, by (a) specifying a new correspondence address; and/or (b) indicating a separate "FEE ADDRESS" for maintenance fee notifications.

CURRENT CORRESPONDENCE ADDRESS (Note: Use Block 1 for any change of address)

Note: A certificate of mailing can only be used for domestic mailings of the Fee(s) Transmittal. This certificate cannot be used for any other accompanying papers. Each additional paper, such as an assignment or formal drawing, must have its own certificate of mailing or transmission.

68533 7590 11/01/2010

MEGAN LYMAN  
1816 SILVER MIST CT.  
ALEXANDRIA, VA 22302

Certificate of Mailing or Transmission  
I hereby certify that this Fee(s) Transmittal is being deposited with the United States Postal Service with sufficient postage for first class mail in an envelope addressed to the MAIL STOP/FEE ADDRESS above or being facsimile transmitted to the USPTO (571) 273-2885, on the date indicated below.

Table with 3 rows: (Depositor's name), (Signature), (Date)

Table with 5 columns: APPLICATION NO., FILING DATE, FIRST NAMED INVENTOR, ATTORNEY DOCKET NO., CONFIRMATION NO.

TITLE OF INVENTION: WIRELESS DIGITAL AUDIO SYSTEM

Table with 7 columns: APPLN. TYPE, SMALL ENTITY, ISSUE FEE DUE, PUBLICATION FEE DUE, PREV. PAID ISSUE FEE, TOTAL FEE(S) DUE, DATE DUE

Table with 3 columns: EXAMINER, ART UNIT, CLASS-SUBCLASS

1. Change of correspondence address or indication of "Fee Address" (37 CFR 1.363).  
 Change of correspondence address (or Change of Correspondence Address Form PTO/SB/122) attached.  
 "Fee Address" indication (or "Fee Address" Indication form PTO/SB/47; Rev 03-02 or more recent) attached. Use of a Customer Number is required.

2. For printing on the patent front page, list:  
(1) the name of the inventor or agent or agents OR, alternatively,  
(2) the name of a single firm (having as a member a registered attorney or agent) and the names of up to 2 registered patent attorneys or agents. If no name is listed, no name will be printed.

Megan F. Lyman  
2  
3

3. ASSIGNEE NAME AND RESIDENCE DATA TO BE PRINTED ON THE PATENT (print or type)  
PLEASE NOTE: Unless an assignee is identified below, no assignee data will appear on the patent. If an assignee is identified below, the document has been filed for recordation as set forth in 37 CFR 3.11. Completion of this form is NOT a substitute for filing an assignment.

(A) NAME OF ASSIGNEE (B) RESIDENCE (CITY AND STATE OR COUNTRY)

Please check the appropriate assignee category or categories (will not be printed on the patent):  Individual  Corporation or other private organization  Government

4a. The following fee(s) are submitted:  
 Issue Fee  
 Publication Fee (No small entity discount permitted)  
 Advance Order - # of Copies \_\_\_\_\_  
4b. Payment of fee(s): (Please first reapply any previously paid issue fee shown above)  
 A check is enclosed.  
 Payment by credit card. Form PTO-2038 is attached.  
 The Director is hereby authorized to charge the required fee(s), any deficiency, or credit any overpayment, to Deposit Account Number \_\_\_\_\_ (enclose an extra copy of this form).

5. Change in Entity Status (from status indicated above)  
 a. Applicant claims SMALL ENTITY status. See 37 CFR 1.27.  b. Applicant is no longer claiming SMALL ENTITY status. See 37 CFR 1.27(g)(2).

NOTE: The Issue Fee and Publication Fee (if required) will not be accepted from anyone other than the applicant; a registered attorney or agent; or the assignee or other party in interest as shown by the records of the United States Patent and Trademark Office.

Authorized Signature: Megan F. Lyman Date: 11/19/2010  
Typed or printed name: Megan F. Lyman Registration No: 57054

This collection of information is required by 37 CFR 1.511. The information is required to obtain or retain a benefit by the public which is to file (and by the USPTO to process) an application. Confidentiality is governed by 35 U.S.C. 122 and 37 CFR 1.14. This collection is estimated to take 12 minutes to complete, including gathering, preparing, and submitting the completed application form to the USPTO. Time will vary depending upon the individual case. Any comments on the amount of time you require to complete this form and/or suggestions for reducing this burden, should be sent to the Chief Information Officer, U.S. Patent and Trademark Office, U.S. Department of Commerce, P.O. Box 1450, Alexandria, Virginia 22313-1450. DO NOT SEND FEES OR COMPLETED FORMS TO THIS ADDRESS. SEND TO: Commissioner for Patents, P.O. Box 1450, Alexandria, Virginia 22313-1450.

Under the Paperwork Reduction Act of 1995, no persons are required to respond to a collection of information unless it displays a valid OMB control number.

Doc code: IDS

Doc description: Information Disclosure Statement (IDS) Filed

PTO/SB/08a (01-10)

Approved for use through 07/31/2012. OMB 0851-0031

U.S. Patent and Trademark Office; U.S. DEPARTMENT OF COMMERCE

Under the Paperwork Reduction Act of 1995, no persons are required to respond to a collection of information unless it contains a valid OMB control number.

<b>INFORMATION DISCLOSURE STATEMENT BY APPLICANT</b> ( Not for submission under 37 CFR 1.99)	Application Number	12570343
	Filing Date	2009-09-30
	First Named Inventor	C. Earl Woolfork
	Art Unit	2614
	Examiner Name	Andrew Flanders
	Attorney Docket Number	1028.4

U.S. PATENTS						Remove
Examiner Initial*	Cite No	Patent Number	Kind Code <sup>1</sup>	Issue Date	Name of Patentee or Applicant of cited Document	Pages, Columns, Lines where Relevant Passages or Relevant Figures Appear
	1	5668880	A	1997-09-16	Alajajian, Philip	
	2	5721783	A	1998-02-24	Anderson, James	
	3	6115478	A	2000-09-05	<del>depfactory Ltd.</del> Schneider	
	4	6236862	B1	2001-05-22	<del>Intersignal LLC</del> Erten et al.	
	5	7505823	B1	2009-03-17	<del>Intrasonics Limited</del> Bartlett et al	
	6	5781542	A	1998-07-14	Tanaka	
	7	6678892	A	<sup>01</sup> <del>2004-08-13</del>	Lavelle et al.	
	8	5491839	A	1996-02-13	Schotz	

SCK  
12/18/10

<b>INFORMATION DISCLOSURE STATEMENT BY APPLICANT</b> ( Not for submission under 37 CFR 1.99)	Application Number	12570343
	Filing Date	2009-09-30
	First Named Inventor	C. Earl Woolfork
	Art Unit	2614
	Examiner Name	Andrew Flanders
	Attorney Docket Number	1028.4

1	GB2252013	GB	A	1992-07-22	Liu, Lu	<input type="checkbox"/>
2	WO0133836	WO	A1	2001-05-10	Lockhart, Peter	<input type="checkbox"/>
3	WO0076272	WO	A1	<del>4099-03-42</del> 2000-12-14	Lindemann, Eric	<input type="checkbox"/>

SC  
12/18/10

If you wish to add additional Foreign Patent Document citation information please click the Add button

**NON-PATENT LITERATURE DOCUMENTS**

Examiner Initials*	Cite No	Include name of the author (in CAPITAL LETTERS), title of the article (when appropriate), title of the item (book, magazine, journal, serial, symposium, catalog, etc), date, pages(s), volume-issue number(s), publisher, city and/or country where published.	T <sup>5</sup>
	1	American National Standard for Methods of Measurement of Compatibility Between Wireless Communication Devices and Hearing Aids - ANSI C63. 19-2001	<input type="checkbox"/>
	2	A Conferencing Spread Spectrum Radio, KM LYE, TT TJHUNG, KC CHUA, TC PEK, WH YUNG, WP GOH, YP CHIA, WK LOH, FL MA, KM LOW 1994 /ACF/	<input type="checkbox"/>
	3	Specification of the Bluetooth System, Version 1.0 B, pp 17-27, 4144, 81-86, 143-147 11/20/99 /ACF/	<input type="checkbox"/>

If you wish to add additional non-patent literature document citation information please click the Add button

**EXAMINER SIGNATURE**

Examiner Signature	/Andrew Flanders/	Date Considered	10/25/2010
--------------------	-------------------	-----------------	------------

\*EXAMINER: Initial if reference considered, whether or not citation is in conformance with MPEP 609. Draw line through a citation if not in conformance and not considered. Include copy of this form with next communication to applicant.

<sup>1</sup> See Kind Codes of USPTO Patent Documents at [www.USPTO.GOV](http://www.USPTO.GOV) or MPEP 901.04. <sup>2</sup> Enter office that issued the document, by the two-letter code (WIPO Standard ST.3). <sup>3</sup> For Japanese patent documents, the indication of the year of the reign of the Emperor must precede the serial number of the patent document. <sup>4</sup> Kind of document by the appropriate symbols as indicated on the document under WIPO Standard ST.16 if possible. <sup>5</sup> Applicant is to place a check mark here if English language translation is attached.



UNITED STATES PATENT AND TRADEMARK OFFICE

UNITED STATES DEPARTMENT OF COMMERCE  
United States Patent and Trademark Office  
Address: COMMISSIONER FOR PATENTS  
P.O. Box 1450  
Alexandria, Virginia 22313-1450  
www.uspto.gov

APPLICATION NO.	ISSUE DATE	PATENT NO.	ATTORNEY DOCKET NO.	CONFIRMATION NO.
12/570,343	01/04/2011	7865258	1028.4	9973

68533 7590 12/15/2010  
MEGAN LYMAN  
1816 SILVER MIST CT.  
RALEIGH, NC 27613

**ISSUE NOTIFICATION**

The projected patent number and issue date are specified above.

**Determination of Patent Term Adjustment under 35 U.S.C. 154 (b)**  
(application filed on or after May 29, 2000)

The Patent Term Adjustment is 0 day(s). Any patent to issue from the above-identified application will include an indication of the adjustment on the front page.

If a Continued Prosecution Application (CPA) was filed in the above-identified application, the filing date that determines Patent Term Adjustment is the filing date of the most recent CPA.

Applicant will be able to obtain more detailed information by accessing the Patent Application Information Retrieval (PAIR) WEB site (<http://pair.uspto.gov>).

Any questions regarding the Patent Term Extension or Adjustment determination should be directed to the Office of Patent Legal Administration at (571)-272-7702. Questions relating to issue and publication fee payments should be directed to the Application Assistance Unit (AAU) of the Office of Data Management (ODM) at (571)-272-4200.

APPLICANT(s) (Please see PAIR WEB site <http://pair.uspto.gov> for additional applicants):

C. Earl Woolfork, Pasadena, CA;

**UNITED STATES PATENT AND TRADEMARK OFFICE  
CERTIFICATE OF CORRECTION**Page 1 of 1

PATENT NO. : 7865258

APPLICATION NO.: 12570343

ISSUE DATE : 01/04/2011

INVENTOR(S) : C. Earl Woolfork

It is certified that an error appears or errors appear in the above-identified patent and that said Letters Patent is hereby corrected as shown below:

Col. 5, ln. 25 reads "A portable wireless digital audio transmitter system" that line should read "A portable wireless digital audio system" as is stated in the amended claims that were submitted on 08/04/2001 on page 3 and were allowed on 11/01/2010. The Applicant respectfully requests that Claim 3 (col. 5, ln. 25) be amended to reflect its correct wording.

**MAILING ADDRESS OF SENDER (Please do not use customer number below):**

Megan Lyman  
1816 Silver Mist Ct.  
Raleigh, NC 27613

This collection of information is required by 37 CFR 1.322, 1.323, and 1.324. The information is required to obtain or retain a benefit by the public which is to file (and by the USPTO to process) an application. Confidentiality is governed by 35 U.S.C. 122 and 37 CFR 1.14. This collection is estimated to take 1.0 hour to complete, including gathering, preparing, and submitting the completed application form to the USPTO. Time will vary depending upon the individual case. Any comments on the amount of time you require to complete this form and/or suggestions for reducing this burden, should be sent to the Chief Information Officer, U.S. Patent and Trademark Office, U.S. Department of Commerce, P.O. Box 1450, Alexandria, VA 22313-1450. DO NOT SEND FEES OR COMPLETED FORMS TO THIS ADDRESS. **SEND TO: Attention Certificate of Corrections Branch, Commissioner for Patents, P.O. Box 1450, Alexandria, VA 22313-1450.**

*If you need assistance in completing the form, call 1-800-PTO-9199 and select option 2.*



## Privacy Act Statement

The **Privacy Act of 1974 (P.L. 93-579)** requires that you be given certain information in connection with your submission of the attached form related to a patent application or patent. Accordingly, pursuant to the requirements of the Act, please be advised that: (1) the general authority for the collection of this information is 35 U.S.C. 2(b)(2); (2) furnishing of the information solicited is voluntary; and (3) the principal purpose for which the information is used by the U.S. Patent and Trademark Office is to process and/or examine your submission related to a patent application or patent. If you do not furnish the requested information, the U.S. Patent and Trademark Office may not be able to process and/or examine your submission, which may result in termination of proceedings or abandonment of the application or expiration of the patent.

The information provided by you in this form will be subject to the following routine uses:

1. The information on this form will be treated confidentially to the extent allowed under the Freedom of Information Act (5 U.S.C. 552) and the Privacy Act (5 U.S.C. 552a). Records from this system of records may be disclosed to the Department of Justice to determine whether disclosure of these records is required by the Freedom of Information Act.
2. A record from this system of records may be disclosed, as a routine use, in the course of presenting evidence to a court, magistrate, or administrative tribunal, including disclosures to opposing counsel in the course of settlement negotiations.
3. A record in this system of records may be disclosed, as a routine use, to a Member of Congress submitting a request involving an individual, to whom the record pertains, when the individual has requested assistance from the Member with respect to the subject matter of the record.
4. A record in this system of records may be disclosed, as a routine use, to a contractor of the Agency having need for the information in order to perform a contract. Recipients of information shall be required to comply with the requirements of the Privacy Act of 1974, as amended, pursuant to 5 U.S.C. 552a(m).
5. A record related to an International Application filed under the Patent Cooperation Treaty in this system of records may be disclosed, as a routine use, to the International Bureau of the World Intellectual Property Organization, pursuant to the Patent Cooperation Treaty.
6. A record in this system of records may be disclosed, as a routine use, to another federal agency for purposes of National Security review (35 U.S.C. 181) and for review pursuant to the Atomic Energy Act (42 U.S.C. 218(c)).
7. A record from this system of records may be disclosed, as a routine use, to the Administrator, General Services, or his/her designee, during an inspection of records conducted by GSA as part of that agency's responsibility to recommend improvements in records management practices and programs, under authority of 44 U.S.C. 2904 and 2906. Such disclosure shall be made in accordance with the GSA regulations governing inspection of records for this purpose, and any other relevant (*i.e.*, GSA or Commerce) directive. Such disclosure shall not be used to make determinations about individuals.
8. A record from this system of records may be disclosed, as a routine use, to the public after either publication of the application pursuant to 35 U.S.C. 122(b) or issuance of a patent pursuant to 35 U.S.C. 151. Further, a record may be disclosed, subject to the limitations of 37 CFR 1.14, as a routine use, to the public if the record was filed in an application which became abandoned or in which the proceedings were terminated and which application is referenced by either a published application, an application open to public inspection or an issued patent.
9. A record from this system of records may be disclosed, as a routine use, to a Federal, State, or local law enforcement agency, if the USPTO becomes aware of a violation or potential violation of law or regulation.

## Electronic Patent Application Fee Transmittal

<b>Application Number:</b>	12570343			
<b>Filing Date:</b>	30-Sep-2009			
<b>Title of Invention:</b>	WIRELESS DIGITAL AUDIO SYSTEM			
<b>First Named Inventor/Applicant Name:</b>	C. Earl Woolfork			
<b>Filer:</b>	Megan Elizabeth Lyman			
<b>Attorney Docket Number:</b>	1028.4			
Filed as Small Entity				
<b>Utility under 35 USC 111(a) Filing Fees</b>				
<b>Description</b>	<b>Fee Code</b>	<b>Quantity</b>	<b>Amount</b>	<b>Sub-Total in USD(\$)</b>
<b>Basic Filing:</b>				
<b>Pages:</b>				
<b>Claims:</b>				
<b>Miscellaneous-Filing:</b>				
<b>Petition:</b>				
<b>Patent-Appeals-and-Interference:</b>				
<b>Post-Allowance-and-Post-Issuance:</b>				
Certificate of correction	1811	1	100	100
<b>Extension-of-Time:</b>				

Description	Fee Code	Quantity	Amount	Sub-Total in USD(\$)
<b>Miscellaneous:</b>				
<b>Total in USD (\$)</b>				<b>100</b>

## Electronic Acknowledgement Receipt

<b>EFS ID:</b>	9232283
<b>Application Number:</b>	12570343
<b>International Application Number:</b>	
<b>Confirmation Number:</b>	9973
<b>Title of Invention:</b>	WIRELESS DIGITAL AUDIO SYSTEM
<b>First Named Inventor/Applicant Name:</b>	C. Earl Woolfork
<b>Customer Number:</b>	68533
<b>Filer:</b>	Megan Elizabeth Lyman
<b>Filer Authorized By:</b>	
<b>Attorney Docket Number:</b>	1028.4
<b>Receipt Date:</b>	14-JAN-2011
<b>Filing Date:</b>	30-SEP-2009
<b>Time Stamp:</b>	11:47:53
<b>Application Type:</b>	Utility under 35 USC 111(a)

### Payment information:

Submitted with Payment	yes
Payment Type	Deposit Account
Payment was successfully received in RAM	\$100
RAM confirmation Number	8812
Deposit Account	504576
Authorized User	

The Director of the USPTO is hereby authorized to charge indicated fees and credit any overpayment as follows:

Charge any Additional Fees required under 37 C.F.R. Section 1.20 (Post Issuance fees)

Charge any Additional Fees required under 37 C.F.R. Section 1.21 (Miscellaneous fees and charges)

**File Listing:**

Document Number	Document Description	File Name	File Size(Bytes)/ Message Digest	Multi Part /.zip	Pages (if appl.)
1	Request for Certificate of Correction	CertificateofCorrectionForm.pdf	164752 6a8a91e3aa1ae620680e3f1fd89dd3be49c6103	no	2

**Warnings:****Information:**

2	Fee Worksheet (PTO-875)	fee-info.pdf	30088 ce3472080d2e9d1c5f5fd5bc7d4f2fd2ed49d200	no	2
---	-------------------------	--------------	---	----	---

**Warnings:****Information:**

<b>Total Files Size (in bytes):</b>	194840
-------------------------------------	--------

This Acknowledgement Receipt evidences receipt on the noted date by the USPTO of the indicated documents, characterized by the applicant, and including page counts, where applicable. It serves as evidence of receipt similar to a Post Card, as described in MPEP 503.

**New Applications Under 35 U.S.C. 111**

If a new application is being filed and the application includes the necessary components for a filing date (see 37 CFR 1.53(b)-(d) and MPEP 506), a Filing Receipt (37 CFR 1.54) will be issued in due course and the date shown on this Acknowledgement Receipt will establish the filing date of the application.

**National Stage of an International Application under 35 U.S.C. 371**

If a timely submission to enter the national stage of an international application is compliant with the conditions of 35 U.S.C. 371 and other applicable requirements a Form PCT/DO/EO/903 indicating acceptance of the application as a national stage submission under 35 U.S.C. 371 will be issued in addition to the Filing Receipt, in due course.

**New International Application Filed with the USPTO as a Receiving Office**

If a new international application is being filed and the international application includes the necessary components for an international filing date (see PCT Article 11 and MPEP 1810), a Notification of the International Application Number and of the International Filing Date (Form PCT/RO/105) will be issued in due course, subject to prescriptions concerning national security, and the date shown on this Acknowledgement Receipt will establish the international filing date of the application.

**UNITED STATES PATENT AND TRADEMARK OFFICE  
CERTIFICATE OF CORRECTION**Page  1  of  1 

PATENT NO. : 7865258

APPLICATION NO.: 12570343

ISSUE DATE : 01/04/2011

INVENTOR(S) : C. Earl Woolfork

It is certified that an error appears or errors appear in the above-identified patent and that said Letters Patent is hereby corrected as shown below:

Col. 5, ln. 25 reads "A portable wireless digital audio transmitter system" that line should read "A portable wireless digital audio system" as is stated in the amended claims that were submitted on 08/04/2010 on page 3 and were allowed on 11/01/2010. The Applicant respectfully requests that Claim 3 (col. 5, ln. 25) be amended to reflect its correct wording.

**MAILING ADDRESS OF SENDER (Please do not use customer number below):**

Megan Lyman  
1816 Silver Mist Ct.  
Raleigh, NC 27613

This collection of information is required by 37 CFR 1.322, 1.323, and 1.324. The information is required to obtain or retain a benefit by the public which is to file (and by the USPTO to process) an application. Confidentiality is governed by 35 U.S.C. 122 and 37 CFR 1.14. This collection is estimated to take 1.0 hour to complete, including gathering, preparing, and submitting the completed application form to the USPTO. Time will vary depending upon the individual case. Any comments on the amount of time you require to complete this form and/or suggestions for reducing this burden, should be sent to the Chief Information Officer, U.S. Patent and Trademark Office, U.S. Department of Commerce, P.O. Box 1450, Alexandria, VA 22313-1450. **DO NOT SEND FEES OR COMPLETED FORMS TO THIS ADDRESS. SEND TO: Attention Certificate of Corrections Branch, Commissioner for Patents, P.O. Box 1450, Alexandria, VA 22313-1450.**

*If you need assistance in completing the form, call 1-800-PTO-9199 and select option 2.*

## Privacy Act Statement

The **Privacy Act of 1974 (P.L. 93-579)** requires that you be given certain information in connection with your submission of the attached form related to a patent application or patent. Accordingly, pursuant to the requirements of the Act, please be advised that: (1) the general authority for the collection of this information is 35 U.S.C. 2(b)(2); (2) furnishing of the information solicited is voluntary; and (3) the principal purpose for which the information is used by the U.S. Patent and Trademark Office is to process and/or examine your submission related to a patent application or patent. If you do not furnish the requested information, the U.S. Patent and Trademark Office may not be able to process and/or examine your submission, which may result in termination of proceedings or abandonment of the application or expiration of the patent.

The information provided by you in this form will be subject to the following routine uses:

1. The information on this form will be treated confidentially to the extent allowed under the Freedom of Information Act (5 U.S.C. 552) and the Privacy Act (5 U.S.C. 552a). Records from this system of records may be disclosed to the Department of Justice to determine whether disclosure of these records is required by the Freedom of Information Act.
2. A record from this system of records may be disclosed, as a routine use, in the course of presenting evidence to a court, magistrate, or administrative tribunal, including disclosures to opposing counsel in the course of settlement negotiations.
3. A record in this system of records may be disclosed, as a routine use, to a Member of Congress submitting a request involving an individual, to whom the record pertains, when the individual has requested assistance from the Member with respect to the subject matter of the record.
4. A record in this system of records may be disclosed, as a routine use, to a contractor of the Agency having need for the information in order to perform a contract. Recipients of information shall be required to comply with the requirements of the Privacy Act of 1974, as amended, pursuant to 5 U.S.C. 552a(m).
5. A record related to an International Application filed under the Patent Cooperation Treaty in this system of records may be disclosed, as a routine use, to the International Bureau of the World Intellectual Property Organization, pursuant to the Patent Cooperation Treaty.
6. A record in this system of records may be disclosed, as a routine use, to another federal agency for purposes of National Security review (35 U.S.C. 181) and for review pursuant to the Atomic Energy Act (42 U.S.C. 218(c)).
7. A record from this system of records may be disclosed, as a routine use, to the Administrator, General Services, or his/her designee, during an inspection of records conducted by GSA as part of that agency's responsibility to recommend improvements in records management practices and programs, under authority of 44 U.S.C. 2904 and 2906. Such disclosure shall be made in accordance with the GSA regulations governing inspection of records for this purpose, and any other relevant (*i.e.*, GSA or Commerce) directive. Such disclosure shall not be used to make determinations about individuals.
8. A record from this system of records may be disclosed, as a routine use, to the public after either publication of the application pursuant to 35 U.S.C. 122(b) or issuance of a patent pursuant to 35 U.S.C. 151. Further, a record may be disclosed, subject to the limitations of 37 CFR 1.14, as a routine use, to the public if the record was filed in an application which became abandoned or in which the proceedings were terminated and which application is referenced by either a published application, an application open to public inspection or an issued patent.
9. A record from this system of records may be disclosed, as a routine use, to a Federal, State, or local law enforcement agency, if the USPTO becomes aware of a violation or potential violation of law or regulation.

## Electronic Acknowledgement Receipt

<b>EFS ID:</b>	9235720
<b>Application Number:</b>	12570343
<b>International Application Number:</b>	
<b>Confirmation Number:</b>	9973
<b>Title of Invention:</b>	WIRELESS DIGITAL AUDIO SYSTEM
<b>First Named Inventor/Applicant Name:</b>	C. Earl Woolfork
<b>Customer Number:</b>	68533
<b>Filer:</b>	Megan Elizabeth Lyman
<b>Filer Authorized By:</b>	
<b>Attorney Docket Number:</b>	1028.4
<b>Receipt Date:</b>	14-JAN-2011
<b>Filing Date:</b>	30-SEP-2009
<b>Time Stamp:</b>	15:11:51
<b>Application Type:</b>	Utility under 35 USC 111(a)

### Payment information:

Submitted with Payment	no
------------------------	----

### File Listing:

Document Number	Document Description	File Name	File Size(Bytes)/ Message Digest	Multi Part /.zip	Pages (if appl.)
1	Request for Certificate of Correction	CertificateofCorrectionForm2.pdf	172994 c9b1235777a504230d35ec957b53f7922715d2b	no	2

### Warnings:

### Information:



Total Files Size (in bytes):

172994

This Acknowledgement Receipt evidences receipt on the noted date by the USPTO of the indicated documents, characterized by the applicant, and including page counts, where applicable. It serves as evidence of receipt similar to a Post Card, as described in MPEP 503.

**New Applications Under 35 U.S.C. 111**

If a new application is being filed and the application includes the necessary components for a filing date (see 37 CFR 1.53(b)-(d) and MPEP 506), a Filing Receipt (37 CFR 1.54) will be issued in due course and the date shown on this Acknowledgement Receipt will establish the filing date of the application.

**National Stage of an International Application under 35 U.S.C. 371**

If a timely submission to enter the national stage of an international application is compliant with the conditions of 35 U.S.C. 371 and other applicable requirements a Form PCT/DO/EO/903 indicating acceptance of the application as a national stage submission under 35 U.S.C. 371 will be issued in addition to the Filing Receipt, in due course.

**New International Application Filed with the USPTO as a Receiving Office**

If a new international application is being filed and the international application includes the necessary components for an international filing date (see PCT Article 11 and MPEP 1810), a Notification of the International Application Number and of the International Filing Date (Form PCT/RO/105) will be issued in due course, subject to prescriptions concerning national security, and the date shown on this Acknowledgement Receipt will establish the international filing date of the application.

**UNITED STATES PATENT AND TRADEMARK OFFICE  
CERTIFICATE OF CORRECTION**

Page  1  of  1

PATENT NO. : 7865258 B2  
APPLICATION NO.: 12/570,343  
ISSUE DATE : Jan. 4, 2011  
INVENTOR(S) : C. Earl Woolfork

It is certified that an error appears or errors appear in the above-identified patent and that said Letters Patent is hereby corrected as shown below:

On the cover page, Related U.S. Application Data should read: Continuation of application No. 12/144,729 filed on Jul. 12, 2008, now Pat. No. 7,684,885, which is a continuation of application No. 10/648,012, filed on Aug. 26, 2003, now Pat. No. 7,412,294 --, which is a continuation-in-part of application No. 10/027,391, filed on Dec. 21, 2001, now abandoned.--

The additional language merely includes information found in Col. 1, Ins. 7-8. Adding this language to the Related U.S. Application Data makes clear the priority claimed and geneology of the patent. Moreover, the language is found in the parent patent, 7,412,294 B1 issued Aug. 12, 2008 in the Related U.S. Application Data. This patent was incorporated by reference into the present patent, 7,865,258 B2. The additional language is a minor change and should be allowed through the Certificate of Correction under 35 U.S.C. 255.

**MAILING ADDRESS OF SENDER (Please do not use customer number below):**

Megan E. Lyman  
1816 Silver Mist Ct.  
Raleigh, NC 27613

This collection of information is required by 37 CFR 1.322, 1.323, and 1.324. The information is required to obtain or retain a benefit by the public which is to file (and by the USPTO to process) an application. Confidentiality is governed by 35 U.S.C. 122 and 37 CFR 1.14. This collection is estimated to take 1.0 hour to complete, including gathering, preparing, and submitting the completed application form to the USPTO. Time will vary depending upon the individual case. Any comments on the amount of time you require to complete this form and/or suggestions for reducing this burden, should be sent to the Chief Information Officer, U.S. Patent and Trademark Office, U.S. Department of Commerce, P.O. Box 1450, Alexandria, VA 22313-1450. **DO NOT SEND FEES OR COMPLETED FORMS TO THIS ADDRESS. SEND TO: Attention Certificate of Corrections Branch, Commissioner for Patents, P.O. Box 1450, Alexandria, VA 22313-1450.**

*If you need assistance in completing the form, call 1-800-PTO-9199 and select option 2.*

## Privacy Act Statement

The **Privacy Act of 1974 (P.L. 93-579)** requires that you be given certain information in connection with your submission of the attached form related to a patent application or patent. Accordingly, pursuant to the requirements of the Act, please be advised that: (1) the general authority for the collection of this information is 35 U.S.C. 2(b)(2); (2) furnishing of the information solicited is voluntary; and (3) the principal purpose for which the information is used by the U.S. Patent and Trademark Office is to process and/or examine your submission related to a patent application or patent. If you do not furnish the requested information, the U.S. Patent and Trademark Office may not be able to process and/or examine your submission, which may result in termination of proceedings or abandonment of the application or expiration of the patent.

The information provided by you in this form will be subject to the following routine uses:

1. The information on this form will be treated confidentially to the extent allowed under the Freedom of Information Act (5 U.S.C. 552) and the Privacy Act (5 U.S.C. 552a). Records from this system of records may be disclosed to the Department of Justice to determine whether disclosure of these records is required by the Freedom of Information Act.
2. A record from this system of records may be disclosed, as a routine use, in the course of presenting evidence to a court, magistrate, or administrative tribunal, including disclosures to opposing counsel in the course of settlement negotiations.
3. A record in this system of records may be disclosed, as a routine use, to a Member of Congress submitting a request involving an individual, to whom the record pertains, when the individual has requested assistance from the Member with respect to the subject matter of the record.
4. A record in this system of records may be disclosed, as a routine use, to a contractor of the Agency having need for the information in order to perform a contract. Recipients of information shall be required to comply with the requirements of the Privacy Act of 1974, as amended, pursuant to 5 U.S.C. 552a(m).
5. A record related to an International Application filed under the Patent Cooperation Treaty in this system of records may be disclosed, as a routine use, to the International Bureau of the World Intellectual Property Organization, pursuant to the Patent Cooperation Treaty.
6. A record in this system of records may be disclosed, as a routine use, to another federal agency for purposes of National Security review (35 U.S.C. 181) and for review pursuant to the Atomic Energy Act (42 U.S.C. 218(c)).
7. A record from this system of records may be disclosed, as a routine use, to the Administrator, General Services, or his/her designee, during an inspection of records conducted by GSA as part of that agency's responsibility to recommend improvements in records management practices and programs, under authority of 44 U.S.C. 2904 and 2906. Such disclosure shall be made in accordance with the GSA regulations governing inspection of records for this purpose, and any other relevant (*i.e.*, GSA or Commerce) directive. Such disclosure shall not be used to make determinations about individuals.
8. A record from this system of records may be disclosed, as a routine use, to the public after either publication of the application pursuant to 35 U.S.C. 122(b) or issuance of a patent pursuant to 35 U.S.C. 151. Further, a record may be disclosed, subject to the limitations of 37 CFR 1.14, as a routine use, to the public if the record was filed in an application which became abandoned or in which the proceedings were terminated and which application is referenced by either a published application, an application open to public inspection or an issued patent.
9. A record from this system of records may be disclosed, as a routine use, to a Federal, State, or local law enforcement agency, if the USPTO becomes aware of a violation or potential violation of law or regulation.

## Electronic Patent Application Fee Transmittal

<b>Application Number:</b>	12570343			
<b>Filing Date:</b>	30-Sep-2009			
<b>Title of Invention:</b>	WIRELESS DIGITAL AUDIO SYSTEM			
<b>First Named Inventor/Applicant Name:</b>	C. Earl Woolfork			
<b>Filer:</b>	Megan Elizabeth Lyman			
<b>Attorney Docket Number:</b>	1028.4			
Filed as Large Entity				
<b>Utility under 35 USC 111(a) Filing Fees</b>				
<b>Description</b>	<b>Fee Code</b>	<b>Quantity</b>	<b>Amount</b>	<b>Sub-Total in USD(\$)</b>
<b>Basic Filing:</b>				
<b>Pages:</b>				
<b>Claims:</b>				
<b>Miscellaneous-Filing:</b>				
<b>Petition:</b>				
<b>Patent-Appeals-and-Interference:</b>				
<b>Post-Allowance-and-Post-Issuance:</b>				
Certificate of correction	1811	1	100	100
<b>Extension-of-Time:</b>				

Description	Fee Code	Quantity	Amount	Sub-Total in USD(\$)
<b>Miscellaneous:</b>				
<b>Total in USD (\$)</b>				<b>100</b>

## Electronic Acknowledgement Receipt

<b>EFS ID:</b>	9292615
<b>Application Number:</b>	12570343
<b>International Application Number:</b>	
<b>Confirmation Number:</b>	9973
<b>Title of Invention:</b>	WIRELESS DIGITAL AUDIO SYSTEM
<b>First Named Inventor/Applicant Name:</b>	C. Earl Woolfork
<b>Customer Number:</b>	68533
<b>Filer:</b>	Megan Elizabeth Lyman
<b>Filer Authorized By:</b>	
<b>Attorney Docket Number:</b>	1028.4
<b>Receipt Date:</b>	24-JAN-2011
<b>Filing Date:</b>	30-SEP-2009
<b>Time Stamp:</b>	16:19:39
<b>Application Type:</b>	Utility under 35 USC 111(a)

### Payment information:

Submitted with Payment	yes
Payment Type	Deposit Account
Payment was successfully received in RAM	\$100
RAM confirmation Number	3072
Deposit Account	504576
Authorized User	

The Director of the USPTO is hereby authorized to charge indicated fees and credit any overpayment as follows:

Charge any Additional Fees required under 37 C.F.R. Section 1.17 (Patent application and reexamination processing fees)

Charge any Additional Fees required under 37 C.F.R. Section 1.19 (Document supply fees)

Charge any Additional Fees required under 37 C.F.R. Section 1.20 (Post Issuance fees)

Charge any Additional Fees required under 37 C.F.R. Section 1.21 (Miscellaneous fees and charges)

**File Listing:**

Document Number	Document Description	File Name	File Size(Bytes)/ Message Digest	Multi Part /.zip	Pages (if appl.)
1	Request for Certificate of Correction	CertofCorrPriority.pdf	165552 ba17a8b0a70272349d9d9d8b8e2531d32425d18b	no	2

**Warnings:**

**Information:**

2	Fee Worksheet (PTO-875)	fee-info.pdf	30089 af1c66881c8951e5ec7af61b9dccc1cdaf4c7f973	no	2
---	-------------------------	--------------	--	----	---

**Warnings:**

**Information:**

**Total Files Size (in bytes):** 195641

**This Acknowledgement Receipt evidences receipt on the noted date by the USPTO of the indicated documents, characterized by the applicant, and including page counts, where applicable. It serves as evidence of receipt similar to a Post Card, as described in MPEP 503.**

**New Applications Under 35 U.S.C. 111**

**If a new application is being filed and the application includes the necessary components for a filing date (see 37 CFR 1.53(b)-(d) and MPEP 506), a Filing Receipt (37 CFR 1.54) will be issued in due course and the date shown on this Acknowledgement Receipt will establish the filing date of the application.**

**National Stage of an International Application under 35 U.S.C. 371**

**If a timely submission to enter the national stage of an international application is compliant with the conditions of 35 U.S.C. 371 and other applicable requirements a Form PCT/DO/EO/903 indicating acceptance of the application as a national stage submission under 35 U.S.C. 371 will be issued in addition to the Filing Receipt, in due course.**

**New International Application Filed with the USPTO as a Receiving Office**

**If a new international application is being filed and the international application includes the necessary components for an international filing date (see PCT Article 11 and MPEP 1810), a Notification of the International Application Number and of the International Filing Date (Form PCT/RO/105) will be issued in due course, subject to prescriptions concerning national security, and the date shown on this Acknowledgement Receipt will establish the international filing date of the application.**

UNITED STATES PATENT AND TRADEMARK OFFICE  
**CERTIFICATE OF CORRECTION**

PATENT NO. : 7,865,258 B2  
APPLICATION NO. : 12/570343  
DATED : January 4, 2011  
INVENTOR(S) : C. Earl Woolfork

Page 1 of 1

It is certified that error appears in the above-identified patent and that said Letters Patent is hereby corrected as shown below:

Col. 5, ln. 25 reads "A portable wireless digital audio transmitter system" that line should read "A portable wireless digital audio system"

Signed and Sealed this  
Twenty-second Day of February, 2011

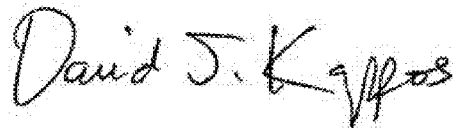
A handwritten signature in black ink that reads "David J. Kappos". The signature is written in a cursive style with a large initial 'D' and 'K'.

David J. Kappos  
*Director of the United States Patent and Trademark Office*



**UNITED STATES PATENT AND TRADEMARK OFFICE  
CERTIFICATE OF CORRECTION**

Page  1  of  1

PATENT NO. : 7,865,258  
APPLICATION NO.: 12/570,343  
ISSUE DATE : January 4, 2011  
INVENTOR(S) : C. Earl Woolfork

It is certified that an error appears or errors appear in the above-identified patent and that said Letters Patent is hereby corrected as shown below:

In section (63) on the face of the patent, insert after "Pat. No. 7,412,294" :

--, which is a continuation-in-part of application No. 10/027,391, filed on Dec. 21, 2001, now abandoned--

Column 1, line 3, cancel the text beginning with "This continuation application" to "entirety by refer-ence." in column 1, lines 10-11, and insert the following text:

This application is a continuation of U.S. patent application No. 12/144,729, filed on July 12, 2008, which is a continuation of U.S. patent application No. 10/648,012, filed on August 26, 2003, which is a continuation-in-part of U.S. patent application No. 10/027,391, filed on December 21, 2001, now abandoned, the disclosures of which are incorporated herein in their entireties by reference.

MAILING ADDRESS OF SENDER (Please do not use customer number below):

Megan Lyman  
1816 Silver Mist Ct.  
Raleigh, NC 27613

This collection of information is required by 37 CFR 1.322, 1.323, and 1.324. The information is required to obtain or retain a benefit by the public which is to file (and by the USPTO to process) an application. Confidentiality is governed by 35 U.S.C. 122 and 37 CFR 1.14. This collection is estimated to take 1.0 hour to complete, including gathering, preparing, and submitting the completed application form to the USPTO. Time will vary depending upon the individual case. Any comments on the amount of time you require to complete this form and/or suggestions for reducing this burden, should be sent to the Chief Information Officer, U.S. Patent and Trademark Office, U.S. Department of Commerce, P.O. Box 1450, Alexandria, VA 22313-1450. DO NOT SEND FEES OR COMPLETED FORMS TO THIS ADDRESS. SEND TO: **Attention Certificate of Corrections Branch, Commissioner for Patents, P.O. Box 1450, Alexandria, VA 22313-1450.**

*If you need assistance in completing the form, call 1-800-PTO-9199 and select option 2.*

## Privacy Act Statement

The **Privacy Act of 1974 (P.L. 93-579)** requires that you be given certain information in connection with your submission of the attached form related to a patent application or patent. Accordingly, pursuant to the requirements of the Act, please be advised that: (1) the general authority for the collection of this information is 35 U.S.C. 2(b)(2); (2) furnishing of the information solicited is voluntary; and (3) the principal purpose for which the information is used by the U.S. Patent and Trademark Office is to process and/or examine your submission related to a patent application or patent. If you do not furnish the requested information, the U.S. Patent and Trademark Office may not be able to process and/or examine your submission, which may result in termination of proceedings or abandonment of the application or expiration of the patent.

The information provided by you in this form will be subject to the following routine uses:

1. The information on this form will be treated confidentially to the extent allowed under the Freedom of Information Act (5 U.S.C. 552) and the Privacy Act (5 U.S.C. 552a). Records from this system of records may be disclosed to the Department of Justice to determine whether disclosure of these records is required by the Freedom of Information Act.
2. A record from this system of records may be disclosed, as a routine use, in the course of presenting evidence to a court, magistrate, or administrative tribunal, including disclosures to opposing counsel in the course of settlement negotiations.
3. A record in this system of records may be disclosed, as a routine use, to a Member of Congress submitting a request involving an individual, to whom the record pertains, when the individual has requested assistance from the Member with respect to the subject matter of the record.
4. A record in this system of records may be disclosed, as a routine use, to a contractor of the Agency having need for the information in order to perform a contract. Recipients of information shall be required to comply with the requirements of the Privacy Act of 1974, as amended, pursuant to 5 U.S.C. 552a(m).
5. A record related to an International Application filed under the Patent Cooperation Treaty in this system of records may be disclosed, as a routine use, to the International Bureau of the World Intellectual Property Organization, pursuant to the Patent Cooperation Treaty.
6. A record in this system of records may be disclosed, as a routine use, to another federal agency for purposes of National Security review (35 U.S.C. 181) and for review pursuant to the Atomic Energy Act (42 U.S.C. 218(c)).
7. A record from this system of records may be disclosed, as a routine use, to the Administrator, General Services, or his/her designee, during an inspection of records conducted by GSA as part of that agency's responsibility to recommend improvements in records management practices and programs, under authority of 44 U.S.C. 2904 and 2906. Such disclosure shall be made in accordance with the GSA regulations governing inspection of records for this purpose, and any other relevant (*i.e.*, GSA or Commerce) directive. Such disclosure shall not be used to make determinations about individuals.
8. A record from this system of records may be disclosed, as a routine use, to the public after either publication of the application pursuant to 35 U.S.C. 122(b) or issuance of a patent pursuant to 35 U.S.C. 151. Further, a record may be disclosed, subject to the limitations of 37 CFR 1.14, as a routine use, to the public if the record was filed in an application which became abandoned or in which the proceedings were terminated and which application is referenced by either a published application, an application open to public inspection or an issued patent.
9. A record from this system of records may be disclosed, as a routine use, to a Federal, State, or local law enforcement agency, if the USPTO becomes aware of a violation or potential violation of law or regulation.

## Electronic Acknowledgement Receipt

<b>EFS ID:</b>	9548321
<b>Application Number:</b>	12570343
<b>International Application Number:</b>	
<b>Confirmation Number:</b>	9973
<b>Title of Invention:</b>	WIRELESS DIGITAL AUDIO SYSTEM
<b>First Named Inventor/Applicant Name:</b>	C. Earl Woolfork
<b>Customer Number:</b>	68533
<b>Filer:</b>	Megan Elizabeth Lyman
<b>Filer Authorized By:</b>	
<b>Attorney Docket Number:</b>	1028.4
<b>Receipt Date:</b>	28-FEB-2011
<b>Filing Date:</b>	30-SEP-2009
<b>Time Stamp:</b>	15:27:31
<b>Application Type:</b>	Utility under 35 USC 111(a)

### Payment information:

Submitted with Payment	no
------------------------	----

### File Listing:

Document Number	Document Description	File Name	File Size(Bytes)/ Message Digest	Multi Part /.zip	Pages (if appl.)
1	Transmittal Letter	CoverSheetForCertificateofCorrection.pdf	74641 d3373340d50412debc24a5cb7fa7bd4277b407a4	no	1

### Warnings:

### Information:

2	Request for Certificate of Correction	258CertofCorr022811.pdf	165347 52909da6882b1033a74d4d8e29cd8e8c2e566d20	no	2
<b>Warnings:</b>					
<b>Information:</b>					
<b>Total Files Size (in bytes):</b>				239988	
<p><b>This Acknowledgement Receipt evidences receipt on the noted date by the USPTO of the indicated documents, characterized by the applicant, and including page counts, where applicable. It serves as evidence of receipt similar to a Post Card, as described in MPEP 503.</b></p> <p><b><u>New Applications Under 35 U.S.C. 111</u></b>  <b>If a new application is being filed and the application includes the necessary components for a filing date (see 37 CFR 1.53(b)-(d) and MPEP 506), a Filing Receipt (37 CFR 1.54) will be issued in due course and the date shown on this Acknowledgement Receipt will establish the filing date of the application.</b></p> <p><b><u>National Stage of an International Application under 35 U.S.C. 371</u></b>  <b>If a timely submission to enter the national stage of an international application is compliant with the conditions of 35 U.S.C. 371 and other applicable requirements a Form PCT/DO/EO/903 indicating acceptance of the application as a national stage submission under 35 U.S.C. 371 will be issued in addition to the Filing Receipt, in due course.</b></p> <p><b><u>New International Application Filed with the USPTO as a Receiving Office</u></b>  <b>If a new international application is being filed and the international application includes the necessary components for an international filing date (see PCT Article 11 and MPEP 1810), a Notification of the International Application Number and of the International Filing Date (Form PCT/RO/105) will be issued in due course, subject to prescriptions concerning national security, and the date shown on this Acknowledgement Receipt will establish the international filing date of the application.</b></p>					

U.S. Patent No.: 7,865,258

U.S. Patent Application No.: 12/570,343

**IN THE UNITED STATES PATENT AND TRADEMARK OFFICE**

In re Patent of:	:	Art Unit: 2615
C. Earl Woolfork	:	
	:	
	:	
For: WIRELESS DIGITAL AUDIO SYSTEM	:	Customer No.: 68533
	:	
	:	

**COVER LETTER FOR RESUBMITTAL OF CERTIFICATE OF CORRECTION FORM**

Dear Sir or Madam:

The Applicant respectfully resubmits this form for a Certificate of Correction. The previous submission (filed Jan. 24, 2011) contained explanation as to why the Certificate should issue. That language should be removed. As was printed in the previous Certificate of Correction form: The additional language merely includes information found in Col. 1, Ins. 7-8. Adding this language to the Related U.S. Application Data makes clear the priority claimed and genealogy of the patent. Moreover, the language is found in the parent patent, 7,412,294 B1 issued Aug. 12, 2008 in the Related U.S. Application Data. This patent was incorporated by reference into the present patent, 7,865,258 B2. The additional language is a minor change and should be allowed through the Certificate of Correction under 35 U.S.C. 255. This resubmittal of Certificate of Correction form ensures that it is in proper format. It is not believed that a second fee is due at this time as this is a resubmission, not a new form. Any overpayment or underpayment of fees associated with this filing are authorized to be charged to Deposit Acct. No. 50-4576. Any questions or concerns can be directed to Ms. Lyman at (919) 341-4023.

Best Regards,

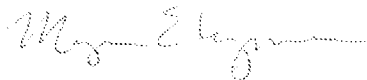

Megan Lyman, Reg. No. 57,054

Date: February 28, 2011

**SPE RESPONSE FOR CERTIFICATE OF CORRECTION**

Paper No.: \_\_\_\_\_

DATE : May 19, 2011

TO SPE OF : ART UNIT 2614

SUBJECT : Request for Certificate of Correction for Appl. No.: 12570343 Patent No.: 7865258

CofC mailroom date: Jan. 24, 2011

Please respond to this request for a certificate of correction within 7 days.

**FOR IFW FILES:**

Please review the requested changes/corrections as shown in the **COCIN** document(s) in the IFW application image. No new matter should be introduced, nor should the scope or meaning of the claims be changed.

Please complete the response (see below) and forward the completed response to scanning using document code **COCX**.

**FOR PAPER FILES:**

Please review the requested changes/corrections as shown in the attached certificate of correction. Please complete this form (see below) and forward it with the file to:

**Certificates of Correction Branch (CofC)  
Randolph Square – 9D10-A  
Palm Location 7580**

**Certificates of Correction Branch  
703-756-1814 \_\_\_\_\_**

**Thank You For Your Assistance**

**The request for issuing the above-identified correction(s) is hereby:**

Note your decision on the appropriate box.

- Approved** All changes apply.
- Approved in Part** Specify below which changes **do not** apply.
- Denied** State the reasons for denial below.

**Comments:** \_\_\_\_\_  
\_\_\_\_\_  
\_\_\_\_\_  
\_\_\_\_\_  
\_\_\_\_\_

**SPE RESPONSE FOR CERTIFICATE OF CORRECTION**

**SPE**

**Art Unit**

[Empty response area for SPE and Art Unit]

**SPE RESPONSE FOR CERTIFICATE OF CORRECTION**

Paper No.: \_\_\_\_\_

DATE : May 19, 2011

TO SPE OF : ART UNIT 2614

SUBJECT : Request for Certificate of Correction for Appl. No.: 12570343 Patent No.: 7865258

CofC mailroom date: Jan. 24,  
2011

Please respond to this request for a certificate of correction within 7 days.

**FOR IFW FILES:**

Please review the requested changes/corrections as shown in the **COCIN** document(s) in the IFW application image. No new matter should be introduced, nor should the scope or meaning of the claims be changed.

Please complete the response (see below) and forward the completed response to scanning using document code **COCX**.

**FOR PAPER FILES:**

Please review the requested changes/corrections as shown in the attached certificate of correction. Please complete this form (see below) and forward it with the file to:

**Certificates of Correction Branch (CofC)  
Randolph Square – 9D10-A  
Palm Location 7580**

\_\_\_\_\_  
**Certificates of Correction Branch**  
**703-756-1814** \_\_\_\_\_

**Thank You For Your Assistance**

**The request for issuing the above-identified correction(s) is hereby:**

Note your decision on the appropriate box.

**Approved**

**All changes apply.**

**Approved in Part**

Specify below which changes **do not** apply.

**Denied**

State the reasons for denial below.

**Comments:** \_\_\_\_\_  
\_\_\_\_\_  
\_\_\_\_\_  
\_\_\_\_\_  
\_\_\_\_\_



**SPE RESPONSE FOR CERTIFICATE OF CORRECTION**

/Curtis Kuntz/

**SPE  
2614**

**Art Unit**

UNITED STATES PATENT AND TRADEMARK OFFICE  
**CERTIFICATE OF CORRECTION**

PATENT NO. : 7,865,258 B2  
APPLICATION NO. : 12/570343  
DATED : January 4, 2011  
INVENTOR(S) : C. Earl Woolfork

Page 1 of 1

It is certified that error appears in the above-identified patent and that said Letters Patent is hereby corrected as shown below:

On the title page item (63), insert after "Pat. No. 7,412,294":

--, which is a continuation-in-part of application No. 10/027,391, filed on Dec. 21, 2001, now abandoned--

Column 1, line 3, cancel the text beginning with "This continuation application" to "entirety by refer-ence." in column 1, lines 10-11, and insert the following text:

--This application is a continuation of U.S. patent application No. 12/144,729, filed on July 12, 2008, which is a continuation of U.S. patent application No. 10/648,012, filed on August 26, 2003, which is a continuation-in-part of U.S. patent application No. 10/027,391, filed on December 21, 2001, now abandoned, the disclosures of which are incorporated herein in their entireties by reference.--

Signed and Sealed this  
Fourteenth Day of June, 2011

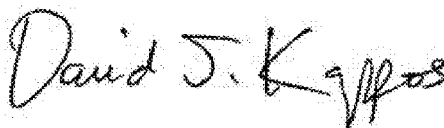

David J. Kappos  
*Director of the United States Patent and Trademark Office*

**ORIGINAL**

**FILED**

AO 120 (Rev. 3/04)

<p><b>TO:</b> Mail Stop 8 Director of the U.S. Patent and Trademark Office P.O. Box 1450 Alexandria, VA 22313-1450</p>	<p><b>REPORT ON THE FILING OR DETERMINATION OF AN ACTION REGARDING A PATENT OR TRADEMARK</b></p>
--	--

In Compliance with 35 U.S.C. § 290 and/or 15 U.S.C. § 1116 you are hereby advised that a court action has been filed in the U.S. District Court Central District of California on the following  Patents of  Trademarks

DOCKET NO. <b>CA CV 11-6673</b>		DATE FILED 8/2/2011	U.S. DISTRICT COURT Central District of California
PLAINTIFF ONE-E-WAY, INC.		DEFENDANT PLANTRONICS, INC.; AUDIOVOX CORPORATION d/b/a ACOUSTIC RESEARCH; TDK U.S.A. CORPORATION, et al.	
PATENT OR TRADEMARK NO.	DATE OF PATENT OR TRADEMARK	HOLDER OF PATENT OR TRADEMARK	
1 7,865,258	1/4/2011	ONE-E-WAY, INC.	
2			
3			
4			
5			

In the above—entitled case, the following patent(s)/ trademark(s) have been included:

DATE INCLUDED	INCLUDED BY			
	<input type="checkbox"/> Amendment	<input type="checkbox"/> Answer	<input type="checkbox"/> Cross Bill	<input type="checkbox"/> Other Pleading
PATENT OR TRADEMARK NO.	DATE OF PATENT OR TRADEMARK	HOLDER OF PATENT OR TRADEMARK		
1				
2				
3				
4				
5				

In the above—entitled case, the following decision has been rendered or judgement issued:

DECISION/JUDGEMENT
--------------------

CLERK	(BY) DEPUTY CLERK	DATE
-------	-------------------	------

Copy 1—Upon initiation of action, mail this copy to Director Copy 3—Upon termination of action, mail this copy to Director  
Copy 2—Upon filing document adding patent(s), mail this copy to Director Copy 4—Case file copy

AO 120 (Rev. 08/10)

TO: <b>Mail Stop 8</b> <b>Director of the U.S. Patent and Trademark Office</b> <b>P.O. Box 1450</b> <b>Alexandria, VA 22313-1450</b>	<b>REPORT ON THE</b> <b>FILING OR DETERMINATION OF AN</b> <b>ACTION REGARDING A PATENT OR</b> <b>TRADEMARK</b>
---	---

In Compliance with 35 U.S.C. § 290 and/or 15 U.S.C. § 1116 you are hereby advised that a court action has been filed in the U.S. District Court **Central District of California** on the following  
 Trademarks or  Patents. (  the patent action involves 35 U.S.C. § 292.);

DOCKET NO. 2:12-cv-00580	DATE FILED 1/23/2012	U.S. DISTRICT COURT Central District of California
PLAINTIFF One-E-Way, Inc.		DEFENDANT Audiovox Corporation
PATENT OR TRADEMARK NO.	DATE OF PATENT OR TRADEMARK	HOLDER OF PATENT OR TRADEMARK
1 7,865,258	1/4/2011	One-E-Way, Inc.
2		
3		
4		
5		

In the above –entitled case, the following patent(s)/ trademark(s) have been included:

DATE INCLUDED	INCLUDED BY <input type="checkbox"/> Amendment <input type="checkbox"/> Answer <input type="checkbox"/> Cross Bill <input type="checkbox"/> Other Pleading	
PATENT OR TRADEMARK NO.	DATE OF PATENT OR TRADEMARK	HOLDER OF PATENT OR TRADEMARK
1		
2		
3		
4		
5		

In the above—entitled case, the following decision has been rendered or judgement issued:

DECISION/JUDGEMENT
--------------------

CLERK	(BY) DEPUTY CLERK	DATE
-------	-------------------	------

Copy 1—Upon initiation of action, mail this copy to Director    Copy 3—Upon termination of action, mail this copy to Director  
 Copy 2—Upon filing document adding patent(s), mail this copy to Director    Copy 4—Case file copy

AO 120 (Rev. 08/10)

<b>TO:</b> <b>Mail Stop 8</b> <b>Director of the U.S. Patent and Trademark Office</b> <b>P.O. Box 1450</b> <b>Alexandria, VA 22313-1450</b>	<b>REPORT ON THE</b> <b>FILING OR DETERMINATION OF AN</b> <b>ACTION REGARDING A PATENT OR</b> <b>TRADEMARK</b>
---	---

In Compliance with 35 U.S.C. § 290 and/or 15 U.S.C. § 1116 you are hereby advised that a court action has been filed in the U.S. District Court **Central District of California** on the following

Trademarks or  Patents. (  the patent action involves 35 U.S.C. § 292.):

DOCKET NO. 2:12-cv-00601	DATE FILED 1/23/2012	U.S. DISTRICT COURT Central District of California
PLAINTIFF One-E-Way, Inc.		DEFENDANT Jaybird Gear LLC
PATENT OR TRADEMARK NO.	DATE OF PATENT OR TRADEMARK	HOLDER OF PATENT OR TRADEMARK
1 7,865,258	1/4/2011	One-E-Way, Inc.
2		
3		
4		
5		

In the above—entitled case, the following patent(s)/ trademark(s) have been included:

DATE INCLUDED	INCLUDED BY <input type="checkbox"/> Amendment <input type="checkbox"/> Answer <input type="checkbox"/> Cross Bill <input type="checkbox"/> Other Pleading		
PATENT OR TRADEMARK NO.	DATE OF PATENT OR TRADEMARK	HOLDER OF PATENT OR TRADEMARK	
1			
2			
3			
4			
5			

In the above—entitled case, the following decision has been rendered or judgement issued:

DECISION/JUDGEMENT
--------------------

CLERK	(BY) DEPUTY CLERK	DATE

Copy 1—Upon initiation of action, mail this copy to Director Copy 3—Upon termination of action, mail this copy to Director  
 Copy 2—Upon filing document adding patent(s), mail this copy to Director Copy 4—Case file copy

AO 120 (Rev. 08/10)

TO: <b>Mail Stop 8</b> <b>Director of the U.S. Patent and Trademark Office</b> P.O. Box 1450 Alexandria, VA 22313-1450	<b>REPORT ON THE                  FILING OR DETERMINATION OF AN                  ACTION REGARDING A PATENT OR                  TRADEMARK</b>
---	--

In Compliance with 35 U.S.C. § 290 and/or 15 U.S.C. § 1116 you are hereby advised that a court action has been filed in the U.S. District Court Central District of California on the following  
 Trademarks or  Patents. (  the patent action involves 35 U.S.C. § 292.);

DOCKET NO. 2:12-cv-00603	DATE FILED 1/23/2012	U.S. DISTRICT COURT Central District of California
PLAINTIFF One-E-Way, Inc.		DEFENDANT Harman International Industries, Inc. d/b/a AKG
PATENT OR TRADEMARK NO.	DATE OF PATENT OR TRADEMARK	HOLDER OF PATENT OR TRADEMARK
1 7,865,258	1/4/2011	One-E-Way, Inc.
2		
3		
4		
5		

In the above—entitled case, the following patent(s)/ trademark(s) have been included:

DATE INCLUDED	INCLUDED BY <input type="checkbox"/> Amendment <input type="checkbox"/> Answer <input type="checkbox"/> Cross Bill <input type="checkbox"/> Other Pleading	
PATENT OR TRADEMARK NO.	DATE OF PATENT OR TRADEMARK	HOLDER OF PATENT OR TRADEMARK
1		
2		
3		
4		
5		

In the above—entitled case, the following decision has been rendered or judgement issued:

DECISION/JUDGEMENT
--------------------

CLERK	(BY) DEPUTY CLERK	DATE
-------	-------------------	------

Copy 1—Upon initiation of action, mail this copy to Director    Copy 3—Upon termination of action, mail this copy to Director  
 Copy 2—Upon filing document adding patent(s), mail this copy to Director    Copy 4—Case file copy

AO 120 (Rev. 08/10)

TO: <b>Mail Stop 8</b> <b>Director of the U.S. Patent and Trademark Office</b> P.O. Box 1450 Alexandria, VA 22313-1450	<b>REPORT ON THE                  FILING OR DETERMINATION OF AN                  ACTION REGARDING A PATENT OR                  TRADEMARK</b>
---	--

In Compliance with 35 U.S.C. § 290 and/or 15 U.S.C. § 1116 you are hereby advised that a court action has been filed in the U.S. District Court **Central District of California** on the following

Trademarks or  Patents. (  the patent action involves 35 U.S.C. § 292.):

DOCKET NO. 2:12-cv-00608	DATE FILED 1/23/2012	U.S. DISTRICT COURT Central District of California
PLAINTIFF One-E-Way, Inc.		DEFENDANT Imation Corporation
PATENT OR TRADEMARK NO.	DATE OF PATENT OR TRADEMARK	HOLDER OF PATENT OR TRADEMARK
1 7,865,258	1/4/2011	One-E-Way, Inc.
2		
3		
4		
5		

In the above --entitled case, the following patent(s)/ trademark(s) have been included:

DATE INCLUDED	INCLUDED BY	
	<input type="checkbox"/> Amendment <input type="checkbox"/> Answer <input type="checkbox"/> Cross Bill <input type="checkbox"/> Other Pleading	
PATENT OR TRADEMARK NO.	DATE OF PATENT OR TRADEMARK	HOLDER OF PATENT OR TRADEMARK
1		
2		
3		
4		
5		

In the above—entitled case, the following decision has been rendered or judgement issued:

DECISION/JUDGEMENT
--------------------

CLERK	(BY) DEPUTY CLERK	DATE
-------	-------------------	------

Copy 1—Upon initiation of action, mail this copy to Director    Copy 3—Upon termination of action, mail this copy to Director  
 Copy 2—Upon filing document adding patent(s), mail this copy to Director    Copy 4—Case file copy

AO 120 (Rev. 08/10)

TO: <b>Mail Stop 8</b> <b>Director of the U.S. Patent and Trademark Office</b> <b>P.O. Box 1450</b> <b>Alexandria, VA 22313-1450</b>	<b>REPORT ON THE</b> <b>FILING OR DETERMINATION OF AN</b> <b>ACTION REGARDING A PATENT OR</b> <b>TRADEMARK</b>
---	---

In Compliance with 35 U.S.C. § 290 and/or 15 U.S.C. § 1116 you are hereby advised that a court action has been filed in the U.S. District Court Central District of California on the following

Trademarks or  Patents. (  the patent action involves 35 U.S.C. § 292.):

DOCKET NO. 2:12-cv-00603	DATE FILED 1/23/2012	U.S. DISTRICT COURT Central District of California
PLAINTIFF One-E-Way, Inc.		DEFENDANT Harman International Industries, Inc. d/b/a AKG
PATENT OR TRADEMARK NO.	DATE OF PATENT OR TRADEMARK	HOLDER OF PATENT OR TRADEMARK
1 7,865,258	1/4/2011	One-E-Way, Inc.
2		
3		
4		
5		

In the above—entitled case, the following patent(s)/ trademark(s) have been included:

DATE INCLUDED	INCLUDED BY <input type="checkbox"/> Amendment <input type="checkbox"/> Answer <input type="checkbox"/> Cross Bill <input type="checkbox"/> Other Pleading	
PATENT OR TRADEMARK NO.	DATE OF PATENT OR TRADEMARK	HOLDER OF PATENT OR TRADEMARK
1		
2		
3		
4		
5		

In the above—entitled case, the following decision has been rendered or judgement issued:

DECISION/JUDGEMENT  SEE ATTACHED NOTICE OF DISMISSAL
--

CLERK Terry Nafisi	(BY) DEPUTY CLERK Phyllis Lopez	DATE 4/30/2012
-----------------------	------------------------------------	-------------------

Copy 1—Upon initiation of action, mail this copy to Director Copy 3—Upon termination of action, mail this copy to Director  
 Copy 2—Upon filing document adding patent(s), mail this copy to Director Copy 4—Case file copy



**ORIGINAL**

**FILED**

AO 120 (Rev. 3/04)

TO: <b>Mail Stop 8</b> Director of the U.S. Patent and Trademark Office P.O. Box 1450 Alexandria, VA 22313-1450	<b>REPORT ON THE                  FILING OR DETERMINATION OF AN                  ACTION REGARDING A PATENT OR                  TRADEMARK</b>
--	--

In Compliance with 35 U.S.C. § 290 and/or 15 U.S.C. § 1116 you are hereby advised that a court action has been filed in the U.S. District Court Central District of California on the following  Patents, or  Trademarks.

DOCKET NO. <b>ACV 11-6673</b>	DATE FILED 8/2/2011	U.S. DISTRICT COURT Central District of California
PLAINTIFF ONE-E-WAY, INC.		DEFENDANT PLANTRONICS, INC.; AUDIOVOX CORPORATION d/b/a ACOUSTIC RESEARCH; TDK U.S.A. CORPORATION, et al.
PATENT OR TRADEMARK NO.	DATE OF PATENT OR TRADEMARK	HOLDER OF PATENT OR TRADEMARK
1 7,865,258	1/4/2011	ONE-E-WAY, INC.
2		
3		
4		
5		

In the above—entitled case, the following patent(s)/ trademark(s) have been included:

DATE INCLUDED	INCLUDED BY	
	<input checked="" type="checkbox"/> Amendment <input checked="" type="checkbox"/> Answer <input checked="" type="checkbox"/> Cross Bill <input checked="" type="checkbox"/> Other Pleading	
PATENT OR TRADEMARK NO.	DATE OF PATENT OR TRADEMARK	HOLDER OF PATENT OR TRADEMARK
1		
2		
3		
4		
5		

In the above—entitled case, the following decision has been rendered or judgement issued:

DECISION/JUDGEMENT Order Dismissing Plantronics, Inc. With Prejudice filed 4/16/2012.
--

CLERK TERRY NAFISI	(BY) DEPUTY CLERK G. Kami	DATE 4/17/2012
-----------------------	------------------------------	-------------------

Copy 1—Upon initiation of action, mail this copy to Director    Copy 3—Upon termination of action, mail this copy to Director  
 Copy 2—Upon filing document adding patent(s), mail this copy to Director    Copy 4—Case file copy

AO 120 (Rev. 08/10)

TO: <b>Mail Stop 8 Director of the U.S. Patent and Trademark Office P.O. Box 1450 Alexandria, VA 22313-1450</b>	<b>REPORT ON THE FILING OR DETERMINATION OF AN ACTION REGARDING A PATENT OR TRADEMARK</b>
---	---

In Compliance with 35 U.S.C. § 290 and/or 15 U.S.C. § 1116 you are hereby advised that a court action has been filed in the U.S. District Court Central District of California on the following

Trademarks or  Patents. (  the patent action involves 35 U.S.C. § 292.);

DOCKET NO. 2:12-cv-00608	DATE FILED 1/23/2012	U.S. DISTRICT COURT Central District of California
PLAINTIFF One-E-Way, Inc.		DEFENDANT imation Corporation
PATENT OR TRADEMARK NO.	DATE OF PATENT OR TRADEMARK	HOLDER OF PATENT OR TRADEMARK
1 7,865,258	1/4/2011	One-E-Way, Inc.
2		
3		
4		
5		

In the above—entitled case, the following patent(s)/ trademark(s) have been included:

DATE INCLUDED	INCLUDED BY <input type="checkbox"/> Amendment <input type="checkbox"/> Answer <input type="checkbox"/> Cross Bill <input type="checkbox"/> Other Pleading	
PATENT OR TRADEMARK NO.	DATE OF PATENT OR TRADEMARK	HOLDER OF PATENT OR TRADEMARK
1		
2		
3		
4		
5		

In the above—entitled case, the following decision has been rendered or judgement issued:

DECISION/JUDGEMENT  NOTICE OF DISMISSAL
---

CLERK Terry Nafisi	(BY) DEPUTY CLERK Brent Pacillas	DATE May 10, 2012
-----------------------	-------------------------------------	----------------------

Copy 1—Upon initiation of action, mail this copy to Director Copy 3—Upon termination of action, mail this copy to Director  
Copy 2—Upon filing document adding patent(s), mail this copy to Director Copy 4—Case file copy

AO 120 (Rev. 08/10)

TO: <b>Mail Stop 8</b> <b>Director of the U.S. Patent and Trademark Office</b> <b>P.O. Box 1450</b> <b>Alexandria, VA 22313-1450</b>	<b>REPORT ON THE</b> <b>FILING OR DETERMINATION OF AN</b> <b>ACTION REGARDING A PATENT OR</b> <b>TRADEMARK</b>
---	---

In Compliance with 35 U.S.C. § 290 and/or 15 U.S.C. § 1116 you are hereby advised that a court action has been filed in the U.S. District Court Central District of California on the following  
 Trademarks or  Patents. (  the patent action involves 35 U.S.C. § 292.);

DOCKET NO. 2:12-cv-00608	DATE FILED 1/23/2012	U.S. DISTRICT COURT Central District of California	
PLAINTIFF One-E-Way, Inc.		DEFENDANT Imation Corporation	
PATENT OR TRADEMARK NO.	DATE OF PATENT OR TRADEMARK	HOLDER OF PATENT OR TRADEMARK	
1 7,865,258	1/4/2011	One-E-Way, Inc.	
2			
3			
4			
5			

In the above—entitled case, the following patent(s)/ trademark(s) have been included:

DATE INCLUDED	INCLUDED BY <input type="checkbox"/> Amendment <input type="checkbox"/> Answer <input type="checkbox"/> Cross Bill <input type="checkbox"/> Other Pleading		
PATENT OR TRADEMARK NO.	DATE OF PATENT OR TRADEMARK	HOLDER OF PATENT OR TRADEMARK	
1			
2			
3			
4			
5			

In the above—entitled case, the following decision has been rendered or judgement issued:

DECISION/JUDGEMENT  NOTICE OF DISMISSAL
---

CLERK Terry Nafisi	(BY) DEPUTY CLERK Brent Pacillas	DATE May 10, 2012
-----------------------	-------------------------------------	----------------------

Copy 1—Upon initiation of action, mail this copy to Director Copy 3—Upon termination of action, mail this copy to Director  
 Copy 2—Upon filing document adding patent(s), mail this copy to Director Copy 4—Case file copy

AO 120 (Rev. 08/10)

TO: <b>Mail Stop 8</b> <b>Director of the U.S. Patent and Trademark Office</b> <b>P.O. Box 1450</b> <b>Alexandria, VA 22313-1450</b>	<b>REPORT ON THE</b> <b>FILING OR DETERMINATION OF AN</b> <b>ACTION REGARDING A PATENT OR</b> <b>TRADEMARK</b>
---	---

In Compliance with 35 U.S.C. § 290 and/or 15 U.S.C. § 1116 you are hereby advised that a court action has been filed in the U.S. District Court Central District of California on the following  
 Trademarks or  Patents. (  the patent action involves 35 U.S.C. § 292.);

DOCKET NO. 2:12-cv-00580	DATE FILED 1/23/2012	U.S. DISTRICT COURT Central District of California
PLAINTIFF One-E-Way, Inc.		DEFENDANT Audiovox Corporation
PATENT OR TRADEMARK NO.	DATE OF PATENT OR TRADEMARK	HOLDER OF PATENT OR TRADEMARK
1 7,865,258	1/4/2011	One-E-Way, Inc.
2		
3		
4		
5		

In the above—entitled case, the following patent(s)/ trademark(s) have been included:

DATE INCLUDED	INCLUDED BY <input type="checkbox"/> Amendment <input type="checkbox"/> Answer <input type="checkbox"/> Cross Bill <input type="checkbox"/> Other Pleading	
PATENT OR TRADEMARK NO.	DATE OF PATENT OR TRADEMARK	HOLDER OF PATENT OR TRADEMARK
1		
2		
3		
4		
5		

In the above—entitled case, the following decision has been rendered or judgement issued:

DECISION/JUDGEMENT  11/1/12 ORDER DISMISSING ACTION PURSUANT TO STIPULATION
---

CLERK Terry Nafisi	(BY) DEPUTY CLERK L Chai	DATE 11/1/12
-----------------------	-----------------------------	-----------------

Copy 1—Upon initiation of action, mail this copy to Director  Copy 3—Upon termination of action, mail this copy to Director  
 Copy 2—Upon filing document adding patent(s), mail this copy to Director Copy 4—Case file copy

AO 120 (Rev. 08/10)

TO: <b>Mail Stop 8</b> <b>Director of the U.S. Patent and Trademark Office</b> <b>P.O. Box 1450</b> <b>Alexandria, VA 22313-1450</b>	<b>REPORT ON THE</b> <b>FILING OR DETERMINATION OF AN</b> <b>ACTION REGARDING A PATENT OR</b> <b>TRADEMARK</b>
---	---

In Compliance with 35 U.S.C. § 290 and/or 15 U.S.C. § 1116 you are hereby advised that a court action has been filed in the U.S. District Court Central District of California on the following

Trademarks or  Patents. (  the patent action involves 35 U.S.C. § 292.);

DOCKET NO. 2:12-cv-00601	DATE FILED 1/23/2012	U.S. DISTRICT COURT Central District of California
PLAINTIFF One-E-Way, Inc.		DEFENDANT Jaybird Gear LLC
PATENT OR TRADEMARK NO.	DATE OF PATENT OR TRADEMARK	HOLDER OF PATENT OR TRADEMARK
1 7,865,258	1/4/2011	One-E-Way, Inc.
2		
3		
4		
5		

In the above—entitled case, the following patent(s)/ trademark(s) have been included:

DATE INCLUDED	INCLUDED BY <input type="checkbox"/> Amendment <input type="checkbox"/> Answer <input type="checkbox"/> Cross Bill <input type="checkbox"/> Other Pleading	
PATENT OR TRADEMARK NO.	DATE OF PATENT OR TRADEMARK	HOLDER OF PATENT OR TRADEMARK
1		
2		
3		
4		
5		

In the above—entitled case, the following decision has been rendered or judgement issued:

DECISION/JUDGEMENT  see attached order
--

CLERK Terry Nafisi	(BY) DEPUTY CLERK Phyllis Lopez	DATE 3/15/2013
-----------------------	------------------------------------	-------------------

Copy 1—Upon initiation of action, mail this copy to Director Copy 3—Upon termination of action, mail this copy to Director  
 Copy 2—Upon filing document adding patent(s), mail this copy to Director Copy 4—Case file copy