



US005566337A

United States Patent [19]
Szymanski et al.

[11] **Patent Number:** **5,566,337**
[45] **Date of Patent:** **Oct. 15, 1996**

[54] **METHOD AND APPARATUS FOR DISTRIBUTING EVENTS IN AN OPERATING SYSTEM**

FOREIGN PATENT DOCUMENTS

0528222 2/1993 European Pat. Off. .
WO91/03017 3/1991 WIPO .

[75] Inventors: **Steven J. Szymanski**, Cupertino;
Thomas E. Saulpaugh, San Jose;
William J. Keenan, Redwood City, all of Calif.

OTHER PUBLICATIONS

IBM: 'OS/2 2.0 Presentation Manager Programming Guide', Mar. 1992, QUE, USA, p. 31-5, last paragraph, p. 31-6, paragraph 3.

[73] Assignee: **Apple Computer, Inc.**, Cupertino, Calif.

Primary Examiner—Jack B. Harvey
Assistant Examiner—Sumati Lefkowitz
Attorney, Agent, or Firm—Burns, Doane, Swecker & Mathis

[21] Appl. No.: **242,204**

[57] **ABSTRACT**

[22] Filed: **May 13, 1994**

[51] Int. Cl.⁶ **G06F 9/00**

[52] U.S. Cl. **395/733; 395/650; 395/700**

[58] Field of Search **395/650, 725, 395/700, 775**

In a computer including an operating system, an event producer for generating an event and detecting that an event has occurred in the computer and an event consumer which need to be informed when events occur in the computer, a system for distributing events including a store for storing a specific set of events of which the at least one event consumer is to be informed, an event manager control unit for receiving the event from the event producer, comparing the received event to the stored set of events, and distributing an appropriate event to an appropriate event consumer, and a distributor for receiving the event from the control unit and directing the control unit to distribute an appropriate event to an appropriate event consumer.

[56] **References Cited**

U.S. PATENT DOCUMENTS

5,155,842	10/1992	Rubin	395/182.2
5,237,684	8/1993	Record et al.	395/650
5,291,608	3/1994	Flurry	395/725
5,305,454	4/1994	Record et al.	395/650
5,321,837	6/1994	Daniel et al.	395/650
5,355,484	10/1994	Record et al.	395/650
5,430,875	7/1995	Ma	395/650

24 Claims, 10 Drawing Sheets

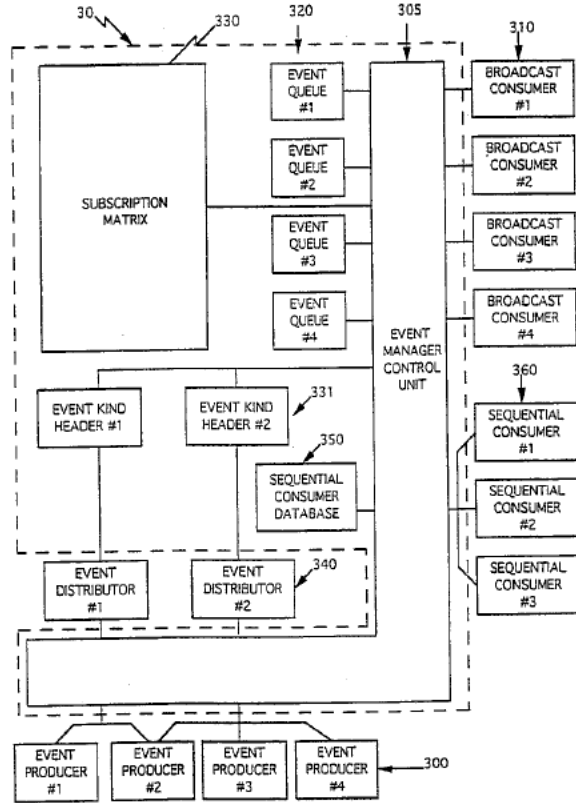
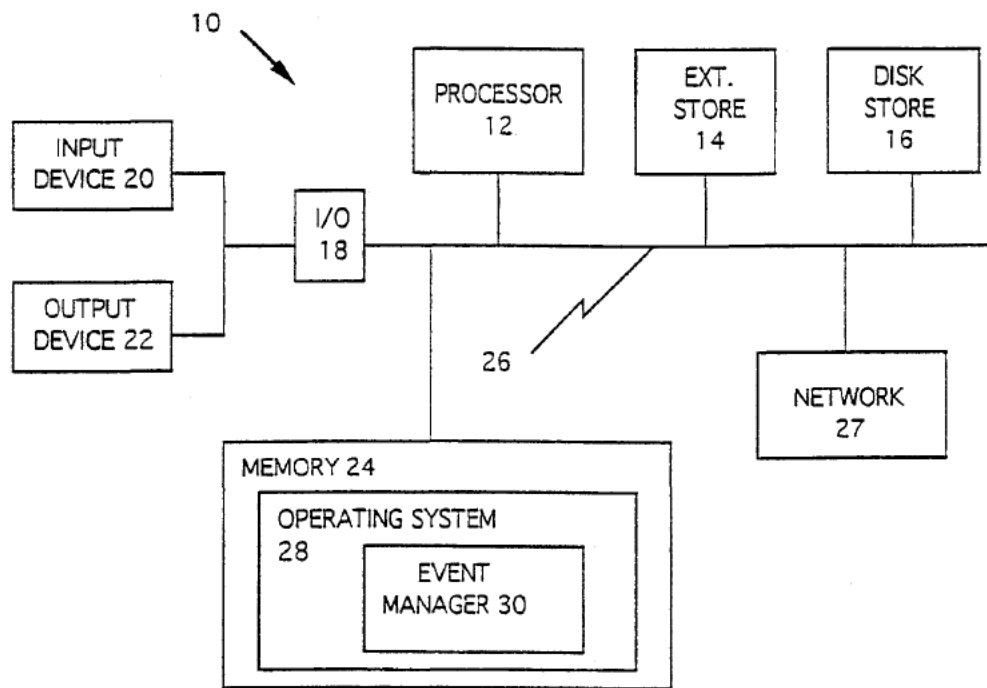

FIG. 1



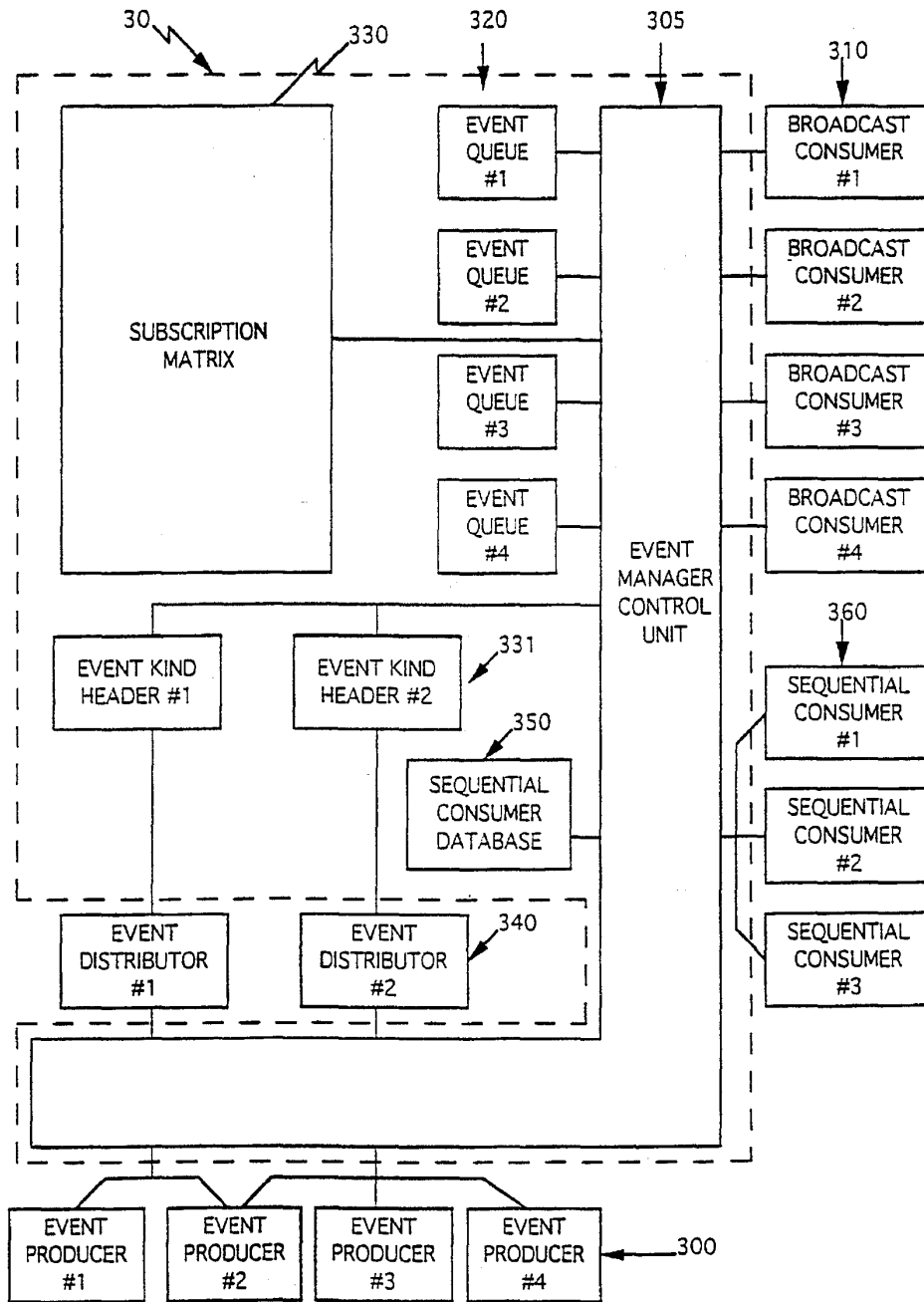

FIG. 2

FIG. 3

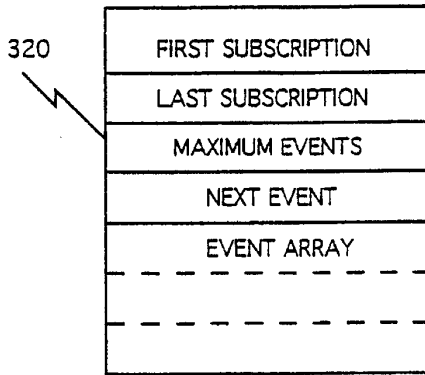

FIG. 6

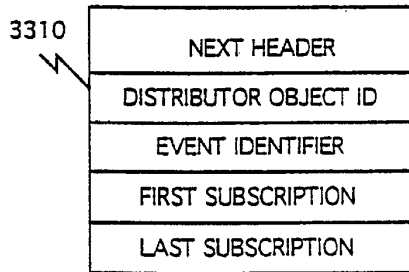

FIG. 5a

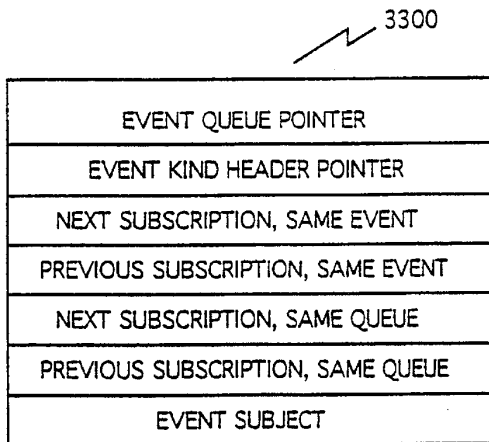

FIG. 7

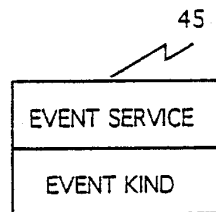

FIG. 5b

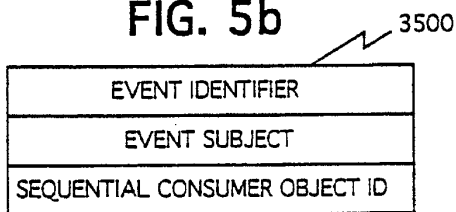
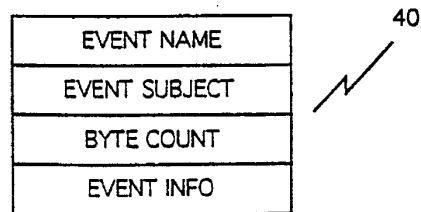

FIG. 8



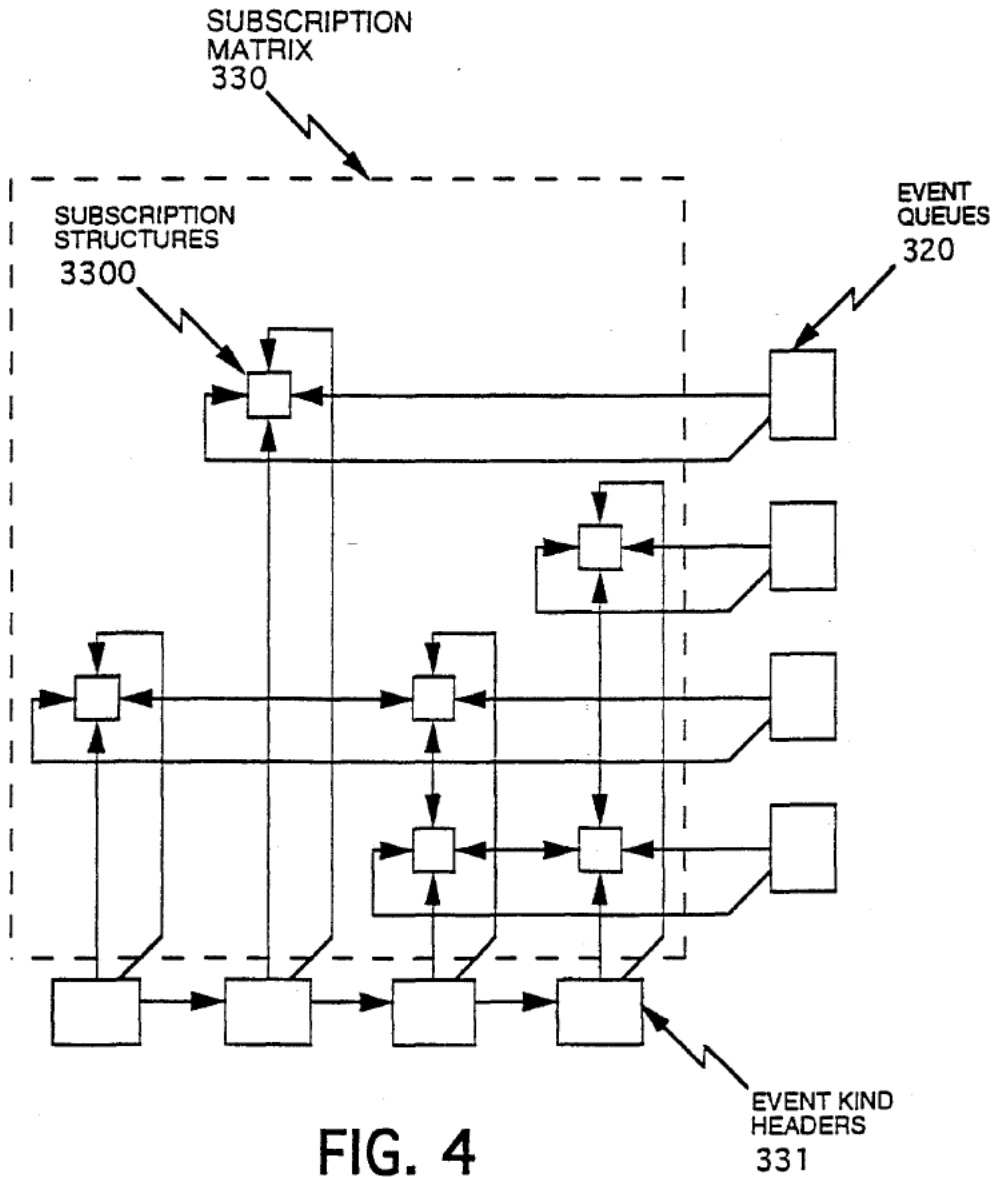

FIG. 4

Explore Litigation Insights

Docket Alarm provides insights to develop a more informed litigation strategy and the peace of mind of knowing you're on top of things.

Real-Time Litigation Alerts



Keep your litigation team up-to-date with **real-time alerts** and advanced team management tools built for the enterprise, all while greatly reducing PACER spend.

Our comprehensive service means we can handle Federal, State, and Administrative courts across the country.

Advanced Docket Research



With over 230 million records, Docket Alarm's cloud-native docket research platform finds what other services can't. Coverage includes Federal, State, plus PTAB, TTAB, ITC and NLRB decisions, all in one place.

Identify arguments that have been successful in the past with full text, pinpoint searching. Link to case law cited within any court document via Fastcase.

Analytics At Your Fingertips



Learn what happened the last time a particular judge, opposing counsel or company faced cases similar to yours.

Advanced out-of-the-box PTAB and TTAB analytics are always at your fingertips.

API

Docket Alarm offers a powerful API (application programming interface) to developers that want to integrate case filings into their apps.

LAW FIRMS

Build custom dashboards for your attorneys and clients with live data direct from the court.

Automate many repetitive legal tasks like conflict checks, document management, and marketing.

FINANCIAL INSTITUTIONS

Litigation and bankruptcy checks for companies and debtors.

E-DISCOVERY AND LEGAL VENDORS

Sync your system to PACER to automate legal marketing.