



US 20050056474A1

(19) **United States**

(12) **Patent Application Publication** (10) **Pub. No.: US 2005/0056474 A1**

Damon

(43) **Pub. Date: Mar. 17, 2005**

(54) **BATTERY RETAINER ASSEMBLY FOR CHILDREN'S RIDE-ON VEHICLES**

(52) **U.S. Cl. 180/68.5; 180/65.1**

(76) **Inventor: Daniel J. Damon, South Wales, NY (US)**

(57) **ABSTRACT**

Correspondence Address:
KOLISCH HARTWELL, P.C.
520 S.W. YAMHILL STREET
SUITE 200
PORTLAND, OR 97204 (US)

Battery retainer assemblies and children's ride-on vehicles including the same. The retainer assembly includes a retaining member coupled to the vehicle's battery compartment. The retaining member is selectively moved between an open position, in which the retaining member permits the battery assembly to be inserted into or removed from the compartment, and a closed position, in which the retaining member obstructs removal of the battery assembly. In some embodiments, the retaining member is adapted to displace the battery assembly as the retaining member is moved to the open position. In some embodiments, the retaining member is adapted to automatically move to the closed position upon insertion of the battery assembly into the compartment and/or engagement with the retaining member. In some embodiments, the retaining member is retained in the open position until selectively released therefrom by a user. Upon release, the retaining member may automatically move to the closed position.

(21) **Appl. No.: 10/808,048**

(22) **Filed: Mar. 23, 2004**

Related U.S. Application Data

(63) **Continuation-in-part of application No. 10/660,904, filed on Sep. 11, 2003.**

Publication Classification

(51) **Int. Cl.⁷ B60R 16/04; B60K 1/00**

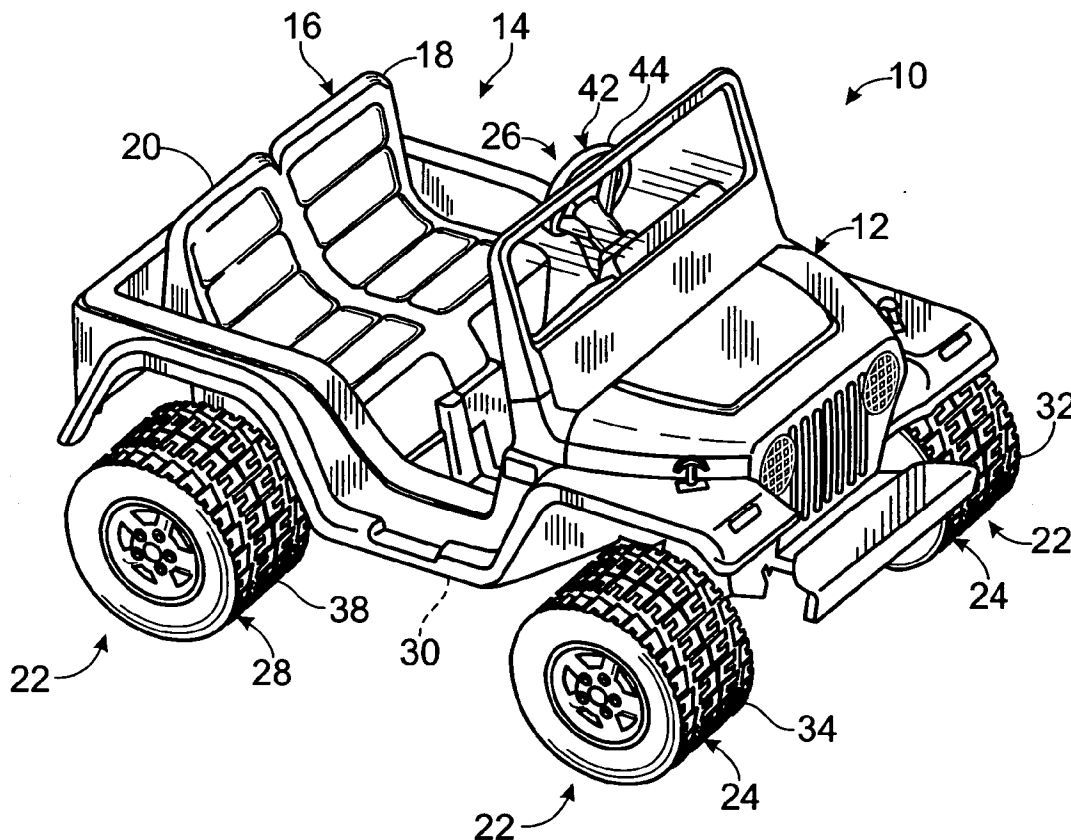

Dynacraft BSC, Inc.
Exhibit 1003
Dynacraft v. Mattel
IPR2018-00042

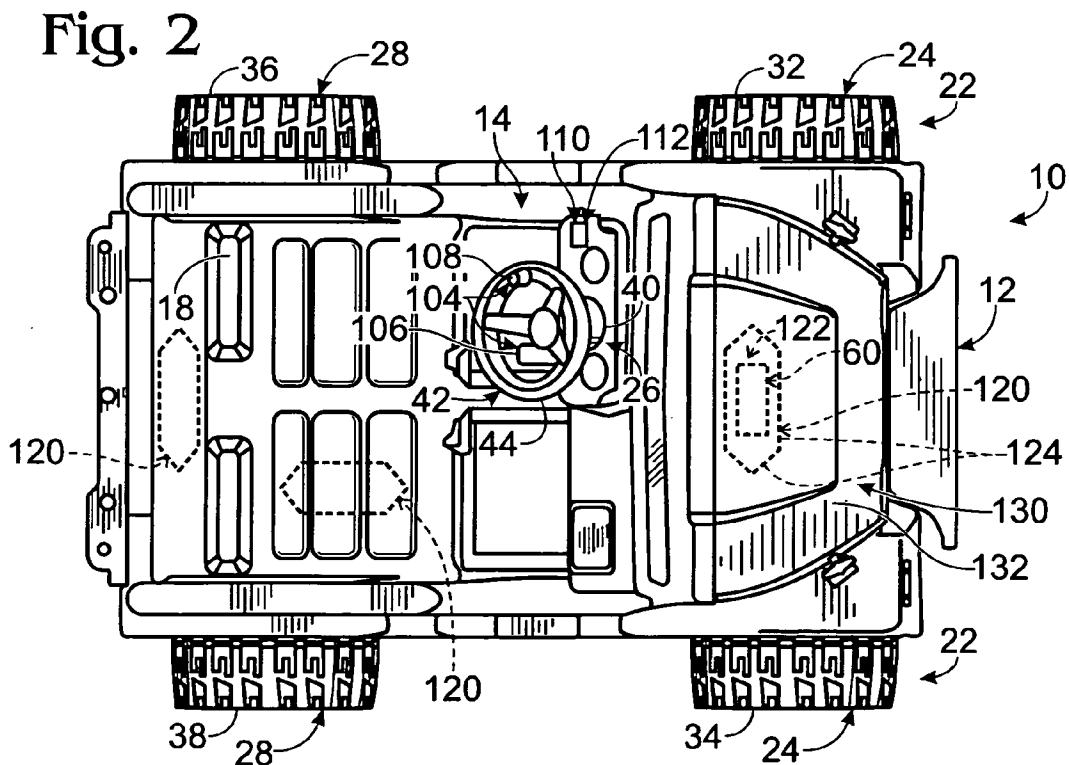
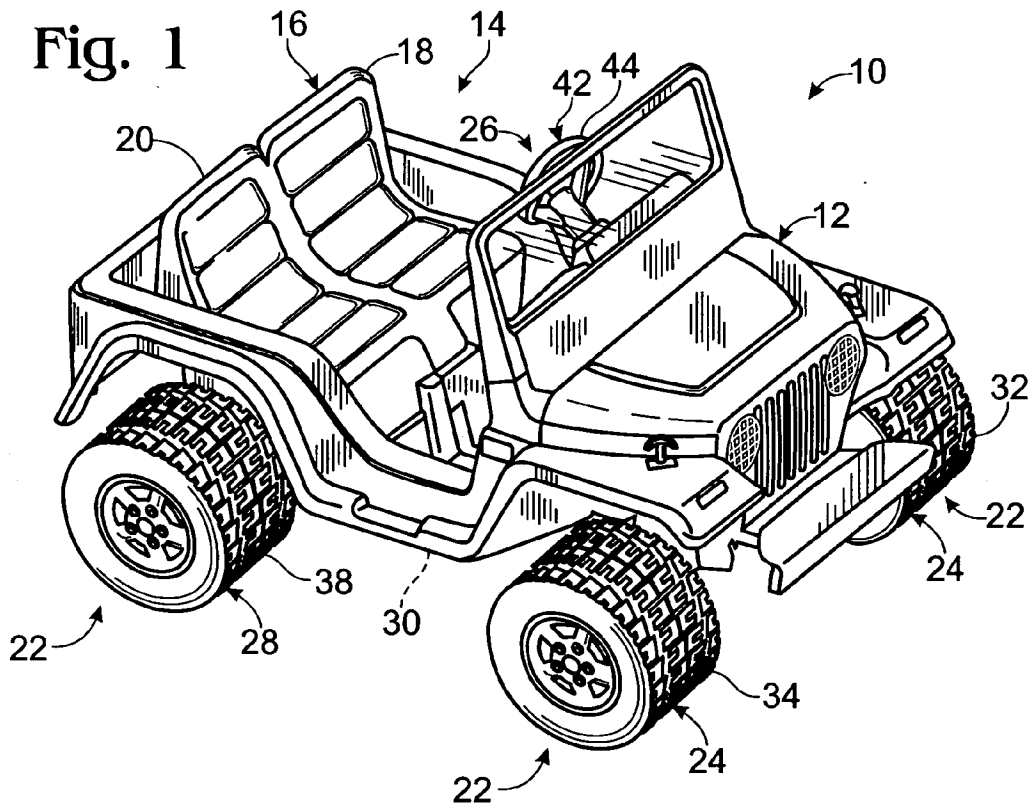

Fig. 3

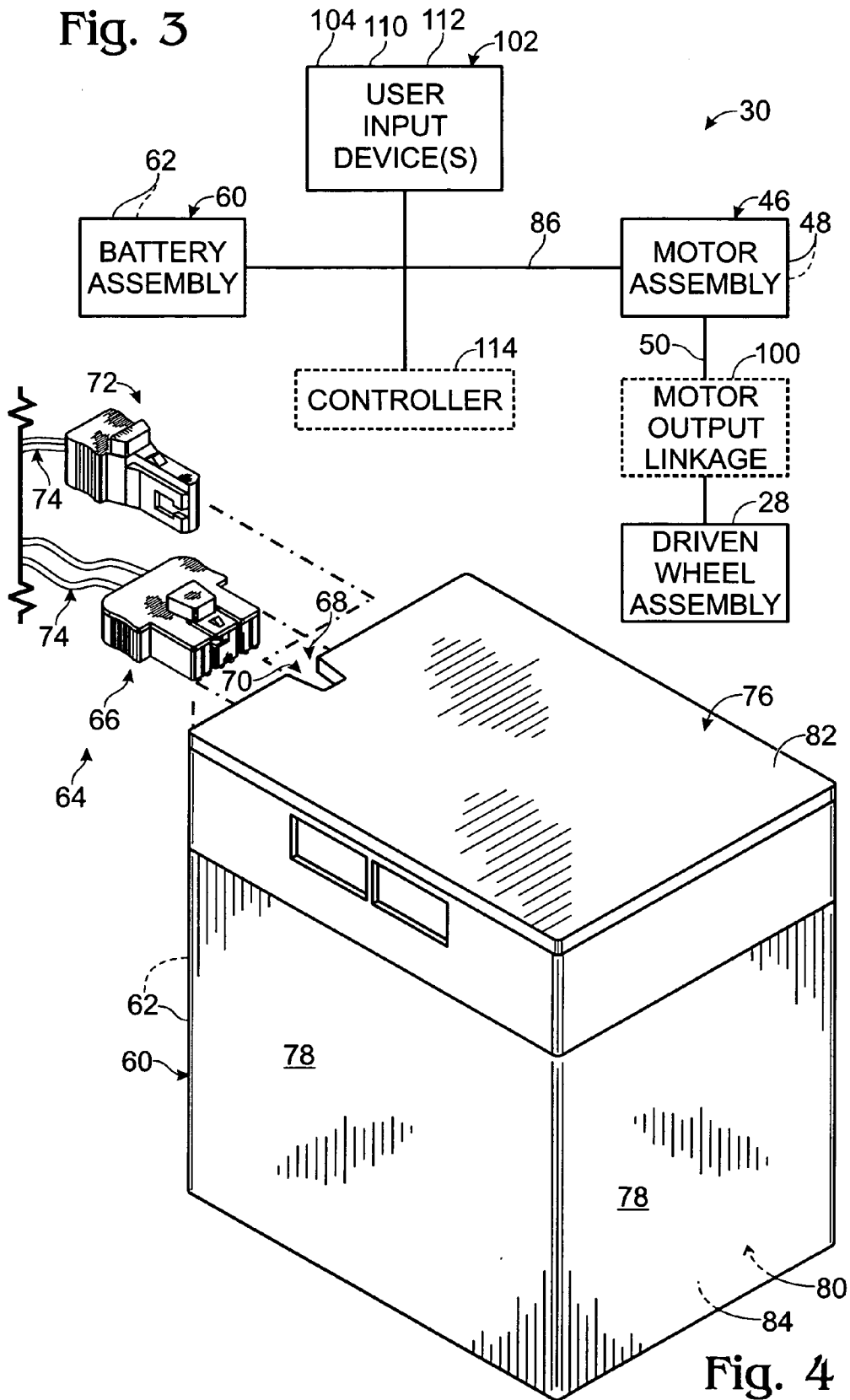

Fig. 4

Fig. 5

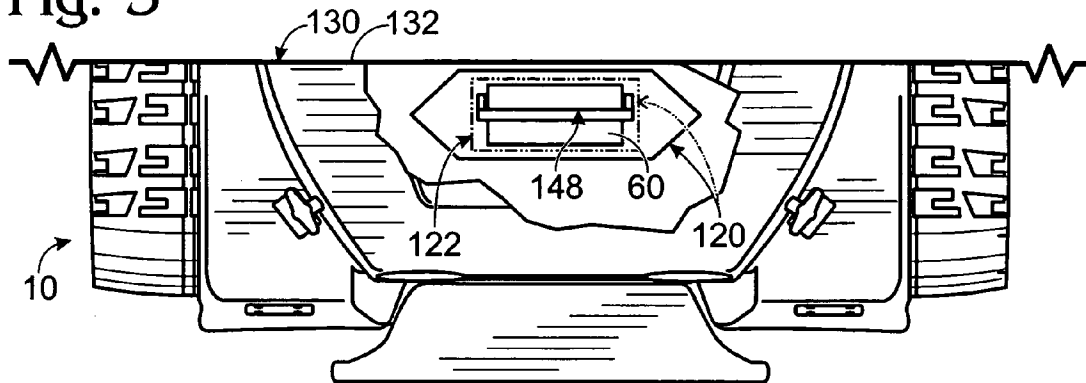

Fig. 6

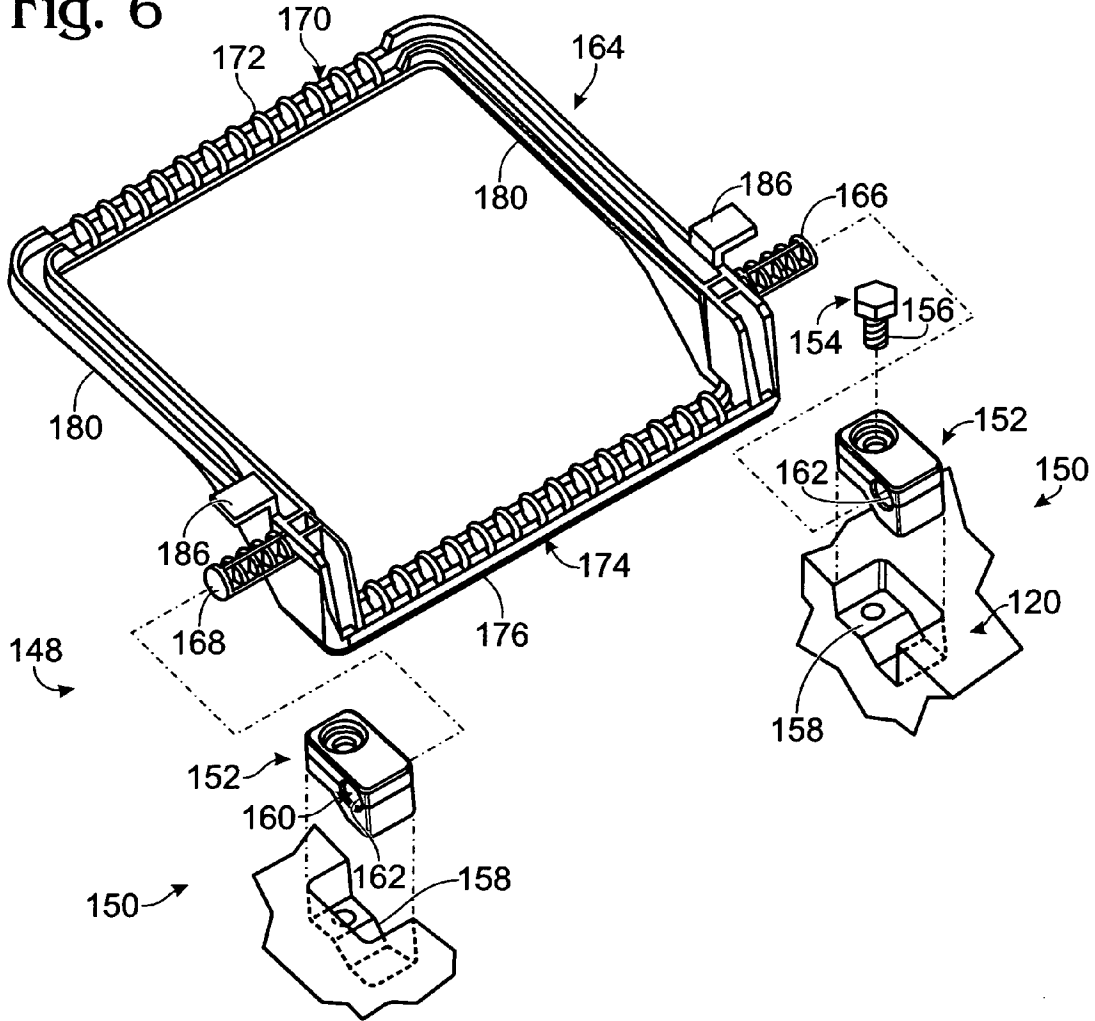

Fig. 7

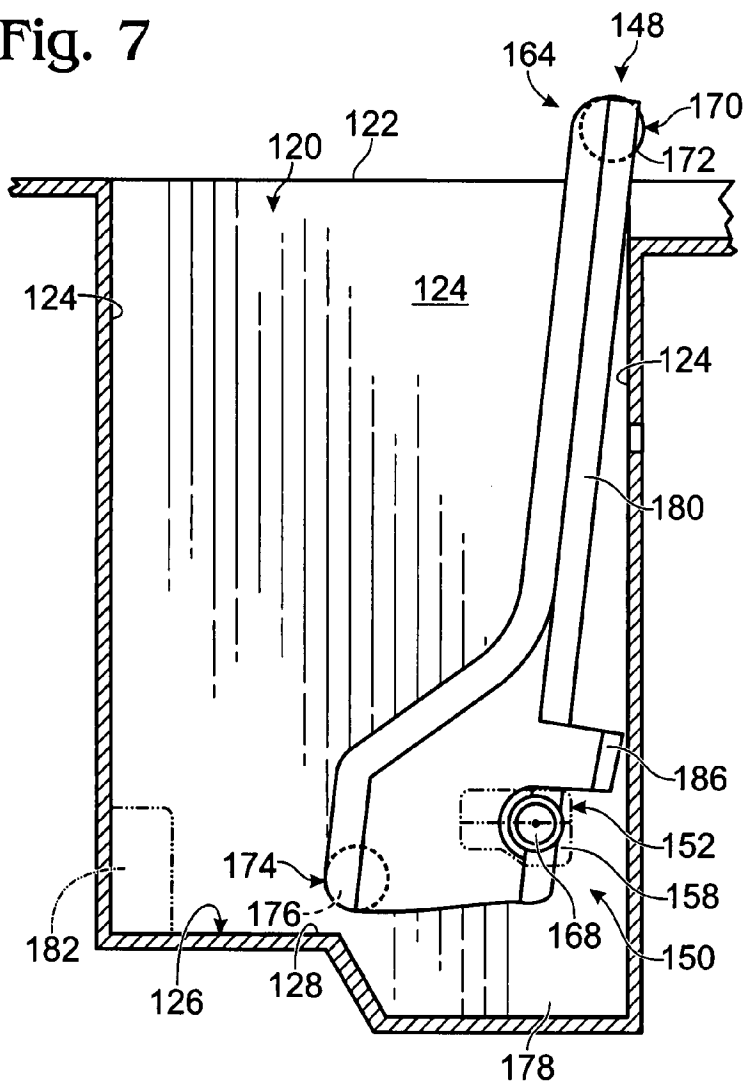
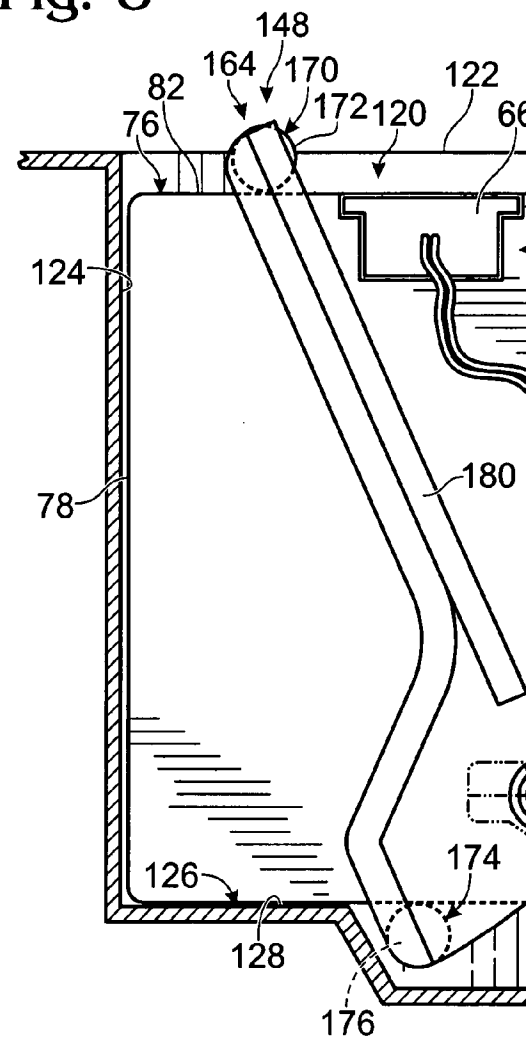

Fig. 8



Explore Litigation Insights

Docket Alarm provides insights to develop a more informed litigation strategy and the peace of mind of knowing you're on top of things.

Real-Time Litigation Alerts



Keep your litigation team up-to-date with **real-time alerts** and advanced team management tools built for the enterprise, all while greatly reducing PACER spend.

Our comprehensive service means we can handle Federal, State, and Administrative courts across the country.

Advanced Docket Research



With over 230 million records, Docket Alarm's cloud-native docket research platform finds what other services can't. Coverage includes Federal, State, plus PTAB, TTAB, ITC and NLRB decisions, all in one place.

Identify arguments that have been successful in the past with full text, pinpoint searching. Link to case law cited within any court document via Fastcase.

Analytics At Your Fingertips



Learn what happened the last time a particular judge, opposing counsel or company faced cases similar to yours.

Advanced out-of-the-box PTAB and TTAB analytics are always at your fingertips.

API

Docket Alarm offers a powerful API (application programming interface) to developers that want to integrate case filings into their apps.

LAW FIRMS

Build custom dashboards for your attorneys and clients with live data direct from the court.

Automate many repetitive legal tasks like conflict checks, document management, and marketing.

FINANCIAL INSTITUTIONS

Litigation and bankruptcy checks for companies and debtors.

E-DISCOVERY AND LEGAL VENDORS

Sync your system to PACER to automate legal marketing.