



US 20070113090A1

(19) **United States**

(12) **Patent Application Publication** (10) **Pub. No.: US 2007/0113090 A1**
Vilella (43) **Pub. Date: May 17, 2007**

(54) **ACCESS CONTROL SYSTEM BASED ON A HARDWARE AND SOFTWARE SIGNATURE OF A REQUESTING DEVICE**

(30) **Foreign Application Priority Data**

Mar. 10, 2004 (BR)..... PI0400265-2

(76) Inventor: **Agostinho De Arruda Villela**, Rio de Janeiro (BR)

Publication Classification

(51) **Int. Cl.**
H04L 9/00 (2006.01)
(52) **U.S. Cl.** 713/170

Correspondence Address:
**BAKER, DONELSON, BEARMAN,
CALDWELL & BERKOWITZ
SUITE 3100 SIX CONCOURSE PARKWAY
ATLANTA, GA 30328 (US)**

(57) **ABSTRACT**

A system and method for the authorization of access to a service by a computational device or devices, which may include a wireless device such as a cell phone or a smart phone. A software agent generates a digital signature for the device each time it attempts to access the service and send it to an authentication server, which compares the digital signature sent with one or more digital signatures on file to determine whether access to the service is permitted. The digital signature is generated by using hashes based on software and hardware configuration data collected from the device. The system may be used in conjunction with other authorization methods and devices.

(21) Appl. No.: **11/591,885**

(22) Filed: **Nov. 2, 2006**

Related U.S. Application Data

(63) Continuation-in-part of application No. 10/598,719, filed as 371 of international application No. PCT/BR05/00030, filed on Mar. 10, 2005.

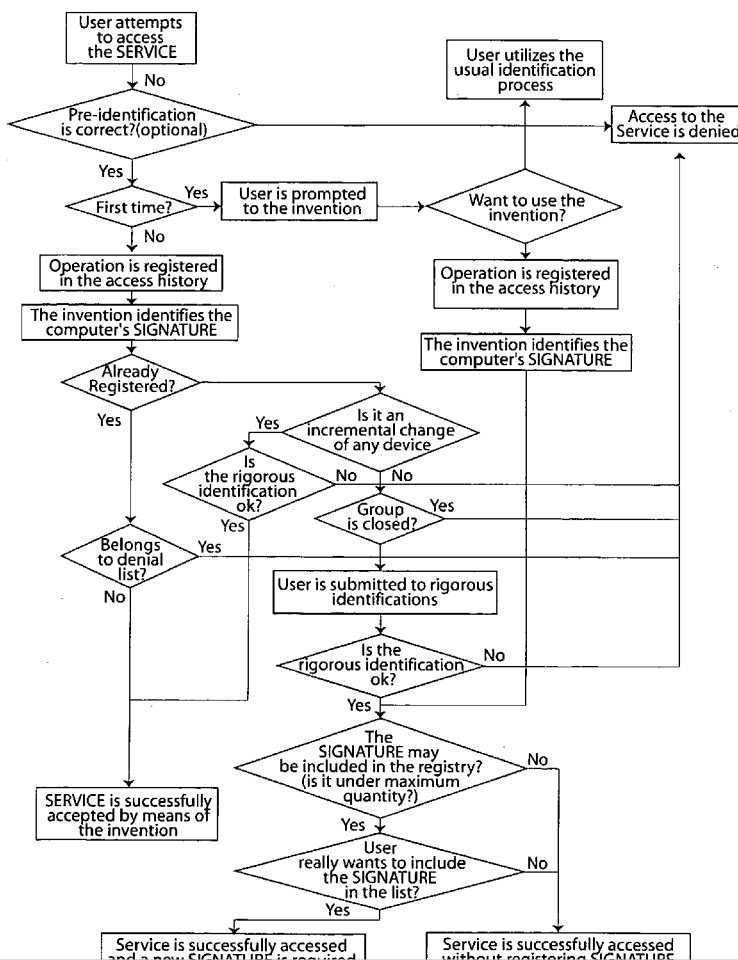

Fig. 1

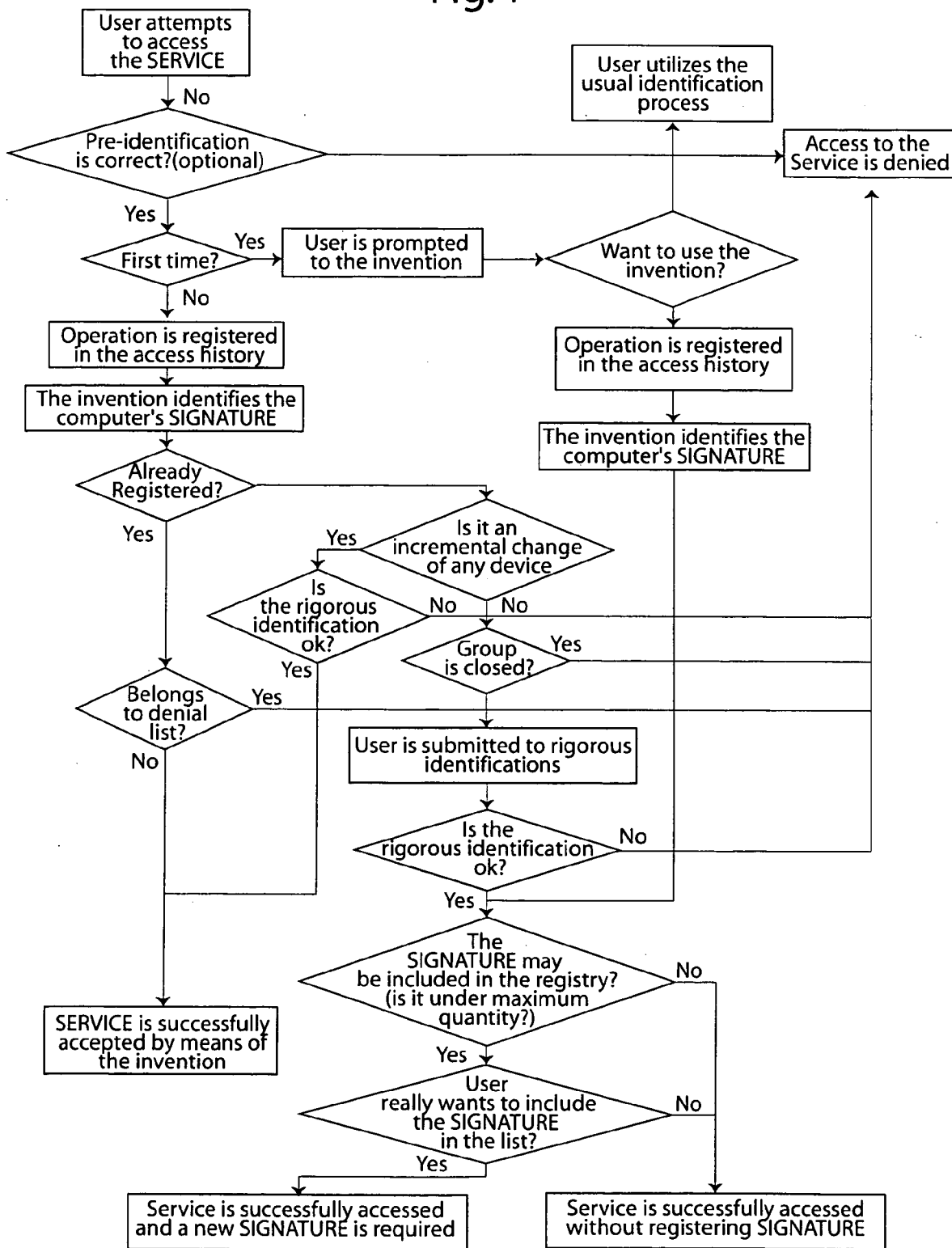

Fig. 2

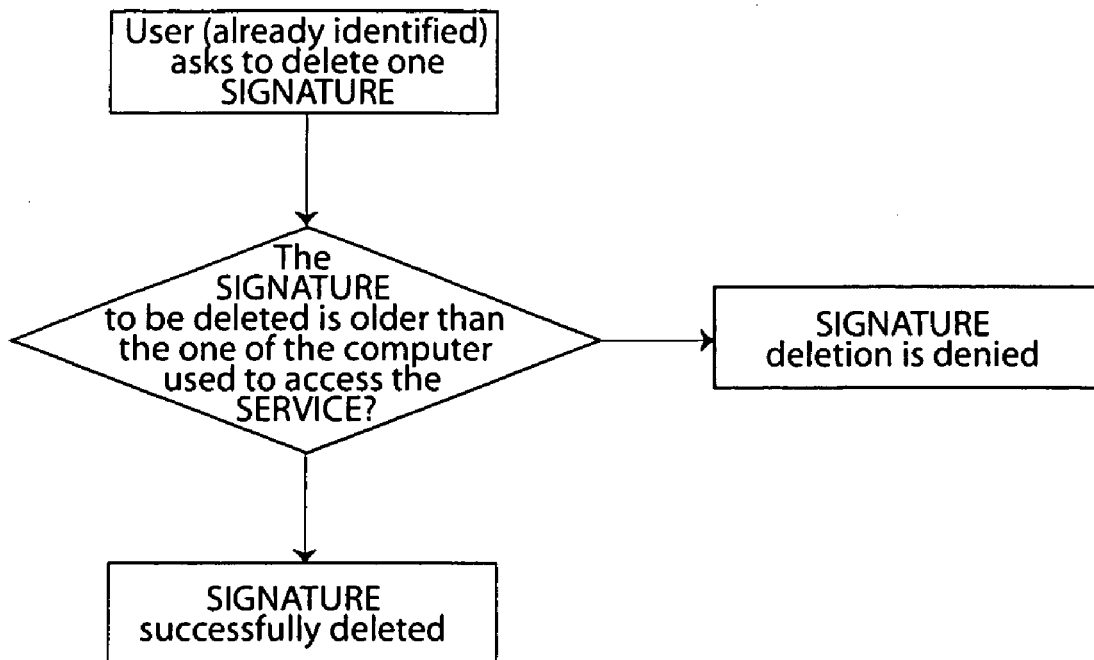

Fig. 3

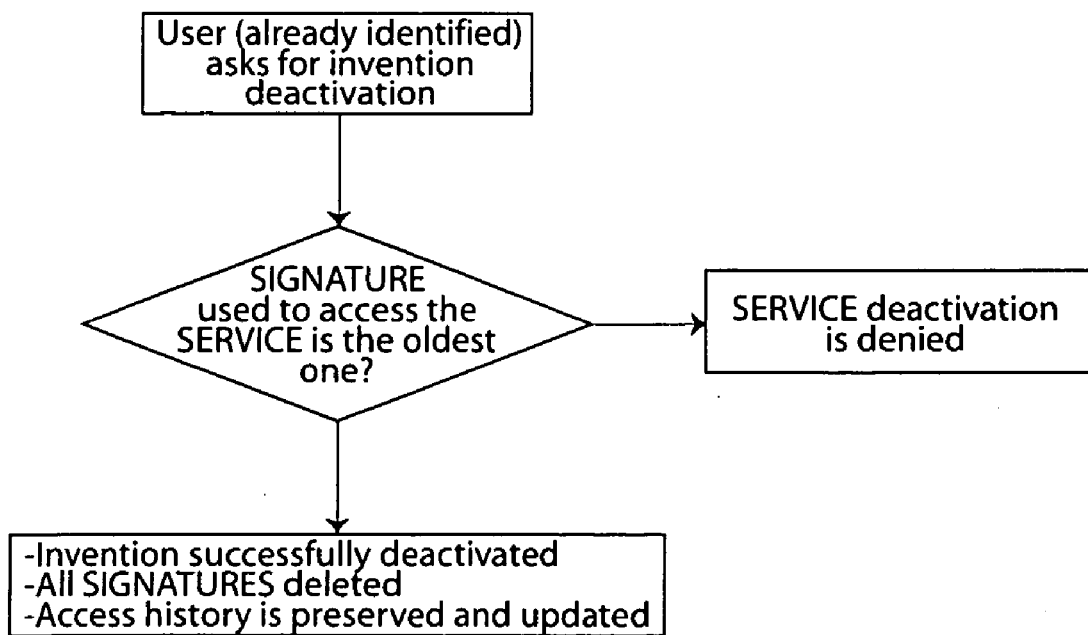

Fig. 4

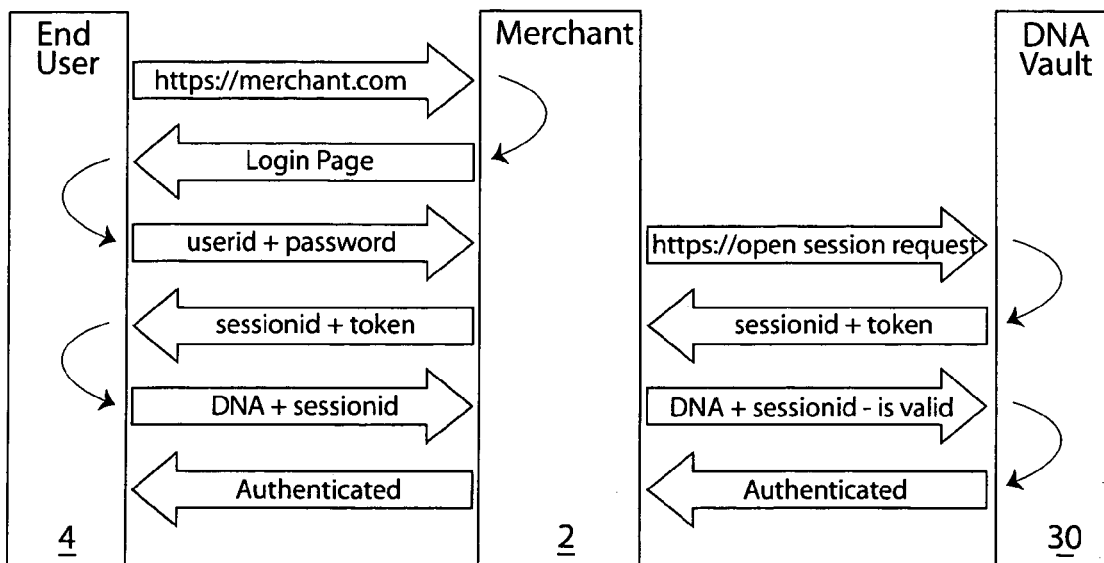
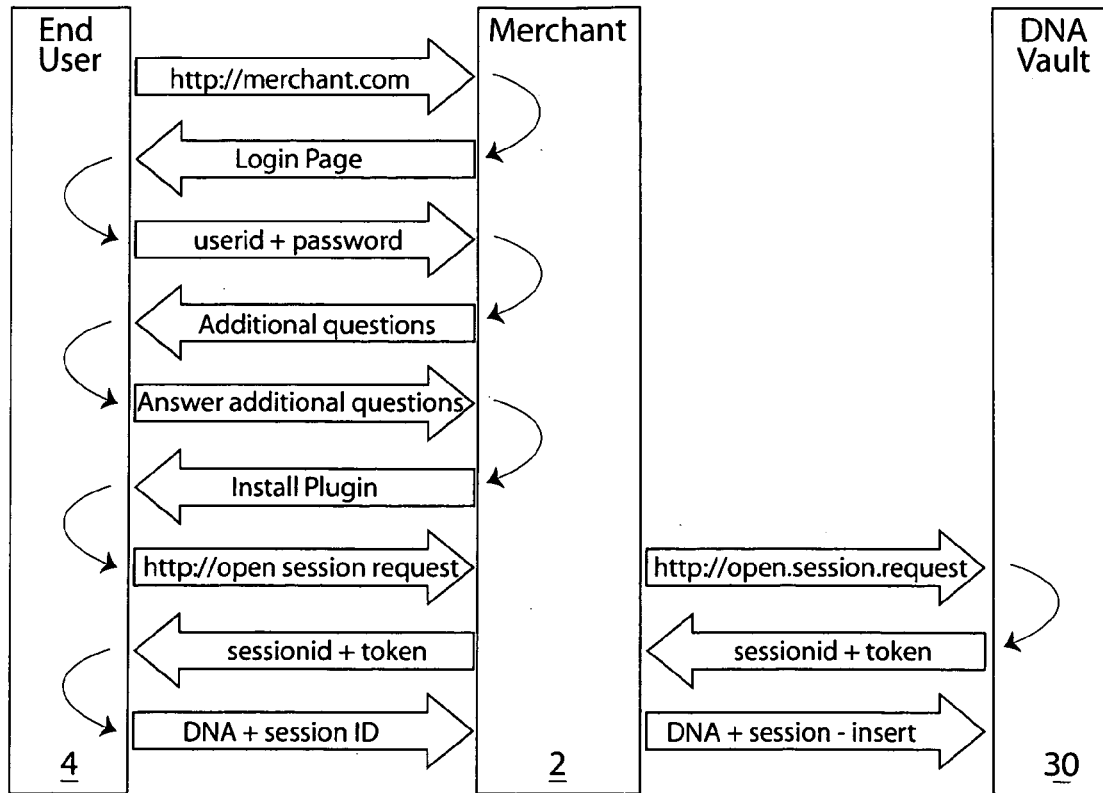
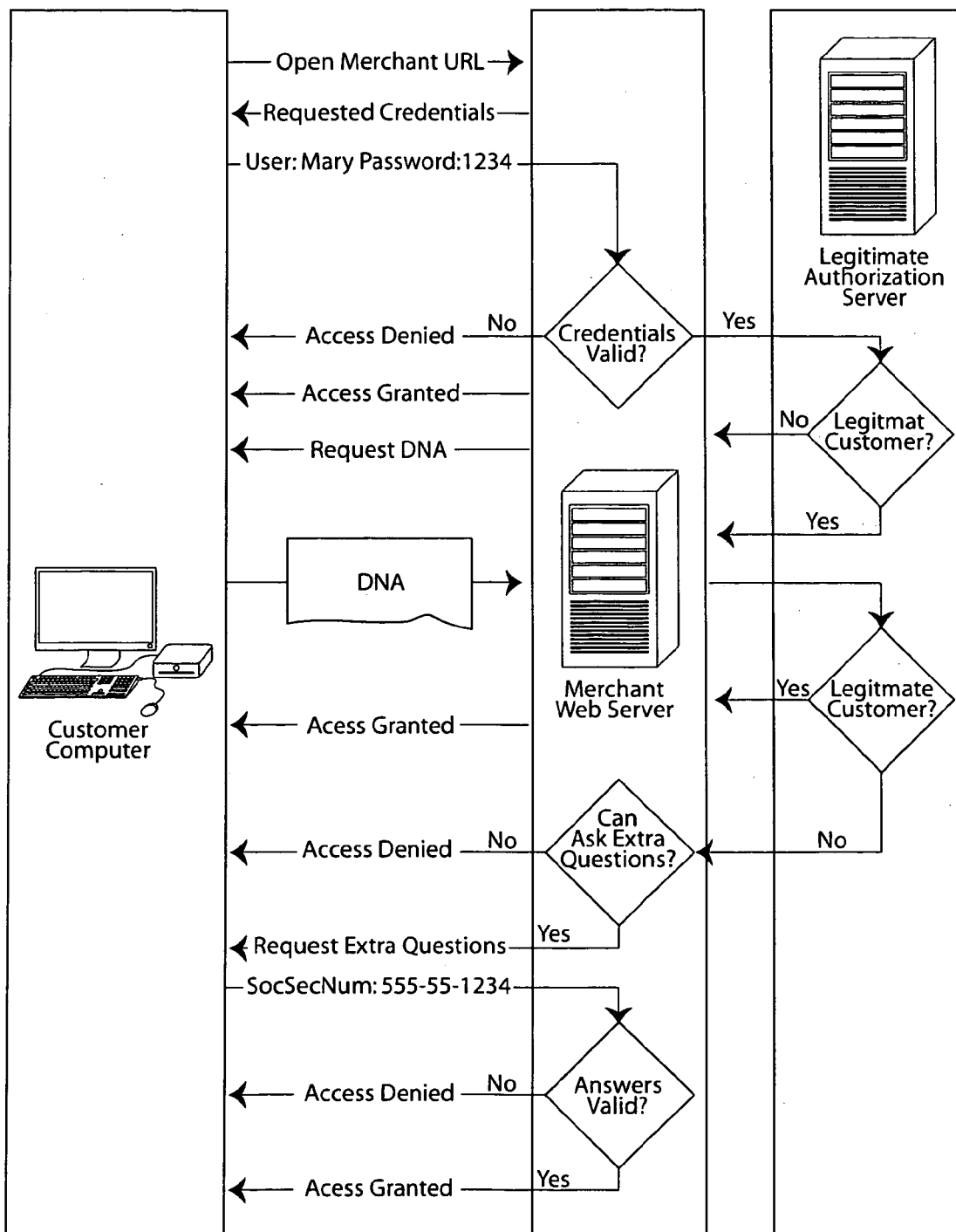

Fig. 5



Explore Litigation Insights

Docket Alarm provides insights to develop a more informed litigation strategy and the peace of mind of knowing you're on top of things.

Real-Time Litigation Alerts



Keep your litigation team up-to-date with **real-time alerts** and advanced team management tools built for the enterprise, all while greatly reducing PACER spend.

Our comprehensive service means we can handle Federal, State, and Administrative courts across the country.

Advanced Docket Research



With over 230 million records, Docket Alarm's cloud-native docket research platform finds what other services can't. Coverage includes Federal, State, plus PTAB, TTAB, ITC and NLRB decisions, all in one place.

Identify arguments that have been successful in the past with full text, pinpoint searching. Link to case law cited within any court document via Fastcase.

Analytics At Your Fingertips



Learn what happened the last time a particular judge, opposing counsel or company faced cases similar to yours.

Advanced out-of-the-box PTAB and TTAB analytics are always at your fingertips.

API

Docket Alarm offers a powerful API (application programming interface) to developers that want to integrate case filings into their apps.

LAW FIRMS

Build custom dashboards for your attorneys and clients with live data direct from the court.

Automate many repetitive legal tasks like conflict checks, document management, and marketing.

FINANCIAL INSTITUTIONS

Litigation and bankruptcy checks for companies and debtors.

E-DISCOVERY AND LEGAL VENDORS

Sync your system to PACER to automate legal marketing.