

Therefore, according to the teachings of Queen *et al.*, human framework region sequences needed to be tailored to each non-human antibody to be humanized. Furthermore, this reference taught that the heavy chain and light chain used for humanization should be derived from the same human antibody.

Applicants submit that the invention recited in independent **claims 1, 7, 15 and 22** herein differs from the teachings of each of the cited references in that it provides humanized antibodies wherein the heavy chain framework region of the humanized antibody is provided by a consensus human variable domain of a human heavy chain immunoglobulin subgroup, such as the V_H subgroup III consensus human variable domain, *e.g.*, of SEQ ID NO:4. The references cited by the Office fail to disclose or suggest the use of such a heavy chain consensus human variable domain.

First, Applicants will comment on the statement by the Examiner that "there is no functional/structural distinction from what applicant has claimed and that taught by the combination of references." As noted above, independent claims 1, 7, 15 and 22 herein recite a "consensus human variable domain of a human heavy chain immunoglobulin subgroup." As noted on page 15, lines 15-25 of the application, consensus sequences (*i.e.*, most commonly occurring residue or pair of residues) of human heavy chain immunoglobulin subgroups are compiled in Kabat *et al.*, *Sequences of Proteins of Immunological Interest*, Fourth Edition, U.S. Dept. of Health & Human Services, pubs., (1987). Kabat *et al.* grouped various heavy and light chain variable domains according to their amino acid sequence identity to form several human immunoglobulin *subgroups*, *i.e.*, human kappa light chains subgroups I to IV, human lambda light chains subgroups I to VI and human heavy chains subgroups I to III (see pages 41-76 and 160-175 of Kabat *et al.*, copies attached). The "occurrences of most common amino acid" (*i.e.*, "consensus human variable domain" of the instant claims) at each position of the variable domain are provided in the second to last column for each immunoglobulin subgroup in Kabat *et al.* The cited references fail to disclose or suggest the use of a consensus human variable domain of a human heavy chain immunoglobulin subgroup having such an amino acid sequence in antibody humanization. Thus, Applicants submit that the heavy chain framework region of the claims herein, in fact, is structurally distinct from the framework regions of the cited references.

Second, with respect to the Examiner's comment that a modification in the framework regions which affects the proximity or orientation of the V_L - V_H interface regions is the same as substituting that FR residue from the import regions that is involved in the effects set forth in paragraph (f) of claim 1, Applicants respectfully invite the Office to point out where exactly the references teach the invention set forth in part (f)(3) of claim 1.

Finally, concerning the allegation that Riechmann *et al.* teaches reduced immunogenicity associated with the humanized antibody, Applicants enclose a copy of Isaacs *et al. The Lancet* **340**:748-752 (1992). Isaacs *et al.* demonstrate that three out of four patients treated with Riechmann's humanized CAMPATH-1H antibody developed antiglobulins that were able to inhibit the binding of CAMPATH-1H to its antigen (see first paragraph of the discussion on page 751 of this reference). On the contrary, repeated administration (*i.e.*, loading dose and 10 weekly doses) of the humanized anti-HER2 antibody (huMAb4D5-8) of Example 1 of the instant application has not lead to an immunogenic response in patients treated therewith (*i.e.* no antibodies against rhuMAb HER2 were detected in any patients). See abstract of Baselga *et al., J. Clin. Oncol.* **14**(3):737-744 (1996), copy attached. Likewise, multidose administrations of an anti-IgE antibody humanized according to the teachings of the instant application and having a consensus human variable domain as claimed herein, did not induce a human antihuman antibody response in any of the patients treated therewith (see column 1, last paragraph on page 311 of Shields *et al., Int. Arch. Allergy Immunol.* **107**:308-312 (1995), copy attached). These data point to the functional distinctness of the claimed consensus human variable domain.

In addition to the desirable lack of immunogenicity of the claimed humanized antibodies, as is apparent from the examples, the binding affinity of an antibody humanized using the claimed method is essentially retained and in some instances is *improved* in the humanized antibody compared to the non-human antibody from which it was derived. As shown, for example, in Table 3 of Example 1, anti-HER2 humanized variants huMAb4D5-6 and huMAb4D5-8 had binding affinities which were superior to the murine antibody from which they were derived. This could not have been predicted from the prior art, especially from Queen *et al.*, which advocated

the best-fit method (see above) and incorporated many (*i.e.*, 15; see Figure 2) murine residues back into the humanized sequence to generate a "high affinity" humanized antibody. The above-mentioned anti-HER2 variants, on the other hand, had only five FR substitutions and were not generated using the "best-fit" method said to be essential by Queen *et al.*

The instantly claimed invention has other novel and non-obvious features. For example, claim 2 involves retaining the human residue, where the corresponding non-homologous import residue is exposed on the surface of the domain. The cited references fail to describe anywhere such a step. Claim 3 is independently patentable, as will be elaborated below. Claim 4 involves replacing consensus glycosylation sites which are not present in the import sequence with the corresponding import residue. The references are silent as to such a step. Similarly, the references fail to describe the additional step of claim 5 of the instant application. Also, the FR residues which can be substituted as now listed in claims 6, 7 and 10 are not disclosed in the cited references. Thus, Applicants submit that the invention recited in the claims of the instant application is clearly non obvious over the cited references.

Accordingly, Applicants request that the above section 103 rejection be withdrawn.

§103 - *In re Durden*

Claims 1, 2, 4-12 and 15 and renumbered claims 19-22 and 24-25 stand rejected under 35 USC §103 as being unpatentable over the Winter patent application, Riechmann *et al.* and Queen *et al.* in view of *In re Durden* 226 USPQ 359 (Fed. Cir. 1985).

The Examiner states that the claimed methods for producing humanized antibodies and for humanization do not appear to differ from what was disclosed in the references. For the reasons given in the previous section, Applicants submit that the instantly claimed methods for humanization and the humanized antibodies are clearly different from what was disclosed in the cited references, especially with respect to the consensus human variable domain forming the FR of the humanized antibody.

Further, the Examiner is respectfully referred to the recent CAFC decisions of In re Brouwer, 37 USPQ2d 1663 (Fed. Cir. 1996) and In re Ochiai, 37 USPQ2d 1127 (Fed. Cir. 1995). These cases stand for the proposition that a *prima facie* case of obviousness cannot be based on Durden, but rather needs to rest on particularized findings. It was held in Brouwer that there are no Durden obviousness rejections *per se*, only sec. 103 obviousness rejections. In the case of the instant claims, where the particular end product is unobvious, these cases hold that the method of making them is also unobvious. In this regard, the Examiner is referred to the Official Gazette notice of 3/26/96, copy enclosed, which establishes guidelines for PTO personnel and the public on the proper consideration of method claims in light of these cases. In this Notice, it is stated that:

[I]nterpreting a claimed invention as a whole requires consideration of all claim limitations. Thus, language in a process claim which recites making or using a nonobvious product must be treated as a material limitation, and a motivation to make or use the nonobvious product must be present in the prior art for a § 103 rejection to be sustained.

In light of Ochiai and Brouwer, Office personnel will consider all claim limitations when analyzing process claims which make or use nonobvious products under § 103. Office personnel will focus on treating claims as a whole and follow the analysis set forth in Graham v. John Deere, 383 U.S. 1, 148 USPQ 459 (1966). (emphasis in original)

Therefore, since there is no motivation in the cited art, as a whole, to make or use the nonobvious product, the claimed methods herein are non-obvious, and Applicants respectfully request that this rejection be reconsidered and withdrawn.

§103 - Claims 3 and 23

Claim 3 and renumbered claim 23 stand rejected under 35 USC §103 as being unpatentable over the Winter patent application, Riechmann *et al.* and Queen *et al.* as applied to claims 1, 2, 4-12, and 15 and further in view of Roitt *et al.*, *Immunology* Gower Medical Publishing Ltd., London, England, pg. 5.5 (1985) for the same reasons set forth in Paper #18.

Applicants submit that claim 3 and FR substitution (c) of claim 23 clearly would not have been obvious in light of the cited references. The three primary references have been discussed

above. Roitt *et al.* merely shows that IgA1 immunoglobulins may possibly have carbohydrate units in their variable domains. No such carbohydrate or oligosaccharide units are depicted in the diagrams of IgD and IgE variable domains in this reference. This reference is not concerned with antibody humanization, much less how to deal with glycosylation sites in humanization. In fact, the 4D5 antibody referred to in Example 1 is fairly unusual in that it has a glycosylation site in its variable region (*i.e.*, residue number 65 of the light chain). As far as Applicants are aware, the instant application teaches, for the first time, how to deal with glycosylation sites in antibody humanization.

Accordingly, Applicants submit that claim 3 and FR substitution (c) of claim 23 are clearly not obvious in light of the references cited and therefore respectfully request that the §103 rejection be withdrawn.

Provisional double patenting rejection

Claims 1-12, 15 and 19-25 are provisionally rejected under the judicially created doctrine of obviousness-type double patenting as being unpatentable over claims 1-12, 15 and 19 of copending application Serial No. 08/439,004. Given the provisional nature of this rejection, Applicants respectfully request that it be held in abeyance pending resolution as to allowable subject matter in this application or in the application on which this provisional rejection is based.] X

§102

Claims 1-12, 15 and 19-25 are rejected under 35 USC §102(e) as being anticipated by US Patent 5,530,101 (the "101 patent"). With respect to claims 1-2 and 19-25, the Examiner is of the view that the 101 patent teaches methods for the production of humanized antibodies wherein the CDR amino acid sequences from the import/donor are exchanged for the human/acceptor CDR amino acid sequences, as well as the alignment of import and human framework regions and selection of substituted human framework antibody residues based on the following effects; the import framework residue noncovalently binds antigen directly, interacts with a CDR, or participates in the V_L-V_H interface. The Examiner asserts that the 101 patent teaches that, if a residue is exposed on the surface of the domain and does not have one of the effects of step (f) of claim 1, one should leave the human residue intact. The Examiner states

that the term "consensus" has been interpreted to include the aligning of murine import framework residues to human acceptor framework residues, in addition to the aligning of all human framework residues and compiling a single "consensus" human framework. The Examiner comments separately on claims 3 and 4, 5, 6-8, 9, 10-12 and 15 and contends that these claims are also anticipated by the 101 patent.

Applicants submit that the instantly claimed invention is not anticipated by the 101 patent for the reasons that follow.

The 101 patent fails to teach the use, in antibody humanization, of a consensus human variable domain, such as that of a human heavy chain immunoglobulin subgroup, as set forth in independent **claims 1, 7, 15 and 22** herein. As to claim 1 (and FR substitution (d) of claim 23), the 101 patent further fails to teach the step of identifying and altering FR residues that participate in the interface between the light chain variable domain and the heavy chain variable domain of an antibody (*i.e.*, the "V_L-V_H interface"). The Examiner takes the view that categories 3, 4 and 5 in columns 14 and 15 of the 101 patent teach selection and substitution of such FR residues, but Applicants respectfully disagree. The FR residues to be identified in categories 3, 4 and 5 of the 101 patent are those which "interact with amino acids in the CDR's", "interact directly with the antigen" or are "rare" for human sequences. There is no explicit teaching in the 101 patent as to category (f)(3) of claim 1 or FR substitution (d) of claim 23 herein.

Hence, Applicants submit that independent claims 1, 7, 15 and 22 as well as FR substitution (d) of claim 23 are clearly novel over the 101 patent.

As to the other rejected claims, Applicants submit that they are further novel over the 101 patent for the reasons which follow.

Claim 2 is concerned with determining whether non-homologous residues are exposed on the surface of the domain or buried within it. Where the non-homologous residue is exposed, the human residue is retained. Applicants submit that determining whether a residue is exposed on the surface of a domain or buried within it as recited in claim 2 is not the same as determining

whether a residue "interacts with a CDR". Applicants contend that the 101 patent in columns 13-14 does not teach the additional step of claim 2 of the instant application.] *

With respect to **claims 3 and 4** (as well as FR substitution (c) of claim 23), Applicants submit that since the Examiner has failed to show where the 101 patent mentions glycosylation, let alone the invention recited in claims 3 and 4 and part (c) of claim 23, these claims must be novel over the 101 patent. If this rejection is to be maintained, Applicants request that the Examiner point out specifically where the 101 patent teaches the method steps of claims 3 and 4 and part (c) of claim 23 herein.

As to **claim 5**, this refers to a step wherein non-homologous residues are identified and the human residue is used, where it represents a residue which is highly conserved across all species at that site. Category 2 in column 14 of the 101 patent refers, on the other hand, to using the "donor amino acid rather than the acceptor". Category 5 in the paragraph bridging columns 15-16 of the 101 patent suggests that neither the donor nor the acceptor residue be used where the donor and acceptor residues are "rare". Clearly, the 101 patent fails to anticipate the method of claim 5 herein.] *

Turning now to **claims 6-8**, the residues specifically mentioned as candidates for substitution in column 15 of the 101 patent (to which the Examiner refers) have been removed from claim 6 and claim 7 (on which claim 8 depends).] *

Concerning **claim 9**, Applicants submit that the 101 patent fails to enable the consensus human variable domain of this claim, but nevertheless the rejection is moot, due to the cancellation of claim 9.

With respect to **claims 10-12**, the residue positions mentioned in column 15 of the 101 patent have been removed from claim 10 (on which claims 11 and 12 depend).] *

As to **claims 19-21**, Applicants submit that these claims are novel over the 101 patent, but they were canceled, and thus the §102 rejection is moot insofar as it applies to these claims.

Serial No. 08/146,206
Page 15

Finally, with respect to **claims 24-25**, Applicants submit that the Examples of the 101 patent require many more FR substitutions than "about 1 to about 5" as recited in these claims.] X

Applicants submit that, for the reasons given above, **claims 1-12, 15 and 19-25** are clearly novel over the 101 patent, and therefore respectfully request that this rejection be reconsidered and withdrawn.

Applicants believe that the amendments and comments here put this case in condition for allowance. Nevertheless, should the Examiner have any further comments or questions, he is invited to call Wendy Lee at (415) 225-1994 concerning these.

Respectfully submitted,
GENENTECH, INC.

Date: June 23, 1997

By: Janet E. Hasak
Janet Hasak
Reg. No. 28,616
(for Wendy M. Lee
Reg. No. 40,378)

460 Pt. San Bruno Blvd.
So. San Francisco, CA 94080-4990
Phone: (415) 225-1994
Fax: (415) 952-9881

Enclosures:
Isaacs et al.
Baselga et al.
Shields et al.
Kabat et al.
OG Notice of 3/26/96



UNITED STATES DEPARTMENT OF COMMERCE
Patent and Trademark Office
 Address: COMMISSIONER OF PATENTS AND TRADEMARKS
 Washington, D.C. 20231

08/146, 206

SERIAL NUMBER	FILING DATE	FIRST NAMED APPLICANT	ATTORNEY DOCKETT NO.
---------------	-------------	-----------------------	----------------------

EXAMINER	<i>28</i>
----------	-----------

ART UNIT	PAPER NUMBER
----------	--------------

DATE MAILED:

EXAMINER INTERVIEW SUMMARY RECORD

All participants (applicant, applicant's representative, PTO personnel):

- (1) PATRICIA NOLAN (3) CHRIS ETSENCHENK
 (2) WENDY LEE (4) _____

Date of interview 7/23/97

Type: Telephonic Personal (copy is given to applicant applicant's representative).

Exhibit shown or demonstration conducted: Yes No. If yes, brief description: _____

Agreement was reached with respect to some or all of the claims in question. was not reached.

Claims discussed: ALL

Identification of prior art discussed: _____

Description of the general nature of what was agreed to if an agreement was reached, or any other comments: It was discussed that Applicant define "consensus" by Framework region residues.

(A fuller description, if necessary, and a copy of the amendments, if available, which the examiner agreed would render the claims allowable must be attached. Also, where no copy of the amendments which would render the claims allowable is available, a summary thereof must be attached.)

1. It is not necessary for applicant to provide a separate record of the substance of the interview.

Unless the paragraph below has been checked to indicate to the contrary, A FORMAL WRITTEN RESPONSE TO THE LAST OFFICE ACTION IS NOT WAIVED AND MUST INCLUDE THE SUBSTANCE OF THE INTERVIEW (e.g., items 1-7 on the reverse side of this form). If a response to the last Office action has already been filed, then applicant is given one month from this interview date to provide a statement of the substance of the interview.

2. Since the examiner's interview summary above (including any attachments) reflects a complete response to each of the objections, rejections and requirements that may be present in the last Office action, and since the claims are now allowable, this completed form is considered to fulfill the response requirements of the last Office action. Applicant is not relieved from providing a separate record of the substance of the interview unless box 1 above is also checked.

Patricia J. Holtz
 Examiner's Signature

IN THE UNITED STATES PATENT AND TRADEMARK OFFICE

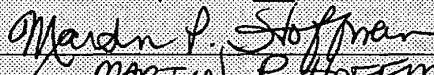
In re Application of Paul J. Carter et al. Serial No.: 08/146,206	Group Art Unit: 1816 Examiner: P. Nolan
Filed: 17 November 1993 For: METHOD FOR MAKING HUMANIZED ANTIBODIES	CERTIFICATE OF HAND DELIVERY I hereby certify that this correspondence is being delivered to Receptionist, Group 1800 of the United States Patent and Trademark Office, Washington, D.C. 20231 on September 2, 1997  Printed Name: MARTIN P. HOFFMAN

#30/f
 C. Hoffman
 10/7/97

SUPPLEMENTAL AMENDMENT

Assistant Commissioner of Patents
 Washington, D.C. 20231
 Sir:

Please amend the application in the following respects:

IN THE SPECIFICATION:

- On page 9, line 1, please replace "muMAb4d5" with --muMAb4D5--.
- On page 9, lines 24, 29, 30 and 31, please replace "huxCD3v9" with --huxCD3v1--.
- On page 9, line 30, please replace "20" with --26--.
- On page 9, line 33, please replace "(o)" with --(●)--.
- On page 84, line 29, please replace "(Fig. 5)" with --(SEQ ID NO:20)--.
- On page 90, please substitute the "SEQUENCE LISTING" with the enclosed paper copy of the "SEQUENCE LISTING".

RECEIVED
 SEP 11 1997
 MATRIX CUSTOMER SERVICE CENTER

REMARKS

This amendment is prepared for the purposes of introducing a substitute sequence listing into the application. Applicants have found that SEQ ID NO:20 from the previously submitted sequence listing corresponds to the heavy chain variable domain sequence of huxCD3v9 (see page 84, line 29), whereas Figure 5 shows the sequence of huxCD3v1. The description of Figure 5 on page 9 has been corrected in this respect and the sequence of huxCD3v1 in Figure 5 is included in the substitute sequence listing as SEQ ID NO:26. Further typographical errors in lines 1 and 33 on page 9 are corrected herein. Furthermore, page 84, line 29 now refers to SEQ ID NO:20, the huxCD3v9 heavy chain variable domain sequence. In accordance with 37 C.F.R. §§1.821(f) and (g), the undersigned hereby states that the content of the paper and the computer readable sequence listings is the same. I further state that this submission includes no new matter.

Respectfully submitted,

GENENTECH, INC.

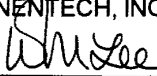
By: 
 Wendy M. Lee
 Reg. No. 40,378

Date: August 29, 1997

1 DNA Way
 South San Francisco, CA 94080-4990
 Phone: (415) 225-1994

SEQUENCE LISTING

(1) GENERAL INFORMATION:

- (i) APPLICANT: Carter, Paul J.
Presta, Leonard G.
 - (ii) TITLE OF INVENTION: Method for Making Humanized Antibodies
 - (iii) NUMBER OF SEQUENCES: 26
 - (iv) CORRESPONDENCE ADDRESS:
 - (A) ADDRESSEE: Genentech, Inc.
 - (B) STREET: 1 DNA Way
 - (C) CITY: South San Francisco
 - (D) STATE: California
 - (E) COUNTRY: USA
 - (F) ZIP: 94080
 - (v) COMPUTER READABLE FORM:
 - (A) MEDIUM TYPE: 3.5 inch, 1.44 Mb floppy disk
 - (B) COMPUTER: IBM PC compatible
 - (C) OPERATING SYSTEM: PC-DOS/MS-DOS
 - (D) SOFTWARE: WinPatin (Genentech)
 - (vi) CURRENT APPLICATION DATA:
 - (A) APPLICATION NUMBER: 08/146206
 - (B) FILING DATE: 17-Nov-1993
 - (C) CLASSIFICATION:
 - F) (vii) PRIOR APPLICATION DATA:
 - (A) APPLICATION NUMBER: 07/715272
 - (B) FILING DATE: 14-JUN-1991
 - (viii) ATTORNEY/AGENT INFORMATION:
 - (A) NAME: Lee, Wendy M.
 - (B) REGISTRATION NUMBER: 40,378
 - (C) REFERENCE/DOCKET NUMBER: P0709P1
 - (ix) TELECOMMUNICATION INFORMATION:
 - (A) TELEPHONE: 650/225-1994
 - (B) TELEFAX: 650/952-9881
- (2) INFORMATION FOR SEQ ID NO:1:

- (i) SEQUENCE CHARACTERISTICS:
 - (A) LENGTH: 109 amino acids
 - (B) TYPE: Amino Acid
 - (D) TOPOLOGY: Linear

(xi) SEQUENCE DESCRIPTION: SEQ ID NO:1:

Asp Ile Gln Met Thr Gln Ser Pro Ser Ser Leu Ser Ala Ser Val
1 5 10 15
Gly Asp Arg Val Thr Ile Thr Cys Arg Ala Ser Gln Asp Val Asn
20 25 30
Thr Ala Val Ala Trp Tyr Gln Gln Lys Pro Gly Lys Ala Pro Lys
35 40 45

Leu Leu Ile Tyr Ser Ala Ser Phe Leu Glu Ser Gly Val Pro Ser
 50 55 60
 Arg Phe Ser Gly Ser Arg Ser Gly Thr Asp Phe Thr Leu Thr Ile
 65 70 75
 Ser Ser Leu Gln Pro Glu Asp Phe Ala Thr Tyr Tyr Cys Gln Gln
 80 85 90
 His Tyr Thr Thr Pro Pro Thr Phe Gly Gln Gly Thr Lys Val Glu
 95 100 105
 Ile Lys Arg Thr
 109

(2) INFORMATION FOR SEQ ID NO:2:

- (i) SEQUENCE CHARACTERISTICS:
 (A) LENGTH: 120 amino acids
 (B) TYPE: Amino Acid
 (D) TOPOLOGY: Linear

(xi) SEQUENCE DESCRIPTION: SEQ ID NO:2:

Glu Val Gln Leu Val Glu Ser Gly Gly Gly Leu Val Gln Pro Gly
 1 5 10 15
 Gly Ser Leu Arg Leu Ser Cys Ala Ala Ser Gly Phe Asn Ile Lys
 20 25 30
 Asp Thr Tyr Ile His Trp Val Arg Gln Ala Pro Gly Lys Gly Leu
 35 40 45
 Glu Trp Val Ala Arg Ile Tyr Pro Thr Asn Gly Tyr Thr Arg Tyr
 50 55 60
 Ala Asp Ser Val Lys Gly Arg Phe Thr Ile Ser Ala Asp Thr Ser
 65 70 75
 Lys Asn Thr Ala Tyr Leu Gln Met Asn Ser Leu Arg Ala Glu Asp
 80 85 90
 Thr Ala Val Tyr Tyr Cys Ser Arg Trp Gly Gly Asp Gly Phe Tyr
 95 100 105
 Ala Met Asp Val Trp Gly Gln Gly Thr Leu Val Thr Val Ser Ser
 110 115 120

(2) INFORMATION FOR SEQ ID NO:3:

- (i) SEQUENCE CHARACTERISTICS:
 (A) LENGTH: 109 amino acids
 (B) TYPE: Amino Acid
 (D) TOPOLOGY: Linear

(xi) SEQUENCE DESCRIPTION: SEQ ID NO:3:

Asp Ile Gln Met Thr Gln Ser Pro Ser Ser Leu Ser Ala Ser Val
 1 5 10 15

Gly Asp Arg Val Thr Ile Thr Cys Arg Ala Ser Gln Asp Val Ser
 20 25 30
 Ser Tyr Leu Ala Trp Tyr Gln Gln Lys Pro Gly Lys Ala Pro Lys
 35 40 45
 Leu Leu Ile Tyr Ala Ala Ser Ser Leu Glu Ser Gly Val Pro Ser
 50 55 60
 Arg Phe Ser Gly Ser Gly Ser Gly Thr Asp Phe Thr Leu Thr Ile
 65 70 75
 Ser Ser Leu Gln Pro Glu Asp Phe Ala Thr Tyr Tyr Cys Gln Gln
 80 85 90
 Tyr Asn Ser Leu Pro Tyr Thr Phe Gly Gln Gly Thr Lys Val Glu
 95 100 105
 Ile Lys Arg Thr
 109

(2) INFORMATION FOR SEQ ID NO:4:

- (i) SEQUENCE CHARACTERISTICS:
 (A) LENGTH: 120 amino acids
 (B) TYPE: Amino Acid
 (D) TOPOLOGY: Linear

(xi) SEQUENCE DESCRIPTION: SEQ ID NO:4:

Glu Val Gln Leu Val Glu Ser Gly Gly Gly Leu Val Gln Pro Gly
 1 5 10 15
 Gly Ser Leu Arg Leu Ser Cys Ala Ala Ser Gly Phe Thr Phe Ser
 20 25 30
 Asp Tyr Ala Met Ser Trp Val Arg Gln Ala Pro Gly Lys Gly Leu
 35 40 45
 Glu Trp Val Ala Val Ile Ser Glu Asn Gly Gly Tyr Thr Arg Tyr
 50 55 60
 Ala Asp Ser Val Lys Gly Arg Phe Thr Ile Ser Ala Asp Thr Ser
 65 70 75
 Lys Asn Thr Ala Tyr Leu Gln Met Asn Ser Leu Arg Ala Glu Asp
 80 85 90
 Thr Ala Val Tyr Tyr Cys Ser Arg Trp Gly Gly Asp Gly Phe Tyr
 95 100 105
 Ala Met Asp Val Trp Gly Gln Gly Thr Leu Val Thr Val Ser Ser
 110 115 120

(2) INFORMATION FOR SEQ ID NO:5:

- (i) SEQUENCE CHARACTERISTICS:
 (A) LENGTH: 109 amino acids
 (B) TYPE: Amino Acid
 (D) TOPOLOGY: Linear

(xi) SEQUENCE DESCRIPTION: SEQ ID NO:5:

Asp Ile Val Met Thr Gln Ser His Lys Phe Met Ser Thr Ser Val
 1 5 10 15
 Gly Asp Arg Val Ser Ile Thr Cys Lys Ala Ser Gln Asp Val Asn
 20 25 30
 Thr Ala Val Ala Trp Tyr Gln Gln Lys Pro Gly His Ser Pro Lys
 35 40 45
 Leu Leu Ile Tyr Ser Ala Ser Phe Arg Tyr Thr Gly Val Pro Asp
 50 55 60
 Arg Phe Thr Gly Asn Arg Ser Gly Thr Asp Phe Thr Phe Thr Ile
 65 70 75
 Ser Ser Val Gln Ala Glu Asp Leu Ala Val Tyr Tyr Cys Gln Gln
 80 85 90
 His Tyr Thr Thr Pro Pro Thr Phe Gly Gly Gly Thr Lys Leu Glu
 95 100 105
 Ile Lys Arg Ala
 109

(2) INFORMATION FOR SEQ ID NO:6:

- (i) SEQUENCE CHARACTERISTICS:
 (A) LENGTH: 120 amino acids
 (B) TYPE: Amino Acid
 (D) TOPOLOGY: Linear

f1

(xi) SEQUENCE DESCRIPTION: SEQ ID NO:6:

Glu Val Gln Leu Gln Gln Ser Gly Pro Glu Leu Val Lys Pro Gly
 1 5 10 15
 Ala Ser Leu Lys Leu Ser Cys Thr Ala Ser Gly Phe Asn Ile Lys
 20 25 30
 Asp Thr Tyr Ile His Trp Val Lys Gln Arg Pro Glu Gln Gly Leu
 35 40 45
 Glu Trp Ile Gly Arg Ile Tyr Pro Thr Asn Gly Tyr Thr Arg Tyr
 50 55 60
 Asp Pro Lys Phe Gln Asp Lys Ala Thr Ile Thr Ala Asp Thr Ser
 65 70 75
 Ser Asn Thr Ala Tyr Leu Gln Val Ser Arg Leu Thr Ser Glu Asp
 80 85 90
 Thr Ala Val Tyr Tyr Cys Ser Arg Trp Gly Gly Asp Gly Phe Tyr
 95 100 105
 Ala Met Asp Tyr Trp Gly Gln Gly Ala Ser Val Thr Val Ser Ser
 110 115 120

(2) INFORMATION FOR SEQ ID NO:7:

- (i) SEQUENCE CHARACTERISTICS:
 - (A) LENGTH: 27 base pairs
 - (B) TYPE: Nucleic Acid
 - (C) STRANDEDNESS: Single
 - (D) TOPOLOGY: Linear

(xi) SEQUENCE DESCRIPTION: SEQ ID NO:7:

TCCGATATCC AGCTGACCCA GTCTCCA 27

(2) INFORMATION FOR SEQ ID NO:8:

- (i) SEQUENCE CHARACTERISTICS:
 - (A) LENGTH: 31 base pairs
 - (B) TYPE: Nucleic Acid
 - (C) STRANDEDNESS: Single
 - (D) TOPOLOGY: Linear

(xi) SEQUENCE DESCRIPTION: SEQ ID NO:8:

GTTTGATCTC CAGCTTGGTA CCHSCDCCGA A 31

(2) INFORMATION FOR SEQ ID NO:9:

- (i) SEQUENCE CHARACTERISTICS:
 - (A) LENGTH: 22 base pairs
 - (B) TYPE: Nucleic Acid
 - (C) STRANDEDNESS: Single
 - (D) TOPOLOGY: Linear

F1

(xi) SEQUENCE DESCRIPTION: SEQ ID NO:9:

AGGTSMARCT GCAGSAGTCW GG 22

(2) INFORMATION FOR SEQ ID NO:10:

- (i) SEQUENCE CHARACTERISTICS:
 - (A) LENGTH: 34 base pairs
 - (B) TYPE: Nucleic Acid
 - (C) STRANDEDNESS: Single
 - (D) TOPOLOGY: Linear

(xi) SEQUENCE DESCRIPTION: SEQ ID NO:10:

TGAGGAGACG GTGACCGTGG TCCCTTGGCC CCAG 34

(2) INFORMATION FOR SEQ ID NO:11:

- (i) SEQUENCE CHARACTERISTICS:
 - (A) LENGTH: 36 base pairs
 - (B) TYPE: Nucleic Acid
 - (C) STRANDEDNESS: Single
 - (D) TOPOLOGY: Linear

(xi) SEQUENCE DESCRIPTION: SEQ ID NO:11:

GTAGATAAAT CCTCTAACAC AGCCTATCTG CAAATG 36

(2) INFORMATION FOR SEQ ID NO:12:

- (i) SEQUENCE CHARACTERISTICS:
 - (A) LENGTH: 36 base pairs
 - (B) TYPE: Nucleic Acid
 - (C) STRANDEDNESS: Single
 - (D) TOPOLOGY: Linear

(xi) SEQUENCE DESCRIPTION: SEQ ID NO:12:

GTAGATAAAT CCAAATCTAC AGCCTATCTG CAAATG 36

(2) INFORMATION FOR SEQ ID NO:13:

- (i) SEQUENCE CHARACTERISTICS:
 - (A) LENGTH: 36 base pairs
 - (B) TYPE: Nucleic Acid
 - (C) STRANDEDNESS: Single
 - (D) TOPOLOGY: Linear

(xi) SEQUENCE DESCRIPTION: SEQ ID NO:13:

GTAGATAAAT CCTCTTCTAC AGCCTATCTG CAAATG 36

(2) INFORMATION FOR SEQ ID NO:14:

- R1
- (i) SEQUENCE CHARACTERISTICS:
 - (A) LENGTH: 68 base pairs
 - (B) TYPE: Nucleic Acid
 - (C) STRANDEDNESS: Single
 - (D) TOPOLOGY: Linear

(xi) SEQUENCE DESCRIPTION: SEQ ID NO:14:

CTTATAAAGG TGTTCACC TATAACCAGA AATCAAGGA TCGTTTCACG 50

ATATCCGTAG ATAAATCC 68

(2) INFORMATION FOR SEQ ID NO:15:

- (i) SEQUENCE CHARACTERISTICS:
 - (A) LENGTH: 30 base pairs
 - (B) TYPE: Nucleic Acid
 - (C) STRANDEDNESS: Single
 - (D) TOPOLOGY: Linear

(xi) SEQUENCE DESCRIPTION: SEQ ID NO:15:

CTATACCTCC CGTCTGCATT CTGGAGTCCC 30

(2) INFORMATION FOR SEQ ID NO:16:

(i) SEQUENCE CHARACTERISTICS:
(A) LENGTH: 107 amino acids
(B) TYPE: Amino Acid
(D) TOPOLOGY: Linear

(xi) SEQUENCE DESCRIPTION: SEQ ID NO:16:

Asp Ile Gln Met Thr Gln Thr Thr Ser Ser Leu Ser Ala Ser Leu
1 5 10 15
Gly Asp Arg Val Thr Ile Ser Cys Arg Ala Ser Gln Asp Ile Arg
20 25 30
Asn Tyr Leu Asn Trp Tyr Gln Gln Lys Pro Asp Gly Thr Val Lys
35 40 45
Leu Leu Ile Tyr Tyr Thr Ser Arg Leu His Ser Gly Val Pro Ser
50 55 60
Lys Phe Ser Gly Ser Gly Ser Gly Thr Asp Tyr Ser Leu Thr Ile
65 70 75
Ser Asn Leu Glu Gln Glu Asp Ile Ala Thr Tyr Phe Cys Gln Gln
80 85 90
Gly Asn Thr Leu Pro Trp Thr Phe Ala Gly Gly Thr Lys Leu Glu
95 100 105
Ile Lys
107

(2) INFORMATION FOR SEQ ID NO:17:

R1
(i) SEQUENCE CHARACTERISTICS:
(A) LENGTH: 107 amino acids
(B) TYPE: Amino Acid
(D) TOPOLOGY: Linear

(xi) SEQUENCE DESCRIPTION: SEQ ID NO:17:

Asp Ile Gln Met Thr Gln Ser Pro Ser Ser Leu Ser Ala Ser Val
1 5 10 15
Gly Asp Arg Val Thr Ile Thr Cys Arg Ala Ser Gln Asp Ile Arg
20 25 30
Asn Tyr Leu Asn Trp Tyr Gln Gln Lys Pro Gly Lys Ala Pro Lys
35 40 45
Leu Leu Ile Tyr Tyr Thr Ser Arg Leu Glu Ser Gly Val Pro Ser
50 55 60
Arg Phe Ser Gly Ser Gly Ser Gly Thr Asp Tyr Thr Leu Thr Ile
65 70 75
Ser Ser Leu Gln Pro Glu Asp Phe Ala Thr Tyr Tyr Cys Gln Gln
80 85 90
Gly Asn Thr Leu Pro Trp Thr Phe Gly Gln Gly Thr Lys Val Glu
95 100 105

Ile Lys
107

(2) INFORMATION FOR SEQ ID NO:18:

- (i) SEQUENCE CHARACTERISTICS:
(A) LENGTH: 107 amino acids
(B) TYPE: Amino Acid
(D) TOPOLOGY: Linear

(xi) SEQUENCE DESCRIPTION: SEQ ID NO:18:

Asp Ile Gln Met Thr Gln Ser Pro Ser Ser Leu Ser Ala Ser Val
1 5 10 15
Gly Asp Arg Val Thr Ile Thr Cys Arg Ala Ser Gln Ser Ile Ser
20 25 30
Asn Tyr Leu Ala Trp Tyr Gln Gln Lys Pro Gly Lys Ala Pro Lys
35 40 45
Leu Leu Ile Tyr Ala Ala Ser Ser Leu Glu Ser Gly Val Pro Ser
50 55 60
Arg Phe Ser Gly Ser Gly Ser Gly Thr Asp Phe Thr Leu Thr Ile
65 70 75
Ser Ser Leu Gln Pro Glu Asp Phe Ala Thr Tyr Tyr Cys Gln Gln
80 85 90
Tyr Asn Ser Leu Pro Trp Thr Phe Gly Gln Gly Thr Lys Val Glu
95 100 105

F1

Ile Lys
107

(2) INFORMATION FOR SEQ ID NO:19:

- (i) SEQUENCE CHARACTERISTICS:
(A) LENGTH: 122 amino acids
(B) TYPE: Amino Acid
(D) TOPOLOGY: Linear

(xi) SEQUENCE DESCRIPTION: SEQ ID NO:19:

Glu Val Gln Leu Gln Gln Ser Gly Pro Glu Leu Val Lys Pro Gly
1 5 10 15
Ala Ser Met Lys Ile Ser Cys Lys Ala Ser Gly Tyr Ser Phe Thr
20 25 30
Gly Tyr Thr Met Asn Trp Val Lys Gln Ser His Gly Lys Asn Leu
35 40 45
Glu Trp Met Gly Leu Ile Asn Pro Tyr Lys Gly Val Ser Thr Tyr
50 55 60
Asn Gln Lys Phe Lys Asp Lys Ala Thr Leu Thr Val Asp Lys Ser
65 70 75

Ser Ser Thr Ala Tyr Met Glu Leu Leu Ser Leu Thr Ser Glu Asp
80 85 90

Ser Ala Val Tyr Tyr Cys Ala Arg Ser Gly Tyr Tyr Gly Asp Ser
95 100 105

Asp Trp Tyr Phe Asp Val Trp Gly Ala Gly Thr Thr Val Thr Val
110 115 120

Ser Ser
122

(2) INFORMATION FOR SEQ ID NO:20:

- (i) SEQUENCE CHARACTERISTICS:
(A) LENGTH: 122 amino acids
(B) TYPE: Amino Acid
(D) TOPOLOGY: Linear

(xi) SEQUENCE DESCRIPTION: SEQ ID NO:20:

Glu Val Gln Leu Val Glu Ser Gly Gly Gly Leu Val Gln Pro Gly
1 5 10 15

Gly Ser Leu Arg Leu Ser Cys Ala Ala Ser Gly Tyr Ser Phe Thr
20 25 30

Gly Tyr Thr Met Asn Trp Val Arg Gln Ala Pro Gly Lys Gly Leu
35 40 45

Glu Trp Val Ala Leu Ile Asn Pro Tyr Lys Gly Val Ser Thr Tyr
50 55 60

Asn Gln Lys Phe Lys Asp Arg Phe Thr Ile Ser Val Asp Lys Ser
65 70 75

Lys Asn Thr Ala Tyr Leu Gln Met Asn Ser Leu Arg Ala Glu Asp
80 85 90

Thr Ala Val Tyr Tyr Cys Ala Arg Ser Gly Tyr Tyr Gly Asp Ser
95 100 105

Asp Trp Tyr Phe Asp Val Trp Gly Gln Gly Thr Leu Val Thr Val
110 115 120

Ser Ser
122

f1

(2) INFORMATION FOR SEQ ID NO:21:

- (i) SEQUENCE CHARACTERISTICS:
(A) LENGTH: 122 amino acids
(B) TYPE: Amino Acid
(D) TOPOLOGY: Linear

(xi) SEQUENCE DESCRIPTION: SEQ ID NO:21:

Glu Val Gln Leu Val Glu Ser Gly Gly Gly Leu Val Gln Pro Gly
1 5 10 15

#33
[Handwritten signature]
 10/7/97

IN THE UNITED STATES PATENT AND TRADEMARK OFFICE

In re Application of Paul J. Carter et al.	Group Art Unit: 1816 Examiner: P. Nolan
Serial No.: 08/146,206 Filed: November 17, 1993 For: METHOD FOR MAKING HUMANIZED ANTIBODIES	CERTIFICATE OF HAND DELIVERY I hereby certify that this correspondence is being delivered to Receptionist, Group 1800 of the United States Patent and Trademark Office, Washington, D.C. 20231 on <i>Sept. 2</i> August, 1997 <i>MARTIN P. HOFFMAN</i> Printed Name: <i>Martin P. Hoffmann</i>

SUPPLEMENTAL INFORMATION DISCLOSURE STATEMENT

RECEIVED
SEP 1 1997
MATRIX CUSTOMER SERVICE CENTER

Assistant Commissioner of Patents
 Washington, D.C. 20231

Sir:

Applicants submit herewith patents, publications or other information (attached hereto and listed on the attached Form PTO-1449) of which they are aware, which they believe may be material to the examination of this application and in respect of which there may be a duty to disclose in accordance with 37 CFR §1.56.

This Information Disclosure Statement:

- (a) accompanies the new patent application submitted herewith. 37 CFR §1.97(a).
- (b) is filed within three months after the filing date of the application or within three months after the date of entry of the national stage of a PCT application as set forth in 37 CFR§1.491.
- (c) as far as is known to the undersigned, is filed before the mailing date of a first Office action on the merits.
- (d) is filed after the first Office Action and more than three months after the application's filing date or PCT national stage date of entry filing but, as far as is known to the undersigned, prior to the mailing date of either a final rejection or a notice of allowance, whichever occurs first, and is accompanied by either the fee (\$230) set forth in 37 CFR §1.17(p) or a certification as specified in 37 CFR §1.97(e), as checked below. Should any fee be due, the U.S. Patent and Trademark Office is hereby authorized to charge Deposit Account No. 07-0630 in the amount of \$220.00 to cover the cost of this Information Disclosure Statement. Any deficiency or overpayment should be charged or credited to this deposit account. **A duplicate of this sheet is enclosed.**

- (e) is filed after the mailing date of either a final rejection or a notice of allowance, whichever occurred first, and is accompanied by the fee (\$130) set forth in 37 CFR §1.17(i)(1) and a certification as specified in 37 CFR §1.97(e), as checked below. **This document is to be considered as a petition requesting consideration of the information disclosure statement.** The U.S. Patent and Trademark Office is hereby authorized to charge Deposit Account No. 07-0630 in the amount of \$130.00 to cover the cost of this Information Disclosure Statement. Any deficiency or overpayment should be charged or credited to this deposit account. **A duplicate of this sheet is enclosed.**

[If either of boxes (d) or (e) is checked above, the following "certification" under 37 CFR §1.97(e) may need to be completed.] The undersigned certifies that:

- Each item of information contained in the information disclosure statement was cited in a communication mailed from a foreign patent office in a counterpart foreign application not more than three months prior to the filing of this information disclosure statement.
- No item of information contained in this information disclosure statement was cited in a communication mailed from a foreign patent office in a counterpart foreign application or, to the knowledge of the undersigned after making reasonable inquiry, was known to any individual designated in 37 CFR §1.56(c) more than three months prior to the filing of this information disclosure statement.

A list of the patent(s) or publication(s) is set forth on the attached Form PTO-1449 (Modified).

A copy of the items on PTO-1449 is supplied herewith:

each none only those listed below:

Those patent(s) or publication(s) which are marked with an asterisk (*) in the attached PTO-1449 form are not supplied because they were previously cited by or submitted to the Office in a prior application Serial No. ____, filed _____ and relied upon in this application for an earlier filing date under 35 USC §120.

A concise explanation of relevance of the items listed on PTO-1449 is:

- not given
- given for each listed item
- given for only non-English language listed item(s) [Required]
- in the form of an English language copy of a Search Report from a foreign patent office, issued in a counterpart application, which refers to the relevant portions of the references.

The Examiner is reminded that a "concise explanation of the relevance" of the submitted prior art "may be nothing more than identification of the particular figure or paragraph of the patent or publication which has some relation to the claimed invention," MPEP §609.

While the information and references disclosed in this Information Disclosure Statement may be "material" pursuant to 37 CFR §1.56, it is not intended to constitute an admission that any patent, publication or other information referred to therein is "prior art" for this invention unless specifically designated as such.

In accordance with 37 CFR §1.97(g), the filing of this Information Disclosure Statement shall not be construed to mean that a search has been made or that no other material information as defined in 37 CFR §1.56(a) exists. It is submitted that the Information Disclosure Statement is in compliance with 37 CFR §1.98 and MPEP §609 and the Examiner is respectfully requested to consider the listed references.

Respectfully submitted,

GENENTECH, INC.

Date: August 29, 1997

By: _____

Wendy M. Lee
Reg. No. 40,378

460 Pt. San Bruno Blvd.
So. San Francisco, CA 94080-4990
Phone: (415) 225-1994
Fax: (415) 952-9881

FORM PTO-1449 LIST OF DISCLOSURES CITED BY APPLICANT (Use several sheets if necessary)	U.S. Dept. of Commerce Patent and Trademark Office	Atty Docket No. P0709P1	Serial No. 08/146,206
		Applicant Carter et al.	
		Filing Date 17 Nov 1993	Group 1806

U.S. PATENT DOCUMENTS							
Examiner Initials	Document Number	Date	Name	Class	Subclass	Filing Date	
<i>TJS</i> ↓	100	4,845,198	04.07.89	Urdal et al.	530	388.22	
	101	5,132,405	21.07.92	Huston et al.	530	387.3	
	102	5,558,864	24.09.96	Bendig et al.	424	133.1	
	103	5,585,089	17.12.96	Queen et al.	424	133.1	

FOREIGN PATENT DOCUMENTS							
Examiner Initials	Document Number	Date	Country	Class	Subclass	Translation Yes No	
<i>TJS</i> ↓	104	323,806 A1	12.07.89	EPO			
	105	338,745 A1	25.10.89	EPO			
	106	365,209 A2	25.04.90	EPO			
	107	365,997 A2	02.05.90	EPO			
	108	432,249 B1	25.09.96	EPO			
	109	682,040 A1	15.11.95	EPO			
	110	WO 87/02671	07.05.87	PCT			
	111	WO 88/09344	01.12.88	PCT			
	112	WO 91/07500	30.05.91	PCT			
	113	WO 92/01047	23.01.92	PCT			
	114	WO 92/04380	19.03.92	PCT			

OTHER DISCLOSURES (Including Author, Title, Date, Pertinent Pages, etc.)		
<i>TJS</i> ↓	115	Amit et al., "Three-Dimensional Structure of an Antigen-Antibody Complex at 2.8 A Resolution" <u>Science</u> 233:747-753 (Aug 1986)
	116	Amzel et al., "The Three Dimensional Structure of a Combining Region-Ligand Complex of Immunglobulin NEW at 3.5-A Resolution" <u>Proc. Natl. Acad. Sci. USA</u> 71(4):1427-1430 (Apr 1974)
	117	Baselga et al., "Phase II Study of Weekly Intravenous Recombinant Humanized Anti-p185/HER2 Monoclonal Antibody in Patients With HER2/neu-Overexpressing Metastatic Breast Cancer" <u>J. Clin. Oncol.</u> 14(3):737-744 (1996)
	118	Beverley & Callard, "Distinctive functional characteristics of human "T" lymphocytes defined by E rosetting or a monoclonal anti-T cell antibody" <u>European Journal of Immunology</u> 11:329-334 (1981)
	119	Bird et al., "Single-chain antigen-binding proteins" <u>Science</u> 242:423-426 (Oct 1988)
	120	Brennan et al., "Preparation of bispecific antibodies by chemical recombination of monoclonal immunoglobulin G ₁ fragments" <u>Science</u> 229:81-83 (July 1985)
	121	Brucoleri et al., "Structure of antibody hypervariable loops reproduced by a conformational search algorithm" <u>Nature</u> 335:564-568 (Oct 1988)
	122	Caron et al., "Biological and Immunological Features of Humanized M195 (Anti-CD33) Monoclonal Antibodies" <u>Cancer Research</u> 52:6761-6767 (Dec 1992)
	123	Choithia & Lesk, "The relation between the divergence of sequence and structure in proteins" <u>EMBO Journal</u> 5(4):823-826 (1986)

Examiner <i>M.T. DAVIS</i>	Date Considered <i>12/05/01</i>
-------------------------------	------------------------------------

*Examiner: Initial if reference considered, whether or not citation is in conformance with MPEP 609; draw line through citation if not in conformance and not considered. Include copy of this form with next communication to applicant.

FORM PTO-1449 LIST OF DISCLOSURES CITED BY APPLICANT (Use several sheets if necessary)	U.S. Dept. of Commerce Patent and Trademark Office		Atty Docket No. P0709P1	Serial No. 08/146,206
	Applicant Carter et al.			
	Filing Date 17 Nov 1993		Group 1806	

OTHER DISCLOSURES (Including Author, Title, Date, Pertinent Pages, etc.)

124	Co & Queen, "Humanized antibodies for therapy" <u>Nature</u> 351:501-502 (Jun 1991)
125	Co et al., "Chimeric and Humanized Antibodies with Specificity for the CD33 Antigen" <u>J. of Immunology</u> 148(4):1149-1154 (Feb 1992)
126	Co et al., "Humanized Anti-Lewis Y Antibodies: In Vitro Properties and Pharmacokinetics in Rhesus Monkeys" <u>Cancer Research</u> 56:1118-1125 (Mar 1996)
127	Colman et al., "Crystal and Molecular Structure of the Dimer of Variable Domains of the Bence-Jones Protein ROY" <u>J. Mol. Biol.</u> 116:73-79 (1977)
128	Colman et al., "Three-dimensional structure of a complex of antibody with influenza virus neuraminidase" <u>Nature</u> 326:358-363 (Mar 1987)
129	Cook et al., "A map of the human immunoglobulin V _H locus completed by analysis of the telometric region of chromosome 14q" <u>Nature Genetics</u> 7:162-168 (Jun 1994)
130	Darsley & Rees, "Nucleotide sequences of five anti-lysozyme monoclonal antibodies" <u>EMBO Journal</u> 4(2):393-398 (1985)
131	Davies & Metzger, "Structural Basis of Antibody Function" <u>Ann. Rev. Immunol.</u> 1:87-117 (1983)
132	Davies et al., "Antibody-Antigen Complexes" <u>Journal of Biological Chemistry</u> 263(22):10541-10544 (Aug. 1988)
133	Eigenbrot et al., "X-Ray Structures of Fragments From Binding and Nonbinding Versions of a Humanized Anti-CD18 Antibody: Structural Indications of the Key Role of V _H Residues 59 to 65" <u>Proteins</u> 18:49-62 (1994)
134	Eigenbrot et al., "X-ray structures of the antigen-binding domains from three variants of humanized anti-p185HER2 antibody 4D5 and comparison with molecular modeling" <u>J. Mol. Biol.</u> 229:969-995 (1993)
135	Ellison et al., "The nucleotide sequence of a human immunoglobulin C _{γ1} gene" <u>Nucleic Acids Research</u> 10(13):4071-4079 (1982)
136	Emery & Adair, "Humanised monoclonal antibodies for therapeutic applications" <u>Exp. Opin. Invest. Drugs</u> 3(3):241-251 (1994)
137	Epp et al., "Crystal and Molecular Structure of a Dimer Composed of the Variable Portions of the Bence-Jones Protein REI" <u>European Journal of Biochemistry</u> 45:513-524 (1974)
138	Fanger et al., "Bispecific antibodies and targeted cellular cytotoxicity" <u>Immunology Today</u> 12(2):51-54 (1991)
139	Fanger et al., "Cytotoxicity mediated by human Fc receptors for IgG" <u>Immunology Today</u> 10(3):92-99 (1989)
140	Feldmann et al., "A Hypothetical Space-Filling Model of the V-Regions of the Galactan-Binding Myeloma Immunoglobulin J539" <u>Molecular Immunology</u> 18(8):683-698 (1981)
141	Fendley et al., "The Extracellular Domain of HER2/neu Is a Potential Immunogen for Active Specific Immunotherapy of Breast Cancer" <u>J. Biol. Resp. Mod.</u> 9:449-455 (1990)
142	Glennie et al., "Preparation and Performance of Bispecific F(ab'γ) ₂ Antibody Containing Thioether-Linked Fab'γ Fragments" <u>J. Immunol.</u> 139(7):2367-2375 (October 1, 1987)
143	Gonzalez et al., "Humanization of Murine 6G425: An Anti-IL8 Monoclonal Antibody Which Blocks Binding of IL8 to Human Neutrophils" <u>1996 Keystone Symposia on Exploring and Exploiting Antibody and Ig Superfamily Combining Sites</u> (Poster) pps. 1-21 (February 1996)

Examiner <i>M. T. Davie</i>	Date Considered <i>12/05/01</i>
--------------------------------	------------------------------------

*Examiner: Initial if reference considered, whether or not citation is in conformance with MPEP 609; draw line through citation if not in conformance and not considered. Include copy of this form with next communication to applicant.

FORM PTO-1449		U.S. Dept. of Commerce Patent and Trademark Office		Atty Docket No. P0709P1	Serial No. 08/146,206
LIST OF DISCLOSURES CITED BY APPLICANT (Use several sheets if necessary)				Applicant Carter et al.	
				Filing Date 17 Nov 1993	
OTHER DISCLOSURES (Including Author, Title, Date, Pertinent Pages, etc.)					
<div style="font-size: 2em; font-weight: bold;">TDS</div> <div style="font-size: 4em; font-weight: bold; margin-top: 20px;">↓</div>	144	Gussow & Seemann, "Humanization of Monoclonal Antibodies" <u>Meth. Enzymology</u> , Academic Press, Inc. Vol. 203:99-121 (1991)			
	145	Hieter et al., "Cloned human and mouse kappa immunoglobulin constant and J region genes conserve homology in functional segments" <u>Cell</u> 22(Part 1):197-207 (1980)			
	146	Houghton, A., "Building a better monoclonal antibody" <u>Immunology Today</u> 9(9):265-267 (1988)			
	147	Huston et al., "Protein engineering of antibody binding sites: Recovery of specific activity in an anti-digoxin single-chain Fv analogue produced in Escherichia coli" <u>Proc. Natl. Acad. Sci. USA</u> 85:5879-5883 (Aug 1988)			
	148	Isaacs et al., "Humanised Monoclonal Antibody Therapy for Rheumatoid Arthritis" <u>Lancet</u> 340:748-752 (September 26, 1992)			
	149	Johnson et al., "Biological and Molecular Modeling Studies Comparing Murine Monoclonal Antibodies with Their Engineered Chimeric and Humanized Counterparts" <u>J. Cell. Biochem. Suppl</u> 0 (13 Part A) (18th Ann. UCLA Symp on Mol. & Cell. Biol., Park City, UT 1/17-22/89) pps. 87 (1989)			
	150	Kabat E., "Origins of Antibody Complementarity and Specificity - Hypervariable Regions and the Minigen Hypothesis" <u>J. of Immunology</u> 125(3):961-969 (Sep 1980)			
	151	Kabat et al. <u>Sequences of Proteins of Immunological Interest</u> , U.S. Dept. of Health and Human Services, NIH, 5th edition Vol. 1:103-108, 324-331 (1991)			
	152	Kabat et al., "Sequences of Proteins of Immunological Interest, 4th Edition" pps. iii-xxvii, 41-76, 160-175 (1987) <i>Dupl.</i>			
	153	Kindt & Capra <u>The Antibody Enigma</u> , New York:Plenum Press pps. 79-86 (1984)			
	154	Lesk & Chothia, "Evolution of Proteins Formed by β -Sheets" <u>J. Mol. Biol.</u> 160:325-342 (1982)			
	155	Lesk & Chothia, "The response of protein structures to amino-acid sequence changes" <u>Phil. Trans. R. Soc. Lond. A</u> 317:345-356 (1986)			
	156	Mariuzza et al., "The Structure Basis of Antigen-Antibody Recognition" <u>Ann. Rev. Biophys. Biophys. Chem.</u> 16:139-159 (1987)			
	157	Nadler et al., "Immunogenicity of Humanized and Human Monoclonal Antibodies" <u>Clin. Pharmacology & Therapeutics</u> pps. 180 (Feb 1994)			
	158	Nelson, H., "Targeted Cellular Immunotherapy with Bifunctional Antibodies" <u>Cancer Cells</u> 3:163-172 (1991)			
	159	Neuberger et al., "Antibody Engineering" <u>Proceedings 8th Intl. Biotech. Symp., Paris II</u> :792-799 (1988)			
	160	Newmark, P., "Making Chimeric Antibodies Even More Human" <u>Bio/Technology</u> 6:468 (May 1988)			
	161	Nishimura et al., "Human c-erbB-2 Proto-Oncogene Product as a Target for Bispecific-Antibody-Directed Adoptive Tumor Immunotherapy" <u>Int. J. Cancer</u> 50:800-804 (1992)			
	162	Nitta et al., "Preliminary trial of specific targeting therapy against malignant glioma" <u>Lancet</u> 335(8686):368-371 (Feb 17, 1990)			
163	Nitta, T. et al., "Bispecific F(ab') ₂ monomer prepared with anti-CD3 and anti-tumor monoclonal antibodies is most potent in induction of cytolysis of human T cells" <u>European Journal of Immunology</u> 19:1437-1441 (1989)				
Examiner <i>M. T. Davis</i>				Date Considered <i>12/05/01</i>	
*Examiner: Initial if reference considered, whether or not citation is in conformance with MPEP 609; draw line through citation if not in conformance and not considered. Include copy of this form with next communication to applicant.					

FORM PTO-1449 LIST OF DISCLOSURES CITED BY APPLICANT (Use several sheets if necessary)	U.S. Dept. of Commerce Patent and Trademark Office		Atty Docket No. P0709P1	Serial No. 08/146,206
	Applicant Carter et al.			
	Filing Date 17 Nov 1993	Group 1806		

OTHER DISCLOSURES (Including Author, Title, Date, Pertinent Pages, etc.)

164	Nolan et al., "Bifunctional antibodies: concept, production and applications" <u>Biochimica et Biophysica Acta</u> 1040:1-11 (1990)
165	O'Connor et al., "Calcium Dependence of an Anti-Protein C Humanized Antibody Involves Framework Residues" (manuscript)
166	Orlandi et al., "Cloning Immunoglobulin Variable Domains for Expression by the Polymerase Chain Reaction" <u>Proc. Natl. Acad. Sci. USA</u> 86:3833-3837 (May 1989)
167	Orlandi et al., "Cloning of cDNA Corresponding to Heavy and Light Chain Immunoglobulin Variable Domains" <u>Protein and Pharmaceutical Engineering</u> pps. 90 (1989)
168	Ostberg & Queen, "Human and humanized monoclonal antibodies: preclinical studies and clinical experience" <u>Biochem. Soc. Transactions</u> pps. 1038-1043 (1995)
169	Padlan et al., "Model-building Studies of Antigen-binding Sites: The Hapten-binding Site of MOPC-315" <u>Cold Springs Harbor Symposia On Quantitative Biology</u> XLI:627-637 (1977)
170	Padlan, E., "Anatomy of the Antibody Molecule" <u>Molecular Immunology</u> 31(3):169-217 (1994)
171	Padlan, E., "Evaluation of the Structural Variation Among Light Chain Variable Domains" <u>Molecular Immunology</u> 16:287-296 (1979)
172	Palm & Hilschmann, "Primary structure of a crystalline monoclonal immunoglobulin K-type L-chain, subgroup I (Bence-Jones preotin Rei); isolation & characterization of the tryptic peptides:..." <u>Hoppes-Sevler's Z. Physiol. Chem.</u> 356:167-191 (Feb 1975)
173	Palm & Hilschmann, "The primary structure of a crystalline, monoclonal immunoglobulin-L-chain of the x-type, subgroup I (Bence-Jones Protein Rei): a contribution to the elucidation of the three-dimensional structure of the immunoglobulins" <u>Hoppe-Sevler's Z. Physiol. Chem.</u> 354:1651-1654 (Dec 1973)
174	Panka et al., "Variable region framework differences result in decreased or increased affinity of variant anti-digoxin antibodies" <u>Proc. Natl. Acad. Sci. USA</u> 85:3080-3084 (May 1988)
175	Presta et al., "Humanization of an anti-VEGF monoclonal antibody for the therapy of solid tumors and other disorders" <u>Cancer Research</u> (in press) pps. 1-32
176	Presta et al., "Humanization of an Antibody Directed Against IgE" <u>J. Immunol.</u> 151(5):2623-2632 (September 1, 1993)
177	Preval & Fougereau, "Specific Interaction between V _H and V _L Regions of Human Monoclonal Immunoglobulins" <u>J. Mol. Biol.</u> 102:657-678 (1976)
178	Queen et al., "Construction of Humanized Antibodies and Testing in Primates" <u>J. Cell. Biochem. Suppl.</u> 15, (Part E) (20th Ann. Mtg. Keystone Symp. Denver, CO, Mar 10-16, 1991) pps. 137 (1991)
179	Queen et al., "Humanised antibodies to the IL-2 receptor" <u>Protein Eng. Antibody Mol. Prophyl. Ther. Appl. Man.</u> Clark, M., Nottingham, UK: Academic Titles pps. 159-70 (1993)
180	Rhodes & Birch, "Large-Scale Production of Proteins from Mammalian Cells" <u>Bio/Technology</u> 6:518, 521, 523 (May 1988)
181	Riechmann, "Declaration" from EP Opposition to EP Patent No. 451,261 B1 (Oct 23, 1996)
182	Riechmann, "Humanizing of Recombinant Antibodies" (Intl. Symp. on Clin. Appl. of Monoclonal Antibodies, Guildford, England) pps. 33-34 (Sep 1987)
183	Riechmann & Winter, "Recombinant Antibodies" (U. of London Royal Postgraduate Medical School, Wolfson Institute, Abstract) (May 1987)

Examiner <i>M.T. Davis</i>	Date Considered <i>12/05/01</i>
-------------------------------	------------------------------------

*Examiner: Initial if reference considered, whether or not citation is in conformance with MPEP 609; draw line through citation if not in conformance and not considered. Include copy of this form with next communication to applicant.

FORM PTO-1449		U.S. Dept. of Commerce Patent and Trademark Office		Atty Docket No. P0709P1	Serial No. 08/146,206
LIST OF DISCLOSURES CITED BY APPLICANT (Use several sheets if necessary)				Applicant Carter et al.	
				Filing Date 17 Nov 1993	
OTHER DISCLOSURES (Including Author, Title, Date, Pertinent Pages, etc.)					
				Riechmann et al. <u>Alignment of VL Sequences</u> (1988)	
	185			Roberts & Rees, "Generation of an antibody with enhanced affinity and specificity for its antigen by protein engineering" <u>Nature</u> 328:731-734 (Aug 1987)	
	186			Rostapshov et al., "Effective method for obtaining long nucleotide chains on partially complementary templates" <u>FEBS Letters</u> 249(2):379-382 (Jun 1989)	
	187			Schneider et al., "The Anti-Idiotypic Response by Cynomolgus Monkeys to Humanized Anti-Tac Is Primarily Directed to Complementarity-Determining Regions H1, H2, and L3" <u>J. of Immunology</u> 150:3086-3090 (Apr 1993)	
	188			Sedlacek et al., "Monoclonal Antibodies in Tumor Therapy", Karger pps. 119-126, 133-179 (1988)	
	189			Shields et al., "Inhibition of Allergic Reactions with Antibodies to IgE" <u>International Archives of Allergy and Immunology</u> 107(1-3):308-312 (May 1995)	
	190			Sims et al., "A Humanized CD18 Antibody Can Block Function Without Cell Destruction" <u>The Journal of Immunology</u> 151(4):2296-2308 (Aug 1993)	
	191			Smith-Gill et al., "A Three-dimensional Model of an Anti-lysozyme Antibody" <u>Mol. Biol.</u> 194:713-724 (1987)	
	192			Songsivilai et al., "Bispecific antibody: a tool for diagnosis and treatment of disease" <u>Clin. Exp. Immunol.</u> 79:315-321 (1990)	
	193			Stanford, "A Predictive Method for Determining Possible Three-dimensional Foldings of Immunoglobulin Backbones Around Antibody Combining Sites" <u>Theor. Biol.</u> 88:421-439 (1981)	
	194			Stickney et al., "Bifunctional Antibody: ZCE/CHA ¹¹¹ Indium BLEDTA-IV Clinical Imaging in Colorectal Carcinoma" <u>Antibody, Immuno Radiopharm</u> 2:1-13 (1989)	
	195			Tighe et al., "Delayed Allograft Rejection in Primates Treated with Anti-IL-2 Receptor Monoclonal antibody Campath-6" <u>Transplantation</u> 45(1):226-228 (Jan 1988)	
	196			Verhoeyen & Riechmann, "Engineering of Antibodies" <u>BioEssays</u> 8(2):74-78 (Feb/Mar 1988)	
	197			Verhoeyen et al., "Grafting Hypervariable Regions in Antibodies" <u>Protein Structure, Folding, and Design</u> 2 (Proc. DuPont-UCLA Symp. Steamboat Springs, CO, Apr 4-11, 1987), Dale L. Oxender, New York:Alan R. Liss, Inc. pps. 501-502 (1987)	
	198			Verhoeyen et al., "Humanising Mouse Antibodies: A Protein Engineering Approach" <u>Soc. for Analytical Cytology</u> (XIIth Intl. Mtg. for the Soc. for Analytical Cytology, Cambridge, UK) pps. 22 and slide presented at mtg	
	199			Verhoeyen et al., "Re-shaped human anti-PLAP antibodies" <u>Monoclonal Antibodies Applications in clinical oncology</u> , Epenetos, 1st edition, Chapman & Hall Medical pps. 37-43 (1991)	
	200			Ward et al., "Expression and Secretion of Repertoires of VH Domains in Escherichia Coli: Isolation of Antigen Binding Activites" <u>Progress in Immunology</u> (7th Intl. Congress Immunol. Berlin, W. Germany), F. Melchers Vol. VII:1144-1151 (1989)	
	201			Ward, E.S. et al., "Binding activities of a repertoire of single immunoglobulin variable domains secreted from Escherichia coli" <u>Nature</u> 341:544-546 (1989)	
	202			Werther et al., "Humanization of an Anti-Lymphocyte Function-Associated Antigen (LFA)-1 Monoclonal Antibody and Reengineering of the Humanized Antibody for Binding to Rhesus LFA-1" <u>J. of Immunology</u> pps. 4986-4995 (1996)	
20	203			Whittle et al., "Construction and Expression of A CDR-Grafted Anti-TNF Antibody" <u>J. Cell Biochem. Suppl.</u> Q (Symp. on Protein and Pharm. Eng. Mol. and Cell. Biol. Park City, Utah)13 Part A:96 (1989)	
Examiner <i>M. T. DAVIS</i>				Date Considered <i>12/08/01</i>	
*Examiner: Initial if reference considered, whether or not citation is in conformance with MPEP 609; draw line through citation if not in conformance and not considered. Include copy of this form with next communication to applicant.					

FORM PTO-1449 U.S. Dept. of Commerce Patent and Trademark Office LIST OF DISCLOSURES CITED BY APPLICANT (Use several sheets if necessary)	Atty Docket No. P0709P1	Serial No. 08/146,206
	Applicant Carter et al.	
	Filing Date 17 Nov 1993	Group 1806
	OTHER DISCLOSURES (Including Author, Title, Date, Pertinent Pages, etc.)	

204	↓	Winter & Neuberger, "Restructuring Enzymes and Antibodies" <u>Investigation and Exploitation of Antibody Combining Sites</u> , Eric Reid, Plenum Press pps. 139-140 (1985)
205	↓	Winter et al., "Protein Engineering by Site Directed Mutagenesis" <u>Chemical Synthesis in Molecular Biology</u> , H. Blocker et al., VCH pps. 189-197 (1987)
206	↓	Winter G., "Antibody Engineering" <u>Phil. Trans. R. Soc. Lond. B</u> 324:99-109 (1989)
207	4 ↓	Woodle et al., "Humanized OKT3 Antibodies: Successful Transfer of Immune Modulating Properties and Idiotypic Expression" <u>J. of Immunology</u> 148(9):2756-2763 (May 1992)

Examiner <u>M.T. Davis</u>	Date Considered <u>12/05/01</u>
----------------------------	---------------------------------

*Examiner: Initial if reference considered, whether or not citation is in conformance with MPEP 609; draw line through citation if not in conformance and not considered. Include copy of this form with next communication to applicant.



Europäisches Patentamt
 European Patent Office
 Office européen des brevets



Publication number: **0 323 806 B1**

12

EUROPEAN PATENT SPECIFICATION

- 45 Date of publication of patent specification: 17.03.93 51 Int. Cl.⁵: **C12N 15/00, A61K 39/395, C12P 21/00, C12N 5/00, G01N 33/574**
- 21 Application number: **88810898.2**
- 22 Date of filing: **28.12.88**

The applicant has filed a statement in accordance with Rule 28(4) EPC (issue of a sample only to an expert). Accession Number(s) of the deposit(s): I-720 and I-818.

54 **Novel chimeric antibodies.**

- 30 Priority: **05.01.88 GB 8800077**
24.08.88 GB 8820099
- 43 Date of publication of application: **12.07.89 Bulletin 89/28**
- 49 Publication of the grant of the patent: **17.03.93 Bulletin 93/11**
- 64 Designated Contracting States:
AT BE CH DE ES FR GB GR IT LI LU NL SE
- 58 References cited:
EP-A- 0 125 023

PROCEEDINGS OF THE NATIONAL ACADEMY OF SCIENCES USA, vol. 81, June 1984; S.CABILLY et al., pp. 3273-3277*

THE JOURNAL OF IMMUNOLOGY, vol. 141, no. 11, 01 December 1988, American Association of Immunologists (US); C.B.BEIDLER et al., pp. 4053-4060*

JOURNAL OF IMMUNOLOGY, vol. 130, 1983; pp. 2302, 2308*

- 73 Proprietor: **CIBA-GEIGY AG**
Klybeckstrasse 141
CH-4002 Basel(CH)
- 72 Inventor: **Hardman, Norman, Dr.**
Gstaltenrainweg 67/3
CH-4125 Riehen(CH)
Inventor: **Gill, Laura Lee, Dr.**
Gstaltenrainweg 67
CH-4125 Riehen(CH)
Inventor: **de Winter, Ronald F.J., Dr.**
Holly Tree Cottage, Flewton End
Milton Ernest, Bedfordshire(GB)
Inventor: **Wagner, Kathrin**
Sundgauerstr. 12
CH-4055 Basle(CH)
Inventor: **Heusser, Christoph, Dr.**
Im Bertschenacker 21
CH-4103 Bottmingen(CH)

EP 0 323 806 B1

Note: Within nine months from the publication of the mention of the grant of the European patent, any person may give notice to the European Patent Office of opposition to the European patent granted. Notice of opposition shall be filed in a written reasoned statement. It shall not be deemed to have been filed until the opposition fee has been paid (Art. 99(1) European patent convention).

Description**FIELD OF THE INVENTION**

5 This invention relates to mouse/human chimeric monoclonal antibodies with high specificity to and affinity for human carcinoembryonic antigen (CEA), derivatives thereof, processes for the preparation of these antibodies and their derivatives, DNAs coding for heavy and light chains of these antibodies, processes for the preparation of said DNAs, mammalian cell lines that produce and secrete the antibodies, processes for the preparation of said cell lines, the use of the chimeric monoclonal antibodies and their
10 derivatives for the diagnosis and therapy of cancer, test kits containing the chimeric monoclonal antibodies, and pharmaceutical preparations containing said antibodies.

BACKGROUND OF THE INVENTION

15 Immunoglobulins (antibodies) play an important role in the immune system of mammals. They are produced by plasma cells and consist of two identical light (L) polypeptide chains and two identical heavy (H) polypeptide chains joined by disulfide bridges, or polymers of this basic four chain unit. The light chains are of type κ or λ , the heavy chains of type μ , δ , γ , α or ϵ . Each chain consists of a variable (V) region and a constant (C) region. The V-regions, which show considerable sequence differences in antibodies with
20 different specificity, comprise highly variable parts, so-called hypervariable or complementarity determining regions (CDRs), flanked by relatively conserved parts, so-called framework regions (FRs).

Antibodies are bifunctional molecules. On the one hand, the N-terminal variable segments of the H- and L-chain polypeptides associate in a highly specific and individual manner, generating a three-dimensional structure with a unique affinity for particular chemical motifs (epitopes) on the surface of an antigen, i.e. a
25 molecule which is recognized as foreign by the organism and induces an immune response. Such epitopes can be small-molecular-weight molecules (haptens) or parts of macromolecular chemical structures such as proteins, carbohydrates and glycoproteins, e.g. cell-surface antigens.

The unique antigen-combining characteristics of the immunoglobulin (Ig) molecule results from genetic recombination of H- and L-chain germline genes early in B-cell differentiation, for example during
30 embryogenesis: one of several hundred V-segments is joined to one of a small number of joining segments (J-segments) and, in the case of the H-chain locus, additional diversity segments (D-segments), forming a totally unique contiguous V-(D)-J rearranged gene segment coding for an Ig molecule with specific antigen-combining characteristics. In addition to antibody diversity caused by simple gene recombination, the precise junction at which V and J segment genes combine may vary slightly. As the joining reaction can
35 occur between different base pairs and additional nucleotides can be added during the recombination process, several different amino acids, not coded in the germline, can be inserted at the site of each potential V-J or D-J combination. Furthermore, somatic mutation of single bases also contributes to Ig diversity.

The other key structural feature of Ig molecules is their ability to activate diverse biological pathways in
40 the immune system. These so-called effector functions (complement binding, stimulation of phagocytosis, triggering of granule release by mast cells) reside primarily in the carboxy-terminal constant region segments of the H-chain polypeptides, giving rise to different Ig classes (IgA, IgE, IgG, etc.) which define the role of the antibody in a particular immune response.

The development of hybridoma technology has made it possible to generate continuous cell lines,
45 mostly murine hybridomas, producing monoclonal antibodies of desired specificity which can be used to identify, isolate and characterize biologically important molecules. However, a major limitation in the use of murine-derived monoclonal antibodies as *in vivo* diagnostic and therapeutic agents is their immunogenicity as foreign proteins, their rather long persistence in the circulation, and the formation of damaging immune complexes. On the other hand, the treatment with human monoclonal antibodies is limited also since human
50 hybridoma cell lines are rarely available, usually unstable and do not produce monoclonal antibodies of appropriate specificity in sufficient quantities and at reasonable costs.

A promising alternative is the modification of immunoglobulin genes by using recombinant DNA
55 technology. One approach to decrease immunogenicity and to avoid undesired immune response, for example, is the production of chimeric antibodies with the advantages and the selectivity of murine mono-clonals, yet the species specific properties of human antibodies.

The overall strategies applicable for the assembly of chimeric genes and the production of chimeric antibodies involve standard procedures of recombinant DNA technology (identification and isolation of Ig genes, insertion of the cloned genes into vectors, transfection into immortalized cell lines, expression of

chimeric proteins). Depending on the source of the genes to be combined and on the nature of the genes coding for the antigen-specific variable region, however, particular problems arise so that new and inventive steps are required to develop workable solutions.

Several research groups have attempted to engineer chimeric antibodies. Their research objectives differ in the conceptual approach, however, and the research results vary considerably with regard to the nature and characteristics of the recombinant molecules.

Chimeric antibodies of several immunoglobulin classes have been produced.

Neuberger et al. (Nature 314, 268, 1985) describe a chimeric IgE λ 1 antibody whose heavy chain is composed of a human ϵ constant region fused to a mouse variable region specific for the hapten 4-hydroxy-3-nitrophenacetyl (NP). The strategy used in the production of the chimeric antibody is to construct a chimeric gene coding for the heavy chain and to introduce this chimeric DNA segment into the J558L mouse cell line in which the expressed chimeric heavy chain is assembled with the endogenous mouse light chain to produce complete IgE molecules.

Boulianne et al. (Nature 312, 643, 1984) succeeded in linking the variable regions of the heavy and light chains from an anti-TNP mouse myeloma to human μ and κ genes, respectively. The chimeric genes were transfected into myeloma cells. The secreted IgM, however, was not as effective as the original mouse IgM and showed different binding qualities.

The generation of chimeric immunoglobulin G by joining human γ constant genes to murine variable genes has been described by various authors.

Patent application WO 87/02671 describes a chimeric antibody which binds to viral antigens, especially hepatitis B surface antigen, created from a human γ 1 region and a variable region from mouse myeloma CRL 8017. The authors also constructed a mouse/human chimeric antibody on the basis of the mouse monoclonal antibody (MAb) L6, as did Liu et al. (Proc. Natl. Acad. Sci. 84, 3439, 1987). MAb L6 [IgG2a(κ)] binds to a carbohydrate antigen found on the surface of cells derived from a variety of human carcinomas. The authors give exact data for the human colon carcinoma cell line C-3347. The γ 2a and κ constant regions of MAb L6 were substituted by human γ 1 and κ constant regions by recombining cDNA modules encoding variable or constant region domains.

Another chimeric monoclonal antibody directed to the surface antigens of human carcinomas was constructed by Sahagan et al. (J. Immunol. 137, 1066, 1986) who fused variable region exons from the IgG1 antibody of the murine hybridoma cell line B6.2 to human γ 1/ κ genes. Binding characteristics for the chimeric Ig were determined with A549.E1 human lung carcinoma cells.

Sun et al. (Proc. Natl. Acad. Sci. 84, 214, 1987) combined DNA fragments coding for the H-chain/L-chain variable regions of anti-colorectal carcinoma (ACRC) antibody, produced by mouse hybridoma 1083-17-A, with human γ 3/C κ regions.

The chimeric MAbs which are subject of the present invention are directed against carcinoembryonic antigen (CEA). CEA is a complex immunoreactive glycoprotein with a molecular weight of 180,000 found in adenocarcinomas of endodermally derived digestive system epithelia and foetal colon. The role of CEA immunoassays for diagnosis and serially monitoring cancer patients for recurrent disease or response to therapy has been widely evaluated and documented. One of the major drawbacks of the use of anti-CEA antibodies for the above purposes has been the cross-reactivity of these reagents with some apparently normal adult tissues.

Previous studies have shown that most conventional hyperimmune antisera raised against CEA using different immunogens cross-react with many different types of carcinomas as well as CEA-related antigens, e.g. non-specific cross-reacting antigen NCA, tumor-extracted CEA-related antigen TEX, various normal faecal antigens (NFA1, NFA2), biliary glycoprotein-I and others, found in normal colonic mucosa, spleen, liver, lung, sweatglands, polymorphonuclear leukocytes and monocytes of apparently normal individuals (for an overview, cf. Herberman & McIntire, "Immunodiagnosis of Cancer", Vol. 9, part 1, N.Y., 1979). This means that the antisera recognize epitopes specific for CEA alone as well as epitopes present on both CEA and CEA-related antigens; it further suggests closely related genes between CEA and CEA-related antigens as well as precursor-product relationships between some of them.

It is suggested that polyclonal antibodies (rabbit, sheep) recognize 10-15 antigenic sites in CEA (Sundblad et al., Protides Biol. Fluids 24, 435, 1976). The epitopes are predominantly located on the peptide moieties of CEA and appear to be strongly conformation dependent. Using monoclonal antibodies, at least 5 different epitopes were detected in CEA (Hedin et al., Mol. Immunol. 23, 1053, 1986).

Anti-CEA monoclonal antibodies have already been employed for the production of chimeric antibodies. In patent application EP 0 125 023, an Ig γ 1 antibody originating from hybridoma cell line CEA.66-E3 is used. The chimeric antibody is not characterized with regard to epitope specificity or cross-reactivity nor are binding or inhibition data included. The inventors describe the use of E. coli for the cloning of DNA

5 fragments and the expression of the chimeric genes. It is well established, however, that prokaryotic cells do not provide the necessary steps for biosynthesis of functional tetrameric antibodies, such as correct nascent polypeptide chain folding, glycosylation and assembly. The inventors of EP 0 125 023 describe (Proc. Natl. Acad. Sci. 81, 3273, 1984) that no detectable antibody activity is found in *E. coli* coproducing
 10 IgG H- and L-chains for the original mouse antibody when prepared following the guidance of the patent specification. The specification lists a number of possible host cells, also including mammalian cells, but these suggestions are not substantiated by the examples. The conceptual approach to the production of chimeric antibodies in the above cited patent application therefore lacks the basis for the expression of the recombinant gene constructs and thus, the secretion of active monoclonal antibodies.

10 OBJECT OF THE INVENTION

The object of the invention is the construction of novel chimeric monoclonal antibodies (MAbs) which

- possess murine variable and human constant region determinants,
- 15 • bind specifically to human carcinoembryonic antigen,
- are produced at a high level in immortalized mammalian cell lines,
- can be used for diagnostic and therapeutic purposes.

In view of the complex antigenic structure of the CEA molecule, the desired chimeric anti-CEA MAbs must have the following characteristics:

- 20 • high affinity for CEA,
- high percentage of binding to CEA-carrying carcinoma cells, both *in vitro* and *in vivo*.
- low percentage or absence of binding to normal tissues and cells.

25 DESCRIPTION OF THE INVENTION

The invention concerns chimeric monoclonal antibodies consisting of variable regions of mouse origin and human constant regions, which recognize human carcinoembryonic antigen (CEA) not present on non-specific cross-reacting antigen NCA, such as NCA₅₅ and NCA₉₅ (Buchegger et al., Int. J. Cancer 33, 643, 1984), on biliary glycoprotein, or on granulocytes, and derivatives thereof.

30 Preferred are chimeric monoclonal antibodies and derivatives thereof with an affinity of at least 2.1 x 10¹⁰ liters/mol for human CEA.

For the production of a chimeric monoclonal antibody, a chimeric light chain and a chimeric heavy chain, each comprising a variable and a constant region, are constructed separately and are therefore distinguished in this description with special emphasis on the variable region of each chimeric construct.

35 The preferred chimeric monoclonal antibody of the invention and its derivatives are characterized in that they comprise light chain variable regions of the formula

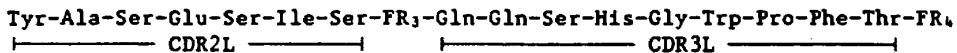
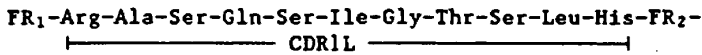

45 (I),

wherein FR₁ is a polypeptide residue comprising 23-28 naturally occurring amino acids, FR₂ is a polypeptide residue comprising 14-16 naturally occurring amino acids, FR₃ is a polypeptide residue comprising 30-34 naturally occurring amino acids and FR₄ is a polypeptide residue comprising 9-11
 50 naturally occurring amino acids, and wherein the amino acid Cys may be in the oxidized state forming S-S-bridges. Especially preferred are a chimeric monoclonal antibody and derivatives thereof comprising light chain variable regions of formula I, wherein the polypeptide residues of the framework regions FR₁, FR₂, FR₃ and FR₄ are those preferably occurring in mammalian, especially murine, antibodies.

Most preferred are a chimeric monoclonal antibody and derivatives thereof according to the invention
 55 comprising light chain variable regions of formula I, wherein FR₁ is a polypeptide residue of the formula

A-Gly-Asp-Ile-Leu-Leu-Thr-Gln-Ser-Pro-Ala-Ile-Leu-Ser-Val-Ser-Pro-
Gly-Glu-Arg-Val-Thr-Phe-Ser-Cys

5

(IA),

wherein A is hydrogen, acyl, or the residue Ala-Ser-Arg, Ser-Arg or Arg, particularly hydrogen,
10 FR₂ is the polypeptide residue

Trp-Tyr-Gln-Gln-Arg-Thr-Asn-Gly-Ser-Pro-Arg-Leu-Leu-Met-Lys

15

(IB),

FR₃ is the polypeptide residue

20

Gly-Ile-Pro-Ser-Arg-Phe-Ser-Gly-Ser-Gly-Ser-Gly-Thr-Asp-Phe-Thr-Leu-
Thr-Ile-Asn-Ser-Val-Glu-Ser-Glu-Asp-Ile-Ala-Asp-Tyr-Tyr-Cys

25

(IC),

and FR₄ is the polypeptide residue

30

Phe-Gly-Ser-Gly-Gly-Thr-Lys-Leu-Glu-Ile-Lys

(ID),

35

and wherein the amino acid Cys may be in the oxidized state forming S-S-bridges.

The invention also relates to a chimeric monoclonal antibody and derivatives thereof comprising light
chain variable regions of formula I, wherein FR₁, FR₂, FR₃ and FR₄ are polypeptide residues of formula IA,
IB, IC and ID, respectively, and wherein one or more, e.g. 1, 2, 3 or 4, single amino acids are replaced by
40 other amino acids outside the regions CDR1L, CDR2L and CDR3L, and wherein the amino acid Cys may be
in the oxidized state forming S-S-bridges.

The preferred chimeric monoclonal antibody of the invention and its derivatives are characterized in that
they comprise heavy chain variable regions of the formula

45

FR₅-Thr-Tyr-Ala-Met-Ala-Trp-Val-FR₆-Ser-Ser-Gly-Gly-Thr-Thr-Tyr-Tyr-Pro-
|----- CDR1H -----| |-----|
Asp-Ser-Val-Lys-Gly-FR₇-Gly-Phe-Tyr-Asp-Gly-Tyr-Leu-Tyr-Val-Val-FR₈
|----- CDR2H -----| |----- CDR3H -----|

50

(II),

wherein FR₅ is a polypeptide residue comprising 32-36 naturally occurring amino acids, FR₆ is a
55 polypeptide residue comprising 14-16 naturally occurring amino acids, FR₇ is a polypeptide residue
comprising 32-34 naturally occurring amino acids and FR₈ is a polypeptide residue comprising 12-14
naturally occurring amino acids, and wherein the amino acid Cys may be in the oxidized state forming S-S-
bridges. Especially preferred are a chimeric monoclonal antibody and derivatives thereof comprising heavy

chain variable regions of formula II, wherein the polypeptide residues of the framework regions FR₆, FR₇, FR₈ and FR₉ are those preferably occurring in mammalian, especially murine, antibodies.

Most preferred are a chimeric monoclonal antibody and derivatives thereof according to the invention comprising heavy chain variable regions of formula II, wherein FR₅ is a polypeptide residue of the formula

5

**B-Gly-Val-Gln-Cys-Glu-Val-Lys-Leu-Val-Glu-Ser-Gly-Gly-Leu-
Val-Lys-Pro-Gly-Gly-Ser-Leu-Lys-Leu-Ser-Cys-Ala-Ala-Ser-Gly-Phe-
Thr-Phe-Arg**

10

(IIA),

wherein B is hydrogen or acyl, particularly hydrogen,

15 FR₆ is the polypeptide residue

Arg-Gln-Thr-Pro-Glu-Lys-Arg-Leu-Glu-Trp-Val-Thr-Ser-Ile

20

(IIB),

FR₇ is the polypeptide residue

25

**Arg-Phe-Thr-Ile-Ser-Arg-Asp-Asn-Ala-Arg-Asn-Ile-Leu-Tyr-
Leu-Gln-Val-Ser-Ser-Leu-Arg-Ser-Glu-Asp-Thr-Ala-Ile-Tyr-Tyr-Cys-
Ala-Arg**

30

(IIC),

and FR₈ is the polypeptide residue

35

Asp-Tyr-Trp-Gly-Gln-Gly-Thr-Ser-Leu-Thr-Val-Ser-Ser

(IID),

40

and wherein the amino acid Cys may be in the oxidized state forming S-S-bridges.

The invention also relates to a chimeric monoclonal antibody and derivatives thereof comprising heavy chain variable regions of formula II, wherein FR₅, FR₆, FR₇ and FR₈ are polypeptide residues of formula IIA, IIB, IIC and IID, respectively, and wherein one or more, e.g. 1, 2, 3 or 4, single amino acids are replaced by
45 other amino acids outside the regions CDR1H, CDR2H and CDR3H, and wherein the amino acid Cys may be in the oxidized state forming S-S-bridges.

Light chain variable regions of formula IA and heavy chain variable regions of formula IIA may comprise an acyl residue, for example formyl or alkanoyl, e.g. palmitoyl, myristoyl or lower alkanoyl, such as acetyl or propionyl.

50 The class of an Ig molecule is defined by the H- and L-chain constant regions as pointed out above. A chimeric monoclonal antibody of the invention may be of any immunoglobulin class, i.e. IgA, IgD, IgE, IgG or IgM. A preferential chimeric monoclonal antibody according to the invention is an immunoglobulin of class G which comprises light chain human constant regions κ or λ , especially human constant regions κ , and heavy chain human constant regions γ 1, γ 2, γ 3 or γ 4, especially human constant regions γ 4.

55 The invention preferentially concerns a chimeric monoclonal antibody and derivatives thereof with light chain variable regions of formula I with the preferred meaning, wherein the amino acid Cys may be in the oxidized state forming S-S-bridges, light chain human constant regions κ , heavy chain variable regions of formula II with the preferred meaning, wherein the amino acid Cys may be in the oxidized state forming S-

S-bridges, and heavy chain human constant regions $\gamma 4$.

Derivatives of chimeric monoclonal antibodies according to the invention are, for example, fragments that retain their specificity for the antigenic determinants of the CEA molecule, such as the univalent fragment Fab and the divalent fragment $F(ab')_2$, conjugates of the chimeric monoclonal antibodies with enzymes, fluorescent markers, metal chelates, cytostatic or cytotoxic substances, avidin, biotin, and the like, and radioactively labelled antibodies.

Enzymes used for antibody conjugates of the invention are, for example horseradish peroxidase, alkaline phosphatase, β -D-galactosidase, glucose oxidase, glucoamylase, carbonic anhydrase, acetylcholinesterase, lysozyme, malate dehydrogenase or glucose-6-phosphate dehydrogenase.

Fluorescent markers conjugated with chimeric antibodies are fluorescein, fluorochrome, rhodamine, and the like.

In such conjugates the antibody is bound to the enzymes or fluorescent markers directly or by the way of a spacer or linker group.

Examples for metal chelators are ethylenediaminetetraacetic acid (EDTA), diethylenetriaminepentaacetic acid (DPTA), 1,4,8,11-tetraazatetradecane, 1,4,8,11-tetraazatetradecane-1,4,8,11-tetraacetic acid, 1-oxa-4,7,12,15-tetraazaheptadecane-4,7,12,15-tetraacetic acid, or the like. Cytostatics, applicable in connection with the chimeric antibodies, are, inter alia, alkylating substances, such as mechlorethamine, triethylenephosphoramide, cyclophosphamide, ifosfamide, chlorambucil, busulfan, melphalan or triaziquone, also nitrosourea compounds, such as carmustine, lomustine, or semustine. Also used are antimetabolites, such as methotrexate, mercaptopurine, cytarabine, fluorouracil, floxuridine, or fltorafur. A further group of cytostatics includes vinblastine and vincristine, as well as certain antibiotics, such as actinomycin-D, daunorubicin (daunomycin), doxorubicin, mithramycin, streptonigrin, mitomycin and bleomycin. Further suitable cytostatics are, inter alia, procarbazine, hydroxyurea, L-asparaginase, dacarbazine, mitotane, estramustine, or podophyllotoxin. Further cytostatic agents are hormones and hormone antagonists, such as corticosteroids, e.g. prednisone, progestins, e.g. hydroxyprogesterone or medroprogesterone, estrogens, e.g. diethylstilbestrol, antiestrogens, e.g. tamoxifen, androgens, e.g. testosterone, and aromatase inhibitors, e.g. aminoglutethimide.

Conjugates of chimeric monoclonal antibodies with cytotoxic substances contain either the intact toxin or the A-chain derived from it. Toxins suitable for antibody-coupling are, among others, several lectins, such as ricin or abrin, or diphtheria toxin A, and the like.

Radioactively labelled chimeric monoclonal antibodies contain e.g. radioactive iodine (^{123}I , ^{125}I , ^{131}I), yttrium (^{90}Y), technetium ($^{99\text{m}}\text{Tc}$), or the like.

The chimeric monoclonal antibodies and derivatives thereof according to the invention are prepared by processes that are known per se, characterized in that mammalian cells as defined further below producing such chimeric monoclonal antibodies are multiplied according to known methods in vitro or in vivo, and, if desired, the resulting monoclonal antibodies are converted into derivatives thereof.

Multiplication in vitro is carried out in suitable culture media, which are the customary standard culture media, for example Dulbecco's Modified Eagle Medium (DMEM) or RPMI 1640 medium, optionally replenished by a mammalian serum, e.g. foetal calf serum, or trace elements and growth-sustaining supplements, e.g. feeder cells such as normal mouse peritoneal exudate cells, spleen cells, bone marrow macrophages, or the like.

As the antibody-producing cells carry a selection marker described in detail hereinbelow, the culture media may be supplemented with selective media, for example media containing G-418 or xanthine, hypoxanthine/thymidine and mycophenolic acid, in order to prevent normal cells from overgrowing the producer cells.

In vitro production allows scale-up to give large amounts of the desired antibodies. Techniques for mammalian cell cultivation under tissue culture conditions are known in the art and include homogeneous suspension culture, e.g. in an airlift reactor or in a continuous stirrer reactor, or immobilized or entrapped cell culture, e.g. in hollow fibres, microcapsules, on agarose microbeads or ceramic cartridges.

The cell culture supernatants are screened for the desired monoclonal antibodies, preferentially with an enzyme immunoassay, e.g. a dot-assay, or a radioimmunoassay.

For isolation of the chimeric monoclonal antibodies, the immunoglobulins in the culture supernatants are first concentrated, e.g. by precipitation with ammonium sulphate, dialysis against hygroscopic material such as PEG, filtration through selective membranes, or the like. If necessary and/or desired, the concentrated antibodies are purified by the customary chromatography methods, for example gel filtration, ion-exchange chromatography, chromatography over DEAE-cellulose or (immuno-)affinity chromatography.

Large quantities of the desired chimeric monoclonal antibodies can also be obtained by multiplying the cells in vivo. For this purpose, cell clones from a histocompatible and/or tolerated Ig-producing cell line are

injected into syngeneic mammals to cause growth of antibody-producing tumors. Optionally, the animals are primed with a hydrocarbon, especially mineral oils such as pristane (tetramethyl pentadecane), prior to the injection. After 1-3 weeks, the antibodies are isolated from the body fluids of those mammals. For example, hybridoma cells derived from Balb/c mice that produce the desired chimeric monoclonal antibodies are injected intraperitoneally into Balb/c mice that have optionally been pre-treated with a hydrocarbon such as pristane, and, after 8-10 days, ascitic fluid is taken from these animals. The chimeric monoclonal antibodies are isolated therefrom by conventional methods as given above.

Fragments of chimeric monoclonal antibodies that retain their specificity towards human CEA, for example Fab or F(ab')₂ fragments, can be obtained from a chimeric antibody prepared as described above by methods known per se, e.g. by genetic manipulation of the appropriate Ig-coding exons, by digestion with enzymes such as papain or pepsin, and/or cleavage of disulfide bonds by chemical reduction.

Conjugates of monoclonal antibodies of the invention are prepared by methods known in the art, e.g. by reacting a monoclonal antibody prepared as described hereinbefore with the enzyme in the presence of a coupling agent, e.g. glutaraldehyde, periodate, N,N'-o-phenylenedimaleimide, N-(m-maleimidobenzoyloxy)-succinimide, N-(3-[2'-pyridyldithio]-propionoxy)-succinimide, N-ethyl-N'-(3-dimethylaminopropyl)-carbodiimide or the like. Conjugates with avidin are prepared likewise. Conjugates with biotin are prepared e.g. by reacting monoclonal antibodies with an activated ester of biotin such as the biotin N-hydroxysuccinimide ester. Conjugates with fluorescent markers are prepared in the presence of a coupling agent, e.g. those listed above, or by reaction with an isothiocyanate, preferably fluorescein-isothiocyanate. Conjugates of the chimeric antibodies of the invention with cytostatic/cytotoxic substances and metal chelates are prepared in an analogous manner.

Chimeric monoclonal antibodies radioactively labelled with iodine (¹²³I, ¹²⁵I, ¹³¹I) are obtained from the monoclonal antibodies according to the invention by iodination known per se, for example with radioactive sodium or potassium iodide and a chemical oxidising agent, such as sodium hypochlorite, chloramine T or the like, or an enzymatic oxidising agent, such as lactoperoxidase, glucose oxidase and glucose. Chimeric monoclonal antibodies according to the invention are coupled to yttrium (⁹⁰Y) for example by diethylenetriaminepentaacetic acid (DTPA)-chelation. Technetium-99m labelled chimeric antibodies are prepared by ligand exchange processes, for example by reducing pertechnate (TcO₄⁻) with stannous ion solution, chelating the reduced technetium onto a Sephadex column and applying the antibodies to this column, or by direct labelling techniques, e.g. by incubating pertechnate, a reducing agent such as SnCl₂, a buffer solution such as a sodium-potassium phthalate-solution, and the antibodies.

The invention also concerns recombinant DNAs comprising an insert coding for a light chain murine variable region and/or for a heavy chain murine variable region of chimeric monoclonal antibodies specific for human CEA as described hereinbefore. By definition such DNAs comprise coding single stranded DNAs, double stranded DNAs consisting of said coding DNAs and of complementary DNAs thereto, or these complementary (single stranded) DNAs themselves.

In particular the invention concerns a recombinant DNA comprising an insert coding for a light chain murine variable region specific for human CEA, originating from genomic DNA of the cell line CE 25. The cell line CE 25 was generated by the fusion of B lymphocytes of the spleen of Balb/c mice and cells from the myeloma P3-NS2/1Ag4 and produces a murine anti-CEA antibody with a κ light chain and a γ 1 heavy chain.

Preferred is a recombinant DNA comprising an insert coding for the polypeptide of formula I, optionally containing introns, especially an insert coding for the polypeptide of formula I wherein FR₁, FR₂, FR₃ and FR₄ are polypeptide residues of formula IA, IB, IC and ID, respectively, optionally containing introns.

An example of such a preferred recombinant DNA is a recombinant DNA comprising an insert of the formula

50

55

1 TCTAGACTGCTGTGGTCTTTTAAGTAGCATGAAAAACATCTGCTAAAGAAGGAATTAGTT 60
 5 61 TGAACATGCTAGAAATACATCTGTGATACTTCATCACTCTTGTGGAAAGATATGCAAG 120
 121 AAGCACTATTGGCTATTATTGGAAAGTGCTATAATGTATTTGATATCTCAACCTCTG 180
 10 181 AAATTCCTTCTGTATGTGGCAGATTGTAAACCTTACAAAGGCTTTCATTCTCTCTCTG 240
 241 AGAAAAATGCTTTGTAGGCAATCCAGAATTTCTTATTTCCTTCTAATGAAATCTCCTCA 200
 15 301 GTGTGATACACTTTAGTTTCATGTGTGTTATGCTTCATGTAATGTTAAGAAAAGTTAAA 360
 361 GATGCTCCAATCCATATTGTAAGAAACATTCCAAGCCATGGAATAAGGCATGGATTTGAG 420
 20 421 ATGCTCTTTATTCCAACTACTGAATATATCTTAGAGATTTCTTTAGACTGTGTTAAATA 480
 481 TGTAACCATTAAAGTAGGAGTCAAGTCTCCTTTAAATCTCAACAGCTCTTCAGGTAACCA 540
 25 541 ACAAAGGATAAAATATTCTAATAAGTCACTAGGAGCATGCTCTTCGACCAGGCTTTTCT 600
 601 TATAAGCAACATGAAGACAGTATGATTTGCATAAGTTTTTCTTTCTTCTAATGTCCCTGC 660
 30 661 CTCITAGAGTATTATAAGAAGATCTTTCTAGGGATGTGTCATGGTCCACAAAAATAGG 720
 M V S T P Q F L V F L L F W I P
 Met Val Ser Thr Pro Gln Phe Leu Val Phe Leu Leu Phe Trp Ile Pro
 35 721 GAAAGTGTGAAGATGGTATCCACACCTCAGTTCCTTGTATTTTGTCTTTCTGGATTCCA 780

40
45
50
55

```

1  AAGCTTGTTCTGTTTCACATGCAAGGAGGGAAACTAAACTGAGTATGGTGAATCCCTAACC 60
   -----+-----+-----+-----+-----+-----+-----+-----+
5  61  AAAGGGAAAAAATGAAACTACAATATGTTTCAAATGCTGTAAGTAAAATCTGGTTTTTTG 120
   -----+-----+-----+-----+-----+-----+-----+-----+
   121 ATGCCTTATATCTGGTATCATCAGTGACTTCAGATTTAGTCCAACCCAGAGCATGGTAT 180
   -----+-----+-----+-----+-----+-----+-----+-----+
  10  181 AGCAGGAAGACATGCAAATAAGTCTTCTCTCTGCCATGAAAACACCTCGGCCCTGACCC 240
   -----+-----+-----+-----+-----+-----+-----+-----+
   241 TGCAGCTCTGACAGAGGAGGCCAGTCCATGGATTTGAGTTCCTCACATTGAGTGATGAGC 300
   -----+-----+-----+-----+-----+-----+-----+-----+
   M N F G F S L I F L V L V
  15 MetAsnPheGlyPheSerLeuIlePheLeuValLeuVal
   301 ACTGAACACAGACACCTCACCATGAACTTCGGGTTCAGCTTGATTTTCCTGTCCITGTT 360
   -----+-----+-----+-----+-----+-----+-----+-----+
   L K G
   LeuLysGly
  20 TTAAGGTAATTIATTGAGAAGAGATGACATCTATTTACGCACATGAGACAGAAAAA
   361 -----+-----+-----+-----+-----+-----+-----+-----+ 420
   V Q
   ValG1
  25 TGTGGTTTGTTTTGTAGTGACAGTTTCCAACCAGTTATTCTCTGTTTGTAGGTGTCCA 480
   -----+-----+-----+-----+-----+-----+-----+-----+
   C E V K L V E S G G G L V K P G G S L K
nCysGluValLysLeuValGluSerGlyGlyGlyLeuValLysProGlyGlySerLeuLy
  30 481 GTGTGAAGTGAAGCTGGTGGAGTCTGGGGAGGCTTAGTGAAGCTGGAGGGTCCCTGAA 540
   -----+-----+-----+-----+-----+-----+-----+-----+
   L S C A A S G F T F R T Y A H A W V R Q
sLeuSerCysAlaAlaSerGlyPheThrPheArgThrTyrAlaMetAlaTrpValArgG1
  35 541 ACTCTCCTGTGCAGCCTCTGGGTTCACTTTCAGGACCTATGCCATGGCTTGGGTTGCGCA 600
   -----+-----+-----+-----+-----+-----+-----+-----+

```



25 (IV).

A recombinant DNA comprising an insert of formula IV wherein one or more, e.g. up to 10, single nucleotides are replaced by other nucleotides outside the nucleotide sequences of formula IV from position 30 575-595, 629-680 and 776-805, respectively, is also preferential.

For the assembly of complete tetrameric immunoglobulin molecules and the expression of active antibodies, the recombinant DNA inserts coding for light and heavy chain variable regions are fused with the corresponding DNAs coding for light and heavy chain constant regions, then incorporated into hybrid vectors and transferred into appropriate host cells with the help of these hybrid vectors.

35 The invention therefore also concerns recombinant DNAs comprising an insert coding for a light chain murine variable region specific for human CEA fused to a human constant region λ . Preferred is a recombinant DNA coding for a preferred murine variable region as described hereinbefore fused to a human constant region λ .

Likewise the invention concerns recombinant DNAs comprising an insert coding for a heavy chain 40 murine variable specific for human CEA fused to a human constant region γ , for example $\gamma 1$, $\gamma 2$, $\gamma 3$ or $\gamma 4$. Preferred is a recombinant DNA coding for a preferred murine variable region as described hereinbefore fused to a human constant region $\gamma 4$.

Furthermore the invention concerns a recombinant DNA which is a hybrid vector comprising an insert coding for a chimeric murine/human light chain as described hereinbefore and/or an insert coding for a 45 chimeric murine/human heavy chain as described hereinbefore, a complete replicon and one or more dominant marker sequences, operationally linked to expression control sequences.

The markers allow for selection of host cells which contain the vector. Selection markers include genes which confer resistance to heavy metals, e.g. copper, antibiotics, e.g. G-418 (geneticin, a neomycin- 50 derivative) or hygromycin, or genes which complement a genetic lesion of the host cell such as the absence of thymidine kinase, hypoxanthine phosphoryl transferase, dihydrofolate reductase or the like. In addition, hybrid vectors optionally contain signal sequences, one or more restriction sites available for the insertion of a structural gene, enhancers and/or expression control sequences. A wide variety of transcriptional and translational regulatory sequences may be employed, depending on the nature of the host. Preferred vectors are suitable for mammalian hosts and are based on viral replication systems, such as simian virus 55 40 (SV40), Rous sarcoma virus (RSV), adenovirus 2, bovine papilloma virus (BPV), papovavirus BK mutant (BKV), or mouse and human cytomegalovirus (CMV). Alternatively, the vectors may contain promoters from mammalian expression products, such as actin, collagen, myosin etc., or the native promoter and control sequences which are normally associated with the immunoglobulin gene sequences. Enhancers are

transcription-stimulating DNA sequences of viral origin, e.g. derived from simian virus such as SV40, polyoma virus, bovine papilloma virus or Moloney sarcoma virus, or of genomic, especially murine origin (mouse Ig enhancer). An origin of replication is provided either by construction of the vector to include an exogeneous origin, such as derived from SV40 or another viral source, or by the host cell chromosomal replication mechanism. Examples of preferred vectors are those derived from pSV-vectors in which the selectable marker is placed under the control of the SV40 early promoter, in particular pSV2gpt carrying the xanthine-guanine phosphoribosyl transferase gene, and pSV2neo, carrying the phosphotransferase gene.

The chimeric gene constructs for the light chain and for the heavy chain are sequentially or simultaneously transferred into the host cells with the help of two vectors. Alternatively, both heavy and light chains are cloned into the same hybrid vector and incorporated in a one step-procedure as a single construct into the host cells.

The recombinant DNAs coding for the desired chimeric monoclonal antibodies can be prepared, for example, by culturing a transformed host.

In particular, such DNAs can be prepared by

- a) isolating murine DNAs from a suitable hybridoma cell line, selecting the desired DNAs coding for the variable regions of monoclonal antibodies directed against human CEA using DNA probes,
- b) isolating human DNAs from a genomic library, selecting the desired DNAs coding for the constant regions of monoclonal antibodies using DNA probes,
- c) constructing chimeric mouse/human genes by incorporating the DNA of step a) and b) into appropriate hybrid vectors,
- d) transferring the obtained hybrid vectors into a recipient host, and
- e) selecting and culturing the transformed host.

The DNA according to step a) of the process described above can be obtained by isolation of genomic DNA or by preparation of cDNA from isolated mRNA. As genomic DNA constructs facilitate gene expression, the preparation and use of genomic DNA is to be preferred.

Genomic DNA from hybridoma cells is isolated by methods known in the art which include steps for disruption of the cells, e.g. by lysis in presence of detergents like Triton, extracting the DNA, e.g. by treatment with phenol and CHCl_3 /isoamyl alcohol, and DNA-precipitation. The DNA is fragmented, conveniently by one or more restriction endonucleases, e.g. XbaI, BglII, EcoRI, HindIII, BamHI, the resulting fragments are replicated on a suitable carrier, e.g. nitrocellulose membranes, and screened with a DNA probe as described in more detail hereinbelow for the presence of the DNA sequences coding for the polypeptide sequence of interest, in particular for the presence of the rearranged H- and L-chain Ig gene loci. By this procedure DNA fragments are found that contain inserts with heavy chain V, D and J regions and light chain V and J regions, respectively, together with a leader sequence and introns, if any.

Genomic human DNA according to step b) of the process described above is isolated from suitable human tissue, preferably from human placenta or human foetal liver cells, according to methods known in the art. A genomic DNA library is constructed therefrom by limited digestion with suitable restriction endonucleases, e.g. HaeIII and AluI, and incorporation into λ Charon phage, e.g. λ Charon 4a, following established procedures. The genomic DNA library is replicated, e.g. on nitrocellulose membranes, and screened with a DNA probe as described below for the DNA sequences of interest.

The DNA probe for the mouse variable regions or the human constant regions may be a synthetic DNA, a cDNA derived from mRNA coding for the desired immunoglobulin or a genomic DNA or DNA fragment of known nucleotide sequence. Preferably a genomic DNA or DNA fragment probe is used. As probes for the detection of the rearranged Ig gene loci of the variable regions of L-/H-chains, DNA fragments of known nucleotide sequences of adjacent conserved variable or constant regions are selected which constitute the Ig loci of the L-/H-chain in the mammal from which the DNA is derived, e.g. Balb/c mice. The utilization of murine DNA probes for the detection of human DNA sequences is based on sequence homologies between the murine and human DNAs. The DNA probe is isolated from suitable tissue of an appropriate mammal, e.g. Balb/c mouse liver, purified by molecular cloning in bacteriophage λ and subcloning appropriate DNA fragments in suitable plasmid vectors, such as pUC12 or pUC13, and recovering/purifying cloned DNA inserts using standard procedures. The purified probe DNA is labelled, e.g. radioactively-labelled by the well-known nick-translation technique, then hybridized with the human DNA library in buffer and salt solutions containing adjuncts, e.g. calcium chelators, viscosity regulating compounds, proteins, non-specific DNA and the like, at temperatures favoring selective hybridization.

Once a fragment has been identified which contains the desired DNA sequence, this fragment may be further manipulated to remove nonessential DNA, modified at one or both termini, and treated to remove all or a portion of intervening sequences, or the like.

The joining of the various DNA fragments in order to produce chimeric genes is performed in accordance with conventional techniques, for example, by blunt- or staggered-end ligation, restriction enzyme digestion to provide for appropriate cohesive termini, filling in cohesive ends as appropriate, alkaline phosphatase treatment to avoid undesirable joining, and ligation with appropriate ligases.

5 The transfer of the recombinant DNAs, e.g. the transfer of hybrid vectors, and the selection of transformed cells is described below.

Moreover, the invention relates to host cells transformed with the recombinant DNAs described above, namely host cells which are transformed with a DNA encoding the light chain and/or a DNA encoding the heavy chain of the desired chimeric antibody.

10 The host cells of the present invention have to be capable of culture in vitro and have to be of higher eukaryotic origin to provide a suitable environment for the production of active antibodies, since the biosynthesis of functional tetrameric antibody molecules requires correct nascent polypeptide chain folding, glycosylation, and assembly. Examples of suitable host cells according to the invention are mammalian cells, e.g. COS-7 cells, Bowes melanoma cells, chinese hamster ovary (CHO) cells, embryonic lung cells L-132, and in particular mammalian cells of lymphoid origin, such as myeloma or lymphoma cells, for
15 example Sp2/0 cells. Sp2/0 (ATCC CRL 1581) is a well-characterized, Ig non-secreting mouse cell line, derived from the fusion of mouse spleen cells with the myeloma X63-Ag8. These host cells are transfected with the chimeric H-chain gene construct alone, with the L-chain gene construct alone, or with both, either transferred with the help of two separate vectors or by using a double-construct (L-chain/H-chain) vector as
20 indicated hereinbefore. Particularly preferred are host cells transfected with both gene constructs, which are transferred with the help of two separate vectors, secreting chimeric monoclonal antibodies with an affinity to CEA as described hereinbefore, for example cells of the cell line EFVIII/γ4Na 75-75/CxGa5-6 (referred to as CE75-5-6). Also particularly preferred are host cells transfected with both gene constructs, which are simultaneously transferred with the help of a double-construct vector, secreting chimeric monoclonal
25 antibodies of the invention, for example cells of the cell line EFIX-pCEA-Ig-(γ4;Cx) (referred to as CE 4-8-13). Further examples of host cells of the invention are cells transfected with similar recombinant plasmids which contain alternative orientations of the H- and L-chain gene constructs, incorporating additional DNA elements to facilitate high levels of expression of the chimeric monoclonal antibodies.

The host cells of the invention are genetically stable, secrete chimeric monoclonal antibodies of the
30 invention of constant specificity and can be activated from deep-frozen cultures by thawing and recloning.

The invention also relates to processes for the preparation of host cells secreting chimeric monoclonal antibodies with specificity to CEA as described hereinbefore, characterized in that a suitable cell is transformed with one or two vectors, e.g. by electroporation, calcium treatment, microinjection or protoplast fusion.

35 Vectors are introduced into mammalian cells by transfection in the presence of helper compounds, e.g. diethylaminoethyl-dextran, dimethyl sulfoxide, glycerol, polyethylene glycol or the like, or as co-precipitates of vector DNA and calcium phosphate. Further suitable methods include direct microinjection of vector DNA into the cell nucleus, protoplast fusion and electroporation, i.e. introduction of DNA by a short electrical pulse which transiently increases the permeability of cell membranes. The subsequent selection of
40 transfected cells can be done using a selection marker which is either covalently integrated into the expression vector or added as a separate entity. Selection markers include genes which confer resistance to antibiotics, e.g. G-418 (geneticin, a neomycin-derivative) or hygromycin, or genes which complement a genetic lesion of the host cell such as the absence of thymidine kinase, hypoxanthine phosphoribosyl transferase, dihydrofolate reductase, or the like.

45 The chimeric monoclonal antibodies and derivatives thereof according to the invention are used in a number of applications, especially for the diagnosis and therapy of cancer.

An example of diagnostic use is the qualitative and quantitative determination of human carcinoembryonic antigen, especially in biological fluids. The chimeric monoclonal antibodies and derivatives thereof may be used in any of the immunoassays known per se that utilize the binding interactions between antigen
50 and monoclonal antibody, such as radioimmunoassays (RIA), enzyme-linked immunoassays, immunofluorescence tests, latex agglutination or haemagglutination.

Any of the known modifications of a RIA can be used, for example RIA in homogeneous phase, solid phase RIA or heterogeneous RIA, single RIA or double (sandwich) RIA with direct or indirect (competitive) determination of CEA. There is preferred a sandwich RIA in which a suitable carrier, for example the
55 plastics surface of a microtitre plate or of a test tube, for example of polystyrene, polypropylene or polyvinyl chloride, glass or plastics beads, filter paper, or dextran, cellulose acetate or nitrocellulose sheets or the like, is coated with an antibody to CEA by simple adsorption or optionally after activation of the carrier, for example with glutaraldehyde or cyanogen bromide, and incubated with the test solution and a solution of an

antibody radioactively labelled with ^{125}I , the dissolved antibody recognizing another epitope of CEA than the carrier-bound antibody, and the amount of CEA is determined by measuring the radioactivity bound to the carrier. One of the two antibodies used in the sandwich RIA is a chimeric monoclonal antibody of the invention, the other one can be a known monoclonal or polyclonal anti-CEA antibody or also a chimeric antibody according to the invention.

5 The chimeric monoclonal antibodies according to the invention can be used as such or in the form of enzyme-conjugated derivatives in an enzyme-immunoassay. Such immunoassays include test procedures in which enzyme-labelled chimeric monoclonal antibody derivatives according to the invention or enzyme-labelled antibodies known per se that recognize and bind an epitope of the antibodies according to the invention are used. The amount of antigen is determined in a cascade-antigen-antibody-complex with the help of an enzymatic test.

10 There is preferred an ELISA (enzyme-linked immunosorbent assay) in which a carrier as described above for a RIA is coated with an anti-CEA antibody and incubated with a test solution containing CEA. After binding of CEA, a second antibody directed against CEA is added which binds to the antibody-antigen-complex. The bound antibodies are developed by a third enzyme-labelled antibody specific for the constant region of the second antibody. The amount of CEA is determined by an enzyme-substrate reaction. One of the antibodies used in the test is a chimeric monoclonal antibody of the invention, the other one can be a known monoclonal or polyclonal anti-CEA antibody or also a chimeric antibody according to the invention. The labelled antibody is, for example, an alkaline phosphatase-labelled goat-anti-human IgG antibody.

20 There is also preferred an ELISA in which a carrier coated with an antibody is incubated with a test solution containing CEA and with a solution of an antibody that is conjugated with an enzyme, the dissolved antibody recognizing a different CEA-epitope than does the carrier-bound antibody. One of the antibodies used in the test is a chimeric monoclonal antibody of the invention, the other one is a known monoclonal or polyclonal anti-CEA antibody.

25 The invention relates also to test kits for the determination of human CEA containing chimeric monoclonal antibodies to human CEA and/or derivatives thereof and, optionally, adjuncts.

Test kits according to the invention for a radioimmunoassay contain, for example, a suitable carrier, optionally freeze-dried or concentrated solutions of one or more monoclonal antibodies, solutions of a radioactively labelled monoclonal antibody or of radioactively labelled human CEA, standard solutions of human CEA, buffer solutions and, optionally, detergents for preventing non-specific adsorption and aggregate formation, pipettes, reaction vessels, calibration curves and the like. One or more of the monoclonal antibodies of the test kit are chimeric monoclonal antibodies of the invention.

30 Test kits according to the invention for an enzyme-immunoassay contain, for example, a suitable carrier, optionally freeze-dried or concentrated solutions of one or more monoclonal antibodies, optionally freeze-dried or concentrated solutions of an enzyme-labelled monoclonal antibody, of enzyme-labelled human CEA, of a polyclonal anti-human CEA serum and/or of enzyme-labelled monoclonal or polyclonal antibodies that recognize and bind the anti-human CEA antibody, enzyme substrates in solid or dissolved form, standard solutions of human CEA, buffer solutions, detergents, pipettes, reaction vessels, calibration curves, colour scale tables and the like. One or more of the monoclonal antibodies of the test kit are chimeric monoclonal antibodies of the invention.

40 In addition, based on their reduced immunogenicity, the chimeric monoclonal antibodies and their derivatives are useful in therapy, for passive immunization without negative immune reactions such as serum sickness or anaphylactic shock, for localization and *in vivo* imaging of tumors, for specific treatment of diseased cells, e.g. site-directed delivery of cytotoxins, immuno-modulators or other pharmaceutically active molecules where local concentration of the active agent is an important factor, or the like. For *in vivo* imaging, the chimeric antibody is radiolabelled or conjugated with a metal chelate complexed with a radionuclide, e.g. iodine, yttrium, technetium, or the like, and radioscanning techniques may be used to detect primary and metastatic tumors. To that end, the radioactive antibody is injected e.g. intravenously and the patient scanned with a gamma imager at regular intervals. Tumors expressing CEA will take up more radioactive antibodies than other tissue and will be clearly recognized by the gamma imaging camera. Preferentially monoclonal antibodies labelled with ^{131}I are used for radioscanning in amounts of 3 to 8 μg representing 15 to 30 μCi per kg body weight. For biocidal activity in the treatment of cancer, the chimeric antibodies are used as derivatives conjugated to cytostatic or cytotoxic substances as described hereinbefore, e.g. ricin A, as radiolabelled derivatives, or else delivered in liposomes containing biocidal reagents.

55 The therapeutic dose for mammals is between approximately 1 mg and 5 mg per kg body weight for monoclonal antibodies themselves, and between 0.1 mg and 5 mg per kg body weight for conjugates with cytotoxic drugs, depending on the status of the patient and the mode of application. Alternatively, the chimeric antibodies can be used in combination with components of the host immune system, e.g.

complement, due to the presence of the native constant region. In vitro, the subject chimeric antibodies can be used in conjunction with complement to remove particular CEA-presenting cells from a mixture of cells.

The invention also relates to pharmaceutical preparations containing a chimeric monoclonal antibody or derivatives thereof with a high specificity for CEA as disclosed hereinbefore. The pharmaceutical preparations contain, for example, chimeric monoclonal antibodies or derivatives thereof in an effective amount together or in admixture with inorganic or organic, solid or liquid pharmaceutically acceptable carriers.

Preferred are pharmaceutical preparations for parenteral application. Preparations for intramuscular, subcutaneous or intravenous application are e.g. isotonic aqueous solutions or suspensions, optionally prepared shortly before use from lyophilized or concentrated preparations. The pharmaceutical preparations may be sterilized and contain adjuvants e.g. for conserving, stabilizing, wetting, emulsifying or solubilizing the ingredients, salts for the regulation of the osmotic pressure, buffer and/or compounds regulating the viscosity, e.g. sodium carboxycellulose, dextran, polyvinylpyrrolidone or gelatine. They are prepared by methods known in the art, e.g. by conventional mixing, dissolving or lyophilizing, and contain from approximately 0.01 % to approximately 50 % of active ingredients. The preparations for injections are processed, filled into ampoules or vials, and sealed under aseptic conditions according to methods known in the art.

The following examples illustrate the invention.

Figure legends

Symbols for restriction sites: A - AluI, B - BamHI, Bg - BglII, E - EcoRI, H - HindIII, Hh - HhaI, P - PstI, Sa - Sall, Sp - SphI, X - XbaI, Xm - XmnI
 V: variable region Ig gene segment
 J: joining segment
 D: diversity segment
 L: leader sequence

Boxes indicate the position of the rearranged V-region and its leader peptide coding segment (black boxes), and the position of J-segments (open boxes).

Figure 1:

A) G: germline configuration of the mouse L-chain Ig gene locus showing the position of J-segments and the origin of the J-region probe
 L2 and L2.5: restriction maps of the CE 25 hybridoma-specific rearranged L-chain Ig genes deduced from Southern blot analysis (Example 3)
 plasmid pCEA-L2a: cloned segment of the L2 gene
 (B) G: germline configuration of the mouse H-chain Ig gene locus showing the position of J-segments and the origin of the J-region probe
 H2 and H8: restriction maps of the CE 25 hybridoma-specific rearranged H-chain Ig genes deduced from Southern blot analysis (Example 3)
 The plasmid pH8a1 is not shown, but it is constructed in an analogous manner to pCEA-L2a and contains the XbaI/XbaI segment of the H8 gene.
 [E]: EcoRI sites in the cloned H8 gene that cannot be detected by Southern blot analysis of CE 25 hybridoma DNA

Figure 2:

Detection of L2- and H8-specific mRNA transcripts in CE 25 hybridoma cells by Northern blot analysis (Example 6):
 RNA blots of 25 and 50 µg of P3-NS2/1Ag4-cell RNA (NS) and CE 25 hybridoma-cell RNA (CE 25)
 (a) using an L2 L-chain gene segment
 (b) using an H8 H-chain gene segment.

Figure 3:

Scheme for construction of the chimeric mouse/human L-chain gene pCEA-CxGa (Examples 8.1 and 8.2)
 Symbols: see above.

Figure 4:

Scheme for construction of the chimeric mouse/human H-chain gene pCEA- γ 4Na (Examples 8.3 and 8.4)

5 Symbols: see above.

Figure 5:

Scheme for the construction of pM1HuC α -1a

10 (Examples 10.1 and 10.2)

Symbols: see above; restriction sites placed in brackets are eliminated during the various cloning procedures.

Figure 6:

15

Scheme for the construction of the chimeric double-construct pCEA(H+L)2neo holding both mouse/human (γ 4; α) anti-CEA, H- and L-chain Ig genes

Symbols: see above; restriction sites placed in brackets are eliminated during the various cloning procedures.

20

Figure 7:

Binding of the chimeric monoclonal antibody secreted by CE 4-8-13 to CEA

OD: optical density.

25

Abbreviations

	bp	base pairs
	CDR	complementarity determining region
30	ddNTP	dideoxynucleotide triphosphate (N = adenine, cytosine, guanine or thymine)
	dNTP	deoxynucleotide triphosphate (N = adenine, cytosine, guanine or thymine)
	DMEM	Dulbecco's minimal essential medium (Dulbecco & Vogt, J. Exp. Med. <u>99</u> , 167, 1954)
	DTT	dithiothreitol
	EDTA	ethylenediaminetetraacetic acid
35	FCS	foetal calf serum
	HEPES	N-2-hydroxyethyl piperazine-N'-2' ethanesulphonic acid
	HAT	hypoxanthine/aminopterin/thymidine
	HT	hypoxanthine/thymidine
	Ig	immunoglobulin
40	kb	kilobase (pairs)
	MOPS	γ -morpholino propanesulphonic acid
	NZ-amine	NZ-amine (10 g/l); NaCl (5 g/l); yeast extract (5 g/l, Difco); casamino acids (1 g/l, Difco) MgSO ₄ · 7H ₂ O (2 g/l), pH 7.5 with NaOH
	PBS	phosphate buffered saline (Dulbecco & Vogt, J. Exp. Med. <u>99</u> , 167, 1954)
45	PBS-CM	PBS without MgCl ₂ and CaCl ₂
	RIA	radioimmunoassay
	SDS	sodium dodecylsulphate
	20 x SET	3 M NaCl, 20 mM EDTA, 0.4 M Tris-HCl, pH 7.8
	SSC	0.15 M NaCl, 0.015 M sodium citrate
50	TE buffer	1 mM EDTA, 10 mM Tris-HCl, pH 8.0
	Tris	Tris (hydroxymethyl)aminomethane

Example 1: Preparation of hybridoma cell line CE 25

55 1.1 Purification of carcinoembryonic antigen (CEA)

Colon carcinoma liver metastases obtained from autopsies (within 6 h of death) are extracted with saline. 1 vol. of tissue is first homogenized in 3 vol. of 0.02M phosphate buffer pH 7.4 at 4 °C for 10 min in

a Sorvall Omnimixer® at 8,000 rpm. The crude homogenate is then centrifuged at 8,000 g for 15 min at 4 °C. The clear supernatant is applied to an immunoadsorbent consisting of a pool of the known anti-CEA monoclonal antibodies MAb 35 and MAb 115 (Haskell et al., *Cancer Res.* 43, 3857, 1983; Buchegger et al., *J. Exp. Med.* 158, 413, 1983) and MAb 73 (Buchegger et al., *Immunol. Letters* 5, 85, 1982) coupled to 5 CNBr-activated Sepharose®. CEA is eluted with 2M ammonium thiocyanate.

1.2 Immunization of Balb/c mice

Balb/c mice two months of age are immunized with CEA by injecting intraperitoneally 15 µg of saline- 10 extracted purified CEA with complete Freund's adjuvant. After 4 months, a series of booster injections comprising 15, 50 and 150 µg of the same saline CEA preparation without Freund's adjuvant given intraperitoneally 5, 4 and 3 days before fusion, respectively.

1.3 Cell fusion

15 Cell fusion is accomplished using 1.5×10^8 spleen cells of immunized mice and 1.5×10^7 cells from the mouse myeloma P3-NS2/1Ag4 according to conventional previously described methods (Koehler & Milstein, *Nature* 256, 495, 1975). After washing, the cells are resuspended in 48 ml of standard Dulbecco's minimum essential medium (Gibco No. 0422501). 3×10^6 normal mouse peritoneal exudate cells per fusion 20 are added as feeder cells. The cells are distributed into 96 x 0.5 ml Costar wells and fed 3 times per week with standard HAT selection medium for 3-6 weeks. When the growth of hybridoma cells becomes visible, the supernatants are screened as described in Example 1.4. Positive hybridomas, for example the cell line CE25 described in Example 1.5, are recloned and stored.

25 1.4 Antibody detection in hybridoma supernatants

Culture fluids of growing hybridomas are tested for the presence of anti-CEA antibody by a modification of the assay of Farr (*J. Infect. Dis.* 103, 239, 1958) as described previously (Accolla et al., *Proc. Natl. Acad. Sci.* 77, 563, 1980). 1:10 (v/v) dilutions of cell culture supernatants are incubated in duplicate with ¹²⁵I-labelled CEA in 0.02M Tris-HCl buffer, pH 7.4. CEA bound to antibodies is precipitated at 4 °C by adding 30 cold, saturated ammonium sulphate solution in the presence of normal human serum.

1.5 Hybridoma storage and processing

35 Hybridoma CE 25 secreting anti-CEA antibody MAb CE 25 can be grown in culture, frozen at -80 °C or in liquid nitrogen and reactivated. The cells are cloned by the method of limiting dilution and expanded by forming ascites in Balb/c mice primed with pristane. Cell line CE 25 was deposited at the "Collection Nationale de Cultures de Microorganismes" of the Institut Pasteur, Paris, on December 15, 1987, under the number I-719.

40 Example 2: Isolation of DNA from the hybridoma cell lines CE 25, P3-NS2/1Ag4 and Balb/c mouse kidney cells

CE 25 hybridoma cells (5×10^7) are grown in suspension culture at 37 °C in DMEM (Seromed) + 10 % 45 FCS (Seromed), 1 mM sodium pyruvate (Seromed), 2 mM glutamine (Seromed), 50 µM 2 mercaptoethanol and 100 µg/ml of gentamycin (Seromed) in a humidified atmosphere of air and 7.5 % CO₂, in 175 cm³ tissue culture flasks (Falcon 3028). Cells are harvested by centrifugation, flash-frozen in liquid nitrogen and kept frozen as a pellet at -80 °C in a clean, sterile plastic capped tube.

The frozen cells are resuspended in 10 ml of PBS to which is added 90 ml of 0.3 M sucrose, 5 mM 50 MgCl₂, 0.1 % (w/v) Triton-® X-100, 10 mM Tris-HCl, pH 7.5, at 4 °C in a clean, sterile 100 ml plastic beaker. Cells are lysed by mixing, and nuclei collected by centrifugation (10 min, 10,000 rpm, 4 °C, Sorvall RC-5 centrifuge, SS-34 rotor). The supernatant is removed and the nuclear pellet resuspended in 4.5 ml of 75 mM NaCl, 24 mM EDTA, pH 8.0. Distilled water (100 µl), SDS (250 µl of a 10 % (w/v) solution in distilled water), and 100 µl of proteinase K solution (Boehringer; 10 mg/ml solution in distilled water) are 55 added and mixed gently. The mixture is incubated at 37 °C overnight.

The solution is extracted by mixing with an equal volume of redistilled phenol saturated with 20 mM Tris-HCl, pH 8.0, at 0 °C. The aqueous phase is recovered after centrifugation (10,000 rpm, room temperature, Sorvall RC-5 Centrifuge, SS-34 Rotor) and extracted twice with an equal volume of

CHCl₃/isoamyl alcohol (24:1, v/v). DNA is precipitated by the addition of one-tenth volume of 3 M NaOAc, pH 5.0, followed by two volumes of absolute ethanol at room temperature. The precipitated DNA is lifted from the ethanolic solution, placed in 1 ml of TE buffer and dissolved overnight at 4 °C. The yield of DNA is approximately 0.5 mg.

5 DNA from cell line P3-NS2/1Ag4 is obtained likewise.

For preparations of DNA from Balb/c mouse kidney tissue, fresh mouse kidney is flash-frozen in liquid nitrogen, ground to a fine powder in a clean, sterile pestle and mortar in the presence of liquid nitrogen, and DNA extracted from an amount of tissue equivalent to 5 x 10⁷ cells, following the procedure described above.

10

Example 3: Analysis of rearranged Ig H- and L-chain gene loci in CE 25 cells

Hybridoma CE 25 contains H- and L-chain Ig gene loci derived from the P3-NS2/1Ag4 cell used as fusion partner for the generation of the hybridoma. The P3-NS2/1Ag4 cell line is derived from the MOPC-21 myeloma (Storb et al., *Nucleic Acids Res.* 8, 4681, 1980). These 'endogenous' rearranged loci are distinguished from CE 25-specific rearranged genes by the following procedures:

15

3.1 Source and preparation of probe DNA fragments

20

The probe DNA segment used for the detection of the Balb/c mouse germline H-chain J-region DNA segment is an approximately 1750 bp BglII/XbaI segment of Balb/c mouse liver DNA, corresponding to nucleotide positions 1130-2881 of the published germline H-chain Ig locus (Newell et al., *Science* 209, 1128, 1980; EMBL data base entry MUSIGCD07).

25

The probe DNA segment used for the detection of the Balb/c mouse germline L-chain J-region segment is an approximately 2240 bp HindIII/XbaI segment of Balb/c mouse liver DNA, corresponding to nucleotide positions 659-2900 of the published germline L-chain Ig locus (Max et al., *Proc. Natl. Acad. Sci.* 76, 3450, 3454, 1979; EMBL data base sequence entry MUSIGKJC2).

30

DNA probes are purified by molecular cloning of Balb/c mouse liver DNA in bacteriophage λ , subcloning appropriate DNA fragments in pUC12- or pUC13-plasmid vectors, and recovering/purifying cloned DNA inserts using standard procedures (Maniatis et al., "Molecular Cloning: A laboratory manual", Cold Spr. Harbour, N.Y., 1982).

35

DNA probes are prepared from 300 ng of purified DNA fragments by nick-translation in the presence of α -³²P-dCTP, E. coli DNA polymerase-I and DNaseI, using the standard published procedure (Rigby et al., *J. Mol. Biol.* 113, 237, 1977). Labelled probe DNA is separated from unincorporated label using Sephadex® G50 (Pharmacia) chromatography with a 10 x 0.5 cm separation column and an elution buffer containing 150 mM NaCl, 10 mM EDTA, 0.1 % (w/v) SDS, 50 mM Tris-HCl, pH 7.5.

3.2 Gel electrophoresis of DNA

40

Samples of DNA (5 μ g) from (a) the P3-NS2/1-Ag4 myeloma used as parental fusion partner in the generation of the CE 25 hybridoma, (b) the CE 25 hybridoma, and (c) Balb/c mouse kidney cells, prepared as described in Example 2, are digested to completion using the restriction enzymes XbaI, BglII, EcoRI + HindIII, BamHI, EcoRI or HindIII (Boehringer) under conditions recommended by the manufacturer. DNA fragments are separated by flat-bed agarose gel electrophoresis using 10 x 20 x 0.5 cm 0.5 % (w/v) agarose (Biorad, standard low M,) gels and electrophoresis buffer containing 25 mM disodium-EDTA, 90 mM Tris-base, 90 mM boric acid, pH 8.3. Fragments of bacteriophage λ digested either with HindIII or with EcoRI are pooled and radioactively labelled using Klenow DNA polymerase I fragment (Boehringer) in the presence of dNTPs and α -³²P-dNTPs using a published procedure (Maniatis et al., "Molecular Cloning: A laboratory manual", Cold Spr. Harbour, N.Y., 1982). These are included in separate lanes of the agarose gel to provide a range of labelled DNA marker fragments of known size. After separation of DNA fragments by electrophoresis they are transferred by blotting at room temperature to nitrocellulose membrane using the published Southern procedure (Southern, *J. Mol. Biol.* 98, 503, 1975) with some minor modifications as follows. After electrophoresis excess agarose is trimmed from the edges of the gel, after which it is soaked at room temperature in 500 ml of 0.25 M HCl solution for 30 min, followed by soaking in 500 ml of 1.5 M NaCl, 0.5 M NaOH for 60 min to denature the DNA. The gel is rinsed briefly with distilled water and then soaked for 60 min in neutralising solution (3 M NaCl, 0.3 M Tris-HCl, pH 7.5). DNA fragments are then transferred overnight to a nitrocellulose membrane (Schleicher & Schuell, 0.45 μ m pore size) by the published procedure referred to above using a solution containing 3 M NaCl, 0.3 M sodium citrate, pH 6.8.

55

The nitrocellulose membrane containing the blotted DNA fragments is air-dried and baked at 80 °C for 2 h under vacuum. After baking, excess dried salts are removed by soaking the membrane in 0.75 M NaCl, 0.075 M sodium citrate, pH 6.8, before hybridizing with radioactively-labelled DNA probes.

5 3.3 DNA hybridization

Nitrocellulose filters prepared as described in Example 3.2 are prehybridized in heat-sealed plastic bags for 4 h at 65 °C in 20 ml of prehybridization solution containing 0.2 ml of 10 % (w/v) SDS, 0.4 ml of 5 % (w/v) sodium pyrophosphate, 0.4 ml of herring sperm DNA (5 mg/ml in distilled water) sheared by passage through an 18 gauge hypodermic needle, 5 ml of Denhardt's solution (Denhardt, BBRC 23, 641, 1966; 0.2 % (w/v) bovine serum albumin, 0.02 % (w/v) polyvinylpyrrolidone, 0.02 % (w/v) Ficoll-400 in 20 x SET buffer (3 M NaCl, 20 mM EDTA, 0.4 M Tris-HCl, pH 7.8)) and 14 ml of distilled water.

The DNA hybridization mixture contains 10⁷ cpm of radioactively-labelled DNA probe, 10 ml of prehybridization solution, prepared as described above, and 10 % (w/v) dextran sulphate (Sigma). The mixture is heated at 100 °C for 20 min to denature the DNA. For hybridization, the prehybridization mixture is removed from the plastic bag and replaced by the hybridization mixture. After excluding air-bubbles the bag is resealed and incubated overnight at 65 °C. To remove non-specifically bound DNA from the membrane, the hybridization mixture and membrane are removed from the plastic bag. The membrane is placed in a bath containing 500 ml of 5 x SSC, 0.1 % (w/v) sodium pyrophosphate and washed for 15 min at 65 °C. The membrane is then washed sequentially at 65 °C for 30 min in 500 ml of solution containing 4 x SSC, 3 x SSC, 2 x SSC and finally 1 x SSC, all containing 0.1 % (w/v) sodium pyrophosphate. The membrane is air-dried, sealed in a clean, thin polythene bag, and autoradiographed at -70 °C using Kodak X-ray film (X-omat TM AR) and image intensifying screens, for up to three days.

The results are summarized in Table 1 below and illustrated in Figure 1:

Table 1

Size of CE 25 hybridoma-specific genomic DNA fragments showing homology with murine H-chain and L-chain Ig J-region DNA probes						
DNA probe	restriction enzyme used/size of fragments in kb					
	XbaI	BglII	EcoRI/HindIII	BamHI	EcoRI	HindIII
H-chain	8.0* 2.1	21.0 20.0	5.6 2.1	10.8 8.3	7.5 2.5	6.3 2.9
L-chain	2.5 2.0*	1.8 1.2	2.1 1.9	6.4 4.5	20.0 18.0	9.5 1.9

* fragments encoding functional H- and L-chain V-region H8 and L2 segments of the CE 25 antibody

By comparison with the parental fusion partner cell line P3-NS2/1Ag4, the CE 25 hybridoma contains two additional rearranged H-chain Ig gene loci and two additional rearranged L-chain Ig gene loci. These are referred to as H2 and H8 (Fig. 1B), and L2 and L2.5 (Fig. 1A), respectively, from the sizes of the mouse genomic DNA fragments detected in XbaI restriction digests by Southern blotting using mouse Ig-specific DNA probes.

Example 4: Molecular cloning of functionally-rearranged H- and L-chain Ig genes of the CE 25 hybridoma

4.1 Preparation of size-selected DNA fractions containing CE 25 hybridoma-specific rearranged H- and L-chain Ig loci

CE 25 hybridoma DNA (50 µg) is digested to completion with XbaI, extracted with an equal volume of CHCl₃/redistilled phenol (1:1, v/v, saturated with 20 mM Tris-HCl, pH 8.0), followed by extraction with an equal volume of CHCl₃ to remove traces of phenol. DNA is precipitated by the addition of 0.1 vol. of 3 M NaOAc, pH 5.0 and 2.5 vol. of absolute ethanol at -20 °C. The DNA pellet is recovered, dissolved in 150 µl of TE buffer and applied to a 12 ml, 5-24 % (w/v) NaCl gradient in TE buffer in a polyallomer tube for the Beckman SW41 rotor. Gradients are centrifuged for 4.5 h at 37,000 rpm at 25 °C, and fractionated from the

bottom. DNA fractions (300 μ l) corresponding to (a) 1.5-2.5 kb-long DNA fragments, and (b) 6.0-9.0 kb-long DNA fragments, are collected, pooled and precipitated using 2.5 vol. of absolute ethanol at -20°C . DNA from pooled fractions (a) and (b) are recovered by centrifugation, dried under vacuum and dissolved in TE buffer to concentrations of 50 ng/ μ l and 200 ng/ μ l, respectively.

4.2 DNA ligations and packaging into bacteriophage particles

DNA samples (1 μ l) from fractions (a) and (b) as described above are ligated overnight at 4°C with 0.8 μ g of λ -OngC/XbaI-digested bacteriophage DNA arms (Stratagene Inc., San Diego, USA) in 5 μ l of a solution containing 10 mM DTT, 1 mM ATP, 10 mM MgCl_2 , 20 mM Tris-HCl, pH 7.6, in the presence of 5 units of T4 DNA ligase (Boehringer). Ligation mixtures are packaged using Gigapack 'PLUS' (Stratagene Inc., San Diego, USA) and plated on *E. coli* K12/VCS257 (prepared by growth on NZ-amin/0.4 % (w/v) maltose) using NZ-amin growth medium, according to the manufacturer's instructions, at a density of approximately 250 pfu/cm² using standard microbiological procedures. Plates are incubated overnight at 37°C .

The L2 and L2.5 rearranged L-chain Ig gene loci are detected in library (a) by Benton & Davis hybridization screening (Science 196, 180, 1977) using the nick-translated ³²P-labelled mouse L-chain Ig DNA probe described in Example 3.1. Positively-hybridizing plaques are plaque-purified, picked using the tip of a sterile pasteur pipette, and the phage resuspended in 1 ml of phage buffer (100 mM NaCl, 8 mM $\text{MgSO}_4 \cdot 7\text{H}_2\text{O}$, 0.01 % (w/v) gelatin, 5 mM Tris-HCl, pH 7.5). Phage lysates (10 ml) are prepared by adsorbing 20 μ l of phage suspension to a 100 μ l volume of cells taken from an overnight culture of *E. coli* K12/VCS257, grown in NZ-amin medium supplemented with 0.4 % (w/v) maltose. The mixture is diluted to 10 ml with fresh NZ-amin medium in sterile 50 ml Falcon tubes and grown overnight at 37°C with vigorous shaking. CHCl_3 (20 μ l) is added and shaking continued at 37°C for 30 min. Recombinant bacteriophage DNA is prepared from the lysates using a published procedure devised by Blattner et al. (Science 202, 1279, 1978). DNA obtained after the final ethanol precipitation step is dissolved in 100 μ l of TE buffer. Yields of phage DNA are approximately 100 μ g.

Samples of DNA (1 μ g) from each positively-hybridizing recombinant bacteriophage are digested to completion using the restriction endonuclease XbaI. An L2 gene segment is identified as a 2 kb XbaI restriction fragment when the digested recombinant DNA samples are analysed by 1 % (w/v) agarose gel electrophoresis. The approximately 2.0 kb L2 gene segment is cut from the agarose gel, purified by phenol/ CHCl_3 extraction and recovered by ethanol precipitation. The purified DNA fragment is then subcloned in both orientations into the pUC12 plasmid cloning vector, linearized by XbaI digestion. All procedures are standard methods (Maniatis et al., "Molecular Cloning: A laboratory manual", Cold Spr. Harbour, N.Y., 1982). Restriction mapping of these plasmid subclones using the restriction endonucleases XbaI, BglII, PstI, HindIII and BamHI confirms that the structure of the cloned L2 gene segment corresponds to that of the original genomic L2 gene segment, deduced from Southern blotting of CE 25 hybridoma DNA as described in Example 3. Plasmids containing the cloned L2 gene segment in either orientation are designated pCEA-L2a and pCEA-L2b. A restriction map of pCEA-L2a is shown in Fig. 1A.

Library (b) is used as a source of the H8 rearranged H-chain Ig gene segment using the same procedure. Screening of recombinant phage for H-chain gene loci is achieved by hybridizing with the H-chain-specific radioactively-labelled DNA probe described in Example 3.1. Positively-hybridizing recombinant phages are plaque-purified, DNA is isolated and digested using XbaI as described above. An H8 gene sequence is identified as an approximately 8 kb restriction fragment when separated from cloning vector DNA by digestion with XbaI followed by 1 % (w/v) agarose gel electrophoresis. The H8 gene is subcloned in both orientations into the plasmid vector pUC12, linearized by digestion using XbaI. Restriction mapping of the DNA subclones using the enzymes XbaI, PstI, HindIII and BamHI confirms that the structure of the cloned H8 gene segment corresponds to that of the genomic H8 rearranged H-chain Ig locus, deduced from Southern blotting of CE 25 hybridoma DNA using an H-chain-specific radioactively-labelled DNA probe as described in Example 3. These H8 DNA subclones are designated pH8a1 and pH8b1. A restriction map of the pH8a1 XbaI insert DNA fragment is shown in Fig. 1B.

4.3 Nucleotide sequence analysis of the L2 and H8 gene segments

Nucleotide sequencing of the L2 and H8 gene loci in pCEA-L2(a or b) and pH8(a1 or b1) is performed using the published Sanger dideoxynucleotide chain-termination method (Sanger et al., Proc. Natl. Acad. Sci. 74, 5463, 1977). Recombinant plasmid DNAs are cut using appropriate restriction endonucleases and DNA fragments to be sequenced recovered by 1 % (w/v) gel electrophoresis. DNA fragments are then

cloned and sequenced in M13 bacteriophage vectors with the Amersham M13 Cloning System, using the instructions supplied (Amersham International PLC, UK).

The L2 gene segment is sequenced from the 5'-XbaI restriction site to nucleotide 1395, located 3' to the rearranged L-chain V-J4 region. The nucleotide sequence is the one given in formula III.

5 This data confirms the restriction map of the cloned L2 gene in this region (Fig. 1A) and defines the sequence of the first exon encoding the N-terminal residues of the L-chain leader peptide (beginning with methionine at position 733 in the sequence), an intervening sequence (nucleotides 781-987), and the coding sequence of the remainder of the leader peptide and the rearranged L2 V-region ending in a proline residue located at the V-J4 region (nucleotides 988-1284). Nucleotides 1285-1395 correspond to the known mouse
10 x-chain Ig germline sequence (between 1725-1836 of the EMBL data bank sequence entry MUSIGKJC2). Nucleotides 680-1284 correspond to a known mouse germline L-chain V-region (L7, Pech et al., Nature 291, 668, 1981) except for 7 changes in the V-region coding sequence, which may arise by somatic mutation. This data defines the amino acid coding sequence of the rearranged L2 L-chain gene encompassing the leader peptide, the three framework regions and complementarity determining regions CDRLs 1-3
15 (nucleotide residues 1069-1102, 1147-1167, 1263-1291) including the in-frame V-J4 junction.

The H8 H-chain gene segment is sequenced from the internal HindIII restriction site to nucleotide 857 located 3' to the rearranged H-chain V-D-J region. The nucleotide sequence is the one given in formula IV.

This data confirms the restriction map of this region of the H8 gene (Fig. 1B) and defines the sequence of the first exon encoding the N-terminal 16 amino acid residues of the leader peptide (beginning with methionine at position 322 in the sequence), an intervening sequence (nucleotides 368-473) and the coding sequence of the remainder of the leader peptide and the H8 V-region up to a serine residue (nucleotides 474-844). Nucleotide residues 797-857 correspond to the mouse H-chain Ig germline sequence (between 2291-2352 of the EMBL data bank sequence entry MUSIGCD007) except for three nucleotide changes which affect the predicted coding sequence of the J-region of the H-chain polypeptide. The first 796
25 nucleotide residues of the sequence are homologous to, but not identical to, known mouse H-chain V-region, as deduced from a search of the available sequence data in the Genbank, NBRF or EMBL libraries. This sequencing data defines the amino acid coding sequence encompassing the leader peptide, the three framework regions and CDRHs 1-3 (nucleotides 575-595, 629-680, 776-805), the origin of the H-chain diversity (D) segment (which originates either from DSP2.3, DSP2.4 or DSP2.6 of the mouse H-chain Ig
30 germline locus) and the in-frame V-D-J4 junction of the rearranged H8 H-chain gene of hybridoma CE 25.

Example 5: Comparison between nucleotide sequences of expressed H-and L-chain Ig mRNAs and nucleotide sequences of rearranged H-and L-chain genes from the mouse hybridoma CE 25

35 5.1 Extraction of total cellular RNA

Total RNA is extracted using the LiCl/urea method described by Auffray & Rougeon (Eur. J. Biochem. 107, 303, 1980) as modified by Le Meur et al. (Cell 23, 561, 1981). CE 25 hybridoma cells (5×10^7) are grown and prepared as described in Example 2. Cell pellets are thawed directly in the tube in the presence
40 of 5 ml of LiCl/urea (3 M LiCl, 6 M urea, 200 μ g/ml heparin, 0.1 % SDS, 10 mM NaOAc, pH 5.0). Subsequent steps are described in the published procedures. The method yields approximately 50 μ g of total cellular RNA. Final purified material is stored under 70 % (v/v) ethanol at -80°C at a known concentration.

45 5.2 Nucleotide sequencing of expressed H- and L-chain Ig mRNAs

Nucleotide sequencing of mRNA from the CE 25 hybridoma is accomplished directly in total cellular RNA preparations utilising specific radioactively-labelled oligonucleotide primers. These primer oligonucleotides are synthesized chemically using a published procedure (Rink et al., Nuc. Acids Res. 12,
50 6369, 1984).

(a) Sequencing of mouse C α -containing mRNA is achieved using a specific oligonucleotide primer of composition HO-5'-dGGGAAGATGGATACAGTTGG-3'-OH. This sequence is complementary to codons 3-12 of the published mouse C α coding sequence (Altenburger et al., Nuc. Acids Res. 9, 971, 1981).

(b) Sequencing of mouse IgG1-specific mRNA is achieved using a specific oligonucleotide primer of
55 composition HO-5'-dGGCCAGTGGATAGAC-3'-OH. This sequence is complementary to codons 7-11 of the CH1 domain (first constant region exon) of the mouse Ig γ 1 H-chain coding sequence (Honjo et al., Proc. Natl. Acad. Sci. 18, 559, 1979).

Both oligonucleotides are radioactively-labelled at the 5'-end in the presence of γ -³²P-ATP (Amersham) using T4-polynucleotide kinase (Pharmacia), to a specific activity of 2×10^6 dpm/pmole. Labelling and separation of radioactively-labelled oligonucleotides from unincorporated γ -³²P-ATP using Sephadex G50 (Pharmacia) chromatography is carried out using a published procedure (Qu et al., Nuc. Acids Res. 11, 5903, 1983).

For sequencing, samples (25 μ g) of stored RNA under ethanol are recovered by centrifugation at 4°C for 30 min using an Eppendorf centrifuge, and resuspended in TE buffer containing 10⁶ dpm of 5'-end-labelled primer. This mixture is aliquoted into 5 x 1 ml Eppendorf tubes containing 1 μ l of annealing buffer, 5 units of reverse transcriptase (Genofit SA, Geneva), 1 μ l of dNTP mixture and 1 μ l of either ddATP (200 μ M), ddGTP (100 μ M), ddCTP (80 μ M) or ddTTP (200 μ M) solution in distilled water in a final volume of 5 μ l (all from Amersham International, UK). The fifth reaction tube contains no ddNTPs and is used to monitor the integrity of the mRNA. Reaction mixtures are incubated at 37°C for 30 min for primer (a), or at 42°C for 30 min for primer (b). Buffers and mixtures are as follows: annealing buffer for primer (a): 60 mM MgCl₂, 0.4 M KCl, 0.5 M Tris-HCl, pH 8.3; annealing buffer for primer (b): 60 mM MgCl₂, 0.6 M NaCl, 0.5 M Tris-HCl, pH 8.3; dNTP mixture: 2 mM concentration of each of dNTPs in distilled water, except for that corresponding to the ddNTP used in the particular sequencing reaction, which is used at a concentration of 0.5 mM.

Sequencing reactions are stopped by the addition of 20 μ l of distilled water and 30 μ l of 0.6 M NaOH to each tube. RNA is hydrolysed by incubation overnight at 37°C. Reaction mixtures are neutralized by the addition of 8.4 μ l of 3 M acetic acid, and DNA precipitated by addition of 2.5 vols. of absolute ethanol in the presence of 0.3 M NaOAc, pH 5.0. The DNA pellets are dried in air at 60°C and resuspended in 2 μ l of sequencing dye mixture and electrophoresed on 6% polyacrylamide/urea DNA sequencing gels using standard materials and procedures (Sanger et al., Proc. Natl. Acad. Sci. 74, 5463, 1977).

The sequence of the L-chain mRNA specifically expressed in mouse hybridoma CE 25 is

```

25
      1160                1180                1200
mRNA: ATGAAGTATGCTTCTGAGTCTATCTCTGGGATCCCTTCCAGGTTTAGTGGCAGTGGATCA
      3'-GACCCTAGGGAAGGTCCAAATCACCGTCACCTAGT
30
      1220                1240                1260
mRNA: GGGACAGATTTTACTCTTACCATCAATAGTGTGGAGTCTGAAGATATTGCAGATTATTAC
      CCCTGTCTAAAATGAGAATGGTAGTTATCACACCTCAGACTTCTATAACGTCTAATAATG
      1280                1300                1320
mRNA: TGTCAACAAAGTCATGGCTGGCCATTCACGTTCCGGCTCGGGGACAAAGTTGGAATAAAA
35
mRNA: ACAGTTGTTTCAGTACCGACCGGTAAGTGCAAGCCGAGCCCTGTTTCAACCTTTATTTT
      CG
mRNA: GCccgactacgacgtgggtgacataggtagaaggg-5'
      |-----|
      primer
40

```

The sequence runs 3'-5' and is complementary to the portion of the cloned and sequenced L2 L-chain Ig gene isolated from CE 25 hybridoma DNA from nucleotide 1166-1322 (cf. Example 4.3).

45

50

55

EP 0 323 806 B1

The sequence of the H-chain mRNA specifically expressed in mouse hybridoma CE 25 is

```

5          614          634          654
mRNA: TCGCCAGACTCCAGAGAAGAGGCTGGAGTGGGTCCATCCATTAGTAGTGGTGGTACCAC
          3'-ACCTCACCCAGTGTAGGTAATCATCACCCACCATGGTG
          674          694          714
mRNA: CTA CTATCCAGACAGTGTGAAGGGCCGATTCCACCATCTCCAGAGATAATGCCAGGAACAT
10      mRNA: GATGATAGGTCGTGCACACTTCCCGGCTAAGTGGTAGAGGTCTCTATTACGGTCCCTGTA
          734          754          774
mRNA: CCTGTACCTGCAAGTGAGCAGTCTGAGGTCTGAGGACACGGCCATTTATTACTGTGCAAG
          794          814          834
15      mRNA: AGGTTTCTATGATGGTTACCTCTATGTTGTGGACTACTGGGGTCAAGGAACCTCACTCAC
          TCCAAAGATACTACCAATGGAGATACAACACCTGATGACCCAGTTTCCTTGGAGTGAGTG
          854
20      mRNA: CGTCTCCTCAGGTAAGAATGGCC
          GCAGA-5'

```

The sequence runs 3'-5' and is complementary to the portion of the cloned and sequenced H8 H-chain Ig gene isolated from CE 25 hybridoma DNA from nucleotide 618-839 (cf. Example 4.3). It does not include the sequence complementary to the primer binding site.

Example 6: Specific transcription of L2- and H8-specific mRNA transcripts in CE 25 hybridoma cells by Northern blot analysis

30 Total cellular RNA from either CE 25 hybridoma cells or from P3-NS2/1Ag4 cells is prepared as described in Example 5. Samples of RNA (25 and 50 µg) are recovered by centrifugation from the ethanol used for storage, after which they are resuspended in 20 µl of solution containing 2.2 M formaldehyde, 50 % (v/v) formamide, 1 mM EDTA, 40 % (w/v) sucrose, 50 mM γ-morpholino propanesulphonic acid (MOPS) pH 7.0, and 0.5 % (w/v) xylene cyanol and 0.5 % (w/v) bromocresol green, used as marker dyes for
35 monitoring the progress of electrophoresis. After mixing, samples are loaded on to 1 % (w/v) agarose gels using an electrophoresis buffer containing 1 mM EDTA, 2.2 M formaldehyde, 50 mM MOPS, pH 7.0. Gels are pre-electrophoresed for 30 min before use.

After electrophoresis, excess agarose is trimmed from the sides of the gel, which is then soaked in 20 x SSC buffer for 5 min. RNA is transferred to nitrocellulose membrane by the standard Northern blot
40 procedure (Maniatis et al., "Molecular Cloning: A laboratory manual", Cold Spr. Harbour, N.Y., 1982). After overnight transfer, the membrane is air-dried and baked for 2 h at 80 °C under vacuum. Before hybridization, the membrane is prehybridized in 20 ml of a solution containing 50 % (v/v) formamide, 5 x SSC buffer, 5 x Denhardt's solution (described in Example 3.3), 10 mM EDTA, 0.1 % (w/v) SDS, 50 mM sodium phosphate, pH 6.8 and 2 ml of sheared herring sperm DNA (5 mg/ml in distilled water, Example 3.3).
45 Incubation is carried out in a heat-sealed plastic bag at 42 °C for 8 h. For hybridization, the prehybridization mixture is removed from the plastic bag and replaced with hybridization solution similar to prehybridization solution but containing 2 x Denhardt's solution instead of 5 x Denhardt's solution, and 2 x 10⁷ cpm of nick-translated ³²P-labelled denatured hybridization probe DNA. The radioactively-labelled DNA probe specific for the rearranged L2 Ig L-chain gene segment is the plasmid pCEA-L2a (Fig. 1A & Fig. 3). The
50 radioactively-labelled DNA specific for the rearranged H8 H-chain gene segment is the plasmid pH8a1 (Fig. 1B). Preparation of nick-translated probe DNA is described in Example 3.1. After hybridization for 16 h at 42 °C, the membrane is removed from the plastic bag and washed twice for 1 h at 42 °C in hybridization mixture without DNA probe, then once in 2 x SSC, 0.1 % (w/v) SDS also at 42 °C, followed by two washes in 0.1 x SSC, 0.1 % (w/v) SDS, both at room temperature. The membrane is then air-dried, placed in a thin
55 plastic bag and exposed to Kodak X-omat TM AR diagnostic film at -70 °C using an image intensifying screen.

The results of the Northern blot analysis are shown in Fig. 2.

Example 7: Molecular cloning of constant region segments of the human Ig gene loci7.1 Human DNA library

5 A human DNA library is constructed in the bacteriophage λ vector Charon 4a, by limited digestion of human foetal liver DNA with restriction endonucleases HaeIII and AluI using published procedures (Lawn et al., Cell 15, 1157, 1978). Approximately 1×10^6 independent recombinant phages are plated on *E. coli* K12/803 and screened by nucleic acid hybridization for the presence of human C α L-chain sequences and for human Ig γ 4 H-chain sequences, as described below.

10

7.2 Isolation of human C α -containing DNA segment

A nick-translated 32 P-labelled mouse Ig L-chain DNA probe is prepared corresponding to that described in Example 3.1, and used to screen recombinant phage using the procedure described in Example 4.2. DNA is isolated from plaque-purified positively-hybridizing plaques using a standard published procedure (Blattner et al., Science 202, 1279, 1978). A 2.5 kb EcoRI DNA fragment encompassing the human C α coding segment (Hieter et al., J. Biol. Chem. 257, 1516, 1982) is isolated in this manner and subcloned in both orientations into the plasmid vector pBR322, linearized using EcoRI. These plasmids are referred to as pDA13b and pDA14a, respectively. A restriction map of pDA14a is constructed and is shown in Fig. 3.

20

7.3 Isolation of human γ 4 H-chain-containing DNA segment

A nick-translated 32 P-labelled mouse IgG H-chain DNA probe corresponding to the XbaI/HhaI fragment of the mouse γ 2b gene locus is used to screen recombinant phage as described previously (Takahashi et al., Cell 29, 671, 1982). One DNA clone (#188) contains the human γ 4 gene locus as determined by restriction mapping and by nucleotide sequence analysis using the Gilbert-Maxam procedure (Proc. Natl. Acad. Sci. 74, 560, 1977). The portion of clone #188 that is sequenced corresponds exactly to that of the published human γ 4 gene between nucleotides 27-98 (EMBL data base sequence entry HUMIGCD2). An approximately 3 kb HindIII/EcoRI DNA restriction fragment, including the 4 exons of the γ 4 gene locus, is subcloned into the plasmid vector pUC12 cleaved using HindIII/EcoRI. The plasmid is designated p γ 4/1. The HindIII site in p γ 4/1 is found in the γ 4 gene locus of Balb/c mouse DNA (nucleotide position 1 of EMBL data base sequence entry HUMIGCD2; Ellison et al., DNA 1, 11, 1981). The EcoRI site is derived from the EcoRI cloning site in the Charon 4a bacteriophage lambda cloning vector at the end of clone #188. A restriction map of p γ 4/1 is shown in Fig. 4.

35

Example 8: Construction of chimeric mouse/human (γ 4;x) anti-CEA H- and L-chain Ig genes and insertion of these genes into separate vectors

Chimeric constructs holding chimeric mouse/human anti-CEA H- and L-chain genes, respectively, are constructed and are sequentially transferred into host cells with the help of two expression vectors as described in the following (examples 8 and 9).

Unless otherwise stated experimental procedures are those described in Maniatis et al. ("Molecular Cloning: A laboratory manual", Cold Spr. Harbour, N.Y., 1982).

8.1 Molecular cloning of a mouse DNA segment containing the L-chain Ig enhancer element

An approximately 475 bp AluI DNA restriction fragment containing the mouse L-chain Ig enhancer of RNA transcription (Picard & Schaffner, Nature 307, 80, 1984; nucleotides 3691-4164 of the Balb/c mouse L-chain Ig locus, EMBL data base sequence entry MUSIGKJC2) is cloned by blunt-end ligation into the pUC12 plasmid vector linearized using the restriction endonuclease SmaI. Ligated DNA is transformed into competent *E. coli* K12/803, and clones are selected after overnight growth on nutrient agar (Oxoid) plates containing 50 μ g/ml of ampicillin. Of the two orientations of insert DNA possible a clone is selected containing the plasmid pEL22, the restriction map of which is shown in Fig. 3. pEL22 contains the 475 bp mouse AluI DNA fragment in the same orientation as in the mouse genome, with its 3' end adjacent to the EcoRI site in the pUC12 vector. Its orientation is determined by nucleotide sequencing with the Sanger sequencing protocol described in Example 4.3, using the modifications for direct sequencing of plasmid DNA molecules (Chen & Seeburg, DNA 4, 165, 1985). The sequencing primer used is the Amersham reverse sequencing primer (Cloning and Sequencing Handbook, Amersham International PLC, UK).

55

8.2 The chimeric L-chain gene (pCEA-C_xGa)

The scheme for the construction of pCEA-C_xGa is shown in Fig. 3. Plasmid pDA14a (Example 7.2) and plasmid pEL22 (Example 8.1) are digested to completion with restriction endonuclease EcoRI. The 2.5 kb EcoRI DNA fragment insert of pDA14a is separated from vector sequences by 1 % (w/v) agarose gel electrophoresis and recovered by ethanol precipitation after phenol/CHCl₃ extraction (Example 3.2). Equimolar amounts of EcoRI-cut pEL22 and pDA14a 2.5 kb DNA insert are ligated together overnight at 4 °C using T4 DNA ligase (Boehringer) and transformed into competent *E. coli* K12/803. Ampicillin-resistant colonies are selected by plating on nutrient agar plates containing 50 μg/ml of ampicillin and incubating overnight at 37 °C. Single colonies are selected and plasmid DNA is prepared from 5 ml mini-cultures according to the procedure described by Ish-Horowitz & Burke (Nucleic Acids Res. 9, 2989, 1981). Digestion of recombinant plasmids using the restriction endonuclease XbaI is used to determine the orientation of the 2.5 kb EcoRI fragment with respect to the transcriptional enhancer-containing element of pEL22. A clone containing these fragments in the desired orientation is selected and plasmid DNA isolated. The corresponding recombinant plasmid is referred to as pKY14a. DNA of pKY14a is partially digested using the restriction endonuclease XbaI, extracted with phenol/CHCl₃ and recovered by ethanol precipitation. After recovery, the DNA is treated with Klenow DNA polymerase-I fragment (Boehringer) in the presence of dNTPs to perform a filling-in reaction on the XbaI-cleaved DNA termini. Flush-ended DNA fragments are blunt-end ligated in the presence of T4 DNA ligase (Boehringer), transformed into competent *E. coli* K12/803, and plasmid DNA mini-preparations made from individual ampicillin-resistant clones, as described above. Restriction mapping of recombinant plasmids by terminal digestion using HindIII + XbaI is used to identify a plasmid recombinant (pXba5.5) containing a deleted XbaI restriction site at the position indicated in parentheses in Fig. 3.

The complete DNA insert (approximately 3 kb) of pXba5.5 is isolated by partial digestion of the plasmid with EcoRI followed by complete digestion with Sall, separation from vector DNA sequences by 1 % (w/v) agarose gel electrophoresis, followed by phenol/CHCl₃ extraction and ethanol precipitation as described above. The approximately 2 kb insert DNA fragment of pCEA-L2a is similarly recovered after terminal digestion with EcoRI/Sall. The recovered DNA fragments are quantified. The eukaryotic plasmid vector pSV2gpt (Mulligen & Berg, Science 209, 1422, 1980) is digested to completion using EcoRI and DNA similarly extracted with phenol/CHCl₃, recovered after ethanol precipitation and quantified. Equimolar amounts of EcoRI-cut pSV2gpt, the 2 kb EcoRI/Sall mouse DNA fragment of pCEA-L2a, and the 3 kb Sall/EcoRI mouse DNA fragment of pXba5.5 are ligated together in a three-way ligation reaction in the presence of T4 DNA ligase (Boehringer). Recombinant plasmids are again selected as described above and those with the correct orientation of DNA fragments characterized by restriction mapping. One recombinant designated pCEA-C_xGa contains the DNA fragments in the orientation shown in Fig. 3. The selectable marker gene (gpt) derived from pSV2gpt and the resulting chimeric mouse/human L-chain Ig gene have the same transcriptional polarity.

8.3 Molecular cloning of a mouse DNA segment containing the H-chain Ig enhancer element

A 1.6 kb HindIII/EcoRI DNA segment from the Balb/c mouse genome (nucleotide positions 1963-3559, EMBL data bank sequence entry MUSIGCD07) is treated with Klenow DNA polymerase-I fragment (Boehringer) in the presence of dNTPs in order to generate a blunt-ended, double-stranded DNA molecule. The DNA is extracted with phenol/CHCl₃ and recovered after ethanol precipitation. Double-stranded HindIII DNA linkers are added by ligation in the presence of T4 DNA ligase (Boehringer) and the extraction/precipitation procedure repeated. The DNA fragment is then treated with restriction endonucleases HindIII + XbaI, and the smaller of the two XbaI/HindIII fragments generated (approximately 670 bp) is isolated after separation from the other by 1 % (w/v) agarose gel electrophoresis. This fragment is cloned in an XbaI/HindIII-cleaved pUC13 plasmid vector using procedures described in Example 8.2. The resulting plasmid, referred to as pDA4 (Fig. 4), contains the mouse H-chain Ig enhancer of transcription.

8.4 The chimeric H-chain gene (pCEA-γ4Na)

The mouse Ig enhancer-containing fragment of pDA4 is recovered after cleavage with EcoRI + HindIII by agarose gel electrophoresis/phenol-CHCl₃ extraction/ethanol precipitation. The 3 kb EcoRI/HindIII DNA insert of pγ4/1 is similarly isolated. The two fragments are ligated together with pBR322 plasmid vector DNA linearized by digestion with EcoRI. After transformation into *E. coli* K12/803, recombinants are selected and plasmid DNA mini-preparations made. Restriction mapping using EcoRI, HindIII and PstI leads to the

identification of recombinant clones containing the desired DNA fragments. One of these clones is designated pDA16a (Fig. 4). The approximately 3.7 kb insert DNA fragment of pDA16a is recovered after terminal digestion using restriction endonucleases XbaI and EcoRI, followed by agarose gel electrophoresis/phenol-CHCl₃ extraction/ethanol precipitation. The approximately 1.7 kb EcoRI/XbaI fragment of pH8a1, containing the rearranged V-D-J4 H-chain segment of the H8 gene is similarly purified. The two fragments are quantified and ligated together in equimolar amounts in a three-way ligation reaction with pSV2neo (Southern & Berg, J. Mol. App. Genet. 1, 327, 1982) linearized using EcoRI restriction endonuclease in the presence of T4 DNA ligase (Boehringer). After transformation into *E. coli* K12/803, recombinants are selected as described above and characterized by restriction mapping using the restriction endonucleases EcoRI, HindIII, PstI and XbaI. A recombinant with the desired orientation of DNA fragments is designated pCEA-γ4Na. In this plasmid the selectable marker gene (neo) derived from the vector pSV2neo has the same transcriptional polarity as the mouse/human chimeric H-chain Ig gene.

Example 9: Transfection and expression of chimeric mouse/human Ig genes pCEA-C_xG_a and pCEA-γ4Na in mouse lymphoid cells

Sp2/0 (ATCC CRL 1581) is a well-characterized mouse cell line of lymphoid origin. It is an Ig non-secreting variant of a cell line obtained from the fusion of a mouse spleen cell with the myeloma X63-Ag8, a subline of the myeloma MOPC-21 (Koehler & Milstein, Eur. J. Immunol. 6, 511, 1976; Shulman et al., Nature 276, 270, 1978). Sp2/0 cells grown in supplemented DMEM as described in Example 2 are harvested by gentle centrifugation (130 g, 4 °C) in 50 ml sterile tubes (Falcon 2070) and washed/resuspended in PBS-CM (Seromed) at a concentration of approximately 1 x 10⁸ cells/ml at 4 °C. Cells are kept on ice for up to 30 min.

9.1 Transfection of Sp2/0 with the chimeric H-chain Ig gene pCEA-γ4Na

Transfection of the chimeric H-chain gene construct (pCEA-γ4Na) is achieved by addition of 20 μg of supercoiled pCEA-γ4Na DNA in 50 μl of TE buffer to 1 x 10⁷ Sp2/0 cells in 200 μl of PBS-CM in a sterile plastic tube, on ice. The cells are drawn into the barrel of a TA750 electro-transfection apparatus (Kruess GmbH, Hamburg, W. Germany) and subjected to one electrical pulse of 3500 V/cm for 10 μs, using the cylindrical electroporation chamber provided by the manufacturers, pre-cooled by drawing sterile, ice-cold PBS-CM into the barrel of the apparatus before use. Cells are expelled gently into a clean, sterile cryotube (Nunc) and kept on ice for 10 min, after which they are incubated at room temperature for a further 20 min after dilution (1:3; v/v) with growth medium (see above). Cells are then distributed into 96 wells in two 48-well tissue culture clusters (Costar) at a cell density of approximately 1 x 10⁵ cells/well in 1 ml of DMEM growth medium containing 15 % FCS, 1 mM sodium pyruvate, 10 mM Hepes, 1 mM glutamine, 100 μM gentamycin (Gibco), 5 ng/ml insulin + 5 ng/ml transferrin + 5 pg/ml selenium (CR-ITS premix., Collaborative Res. Inc.), 56 μg/ml folic acid (Seromed), 36 μg/ml L-asparagine (Calbiochem), 116 μg/ml L-arginine HCl (Calbiochem). After incubation for 48 h at 37 °C in a humidified atmosphere containing 7.5 % CO₂ (Heraeus Cytoperm incubator), transfected cells are selected by addition of 1 mg/ml of G418-sulphate (Geneticin, Gibco 066-1811). Medium and drug are changed every 2 days. Cells are screened for the expression of human IgG after 14 days using the "dot" assay described in Example 9.2.

9.2 Selection of transfectants containing intracellular human Ig H-chain polypeptide

No H-chain Ig protein is expected to be detected in the medium of Sp2/0 cells transfected with the chimeric H-chain gene construct alone, because H-chains are only secreted after they become associated with L-chains, but Sp2/0 cells do not contain functional L-chain polypeptide. Confirmation of expression of intracellular H-chain polypeptides in cells transfected with the chimeric Ig H-chain gene pCEA-γ4Na is performed as follows. Transfected cells (1 x 10⁵) are collected from culture medium by gentle centrifugation, washed with PBS and resuspended in 10 μl of H₂O. Cells are ruptured by three rounds of freezing in dry ice and thawing at 37 °C. Cell debris is removed by centrifugation at 5'000 g (Eppendorf Microcentrifuge) at room temperature. The intracellular heavy chain expression is analysed by a procedure described by Towbin & Gordon (J. Immun. Meth. 72, 313, 1984) by dotting samples (1 μl) of the supernatant on to acetate cellulose membrane (Millipore HAWAG, 0.45 μm pore size). After blocking non-specific binding by incubating membranes in RIA-buffer (1 % BSA (Fluka Fraction V, 05480), 0.2 % NaN₃ (Merck), 0.1 % phenol red (Seromed) in PBS) at 37 °C for 20 min, they are washed in PBS and then incubated for 2 h at 37 °C in developing serum containing goat-anti-human IgG (alkaline phosphatase-labelled, Tago) at a

dilution of 1:1000 in RIA-buffer. Membranes are washed 6x in PBS followed by 6x in H₂O after which they are incubated at room temperature for 15 min in substrate buffer consisting of a 1:1 mixture of the following two solutions prepared immediately before use: (a) 1 mg/ml of Fast Blue B salt (Fluka, 44660) in H₂O; (b) 1 mg/ml of 2-naphthylphosphate, monosodium salt (Fluka, 71100) in 60 mM borate buffer, pH 9.7. The reaction is stopped by incubating membranes in methanol:acetic acid:water (5:1:5, v/v). Viable cells, corresponding to those giving strong colour signal signifying alkaline phosphatase activity (thus expressing high levels of intracellular human IgG heavy chain), are cloned. From several such cloned cell lines, one (EFVIII/γ4Na75-75) is chosen for a second round of transfection with the chimeric L-chain gene construct plasmid pCEA-C_xGa.

9.3 Transfection of EFVIII/γ4Na75-75 with the chimeric L-chain Ig gene pCEA-C_xGa

Cells of EFVIII/γ4Na75-75 or any other cell line prepared according to Example 9.2 are expanded by growth in the medium described in Example 2. Approximately 1 x 10⁷ cells are collected by gentle centrifugation, and washed/resuspended in 200 μl of PBS-CM on ice. Cells are then transfected using 10 μg of supercoiled pCEA-C_xGa DNA, and transfectants plated in tissue culture clusters using the procedure described in Example 9.2. After growth for 60 h transfected cells are selected using growth medium containing 0.125 μg/ml of mycophenolic acid (Calbiochem, 475913, from Behring Diagnostics), 250 μg/ml of xanthine, and a 1:45 dilution of hypoxanthine/thymidine (HT, 50x conc., Boehringer, 623091). The concentration of mycophenolic acid is increased to 0.5 μg/ml within the following 14 day growth period, keeping the amount of HT and xanthine constant. After this period, cell culture medium from wells of tissue culture clusters is assayed for secreted human IgG, as described in Example 9.4.

9.4 Antibody detection assay and determination of level of secreted human IgG in transfected cells

Flat-bottomed micro-ELISA plates (Immulon, Dynatech, M129A) are coated either with 1 μg/well of goat-anti-human α antibody (Tago, 060401) or with 500 ng/well of purified human carcinoembryonic antigen (Tu241, a gift from Prof. J.-P. Mach, Department of Biochemistry, University of Lausanne), by incubation overnight at 4 °C. After washing with PBS, non-specific binding is blocked by incubating with RIA-buffer (Example 9.2) for 20 min at 37 °C in a humidified chamber, followed by further washing with PBS. Cell supernatants (50 μl) are added and incubated for 2 h at 37 °C. After washing with PBS, bound chimeric antibody is developed using alkaline phosphatase-labelled goat-anti-human IgG antibody (Tago, 902002) at the recommended dilution (1:1000) in RIA-buffer. Plates are incubated for 2 h at 37 °C. Plates are washed several times with PBS before addition of 150 μl of substrate buffer which consists of 2 tablets of phosphatase substrate (p-nitrophenylphosphate, Sigma, 104R) in 10 ml of substrate buffer (800 ml of H₂O, 97 ml of diethanolamine, 130 ml of 1 M HCl, 200 mg of NaN₃, 200 mg of MgCl₂·6H₂O, pH adjusted to 9.7. After incubation for 15 min at 37 °C the colour reaction is stopped by addition of 50 μl of 1 M NaOH. E₄₀₅₋₄₉₅ measured using a Titertek Multiscan MC. Viable cells from parallel wells having high levels of secreted human IgG are cloned. One of several such clones is designated EFVIII/γ4Na75-75/C_xGa5-6 (referred to as CE 75-5-6) and was deposited at the "Collection Nationale de Cultures de Microorganismes" of the Institut Pasteur, Paris, on Dec. 15, 1987, under the number I-720.

For quantitation of the amount of chimeric antibody (γ4; α) secreted by CE 75-5-6, several standard human IgG4 α myeloma proteins (from Dr. F. Skvaril, Institute of Cancer Research, Berne) are used. Based on this test the transfectoma CE 75-5-6 secretes 1 μg/ml of chimeric antibody into the culture medium after 6 days growth.

Example 10: Construction of chimeric mouse/human (γ4; α) anti-CEA H- and L-chain genes and insertion of these genes into a double-construct vector

Chimeric constructs containing chimeric mouse/human anti-CEA H- and L-chain-genes, respectively, are constructed and are transferred into host cells with the help of a single vector comprising chimeric H- as well as L-chain genes as described in the following examples 10 and 11. Unless otherwise stated experimental procedures are those described in Maniatis et al. ("Molecular Cloning: A laboratory manual", Cold Spr. Harbour, N.Y., 1982).

10.1 Molecular cloning of a mouse DNA segment containing the L-chain Ig enhancer element (mouse Ig L-chain- ΔC_x precursor)

The mouse C_x gene is deleted from the germline sequences by isolating a 2 kb PstI/XmnI and a 1.1 kb XmnI/BamHI fragment from pLCEA/14A. (Walfield et al., Nucl. Acids Res. 8, 4689, 1980). This plasmid contains the mouse NS2 C_x light chain gene, rearranged at the J2 joining segment, on a 7.0 kb BamHI/BamHI restriction fragment. This fragment is equivalent to the 7.0 kb BamHI/BamHI fragment derived from MOPC21/NS-1n as described by Walfield et al. (see above). The exact sequence of the 3.9 kb PstI/BamHI fragment is given in the EMBL data base entry MUSIGKJC2, nucleotide positions 2368-6258.

The cloning of these two fragments into the vector pUC12, double-restricted with PstI and BamHI, creates a recombinant plasmid designated pM1 ΔC_x . The resultant cloned fragment contains germline sequences from the mouse immunoglobulin light chain locus starting at the PstI site, 268 bp downstream of the J5 joining segment, through to the BamHI site, 3884 bp downstream of the PstI site. Nucleotide positions below are indicated relative to the first base of this PstI recognition sequence. The fragment includes the mouse Ig C_x enhancer sequences at 1542-1666 in its original germline configuration. The mouse C_x coding region has been deleted between positions 2021 and 2754 using existing XmnI sites at these positions, recreating an XmnI site at the junction of the deleted C_x gene. The total PstI/BamHI fragment measures 3152 bp and now has a unique XmnI site at the site of the deleted mouse C_x gene at position 2017-2026, for cloning purposes. A restriction map of pM1 ΔC_x is shown in Figure 5.

10.2 The chimeric L-chain gene (pMcea^hC_x-1a)

The human C_x coding sequences are isolated from plasmid pDA14a, a pBR322 recombinant, containing a 2.5 kb EcoRI/EcoRI fragment within which is located the ca. 320 bp human C_x coding region. This plasmid has been described in Example 7.2 and a restriction map is shown in figures 3 and 5. A 724 bp SphI/HhaI fragment is purified and the 3' protruding ends trimmed with bacteriophage T4 DNA-polymerase. The fragment starts 106 bp 5' and extends 296 bp 3' of the human C_x coding region. It includes also the polyadenylation site which lies 177 bp 3' of the C_x coding sequence.

pM1 ΔC_x contains two XmnI sites, one at the junction of the deleted mouse C_x sequences and one in the β -lactamase coding sequence derived from pUC12, which confers resistance to ampicillin. pM1 ΔC_x is partially restricted to ampicillin. pM1 ΔC_x is partially restricted with XmnI and the linear form gel-purified. 50 % of this material is restricted at the XmnI site in the β -lactamase coding sequence, 50 % is restricted at the required former mouse C_x location.

Insertion of the human C_x fragment in the first XmnI site results in a recombinant plasmid without a functional β -lactamase gene, hence only recombinants are found which contain the human C_x fragment at the position of the former mouse C_x region. Two orientations are possible. The recombinant plasmid containing the human C_x fragment in the correct orientation, N-terminus closest to the mouse enhancer region, is identified by restriction analysis of the recombinant plasmids with restriction endonuclease AvaiI. This plasmid is designated pM1Hu C_x -1a.

The mouse CEA light chain sequences are isolated from the recombinant plasmid pCEA-L2a. This plasmid contains an 1.9 kb XbaI/XbaI fragment coding for the functional variable part of the mouse anti-CEA light chain and is described previously (Example 4.2). A restriction map is shown in Figs. 1A, 3 and 6.

By partial XbaI restriction followed by total EcoRI restriction, the mouse anti-CEA light chain variable segment is isolated on a 1.9 kb EcoRI/XbaI fragment. This fragment has an extra 24 bp derived from the pUC12 polylinker, including restriction sites for BamHI, SmaI and SacI. These sites lie 5' of the mouse variable anti-CEA coding region. In the final genomic construct they are positioned at the junction of the recombinant fragment and the expression vector.

The 1.9 kb EcoRI/XbaI fragment is joined to the 3.8 kb PstI/BamHI fragment from pM1Hu C_x -1a described above, containing the mouse Ig C_x enhancer and the human C_x coding region. For cloning purposes it is isolated as an XbaI/EcoRI fragment using the XbaI site 18 bp downstream of the PstI site and the EcoRI site in the pUC12 polylinker, which adds 18 bp downstream of the BamHI site including SmaI and SacI restriction sites. These polylinker sequences are positioned at the second junction of recombinant fragment and expression vector.

The two fragments are joined and cloned into the expression vector pSV2gpt, restricted with EcoRI, in a three way ligation. Two orientations of the fragment, relative to the gpt gene, are isolated, either both gpt and mouse variable anti-CEA-human C_x in the same transcriptional orientation (orientation a) or in opposite transcriptional orientation (orientation b). Both orientations are identified by double restriction with restriction

endonucleases HindIII and PstI. They are designated pMceaC_x^h-1a and pMceaC_x^h-1b. Their DNA insert contains the full coding region of the mouse variable anti-CEA-human C_x constant immunoglobulin light chain in the original mouse genomic configuration. The fragment is recovered as a single EcoRI/EcoRI fragment of ca. 5.7 kb.

5

10.3 The chimeric H-chain gene (pCEA- γ 4Na)

The chimeric H-chain gene pCEA- γ 4Na is constructed as described in examples 8.3 and 8.4.

10.4 The chimeric double-construct holding both mouse/human (γ 4;_x) anti-CEA H- and L-chain Ig genes (pCEA(H+L)2neo)

Both the mouse anti-CEA-human constant chimeric light and heavy chain are contained on a single EcoRI/EcoRI fragment, the light chain on a 5.7 kb fragment in pMceaC_x^h-1a, the heavy chain on a 5.3 kb EcoRI/EcoRI fragment in pCEA- γ 4Na.

By joining the light and heavy chain EcoRI/EcoRI fragments and destroying the EcoRI site at the junction, a double gene construct is created where all coding sequences and regulatory sequences for the mouse/human (γ 4;_x) anti-CEA H- and L-chain Ig genes are located on an 11.0 kb EcoRI/EcoRI fragment.

pMceaC_x^h-1a and pCEA- γ 4Na are partially restricted with EcoRI followed by filling in of the 5' overhang with the large fragment of *E. coli* DNA polymerase I (Klenow fragment). The linear form of each plasmid is gel purified followed by double restriction with restriction endonucleases EcoRI and HpaI. This releases the chimeric fragment from the pSV2gpt or pSV2neo vector, respectively, since the only restriction sites for HpaI are in the two vectors. Only one of the EcoRI 5' ends of each fragment is a blunt end. The other end remains a 'sticky' 5'-EcoRI overhang. The two fragments are ligated together in a 1:1 ratio with bacteriophage T4 ligase to form concatemeric molecules. A certain number of the light chain fragments are joined to a blunt-end of a heavy chain fragment. Total restriction with EcoRI produces a certain number of 11.0 kb EcoRI/EcoRI fragments of which a third part is a light chain joined to a heavy chain mouse/human (γ 4;_x) anti-CEA chimeric fragment. The remaining two thirds consist of heavy-heavy and light-light chain dimers which are presumably not clonable.

Gel purification of the ca. 11.0 kb EcoRI/EcoRI fragments followed by cloning into the pSV2neo or pSV2gpt expression vector, restricted with EcoRI, and transformation to competent *E. coli* K12/803 results in a number of recombinant plasmids. These are screened by colony hybridization to the 1.9 kb XbaI/XbaI fragment coding for the mouse anti-CEA variable light chain sequences, isolated from plasmid pCEA-L2a (Example 4.2). DNA is prepared from positive colonies and recombinant plasmids having both the heavy and light chain mouse/human (γ 4;_x) anti-CEA chimeric DNA fragments are identified by restriction enzyme analysis with restriction endonucleases EcoRI, XmnI and PstI. One recombinant plasmid obtained this way is designated pCEA(H+L)2neo. The anti-CEA light and heavy chain chimeric fragments are arranged in opposite transcriptional orientation. The anti-CEA heavy chain fragment is in the same transcriptional orientation as the neo gene in pSV2neo. The EcoRI site at the junction of the anti-CEA light and heavy chain chimeric fragments is destroyed but the expected XmnI site, which is created by joining two blunted EcoRI sites, is not present. From this double chimeric gene construct the mouse/human (γ 4;_x) anti-CEA light and heavy chain coding and regulatory sequences are isolated as a single ca. 11.0 kb EcoRI/EcoRI fragment. A restriction map of pCEA(H+L)2neo is shown in Figure 6.

Example 11: Transfection and expression of the chimeric mouse/human (γ 4;_x) anti-CEA Ig H- and L-chain double gene construct pCEA(H+L)2neo in mouse lymphoid cells

Transfection of the chimeric mouse/human (γ 4;_x) anti-CEA Ig gene double-construct pCEA(H+L)2neo is achieved by isolation of the coding regions of the mouse/human (γ 4;_x) anti-CEA H- and L-chains on a single ca. 11.0 kb EcoRI/EcoRI DNA fragment from pCEA(H+L)2neo. 15 μ g of this fragment are mixed with 1.5 μ g pSV2neo, linearized with EcoRI, in 50 μ l of TE buffer and subsequently transfected to Sp2/0 mouse lymphoid cells, exactly as described in example 9 for the chimeric mouse/human (γ 4;_x) anti-CEA single Ig gene constructs.

Selection for neomycin resistance, antibody detection and determination of level of secreted IgG in transfected cells are carried out exactly as described in Example 9.2 and 9.3, respectively. One clonal cell line isolated in this manner and selected for high expression of the chimeric monoclonal antibody is designated EFIX-pCEA-Ig-(γ 4;_x) 4-8-13 (referred to as CE 4-8-13) and was deposited at the "Collection Nationale de Cultures de Microorganismes" of the Institut Pasteur, Paris, on Nov. 22, 1988, under the

number I-818.

The transfectoma CE 4-8-13 secretes 10 µg/ml of chimeric antibody into the culture medium after 6 days growth, as determined by the procedures described in example 9.4.

5 Example 12: Characterization of the chimeric monoclonal antibody

The binding of the chimeric monoclonal antibody ($\gamma 4;x$) to CEA is determined by the ELISA test described in Example 9.4 for the selection of chimeric antibodies. With the chimeric anti-CEA MAb secreted by the cell line CE 4-8-13, less than 8 ng/ml of the MAb is required to result in an optical density of 0.1 in the test (see Figure 7). For competition tests, purified CEA antigen and a purified Ig fraction from mouse ascites fluid generated from the CE 25 hybridoma are used. Methods used are based on published procedures (Voller et al., "Manual of Clinical Immunology", 1976, 506). The binding of the chimeric antibody to purified CEA in the ELISA test is inhibited either by soluble CEA or with purified murine CE 25 antibody. Over 99 % of secreted chimeric monoclonal antibody can be absorbed on immobilized CEA antigen. 15 Whereas the parental CE 25 hybridoma produces a murine ($\gamma 1;x$) antibody when developed using goat-anti-mouse IgG₁ (alkaline phosphatase labelled), CE 75-5-6 and CE 4-8-13 do not.

The above immunological tests demonstrate that the antibody secreted by cell lines CE 75-5-6 and CE 4-8-13:

- (a) bind to the CEA antigen;
- 20 (b) possess human constant region ($\gamma 4;x$) determinants and lack corresponding determinants of mouse origin;
- (c) are inhibited by the corresponding murine antibody produced by hybridoma CE 25;
- (d) bind specifically to the CEA antigen, since their binding is inhibited by soluble CEA;
- 25 (e) are produced at high levels in transfectomas containing the chimeric H- and L-chain Ig genes as described above (1 µg/ml by CE 75-5-6; 10 µg/ml by CE 4-8-13).

Example 13: Isolation and purification of chimeric monoclonal antibodies for diagnostic/therapeutic purposes

30 13.1 In vitro synthesis

A cell line as described above synthesizing the chimeric monoclonal antibodies is grown on the glass beads of a packed bed column. The preculture for this column is prepared as follows: The cells from 4 confluent 175 cm² tissue culture flasks are used to inoculate one Nunc stapler. The adherent cells are detached from the flask by rinsing the confluent cell layer with a trypsin/Versene solution made up of equal volumes of trypsin solution (Gibco, 0.5 g/l) and Versene (Gibco, 1:5000). 4 x 10⁶ cells are suspended in 400 ml of modified conditioned DMEM medium (DMEM_{med} = DMEM containing in addition 1 mM Na-pyruvate, 2 mM glutamine, 50 µM 2-mercaptoethanol, 10 mM Hepes and, if not indicated otherwise, 10 % FCS). The volume of the suspension is brought to 500 ml by adding fresh DMEM_{med}. 500 ml cell suspension are transferred to a Nunc stapler and incubated at 37 °C in an atmosphere of air containing 10 % CO₂. 40 Four, seven and ten days after inoculation, additional medium (3 x 500 ml) is added. Fourteen days after inoculation the cells are harvested and used to inoculate the packed bed reactor. The conditioned medium is first removed from the stapler. 500 ml trypsin/Versene solution is added to the stapler and the entire cell layer is soaked with this solution. Free trypsin/Versene solution is poured off and the cell layer is left in contact with remaining trypsin/Versene for 5 min. 500 ml conditioned medium is added back to the cells. 45 The cells are detached by shaking the stapler thoroughly. An additional 1.5 l of conditioned medium are added to the stapler and the entire suspension is then transferred to the packed bed reactor. The reactor consists of a 10 l cylindrical glass vessel filled with boro-silicate glass beads of 2 mm diameter. The medium is circulated through the reactor by an external pump at a rate of 45 l/h. The dissolved oxygen concentration and the pH of the circulating medium is measured and controlled continuously. Pure oxygen is used to keep the minimal dissolved oxygen level above 10 % saturation and CO₂ and 1.0 NaOH are used to control the pH between 7.0 and 7.3. The liquid volume in the reactor and the external circuit is 5 l. The system is kept in a water bath at 37 °C. After inoculation the cells are allowed to grow in a DMEM_{med} medium containing 10 % serum. As soon as the glucose level in the medium drops below 1 g/l continuous exchange of medium is initiated at a rate of 2 l/day. When the level of dissolved oxygen decreases to 20 % 55 the serum concentration in the feed medium is lowered to 1.25 %. Two days later the exchange ratio is increased by 1 l/day. On subsequent days the exchange rate is increased further until a maximum value of 5 l/day is reached. From this time onward the outflowing medium is collected for the isolation and purification of the chimeric antibody.

13.2 Isolation and purification of chimeric monoclonal antibodies

The culture medium is filtered using a Minitan ultrafiltration system (Millipore Corp., Bedford, Mass.), through a 0.1 μm cassette filter (type VVLPOMPO4, Millipore). The filtrate is concentrated 10-fold using the
 5 Minitan ultrafiltration system fitted with 30,000 MW cut-off filter cassettes (type PTTKOMPO4, Millipore). The concentrated retentate is then prepared for chromatography on protein-A Sepharose by addition of glycine and NaCl to a final concentration of 1.5 M glycine and 3 M NaCl and the pH adjusted to 8.6 with 5 M NaOH. After passing the culture medium concentrate through a column containing protein-A Sepharose
 10 CL-4B (Pharmacia, Uppsala, Sweden), unbound material is washed from the column with binding buffer (1.5 M glycine, 3 M NaCl, pH 8.9 with NaOH) and the column eluted with a stepwise gradient of decreasing pH consisting of 100 mM citric acid adjusted to pH 3.0, 4.0, 5.0 and 6.0 with 5 M NaOH as described in the Pharmacia application note (Separation News Vol. 13, No. 5). The highest concentration of chimeric antibody is determined by an ELISA test to elute at pH 4.0.

15 Example 14: Determination of CEA with an enzyme-linked immunosorbent assay (ELISA)

14.1 Labelling of chimeric monoclonal antibodies with alkaline phosphatase

1.4 mg of a chimeric monoclonal antibody in 1.4 ml of PBS are coupled for 2 h with a solution
 20 containing 5 mg of alkaline phosphatase (Sigma P6774, type VII-T) according to the standard method of Voller et al. (Bull. World Health Organ. 53, 55, 1976) using glutaraldehyde (0.2 % v/v). The conjugate is transferred into 5 ml of Tris buffer 0.05 M, pH 8.0, containing 1 mM MgCl_2 , 1 % BSA and 0.02 % NaN_3 . The solution is kept in the dark at 4 °C.

25 14.2 Assay procedure

Polypropylene microtitre plates (Dynatech) are coated over a period of 2 h at 37 °C and overnight at 4 °C with 150 μl of a solution of the chimeric monoclonal antibody secreted by cell line CE 75-5-6 or CE 4-8-13 10 $\mu\text{g/ml}$ in a buffer pH 8.6 (carbonate-buffered 0.9 % saline containing 0.02 % sodium azide). The
 30 plates are washed five times with PBS, and protein-reactive sites still present are saturated by incubation for 1 h at 37 °C with 250 μl of a buffer pH 7.4 (0.2 % gelatine and 0.2 % NaN_3 in PBS). Plates coated in this manner can be kept at 4 °C in this buffer for a few days.

50 μl of a dilution series of a test solution or a standard solution containing purified human CEA, 50 μl of buffer pH 7.4 and 50 μl of a solution of the phosphatase-labelled monoclonal anti-CEA antibody MAb 35
 35 (Haskell et al., Cancer Res. 43, 3857, 1983) recognizing a different CEA-epitope than the chimeric antibody (Example 14.1) diluted 1:100 with buffer pH 7.4 are mixed and incubated in the wells of the microtitre plates for 2 h at 37 °C and for 30 minutes at 4 °C. The plates are washed five times with PBS, then incubated for 30 min at 37 °C with 150 μl of a solution of p-nitrophenyl phosphate (1 mg/ml in 10 % diethanolamine buffer, 0.5 mM MgCl_2 , pH 9.8). By measuring the optical density at 405 nm, the amount of released p-
 40 nitrophenol is determined, which is proportional to the amount of the bound enzyme phosphatase and hence proportional to the amount of human CEA in the test solution.

The test can also be carried out by using the enzyme-labelled chimeric monoclonal antibody secreted by cell line CE 75-5-6 or CE 4-8-13 and coating the microtitre plates with the monoclonal anti-CEA antibody MAb 35 recognizing a different CEA-epitope than the chimeric antibody.

45 14.3 Test kit for ELISA

A test kit for the assay described in Example 14.2 contains:
 polypropylene microtitre plates,
 50 20 ml of the chimeric monoclonal anti-CEA antibody secreted by cell line CE 75-5-6 or CE 4-8-13 (10 $\mu\text{g/ml}$) in carbonate-buffered saline (0.9 % NaCl, 0.42 % NaHCO_3 , 0.0072 % Na_2CO_3 , 0.02 % NaN_3),
 1 ml of the alkaline phosphatase-coupled monoclonal anti-CEA antibody MAb 35 recognizing a different CEA-epitope than the chimeric antibody (0.3 mg antibody per ml) in Tris-buffer (0.05 M, 1 mM MgCl_2 , 1 % BSA, 0.02 % NaN_3 , pH 8.0),
 55 2 ml of standard solution containing 5 μg purified human CEA,
 300 ml of PBS,
 300 ml of buffer pH 7.4 (0.2 % gelatine and 0.2 % NaN_3 in PBS)
 50 ml of p-nitrophenyl phosphate (1 mg/ml) in diethanolamine buffer (10 %, 0.5 mM MgCl_2 , 0.02 % NaN_3 ,

adjusted to pH 8.9 with HCl),
 calibration curve,
 colour intensity scale,
 instruction manual.

5

Example 15: Pharmaceutical preparation for parenteral application

120 mg chimeric monoclonal antibody prepared according to Example 13 are dissolved in 5 ml physiological saline. The solution is passed through a bacteriological filter, and the filtrate filled in an ampoule under aseptic conditions. The ampoule is preferentially stored in the cold, e.g. at -20 °C.

10

Claims

Claims for the following Contracting States : AT, BE, CH, DE, FR, GB, IT, LI, LU, NL, SE

- 15 1. A chimeric monoclonal antibody consisting of variable regions of mouse origin and human constant regions, which recognizes epitopes of human carcinoembryonic antigen (CEA) not present on non-specific cross-reacting antigen NCA₅₅ and NCA₉₅, on biliary glycoprotein, or on granulocytes, and derivatives thereof.
- 20 2. A chimeric monoclonal antibody and derivatives thereof according to claim 1 with an affinity of at least 2.1×10^{10} liters/mol for human CEA.
3. A chimeric monoclonal antibody and derivatives thereof according to claim 1 or 2 comprising light chain variable regions of the formula

25

FR₁-Arg-Ala-Ser-Gln-Ser-Ile-Gly-Thr-Ser-Leu-His-FR₂-
 ─────────────────────────────────── CDR1L ───────────────────────────────────

30

Tyr-Ala-Ser-Glu-Ser-Ile-Ser-FR₃-Gln-Gln-Ser-His-Gly-Trp-Pro-Phe-Thr-FR₄
 ─────────────────── CDR2L ─────────────────── ─────────────────── CDR3L ───────────────────
 (I),

35

wherein FR₁ is a polypeptide residue comprising 23-28 naturally occurring amino acids, FR₂ is a polypeptide residue comprising 14-16 naturally occurring amino acids, FR₃ is a polypeptide residue comprising 30-34 naturally occurring amino acids and FR₄ is a polypeptide residue comprising 9-11 naturally occurring amino acids, and wherein the amino acid Cys may be in the oxidized state forming S-S-bridges.

40

4. A chimeric monoclonal antibody and derivatives thereof according to any of the claims 1-3 comprising light chain variable regions of formula I, wherein the polypeptide residues of the framework regions FR₁, FR₂, FR₃ and FR₄ are those preferably occurring in murine antibodies.
5. A chimeric monoclonal antibody and derivatives thereof according to any of the claims 1-4 comprising light chain variable regions of formula I, wherein FR₁ is a polypeptide residue of the formula

45

A-Gly-Asp-Ile-Leu-Leu-Thr-Gln-Ser-Pro-Ala-Ile-Leu-Ser-Val-Ser-Pro-
 Gly-Glu-Arg-Val-Thr-Phe-Ser-Cys

50

(IA),

55

wherein A is hydrogen, acyl, or the residue Ala-Ser-Arg, Ser-Arg or Arg,

FR₂ is the polypeptide residue

Trp-Tyr-Gln-Gln-Arg-Thr-Asn-Gly-Ser-Pro-Arg-Leu-Leu-Met-Lys

(IB),

5

FR₃ is the polypeptide residue

Gly-Ile-Pro-Ser-Arg-Phe-Ser-Gly-Ser-Gly-Ser-Gly-Thr-Asp-Phe-Thr-Leu-
Thr-Ile-Asn-Ser-Val-Glu-Ser-Glu-Asp-Ile-Ala-Asp-Tyr-Tyr-Cys

10

(IC),

15

and FR₄ is the polypeptide residue

20

Phe-Gly-Ser-Gly-Gly-Thr-Lys-Leu-Glu-Ile-Lys

(ID),

25

and wherein the amino acid Cys may be in the oxidized state forming S-S-bridges.

6. A chimeric monoclonal antibody and derivatives thereof according to claim 3 comprising light chain variable regions of formula I, wherein FR₁, FR₂, FR₃ and FR₄ are polypeptide residues of formula IA, IB, IC and ID, respectively, wherein one or more single amino acids are replaced by other amino acids outside the regions CDR1L, CDR2L and CDR3L, and wherein the amino acid Cys may be in the oxidized state forming S-S-bridges.
7. A chimeric monoclonal antibody and derivatives thereof according to any of the claims 1-6 comprising heavy chain variable regions of the formula

30

35

FR₅-Thr-Tyr-Ala-Met-Ala-Trp-Val-FR₆-Ser-Ser-Gly-Gly-Thr-Thr-Tyr-Tyr-Pro-
|----- CDR1H -----| |-----
 Asp-Ser-Val-Lys-Gly-FR₇-Gly-Phe-Tyr-Asp-Gly-Tyr-Leu-Tyr-Val-Val-FR₈
|----- CDR2H -----| |----- CDR3H -----|

40

(II),

45

wherein FR₅ is a polypeptide residue comprising 32-36 naturally occurring amino acids, FR₆ is a polypeptide residue comprising 14-16 naturally occurring amino acids, FR₇ is a polypeptide residue comprising 32-34 naturally occurring amino acids and FR₈ is a polypeptide residue comprising 12-14 naturally occurring amino acids, and wherein the amino acid Cys may be in the oxidized state forming S-S-bridges.

50

8. A chimeric monoclonal antibody and derivatives thereof according to any of the claims 1-7 comprising heavy chain variable regions of formula II, wherein the polypeptide residues of the framework regions FR₅, FR₆, FR₇ and FR₈ are those preferably occurring in murine antibodies.
9. A chimeric monoclonal antibody and derivatives thereof according to any of the claims 1-8 comprising heavy chain variable regions of formula II, wherein FR₅ is a polypeptide residue of the formula

55

B-Gly-Val-Gln-Cys-Glu-Val-Lys-Leu-Val-Glu-Ser-Gly-Gly-Gly-Leu-
Val-Lys-Pro-Gly-Gly-Ser-Leu-Lys-Leu-Ser-Cys-Ala-Ala-Ser-Gly-Phe-
5 Thr-Phe-Arg

(IIA),

wherein B is hydrogen or acyl,

FR₆ is the polypeptide residue

Arg-Gln-Thr-Pro-Glu-Lys-Arg-Leu-Glu-Trp-Val-Thr-Ser-Ile

(IIB),

FR₇ is the polypeptide residue

Arg-Phe-Thr-Ile-Ser-Arg-Asp-Asn-Ala-Arg-Asn-Ile-Leu-Tyr-
Leu-Gln-Val-Ser-Ser-Leu-Arg-Ser-Glu-Asp-Thr-Ala-Ile-Tyr-Tyr-Cys-
25 Ala-Arg

(IIC),

and FR₈ is the polypeptide residue

Asp-Tyr-Trp-Gly-Gln-Gly-Thr-Ser-Leu-Thr-Val-Ser-Ser

(IID),

and wherein the amino acid Cys may be in the oxidized state forming S-S-bridges.

- 40 10. A chimeric monoclonal antibody and derivatives thereof according to claim 7 comprising heavy chain variable regions of formula II wherein FR₅, FR₆, FR₇ and FR₈ are polypeptide residues of formula IIA, IIB, IIC and IID, respectively, wherein one or more single amino acids are replaced by other amino acids outside the regions CDR1H, CDR2H and CDR3H, and wherein the amino acid Cys may be in the oxidized state forming S-S-bridges.
- 45 11. A chimeric monoclonal antibody and derivatives thereof according to any of the claims 1-10 comprising light chain human constant regions κ or λ .
- 50 12. A chimeric monoclonal antibody and derivatives thereof according to any of the claims 1-11 comprising heavy chain human constant regions γ 1, γ 2, γ 3 or γ 4.
13. A chimeric monoclonal antibody and derivatives thereof according to any of the claims 1-12 comprising light chain human constant regions κ and heavy chain human constant regions γ 4.
- 55 14. A chimeric monoclonal antibody and derivatives thereof according to any of the claims 1-13 with light chain variable regions of formula I wherein FR₁, FR₂, FR₃ and FR₄ are polypeptide residues of the formula IA, IB, IC and ID, respectively, and wherein the amino acid Cys may be in the oxidized state forming S-S-bridges, a light chain human constant region κ , a heavy chain variable region of formula II

wherein FR₅, FR₆, FR₇ and FR₈ are polypeptide residues of formula IIA, IIB, IIC and IID, respectively, and wherein the amino acid Cys may be in the oxidized state forming S-S-bridges and a heavy chain human constant region γ 4.

- 5 15. A derivative of a chimeric monoclonal antibody according to any of the claims 1-14 which is a fragment.
16. A derivative of a chimeric monoclonal antibody according to any of the claims 1-14 which is a conjugate with an enzyme, a fluorescent marker, a metal chelate, a cytostatic or cytotoxic substance, avidin or biotin.
- 10 17. A derivative of a chimeric monoclonal antibody according to any of the claims 1-14 which is radioactively labelled.
18. A process for the preparation of chimeric monoclonal antibodies and derivatives thereof according to claim 1, characterized in that mammalian cells producing such chimeric monoclonal antibodies are multiplied in vitro and, if desired, the resulting chimeric monoclonal antibodies are converted into derivatives thereof.
- 15 19. A process for the preparation of chimeric monoclonal antibodies and derivatives thereof according to claim 1, characterized in that mammalian cells producing such chimeric monoclonal antibodies are multiplied in vivo and, if desired, the resulting chimeric monoclonal antibodies are converted into derivatives thereof.
- 20 20. A recombinant DNA comprising an insert coding for a light chain murine variable region and/or for a heavy chain murine variable region of chimeric monoclonal antibodies according to claim 1.
21. A recombinant DNA according to claim 20 comprising an insert coding for a light chain murine variable region specific for human CEA which originates from genomic DNA of the cell line CE 25, having the deposit accession number CNCM I-719.
- 30 22. A recombinant DNA according to claim 20 or 21 comprising an insert coding for the polypeptide of formula I, optionally containing introns.
23. A recombinant DNA according to any of the claims 20-22 comprising an insert coding for the polypeptide of formula I wherein FR₁, FR₂, FR₃ and FR₄ are polypeptides of formula IA, IB, IC and ID, respectively, optionally containing introns.
- 35
- 40
- 45
- 50
- 55

24. A recombinant DNA according to any of the claims 20-23 comprising an insert of the formula

```

TCTAGACTGCTGTGGTCTTTTAAGTAGCATGAAAAACATCTGCTAAAGAAGGAATTAGTT
 1 -----+-----+-----+-----+-----+-----+-----+ 60
5
TGAACATGCTAGAAATACATCTGTGATACTCTCATCACTCTTGTGGAAAGATATGCAAG
61 -----+-----+-----+-----+-----+-----+-----+ 120
AAGCACTATTTGGCTATTATTTGGAAAGTGTATAATGTATTTTGATATCTCAACCTCTG
10 121 -----+-----+-----+-----+-----+-----+-----+ 180
AAATTCTTCTGTATGTTGGCAGATTGTAACCTTTACAAGGCTTTCATTCTTCTCTCTGG
181 -----+-----+-----+-----+-----+-----+-----+ 240
AGAAAAATGTCTTTGTAGGCAATCCAGAATTTCTATTTCTTGCTAATGAAATCTCCTCA
15 241 -----+-----+-----+-----+-----+-----+-----+ 200
GTGTGATATCACTTTAGTTTCATGTGTGTTATGCTTCATGTAATGTTAAGAAAGTTAAA
301 -----+-----+-----+-----+-----+-----+-----+ 360
GATGCTCCAATCCATATTGTAAGAAACATTCCAAGCCATGGAATAAGGCATGGATTTGAG
20 361 -----+-----+-----+-----+-----+-----+-----+ 420
ATGCTCTTTATTTCAAACACTACTGAATATATCTTAGAGATTTCTTTAGACTGTGTTAAATA
421 -----+-----+-----+-----+-----+-----+-----+ 480
TGTAACCATTTAAGTAGGAGTCAAGTCTCCTTTAAATCTCAACAGCTCTTCAGGTAACCA
25 481 -----+-----+-----+-----+-----+-----+-----+ 540
ACAAAAGGATAAATATTCTAATAAGTCACTAGGAGCATGCTCTTCTGACCAGGCTTTTCT
541 -----+-----+-----+-----+-----+-----+-----+ 600
TATAAGCAACATGAAGACAGTATGATTTGCATAAGTTTTTCTTCTCTAATGTCCCTGC
30 601 -----+-----+-----+-----+-----+-----+-----+ 660
CTCTTAGAGTATTATAAGAAGATCTTTCTAGGGATGTGTCATGGTCCACACAAAAATAGG
661 -----+-----+-----+-----+-----+-----+-----+ 720
          M V S T P Q F L V F L L F W I P
          MetValSerThrProGlnPheLeuValPheLeuLeuPheTrpIlePro
35 GAAAGTGTGAAGATGGTATCCACACCTCAGTTCCTTGTATTTTGGCTTTTCTGGATTCCA
721 -----+-----+-----+-----+-----+-----+-----+ 780

```

40

45

50

55

```

GGTAATGACTGTTTGGGTGTGGCAAAAAAGTGGAGATGTTATTTAAATACAAAATTTTCT
781 -----+-----+-----+-----+-----+-----+-----+-----+-----+-----+ 840
5  TGCTTTATTGGGAAGCCAATGTCACATGGGAATTGACTTTCAGTTTAAAGAAATTGATAC
841 -----+-----+-----+-----+-----+-----+-----+-----+-----+-----+ 900
AATAAAAAGTCATTTATTTTTCTAAGTTGTTTAGAAGTGACTTTTCATATTTCAGTGTATGA
901 -----+-----+-----+-----+-----+-----+-----+-----+-----+-----+ 960
10                A S R G D I L L T Q S
                AlaSerArgGlyAspIleLeuLeuThrGlnSer
TCGACTAATGTATCTTCCATTTTTCCAGCCTCCAGAGGTGACATCTTGCTGACTCAGTCT
961 -----+-----+-----+-----+-----+-----+-----+-----+-----+-----+ 1020
15  P A I L S V S P G E R V T F S C R A S Q
    ProAlaIleLeuSerValSerProGlyGluArgValThrPheSerCysArgAlaSerGln
CCAGCCATCCTGTCTGTGAGTCCAGGAGAAAGAGTCACTTTCTCTGCAGGGCCAGTCAG
1021 -----+-----+-----+-----+-----+-----+-----+-----+-----+-----+ 1080
20  S I G T S L H W Y Q Q R T N G S P R L L
    SerIleGlyThrSerLeuHisTrpTyrGlnGlnArgThrAsnGlySerProArgLeuLeu
AGCATTGGCACAAGCTTACACTGGTATCAGCAAAGAACAATGGTTCTCCAAGGCTTCTC
1081 -----+-----+-----+-----+-----+-----+-----+-----+-----+-----+ 1140
25  M K Y A S E S I S G I P S R F S G S G S
    MetLysTyrAlaSerGluSerIleSerGlyIleProSerArgPheSerGlySerGlySer
ATGAAGTATGCTTCTGAGTCTATCTCTGGGATCCCTTCCAGGTTTAGTGGCAGTGGATCA
1141 -----+-----+-----+-----+-----+-----+-----+-----+-----+-----+ 1200
30  G T D F T L T I N S V E S E D I A D Y Y
    GlyThrAspPheThrLeuThrIleAsnSerValGluSerGluAspIleAlaAspTyrTyr
GGGACAGATTTTACTCTTACCATCAATAGTGTGGAGTCTGAAGATATTGCAGATTATTAC
1201 -----+-----+-----+-----+-----+-----+-----+-----+-----+-----+ 1260
35  C Q Q S H G W P F T F G S G T K L E I K
    CysGlnGlnSerHisGlyTrpProPheThrPheGlySerGlyThrLysLeuGluIleLys
TGTCACAAAGTCATGGCTGGCCATTACGTTCCGGCTCGGGACAAAGTTGGAAATAAAA
1261 -----+-----+-----+-----+-----+-----+-----+-----+-----+-----+ 1320
CGTAAGTGGACTTTTGTTCATTTACTTGTGACGTTTTGGTTCTGTTTGGGTAGCTTGTGT
1321 -----+-----+-----+-----+-----+-----+-----+-----+-----+-----+ 1380
40  GAATTTGTGATATT
1381 -----+-----+-----+-----+-----+-----+-----+-----+-----+-----+ 1395

```

(III).

- 45 25. A recombinant DNA according to claim 22 comprising an insert of formula III wherein one or more single nucleotides are replaced by other nucleotides outside the nucleotide sequences of formula III from position 1069-1102, 1147-1167 and 1263-1291, respectively.
- 50 26. A recombinant DNA according to claim 20 comprising an insert coding for a heavy chain murine variable region specific for human CEA which originates from genomic DNA of the cell line CE 25, having the deposit accession number CNCM I-719.
27. A recombinant DNA according to claim 20 or 26 comprising an insert coding for the polypeptide of formula II, optionally containing introns.
- 55 28. A recombinant DNA according to claim 20, 26 or 27 comprising an insert coding for the polypeptide of formula II wherein FR₅, FR₆, FR₇ and FR₈ are polypeptide residues of formula IIA, IIB, IIC and IID, respectively, optionally containing introns.

29. A recombinant DNA according to any of the claims 20, 26-28 comprising an insert of the formula

```

5     1  AAGCTTGTTCGTTCACATGCAAGGAGGGAAACTAAACTGAGTATGGTGAATCCCTAACC 60
      61  AAAGGGAAAAATGAAACTACAATATGTTTCAAATGCTGTAAGTAAATCTGGTTTTTTG 120
10    121 ATGCCTTATATCTGGTATCATCAGTGACTTCAGATTTAGTCCAACCCAGAGCATGGTAT 180
      181  AGCAGGAAGACATGCAAATAAGTCTTCTCTGCCCATGAAAACACCTCGGCCCTGACCC 240
15    241  TGCAGCTCTGACAGAGGAGGCCAGTCCATGGATTTGAGTTCCTCACATTAGTGATGAGC 300
      M N F G F S L I F L V L V
      MetAsnPheGlyPheSerLeuIlePheLeuValLeuVal
20    301  ACTGAACACAGACACCTCACCATGAACTTCGGGTTTCAGCTTGATTTTCCTTGTCCTTGT 360
      L K G
      LeuLysGly
      TAAAAAGGTAATTTATTGAGAAGAGATGACATCTATTTTACGCACATGAGACAGAAAAAA
25    361  -----+-----+-----+-----+-----+-----+-----+-----+ 420
      V Q
      ValG1
      TGTGGTTTGTTTTGTTAGTGACAGTTTTCCAACCAGTTATTCTCTGTTTGTAGGTGTCCA
30    421  -----+-----+-----+-----+-----+-----+-----+-----+ 480
      C E V K L V E S G G G L V K P G G S L K
      nCysGluValLysLeuValGluSerGlyGlyGlyLeuValLysProGlyGlySerLeuLy
481  481  GTGTGAAGTGAAGCTGGTGGAGTCTGGGGGAGGCTTAGTGAAGCCTGGAGGGTCCCTGAA 540
      L S C A A S G F T F R T Y A M A W V R Q
35    541  sLeuSerCysAlaAlaSerGlyPheThrPheArgThrTyrAlaMetAlaTrpValArgGl 600
      ACTCTCTGTGCAGCCTCTGGGTTCACTTTCAGGACCTATGCCATGGCTTGGGTTGCCCA
40    601  -----+-----+-----+-----+-----+-----+-----+-----+ 660
      T P E K R L E W V T S I S S G G T T Y Y
      nThrProGluLysArgLeuGluTrpValThrSerIleSerSerGlyGlyThrThrTyrTy
      GACTCCAGAGAAGAGGCTGGAGTGGGTCACATCCATTAGTAGTGGTGGTACCACCTACTA
55

```

```

P D S V K G R F T I S R D N A R N I L Y
rProAspSerValLysGlyArgPheThrIleSerArgAspAsnAlaArgAsnIleLeuTy
TCCAGACAGTGTGAAGGGCCGATTCCACCATCTCCAGAGATAATGCCAGGAACATCCTGTA
5 661 -----+-----+-----+-----+-----+-----+-----+-----+-----+-----+ 720
L Q V S S L R S E D T A I Y Y C A R G F
rLeuGlnValSerSerLeuArgSerGluAspThrAlaIleTyrTyrCysAlaArgGlyPh
CCTGCAAGTGAGCAGTCTGAGGTCTGAGGACACGGCCATTATTACTGTGCAAGAGGTTT
10 721 -----+-----+-----+-----+-----+-----+-----+-----+-----+-----+ 780
Y D G Y L Y V V D Y W G Q G T S L T V S
eTyrAspGlyTyrLeuTyrValValAspTyrTrpGlyGlnGlyThrSerLeuThrValSe
CTATGATGGTTACCTCTATGTTGTGGACTACTGGGGTCAAGGAACCTCACTCACCGTCTC
15 781 -----+-----+-----+-----+-----+-----+-----+-----+-----+-----+ 840
S
rSer
CTCAGGTAAGAATGGCC
20 841 -----+-----+-----+-----+-----+-----+-----+-----+-----+-----+ 857

```

(IV).

- 25 30. A recombinant DNA according to claim 27 comprising an insert of formula IV wherein one or more single nucleotides are replaced by other nucleotides outside the nucleotide sequences of formula IV from position 575-595, 629-680 and 776-805, respectively.
- 30 31. A recombinant DNA according to claim 20 comprising an insert coding for a light chain murine variable region fused to a human constant region x or λ .
32. A recombinant DNA according to claim 31 comprising an insert of formula III fused to a human constant region x .
- 35 33. A recombinant DNA according to claim 20 comprising an insert coding for a heavy chain murine variable region fused to a human constant region γ_1 , γ_2 , γ_3 or γ_4 .
34. A recombinant DNA according to claim 33 comprising an insert of formula IV fused to a human constant region γ_4 .
- 40 35. A recombinant DNA according to claim 20 which is a hybrid vector comprising an insert coding for a chimeric murine/human light chain according to claim 31 and/or a chimeric murine/human heavy chain according to claim 33, a complete replicon and one or more dominant marker sequences, operationally linked to expression control sequences.
- 45 36. A recombinant DNA according to claim 20 which is a hybrid vector comprising an insert coding for a chimeric murine/human light chain according to claim 32 and/or a chimeric murine/human heavy chain according to claim 34, a complete replicon and one or more dominant marker sequences, operationally linked to expression control sequences.
- 50 37. A recombinant DNA which is a hybrid vector according to claim 35 or 36 suitable for mammalian hosts.
38. A recombinant DNA which is a hybrid vector according to claim 35, 36 or 37 wherein the vector is derived from plasmid pSV.
- 55 39. A recombinant DNA which is a hybrid vector according to claim 38 wherein the vector is derived from plasmid pSV2gpt or from plasmid pSV2neo.

40. A process for the preparation of recombinant DNAs according to claim 20 comprising culturing a transformed host.
41. A process according to claim 40 comprising the steps of
- a) isolating murine DNAs from a suitable hybridoma cell line, selecting the desired DNAs coding for the variable regions of monoclonal antibodies directed against human CEA using DNA probes,
 - b) isolating human DNAs from a genomic library, selecting the desired DNAs coding for the constant regions of monoclonal antibodies using DNA probes,
 - c) constructing chimeric mouse/human genes by incorporating the DNAs of step a) and b) into appropriate hybrid vectors,
 - d) transferring the obtained hybrid vectors into a recipient host, and
 - e) selecting and culturing the transformed host.
42. A host cell which is transformed with recombinant DNAs according to any of the claims 31-39.
43. A host cell according to claim 42 which is a mammalian cell of lymphoid origin.
44. A host cell according to claim 42 which is a cell derived from the Ig non-secreting mouse hybridoma cell line Sp2/0 (ATCC CRL 1581).
45. A host cell according to claim 42 or 44 which is transformed with one or two vectors according to any of the claims 36-39.
46. A host cell according to claim 45 which is a cell of the cell line EFVII/ γ 4Na75-75/C \times Ga5-6 (CE 75-5-6, having the deposit accession number CNCM I-720).
47. A host cell according to claim 45 which is a cell of the cell line EFIX-pCEA-Ig-(γ 4;C \times) (CE 4-8-13, having the deposit accession number CNCM I-818).
48. A host cell according to claim 42 characterized in that it secretes chimeric monoclonal antibodies according to claim 1.
49. A process for the preparation of a host cell according to claim 42 or 48, characterized in that a suitable cell is transformed with one or two vectors by electroporation, calcium treatment, microinjection or protoplast fusion.
50. Chimeric monoclonal antibodies and derivatives thereof according to claim 1 for use in a method for the treatment of humans and for diagnosis.
51. The use of chimeric monoclonal antibodies and derivatives thereof according to claim 1 for the in vitro diagnosis of cancer.
52. The use of chimeric monoclonal antibodies and derivatives thereof according to claim 1 for the qualitative and quantitative in vitro determination of human CEA.
53. The use according to claim 51 of chimeric monoclonal antibodies and derivatives thereof in a radioimmunoassay or an enzyme-immunoassay.
54. Test kits for the qualitative and quantitative determination of human CEA containing chimeric monoclonal antibodies according to claim 1 and/or derivatives thereof and, optionally, other monoclonal or polyclonal antibodies and/or adjuncts.
55. A pharmaceutical composition containing a chimeric monoclonal antibody or derivatives thereof according to claim 1.

Claims for the following Contracting States : ES, GR

1. A process for the preparation of a chimeric monoclonal antibody consisting of variable regions of mouse origin and human constant regions, which recognizes epitopes of human carcinoembryonic antigen (CEA), not present on non-specific cross-reacting antigen NCA₅₅ and NCA₉₅, on biliary glycoprotein, or on granulocytes, and derivatives thereof, characterized in that mammalian cells producing such chimeric monoclonal antibodies are multiplied in vivo or in vitro and, if desired, the resulting chimeric monoclonal antibodies are converted into derivatives thereof.
2. A process according to claim 1 for the preparation of a chimeric monoclonal antibody and derivatives thereof with an affinity of at least 2.1×10^{10} liters/mol for human CEA.
3. A process according to claim 1 or 2 for the preparation of a chimeric monoclonal antibody and derivatives thereof comprising light chain variable regions of the formula

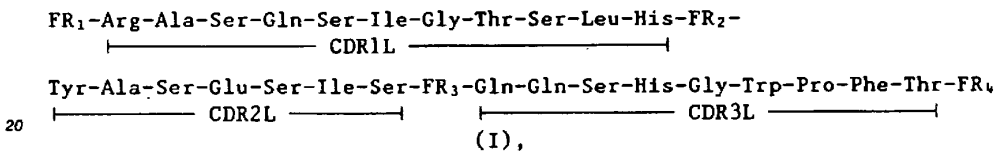

wherein FR₁ is a polypeptide residue comprising 23-28 naturally occurring amino acids, FR₂ is a polypeptide residue comprising 14-16 naturally occurring amino acids, FR₃ is a polypeptide residue comprising 30-34 naturally occurring amino acids and FR₄ is a polypeptide residue comprising 9-11 naturally occurring amino acids, and wherein the amino acid Cys may be in the oxidized state forming S-S-bridges.

4. A process according to any of the claims 1-3 for the preparation of a chimeric monoclonal antibody and derivatives thereof comprising light chain variable regions of formula I, wherein the polypeptide residues of the framework regions FR₁, FR₂, FR₃ and FR₄ are those preferably occurring in murine antibodies.
5. A process according to any of the claims 1-4 for the preparation of a chimeric monoclonal antibody and derivatives thereof comprising light chain variable regions of formula I, wherein FR₁ is a polypeptide residue of the formula

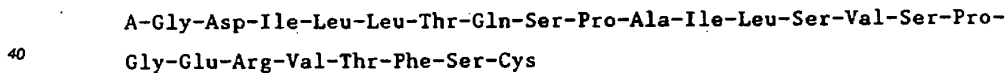

(IA),

wherein A is hydrogen, acyl, or the residue Ala-Ser-Arg, Ser-Arg or Arg,

FR₂ is the polypeptide residue

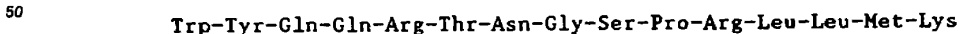

(IB),

FR₃ is the polypeptide residue

Gly-Ile-Pro-Ser-Arg-Phe-Ser-Gly-Ser-Gly-Ser-Gly-Thr-Asp-Phe-Thr-Leu-
 Thr-Ile-Asn-Ser-Val-Glu-Ser-Glu-Asp-Ile-Ala-Asp-Tyr-Tyr-Cys

5

(IC),

and FR₄ is the polypeptide residue

10

Phe-Gly-Ser-Gly-Gly-Thr-Lys-Leu-Glu-Ile-Lys

15

(ID),

and wherein the amino acid Cys may be in the oxidized state forming S-S-bridges.

20 6. A process according to claim 3 for the preparation of a chimeric monoclonal antibody and derivatives thereof comprising light chain variable regions of formula I, wherein FR₁, FR₂, FR₃ and FR₄ are polypeptide residues of formula IA, IB, IC and ID, respectively, wherein one or more single amino acids are replaced by other amino acids outside the regions CDR1L, CDR2L and CDR3L, and wherein the amino acid Cys may be in the oxidized state forming S-S-bridges.

25

7. A process according to any of the claims 1-6 for the preparation of a chimeric monoclonal antibody and derivatives thereof comprising heavy chain variable regions of the formula

30

FR₅-Thr-Tyr-Ala-Met-Ala-Trp-Val-FR₆-Ser-Ser-Gly-Gly-Thr-Thr-Tyr-Tyr-Pro-
 |----- CDR1H -----| |-----
 Asp-Ser-Val-Lys-Gly-FR₇-Gly-Phe-Tyr-Asp-Gly-Tyr-Leu-Tyr-Val-Val-FR₈
 ----- CDR2H -----| |----- CDR3H -----|

35

(II),

wherein FR₅ is a polypeptide residue comprising 32-36 naturally occurring amino acids, FR₆ is a polypeptide residue comprising 14-16 naturally occurring amino acids, FR₇ is a polypeptide residue comprising 32-34 naturally occurring amino acids and FR₈ is a polypeptide residue comprising 12-14 naturally occurring amino acids, and wherein the amino acid Cys may be in the oxidized state forming S-S-bridges.

40

45 8. A process according to any of the claims 1-7 for the preparation of a chimeric monoclonal antibody and derivatives thereof comprising heavy chain variable regions of formula II, wherein the polypeptide residues of the framework regions FR₅, FR₆, FR₇ and FR₈ are those preferably occurring in murine antibodies.

50 9. A process according to any of the claims 1-8 for the preparation of a chimeric monoclonal antibody and derivatives thereof comprising heavy chain variable regions of formula II, wherein FR₅ is a polypeptide residue of the formula

55

B-Gly-Val-Gln-Cys-Glu-Val-Lys-Leu-Val-Glu-Ser-Gly-Gly-Gly-Leu-
Val-Lys-Pro-Gly-Gly-Ser-Leu-Lys-Leu-Ser-Cys-Ala-Ala-Ser-Gly-Phe-
5 Thr-Phe-Arg

(IIA),

wherein B is hydrogen or acyl,

10 FR₆ is the polypeptide residue

Arg-Gln-Thr-Pro-Glu-Lys-Arg-Leu-Glu-Trp-Val-Thr-Ser-Ile

15 (IIB),

FR₇ is the polypeptide residue

20 Arg-Phe-Thr-Ile-Ser-Arg-Asp-Asn-Ala-Arg-Asn-Ile-Leu-Tyr-
Leu-Gln-Val-Ser-Ser-Leu-Arg-Ser-Glu-Asp-Thr-Ala-Ile-Tyr-Tyr-Cys-
25 Ala-Arg

(IIC),

and FR₈ is the polypeptide residue

30 Asp-Tyr-Trp-Gly-Gln-Gly-Thr-Ser-Leu-Thr-Val-Ser-Ser

35 (IID),

and wherein the amino acid Cys may be in the oxidized state forming S-S-bridges.

- 40 10. A process according to claim 7 for the preparation of a chimeric monoclonal antibody and derivatives thereof comprising heavy chain variable regions of formula II wherein FR₅, FR₆, FR₇ and FR₈ are polypeptide residues of formula IIA, IIB, IIC and IID, respectively, wherein one or more single amino acids are replaced by other amino acids outside the regions CDR1H, CDR2H and CDR3H, and wherein the amino acid Cys may be in the oxidized state forming S-S-bridges.
- 45 11. A process according to any of the claims 1-10 for the preparation of a chimeric monoclonal antibody and derivatives thereof comprising light chain human constant regions κ or λ .
12. A process according to any of the claims 1-11 for the preparation of a chimeric monoclonal antibody and derivatives thereof comprising heavy chain human constant regions γ 1, γ 2, γ 3 or γ 4.
- 50 13. A process according to any of the claims 1-12 for the preparation of a chimeric monoclonal antibody and derivatives thereof comprising light chain human constant regions κ and heavy chain human constant regions γ 4.
- 55 14. A process according to any of the claims 1-13 for the preparation of a chimeric monoclonal antibody and derivatives thereof with light chain variable regions of formula I wherein FR₁, FR₂, FR₃ and FR₄ are polypeptide residues of the formula IA, IB, IC and ID, respectively, and wherein the amino acid Cys may be in the oxidized state forming S-S-bridges, a light chain human constant region κ , a heavy chain

variable region of formula II wherein FR₅, FR₆, FR₇ and FR₈ are polypeptide residues of formula IIA, IIB, IIC and IID, respectively, and wherein the amino acid Cys may be in the oxidized state forming S-S-bridges and a heavy chain human constant region γ4.

- 5 15. A process according to any of the claims 1-14 for the preparation of a derivative of a chimeric monoclonal antibody, characterized in that the monoclonal antibody is cleaved enzymatically or chemically into a fragment.
- 10 16. A process according to any of the claims 1-14 for the preparation of a derivative of a chimeric monoclonal antibody, characterized in that the monoclonal antibody is conjugated with an enzyme, a fluorescent marker, a metal chelate, a cytostatic or cytotoxic substance, avidin or biotin.
- 15 17. A process according to any of the claims 1-14 for the preparation of a derivative of a chimeric monoclonal antibody, characterized in that the monoclonal antibody is radioactively labelled.
18. A process for the preparation of a recombinant DNA comprising an insert coding for a light chain murine variable region and/or for a heavy chain murine variable region of chimeric monoclonal antibodies prepared by a process according to claim 1, characterized in that said process comprises culturing a transformed host.
- 20 19. A process according to claim 18 for the preparation of a recombinant DNA, characterized in that said process comprises the steps of
 - a) isolating murine DNAs from a suitable hybridoma cell line, selecting the desired DNAs coding for the variable regions of monoclonal antibodies directed against human CEA using DNA probes,
 - 25 b) isolating human DNAs from a genomic library, selecting the desired DNAs coding for the constant regions of monoclonal antibodies using DNA probes,
 - c) constructing chimeric mouse/human genes by incorporating the DNAs of step a) and b) into appropriate hybrid vectors,
 - 30 d) transferring the obtained hybrid vectors into a recipient host, and
 - e) selecting and culturing the transformed host.
20. A process according to claim 18 or 19 for the preparation of a recombinant DNA comprising an insert coding for a light chain murine variable region specific for human CEA which originates from genomic DNA of the cell line CE 25, having the deposit accession number CNCM I-719
- 35 21. A process according to claim 18, 19 or 20 for the preparation of a recombinant DNA comprising an insert coding for the polypeptide of formula I, optionally containing introns.
22. A process according to any of the claims 18-21 for the preparation of a recombinant DNA comprising an insert coding for the polypeptide of formula I wherein FR₁, FR₂, FR₃ and FR₄ are polypeptides of formula IA, IB, IC and ID, respectively, optionally containing introns.
- 40 23. A process according to any of the claims 18-22 for the preparation of a recombinant DNA comprising an insert of the formula

45
 TCTAGACTGCTGTGGTCTTTTAAGTAGCATGAAAAACATCTGCTAAAGAAGGAATTAGTT
 1 -----+-----+-----+-----+-----+-----+-----+-----+ 60

50

55

EP 0 323 806 B1

5 TGAACATGCTAGAAATACATCTGTGATACTCTCATCACTCTTGTGGAAAGATATGCAAG 120
 61 -----+-----+-----+-----+-----+-----+-----+-----+-----+-----+
 AAGCACTATTTGGCTATTATTTGGAAAGTGTATAATGTATTTTGATATCTCAACCTCTG
 121 -----+-----+-----+-----+-----+-----+-----+-----+-----+-----+ 180
 AAATTCCTCTGTATGTTGGCAGATTGTAACCTTTACAAGGCTTTCATTCTCTTCTCTGG
 181 -----+-----+-----+-----+-----+-----+-----+-----+-----+-----+ 240
 10 AGAAAAATGTCTTTGTAGGCAATCCAGAATTCTTATTCTTGCTAATGAAATCTCCTCA
 241 -----+-----+-----+-----+-----+-----+-----+-----+-----+-----+ 200
 GTGTGATATCACTTTAGTTTCATGTGTTGTTATGCTTCATGTAATGTTAAGAAAGTAAA
 301 -----+-----+-----+-----+-----+-----+-----+-----+-----+-----+ 360
 15 GATGCTCCAATCCATATTGTAAGAAACATTCCAAGCCATGGAATAAGGCATGGATTGAG
 361 -----+-----+-----+-----+-----+-----+-----+-----+-----+-----+ 420
 ATGCTCTTTATTTCAAACACTGAATATATCTTAGAGATTCTTTAGACTGTGTTAAATA
 421 -----+-----+-----+-----+-----+-----+-----+-----+-----+-----+ 480
 20 TGTAACCATTTAAGTAGGAGTCAAGTCTCCTTTAAATCTCAACAGCTCTTCAGGTAACCA
 481 -----+-----+-----+-----+-----+-----+-----+-----+-----+-----+ 540
 ACAAAAGGATAAATATTCTAATAAGTCACTAGGAGCATGCTCTTCTGACCAGGTCTTTCT
 541 -----+-----+-----+-----+-----+-----+-----+-----+-----+-----+ 600
 25 TATAAGCAACATGAAGACAGTATGATTGCATAAGTTTTCTTTCTTCTAATGTCCCTGC
 601 -----+-----+-----+-----+-----+-----+-----+-----+-----+-----+ 660
 CTCTTAGAGTATTATAAGAAGATCTTTCTAGGGATGTGTCATGGTCCACACAAAAATAGG
 661 -----+-----+-----+-----+-----+-----+-----+-----+-----+-----+ 720
 30 M V S T P Q F L V F L L F W I P
 MetValSerThrProGlnPheLeuValPheLeuLeuPheTrpIlePro
 721 GAAAGTGTGAAGATGGTATCCACACCTCAGTTCCTTGTATTTTGGCTTTCTGGATTCCA 780
 35 GGTAATGACTGTTGGGTGTGGCAAAAAGTGGAGATGTTATTAAATACAAAATTTTCT
 781 -----+-----+-----+-----+-----+-----+-----+-----+-----+-----+ 840
 TGCTTTATTTGGAAGCCAATGTCACATGGGAATTGACTTTTCAGTTTAAAGAAATTGATAC
 841 -----+-----+-----+-----+-----+-----+-----+-----+-----+-----+ 900
 40 AATAAAAGTCATTTATTTTCTAAGTTGTTAGAAGTGACTTTCATATTGAGTGTATGA
 901 -----+-----+-----+-----+-----+-----+-----+-----+-----+-----+ 960
 A S R G D I L L T Q S
 AlaSerArgGlyAspIleLeuLeuThrGlnSer
 45 961 TCGACTAATGTATCTTCCATTTTTCCAGCCTCCAGAGGTGACATCTTGTGCTGACTCAGTCT 1020
 P A I L S V S P G E R V T F S C R A S Q
 ProAlaIleLeuSerValSerProGlyGluArgValThrPheSerCysArgAlaSerGln
 50 1021 CCAGCCATCCTGTCTGTGAGTCCAGGAGAAAGAGTCACTTTCTCCTGCAGGGCCAGTCAG 1080
 S I G T S L H W Y Q Q R T N G S P R L L
 SerIleGlyThrSerLeuHisTrpTyrGlnGlnArgThrAsnGlySerProArgLeuLeu
 55 1081 AGCATTGGCACAAGCTTACACTGGTATCAGCAAAGAACAATGGTTCTCCAAGGCTTCTC 1140
 -----+-----+-----+-----+-----+-----+-----+-----+-----+-----+

```

5      M K Y A S E S I S G I P S R F S G S G S
      MetLysTyrAlaSerGluSerIleSerGlyIleProSerArgPheSerGlySerGlySer
      ATGAAGTATGCTTCTGAGTCTATCTCTGGGATCCCTTCCAGGTTTAGTGGCAGTGGATCA
1141 -----+-----+-----+-----+-----+-----+-----+-----+-----+ 1200

      G T D F T L T I N S V E S E D I A D Y Y
      GlyThrAspPheThrLeuThrIleAsnSerValGluSerGluAspIleAlaAspTyrTyr
10     GGGACAGATTTTACTCTTACCATCAATAGTGTGGAGTCTGAAGATATTGCAGATTATTAC
1201 -----+-----+-----+-----+-----+-----+-----+-----+-----+ 1260

      C Q Q S H G W P F T F G S G T K L E I K
      CysGlnGlnSerHisGlyTrpProPheThrPheGlySerGlyThrLysLeuGluIleLys
15     TGTCAACAAAGTCATGGCTGGCCATTACAGTTCGGCTCGGGGACAAAGTTGGAATAAAA
1261 -----+-----+-----+-----+-----+-----+-----+-----+-----+ 1320

      CGTAAGTGGACTTTTGTTCATTIACCTTGTGACGTTTGGTTCTGTTTGGGTAGCTTGTGT
1321 -----+-----+-----+-----+-----+-----+-----+-----+-----+ 1380

20     GAATTTGTGATATTT
1381 -----+----- 1395
      (III).

```

- 25 **24.** A process according to claim 21 for the preparation of a recombinant DNA comprising an insert of formula III wherein one or more single nucleotides are replaced by other nucleotides outside the nucleotide sequences of formula III from position 1089-1102, 1147-1167 and 1263-1291, respectively.
- 30 **25.** A process according to claim 18 for the preparation of a recombinant DNA comprising an insert coding for a heavy chain murine variable region specific for human CEA which originates from genomic DNA of the cell line CE 25, having the deposit accession number CNCM I-719.
- 26.** A process according to claim 18 or 25 for the preparation of a recombinant DNA comprising an insert coding for the polypeptide of formula II, optionally containing introns.
- 35 **27.** A process according to claim 18, 25 or 26 for the preparation of a recombinant DNA comprising an insert coding for the polypeptide of formula II wherein FR₅, FR₆, FR₇ and FR₈ are polypeptide residues of formula IIA, IIB, IIC and IID, respectively, optionally containing introns.
- 40 **28.** A process according to any of the claims 18, 25-27 for the preparation of a recombinant DNA comprising an insert of the formula

45

50

55

```

AAGCTTGTCTGTTACATGCAAGGAGGGAACTAAACTGAGTATGGTGAATCCCTAACC
1  -----+-----+-----+-----+-----+-----+-----+-----+-----+-----+ 60
AAAGGGAAAAAATGAAACTACAATATGTTTCAAATGCTGTAACCTGAAATCTGGTTTTTTG
5  61  -----+-----+-----+-----+-----+-----+-----+-----+-----+-----+ 120
ATGCCTTATATCTGGTATCATCAGTGACTTCAGATTAGTCCAACCCAGAGCATGGTAT
121 -----+-----+-----+-----+-----+-----+-----+-----+-----+-----+ 180
AGCAGGAAGACATGCAATAAGTCTTCTCTCTGCCATGAAAACACCTCGGCCCTGACCC
10  181 -----+-----+-----+-----+-----+-----+-----+-----+-----+-----+ 240
TGCAGCTCTGACAGAGGAGGCCAGTCCATGGATTGAGTTCCTCACATTAGTGATGAGC
241 -----+-----+-----+-----+-----+-----+-----+-----+-----+-----+ 300

           M N F G F S L I F L V L V
           MetAsnPheGlyPheSerLeuIlePheLeuValLeuVal
15  ACTGAACACAGACACCTCACCATGAACCTCGGGTTCAGCTTGATTTTCCTTGTCCTTGT
301 -----+-----+-----+-----+-----+-----+-----+-----+-----+-----+ 360

           L K G
           LeuLysGly
20  TAAAAAGGTAATTTATTGAGAAGAGATGACATCTATTTTACGCACATGAGACAGAAAAAA
361 -----+-----+-----+-----+-----+-----+-----+-----+-----+-----+ 420

                                           V Q
                                           ValG1
25  TGTGGTTTGTITTTAGTGACAGTTTTCCAACCAGTTATTCTCTGTTTGTAGGTGTCCA
421 -----+-----+-----+-----+-----+-----+-----+-----+-----+-----+ 480

           C E V K L V E S G G G L V K P G G S L K
           nCysGluValLysLeuValGluSerGlyGlyGlyLeuValLysProGlyGlySerLeuLy
30  GTGTGAAGTGAAGCTGGTGGAGTCTGGGGAGGCTTAGTGAAGCCTGGAGGGTCCCTGAA
481 -----+-----+-----+-----+-----+-----+-----+-----+-----+-----+ 540

           L S C A A S G F T F R T Y A M A W V R Q
           sLeuSerCysAlaAlaSerGlyPheThrPheArgThrTyrAlaMetAlaTrpValArgGl
35  ACTCTCTGTGCAGCCTCTGGGTTCACCTTTCAGACCTATGCCATGGCTTGGGTTCGCCA
541 -----+-----+-----+-----+-----+-----+-----+-----+-----+-----+ 600

           T P E K R L E W V T S I S S G G T T Y Y
           nThrProGluLysArgLeuGluTrpValThrSerIleSerSerGlyGlyThrThrTyrTy
40  GACTCCAGAGAAGAGGCTGGAGTGGGTCCACATCCATTAGTAGTGGTGGTACCACCTACTA
601 -----+-----+-----+-----+-----+-----+-----+-----+-----+-----+ 660

           P D S V K G R F T I S R D N A R N I L Y
           rProAspSerValLysGlyArgPheThrIleSerArgAspAsnAlaArgAsnIleLeuTy
45  ICCAGACAGTGTGAAGGCCGATTCCACATCTCCAGAGATAATGCCAGAACATCCTGTA
661 -----+-----+-----+-----+-----+-----+-----+-----+-----+-----+ 720

           L Q V S S L R S E D T A I Y Y C A R G F
           rLeuGlnValSerSerLeuArgSerGluAspThrAlaIleTyrTyrCysAlaArgGlyPh
50  CCTGCAAGTGAGCAGTCTGAGGTCTGAGGACACGGCCATTTATTACTGTGCAAGAGGTTT
721 -----+-----+-----+-----+-----+-----+-----+-----+-----+-----+ 780

           Y D G Y L Y V V D Y W G Q G T S L T V S
           eTyrAspGlyTyrLeuTyrValValAspTyrTrpGlyGlnGlyThrSerLeuThrValSe
55  CTATGATGGTTACCTCTATGTTGGACTACTGGGGTCAAGGAACCTCACTCACCGTCTC
781 -----+-----+-----+-----+-----+-----+-----+-----+-----+-----+ 840

```

5
 S
 rSer
 CTCAGGTAAGAATGGCC
 841 -----+----- 857

(IV).

10

29. A process according to claim 26 for the preparation of a recombinant DNA comprising an insert of formula IV wherein one or more single nucleotides are replaced by other nucleotides outside the nucleotide sequences of formula IV from position 575-595, 629-680 and 776-805, respectively.
- 15 30. A process according to claim 18 for the preparation of a recombinant DNA comprising an insert coding for a light chain murine variable region fused to a human constant region α or λ .
- 20 31. A process according to claim 30 for the preparation of a recombinant DNA comprising an insert of formula III fused to a human constant region α .
32. A process according to claim 18 for the preparation of a recombinant DNA comprising an insert coding for a heavy chain murine variable region fused to a human constant region γ 1, γ 2, γ 3 or γ 4.
- 25 33. A process according to claim 32 for the preparation of a recombinant DNA comprising an insert of formula IV fused to a human constant region γ 4.
34. A process according to claim 18 for the preparation of a recombinant DNA which is a hybrid vector comprising an insert coding for a chimeric murine/human light chain prepared by a process according to claim 31 and/or a chimeric murine/human heavy chain prepared by a process according to claim 33, a complete replicon and one or more dominant marker sequences, operationally linked to expression control sequences.
- 30 35. A process according to claim 18 for the preparation of a recombinant DNA which is a hybrid vector comprising an insert coding for a chimeric murine/human light chain prepared by a process according to claim 32 and/or a chimeric murine/human heavy chain prepared by a process according to claim 34, a complete replicon and one or more dominant marker sequences, operationally linked to expression control sequences.
- 35 36. A process according to claim 34 or 35 for the preparation of a recombinant DNA which is a hybrid vector suitable for mammalian hosts.
37. A process according to claim 34, 35 or 36 for the preparation of a recombinant DNA which is a hybrid vector wherein the vector is derived from plasmid pSV.
- 40 38. A process according to claim 37 for the preparation of a recombinant DNA which is a hybrid vector wherein the vector is derived from plasmid pSV2gpt or from plasmid pSV2neo.
- 45 39. A host cell which is transformed with recombinant DNAs prepared by a process according to any of the claims 30-38.
- 50 40. A host cell according to claim 39 which is a mammalian cell of lymphoid origin.
41. A host cell according to claim 39 which is a cell derived from the Ig non-secreting mouse hybridoma cell line Sp2/0 (ATCC CRL 1581).
- 55 42. A host cell according to claim 39 or 41 which is transformed with one or two vectors prepared by a process according to any of the claims 35-38.

43. A host cell according to claim 42 which is a cell of the cell line EFVIII- γ 4Na75-75/C \times Ga5-6 (CE 75-5-6, having the deposit accession number CNCM I-720).
44. A host cell according to claim 42 which is a cell of the cell line EFIX-pCEA-Ig-(γ 4;C \times) (CE 4-8-13, having the deposit accession number CNCM I-818).
45. A host cell according to claim 39 characterized in that it secretes chimeric monoclonal antibodies prepared by a process according to claim 1.
46. A process for the preparation of a host cell according to claim 39 or 45, characterized in that a suitable cell is transformed with one or two vectors by electroporation, calcium treatment, microinjection or protoplast fusion.
47. A process for the preparation of a pharmaceutical composition containing a chimeric monoclonal antibody or derivatives thereof prepared by a process according to claim 1, characterized in that the monoclonal antibody is mixed with a pharmaceutical carrier.

Patentansprüche

Patentansprüche für folgende Vertragsstaaten : AT, BE, CH, DE, FR, GB, IT, LI, LU, NL, SE

1. Chimärer monoklonaler Antikörper, bestehend aus variablen Regionen des Maus-Origin und humanen konstanten Regionen, der Epitope von menschlichem Carcinoembryonal-Antigen (CEA) erkennt, die nicht vorhanden sind auf den nicht-spezifisch kreuzreagierenden Antigenen NCA₆₅ und NCA₉₅, auf biliärem Glycoprotein oder auf Granulocysten, und Derivaten davon.
2. Chimärer monoklonaler Antikörper und Derivate davon nach Anspruch 1 mit einer Affinität von wenigstens $2,1 \times 10^{10}$ Liter/Mol für Human-CEA.
3. Chimärer monoklonaler Antikörper und Derivate davon nach Anspruch 1 oder 2, umfassend die variable Regionen der leichten Ketten der Formel

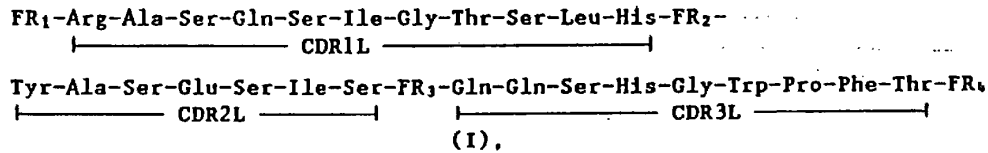

- worin FR₁ ein Polypeptidrest ist, umfassend 23-28 natürlich vorkommende Aminosäuren, FR₂ ist ein Polypeptidrest, umfassend 14-16 natürlich vorkommende Aminosäuren, FR₃ ist ein Polypeptidrest, umfassend 30-34 natürlich vorkommende Aminosäuren und FR₄ ist ein Polypeptidrest, umfassend 9-11 natürlich vorkommende Aminosäuren, und worin die Aminosäure Cys in oxidiertem Zustand S-S-Brücken bilden kann.
4. Chimärer monoklonaler Antikörper und Derivate davon nach einem der Ansprüche 1 bis 3, umfassend die variable Regionen der leichten Kette der Formel I, worin die Polypeptidreste der Gerüstregionen FR₁, FR₂, FR₃ und FR₄ solche sind, die vorzugsweise in Maus-Antikörpern auftreten.
5. Chimärer monoklonaler Antikörper und Derivate davon nach einem der Ansprüche 1 bis 4, umfassend die variable Regionen der leichten Kette der Formel I, worin FR₁ ein Polypeptidrest ist der Formel

A-Gly-Asp-Ile-Leu-Leu-Thr-Gln-Ser-Pro-Ala-Ile-Leu-Ser-Val-Ser-Pro-
Gly-Glu-Arg-Val-Thr-Phe-Ser-Cys

5

(IA),

worin A Wasserstoff, Acyl oder der Rest Ala-Ser-Arg, Ser-Arg oder Arg ist,
FR₂ ist der Polypeptidrest

10

Trp-Tyr-Gln-Gln-Arg-Thr-Asn-Gly-Ser-Pro-Arg-Leu-Leu-Met-Lys

15

(IB),

FR₃ ist der Polypeptidrest

20

Gly-Ile-Pro-Ser-Arg-Phe-Ser-Gly-Ser-Gly-Ser-Gly-Thr-Asp-Phe-Thr-Leu-
Thr-Ile-Asn-Ser-Val-Glu-Ser-Glu-Asp-Ile-Ala-Asp-Tyr-Tyr-Cys

25

(IC),

und FR₄ ist der Polypeptidrest

30

Phe-Gly-Ser-Gly-Gly-Thr-Lys-Leu-Glu-Ile-Lys

(ID),

35

und worin die Aminosäure Cys in oxidiertem Zustand S-S-Brücken bilden kann.

6. Chimärer monoklonaler Antikörper und Derivate davon nach Anspruch 3, umfassend variable Regionen der leichten Kette der Formel I, worin FR₁, FR₂, FR₃ und FR₄ entsprechende Polypeptidreste der Formel IA, IB, IC und ID sind, worin eine oder mehrere einzelne Aminosäuren durch andere Aminosäuren außerhalb der Regionen CDR1L, CDR2L und CDR3L ersetzt sind, und worin die Aminosäure Cys in oxidiertem Zustand S-S-Brücken bilden kann.

40

7. Chimärer monoklonaler Antikörper und Derivate davon nach einem der Ansprüche 1 bis 6, umfassend variable Regionen der schweren Kette der Formel

45

FR₅-Thr-Tyr-Ala-Met-Ala-Trp-Val-FR₆-Ser-Ser-Gly-Gly-Thr-Thr-Tyr-Tyr-Pro-
|----- CDR1H -----| |-----
50 Asp-Ser-Val-Lys-Gly-FR₇-Gly-Phe-Tyr-Asp-Gly-Tyr-Leu-Tyr-Val-Val-FR₈
|----- CDR2H -----| |----- CDR3H -----|

(II),

worin FR₅ ein Polypeptidrest ist, bestehend aus 32-36 natürlich vorkommenden Aminosäuren, FR₆ ist ein Polypeptidrest, bestehend aus 14-16 natürlich vorkommenden Aminosäuren, FR₇ ist ein Polypeptidrest, bestehend aus 32-34 natürlich vorkommenden Aminosäuren und FR₈ ist ein Polypeptidrest, bestehend aus 12-14 natürlich vorkommenden Aminosäuren, und worin die Aminosäure Cys in

55

oxidiertem Zustand S-S-Brücken bilden kann.

8. Chimärer monoklonaler Antikörper und Derivate davon nach einem der Ansprüche 1 bis 7, umfassend variable Regionen der schweren Kette der Formel II, worin die Polypeptidreste der Gerüstregionen FR₅, FR₆, FR₇ und FR₈ solche sind, die vorzugsweise in Maus-Antikörpern auftreten.
9. Chimärer monoklonaler Antikörper und Derivate davon nach einem der Ansprüche 1 bis 8, umfassend variable Regionen der schweren Kette der Formel II, worin FR₅ ein Polypeptidrest der Formel

B-Gly-Val-Gln-Cys-Glu-Val-Lys-Leu-Val-Glu-Ser-Gly-Gly-Gly-Leu-
Val-Lys-Pro-Gly-Gly-Ser-Leu-Lys-Leu-Ser-Cys-Ala-Ala-Ser-Gly-Phe-
Thr-Phe-Arg

(IIA),

ist, worin B Wasserstoff oder Acyl ist,
FR₆ ist der Polypeptidrest

Arg-Gln-Thr-Pro-Glu-Lys-Arg-Leu-Glu-Trp-Val-Thr-Ser-Ile

(IIB),

FR₇ ist der Polypeptidrest

Arg-Phe-Thr-Ile-Ser-Arg-Asp-Asn-Ala-Arg-Asn-Ile-Leu-Tyr-
Leu-Gln-Val-Ser-Ser-Leu-Arg-Ser-Glu-Asp-Thr-Ala-Ile-Tyr-Tyr-Cys-
Ala-Arg

(IIC),

und FR₈ ist der Polypeptidrest

Asp-Tyr-Trp-Gly-Gln-Gly-Thr-Ser-Leu-Thr-Val-Ser-Ser

(IID),

und worin die Aminosäure Cys in oxidiertem Zustand S-S-Brücken bilden kann.

10. Chimärer monoklonaler Antikörper und Derivate davon nach Anspruch 7, umfassend variable Regionen der schweren Kette der Formel I, worin FR₅, FR₆, FR₇ und FR₈ entsprechende Polypeptidreste der Formel IIA, IIB, IIC und IID sind, worin eine oder mehrere einzelne Aminosäuren durch andere Aminosäuren außerhalb der Regionen CDR1H, CDR2H und CDR3H ersetzt sind, und worin die Aminosäure Cys in oxidiertem Zustand S-S-Brücken bilden kann.
11. Chimärer monoklonaler Antikörper und Derivate davon nach einem der Ansprüche 1 bis 10, umfassend die konstanten Regionen κ oder λ der humanen leichten Kette.
12. Chimärer monoklonaler Antikörper und Derivate davon nach einem der Ansprüche 1 bis 11, umfassend die konstanten Regionen γ 1, γ 2, γ 3 oder γ 4 der humanen schweren Kette.

13. Chimärer monoklonaler Antikörper und Derivate davon nach einem der Ansprüche 1 bis 12, umfassend die konstanten Regionen κ der humanen leichten Kette und die konstanten Regionen γ^4 der humanen schweren Kette.
- 5 14. Chimärer monoklonaler Antikörper und Derivate davon nach einem der Ansprüche 1 bis 13 mit variablen Regionen der leichten Kette der Formel I, worin FR_1 , FR_2 , FR_3 und FR_4 entsprechende Polypeptidreste der Formel IA, IB, IC und ID sind, und worin die Aminosäure Cys in oxidiertem Zustand S-S-Brücken bilden kann, einer konstanten Region κ der humanen leichten Kette, einer variablen Region der schweren Kette der Formel II, worin FR_5 , FR_6 , FR_7 und FR_8 entsprechende Polypeptidreste der Formel IIA, IIB, IIC und IID sind, und worin die Aminosäure Cys in oxidiertem Zustand S-S-Brücken bilden kann, und einer konstanten Region γ^4 der humanen schweren Kette.
- 10 15. Derivat eines chimären monoklonalen Antikörpers nach einem der Ansprüche 1 bis 14, das ein Fragment ist.
- 15 16. Derivat eines chimären monoklonalen Antikörpers nach einem der Ansprüche 1 bis 14, das ein Konjugat ist mit einem Enzym, einem fluoreszierenden Marker, einem Metallchelat, einer cytotostatischen oder cytotoxischen Substanz, Avidin oder Biotin.
- 20 17. Derivat eines chimären monoklonalen Antikörpers nach einem der Ansprüche 1 bis 14, das radioaktiv markiert ist.
18. Verfahren zur Herstellung von chimären monoklonalen Antikörpern und von Derivaten davon nach Anspruch 1, dadurch gekennzeichnet, daß Säugerzellen, die solche chimären monoklonalen Antikörper produzieren, in vitro vermehrt werden und gewünschtenfalls die erhaltenen chimären monoklonalen Antikörper in Derivate davon umgewandelt werden.
- 25 19. Verfahren zur Herstellung eines chimären monoklonalen Antikörpers und von Derivaten davon nach Anspruch 1, dadurch gekennzeichnet, daß Säugerzellen, die solche chimären monoklonalen Antikörper produzieren, in vivo vermehrt werden und gewünschtenfalls die erhaltenen chimären monoklonalen Antikörper in Derivate davon umgewandelt werden.
- 30 20. Rekombinante DNA, umfassend ein Insert, das für eine variable Region der leichten Kette der Maus und/oder eine variable Region der schweren Kette der Maus eines chimären monoklonalen Antikörpers nach Anspruch 1 kodiert.
- 35 21. Rekombinante DNA nach Anspruch 20, umfassend ein Insert, das für eine variable Region der leichten Kette der Maus kodiert, die spezifisch ist für Human-CEA, das aus genomischer DNA der Zelllinie CE 25 herrührt, mit der Hinterlegungsnummer CNCM I-719.
- 40 22. Rekombinante DNA nach Anspruch 20 oder 21, umfassend ein Insert, das für das Polypeptid der Formel I kodiert, das gegebenenfalls Introns enthält.
- 45 23. Rekombinante DNA nach einem der Ansprüche 20 bis 22, umfassend ein Insert, das für das Polypeptid der Formel I kodiert, worin FR_1 , FR_2 , FR_3 und FR_4 entsprechende Polypeptide der Formel IA, IB, IC und ID sind, das gegebenenfalls Introns enthält.
- 50
- 55

EP 0 323 806 B1

24. Rekombinante DNA nach einem der Ansprüche 20 bis 23, umfassend ein Insert der Formel

```
5 1 TCTAGACTGCTGTGGTCTTTTAAGTACCATGAAAAACATCTGCTAAAGAAGGAATTAGTT 60
   1-----+-----+-----+-----+-----+-----+-----+
61 TGAACATGCTAGAAATACATCTGTGATACTCTCATCACTCTTGTGGAAAGATATGCAAG 120
   1-----+-----+-----+-----+-----+-----+-----+
10 121 AAGCACTATTTGGCTATTIATTTGGAAAGTGCTATAATGTATTTTGATATCTCAACCTCTG 180
    1-----+-----+-----+-----+-----+-----+-----+
181 AAATTCCTTCTGTATGTTGGCAGATTGTAACCTTTACAAGGCTTTCATTCTTCTCTGG 240
    1-----+-----+-----+-----+-----+-----+-----+
```

15

20

25

30

35

40

45

50

55

```

AGAAAAATGTCTTGTAGGCAATCCAGAATTTCTTATTTCTTGCTAATGAAATCTCCTCA
241 -----+-----+-----+-----+-----+-----+-----+-----+-----+-----+ 200
GTGTGATATCACTTTAGTTTCATGTTGTTATGCTTCATGTAATGTTAAGAAAGTAAA
5 301 -----+-----+-----+-----+-----+-----+-----+-----+-----+-----+ 360
GATGCTCCAATCCATATTGTAAGAAACATTCCAAGCCATGGAATAAGGCATGGATTGAG
361 -----+-----+-----+-----+-----+-----+-----+-----+-----+-----+ 420
ATGCTCTTTATTTCAAACACTGAATAATCTTAGAGATTTCTTTAGACTGTGTTAAATA
10 421 -----+-----+-----+-----+-----+-----+-----+-----+-----+-----+ 480
TGTAACCAATTTAAGTAGGAGTCAAGTCTCCTTTAAATCTCAACAGCTCTTCAGGTAACCA
481 -----+-----+-----+-----+-----+-----+-----+-----+-----+-----+ 540
ACAAAAGGATAAATATTCTAATAAGTCACTAGGAGCATGCTCTTCTGACCAGGTCTTTCT
15 541 -----+-----+-----+-----+-----+-----+-----+-----+-----+-----+ 600
TATAAGCAACATGAAGACAGTATGATTGCATAAGTTTTCTTTCTTCTAATGTCCCTGC
601 -----+-----+-----+-----+-----+-----+-----+-----+-----+-----+ 660
CTCTTAGAGTATTATAAGAAGATCTTTCTAGGGATGTGTCATGGTCCACACAAAAATAGG
20 661 -----+-----+-----+-----+-----+-----+-----+-----+-----+-----+ 720
                M V S T P Q F L V F L L F W I P
                MetValSerThrProGlnPheLeuValPheLeuLeuPheTrpIlePro
GAAAGTGTGAAGATGGTATCCACACCTCAGTTCCTTGTATTTTTGCTTTTCTGGATTCCA
25 721 -----+-----+-----+-----+-----+-----+-----+-----+-----+-----+ 780
GGTAATGACTGTTTGGGTGTGGCAAAAAGTGGAGATGTTATTTAAATACAAAATTTTCT
781 -----+-----+-----+-----+-----+-----+-----+-----+-----+-----+ 840
TGCTTTATTTGGAAGCCAATGTCACATGGGAATTGACTTTCAGTTAAAGAAATTGATAC
30 841 -----+-----+-----+-----+-----+-----+-----+-----+-----+-----+ 900
AATAAAAGTCATTTATTTTTCTAAGTGTTTAGAAGTGACTTTCATATTCAGTGTATGA
901 -----+-----+-----+-----+-----+-----+-----+-----+-----+-----+ 960
                A S R G D I L L T Q S
                AlaSerArgGlyAspIleLeuLeuThrGlnSer
TCGACTAATGTATCTTCCATTTTTCCAGCCTCCAGAGGTGACATCTTGTGACTCAGTCT
961 -----+-----+-----+-----+-----+-----+-----+-----+-----+-----+ 1020
P A I L S V S P G E R V T F S C R A S Q
ProAlaIleLeuSerValSerProGlyGluArgValThrPheSerCysArgAlaSerGln
40 CCAGCCATCCTGTCTGTGAGTCCAGGAGAAAGAGTCACTTTCTCCTGCAGGGCCAGTCAG
1021 -----+-----+-----+-----+-----+-----+-----+-----+-----+-----+ 1080
S I G T S L H W Y Q Q R T N G S P R L L
SerIleGlyThrSerLeuHisTrpTyrGlnGlnArgThrAsnGlySerProArgLeuLeu
45 AGCAATGGCACAAGCTTACACTGGTATCAGCAAAGAACAATGGTTCTCCAAGGCTTCTC
1081 -----+-----+-----+-----+-----+-----+-----+-----+-----+-----+ 1140
M K Y A S E S I S G I P S R F S G S G S
MetLysTyrAlaSerGluSerIleSerGlyIleProSerArgPheSerGlySerGlySer
50 ATGAAGTATGCTTCTGAGTCTATCTCTGGGATCCCTTCCAGGTTTAGTGGCAGTGGATCA
1141 -----+-----+-----+-----+-----+-----+-----+-----+-----+-----+ 1200
G T D F T L T I N S V E S E D I A D Y Y
GlyThrAspPheThrLeuThrIleAsnSerValGluSerGluAspIleAlaAspTyrTyr
55 GGGACAGATTTTACTCTTACCATCAATAGTGTGGAGTCTGAAGATATTGCAGATTATTAC
1201 -----+-----+-----+-----+-----+-----+-----+-----+-----+-----+ 1260

```

C Q Q S H G W P F T F G S G T K L E I K
 CysGlnGlnSerHisGlyTrpProPheThrPheGlySerGlyThrLysLeuGluIleLys
 5 TGTCAACAAAGTCATGGCTGGCCATTACGTTTCGGCTCGGGGACAAAGTTGAAATAAAA
 1261 -----+-----+-----+-----+-----+-----+-----+ 1320
 CGTAAGTGGACTTTTGTTCATTACTTGTGACGTTTGGTTCTGTTTGGGTAGCTTGTGT
 1321 -----+-----+-----+-----+-----+-----+-----+ 1380
 70 GAATTTGTGATATTT
 1381 -----+----- 1395
 (III).

- 15
25. Rekombinante DNA nach Anspruch 22, umfassend ein Insert der Formel III, worin ein oder mehrere Nukleotide durch andere Nukleotide ersetzt sind außerhalb der Nukleotidsequenzen der Formel III von Position 1069-1102, 1147-1167 und 1263-1291.
- 20
26. Rekombinante DNA nach Anspruch 20, umfassend ein Insert, das für eine variable Region der schweren Kette der Maus kodiert, die spezifisch ist für Human-CEA, das aus der genomischen DNA der Zelllinie CE 25 herrührt, mit der Hinterlegungsnummer CNCM I-719.
- 25
27. Rekombinante DNA nach Anspruch 20 oder 26, umfassend ein Insert, das für das Polypeptid der Formel II kodiert, das gegebenenfalls Introns enthält.
- 30
28. Rekombinante DNA nach einem der Ansprüche 20, 26 oder 27, umfassend ein Insert, das für das Polypeptid der Formel II kodiert, worin FR₅, FR₆, FR₇ und FR₈ entsprechende Polypeptidreste der Formel IIA, IIB, IIC und IID sind, das gegebenenfalls Introns enthält.
- 35
29. Rekombinante DNA nach einem der Ansprüche 20, 26 bis 28, umfassend ein Insert der Formel

AAGCTTGTTCCTTACATGCAAGGAGGAACTAAACTGAGTATGGTGAATCCCTAACC
 35 1 -----+-----+-----+-----+-----+-----+-----+ 60
 AAAGGGAAAAATGAACTACAATATGTTTCAAATGCTGTAACGAAATCTGGTTTTTTG
 61 -----+-----+-----+-----+-----+-----+-----+ 120
 ATGCCTTATATCTGGTATCATCAGTGACTTCAGATTTAGTCCAACCCAGAGCATGGTAT
 40 121 -----+-----+-----+-----+-----+-----+-----+ 180

45

50

55

AGCAGGAAGACATGCAAATAAGTCTTCTCTGCCCATGAAAACACCTCGGCCCTGACCC
 5 181 -----+-----+-----+-----+-----+-----+-----+ 240
 TGCAGCTCTGACAGAGGAGGCCAGTCCATGGATTTGAGTTCTCATTACAGTATGAGC
 241 -----+-----+-----+-----+-----+-----+-----+ 300
 M N F G F S L I F L V L V
 MetAsnPheGlyPheSerLeuIlePheLeuValLeuVal
 10 ACTGAACACAGACACCTCACCATGAACTTCGGGTTGAGTTGATTTCTTGTCTTGT
 301 -----+-----+-----+-----+-----+-----+-----+ 360
 L K G
 LeuLysGly
 15 TIAAAGGTAATTTATTGAGAAGAGATGACATCTATTTACGCACATGAGACAGAAAAA
 361 -----+-----+-----+-----+-----+-----+-----+ 420
 V Q
 ValG1
 20 TGTGGTTTGTITTTGTTAGTGACAGTTTTCCAACCAGTTATTCTCTGTTTGIAGGTGTCCA
 421 -----+-----+-----+-----+-----+-----+-----+ 480
 C E V K L V E S G G G L V K P G G S L K
 nCysGluValLysLeuValGluSerGlyGlyLeuValLysProGlyGlySerLeuLy
 25 G1GTGAAGTGAAGCTGGTGGAGTCTGGGGAGGCTTAGTGAAGCCTGGAGGGTCCCTGAA
 481 -----+-----+-----+-----+-----+-----+-----+ 540
 L S C A A S G F T F R T Y A M A W V R Q
 sLeuSerCysAlaAlaSerGlyPheThrPheArgThrTyrAlaMetAlaTrpValArgG1
 30 ACTCTCCTGTGCAGCCTCTGGGTTCACTTTCAGGACCTATGCCATGGCTTGGGTTCCGCA
 541 -----+-----+-----+-----+-----+-----+-----+ 600
 T P E K R L E W V T S I S S G G T T Y Y
 nThrProGluLysArgLeuGluTrpValThrSerIleSerSerGlyGlyThrThrTyrTy
 35 GACTCCAGAGAAGAGGCTGGAGTGGGTCAATCCATTAGTAGTGGTGGTACCACCTACTA
 601 -----+-----+-----+-----+-----+-----+-----+ 660
 P D S V K G R F T I S R D N A R N I L Y
 rProAspSerValLysGlyArgPheThrIleSerArgAspAsnAlaArgAsnIleLeuTy
 40 TCCAGACAGTGTGAAGGGCCGATTACCACTCTCCAGAGATAATGCCAGGAACATCCTGTA
 661 -----+-----+-----+-----+-----+-----+-----+ 720
 L Q V S S L R S E D T A I Y Y C A R G F
 rLeuGlnValSerSerLeuArgSerGluAspThrAlaIleTyrTyrCysAlaArgGlyPh
 45 CCTGCAAGTGAGCAGTCTGAGGTTCTGAGGACACGGCCATTTATTACTGTGCAAGAGGTTT
 721 -----+-----+-----+-----+-----+-----+-----+ 780
 Y D G Y L Y V V D Y W G Q G T S L T V S
 eTyrAspGlyTyrLeuTyrValValAspTyrTrpGlyGlnGlyThrSerLeuThrValSe
 50 CTATGATGGTTACCTCTATGTGTGGACTACTGGGGTCAAGGAACCTCACTACCCTCTC
 781 -----+-----+-----+-----+-----+-----+-----+ 840
 S
 rSer
 CTCAGGTAAGAATGGCC
 841 -----+-----+-----+-----+-----+-----+-----+ 857

55

(IV).

- 5 30. Rekombinante DNA nach Anspruch 27, umfassend ein Insert der Formel IV, worin ein oder mehrere Nukleotide durch andere Nukleotide ersetzt sind außerhalb der Nukleotidsequenzen der Formel IV von Position 575-595, 629-680 und 776-805.
31. Rekombinante DNA nach Anspruch 20, umfassend ein Insert, das für eine variable Region der leichten Kette der Maus fusioniert mit einer konstanten Region x oder λ kodiert.
- 10 32. Rekombinante DNA nach Anspruch 31, umfassend ein Insert der Formel III, fusioniert mit einer humanen konstanten Region x .
33. Rekombinante DNA nach Anspruch 20, umfassend ein Insert, das für eine variable Region der schweren Kette der Maus fusioniert mit einer konstanten Region $\gamma 1$, $\gamma 2$, $\gamma 3$ oder $\gamma 4$ kodiert.
- 15 34. Rekombinante DNA nach Anspruch 33, umfassend ein Insert der Formel IV fusioniert mit einer humanen konstanten Region $\gamma 4$.
- 20 35. Rekombinante DNA nach Anspruch 20, die ein Hybridvektor ist, umfassend ein Insert, kodierend für eine chimäre Maus/Human-leichte Kette nach Anspruch 31 und/oder eine chimäre Maus/Human-schwere Kette nach Anspruch 33, ein vollständiges Replikon und eine oder mehrere dominante Markersequenzen, gegebenenfalls an Expressionssteuerungssequenzen gebunden.
- 25 36. Rekombinante DNA nach Anspruch 20, die ein Hybridvektor ist, umfassend ein Insert, kodierend für eine chimäre Maus/Human-leichte Kette nach Anspruch 32 und/oder eine chimäre Maus/Human-schwere Kette nach Anspruch 34, ein vollständiges Replikon und eine oder mehrere dominante Markersequenzen, gegebenenfalls an Expressionssteuerungssequenzen gebunden.
- 30 37. Rekombinante DNA, die ein Hybridvektor ist, nach Anspruch 35 oder 36, geeignet für Säuger-Wirte.
38. Rekombinante DNA, die ein Hybridvektor ist, nach Anspruch 35, 36 oder 37, worin der Vektor aus dem Plasmid pSV abgeleitet ist.
- 35 39. Rekombinante DNA, die ein Hybridvektor ist, nach Anspruch 38, worin der Vektor aus dem Plasmid pSV2gpt oder aus dem Plasmid pSV2neo abgeleitet ist.
40. Verfahren zur Herstellung von rekombinanten DNAs nach Anspruch 20, gekennzeichnet durch Kultivieren eines transformierten Wirtes.
- 40 41. Verfahren nach Anspruch 40, umfassend die Stufen
- a) Isolieren von Maus-DNAs aus einer geeigneten Hybridoma-Zelllinie, Selektieren der gewünschten DNAs, die für die variablen Regionen von monoklonalen Antikörpern kodieren, die gegen Human-CEA gerichtet sind, unter Verwendung von DNA-Sonden,
 - 45 b) Isolieren von Human-DNAs aus einer genomischen Bibliothek, Selektieren der gewünschten DNAs, die für die konstanten Regionen monoklonaler Antikörper kodieren, unter Verwendung von DNA-Sonden,
 - c) Konstruieren der chimären Maus/Human-Gene durch Einbringen der DNAs von Stufe a) und b) in entsprechende Hybridvektoren,
 - d) Transferieren der erhaltenen Hybridvektoren in einen Rezipienten-Wirt, und
 - 50 e) Selektieren und Kultivieren des transformierten Wirtes.
42. Wirtszelle, transformiert mit rekombinanten DNAs nach einem der Ansprüche 31 bis 39.
43. Wirtszelle nach Anspruch 42, die eine Säugerzelle lymphoiden Ursprunges ist.
- 55 44. Wirtszelle nach Anspruch 42, die eine Zelle ist, abgeleitet aus der Ig nicht-sekretierenden Maus-Hybridom-Zelllinie Sp2/O (ATCC CRL 1581).

45. Wirtszelle nach Anspruch 42 oder 44, die mit einem oder zwei Vektoren nach einem der Ansprüche 36 bis 39 transformiert ist.
46. Wirtszelle nach Anspruch 45, die eine Zelle der Zelllinie EFVIII/γ4Na 75-75/C_xGa5-6 ist (CE 75-5-6 mit der Hinterlegungsnummer CNCM I-720).
47. Wirtszelle nach Anspruch 45, die eine Zelle der Zelllinie EFIX-pCEA-Ig-(γ4;C_x) ist (CE 4-8-13 mit der Hinterlegungsnummer CNCM I-818).
48. Wirtszelle nach Anspruch 42, dadurch gekennzeichnet, daß sie chimäre monoklonale Antikörper nach Anspruch 1 sekretiert.
49. Verfahren zur Herstellung einer Wirtszelle nach Anspruch 42 oder 48, dadurch gekennzeichnet, daß eine geeignete Zelle mit einem oder zwei Vektoren durch Elektroporation, Calciumbehandlung, Mikroinjektion oder Protoplastenfusion transformiert wird.
50. Chimäre monoklonale Antikörper und Derivate davon nach Anspruch 1 zur Verwendung in einer Methode für die Behandlung von Menschen und zur Diagnose.
51. Verwendung von chimären monoklonalen Antikörpern und Derivaten davon nach Anspruch 1 für die in vitro-Diagnose von Krebs.
52. Verwendung von chimären monoklonalen Antikörpern und Derivaten davon nach Anspruch 1 zur qualitativen und quantitativen in vitro-Bestimmung von Human-CEA.
53. Verwendung nach Anspruch 51 von chimären monoklonalen Antikörpern und Derivaten davon in einem Radioimmunoassay oder einem Enzym-Immunoassay.
54. Test-Ausrüstung für die qualitative und quantitative Bestimmung von Human-CEA, enthaltend chimäre monoklonale Antikörper nach Anspruch 1 und/oder Derivate davon und gegebenenfalls andere monoklonale oder polyklonale Antikörper und/oder Begleitstoffe.
55. Pharmazeutische Zusammensetzung, enthaltend einen chimären monoklonalen Antikörper oder Derivate davon nach Anspruch 1.

Patentansprüche für folgende Vertragsstaaten : ES, GR

1. Verfahren zu Herstellung eines chimären monoklonaler Antikörpers, bestehend aus variablen Regionen des Maus-Origin und humanen konstanten Regionen, der Epitope von menschlichem Carcinoembryonal-Antigen (CEA) erkennt, die nicht vorhanden sind auf den nicht-spezifisch kreuzreagierenden Antigenen NCA₅₅ und NCA₉₅, auf biliärem Glycoprotein oder auf Granulocyten, und Derivaten davon, dadurch gekennzeichnet, daß Säugerzellen, die solche chimären monoklonalen Antikörper produzieren, in vitro vermehrt werden und gewünschtenfalls die erhaltenen chimären monoklonalen Antikörper in Derivate davon umgewandelt werden.
2. Verfahren nach Anspruch 1 zur Herstellung eines chimären monoklonalen Antikörpers und Derivaten davon mit einer Affinität von wenigstens $2,1 \times 10^{10}$ Liter/Mol für Human-CEA.
3. Verfahren nach Anspruch 1 oder 2 zur Herstellung eines chimären monoklonalen Antikörpers und Derivaten davon, umfassend die variablen Regionen der leichten Ketten der Formel

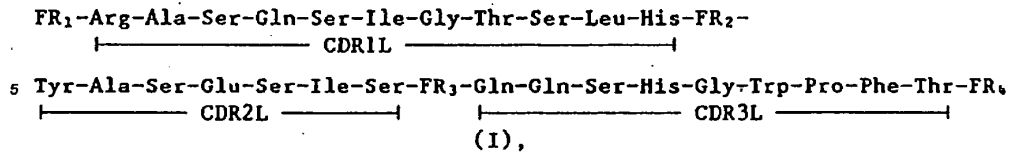

10 worin FR₁ ein Polypeptidrest ist, umfassend 23-28 natürlich vorkommende Aminosäuren, FR₂ ist ein Polypeptidrest, umfassend 14-16 natürlich vorkommende Aminosäuren, FR₃ ist ein Polypeptidrest, umfassend 30-34 natürlich vorkommende Aminosäuren und FR₄ ist ein Polypeptidrest, umfassend 9-11 natürlich vorkommende Aminosäuren, und worin die Aminosäure Cys in oxidiertem Zustand S-S-Brücken bilden kann.

- 15
4. Verfahren nach einem der Ansprüche 1 bis 3 zur Herstellung eines chimären monoklonalen Antikörpers und Derivaten davon, umfassend die variablen Regionen der leichten Kette der Formel I, worin die Polypeptidreste der Gerüstregionen FR₁, FR₂, FR₃ und FR₄ solche sind, die vorzugsweise in Maus-Antikörpern auftreten.
 - 20 5. Verfahren nach einem der Ansprüche 1 bis 4 zur Herstellung eines chimären monoklonalen Antikörpers und Derivaten davon, umfassend die variablen Regionen der leichten Kette der Formel I, worin FR₁ ein Polypeptidrest ist der Formel

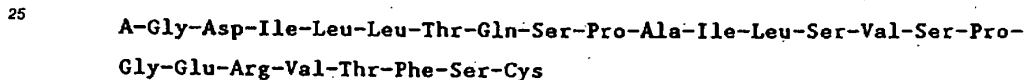

30 (IA),

worin A Wasserstoff, Acyl oder der Rest Ala-Ser-Arg, Ser-Arg oder Arg ist,
 FR₂ ist der Polypeptidrest



40 (IB),

FR₃ ist der Polypeptidrest

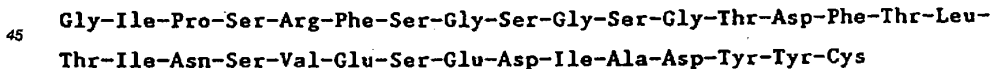

50 (IC),

und FR₄ ist der Polypeptidrest

55

Phe-Gly-Ser-Gly-Gly-Thr-Lys-Leu-Glu-Ile-Lys

5 (ID),

und worin die Aminosäure Cys in oxidiertem Zustand S-S-Brücken bilden kann.

10 6. Verfahren nach Anspruch 3 zur Herstellung eines chimären monoklonalen Antikörpers und Derivaten davon, umfassend variablen Regionen der leichten Kette der Formel I, worin FR₁, FR₂, FR₃ und FR₄ entsprechende Polypeptidreste der Formel IA, IB, IC und ID sind, worin eine oder mehrere einzelne Aminosäuren durch andere Aminosäuren außerhalb der Regionen CDR1L, CDR2L und CDR3L ersetzt sind, und worin die Aminosäure Cys in oxidiertem Zustand S-S-Brücken bilden kann.

15 7. Verfahren nach einem der Ansprüche 1 bis 6 zur Herstellung eines chimären monoklonalen Antikörpers und Derivaten davon, umfassend die variablen Regionen der schweren Kette der Formel

20 **FR₅-Thr-Tyr-Ala-Met-Ala-Trp-Val-FR₆-Ser-Ser-Gly-Gly-Thr-Thr-Tyr-Tyr-Pro-**
 |----- CDR1H -----| |-----|
Asp-Ser-Val-Lys-Gly-FR₇-Gly-Phe-Tyr-Asp-Gly-Tyr-Leu-Tyr-Val-Val-FR₈
 |----- CDR2H -----| |----- CDR3H -----|

25 (II),

worin FR₅ ein Polypeptidrest ist, bestehend aus 32-36 natürlich vorkommenden Aminosäuren, FR₆ ist ein Polypeptidrest, bestehend aus 14-16 natürlich vorkommenden Aminosäuren, FR₇ ist ein Polypeptidrest, bestehend aus 32-34 natürlich vorkommenden Aminosäuren und FR₈ ist ein Polypeptidrest, bestehend aus 12-14 natürlich vorkommenden Aminosäuren, und worin die Aminosäure Cys in oxidiertem Zustand S-S-Brücken bilden kann.

30 8. Verfahren nach einem der Ansprüche 1 bis 7 zur Herstellung eines chimären monoklonalen Antikörpers und Derivaten davon, umfassend variablen Regionen der schweren Kette der Formel II, worin die Polypeptidreste der Gerüstregionen FR₅, FR₆, FR₇ und FR₈ solche sind, die vorzugsweise in Maus-Antikörpern auftreten.

40 9. Verfahren nach einem der Ansprüche 1 bis 8 zur Herstellung eines chimären monoklonalen Antikörpers und Derivaten davon, umfassend die variablen Regionen der schweren Kette der Formel II, worin FR₅ ein Polypeptidrest der Formel

45 **B-Gly-Val-Gln-Cys-Glu-Val-Lys-Leu-Val-Glu-Ser-Gly-Gly-Gly-Leu-**
Val-Lys-Pro-Gly-Gly-Ser-Leu-Lys-Leu-Ser-Cys-Ala-Ala-Ser-Gly-Phe-
Thr-Phe-Arg

(IIA),

50 ist, worin B Wasserstoff oder Acyl ist,
 FR₅ ist der Polypeptidrest

Arg-Gln-Thr-Pro-Glu-Lys-Arg-Leu-Glu-Trp-Val-Thr-Ser-Ile

55 (IIB),

FR₇ ist der Polypeptidrest

Arg-Phe-Thr-Ile-Ser-Arg-Asp-Asn-Ala-Arg-Asn-Ile-Leu-Tyr-
 5 Leu-Gln-Val-Ser-Ser-Leu-Arg-Ser-Glu-Asp-Thr-Ala-Ile-Tyr-Tyr-Cys-
 Ala-Arg

(IIC),

10 und FR₈ ist der Polypeptidrest

15 Asp-Tyr-Trp-Gly-Gln-Gly-Thr-Ser-Leu-Thr-Val-Ser-Ser

(IID),

20 und worin die Aminosäure Cys in oxidiertem Zustand sein kann, S-S-Brücken bildend.

10. Verfahren nach Anspruch 7 zur Herstellung eines chimären monoklonalen Antikörpers und Derivaten davon, umfassend schwere Kette-variable Regionen der Formel II, worin FR₅, FR₆, FR₇ und FR₈ entsprechende Polypeptidreste der Formel IIA, IIB, IIC und IID sind, worin eine oder mehrere einzelne Aminosäuren durch andere Aminosäuren außerhalb der Regionen CDR1H, CDR2H und CDR3H ersetzt sind, und worin die Aminosäure Cys in oxidiertem Zustand sein kann, S-S-Brücken bildend.
- 25 11. Verfahren nach einem der Ansprüche 1 bis 10 zur Herstellung eines chimären monoklonalen Antikörpers und Derivaten davon, umfassend die konstanten Regionen κ oder λ der humanen leichten Kette.
- 30 12. Verfahren nach einem der Ansprüche 1 bis 11 zur Herstellung eines chimären monoklonalen Antikörpers und Derivaten davon, umfassend die konstanten Regionen γ 1, γ 2, γ 3 oder γ 4 der humanen schweren Kette.
- 35 13. Verfahren nach einem der Ansprüche 1 bis 12 zur Herstellung eines chimären monoklonalen Antikörpers und Derivaten davon, umfassend die konstanten Regionen κ der humanen leichten Kette und die konstanten Regionen γ 4 der humanen schweren Kette.
- 40 14. Verfahren nach einem der Ansprüche 1 bis 13 zur Herstellung eines chimären monoklonalen Antikörpers und Derivaten davon mit variablen Regionen der leichten Kette der Formel I, worin FR₁, FR₂, FR₃ und FR₄ entsprechende Polypeptidreste der Formel IA, IB, IC und ID sind, und worin die Aminosäure Cys in oxidiertem Zustand S-S-Brücken bilden kann, einer konstanten Region κ der humanen leichten Kette, einer variablen Region der schweren Kette der Formel II, worin FR₅, FR₆, FR₇ und FR₈ entsprechende Polypeptidreste der Formel IIA, IIB, IIC und IID sind, und worin die Aminosäure Cys in oxidiertem Zustand S-S-Brücken bilden kann, und einer konstanten Region γ 4 der humanen schweren Kette.
- 45 15. Verfahren nach einem der Ansprüche 1 bis 14 zur Herstellung eines Derivates eines chimären monoklonalen Antikörpers, dadurch gekennzeichnet, daß der monoklonale Antikörper enzymatisch oder chemisch in ein Fragment gespalten wird.
- 50 16. Verfahren nach einem der Ansprüche 1 bis 14 zur Herstellung eines Derivates eines chimären monoklonalen Antikörpers, dadurch gekennzeichnet, daß der monoklonale Antikörper konjugiert wird mit einem Enzym, einem fluoreszierenden Marker, einem Metallchelat, einer cytotostatischen oder cytotoxischen Substanz, Avidin oder Biotin.
- 55 17. Verfahren nach einem der Ansprüche 1 bis 14 zur Herstellung eines Derivates eines chimären monoklonalen Antikörpers, dadurch gekennzeichnet, daß der monoklonale Antikörper radioaktiv markiert

ist.

- 5
18. Verfahren zur Herstellung einer rekombinanten DNA, umfassend ein Insert, das für eine variable Region der leichten Kette der Maus und/oder eine variable Region der schweren Kette der Maus der nach einem Verfahren gemäß Anspruch 1 hergestellten chimären monoklonalen Antikörper kodiert, dadurch gekennzeichnet, daß das Verfahren das Kultivieren eines transformierten Wirtes umfaßt.
19. Verfahren nach Anspruch 18 zur Herstellung einer rekombinanten DNA, dadurch gekennzeichnet, daß das Verfahren die Stufen umfaßt
- 10
- a) Isolieren von Maus-DNAs aus einer geeigneten Hybridom-Zelllinie, Selektieren der gewünschten DNAs, die für die variablen Regionen von monoklonalen Antikörpern kodieren, die gegen Human-CEA gerichtet sind, unter Verwendung von DNA-Sonden,
 - b) Isolieren von Human-DNAs aus einer genomischen Bibliothek, Selektieren der gewünschten DNAs, die für die konstanten Regionen monoklonaler Antikörper kodieren, unter Verwendung von
 - 15 DNA-Sonden,
 - c) Konstruieren der chimären Maus/Human-Gene durch Einbringen der DNAs von Stufe a) und b) in entsprechende Hybridvektoren,
 - d) Transferieren der erhaltenen Hybridvektoren in einen Rezipienten-Wirt, und
 - 20 e) Selektieren und Kultivieren des transformierten Wirtes.
- 20
20. Verfahren nach Anspruch 18 oder 19 zur Herstellung einer rekombinanten DNA, umfassend ein Insert, das für eine variable Region der leichten Kette der Maus kodiert, die spezifisch ist für Human-CEA, das aus genomischer DNA der Zelllinie CE 25 herrührt, mit der Hinterlegungsnummer CNCM I-719.
- 25
21. Verfahren nach Anspruch 18, 19 oder 20 zur Herstellung einer rekombinanten DNA, umfassend ein Insert, das für das Polypeptid der Formel I kodiert, das gegebenenfalls Introns enthält.
22. Verfahren nach einem der Ansprüche 18 bis 21 zur Herstellung einer rekombinanten DNA, umfassend ein Insert, das für das Polypeptid der Formel I kodiert, worin FR₁, FR₂, FR₃ und FR₄ entsprechende
- 30 Polypeptide der Formel IA, IB, IC und ID sind, das gegebenenfalls Introns enthält.
23. Verfahren nach einem der Ansprüche 18 bis 22 zur Herstellung einer rekombinanten DNA, umfassend ein Insert der Formel

35

40

45

50

55

EP 0 323 806 B1

1 TCTAGACTGCTGTGGTCTTTTAAAGTAGCATGAAAAACATCTGCTAAAGAAGGAATTAGTT 60
5 1 GAACATGCTAGAAATACATCTGTGATACTCTCATCACTCTTGTGGAAAGATATGCAAG 120
61 1 AAGCACTATTTGGCTATTATTTGGAAAGTCTATAATGTATTTGATAICTCAACCTCTG 180
121 1 AAATCTTCTGTATGTTGGCAGATTGTAACCTTTACAAGGCTTTCATTCTTCTCTG 240
181 1 AGAAAAATGCTTTGTAGGCAATCCAGAATTTCTTATTTCTTGCTAATGAAATCTCCTCA 200
241 1 GTGTGATACACTTTAGTTTCATGTGTTGTTATGCTTCATGTAATGTTAAGAAAGTAAA 360
301 1 GATGCTCCAATCCATATTGTAAGAAACATTCCAAGCCATGGAATAAGGCATGGATTGAG 420
361 1 ATGCTCTTTATTTCAAACACTACTGAATATATCTTAGAGATTTCTTTAGACTGTGTTAAATA 480
421 1 TGTAAACCATTAAAGTAGGAGTCAAGTCTCCTTTAAATCTCAACAGCTTTCAGGTAACCA 540
481 1 ACAAAGGATAAAATATCTAATAAGTCACTAGGAGCATGCTCTTCTGACCAGGTCTTCT 600
541 1 TATAAGCAACATGAAGACAGTATGATTTGCATAAGTTTTTCTTTCTTCTAATGTCCTGC 660
601 1 CTCTTAGAGTATTATAAGAAGATCTTTCTAGGGATGTGTCATGGTCCACACAAAAATAGG 720
661

35
40
45
50
55

EP 0 323 806 B1

```

M V S T P Q F L V F L L F W I P
MetValSerThrProGlnPheLeuValPheLeuLeuPheTrpIlePro
5 721 -----+-----+-----+-----+-----+-----+-----+-----+-----+-----+ 780
GGTAATGACTGTTTGGGTGTGGCAAAAAGTGGAGATGTTATTTAAATACAAAATTTTCT
781 -----+-----+-----+-----+-----+-----+-----+-----+-----+-----+ 840
TGCTTTATTTGGAAGCCAATGTCACATGGGAATTGACTTTCAGTTTAAAGAAATTGATAC
10 841 -----+-----+-----+-----+-----+-----+-----+-----+-----+-----+ 900
AATAAAAAGTCATTTATTTTCTAAGTTGTTAGAAGTGACTTTCATATTCAGTGTATGA
901 -----+-----+-----+-----+-----+-----+-----+-----+-----+-----+ 960
A S R G D I L L T Q S
AlaSerArgGlyAspIleLeuLeuThrGlnSer
15 961 -----+-----+-----+-----+-----+-----+-----+-----+-----+-----+ 1020
TCGACTAATGTATCTTCCATTTTTCCAGCCTCCAGAGGTGACATCTTGCTGACTCAGTCT
P A I L S V S P G E R V T F S C R A S Q
20 ProAlaIleLeuSerValSerProGlyGluArgValThrPheSerCysArgAlaSerGln
CCAGCCATCCTGTCTGTGAGTCCAGGAGAAAGAGTCACTTCTCCTGCAGGGCCAGTCAG
1021 -----+-----+-----+-----+-----+-----+-----+-----+-----+-----+ 1080
S I G T S L H W Y Q Q R T N G S P R L L
SerIleGlyThrSerLeuHisTrpTyrGlnGlnArgThrAsnGlySerProArgLeuLeu
25 1081 -----+-----+-----+-----+-----+-----+-----+-----+-----+-----+ 1140
AGCATTGGCACAAGCTTACTGTTATCAGCAAAGAACAAATGGTTCTCCAAGGCTTCTC
M K Y A S E S I S G I P S R F S G S G S
MetLysTyrAlaSerGluSerIleSerGlyIleProSerArgPheSerGlySerGlySer
30 1141 -----+-----+-----+-----+-----+-----+-----+-----+-----+-----+ 1200
ATGAAGTATGCTTCTGAGTCTATCTCTGGGATCCCTTCCAGGTTTAGTGGCAGTGGATCA
G T D F T L T I N S V E S E D I A D Y Y
GlyThrAspPheThrLeuThrIleAsnSerValGluSerGluAspIleAlaAspTyrTyr
35 1201 -----+-----+-----+-----+-----+-----+-----+-----+-----+-----+ 1260
GGGACAGATTTTACTTCTTACCATCAATAGTGTGGAGTCTGAAGATATTGCAGATTATTAC
C Q Q S H G W P F T F G S G T K L E I K
CysGlnGlnSerHisGlyTrpProPheThrPheGlySerGlyThrLysLeuGluIleLys
40 1261 -----+-----+-----+-----+-----+-----+-----+-----+-----+-----+ 1320
TGTCAACAAAGTCATGGCTGGCCATTACGTTTCGGCTCGGGACAAAGTTGAAATAAAA
CGTAAGTGGACTTTTGTTCAATTACTTGTGACGTTTGGTTCTGTTGGGTAGCTTGTGT
1321 -----+-----+-----+-----+-----+-----+-----+-----+-----+-----+ 1380
GAATTTGTGATATTT
45 1381 -----+----- 1395

```

(III).

- 50 24. Verfahren nach Anspruch 21 zur Herstellung einer rekombinanten DNA, umfassend ein Insert der Formel III, worin ein oder mehrere Nukleotide durch andere Nukleotide ersetzt sind außerhalb der Nukleotidsequenzen der Formel III von Position 1069-1102, 1147-1167 und 1263-1291.
- 55 25. Verfahren nach Anspruch 18 zur Herstellung einer rekombinanten DNA, umfassend ein Insert, das für eine variable Region der schweren Kette der Maus kodiert, die spezifisch ist für Human-CEA, das aus der genomischen DNA der Zelllinie CE 25 herrührt, mit der Hinterlegungsnummer CNCM I-719.

26. Verfahren nach Anspruch 18 oder 25 zur Herstellung einer rekombinanten DNA, umfassend ein Insert, das für das Polypeptid der Formel II kodiert, das gegebenenfalls Introns enthält.
27. Verfahren nach Anspruch 18, 25 oder 26 zur Herstellung einer rekombinanten DNA, umfassend ein Insert, das für das Polypeptid der Formel II kodiert, worin FR₅, FR₆, FR₇ und FR₈ entsprechende Polypeptidreste der Formel IIA, IIB, IIC und IID sind, das gegebenenfalls Introns enthält.
28. Verfahren nach einem der Ansprüche 18, 25-27 zur Herstellung einer rekombinanten DNA, umfassend ein Insert der Formel

10

1 AAGCTTGTTCCTGTTACATGCAAGGAGGGAAACTAAACTGAGTATGGTGAATCCCTAACC 60

15 61 AAAGGGAAAAATGAAACTACAATATGTTTCAAATGCTGTAACCGAAATCTGGTTTTTTG 120

121 ATGCCTTATATCTGGTATCATCAGTGACTTCAGATTTAGTCCAACCCAGAGCATGGTAT 180

181 AGCAGGAAGACATGCAAATAAGTCTTCTCTCTGCCCATGAAAACACCTCGGCCCTGACCC 240

20 241 TGCAGCTCTGACAGAGGAGGCCAGTCCATGGATTGAGTTCCTCACATTGATGATGAGC 300

M N F G F S L I F L V L V
MetAsnPheGlyPheSerLeuIlePheLeuValLeuVal

25 301 ACTGAACACAGACACCTCACCATGAACTTCGGGTTACGCTTGATTTTCCTTGTCTTGT 360

L K G
LeuLysGly

30 361 TTAAGGTAATTTATTGAGAAGAGATGACATCTATTTTACGCACATGAGACAGAAAAAA 420

V Q
ValG1

35 421 TGTGGTTTGTGTTTGTAGTGACAGTTTCCAACCCAGTTATTCTCTGTTTGTAGGTGTC 480

40

45

50

55

```

      C E V K L V E S G G G L V K P G G S L K
nCysGluValLysLeuValGluSerGlyGlyGlyLeuValLysProGlyGlySerLeuLy
GTGTGAAGTGAAGCTGCTGGAGTCTGGGGAGGCTTAGTGAAGCCTGGAGGGTCCCTGAA
481 -----+-----+-----+-----+-----+-----+-----+ 540
5
      L S C A A S G F T F R T Y A M A W V R Q
sLeuSerCysAlaAlaSerGlyPheThrPheArgThrTyrAlaMetAlaTrpValArgGl
ACTCTCCTGTGCAGCCTCTGGGTTCACTTTCAGGACCTATGCCATGGCTTGGGTTCCGCA
541 -----+-----+-----+-----+-----+-----+-----+ 600
10
      T P E K R L E W V T S I S S G G T T Y Y
nThrProGluLysArgLeuGluTrpValThrSerIleSerSerGlyGlyThrThrTyrTy
GACTCCAGAGAAGAGGCTGGAGTGGGTCACATCCATTAGTAGTGGTGGTACCACCTACTA
601 -----+-----+-----+-----+-----+-----+-----+ 660
15
      P D S V K G R F T I S R D N A R N I L Y
rProAspSerValLysGlyArgPheThrIleSerArgAspAsnAlaArgAsnIleLeuTy
TCCAGACAGTGTGAAGGGCCGATTACCATCTCCAGAGATAATGCCAGGAACATCCTGTA
661 -----+-----+-----+-----+-----+-----+-----+ 720
20
      L Q V S S L R S E D T A I Y Y C A R G F
rLeuGlnValSerSerLeuArgSerGluAspThrAlaIleTyrTyrCysAlaArgGlyPh
CCTGCAAGTGAGCAGTCTGAGGTCTGAGGACACGGCCATTTATTACTGTGCAAGAGGTTT
721 -----+-----+-----+-----+-----+-----+-----+ 780
25
      Y D G Y L Y V V D Y W G Q G T S L I V S
eTyrAspGlyTyrLeuTyrValValAspTyrTrpGlyGlnGlyThrSerLeuThrValSe
CTATGATGGTTACCTCTATGTGTGGACTACTGGGTCAAGGAACCTCACTCACCGTCTC
781 -----+-----+-----+-----+-----+-----+-----+ 840
30
      S
rSer
CTCAGGTAAGAATGGCC
841 -----+----- 857

```

(IV).

29. Verfahren nach Anspruch 26 zur Herstellung einer rekombinanten DNA, umfassend ein Insert der Formel IV, worin ein oder mehrere Nukleotide durch andere Nukleotide ersetzt sind außerhalb der Nukleotidsequenzen der Formel IV von Position 575-595, 629-680 und 776-805.
30. Verfahren nach Anspruch 18 zur Herstellung einer rekombinanten DNA, umfassend ein Insert, das für eine variable Region der leichten Kette der Maus fusioniert mit einer Humanen-konstanten Region α oder λ kodiert.
31. Verfahren nach Anspruch 30 zur Herstellung einer rekombinanten DNA, umfassend ein Insert der Formel III, fusioniert an eine Humane-konstante Region α .
32. Verfahren nach Anspruch 18 zur Herstellung einer rekombinanten DNA, umfassend ein Insert, das für eine variable Region der schweren Kette der Maus fusioniert mit einer Humanen-konstanten Region γ 1, γ 2, γ 3 oder γ 4 kodiert.
33. Verfahren nach Anspruch 32 zur Herstellung einer rekombinanten DNA, umfassend ein Insert der Formel IV fusioniert mit einer Humanen-konstanten Region γ 4.
34. Verfahren nach Anspruch 18 zur Herstellung einer rekombinanten DNA, die ein Hybridvektor ist, umfassend ein Insert, kodierend für eine chimäre Maus/Human-leichte Kette, hergestellt durch ein

Verfahren gemäß Anspruch 31 und/oder eine chimäre Maus/Human-schwere Kette, hergestellt nach einem Verfahren gemäß Anspruch 33, ein vollständiges Replikon und eine oder mehrere dominante Markersequenzen, gegebenenfalls an Expressionssteuerungssequenzen gebunden.

- 5 35. Verfahren nach Anspruch 18 zur Herstellung einer rekombinanten DNA, die ein Hybridvektor ist, umfassend ein Insert, kodierend für eine chimäre Maus/Human-leichte Kette, hergestellt nach einem Verfahren gemäß Anspruch 32 und/oder eine chimäre Maus/Human-schwere Kette, hergestellt nach einem Verfahren gemäß Anspruch 34, ein vollständiges Replikon und eine oder mehrere dominante Markersequenzen, gegebenenfalls an Expressionssteuerungssequenzen gebunden.
- 10 36. Verfahren nach Anspruch 34 oder 35 zur Herstellung einer rekombinanten DNA, die ein für Säuger-Wirte geeigneter Hybridvektor ist.
- 15 37. Verfahren nach Anspruch 34, 35 oder 36 zur Herstellung einer rekombinanten DNA, die ein Hybridvektor ist, worin der Vektor aus dem Plasmid pSV abgeleitet ist.
38. Verfahren nach Anspruch 37 zur Herstellung einer rekombinanten DNA, die ein Hybridvektor ist, worin der Vektor aus dem Plasmid pSV2gpt oder aus dem Plasmid pSV2neo abgeleitet ist.
- 20 39. Wirtszelle, transformiert mit rekombinanten DNAs, hergestellt nach einem Verfahren gemäß einem der Ansprüche 30 bis 38.
40. Wirtszelle nach Anspruch 39, die eine Säugerzelle lymphoiden Ursprunges ist.
- 25 41. Wirtszelle nach Anspruch 39, die eine Zelle ist, abgeleitet aus der Ig nicht-sekretierenden Maus-Hybridoma-Zelllinie Sp2/O (ATCC CRL 1581).
42. Wirtszelle nach Anspruch 39 oder 41, die mit einem oder zwei Vektoren transformiert ist, die nach einem Verfahren gemäß einem der Ansprüche 35 bis 38 hergestellt sind.
- 30 43. Wirtszelle nach Anspruch 42, die eine Zelle der Zelllinie EFVIII/γ4Na75-75/C_xGa5-6 ist (CE 75-5-6 mit der Hinterlegungsnummer CNCM I-720).
44. Wirtszelle nach Anspruch 42, die eine Zelle der Zelllinie EFIX-pCEA-Ig-(γ4;C_x) ist (CE 4-8-13 mit der Hinterlegungsnummer CNCM I-818).
- 35 45. Wirtszelle nach Anspruch 39, dadurch gekennzeichnet, daß sie chimäre monoklonale Antikörper sekretiert, die nach einem Verfahren gemäß Anspruch 1 hergestellt sind.
- 40 46. Verfahren zur Herstellung einer Wirtszelle nach Anspruch 39 oder 45, dadurch gekennzeichnet, daß eine geeignete Zelle mit einem oder zwei Vektoren durch Elektroporation, Calciumbehandlung, Mikroinjektion oder Protoplastenfusion transformiert wird.
- 45 47. Verfahren zur Herstellung einer pharmazeutischen Zusammensetzung, enthaltend einen chimären monoklonalen Antikörper oder Derivate davon, hergestellt nach einem Verfahren gemäß Anspruch 1, dadurch gekennzeichnet, daß der monoklonale Antikörper mit einem pharmazeutischen Träger vermischt wird.

Revendications

50 **Revendications pour les Etats contractants suivants : AT, BE, CH, DE, FR, GB, IT, LI, LU, NL, SE**

- 55 1. Anticorps monoclonal chimérique constitué de régions variables d'origine murine et de régions constantes d'origine humaine, qui reconnaît des épitopes d'antigène carcinoembryonnaire humain (CEA) non-présents sur les antigènes à réaction croisée non-spécifiques NCA₅₅ et NCA₈₅, sur la glycoprotéine biliaire, ou sur les granulocytes, et leurs dérivés.
2. Anticorps monoclonal chimérique et ses dérivés selon la revendication 1 ayant une affinité d'au moins $2,1 \times 10^{10}$ litres/mole pour le CEA humain.

3. Anticorps monoclonal chimérique et ses dérivés selon la revendication 1 ou 2, comprenant des régions variables à chaîne légère de formule

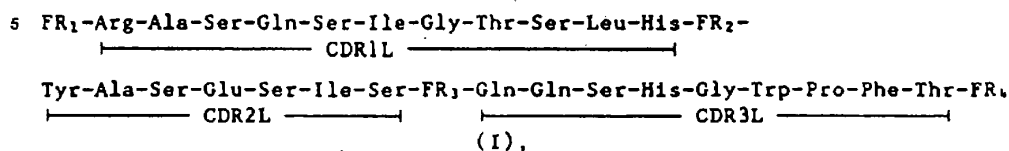

15 dans laquelle FR₁ est un résidu polypeptide comprenant 23-28 acides aminés naturels, FR₂ est un résidu polypeptide comprenant 14-16 acides aminés naturels, FR₃ est un résidu polypeptide comprenant 30-34 acides aminés naturels et FR₄ est un résidu polypeptide comprenant 9-11 acides aminés naturels, et où l'acide aminé cys peut être à l'état oxydé, formant des ponts S-S.

4. Anticorps monoclonal chimérique et ses dérivés selon l'une quelconque des revendications 1 à 3 comprenant des régions variables à chaîne légère de formule I, où les résidus polypeptides des régions d'ossature FR₁, FR₂, FR₃ et FR₄ sont ceux qui apparaissent de préférence dans les anticorps murins.
- 20
5. Anticorps monoclonal chimérique et ses dérivés selon l'une quelconque des revendications 1 à 4 comprenant des régions variables à chaîne légère de formule I, où FR₁ est un résidu polypeptide de formule
- 25



(IA),

35 dans laquelle A est un hydrogène, un acyle, ou le résidu Ala-Ser-Arg, Ser-Arg ou Arg, FR₂ est le résidu polypeptide

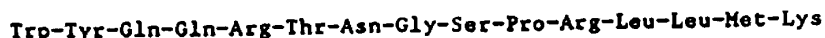

(IB),

FR₃ est le résidu polypeptide

45

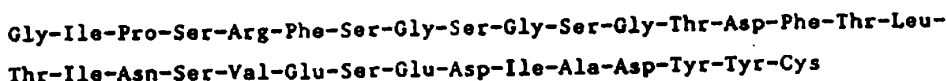

(IC),

et FR₄ est le résidu polypeptide

55

Phe-Gly-Ser-Gly-Gly-Thr-Lys-Leu-Glu-Ile-Lys

5

(ID),

et où l'acide aminé cys peut être à l'état oxydé, formant des ponts S-S.

- 10 6. Anticorps monoclonal chimérique et ses dérivés selon la revendication 3 comprenant des régions variables à chaîne légère de formule I, où FR₁, FR₂, FR₃ et FR₄ sont des résidus polypeptidiques de formules IA, IB, IC et ID, respectivement, où un ou plusieurs acides aminés isolés sont remplacés par d'autres acides aminés en dehors des régions CDR1L, CDR2L, et CDR3L, et où l'acide aminé cys peut être à l'état oxydé, formant des ponts S-S.

15

7. Anticorps monoclonal chimérique et ses dérivés selon l'une quelconque des revendications 1-6 comprenant des régions variables à chaîne lourde de formule

20 **FR₅-Thr-Tyr-Ala-Met-Ala-Trp-Val-FR₆-Ser-Ser-Gly-Gly-Thr-Thr-Tyr-Tyr-Pro-**
 |----- CDR1H -----| |-----|
Asp-Ser-Val-Lys-Gly-FR₇-Gly-Phe-Tyr-Asp-Gly-Tyr-Leu-Tyr-Val-Val-FR₈
 |----- CDR2H -----| |----- CDR3H -----|

25

(II),

dans laquelle FR₅ est un résidu polypeptide comprenant 32-36 acides aminés naturels, FR₆ est un résidu polypeptide comprenant 14-16 acides aminés naturels, FR₇ est un résidu polypeptide comprenant 32-34 acides aminés naturels et FR₈ est un résidu polypeptide comprenant 12-14 acides aminés naturels, et où l'acide aminé cys peut être à l'état oxydé formant des ponts S-S.

30

8. Anticorps monoclonal chimérique et ses dérivés selon l'une quelconque des revendications 1-7 comprenant des régions variables à chaîne lourde de formule II, où les résidus polypeptides des régions d'ossature FR₅, FR₆, FR₇ et FR₈ sont ceux que l'on trouve de préférence dans les anticorps murins.

35

9. Anticorps monoclonal chimérique et ses dérivés selon l'une quelconque des revendications 1-8 comprenant des régions variables à chaîne lourde de formule II, où FR₅ est un résidu polypeptidé de formule

40

B-Gly-Val-Gln-Cys-Glu-Val-Lys-Leu-Val-Glu-Ser-Gly-Gly-Gly-Leu-
Val-Lys-Pro-Gly-Gly-Ser-Leu-Lys-Leu-Ser-Cys-Ala-Ala-Ser-Gly-Phe-
Thr-Phe-Arg

45

(IIA),

dans laquelle B est un hydrogène ou un acyle,
 FR₆ est le résidu polypeptide

50

Arg-Gln-Thr-Pro-Glu-Lys-Arg-Leu-Glu-Trp-Val-Thr-Ser-Ile

55

(IIB),

FR₇ est le résidu polypeptide

**Arg-Phe-Thr-Ile-Ser-Arg-Asp-Asn-Ala-Arg-Asn-Ile-Leu-Tyr-
Leu-Gln-Val-Ser-Ser-Leu-Arg-Ser-Glu-Asp-Thr-Ala-Ile-Tyr-Tyr-Cys-
Ala-Arg**

(IIC),

et FR₈ est le résidu polypeptide

Asp-Tyr-Trp-Gly-Gln-Gly-Thr-Ser-Leu-Thr-Val-Ser-Ser

(IID),

et où l'acide aminé cys peut être à l'état oxydé formant des ponts S-S.

10. Anticorps monoclonal chimérique et ses dérivés selon la revendication 7, comprenant des régions variables à chaîne lourde de formule II, où FR₅, FR₆, FR₇ et FR₈ sont des résidus polypeptides de formule IIA, IIB, IIC et IID, respectivement, où un ou plusieurs acides aminés isolés sont remplacés par d'autres acides aminés en dehors des régions CDR1H, CDR2H et CDR3H, et où l'acide aminé cys peut être à l'état oxydé formant des ponts S-S.
11. Anticorps monoclonal chimérique et ses dérivés selon l'une quelconque des revendications 1-10 comprenant des régions constantes humaines à chaîne légère α ou λ .
12. Anticorps monoclonal chimérique et ses dérivés selon l'une quelconque des revendications 1-11 comprenant des régions constantes humaines à chaîne lourde γ 1, γ 2, γ 3, ou γ 4.
13. Anticorps monoclonal chimérique et ses dérivés selon l'une quelconque des revendications 1-12, comprenant des régions constantes à chaîne légère et des régions constantes humaines α à chaîne lourde γ 4.
14. Anticorps monoclonal chimérique et ses dérivés selon l'une quelconque des revendications 1-13 avec des régions variables à chaîne légère de formule I où FR₁, FR₂, FR₃ et FR₄ sont des résidus polypeptides de formule IA, IB, IC et ID, et où l'acide aminé cys peut être à l'état oxydé formant des ponts S-S, une région constante humaine à chaîne légère α , une région variable à chaîne lourde de formule II, où FR₅, FR₆, FR₇ et FR₈ sont des résidus polypeptides de formules IIA, IIB, IIC, et IID, respectivement, et où l'acide aminé cys peut être à l'état oxydé formant des ponts S-S et une région constante humaine à chaîne lourde γ 4.
15. Dérivé d'un anticorps monoclonal chimérique selon l'une quelconque des revendications 1-14 qui est un fragment.
16. Dérivé d'un anticorps monoclonal chimérique selon l'une quelconque des revendications 1-14 qui est un conjugué avec une enzyme, un marqueur fluorescent, un chélate métallique, une substance cytostatique ou cytotoxique, l'avidine ou la biotine.
17. Dérivé d'un anticorps monoclonal chimérique selon l'une quelconque des revendications 1-14 qui est radioactivement marqué.
18. Procédé de préparation d'anticorps monoclonaux chimériques et de leurs dérivés selon la revendication 1, caractérisé en ce qu'on multiplie *in vitro* des cellules de mammifère produisant de tels anticorps monoclonaux chimériques et, si on le désire, en ce qu'on transforme des anticorps monoclonaux chimériques résultants en leurs dérivés.

19. Procédé de préparation d'anticorps monoclonaux chimériques et de leurs dérivés selon la revendication 1, caractérisé en ce qu'on multiplie in vivo des cellules de mammifère produisant de tels anticorps monoclonaux chimériques et, si on le désire, on transforme les anticorps monoclonaux chimériques résultants en leurs dérivés.
- 5 20. ADN recombinant comprenant un insert codant pour une région variable murine à chaîne légère et/ou pour une région variable murine à chaîne lourde d'anticorps monoclonaux chimériques selon la revendication 1.
- 10 21. ADN recombinant selon la revendication 20 comprenant un insert codant pour une région variable murine à chaîne légère spécifique du CEA humain qui provient de l'ADN génomique de la lignée cellulaire CE 25, ayant le n° d'accès au dépôt CNCM I-719.
22. ADN recombinant selon la revendication 20 ou 21 comprenant un insert codant pour le polypeptide de formule I, contenant facultativement des introns.
- 15 23. ADN recombinant selon l'une quelconque des revendications 20-22 comprenant un insert codant pour les polypeptides de formule I, où FR₁, FR₂, FR₃ et FR₄ sont des polypeptides de formule IA, IB, IC et ID, respectivement, contenant facultativement des introns.
- 20 24. ADN recombinant selon l'une quelconque des revendications 20-23 comprenant un insert de formule

```

25      1  TCTAGACTGCTGTGGTCTTTAAGTAGCATGAAAAACATCTGCTAAAGAAGGAATTAGTT      60
          +-----+-----+-----+-----+-----+-----+-----+-----+
          61  TGAACATGCTAGAAATACATCTGTGATACTCTCATCACTCTTGTGGAAAGATATGCAAG      120
          +-----+-----+-----+-----+-----+-----+-----+-----+
          121 AAGCACTATTTGGCTATTATTGGAAAGTGCTATAATGATATTTGATATCTCAACCTCTG      180
          +-----+-----+-----+-----+-----+-----+-----+-----+
          181 AAATTCTTCTGTATGTTGGCAGATTGTAACCTTTACAAGGCTTTCATTCTTCTCTCTGG      240
          +-----+-----+-----+-----+-----+-----+-----+-----+
          241 AGAAAAATGCTTTGTAGGCAATCCAGAATTTCTTATTTCTTGCTAATGAAATCTCCTCA      200
          +-----+-----+-----+-----+-----+-----+-----+-----+
          301 GTGTGATATCACITTAGTTTCATGTGTTGTTATGCTTCATGTAATGTTAAGAAAGTTAAA      360
          +-----+-----+-----+-----+-----+-----+-----+-----+
          40  361  GATGCTCCAATCCATATTGTAAGAAACATTCCAAGCCATGGAATAAGGCATGGATTTGAG      420
          +-----+-----+-----+-----+-----+-----+-----+-----+
          421 ATGCTCTTTATTTCAAACACTACTGAATATATCTTAGAGATTTCTTTAGACTGTGTTAAATA      480
          +-----+-----+-----+-----+-----+-----+-----+-----+
          481 TGTAACCATTTAAGTAGGAGTCAAGTCTCCTTTAAATCTCAACAGCTCTTCAGGTAACCA      540
          +-----+-----+-----+-----+-----+-----+-----+-----+
          541 ACAAAAAGGATAAATATTCTAATAAGTCACTAGGAGCATGCCTTCTGACCAGGTCTTTCT      600
          +-----+-----+-----+-----+-----+-----+-----+-----+
          50  601  TATAAGCAACATGAAGACAGTATGATTTGCATAAGTTTTTCTTTCTTCTAATGTCCCTGC      660
          +-----+-----+-----+-----+-----+-----+-----+-----+
          661 CTCTTAGAGTATTATAAGAAGATCTTTCTAGGGATGTGTTCATGGTCCACAAAAATAGG      720
          +-----+-----+-----+-----+-----+-----+-----+-----+
          55      N V S T P Q F L V F L L F W I P
              MetValSerThrProGlnPheLeuValPheLeuLeuPheTrpIlePro
          721  GAAAGTGTGAAGATGGTATCCACACCTCAGTTCCCTTGATTTTTGCTTTTCTGGATTCCA      780
          +-----+-----+-----+-----+-----+-----+-----+-----+
  
```

781 GGTAATGACTGTTGGGTGTGGCAAAAAGTGGAGATGTTATTATAAATACAAAATTTTCT 840
 841 TGCTTTATTTGGAAGCCAATGTCACATGGGAATTGACTTTCAGTTTAAAGAAATTGATAC 900
 5 901 AATAAAGTCATTTATTTTCTAAGTTGTTTAGAAGTGACTTTCATATTTCAGTGTTATGA 960
 10 A S R G D I L L T Q S
 AlaSerArgGlyAspIleLeuLeuThrGlnSer
 961 TCGACTAATGTATCTTCCATTTTCCAGCCTCCAGAGGTGACATCTTGCTGACTCAGTCT 1020
 P A I L S V S P G E R V T F S C R A S Q
 ProAlaIleLeuSerValSerProGlyGluArgValThrPheSerCysArgAlaSerGln
 15 1021 CCAGCCATCCTGCTGTGTGAGTCCAGGAGAAAGAGTCACTTCTCCTGCAGGGCCAGTCAG 1080
 S I G T S L H W Y Q Q R T N G S P R L L
 SerIleGlyThrSerLeuHisTrpTyrGlnGlnArgThrAsnGlySerProArgLeuLeu
 20 1081 AGCATTGGCACAAGCTTACACTGGTATCAGCAAAGAACAATGGTTCCTCAAGGCTTCTC 1140
 M K Y A S E S I S G I P S R F S G S G S
 MetLysTyrAlaSerGluSerIleSerGlyIleProSerArgPheSerGlySerGlySer
 25 1141 ATGAAGTATGCTTCTGAGTCTATCTCTGGGATCCCTTCCAGGTTTAGTGGCAGTGGATCA 1200
 G T D F T L T I N S V E S E D I A D Y Y
 GlyThrAspPheThrLeuThrIleAsnSerValGluSerGluAspIleAlaAspTyrTyr
 1201 GGGACAGATTTTACTCTTACCATCAATAGTGTGGAGTCTGAAGATATTGCAGATTATTAC 1260
 30 C Q Q S H G W P F T F G S G T K L E I K
 CysGlnGlnSerHisGlyTrpProPheThrPheGlySerGlyThrLysLeuGluIleLys
 1261 TGTCAACAAAGTCATGGCTGGCCATTCACGTTCCGGCTCGGGGACAAAGTTGGAATAAAA 1320
 35 CGTAAGTGGACTTTTGTTCATTTACTTGTGACGTTTTGCTTCTGTTTGGGTAGCTTGTCT 1380
 1381 GAATTTGTGATATT 1395
 (III).

25. ADN recombinant selon la revendication 22 comprenant un insert de formule III où un ou plusieurs nucléotides isolés sont remplacés par d'autres nucléotides en dehors des séquences nucléotidiques de formule III à partir des positions 1069-1102, 1147-1167, et 1263-1291, respectivement.
26. ADN recombinant selon la revendication 20 comprenant un insert codant pour une région variable murine à chaîne lourde spécifique du CEA humain qui provient de l'ADN génomique de la lignée cellulaire CE 25, ayant le N° d'accès au dépôt CNCM I-719.
27. ADN recombinant selon la revendication 20 ou 26 comprenant un insert codant pour le polypeptide de formule II, contenant facultativement des introns.
28. ADN recombinant selon la revendication 20, 26 ou 27, comprenant un insert codant pour le polypeptide de formule I, où FR₅, FR₆, FR₇ et FR₈ sont des résidus polypeptides de formule IIA, IIB, IIC et IID, respectivement, contenant facultativement des introns.
29. ADN recombinant selon l'une quelconque des revendications 20, 26-28, comprenant un insert de formule

EP 0 323 806 B1

1 AAGCTTGTTCGTTACATGCAAGGAGGGAACTAACTGAGTATGGTGAATCCCTAACC 60
 5 61 AAAGGGAAAAATGAACTACAATATGTTTCAAATGCTGTAAGTCAAATCTGGTTTTTGG 120
 121 ATGCCTTATATCTGGTATCATCAGTGAAGTTCAGATTTAGTCCAACCCAGAGCATGGTAT 180
 181 AGCAGGAAGACATGCAAATAAGTCTTCTCTCTGCCATGAAAACACCTCGGCCCTGACCC 240
 241 TGCAGCTCTGACAGAGGAGGCCAGTCCATGGATTGAGTTCCTCACATTGAGTATGAGC 300
 15 M N F G F S L I F L V L V
 MetAsnPheGlyPheSerLeuIlePheLeuValLeuVal
 301 ACTGAACACAGACACCTCACCATGAACTTCGGGTTGAGCTTGATTTTCCTTGTCTTGT 360
 L K G
 LeuLysGly
 20 TTAAAAGGTAATTTATTGAGAAGAGATGACATCTATTTTACGCACATGAGACAGAAAAA 420
 361 420
 V Q
 ValG1
 25 TGIGGTTTGTITTTGTTAGTGACAGTTTTCCAACCAGTTATTCTCTGTTGTAGGTGTCCA 480
 421 480
 C E V K L V E S G G G L V K P G G S L K
 nCysGluValLysLeuValGluSerGlyGlyGlyLeuValLysProGlyGlySerLeuLy
 30 481 GTGTGAAGTGAAGCTGGTGGAGTCTGGGGGAGGCTTAGTGAAGCCTGGAGGGTCCCTGAA 540
 481 540

35

40

45

50

55

```

      L S C A A S G F T F R T Y A M A W V R Q
sLeuSerCysAlaAlaSerGlyPheThrPheArgThrTyrAlaMetAlaTrpValArgGl
ACTCTCCTGTGCAGCCTCTGGGTTCACTTTCAGGACCTATGCCATGGCTTGGGTTCCGCCA
541 -----+-----+-----+-----+-----+-----+-----+-----+-----+-----+ 600
5
      T P E K R L E W V T S I S S G G T T Y Y
nThrProGluLysArgLeuGluTrpValThrSerIleSerSerGlyGlyThrThrTyrTy
GACTCCAGAGAAGAGGCTGGAGTGGGTCACATCCATTAGTAGTGGTGGTACCACCTACTA
601 -----+-----+-----+-----+-----+-----+-----+-----+-----+-----+ 660
10
      P D S V K G R F T I S R D N A R N I L Y
rProAspSerValLysGlyArgPheThrIleSerArgAspAsnAlaArgAsnIleLeuTy
TCCAGACAGTGTGAAGGGCCGATTCCACATCTCCAGAGATAATGCCAGGAACATCCTGTA
661 -----+-----+-----+-----+-----+-----+-----+-----+-----+-----+ 720
15
      L Q V S S L R S E D T A I Y Y C A R G F
rLeuGlnValSerSerLeuArgSerGluAspThrAlaIleTyrTyrCysAlaArgGlyPh
CCTGCAAGTGAGCAGTCTGAGCTCTGAGGACACGGCCATTATTACTGTGCAAGAGGTTT
721 -----+-----+-----+-----+-----+-----+-----+-----+-----+-----+ 780
20
      Y D G Y L Y V V D Y W G Q G T S L T V S
eTyrAspGlyTyrLeuTyrValValAspTyrTrpGlyGlnGlyThrSerLeuThrValSe
CTATGATGGTTACCTCTATGTTGTGACTACTGGGGTCAAGGAACCTCACTCACCGTCTC
781 -----+-----+-----+-----+-----+-----+-----+-----+-----+-----+ 840
25
      S
rSer
CTCAGGTAAGAATGGCC
841 -----+-----+-----+-----+-----+-----+-----+-----+-----+-----+ 857

```

(IV).

- 30
30. ADN recombinant selon la revendication 27 comprenant un insert de formule IV dans lequel un ou plusieurs nucléotides isolés sont remplacés par d'autres nucléotides en dehors des séquences nucléotidiques de formule IV provenant des positions 575-595, 629-680 et 776-805, respectivement.
- 35
31. ADN recombinant selon la revendication 20 comprenant un insert codant pour une région variable murine à chaîne légère fusionnée à une région constante humaine x ou λ .
32. ADN recombinant selon la revendication 31 comprenant un insert de formule III fusionné à une région constante humaine x .
- 40
33. ADN recombinant selon la revendication 20 comprenant un insert codant pour une région variable murine à chaîne lourde fusionnée à une région constante humaine γ_1 , γ_2 , γ_3 ou γ_4 .
- 45
34. ADN recombinant selon la revendication 33 comprenant un insert de formule IV fusionné à une région constante humaine γ_4 .
- 50
35. ADN recombinant selon la revendication 20 qui est un vecteur hybride comprenant un insert codant pour une chaîne légère murine/humaine chimérique selon la revendication 31 et/ou une chaîne lourde murine/humaine chimérique selon la revendication 33, un réplicon complet et une ou plusieurs séquences marqueuses dominantes, liées de manière opératoire à des séquences de commande d'expression.
- 55
36. ADN recombinant selon la revendication 20 qui est un vecteur hybride comprenant un insert codant pour une chaîne légère murine/humaine chimérique selon la revendication 32, et/ou une chaîne lourde murine/humaine chimérique selon la revendication 34, un réplicon complet et une ou plusieurs séquences marqueuses dominantes, liées de façon opératoire à des séquences de commande d'expression.

EP 0 323 806 B1

37. ADN recombinant qui est un vecteur hybride selon la revendication 35 ou 36 approprié à des hôtes mammifères.
- 5 38. ADN recombinant qui est un vecteur hybride selon la revendication 35, 36 ou 37, dans lequel le vecteur est dérivé du plasmide pSV.
39. ADN recombinant qui est un vecteur hybride selon la revendication 38, dans lequel le vecteur hybride est dérivé du plasmide pSV2gpt ou du plasmide pSV2neo.
- 10 40. Procédé de préparation d'ADN recombinant selon la revendication 20 dans lequel on cultive un hôte transformé.
41. Procédé selon la revendication 40 comprenant les étapes de
- 15 a) isolement d'ADN murins provenant d'une lignée cellulaire d'hybridome appropriée, sélection des ADN désirés codant pour les régions variables des anticorps monoclonaux dirigés contre le CEA humain en utilisant des sondes d'ADN,
- b) isolement des ADN humains à partir d'une bibliothèque génomique, sélection des ADN désirés codant pour les régions constantes des anticorps monoclonaux en utilisant des sondes d'ADN,
- 20 c) construction de gènes murins/humains chimériques par incorporation des ADN des étapes a) et b) dans des vecteurs hybrides appropriés,
- d) transfert des vecteurs hybrides obtenus chez un hôte récepteur, et
- e) sélection et culture de l'hôte transformé.
42. Cellule hôte qui est transformée avec les ADN recombinants selon l'une quelconque des revendications 31-39.
- 25 43. Cellule hôte selon la revendication 42 qui est une cellule de mammifère d'origine lymphoïde.
44. Cellule hôte selon la revendication 42 qui est une cellule dérivée de la lignée cellulaire d'hybridome de souris non-sécrétrice d'Ig Sp20 (ATCC CRL 1581).
- 30 45. Cellule hôte selon la revendication 42 ou 44 qui est transformée avec un ou deux vecteurs selon l'une quelconque des revendications 36-39.
- 35 46. Cellule hôte selon la revendication 45 qui est une cellule de la lignée cellulaire EFVIII/γ4Na75-75/CxGa5-6 (CE 75-5-6) ayant le numéro d'accès au dépôt CNCM I-720.
47. Cellule hôte selon la revendication 45 qui est une cellule de la lignée cellulaire EFIX-pCEA-Ig-(γ4;Cx) (CE 4-8-13), ayant le numéro d'accès au dépôt CNCM I-818.
- 40 48. Cellule hôte selon la revendication 42, caractérisée en ce qu'elle sécrète des anticorps monoclonaux chimériques selon la revendication 1.
49. Procédé de préparation d'une cellule hôte selon la revendication 42 ou 48, caractérisé en ce qu'on transforme une cellule appropriée avec un ou deux vecteurs par électroporation, traitement au calcium, microinjection ou fusion de protoplaste.
- 45 50. Anticorps monoclonaux chimériques et leurs dérivés selon la revendication 1 pour utilisation dans le traitement de l'homme et pour le diagnostic.
- 50 51. Utilisation d'anticorps monoclonaux chimériques et de leurs dérivés selon la revendication 1 pour le diagnostic in vitro du cancer.
52. Application d'anticorps monoclonaux chimériques et de leurs dérivés selon la revendication 1 pour la détermination qualitative ou quantitative in vitro du CEA humain.
- 55 53. Application selon la revendication 51 d'anticorps monoclonaux chimériques et de leurs dérivés dans un radioimmunosage ou un immunodosage enzymatique.

54. Nécessaires expérimentaux pour la détermination qualitative et quantitative de CEA humain contenant des anticorps monoclonaux chimériques selon la revendication 1 et/ou leurs dérivés et, facultativement, d'autres anticorps monoclonaux ou polyclonaux et/ou additifs.

5 55. Composition pharmaceutique contenant un anticorps monoclonal chimérique ou un de ses dérivés selon la revendication 1.

Revendications pour les Etats contractants suivants : ES, GR

10 1. Procédé de préparation d'un anticorps monoclonal chimérique constitué de régions variables d'origine murine et de régions constantes d'origine humaine, qui reconnaît des épitopes d'antigène carcinoembryonnaire humain (CEA), non-présent sur les antigènes à réaction croisée non-spécifiques NCA₅₅ et NCA₉₅, sur une glycoprotéine biliaire ou sur des granulocytes, et de ses dérivés, caractérisé en ce qu'on multiplie *in vivo* ou *in vitro* les cellules de mammifère produisant de tels anticorps monoclonaux chimériques et, si on le désire, en ce qu'on transforme l'anticorps monoclonal chimérique résultant en leurs dérivés.

20 2. Procédé selon la revendication 1 de préparation d'un anticorps monoclonal chimérique et de ses dérivés ayant une affinité d'au moins $2,1 \times 10^{10}$ litres/mole pour le CEA humain.

3. Procédé selon la revendication 1 ou 2 de préparation d'un anticorps monoclonal chimérique et ses dérivés comprenant des régions variables à chaîne légère de formule

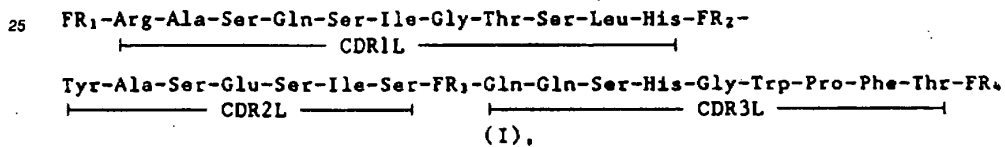

30 dans laquelle FR₁ est un résidu polypeptide comprenant 23-28 acides aminés naturels, FR₂ est un résidu polypeptide comprenant 14-16 acides aminés naturels, FR₃ est un résidu polypeptide comprenant 30-34 acides aminés naturels et FR₄ est un résidu polypeptide comprenant 9-11 acides aminés naturels et où l'acide aminé cys peut être à l'état oxydé formant des ponts S-S.

40 4. Procédé selon l'une quelconque des revendications 1-3 pour la préparation d'un anticorps monoclonal chimérique et ses dérivés comprenant des régions variables à chaîne légère de formule I, où les résidus polypeptides des régions d'ossature FR₁, FR₂, FR₃ et FR₄ sont celles que l'on trouve de préférence dans les anticorps murins.

45 5. Procédé selon l'une quelconque des revendications 1-4 pour la préparation d'un anticorps monoclonal chimérique et ses dérivés comprenant des régions variables à chaîne légère de formule

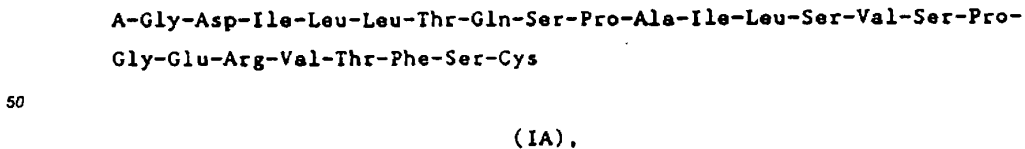

55 où A est un hydrogène, un acyle, ou le résidu Ala-Ser-Arg, Ser-Arg ou Arg, FR₂ est le résidu polypeptide

Trp-Tyr-Gln-Gln-Arg-Thr-Asn-Gly-Ser-Pro-Arg-Leu-Leu-Met-Lys

(IB),

5

FR₃ est le résidu polypeptide

10 Gly-Ile-Pro-Ser-Arg-Phe-Ser-Gly-Ser-Gly-Thr-Asp-Phe-Thr-Leu-
Thr-Ile-Asn-Ser-Val-Glu-Ser-Glu-Asp-Ile-Ala-Asp-Tyr-Tyr-Cys

(IC),

15

et FR₄ est le résidu polypeptide

20

Phe-Gly-Ser-Gly-Gly-Thr-Lys-Leu-Glu-Ile-Lys

(ID),

25

et où l'acide aminé cys peut être à l'état oxydé formant des ponts S-S.

6. Procédé selon la revendication 3 pour la préparation d'un anticorps monoclonal chimérique et ses dérivés comprenant des régions variables à chaîne légère de formule L, où FR₁, FR₂, FR₃ et FR₄ sont des résidus polypeptides de formules IA, IB, IC et ID, respectivement, où un ou plusieurs acides aminés isolés sont remplacés par d'autres acides aminés en dehors des régions CDR1L, CDR2L et CDR3L et où l'acide aminé cys peut être à l'état oxydé formant des ponts S-S.

7. Procédé selon l'une quelconque des revendications 1-6 pour la préparation d'un anticorps monoclonal chimérique ou de ses dérivés comprenant des régions variables à chaîne lourde de formule

FR₅-Thr-Tyr-Ala-Met-Ala-Trp-Val-FR₆-Ser-Ser-Gly-Gly-Thr-Thr-Tyr-Tyr-Pro-
 ─────────── CDR1H ─────────── ───
 40 Asp-Ser-Val-Lys-Gly-FR₇-Gly-Phe-Tyr-Asp-Gly-Tyr-Leu-Tyr-Val-Val-FR₈
 ─────────── CDR2H ─────────── ─────────── CDR3H ───────────

(II),

45 dans lequel FR₅ est un résidu polypeptide comprenant 32-36 acides aminés naturels, FR₆ est un résidu polypeptide comprenant 14-16 acides aminés naturels, FR₇ est un résidu polypeptide comprenant 32-34 acides aminés naturels et FR₈ est un résidu polypeptide comprenant 12-14 acides aminés naturels, et où l'acide aminé cys peut être à l'état oxydé formant des ponts S-S.

8. Procédé selon l'une quelconque des revendications 1-7 pour la préparation d'un anticorps monoclonal chimérique et ses dérivés comprenant des régions variables à chaîne lourde de formule II, où les résidus polypeptides des régions d'ossature FR₅, FR₆, FR₇ et FR₈ sont celles que l'on trouve de préférence dans les anticorps murins.

9. Procédé selon l'une quelconque des revendications 1-8 pour la préparation d'un anticorps monoclonal chimérique et ses dérivés comprenant des régions variables à chaîne lourde de formule II, où FR₅ est un résidu polypeptide de formule

**B-Gly-Val-Gln-Cys-Glu-Val-Lys-Leu-Val-Glu-Ser-Gly-Gly-Gly-Leu-
Val-Lys-Pro-Gly-Gly-Ser-Leu-Lys-Leu-Ser-Cys-Ala-Ala-Ser-Gly-Phe-
5 Thr-Phe-Arg**

(IIA),

où B est un hydrogène ou un acyle,
10 FR₆ est le résidu polypeptide

Arg-Gln-Thr-Pro-Glu-Lys-Arg-Leu-Glu-Trp-Val-Thr-Ser-Ile

(IIB),

FR₇ est le résidu polypeptide

**Arg-Phe-Thr-Ile-Ser-Arg-Asp-Asn-Ala-Arg-Asn-Ile-Leu-Tyr-
Leu-Gln-Val-Ser-Ser-Leu-Arg-Ser-Glu-Asp-Thr-Ala-Ile-Tyr-Tyr-Cys-
25 Ala-Arg**

(IIC),

et FR₈ est le résidu polypeptide

Asp-Tyr-Trp-Gly-Gln-Gly-Thr-Ser-Leu-Thr-Val-Ser-Ser

(IID),

et où l'acide aminé cys peut être à l'état oxydé formant des ponts S-S.

10. Procédé selon la revendication 7 pour la préparation d'un anticorps monoclonal chimérique et ses dérivés comprenant des régions variables à chaîne lourde de formule II dans laquelle FR₆, FR₆, FR₇ et FR₈ sont des résidus polypeptidiques de formules IIA, IIB, IIC et IID, respectivement, où un ou plusieurs acides aminés isolés sont remplacés par d'autres acides aminés en dehors des régions CDR1H, CDR2H et CDR3H et où l'acide aminé cys peut être à l'état oxydé formant des ponts S-S.
- 45 11. Procédé selon l'une quelconque des revendications 1-10 pour la préparation d'un anticorps monoclonal chimérique et ses dérivés comprenant des régions constantes humaines à chaîne légère κ ou λ .
12. Procédé selon l'une quelconque des revendications 1-11 pour la préparation d'un anticorps monoclonal chimérique et ses dérivés comprenant des régions constantes humaines à chaîne lourde γ 1, γ 2, γ 3 ou γ 4.
- 50 13. Procédé selon l'une quelconque des revendications 1-12 pour la préparation d'un anticorps monoclonal chimérique et ses dérivés comprenant des régions constantes humaines à chaîne légère et des régions constantes humaines à chaîne lourde γ 4;
- 55 14. Procédé selon l'une quelconque des revendications 1-13 pour la préparation d'un anticorps monoclonal chimérique et ses dérivés avec des régions variables à chaîne légère de formule I dans laquelle FR₁, FR₂, FR₃ et FR₄ sont des résidus polypeptidiques de formules IA, IB, IC et ID, respectivement et où

l'acide aminé cys peut être à l'état oxydé formant des ponts S-S, une région constante humaine à chaîne légère α , une région variable à chaîne lourde de formule II dans laquelle FR₅, FR₆, FR₇ et FR₈ sont des résidus polypeptides de formule IIA, IIB, IIC et IID, respectivement et où l'acide aminé cys peut être à l'état oxydé formant des ponts S-S et une région constante humaine à chaîne lourde γ 4.

- 5
15. Procédé selon l'une quelconque des revendications 1-14 pour la préparation d'un dérivé d'un anticorps monoclonal chimérique, caractérisé en ce que l'anticorps monoclonal est clivé de façon enzymatique ou chimique en un fragment.
- 10 16. Procédé selon l'une quelconque des revendications 1-14 pour la préparation d'un dérivé d'un anticorps monoclonal chimérique, caractérisé en ce que l'anticorps monoclonal est conjugué avec une enzyme, un marqueur de fluorescence, un chélate métallique, une substance cytotatique ou cytotoxique, l'avidine ou la biotine.
- 15 17. Procédé selon l'une quelconque des revendications 1-14 pour la préparation d'un dérivé d'un anticorps monoclonal chimérique, caractérisé en ce que l'anticorps monoclonal est radioactivement marqué.
18. Procédé de préparation d'un ADN recombinant comprenant un insert codant pour une région variable murine à chaîne légère et/ou pour une région variable murine à chaîne lourde d'anticorps monoclonaux chimériques préparés selon la revendication 1, caractérisé en ce que ledit procédé comprend la culture d'un hôte transformé.
- 20 19. Procédé selon la revendication 18 de préparation d'un ADN recombinant, caractérisé en ce que ledit procédé comprend les étapes de
- 25 a) isolement d'ADN murins provenant d'une lignée cellulaire d'hybridome appropriée, sélection des ADN désirés codant pour les régions variables des anticorps monoclonaux dirigés contre le CEA humain en utilisant des sondes d'ADN,
- b) isolement des ADN humains à partir d'une bibliothèque génomique, sélection des ADN désirés codant pour les régions constantes des anticorps monoclonaux en utilisant des sondes d'ADN,
- 30 c) construction de gènes murins/humains chimériques par incorporation des ADN des étapes a) et b) dans des vecteurs hybrides appropriés,
- d) transfert des vecteurs hybrides obtenus chez un hôte récepteur, et
- e) sélection et culture de l'hôte transformé.
- 35 20. Procédé selon la revendication 18 ou 19 pour la préparation d'un ADN recombinant comprenant un insert codant pour une région variable murine à chaîne légère spécifique du CEA humain qui provient de l'ADN génomique de la lignée cellulaire CE 25, ayant le numéro d'accès au dépôt CNCM I-719.
- 40 21. Procédé selon la revendication 18, 19 ou 20, de préparation d'un ADN recombinant comprenant un insert codant pour le polypeptide de formule I, contenant facultativement des introns.
22. Procédé selon l'une quelconque des revendications 18-21, de préparation d'un ADN recombinant comprenant un insert codant pour le polypeptide de formule I dans lequel FR₁, FR₂, FR₃ et FR₄ sont des polypeptides de formule IA, IB, IC et ID, respectivement, contenant facultativement des introns.
- 45 23. Procédé selon l'une quelconque des revendications 18-22 de préparation d'un ADN recombinant comprenant un insert de formule
- 50
- 55

1 TCTAGACTGCTGTGGTCITTTAAGTAGCATGAAAAACATCTGCTAAAGAAGGAATTAGTT 60
 5 61 TGAACATGCTAGAAATACATCTGTGATACTCTCATCACTCTTGTGGAAAGATATGCAAG 120
 121 AAGCACTATTTGGCTATTATTGGAAAGTGCTATAATGTATTTTGATATCTCAACCTCTG 180
 10 181 AAATTCTTCTGTATGTTGGCAGATTGTAACCTTTACAAGGCTTTCATTCTCTTCTCTGG 240
 241 AGAAAAATGCTTTGTAGGCAATCCAGAATTTCTATTTCTTGCTAATGAAATCTCCTCA 200
 15 301 GTGTGATATCACITTAGTTTCATGTGTTGTTATGCTTCATGTAATGTTAAGAAAGTAAA 360
 361 GATGCTCCAATCCATATTGTAAGAAACATTCCAAGCCATGGAATAAGGCATGGATTGAG 420
 20 421 ATGCTCTTTATTTCAAACTACTGAATATATCTTAGAGATTTCTTTAGACTGTGTTAAATA 480
 481 TGTAACCATTTAAGTAGGAGTCAAGTCTCCTTTAAATCTCAACAGCTTTCAGGTAACCA 540
 25 541 ACAAAGGATAAATATTCTAATAAGTCACTAGGAGCATGCTCTTCTGACCAGGTCTTTCT 600
 601 TATAAGCAACATGAAGACAGTATGATTTGCATAAGTTTTTCTTCTTAATGTCCCTGC 660
 30 661 CTCTTAGAGTATTATAAGAAGATCTTTCTAGGGATGTGTCATGGTCCACAAAAATAGG 720
 M V S T P Q F L V F L L F W I P
 MetValSerThrProGlnPheLeuValPheLeuLeuPheTrpIlePro
 35 721 GAAAGTGTGAAGATGGTATCCACACCTCAGTTCCTTGTATTTTGGCTTTTCTGGATTCCA 780
 781 GGTAATGACTGTTTGGGTGTGGCAAAAAAGTGGAGATGTTATTTAAATACAAAATTTTCT 840
 40 841 TGCTTTATTTGGAAGCCAATGTCACATGGGAATTGACTTTCAGTTTAAAGAAATTGATAC 900
 901 AATAAAAGTCATTTATTTTCTAAGTTGTTAGAAGTGACTTTCATATTCAGTGTATGA 960
 A S R G D I L L T Q S
 AlaSerArgGlyAspIleLeuLeuThrGlnSer
 45 961 TCGACTAATGTATCTTCCATTTTTCCAGCCTCCAGAGGTGACATCTTGCTGACTCAGTCT 1020
 P A I L S V S P G E R V T F S C R A S Q
 ProAlaIleLeuSerValSerProGlyGluArgValThrPheSerCysArgAlaSerGln
 50 1021 CCAGCCATCCTGCTGTGAGTCCAGGAGAAAGAGTCACTTCTCCTGCAGGGCCAGTCAG 1080

55

S I G T S L H W Y Q Q R T N G S P R L L
 SerIleGlyThrSerLeuHisTrpTyrGlnGlnArgThrAsnGlySerProArgLeuLeu
 AGCATTGGCACAAGCTTACACTGGTATCAGCAAAGAACAATGGTTCTCCAAGGCTTCTC
 1081 -----+-----+-----+-----+-----+-----+-----+-----+-----+-----+ 1140
 5
 M K Y A S E S I S G I P S R F S G S G S
 MetLysTyrAlaSerGluSerIleSerGlyIleProSerArgPheSerGlySerGlySer
 ATGAAGTATGCTTCTGAGTCTATCTCTGGGATCCCTTCCAGGTTAGTGGCAGTGGATCA
 1141 -----+-----+-----+-----+-----+-----+-----+-----+-----+-----+ 1200
 10
 G T D F T L T I N S V E S E D I A D Y Y
 GlyThrAspPheThrLeuThrIleAsnSerValGluSerGluAspIleAlaAspTyrTyr
 GGGACAGATTTTACTCTTACCATCAATAGTGTGGAGTCTGAAGATATTGCAGATTATTAC
 1201 -----+-----+-----+-----+-----+-----+-----+-----+-----+-----+ 1260
 15
 C Q Q S H G W P F T F G S G T K L E I K
 CysGlnGlnSerHisGlyTrpProPheThrPheGlySerGlyThrLysLeuGluIleLys
 TGTCAACAAAGTCATGGCTGGCCATTACGTTTCGGCTCGGGGACAAAGTTGAAATAAAA
 1261 -----+-----+-----+-----+-----+-----+-----+-----+-----+-----+ 1320
 20
 CGTAAGTGGACTTTTGTTCATTACTTGTGACGTTTGGTTCTGTTTGGGTAGCTTGTGT
 1321 -----+-----+-----+-----+-----+-----+-----+-----+-----+-----+ 1380
 GAATTTGTGATATT
 1381 -----+-----+-----+-----+-----+-----+-----+-----+-----+-----+ 1395
 (III).

- 25
24. Procédé selon la revendication 21 de préparation d'un ADN recombinant comprenant un insert de formule III dans lequel un ou plusieurs nucléotides isolés sont remplacés par d'autres nucléotides en dehors des séquences de nucléotides de formule III à partir des positions 1069-1102, 1147-1167 et 1263-1291, respectivement.
- 30
25. Procédé selon la revendication 18 de préparation d'un ADN recombinant comprenant un insert codant pour une région variable murine à chaîne lourde spécifique du CEA humain qui provient de l'ADN génomique de la lignée cellulaire CE 25, ayant le numéro d'accès au dépôt CNCM I-719.
- 35
26. Procédé selon la revendication 18 ou 25, de préparation d'un ADN recombinant comprenant un insert codant pour le polypeptide de formule II, contenant facultativement des introns.
- 40
27. Procédé selon la revendication 18, 25 ou 26 de préparation d'un ADN recombinant comprenant un insert codant pour le polypeptide de formule II dans laquelle FR₅, FR₆, FR₇ et FR₈ sont des résidus polypeptidiques de formule IIA, IIB, IIC et IID, respectivement, contenant facultativement des introns.
- 45
28. Procédé selon l'une quelconque des revendications 18,25-27 de préparation d'un ADN recombinant comprenant un insert de formule
- 50
- 55

1 AAGCTTGTTCATGCAAGGAGGAACTAACTGAGTATGGTGAATCCCTAACC 60
 5 61 AAAGGGAAAAAATGAAACTACAATATGTTTCAAATGCTGTAAGTAAAATCTGGTTTTTTG 120
 121 ATGCCTTATATCTGGTATCATCAGTGACTTCAGATTTAGTCCAACCCAGAGCATGGTAT 180
 10 181 AGCAGGAAGACATGCAAATAAGTCTTCTCTGCCCATGAAACACCTCGGCCCTGACCC 240
 241 TGCAGCTCTGACAGAGGAGGCCAGTCCATGGATTTGAGTTCCTCACATTGAGTATGAGG 300
 15 M N F G F S L I F L V L V
 MetAsnPheGlyPheSerLeuIlePheLeuValLeuVal
 301 ACTGAACACAGACACCTCACCATGAACTTCGGGTTTCAGCTTGATTTTCCTTGTCTTGT 360
 20 L K G
 LeuLysGly
 361 TTAAAAGGTAATTTATTGAGAAGAGATGACATCTATTTTACGCACATGAGACAGAAAAA 420
 V Q
 ValG1
 25 TGTGTTTTGTTTTGTTAGTGACAGTTTTCCAACCAGTTATTCTCTGTTTGTAGGTGTCCA 480
 30 C E V K L V E S G G G L V K P G G S L K
 nCysGluValLysLeuValGluSerGlyGlyGlyLeuValLysProGlyGlySerLeuLy
 481 GTGTGAAGTGAAGCTGGTGGAGTCTGGGGAGGCTTAGTGAAGCCTGGAGGGTCCCTGAA 540

35

40

45

50

55

```

      L S C A A S G F T F R T Y A M A W V R Q
      sLeuSerCysAlaAlaSerGlyPheThrPheArgThrTyrAlaMetAlaTrpValArgGl
      ACTCTCCTGIGCAGCCTCTGGGTTCACTTTCAGGACCTATGCCATGGCTTGGGTTCCGCA
541 -----+-----+-----+-----+-----+-----+-----+-----+-----+-----+ 600
5      T P E K R L E W V T S I S S G G T T Y Y
      nThrProGluLysArgLeuGluTrpValThrSerIleSerSerGlyGlyThrThrTyrTy
      GACTCCAGAGAAGAGGCTGGAGTGGGTCACATCCATTAGTAGTGGTGGTACCACCTACTA
601 -----+-----+-----+-----+-----+-----+-----+-----+-----+-----+ 660
10     P D S V K G R F T I S R D N A R N I L Y
      rProAspSerValLysGlyArgPheThrIleSerArgAspAsnAlaArgAsnIleLeuTy
      TCCAGACAGTGTGAAGGCCGATTCCACCATCTCCAGAGATAATGCCAGGAACATCCTGTA
661 -----+-----+-----+-----+-----+-----+-----+-----+-----+-----+ 720
15     L Q V S S L R S E D T A I Y Y C A R G F
      rLeuGlnValSerSerLeuArgSerGluAspThrAlaIleTyrTyrCysAlaArgGlyPh
      CCTGCAAGTGAGCAGCTCTGAGGTTCTCAGGACACGGCCATTTATTACTGTGCAAGAGGTTT
721 -----+-----+-----+-----+-----+-----+-----+-----+-----+-----+ 780
20     Y D G Y L Y V V D Y W G Q G T S L T V S
      eTyrAspGlyTyrLeuTyrValValAspTyrTrpGlyGlnGlyThrSerLeuThrValSe
      CTATGATGGTTACCTCTATGTTGTGGACTACTGGGGTCAAGGAACCTCACTCACCGTCTC
781 -----+-----+-----+-----+-----+-----+-----+-----+-----+-----+ 840

      S
      rSer
      CTCAGGTAAGAATGGCC
841 -----+-----+-----+-----+-----+-----+-----+-----+-----+-----+ 857

```

30 (IV).

- 35 29. Procédé selon la revendication 26 de préparation d'un ADN recombinant comprenant un insert de formule IV dans lequel un ou plusieurs nucléotides isolés sont remplacés par d'autres nucléotides en dehors des séquences de nucléotides de formule IV à partir des positions 575-595, 629-680 et 776-805, respectivement.
- 40 30. Procédé selon la revendication 18 de préparation d'un ADN recombinant comprenant un insert codant pour une région variable murine à chaîne légère fusionnée à une région constante humaine α ou λ .
- 31. Procédé selon la revendication 30 de préparation d'un ADN recombinant comprenant un insert de formule III fusionné à une région constante humaine α .
- 45 32. Procédé selon la revendication 18 de préparation d'un ADN recombinant comprenant un insert codant pour une région variable murine à chaîne lourde fusionnée à une région constante humaine γ 1, γ 2, γ 3, ou γ 4.
- 50 33. Procédé selon la revendication 32 de préparation d'un ADN recombinant comprenant un insert de formule IV fusionné à une région constante humaine γ 4.
- 55 34. Procédé selon la revendication 18 de préparation d'un ADN recombinant qui est un vecteur hybride comprenant un insert codant pour une chaîne légère murine/humaine chimérique préparé par un procédé selon la revendication 31, et/ou une chaîne lourde murine/humaine chimérique préparée par un procédé selon la revendication 33, un réplicon complet et une ou plusieurs séquences marqueuses dominantes, liées de façon opératoire à des séquences de commande d'expression.

- 5 35. Procédé selon la revendication 18 de préparation d'un ADN recombinant qui est un vecteur hybride comprenant un insert codant pour une chaîne légère murine/humaine chimérique préparée par un procédé selon la revendication 32 et/ou une chaîne lourde murine/humaine chimérique préparée par un procédé selon la revendication 34, un réplicon complet et une ou plusieurs séquences marqueuses dominantes, liées de façon opératoire à des séquences de commande d'expression.
36. Procédé selon la revendication 34 ou 35 de préparation d'un ADN recombinant qui est un vecteur hybride approprié à des hôtes mammifères.
- 10 37. Procédé selon la revendication 34, 35 ou 36 de préparation d'un ADN recombinant qui est un vecteur hybride dans lequel le vecteur est dérivé du plasmide pSV.
38. Procédé selon la revendication 37 pour la préparation d'un ADN recombinant qui est un vecteur hybride dans lequel le vecteur est dérivé du plasmide pSV2gpt ou du plasmide pSV2neo.
- 15 39. Cellule hôte qui est transformée avec les ADN recombinants préparés par un procédé selon l'une quelconque des revendications 30-38.
40. Cellule hôte selon la revendication 39, qui est une cellule de mammière d'origine lymphoïde.
- 20 41. Cellule hôte selon la revendication 39, qui est une cellule dérivée de la lignée cellulaire d'hybridome de souris non-sécrétante d'Ig Sp2/0 (ATCC CRL 1581)
42. Cellule hôte selon la revendication 39 ou 41 qui est transformée avec un ou deux vecteurs préparés par l'un des procédés selon les revendications 35-38.
- 25 43. Cellule hôte selon la revendication 42 qui est une cellule de la lignée cellulaire EFVIII/γ4Na75-75/C_xGa5-6 (CE 75-5-6), ayant le numéro d'accès au dépôt CNCM I-719.
- 30 44. Cellule hôte selon la revendication 42 qui est une cellule de la lignée cellulaire EFIX-pCEA-Ig-(γ4;C_x) (CE 4-8-13), ayant le numéro d'accès au dépôt CNCM I-818.
45. Cellule hôte selon la revendication 39, caractérisée en ce qu'elle sécrète des anticorps monoclonaux chimériques préparés par un procédé selon la revendication 1.
- 35 46. Procédé de préparation d'une cellule hôte selon la revendication 39 ou 45, caractérisé en ce qu'on transforme une cellule appropriée avec un ou deux vecteurs par électroporation, traitement au calcium, microinjection ou fusion de protoplaste.
- 40 47. Procédé de préparation d'une composition pharmaceutique contenant un anticorps monoclonal chimérique et ses dérivés préparé par un procédé selon la revendication 1, caractérisé en ce qu'on mélange l'anticorps monoclonal avec un support pharmaceutique.

45

50

55

FIGURE 1A

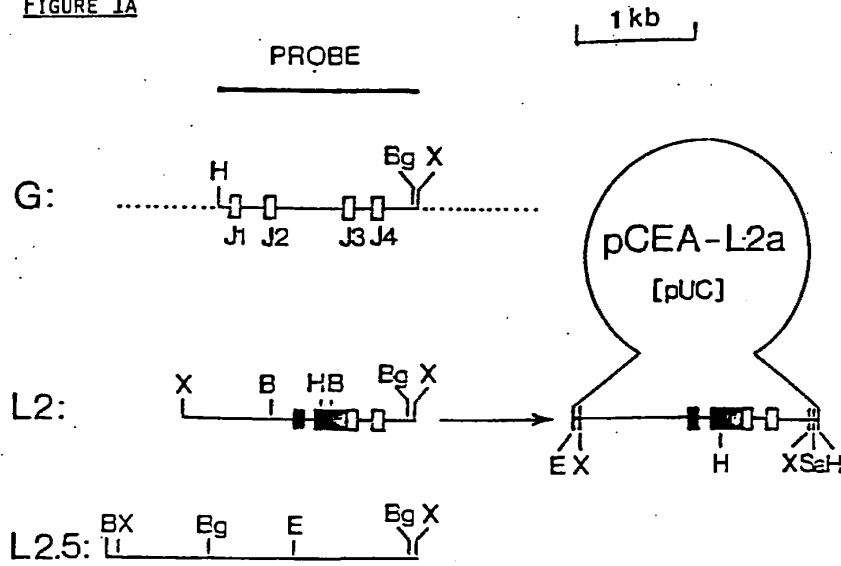

FIGURE 1B

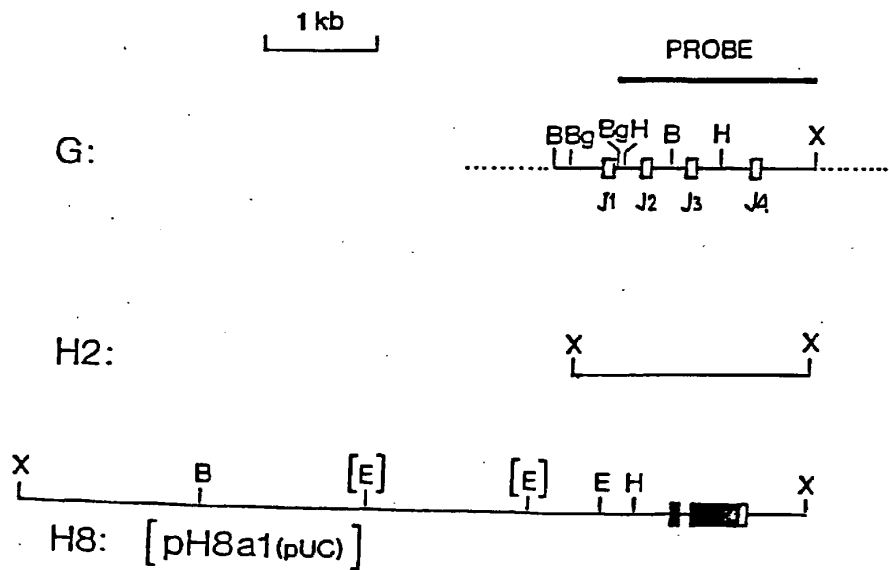

FIGURE 2

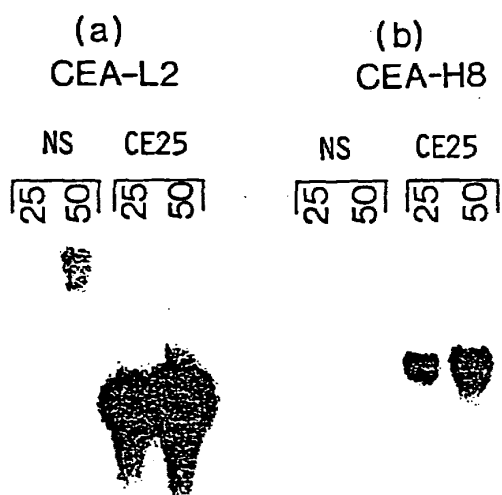

FIGURE 3

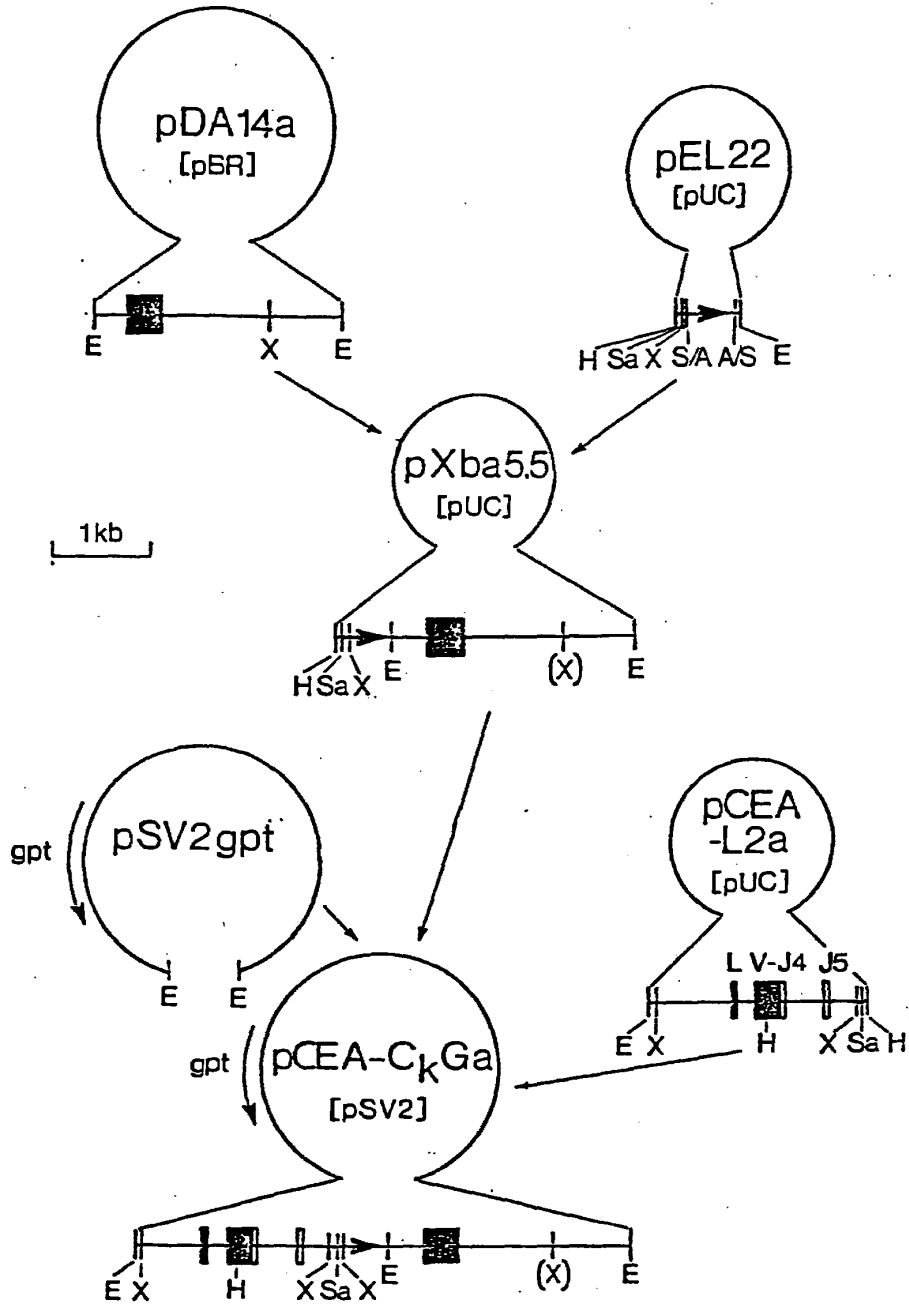

FIGURE 4

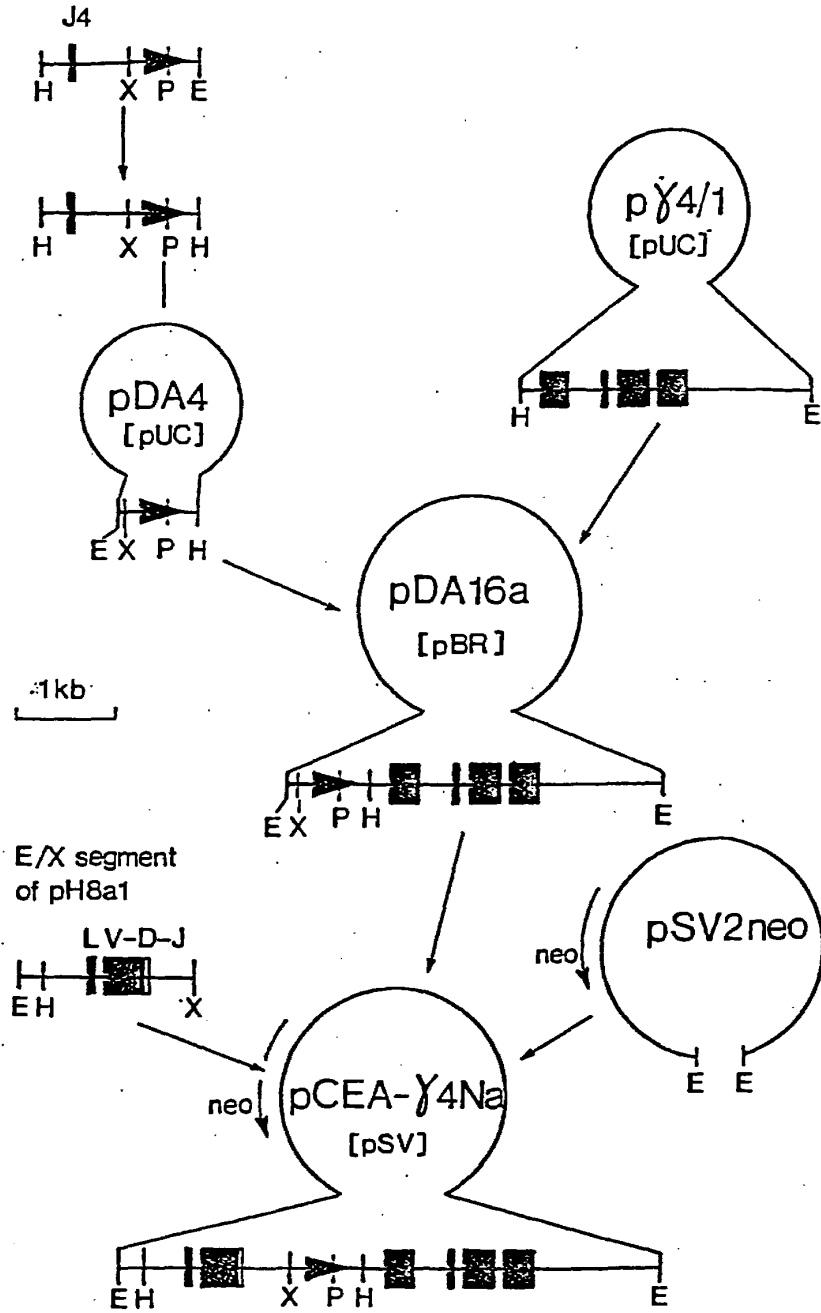

Figure 5

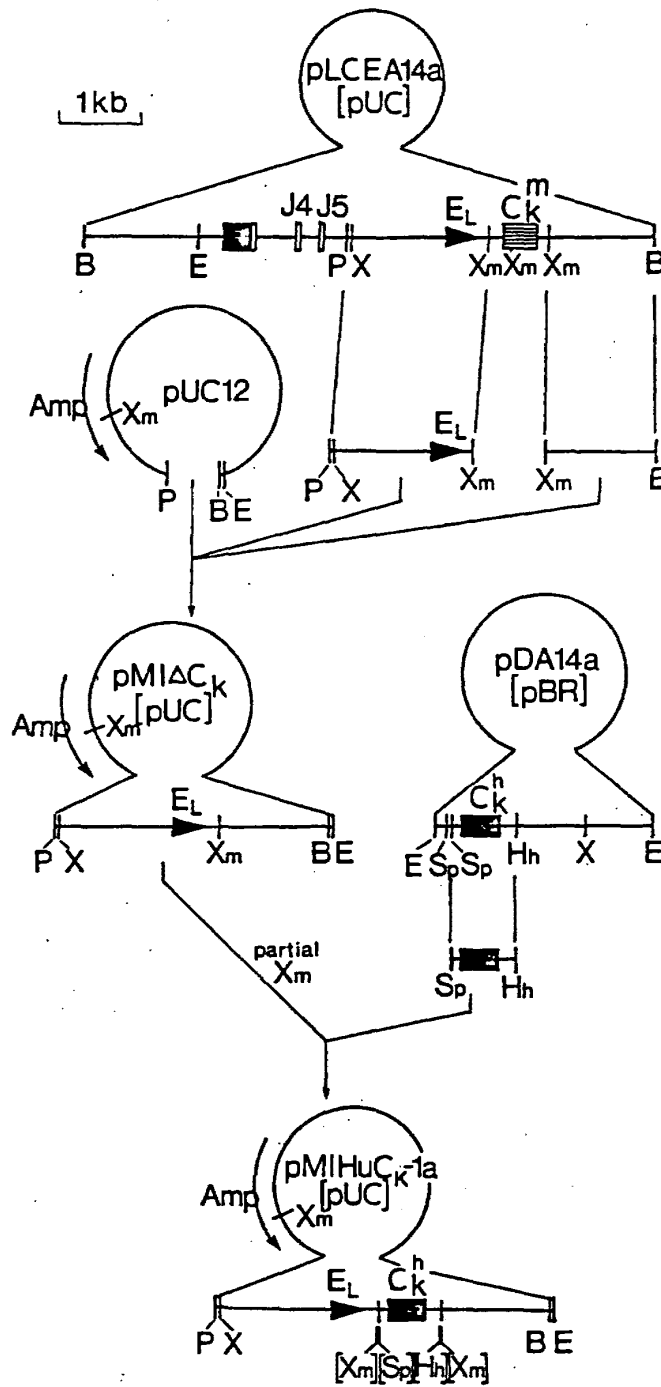

Figure 6

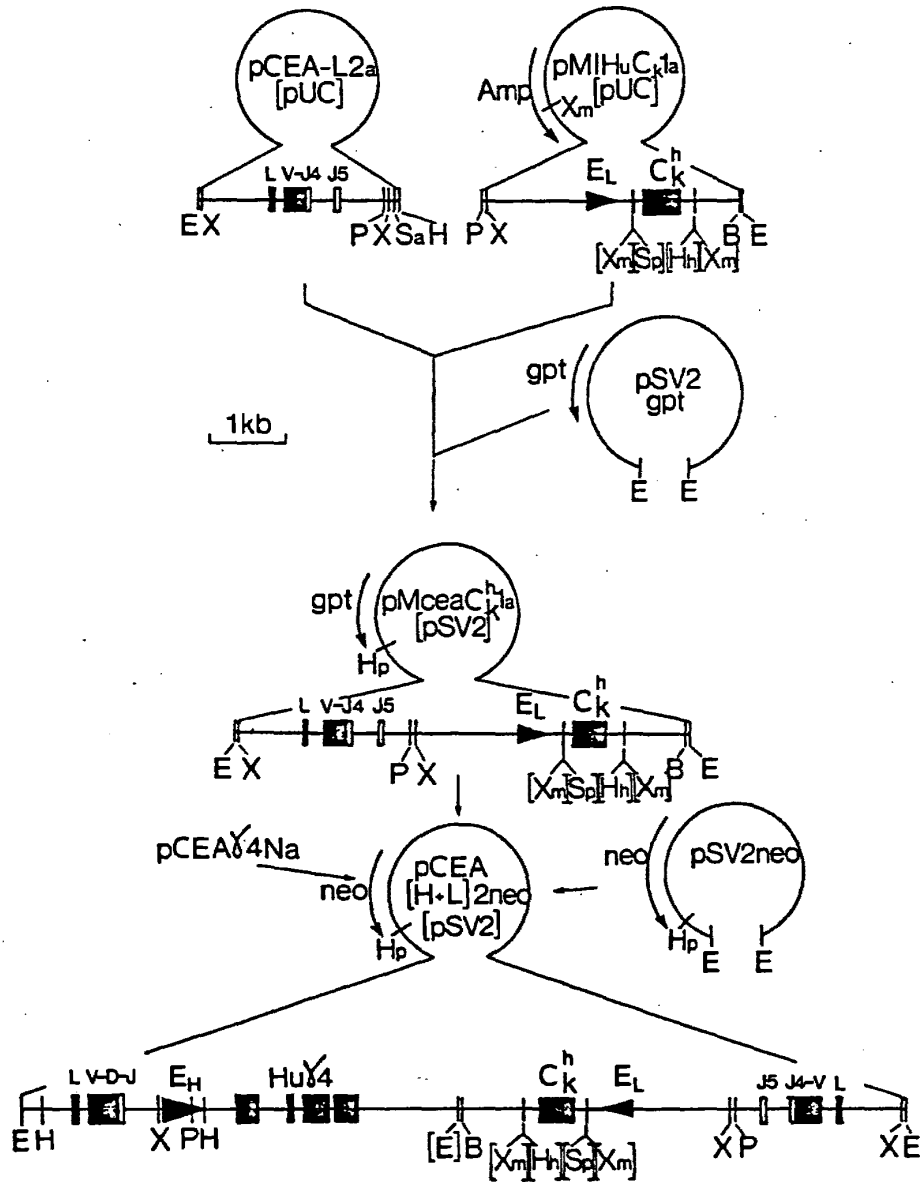
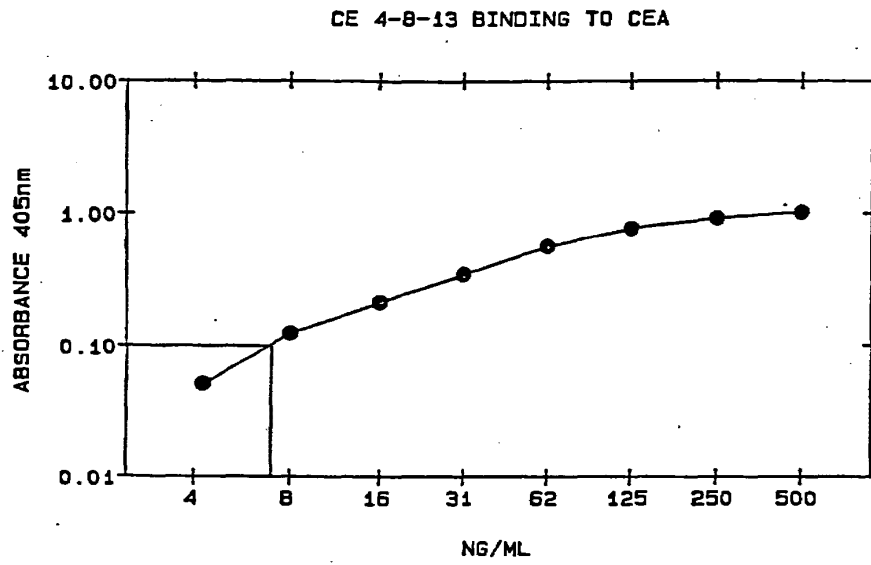

Figure 7



⑫

EUROPEAN PATENT APPLICATION

⑲ Application number: **89310415.8**

⑸ Int. Cl.⁵: **C12N 15/13 , C12P 21/08**

⑳ Date of filing: **11.10.89**

⑳ Priority: **17.10.88 US 260558**

⑦ Applicant: **Becton Dickinson and Company**
One Becton Drive
Franklin Lakes New Jersey 07417-1880(US)

㉑ Date of publication of application:
25.04.90 Bulletin 90/17

⑧ Inventor: **Hinton, Robert**
151 Calderon No. 177
Mountain View California(US)
Inventor: **Oi, Vernon T.**
1259 Marilyn Court
Mountain View California(US)

㉒ Designated Contracting States:
AT BE CH DE ES FR GB GR IT LI LU NL SE

⑦ Representative: **Ruffles, Graham Keith et al**
MARKS & CLERK 57-60 Lincoln's Inn Fields
London WC2A 3LS(GB)

④ Anti-leu 3A amino acid sequence.

⑦ The nucleotide and amino acid sequence of Anti-Leu 3a and chimeric and mosaic variants thereof is disclosed.

EP 0 365 209 A2

ANTI-LEU 3a AMINO ACID SEQUENCE

Field of the Invention

This invention relates to an amino acid sequence for an anti-CD4 antibody and more particularly relates to an amino acid sequence for the anti-CD4 antibody, Anti-Leu 3a, and a chimeric variant thereof.

Background of the Invention

CD4 is an antigen on certain T lymphocytes (i.e., the helper subset) that has a molecular weight of approximately 55 Kd. It is thought to consist of four domains (V₁ - V₄) that extend from the cell membrane outward in serial fashion.

Recently, the CD4 antigen or CD4⁺ cells have been implicated in certain immune system diseases ranging from autoimmune diseases, such as rheumatoid arthritis and multiple sclerosis, to AIDS. Treatment of these diseases with anti-CD4 agents (i.e., chemical or biological materials that bind to or block the function of the CD4 antigen) has been suggested. See, e.g., U.S. Pat. No. 4,695,459 and Weber et al., *Sci. Amer.*, 259:101 (1988).

Not all anti-CD4 agents, and in particular not all anti-CD4 monoclonal antibodies, however, have the same effect on the CD4 antigen or CD4⁺ cells. That is, not all anti-CD4 monoclonal antibodies bind to the same region or epitope on CD4. Where a particular monoclonal antibody binds to CD4 is important in a disease such as AIDS, for example. Sattentau et al., *Science*, 234:1120 (1986), showed that not all anti-CD4 antibodies would cross-block each other in competitive binding studies with CD4⁺ cells or would block the binding of HIV to CD4⁺ cells. Recent work, summarized by Weber et al., *supra*, suggests that a specific amino acid sequence in the outermost or V₁ domain of the CD4 molecule is site where HIV binds to CD4, and suggests that this is the site (or very near to it) where the monoclonal antibody, anti-Leu 3a (Becton Dickinson Immunocytometry Systems, BDIS), binds. Also near this site, but different from the site to which Anti-Leu 3a binds, is the site at which another monoclonal antibody, OKT4a (Ortho Diagnostics), binds.

The ability of Anti-Leu 3a to block HIV binding has been attributed to its structure being the same or nearly the same as a portion of the gp120 region of the HIV virus. The gp120 region of the virus has been shown to bind to CD4. Thus, Anti-Leu 3a has a structure that looks like the HIV binding region on gp120 but lacks the disease carrying properties of the virus itself. As result, the use of Anti-Leu 3a as

a vaccine is being attempted. See Matthews et al., *Sci. Amer.*, 259:120 (1988).

Anti-Leu 3a is a mouse monoclonal antibody derived from clone SK3 which was originally described by Evans et al., *PNAS*, 78:544 (1981). SK3 was derived from hybridization of mouse NS-1 myeloma cells with spleens from BALB/c mice immunized with sheep red blood cell rosettes of human peripheral blood. It is a IgG₁ type antibody having a kappa light chain. Because Anti-Leu 3a is a mouse monoclonal antibody, however, its use a therapeutic agent, such as an AIDS vaccine, raises certain problems.

Mouse monoclonal antibodies or in fact any other non-human antibodies will be immunogenic when used as a human therapeutic agent. The mouse monoclonal antibody will be recognized as being "non-self" by the recipient's immune system. Thus, once a mouse monoclonal antibody has been used, anti-mouse antibodies will be formed in the host which then will limit the subsequent effectiveness of the agent in the course of further or subsequent treatment. Accordingly, it would be preferable to use human monoclonal antibody. The preparation of a human antibody, however, raises a number of serious practical and ethical questions.

One alternative method to make the mouse monoclonal antibody less immunogenic while retaining the binding specificity of antibody is to make the antibody "chimeric." In one embodiment of this format, the mouse variable region of the antibody is coupled to the constant region of the same type antibody but from another species or another strain of the same species. In the preferred human therapeutic embodiment, the other species is human. For veterinary purposes, the species to be treated will comprise the other species.

Simply stated, the gene for the mouse variable region is isolated and spliced by appropriate genetic engineering techniques, such as those described in chapters 5 and 6 of *Recombinant DNA: A Short Course* (Watson et al., eds., 1983), to the gene for the human constant region. The resulting gene then will code for an immunoglobulin having the mouse variable region and human constant region. A vector carrying this new gene then may be placed in a prokaryotic or eukaryotic organism for expression of the immunoglobulin. A specific embodiment for this type of chimeric antibody for expression in eukaryotic organisms is set forth in USSN 644,473 filed August 27, 1984, and for expression in prokaryotic organisms is set forth in USSN 483,457 filed April 8, 1983.

The application USSN 644,473 corresponds with published European Patent Specification

173494. The application USSN 483,457 corresponds with published US Patent 4816567.

Another embodiment of a chimeric format is set forth in UK Pat. Appl. GB 2 188 638 filed March 27, 1986, and also is described in Jones et al., Nature, 321:522 (1986). In this approach, the chimeric antibody is "humanized" by introducing more human sequences into the variable gene region while retaining the specific mouse binding regions.

This embodiment of an antibody takes advantage of the fact that the variable region of both mouse and human immunoglobulins is comprised of four framework residues (FRs) which are interspersed with three complementarity determining residues (CDRs). The CDRs mediate antigen binding. Thus, in this approach, the mouse variable region genes coding for one or more of the CDRs are spliced into the human framework variable region and the resulting "mosaic" variable region may be spliced onto the human constant region forming a different type of chimeric antibody. Vectors containing these constructs may be transferred in to expressions systems as described above. A schematic for the traditional and mosaic forms of chimeric antibodies is shown in FIG. 1.

The ability to manipulate the gene sequences for any particular monoclonal antibody provides one further opportunity to design the antibody to precise specifications. By using appropriate recombinant DNA techniques, it is possible to create specific mutations in the nucleic acid sequence of the variable region gene. In some cases, this will lead to a change in the amino acid sequence of the immunoglobulin. This change, in turn, may lead to a conformational change in the structure of the immunoglobulin which may improve or diminish the binding capability or activities of the immunoglobulin. Thus, it may be possible to design two different immunoglobulins that have the same conformation and binding specificity but have different sequences.

This ability will effect not only the therapeutic format of the antibody but also will enable one to improve the diagnostic characteristics of the antibody. For example, one might use the chimeric or mosaic format to construct an antibody fragment (e.g., Fab') with different secondary properties but having the same or improved binding capabilities.

While the importance of the ability to change the conformation or structure of an immunoglobulin or to render it less immunogenic is unquestioned, the ability to make this changes requires identification of the specific sequence of the antibody in question. Thus, in order to make a chimeric or mosaic version of an antibody or to alter its conformation, the sequence must be known. Once it is known, improvements in its therapeutic capabilities

then may be made.

Summary of the Invention

This invention comprises the amino acid sequence for the monoclonal antibody Anti-Leu 3a variable region. It further comprises the amino acid sequence for each of the CDR portions of the Anti-Leu 3a variable region. A chimeric antibody having the amino acid sequence for the variable region and a mosaic antibody having one or more of the amino acid sequences for the CDR portion of the variable region also are claimed.

Description of the Drawings

FIG. 1 comprises a schematic comparison of the chimeric and mosaic IgG antibodies. Chimeric antibodies consist of mouse variable regions



and human constant regions



The mouse variable region contains the CDR (■) and the FR (□). Mosaic antibodies consist of synthetic mouse human variable regions



containing mouse CDRs (■) and human FRs (□) and human constant regions.

FIG. 2. comprises the nucleotide chain and deduced amino acid sequence of the cloned Anti-Leu 3a light chain variable region gene, 206 V_L.

FIG. 3 comprises the nucleotide and deduced amino acid sequence of the cloned Anti-Leu 3a heavy chain variable region gene, 316-V_H.

FIG. 4 comprises the nucleotide and predicted amino acid sequence of the mosaic Anti-Leu 3a light chain variable region gene, KOL/206-V_L.

FIG. 5 comprises the nucleotide and predicted amino acid sequence of the mosaic Anti-Leu 3a heavy chain variable region gene, KOL/318-V_H.

FIG. 6 comprises a schematic synthesis strategy for mosaic light and heavy chain variable regions, wherein FRs are shown by thin boxes, CDRs as thick boxes, restriction sites by arrows and over-lapping, single-stranded oligonucleotides are represented by solid lines below each gene.

FIG. 7 comprises partial DNA restriction

maps of human kappa and human gamma 1 expression vectors containing Anti-Leu 3a variable region sequences wherein exons are indicated by open boxes, enhancer elements are shown as open circles, dominant selectable markers are represented by shaded boxes, and antibiotic resistance genes are depicted with broken lines.

For FIG.s 2-5, the deduced amino acid sequence is shown below the nucleotide sequence in three letter code. The sequence of the mature protein is capitalized while the leader peptide is in lower case letters. CDRs are boxed. DNA regulatory elements (e.g., Parslow box and TATA box) are highlighted in boldface letters. Donor and acceptor splice sites are underlined and splice junctions are indicated by an up arrow.

Detailed Description of the Invention

Organization of mouse immunoglobulin genome has been well described by Honjo, *Ann. Rev. Immunol.*, 1:499 (1983). Briefly, the immunoglobulin gene system comprises three separate loci of L_x , L_λ and H (light and heavy) chain genes, each chain containing the variable (V) and constant (C) genes. The L_x , L_λ and H chain genes are located on mouse chromosomes 6, 16 and 12 respectively and on are located on human chromosomes 2, 22 and 14 respectively. Within each of the genes, a variety of introns and exons may exist.

Referring to FIG. 2, the variable region sequence for the kappa light chain of Anti-Leu 3a was determined as follows. DNA containing the mouse variable region light chain gene was isolated from clone SK3 by screening a genomic library using hybridization probes. Genomic DNA was partially digested with MboI, ligated into the lambda replacement vectors EMBL3 or EMBL4, packaged, and amplified on an appropriate *E. coli* host. The libraries were screened using a ~ 0.85 Kb SacI HindIII probe from the mouse J_x - C_x intron, or a ~ 0.70 Kb XbaI EcoRI enhancer probe from the mouse heavy chain intron. Positive clones were characterized by Southern blotting, then were subcloned into the cloning vector pUC13.

Once the DNA for each of the light and heavy chain variable regions was isolated, it was sequenced by the chain termination method of Sanger et al., *PNAS*, 74:5483 (1977). Appropriate restriction fragments were subcloned into the sequencing vectors M13mp18, M13mp19 and PTZ18R, and the cloning vector pUC13. 35 S-labelled templates were sequenced with Klenow fragment or AMV-reverse transcriptase.

The nucleotide sequence from positions 538 through 882 comprises the coding region for the

Anti-Leu 3a V_x chain. The amino acid sequence corresponding to the nucleotide sequence from positions 549 through 881 further comprises the structure of the variable region of the Anti-Leu 3a kappa light chain.

Referring to FIG. 3, the variable region sequence for the heavy chain of Anti-Leu 3a was determined as described above for the light chain except that appropriate restriction fragments were subcloned into the sequencing vectors M13mp18 and M13mp19 (Pharmacia), and the cloning vectors pUC12 and pUC13.

The nucleotide sequence from positions 373 through 738 comprises the coding region for the Anti-Leu 3a V_H chain. The amino acid sequence corresponding to the nucleotide sequence from positions 384 through 737 further comprises the structure of the variable region of the Anti-Leu 3a heavy chain.

Once isolated, the nucleotide sequences for each or either of the variable region chains may be combined with nucleotide sequences for the human constant region. Once combined, the vector into which they are combined may be placed in an expression system for production of the chimeric antibody. Preferably, the method of Morrison and Oi as set forth in USSN 644,473 is used to construct the chimeric antibody; however, the methods set forth in USSN 483,457 may be used to construct the chimeric antibody in a prokaryotic system, such as *E. coli*.

Briefly, the 206 - V_x and 316 - V_H variable region genes were spliced to human kappa and human gamma 1 constant region genes and were inserted into the vectors pSV184neo and PSV2ΔHgpt respectively. The 206 - V_x gene was spliced to the human x gene at a unique HindIII site located in the large intron between the J_x and C_x exons. The 316 - V_H gene was spliced to the human gamma 1 gene at a unique EcoRI site located in the large intron between the J_H and C_H exons.

Transfection of a eukaryotic cell line was accomplished by the method described by Morrison et al., *PNAS*, 81:6851 (1984).

One Chimeric cell line that resulted from this transfection was named V23. This cell line produces a chimeric mouse:human gamma 1 immunoglobulin that binds to the CD4 antigen on CD4⁺ cells as confirmed by flow cytometric analyses and as confirmed by SDS-polyacrylamide gel electrophoresis of antigen antibody complexes from labelled cells.

Referring to FIG.s 4 and 5, the nucleotide sequence of the V_x and V_H CDRs was determined next. The mosaic light chain variable region was synthesized from two 200 base-pair restriction fragments, each consisting of six oligonucleotides. The mosaic heavy chain variable region was synthe-

sized from two 100 base-pair restriction fragments consisting of four oligonucleotides each and a 200 base-pair restriction fragment consisting of eight oligonucleotides. See FIG. 6.

Taking advantage of the degeneracy of the genetic code, unique restriction sites then were designed into each gene to facilitate CDR replacement by cassette mutagenesis. Thus, an altered amino acid sequence could be introduced by replacing the existing DNA sequence with a synthetic double-stranded restriction fragment. The human myeloma cell line KOL was used as a source of FRs for both the V_x and V_H chains even though it has a lambda light chain. KOL has been previously described by Bernstein et al., J. Mol. Biol., 112:535 (1977). The resulting mosaic genes then were subcloned into the bacterial cloning vectors PTZ18R and PTZ19R (Pharmacia) and were sequenced on both strands by the chain termination method described above.

Referring to FIG. 4, the nucleotide sequence from positions 43 through 387 comprise the mosaic V_x chain. The sequences from positions 120-164, 210-230 and 327-353 comprise the CDR₁, CDR₂ and CDR₃ regions respectively. The amino acid sequence for each CDR then was deduced from the nucleotide sequence.

Referring to FIG. 5, the nucleotide sequence from positions 20 through 385 comprise the mosaic V_H chain. The sequences from positions 121-136, 178-228 and 325-351 comprise the CDR₁, CDR₂ and CDR₃ regions respectively. The amino acid sequence for each CDR then was deduced from the nucleotide sequence.

As described above, expression vectors then were made to splice the mosaic constructs to the respective constant region genes. The vectors pSV184ΔHneo and PSV2ΔHgpt were used with the V_x and V_H mosaics respectively. Constant regions from KOL also were used as previously described. Each vector was modified by site-directed mutagenesis to permit insertion of the variable region mosaics. See FIG. 7.

Transfection of a eukaryotic cell line was accomplished by the method described in Oi and Morrison, BioTechniques, 4:214 (1986).

One mosaic cell line that resulted from this transfection was named 181-21. This cell line produces a mosaic mouse:human gamma 1 immunoglobulin that binds to the CD4 antigen on CD4⁺ cells as confirmed by flow cytometric analyses and as confirmed by SDS-polyacrylamide gel electrophoresis of antigen-antibody complexes from labelled cells.

The V23 and 181-21 cell lines described above that produce the chimeric and mosaic Anti-Leu 3a antibodies have been deposited in the laboratory of Dr. Vernon Oi at the Becton Dickinson Monoclonal

Center, Mountain View, California. It will be apparent to one skilled in the art that these are not the only possible combinations of Anti-Leu 3a derived sequences. Other combinations of sequences could include 1) having less than all CDRs in the construct be of mouse origin (e.g., combining CDR₁ in one or both chains from Anti-Leu 3a with CDR₂ and CDR₃ from another species), 2) having only the heavy or light chain be chimeric or mosaic (and thus having the other chain be totally of mouse origin) and 3) having a construct comprised of a mosaic chain and a chimeric chain. Other constructs may be made of different nucleotide sequences that have the structure and anti-CD4 binding function of Anti-Leu 3a but not do not necessarily have the entire Anti-Leu 3a sequence. Still other constructs may represent only a portion of the antibody (e.g., Fab' fragment). Finally, other constructs could be made comprising anti-CD4 peptides that have both Anti-Leu 3a like binding functions (but lack an immunoglobulin structure) and the sequence of any of the variants described in FIG.s 2-5.

All publications and patent applications mentioned in this specification are indicative of the level of ordinary skill in the art to which this invention pertains. All publications and patent applications are herein incorporated by reference to the same extent as if each individual publication or patent application was specifically and individually indicated to be incorporated by reference.

It will be apparent to one of ordinary skill in the art that many changes and modifications can be made in the invention without departing from the spirit or scope of the appended claims.

Claims

1. A chimeric antibody having a human constant region and having a mouse variable region comprising an amino acid sequence for a V_x chain as described in FIG. 2.

2. A chimeric antibody having a human constant region and having a mouse variable region comprising an amino acid sequence for a V_H chain as described in FIG. 3.

3. A chimeric antibody having a human constant region, and having a mouse variable region comprising an amino acid sequence for a V_x chain as described in FIG. 2 and an amino acid sequence for a V_H chain as described in FIG. 3.

4. An antibody having a mouse:human mosaic variable region comprising an amino acid sequence for a V_x chain as described in FIG. 4.

5. An antibody having a mouse:human mosaic variable region comprising an amino acid sequence for a V_H chain as described in FIG. 5.

6. An antibody having a mouse:human mosaic variable region comprising an amino acid sequence for a V_x chain as described in FIG. 4 and an amino acid sequence for a V_H chain as described in FIG. 5.

7. A chimeric antibody having a human constant region, and having a mouse:human mosaic variable region comprising an amino acid sequence for a V_x chain as described in FIG. 4 and having an amino acid sequence for a V_H chain as described in FIG. 5.

8. An antibody having a mouse:human mosaic variable region comprising at least one of the CDR amino acid sequences as described in FIG. 5.

9. An antibody having a mouse:human mosaic variable region comprising at least one of the CDR amino acid sequences as described in FIG. 6.

10. A nucleotide sequence for an anti-CD4 agent comprising any of the nucleotide sequences as described in any of FIG.s 2-5.

5

10

15

20

25

30

35

40

45

50

55

6

FIG-1

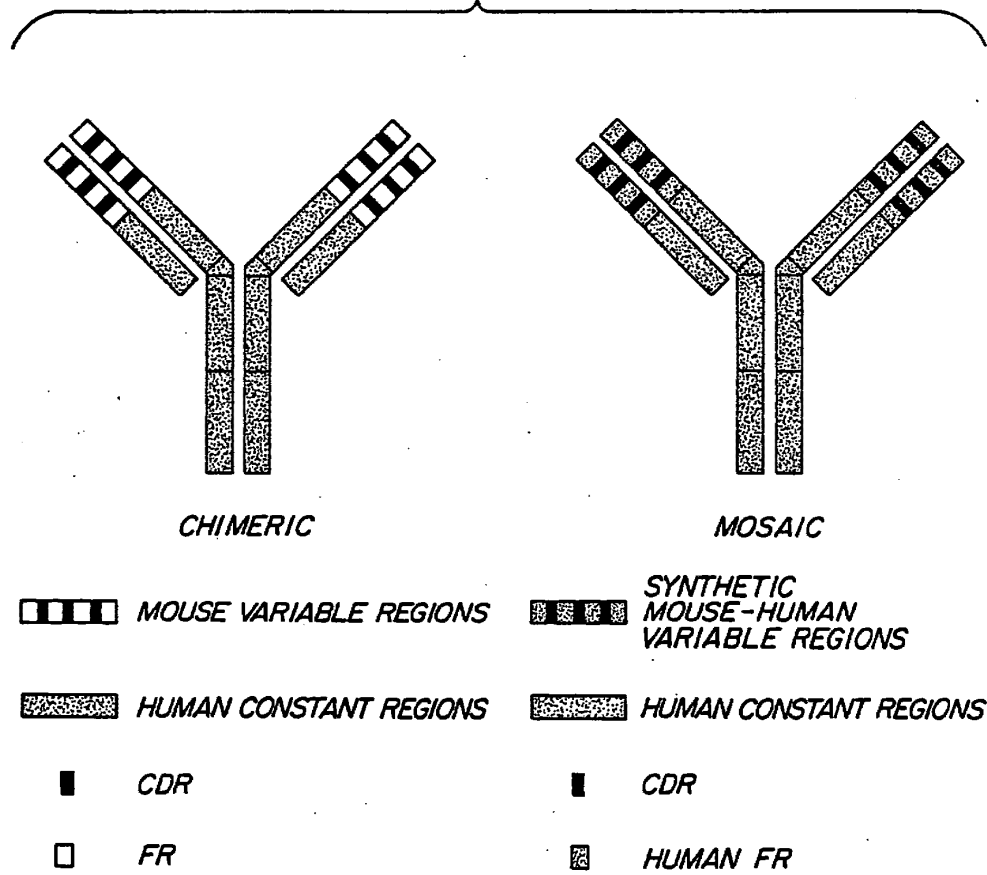

10 20 30 40 50 60
 TTTAAATGATGCTTTGTAAGCCTTAAATAAACACAAATAAACATTGAGCCAGAAAAGAAA
 70 80 90 100 110 120
 AAAAAAAAAAGACACATGTGATGCTCTAGTAAATTTTCTGCTGACACCAACTCCCCATCGG
 130 140 150 160 170 180
 TGAAACAGGAGCAGGTGCCCTTGGACCAACAGCACATACTCTGCTGATTGTCATATGAAA
 PARSLOW
 190 200 210 220 230 240
 TAATTTATAACAGCCAGGCTTCTTTAAGGGCAGCTGCCAGGAGCCTAAGAAGCATCCT
 TATA
 250 260 270 280 290 300
 CTCATCTAGTTCTCAGAGATGAGACAGACACAATCCTGCTATGGGTGCTCCTGCTCTGG
 metgluthraspthrileleuleutrprvalleuleuleutrpr
 310 320 330 340 350 360
 GTTCAGGTGAGAGTGCAGAGAAGTGTGGGAGCAACCTCTGCGACCATCATGACTTTCC
 valprog↑
 370 380 390 400 410 420
 ATGCATATGGACTCCTGAATGTTATAATTAATCCATTTGTAATTGGTTTTAAGTTTCCTG
 430 440 450 460 470 480
 ATTCCCTTTCAGTTCCTGATGTCTCATATTGATGTCCACAACATTCTTTATATTTTTAAA
 490 500 510 520 530 540
 TGAAATGGGAAGTCCTTTATACATATATAACAATTGTCTGTGTGTTTATCATTCCAGGCT
 lys
 550 560 570 580 590 600
 CCACTGGTGACATTGTGCTGACCCAATCTCCAGCTTCTTTGGCTGTGTCTCTAGGGCAGA
 erthrglyAspIleValLeuThrGlnSerProAlaSerLeuAlaValSerLeuGlyGlnA
 610 620 630 640 650 660
 GGGCCACCATCTCCTGCAAGGCCAGCCAAAGTGTGATTATGATGGTGATAGTTATATGA
 rgAlaThrIleSerCysLysAlaSerGlnSerValAspTyrAspGlyAspSerTyrMeta
 670 680 690 700 710 720
 ACTGGTACCAACAGAAACCAGGACAGCCACCCAAACTCCTCATCTATGCTGCATCCAATC
 snTrpTyrGlnGlnLysProGlyGlnProProLysLeuLeuIleTyrAlaAlaSerAsnL
 730 740 750 760 770 780
 TAGAATCTCGGATCCAGCCAGATTTACTGGCAGTGGGTCTGGGACAGACTTCACCTCA
 euGluSerGlyIleProAlaArgPheThrGlySerGlySerGlyThrAspPheThrLeuA
 790 800 810 820 830 840
 ACATCCATCCTGTGGAGGAGGAGGATACTGCAACCTATTACTGTCAACAAAGTTATGAGG
 snIleHisProValGluGluGluAspThrAlaThrTyrTyrCysGlnGlnSerTyrGluA
 850 860 870 880 890 900
 ATCCTCCGACATTCGCTGGAGGCCAACCTGGAAATCAAGCGTAAGTAGAATCCAAAGT
 spProProThrPheAlaGlyGlyThrAsnLeuGluIleLysA

10 20 30 40 50 60
 GAATTCACAAAAAGTTTATGGGATACATTTCTCAGAGAGGAATAGGATTTTGACCTGAG

70 80 90 100 110 120
 CATCCTGCTGCCTGAGCCATCTGATGACAGTTCTTCAGCTGGACTAGTTCCTTATCTAAG

130 140 150 160 170 180
 AAATACACCGCTCATGAATATGTAATCACCCGAGTCTATGGCAGTAATACTGGGATGT
 PARSLOW TATA

190 200 210 220 230 240
 CCACACCATGAAAACAACCTATGATCAGTGCATCTCCACAGTCCCTGAACACACTGACT

250 260 270 280 290 300
 CTAACCATGGAATGGAGGATCTTTCTCTCATCCTGTCAGGAAGTGCAGGTAAGGGGCTC
 metglutrpargilepheleupheileleuserglythralag

310 320 330 340 350 360
 ACCAGTTCCAAATCTGAAGTGGAGACAGGACCTGAGGTGACAATGACTTCTACTCTGCCT

370 380 390 400 410 420
 TTCTCTCCACAGGTGTCCACTCCCAGGTTTCAGCTGCAGCAGTCTGGACCTGAGCTGGTGA
 lyvalhisserGlnValGlnLeuGlnGlnSerGlyProGluLeuValL

430 440 450 460 470 480
 AGCCTGGGGCTTCAGTGAAGATGTCTGCAAGGCTTCTGGATACACATTCACTGACTATG
 ysProGlyAlaSerValLysMetSerCysLysAlaSerGlyTyrThrPheThrAspTyrV

490 500 510 520 530 540
 TTATAAACTGGGTGAAGCAGAGAACTGGACAGGGCCTTGAGTGGATTGGAGAGACTTATA
 alIleAsnTrpValLysGlnArgThrGlyGlnGlyLeuGluTrpIleGlyGluThrTyrT

550 560 570 580 590 600
 CTGGAAGTGGCAGTAGTTATTACAATGAGAAGTTCAAGGACAAGGCCACACTGACTGTAG
 hrGlySerGlySerSerTyrTyrAsnGluLysPheLysAspLysAlaThrLeuThrValA

610 620 630 640 650 660
 ACAAAGCCTCCAATATAGCCTACATGCAGCTCAGCAGCCTGACATCTGAGGACTCTGCGG
 spLysAlaSerAsnIleAlaTyrMetGlnLeuSerSerLeuThrSerGluAspSerAlaV

670 680 690 700 710 720
 TCTATTTCTGTCCAAGACGGGGTAAAGGAACCGGGTTTGCTTTTGGGGCCAAGGGACTC
 alTyrPheCysAlaArgArgGlyLysGlyThrGlyPheAlaPheTrpGlyGlnGlyThrL

730 740 750 760
 TGGTCACTGTCTCTGCAGGTGAGTCCCTAACTTCTCCCATCTCTAGA
 euValThrValSerAlaG

KOL/206-VI.

Figure 4

10	20	30	40	50	60
GAATTCTGTGTGTAAGTATGTATTTCTCTCTCATTCTTTCAGCTTCCAGCAGTGAAGCG					
AserserserGluSerV					
70	80	90	100	110	120
TGTTAACCCAAAGCTCCATCTGCTTCTGGCACTCCTGGACAACCGCTCACCATCTCTGCA					
alLeuThrGlnProProSerAlaSerGlyThrProGlyGlnArgValThrIleSerCysL					
130	140	150	160	170	180
AAGCTAGCCAAAGTGTGGATTATGATGGTGATAGTTATATGAAGTGGTATCAACAACCTTC					
ysAlaSerGlnSerValAspTyrAspGlyAspSerTyrMetAsnTrpTyrGlnGlnLeuP					
190	200	210	220	230	240
CCGGGATGGCACCCAAGCTTCTCATCTATGCTGCATCCAATCTGGAATCTGGAGTCCCAA					
roGlyMetAlaProLysLeuLeuIleTyrAlaAlaSerAsnLeuGluSerGlyValProT					
250	260	270	280	290	300
CCAGATTTAGTGGATCCAAGTCTGGGACATCTGCATCTCTCGCTATCAGTGGTCTAGAGG					
hrArgPheSerGlySerLysSerGlyThrSerAlaSerLeuAlaIleSerGlyLeuGluA					
310	320	330	340	350	360
CAGAGGATGAGTCAGATTACTGCCAACAATCATATGAAGATCCTCCGACATTCGGTA					
laGluAspGluSerAspTyrTyrCysGlnGlnSerTyrGluAspProProThrPheGlyT					
370	380	390			
CCGGAACCAAAGTGACTGTACTAGGACGTAAGTAGAC					
hrGlyThrLysValThrValLeuGlyA					

KOL/316-VII

Figure 5

10 20 30 40 50 60
 GAATTCTCTGTTGTTTTCAGGTCTCCAGAGTGAGGTCCAACTAGTGCAGTCTGGAGGAGGC
 |LyvalGlnserGluValGlnLeuValGlnSerGlyGlyGly

70 80 90 100 110 120
 GTGGTGCAGCCTGGGAGATCTCTGAGACTGTCCTGTTCGAGCTCTGGATTCATCTTCAGT
 ValValGlnProGlyArgSerLeuArgLeuSerCysSerSerSerSerGlyPheIlePheSer

130 140 150 160 170 180
GACTACGTAATAAACTGGGTGAGACAGGCTCCAGGCAAAGGCCTTGAGTGGGTCGCTGAG
AspTyrValIleAsnTrpValArgGlnAlaProGlyLysGlyLeuGluTrpValAlaGlu

190 200 210 220 230 240
ACTTATACTGGATCCGGTAGTAGTTATTACAATGAGAAGTTCAAGGACAGGTTACAATC
ThrTyrThrGlySerGlySerSerTyrTyrAsnGluLysPheLysAspArgPheThrIle

250 260 270 280 290 300
 TCGAGAAACGACTCCAAGAACACTCTTCTCCTGCAGATGGACTCTCTGAGACCTGAGGAC
 SerArgAsnAspSerLysAsnThrLeuPheLeuGlnMetAspSerLeuArgProGluAsp

310 320 330 340 350 360
 ACTGGAGTCTACTTCTGTGCAAGAAGAGGTAAGGAACAGGGTTTGCTTTCTGGGGTCAA
 ThrGlyValTyrPheCysAlaArgArgGlyLysGlyThrGlyPheAlaPheTrpGlyGln

370 380 390 400 410
 GGTACCCCTGTCACTGTCTCTTCAGGTGAGTCCTAACTTCTCCATTCTAGA
 GlyThrProValThrValSerSerG

FIG-6

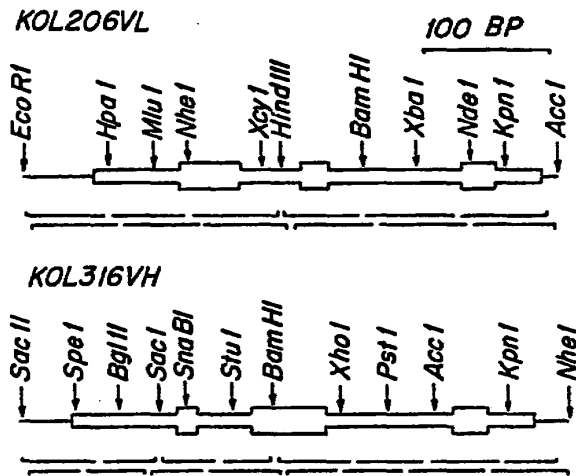
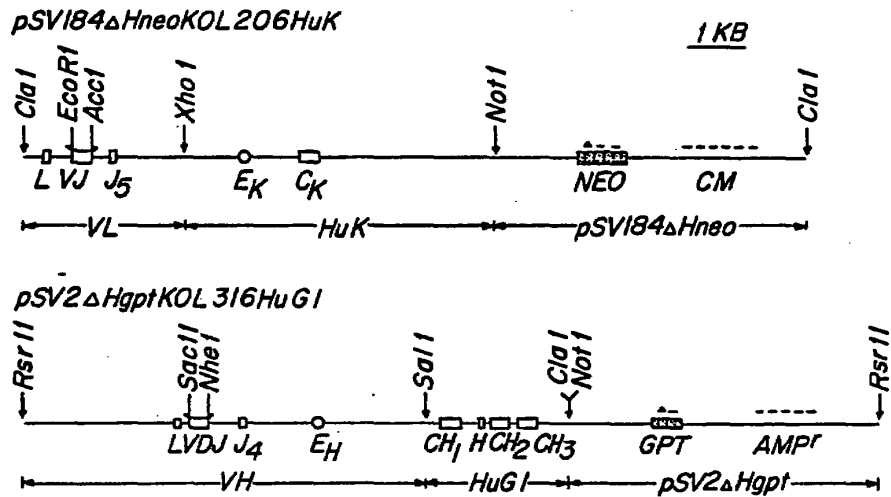

FIG-7



EUROPEAN PATENT APPLICATION

Application number: **89310415.8**

Int. Cl.⁵: **C12N 15/13, C12P 21/08**

Date of filing: **11.10.89**

Priority: **17.10.88 US 260558**

Applicant: **Becton Dickinson and Company**
One Becton Drive
Franklin Lakes New Jersey 07417-1880(US)

Date of publication of application:
25.04.90 Bulletin 90/17

Inventor: **Hinton, Robert**
151 Calderon No. 177
Mountain View California(US)

Designated Contracting States:
AT BE CH DE ES FR GB GR IT LI LU NL SE

Inventor: **Oi, Vernon T.**

Date of deferred publication of the search report:
25.07.90 Bulletin 90/30

1259 Marilyn Court
Mountain View California(US)

Representative: **Ruffles, Graham Keith et al**
MARKS & CLERK 57-60 Lincoln's Inn Fields
London WC2A 3LS(GB)

Anti-leu 3A amino acid sequence.

The nucleotide and amino acid sequence of Anti-Leu 3a and chimeric and mosaic variants thereof is disclosed.

EP 0 365 209 A3



DOCUMENTS CONSIDERED TO BE RELEVANT			
Category	Citation of document with indication, where appropriate, of relevant passages	Relevant to claim	CLASSIFICATION OF THE APPLICATION (Int. CL.6)
Y,D	PROC. NATL. ACAD. SCI. USA, vol. 78, no. 1, January 1981, pages 544-548; R.L. EVANS et al.: "Thymus-dependent membrane antigens in man: Inhibition of cell-mediated lympholysis by monoclonal antibodies to TH2 antigen" * Page 544; "Introduction" *	1-10	C 12 N 15/13 C 12 P 21/08
Y,P	WO-A-8 809 181 (TANOX BIOSYSTEMS) * Claim 19 *	1-10	
Y	SCIENCE, vol. 239, 25th March 1988, pages 1534-1536; M. VERHOEYEN et al.: "Reshaping human antibodies: Grafting an antilysozyme activity" * The whole document *	1-10	
A	NATURE, vol. 334, 14th July 1988, pages 159-162; N.R. LANDAU et al.: "The envelope glycoprotein of the human immunodeficiency virus binds to the immunoglobulin-like domain of CD4"		
			TECHNICAL FIELDS SEARCHED (Int. CL.5)
			C 12 N C 12 P
The present search report has been drawn up for all claims			
Place of search THE HAGUE		Date of completion of the search 04-05-1990	Examiner TURMO Y BLANCO C.E.
CATEGORY OF CITED DOCUMENTS X : particularly relevant if taken alone Y : particularly relevant if combined with another document of the same category A : technological background O : non-written disclosure P : intermediate document		T : theory or principle underlying the invention E : earlier patent document, but published on, or after the filing date D : document cited in the application L : document cited for other reasons & : member of the same patent family, corresponding document	

EPO FORM 1501 (01.82) (P/801)

12 **EUROPEAN PATENT APPLICATION**

21 Application number: **89119361.7**

51 Int. Cl.5: **C12N 15/13 , C12N 5/10 ,**
C12P 21/08 , A61K 39/395

22 Date of filing: **18.10.89**

20 Priority: **19.10.88 US 259943**

43 Date of publication of application:
02.05.90 Bulletin 90/18

94 Designated Contracting States:
AT BE CH DE ES FR GB GR IT LI LU NL SE

71 Applicant: **THE DOW CHEMICAL COMPANY**
2030 Dow Center Abbott Road
Midland, MI 48640(US)

72 Inventor: **Mezes, Peter**
5101 Oakridge Drive
Midland Michigan 48640(US)
Inventor: **Gourlle, Brian**
3713 Orchard Drive
Midland Michigan 48640(US)
Inventor: **Rixon, Mark**
4110 Castle Drive
Midland Michigan 48640(US)

76 Representative: **Huber, Bernhard, Dipl.-Chem.**
et al
Patentanwälte H. Welckmann, Dr. K. Fincke
F.A. Welckmann, B. Huber Dr. H. Liska, Dr. J.
Prechtel Mühistrasse 22 Postfach 860 820
D-8000 München 86(DE)

54 **A novel family of high affinity, modified antibodies for cancer treatment.**

57 This invention concerns a family of chimeric antibodies with high affinities to a high molecular weight, tumor-associated sialylated glycoprotein antigen (TAG72) of human origin. These antibodies have (1) high affinity animal V_H and V_L sequences which mediate TAG-72 binding and (2) human C_H and C_L regions. They are thought to produce significantly fewer side-effects when administered to human patients by virtue of their human C_H and C_L antibody domains. The nucleotide and amino acid sequences of $V_{H\alpha}$ TAG V_H , CC46 V_H , CC49 H , CC83 V_H , and CC92 V_H , and CC49 L , CC83 V_L , and CC92 V_L idiotype sequences are disclosed, as well as *in vivo* methods of treatment and diagnostic assay using these chimeric antibodies.

EP 0 365 997 A2

A NOVEL FAMILY OF HIGH AFFINITY, MODIFIED ANTIBODIES FOR CANCER TREATMENT

This invention relates to the field of immunoglobulin production and modifications to naturally occurring antibody amino acid sequences. Specifically, the invention relates to using recombinant DNA techniques to produce chimeric genes and to take advantage of these gene modification techniques to construct chimeric antibodies.

5 Antibodies are specific immunoglobulin (Ig) polypeptides produced by the vertebrate immune system in response to challenges by foreign proteins, glycoproteins, cells or other antigenic foreign substances. The sequence of events which permits the organism to overcome invasion by foreign cells or to rid the system of foreign substances is at least partially understood. An important part of this process is the manufacture of antibodies which bind specifically to a particular foreign substance. The binding specificity of such
10 polypeptides to a particular antigen is highly refined, and the multitude of specificities capable of being generated by the individual vertebrate is remarkable in its complexity and variability. Millions of antigens are capable of eliciting antibody responses, each antibody almost exclusively directed to the particular antigen which elicited it.

Two major sources of vertebrate antibodies are Presently utilized--generation *in situ* by the mammalian
15 B lymphocytes, and generation in cell culture by B-cell hybrids. Antibodies are generated *in situ* as a result of the differentiation of immature B lymphocytes into plasma cells, which occurs in response to stimulation by specific antigens. In the undifferentiated B cells, the portions of DNA coding for the various regions on the immunoglobulin chains are separated in the genomic DNA. The sequences are assembled sequentially prior to expression. A review of this process has been given by Gough, *Trends in Biochem. Sci.* 6, 203
20 (1981).

The resulting rearranged gene is capable of expression in the mature B lymphocyte to produce the desired antibody. However, even when a particular mammal is exposed to only a single antigen a uniform population of antibodies does not result. The *in situ* immune response to any particular antigen is defined by the mosaic of responses to the various determinants which are present on the antigen. Each subset of
25 homologous antibodies is contributed by a single population of B cells--hence *in situ* generation of antibodies is "polyclonal".

This limited but inherent heterogeneity has been overcome in numerous particular cases by use of hybridoma technology to create "monoclonal" antibodies in cell cultures by B cell hybridomas [See Kohler and Milstein, C., *Nature* 256, 495-497 (1975)].

30 In this process, the relatively short-lived, or mortal, splenocytes or lymphocytes from a mammal which has been injected with antigen are fused with an immortal tumor cell line, thus producing hybrid cells or "hybridomas" which are both immortal and capable of producing the genetically coded antibody of the B cell. The hybrids thus formed are segregated into single genetic strains by selection, dilution, and regrowth, and each strain thus represents a single genetic line. They therefore produce antibodies which are assured
35 to be homogeneous against a desired antigen. These antibodies, referencing their pure genetic parentage, are called "monoclonal".

Monoclonal antibodies with mono-specificity have greatly influenced immunology, and their usefulness has already been demonstrated in such sciences as biology, pharmacology, chemistry and others. Such monoclonal antibodies have found widespread use not only as diagnostics reagents [see, for example,
40 *Immunology for the 80's*, Eds. Voller, A., Bartlett, A., and Bidwell, D., MTP Press, Lancaster, (1981), but also therapy (see, for example, Ritz, J. and Schlossman, S.F., *Blood* 59, 1-11, (1982)].

Monoclonal antibodies produced by hybridomas, while theoretically effective as discussed above and clearly preferable to polyclonal antibodies because of their specificity, suffer from an important disadvantage. In many applications, the use of monoclonal antibodies produced in non-human animals is severely
45 restricted where the monoclonal antibodies are to be used in humans. Repeated injections of a "foreign" antibody in humans, such as a mouse antibody, may lead to harmful hypersensitivity reactions. Such a non-human derived monoclonal antibody, when injected into humans, causes a anti-nonhuman antibody (ANHA) response. For a discussion of a specific ANHA response caused by using murine-derived antibodies, human anti-mouse antibody (HAMA) response, see Shawler et al., *Journal of Immunology* 135, 1530-1535
50 (1985).

It is believed that animal immunoglobulins having human constant regions will generate less of a ANHA response when injected into humans than animal immunoglobulins having nonhuman constant regions. As such, monoclonal antibodies having good binding affinities for selected antigens and having human constant regions are thought to possess great potential utility for immunological diagnosis and therapy of human patients with cancer.

Various attempts have so far been made to manufacture human-derived monoclonal antibodies by using human hybridomas. For example, human-human hybridomas [Olsson, L. et al., *Proc.Natl.Acad.Sci. (USA)*, 77, 5429 (1980)]; human-murine hybridomas [(Schlom, J., et al. (*ibid*) 77, 6841 (1980)] and several other xenogenic hybrid combinations have been prepared. Human monoclonal antibodies have also been produced by transformation of lymphocytes using Epstein-Barr virus. However, such hybridomas may potentially harbor pathogenic human viruses. Alternatively, primary, antibody producing B cells have been immortalized *in vitro* by transformation with viral DNA. Unfortunately, yields of monoclonal antibodies from human hybridoma cell lines are relatively low (1 µg/mL in human compared to 100 µg/mL in mouse hybridomas), and production costs are high.

While human immunoglobulins are highly desirable in immunological diagnosis and therapy of human cancer patients, human hybridoma techniques have not yet reached the stage where human monoclonal antibodies with required antigenic specificities can be easily obtained. In addition, for obvious ethical reasons, researchers can not immunize human subjects with selected toxic or otherwise deleterious antigens to generate antibodies against the specific antigen. This imposes great restrictions on immunological diagnosis and therapy of human patients.

The production of human-derived monoclonal antibodies is certainly possible, but is still inefficient in view of its low reproducibility and the other problems noted above. Additionally, see *Nature* 300, 316-317 (1982)]. Consequently, most monoclonal antibodies are derived from non-human animals.

A monoclonal antibody which reacts with high binding affinity to human tumor antigens, but which is not recognized as a foreign substance by humans is highly desirable. A method to overcome this difficulty is to create artificially an antibody which is very similar to a human antibody and is not recognized as a foreign substance within the human body, i.e., a chimeric, or "humanized" antibody.

Typically in chimeric antibodies, the variable region of both light and heavy chains mimics the variable regions of antibodies derived from one species of mammals, while the constant portions are homologous to the sequences in antibodies derived from humans. One clear advantage to such chimeric forms is that, for example, the variable regions can conveniently be derived from presently known sources using readily available hybridomas of B cells from non-human host organisms in combination with constant regions derived from, for example, human cell preparations. While the specificity of the variable region is not affected by its source, the constant region being human, is less likely to elicit an immune response from a human subject when the antibodies are injected than would the constant region from a non-human source.

One known human tumor antigen is tumor-associated glycoprotein (TAG72). TAG72 is associated with the surface of certain tumor cells of human origin, specifically the LS174T tumor cell line. LS174T [American Type Culture Collection (herein ATCC) No.CL 188] is a variant of the LS180 (ATCC No. CT 187) colon adenocarcinoma line.

The karyotype of LS174T is similar to that of LS180 with a missing X chromosome in a majority of the cells. Data has been presented as described in Johnson, V.G. et al., *Cancer Res.* 46, 850-857 (1986), to characterize the TAG72 molecule as a mucin. This conclusion is based on the following observations: (a) TAG72 has a high molecular weight ($>1 \times 10^6$) as shown by its exclusion from a Sepharose™ CL-4B column; (b) the density of TAG72 determined by equilibrium centrifugation in CsCl was 1.45 gm/mL, indicating a heavily glycosylated glycoprotein; (c) TAG72 demonstrates a change in migration after neuraminidase digestion, indicating that it is a heavily sialylated molecule with an abundance of O-glycosidically linked oligosaccharides characteristic of mucins; (d) blood group antigens commonly found on mucins are found on affinity-purified TAG72; and (e) Chondroitinase ABC digestion had no effect on TAG72, thus demonstrating that the TAG72 epitope is not expressed on a chondroitin sulfate proteoglycan.

Numerous murine monoclonal antibodies have been developed which have binding specificity for TAG72. One of these monoclonal antibodies, designated B72.3, is a murine IgG1 produced by hybridoma B72.3 (ATCC No. HB-8108). B72.3 is a first generation monoclonal antibody developed using a human breast carcinoma extract as the immunogen (see Colcher, D. et al., *Proc.Natl. Acad.Sci. (USA)* 78, 3199-3203 (1981); and U.S. Patents 4,522,918 and 4,612,282). As used herein, the expression "first generation monoclonal antibody" means a monoclonal antibody produced using, as the immunogen, a crude cell extract.

Other monoclonal antibodies directed against TAG72 are designated "CC" (colon cancer). CC monoclonal antibodies are a family of second generation murine monoclonal antibodies. As used herein, the expression "second generation monoclonal antibody" means a monoclonal antibody produced using, as the immunogen, an antigen purified with a first generation monoclonal antibody. CC monoclonal antibodies were prepared using TAG72 purified with B72.3. A discussion of the method for Producing the CC antibodies is set forth in United States Patent Application 7-073,685 (USPA 7-073,685), the application was filed by Schlom et al. on July 15, 1987 and is available to the public from the National Technical Information

Service. Because of their relatively good binding affinities to TAG72, the following CC antibodies have been deposited at the ATCC, with restricted access having been requested: CC49 (ATCC No. HB 9459); CC83 (ATCC No. HB 9453); CC46 (ATCC No. HB 9458); CC92 (ATCC No. HB 9454); CC30 (ATCC NO. HB 9457); CC11 (ATCC No. 9455); and CC15 (ATCC No. HB 9460).

5 In the known art, no human antibody has been isolated which relatively strongly binds to TAG72. Consequently, suitable antibodies must be engineered.

It is known that the function of an Ig molecule is dependent on its three dimensional structure, which in turn is dependent on its primary amino acid sequence. Thus, changing the amino acid sequence of an Ig may adversely affect its activity. Moreover, a change in the DNA sequence coding for the Ig may affect the ability of the cell containing the DNA sequence to express, secrete or assemble Ig.

10 USPA 7-073,685 teaches that the CC antibodies may be altered into their chimeric form by substituting, e.g., human constant regions (Fc) domains for mouse constant regions by recombinant DNA techniques known in the art. It is believed that the proposals set out in USPA 7-073,685 did not lead to an actual attempt to express any chimeric Ig polypeptide chains, nor to produce Ig activity, nor to secrete and assemble Ig chains into the desired chimeric Igs.

15 It is therefore not at all clear from the art that known recombinant DNA techniques will routinely produce a chimeric animal-human antibody from selected DNA sources that generate functional chimeric antibodies which bind specifically to selected human carcinomas and which reduce the initiation of ANHA side-effects when injected into humans.

20 Surprisingly, the present invention is able to meet many of these above mentioned needs and provides a method for supplying the desired antibodies. For example, the present invention provides a method to fuse genes coding for at least a part of an animal Ig which binds to human carcinomas expressing TAG72 and genes coding for at least part of a human Ig. Also the present invention can provide a method to achieve expression of protein which can be secreted and assembled to give a functional chimeric antibody.

25 Further the present invention provides an expression vector containing a DNA sequence which encodes antibodies and portions thereof which are directed against TAG72.

The present invention also provides cells transformed with expression vectors containing a DNA sequence which encodes antibodies and portions thereof which are directed against TAG72.

30 Finally, the present invention provides novel antibodies for use in *in vivo* diagnostic assays; *in vivo* therapy; and radioimmunoguided surgery.

Consequently, this invention concerns an antibody or antibody fragment comprising a variable region having a light chain (V_L) and a heavy chain (V_H), said V_H being encoded by a DNA sequence effectively homologous to the $V_{H\alpha}$ TAG germline gene ($V_{H\alpha}$ TAG), as shown in Figure 2, wherein the variable region binds to TAG72 at least 25% greater than the variable region of B72.3 binds to TAG72, with the binding affinities of the antibody and B72.3 being measured by the same technique.

This invention also concerns a DNA sequence encoding at least a portion of an antibody heavy chain, said sequence comprising a DNA sequence segment being effectively homologous to the $V_{H\alpha}$ TAG germline gene ($V_{H\alpha}$ TAG), wherein the DNA sequence segment encodes at least a portion of a heavy chain variable region (V_H).

40 Further, the invention concerns a DNA sequence comprising:

(A) a sequence segment encoding for a heavy chain, said sequence segment having

(1) a sequence subsegment being effectively homologous to the $V_{H\alpha}$ TAG germline gene ($V_{H\alpha}$ TAG), wherein the DNA sequence segment encodes at least a portion of a V_H , and

(2) a sequence subsegment encoding for at least a portion of a C_H ; and

45 (B) a sequence segment encoding for a light chain, said sequence segment having

(1) a sequence subsegment encoding for at least a portion of an animal light chain variable region (V_L), and

(2) a sequence subsegment encoding for at least a portion of a human light chain constant region (C_L), wherein the antibody encoded by the DNA sequence binds to TAG72 at least 25% greater than the variable region of B72.3 binds to TAG72, with the binding affinities of the antibody and B72.3 being measured by the same technique.

The invention further includes the aforementioned antibody alone or conjugated to an imaging marker or therapeutic agent. The invention also includes a composition comprising the aforementioned antibody in unconjugated or conjugated form in a pharmaceutically acceptable, non-toxic, sterile carrier.

55 The invention is also directed to a method for *in vivo* diagnosis of cancer which comprises administering to an animal a pharmaceutically effective amount of the aforementioned composition for the *in situ* detection of carcinoma lesions.

The invention is also directed to a method for intraoperative therapy which comprises (a) administering

to an animal a pharmaceutically effective amount of the aforementioned composition, whereby the tumors are localized, and (b) excision of the localized tumors.

Additionally, the invention also concerns process for preparing the various antibodies or antibody fragments, their conjugates, a suitable recombinant expression vehicle, and the insertion into a suitable host. Some of these processes are expressed as follows. A process for preparing an antibody or antibody fragment comprising contacting a V_H region with a V_L region to form a variable region of the antibody or antibody fragment. A process for preparing an antibody or antibody fragment conjugate comprising contacting an antibody or antibody fragment with an imaging marker or therapeutic agent. A process for preparing a recombinant expression vehicle comprising inserting a DNA sequence into an expression vehicle. A process for preparing a transformed host comprising inserting the plasmid into a suitable host.

In other aspects, the invention is directed to DNA which encodes the aforementioned antibodies and fragments thereof, as well as expression vectors or plasmids capable of effecting the production of such immunoglobulins in suitable host cells. It includes the host cells and cell cultures which result from transformation with these vectors.

15

Description of the Drawings

Figure 1 illustrates a basic immunoglobulin structure, with the enzymatic cleavage sites being indicated.

Figure 2 illustrates the nucleotide sequences of $V_H\alpha$ TAG V_H , CC46 V_H , CC49 V_H , CC83 V_H and CC92 V_H .

Figure 3 illustrates the amino acid sequences of $V_H\alpha$ TAG V_H , CC46 V_H , CC49 V_H , CC83 V_H and CC92 V_H .

Figure 4a illustrates the nucleotide sequence and Figure 4b illustrates the corresponding amino acid sequence of the CC49 V_L .

Figure 5a illustrates the nucleotide sequence and Figure 5b illustrates the corresponding amino acid sequence of the CC83 V_L .

Figure 6a illustrates the nucleotide sequence and Figure 6b illustrates the corresponding amino acid sequence of the CC92 V_L .

Figure 7 illustrates the nucleotide sequence of the *Hind* III-*Pst* I fragment isolated from the plasmid pGD1.

Figure 8 illustrates the plasmid map of the pBLUESCRIPT SK(-).

Figure 9 illustrates the plasmid map of the pRL101.

Figure 10 illustrates a restriction enzyme map of the CC49 L chain genomic DNA insert in pRL101.

Figure 11 illustrates the plasmid map of the pRL200.

Figure 12 illustrates a restriction enzyme map of the CC83 L chain genomic DNA insert in pRL200.

Figure 13 illustrates the nucleotide sequence of the *Eco* RI-*Bam* HI fragment isolated from the plasmid pNP0.

Figure 14 illustrates the plasmid map of the pHH49.

Figure 15 illustrates the plasmid map of the pHS83.

Figure 16 shows the nucleotide sequence of CC49 V_H , with the underlined segments showing the sequences derived using oligonucleotide primers on mRNA.

Figure 17 shows the nucleotide sequence of CC83 V_H , with the underlined segments show the sequences derived using oligonucleotide primers on mRNA.

Figure 18 shows the amino acid sequence of CC49 V_H , with the underlined segments show the sequences determined by protein sequencing.

Figure 19 shows the amino acid sequence of CC83 V_H , with the underlined segments show the sequences determined by protein sequencing.

Figure 20 shows the results of a SDS polyacrylamide gel, with the results of PNGase F treatment of CC83 antibody.

Figure 21 illustrates the restriction enzyme map of human gamma 1, gamma 2, gamma 3, and gamma 4.

Figure 22 illustrates the plasmid map of pSV2gpt/R/B.

Figure 23 illustrates the plasmid map of pSV2gpt- γ 1-7.8.

Figure 24 illustrates the plasmid map of pSV2gpt- γ 1-2.3.

Figure 25 illustrates the plasmid map of pSV2gpt- γ 2.

Figure 26 illustrates the plasmid map of pSV2gpt- γ 3.

55

Figure 27 illustrates the plasmid map of pSV2gpt- γ 4.

Figure 28 illustrates the plasmid map of p49- γ 1-7.8.

Figure 29 illustrates the plasmid map of p49- γ 1-2.3.

Figure 30 illustrates the plasmid map of p49- γ 2.

5 Figure 31 illustrates the plasmid map of p49- γ 3.

Figure 32 illustrates the plasmid map of p49- γ 4.

Figure 33 illustrates the plasmid map of p83- γ 1-7.8.

Figure 34 illustrates the plasmid map of p83- γ 1-2.3.

10 Figure 35 illustrates the plasmid map of p83- γ 2.

Figure 36 illustrates the plasmid map of p83- γ 3.

Figure 37 illustrates the plasmid map of p83- γ 4.

Figure 38 illustrates the overall reaction for the engineering of hybrid genes based on the method of Horton et al., *Gene* 77, 61 (1989).

Figures 39A, 39B, and 39C show the biodistribution and whole body retention of CH44-1.

15 Figures 40A and 40B show the biodistribution and whole body retention of CH84-1.

The immunoglobulin of this invention have been developed to address the problems of murine monoclonal antibodies disclosed in the prior art. It is characterized by having a chimeric structure composed of a heavy chain variable region encoded by DNA derived from the $V_H\alpha$ TAG.

20

Definitions

As used herein, "immunoglobulin" refers to a tetramer or aggregate thereof whether or not specific immunoreactive activity is a property. "Antibodies" refers to such assemblies which have significant known specific immunoreactive activity to an antigen, comprising light and heavy chains, with or without covalent linkage between them: "Non-specific immunoglobulin" ("NSI") means those immunoglobulins which do not possess known specificity to an antigen.

The basic immunoglobulin structural unit in vertebrate systems is relatively well understood [Edelman, G.M., *Ann.N.Y.Acad.Sci.*, 190, 5 (1971)]. As seen in Figure 1, the units are composed of two identical light polypeptide chains of molecular weight approximately 23,000 daltons, and two identical heavy chains of molecular weight 53,000-70,000. The four chains are joined by disulfide bonds in a "Y" configuration wherein the light chains bracket the heavy chains starting at the mouth of the Y and continuing through the diversity region.

Heavy chains are classified as gamma, mu, alpha, delta, or epsilon, with some subclasses among them. The nature of this chain, as it has a long constant region, determines the "class" of the antibody as IgA, IgD, IgE, IgG or IgM.

Light chains are classified as either kappa (κ) or lambda (λ). Each heavy chain class may be bound with either a kappa or lambda light chain. In general, the light and heavy chains are covalently bonded to each other, and the "tail" portions of the two heavy chains are bonded to each other by covalent disulfide linkages when the immunoglobulins are generated either by hybridomas or by B cells. However, if non-covalent association of the chains can be effected in the correct geometry, the aggregate of non-disulfide-linked chains will still be capable of reaction with antigen.

The amino acid sequences run from an N-terminus at the forked edges of the Y to the C-terminus at the bottom of each chain. At the N-terminus is a variable region and at the C-terminus is a constant region.

45 The terms "constant" and "variable" are used functionally. The variable regions of both light (V_L) and heavy (V_H) chains determine binding recognition and specificity to the antigen. The constant region domains of light (C_L) and heavy (C_H) chains confer important biological properties such as antibody chain association, secretion, transplacental mobility, and complement binding.

The variable region is linked in each chain to the constant region by a linkage linking the V gene sequence and the C gene sequence. The linkage occurs at the genomic level, combining nucleotide sequences via recombination sites. The linking sequence is known currently as a "J" sequence in the light chain gene, which encodes about 12 amino acids, and as a combination of a "D" sequence and a "J" sequence in the heavy chain gene, which together encode approximately 25 amino acids.

55 "Chimeric antibody" for purposes of this invention refers to an antibody having in the heavy chain a variable region amino acid sequence encoded by a nucleotide sequence derived from a murine germline gene and a constant region amino acid sequences encoded by a nucleotide sequence derived from a human gene.

However, the present invention is not intended to be narrowly limited to merely substituting human C

genes sequences encoding immunoglobulin constant regions for murine C gene sequences encoding immunoglobulin constant regions. Thus the present invention is not limited to whether or not the fusion point is at the variable/constant boundary.

5 Through various techniques, it is now possible to produce altered chimeric antibodies, composite chimeric antibodies, and fragmented chimeric antibodies encoded by nucleotide sequences disclosed herein.

"Composite" immunoglobulins comprise polypeptide variable regions not hitherto found associated with each other in nature. It is not critical whether any of the above are covalently or noncovalently aggregated, so long as the aggregation is capable of selectively reacting with a particular antigen or antigen family.

10 "Altered antibodies" means antibodies wherein the amino acid sequences, particularly in the variable region, has been varied. Because of the relevance of recombinant DNA techniques to this invention, one need not be confined to the amino acid sequences of antibodies selected from natural sources; amino acid sequences of the antibodies can be redesigned to obtain desired characteristics. The possible variations are many and range from the changing of just one or a few amino acids to the complete redesign of an antibody variable and/or constant region.

Changes in the variable region will be made in order to improve the antigen binding characteristics. Changes in the constant region will, in general, be made in order to improve the cellular process characteristics, such as complement fixation, interaction with membranes, and other effector functions. Alterations, can be made by standard recombinant techniques and also by oligonucleotide-directed mutagenesis techniques [Daibadie-McFarland, et al. *Proc.Natl.Acad.Sci.(USA)* 79, 6409 (1982)].

20 "Fragments" of immunoglobulins include segments of proteolytically-cleaved or recombinantly-prepared portions of an antibody molecule that are capable of selectively reacting with a particular antigen or antigen family. Nonlimiting examples of such proteolytic and/or recombinant fragments include "Fab", "F(ab)₂", and "Fab'", with their proteolytic cleavage sites being shown in Figure 1; as well as "Fv". Recombinant techniques for producing Fv fragments are set forth in WO 88/01649, WO 88/06630, WO 88/07085, WO 25 88/07086 and WO 88/09344.

In this invention, "animals" is meant to include bovines, Porcine, rodents; and primates, including humans, and others.

30 "Expression vector" is given a functional definition of any DNA sequence which is capable of effecting expression of a specified DNA code in a suitable host is included in this term. As at present, such vectors are frequently in the form of plasmids; thus "plasmid" and "expression vector" are often used interchangeably. However, the invention is intended to include such other forms of expression vectors which serve equivalent functions and which may, from time to time, become known in the art.

35 By "transformation" is meant the introduction of DNA into a recipient host cell that changes the genotype and consequently results in a change in the recipient cell.

"Host cells" refers to cells which have been recombinantly transformed with vectors constructed using recombinant DNA techniques. As defined herein, the antibody or modification thereof produced by a host cell is by virtue of this transformation.

40 In descriptions of processes for isolation of antibodies from recombinant hosts, the terms "cell" and "cell culture" are used interchangeably to denote the source of antibody unless it is clearly specified otherwise. In other words, recovery of antibody from the "cells" may mean either from spun down whole cells, or from the cell culture containing both the medium and the suspended cells.

45 Abbreviations

Nucleic acids, amino acids, peptides, protective groups, active groups and similar moieties, when abbreviated, are abbreviated according to the IUPACIUB (Commission on Biological Nomenclature) or the practice in the fields concerned. The following are examples.

50

Reagents

EDTA: Ethylenediaminetetraacetic acid

55 SDS: Sodium dodecylsulfate

Nucleic Acids

RNA: Ribonucleic acid
DNA: Deoxyribonucleic acid

5

Nitrogenous Bases	
Purines	Pyrimidines
A: Adenine	T: Thymine
G: Guanine	C: Cytosine
	U: Uracil

10

Both DNA and RNA contain long chains of phosphoric acid, a sugar, and nitrogenous bases. DNA is a double stranded helix, wherein the sugar is 2-deoxyribose, whereas RNA is single stranded, wherein the sugar is D-ribose. The four nitrogenous bases which characterize DNA nucleotides are linked in complementary pairs by hydrogen bonds to form the double helix of DNA: adenine is linked to thymine; guanine is linked to cytosine. In RNA, uracil is substituted for thymine in the listed DNA pairs.

Amino Acids

20

Gly: glycine
Ala: alanine
Phe: phenylalanine
Tyr: tyrosine
25 Val: valine
Leu: leucine
Ile: isoleucine
Ser: serine
Asp: aspartic acid
30 Lys: lysine
Arg: arginine
His: histidine
Thr: threonine
Cys: cysteine
35 Met: methionine
Glu: glutamic acid
Trp: tryptophan
Pro: proline
Asn: asparagine
40 Gln: glutamine

Variable Region

The DNA encoding the heavy chain consists of a V_H gene sequence, a D_H gene sequence, and a J_H gene sequence. The DNA encoding the light chain consists of a V_L gene sequence, and a J_L gene sequence.

50

V_H Gene Sequence

The present invention is directed to selected chimeric antibodies having the V_H region encoded by a DNA sequence derived from a germline gene that is specifically reactive against TAG72 ($V_H\alpha$ TAG), the sequence of which is set forth in Figure 2. The chimeric antibodies are selected on the basis of their ability to bind TAG72, namely wherein the variable region binds to TAG72 at least 25 percent greater than the variable region of B72.3 binds to TAG72. Generally, the binding affinities of the chimeric antibody and B72.3 are measured by the same technique. Exemplary techniques for measuring antibody binding affinity are set forth in the following references: Scatchard G., *Annals of the N.Y. Acad. of Sciences* 51, 660 (1949); Steward, M.W., and Petty, R.E., *Immunology* 23, 881 (1972); Muraro, R., et al., *Cancer Research*

48, 4588 (1988); and Heyman. B., *J. of Immunol. Methods* 68, 193-204 (1984).

A skilled artisan will appreciate that, as a result of the present invention, namely the nucleotide sequence of (and amino acid sequences encoded by) the $V_H\alpha$ TAG, the present invention is intended to include effectively homologous nucleotide sequences and corresponding amino acid sequences.

5 "Effectively homologous" refers to identity or near identity of nucleotide or amino acid sequences. Thus, in this disclosure it will be understood that minor sequence variation can exist within homologous sequences and that any sequences exhibiting at least 80% homology are deemed equivalent.

Homology is expressed as the fraction or percentage of matching bases (or amino acids) after two sequences (possibly of unequal length) have been aligned. The term alignment is used in the sense defined by Sankoff and Kruskal in Chapter One of their book, The Time Warps, String Edits, and Macromolecules: The Theory and Practice of Sequence Comparison, Addison-Wesley, Reading, MA, (1983). Roughly, two sequences are aligned by maximizing the number of matching bases (or amino acids) between the two sequences with the insertion of a minimal number of "blank" or "null" bases into either sequence to bring about the maximum overlap.

15 As is understood in the art, nucleotide mismatches can occur at the third or wobble base in the codon without causing amino acid substitutions in the final polypeptide sequence. Also, minor nucleotide modifications (e.g., substitutions, insertions or deletions) in certain regions of the gene sequence can be tolerated and considered insignificant whenever such modifications result in changes in amino acid sequence that do not alter functionality of the final product. It has been shown that chemically synthesized copies of whole, or parts of, gene sequences can replace the corresponding regions in the natural gene without loss of gene function.

Homologs of specific DNA sequences may be identified by those skilled in the art using the test of cross-hybridization of nucleic acids under conditions of stringency as is well understood in the art [as described in Nucleic Acid Hybridization, Hames and Higgins (eds.), IRL Press, Oxford, UK (1985)]. Given two sequences, algorithms are available for computing their homology: e.g. Needleham and Wunsch, *J.Mol.Biol.*, 48, 443-453 (1970); and Sankoff and Kruskal (cited above) pgs. 23-29. Also, commercial services are available for performing such comparisons, e.g. Intelligenetics, Inc. (Palo Alto, CA).

30 D_H and J_H Gene Sequences

The D_H and J_H gene segments exist in various types, although the type of D or J gene segment selected is not critical to the invention. That is the D_H and J_H may be derived from any animal. Preferred animals include mice and humans. Obviously, human D_H and/or J_H gene segments are particularly preferred, but the invention is not so limited if a D or J gene segment from another animal species provides an important property, i.e., increased binding to TAG72.

Exemplary murine D_H and J_H sequences are set forth in "Organization, Structure, and Assembly of Immunoglobulin Heavy Chain Diversity DNA Segments", Kurosawa and Tonegawa, *J.Exp.Med.* 155, 201 (1982); and "Sequences of the Joining Region Genes for Immunoglobulin Heavy Chains and Their Role in Generation of Antibody Diversity" Gough and Bernard, *Proc.Natl.Acad. Sci.(USA)*, 78, 509 (1981).

40 Exemplary human D_H and J_H sequences are set forth in an article titled "Human Immunoglobulin D Segments encoded in Tandem Multigenic Families" by Siebenlist et al. in *Nature* 294, 631 (1981); and exemplary human J_H sequences are set forth in "Structure of the Human Immunoglobulin μ Locus: Characterization of Embryonic and Rearranged J and D Genes" by Ravetch et al., *Cell*, 27, 583 (1981).

45

V_L and J_L Gene Sequences

Generally, any V_L and J_L gene sequences may be employed that encodes a portion of a V_L which is complementary to the V_H encoded by a nucleotide sequence effectively homologous to V_H α TAG. By "complementary" means a V_L that binds to the V_H and which yields an antibody variable region having a binding affinity of at least 25% more than B72.3, as measured by any standard technique for measuring binding affinity constants.

55 The type of V_L and J_L gene segment selected is not critical to the invention. That is the V_L and J_L may be derived from any animal. Preferred animals include mice and humans. Obviously, human V_L and/or J_L gene segments are particularly preferred, but the invention is not so limited if a J_L gene segment from another species provides an important property, i.e., increased binding to TAG72.

Murine J_L sequences are set forth in an article titled "The nucleotide Sequence of a 5,5-kilobase DNA

Segment Containing the Mouse Kappa Immunoglobulin J and C Region Genes" by Max. et al. in *J.Biol. Chem.* 256, 5116-5120 (1981). Human J_L sequences are set forth in an article titled "Evolution of Human Immunoglobulin K J Region Genes" by Heiter et al. in *The Journal of Biological Chemistry* 357(2), 1516-1522 (1982).

5

Derivation of Variable Regions

Given the above teachings, it now becomes possible to derive numerous specific embodiments of antibody variable regions within the scope of the present invention, i.e., having effectively homologous V_H sequences to V_HαTAG and binding to TAG72 at least 25% greater than the variable region of B72.3 binds to TAG72, with the binding affinities of the antibody and B72.3 being measured by the same technique. Several possible techniques are set forth below.

15

Naturally-Produced Variable Regions

In response to an immunogen, TAG72, an immunized animal will expand selected antibody producing B cells. The variable region of antibodies produced by the B cells will be encoded by rearranged germline heavy and light chain DNA. For example, the rearranged germline heavy chain will include the V, D, and J gene segments including the leader sequence, as well as any introns which may be subsequently removed. The light chain coding DNA will include the V and J gene segments including the leader sequence, as well as any introns which may be subsequently removed.

Variability may result from somatic mutations occurring in a B cell during productive rearrangement of the V_HαTAG. These somatic mutations are nucleotide changes that may or may not result in an amino acid change that alters the activity toward TAG72 of the productively rearranged V_H.

Screening Techniques

30

Monoclonal or polyclonal antibodies may be screened to determine which of said antibodies selectively bind to TAG72. Such screening may be accomplished by any of a number of well-known procedures, such as solid-phase radioimmunoassay, enzyme-linked immunosorbent assays, rosetting assays and blocking assays. The above-described procedures are well-known in the art.

The nucleotide sequences of encoding variable regions of antibodies produced from the productive rearrangement of the V_HαTAG have now been obtained. In addition to the nucleotide sequence of V_HαTAG, Figure 2 also shows the nucleotide sequences encoding the heavy chain variable regions of CC46, CC49, CC83 and CC92 antibodies, respectively. Figure 3 shows the amino acid sequences of V_HαTAG V_H, CC46 V_H, CC49 V_H, CC83 V_H, and CC92 V_H, corresponding to the nucleotide sequences set forth in Figure 2. A comparison of the nucleotide and amino acid sequences of V_HαTAG V_H, CC46 V_H, CC49 V_H, CC83 V_H and CC92 V_H shows a most striking feature, namely that the chains have extraordinary similarity.

The relative similarity of the DNA encoding the CC46 V_H, CC49 V_H, CC83 V_H, and CC92 V_H regions, particularly in the 5' flanking segment, proves that those DNA sequences are derived from V_HαTAG. Somatic mutations occurring during productive rearrangement of the V_H region gene to be expressed in a B cell give rise to some nucleotide changes that may or may not result in a homologous amino acid change between two productively rearranged V_HαTAG producing hybridomas.

The nucleotide sequences and corresponding amino acid sequences of CC49 V_L are shown in Figures 4a and 4b, respectively. The nucleotide sequences and corresponding amino acid sequences of CC83 V_L are shown in Figures 5a and 5b, respectively. The nucleotide sequences and corresponding amino acid sequences of CC92 V_L are shown in Figures 6a and 6b, respectively.

Probe Techniques

Other antibodies encoded by DNA derived from V_HαTAG may be derived by using V_HαTAG as a hybridization probe. Generally, a probe made from the DNA or RNA of the V_HαTAG or rearranged genes containing the recombinant V_HαTAG could be used by those skilled in the art to find homologous genes in unknown hybridomas. Such homologous antibodies will have a DNA sequence whose mRNA hybridizes

with the probe of all or a part of the $V_{H\alpha}$ TAG germline gene and its flanking regions. By "flanking regions" is meant to include those DNA sequences from the 5' end of the $V_{H\alpha}$ TAG to the 3' end of the upstream gene, and from 3' end of the $V_{H\alpha}$ TAG to the 5' end of the downstream gene.

5

Rationally Synthesized Variable Regions

A yet further approach is the rational synthesis of altered variable regions of the antibodies disclosed herein, as well as antibodies discovered via probing. Such an approach has several potential advantages.

10 Namely, a researcher would not have to screen immunized host animals attempting first to cull those antibodies which bind to TAG and next to cull those antibodies which specifically have V_H regions encoded by DNA derived from $V_{H\alpha}$ TAG.

15 Mutagenic Techniques

The V_H and/or V_L gene segments may be "altered" by mutagenesis. Exemplary techniques include the addition, deletion, or nonconservative substitution of a limited number of various nucleotides or the conservative substitution of many nucleotides, provided that the proper reading frame is maintained.

20 Substitutions, deletions, insertions or any subcombination may be combined to arrive at a final construct. Since there are 64 possible codon sequences but only twenty known amino acids, the genetic code is degenerate in the sense that different codons may yield the same amino acid. However, the code is precise for each amino acid; thus there is at least one codon for each amino acid, i.e., each codon yields a single amino acid and no other. It will be apparent that during translation, the proper reading frame must be maintained in order to obtain the proper amino acid sequence in the polypeptide ultimately produced.

Techniques for additions at predetermined amino acid sites having a known sequence are well known. Exemplary techniques include oligonucleotide-mediated, site-directed mutagenesis and polymerase chain reaction.

Techniques for deletions at predetermined amino acid sites having a known Sequence are well known. 30 Exemplary techniques include oligonucleotide-mediated site-directed mutagenesis and the polymerase chain reaction.

Techniques for substitutions at predetermined amino acid sites having a known sequence are well known. Exemplary techniques include site-directed mutagenesis, and the polymerase chain reaction technique.

35 Oligonucleotide site-directed mutagenesis in essence involves hybridizing an oligonucleotide coding for a desired mutation with a single strand of DNA containing the region to be mutated and using the single strand as a template for extension of the oligonucleotide to produce a strand containing the mutation. This technique, in various forms, is described by Zoller, M.J. and Smith, M., *Nuc. Acids Res.* 10, 6487-6500 (1982); Norris, K., Norris, F., Christiansen, L. and Fahl, N., *Nuc. Acids Res.* 11, 5103-5112 (1983); Zoller, M.J. and Smith, M., *DNA* 3, 479-488 (1984); Kramer, W., Schughart, K. and Fritz, W. J., *Nuc. Acids Res.* 10, 6475-6485 (1982).

Polymerase chain reaction (PCR) in essence involves exponentially amplifying DNA in vitro using sequence specified oligonucleotides. The oligonucleotides can incorporate sequence alterations if desired. The polymerase chain reaction technique is described in Mullis and Faloona, *Meth.Enz.* 155, 335-350 (1987). Examples of mutagenesis using PCR are described in Higuchi et al., *Nucl. Acids Res.* 16, 7351-7367 (1988), Ho et al., *Gene* 77, 51-59 (1989), and "Engineering Hybrid Restriction Genes Without the Use of Restriction Enzymes: Gene Splicing by Overlap Extension", Horton et al., *Gene* 77, 61 (1989).

Alteration of the antibody variable regions may be of particular use in the therapeutic use of monoclonal antibodies. At present, when a chimeric antibody comprising a complete mouse variable domain is injected 50 into a human, the human body's immune system recognizes the mouse variable domain, albeit less than a complete murine antibody, as foreign and produces an immune response thereto. Thus, on subsequent injections of the mouse antibody or chimeric antibody into the human, its effectiveness is considerably reduced by the action of the body's immune system against the foreign antibody. Consequently, alterations of the murine V_H and V_L regions may reduce the human immune response to the altered antibody.

55

Recombinant Techniques

The antibodies may be constructed by recombinant techniques. In other words, because the nucleotide sequences of various V_H - and V_L -encoding regions are now provided, a skilled artisan could *in vitro* produce a complete gene coding for the heavy and light chain variable regions.

The constructed gene may be engineered in which selected D_H and J_H gene segments are in functional combination with a selected V_H gene segment, i.e., the $V_H\alpha$ TAG segment, or the V_H gene segment of CC49 or CC83.

For example, the constructed heavy chain coding DNA will include D_H and J_H gene sequences which are contiguous with the 3' end of the germline $V_H\alpha$ TAG gene segment, thereby completing the CDR3 and framework (FR) 4 of the V_H domain. A leader sequence may be present but may be subsequently removed.

Depending upon the light chain employed, it may also be necessary to provide a constructed light chain coding DNA. Such a DNA gene will comprise a V_L gene segment in functional combination, e.g., contiguous with a J_L gene segment, including the leader sequence which may be subsequently removed. The J_L gene segment will vary depending upon whether the light chain is of the lambda or kappa system. The J region sequence is contiguous with the end of the V_L exon to complete FR 4 of the V_L domain. Such a construction may be carried out by the techniques used to construct the V_H gene.

The constructed gene may be engineered by conventional recombinant techniques for example, to provide a gene insert in a plasmid capable of expression. Thereafter, the plasmids may be expressed in host cells. Exemplary recombinant biological techniques are set forth below.

In providing a fragment encoding either the light chain or heavy chain variable region, it will usually be desirable to include all or a portion of the intron downstream from the J region, particularly where the variable region is derived from the host in which the fused gene is to be expressed. Where the intron is retained, it will be necessary that there be functional splice acceptor and donor sequences at the intron termini. The intron between the J and the constant region of the fused gene may be primarily the intron sequence associated with (1) the constant region, (2) the J domain, or (3) portions of each. The last may be a matter of convenience where there is a convenient restriction site in the introns from the two sources. It may be necessary to provide adapters to join the intron to the constant region. In some instances, all or a portion of the intron may be modified by deletion, nucleotide substitution(s) or insertion, to enhance ease of manipulation, expression, or the like. Preferably, a sufficient amount of the intron should be present to contain an enhancer that is functionally active with the naturally-occurring promoter.

Alternatively, it may be desirable to have the fused gene free of the intron between the J gene and C gene. Thus, the 3' terminus of the J gene will be adjacent to the 5' terminus of the C gene. One can use an exonuclease and, by employing varying periods of digestion, one can provide for varying 3'-termini, which can then be used for linking to the constant region and selection made for a functional product in a variety of ways; or by splicing with overlap extension using polymerase chain reaction technology, see Horton et al., *supra*. In this case, an artificial promoter, which does not need to be functionally active with an enhancer, will generally be utilized.

In one preferred embodiment, the genes encoding the V_H and V_L regions may be altered by replacing at least parts of the complementarity determining regions (CDRs) in the light or heavy chain variable domains of the antibody with analogous parts of CDRs from an antibody of different specificity. An exemplary technique replacing the CDRs is taught in European Published Patent Application 0 239 400, by Gregory Winter; and in PCT application Wo 88/09344, by Huston et al. In an altered antibody of the present invention, only the CDRs of the antibody will be foreign to a human body, and this should minimize side effects if used for human therapy. However, human and mouse framework regions have characteristic features which distinguish human from mouse framework regions. Thus, an antibody comprised of mouse CDRs in a human framework may well be no more foreign to the body than a genuine human antibody.

The nucleotide sequences corresponding to the V_H amino acid sequences of the $V_H\alpha$ TAG, CC46, CC49, CC83 and CC92, as well as of the CC49, CC83 and CC92 V_L gene segments are provided. Consequently, it is envisaged that the CDRs from the antibodies of the present invention could be grafted onto the framework regions of a human antibody.

Generally, the CDR regions from a human V_H or V_L domain may be replaced by CDRs from the V_H or V_L regions of antibodies of the present invention. Exemplary human antibodies from which the framework portions may be used include human plasmacytoma NEWM, [Jones et al., "Replacing the complementarity-determining regions in a human antibody with those from a mouse", *Nature* 321, 522-525 (1986)], publicly available from Dr. Greg Winter; and various other human V_H and V_L genes available from Dr. Terence Rabbitts, both researchers being from the Medical Research Council, 20 Park Crescent, London, W1N 4AL.

The determination as to what constitutes a CDR and what constitutes a framework region may be made on the basis of the amino-acid sequences of a selected Ig as indicated in Kabat et al., Sequences of Proteins of Immunological Interest. Fourth Edition (1987), U.S. Dept. of Health and Human Services, NIH.

The four framework regions largely adopt a β -sheet conformation and the CDRs form loops connecting, and in some cases forming part of, the β -sheet structure.

Moreover, not all of the amino-acid residues in the loop regions are solvent accessible and in one case, amino-acid residues in the framework regions are involved in antigen binding. [Amit, A.G., Mariuzza, R.A., Phillips, S.E.V. and Poljak, R.J., *Science* 233, 747-753, (1986)].

It is also known that the variable regions of the two parts of an antigen binding site are held in the correct orientation by inter-chain, non-covalent interactions. These may involve amino-acid residues within the CDRs.

Thus, in order to transfer the antigen binding capacity of one variable domain to another, it may not be necessary to replace all of the CDRs with the complete CDRs from the donor variable region. It may be necessary only to transfer those residues which are necessary for the antigen binding site, and this may involve transferring framework region residues as well as CDR residues.

It is thus clear that merely replacing one or more CDRs with complementary CDRs may not always result in a functional altered antibody. However, given the explanations set forth in European Published Patent Application 0 239 400, it will be well within the competence of those skilled in the art, either by carrying out routine experimentation or by trial and error testing, to obtain a functional altered antibody.

Preferably, the variable domains in both the heavy and light chains are altered by at least partial CDR replacement and, if necessary, by partial framework region replacement and sequence changing. Although the CDRs may be derived from an antibody of the same class or even subclass as the antibody from which the framework regions are derived, it is envisaged that the CDRs will be derived from an antibody of different class and preferably from an antibody from a different species.

Composite Variable Regions

Generally, the V gene encoding the V_L is the same V gene which encodes the V_L naturally combined with the V_H of choice. For example, the V gene which encodes the V_L regions of CC49 and CC83 are beneficially used when employing the V gene which encodes the V_H of CC49 and CC83, respectively.

Surprisingly, because the V_H regions of the antibodies of the present invention are encoded by V_H genes derived from V_H αTAG, composite antibodies may be beneficially formed. In other words, the V_H region of one antibody of the present invention may suitably be combined with the V_L region of another antibody of the present invention. Although the amino acid sequences of the CC49 and CC83 heavy chains are superficially close, it would be expected that a change of a few or even one amino acid would drastically affect the binding function of the antibody, i.e., the resultant antibodies are generally presumed to be a non-specific immunoglobulin (NSI), i.e., lacking in antibody character, (see European Published Patent Application 0 125 023).

Quite surprisingly, it has now been found that an antibody having the requisite V_H of this invention, need not be recombined only with a V_L from the same naturally occurring animal antibody. For instance, as set forth in the examples, it is possible to produce a chimeric antibody having a heavy chain with a V_H from CC83 and a light chain with a V_L from CC49, wherein the composite antibody thus formed has a binding specificity 25% greater than the binding affinity of B72.3 to TAG72.

Constant Regions

Heavy Chain (C_H) Domain

The C_H domains may be of various human isotypes, i.e., IgG (e.g., IgG₁, IgG₂, IgG₃ and IgG₄), IgA, IgD, IgM, as well as the various subtypes of the individual groups.

For a discussion of the human γ_1 , see Ellison et al., "The nucleotide sequence of a human immunoglobulin C-gamma-1 gene", *Nucl. Acid Res* 10, 4071-4079 (1982); Takahashi et al., "Structure of human immunoglobulin gamma genes: Implications for evolution of a gene family", *Cell* 29, 671-679 (1982). For a discussion of the human gamma 2 (γ_2), see Krawinkel et al., "Comparison of the hinge-coding segments in human immunoglobulin gamma heavy genes and the linkage of the gamma 2 and gamma 4 subclass genes", *EMBO J* 1, 403-407 (1982); Ellison et al., "Linkage and sequence homology of two human immunoglobulin gamma heavy chain constant region genes", *Proc. Nat. Acad. Sci. (USA)* 79, 1984-1988 (1982); Takahashi et al., *infra*. For a discussion of human gamma 3 (γ_3), see Krawinkel et al. *infra*, and

Takahashi et al., *intra*. For a discussion of human gamma 4 ($\gamma 4$), see Ellison et al. "Nucleotide sequence of a human immunoglobulin C-gamma-4 gene, *DNA* 1, 11-18 (1981), Krawinkel et al. *intra*, and Takahashi et al., *intra*.

For a discussion of the human mu, see Rabbitts et al., Human Immunoglobulin Heavy Chain Genes: Evolutionary Comparisons of $C\mu$, $C\delta$, and $C\gamma$ genes and Associated Switch Sequences", *Nucl. Acid Res.* 9, 4509-45024.

For a discussion of the human alpha, see Flanagan et al., "Mechanisms of Divergence and Convergence of the Human Immunoglobulin alpha 1 and alpha 2 Constant Region Gene Sequences", *Cell* 36, 681-688 (1984).

For a discussion of the human delta, see White et al., "Human Immunoglobulin D: Genomic Sequences of the Delta Heavy Chain", *Science* 228, 733-737 (1985).

For a discussion of the human epsilon, see Max et al., "Duplication and Deletion in the Human Immunoglobulin ϵ Genes", *Cell* 29, 691-699 (1982).

15

Light Chain (C_L) Domain

The C_L domain may be human kappa (κ) or human lambda (λ).

For a discussion of the human κ , see "Cloned Human and Mouse Kappa Immunoglobulin Constant and J Region Genes Conserve Homology in Functional Segments", Heiter et al., *Cell* 22, 187-207, November (1980)

For a discussion of the human λ , see "Processed Genes: A Dispersed Human Immunoglobulin Gene Bearing Evidence of RNA-Type Processing", Hollis et al., *Nature* 296, 321-325 (1982).

The C_H and/or C_L gene segments may be "altered" by mutagenesis. Exemplary techniques include the addition, deletion, or nonconservative substitution of a limited number of various nucleotides or the conservative substitution of many nucleotides, provided that the proper reading frame is maintained. In addition, entire domains of the protein can be altered, for example, by substituting C_H2 for C_H3 . This substitution is made at the DNA level by inserting, deleting or substituting entire exons of sequence.

30

Construction of Antibodies

Immunizations

35

The first technique for producing antibodies, whether monoclonal or polyclonal, having V_H regions encoded by DNA derived from $V_H\alpha$ TAG is to immunize a host animal with purified TAG72. Exemplary protocols for immunizing a host animal with TAG72 are set forth in U.S. Patents 4,522,918 and 4,612,282, using a human breast carcinoma extract as the immunogen; and United States Patent Application 7-073,685 (which is available to the public), using TAG72 purified with B72.3 as the immunogen.

Thereafter, monoclonal or polyclonal antibodies produced from the immunization protocol are screened to determine which of said antibodies selectively bind to TAG72. Such screening may be accomplished by any of a number of well-known procedures, such as solid-phase radioimmunoassay, enzyme-linked immunosorbent assays, rosetting assays and blocking assays. The above-described procedures are well-known in the art.

45

Synthesis of Amino Acid Sequences

Immunoglobulins of the present invention can be synthesized from their constituent amino acids. Suitable techniques are the Merrifield solid phase method, as described in *J. Amer. Chem. Soc.* 85, 2149-2154 (1963). This solid phase method for synthesizing sequences of amino acids is also described on pages 1-4 of a book by Stewart and Young, Solid Phase Peptide Synthesis (W. H. Freeman and Co., San Francisco, 1969).

55

Construction of DNA

DNA Encoding the V_H and V_L

The DNA encoding the antibody heavy and light chains may be obtained from a variety of sources known to those of ordinary skill in the art, for example, genomic DNA, cDNA, synthetic DNA, or a combination thereof.

Cells coding for the desired sequence may be isolated, and genomic DNA fragmented by one or more restriction enzymes. The genomic DNA may or may not include naturally-occurring introns. The resulting fragments may then be cloned and screened using a heavy chain J region (J_H) probe for the presence of the DNA sequence coding for the polypeptide sequence of interest. DNA fragments isolated by preparative agarose gel electrophoresis are ligated. Recombinant plaques of the libraries are screened with a mouse J_H probe.

The DNA may also be obtained from a cDNA library. Messenger RNA coding for heavy or light chain is isolated from a suitable source, either mature B cells or a hybridoma culture, employing standard techniques of RNA isolation, and the use of oligo-dT cellulose chromatography to segregate the poly-A mRNA. The poly-A mRNA may, further, be fractionated to obtain sequences of sufficient size to code for the amino acid sequences in the light or heavy chain of the desired antibody as necessary.

A cDNA library is then prepared from the mixture of mRNA using a suitable primer, preferably a nucleic acid sequence which is characteristic of the desired cDNA. Such a primer may be synthesized based on the amino acid sequence of the antibody. In the alternative cDNA from unfractionated poly-A mRNA from a cell line producing the desired antibody or poly-dT may also be used. The resulting cDNA is optionally size fractionated on polyacrylamide gel and then extended with, for example, dC residues for annealing with pBR322 or other suitable cloning vector which has been cleaved by a suitable restriction enzyme, such as Pst I, and extended with dG residues. Alternative means of forming cloning vectors containing the cDNA using other tails and other cloning vector remainder may, of course, also be used but the foregoing is a standard and preferable choice. A suitable host cell strain, typically *Escherichia coli* (*E. coli*), is transformed with the annealed cloning vectors, and the successful transformants identified by means of, for example, ampicillin or tetracycline resistance or other phenotypic characteristics residing on the cloning vector plasmid.

Successful transformants are picked and transferred to microtiter dishes or other support for further growth and preservation. Nitrocellulose filter imprints of these growing cultures are then probed with suitable nucleotide sequences containing bases known to be complementary to desired sequences in the cDNA. Several types of probe may be used, preferably synthetic single stranded DNA sequences labeled by kinasing with γ -³²P ATP. The cells fixed to the nitrocellulose filter are lysed, the DNA denatured, and then fixed before reaction with kinased probe. Clones which successfully hybridize are detected by contact with a photoplate, then plasmids from the growing colonies isolated and sequenced by means known in the art to verify that the desired portions of the gene are present.

The desired gene fragments are excised and tailored to assure appropriate reading frame with the control segments when inserted into suitable expression vectors. Typically, nucleotides are added to the 5' end to include a start signal and a suitably positioned restriction endonuclease site.

Because the inventors have provided the nucleotide sequences of the V_H TAG, the DNA also may be synthetically synthesized, for example, using an Applied Biosystems™ Model 380A DNA Synthesizer, and constructed by standard techniques.

Finally, an exemplary technique for utilizing combination of the above techniques is by splicing with overlap extension using polymerase chain reaction technology, see Horton et al., *supra*. Generally, a synthetically synthesized primer, having a so-called "wagging tail", may be inserted with a selected sequence, for example genomic DNA. Thereafter, the sequences are amplified and spliced together.

DNA Encoding the C_H and C_L

The DNA fragment encoding the amino acid sequence of the human constant region may be obtained by screening the chromosomal DNA of cells producing human immunoglobulin.

Vectors

The desired DNA fragment may be positioned in a biologically functional expression vehicle which may contain appropriate control sequences not present in the selected DNA fragment. By "biologically func-

tional" is meant that the expression vehicle provides for replication and/or expression in an appropriate host, either by maintenance as an extrachromosomal element or by integration into the host genome. A large number of vectors are available or can be readily prepared, and are well-known to skilled artisans.

5 A number of plasmids, such as those described in European Published Patent Appins. 0036776, 0048970 and 0051873, have been described which already contain a promoter in reading frame with the gene and compatible with the proposed host cell.

The vectors and methods disclosed herein are suitable for use over a wide range of microorganisms, either prokaryotic or eukaryotic, which are susceptible to transformation. The plasmid will be capable of replicating in the microorganism, particularly a bacterium.

10 In general, plasmid vectors containing the appropriate promoters, which can be used by the microbial organism for expression of its own protein, also contain control sequences, ribosome binding sites, and transcription termination sites. Generally, the replicon and control sequences which are derived from species compatible with the host cell are used in connection with these hosts.

15 Smaller or larger SV40 fragments may also be used, provided there is included the approximately 250 base pair (bp) sequence extending from the Hind III site toward the Pvu II site located in the viral origin of replication. Further, it is also possible, and often desirable, to utilize promoter or control sequences normally associated with the desired gene sequence, provided such control sequences are compatible with the host cell systems.

20 Finally, the plasmid should desirably have a gene, a marker gene, that is capable of providing a phenotypical property which allows for selection of host cells containing the expression vector. Particularly useful is a gene that provides for survival selection. Survival selection can be achieved by providing resistance to a growth inhibiting substance or providing a growth factor capability to a bacterium deficient in such capability.

25 In general, prokaryotes are preferred. For example, pBR322 a plasmid derived from an *E. coli* species [Bolivar, et al., *Gene* 2, 95 (1977)] is particularly useful. pBR322 contains genes for ampicillin and tetracycline resistance and thus provides an easy means for identifying transformed cells.

30 While these prokaryotes are the most commonly used, other microbial strains which may be used include *E. coli* strains such as *E. coli* B, *E. coli* K12 strain 294 (ATCC No. 31446) and *E. coli* X1776 (ATCC No. 31537), *E. coli* W3110 (F⁻, γ⁻, prototrophic, ATCC No. 27325), bacilli such as *Bacillus subtilis*, and other enterobacteriaceae such as *Salmonella typhimurium* or *Serratia marcescens*, and various *Pseudomonas* species may be used. These examples are intended to be illustrative only.

In addition to prokaryotes, eukaryotic microbes may also be used. *Saccharomyces cerevisiae*, or common baker's yeast, is the most commonly used among eukaryotic microorganisms although a number of other strains are commonly available.

35 For expression in *Saccharomyces*, the plasmid YRp7, for example, [Stinchcomb, et al., *Nature* 282, 39 (1979); Kingsman et al., *Gene* 7, 141 (1979); Tschemper, et al., *Gene* 10, 157 (1980)] is commonly used. This plasmid already contains the *trp1* gene which provides a selection marker for a mutant strain of yeast lacking the ability to grow in tryptophan, for example ATCC No. 44076 or PEP4-1 [Jones, *Genetics* 85, 12 (1977)]. The presence of the *trp1* lesion as a characteristic of the yeast host cell genome then provides an effective environment for detecting transformation by growth in the absence of tryptophan.

40 Any plasmid vector containing a yeast-compatible promoter, origin of replication and termination sequence is suitable for use in yeast. Suitable promoting sequences in yeast vectors include the promoters for 3-phosphoglycerate kinase [Hitzeman, et al., *J. Biol. Chem.* 255, 2073 (1980)] or other glycolytic enzymes [Hess, et al., *J. Adv. Enzyme Reg.* 7, 149 (1968); Holland et al., *Biochemistry* 17, 4900 (1978)].

45 For use in mammalian cells, the control functions on the expression vectors are often provided by viral material. For example, commonly used promoters are derived from polyoma, Adenovirus 2, and most frequently Simian Virus 40 (SV40). The early and late promoters of SV40 virus are particularly useful because both are obtained easily from the virus as a fragment which also contains the SV40 viral origin of replication [Fiers, et al., *Nature* 273, 113 (1978)].

50 For example, pSV2neo contains a gene for ampicillin resistance neomycin resistance, which is under the control of an SV40 promoter. Thus, pSV2neo provides easy means for identifying cells transformed with genes for both the animal variable region and human constant region.

65 Preparation of Chimeric DNA

The genes coding for the heavy chain or the light chain will be constructed by joining the 5'-end of a DNA fragment which encodes the constant region to the 3' end of a DNA fragment which encodes the

variable region. The DNA sequence coding for the antibody amino acid sequence may be obtained in association with the promoter and replication site from genomic DNA. To the extent that the host cells recognize the transcriptional regulatory and translational initiation signals associated with the heterologous genes, then the region 5' and 3' of the variable region coding sequence may be retained with the variable region coding sequence and employed for transcriptional and translational initiation regulation. The non-coding region 3' to the constant region may be retained for its transcriptional termination regulatory sequences, such as termination and polyadenylation. In referring to 5' or 3' for a double strand, it is intended to mean the direction of transcription, with 5' being upstream from 3'.

The intron sequence between the variable region for each respective chain may be joined to the corresponding human constant DNA fragment at any convenient restriction site. In providing a fragment encoding the variable region, it will usually be desirable to include a portion of the intron downstream from the J region. Where the intron is retained, it will be necessary that there be functional splice acceptor and donor sequences at the intron termini. The contiguous non-coding region 5' to the variable region will normally include those sequences involved with initiation of transcription and translation, such as the TATA box, capping sequence and CAAT sequence. Usually, the 5'-non-coding sequence does not exceed about 1-2 kilo bases (kb).

An enhancer sequence should exist between the J region and the constant region. The enhancer employed may be the enhancer of either (1) the animal V region or the (2) the human constant region.

By retaining the 3'-region naturally contiguous to the DNA sequence coding for the constant region, the transcriptional termination signals may be provided for the gene. Where the transcriptional termination signals are not satisfactorily functional in the expression host cell, then a 3' region functional in the host cell may be substituted. Conveniently, the non-coding 3' region may be obtained from a non-coding contiguous 3' region of a constant region from the expression host. The 3'-non-coding region may be joined to the constant region by any of the means described previously for manipulation and ligation of DNA fragments. This region could then be used as a building block in preparing the gene.

Preparation of Expression Vehicles

Construction of suitable expression vehicles containing the desired coding and control sequences may be produced as follows. The termini of the vectors and DNA fragments may then be religated to form the desired expression vehicles. The methods employed are not dependent on the DNA source, or intended host.

DNA fragments coding for the light chain and heavy chain may be inserted into separate expression vehicle, or into the same vector. Preferably, the fused genes encoding the light and heavy chimeric chains are assembled in two different expression vectors which can be used to cotransform a recipient cell, either concurrently or sequentially.

The means for insertion of the DNA fragments containing the chimeric genes into expression vectors includes using restriction endonucleases. "Restriction endonucleases" (or "restriction enzymes") are hydrolytic enzymes capable of catalyzing site-specific cleavage of DNA molecules. The locus of restriction endonuclease action is determined by the existence of a specific nucleotide sequence. Such a sequence is termed the recognition site for the restriction endonuclease. Many restriction endonucleases from a variety of bacterial species have been isolated and characterized in terms of the nucleotide sequence of their recognition sites. Some restriction endonucleases hydrolyze the phosphodiester bonds on both strands at the same point, producing blunt ends. Others catalyze hydrolysis of bonds separated by a few nucleotides from each other, producing free single stranded regions at each end of the cleaved molecule. Such single stranded ends are self-complementary, hence cohesive, and may be used to rejoin the hydrolyzed DNA. Exemplary restriction enzymes include *Aat* II, *Bam* HI, *Eco* RI, *Hind* III, *Nde* I, *Spe* I, *Xba* I, *Sac* I, *Bgl* II, *Pst* I, *Sal* I and *Pvu* II.

Additionally, the expression vector may have a polylinker inserted therein which has a plurality of unique restriction sites. By digestion of the expression vector with the appropriate restriction enzymes, the polylinker will be cleaved so that at least one DNA fragment containing the gene can be inserted. Where the polylinker allows for distinguishable termini, the DNA fragment can be inserted in a single orientation; were the termini are the same, insertion of the DNA fragment will result in plasmids having two different orientations.

Cleavage is performed by treating the plasmid with a restriction enzyme(s). In general, about 10 µg plasmid or DNA fragments is used with about 10 units of enzyme in about 100 µl of buffer solution. Endonuclease digestion will normally be carried out at temperatures ranging from 37° to 65° C, at a pH of

from 7 to 9. (Appropriate buffers and substrate amounts for particular restriction enzymes are specified by the manufacturers.) Time for the reaction will be from 1 to 18 hours.

It may be useful to prevent religation of the cleaved vector by pretreatment with alkaline phosphatase. Specific conditions are prescribed by the manufacturer.

5 After the restriction enzyme digest is complete, protein is removed by extraction with phenol and chloroform. The nucleic acid is recovered from the aqueous fraction (containing about 0.3M sodium acetate) by precipitation with about 2.5 volumes of ethanol.

Descriptions of methods of cleavage with restriction enzymes may be found in the following articles: Greene et al., Methods in Molecular Biology, Vol. 9, ed. Wickner, R. B., Marcel Dekker, Inc., New York, 10 "DNA Replication and Biosynthesis"; Mertz and Davis, *Proc. Nat. Acad. Sci.,(USA)*, 69, 3370 (1972).

Size separation of the cleaved fragments by agarose gel electrophoresis is readily performed to follow the course of the reaction. Once the digestion has gone to the desired degree, the endonuclease may be inactivated by heating above 65° C for about 10 minutes or organic extraction.

The desired fragment is then purified from the digest. Suitable purification techniques include gel 15 electrophoresis or sucrose gradient centrifugation.

The plasmid vehicle and foreign DNA fragments are then ligated with DNA ligase to recircularize. This process is referred to as annealing and DNA ligation.

An appropriately buffered medium containing the DNA fragments, DNA ligase, and appropriate cofactors is employed. The temperature employed will be between 25° to 4° C. When DNA segments hydrogen 20 bond, the DNA ligase will be able to introduce a covalent bond between the two segments. The time employed for the annealing will vary with the temperature employed, the nature of the salt solution, as well as the nature of the sticky ends or cohesive termini. Generally, the time for ligation may be from 5 to 18 hours. See Maniatis T., *Molecular Cloning*, Cold Spring Harbor, *supra*.

25

Host Cells

Thereafter, the expression vehicle constructs may be used to transform an appropriate host cell. Suitable host cells include cells derived from unicellular as well as multicellular organisms.

30 The chimeric immunoglobulin genes can be expressed in nonlymphoid cells such as bacteria or yeast.

Various unicellular microorganisms can be transformed, such as bacteria. That is, those unicellular organisms which are capable of being grown in cultures or fermentation. Since bacteria are generally the most convenient organisms to work with, bacteria will be hereinafter referred to as exemplary of the other unicellular organisms. Bacteria, which are susceptible to transformation, include members of the Enterobacteriaceae, such as strains of *Escherichia coli*; *Salmonella*; Bacillaceae, such as *Bacillus subtilis*; 35 *Pneumococcus*; *Streptococcus*, and *Haemophilus influenzae*.

When expressed in bacteria, the immunoglobulin heavy chains and light chains become part of inclusion bodies. The chains then must be isolated, purified and then assembled into functional immunoglobulin molecules.

40 In addition to prokaryotes, eukaryotic microbes, such as yeast cultures may also be used. *Saccharomyces cerevisiae*, or common baker's yeast is the most commonly used among eukaryotic microorganisms, although a number of other strains are commonly available. The presence of the *trp1* lesion as a characteristic of the yeast host cell genome provides an effective environment for detecting transformation by growth in the absence of tryptophan.

45 In addition to microorganisms, cultures of cells derived from multicellular organisms may also be used as hosts. In principle, any such cell culture is workable, whether from vertebrate or invertebrate culture, provided that the cell line is one that at least originally produced antibodies. Propagation of vertebrate cells in culture has become a routine procedure in recent years [*Tissue Culture*, Academic Press, Kruse and Patterson, editors (1973)]. Examples of such useful host cell lines are Sp2/0, VERO and HeLa cells, Chinese 50 hamster ovary (CHO) cell lines, and W138, BHK, COS-7 and MDCK cell lines.

The preferred recipient cell line is a plasmacytoma cell such as B lymphocytes or hybridoma cells. Plasmacytoma cells can synthesize, assemble and secrete immunoglobulins encoded by transformed immunoglobulin genes. Further, they possess the mechanism for glycosylation of the immunoglobulin. Sp2/0 is a preferred recipient cell because it is an immunoglobulin-nonproducing plasmacytoma cell. The 55 cell produces only immunoglobulin encoded by the transformed immunoglobulin genes. Plasmacytoma cells can be grown in culture or in the peritoneum of mice where secreted immunoglobulin can be obtained from ascites fluid.

Transformation of Host Cells

Transformation of host cells is accomplished as follows. The expression vehicle is linearized and the DNA is inserted into host cells for production of the antibody. Exemplary methods for inserting the DNA into host cells include electroporation, protoplast fusion, calcium phosphate-precipitation, or other conventional techniques, which use dextran sulfate, and PEG.

If cells without formidable cell wall barriers are used as host cells, transformation may be carried out by the calcium phosphate precipitation method as described by Graham and Van der Eb, *Virology*, 52, 546 (1978).

If prokaryotic cells or cells which contain substantial cell wall constructions are used, the preferred method of transformation is calcium treatment using calcium chloride as described by Cohen, F.N. et al, *Proc. Natl. Acad. Sci.(USA)* 69, 2110 (1972).

The host cells may be transformed via either co-transformation or targeted transformation.

For co-transformation, the genes coding for the light chain and heavy chain may be used to transform separate cell cultures, either of the same or of differing species; separate plasmids for light and heavy chain may be used to co-transform a single cell culture; or finally, a single expression plasmid containing both genes and capable of expressing the genes for both light and heavy chain may be transformed into a single cell culture.

In the targeted transformation technique, the host cells are transformed with genes encoding for the light chain, and the cells containing the light chain marker are selected. The light chain is found using cytochemical staining or possibly by detection of the light chain in the supernatant if it has been secreted. Cells selected to have the light chain are transformed with the heavy chain construct, and resultant cells additionally containing the heavy chain marker selected.

It is known that some immortalized lymphoid cell lines, such as plasmacytoma cell lines, in their normal state secrete isolated Ig light or heavy chains. Consequently, if such a cell line is transformed with the vector containing the chimeric heavy or light chain of the present invention, it will not be necessary to transform the cell line or another cell line with the other Ig chain, provided that the normally secreted chain is complementary to the variable domain of the Ig chain encoded by the vector initially used to transform the cell line.

Selection and Expression of Transformed Host Cells

Generally, after transformation of the host cells, the cells may be grown for about 48 hours to allow for expression of marker genes. The cells are then placed in a selective medium, where untransformed cells are killed, leaving only cells transformed with the DNA constructions.

Heavy and light chains or portions thereof, may be produced in isolation from each other and antibodies and fragments thereof may be obtained. Such preparations require the use of techniques to reassemble isolated chains.

The ability of the method of the invention to produce heavy and light chains or portions thereof, in isolation from each other offers the opportunity to obtain unique assemblies of immunoglobulins, Fab regions, and univalent antibodies. It is possible to recombine the heavy and light chains *in vitro*, disrupted by cleavage of only the interchain disulfides, and to regain antibody activity even without restoration of the inter-chain disulfides [see Edelman, G.M., et al., *Proc. Natl. Acad. Sci. (USA)* 50, 753 (1963)].

The transformed cells are grown under conditions appropriate to the production of the light chains and/or heavy chains, and assayed for heavy and/or light chain protein synthesis. Exemplary assay techniques include enzyme-linked immunosorbent assay (ELISA), radioimmunoassay (RIA), or fluorescence-activated cell sorter analysis (FACS), immunohistochemistry and the like.

The binding affinity of monoclonal antibodies for TAG72 is determined by means well known in the art (see Heyman, B. et al. *J. Immunol. Methods* 68, 193-204 (1984) and as described in detail in the Examples provided hereinafter).

Selected positive cultures are subcloned in order to isolate pure transformed colonies. A suitable technique for obtaining subclones is via the limited dilution method taught by McKeara in *Monoclonal Antibodies*, Plenum Press, N.Y. (1980).

Hybridomas that produce such chimeric antibodies may be grown using known procedures. The transformed cells can secrete large quantities of the light chains and/or heavy chains by culture *in vitro*, such as by hollow fiber systems, spinner culture, static culture; or *in vivo* such as ascites production.

The chimeric antibodies may be produced in large quantities by injecting a hybridoma into the

peritoneal cavity of pristane-primed mice, and after an appropriate time (about 1-2 weeks), harvesting ascites fluid from the mice, which yields a very high titer of homogeneous monoclonal antibody, and isolating the monoclonal antibodies therefrom by methods well known in the art [see Stramignoni, P. et al., *Intl. J. Cancer* 31, 543-552 (1983)]. The hybridomas are grown up *in vivo*, as tumors in animals, the serum or ascites fluid of which can provide up to about 50 mg/mL of monoclonal antibodies. Usually, injection (preferably intraperitoneal) of about 10^6 to 10^7 histocompatible hybridoma cells into mice or rats will result in tumor formation after a few weeks. The antibodies can then be collected and processed by well known methods. (See generally, Immunological Methods, vols. I & II, eds. Lefkoviits, I. and Pernis, B., (1979 & 1981) Academic Press, New York, N.Y.; and Handbook of Experimental Immunology, ed. Weir, D., (1978) Blackwell Scientific Publications, St. Louis, MO.)

The antibodies can then be stored in various buffer solutions such as phosphate buffered saline (PBS), which gives a generally stable antibody solution for further use.

The chimeric antibodies of the present invention may be fragmented using known protease enzymes, for example papain and pepsin, to obtain highly immunoreactive F(ab)₂, F(ab') and Fab fragments. In addition, active fragments of Ig formed by proteolysis (approximately 50,000 MW) can be split into their fully reduced heavy chain and light chain components and fairly efficiently reconstructed to give an active antibody [Haber, E., *Proc. Natl. Acad. Sci. (USA)* 52, 1099 (1964); Whitney, P.L., et al., *Proc. Natl. Acad. Sci. (USA)* 53, 524 (1965)]. The reactivity of the resulting F(ab)₂, F(ab') and Fab fragments are determined by methods as described above for the complete monoclonal antibody molecule.

Uses of the Antibodies

The antibodies of the present invention, as well as immunoreactive fragments or recombinants thereof, provide unique benefits for use in a variety of cancer treatments. In addition to the ability to bind specifically to malignant cells and to localize tumors, the antibodies have constant variable regions which do not bind detectably to normal cells such as fibroblasts, endothelial cells, or epithelial cells in the major organs.

Specifically, the antibodies, immunoreactive fragments or recombinants thereof are useful for, but not limited to, the following types of cancer treatment: (1) *in vivo* diagnostic assays conjugated to an imaging marker, for the *in situ* detection of carcinoma lesions, as further described below; (2) *in vivo* therapy, using the antibodies of the present invention alone or conjugated to a therapeutic agent such as a radionuclide, toxin, effector cells, other antibodies or via a complement mechanism, as described below; and (3) radioimmunoguided surgery, as described below.

Moreover, a pharmaceutical composition comprising the antibodies of the present invention in a pharmaceutically acceptable, non-toxic, sterile carrier such as physiological saline, non-toxic buffers and the like, is also now possible.

Injectable compositions of the present invention may be either in suspension or solution form. In solution form the complex (or when desired the separate components) is dissolved in a pharmaceutically acceptable carrier. Such carriers comprise a suitable solvent, preservatives such as benzyl alcohol, if needed, and buffers. Useful solvents include, for example, water, aqueous alcohols, glycols, and phosphonate or carbonate esters. Such aqueous solutions contain no more than 50% of the organic solvent by volume.

Injectable suspensions as compositions of the present invention require a liquid suspending medium, with or without adjuvants, as a carrier. The suspending medium can be, for example, aqueous polyvinylpyrrolidone, inert oils such as vegetable oils or highly refined mineral oils, or aqueous carboxymethylcellulose. Suitable physiologically acceptable adjuvants, if necessary to keep the complex in suspension, may be chosen from among thickeners such as carboxymethylcellulose, polyvinylpyrrolidone, gelatin, and the alginates. Many surfactants are also useful as suspending agents, for example, lecithin, alkylphenol, polyethylene oxide adducts, naphthalenesulfonates, alkylbenzenesulfonates, and the polyoxyethylene sorbitan esters. Many substances which effect the hydrophobicity, density, and surface tension of the liquid suspension medium can assist in making injectable suspensions in individual cases. For example, silicone antifoams, sorbitol, and sugars are all useful suspending agents.

Because cancer cells are heterogeneous and consequently, a single monospecific chimeric antibody may not be able to recognize all cells expressing different epitopes of a tumor.

Thus, it may be desirable to administer several different chimeric antibodies of the present invention. The sequential use of these various antibodies should substantially reduce the anti-idiotypic responses in human patients when compared to repeated use of a single antibody. For example, CH92, CH88, and CH44 could be sequentially administered to a patient. Since these antibodies have different light chains and, in

fact different CDR3 regions anti-idiotypic responses should be minimized.

In Vivo Diagnostic Assays

In vivo diagnostic assays of human tumors or metastasis thereof using the antibodies, immunoreactive fragments or recombinants thereof are conjugated to a marker, administered to a patient, and then the presence of the imaging marker in the patient is detected by exposing the patient to an appropriate detection means.

Administration and detection of the antibody-imaging marker conjugate as well as methods of conjugation of the antibody to the imaging marker are accomplished by methods readily known or readily determined, as described, for example, in Goldenberg, D.M. et al., *New England J. Med.*, 298, 1384-1388 (1978); Goldenberg, D.M. et al., *J. Amer. Med. Assoc.* 280, 630-635 (1983); Goldenberg, D.M. et al., *Gastroenterol.* 84, 524-532 (1983); Siccardi A.G. et al., *Cancer Res.* 46, 4817-4822 (1986); Epenetos, A.A. et al., *Cancer* 55, 984-987 (1985); Philben, V.J. et al., *Cancer* 57, 571-576 (1986); Chiou, R. et al., *Cancer Inst.* 76, 849-855 (1986); Colcher, E. et al., *Cancer Res.*, 43, 736-742 (1983); Colcher, E. et al., *Laboratory Research Methods in Biology and Medicine Immunodiagnosics*, New York, Alan R. Liss, pp. 215-258 (1983); Keenan, A.M. et al., *J. Nucl. Med.* 25, 1197-1203 (1984); Colcher D. et al., *Cancer Res.* 47, 1185-1189 (1987); Estaban, J.M. et al., *Intl. J. Cancer* 39, 50-59 (1987); Martin, D.T., et al., *Curr. Surg.* 41, 193-194 (1984); Martin, E.W. Jr. et al., *Hybridoma* 5, S97-S108 (1986); Martin, D.T. et al., *Am. J. Surg.* 150, 672-675 (1985); Meares et al., *Anal. Biochem.* 142, 68-78 (1984); and Krejcarek et al., *Biochem. and Biophys. Res. Comm.* 77, 581-585 (1977).

The dosage will vary depending upon the age and weight of the patient. Generally, the dosage should be effective to visualize or detect tumor sites, distinct from normal tissues. Preferably, a one-time dosage will be between 0.1 to 200 mg of an antibody-marker conjugate per patient.

Examples of imaging markers which can be conjugated to the antibody are well known to those skilled in the art and include substances which can be detected by diagnostic imaging using a gamma scanner or hand held gamma probe or Positron Emission Tomography or the like, as described in the references cited above, and substances which can be detected by nuclear magnetic resonance imaging using a nuclear magnetic resonance spectrometer or the like, as described in the references cited above.

Suitable examples of substances which can be detected using a gamma scanner or the like include, for example, radioisotopes such as ^{125}I , ^{131}I , ^{123}I , ^{111}In , ^{105}Rh , ^{153}Sm , ^{67}Cu , ^{67}Ga , ^{166}Ho , ^{177}Lu , ^{186}Re , ^{188}Re , and $^{99\text{m}}\text{Tc}$. ^{125}I , ^{123}I , ^{153}Sm and $^{99\text{m}}\text{Tc}$ are preferred due to their low energy and suitability for long range detection.

An example of a substance which can be detected using a nuclear magnetic resonance spectrometer or the like is gadolinium (Gd).

In Vivo Cancer Treatment

In this method, the antibody-therapeutic agent conjugate can be delivered to the carcinoma site thereby directly exposing the carcinoma tissue to the therapeutic agent.

The antibodies of the present invention, immunoreactive fragments or recombinants thereof may be administered in a pharmaceutically effective amount for the *in vivo* treatment of human carcinomas or metastasis thereof. A "pharmaceutically effective amount" of the antibody, immunoreactive fragment or recombinant thereof, conjugated or unconjugated to a therapeutic agent, means the amount of said antibodies in the pharmaceutical composition should be sufficient to achieve effective binding with the antigens against which said antibodies have specific affinity. The pharmaceutical composition may be administered in a single or multiple dosage.

Methods of preparing and administering conjugates of the antibody, immunoreactive fragments or recombinants thereof and a therapeutic agent are well known or readily determined by those skilled in the art. Moreover, suitable dosages will depend on the age and weight of the patient and the therapeutic agent employed and are well known or readily determined by those skilled in the art. Representative protocols are described in the references cited below.

Examples of the antibody-therapeutic agent conjugates which can be used in therapy include the following: (1) antibodies coupled to radionuclides, such as ^{131}I , ^{90}Y , ^{105}Rh , ^{47}Sc , ^{67}Cu , ^{212}Bi , ^{211}At , ^{67}Ga , ^{125}I , ^{186}Re , ^{188}Re , ^{177}Lu , $^{99\text{m}}\text{Tc}$, ^{153}Sm , ^{123}I and ^{111}In as described, for example, in Goldenberg, D.M. et al., *Cancer Res.* 41, 4354-4380 (1981); Carrasquillo, J.A. et al., *Cancer Treat. Rep.* 68, 317-328 (1984);

Zalcborg, J.R. et al., *J. Natl. Cancer Inst.* 72, 697-704 (1984); Jones, D.H. et al., *Int. J. Cancer* 35, 715-720 (1985); Lange, P.H. et al., *Surgery* 98, 143-150 (1985); Kaltovich, F.A. et al., *J. Nucl. Med.* 27, 897 (1986); Order, S.E. et al., *Int. J. Radiother. Oncol. Biol. Phys.* 8, 259-261 (1982); Courtenay-Luck, N. et al., *Lancet* 1, 1441-1443 (1984) and Ettinger, D.S. et al., *Cancer Treat. Rep.* 66, 289-297 (1982); (2) antibodies coupled to drugs or biological response modifiers such as methotrexate, adriamycin, and lymphokines such as interferon as described, for example, in Chabner, B. et al., *Cancer, Principles and Practice of Oncology*, Philadelphia, PA, J.B. Lippincott Co. Vol. 1, pp. 290-328 (1985); Oldham, R.K. et al., *Cancer, Principles and Practice of Oncology*, Philadelphia, PA, J.B. Lippincott Co., Vol. 2, pp. 2223-2245 (1985); Deguchi, T. et al., *Cancer Res.* 46, 3751-3755 (1986); Deguchi, T. et al., *Fed. Proc.* 44, 1684 (1985); Embleton, M.J. et al., *Br. J. Cancer* 49, 559-565 (1984) and Pimm, M.V. et al., *Cancer Immunol. Immunother.* 12, 125-134 (1982); (3) antibodies coupled to toxins, as described, for example, in Uhr, J.W. et al., *Monoclonal Antibodies and Cancer*, Academic Press, Inc., pp. 85-98 (1983); Vitetta, E.S. et al., *Biotechnology and Bio. Frontiers*, Ed. P.H. Abelson, pp. 73-85 (1984) and Vitetta, E.S. et al., *Sci.*, 219, 644-650 (1983); (4) heterofunctional antibodies, for example, antibodies coupled or combined with another antibody so that the complex binds both to the carcinoma and effector cells, e.g., killer cells such as T cells, as described, for example, in Perez, P. et al., *J. Exper. Med.* 163, 166-178 (1986); and Lau, M.A. et al. *Proc. Natl. Acad. Sci. (USA)* 82, 8648-8652 (1985); and (5) native, i.e., non-conjugated or non-complexed, antibodies, as described in, for example, Herlyn, D. et al., *Proc. Natl. Acad. Sci., (USA)* 79, 4761-4765 (1982); Schulz, G. et al., *Proc. Natl. Acad. Sci., (USA)* 80, 5407-5411 (1983); Capone, P.M. et al., *Proc. Natl. Acad. Sci., (USA)* 80, 7328-7332 (1983); Sears, H.F. et al., *Cancer Res.* 45, 5910-5913 (1985); Nepom. G.T. et al., *Proc. Natl. Acad. Sci., (USA)* 81, 2864-2867 (1984); Koprowski, H. et al., *Proc., Natl. Acad. Sci., (USA)* 81, 216-219 (1984); and Houghton, A.N. et al., *Proc. Natl. Acad. Sci., (USA)* 82, 1242-1246 (1985).

The methods for combining the antibody or antibody fragment to a desired therapeutic agent as described above are conventional and well known in the art. For example, the methods given in the references above.

Radiolmmunoguided Surgery

Antibodies, immunoreactive fragments or recombinants thereof, are important for radioimmunoguided surgery (RIGS). In RIGS, an intraoperative therapy, tumors are localized and excised. An antibody labeled with an imaging marker is injected into the patient, and bound antibody localized by a hand-held gamma detecting probe (GDP) and excised. An exemplary GDP is Neoprobe™, commercially available from Neoprobe Corporation, Tampa, FL. See Martin et al., "Radioimmunoguided surgery: a new approach to the intraoperative detection of tumor using antibody B72.3", *Amer. J. Surg.* 156, 386-392 (1988); Martin et al. "Radioimmunoguided surgery: intraoperative use of antibody 17- 1A in colorectal cancer", *Hybridoma* 5, S97-S108 (1986).

Administration and detection of the antibody-imaging marker conjugate as well as methods of conjugation of the antibody to the imaging marker are accomplished by methods readily known or readily determined by one skilled in the art, as described, for example, above.

The dosage will vary depending upon the age and weight of the patient, but generally a one time dosage of 0.1 to 200 mg of antibody-marker conjugate per patient is sufficient.

The following nonlimiting examples are merely for illustration of the construction and expression of chimeric DNA sequences encoding the antibodies of this invention. All temperatures not otherwise indicated are in Centigrade. All percents not otherwise indicated are by weight.

Examples

Replacement of Mouse Constant Regions

CC antibodies were derived from mice, and are significantly less capable of carrying out the effector functions possessed by the human constant regions.

Consequently, in the following examples, selected antibodies are "humanized" by genetically removing the constant regions of the heavy and light chains and replacing them with their human equivalents.

The mouse light chain constant region genes were replaced with the human kappa (k) gene, and the mouse heavy chain genes were replaced with each of the four human gamma isotypes (γ 1, γ 2, γ 3 and γ 4).

Each of these four gamma isotypes possess unique biological properties. For a general review, see "The Human IgG subclasses", Hamilton, R.G. (1989) Doc. No. CB0051-289, Calbiochem Corporation.

5 Preparation of Heavy and Light Chain Variable Region

Isolation of CC49 light chain

10 CC49 hybridoma cells secrete an antibody having an IgG₁ isotype heavy chain and a kappa light chain. Total DNA from CC49 hybridoma cells, Balb/C mouse kidney cells and NSI plasmacytoma cells was isolated according to the procedures set forth in *Cell* 24, 353-356 (1981).

Generally, about 10-20 µg of the extracted DNA from each cell line was digested to completion with 80 units of *Bam* HI, *Eco* RI, *Hind* III, *Spe* I, *Xba* I, *Sac* I, *Bgl* II, and *Pst* I in 50-100 microliters of a reaction
15 mixture containing the appropriate reaction buffer at 37° C overnight.

Next, the total extracted DNA from each cell line was subjected to the Southern hybridization technique, developed by E. M. Southern, [*J. Mol. Biol.* 98, 503-517 (1975)]. The DNA fragments were fractionated on the basis of their size by means of electrophoresis on a 0.8% agarose gel. The double-stranded DNA fragments were modified into single-stranded DNA fragments in an alkali solution; and then a nitrocellulose
20 filter was placed into close contact with the gel to transfer the modified DNA segments onto the filter in the presence of a high salt concentration solution.

Hybridization was carried out using, as the probe, a random primed ³²P-labelled L chain.

More specifically, the probe was a 1.71 kilo base pair (kbp) *Hind* III-*Pst* I fragment containing the coding exons for the murine J_L regions (J1-J5) and was isolated from the plasmid pGD1. A nucleotide
25 sequence of the probe fragment is provided in Figure 7. This plasmid is described in "Site Directed Cleavage of Immunoglobulin Gene Segments by Lymphoid Cell Extracts", Agostaro et al., *Can. J. Biochem. Cell Biol.* 63, 969-976 (1985). The plasmid was provided by Nobumichi Hozumi and John Roder, Mt. Sinai Research Institute, Toronto, Ontario, Canada.

To radiolabel the probe, alpha-³²P dCTP was obtained from Amersham, Arlington Heights, IL, USA, and the random priming kit was obtained from Pharmacia, Piscataway, NJ, USA.
30

The signals in Southern transfers were visualized by autoradiography using Kodak X-OMATTM AR film. No obviously rearranged band was observed. Thus, relative to the standards, no unique band was detected on the autoradiogram for the CC49 DNA digested with *Hind* III. It could not be ruled out from the Southern data, however, that the rearranged band for the L chain was masked by a band migrating in the CC49 *Hind*
35 III digested DNA parallel to the band resulting from a *Hind* III digest of mouse kidney cell DNA (representing the germline DNA). This actually turned out to be the case.

40 Preparation of Plasmid Containing Mouse V_L Genes

LAMBDA-ZAPTM, a lambda-based insertion cloning vector capable of self excision, was purchased from Stratagene Co., La Jolla, CA, USA. LAMBDA-ZAPTM is described on pages 20-21 of the 1987 Stratagene catalog. The cohesive (cos) ends of LAMBDA-ZAPTM were ligated overnight by following the manufacturer's protocol.

45 Twenty micrograms of the ligated LAMBDA-ZAPTM were digested with 5 microliters (15 units) of *Spe* I, purchased from New England Biolabs, Inc. The total volume of the digest was 100 microliters. After 55 minutes of digestion, another 6 units of *Spe* I were added. After 70 minutes, the reaction was stopped by phenol extraction and ethanol precipitation carried out as per Stratagene's protocol.

Digestion with *Spe* I restriction enzyme results in production of "sticky ends" at both termini. These
50 sticky ends were modified with T4 DNA polymerase to create half filled-in *Spe* I sticky ends, e.g., 5' ACT/3' TCATG. To accomplish the half fill-in reaction, the DNA pellet obtained in the ethanol precipitation above was dissolved in 8 microliters of water. To this was added 2 microliters of 10 millimolar dTTP, 2 microliters of 10 millimolar dCTP, 2 microliters of Stratagene's 10X ligase buffer, 4 microliters of reionized, distilled water, and 2 microliters of a Klenow fragment from Bethesda Research Laboratories (BRL). The
55 reaction was carried out at ambient temperatures for 30 minutes. The reaction was stopped by inactivating the DNA polymerase at 65° C for 10 minutes.

One hundred sixty micrograms of total CC49 hybridoma DNA (containing the mouse light chain promoter and the L and VJ exons) were digested to completion with *Hind* III. Fragments between about 1

kb to about 20 kb were cut out of 0.8% agarose gels. The DNA was purified using GENECLANTM, which is commercially available from BIO 101 (La Jolla, CA, USA).

The total CC49 hybridoma DNA *Hind* III digested fragments were half-filled similarly to the LAMBDA-ZAPTM's *Spe* I fragments with the exception that dATP and dGTP were employed. The half-filled *Hind* III digested fragments produced 5' AGCTT/3' GAA sticky ends, which are compatible with the *Spe* I half-filled LAMBDA-ZAPTM fragment above.

After phenol extraction and ethanol precipitation, according to the teachings of *Maniatis*, the total CC49 hybridoma *Hind* III modified and LAMBDA-ZAPTM *Spe* I modified DNA fragments were ligated by means of T4 DNA ligase. The ligation reaction was set using a 6.1 microliter ligation mixture containing the following: about 0.2 micrograms of the total CC49 hybridoma *Hind* III modified DNA in a 3 microliter solution, about 1 microgram of LAMBDA-ZAPTM *Spe* I modified DNA in a 1 microliter solution, 0.6 microliters of Stratagene's 10X ligase buffer, 0.5 microliters 10 millimolar ATP, and 1 microliter of Stratagene ligase. This was incubated overnight in a water bath and the temperature lowered incrementally from about 18 °C to about 4 °C. This ligation eliminated both the *Hind* III and the *Spe* I sites.

A genomic library of ligated mix was made according to Stratagene's protocol. Briefly, 2 microliters of the ligation mix produced above was used in Stratagene's Gigapack Gold packaging system, following the directions of the manufacturer. Fifteen 150 mm plates having a density of 50,000 plaques per plate were screened, as per manufacturer's directions, for positive clones by hybridization to nitrocellulose filters, obtained from Schleicher-Schuell, Keene, NH, USA. The <32P> random-labelled probe derived from pGD1, which was described above, was used for hybridization. Two positive clones were obtained.

Each clone was plaque purified and recombinant plasmids (phagemids) of LAMBDA-ZAPTM containing the CC49 L chain variable region were obtained by using Stratagene's automatic excision protocol. The vector portion of the resulting recombined plasmid is called pBLUESCRIPT SK(-) and consists of 2964 bp as described in the 1987 Stratagene catalog. A plasmid map of pBLUESCRIPT SK(-) is shown in Fig. 8.

The DNA from the two positive clones was partially sequenced and both were identical. One of the clones, which was named pRL101, was used for further studies.

Restriction Mapping of CC49 Light Chain

pRL101 was 7.61 kb, and the size of the DNA insert was determined by restriction enzyme mapping to be 4.65 kb. A plasmid map of pRL101 is shown in Figure 9. A restriction enzyme map of the CC49 L chain genomic DNA insert in pRL101 is shown in Fig. 10.

Isolation of CC83 Light Chain Variable Region

The procedures used to isolate the CC83 light chain were essentially those used to isolate the CC49 light chain, with the following exception.

A genomic library containing 7×10^5 plaques was screened using as the probe the <32P> random-labelled 1.71 *Hind* III-*Pst* I fragment derived from pGD1, as described above. One positive clone was obtained. The positive clone was named pRL200.

Restriction Mapping of CC83 Light Chain

pRL200 was 7.44 kb, and the size of the DNA insert was determined by restriction enzyme mapping to be 4.48 kb. A plasmid map of pRL200 is shown in Figure 11. A restriction enzyme map of the CC83 L chain genomic DNA insert in pRL200 is shown in Fig. 12.

Isolation of CC49 Heavy Chain Variable Region

The procedures used to isolate the CC49 heavy chain were essentially those used to isolate CC49 light chain, including the screening of the same CC49 *Hind* III modified DNA.

The hybridization probe used to screen the library was generated from pNP9, which contains a 1.98 kbp *Eco* RI-*Bam* HI fragment containing the coding exons for J_H3 and J_H4 of the CC49 immunoglobulin heavy chain. The nucleotide sequence of the probe fragment is provided in Figure 13. The plasmid was

provided by Dr. Nobumichi Hozumi and Dr. John Roder, Mt. Sinai Research Institute, Toronto, Ontario, Canada.

A genomic library containing 9.5×10^5 plaques was screened, from which one positive clone was obtained. The positive clone was named pHH49.

6

Restriction Mapping of CC49 Heavy Chain

pHH49 was about 7.0 kb, and the size of the DNA insert was determined by restriction enzyme mapping to be about 4.0 kb. A plasmid map of pHH49 is shown in Figure 14.

Isolation of CC83 Heavy Chain Variable Region

The procedures used to isolate the CC83 heavy chain were essentially those used to isolate CC49 heavy chain, with the following exceptions.

About thirteen micrograms of ligated LAMBDA-ZAP™ vector DNA were digested with 12 units of *Spe* I, purchased from New England Biolabs, Inc., in a total of 100 microliters of an appropriate buffer. The LAMBDA-ZAP™ was digested at 37 °C for one hour. The reaction mixture was phenol extracted and ethanol precipitated as per Stratagene's protocol. The *Spe* I digested LAMBDA-ZAP™ was dephosphorylated according to procedures set forth in *Maniatis* except that 40 fold excess of calf intestinal alkaline phosphatase (Boehringer Mannheim, Indianapolis, IN, USA) was used.

DNA from CC83 was digested to completion with *Spe* I. Fragments between about 3 kb to about 40 kb were isolated from a 0.8 percent agarose gel slice by electroelution as described by Maniatis, and ligated with the dephosphorylated *Spe* I-cut LAMBDA-ZAP™ vector.

A genomic library containing 5×10^5 plaques was screened using the probe generated from pNP9, the sequence of which is provided in Figure 13. One positive clone was obtained. The positive clone was named pHS83.

30

Restriction Mapping of CC83 Heavy Chain

pHS83 was 7.95 kb, and the size of the DNA insert was determined by restriction enzyme mapping to be about 5 kb. A plasmid map of pHS83 is shown in Figure 15.

35

Sequencing of CC46, CC49, CC83 and CC92 mRNA

Total RNA from about 1×10^7 CC49 cells frozen at -70 °C was extracted essentially as reported by *Maniatis*, with the following exceptions. Four molar guanidinium isothiocyanate and 2.5 molar sodium citrate, pH 7.0, and a SW40TI rotor centrifuged at 31,000 rpm were used.

A total of 2.7 mg of CC49 RNA was isolated. After centrifugation, poly A+ mRNA was purified from about 1.68 mg of RNA by oligo(dT)-cellulose chromatography using Type 3 oligo(dT)-cellulose obtained from Collaborative Research, Inc., Bedford, MA, USA. The procedure was as described by Aviv and Leder, *Proc. Nat'l. Acad. Sci. (USA)* **69**, 1408 (1972). A total of 50.24 µg of poly A+ mRNA was obtained from 1.68 milligrams of mRNA.

A total of 3.82 mg of CC83 RNA was isolated from approximately 1×10^7 cells. A total of 54.6 µg of poly A+ mRNA was isolated from 1.91 milligrams of total RNA.

A total of 0.814 mg of CC92 RNA was isolated from approximately 2.6×10^8 cells. A total of 41.88 micrograms of poly A+ RNA was isolated from 0.814 mg of total RNA.

A total of 1.7 mg of CC46 RNA was isolated from approximately 2.89×10^8 cells. A total of 68.88 micrograms of poly A+ RNA was isolated from 1.7 mg of total RNA.

Synthetic oligonucleotide primers were synthesized using an Applied Biosystems' (Applied Biosystems (ABI), Foster City, CA, USA) Model 380A DNA synthesizer, by phosphoramidite-based chemistry as specified by ABI. The oligonucleotides were purified, as specified by the manufacturer, after electrophoresis on a 20% polyacrylamide gel containing 7M urea. Oligonucleotide concentrations were determined spectrophotometrically at an optical density of 280 nm, where 1 OD 280 nm unit is equal to 33 µg/mL of single-stranded DNA.

65

The following oligonucleotide primers were made for mRNA sequencing: (1) For the CC49, CC83 and CC92 light chains, K_L(-), a 22-mer:

5'-GGAAGATGGATACAGTTGGTGC-3'

complimentary to the coding sequence of the 5' end of the constant region for mouse immunoglobulin kappa chains, is used to determine the 3' most mRNA sequence of the light chain variable region.

Additionally, or CC49 light chain, 49FR1(-), a 17-mer:

5'-GGAAGATGGATACAGTTGGTGC-3'

was used to determine the remaining sequence.

Additionally, for CC83 light chain, J4(-), a 24-mer:

5'-CCAACCTTTGTCCCGAGCCGAACG-3'

and also 83L CDR2(-), a 17-mer:

5'-CAGGGACTCCAGTGTGC-3'

was used to determine the remaining sequence.

Additionally, for CC92 light chain, J5(-):

5'-CGTTTCAGCTCCAGCTTGGTCCC-3'

was used to determine the remaining sequence.

For the CC46, CC49, CC83, and CC92 γ 1 heavy chains, CH1(-), a 24-mer:

5'-ATGGAGTTAGTTTGGGCAGCAGAT-3'

complimentary to the coding sequence of the 5' end of the murine γ 1 heavy chain constant region. The

CH1 (-) 24-mer is used to determine the 3'-most mRNA sequence of heavy chain variable regions.

Additionally, for the CC49 heavy chain, JH4(-)-20mer:

5'-GGTGACTGAGGTTCTTGAC-3'

was used to determine the remaining sequence.

Additionally, for the CC83 heavy chain, JH2(-)-16mer:

5'-CTGAGGAGACTGTGAG-3'

was used to determine the remaining sequence.

Additionally, for the CC92 heavy chain and the B72.3 heavy chain, B72.3/CC92 HC-20mer:

5'-CCTTGAACCTTCTCATTGTAC-3'

was used to determine the remaining sequence.

The following procedures were carried out as outlined by Jan Gelliebtter in BRL *FOCUS* 9, 1 (1987).

The oligonucleotide primers were end-labelled as follows: 100 ng of oligonucleotide were combined in 50mM Tris HCl (pH 8), 10mM MgCl₂, 5mM dithiothreitol, and 1mM spermidine, 100 μ Ci (γ -³²P) ATP (Amersham, 5000 Ci/mMole) and 7 units of T4 polynucleotide kinase in a volume of 13 μ l. The reaction was allowed to proceed at 37 °C for 30 minutes, then heated for 5 minutes at 65 °C to inactivate the kinase, and then 7 μ l of water was added to make the concentration 5 ng/ μ l. The labelled primers were stored at -20 °C until needed.

Separate samples, each containing about 13 micrograms of poly(A)⁺ mRNA of CC49, CC83, CC92, or CC46, respectively, were resuspended in 10 μ l of annealing buffer [10mM Tris HCl (pH 8.3), and 250mM KCl].

A 5 ng sample of end-labelled oligonucleotide primer was added to each mRNA sample, heated to 80 °C for 3 minutes, and annealed for 45 minutes at 61 °C, for the K_L(-) and 65 °C for the CH1(-) oligonucleotides. AMV reverse transcriptase (Boehringer Mannheim) was used at a level of 6 units for each mRNA sequencing reaction. The remainder of the sequencing was carried out as set forth in BRL *FOCUS* 9, 1 (1987).

Initial sequence data showed that the heavy and light chains were rearranged as follows: CC49 kappa light chain used a J5; CC49 γ 1 heavy chain used a J_H4. The CC83 light chain used a J4; the CC83 gamma 1 used a J_H2. The CC46 kappa light chain used a J2; the CC46 heavy chain used a J_H3. The CC92 light chain used a J5; the CC92 gamma 1 used a J_H2.

Figure 16 shows the nucleotide sequence of CC49 V_H, with the underlined segments showing the sequences derived using oligonucleotide primers on mRNA.

Figure 17 shows the nucleotide sequence of CC83 V_H, with the underlined segments show the sequences derived using oligonucleotide primers on mRNA.

The entire nucleotide sequences of CC46 V_H and CC92 V_H, shown in Figure 2, were derived using oligonucleotide primers on mRNA.

Figure 4a shows the nucleotide sequence of CC49 V_L, with the underlined segments show the sequences derived using oligonucleotide primers on mRNA.

Figure 5a shows the nucleotide sequence of CC83 V_L, with the underlined segments show the sequences derived using oligonucleotide primers on mRNA.

The entire nucleotide sequence of CC92 V_L, shown in Figure 6, was derived using oligonucleotide primers on mRNA.

5 Protein Sequence

Purified murine CC49 and CC83 immunoglobulin molecules were sent to Dr. George Tarr at the University of Michigan Protein Sequencing facility for NH₂-terminal amino acid sequence analysis. Dr. Tarr used the Edman degradation method, as modified by Tarr, G.E., in "Manual Edman Sequencing System",
10 Microcharacterization of Polypeptides: A Practical Manual [John E. Shively, ed., Humana Press, Inc., Clifton, N.J., pp 155-194 (1986)]. Briefly, Dr. Tarr reduced and alkylated the immunoglobulin molecules. The light and heavy chains of the immunoglobulin molecules were separated by reverse phase HPLC.

Figure 4b shows the amino acid sequence for CC49 V_L, with the results of the amino acid sequence determination for the first 24 amino acids of the mature CC49 V_L being underlined. Figure 5b shows the
15 amino acid sequence for CC83 V_L, with the results of the amino acid sequence determination for the first 51 amino acids of the mature CC83 V_L being underlined. ASN-20 could not be determined in the CC83 light chain, because of the presence of N-linked carbohydrate residues at this position, which is shown in the PNGase F experiment below. The sequence Asn-Ile-Thr corresponds to the consensus sequence Asn-X-Thr/Ser for carbohydrate attachment to Asn.

20 Since the heavy chains of immunoglobulins CC49 and CC83 are blocked at the N-terminus and unavailable for amino acid sequence determination, the native glycopeptide was treated with cyanogen bromide (CNBr) to cleave at the methionine residues. The cleavage resulted in fragments, which were purified by reverse phase HPLC. N-terminal amino acid sequencing was performed on the CNBr fragments.

The results of the amino acid determination of one of the CC49 V_H CNBr peptide fragments are
25 indicated as underlined residues in Figure 18. The results of the amino acid determination of one of the CC83 V_H CNBr peptide fragments are indicated as underlined residues in Figure 19. As with CC49, all other peptide sequences correspond to CNBr fragments derived from the constant region of mouse γ 1.

30 Determination of N-Linked Carbohydrate on CC83 L Chain

This experiment was done to verify that there is an N-linked carbohydrate attached to the CC83 light chain, presumably at ASN-20 (see Figure 5b). The enzyme glycopeptidase F (PNGase F), which is isolated from the culture filtrate of *Flavobacterium meningosepticum* [Tarentino, A. L et al., *Biochemistry* 24,
35 4665-4671 (1985)], will cleave high mannose and/or biantennary complex sugars N-linked to ASN to generate a free carbohydrate structure and an ASP residue from the ASN to which it was attached. The difference in molecular weight between the glycosylated and unglycosylated form of the same peptide can be determined by SDS-PAGE.

Twelve microgram reactions with and without PNGase F (Boehringer Mannheim, Indianapolis, IN, USA)
40 for the purified murine antibodies CC49, CC83 and CC11 F(ab')₂ (a positive control) were carried out in a final aqueous reaction volume of 40 microliters. Four microliters of 10 x buffer (1M potassium phosphate, 0.1M disodium EDTA pH 7.4) were added to each reaction mix. To those tubes designated "with PNGase F", 7.5 microliters of PNGase F were also added and all tubes were incubated at 37 °C for 1 h. To the react on tubes was added 40 microliters of Laemmli 2X sample dilution buffer containing β -mercaptoethanol. A
45 10 percent SDS polyacrylamide gel was electrophoresed, the gel stained with Coomassie Brilliant Blue R-250 and destained. Figure 20 shows the results. As shown in lane 2, a new band (*) appears in the PNGase F treated CC83 sample but not in the untreated CC83 sample (lane 3). The new band is approximately 2,000-3,000 molecular weight smaller than the native light chain band, which represents the removal of an N-linked carbohydrate moiety. The only consensus glycosylation site for the CC83 light chain is at ASN 20,
50 so by inference it is assumed that this is the actual site of glycosylation and why it did not show up on the N-terminal sequence analysis of the CC83 light chains as ASN. The CC49 light chain does not change mobility when treated with PNGase F (lane 6), but a new band is observed for the heavy chain fragment of CC11 F(ab')₂ (lane 4*) which serves as a positive control. mRNA sequence data of CC11 heavy chain indicates a consensus glycosylation site in the V domain (data not shown). The standards (lane 1) are
55 bovine serum albumin (BSA), MW 68,000 and soybean trypsin inhibitor (STI), MW 21,500.

DNA Sequence

Plasmid DNA was sequenced directly using the Sequenase DNA sequencing kit, obtained from United States Biochemical (USB), Cleveland, OH, USA. USB's protocol was followed to sequence double stranded DNA. The DNA of each variable region was sequenced using the J_H or J_L oligo determined from the mRNA sequence information to be specific for each productively rearranged heavy chain or light chain gene, respectively.

After the initial sequences were determined, the sequence was extended further by using additional primers. The additional primers were synthesized using information gathered from the sequences previously generated.

Using the above technique, the DNA sequences of the entire heavy chain variable region exons and light chain variable region exons of CC49 and CC83 were obtained. The DNA sequence was compiled and analyzed using Hitachi's DNA sequence analysis software program DNASISTM.

The following oligonucleotide primers were made for DNA sequencing:

(1) For both light chains, C_K intron(-):

5'-GAAAACCTGTGTCTTACAC 3'

(2) For the CC49 light chain, CC49 FRI(+):

5'-GTACCTGTGGGGACATTG 3',

and JK5(-)-23mer

5'CGTTTCAGCTCCAGCTTGGTCCC-3'

(3) For the CC83 light chain, CC83 CDR2(-):

5'-CAGGGACTCCAGTGTGC 3',

CC83 L intron (-):

5'GACTTCAAGATACAAATGTTAG-3',

and JK4(-)-20mer:

5'-CCAACTTTGTCCCGAGCCGAACG.

The complete nucleotide sequences for CC49 V_L and CC83 V_L are shown in Figures 4a and 5a, respectively.

For the CC49 heavy chain, J_H4 (-)-20mer:

5'GGTGACTGAGGTTCCCTTGAC-3' and J_H4 Intron (-):

5'-GCAATGCTCAGAAACTCC.

For the CC83 heavy chain, JH2(-)-16mer:

5'CTGAGGAGACTGTGAG-3'

and J_H2 Intron(-):

5'-GCAGTAAAATCTATCTAAGCTG.

Thereafter, the sequencing of each heavy chain was extended with the following sequences: CC49/83

HC/5 (+)

5'-GCACTGCTCATGATATGCAAATC-3';

CC49/83 HC/5 (-)

5'-GATTTGCATATCATGAGCAGTGC-3';

and CC49/83 H chain FRI(-)

5'-CTCAGCGTCAGACTGCTG-3'.

The complete nucleotide sequences for CC49 V_H and CC83 V_H are shown in Figure 2.

Comparisons were made between the characterized mRNA sequence and the characterized DNA sequence, and between the characterized amino acid sequence with the amino acid sequence predicted from the DNA sequence. Based on these comparisons, the plasmid clones were identified to contain the correct DNA sequence to code for the CC49 and CC83 heavy and light chain variable regions.

The predicted amino acid sequences from the nucleotide sequences of the heavy chain variable regions of CC49 and CC83, as shown in Figure 2, show extensive sequence similarity throughout the framework regions and hypervariable regions 1 and 2. Hypervariable region 3 is quite different between the two due to the recombination of the V_H region with different D and J_H sequences, namely that the cc49 γ 1 heavy chain used a J_H4, and the CC83 gamma 1 used a J_H2.

The extensive DNA sequence homology 5' to the coding regions in the CC49 and CC83 heavy chain variable region genes shows the two heavy chain variable region genes were derived from the same germline exons.

Isolation of V_H TAG, Germline Precursor Gene to the Heavy Chain of CC46, CC49, CC83, and CC92

The procedures used to isolate the germline precursor gene to the heavy chain variable regions of

CC46, CC49, CC83, and CC92 were essentially those used to isolate the CC49 heavy chain variable region except that the DNA used to generate the LAMBDA-ZAP™ library came from an irrelevant hybridoma cell line (i.e., a cell line which produces antibodies that do not appreciably bind to TAG72). A genomic library containing approximately 900,000 plaques was screened from which one positive clone was isolated. The positive clone was named pV_{Hα}TAG. pV_{Hα}TA was about 5.2 kb, and the size of the DNA insert was determined by restriction enzyme mapping to be about 2.2 kb.

DNA sequence of V_{Hα}TAG

10

The following oligonucleotide primers were used for determining the DNA sequence of V_{Hα}TAG:

B72.3/CC92 HC-20mer: 5'-CCTTGAACCTTCATTGTAC-3';

CC49/CC83 HC 5'(+): 5'-GCACTGCTCATGATATGCAAATC-3';

CC49/CC83 HC 5'(-): 5'-GATTGCATATCATGAGCAGTGC-3';

15 V_{Hα}TAG IVS (+): 5'-CTAAAGTGGAGTCAGGGCCTG-3';

V_{Hα}TAG IVS (-): 5'-CAGGCCCTGACTCCACTTTAG-3';

V_{Hα}TAG CDR2 (+): 5'-GAATGGATTGGATATATTCTC-3'.

The complete nucleotide sequence of V_{Hα}TAG is shown in Figure 2.

20

Isolation of Human Heavy Constant Genes

Plasmid constructs containing the various heavy chain human constant regions (pγ1, pγ2, pγ3, and pγ4) were provided by Dr. Ilan R. Kirsch of the National Cancer Institute, Bethesda, Maryland.

25

Restriction enzyme mapping was performed on these genes to confirm their identity. Restriction maps for the human constant regions are enclosed in Figure 21.

Chimeric Light Chain

30

Murine CC49 V Region

35

The *Hind* III site of the CC49 light chain genomic DNA located in the murine intron region between J5 and C_k (see Max, Edward E. et al., *J. Biol. Chem.* 256, 5116 (1981)) was lost in the cloning procedure where half-filled *Hind* III sites were ligated to half-filled *Spe* I sites in the LAMBDA-ZAP vector. The plasmid pRL101 (Figure 9) carried this modification. The intron *Hind* III site was regenerated as outlined in the steps below in order to enable a *Hind* III-*Bam* HI human germline kappa light chain DNA fragment (see Hieter, P. et al., *J. Biol. Chem.* 257, 1516 (1982)) to be ligated to the murine variable region directly. All steps were performed using standard molecular biology techniques familiar to artisans and can be found in a manual such as *Manatis*.

40

A 1.69 kb *Bam* HI-*Pst* I fragment is isolated from pRL101, described supra. A 2.96 kb *Bam* HI-*Pst* I fragment is isolated from pBluescript SK(-) (purchased from Stratagene), described supra. The two fragments are then ligated and pRL103, below, is isolated.

45

50

55

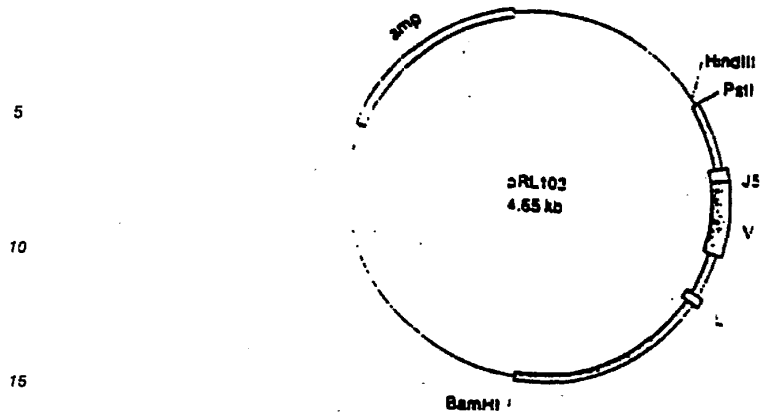

5

10

15

Plasmid pGD1, (described supra), was digested with *Pst* I and *Hind* III restriction enzymes to yield the necessary 1.03 kb intron-containing fragment, and pRL103 was also digested with *Pst* I and *Hind* III restriction enzymes to remove the small fragment of DNA in the polylinker.

20

The resulting fragments were ligated with T4 DNA ligase to produce a 5.68 kb plasmid, called pRL104. A partial restriction map of pGD1 and pRL104 are shown below.

25

30

35

40

45

50

55

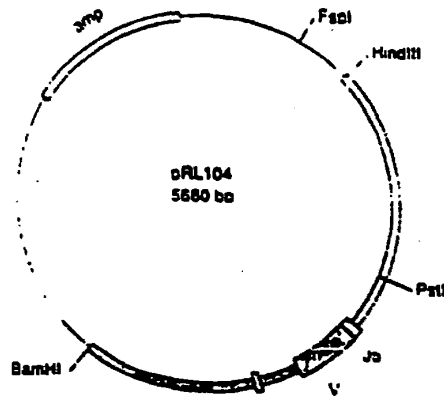

Human C_K Region

Plasmid phum C_K was obtained from Dr. John Roder, Mt Sinai Research Institute, Toronto, Ontario, Canada. The plasmid is derived from pBR322, with a 12 kb *Bam* HI fragment containing the human C_K exon inserted therein. pBR322 is described on page 171 of the 1987 Stratagene catalog. The 12 kb *Bam* HI fragment restriction map is shown below [from Heiter. P. et al., *J. Biol. Chem* 257, 1516 (1982)].

phumCk

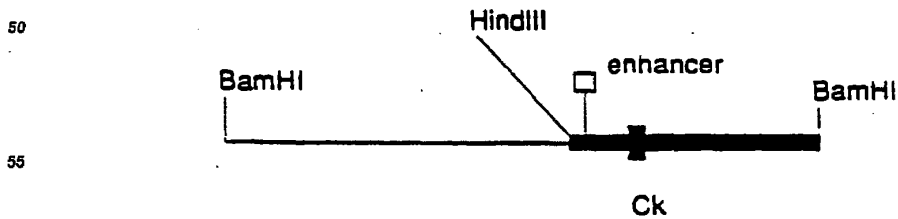

The plasmid phum C_k was digested with *Hind* III and *Bam* HI restriction enzymes to yield a 5.0 kb fragment, containing the human C_k exon. pRL104 was digested with *Fsp* I and *Hind* III restriction enzymes to yield a 4.2 kb fragment, containing the mouse light chain variable exons of CC49.

5 The two resulting fragments were joined with T4 DNA ligase to produce a 9.2 kb fragment among the mixture of resulting fragments. This mixture was digested with *Bam* HI to yield an 7.7 kb *Bam* HI CC49 L chain chimeric construct with *Bam* HI sticky ends, which contains both the mouse variable region exons and the human constant region (kappa) exon. These constructions utilize the human enhancer sequences and the murine promoter sequences.

10 The chimeric *Bam* HI fragment containing both the murine light chain variable region exons (L and VJ) and the human constant region kappa (k) exon ws ligated into the BamHI site of with the plasmid pSV2neo (5.6 kb), a pBR322-derived plasmid containing the selectable marker gene *neo* (obtained from ATCC). The presence of the active *neo* gene renders a cell resistant to growth inhibition by Geneticin, a neomycin-like drug also called G418.

15 The chimeric *Bam* HI fragment was inserted into pSV2neo in both orientations as shown below. Both transcriptional orientations of the chimeric light chain gene, relative to the neo gene, were constructed. Plasmid pSV2neo was linearized at the Bam HI site, dephosphorylated (according to procedures set forth in *Maniatis*) using calf intestinal alkaline phosphatase (to prevent self-ligation) and ligated with chimeric CC49 L chain *Bam* HI fragments from above.

20

25

30

35

40

45

50

55

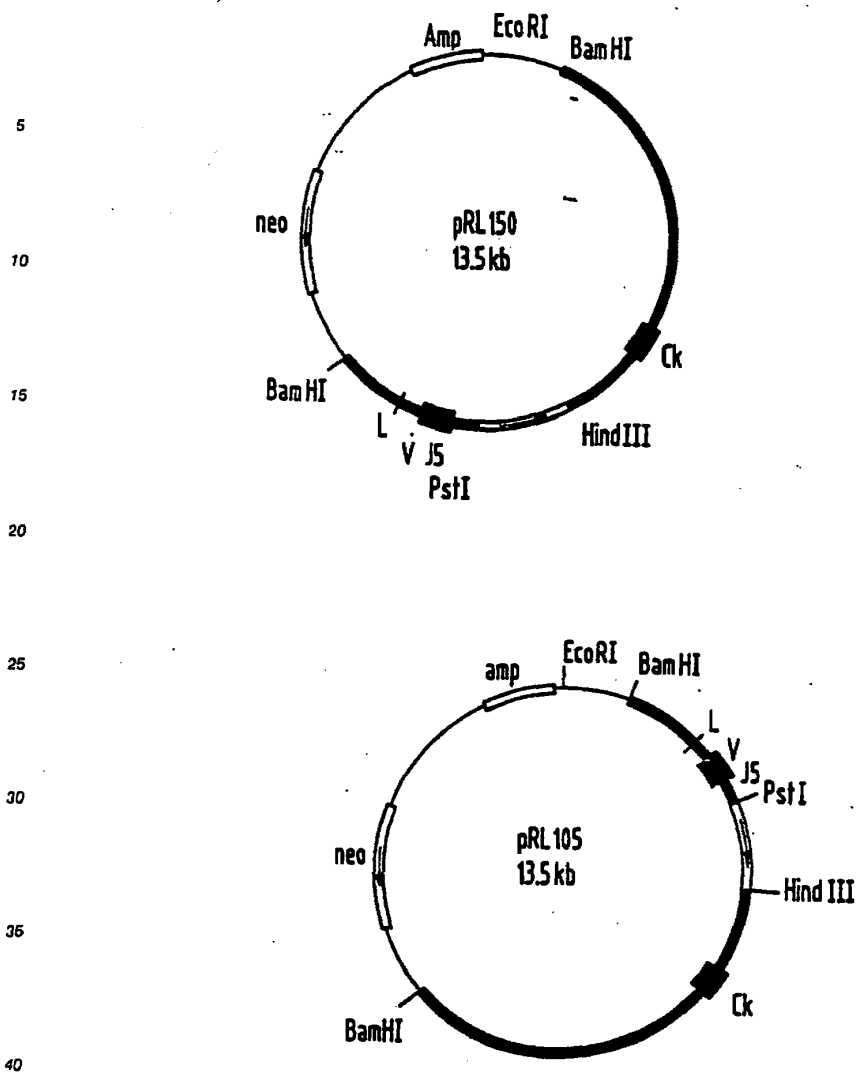

The transcriptional orientations of the *neo* gene and the CC49 chimeric light chain are indicated by arrows in pRL150 and pRL105. The portions are derived from pSV2neo are indicated. These plasmids were purified on a large scale from preparative scale (1.0L) fermentation of *E. coli* clones replicating each of the plasmids. The purified plasmids were used to introduce the chimeric CC49 light chain into SP2/0 plasmacytoma cells as discussed below.

Murine CC83 V_L Region and Human C_K Region

50 The *Hind* III site in pRL200 which was lost in the cloning process of the CC83 light chain was regenerated for the same reason as for the CC49 light chain chimeric construction. The regeneration was accomplished as follows. The plasmid pRL200 was linearized at a unique *Nhe* I site, and both of its sticky ends were converted to blunt ends by filling in with dNTPs and DNA polymerase I. A *Bam* HI phosphorylated linker (purchased from New England Biolabs) was ligated to the filled-in site. The new plasmid is called pRL201 and is shown below.

55

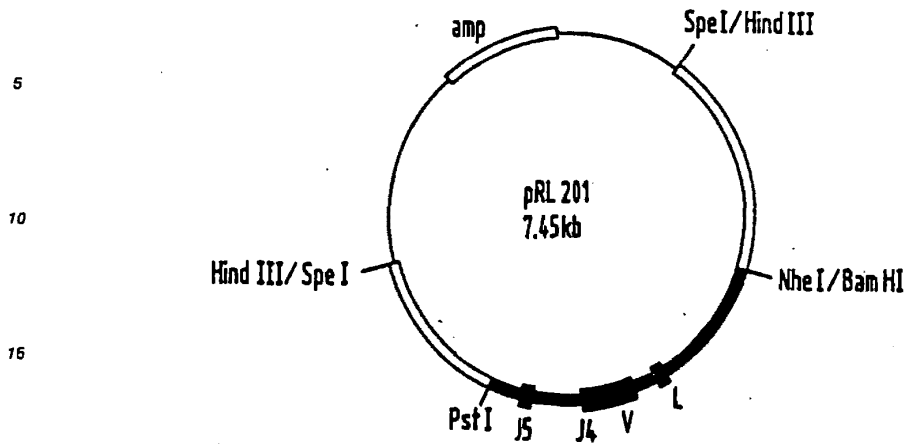

20 The 2.5 kb *Bam* HI-*Pst* I fragment from pRL201 containing the CC83 light chain variable region genomic DNA was conveniently ligated to the 4kb *Bam* HI-*Pst* I vector fragment from pRL104 which was described earlier in the CC49 light chain constructions and which already had the *Hind* III-bearing intron fragment. The new plasmid is called pRL202 and is shown below.

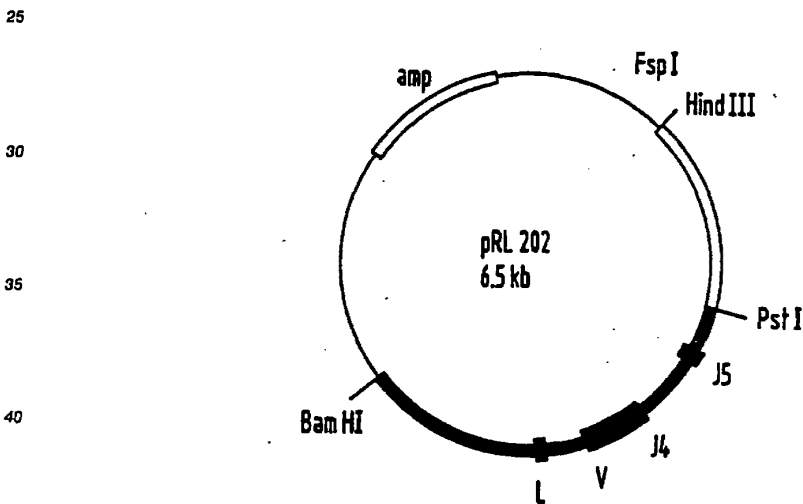

45 The approximately 5.05 kb *Fsp*I-*Hind* III fragment from pRL202 was isolated and ligated with the human C_{κ} -containing 5.0 kb *Hind* III-*Bam* HI fragment already described for the CC49 light chain chimeric construction. The generation of the CC83 light chain vector was accomplished from this point in an identical fashion as carried out for the CC49 light chain. The resulting 8.5 kb *Bam* HI CC83 light chain chimeric construct was also ligated to pSV2neo-*Bam* HI (phosphatased) and plasmids with both possible orientations of the insert were obtained as diagramed below.

50

55

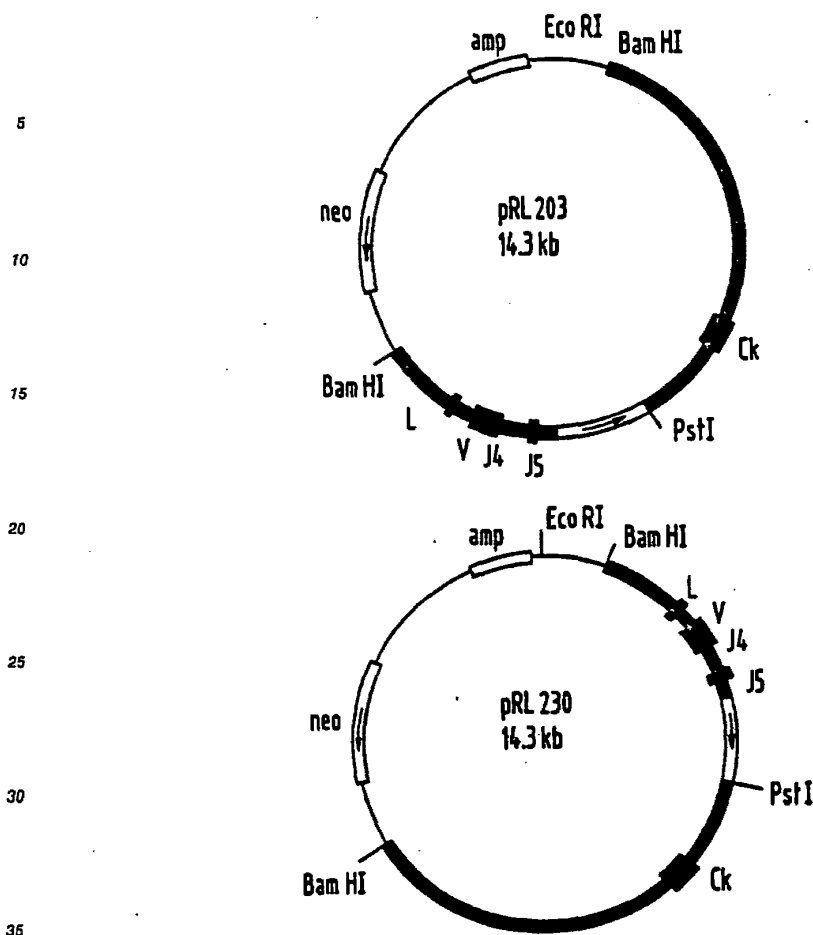

The transcriptional orientations of the *neo* gene and the CC83 chimeric light chain are indicated by arrows in pRL203 and pRL230. These plasmids were purified on a large scale from preparative scale (1.0L) fermentation in a commercial incubator of *E. coli* clones replicating each of the plasmids. The purified plasmids were used to introduce the chimeric CC83 light chain into Sp2/0 plasmacytoma cells, as discussed later.

All four of the chimeric light chain plasmid constructs (pRL105, pRL150, pRL203 and pRL230) can be linearized by digesting with the restriction enzyme *Aat* II. The *Aat* II site in the plasmids is in a region that is not essential for the expression of the chimeric light chain gene or the selectable marker gene, *neo*.

Chimeric Heavy Chains

50 Human Gamma Constant Gene Exons

The plasmid vector used to carry the chimeric heavy chain constructs is designated pSV2gpt, set forth in Mulligan and Berg, "Selection of animal cells that express the *E. coli* gene coding for xanthine-guanine phosphoribosyltransferase", *Proc. Natl. Acad. Sci (USA)* 78(4), 2072-2076 (1982). pSV2gpt is a pBR322 derived plasmid containing the selectable marker gene, guanine phosphoribosyl transferase (gpt), which can be used for selective growth in media containing mycophenolic acid. To prepare pSVgpt as a recipient for the human C γ 1, C γ 2, C γ 3, C γ 4 exons, it was digested with *Eco* RI and *Bam* HI. The digested DNA was fractionated on a 4 percent polyacrylamide gel and the 4.5 kb vector fragment was recovered from the gel

by electroelution as described in *Maniatis*. This linearized plasmid was designated pSV2gpt/R/B, a plasmid map is shown in Figure 22. It is able to accept *Eco* RI-*Bam* HI ended fragments.

The 5' *Hind* III sites, present on the human IgG₁ constant region fragments, were converted to *Eco* RI sites for directed cloning into the *Eco* RI site of pSV2-gpt. For γ 1, γ 2, γ 3, and γ 4, the *Eco* RI site in vector, pBR322 was employed.

C γ 1

The fragment containing the human C γ 1 exons was obtained by digesting and linearizing p γ 1 with *Hind* III followed by filling in the *Hind* III sticky ends using all four dNTP's and the Klenow fragment of DNA Polymerase to make the *Hind* III ends blunt. An *Eco* RI linker was ligated to the blunt ends to replace the *Hind* III site with an *Eco* RI site. This construct was then digested with *Eco* RI and *Bam* HI to release a 7.8 kb fragment containing the C γ 1 exons. This fragment was called C γ 1-7.8 kb.

The fragment were each ligated into the *Eco* RI-*Bam* HI sites of pSV2-gpt/R/B. This vector (pSV2-gpt- γ 1-7.2) design allows us to insert any murine heavy chain variable region gene (with *Eco* RI ends) into the *Eco* RI site of the human IgG heavy chain vectors. More specifically, 125 ng of the human C γ 1-7.8 kb fragment was ligated to 100 ng of the linearized pSV2gpt/R/B vector in a volume of 10 μ l using 400 units of T4 DNA ligase (obtained from New England Biolabs). Frozen competent *E. coli* DH1 cells from Invitrogen (San Diego, CA) were transformed with a ligation reaction according to the Invitrogen's protocol. The resulting plasmid was designated pSV2gpt γ 1-7.8. A plasmid map of pSV2gpt γ 1-7.8 is shown in Figure 23.

In addition, another shorter fragment containing the C γ 1 exons was generated. Concerns about the total size of the chimeric heavy chain vector, with a 7.8kb C γ 1 fragment, a 4.5kb pSV2-gpt/R/B vector, and a CC49 variable region of 1.9kb (total = 14.2kb) prompted the need to reduce the large size of the 7.8kb C γ 1 *Eco* RI-*Bam* HI fragment. The coding region of 7.8kb C γ 1 occupies only the first 1/3 of the 5' end of the fragment.

Size reduction was accomplished by converting a downstream *Pvu* II site to a *Bam* HI site by blunt-end addition of a *Bam* HI linker. The *Hind* III site of p γ -1 was converted to an *Eco* RI site by digestion of p γ -1 with *Hind* III, filling in the 3' end to create a blunt end, and addition of *Eco* RI linkers as above. The *Pvu* II site 2.3 kb downstream was converted to a *Bam* HI site by subsequent digestion with *Pvu* II and ligation of *Bam* HI linkers directly to the blunt *Pvu* II ends. This construct was then digested with *Eco* RI and *Bam* HI to release a 2.3 kb fragment containing the C γ 1 exons. The shortened *Eco*RI-*Bam*HI fragment (2.3 kb) still contains the γ 1 exons and the 3' polyadenylation sequence. This reduces the total vector size by 5.5kb, making the overall construct more manageable (total-8.7 kb).

Approximately 200 ng of the human C γ 1 2.3 kb fragment was ligated to 100 ng of the linearized plasmid pSV2gpt/R/B vector in a volume of 10 μ l using 400 units of T4 DNA ligase (New England Biolabs). Frozen competent *E. coli* cells, obtained from Invitrogen, were transformed with the ligation reaction according to Invitrogen's protocol. The resulting plasmid was designated pSV2gpt γ 1-2.3. A plasmid map of pSV2gpt γ 1-2.3 is shown in Figure 24.

DNA fragments containing the other three human IgG constant region exons were also isolated. The C γ 2 exons were recovered from the plasmid p γ 2 as a 4.0 kb *Eco* RI-*Bam* HI fragment. The C γ 3 exons were recovered from the plasmid p γ 3 as an 8.0 kb *Eco* RI-*Bam* HI fragment. The C γ 4 exons were recovered from the plasmid p γ 4 as a 7.6 kb *Eco* RI-*Bam* HI fragment. The fragments were separately ligated into a pSV2gpt/R/B as described for C γ 1-7.8 and C γ 1-2.3. Plasmid maps of the resultant plasmids are shown in Figure 25, pSV2gpt- γ 2; Figure 26, pSV2gpt- γ 3; and Figure 27, pSV2gpt- γ 4.

Heavy Chain Chimeric Constructs:

The complete heavy chain variable region human γ 1 constant region chimeric constructs were generated by inserting a fragment containing the murine heavy chain variable region exons into the plasmids containing the human γ 1 constant region exons described as follows.

Eco RI fragments containing the murine heavy chain variable region genes from CC49 and CC83 hybridoma cells were then ligated into each of the γ 1- γ 4-containing pSV2-gpt vectors (pSV2gpt- γ 1; pSV2gpt- γ 2; pSV2gpt- γ 3; pSV2gpt- γ 4;) as follows.

CC49

A fragment containing the heavy chain variable region exons coding for the CC49 heavy chain variable region was prepared by digesting 14 μ g of pHH49 with 50 units of *Eco* RI (obtained from BRL) at 37 °C for 2 hours. The digest was fractionated on a 4 percent polyacrylamide gel and the 1.9 kb *Eco* RI fragment containing the heavy chain variable region exons of CC49 was recovered by electroelution as described by *Maniatis*. This fragment was designated f49R.

A fragment containing the 7.8 kb sequence encoding for γ 1 was prepared as follows.

Approximately 50 μ g of the vector pSV2gpt γ 1-7.8 was digested with *Eco* RI. The resultant fragment was dephosphorylated (to prevent self ligation) using calf intestinal alkaline phosphatase as described by *Maniatis*. The fragment was purified from the 0.8 percent agarose gel by electroelution. This vector was designated pSV2gpt γ 1-7.8/R.

The *Eco*RI site is located 245 bp upstream of the transcription initiation sites, and contains the promoter and the necessary tissue-specific sequences for efficient expression. The intron regions 3' of the variable region genes contain the murine heavy chain enhancer sequences which are absent on the human IgG heavy chain vectors. Therefore, the heavy chain chimeric vectors use both murine promoter and enhancer sequences.

Approximately 325 ng of linearized pSV2gpt γ 1-7.8/R was ligated with 188 ng of f49R in a volume of 10 μ L with 1 unit of T4 DNA ligase (BRL). Frozen competent *E. coli* AG-1 cells from Stratagene were transformed with the ligation reaction according to their protocol. The resulting plasmid was designated p49 γ 1-7.8. Figure 28 illustrates a plasmid map for p49 γ 1-7.8.

Approximately 50 μ g of the vector pSV2gpt γ 1-2.3 was digested as for SV2gpt γ 1-7.8 with *Eco* RI. The resultant fragment was dephosphorylated using calf intestinal alkaline phosphatase as described by *Maniatis*. The fragment was purified from an 0.8 percent agarose gel by electroelution. This linearized plasmid was designated pSV2gpt γ 1-2.3/R.

Approximately 300 ng of the linearized plasmid pSV2gpt γ 1-2.3/R was ligated with 188 ng of f49R in a volume of 10 μ l with 1 unit of T4 DNA ligase (BRL). Frozen competent *E. coli* AG-1 cells from Stratagene (La Jolla, CA) were transformed with the ligation reaction according to their protocol. The resulting plasmid was designated p49 γ 1-2.3. Figure 29 illustrates a plasmid map for p49 γ 1-2.3.

Plasmids pSV2gpt γ 2, pSV2gpt γ 3 and pSV2gpt γ 4 were separately digested with *Eco* RI to produce the linear plasmid vectors pSV2gpt γ 2/R, pSV2gpt γ 3/R and pSV2gpt γ 4/R respectively. Each of these 3 linear plasmid vectors were separately ligated with f49R. Plasmid maps of the resulting plasmids are shown in Figure 30, p49 γ 2; Figure 31, p49 γ 3; and Figure 32, p49 γ 4.

CC83

Chimeric constructs containing the heavy chain variable region of CC83 were generated in a similar manner as the chimeric constructs of CC49. A fragment containing the heavy chain variable region exons coding for the CC83 heavy chain region was prepared by digesting 19 μ g of pHS83 with 50 units of *Eco* RI (obtained from BRL) at 37 °C for 2 hours. The digest was fractionated on a 4 percent polyacrylamide gel and the 2.9 kb *Eco* RI fragment containing the heavy chain variable region exons of CC83 were recovered by electroelution as described in *Maniatis*. This fragment was designated f83R.

Approximately 300 ng of the linearized plasmid pSV2gpt γ 1-7.8/R, obtained as above, was ligated with 270 ng of f83R in a volume of 10 μ l with 1 unit of T4 DNA ligase (obtained from BRL). Frozen competent *E. coli* AG-1 cells, obtained from Stratagene, were transformed with the ligation reaction according to Stratagene's protocol. The resulting plasmid was designated p83 γ 1-7.8. Figure 33 illustrates the plasmid map of p83 γ 1-7.8.

Approximately 90 ng of linearized plasmid pSV2gpt γ 1-2.3/R, obtained as above, was ligated with 270 ng of f83R in a volume of 10 μ l with 1 unit of T4 DNA ligase (BRL). Frozen competent *E. coli* AG-1 cells from Stratagene were transformed with the ligation reaction according to their protocol. The resulting plasmid was designated p83 γ 1-2.3. Figure 34 illustrates the plasmid map of p83 γ 1-2.3.

Plasmids pSV2gpt γ 2, pSV2gpt γ 3 and pSV2gpt γ 4 were separately digested as above for pSV2gpt γ 2/R, pSV2gpt γ 3/R and pSV2gpt γ 4/R, respectively, with *Eco* RI to produce the linear plasmid vectors pSV2gpt γ 2/R, pSV2gpt γ 3/R and pSV2gpt γ 4/R respectively. Each of these 3 linear plasmid vectors were separately ligated with f83R. Plasmid maps for the resulting plasmids are shown in Figure 35, p83 γ 2; Figure 36, p83 γ 3; and Figure 37, p83 γ 4.

All ten of the circular plasmid constructs (p49 γ 1-7.8; p49 γ 1-2.3; p83 γ 1-7.8; p83 γ 1-2.3, p49 γ 2; p83 γ 2; p49 γ 3; p83 γ 3; p49 γ 4; and p83 γ 4) were then linearized for transformation by digesting with the restriction enzyme *Nde* I. The *Nde* I site in the plasmids is in a region that is not essential for the expression of the

chimeric immunoglobulin gene or the selectable marker gene, gpt. The plasmids need to be in a linear form prior to transformation into a recipient cell to enhance selected integration of the DNA into the host cell genomic DNA.

5

Verification of Construction

Since the EcoRI fragments can be ligated in either orientation, the correct orientation was determined by digestion with Nco I. In the constructions set forth above, correct ligations for plasmid construction are confirmed by performing restriction enzyme site mapping on the plasmid. The restriction enzyme map generated from restriction enzyme digestion and gel electrophoresis is compared to that which can be theoretically generated from the individual starting fragments. Because of the experience with the transcriptional orientation in the light chain vectors, the heavy chain vectors were constructed only in the opposite transcriptional orientation to the gpt gene.

15

Transformation of Plasmids into Mouse Plasmacytoma Cells

When both light chain and heavy chain chimeric genes were transformed into the same cell, tetrameric (H₂L₂) immunoglobulins are obtained. Synthesis and secretion of these "chimeric" antibody proteins was accomplished by introducing the chimeric (mouse V:human C region) genes into mouse plasmacytoma cells (Sp2/0). Transformation was achieved by electroporation [Sahagan, B.C. et al., J. Immunology 137, 1066 (1986)].

Expression of chimeric (mouse V:human C region) genes in transformed mouse plasmacytoma cells (Sp2/0) is achieved using two different techniques. In one mode, different ratios of light chain genes to heavy chain genes can be introduced together. This is referred to as cotransformation. Alternatively, stable clones carrying the chimeric light chain gene can be obtained and subsequently used in a second mode referred to as targeted transformation. In each method, the goal is to obtain clones containing genes for both the H chain and L chain which produce intact H₂L₂ immunoglobulin mentioned above.

30

A. Cotransformations

Co-transformation involves the transformation of cells with both drug resistance markers at the same time and subsequent selection with one or both drugs. Co-transformation of heavy chain and light chain vectors (at ratios of 1:1 and 1:10, respectively) was originally performed using only neo selection. Neo-resistant cell lines were obtained which expressed the first chimeric IgG1 antibodies with demonstrable TAG72 binding activity. Cotransformation was conducted pursuant to the protocols set forth in Cornelia Gorman, "High Efficiency Gene Transfer into Mammalian Cells", DNA Cloning, Vol II, D. M. Glover ed, IRL Press, Oxford, England (1985).

40

B. Targeted Transformations

Constructs containing light and heavy chimeric immunoglobulin genes were sequentially transformed using into Sp2/0 mouse plasmacytoma cells. Targeted transformation involves transformation and selection with a vector containing a first drug-resistance gene (i.e., Geneticin for the chimeric light chain gene vector), followed by transformation and selection with a vector containing a second drug resistance gene (i.e., mycophenolic acid for the chimeric heavy chain gene vector).

60

Neo Selection

Prior to transformation with pSV2-neo vectors which contain chimeric light chain constructions, drug selection conditions for inhibition of growth of untransformed Sp2/0 plasmacytoma cells [obtained from the American Type Culture Collection (ATCC)] were established by titration of the neomycin-like drug, Geneticin (GIBCO). Published values for concentrations of Geneticin used for drug selection ranged from 100-1000 µg/mL. Concentrations above 400 µg/mL were found to prevent growth of Sp2/0 cells in our

55

tissue culture environment.

Construction of Light Chain Containing Cells

5 Sp2/0 mouse plasmacytoma cells were initially transformed with light chain-containing pSV2-neo vectors as follows. Cells were grown in RPMI 1640 medium with 5 percent fetal calf serum. Cells were washed in PBS and suspended to a concentration of 1×10^7 viable cells/mL PBS. 0.8 mL of cells were transferred to an electroporation curvette (on ice) containing 20 μ g of light chain-containing pSV2-neo
10 vector (pRL105 and pRL 150 for the CC49 chimeric L chain and pRL203 and pRL230 for the CC83 chimeric L chain) linearized with Aat II restriction endonuclease. Aat II was inactivated by heating the samples to 65 °C for 10 minutes. The linearized DNA was ethanol precipitated and subsequently dissolved in 10-20 microliters of PBS. After 15 minutes on ice, electroporation was performed using a Gene Pulser elec-
15 troporation apparatus with added capacitance extender (BioRad) at 0.2 kvolts and 960 μ F. The time constant (τ) was generally about 26 msec.

After transformation, cells were allowed to recover on ice for 15 minutes to allow relaxation of perturbed membranes. Afterwards, the cells were suspended in 24 mL of RPMI 1640 medium containing 5% fetal calf serum (RPMI+) and transferred to a 96 or 24 well plate. To decrease the probability of more than one drug resistant cell per well, the cells were also diluted 10-fold in medium (RPMI+) and plated into another 96-
20 well (or 24 well) plate. The cell suspension was incubated at 37 °C and 5 percent CO₂ atmosphere.

After 48 hours (to allow for expression of drug resistance), the medium was removed and replaced with medium containing 1 mg/mL Geneticin.

After 7-10 days, Geneticin-resistant clones were subcultured and the cells screened for chimeric light chains by cyto staining.

25

Cytostaining

Aliquots of cells were pelleted onto a glass slide using a cytospin-2 centrifuge (Shandon, Inc.). After air
30 drying, the cells were fixed in acetic acid/ethanol (5 parts acetic acid/95 parts ethanol). After rinsing 3 times with PBS (without CA²⁺ and Mg²⁺), the slides were placed in a humid chamber (100% RH), and stained for 20 minutes with 20 μ l of goat anti-human Kappa-FITC, a fluorescent dye-conjugated antibody which is specific for human kappa light chains. The conjugated antibody was diluted 1:3 with 1% BSA in PBS. After washing overnight with PBS, the slides were mounted with fluoromount-G, histologic mounting medium
35 (obtained from Southern Biotech) under a coverslip. The slides were observed with an Olympus model BH-2 microscope equipped with an epi-illumination U.V. attachment.

Based on the intensity of fluorescence, the constructions with the orientation of the light chain in opposite transcriptional orientation relative to the direction of transcription of the neo^r gene in the vector, was found to give the highest L chain expression. Therefore, pRL105 was the preferred CC49 L chain
40 construction and pRL230 was the favored CC83 L chain construction. As a result of these experiments the following chimeric light chain-containing cell lines (derived from Sp2/0) were used for the targeted transformations:

For the CC49 chimeric L chain one cell line (49K-13-13) was obtained which expressed the chimeric light chain derived from CC49. This cell line was used for all subsequent targeted transformations with
45 chimeric heavy chain vectors for constructs using the chimeric CC49 light chain.

For the CC83 chimeric L chain three cell lines (83K-26-5, 33K-34-10, and 83K-42-2) were obtained which expressed the chimeric light chain derived from CC83. One cell line (83K-26-5) stained more intensely than the others and had localized regions of cytoplasmic immunofluorescence. All three cell lines were compared for their relative ability to produce high levels of chimeric antibody after transformation with
50 the chimeric CC83 g1 heavy chain vector. More clones expressing chimeric antibodies were derived from electroporation of the 83K-34-10 target than either of the other two chimeric light chain target cell lines. Therefore, the 83K-34-10 light chain cell line was used as a target for subsequent electroporations with chimeric heavy chain vectors for constructs containing the CC83 light chain variable region.

65

Generation of *gpt* Resistant clones carrying CC49 and CC83 chimeric H chain constructions

Prior to transformation with PSV2-*gpt* vectors, which contain chimeric heavy chain constructions, drug

selection for inhibition of growth of untransformed Sp2/0 plasmacytoma cells [obtained from the American Type Culture Collection (ATCC)] were established. Conditions for drug selection of cells transformed with pSV2-gpt vectors were more difficult to establish. The *E. coli gpt* gene, which codes for the enzyme guanosine phosphoribosyl transferase, confers the ability to utilize xanthine and hypoxanthine as substrates for the biosynthesis of guanine when the mammalian guanine metabolic pathway is inhibited by mycophenolic acid (MPA).

Published values for the concentrations of MPA which allow for the growth of other lymphoid cell lines transformed with pSV2-gpt vectors were found to be almost two orders of magnitude too high to allow for the growth of Sp2/0 cells transformed with pSV2-gpt vectors in our tissue culture environment. Subsequently, a concentration of 0.1ug/mL of MPA was found to be optimal for selection of gpt resistance. In addition, the use of aminopterin and thymidine (to further shut down the guanine pathway) was found to be unnecessary.

15 Generation of Clones Producing of Chimeric 44 Antibody

CH44-1

20 49K-13-13 cells were used as a target for chimeric heavy chain constructs. The cells were transformed with 20 µg chimeric heavy chain DNA vector (p49-γ1-7.8 or p49-γ1-2.3) linearized by *Nde* I digestion. Transformation by electroporation was performed as above for chimeric light chains.

Selection after 48 hours, however, was performed by replacing the geneticin-containing medium with medium containing geneticin and 0.3 µg/mL mycophenolic acid, 250 µg/mL xanthine, and 10 µg/mL hypoxanthine.

Transformed cells grew to macroscopically visible colonies in 14 days. At that time, 50ul of supernatant was removed and assayed by ELISA methods for binding to TAG and expression of human IgG constant region. Wells containing cells with positive TAG binding were expanded to 24-well plates with fresh drug selection medium and allowed to grow for 3-7 days.

30 Subcloning was performed as follows. Viable cell counts were determined and the cells were replated into two 96-well plates. One plate received 50 viable cells and the other received 250 viable cells. The unsubcloned cells were expanded to 6-well plates until the cell density was sufficient to allow for storage in liquid nitrogen in the event that re-subcloning would be necessary.

After subcloning, those clones exhibiting the highest chimeric antibody production were selected for chimeric antibody production in bioreactors.

CH44-2

40 The Procedures used to sequentially transform the Sp2/0 plasmacytoma cells in the construction of CH44-1 were repeated with the exception that 20 µg of p49-γ2, was used as the chimeric heavy chain vector.

45 CH44-3

The procedures used to sequentially transform the Sp2/0 plasmacytoma cells in the construction of CH44-1 were repeated with the exception that 20 µg of p49-γ3, was used as the heavy chain vector.

50 CH44-4

The procedures used to sequentially transform the Sp2/0 plasmacytoma cells in the construction of CH44-1 were repeated with the exception that 20 µg of p49-γ4, was used as the heavy chain vector.

55

Generation of Clones Producing of Chimeric 88 Antibody

CH88-1

The procedures used to sequentially transform the Sp2/0 plasmacytoma cells in the construction of CH44-1 were repeated with the following exceptions:

83K-26-5, 83K-34-10, and 83K-42-2 cells demonstrating production of chimeric CC83 light chain were transformed as described in the transformation of CH44-1, with the exception that 20 μ g of p83- γ 1-7.8 or p83- γ 1-2.3, the pSV2gpt vector which contains the chimeric CC83 heavy chain gene was used as the heavy chain vector.

CH88-2

The procedures used to sequentially transform the Sp2/0 plasmacytoma cells in the construction of CH88-1 were repeated with the exception that 20 μ g of p83- γ 2, was used as the heavy chain vector.

CH88-3

The procedures used to sequentially transform the Sp2/0 plasmacytoma cells in the construction of CH88-1 were repeated with the exception that 20 μ g of p83- γ 3, was used as the heavy chain vector.

CH88-4

The procedures used to sequentially transform the Sp2/0 plasmacytoma cells in the construction of CH88-1 were repeated with the exception that 20 μ g of p83- γ 4, was used as the heavy chain vector.

Generation of Clones Producing of Chimeric 84 Antibody

Because of the high degree of sequence similarity between the heavy chain variable regions of CC49 and CC83, chimeric antibodies were generated whose light and heavy chains were derived from different parents by mixed targeted transformations. To generate both "mixed" combinations, the chimeric heavy chain γ 1 isotype vectors of CC49 and CC83 were electroporated into the chimeric light chain targets 83K34-10 and 49K-13-13 respectively. The resulting cell lines were designated CH48-1 and CH84-1, where the first numerical designation represents the heavy chain and light chain parents, respectively. For example, CH48-1 represents the γ 1 isotype with the heavy chain derived from CC49 and the light chain derived from CC83.

The CH48-1 composite antibody did not bind to TAG72. This was not due to the inability to make bona fide chimeric antibody. Since most drug-resistant cell lines produced chimeric IgG (as determined by ELISA analysis using Goat Anti-Human Ig trap with Goat Anti-Human IgG-Alkaline Phosphatase as a probe). If any binding affinity were present, it was significantly less than that observed for the first generation antibody B72.3, which was approximately an order of magnitude less affinity for TAG72 than either CC49 or CC83.

Surprisingly, CH84-1 bound to TAG72 with affinity similar to both parents. This new antibody was generated de novo in our laboratory and has not yet been detected in nature.

Competition studies were undertaken to determine the specificity of this new mixed-antibody, CH84-1. It should be noted that both CC49 and CC83 exhibit some competitive recognition for the TAG72 antigen. It was found that CH84-1 competed more with CC49 for binding to TAG72 than it did with CC83. This would indicate that the specificity for binding to TAG72 lies in the light chain.

Human γ 2, -3, and -4 isotypes were also generated with this mixed-antibody, producing CH84-2, CH84-3, CH84-4 clones.

CH84-1

The procedure used to sequentially transform the Sp2/0 plasmacytoma cells in the construction of CH44-1 were repeated with the following exception:

49K-13-13 cells demonstrating production of CH44 light chain by cyto staining were then transformed as

described in the transformed of CH44-1, with the exception that 20 μ g of p83 γ 1-2.3, the pSV2gpt vector which contains the CH83 heavy chain gene was substituted for p49 γ 1-2.3, the pSV2gpt vector which contains the CH44 heavy chain gene.

5
CH84-2

The procedures used to sequentially transform the Sp2/0 plasmacytoma cells in the construction of CH84-1 were repeated with the exception that 20 μ g of p83 γ 2, was substituted for p83 γ 1-2.3.

10

CH84-3

15 The procedures used to sequentially transform the Sp2/0 plasmacytoma cells in the construction of CH84-1 were repeated with the exception that 20 μ g of p83 γ 3, was substituted for p83 γ 1-2.3.

CH84-4

20 The procedures used to sequentially transform the Sp2/0 plasmacytoma cells in the construction of CH84-1 were repeated with the exception that 20 μ g of p83 γ 4, was substituted for p83 γ 1-2.3.

Purification of Recombinant Antibodies

25

Cells expressing the chimeric antibodies were removed by centrifugation from the culture medium and the medium was filtered through a 0.2 μ m filter. Chimeric antibodies were purified in two steps from culture supernatants. In the first step of the purification, a protein A affinity cartridge (Nygene Corporation Yonkers, NY) was utilized according to the manufacturer's specifications. Up to 1.0 L of culture supernatant was passed through a 1 mg capacity cartridge, at 5 mL/min. The cartridge was washed with phosphate buffered saline (PBS) to remove traces of albumin. The chimeric antibody was recovered by elution with 0.1M sodium nitrate buffer, pH 3.0. The pH of the fractions containing the chimeric antibody were immediately adjusted to neutrality with a 1M solution of Trizma base. Final purification was achieved from this solution, after concentration on an Amicon centricon 30 unit, by gel filtration using a Pharmacia Superose 12 HR 35 16/50 column as specified by the manufacturer (Pharmacia, Piscataway, NJ).

EXAMPLE: Generation of an Immunoglobulin Containing the Murine V_H α TAG germline Variable Region

40 The following examples are set forth to provide a skilled artisan with a reproducible technique for preparing an antibody having a V_H region encoded by a DNA sequence derived from V_H α TAG.

Components for an Expressible V_H α TAG Heavy Chain Gene

45

A mouse-human chimeric antibody molecule can be generated which contains the murine V_H α TAG germline heavy chain variable region, a light chain variable region that is complementary to the V_H α TAG V_H, such as either the CC49 or CC83 murine light chain variable region, and human constant regions.

The 2.2 kb HindIII germline DNA fragment containing the V_H α TAG V_H exon sequence is used as a template to obtain a functionally rearranged V_H α TAG variable region. The murine genomic J-C μ intron region is used as a source for the murine heavy chain enhancer sequences. This latter region is obtained from the plasmid pNP9 (see example above on "Isolation of CC49 Heavy Chain Variable Region"). Figure 38 shows the overall reaction for the engineering of hybrid genes based on the method of Horton et al., (1989), supra. Four oligonucleotides (oligos) are designed to be used in enzymatic amplification and modification of the target DNA. Oligo 1 anneals to the 5' end of V_H α TAG spanning the EcoRI site which is 249 bp 5' to the ATG initiation codon. Oligo 2 anneals to sequences complementary to the 3' end of the V_H α TAG exon and also contains sequences coding for a D segment. The D segment sequences in oligo 2 do not anneal with any V_H α TAG sequences. Oligo 3 contains sequences complementary to the 5' end of 65

the murine genomic J-C μ region and incorporates sequences encoding the D segment (same as in oligo 2) and the J segment. Oligo 4 anneals to the 3' end of the J-C μ region and contains sequences complementary to the *EcoRI* site located 1219 bp 3' to J μ 4. The sequence of these oligos follow:

Oligo 1 5' *GTCTAGAATTCA*TAAAACTTTATG (25 mer)

5 Oligo 2 CAGTGTATTTCTGTAAAAGATCTACTATGGTTACG (35 mer)

Oligo 3 3 5' TCTACTATGGTTACGTGGGGTCAAGGAA-CCTCAGTCACCGTCTCCTCAGGTAAGAATGGCCTCTCCAGGTCT 3' (72 mer)

Oligo 4 5' ACTTCTAAAATGTATTTAGAAATTCATTTTC 3'

In this example, the D sequence is SP2.3 taken from the published sequence of Kurosawa and
10 Tonegawa *J. Exp. Med.*, 155:201 (1982). The D sequence is shown in bold face type in oligos 2 and 3. Any other characterized murine or human D segment can be used by substituting their sequence in these positions of oligo 2 and 3.

The J segment in oligo 3 is underlined. It is the murine J μ 4 taken from the published sequence of
15 Gough and Bernard *Proc. Natl. Acad. Sci. (USA)*, 78:509 (1981). The inclusion of any other murine or human J segment can be made by substituting their sequences for the sequence of J μ 4 in oligo 3.

In oligo 1 and 4 the *EcoRI* sites (*GAATTC*) are shown in italics.

Assembly of Intact V μ α TAG Genes

20

Two separate DNA amplification reactions are performed using the components described above. DNA
amplification reaction #1 copies the V μ α TAG sequence and adds a D segment to its 3' end. DNA
amplification reaction #2 copies the murine intron sequences containing the heavy chain enhancer
sequences and adds the D and J segments encoded within oligo 3. The amplified products from reaction 1
25 and 2 are gel purified, combined and oligos 1 and 4 are added to initiate reaction #3. In reaction 3, the
products of reactions 1 and 2 anneal across their common D sequences. Subsequent DNA amplification
from oligos 1 and 4 yields the product shown at the bottom of Figure 38. This fragment is digested with
EcoRI and gel purified. The modified V μ α TAG fragment is ligated into the *EcoRI* site of pSV2gpt γ 1(2.3) as
described in the above example "Heavy Chain Chimeric Constructs". The entire V μ α TAG-D-J-enhancer
30 containing fragment is sequenced completely to ensure that no mutations have been introduced during the
DNA amplification reactions. The other three heavy chain γ isotypes can be generated by ligating the same
modified V μ α TAG fragment into the other three γ containing pSV2gpt vectors (pSV2gpt- γ 2; pSV2gpt- γ 3;
pSV2gpt- γ 4).

35

Expression of the Modified V μ α TAG Gene

The modified V μ α TAG gene containing plasmids can be linearized with *NdeI* and introduced via
electroporation into the chimeric CC49 or CC83 light chain expressing cell lines (see example above, "C.
40 Targeted Transformations"). The transformed cells are selected for growth in the presence of Geneticin and
mycophenolic acid as outlined above in "C. Targeted Transformations". The presence of expressed
antibody is monitored by TAG72 ELISA (see section in RESULTS, Enzyme-Linked Immunoassays (ELISA)).
The expressed antibody from these cells will contain human Ig γ 1,x constant regions with the CC49 or
CC83 light chain variable region and a heavy chain variable region from the modified V μ α TAG germline V μ
45 exons.

Four examples of modified V μ α TAG heavy chain variable region constructs having a variety of D and J
segments are shown below;

50

V μ Segment	D Segment	J Segment
V μ α TAG #i	mouse D (SP2.3)	mouse J
V μ α TAG #ii	human D (D1)	mouse J
V μ α TAG #iii	mouse D (SP2.3)	human J
55 V μ α TAG #iv	human D (D1)	human J

The sequence of the human D sequence D1 is obtained from Siebenlist et al., *Nature*, 294:631 (1981). The

sequence of the human J_H1 obtained from Ravetch et al., *Cell* 27, 583 (1981).

The generation of V_HαTAG #i is described with the above diagramed oligos 1 through 4. To generate V_HαTAG #ii through -iv the corresponding D and J segments need to be changed in oligos 2 and 3. The following oligos delineate these changes. Substitution of these oligos in reaction #1 and reaction #2 will result in the generation of the V_HαTAG #ii through -iv.

V_HαTAG #ii

10 Oligo 2 5' CAGTGTATTTCTGTAAAAGAGTACTGGTGGTGTAT (34 mer)
 Oligo 3 5' G TACTGGTGGTGTATTGGGGTCAAGGAACC-
TCAGTCACCGTCTCCTCAGGTAAGAATGGCCTCTCCAGGTCT 3' (72 mer)

V_HαTAG #iii

15 Oligo 2 5' CAGTGTATTTCTGTAAAAGATCTACTATGGTTACG (35 mer)
 Oligo 3 5' TCTACTATGGTTACGTGGGGCCAGGGCACC-
CTGGTCACCGTCTCCTCAGGTAAGAATGGCCTCTCCAGGTCT 3' (72 mer)

V_HαTAG #iv

20 Oligo 2 5' CAGTGTATTTCTGTAAAAGAGTACTGGTGGTGTAT (35 mer)
 Oligo 3 5' G TACTGGTGGTGTATTGGGGCCAGGGCACC-
CTGGTCACCGTCTCCTCAGGTAAGAATGGCCTCTCCAGGTCT 3' (72 mer)

Results

30 A. Chimeric Antibody Producing Cell Lines

Simultaneous detection of heavy and light chains was accomplished using two probe antibodies:

- 1) Goat anti-human kappa labeled with the fluorescing dye FITC and;
- 2) Goat anti-human IgG labeled with the fluorescing dye TRITC.

35 Cell lines having positive responses for both heavy and light chains were tested further for associated chimeric immunoglobulin production and biological activity viz. binding to TAG72.

Enzyme-Linked Immunoassays (ELISA)

40 In order to select a transformed cell producing a chimeric monoclonal antibody, the ELISA technique was employed. Clones containing the heavy chain and light chain drug selection constructs were selected by their growth in selective culture medium. The following cell lines were tested (1) CH44-1: a cell line having CC49 V_H, CC49 V_L, and constant region of IgG₁; (2) CH44-2: a cell line having CC49 V_H, CC49 V_L,
 45 and constant region of IgG₂; (3) CH44-4: a cell line having CC49 V_H, CC49 V_L, and constant region of IgG₄; (4) CH88-1: a cell line having V_H, CC83 V_L, and constant region of IgG₁; (5) CH88-2: a cell line having CC83 V_H, CC83 V_L, and constant region of IgG₂; (6) CH88-3: a cell line having CC83 V_H, CC83 V_L, and constant region of IgG₃; (7) CH88-4: a cell line having CC83 V_H, CC83 V_L, and constant region of IgG₄; (8) CH84-1: a cell line having CC83 V_H, CC49 V_L, and constant region of IgG₁; (9) CH84-2: a cell line having CC83 V_H,
 50 CC49 V_L, and constant region of IgG₂; (10) CH84-3: a cell line having CC83 V_H, CC49 V_L, and constant region of IgG₃; and (11) CH84-4: a cell line having CC83 V_H, CC49 V_L, and constant region of IgG₄.

Supernatants of these cultures were subjected to ELISA. The presence of chimeric anti-TAG72 antibody was measured directly by reaction of an excess of goat anti-human IgG antibody labeled with an enzyme such as alkaline phosphatase, after allowing the chimeric anti-TAG72 antibody to bind to microtiter wells coated with antigen (TAG72). Anti-TAG72 activity was determined as a criterion for successful recom-
 55 bination.

After growth for 14 days, 50 μl of supernatant was removed from the wells of the subcloned cells and re-assayed for TAG binding by ELISA. Samples of supernatants (50 μl) from drug resistant cell lines were

applied to wells of Nunc Immulon 96-well plates which had previously been coated with TAG antigen (1/50 dilution). After washing to remove unbound material, the wells were incubated with Goat Anti-Human IgG antibodies conjugated with Alkaline Phosphatase (GAHlgG-AP) as a probe to detect the human constant regions of the chimeric antibodies which had bound to the TAG antigen immobilized on the plate. Another washing to remove unbound probe (GAHlgG-AP), followed by addition of a chromogenic alkaline phosphatase substrate, allowed color to develop in those wells which possessed TAG binding associated with human constant regions (i.e., chimeric anti-TAG72 antibodies). Absorbance readings at 405 nm indicate the relative amount of chimeric antibody produced by the drug-resistant cell lines.

CH44-1

Anti-TAG72 activity was used as a criterion for successful recombination. Wells of microtiter plates were coated with TAG by incubating 50 μ l of a 1:75 dilution of purified TAG72 [Muraro, R., et al., *Cancer Research* 48, 4588-4596 (1988)] for 18 hours at room temperature. The wells were then washed 4 times with phosphate buffered saline (PBS), and then blocked with BSA, by incubating 50 μ l of 0.5 percent BSA in PBS for 2 hours at 37° C, followed by washing 4 times with PBS. These plates are stable if kept moist at 4° C. 50 microliters of sample are then applied to each well. A blank containing fresh medium is used as a control. All of the samples were incubated either in the plate for 90 minutes at 37° C or overnight at 4° C in a closed container.

The plates were then washed 4 times with PBS, and goat anti-human IgG-alkaline phosphatase (Southern Biotech Assoc.) was applied to each well by adding 50 μ l of a 1:250 dilution. The solution was incubated at 37° C for 90 minutes. Color development was monitored after washing the plates 4 times with PBS to remove the probe.

The substrate was incubated in 200 μ l solution of substrate p-nitrophenyl phosphate (Kirkegaard & Perry) in ethanolamine buffered saline for 6 minutes at room temperature for color development. The optical density at 450 nm of each well was read by a Dynatech microplate reader (Dynatech Inc.).

The Sp2/0 colonies in wells with supernatants having TAG72-binding chimeric antibody activity were subcloned by limited dilution. Individual subclones were chosen on the basis of relatively high production of chimeric antibody.

CH44-2

The TAG-ELISA procedure used with CH44-1 was repeated with the exception that the antibody was CH44-2.

CH44-3

The TAG-ELISA procedure used with CH44-1 was repeated with the exception that the antibody was CH44-3.

CH44-4

The TAG-ELISA procedure used with CH44-1 was repeated with the exception that the antibody was CH44-4.

CH88-1

The TAG-ELISA procedure used with CH44-1 was repeated with the exception that the antibody was CH88-1.

CH88-2

The TAG-ELISA procedure used with CH44-1 was repeated with the exception that the antibody was CH88-2.

6 CH88-3

The TAG-ELISA Procedure used with CH44-1 was repeated with the exception that the antibody was CH88-3.

10 CH88-4

The TAG-ELISA Procedure used with CH44-1 was repeated with the exception that the antibody was CH88-4.

15 CH84-1

20 The TAG-ELISA procedure used with CH44-1 was repeated with the exception that the antibody was CH84-1.

CH84-2

25 The TAG-ELISA procedure used with CH44-1 was repeated with the exception that the antibody was CH84-2.

CH84-3

30 The TAG-ELISA procedure used with CH44-1 was repeated with the exception that the antibody was CH84-3.

35 CH84-4

The TAG-ELISA procedure used with CH44-1 was repeated with the exception that the antibody was CH84-4.

40 CH48-1

45 The TAG-ELISA procedure used with CH44-1 was repeated with the exception that the antibody was CH84-4.

B. *In vivo* Carcinoma Targeting

50 The chimeric monoclonal antibodies used in animal studies and shown in Tables 1- 4 below were labeled with Na¹²⁵I using Iodogen (Pierce Chemical, Rockford, IL). More specifically, from about 0.5-2 mg of purified chimeric monoclonal antibodies were adjusted to about 0.5 mL 0.1M sodium phosphate buffer (pH 7.2) and then added to a 12 cm x 75 cm glass tube coated with 50 µg of Iodogen followed by addition of from 0.1 -0.5 mCi of Na¹²⁵I (New England Nuclear, Boston, MA). After a 2 min incubation at room temperature, the protein was removed from the insoluble Iodogen, and the unincorporated ¹²⁵I was separated from the antibody by gel filtration through a 10 mL column Sephadex™ G-25 using PBS as the buffer. The iodination protocol yielded labeled IgG chimeric antibody with a specific activity of 0.05 to 0.2 µCi/µg.

Female athymic mice (nu/nu) on a CD1 background were obtained from Charles River at approximately

4 weeks of age. Nine days later, mice were inoculated subcutaneously (0.1 mL/mouse) with LS174T cells (1×10^6 cells/animal).

Athymic mice bearing carcinomas 70 to 400 mg in weight, approximately 12 to 13 days after inoculation of the cells were given injections intravenously of from 0.5 to 2.0 μCi (10-50 μg protein) in PBS of the chimeric monoclonal antibodies, which had been iodinated as described above. Groups of five mice were sacrificed at varying times by exsanguination, the carcinoma and normal tissues were excised and weighed, and the cpm were measured in a gamma counter. The cpm/mg of each tissue was then determined and compared to that found in the carcinoma.

The results for CH44-1 are shown in Tables 1-2, and Figures 39A, 39B, and 39C. The results for CH84-1 are shown in Tables 3-4, and Figures 40A and 40B.

Percent Injected Dose Per Gram of ^{125}I -Labeled Antibody

Table 1

Tissue	CH44-1			
	0.75 Hour	23.5 Hours	49.5 Hours	122 Hours
blood, total	29.70	15.84	8.09	7.31
Liver	8.13	4.13	2.19	1.96
Spleen	6.19	3.39	2.12	1.36
Kidney	4.35	2.80	1.52	1.33
tumor	3.31	25.95	28.83	44.16
lung	7.34	5.39	2.90	2.36
tumor,wt	0.18	0.12	0.09	0.11

As shown in Table 1, at approximately 122 hours post-injection, the percent injected dose to tumor for CH44-1 was 44.16 percent. CH44-1 was, therefore, efficient in targeting the human tumor in-situ. This demonstrates that the chimeric monoclonal antibodies of the present invention were efficient for *in vivo* carcinoma targeting and thus are useful for *in vivo* treatment of cancer.

Percent Injected Dose Per Organ of ^{125}I -Labeled Antibody

Table 2

Tissue	CH44-1			
	0.75 Hour	23.5 Hours	49.5 Hours	122 Hours
blood, total	47.72	23.03	13.29	12.01
Liver	10.97	5.20	3.20	2.69
Spleen	1.09	0.48	0.25	0.22
Kidney	1.25	0.72	0.42	0.40
tumor	0.57	3.08	2.82	4.55
lung	1.20	0.87	0.57	0.37
GI tract	6.64	4.78	3.98	2.83
carcass	43.17	49.68	35.35	29.95
whole body retention	91.30	76.34	53.28	46.20

As shown in Table 2, at 122 hours post-injection, the percent of injected dose tumor for CH44-1 was 4.55 percent. CH44-1 was, therefore efficient in targeting the human tumor in-situ. This demonstrates that the chimeric monoclonal antibodies of the present invention were efficient for *in vivo* carcinoma targeting and thus were useful in *in vivo* treatment of cancer.

Percent Injected Dose Per Gram of ¹²⁵I-Labeled Antibody

Table 3

Tissue	CH84-1			
	1 Hour	23 Hours	47 Hours	118-119 Hours
blood	30.68	15.65	6.74	6.49
Liver	12.55	4.26	2.35	1.57
Spleen	10.93	3.35	2.56	1.70
Kidney	5.59	2.51	1.53	1.55
tumor	4.06	20.52	17.58	30.27
lung	10.77	4.80	2.58	2.24
tumor,wt.	0.15	0.22	0.20	0.24

As shown in Table 3, at approximately 118 hours post-injection, the percent of injected dose to tumor for CH84-1 was 30.27 percent. CH84-1 was, therefore, efficient in targeting the human tumor in-situ. This demonstrates that the chimeric monoclonal antibodies of the present invention were efficient for *in vivo* carcinoma targeting and thus were useful in *in vivo* treatment of cancer.

Percent Injected Dose Per Organ of ¹²⁵I-Labeled Antibody

Table 4

Tissue	CH84-1			
	1 Hour	23 Hours	47 Hours	118-119 Hours
blood, total	45.98	22.11	10.08	9.37
Liver	13.64	5.34	3.13	1.94
Spleen	1.35	0.49	0.32	0.16
Kidney	1.39	0.62	0.38	0.38
tumor	0.59	4.33	3.63	7.02
lung	1.77	0.69	0.42	0.31
GI tract	7.38	4.92	3.41	2.32
carcass	44.83	52.19	30.32	24.06
whole body retention	93.58	81.00	47.14	45.48

As shown in Table 4, at approximately 118 post-injection, the percent of injected dose to tumor for CH84-1 was 7.02 percent. CH84-1 was, therefore, efficient in targeting the human tumor in-situ. This demonstrates that the chimeric monoclonal antibodies of the present invention were efficient for *in vivo* carcinoma targeting and thus were useful in *in vivo* treatment of cancer.

Deposit of Cell lines Producing Chimeric Antibodies

Eleven illustrative cell lines secreting chimeric antibodies, all having a kappa light chains, made by the above examples were deposited at the American Type Culture Collection (ATCC) on October 19, 1988. Specifically, the following cell lines have been deposited: (1) CH44-1: a cell line having CC49 V_H, CC49 V_L, and constant region of IgG₁ (ATCC No. HB 9884); (2) CH44-2: a cell line having CC49 V_H, CC49 V_L, and constant region of IgG₂ (ATCC No. HB 9880); (3) CH44-4: a cell line having CC49 V_H, CC49 V_L, and constant region of IgG₄ (ATCC No. 9877); (4) CH88-1: a cell line having V_H, CC83 V_L, and constant region of IgG₁ (ATCC No. 9882); (5) CH88-2: a cell line having CC83 V_H, CC83 V_L, and constant region of IgG₂ - (ATCC No. 9881); (6) CH88-3: a cell line having CC83 V_H, CC83 V_L, and constant region of IgG₃ (ATCC No. 9876); (7) CH88-4: a cell line having CC83 V_H, CC83 V_L, and constant region of IgG₄ (ATCC No. 9874); (8) CH84-1: a cell line having CC83 V_H, CC49 V_L, and constant region of IgG₁ (ATCC No. 9883); (9) CH84-2: a cell line having CC83 V_H, CC49 V_L, and constant region of IgG₂ (ATCC No. 9879); (10) CH84-3: a cell line having CC83 V_H, CC49 V_L, and constant region of IgG₃ (ATCC No. 9878); and (11) CH84-4: a cell line having CC83 V_H, CC49 V_L, and constant region of IgG₄ (ATCC No. 9875).

The present invention is not to be limited in scope by the cell lines deposited since the deposited embodiments are intended as a single illustration of one aspect of the invention and all cell lines which are functionally equivalent are within the scope of the invention. Indeed, while this invention has been described in detail and with reference to specific embodiments thereof, it will be apparent to one skilled in the art that various changes and modifications could be made therein without departing from the spirit and scope of the appended claims.

Claims

1. An antibody or antibody fragment comprising:
 a variable region having a light chain (V_L) and a heavy chain (V_H), said V_H being encoded by a DNA sequence effectively homologous to the V_HαTAG germline gene (V_HαTAG), wherein the variable region binds to TAG72 at least 25% greater than the variable region of B72.3 binds to TAG72, with the binding affinities of the antibody and B72.3 being measured by the same technique.

2. The antibody or antibody fragment of Claim 1, wherein:
- (A) the V_L is encoded by an animal V gene segment and an animal J gene segment; and
 - (B) the V_H is further encoded by an animal D gene segment and an animal J gene segment.
3. The antibody or antibody fragment according to Claim 2, wherein the light chain J segment is
5 encoded by a gene selected from murine and human J gene segments.
4. The antibody or antibody fragment according to Claim 2, wherein the heavy chain D gene segment is encoded by a gene selected from murine and human D gene segments, and the J gene segment is encoded by a gene selected from murine and human J gene segments.
5. The antibody or antibody fragment of Claim 1, wherein the variable region is derived from the
10 variable regions of CC46, CC49, CC83 or CC92.
6. The antibody or antibody fragment of Claim 1, wherein the variable region comprises (1) complementarity diversity regions (CDR) being encoded by a gene derived from the $V_H\alpha$ TAG, and (2) framework regions, adjacent to the CDR regions, derived from human genes.
7. The antibody or antibody fragment of Claim 1, further comprising a constant region having at least a
15 portion of a human light chain (C_L) and a human heavy chain (C_H).
8. The antibody or antibody fragment of Claim 7, wherein the C_H is IgG₁₋₄, IgM, IgA, IgD or IgE.
9. The antibody or antibody fragment of Claim 7, wherein C_L is kappa or lambda.
10. The antibody or antibody fragment of Claim 1, wherein it is produced by a cell line from CH44-1,
CH44-2, CH44-4, CH88-1, CH88-2, CH88-3, CH88-4, CH84-1, CH84-2, CH84-3 or CH84-4.
- 20 11. An antibody or antibody fragment conjugate comprising antibody or antibody fragment of any one of Claims 1 through 10 conjugated to an imaging marker.
12. The antibody or antibody fragment conjugate of Claim 11, wherein the imaging marker is ¹²⁵I, ¹³¹I,
¹²³I, ¹¹¹In, ¹⁰⁵Rh, ¹⁵³Sm, ⁶⁷Cu, ⁶⁷Ga, ¹⁶⁶Ho, ¹⁷⁷Lu, ¹⁸⁶Re, ¹⁸⁸Re or ^{89m}Tc.
13. A antibody or antibody fragment conjugate comprising the antibody or antibody fragment of any one
25 of Claims 1 through 10 conjugated to a therapeutic agent.
14. The antibody or antibody fragment conjugate of Claim 13, wherein the therapeutic agent is a radionuclide, drug or biological response modifier, toxin or another antibody.
15. The antibody or antibody fragment conjugate of Claim 14, wherein the radionuclide is ¹³¹I, ⁹⁰Y,
¹⁰⁵Rh, ⁴⁷Sc, ⁶⁷Cu, ²¹²Bi, ²¹¹At, ⁶⁷Ga, ¹²⁵I, ¹⁸⁶Re, ¹⁸⁸Re, ¹⁷⁷Lu, ^{89m}Tc, ¹⁵³Sm, ¹²³I or ¹¹¹In.
- 30 16. The antibody or antibody fragment conjugate of Claim 14, wherein the drug or biological response modifier is methotrexate, adriamycin or lymphokine.
17. A DNA sequence encoding at least a portion of an antibody heavy chain, said sequence comprising a DNA sequence segment being effectively homologous to the $V_H\alpha$ TAG germline gene ($V_H\alpha$ TAG),
35 therein the DNA sequence segment encodes at least a portion of a heavy chain variable region (V_H).
18. The DNA sequence of Claim 17, wherein the sequence further comprises a DNA sequence segment animal D genes and a DNA sequence segment of animal J genes.
19. The DNA sequence of Claim 18, wherein the DNA sequence encoding the V_H is derived from sequences encoding the V_H regions of CC46, CC49, CC83, and CC92.
- 40 20. The DNA sequence of Claim 18, wherein the sequence encodes for a V_H having (1) at least one complementarity diversity region (CDR) encoded by a gene effectively homologous to the $V_H\alpha$ TAG, and (2) framework regions, adjacent to the CDR regions, encoded by a human gene.
21. The DNA sequence of Claim 17, further comprising sequence segment encoding for at least a portion of a human heavy chain constant region (C_H).
- 45 22. The DNA Sequence of Claim 21, wherein the sequence segment encodes for at least a portion of a C_H gene encoding IgG₁₋₄, IgM, IgA, IgD or IgE.
23. A DNA sequence comprising:
- (A) a sequence segment encoding for an antibody or antibody fragment heavy chain, said sequence segment having
50 (1) a sequence subsegment being effectively homologous to the $V_H\alpha$ TAG germline gene ($V_H\alpha$ TAG), wherein the DNA sequence segment encodes at least a portion of a V_H , and (2) a sequence subsegment encoding for at least a portion of a C_H ; and
 - (B) a sequence segment encoding for an antibody or antibody fragment light chain, said sequence segment having
55 (1) a sequence subsegment encoding for at least a portion of an animal light chain variable region (V_L), and (2) a sequence subsegment encoding for at least a portion of a human light chain constant region (C_L), wherein the antibody or antibody fragment encoded by the DNA sequence binds to TAG72 at least 25% greater than the variable region of B72.3 binds to TAG72, with the binding affinities of the antibody and

B72.3 being measured by the same technique.

24. The DNA sequence of Claim 23, wherein the sequence segment encoding for at least a portion of a C_H gene encoding IgG₁₋₄, IgM, IgA, IgD or IgE.

25. The DNA sequence of Claim 23, wherein the sequence segment encoding for at least a portion of a C_L gene encoding kappa or lambda.

26. A biologically functional expression vehicle containing the DNA sequence of any one of Claims 17 through 25.

27. A cell transformed with the biologically functional expression vehicle of Claim 26.

28. A cell which comprises the characteristics of a cell of CH44-1, CH44-2, CH44-4, CH88-1, CH88-2, CH88-3, CH88-4, CH84-1, CH84-2, CH84-3 or CH84-4.

29. A composition comprising the antibody or antibody fragment of any one of Claims 1 through 10, in a pharmaceutically acceptable, non-toxic, sterile carrier.

30. A composition comprising the antibody or antibody fragment conjugate of any one of Claims 11 through 12, in a pharmaceutically acceptable, non-toxic, sterile carrier.

31. A composition comprising the antibody or antibody fragment conjugate of any one of Claims 13 through 16, in a pharmaceutically acceptable, non-toxic, sterile carrier.

32. A process for preparing an antibody or antibody fragment which comprises contacting a V_H region, as defined in Claim 1, with a V_L region, as defined in Claim 2, to form a variable region of the antibody or antibody fragment.

33. A process for preparing an antibody or antibody fragment conjugate which comprises contacting an antibody or antibody fragment, as defined in any one of Claims 1 through 10, with an imaging marker or therapeutic agent.

34. A process for preparing a recombinant expression vehicle which comprises inserting a DNA sequence, as defined in any one of Claims 17 through 25, into an expression vehicle.

35. A process for preparing a transformed host which comprises inserting the expression vehicle, as defined in Claim 26, into a suitable host.

30

35

40

45

50

55

V_HαTAG
CC49
CC83

-290
CCTTCTCTTCCTCCACCACCAAATCCACATTTGTAATCAAC
.....
.....

V_HαTAG
CC49
CC83

-205
ATGTTAACATATCACAGAGTGGAGCAACAGAATCAGGGCAAAAATATGCTGAGAGATTTATCCCTGTCGTTACAACCAAAGCATC
.....T.....
.....

V_HαTAG
CC49
CC83

-120
TGTCTAGAATTCATAAAAAC'TTATGGGATACATTTCTCAGAGAGGAATAGGATTTGGACCTGACGATCCTGCTGCCCGAGCCA
.....
.....

V_HαTAG
CC49
CC83

-35
TGTGATGACAGTTCTTCTCCAGTTGMACTAGGTCCTTATCTAAGAAATGCACCTGCTCATGAATATGCAAATCACCCGAGTCTATG
.....
.....

V_HαTAG
CC46
CC49
CC83
CC92

52
GCAGTAAATACAGAGATGTTTATACCATAAAAACAATATATGATCAGTGTCTTCTCCGCTATCCCTGGACACACTGACTCTAACC
.....G.....
.....

V_HαTAG
CC46
CC49
CC83
CC92

121
ATG GAA TGG AGC TGG GTC TTT CTC TTC TTC CTG TCA GTA ACT ACA G GTAAGGGGCTCACCATTTCCAAA
.....
.....
.....
.....

FIG.2

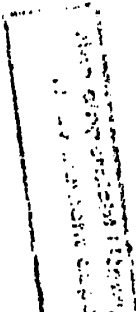

EP 0 365 997 A2

		(intron)																				197	
V _H αTAG	TCTAAAGTGGAGTCAGGGCCTGAGGTGACAAAGATATCCACTTTGGCTTTCACAG	GT	GTC	CAC	TCC	CAG	GTT	CAG															
CC46																						
CC49																						
CC83																						
CC92																						
V _H αTAG	CTG CAG CAG TCT GAC GCT GAG TTG GTG AAA CCT GGG GCT TCA GTG AAG ATA TCC TGC AAG GCT																						260
CC46	..A																						
CC49	T..																						
CC83	T..																						
CC92																						
V _H αTAG	TCT GGC TAC ACC TTC ACT	CDR 1 GAC CAT GCT ATT CAC					TGG	GTG	AAG	CAG	AAG	CCT	GAA	CAG	GGC	CTG	323						
CC46																					
CC49																					
CC83																					
CC92																					
V _H αTAG	GAA TGG ATT GGA	CDR 2 TAT ATT TCT CCC GGA AAT GGT GAT ATT AAG TAC AAT GAG AAG TTC AAG											GGC	386									
CC46																					
CC49																					
CC83																					
CC92																					
V _H αTAG	AAG GCC ACA CTG ACT GCA GAC AAA TCC TCC AGC ACT GCC TAC ATG CAG CTC AAC AGC CTG ACA																						409
CC46																						
CC49																						
CC83																						
CC92																						

 New classification / New
 Nomenclature dep

EP 0 365 997 A2

FIG.2 continued

Ned elnsersicht | Na
 Nouvellement c

483

V _H CTAG	TCT GAG GAT TCT GCA GTG TAT TTC TGT AAA AGA CACAGTGTGTAAACCACATCCTGAGTGTGTCAGAAATCCTG
CC46	..GCCG G.C GGC TAC GGG GTT GCT TTC TGG GGC CAA GGG
CC49C. ... TCC CTG AAT ATG GCC TAC TGG GGT CAA GGA
CC83G. ... TCC TTC TAC GGC AAC --- TGG GGC CAA GGC
CC92C. ... TCT CTA TCC GGG GAC TCC TGG GGC CAG GGC

CDR 3

568

V _H CTAG	GGGGAGCAGAAAGATACACTGGGACTGAGAAGACAGAAAAATTAATCCTTAGACTTGCTCAGAAATCGTAATTTTGAATGCCTAT
CC46	ACT CTG GTC ACT GTC TCT GCA
CC49	ACC TCA GTC ACC GTC TCC TCA
CC83	ACC ACC CTC ACA GTC TCC TCA
CC92	ACC ACT CTC ACA GTC TCC TCA

611

V _H CTAG	TTATTTTCATCTTGCTCACACACCTATATTGCTTTTGTAAAGCTT
---------------------	---

FIG.2 continued

EP 0 385 997 A2

	-19	leader peptide												-10								
V _H αTAG	Met	Glu	Trp	Ser	Trp	Val	Phe	Leu	Phe	Phe	Leu	Ser	Val	Thr	Thr	Gly	Val	His	Ser	Gln	Val	
CC46	Phe
CC49
CC83
CC92
V _H αTAG																						
CC46	Gln	Leu	Gln	Gln	Ser	Asp	Ala	Glu	Leu	Val	Lys	Pro	Gly	Ala	Ser	Val	Lys	Ile	Ser	Cys	Lys	
CC49	Arg
CC83
CC92
V _H αTAG																						
CC46	Ala	Ser	Gly	Tyr	Thr	Phe	Thr	Asp	His	Ala	Ile	His	Trp	Val	Lys	Gln	Lys	Pro	Glu	Gln	Gly	
CC49	Asn	
CC83	
CC92	
V _H αTAG																						
CC46	Leu	Glu	Trp	Ile	Gly	Tyr	Ile	Ser	Pro	Gly	Asn	Gly	Asp	Ile	Lys	Tyr	Asn	Glu	Lys	Phe	Lys	
CC49	Phe	
CC83	Phe	Asp	.	Phe	Arg	.	.	
CC92	Asp	
V _H αTAG																						
CC46	Gly	Lys	Ala	Thr	Leu	Thr	Ala	Asp	Lys	Ser	Ser	Ser	Thr	Ala	Tyr	Met	Gln	Leu	Asn	Ser	Leu	
CC49	Val	.	Phe	.	.	.	
CC83	
CC92	Pro	.	Asn	.	Val	

New cloneraicht
 Mouvement

EP 0 365 997 A2

FIG.3

FIG.4a

(NUCLEOTIDE SEQUENCE OF CC-49 V.)

1	CC	ATC	CAC	TCT	CAC	ACA	CAC	TGC	CCA	GGC	ATT	TGC	TTT	TGT	ATT	TGC	47
48	TGG	CTG	CTT	TGC	ATA	GAC	CCC	TCC	AGC	CTA	ACC	CAG	CTG	CTC	AGA	ATT	95
96	TAT	AAA	CCA	GTA	TGA	ACT	GAG	CAG	CAT	CAG	ACA	<u>GGC</u>	<u>AGG</u>	<u>GGA</u>	<u>AGC</u>	<u>AAG</u>	143
144	<u>ATG</u>	<u>GAT</u>	<u>TCA</u>	<u>CAG</u>	<u>GCC</u>	<u>CAG</u>	<u>GTT</u>	<u>CTT</u>	<u>ATG</u>	<u>TTA</u>	<u>CTG</u>	<u>CTG</u>	<u>CTA</u>	<u>TGG</u>	<u>GTA</u>	<u>TCT</u>	191
192	<u>GGT</u>	GAG	AAA	TTT	AAA	AGT	ATT	ATC	ATT	TCA	GAG	TTA	CAC	CTT	TTT	ATA	239
240	TAA	GAA	ATT	TAT	ACT	TTG	TGC	AAG	TGT	GTA	ATA	TTA	CTT	CCA	TAA	TAA	287
288	CTC	TGA	CAA	TAT	GAC	ATT	ACA	AAG	ACC	TTT	GAC	AAA	TTT	CAA	CTG	TTA	335
336	TAA	TAA	TCT	ATT	TGT	GTA	TGT	ATT	CAT	GTT	CAC	TTT	CTA	CTT	ATT	TCA	383
384	<u>GGT</u>	<u>ACC</u>	<u>TGT</u>	<u>GGG</u>	<u>GAC</u>	ATT	GTG	ATG	TCA	CAG	TCT	CCA	TCC	TCC	CTA	CCT	431
432	GTG	TCA	GTT	GGC	GAG	AAG	GTT	ACT	TTG	AGC	TGC	AAG	TCC	AGT	CAG	AGC	479
480	CTT	TTA	TAT	AGT	GGT	AAT	CAA	AAG	AAC	TAC	TTG	GCC	TGG	TAC	CAG	CAG	527
528	AAA	CCA	GGG	CAG	TCT	CCT	AAA	CTG	CTG	ATT	TAC	TGG	GCA	TCC	GCT	AGG	575
576	GAA	TCT	GGG	GTC	CCT	GAT	CGC	TTC	ACA	GGC	AGT	GGA	TCT	GGG	ACA	GAT	623
624	TTC	ACT	CTC	TCC	ATC	AGC	AGT	GTG	AAG	ACT	GAA	GAC	CTG	<u>GCA</u>	<u>GTT</u>	<u>TAT</u>	671
672	<u>TAC</u>	<u>TGT</u>	<u>CAG</u>	<u>CAG</u>	<u>TAT</u>	<u>TAT</u>	<u>AGC</u>	<u>TAT</u>	<u>CCC</u>	<u>CTC</u>	<u>ACG</u>	<u>TTC</u>	<u>GGT</u>	<u>GCT</u>	<u>GGG</u>	<u>ACC</u>	719
720	<u>AAG</u>	<u>CTG</u>	<u>GTG</u>	<u>CTG</u>	<u>AAA</u>	<u>CGT</u>	AAG	TAC	ACT	TTT	CTC	ATC	TTT	TTT	TAT	GTG	767
768	TAA	GAC	ACA	GGT	TTT	CAT	GTT	AGG	AGT	T							

The underlined segments show the portions verified by mRNA sequencing.

Nes d'ingarcicht / New
 Neuvalliment C.A.P.

EP 0 365 997 A2

FIG.4b

(AMINO ACID SEQUENCE OF CC-49 VL)

New alignment file
file/alignment

				MET	ASP	SER	GLN	ALA	GLN	VAL	LEU	MET	LEU	LEU	LEU	LEU	TRP
VAL	SER	GLY	THR	CYS	GLY	//ASP	ILE	<u>VAL</u>	<u>MET</u>	<u>SER</u>	<u>GLN</u>	<u>SER</u>	<u>PRO</u>	<u>SER</u>	<u>SER</u>	<u>LEU</u>	
<u>PRO</u>	<u>VAL</u>	<u>SER</u>	<u>VAL</u>	<u>GLY</u>	<u>GLU</u>	<u>LYS</u>	<u>VAL</u>	<u>THR</u>	<u>LEU</u>	<u>SER</u>	<u>CYS</u>	<u>LYS</u>	SER	SER	GLN	SER	
LEU	LEU	TYR	SER	GLY	ASN	GLN	LYS	ASN	TYR	LEU	ALA	TRP	TYR	GLN	GLN	LYS	
PRO	GLY	GLN	SER	PRO	LYS	LEU	LEU	ILE	TYR	TRP	ALA	SER	ALA	ARG	GLU	SER	
GLY	VAL	PRO	ASP	ARG	PHE	THR	GLY	SER	GLY	SER	GLY	THR	ASP	PHE	THR	LEU	
SER	ILE	SER	SER	VAL	LYS	THR	GLU	ASP	LEU	ALA	VAL	TYR	TYR	CYS	GLN	GLN	
TYR	TYR	SER	TYR	PRO/	LEU	THR	PHE	GLY	ALA	GLY	THR	LYS	LEU	VAL	LEU	LYS	

EP 0 365 997 A2

"/" indicates the end of the V segment and the beginning of the J5 segment.
 "//" indicates the end of the leader sequence and the beginning of the mature protein.
 The amino acid sequence determination for the first 24 amino acids of the mature CC49 VL are underlined.

FIG.5a

(NUCLEOTIDE SEQUENCE OF CC-83 V,)

1	CCT	AGA	GGC	CAG	CAC	AGC	TGC	CCA	TGA	TTT	ATA	AAC	CAG	GTC	TTT	GCA	48
49	GTG	AGA	TCT	CAA	ATA	<u>CAT</u>	<u>CAG</u>	<u>ACC</u>	<u>AGC</u>	<u>ATG</u>	<u>GGC</u>	<u>ATC</u>	<u>AAG</u>	<u>ATG</u>	<u>GAG</u>	<u>ACA</u>	96
97	<u>CAT</u>	<u>TCT</u>	<u>CAG</u>	<u>GTC</u>	<u>TTT</u>	<u>GTA</u>	<u>TAC</u>	<u>ATG</u>	<u>TTG</u>	<u>CTG</u>	<u>TGG</u>	<u>TTG</u>	<u>TCT</u>	GGT	GAG	A	142
143	CAT	TTA	AAA	GTA	TTA	TAA	AAT	CTT	AAA	AGT	AAT	CTA	TTT	AAA	TAG	CTT	190
191	TTT	CCT	ATA	GGA	AGC	CAA	TAT	TAG	GCA	GAC	AAT	GCC	ATT	AGA	TAA	GAC	238
239	AIT	TTG	GAT	TCT	AAC	ATT	TGT	ATC	TTG	AAG	TCT	TTA	TAT	GTG	TGA	GTT	286
287	TAT	ACA	CAT	TAT	CTG	TTT	CTG	TTT	GCA	<u>GGT</u>	<u>GTT</u>	<u>GAA</u>	<u>GGA</u>	<u>GAC</u>	<u>ATT</u>	<u>GTG</u>	334
335	<u>ATG</u>	<u>ACC</u>	<u>CAG</u>	<u>TCT</u>	<u>CAC</u>	<u>AAA</u>	<u>TTC</u>	<u>ATG</u>	<u>TCC</u>	<u>GCA</u>	<u>TCA</u>	<u>GTG</u>	<u>GGA</u>	<u>GAC</u>	<u>AGG</u>	<u>GTC</u>	382
383	<u>AAC</u>	<u>ATC</u>	<u>ACC</u>	<u>TGC</u>	<u>AAG</u>	<u>GCC</u>	<u>AGT</u>	<u>CAG</u>	<u>TAT</u>	<u>GTG</u>	<u>GCT</u>	<u>ACT</u>	<u>GCT</u>	<u>GTA</u>	<u>GCC</u>	<u>TGG</u>	430
431	<u>TTT</u>	<u>CAG</u>	<u>CAT</u>	<u>AAA</u>	<u>CCA</u>	<u>GGT</u>	<u>CAG</u>	<u>TCT</u>	<u>CCT</u>	<u>AAA</u>	<u>CTA</u>	<u>CTG</u>	<u>ATT</u>	<u>TAC</u>	<u>GGG</u>	<u>GCA</u>	478
479	<u>TCC</u>	<u>ACC</u>	<u>CGG</u>	<u>CAC</u>	<u>ACT</u>	<u>GGA</u>	<u>GTC</u>	<u>CCT</u>	<u>GAT</u>	<u>CGC</u>	<u>TTC</u>	<u>ACA</u>	<u>GGC</u>	<u>AGT</u>	<u>GGA</u>	<u>TCT</u>	526
527	<u>GGG</u>	<u>ACA</u>	<u>GAT</u>	<u>TTC</u>	<u>ACT</u>	<u>CTC</u>	<u>ATC</u>	<u>ATT</u>	<u>AGC</u>	<u>AAT</u>	<u>GTG</u>	<u>CAG</u>	<u>TCT</u>	<u>GAG</u>	<u>GAC</u>	<u>TTG</u>	574
575	<u>GCA</u>	<u>GAT</u>	<u>TAT</u>	<u>TTG</u>	<u>TGT</u>	<u>CAG</u>	<u>CAT</u>	<u>TAT</u>	<u>AGC</u>	<u>GGC</u>	<u>TAT</u>	<u>CCA</u>	<u>TTC</u>	<u>ACG</u>	<u>TTC</u>	<u>GGC</u>	622
623	<u>TCG</u>	<u>GGG</u>	<u>ACA</u>	<u>AAG</u>	<u>TTG</u>	<u>GAA</u>	<u>ATA</u>	<u>AAA</u>	<u>CGT</u>	AAG	TAG	ACT	TTT	GCT	CAT	TTA	670
671	CTT	GTG	ACG	TTT	TGG												

Nucleotide sequence of CC-83 V

EP 0 365 997 A2

The underlined segments show the portions verified by mRNA sequencing.

FIG.5b

(AMINO ACID SEQUENCE OF CC-83 V_L)

Nea elporciat / Newby III
 Nouvelle èpise

MET	GLY	ILE	LYS	MET	GLU	THR	HIS	SER	GLN	VAL	PHE	VAL	TYR	MET	LEU	LEU
TRP	LEU	SER	GLY	VAL	GLU	GLY	//ASP	ILE	VAL	MET	THR	GLN	SER	HIS	LYS	PHE
<u>MET</u>	<u>SER</u>	<u>ALA</u>	<u>SER</u>	<u>VAL</u>	<u>GLY</u>	<u>ASP</u>	<u>ARG</u>	<u>VAL</u>	<u>ASN</u>	<u>ILE</u>	<u>THR</u>	<u>CYS</u>	<u>LYS</u>	<u>ALA</u>	<u>SER</u>	<u>GLN</u>
<u>TYR</u>	<u>VAL</u>	<u>ALA</u>	<u>THR</u>	<u>ALA</u>	<u>VAL</u>	<u>ALA</u>	<u>TRP</u>	<u>PHE</u>	<u>GLN</u>	<u>HIS</u>	<u>LYS</u>	<u>PRO</u>	<u>GLY</u>	<u>GLN</u>	<u>SER</u>	<u>PRO</u>
<u>LYS</u>	<u>LEU</u>	<u>LEU</u>	<u>ILE</u>	<u>TYR</u>	<u>GLY</u>	<u>ALA</u>	SER	THR	ARG	HIS	THR	GLY	VAL	PRO	ASP	ARG
PHE	THR	GLY	SER	GLY	SER	GLY	THR	ASP	PHE	THR	LEU	ILE	ILE	SER	ASN	VAL
GLN	SER	GLU	ASP	LEU	ALA	ASP	TYR	LEU	CYS	GLN	HIS	TYR	SER	GLY	TYR	PRO/
PHE	THR	PHE	GLY	SER	GLY	THR	LYS	LEU	GLU	ILE	LYS					

EP 0 365 997 A2

"/" indicates the end of the V segment and the beginning of the J4 segment.
 "//" Indicates the end of the leader sequence and the beginning of the mature protein.
 *ASN20 is not determined. It occurs in the consensus sequence ASN-X-SER/Thr where N-glycosylation is likely.
 The amino acid sequence determination for the first 51 amino acids of the mature CC83 V_L are underlined.

Nea oingerisikt /
Nouvellement depose

CC-92 Light Chain Variable Region Sequence

GAGTCACAGATCCAGGTCCTTTGTATTCGTGTTTCTCTEGTTGTCTEGTGTGACGGAGA
CATTGTGATGACCCAGTCTCACAAATTCATGTCCACATCAGTAGGAGACAGGECTCAGCA
T
CACCTGCAAGGCCAETCAGGATGTGAGTAGTGCTGTAGGGTGGTTTCAACAGAAACCA
EG
ACAATCTCCTAAATTAETGATTTATTCGGCATCCTACCGGTATACTGGAGTCCCTGATCG
CTTCACTGGCAGTGGATCTCGGACGGATTTCACTTTCACCATCACCAGTGTGCAGGCTGA
AGACCTGGCAETTTAETGTCAGCAACATTATAGTAGTCCGCTCACGTTCCGGTCTGG
GACCAAGCTGGAGCTGAAAC*

FIG.6a

Neu eingereicht / Rec
Nouvellement de

Ser His Arg Ser Arg Ser Phe Val Phe Val Phe Leu Trp Leu Ser Gly Val Asp Gl
Asp Ile Val Met Thr Gln Ser His Lys Phe Met Ser Thr Ser Val Gly Asp Arg Va
Ser Ile Thr Cys Lys Ala Ser Gln Asp Val Ser Ser Ala Val Gly Trp Phe Gln Gl
Lys Pro Gly Gln Ser Pro Lys Leu Leu Ile Tyr Ser Ala Ser Tyr Arg Tyr Thr Gl
Val Pro Asp Arg Phe Thr Gly Ser Gly Ser Arg Thr Asp Phe Thr Phe Thr Ile Th
Ser Val Gln Ala Glu Asp Leu Ala Val Tyr Tyr Cys Gln Gln His Tyr Ser Ser Pr
Leu Thr Phe Gly Ala Gly Thr Lys Leu Gly Leu Lys

FIG.6b Amino Acid Sequence of CC92 light chain variable region

EP 0 365 997 A2

Neu eingereicht / Ne
 Nouvellement c

Mouse Ig kappa germline J-C region, J1 to J5

AAGCTTTCGCCTACCCACTGCTCTGTTCCCTCTTCAGTGAGGAGGGTTTTGTACAGCCAG
 ACAGTGGAGTACTACCACTGTGGTGGACGTTCCGGTGGAGGCACCAAGCTGGAAATCAA
 AC
 GTAAGTAGAATCCAAAGTCTCTTTCTTCCGTTGTCTATGTCTGTGGCTTCTATGTCTAAA
 AATGATGTATAAAATCTTACTCTGAAACCAGATTCTGGCACTCTCCAAGGCAAAGATAC
 A
 GAGTAACTCCGTAAGCAAAGCTGGGAATAGGCTAGACATGTTCTCTGGAGAATGAATG
 CC
 AGTGTAAATAATTAACACAAGTGATAGTTTCAGAAATGCTCAAAGAAGCAGGGTAGCCT
 GC
 CCTAGACAAACCTTACTCGGTGCTCAGACCATGCTCAGTTTTGTATGGGGGTGAGTG
 AAGGGACACCAETGTGTGTACACGTTCCGGAGGGGGACCAAGCTGGAAATAAAACGT
 AAG
 TAGTCTTCTCAACTCTTGTTCACTAAGTCTAACCTTGTTAAGTTGTTCTTTGTTGTGTGT
 TTTCTTAAGGAGATTTTCAGGGATTTAGCAAATTCATTCTCAGATCAGGTGTTAAGGAG
 GGAAACTGTCCACAAGAGGTTGGAATGATTTTCAGGCTAAATTTTAGGCTTTCTAAA
 C
 CAAAGTAACTAACTAGGGGAAGAGGGATAATTGTCTACCTAGGGAGGGTTTTGTGGA
 GG
 TAAAGTTAAAATAAATCACTGTAATCACATTCAGTGATGGGACCAGACTGGAAATAA
 AA
 CCTAAGTACATTTTTGCTCAACTGCTTGTGAAGTTTTGGTCCATTGTGTCCTTTGTATG
 AGTTTGTGGTGTACATTAGATAAATGAACTATTCCTGTAACCCAAAACCTTAAATAGAA
 G
 AGAACCAAAAATCTAGCTACTGTACAAGCTGAGCAAACAGACTGACCTCATGTCAGATT
 T
 GTGGGAGAAATGAGAAAGGAACAGTTTTTCTCTGAACTTAGCCTATCTAACTGGATCGC
 C
 TCAGGCAGGTTTTGTAAAGGGGGCGCAGTGATATGAATCACTGTGATTCACGTTCCG
 C
 TCGGGGACAAAGTTGGAAATAAACGTAAGTAGACTTTTTGCTCATTTACTTGTGACGTT
 T
 TGGTCTGTTTGGGTAACCTTGTGTGAATTTGTGACATTTGGCTAAATGAGCCATTCCTG
 GCAACCTGTGCATCAATAGAAGATCCCCAGAAAAGAGTCAGTGTGAAAGCTGAGCGA
 AA
 AACTCGTCTTAGGCTTCTGAGACCAGTTTTGTAAGGGGAATGTAGAAGAAAGAGCTGG
 GC
 TTTTCTCTGAATTTGGCCCATCTAGTTGGACTGGCTTACAGGCAGTTTTGTAGAGA
 GGGGCATGTCATAGTCCCTCACTGTGGCTCACGTTCCGCTGCTGGGACCAAGCTGGAGCTG
 A
 AACGTAAGTACACTTTTCTCATCTTTTTTATGTGTAAGACACAGGTTTTCATGTTAGGA
 GTTAAAGTCAGTTCAGAAAATCTTGAGAAAATGGAGAGGGCTCATTATCAGTTGACGT
 GG
 CATACAGTGTGAGATTTTCTGTTTATCAAGCTAGTGAGATTAGGGGCAAAAAGAGGCTT
 T
 AGTTGAGAGGAAAGTAATTAATACTATGGTCACCATCCAAGAGATTGGATCGGAGAAT
 AA
 GCATGAGTAGTTATTGAGATCTGGGTCTGACTGCAG*

FIG. 7

Nes eingereicht / Ne
Nouvellement dépos.

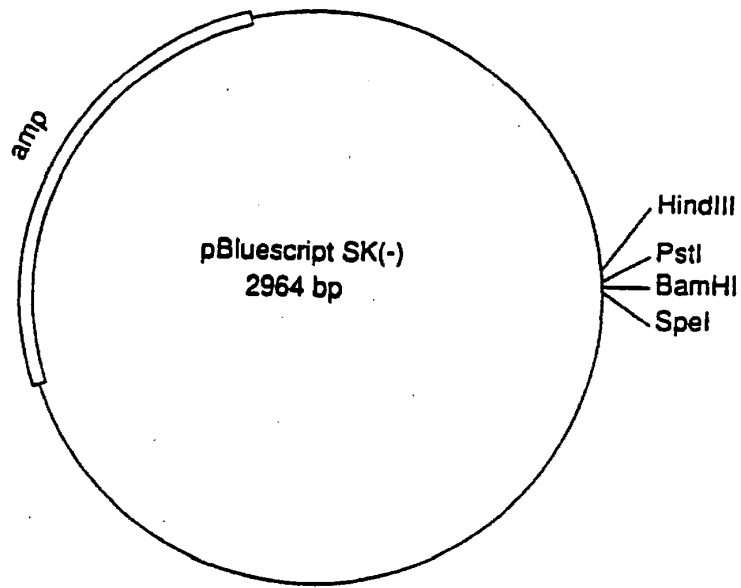

FIG. 8

Neu eingereicht / Newly filed
Nouvellement déposé

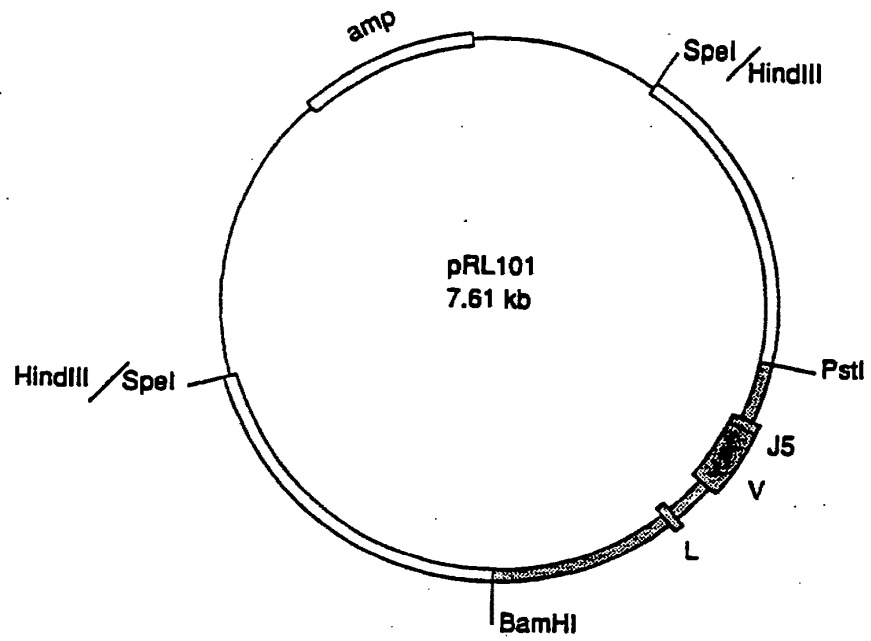
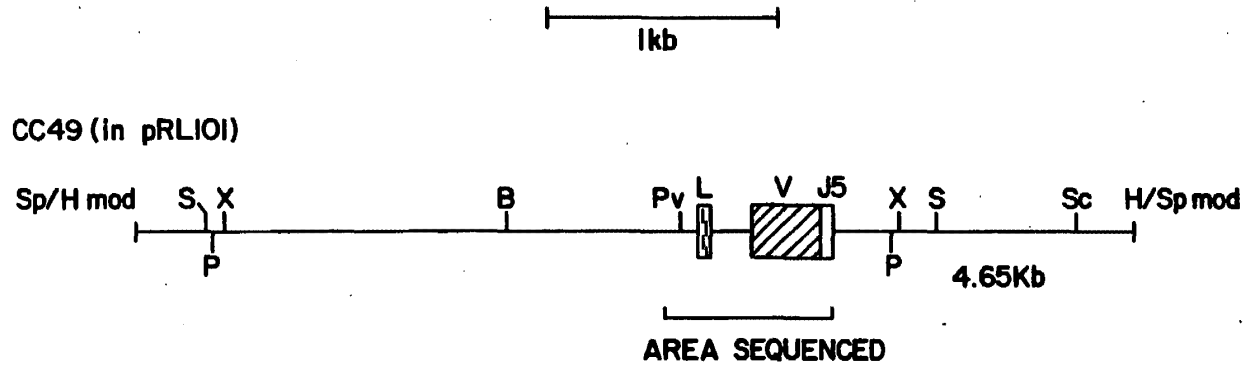

FIG. 9

FIG. 10



**KEY TO
RESTRICTION ENZYMES:**

- B - Bam HI
 - Bg- Bgl II
 - C- Cla I
 - E - Eco RI
 - H - Hind III
 - N - Nhe I
 - P - Pst I
 - Pv- Pvu II
 - S - Sac I
 - Sc- Sac II
 - Sp- Spe I
 - St- Stu I
 - X - Xba I
- mod= half-filled in

EP 0 365 997 A2

..
.
.
.
.
.

Nes eingereicht / italy to...
Nouvellement déposé

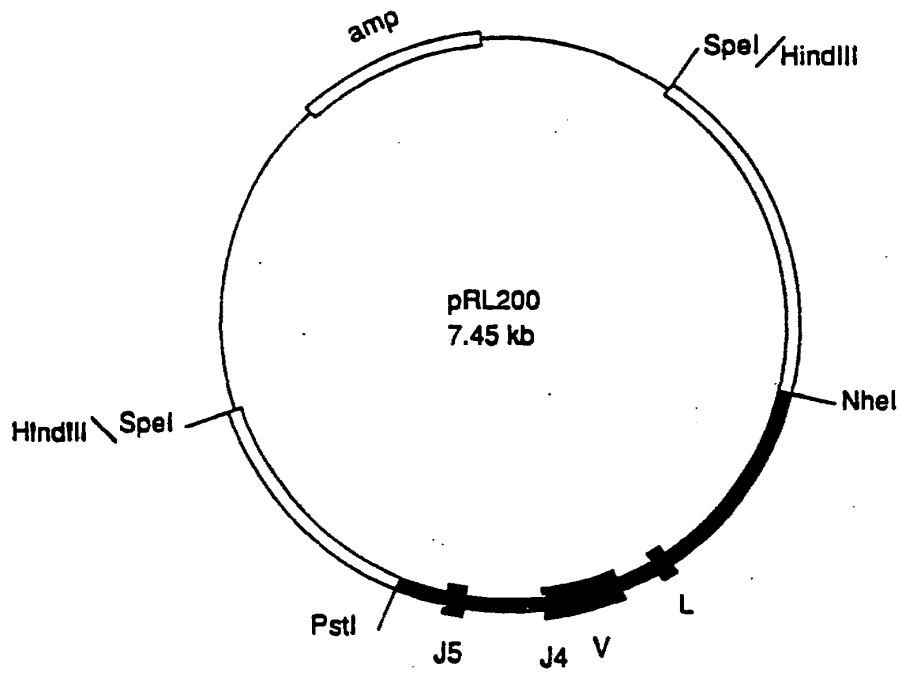

FIG. II

Nea oingerisht |
Nouvellemen

Mouse Ig germline J-H genes from pNP9

GGATCCTGGCCAGCATTGCCGCTAGGTCCCTCTCTTCTATGCTTCTTTGTCCCTCACTG
GCCTCCATCTGAGATAATCCTGGAGCCCTAGCCAAGGATCATTTATTGTCAGGGGTCTAA
TCATTGTTGTACAATGTGCCTGGTTTGCTTACTGGGGCCAAGGGACTCTGGTCACTGTC
TCTGCAGGTGAGTCCTAACTTCTCCATTCTAAATGCATGTTGGGGGGATTCTGAGCCTT
CAGGACCAAGATTCTCTGCAAACGGGAATCAAGATTCAACCCCTTTGTCCTCAAGTTGA
G
ACATGGGTCTGGGTCAAGGACTCTCTGCCTGCTGGTCTGTGGTGACATTAGAAGTGAAG
T
ATGATGAAGGATCTGCCAGAAGTGAAGCTTGAAGTCTGAGGCAGAATCTTGTCCAGGG
TC
TATCGGACTCTTGTGAGAATTAGGGGCTGACAGTTGATGGTGACAATTCAGGGTCACT
G
ACTGTCAGGTTTCTCTGAGGTGAGGCTGGAATATAGGTCACCTTGAAGACTAAAGAGG
GG
TCCAGGGGCTTTTCTGCACAGGCAGGGAACAGAATGTGGAACAATGACTTGAATGGTT
GA
TTCTTGTGTGACACCAAGAATTGGCATAATGTCTGAGTTGCCCAAGGETGATCTTAGCTA
GACTCTGGGGTTTTTGTCCGGTACAGAGGAAAAACCACTATTGTGATTACTATGCTATG
GACTACTGGGGTCAAGGAACCTCAGTCACCGTCTCCTCAGGTAAGAATGECCTCTCCAG
G
TCTTTATTTTTAACCTTTGTTATGGAGTTTTCTGAGCATTGCAGACTAATCTTGGATATT
TGCCCTGAGGEAGCCGECTGAGAGAAGTTGGGAAATAAATCTGTCTAEGGATCTCAGA
GC
CTTTAGGACAGATTATCTCCACATCTTTGAAAACTAAGAATCTGTGTGATGGTGTGGT
GGAGTCCCTGGATGATGGGATAGGGACTTTGGAGGCTCATTGAGGGAGATGCTAAAA
CA
ATCCTATGGCTGGAGGGATAGTTGGGGCTGTAGTTGGAGATTTTCAGTTTTAGAATGA
A
GTATTAGCTGCAATACTTCAAGGACCACCTCTGTGACAACCATTTTATACAGTATCCAGG
CATAGGGACAAAAAGTGGAGTGGGGCACTTTCTTTAGATTTGTGAGGAATGTTCCACAC
T
AGATTGTTTAAAACTTCAATTTGTTGGAAGGAGCTGTCTTAGTGATTGAGTCAAGGGAGA
A
AGGCATCTAGCCTCGGTCTCAAAGGGTAGTTGCTGTCTAGAGAGGTCTGGTGGAGCCT
G
CAAAAGTCCAGCTTTCAAAGGAACACAGAAGTATGTGTATGGAATATTAGAAGATGTT
GC
TTTTACTTTAAGTTGGTTCTAGGAAAAATAGTTAAATACTGTGACTTTAAAATGTGAG
AGGGTTTTCAAGTACTCATTTTTTTAAATGTCCAAAATTTTGTCAATCAATTTGAGGTC
TTGTTTGTGTAGAACTGACATTACTTAAAGTTTAAACCGAGGAATGGGAGTGAGGCTCTC
T
CATACCCTATTCAGAAGTCACTTTTAAACAATAATAAATTAAGTTTAAAATATTTTTAAAT
GAATTGAGCAATGTTGAGTTGAGTCAAGATGGCCGATCAGAACCAGAACACCTGCAGC
AG
CTGGCAGGAAGCAGGTCATGTGGCAAGGCTATTTGGGGAAAGGGAAAATAAAACCACT
AGG
TAAACTTGTAGCTGTGGTTGAAGAAGTGGTTTTGAAACACTCTGTCCAGCCCCACCAA
CCGAAAGTCCAGGCTGAGCAAAACACCACCTGGGTAATTTGCATTTCTAAAATAAGTTG
A
GGATTAGCCGAAACTGGAGAGGTCCTTTTAACTTATTGAGTTCAACCTTTTAAATTT
AGCTTGAAGTCTAGTTTCCCCAACTTAAAGTTTATCGACTTCTAAAATGTATTAGA
ATTC*
?

FIG. 13

Nes alignement / Newly file
Nouvellement disposé

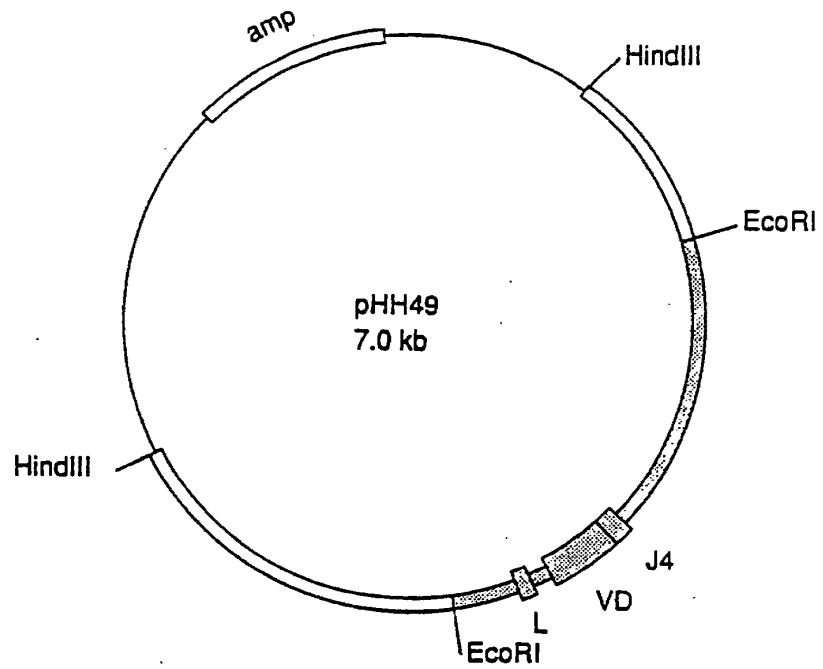

FIG.14

Nes afgevocht / Nou,
Nouvellement déposés

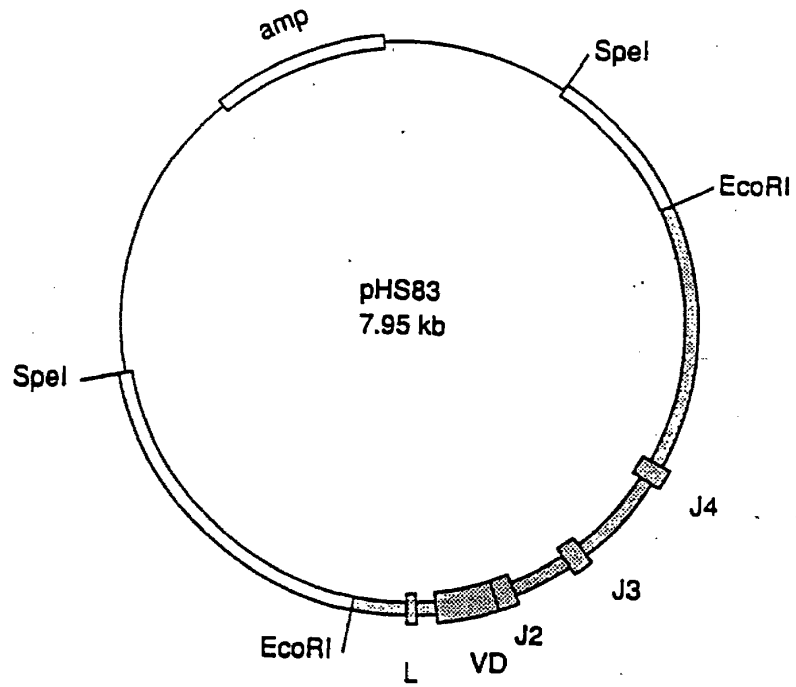

FIG. 15

FIG.16

(NUCLEOTIDE SEQUENCE OF CC-49 V_{II})

Neu eingereicht / Newly filed
 Nouvellement déposé

239	TIA	ACA	TAT	CAC	AGA	GTG	GAG	CAA	CAG	AAT	CAG	GGC	AAA	AAT	ATG	CTG	286
287	AGA	GAT	TTT	TCC	CTG	TCG	TTA	CAA	CCA	AAG	CAT	CTG	TCT	AGA	ATT	CAT	334
335	AAA	AAC	TTT	ATG	GGA	TAC	ATT	TCC	TCA	GAG	AGG	AAT	AGG	ATT	TGG	ACC	382
383	TGA	GCA	TCC	TGC	TGC	CCG	AGC	CAT	GTG	ATG	ACA	GTT	CTT	CTC	CAG	TTG	430
431	AAC	TAG	GTC	CTT	ATC	TAA	GAA	ATG	CAC	TGC	TCA	TGA	TAT	GCA	AAT	CAC	478
479	CCG	AGT	CTA	TGG	CAG	TAA	ATA	CAG	AGA	TGT	TCA	TAC	CAT	AAA	AAC	AAT	526
527	ATG	TGA	TCA	GTG	TCT	TCT	CCG	CTA	TCC	CTG	GAC	ACA	CTG	ACT	CTA	ACC	574
575	ATG	GAA	TGG	AGC	TGG	GTC	TTT	CTC	TTC	TTC	CTG	TCA	GTA	ACT	ACA	GGTA	623
624	AGG	GGC	TCA	CCA	TTT	CCA	AAT	CTA	AAG	TGG	AGT	CAG	GGC	CTG	AGG	TGA	671
672	CAA	AGA	TGT	CCA	CTT	TGG	CTG	TCC	ACA	GGT	GTC	CAC	TCC	CAG	GTT	CAG	719
720	TTG	CAG	CAG	TCT	GAC	GCT	GAG	TTG	GTG	AAA	CCT	GGG	GCT	TCA	GTG	AAG	767
768	ATT	TCC	TGC	AAG	GCT	TCT	GGC	TAC	ACC	TTC	ACT	GAC	CAT	GCA	ATT	CAC	815
816	TGG	GTG	AAA	CAG	AAC	CCT	GAA	CAG	GGC	CTG	GAA	TGG	ATT	<u>GGA</u>	<u>TAT</u>	<u>TTT</u>	863
864	<u>TCT</u>	<u>CCC</u>	<u>GGA</u>	<u>AAT</u>	<u>GAT</u>	<u>GAT</u>	<u>TTT</u>	<u>AAA</u>	<u>TAC</u>	<u>AAT</u>	<u>GAG</u>	<u>AGG</u>	<u>TTC</u>	<u>AAG</u>	<u>GGC</u>	<u>AAG</u>	911
912	<u>GCC</u>	<u>ACA</u>	<u>CTG</u>	<u>ACT</u>	<u>GCA</u>	<u>GAC</u>	<u>AAA</u>	<u>TCC</u>	<u>TCC</u>	<u>AGC</u>	<u>ACT</u>	<u>GCC</u>	<u>TAC</u>	<u>GTG</u>	<u>CAG</u>	<u>CTC</u>	959
960	<u>AAC</u>	<u>AGC</u>	<u>CTG</u>	<u>ACA</u>	<u>TCT</u>	<u>GAG</u>	<u>GAT</u>	<u>TCT</u>	<u>GCA</u>	<u>GTG</u>	<u>TAT</u>	<u>TTC</u>	<u>IGT</u>	<u>ACA</u>	<u>AGA</u>	<u>TCC</u>	1007
1008	<u>CTG</u>	<u>AAT</u>	<u>ATG</u>	<u>GCC</u>	<u>TAC</u>	<u>TGG</u>	<u>GGT</u>	<u>CAA</u>	<u>GGA</u>	<u>ACC</u>	<u>TCA</u>	<u>GTC</u>	<u>ACC</u>	<u>GTC</u>	<u>TCC</u>	<u>TCAG</u>	1056

The underlined segments show the portions verified by mRNA sequencing.

EP 0 365 997 A2

FIG.17
(NUC EOTIDE SEQUENCE OF CC-83 V_{II})

Newly filed / Newly filed
Nouvellement déposé

478	TGA	ACA	TAT	CAC	AGA	GTG	GAG	CAA	CAG	AAT	CAG	GGC	AAA	AAT	ATG	CTG	525
526	AGA	GAT	TTA	TCC	CTG	TCG	TTA	CAA	CCA	AAG	CAT	CTG	TCT	AGA	ATT	CAT	573
574	AAA	AAC	TTT	ATG	GGA	TAC	ATT	TCC	TCA	GAG	AGG	AAT	AGG	ATT	TGG	ACC	621
622	TGA	GCA	TCC	TGC	TGC	CCG	AGC	CAT	GTG	ATG	ACA	GTT	CTT	CTC	CAG	TTG	669
670	AAC	TAG	GTC	CTT	ATC	TAA	GAA	ATG	CAC	TGC	TCA	TGA	TAT	GCA	AAT	CAC	717
718	CCG	AGT	CTA	TGG	CAG	TAA	ATA	CAG	AGA	TGT	TCA	TAC	CAT	AAA	AAC	AAT	765
766	ATA	TGA	TCA	GTG	TCT	TCT	CCG	CTA	TCC	CTG	GAC	ACA	CTG	ACT	CTA	ACC	813
814	ATG	GAA	TGG	AGC	TGG	GTC	TTT	CTC	TTC	TTC	CTG	TCA	GTA	ACT	ACA	GGTA	862
863	AGG	GGC	TCA	CCA	TTT	CCA	AAT	CTA	AAG	TGG	AGT	CAG	GGC	CTG	AGG	TGA	910
911	CAA	AGA	TAT	CCA	CTT	TGG	CTT	TCC	ACA	GGT	GTC	CAC	TCC	CAG	GTT	CAG	958
959	TTG	CAG	CAG	TCT	GAC	GCT	GAG	TTG	GTG	AAA	CCT	GGG	GCT	TCA	GTG	AAG	1006
1007	ATT	TCC	TGC	AAG	GCT	TCT	GGC	TAC	ACC	TTC	ACT	GAC	CAT	GCT	ATT	CAC	1054
1055	TGG	GTG	AAG	CAG	AAG	CCT	GAA	CAG	GGC	CTG	GAA	TGG	ATT	GGA	<u>TAT</u>	<u>ATT</u>	1102
1103	<u>TCT</u>	<u>CCC</u>	<u>GGA</u>	<u>AAT</u>	<u>GAT</u>	<u>GAT</u>	<u>ATT</u>	<u>AAG</u>	<u>TAC</u>	<u>AAT</u>	<u>GAG</u>	<u>AAG</u>	<u>TTC</u>	<u>AAG</u>	<u>GGC</u>	<u>AAG</u>	1150
1151	<u>GCC</u>	<u>ACA</u>	<u>CTG</u>	<u>ACT</u>	<u>GCA</u>	<u>GAC</u>	<u>AAA</u>	<u>TCC</u>	<u>TCC</u>	<u>AGT</u>	<u>ACT</u>	<u>GCC</u>	<u>TAC</u>	<u>ATG</u>	<u>CAA</u>	<u>CTC</u>	1198
1199	<u>AAC</u>	<u>AGC</u>	<u>CTG</u>	<u>ACA</u>	<u>TCT</u>	<u>GAG</u>	<u>GAT</u>	<u>TCT</u>	<u>GCA</u>	<u>GTG</u>	<u>TAT</u>	<u>TTC</u>	<u>TGT</u>	<u>AGA</u>	<u>AGA</u>	<u>TCC</u>	1246
1247	<u>TTC</u>	<u>TAC</u>	<u>GGC</u>	<u>AAC</u>	<u>TGG</u>	<u>GGC</u>	<u>CAA</u>	<u>GGC</u>	<u>ACC</u>	<u>ACC</u>	<u>CTC</u>	<u>ACA</u>	<u>GTC</u>	<u>TCC</u>	<u>TCA</u>	<u>G</u>	

EP 0 365 997 A2

The underlined segments show the portions verified by mRNA sequencing.

FIG.18

(AMINO ACID SEQUENCE OF CC-49 V,,)

Nea aingersicht / Newly filed
Nouvellement déposé

MET	GLU	TRP	SER	TRP	VAL	PHE	LEU	PHE	PIE	LEU	SER	VAL	TIIR	TIIR
GLY	VAL	IIS	SER	//GLN	VAL	GLN	LEU	GLN	GLN	SER	ASP	ALA	GLU	LEU
VAL	LYS	PRO	GLY	ALA	SER	VAL	LYS	IIE	SER	CYS	LYS	ALA	SER	GLY
TYR	TIIR	PIIE	THR	ASP	HIS	ALA	ILE	IIS	TRP	VAL	LYS	GLN	ASN	PRO
GLU	GLN	GLY	LEU	GLU	TRP	ILE	GLY	TYR	PIIE	SER	PRO	GLY	ASN	ASP
ASP	PIIE	LYS	TYR	ASN	GLU	ARG	PHE	LYS	GLY	LYS	ALA	TIIR	LEU	TIIR
ALA	ASP	LYS	SER	SER	SER	THR	ALA	TYR	VAL	GLN	LEU	ASN	SER	LEU
TIIR	SER	GLU	ASP	SER	ALA	VAL	TYR	PHE	CYS	TIIR	ARG	SER	LEU	ASN
MET	<u>ALA</u>	<u>TYR</u>	TRP	<u>GLY</u>	<u>GLN</u>	<u>GLY</u>	THR	SER	VAL	THR	VAL	SER	SER	

" indicates where the mature protein begins.

the underlined residues were determined by protein sequence. TRP can not be determined by the method used.

EP 0 365 997 A2

Neu eingereicht / Newly filed
 Neuvvellement dépos 

FIG. 19

(AMINO ACID SEQUENCE OF CC-83 V_{II})

MET	GLU	TRP	SER	TRP	VAL	PHE	LEU	PHE	PHE	LEU	SER	VAL	THR	THR
GLY	VAL	HIS	SER	//GLN	VAL	GLN	LEU	GLN	GLN	SER	ASP	ALA	GLU	LEU
VAL	LYS	PRO	GLY	ALA	SER	VAL	LYS	ILE	SER	CYS	LYS	ALA	SER	GLY
TYR	THR	PHE	THR	ASP	HIS	ALA	ILE	HIS	TRP	VAL	LYS	GLN	LYS	PRO
GLU	GLN	GLY	LEU	GLU	TRP	ILE	GLY	TYR	ILE	SER	PRO	GLY	ASN	ASP
ASP	ILE	LYS	TYR	ASN	GLU	LYS	PHE	LYS	GLY	LYS	ALA	THR	LEU	THR
ALA	ASP	LYS	SER	SER	SER	THR	ALA	TYR	MET	<u>GLN</u>	<u>LEU</u>	<u>ASN</u>	<u>SER</u>	<u>LEU</u>
THR	SER	GLU	ASP	SER	ALA	VAL	TYR	PHE	CYS	ARG	ARG	SER	PHE	
TYR	GLY	ASN	TRP	GLY	GLN	GLY	THR	THR	LEU	THR	VAL	SER	SER	

"//" indicates where the mature protein begins.
 The underlined residues were determined by protein sequence.

EP 0 365 997 A2

Nes aingericht / Newly filed
Nouvellement déposé

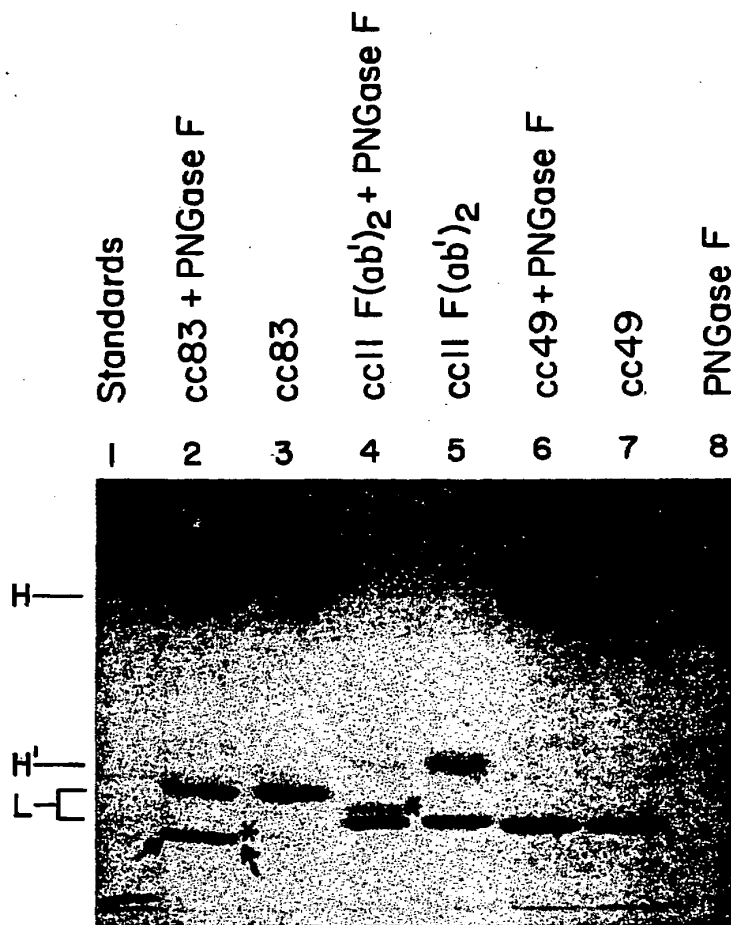

FIG. 20

Nes eingereicht / Newly filed
Nouvellement déposé

Human Heavy Chain Constant Regions

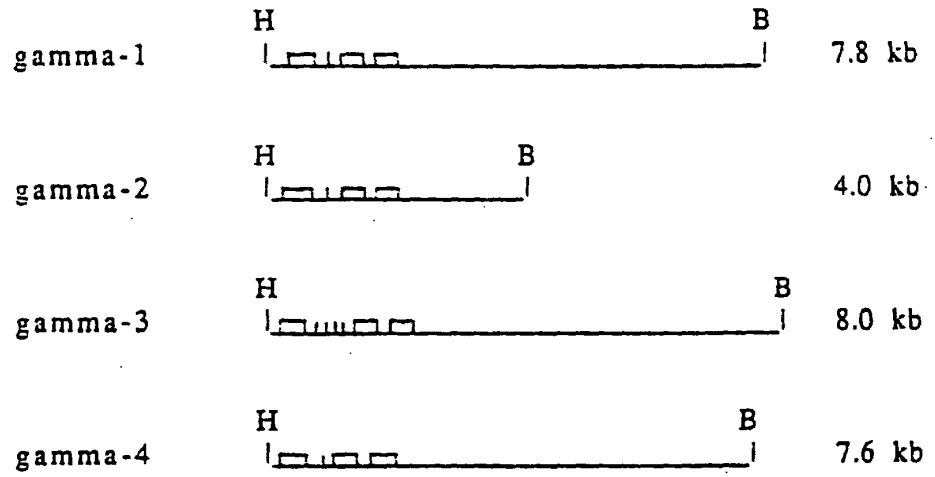

FIG. 21

Neu eingereicht / New.
Nouvellement déposé

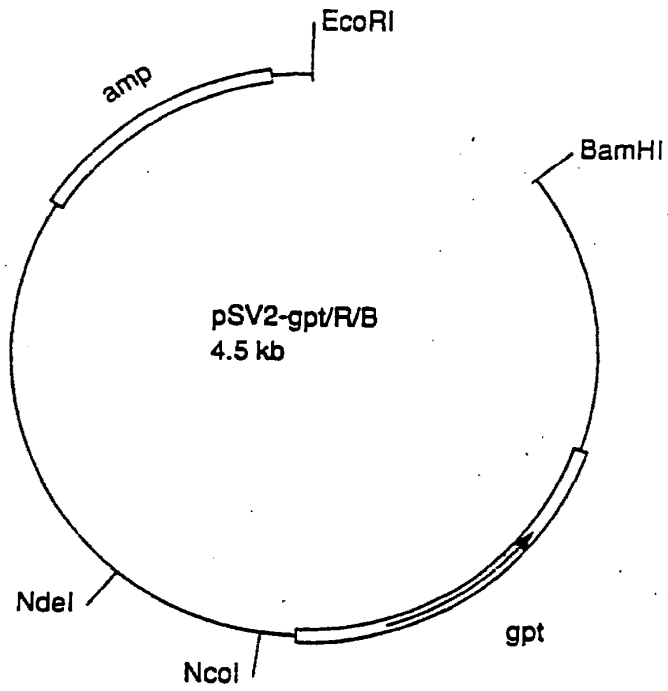

FIG.22

Nes eingereicht / New
Nouvellement déposé

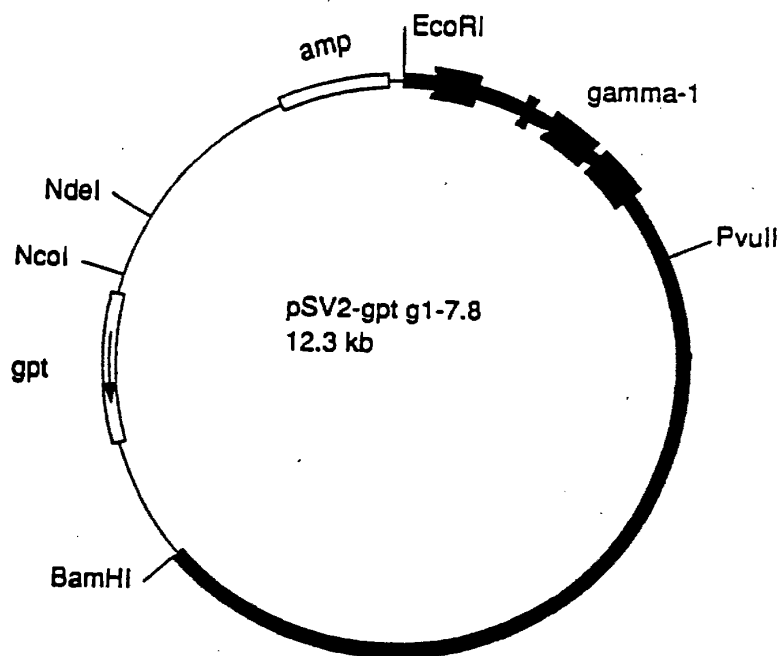

FIG. 23

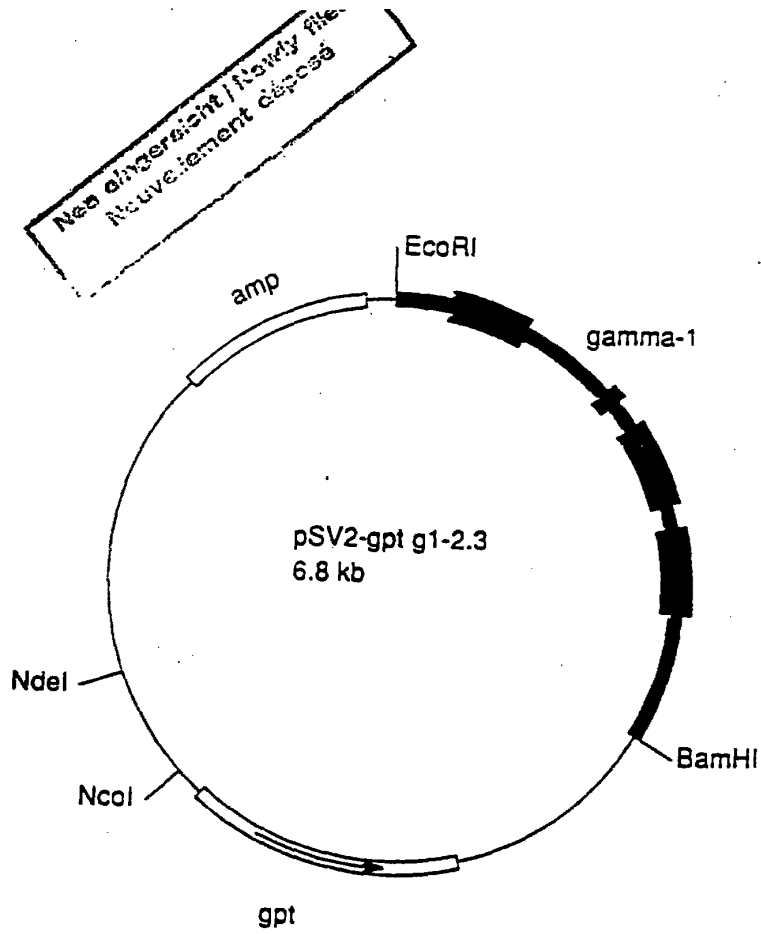

FIG. 24

Nea dingerisicht / newly filed
Nouvellement déposé

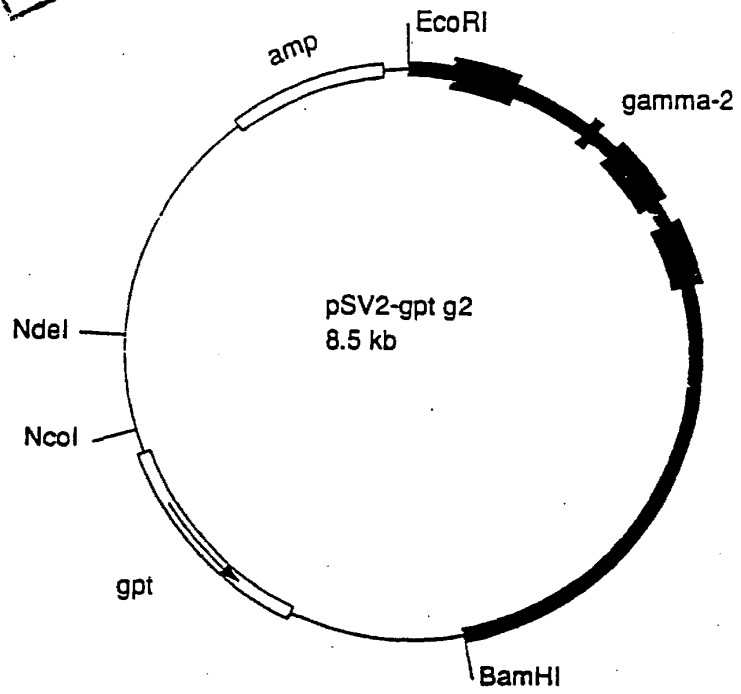

FIG. 25

Neu eingereicht / newly filed
Nouvellement déposé

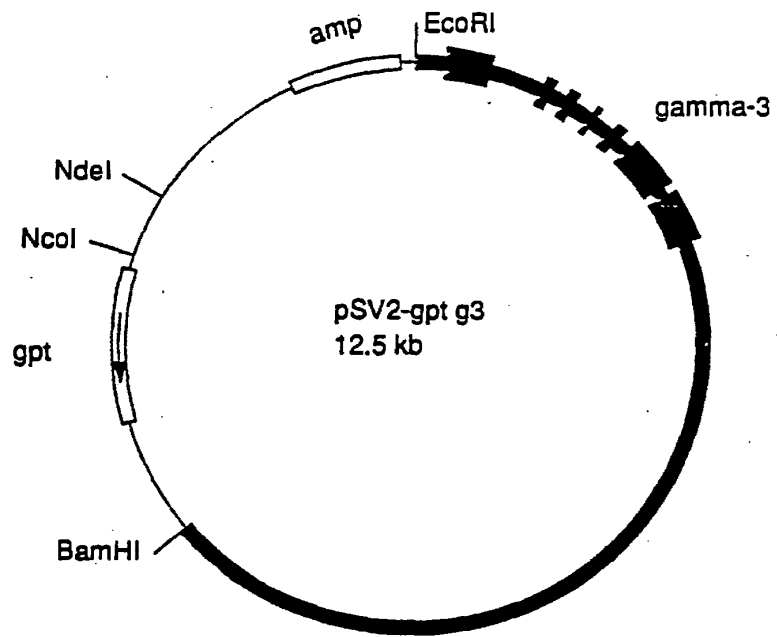

FIG.26

Nes eingereicht / Newly filed
Nouvellement déposé

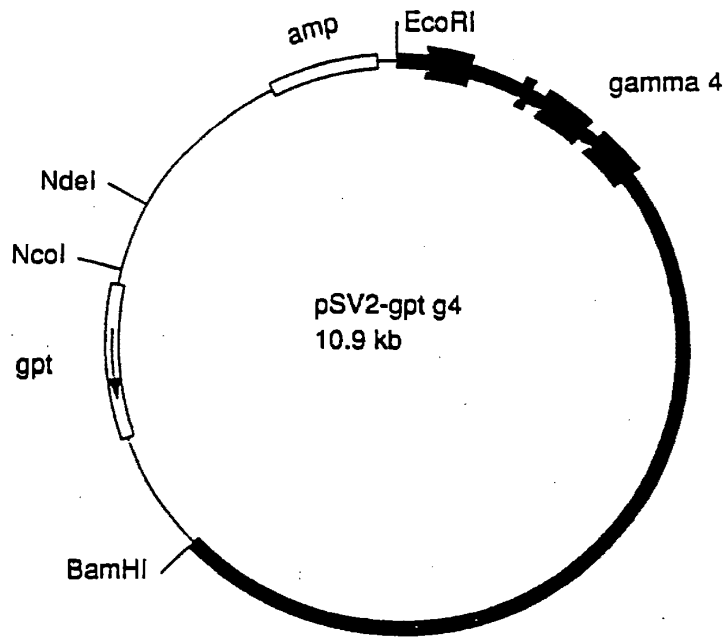

FIG. 27

Nes eingereicht / Newly
Nouvellement déposé

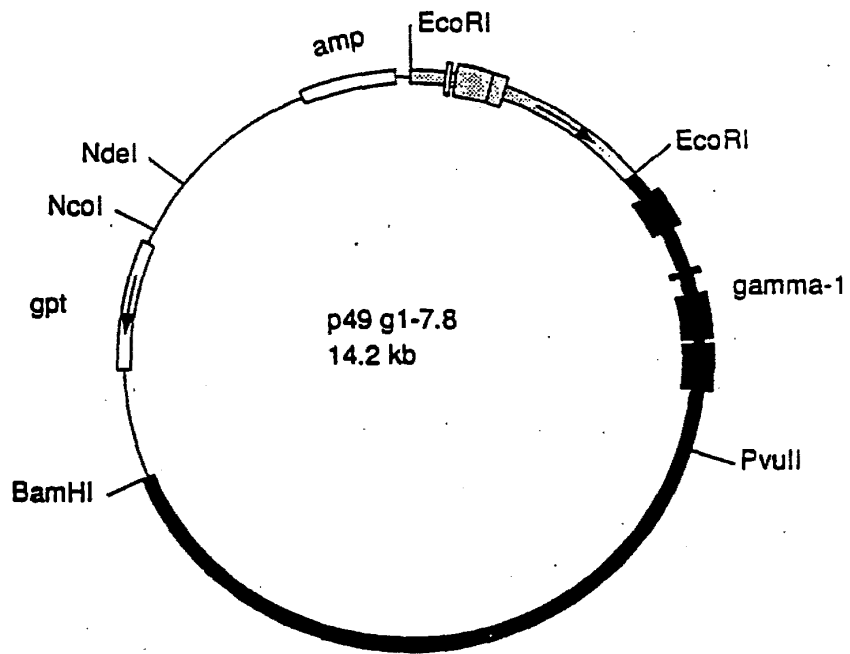

FIG. 28

Neu eingereicht / Newly filed
Nouvellement déposé

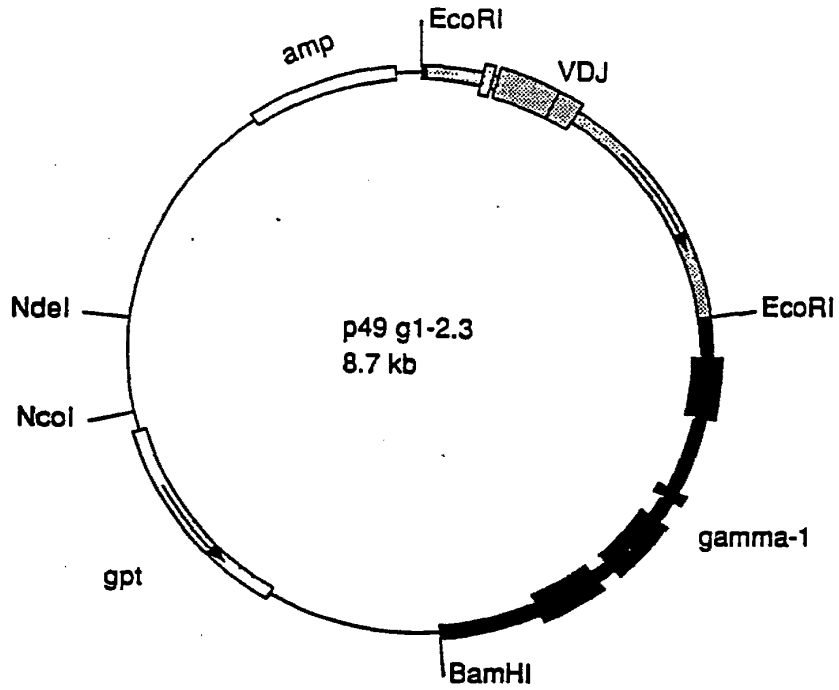

FIG.29

Nea eingersicht / Nowy
Nouvellement déposé

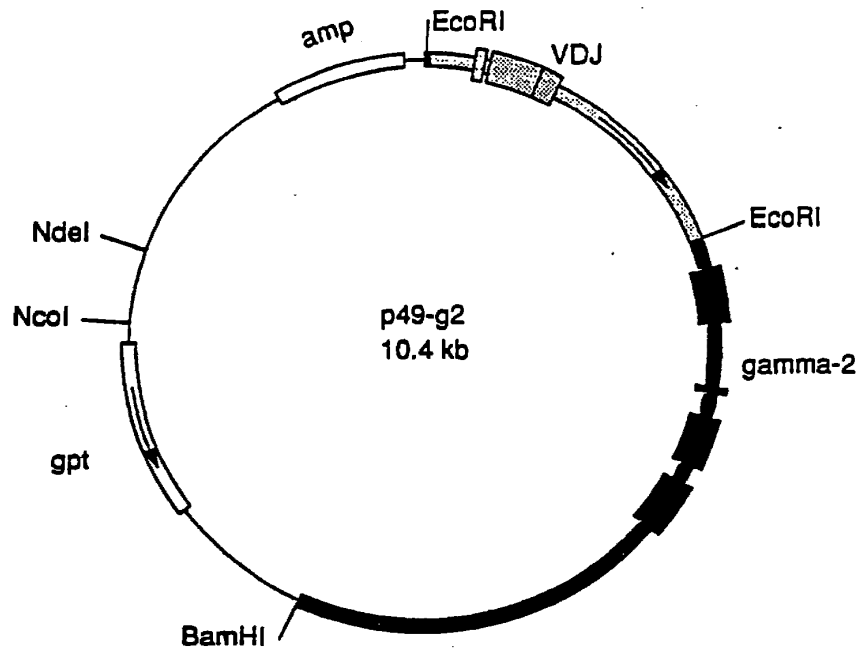

FIG.30

Nes eingereicht / Rev.
Nouvellement déposé

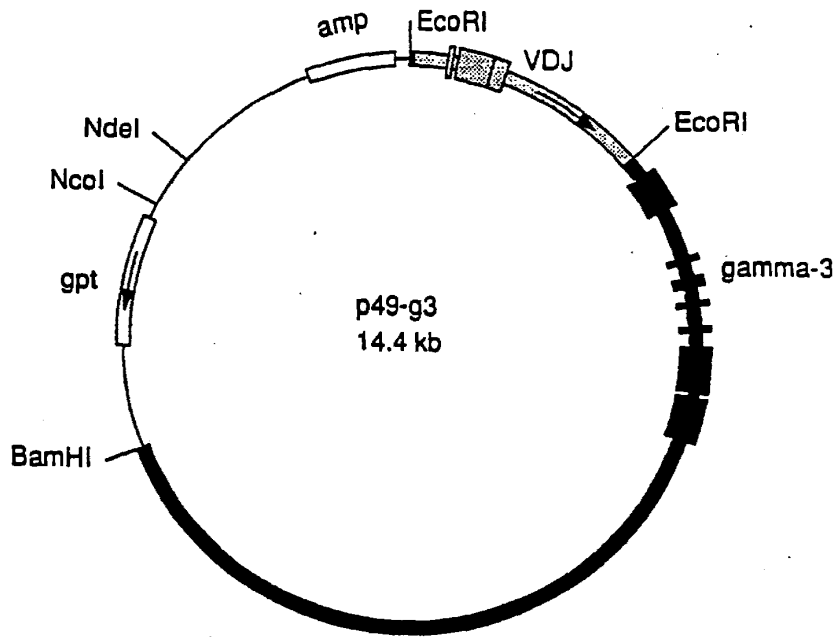

FIG. 31

Nas aingericht / Newly filed
Nouvellement déposé

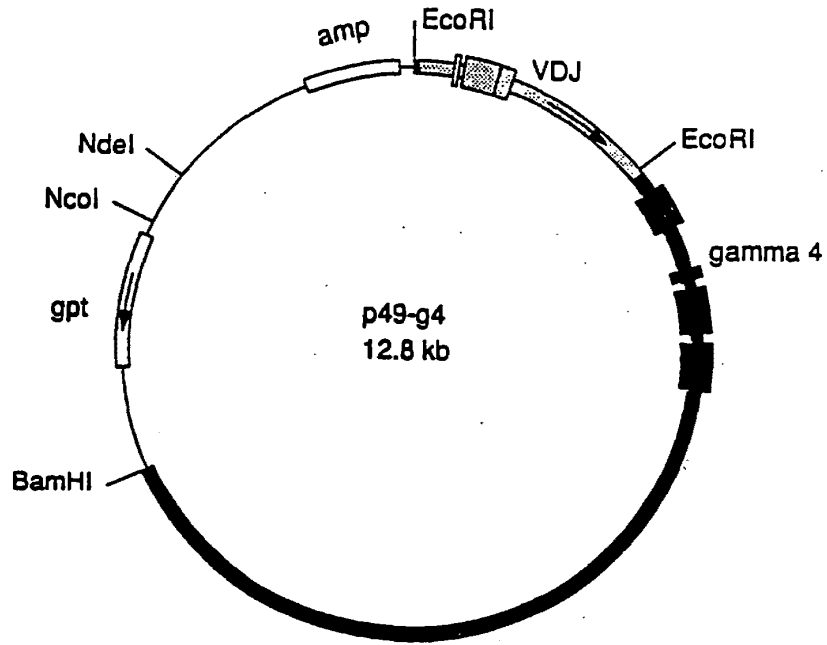

FIG. 32

Nea aingericht / Newly filed
Nouvellement déposé

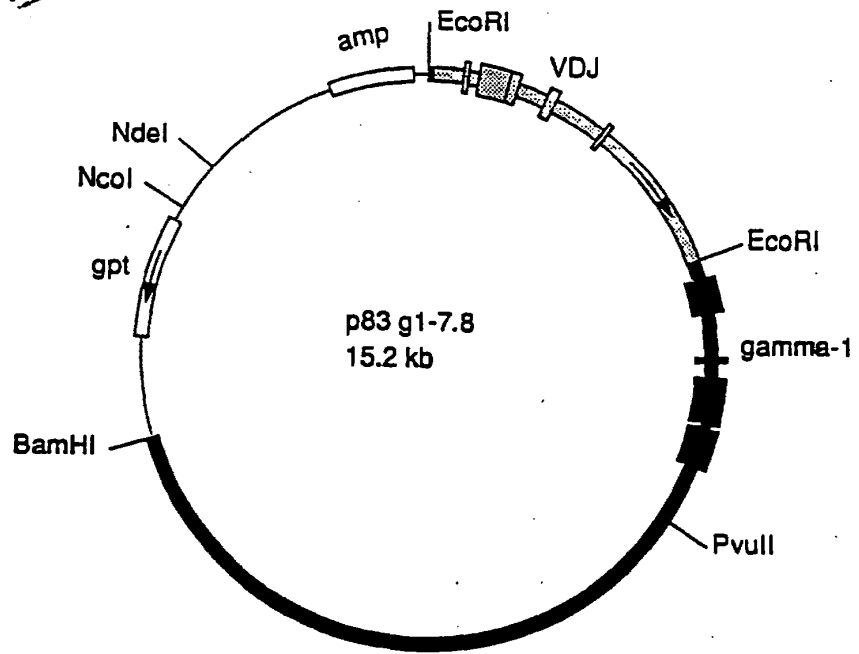

FIG. 33

Nee eingereicht / Newly filed
Nouvellement déposé

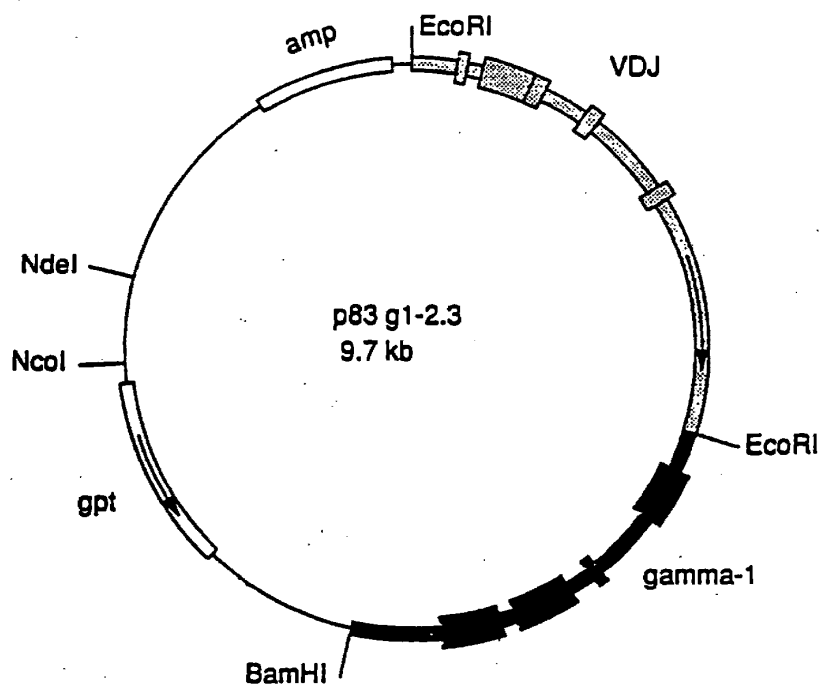

FIG.34

Nouveau dessin / Re
Nouvellement dépu-

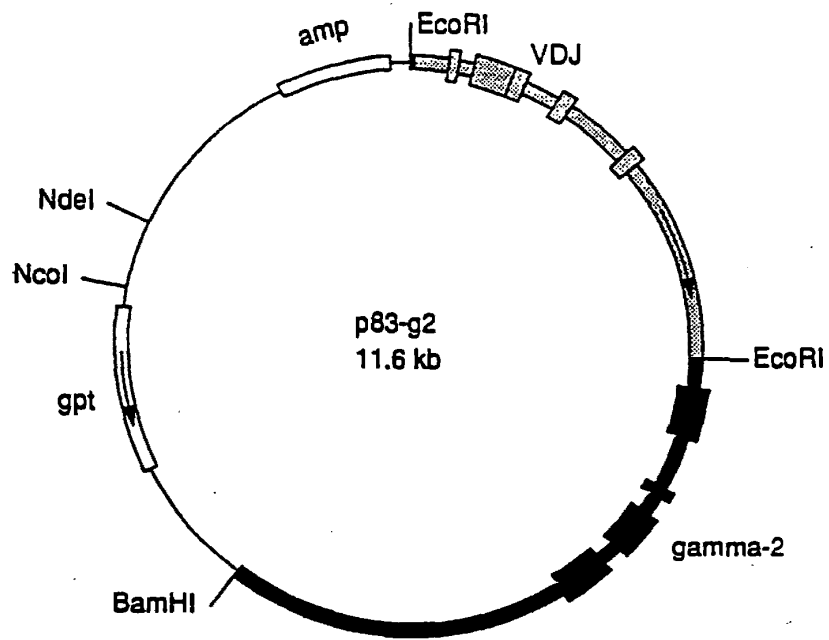

FIG.35

Nes ingerrecht / Newly
Nouvellement déposé

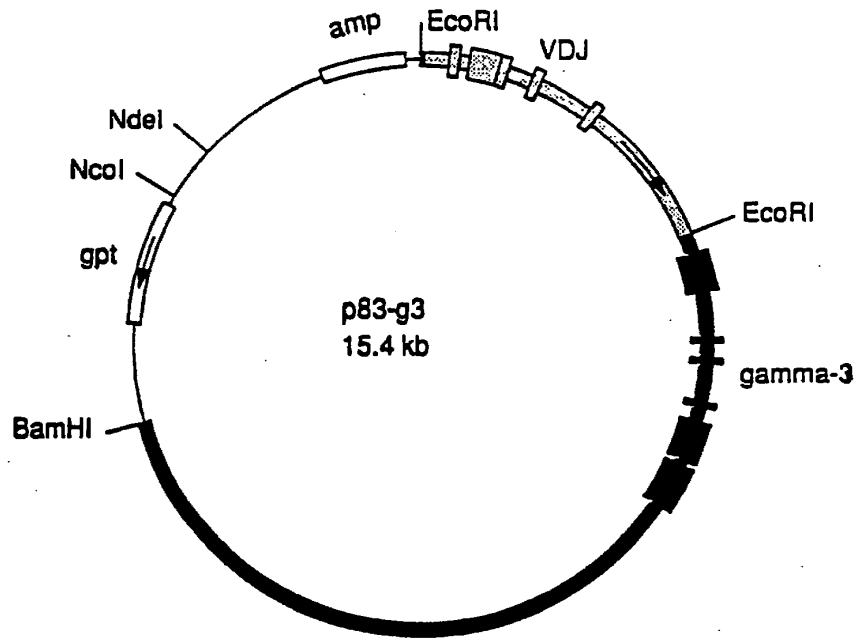

FIG. 36

Neu eingereicht / Newly t.
Nouvellement déposé

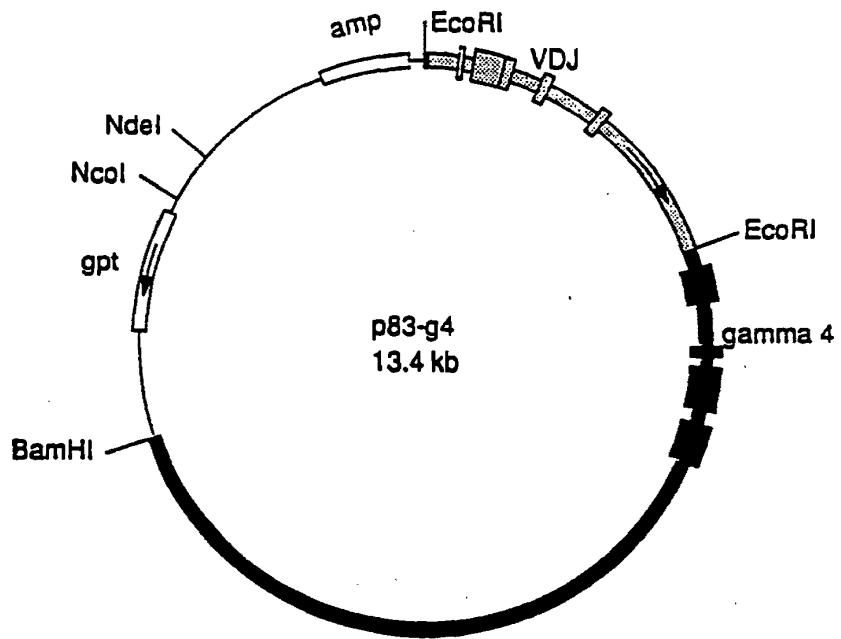
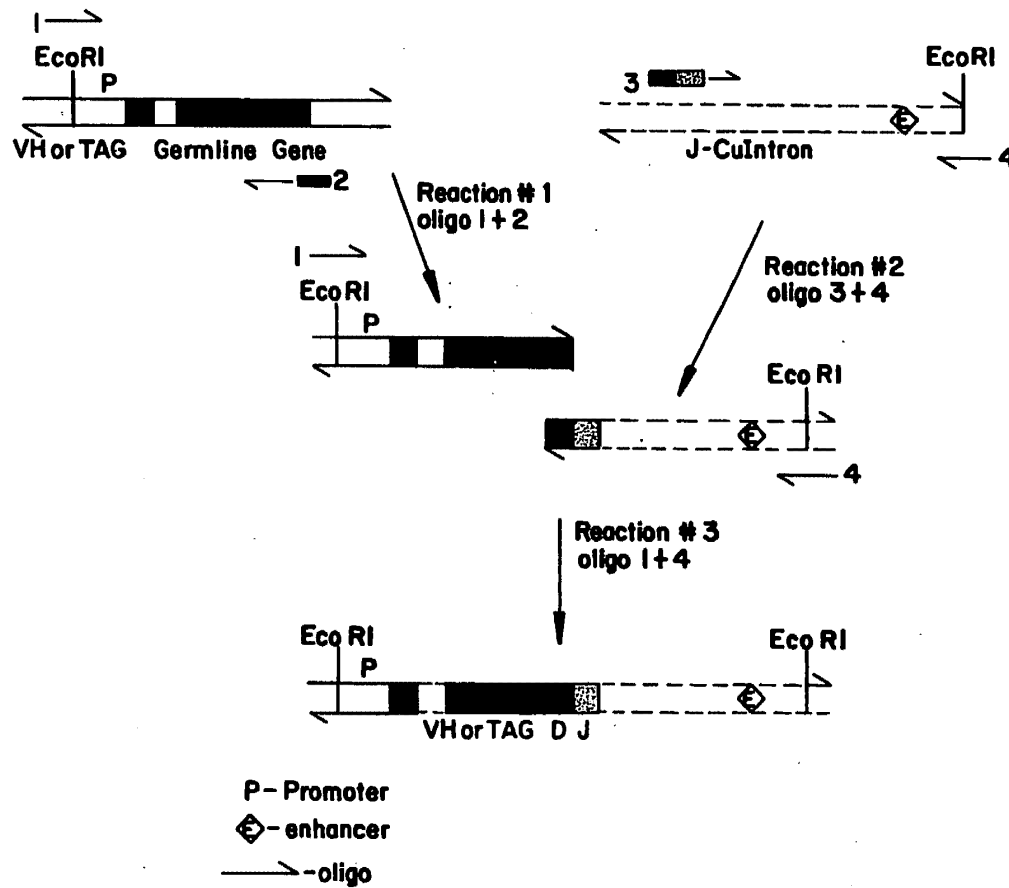

FIG. 37

FIG. 38



Non enregistré / newly
 Nouvellement déposé

EP 0 365 997 A2

.....

Neu eingereicht / Ne
Nouvellement d

FIG. 39a

BIODISTRIBUTION OF I25-I CH44
NORMAL TISSUE UPTAKE

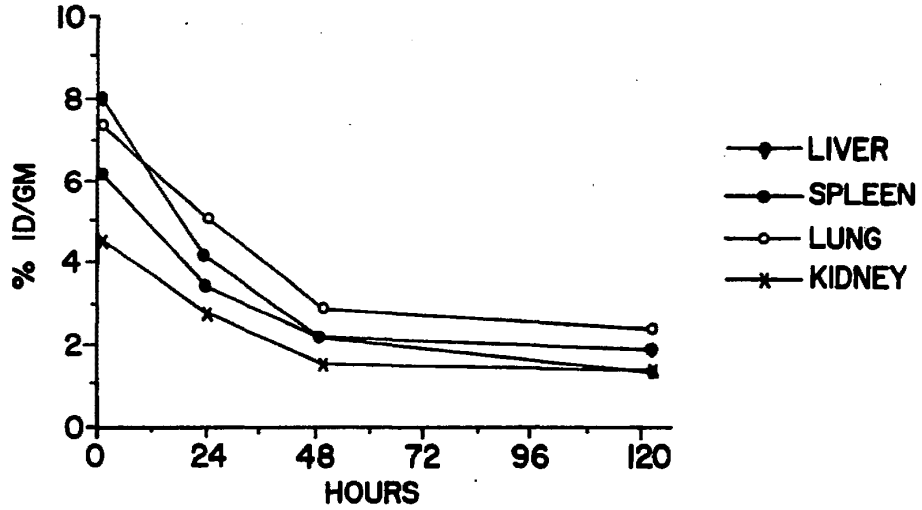
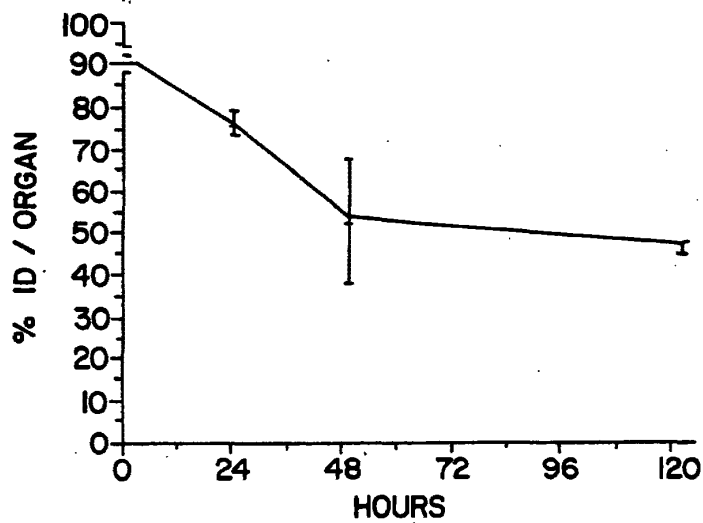

FIG. 39b

WHOLE BODY RETENTION OF I25-I CH44



Not eingeschicht / Newly
Nouvellement dépos 

FIG. 39c

BIODISTRIBUTION OF ¹²⁵I CH44

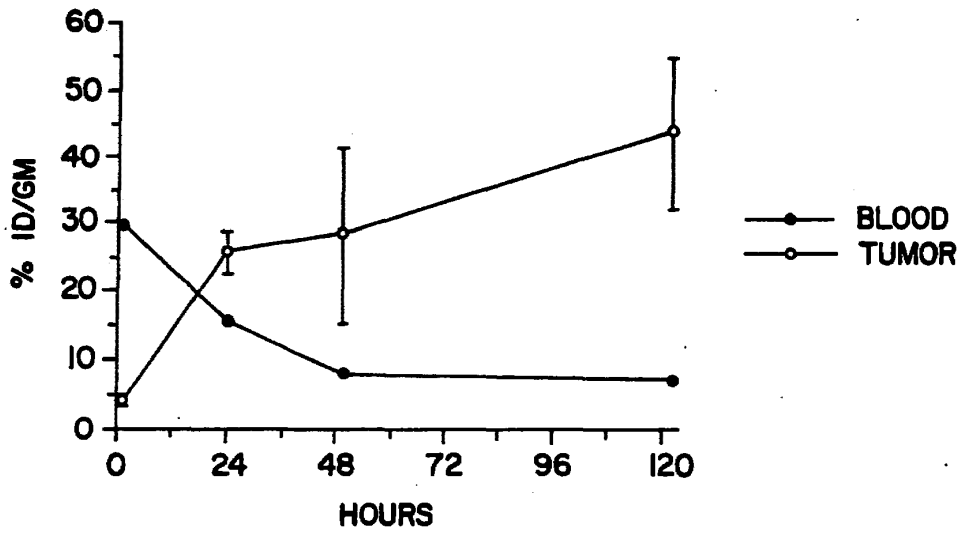

Nen eingereicht / Newly
Nouvellement déposé

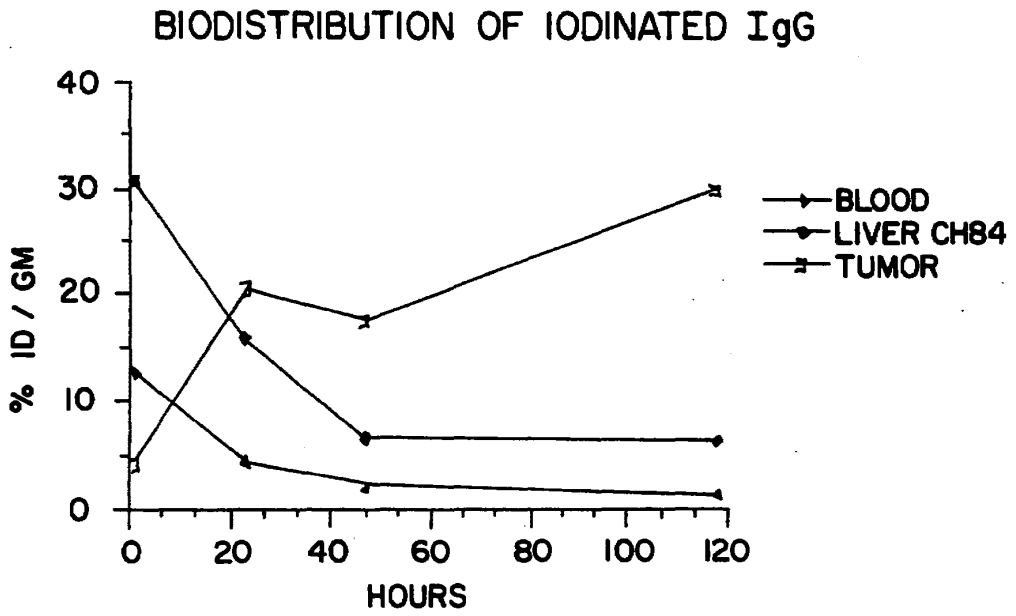

FIG.40a

Naa aingerisht / Newu
Nouvellement déposé

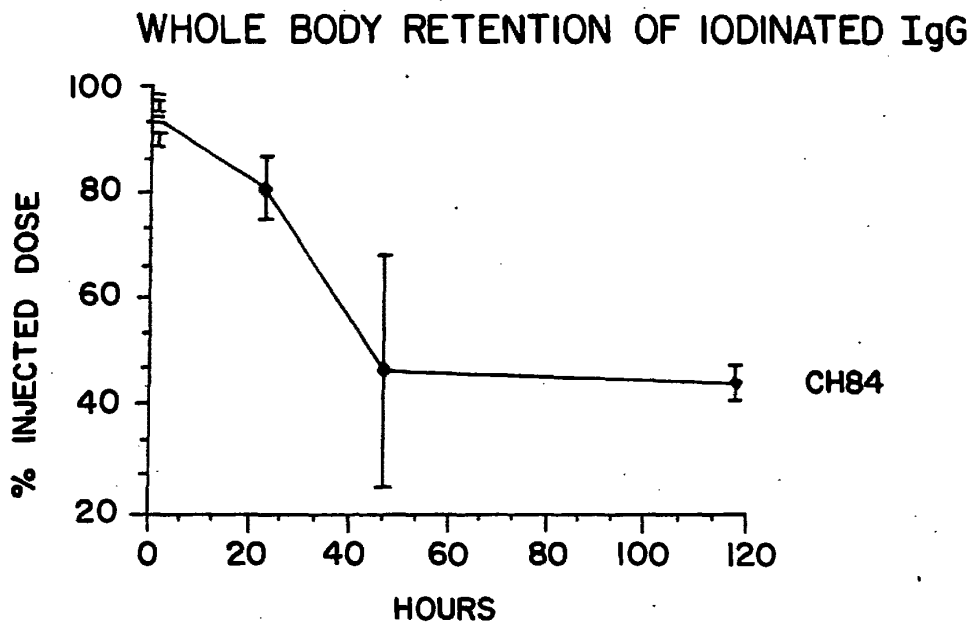

FIG.40b



Europäisches Patentamt
European Patent Office
Office européen des brevets



Publication number: **0 365 997 A3**

12

EUROPEAN PATENT APPLICATION

21 Application number: **89119361.7**

51 Int. Cl.⁵: **C12N 15/13, C12N 5/10,
C12P 21/08, A61K 39/395**

22 Date of filing: **18.10.89**

30 Priority: **19.10.88 US 259943**

43 Date of publication of application:
02.05.90 Bulletin 90/18

84 Designated Contracting States:
AT BE CH DE ES FR GB GR IT LI LU NL SE

88 Date of deferred publication of the search report:
04.03.92 Bulletin 92/10

71 Applicant: **THE DOW CHEMICAL COMPANY**
2030 Dow Center Abbott Road
Midland, MI 48640(US)

72 Inventor: **Mezes, Peter**
5101 Oakridge Drive
Midland Michigan 48640(US)
Inventor: **Gourlle, Brian**
3713 Orchard Drive
Midland Michigan 48640(US)
Inventor: **Rixon, Mark**
4110 Castle Drive
Midland Michigan 48640(US)

7A Representative: **Huber, Bernhard, Dipl.-Chem.**
et al
Patentanwälte H. Weickmann, Dr. K. Fincke
F.A. Weickmann, B. Huber Dr. H. Liska, Dr. J.
Prechtel Kopernikusstrasse 9 Postfach 86 08
20
W-8000 München 86(DE)

54 **A novel family of high affinity, modified antibodies for cancer treatment.**

57 This invention concerns a family of chimeric antibodies with high affinities to a high molecular weight, tumor-associated sialylated glycoprotein antigen (TAG72) of human origin. These antibodies have (1) high affinity animal V_H and V_L sequences which mediate TAG-72 binding and (2) human C_H and C_L regions. They are thought to produce significantly fewer side-effects when administered to human patients by virtue of their human C_H and C_L antibody domains. The nucleotide and amino acid sequences of V_HαTAG V_H, CC46 V_H, CC49_H, CC83 V_H, and CC92 V_H, and CC49_L, CC83 V_L, and CC92 V_L idiotype sequences are disclosed, as well as *in vivo* methods of treatment and diagnostic assay using these chimeric antibodies.

EP 0 365 997 A3



European
Patent Office

**EUROPEAN SEARCH
REPORT**

Application Number

EP 89 11 9361

DOCUMENTS CONSIDERED TO BE RELEVANT			
Category	Citation of document with indication, where appropriate, of relevant passages	Relevant to claim	CLASSIFICATION OF THE APPLICATION (Int. Cl.8)
X,D	CHEMICAL ABSTRACTS, vol. 110, no. 13, 27th March 1989, page 546, abstract no. 113055e, Columbus, Ohio, US; & US-A-73 685 (UNITED STATES DEPT. OF HEALTH AND HUMAN SERVICES) 01-03-1988 & WO-A-89 00 692 (26-01-1989) * The whole document, especially table 2 (Cat. P,X) * -----	1-16, 28-33	C 12 N 15/13 C 12 N 5/10 C 12 P 21/08 A 61 K 39/395
X	PROTEIN ENGINEERING, vol. 1, no. 6, 4th April 1987, pages 499-505, IRL Press Ltd, Oxford, GB; N. WHITTLE et al.: "Expression in COS cells of a mouse-human chimaeric B72.3 antibody" * The whole article * -----	17-22,34, 35	
P,X	WO-A-8 901 783 (CELLTECH LTD)(09-03-1989) * The whole document * -----	17-22,34, 35	
			TECHNICAL FIELDS SEARCHED (Int. Cl.5)
			C 12 N C 12 P A 61 K C 07 K G 01 N
The present search report has been drawn up for all claims			
Place of search The Hague		Date of completion of search 18 November 91	Examiner CUPIDO M.
CATEGORY OF CITED DOCUMENTS X : particularly relevant if taken alone Y : particularly relevant if combined with another document of the same category A : technological background O : non-written disclosure P : intermediate document T : theory or principle underlying the invention		E : earlier patent document, but published on, or after the filing date D : document cited in the application L : document cited for other reasons & : member of the same patent family, corresponding document	



(12) **EUROPEAN PATENT SPECIFICATION**

- (45) Date of publication and mention of the grant of the patent:
25.09.1996 Bulletin 1996/39
- (51) Int Cl.⁶: **C07K 16/28, C12N 5/12, A61K 51/00, A61K 39/395, G01N 33/53, G01N 33/535**
- (21) Application number: **90909864.2**
- (86) International application number:
PCT/US90/02979
- (22) Date of filing: **30.05.1990**
- (87) International publication number:
WO 90/15076 (13.12.1990 Gazette 1990/28)

(54) **MONOCLONAL ANTIBODIES AGAINST LEUKOCYTE ADHESION RECEPTOR BETA-CHAIN, METHODS OF PRODUCING THESE ANTIBODIES AND USE THEREFORE**

GEGEN DIE BETA-KETTE DES LEUKOZYTEN-ADHÄSIONS-REZEPTORS GERICHTETE MONOKLONALE ANTIKÖRPER, VERFAHREN ZU IHRER HERSTELLUNG UND IHRE VERWENDUNG

ANTICORPS MONOCLONAUX CONTRE LA CHAÎNE BETA DE RECEPTEURS D'ADHESION DE LEUCOCYTES, PROCÉDE DE PRODUCTION DE CES ANTICORPS ET UTILISATION

- (84) Designated Contracting States:
AT BE CH DE DK ES FR GB IT LI LU NL SE
- (30) Priority: **02.06.1989 US 361271**
- (43) Date of publication of application:
19.06.1991 Bulletin 1991/25
- (73) Proprietor: **THE JOHNS HOPKINS UNIVERSITY SCHOOL OF MEDICINE**
Baltimore, MD 21205 (US)
- (72) Inventor: **HILDRETH, James, E.**
Baltimore, MD 21231 (US)
- (74) Representative: **VOSSIUS & PARTNER**
Postfach 86 07 67
81634 München (DE)
- (56) References cited:
- | | |
|------------------------|----------------------|
| EP-A- 314 863 | EP-A- 346 078 |
| EP-A- 365 837 | WO-A-88/06592 |
| US-A- 4 506 009 | |
- **JOURNAL OF IMMUNOLOGY**, vol. 136, no. 12, 15 June 1986, BALTIMORE, USA, pages 4548-4553; T. POHLMAN et al.
 - **R. LARSON et al.**, IN: "Leucocyte Typing IV. White cell differentiation antigens, Eds. W. Knapp et al., 1989 Oxford University Press, Oxford, GB see pages 566-570
 - **M. DIAMOND et al.** IN: "Leucocyte Typing IV. White cell differentiation antigens. Eds. W. Knapp et al." 1989, Oxford University Press, Oxford, GB see pages 570-574
 - **European Journal of Immunology**, vol. 17, issued 1987, "The Role of p150, 95 in Adhesion, Migration, Chemotaxis and Phagocytosis of Human Monocytes", (Kelzer et al.), pp. 1317-1322, see pp. 1317-1318.
 - **IMMUNOLOGY**, vol. 61, issued 1987, "DIFFERENTIAL FUNCTION OF LFA-1 Family Molecules, CCD11 and CD18 in Adhesion of human Monocytes, pp. 261-267, see pp. 261-262
 - **The Journal of Immunology**, vol. 134, no. 5, issued May 1985, "The human Lymphocyte function-associated (HLFA) antigen and a related macrophage differentiation antigen (HMAL-1): functional effects of subunit-specific monoclonal antibodies", (Hildreth et al.), pp. 3272-3280, see entire article.
 - **WEIR, D.M.**, "Handbook of experimental immunology", vol. 4, published 1986 by Blackwell Scientific Publications (Oxford), see pages 108.1-108.9.
 - **McMichael, A.J.**, "Leukocyte Typing III white cell differentiation antigens", published 1987 by Oxford University press (Oxford), see pages 839-844.

- The Journal of Biological Chemistry, vol. 262, no. 12 issued 25 April 1987. "Isolation and Characterization of the receptor on human Neutrophils that mediates cellular adherence", (Hickstein et al.), pp. 5576-5580, see p. 5576
- Journal of Experimental Medicine, vol. 158, issued December 1983, "A human Leukocyte differentiation antigen family with distinct alpha-sub- units and a common beta-subunit: The lymphocyte function-associated antigen (LFA-1), the C3B-1 complement receptor O1CM1/MAC-1) and p150, 95 Molecule", (Sanchez-Madrid et al.), pp. 1785-1803, see pp. 1875-1877.
- Scandanavian Journal of Immunology, vo. 28, issued November 1988, "Immunological mapping of the human leukocyte adhesion Glycoprotein (GP90 (Cd18) by monoclonal antibodies", (Nortamo et al.), pp. 537-546, see pp. 537-539

Remarks:

The file contains technical information submitted after the application was filed and not included in this specification

Note: Within nine months from the publication of the mention of the grant of the European patent, any person may give notice to the European Patent Office of opposition to the European patent granted. Notice of opposition shall be filed in a written reasoned statement. It shall not be deemed to have been filed until the opposition fee has been paid. (Art. 99(1) European Patent Convention).

Description

This invention relates to monoclonal antibodies specific for an epitope on the leukocyte adhesion receptor β -chain which can be used to suppress intercellular leukocyte adhesion.

Human immunodeficiency virus (HIV) is the etiologic agent of acquired immunodeficiency syndrome (AIDS), a fatal disease characterized by profound immunosuppression, opportunistic infections, and neuropathies. Although only a small fraction of circulating lymphocytes are infected with the virus, there is a marked loss of T cells bearing the virus receptor CD4. The depletion of CD4⁺-T cells appears to contribute significantly to the immunosuppression associated with AIDS. Syncytium formation resulting from HIV-induced cell fusion has been shown to be the primary cytopathic effect of the virus *in vitro* and has been postulated to account for the loss of CD4⁺-T cells *in vivo*. CD4 through its interaction with the HIV envelope glycoprotein gp120 plays an important role in syncytium formation.

Although the CD4 receptor appears to play a significant role in the etiology of AIDS, several observations suggest that molecules on the surface of uninfected cells other than CD4 are also involved in HIV-induced cell fusion. First, fusion of HIV-infected cells to uninfected cells does not correlate with CD4-density on the surface of the uninfected cells. In addition, whereas transfection of non-lymphoid human cells with CD4 receptors renders such cells capable of fusion to HIV-infected cells, this is not true for CD4-transfected mouse cells. Finally, there is a disparity in the capacity of sera from AIDS patients to block binding of HIV particles to CD4⁺-cells and the capacity of the same sera to block fusion of HIV-infected cells to CD4⁺-uninfected cells.

CD4 interacts directly with class II major histocompatibility complex (MHC) molecules in class II MHC-restricted T helper cell responses. The involvement of the leukocyte adhesion receptor (LAR) LFA-1, in such responses has been demonstrated using anti-LFA-1 monoclonal antibodies (mAb). Structural similarities between gp120 and class II MHC suggested that the binding of gp120 to CD4 may mimic the interaction between class II MHC molecules and CD4. By analogy, the role of LAR in HIV-mediated cell fusion was examined. In the present invention, a mAb against LFA-1 completely inhibits HIV-mediated fusion of uninfected T cell blasts to HIV infected cells. This result indicates that LFA-1 is involved in HIV-induced syncytium formation, a major cytopathic mechanism of the virus.

The LFA-1 molecule, which is expressed on T and B lymphocytes as well as on macrophages, thymocytes, granulocytes, and a subpopulation of bone marrow cells, is composed of two non-covalently associated polypeptides of 175,000 Kd (α ; CD11a) and 95,000 Kd (β ; CD18). The β -chain of LFA-1 is also common to two other leukocyte antigens: Mac-1 (α -chain 165,000 Kd; CD11b); the type-three complement receptor; and

LeuM5 (α -chain 150,000 Kd; CD11c), a molecule possibly associated with type-four complement receptor activity. Although the three α -subunits differ in size, there is evidence suggesting that all three subunits are encoded by a single gene or duplicated genes. cDNA encoding the human β -chain has been cloned and found to be 50% identical in primary structure to the β -chain of integrin, a chick fibroblast fibronectin receptor. These studies and others have shown that molecules of the LFA-1 glycoprotein family are members of the larger arginine-glycine-aspartate (RGD) adhesion family known as integrins.

At present, methods of limited effectiveness exist for the treatment of AIDS or other disorders in which the intercellular interaction of lymphocytes helps to mediate the pathologic state. Those drugs which are administered generally have severe contraindications associated with their use. Consequently, a considerable need exists for a therapeutic agent which can inhibit lymphocytic intercellular interaction in AIDS and other immune response mediated disorders.

SUMMARY OF THE INVENTION

One way to ameliorate immune response mediated disorders would be to suppress intercellular leukocyte adhesion using a monoclonal antibody which binds to a leukocyte adhesion receptor. In so doing, intercellular leukocyte binding is suppressed thereby decreasing the likelihood of cell-to-cell transmission of infectious agents and immune response activation.

In order to provide a means to ameliorate immune response mediated disorders, the inventor has developed monoclonal antibodies which bind to an epitope on the leukocyte adhesion receptor and suppresses the ability of leukocytes to adhere to each other. These monoclonal antibodies, if desired, can be therapeutically or diagnostically labelled.

BRIEF DESCRIPTION OF THE FIGURES

- Figure 1. Inhibition of syncytium formation by mAb.
- Figure 2. Dose dependent inhibition of syncytium formation by H52 IgG.
- Figure 3. H52 blocks syncytia formation at the level of PHA-blasts not 8E5 cells.
- Figure 4. Inhibition of gp120 binding to CEM cells by mAb.

DETAILED DESCRIPTION OF THE INVENTION

The present invention relates to monoclonal antibodies with specificity for leukocyte adhesion receptor β -chain secreted by hybridoma cell line ATCC HB 10160. These monoclonal antibodies are highly useful for both the *in vitro* and *in vivo* immunological detection of antigens having these β -chains and for immunotherapy of cells bearing these receptors having these β -

chains.

In the invention a monoclonal antibody (H52) (ATCC HB 10160) is disclosed which binds to an epitope on the leukocyte adhesion receptor β -chain. This specificity enables H52, and like monoclonal antibodies with the specificity of H52, to be used to suppress intercellular adhesion. As a consequence, H52 is useful in ameliorating immune response mediated disorders such as AIDS, autoimmune disease, and graft, including graft versus host, rejection. H52 is obtained from, or has the identifying characteristics of, an antibody obtained from the cell line having ATCC accession number HB X. This cell line was placed on deposit for 30 years at the American Type Culture Collection (ATCC) in Rockville, Maryland prior to June 1, 1989.

Methods of Producing and Characterizing Monoclonal Antibodies

The general method used for production of hybridomas secreting monoclonal antibodies is well known (Kohler, *et al.*, *European J. Imm.*, **6**:292, 1976). Briefly, BALB/c mice were immunized with human splenic adherent cells and later boosted with the same type of cells. After 4 days, the animals were sacrificed and the spleen cells fused with mouse myeloma P3X65 Ag8. Hybridomas were screened for antibody production and positive clones were tested for reactivity towards human spleen tissue sections.

The present invention is directed to monoclonal antibodies, and hybridomas which produce them, which are reactive with the leukocyte adhesion receptor β -chain.

The isolation of hybridomas secreting monoclonal antibodies with the reactivity of the monoclonal antibodies of the invention can be accomplished using routine screening techniques to determine the elementary reaction pattern of the monoclonal antibody of interest. Thus, if a monoclonal antibody being tested reacts with the leukocyte adhesion receptor β -chain such that intercellular adhesion is suppressed, then the antibody being tested and the antibody produced by the hybridomas of the invention are equivalent.

Alternatively, it is possible to evaluate, without undue experimentation, a monoclonal antibody to determine whether it has the same specificity as monoclonal antibody H52 of the invention by determining whether the monoclonal antibody being tested prevents H52 from binding to a particular antigen, for example the LFA-1 receptor with which H52 is normally reactive. If the monoclonal antibody being tested competes with H52, as shown by a decrease in binding by H52, then it is likely that the two monoclonal antibodies bind to the same epitope.

Still another way to determine whether a monoclonal antibody has the specificity of H52 is to pre-incubate H52 with an antigen with which it is normally reactive (for example, LFA-1 receptor), and determine if the

monoclonal antibody being tested is inhibited in its ability to bind the antigen. If the monoclonal antibody being tested is inhibited then, in all likelihood, it has the same epitopic specificity as the monoclonal antibody of the invention.

While the *in vivo* use of a monoclonal antibody from a foreign donor species in a different host recipient species is usually uncomplicated, a potential problem which may arise is the appearance of an adverse immunological response by the host to antigenic determinants present on the donor antibody. In some instances, this adverse response can be so severe as to curtail the *in vivo* use of the donor antibody in the host. Further, the adverse host response may serve to hinder the intercellular adhesion-suppressing efficacy of the donor antibody. One way in which it is possible to circumvent the likelihood of an adverse immune response occurring in the host is by using chimeric antibodies (Sun, *et al.*, *Hybridoma*, **5** (Supplement 1):S17, 1986; Oi, *et al.*, *Bio Techniques*, **4**(3): 214, 1986). Chimeric antibodies are antibodies in which the various domains of the antibodies' heavy and light chains are coded for by DNA from more than one species. Typically, a chimeric antibody will comprise the variable domains of the heavy (V_H) and light (V_L) chains derived from the donor species producing the antibody of desired antigenic specificity, and the variable domains of the heavy (C_H) and light (C_L) chains derived from the host recipient species. It is believed that by reducing the exposure of the host immune system to the antigenic determinants of the donor antibody domains, especially those in the C_H region, the possibility of an adverse immunological response occurring in the recipient species will be reduced. Thus, for example, it is possible to produce a chimeric antibody for *in vivo* clinical use in humans which comprises mouse V_H and V_L domains coded for by DNA isolated from ATCC HB X, and C_H and C_L domains coded for with DNA isolated from a human leukocyte.

Under certain circumstances, monoclonal antibodies of one isotype might be more preferable than those of another in terms of their diagnostic or therapeutic efficacy. For example, from studies on antibody-mediated cytotoxicity, it is known that unmodified mouse monoclonal antibodies of isotype gamma-2a and gamma-3 are generally more effective in lysing target cells than are antibodies of the gamma-1 isotype. This differential efficacy is thought to be due to the ability of the gamma-2a and gamma-3 isotypes to more actively participate in the cytolytic destruction of target cells. Particular isotypes of a monoclonal antibody can be prepared either directly, by selecting from the initial fusion, or prepared secondarily, from a parental hybridoma secreting a monoclonal antibody of different isotype by using the sib selection technique to isolate class-switch variants (Steplewski, *et al.*, *Proceedings of the National Academy of Science, U.S.A.*, **82**:8653, 1985; Spira, *et al.*, *Journal of Immunological Methods*, **74**:307, 1984). Thus, the monoclonal antibodies of the invention would include class-switch

variants having the specificity of monoclonal antibody H52 which is produced by ATCC HB X.

When the monoclonal antibodies of the invention are used in the form of fragments, such as, for example, Fab and F(ab')₂, and especially when these fragments are therapeutically labeled, any isotype can be used since amelioration of the immune response disorders in these situations is not dependent upon complement-mediated cytolytic destruction of those cells bearing the leukocyte adhesion receptor.

The term "immune response mediated disorder" denotes disorders in which the hosts' immune system contributes to the disease condition either directly or indirectly. Examples of disorders which are mediated by the immune response includes AIDS, autoimmune disease, and graft rejection. As used herein, graft rejection encompasses both host versus graft and graft versus host rejection.

The monoclonal antibodies of the invention can be used in any animal in which it is desirable to administer *in vitro* or *in vivo* immunodiagnosis or immunotherapy. The term "animal" as used herein is meant to include both humans as well as non-humans.

The term "antibody" as used in this invention is meant to include intact molecules as well as fragments thereof, such as, for example, Fab and F(ab')₂, which are capable of binding the epitopic determinant.

DIAGNOSTIC USES

The monoclonal antibodies of the invention are suited for use in immunoassays in which they can be utilized in liquid phase or bound to a solid phase carrier. In addition, the monoclonal antibodies in these immunoassays can be detectably labeled in various ways. Examples of types of immunoassays which can utilize monoclonal antibodies of the invention are competitive and non-competitive immunoassays in either a direct or indirect format. Examples of such immunoassays are the radioimmunoassay (RIA) and the sandwich (immunometric) assay. Detection of the antigens using the monoclonal antibodies of the invention can be done utilizing immunoassays which are run in either the forward, reverse, or simultaneous modes, including immunohistochemical assays on physiological samples.

The monoclonal antibodies of the invention can be bound to many different carriers and used to detect the presence of leukocyte adhesion factor. Examples of well-known carriers include glass, polystyrene, polypropylene, polyethylene, dextran, nylon, amylases, natural and modified celluloses, polyacrylamides, agaroses and magnetite. The nature of the carrier can be either soluble or insoluble for purposes of the invention. Those skilled in the art will know of other suitable carriers for binding monoclonal antibodies, or will be able to ascertain such, using routine experimentation.

There are many different labels and methods of labeling known to those of ordinary skill in the art. Exam-

ples of the types of labels which can be used in the present invention include enzymes, radioisotopes, fluorescent compounds, chemiluminescent compounds, and bioluminescent compounds. Those of ordinary skill in the art will know of other suitable labels for binding to the monoclonal antibody, or will be able to ascertain such, using routine experimentation. Furthermore, the binding of these labels to the monoclonal antibody of the invention can be done using standard techniques common to those of ordinary skill in the art.

For purposes of the invention, the leukocyte adhesion factor β -chain which is detected by the monoclonal antibodies of the invention may be present in biological fluids and tissues. Any sample containing a detectable amount of leukocyte adhesion factor β -chain can be used. Normally, a sample is a liquid such as urine, saliva, cerebrospinal fluid, blood, serum and the like, or a solid or semi-solid such as tissues, feces, and the like.

Another technique which may also result in greater sensitivity consists of coupling the antibodies to low molecular weight haptens. These haptens can then be specifically detected by means of a second reaction. For example, it is common to use such haptens as biotin, which reacts with avidin, or dinitrophenyl, pyridoxal, and fluorescein, which can react with specific anti-hapten antibodies.

As used in this invention, the term "epitope" is meant to include any determinant capable of specific interaction with the monoclonal antibodies of the invention. Epitopic determinants usually consist of chemically active surface groupings of molecules such as amino acids or sugar side chains and usually have specific three dimensional structural characteristics, as well as specific charge characteristics.

In using the monoclonal antibodies of the invention for the *in vivo* detection of antigen, the detectably labeled monoclonal antibody is given in a dose which is diagnostically effective. The term "diagnostically effective" means that the amount of detectably labeled monoclonal antibody is administered in sufficient quantity to enable detection of the site having the leukocyte adhesion receptor β -chain for which the monoclonal antibodies are specific.

The concentration of detectably labeled monoclonal antibody which is administered should be sufficient such that the binding to those cells having leukocyte adhesion receptor is detectable compared to the background signal. Further, it is desirable that the detectably labeled monoclonal antibody be rapidly cleared from the circulatory system in order to give the best target-to-background signal ratio.

As a rule, the dosage of detectably labeled monoclonal antibody for *in vivo* diagnosis will vary depending on such factors as age, sex and extent of disease of the individual. The dosage of monoclonal antibody can vary from about 0.01 mg/m² to about 20 mg/m², preferably about 0.1 mg/m² to about 10mg/m².

For *in vivo* diagnostic imaging, the type of detection

instrument available is a major factor in selecting a given radioisotope. The radioisotope chosen must have a type of decay which is detectable for a given type of instrument. Still another important factor in selecting a radioisotope for *in vivo* diagnosis is that the half-life of the radioisotope be long enough so that it is still detectable at the time of maximum uptake by the target, but short enough so that deleterious radiation with respect to the host is minimized. Ideally, a radioisotope used for *in vivo* imaging will lack a particle emission, but produce a large number of photons in the 140-250 keV range, which may be readily detected by conventional gamma cameras.

For *in vivo* diagnosis radioisotopes may be bound to immunoglobulin either directly or indirectly by using an intermediate functional group. Intermediate functional groups which often are used to bind radioisotopes which exist as metallic ions to immunoglobulins are the bifunctional chelating agents such as diethylenetriaminepentaacetic acid (DTPA) and ethylenediaminetetraacetic acid (EDTA) and similar molecules.

The monoclonal antibodies of the invention can also be labeled with a paramagnetic isotope for purposes of *in vivo* diagnosis, as in magnetic resonance imaging (MRI) or electron spin resonance (ESR). In general, any conventional method for visualizing diagnostic imaging can be utilized. Usually gamma and positron emitting radioisotopes are used for camera imaging and paramagnetic isotopes for MRI.

The monoclonal antibodies of the invention can be used to monitor the course of amelioration of an immune response mediated disorder in an individual. Thus, by measuring the increase or decrease in the number of leukocytes or changes in the concentration of antigen shed into various body fluids, it would be possible to determine whether a particular therapeutic regimen aimed at ameliorating the immune response mediated disorder is effective.

THERAPEUTIC USES

The term "ameliorate" denotes a lessening of the detrimental affect of the immune response mediated disorder in the animal receiving therapy. The term "therapeutically effective" means that the amount of monoclonal antibody used is of sufficient quantity to ameliorate the cause of disease due to the immune response.

The monoclonal antibodies of the invention can also be used for immunotherapy in an animal having an immune response mediated disorder caused by leukocytes which express leukocyte adhesion receptor β -chain with epitopes reactive with the monoclonal antibodies of the invention. When used in this manner, the dosage of monoclonal antibody can vary from about 10 mg/m² to about 2000 mg/m².

When used for immunotherapy, the monoclonal antibodies of the invention may be unlabeled or labeled with a therapeutic agent. These agents can be coupled either directly or indirectly to the monoclonal antibodies

of the invention. One example of indirect coupling is by use of a spacer moiety. These spacer moieties, in turn, can be either insoluble or soluble (Diener, *et al.*, *Science*, 231:148, 1986) and can be selected to enable drug release from the monoclonal antibody molecule at the target site. Examples of therapeutic agents which can be coupled to the monoclonal antibodies of the invention for immunotherapy are drugs, radioisotopes, lectins, and toxins.

The drugs with which can be conjugated to the monoclonal antibodies of the invention include compounds which are classically referred to as drugs such as for example, mitomycin C, daunorubicin, and vinblastine.

In using radioisotopically conjugated monoclonal antibodies of the invention for immunotherapy certain isotypes may be more preferable than others depending on such factors as leukocyte distribution as well as isotope stability and emission. If desired, the leukocyte distribution can be evaluated by the *in vivo* diagnostic techniques described above. Depending on the immune response mediated disorder some emitters may be preferable to other. In general, alpha and beta particle-emitting radioisotopes are preferred in immunotherapy. Preferred are short range, high energy alpha emitters such as ²¹²Bi. Examples of radioisotopes which can be bound to the monoclonal antibodies of the invention for therapeutic purposes are ¹²⁵I, ¹³¹I, ⁹⁰Y, ⁶⁷Cu, ²¹²Bi, ²¹¹At, ²¹²Pb, ⁴⁷Sc, ¹⁰⁹Pd and ¹⁸⁸Re.

Lectins are proteins, usually isolated from plant material, which bind to specific sugar moieties. Many lectins are also able to agglutinate cells and stimulate lymphocytes. However, ricin is a toxic lectin which has been used immunotherapeutically. This is accomplished by binding the alpha-peptide chain of ricin, which is responsible for toxicity, to the antibody molecule to enable site specific delivery of the toxic effect.

Toxins are poisonous substances produced by plants, animals, or microorganisms that, in sufficient dose, are often lethal. Diphtheria toxin is a substance produced by *Corynebacterium diphtheria* which can be used therapeutically. This toxin consists of an alpha and beta subunit which under proper conditions can be separated. The toxic A component can be bound to an antibody and used for site specific delivery to a leukocyte expressing leukocyte adhesion factor β -chain for which the monoclonal antibodies of the invention are specific.

Other therapeutic agents which can be coupled to the monoclonal antibodies of the invention are known, or can be easily ascertained, by those of ordinary skill in the art.

The dosage ranges for the administration of the monoclonal antibodies of the invention are those large enough to produce the desired effect in which the symptoms of the immune response mediated disorder are ameliorated. The dosage should not be so large as to cause adverse side effects, such as unwanted cross-reactions, anaphylactic reactions, and the like. Generally, the dosage will vary with the age, condition, sex and

extent of the disease in the patient and can be determined by one of skill in the art. The dosage can be adjusted by the individual physician in the event of any counterindications. Dosage can vary from about 0.1 mg/m² to about 2000 mg/m², preferably about 0.1 mg/m² to about 500 mg/m²/dose, in one or more dose administrations daily, for one or several days.

Generally, when the monoclonal antibodies of the invention are administered conjugated with therapeutic agents lower dosages, as compared those used for *in vivo* immunodiagnostic imaging, can be used.

The monoclonal antibodies of the invention can be administered parenterally by injection or by gradual perfusion over time. The monoclonal antibodies of the invention can be administered intravenously, intraperitoneally, intramuscularly, subcutaneously, intracavity, or transdermally.

Preparations for parenteral administration include sterile aqueous or non-aqueous solutions, suspensions, and emulsions. Examples of non-aqueous solvents are propylene glycol, polyethylene glycol, vegetable oils such as olive oil, and injectable organic esters such as ethyl oleate. Aqueous carriers include water, alcoholic/aqueous solutions, emulsions or suspensions, including saline and buffered media. Parenteral vehicles include sodium chloride solution, Ringer's dextrose, dextrose and sodium chloride, lactated Ringer's, or fixed oils. Intravenous vehicles include fluid and nutrient replenishers, electrolyte replenishers (such as those based on Ringer's dextrose), and the like. Preservatives and other additives may also be present such as, for example, antimicrobials, anti-oxidants, chelating agents, and inert gases and the like.

The invention also relates to a method for preparing a medicament or pharmaceutical composition comprising the monoclonal antibodies of the invention, the medicament being used for therapy of immune response mediated disorders due to leukocytes expressing leukocyte adhesion receptor β -chain reactive with the monoclonal antibodies of the invention.

The above disclosure generally describes the present invention. A more complete understanding can be obtained by reference to the following specific examples which are provided herein for purposes of illustration only, and are not intended to limit the scope of the invention.

EXAMPLE 1

PREPARATION OF ANTIADHESION MONOCLONAL FACTOR ANTIBODIES

Female Balb/c mice (6 to 8 weeks old) were injected intraperitoneally with 10⁷ human splenic adherent cells in phosphate buffered saline. This treatment was repeated after 14 days and again after 21 days. Four days after the final injection the spleen was removed from one of the immunized mice and a single cell suspension pre-

pared. The splenic cells were fused to Balb/c derived P3 X 653.Ag8 myeloma cells with 50% polyethylene glycol after the method of Kohler and Milstein (Nature:256:495, 1976). After establishing growing hybridoma colonies, supernatants from these cells were tested for antibodies against human antigens by immunohistochemistry on cryostat sections (4 μ) of frozen human spleens (Naiem, et al., J. Immun. Meth., 50:145, 1982). H52 (H52.G1.2) was selected for cloning and re-cloning by immunohistochemistry, radioimmunoassays on human cells, and by radioimmunoprecipitation from human cells.

EXAMPLE 2

INHIBITION OF SYNCYTIUM FORMATION BY MONOCLONAL ANTIBODY

The effect of mAb on the fusion of 8E5 cells to PHA-blasts was determined in a syncytium formation assay. The 8E5 and A3.01 cell lines were maintained in complete medium (RPMI-1640 supplemented with 10% FBS (HyClone) and 10 mM HEPES). The 8E5 cell line is a surviving clone of A.301 cells infected with LAV. 8E5 cells carry a single copy of the entire LAV genome but produce non-infectious virus particles due to a point mutation in the reverse transcriptase gene. 8E5 cells express HIV envelope glycoproteins and when mixed with CD4-positive PHA-blasts and T cell lines produce cytopathic effects identical to those observed in cultures of T cells infected with wild-type virus.

PHA-blasts were generated by incubating peripheral blood mononuclear cells for 3 days in the presence of PHA (Wellcome Diagnostics) at a concentration of 0.25 μ g/ml in complete medium. Cells were washed 3 times with PBS and resuspended in complete medium at a density of 5 X 10⁶/ml. MAb were used in the form of purified IgG at a concentration of 25 μ g/ml. PHA-blasts were mixed with an equal volume (30 μ l) of monoclonal antibody or medium in the wells of half-area 96-well plates (Costar) and incubated for 30 minutes at 25°C. Thirty μ l of 8E5 cells were then added followed by incubation for 10 hr at 37°C in a humidified CO₂ incubator. Control wells consisted of PHA-blasts incubated with an equal number of uninfected A.301 cells. In the assay, syncytia or balloon cells consisting of 10 to 50 or more fused cells form within 4 and 10 hours after mixing 8E5 cells with PHA blasts and CD4⁺ T cell lines, respectively. Continued incubation results in rapid syncytia death as determined by vital dye exclusion.

To determine their effect on HIV-mediated cell fusion mAb against human leukocyte antigens were added to co-cultures of PHA-blasts and 8E5 cells. The mAb tested were: H52, anti-CD18 (LFA-1 β); MHM.24, anti-CD11a (LFA-1 α); H5A4, anti-CD11b (Mac-1 α); H5A5, anti-CD45 (leukocyte common antigen); MHM. 5, anti-HLA-A,B,C; Leu3a, anti-CD4. All antibodies are IgG1,k isotype.

As shown in Fig. 1, H52, against an epitope on the β -subunit of LFA-1 (CD 18), completely inhibited syncytium formation. Fusion was also blocked by a mAb (MHM.24) against the α -subunit of LFA-1 (CD11a). However, the mAb MHM.24 was less effective than mAb H52 since very small syncytia were rarely observed. H5A4, a mAb against a different member of the LAR family, Mac-1 (complement receptor type-3; CD11b), had no effect on the fusion of 8E5 cells to the PHA blasts. Also, fusion was not affected by two mAb recognizing unrelated cell surface proteins: MHM.5, anti-HLA-A,B,C, and H5A5, anti-leukocyte common antigen (CD45). Since these two antigens are expressed at equal or higher densities than LAR on PHA blasts, the failure of the latter two antibodies to block fusion suggests that inhibition by anti-LAR antibodies was not due to a non-specific steric effect. Leu3a, a mAb against CD4, which has been previously shown to block binding of gp120 to CD4, completely inhibited fusion of 8E5 to PHA-blasts (Fig. 1). Inhibition of fusion by Leu3a and the absence of fusion between the PHA-blasts and uninfected A.301 cells (Fig. 1, control) confirmed that the fusion was mediated by HIV. A number of commercially available mAb against gp120 failed to inhibit fusion in the assay system. PHA-blasts and the 8E5 cells formed very large aggregates within 1 hr of mixing in the syncytium assay. These aggregates were completely inhibited by H52, MHM.24, and Leu3a, but not by the other mAb. The inhibition of syncytium formation by mAb H52 was observed whether the PHA blasts were mixed with 8E5 cells infected with the mutant virus or the CEM T cell line infected with wild type HIV (HTLV-IIIb).

EXAMPLE 3

INHIBITION OF SYNCYTIUM FORMATION BY H52

PHA-blasts, generated as described in Example 1, were incubated with various concentrations of purified H52 or PLM-2 IgG before adding 8E5 cells. PLM-2 is an IgG1,k mAb against CD18 which does not inhibit LFA-1-mediated functions. The assay was carried out exactly as described in Example 1. Syncytia were counted on an inverted microscope using a low power objective (40X) after adding trypan blue (0.1%). Data shown in Fig. 2 are the mean syncytia count/ 10^6 8E5 cells of duplicate wells.

The H52 mAb blocked 8E5-PHA-blast fusion in a dose-dependent manner with complete inhibition observed at concentrations above $3 \mu\text{g/ml}$ (Fig. 2). The inhibition of LFA-1-mediated lymphocyte adhesion functions by mAb H52 shows a very similar dose-dependency. PLM-2, a mAb against a CD18 epitope not associated with LFA-1 adhesion functions, did not affect fusion at any concentration (Fig. 2).

Studies were also done to determine the level at which fusion was blocked by H52. PHA-blasts and 8E5 cells (2.5×10^6) were incubated for 1 hr on ice in 0.5 ml

of complete medium alone or complete medium containing purified H52 or PLM-2 IgG at $25 \mu\text{g/ml}$. After pelleting the cells, unbound mAb was removed by washing 2 times with 10 ml of PBS. The antibody-coated PHA blasts, and 8E5 cells were then resuspended in complete medium and mixed with uncoated 8E5 cells and PHA blasts, respectively, followed by incubation at 37°C for 10 hr as described in Example 1. Syncytia formation was scored as described above.

Previous studies have shown that inhibition of lymphocyte interactions by anti-LFA-1 antibodies is a uni-directional effect even when both cell types express LFA-1. To determine if the effect of anti-LFA-1 mAb on syncytium formation was also uni-directional, LFA-1 expression was analyzed by flow cytometry. Both 8E5 cells and PHA-blasts expressed LFA-1, although the expression on 8E5 was substantially less than on the blasts.

Each cell type was pre-coated with mAb H52 or the control mAb PLM-2 and washed to remove unbound mAb before assaying syncytium formation. Pre-coating PHA-blasts with H52 resulted in near complete inhibition of fusion while similar treatment of the 8E5 cells had no effect (Fig. 3). Fusion was not affected by pre-coating either the PHA-blasts or the 8E5 cells with the control mAb. This result showed that the anti-LFA-1 antibody blocked fusion at the level of the PHA-blast and not the HIV-infected 8E5 cells. This suggests that LAR on the CD4⁺ cells interacted with a ligand expressed on 8E5 cells.

EXAMPLE 4

INHIBITION OF HIV gp120 BINDING BY H52

Non-specific agents such as dextran sulfate that block the interaction of HIV envelope glycoprotein gp120 with CD4 by steric effects are known to inhibit HIV-mediated cell-cell fusion. Consequently, the binding of mAb H52 to LFA-1 on the surface of CD4⁺-cells was tested to determine whether H52 interfered with the binding of gp120 to CD4.

To purify gp120, HIV was pelleted ($110,000 \times g$, 1.5 hr) from culture supernatants of infected PHA-blasts cells and washed once with PBS. The virus was resuspended in PBS and vortexed vigorously to shear off gp120, followed by centrifugation at $110,000 \times g$. The resulting supernatant was concentrated using a 30,000 dalton cut-off Centricon filter. The retained proteins, which consisted primarily of gp120 and bovine serum albumin (BSA; 10 to 30%), were radioiodinated using the standard chloramine-T method. The labeled proteins (2 to $5 \mu\text{Ci/g}$) were diluted in PBS containing a high concentration of BSA (2%) to eliminate binding of ^{125}I -BSA. CD4⁺-CEM cells (5×10^5) were preincubated with Leu3a, H52, and PLM-2 mAb at $25 \mu\text{g/ml}$ in complete medium (see Example 1) before adding 50 ng of radioiodinated gp120. Following a 1 hr incubation at 0°C the cells were washed twice and bound radiolabel meas-

ured. Background binding was determined by preincubating cells with a 200-fold excess of unlabeled gp120. Consistent with previous findings, cells pre-coated with the Leu3a mAb (anti-CD4) did not bind gp120 (Fig. 4). In contrast, pre-coating cells with either mAb H52 or the control mAb PLM-2 had no inhibitory effect on the binding of gp120. This result demonstrated that inhibition of syncytium formation by mAb H52 was not due to interference with HIV receptor function since binding of gp120 to CD4 was not blocked by this mAb.

The invention now being fully described, it will be apparent to one of ordinary skill in the art that many changes and modifications can be made without departing from the spirit or scope of the invention.

Claims

1. A continuous hybridoma cell line which secretes monoclonal antibodies with the binding specificity of the H52 monoclonal antibody which is secreted by hybridoma cell line ATCC HB 10160.
2. The hybridoma of claim 1 which is ATCC HB 10160 and its isotype switch variants.
3. A monoclonal antibody which binds to leukocyte adhesion receptor β -chain, wherein the monoclonal antibody inhibits intercellular leukocyte adhesion and binds to the epitope on the leukocyte adhesion receptor β -chain to which monoclonal antibody H52 (secreted by hybridoma cell line ATCC HB 10160) binds.
4. The monoclonal antibody of claim 3 which is monoclonal antibody H52.
5. The monoclonal antibody of claim 3 or claim 4 which is chimeric.
6. The monoclonal antibody of any one of claims 3 to 5 which is in the form of an antibody fragment.
7. The monoclonal antibody of claim 6 wherein the antibody fragment is a Fab or F(ab')₂ fragment.
8. The monoclonal antibody of claim 3 wherein the leukocyte adhesion receptor is selected from the group consisting of LFA-1, Mac-1 and Leu M5.
9. Monoclonal antibody of any of claims 3 to 8 for use in ameliorating an immune response mediated disorder in an animal.
10. Monoclonal antibody of claim 9 for use in the treatment of AIDS.
11. Monoclonal antibody of claim 9 for use in the treatment of autoimmune disease.
12. Monoclonal antibody of claim 9 for use in the treatment of graft rejection.
13. Monoclonal antibody of claim 9 which is parenterally administered.
14. Monoclonal antibody of claim 13 which is administered by subcutaneous, intramuscular, intraperitoneal, intracavity, transdermal, or intravenous injection.
15. Monoclonal antibody of claim 9 which is administered at a dosage of about 0.01 mg/kg/dose to about 2000 mg/kg/dose.
16. Monoclonal antibody of claim 9 which is therapeutically labeled.
17. Monoclonal antibody of claim 16 wherein the therapeutic label is selected from the group consisting of a radioisotope, a drug, a lectin, and a toxin.
18. A method of detecting leukocyte adhesion receptor which comprises contacting a source suspected of containing the receptor with a diagnostically effective amount of detectably labeled H52 (ATCC HB 10160) monoclonal antibody, or fragment thereof, and determining whether the antibody binds to the source.
19. The method of claim 18 wherein the detectable label is selected from the group consisting of a radioisotope, a fluorescent compound, a colloidal metal, a chemiluminescent compound, a bioluminescent compound and an enzyme.
20. Detectably labeled H52 [ATCC HB 10160] monoclonal antibody, or fragment thereof, for use in the detection of leukocyte adhesion receptor.
21. Monoclonal antibody of claim 20 wherein the detectable label is selected from the group consisting of a radioisotope and a paramagnetic label.
22. Pharmaceutical composition comprising a monoclonal antibody according to any one of claims 3 to 8, optionally in combination with a pharmaceutically acceptable carrier.
23. A method for the preparation of the monoclonal antibody according to any one of claims 3 to 17 and 20 to 21 which comprises culturing a hybridoma cell line according to claim 1 or a corresponding cell line and isolating the desired monoclonal antibody, optionally followed by the fragmenting and/or labeling of the antibody.

Patentansprüche

1. Kontinuierliche Hybridomzelllinie, die monoclonale Antikörper mit der Bindungsspezifität des monoclonalen Antikörpers H52 sezerniert, der von der Hybridomzelllinie ATCC HB 10160 sezerniert wird.
2. Hybridom nach Anspruch 1, das ATCC HB 10160 ist und seine Isotyp-Klassensprungsvarianten.
3. Monoclonaler Antikörper, der an die β -Kette des Leukocyten-Adhäsionsrezeptors bindet, wobei der monoclonale Antikörper die interzelluläre Leukocyten-Adhäsion inhibiert und an das Epitop auf der β -Kette des Leukocyten-Adhäsionsrezeptors bindet, an welches der monoclonale Antikörper H52 (sezerniert von der Hybridomzelllinie ATCC HB 10160) bindet.
4. Monoclonaler Antikörper nach Anspruch 3, der der monoclonale Antikörper H52 ist.
5. Monoclonaler Antikörper nach Anspruch 3 oder Anspruch 4, der eine Chimäre ist.
6. Monoclonaler Antikörper nach einem der Ansprüche 3 bis 5, der in der Form eines Antikörperfragmentes vorliegt.
7. Monoclonaler Antikörper nach Anspruch 6, wobei das Antikörperfragment ein Fab- oder F(ab')₂-Fragment ist.
8. Monoclonaler Antikörper nach Anspruch 3, wobei der Leukocyten-Adhäsionsrezeptor ausgewählt ist aus LFA-1, Mac-1 und Leu M5.
9. Monoclonaler Antikörper nach einem der Ansprüche 3 bis 8 zur Verwendung in der Verbesserung einer Immunantwortvermittelten Störung in einem Tier.
10. Monoclonaler Antikörper nach Anspruch 9 zur Verwendung in der Behandlung von AIDS.
11. Monoclonaler Antikörper nach Anspruch 9 zur Verwendung in der Behandlung einer Autoimmunkrankheit.
12. Monoclonaler Antikörper nach Anspruch 9 zur Verwendung in der Behandlung einer Transplantatabstoßung.
13. Monoclonaler Antikörper nach Anspruch 9, der parenteral verabreicht wird.
14. Monoclonaler Antikörper nach Anspruch 13, der durch subkutane, intramuskuläre, intraperitoneale,

intrakavitäre, perkutane oder intravenöse Injektion verabreicht wird.

15. Monoclonaler Antikörper nach Anspruch 9, der in einer Dosierung von etwa 0,01 mg/kg/Dosis bis etwa 2000 mg/kg/Dosis verabreicht wird.
16. Monoclonaler Antikörper nach Anspruch 9, der therapeutisch markiert ist.
17. Monoclonaler Antikörper nach Anspruch 16, wobei der therapeutische Marker ausgewählt ist aus der Gruppe Radioisotop, Arzneistoff, Lectin und Toxin.
18. Verfahren zum Nachweis von Leukocyten-Adhäsionsrezeptoren, umfassend das Inkontaktbringen einer Quelle, von der man annimmt, daß sie den Rezeptor enthält, mit einer diagnostisch wirksamen Menge des nachweisbar markierten monoclonalen Antikörpers H52 (ATCC HB 10160), oder eines Fragments davon und die Bestimmung, ob der Antikörper an die Quelle bindet.
19. Verfahren nach Anspruch 18, wobei der nachweisbare Marker ausgewählt ist aus einem Radioisotop, einer fluoreszierenden Verbindung, einem kolloidalen Metall, einer chemilumineszierenden Verbindung, einer biolumineszierenden Verbindung und einem Enzym.
20. Nachweisbar markierter monoclonaler Antikörper H52 (ATCC HB 10160), oder ein Fragment davon zur Verwendung beim Nachweis eines Leukocyten-Adhäsionsrezeptors.
21. Monoclonaler Antikörper nach Anspruch 20, wobei der nachweisbare Marker ausgewählt ist aus einem Radioisotop und einem paramagnetischen Marker.
22. Arzneimittel, umfassend einen monoclonalen Antikörper nach einem der Ansprüche 3 bis 8, gegebenenfalls in Kombination mit einem pharmazeutisch verträglichen Träger.
23. Verfahren zur Herstellung des monoclonalen Antikörpers nach einem der Ansprüche 3 bis 17 und 20 bis 21, umfassend das Züchten einer Hybridomzelllinie nach Anspruch 1 oder einer entsprechenden Zelllinie und das Isolieren des gewünschten monoclonalen Antikörpers, gegebenenfalls gefolgt von der Fragmentierung und/oder Markierung des Antikörpers.

Revendications

1. Lignée cellulaire d'hybridome continue qui sécrète des anticorps monoclonaux avec la spécificité de

- liaison de l'anticorps monoclonal H52 qui est sécrété par la lignée cellulaire d'hybridome ATCC HB 10160.
2. Hybridome suivant la revendication 1, qui est ATCC HB 10160 et ses variants par commutation d'isotype.
 3. Anticorps monoclonal qui se lie à la chaîne bêta de récepteurs d'adhérence de leucocytes, dans lequel l'anticorps monoclonal inhibe l'adhérence intercellulaire des leucocytes et se lie à l'épitope sur la chaîne bêta de récepteurs d'adhérence de leucocytes auquel se lie l'anticorps monoclonal H52 (sécrété par la lignée cellulaire d'hybridome ATCC HB 10160).
 4. Anticorps monoclonal suivant la revendication 3, qui est l'anticorps monoclonal H52.
 5. Anticorps monoclonal suivant les revendications 3 ou 4, qui est chimérique.
 6. Anticorps monoclonal suivant l'une quelconque des revendications 3 à 5, qui est sous la forme d'un fragment d'anticorps.
 7. Anticorps monoclonal suivant la revendication 6, dans lequel le fragment d'anticorps est un fragment Fab ou F(ab')₂.
 8. Anticorps monoclonal suivant la revendication 3, dans lequel le récepteur d'adhérence de leucocytes est choisi dans le groupe consistant en LFA-1, Mac-1 et Leu M5.
 9. Anticorps monoclonal suivant l'une quelconque des revendications 3 à 8, utile dans l'amélioration d'un trouble médié par une réponse immune chez l'animal.
 10. Anticorps monoclonal suivant la revendication 9, utile dans le traitement du SIDA.
 11. Anticorps monoclonal suivant la revendication 9, utile dans le traitement de maladie auto-immune.
 12. Anticorps monoclonal suivant la revendication 9, utile dans le traitement de rejet de greffe.
 13. Anticorps monoclonal suivant la revendication 9, qui est administré par voie parentérale.
 14. Anticorps monoclonal suivant la revendication 13, qui est administré par injection sous-cutanée, intramusculaire, intrapéritonéale, intracavité, transdermique ou intraveineuse.
 15. Anticorps monoclonal suivant la revendication 9, qui est administré à raison d'environ 0,01 mg/kg/dose à environ 2000 mg/kg/dose.
 16. Anticorps monoclonal suivant la revendication 9, qui est marqué de façon thérapeutique.
 17. Anticorps monoclonal suivant la revendication 16, dans lequel le marqueur thérapeutique est choisi dans le groupe consistant en un radioisotope, un médicament, une lectine et une toxine.
 18. Méthode pour la détection d'un récepteur d'adhérence de leucocytes, qui comprend la mise en contact d'une source suspectée de contenir le récepteur avec une quantité efficace du point de vue diagnostique d'anticorps monoclonal H52 (ATCC HB10160) ou d'un fragment de celui-ci, marqué de façon à pouvoir être détecté, et la détermination de l'existence ou non d'une liaison de l'anticorps à la source.
 19. Méthode suivant la revendication 18, dans laquelle le marqueur détectable est choisi dans le groupe consistant en un radioisotope, un composé fluorescent, un métal colloïdal, un composé chimioluminescent, un composé bioluminescent et une enzyme.
 20. Anticorps monoclonal H52 (ATCC HB 10160) ou fragment de celui-ci, marqué de façon à pouvoir être détecté, utile dans la détection de récepteur d'adhérence de leucocytes.
 21. Anticorps monoclonal suivant la revendication 20, dans lequel le marqueur détectable est choisi dans le groupe consistant en un radioisotope et un marqueur paramagnétique.
 22. Composition pharmaceutique comprenant un anticorps monoclonal suivant l'une quelconque des revendications 3 à 8, éventuellement en combinaison avec un support acceptable du point de vue pharmaceutique.
 23. Procédé pour la préparation d'un anticorps monoclonal suivant l'une quelconque des revendications 3 à 17 et 20 à 21, qui comprend la culture d'une lignée cellulaire d'hybridome suivant la revendication 1, ou d'une lignée cellulaire correspondante et l'isolement de l'anticorps monoclonal désiré, suivis éventuellement de la fragmentation et/ou du marquage de l'anticorps.

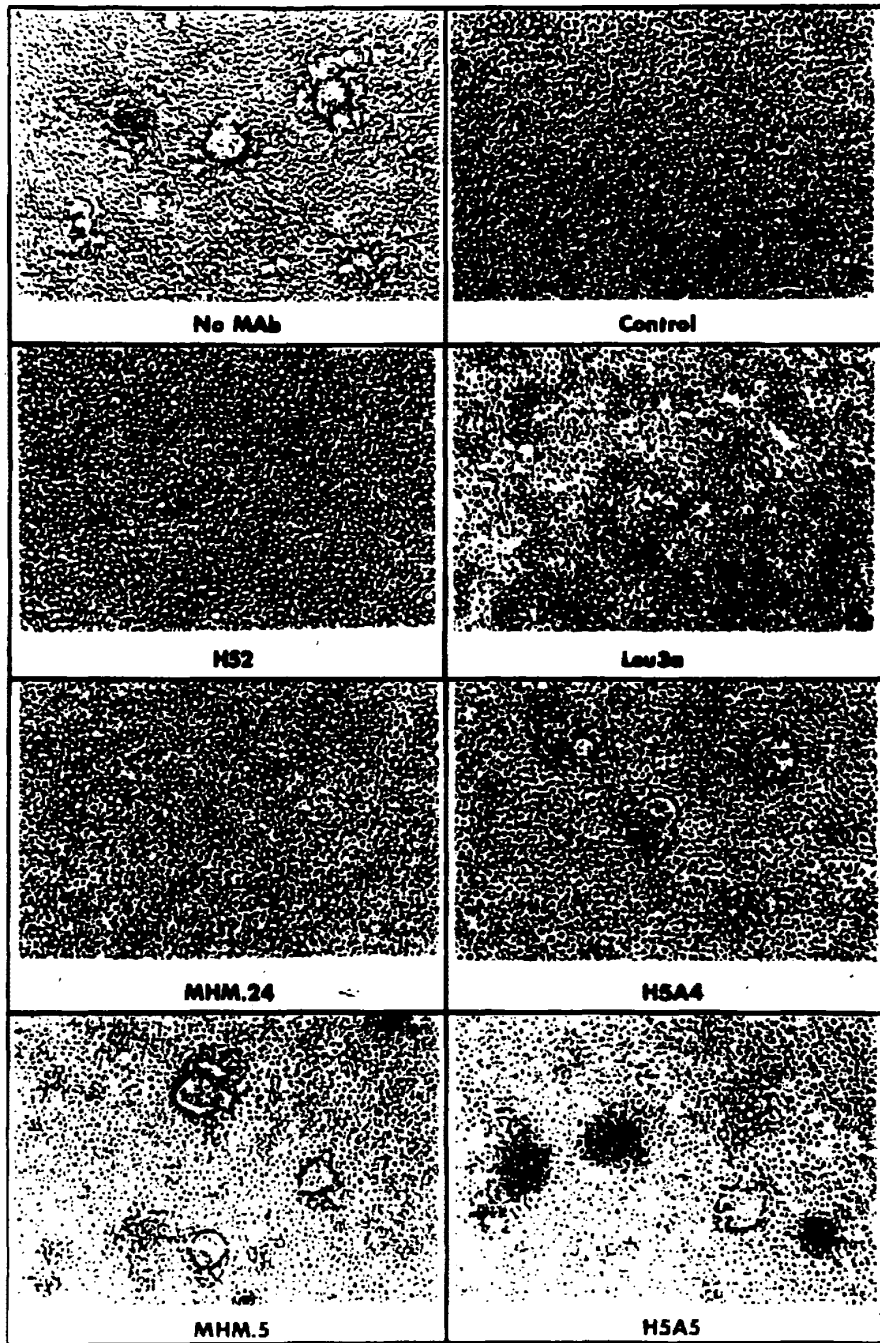

FIG. 1

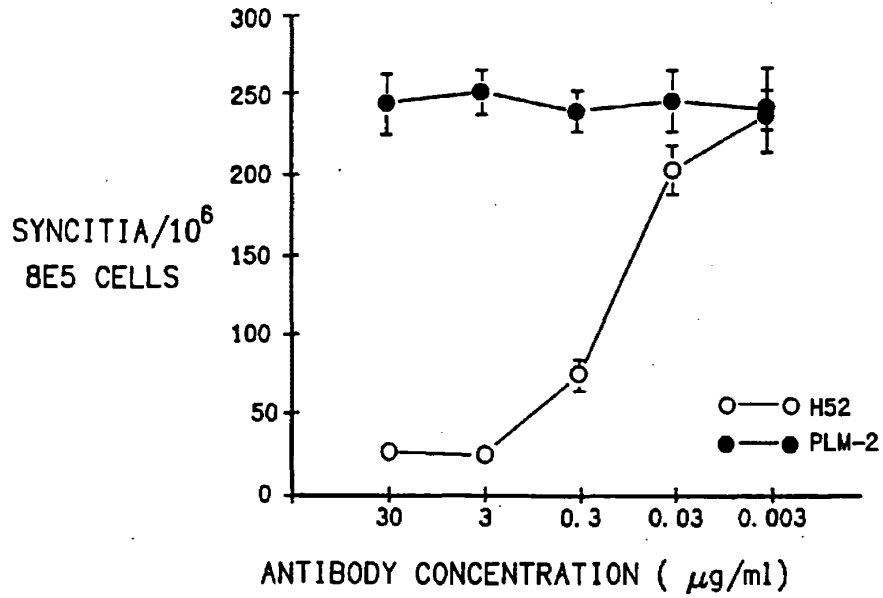

FIG. 2

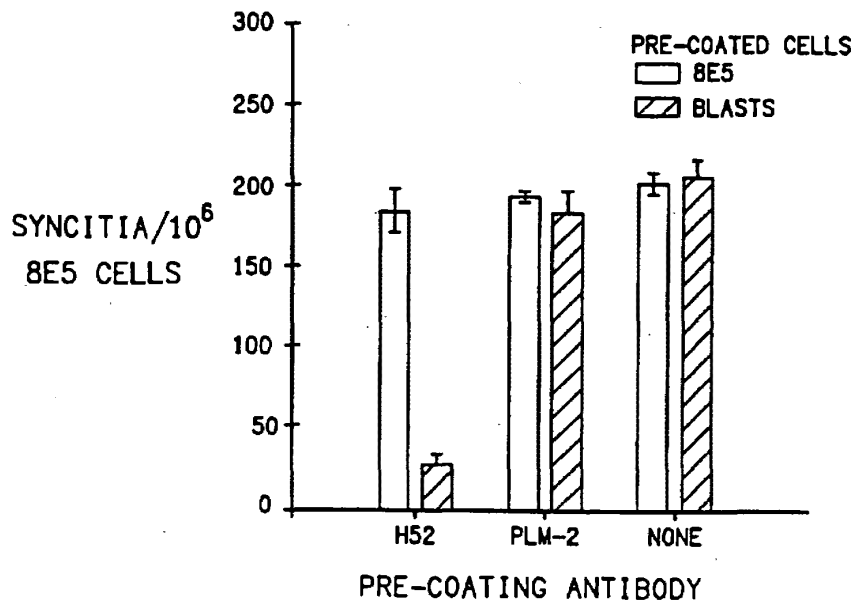

FIG. 3

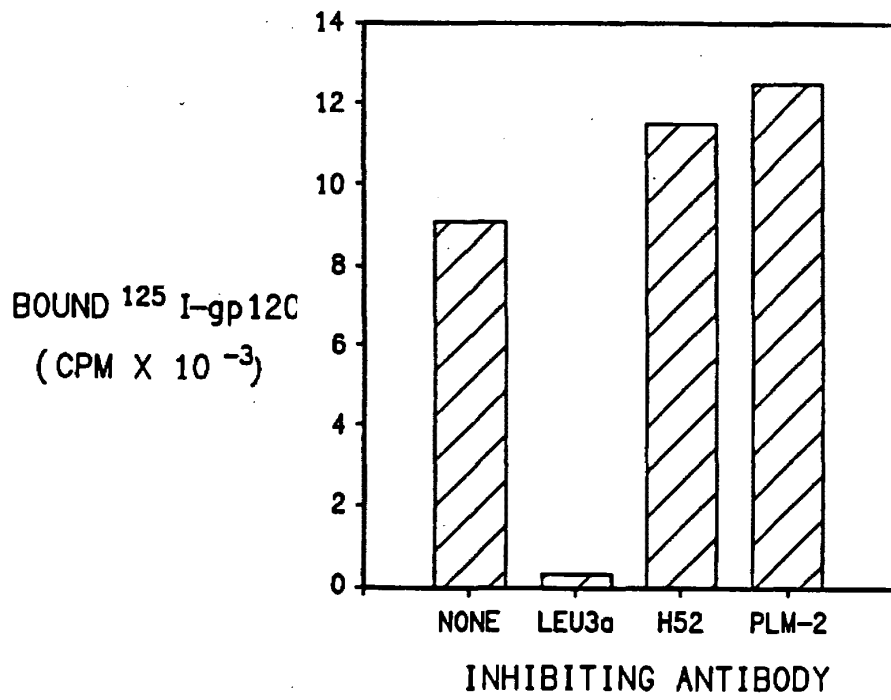

FIG. 4



EUROPEAN PATENT APPLICATION

Application number: **95105609.2**

Int. Cl.⁸: **C07K 16/46, A61K 39/395**

Date of filing: **28.12.89**

This application was filed on 13 - 04 - 1995 as a
divisional application to the application
mentioned under INID code 60.

Priority: **28.12.88 US 290975**
13.02.89 US 310252

Date of publication of application:
15.11.95 Bulletin 95/46

Publication number of the earlier application in
accordance with Art.76 EPC: **0 451 216**

Designated Contracting States:
AT BE CH DE ES FR GB IT LI LU NL SE

Applicant: **PROTEIN DESIGN LABS, INC.**
2375 Garcia Avenue
Mountain View, CA 94043 (US)

Inventor: **Queen, Cary L.**
1300 Oak Creek Drive
Palo Alto,
California 94304 (US)
Inventor: **Selick, Harold Edwin**
1673 Sunnyslope Avenue
Belmont,
California 94002 (US)

Representative: **Bizley, Richard Edward et al**
Hepworth, Lawrence, Bryer & Bizley
Merlin House
Falconry Court
Bakers Lane
Epping
Essex CM16 5DQ (GB)

Humanized immunoglobulins and their production and use.

The invention provides a method of producing a humanized immunoglobulin (Ig) comprising the step of combining complementarity determining regions from a donor Ig with a framework that is a consensus sequence of frameworks of many human antibodies.

EP 0 682 040 A1

Field of the Invention

The present invention relates generally to the combination of recombinant DNA and monoclonal antibody technologies for developing novel therapeutic agents and, more particularly, to the production of non-immunogenic antibodies and their uses.

Background of the Invention

In mammals, the immune response is mediated by two types of cells that interact specifically with foreign material, *i.e.*, antigens. One of these cell types, B-cells, are responsible for the production of antibodies. The second cell class, T-cells, include a wide variety of cellular subsets controlling the *in vivo* function of both B-cells and a wide variety of other hematopoietic cells, including T-cells.

One way in which T-cells exert this control is through the production of a lymphokine known as interleukin-2 (IL-2), originally named T-cell growth factor. IL-2's prime function appears to be the stimulation and maintenance of T-cells. Indeed, some immunologists believe that IL-2 may be at the center of the entire immune response (see, Farrar, J., et al., *Immunol. Rev.* 63:129-166 (1982), which is incorporated herein by reference).

To exert its biological effects, IL-2 interacts with a specific high-affinity membrane receptor (Greene, W., et al., *Progress in Hematology XIV*, E. Brown, Ed., Grune and Statton, New York (1986), at pgs. 283 ff). The human IL-2 receptor is a complex multichain glycoprotein, with one chain, known as the Tac peptide, being about 55kD in size (see, Leonard, W., et al., *J. Biol. Chem.* 260:1872 (1985), which is incorporated herein by reference). A gene encoding this protein has been isolated, and predicts a 272 amino acid peptide, including a 21 amino acid signal peptide (see, Leonard, W., et al., *Nature* 311: 626 (1984)). The 219 NH₂-terminal amino acids of the p55 Tac protein apparently comprise an extracellular domain (see, Leonard, W., et al., *Science*, 230:633-639 (1985), which is incorporated herein by reference).

Much of the elucidation of the human IL-2 receptor's structure and function is due to the development of specifically reactive monoclonal antibodies. In particular, one mouse monoclonal antibody, known as anti-Tac (Uchiyama, et al., *J. Immunol.* 126:1393 (1981)) has shown that IL-2 receptors can be detected on T-cells, but also on cells of the monocyte-macrophage family, Kupffer cells of the liver, Langerhans' cells of the skin and, of course, activated T-cells. Importantly, resting T-cells, B-cells or circulating macrophages typically do not display the IL-2 receptor (Herrmann, et al., *J. Exp. Med.* 162:1111 (1985)).

The anti-Tac monoclonal antibody has also been used to define lymphocyte functions that require IL-2 interaction, and has been shown to inhibit various T-cell functions, including the generation of cytotoxic and suppressor T lymphocytes in cell culture. Also, based on studies with anti-Tac and other antibodies, a variety of disorders are now associated with improper IL-2 receptor expression by T-cells, in particular adult T-cell leukemia.

More recently, the IL-2 receptor has been shown to be an ideal target for novel therapeutic approaches to T-cell mediated diseases. It has been proposed that IL-2 receptor specific antibodies, such as the anti-Tac monoclonal antibody, can be used either alone or as an immunoconjugate (e.g., with Ricin A, isotopes and the like) to effectively remove cells bearing the IL-2 receptor. These agents can, for example, theoretically eliminate IL-2 receptor-expressing leukemic cells, certain B-cells, or activated T-cells involved in a disease state, yet allow the retention of mature normal T-cells and their precursors to ensure the capability of mounting a normal T-cell immune response as needed. In general, most other T-cell specific agents can destroy essentially all peripheral T-cells, which limits the agents' therapeutic efficacy. Overall, the use of appropriate monoclonal antibodies specific for the IL-2 receptor may have therapeutic utility in autoimmune diseases, organ transplantation and any unwanted response by activated T-cells. Indeed, clinical trials have been initiated using, e.g., anti-Tac antibodies (see, generally, Waldman, T., et al., *Cancer Res.* 45:625 (1985) and Waldman, T., *Science* 232:727-732 (1986), both of which are incorporated herein by reference).

Unfortunately, the use of the anti-Tac and other non-human monoclonal antibodies have certain drawbacks, particularly in repeated therapeutic regimens as explained below. Mouse monoclonal antibodies, for example, do not fix human complement well, and lack other important immunoglobulin functional characteristics when used in humans.

Perhaps more importantly, anti-Tac and other non-human monoclonal antibodies contain substantial stretches of amino acid sequences that will be immunogenic when injected into a human patient. Numerous studies have shown that, after injection of a foreign antibody, the immune response elicited by a patient against an antibody can be quite strong, essentially eliminating the antibody's therapeutic utility after an initial treatment. Moreover, as increasing numbers of different mouse or other antigenic (to humans)

monoclonal antibodies can be expected to be developed to treat various diseases, after the first and second treatments with any different non-human antibodies, subsequent treatments even for unrelated therapies can be ineffective or even dangerous in themselves.

5 While the production of so-called "chimeric antibodies" (e.g., mouse variable regions joined to human constant regions) (see, for example, WO89/09622) has proven somewhat successful, a significant immunogenicity problem remains. In general, the production of human immunoglobulins reactive with the human IL-2 receptor, as with many human antigens, has been extremely difficult using typical human monoclonal antibody production techniques. Similarly, past attempts utilizing recombinant DNA technology to produce so-called "humanized" antibodies (see e.g., EPO Publication No. 0239400), provides uncertain
10 results, in part due to unpredictable binding affinities.

Thus, there is a need for improved forms of human-like immunoglobulins, such as those specific for the human IL-2 receptor, that are substantially non-immunogenic in humans, yet easily and economically produced in a manner suitable for therapeutic formulation and other uses. The present invention fulfills these and other needs.

15 The hypervariable regions (also called Complementarity Determining Regions, abbreviated to "CDRs") of immunoglobulins were originally defined by Kabat et al., ("Sequences of Proteins of Immunological Interest" Kabat, E., et al., U.S. Department of Health and Human Services, (1983)) based on extent of sequence variability, to consist of residues 24-34 (L1), 50-56 (L2) and 89-97 (L3) in the light chain variable domain (V_L) and 31-35 (H1), 50-65 (H2) and 95-102 (H3) in the heavy chain variable domain (V_H), using
20 Kabat's standard numbering system for antibody amino acids. The CDRs are believed to contact the target antigen of an antibody and to be primarily responsible for binding. More recently Chothia et al (Chothia and Lesk, J. Mol. Biol., 196:901-917 (1987)) have given an alternate definition of the hypervariable regions or CDRs as consisting of residues 26-32 (L1), 50-52 (L2), 91-96 (L3) in V_L and residues 26-32 (H1), 53-55 (H2), 96-101 (H3) in V_H. The Chothia definition is based on the residues that constitute the loops in the 3-
25 dimensional structures of antibodies. It is particularly important to note that for each of the six CDRs the Chothia CDR is actually a subset of (i.e. smaller than) the Kabat CDR, with the single exception of H1 (the first heavy chain CDR), where the Chothia CDR contains amino acids 26-30 that are not in the Kabat CDR.

Riechmann et al ("Reshaping human antibodies for therapy", Nature, Vol 332, pp 323-326, (March 1988)) describe work in which precisely the Kabat CDRs were transferred to a pre-determined human
30 framework (NEW again for the heavy chain and REI for the light chain). However, they found that antibody containing the humanized heavy chain lost most of its binding affinity and ability to lyse target cells. They therefore made a new humanized antibody containing the Kabat CDRs from the mouse antibody and two amino acid changes in Chothia CDR H1, but no other mouse amino acids.

35 Summary of the Invention

The invention provides a method of producing a humanized immunoglobulin (Ig) chain having one or more complementarity determining regions (CDR's) from a donor Ig and a framework region from a human Ig, said method comprising: comparing the framework or variable region amino acid sequence of the donor
40 Ig light or heavy chain with corresponding sequences in a collection of human Ig chains; and selecting to provide the human Ig light or heavy chain framework, a sequence from the collection which has at least about 65% homology with the donor framework.

In another aspect, the invention provides a method of producing a humanized immunoglobulin (Ig) heavy chain comprising the step of combining complementarity determining regions from a donor Ig heavy chain with the framework of a human acceptor Ig heavy chain selected so that the sequence of the
45 humanized Ig heavy chain framework is 65% or more identical to the sequence of the donor Ig heavy chain framework.

A further aspect of the invention is a method of producing a humanized immunoglobulin (Ig) comprising the step of combining complementarity determining regions from a donor Ig with a framework that is a
50 consensus sequence of frameworks of many human antibodies.

The present invention provides novel compositions useful, for example, in the treatment of T-cell mediated human disorders, the compositions containing human-like immunoglobulins specifically capable of blocking the binding of human IL-2 to its receptor and/or capable of binding to the p55 Tac protein on human IL-2 receptors. The immunoglobulins can have two pairs of light chain/heavy chain complexes,
55 typically at least one pair having chains comprising mouse complementarity determining regions functionally joined to human framework region segments. For example, mouse complementarity determining regions, with or without additional naturally-associated mouse amino acid residues, can be used to produce human-like antibodies capable of binding to the human IL-2 receptor at affinity levels stronger than about

10^8 M^{-1} .

The immunoglobulins, including binding fragments and other derivatives thereof, of the present invention may be produced readily by a variety of recombinant DNA techniques, with ultimate expression in transfected cells, preferably immortalized eukaryotic cells, such as myeloma or hybridoma cells. Polynucleotides comprising a first sequence coding for human-like immunoglobulin framework regions and a second sequence set coding for the desired immunoglobulin complementarity determining regions can be produced synthetically or by combining appropriate cDNA and genomic DNA segments.

The human-like immunoglobulins may be utilized alone in substantially pure form, or complexed with a cytotoxic agent, such as a radionuclide, a ribosomal inhibiting protein or a cytotoxic agent active at cell surfaces. All of these compounds will be particularly useful in treating T-cell mediated disorders. The human-like immunoglobulins or their complexes can be prepared in a pharmaceutically accepted dosage form, which will vary depending on the mode of administration.

The present invention also provides novel methods for designing human-like immunoglobulin chains having one or more complementarity determining regions (CDR's) from a donor immunoglobulin and a framework region from a human immunoglobulin, the preferred methods may involve first comparing the framework or variable region amino acid sequence of the donor immunoglobulin to corresponding sequences in a collection of human immunoglobulin chains, and selecting as the human immunoglobulin one of the more homologous sequences from the collection. The human immunoglobulin, or acceptor immunoglobulin, sequence is typically selected from a collection of at least 10 to 20 immunoglobulin chain sequences, and usually will have the highest homology to the donor immunoglobulin sequence of any sequence in the collection. The human immunoglobulin framework sequence will typically have about 65 to 70% homology or more to the donor immunoglobulin framework sequences. The donor immunoglobulin may be either a heavy chain or light chain (or both), and the human collection will contain the same kind of chain. A humanized light and heavy chain can be used to form a complete humanized immunoglobulin or antibody, having two light/heavy chain pairs, with or without partial or full-length human constant regions and other proteins.

Whether or not in conjunction with the above comparison step, additional amino acids in an acceptor immunoglobulin chain may be replaced with amino acids from the CDR-donor immunoglobulin chain. More specifically, further optional substitutions of a human framework amino acid of the acceptor immunoglobulin with a corresponding amino acid from a donor immunoglobulin will be made at positions in the immunoglobulins where:

- (a) the amino acid in the human framework region of an acceptor immunoglobulin is rare for that position and the corresponding amino acid in the donor immunoglobulin is common for that position in human immunoglobulin sequences; or
- (b) the amino acid is immediately adjacent to one of the CDR's; or
- (c) the amino acid is predicted to have a side chain atom capable of interacting with the antigen or with the CDR's of the humanized immunoglobulin, optionally within about 3Å of the CDR's in a three-dimensional immunoglobulin model.

The humanized immunoglobulin chain will typically comprise at least about 3 amino acids from the donor immunoglobulin in addition to the CDR's, usually at least one of which is immediately adjacent to a CDR in the donor immunoglobulin. The heavy and light chains may each be designed by using any one or all three of the position criteria.

When combined into an intact antibody, the humanized light and heavy chains of the present invention will be substantially non-immunogenic in humans and retain substantially the same affinity as the donor immunoglobulin to the antigen (such as a protein or other compound containing an epitope). These affinity levels can vary from about 10^8 M^{-1} or higher, and may be within about 4 fold of the donor immunoglobulin's original affinity to the antigen.

BRIEF DESCRIPTION OF THE FIGURES

Figure 1. Comparison of sequences of anti-Tac heavy chain (upper lines) and Eu heavy chain (lower lines). The 1-letter code for amino acids is used. The first amino acid on each line is numbered at the left. Identical amino acids in the two sequences are connected by lines. The 3 CDRs are underlined. Other amino acid positions for which the anti-Tac amino acid rather than the Eu amino acid was used in the humanized anti-Tac heavy chain are denoted by an *.

Figure 2. Comparison of sequences of anti-Tac light chain (upper lines) and Eu light chain (lower lines). The single-letter code for amino acids is used. The first amino acid on each line is numbered at the left. Identical amino acids in the two sequences are connected by lines. The 3 CDRs are underlined. Other

amino acid positions for which the anti-Tac amino acid rather than the Eu amino acid was used in the humanized anti-Tac heavy chain are denoted by an *.

Figure 3. Nucleotide sequence of the gene for the humanized anti-Tac heavy chain variable region gene. The translated amino acid sequence for the part of the gene encoding protein is shown underneath the nucleotide sequence. The nucleotides TCTAGA at the beginning and end of the gene are Xba I sites. The mature heavy chain sequence begins with amino acid #20 Q.

Figure 4. Nucleotide sequence of the gene for the humanized anti-Tac light chain variable region gene. The translated amino acid sequence for the part of the gene encoding protein is shown underneath the nucleotide sequence. The nucleotides TCTAGA at the beginning and end of the gene are Xba I sites. The mature light chain sequence begins with amino acid #21 D.

Figure 5. A. Sequences of the four oligonucleotides used to synthesize the humanized anti-Tac heavy chain gene, printed 5' to 3'. B. Relative positions of the oligonucleotides. The arrows point in the 3' direction for each oligonucleotide.

Figure 6. (A) Sequences of the four oligonucleotides used to synthesize the humanized anti-Tac light chain gene, printed 5' to 3'. (B) Relative positions of the oligonucleotides. The arrows point in the 3' direction for each oligonucleotide. The position of a Hind III site in the overlap of JFD2 and JFD3 is shown.

Figure 7. Schematic diagram of the plasmid pHuGTAC1 used to express the humanized anti-Tac heavy chain. Relevant restriction sites are shown, and coding regions of the heavy chain are displayed as boxes. The direction of transcription from the immunoglobulin (Ig) promoter is shown by an arrow. E_H = heavy chain enhancer, Hyg = hygromycin resistance gene.

Figure 8. Schematic diagram of the plasmid pHuLTAC used to express the humanized anti-Tac light chain. Relevant restriction sites are shown, and coding regions of the light chain are displayed as boxes. The direction of transcription from the Ig promoter is shown by an arrow.

Figure 9. Fluorocytometry of HUT-102 and Jurkat cells stained with anti-Tac antibody or humanized anti-Tac antibody followed respectively by fluorescein-conjugated goat anti-mouse Ig antibody or goat anti-human Ig antibody, as labeled. In each panel, the dotted curve shows the results when the first antibody was omitted, and the solid curve the results when first and second (conjugated) antibodies were included as described.

Figure 10. (A) Fluorocytometry of HUT-102 cells stained with 0-40 ng of anti-Tac as indicated, then with biotinylated anti-Tac, and then with phycoerythrin-conjugated avidin. (B) Fluorocytometry of HUT-102 cells stained with the indicated antibody, then with biotinylated anti-Tac, and then with phycoerythrin-conjugated avidin.

DETAILED DESCRIPTION OF THE INVENTION

In accordance with one embodiment of the present invention, human-like immunoglobulins specifically reactive with desired epitopes, such as those on the IL-2 receptor on human T-cells, are provided. These immunoglobulins, which have binding affinities of at least about 10^8 M⁻¹, and preferably 10^9 M⁻¹ to 10^{10} M⁻¹ or stronger, are capable of, e.g., blocking the binding of IL-2 to human IL-2 receptors. The human-like immunoglobulins will have a human-like framework and can have complementarity determining regions (CDR's) from an immunoglobulin, typically a mouse immunoglobulin, specifically reactive with an epitope on p55 Tac protein. The immunoglobulins of the present invention, which can be produced economically in large quantities, find use, for example, in the treatment of T-cell mediated disorders in human patients by a variety of techniques.

The basic antibody structural unit is known to comprise a tetramer. Each tetramer is composed of two identical pairs of polypeptide chains, each pair having one "light" (about 25kD) and one "heavy" chain (about 50-70kD). The NH₂-terminus of each chain begins a variable region of about 100 to 110 or more amino acids primarily responsible for antigen recognition. The COOH terminus of each chain defines a constant region primarily responsible for effector function.

Light chains are classified as either kappa or lambda. Heavy chains are classified (and subclassified) as gamma, mu, alpha, delta, or epsilon, and define the antibody's isotype as IgG, IgM, IgA, IgD and IgE, respectively. Within light and heavy chains, the variable and constant regions are joined by a "J" region of about 12 or more amino acids, with the heavy chain also including a "D" region of about 12 more amino acids. (See, generally, Fundamental Immunology, Paul, W., Ed., Chapter 7, pgs. 131-166, Raven Press, N.Y. (1984), which is incorporated herein by reference.)

The variable regions of each light/heavy chain pair form the antibody binding site. The chains all exhibit the same general structure of relatively conserved framework regions joined by three hypervariable regions, also called CDR's (see, "Sequences of Proteins of Immunological Interest," Kabat, E., et al., U.S.

Department of Health and Human Services, (1983); and Cholthia and Lesk, *J. Mol. Biol.*, 196:901-917 (1987), which are incorporated herein by reference). The CDR's from the two chains of each pair are aligned by the framework regions, enabling binding to a specific epitope.

As used herein, the term "immunoglobulin" refers to a protein consisting of one or more polypeptides substantially encoded by immunoglobulin genes. The recognized immunoglobulin genes include the kappa, lambda, alpha, gamma, delta, epsilon and mu constant region genes, as well as the myriad immunoglobulin variable region genes. The immunoglobulins may exist in a variety of forms besides antibodies; including, for example, Fv, Fab, and F(ab)₂, as well as in single chains (e.g., Huston, et al., *Proc. Nat. Acad. Sci. U.S.A.*, 85:5879-5883 (1988) and Bird, et al., *Science*, 242:423-426 (1988), which are incorporated herein by reference). (See, generally, Hood, et al., "Immunology", Benjamin, N.Y., 2nd ed. (1984), and Hunkapiller and Hood, *Nature*, 323:15-16 (1986), which are incorporated herein by reference).

Chimeric antibodies are antibodies whose light and heavy chain genes have been constructed, typically by genetic engineering, from immunoglobulin gene segments belonging to different species. For example, the variable (V) segments of the genes from a mouse monoclonal antibody may be joined to human constant (C) segments, such as γ_1 and γ_3 . A typical therapeutic chimeric antibody is thus a hybrid protein consisting of the V or antigen-binding domain from a mouse antibody and the C or effector domain from a human antibody (e.g., A.T.C.C. Accession No. CRL 9688 secretes an anti-Tac chimeric antibody), although other mammalian species may be used.

As used herein, the term "framework region" refers to those portions of immunoglobulin light and heavy chain variable regions that are relatively conserved (i.e., other than the CDR's) among different immunoglobulins in a single species, as defined by Kabat, et al., *op. cit.* As used herein, a "human-like framework region" is a framework region that in each existing chain comprises at least about 70 or more amino acid residues, typically 75 to 85 or more residues, identical to those in a human immunoglobulin.

As used herein, the term "human-like immunoglobulin" refers to an immunoglobulin comprising a human-like framework and in which any constant region present is substantially homologous to a human immunoglobulin constant region, i.e., at least about 85-90%, preferably about 95% identical. Hence, all parts of a human-like immunoglobulin, except possibly the CDR's, are substantially homologous to corresponding parts of one or more native human immunoglobulin sequences. For example, a human-like immunoglobulin would not encompass a chimeric mouse variable region/human constant region antibody.

In accordance with another general aspect of the present invention, also included are criteria by which a limited number of amino acids in the framework of a human-like or humanized immunoglobulin chain are chosen to be the same as the amino acids at those positions in the donor Ig rather than in the acceptor Ig, in order to increase the affinity of an antibody comprising the humanized immunoglobulin chain.

This aspect of the present invention is based in part on the model that two contributing causes of the loss of affinity in prior means of producing humanized antibodies (using as examples mouse antibodies as the source of CDR's) are:

(1) When the mouse CDR's are combined with the human framework, the amino acids in the framework close to the CDR's become human instead of mouse. Without intending to be bound by theory, we believe that these changed amino acids may slightly distort the CDR's, because they create different electrostatic or hydrophobic forces than in the donor mouse antibody, and the distorted CDR's may not make as effective contacts with the antigen as the CDR's did in the donor antibody;

(2) Also, amino acids in the original mouse antibody that are close to, but not part of, the CDR's (i.e., still part of the framework), may make contacts with the antigen that contribute to affinity. These amino acids are lost when the antibody is humanized, because all framework amino acids are made human.

To avoid these problems, and to produce humanized antibodies that have a very strong affinity for a desired antigen, the present invention uses the following four criteria for designing humanized immunoglobulins. These criteria may be used singly, or when necessary in combination, to achieve the desired affinity or other characteristics.

Criterion I: As acceptor, use a framework from a particular human immunoglobulin that is unusually homologous to the donor immunoglobulin to be humanized, or use a consensus framework from many human antibodies. For example, comparison of the sequence of a mouse heavy (or light) chain variable region against human heavy (or light) variable regions in a data bank (for example, the National Biomedical Research Foundation Protein Identification Resource) shows that the extent of homology to different human regions varies greatly, typically from about 40% to about 60-70%. By choosing as the acceptor immunoglobulin one of the human heavy (respectively light) chain variable regions that is most homologous to the heavy (respectively light) chain variable region of the donor immunoglobulin, fewer amino acids will be changed in going from the donor immunoglobulin to the humanized immunoglobulin. Hence, and again without intending to be bound by theory, it is believed that there is a smaller chance of

changing an amino acid near the CDR's that distorts their conformation. Moreover, the precise overall shape of a humanized antibody comprising the humanized immunoglobulin chain may more closely resemble the shape of the donor antibody, also reducing the chance of distorting the CDR's.

Typically, one of the 3-5 most homologous heavy chain variable region sequences in a representative collection of at least about 10 to 20 distinct human heavy chains will be chosen as acceptor to provide the heavy chain framework, and similarly for the light chain. Preferably, one of the 1-3 most homologous variable regions will be used. The selected acceptor immunoglobulin chain will most preferably have at least about 65% homology in the framework region to the donor immunoglobulin.

Regardless of how the acceptor immunoglobulin is chosen, higher affinity may be achieved by selecting a small number of amino acids in the framework of the humanized immunoglobulin chain to be the same as the amino acids at those positions in the donor rather than in the acceptor. The following criteria define what amino acids may be so selected. Preferably, at most or all amino acid positions satisfying one of these criteria, the donor amino acid will in fact be selected.

Criterion II: If an amino acid in the framework of the human acceptor immunoglobulin is unusual (*i.e.*, "rare", which as used herein indicates an amino acid occurring at that position in no more than about 10% of human heavy (respectively light) chain V region sequences in a representative data bank), and if the donor amino acid at that position is typical for human sequences (*i.e.*, "common", which as used herein indicates an amino acid occurring in at least about 25% of sequences in a representative data bank), then the donor amino acid rather than the acceptor may be selected. This criterion helps ensure that an atypical amino acid in the human framework does not disrupt the antibody structure. Moreover, by replacing an unusual amino acid with an amino acid from the donor antibody that happens to be typical for human antibodies, the humanized antibody may be made less immunogenic.

Criterion III: In the positions immediately adjacent to the 3 CDR's in the humanized immunoglobulin chain, the donor amino acid rather than acceptor amino acid may be selected. These amino acids are particularly likely to interact with the amino acids in the CDR's and, if chosen from the acceptor, distort the donor CDR's and reduce affinity. Moreover, the adjacent amino acids may interact directly with the antigen (Amit *et al.*, *Science*, 233, 747-753 (1986), which is incorporated herein by reference) and selecting these amino acids from the donor may be desirable to keep all the antigen contacts that provide affinity in the original antibody.

Criterion IV: A 3-dimensional model, typically of the original donor antibody, shows that certain amino acids outside of the CDR's are close to the CDR's and have a good probability of interacting with amino acids in the CDR's by hydrogen bonding, Van der Waals forces, hydrophobic interactions, etc. At those amino acid positions, the donor amino acid rather than the acceptor immunoglobulin amino acid may be selected. Amino acids according to this criterion will generally have a side chain atom within about 3 angstrom units of some site in the CDR's and must contain atoms that could interact with the CDR atoms according to established chemical forces, such as those listed above. Computer programs to create models of proteins such as antibodies are generally available and well known to those skilled in the art (see, Loew *et al.*, *Int. J. Quant. Chem., Quant. Biol. Symp.*, 15:55-66 (1988); Bruccoleri *et al.*, *Nature*, 335, 564-568 (1988); Chothia *et al.*, *Science*, 233:755-758 (1986), all of which are incorporated herein by reference). These do not form part of the invention. Indeed, because all antibodies have similar structures, the known antibody structures, which are available from the Brookhaven Protein Data Bank, can be used if necessary as rough models of other antibodies. Commercially available computer programs can be used to display these models on a computer monitor, to calculate the distance between atoms, and to estimate the likelihood of different amino acids interacting (see, Ferrin *et al.*, *J. Mol. Graphics*, 6:13-27 (1988)).

Humanized or human-like antibodies generally have at least three potential advantages over mouse or in some cases chimeric antibodies for use in human therapy:

1) Because the effector portion is human, it may interact better with the other parts of the human immune system (*e.g.*, destroy the target cells more efficiently by complement-dependent cytotoxicity (CDC) or antibody-dependent cellular cytotoxicity (ADCC)).

2) The human immune system should not recognize the framework or constant region of the humanized antibody as foreign, and therefore the antibody response against such an injected antibody should be less than against a totally foreign mouse antibody or a partially foreign chimeric antibody.

3) Injected mouse antibodies have been reported to have a half-life in the human circulation much shorter than the half-life of normal antibodies (D. Shaw *et al.*, *J. Immunol.*, 138:4534-4538 (1987)). Injected humanized antibodies will presumably have a half-life more similar to naturally occurring human antibodies, allowing smaller and less frequent doses to be given.

The present invention is specifically directed to improved humanized immunoglobulins (e.g., capable of binding the human IL-2 receptor) with respect to those described in EPA publication no. 0239400. That application, the disclosure of which is excluded from coverage herein, describes, for certain immunoglobulins, substituting CDR's regions in the light or heavy chain variable domains of an acceptor antibody with analogous parts of CDR's (typically solvent accessible) from an antibody of different specificity. Also, that application discusses, for certain immunoglobulins, the possibility of only transferring residues that are (solvent) accessible from the antigen binding site, which residues apparently may include certain framework regions (specifically, residues known to be involved in antigen binding as described in Amit et al., *Science* 233: 747-753 (1986) or perhaps residues essential for inter-chain interactions - but for the selection of which insufficient guidance is provided in that application). Thus, for example, a preferred embodiment of the present invention entails substituting entire CDR's and framework amino acids immediately adjacent one (or preferably each) of the CDR's. In general, any framework residue that also makes contact with the CDR's to, e.g., maintain their conformation (and usually their antigen binding specificity) are specifically included within preferred embodiments of the present invention as described in detail, *supra*.

In one aspect, the present invention is directed to recombinant DNA segments encoding the heavy and/or light chain CDR's (typically with other amino acid residues as described above) from an immunoglobulin capable of binding to a desired epitope, such as on the human IL-2 receptor (e.g., the anti-Tac monoclonal antibody). The DNA segments encoding these regions will typically be joined to DNA segments encoding appropriate human-like framework regions. For example, the preferred DNA sequences, which on expression code for the polypeptide chains comprising the anti-Tac heavy and light chain hypervariable regions (with human-like framework regions), are shown in Figures 3 and 4, respectively. Due to codon degeneracy and non-critical amino-acid substitutions, other DNA sequences can be readily substituted for those sequences, as detailed below.

The DNA segments will typically further include an expression control DNA sequence operably linked to the human-like antibody coding sequences, including naturally-associated or heterologous promoter regions. Preferably, the expression control sequences will be eukaryotic promoter systems in vectors capable of transforming or transfecting eukaryotic host cells, but control sequences for prokaryotic hosts may also be used. Once the vector has been incorporated into the appropriate host, the host is maintained under conditions suitable for high level expression of the nucleotide sequences, and, as desired, the collection and purification of the light chains, heavy chains, light/heavy chain dimers or intact antibodies, binding fragments or other immunoglobulin forms may follow.

Human constant region DNA sequences can be isolated in accordance with well known procedures from a variety of human cells, but preferably immortalized B-cells (see, Kabat *op. cit.* and WP87/02671). For example, the human kappa immunoglobulin constant and J region genes and sequences are described in Heiter et al., *Cell* 22:197-207 (1980) and the nucleotide sequence of a human immunoglobulin C_{γ1} gene is described in Ellison et al., *Nucl. Acid. Res.* 10:4071 (1982), both of which are incorporated herein by reference. The CDR's for producing the immunoglobulins of the present invention will be similarly derived from monoclonal antibodies capable of binding to the desired antigen (e.g., the human IL-2 receptor) and produced in any convenient mammalian source, including, mice, rats, rabbits, or other vertebrate capable of producing antibodies by well known methods. Suitable source cells for the DNA sequences and host cells for immunoglobulin expression and secretion can be obtained from a number of sources, such as the American Type Culture Collection ("Catalogue of Cell Lines and Hybridomas," Fifth edition (1985) Rockville, Maryland, U.S.A., which is incorporated herein by reference).

In addition to the human-like immunoglobulins specifically described herein, other "substantially homologous" modified immunoglobulins can be readily designed and manufactured utilizing various recombinant DNA techniques well known to those skilled in the art. For example, for the IL-2 receptor immunoglobulins the framework regions can vary from the sequences in Figures 3 and 4 at the primary structure level by several amino acid substitutions, terminal and intermediate additions and deletions, and the like. Moreover, a variety of different human framework regions may be used singly or in combination as a basis for the human-like immunoglobulins of the present invention. In general, modifications of the genes may be readily accomplished by a variety of well-known techniques, such as site-directed mutagenesis (see, Gillman and Smith, *Gene* 8:81-97 (1979) and Roberts, S. et al, *Nature* 328:731-734 (1987), both of which are incorporated herein by reference). Alternatively, polypeptide fragments comprising only a portion of the primary antibody structure may be produced, which fragments possess one or more immunoglobulin activities (e.g., complement fixation activity). Also because like many genes, the immunoglobulin-related genes contain separate functional regions, each having one or more distinct biological activities, the genes may be fused to functional regions from other genes (e.g., enzymes, see, commonly assigned U.S.S.N. 132,387, filed Dec. 15, 1987, which is incorporated herein by reference) to produce fusion proteins (e.g.,

immunotoxins) having novel properties.

The nucleic acid sequences of the present invention capable of ultimately expressing the desired human-like antibodies can be formed from a variety of different polynucleotides (genomic or cDNA, RNA, synthetic oligonucleotides, etc.) and components (e.g., V, J, D, and C regions), as well as by a variety of different techniques. Joining appropriate genomic sequences is presently the most common method of production, but cDNA sequences may also be utilized (see, European Patent Publication No. 0239400 and Reichmann, L., et al., *Nature* 332:323-327 (1988), both of which are incorporated herein by reference).

As stated previously, the DNA sequences will be expressed in hosts after the sequences have been operably linked to (i.e., positioned to ensure the functioning of) an expression control sequence. These expression vectors are typically replicable in the host organisms either as episomes or as an integral part of the host chromosomal DNA. Commonly, expression vectors will contain selection markers, e.g., tetracycline or neomycin, to permit detection of those cells transformed with the desired DNA sequences (see, e.g., U.S. Patent 4,704,362, which is incorporated herein by reference).

E. coli is one prokaryotic host useful particularly for cloning the DNA sequences of the present invention. Other microbial hosts suitable for use include bacilli, such as *Bacillus subtilis*, and other enterobacteriaceae, such as *Salmonella*, *Serratia*, and various *Pseudomonas* species. In these prokaryotic hosts, one can also make expression vectors, which will typically contain expression control sequences compatible with the host cell (e.g., an origin of replication). In addition, any number of a variety of well-known promoters will be present, such as the lactose promoter system, a tryptophan (trp) promoter system, a beta-lactamase promoter system, or a promoter system from phage lambda. The promoters will typically control expression, optionally with an operator sequence, and have ribosome binding site sequences and the like, for initiating and completing transcription and translation.

Other microbes, such as yeast, may also be used for expression. *Saccharomyces* is a preferred host, with suitable vectors having expression control sequences, such as promoters, including 3-phosphoglycerate kinase or other glycolytic enzymes, and an origin of replication, termination sequences and the like as desired.

In addition to microorganisms, mammalian tissue cell culture may also be used to express and produce the polypeptides of the present invention (see, Winnacker, "From Genes to Clones," VCH Publishers, N.Y., N.Y. (1987), which is incorporated herein by reference). Eukaryotic cells are actually preferred, because a number of suitable host cell lines capable of secreting intact immunoglobulins have been developed in the art, and include the CHO cell lines, various COS cell lines, HeLa cells, myeloma cell lines, etc, but preferably transformed B-cells or hybridomas. Expression vectors for these cells can include expression control sequences, such as an origin of replication, a promoter, an enhancer (Queen, C., et al., *Immunol. Rev.* 89:49-68 (1986), which is incorporated herein by reference), and necessary processing information sites, such as ribosome binding sites, RNA splice sites, polyadenylation sites, and transcriptional terminator sequences. Preferred expression control sequences are promoters derived from SV40 with enhancer (see, Mulligan and Berg, *Science* 209:1422-1427 (1980), an immunoglobulin gene, Adenovirus, Bovine Papilloma Virus, and the like.

The vectors containing the DNA segments of interest (e.g., the heavy and light chain encoding sequences and expression control sequences) can be transferred into the host cell by well-known methods, which vary depending on the type of cellular host. For example, calcium chloride transfection is commonly utilized for prokaryotic cells, whereas calcium phosphate treatment or electroporation may be used for other cellular hosts. (See, generally, Maniatis, et al., *Molecular Cloning: A Laboratory Manual*, Cold Spring Harbor Press, (1982), which is incorporated herein by reference.)

Once expressed, the whole antibodies, their dimers, individual light and heavy chains, or other immunoglobulin forms of the present invention can be purified according to standard procedures of the art, including ammonium sulfate precipitation, affinity columns, column chromatography, gel electrophoresis and the like (see, generally, Scopes, R., *Protein Purification*, Springer-Verlag, N.Y. (1982)). Substantially pure immunoglobulins of at least about 90 to 95% homogeneity are preferred, and 98 to 99% or more homogeneity most preferred, for pharmaceutical uses. Once purified, partially or to homogeneity as desired, the polypeptides may then be used therapeutically (including extracorporeally) or in developing and performing assay procedures, immunofluorescent stainings, and the like. (See, generally, *Immunological Methods*, Vols. I and II, Lefkovits and Pernis, eds., Academic Press, New York, N.Y. (1979 and 1981)).

The IL-2 receptor specific antibodies exemplified in the present invention will typically find use individually in treating a T-cell mediated disease state. Generally, where the cell linked to a disease has been identified as IL-2 receptor bearing, then the human-like antibodies capable of blocking the binding of IL-2 to the human IL-2 receptor are suitable (see, U.S.S.N. 085,707, entitled "Treating Human Malignancies and Disorders," which is incorporated herein by reference). For example, typical disease states suitable for

treatment include graft versus host disease and transplant rejection in patients undergoing an organ transplant, such as heart, lungs, kidneys, liver, etc. Other diseases include autoimmune diseases, such as Type I diabetes, multiple sclerosis, rheumatoid arthritis, systemic lupus erythematosus, and myasthenia gravis.

5 The human-like antibodies of the present invention may also be used in combination with other antibodies, particularly human monoclonal antibodies reactive with other markers on cells responsible for the disease. For example, suitable T-cell markers can include those grouped into the so-called "Clusters of Differentiation," as named by the First International Leukocyte Differentiation Workshop, Leukocyte Typing, Bernard, et al., Eds., Springer-Verlag, N.Y. (1984), which is incorporated herein by reference.

10 The antibodies can also be used as separately administered compositions given in conjunction with chemotherapeutic or immunosuppressive agents. Typically, the agents will include cyclosporin A or a purine analog (e.g., methotrexate, 6-mercaptopurine, or the like), but numerous additional agents (e.g., cyclophosphamide, prednisone, etc.) well-known to those skilled in the art may also be utilized.

A preferred pharmaceutical composition of the present invention comprises the use of the subject 15 antibodies in immunotoxins. Immunotoxins are characterized by two components and are particularly useful for killing selected cells in vitro or in vivo. One component is a cytotoxic agent which is usually fatal to a cell when attached or absorbed. The second component, known as the "delivery vehicle," provides a means for delivering the toxic agent to a particular cell type, such as cells comprising a carcinoma. The two components are commonly chemically bonded together by any of a variety of well-known chemical 20 procedures. For example, when the cytotoxic agent is a protein and the second component is an intact immunoglobulin, the linkage may be by way of heterobifunctional cross-linkers, e.g., SPDP, carbodiimide, glutaraldehyde, or the like. Production of various immunotoxins is well-known with the art, and can be found, for example in "Monoclonal Antibody-Toxin Conjugates: Aiming the Magic Bullet," Thorpe et al, Monoclonal Antibodies in Clinical Medicine, Academic Press, pp. 168-190 (1982), which is incorporated herein by 25 reference.

A variety of cytotoxic agents are suitable for use in immunotoxins. Cytotoxic agents can include radionuclides, such as Iodine-131, Yttrium-90, Rhenium-188, and Bismuth-212; a number of chemotherapeutic drugs, such as vindesine, methotrexate, adriamycin, and cisplatin; and cytotoxic 30 proteins such as ribosomal inhibiting proteins like pokeweed antiviral protein, *Pseudomonas* exotoxin A, ricin, diphtheria toxin, ricin A chain, etc., or an agent active at the cell surface, such as the phospholipase enzymes (e.g., phospholipase C). (See, generally, commonly assigned U.S.S.N. 07/290,968 filed December 28, 1988), "Chimeric Toxins," Olsnes and Phil, Pharmac. Ther., 25:355-381 (1982), and "Monoclonal Antibodies for Cancer Detection and Therapy," eds. Baldwin and Byers, pp. 159-179, 224-266, Academic Press (1985), all of which are incorporated herein by reference.)

35 The delivery component of the immunotoxin will include the human-like immunoglobulins of the present invention. Intact immunoglobulins or their binding fragments, such as Fab, are preferably used. Typically, the antibodies in the immunotoxins will be of the human IgM or IgG isotype, but other mammalian constant regions may be utilized as desired.

The human-like antibodies and pharmaceutical compositions thereof of this invention are particularly 40 useful for parenteral administration, i.e., subcutaneously, intramuscularly or intravenously. The compositions for parenteral administration will commonly comprise a solution of the antibody or a cocktail thereof dissolved in an acceptable carrier, preferably an aqueous carrier. A variety of aqueous carriers can be used, e.g., water, buffered water, 0.4% saline, 0.3% glycine and the like. These solutions are sterile and generally free of particulate matter. These compositions may be sterilized by conventional, well known sterilization 45 techniques. The compositions may contain pharmaceutically acceptable auxiliary substances as required to approximate physiological conditions such as pH adjusting and buffering agents, toxicity adjusting agents and the like, for example sodium acetate, sodium chloride, potassium chloride, calcium chloride, sodium lactate, etc. The concentration of antibody in these formulations can vary widely, i.e., from less than about 0.5%, usually at or at least about 1% to as much as 15 or 20% by weight and will be selected primarily 50 based on fluid volumes, viscosities, etc., in accordance with the particular mode of administration selected.

Thus, a typical pharmaceutical composition for intramuscular injection could be made up to contain 1 ml sterile buffered water, and 50 mg of antibody. A typical composition for intravenous infusion could be made up to contain 250 ml of sterile Ringer's solution, and 150 mg of antibody. Actual methods for preparing parenterally administrable compositions will be known or apparent to those skilled in the art and 55 are described in more detail in, for example, Remington's Pharmaceutical Science, 15th ed., Mack Publishing Company, Easton, Pennsylvania (1980), which is incorporated herein by reference.

The antibodies of this invention can be lyophilized for storage and reconstituted in a suitable carrier prior to use. This technique has been shown to be effective with conventional immune globulins and art-

known lyophilization and reconstitution techniques can be employed. It will be appreciated by those skilled in the art that lyophilization and reconstitution can lead to varying degrees of antibody activity loss (e.g., with conventional immune globulins, IgM antibodies tend to have greater activity loss than IgG antibodies) and that use levels may have to be adjusted to compensate.

5 The compositions containing the present human-like antibodies or a cocktail thereof can be administered for prophylactic and/or therapeutic treatments. In therapeutic application, compositions are administered to a patient already suffering from a disease, in an amount sufficient to cure or at least partially arrest the disease and its complications. An amount adequate to accomplish this is defined as a "therapeutically effective dose." Amounts effective for this use will depend upon the severity of the infection
10 and the general state of the patient's own immune system, but generally range from about 1 to about 200 mg of antibody per dose, with dosages of from 5 to 25 mg per patient being more commonly used. It must be kept in mind that the materials of this invention may generally be employed in serious disease states, that is life-threatening or potentially life-threatening situations. In such cases, in view of the minimization of extraneous substances and the lower probability of "foreign substance" rejections which are achieved by
15 the present human-like antibodies of this invention, it is possible and may be felt desirable by the treating physician to administer substantial excesses of these antibodies.

In prophylactic applications, compositions containing the present antibodies or a cocktail thereof are administered to a patient not already in a disease state to enhance the patient's resistance. Such an amount is defined to be a "prophylactically effective dose." In this use, the precise amounts again depend upon the
20 patient's state of health and general level of immunity, but generally range from 0.1 to 25 mg per dose, especially 0.5 to 2.5 mg per patient. A preferred prophylactic use is for the prevention of kidney transplant rejection.

Single or multiple administrations of the compositions can be carried out with dose levels and pattern being selected by the treating physician. In any event, the pharmaceutical formulations should provide a
25 quantity of the antibody(ies) of this invention sufficient to effectively treat the patient.

Human-like antibodies of the present invention can further find a wide variety of utilities in vitro. By way of example, the exemplary antibodies can be utilized for T-cell typing, for isolating specific IL-2 receptor bearing cells or fragments of the receptor, for vaccine preparation, or the like.

For diagnostic purposes, the antibodies may either be labeled or unlabeled. Unlabeled antibodies can
30 be used in combination with other labeled antibodies (second antibodies) that are reactive with the human-like antibody, such as antibodies specific for human immunoglobulin constant regions. Alternatively, the antibodies can be directly labeled. A wide variety of labels may be employed, such as radionuclides, fluors, enzymes, enzyme substrates, enzyme cofactors, enzyme inhibitors, ligands (particularly haptens), etc. Numerous types of immunoassays are available and are well known to those skilled in the art.

Kits can also be supplied for use with the subject antibodies in the protection against or detection of a cellular activity or for the presence of a selected antigen. Thus, the subject antibody composition of the present invention may be provided, usually in a lyophilized form in a container, either alone or in conjunction with additional antibodies specific for the desired cell type. The antibodies, which may be conjugated to a label or toxin, or unconjugated, are included in the kits with buffers, such as Tris,
40 phosphate, carbonate, etc., stabilizers, biocides, inert proteins, e.g., serum albumin, or the like, and a set of instructions for use. Generally, these materials will be present in less than about 5% wt. based on the amount of active antibody, and usually present in total amount of at least about 0.001% wt. based again on the antibody concentration. Frequently, it will be desirable to include an inert extender or excipient to dilute the active ingredients, where the excipient may be present in from about 1 to 99% wt. of the total
45 composition. Where a second antibody capable of binding to the chimeric antibody is employed in an assay, this will usually be present in a separate vial. The second antibody is typically conjugated to a label and formulated in an analogous manner with the antibody formulations described above.

The following examples are offered by way of illustration, not by limitation.

50 EXPERIMENTAL

Design of genes for human-like light and heavy chains

The sequence of the human antibody Eu (Sequences of Proteins of Immunological Interest, Kabat, E.,
55 et al., U.S. Dept. of Health and Human Services, 1983) was used to provide the framework of the humanized antibody, because the amino acid sequence of the heavy chain of anti-Tac is more homologous to the heavy chain of this antibody than to any other heavy chain sequence in the National Biomedical Foundation Protein Identification Resource.

To select the sequence of the humanized heavy chain, the anti-Tac heavy chain sequence (see, commonly assigned U.S.S.N.'s 186,862 and 223,037, which are incorporated herein by reference) was aligned with the sequence of the Eu heavy chain (Figure 1). At each position, the Eu amino acid was selected for the humanized sequence, unless that position fell in any one of the following categories, in which case the anti-Tac amino acid was selected.

- (1) The position fell within a complementarity determining region (CDR), as defined by Kabat, et al., *op. cit.* (amino acids 31-35, 50-66, 99-106);
- (2) The Eu amino acid was unusual for human heavy chains at that position, whereas the anti-Tac amino acid was typical for human heavy chains at that position (amino acids 27, 93, 95, 98, 107-109, 111);
- (3) The position was immediately adjacent to a CDR in the amino acid sequence of the anti-Tac heavy chain (amino acids 30 and 67).
- (4) 3-dimensional modeling of the anti-Tac antibody suggested that the amino acid was physically close to the antigen binding region (amino acids 48 and 68).

Some amino acids fell in more than one of these categories but are only listed in one.

To select the sequence of the humanized light chain, the anti-Tac light chain sequence was aligned with the sequence of the Eu light chain (Figure 2). The Eu amino acid was selected at each position, unless the position again fell into one of the categories (1) - (4), (with light chain replacing heavy chain in the category definitions):

- (1) CDRs (amino acids 24-34, 50-56, 89-97).
- (2) Anti-Tac amino acid more typical than Eu (amino acids 48 and 63).
- (3) Adjacent to CDRs (no amino acids; Eu and anti-Tac were already the same at all these positions).
- (4) Possible 3-dimensional proximity to binding region (amino acid 60).

The actual nucleotide sequence of the heavy (Figure 3) and light chain (Figure 4) genes were selected as follows:

- (1) the nucleotide sequences code for the amino acid sequences chosen as described above.
- (2) 5' of these coding sequences, the nucleotide sequences code for a leader (signal) sequence, namely the leader of the light chain of the antibody MOPC 63 and the leader of the heavy chain of the antibody PCH 108A (Kabat et al., *op. cit.*). These leader sequences were chosen as typical of antibodies.
- (3) 3' of the coding sequences, the nucleotide sequences are the sequences that follow the mouse light chain J5 segment and the mouse heavy chain J2 segment, which are part of the anti-Tac sequences. These sequences are included because they contain splice donor signals.
- (4) At each end of the sequence is an Xba I site to allow cutting at the Xba I sites and cloning into the Xba I site of a vector.

35 Construction of humanized light and heavy chain genes

To synthesize the heavy chain, four oligonucleotides HES12, HES13, HES14, HES15 (Figure 5A) were synthesized using an Applied Biosystems 380B DNA synthesizer. Two of the oligonucleotides are part of each strand of the heavy chain, and each oligonucleotide overlaps the next one by about 20 nucleotides to allow annealing (Figure 5B). Together, the oligonucleotides cover the entire humanized heavy chain (Figure 3) with a few extra nucleotides at each end to allow cutting at the Xba I sites. The oligonucleotides were purified from polyacrylamide gels.

Each oligonucleotide was phosphorylated using ATP and T4 polynucleotide kinase by standard procedures (see, Maniatis, *op. cit.*). To anneal the phosphorylated oligonucleotides, they were suspended together in 40 ul of TA (33 mM Tris acetate, pH 7.9, 66 mM potassium acetate, 10 mM magnesium acetate) at a concentration of about 3.75 uM each, heated to 95 deg for 4 min. and cooled slowly to 4 deg. To synthesize the complete gene from the oligonucleotides by synthesizing the opposite strand of each oligonucleotide (Figure 5B), the following components were added in a final volume of 100ul:

- 10 ul annealed oligonucleotides 0.16 mM each deoxyribonucleotide
- 0.5 mM ATP
- 0.5 mM DTT
- 100 ug/ml BSA
- 3.5 ug/ml T4 g43 protein (DNA polymerase)
- 25 ug/ml T4 g44/62 protein (polymerase accessory protein)
- 25 ug/ml 45 protein (polymerase accessory protein)

The mixture was incubated at 37 deg for 30 min. Then 10 u of T4 DNA ligase was added and incubation at 37 deg resumed for 30 min. The polymerase and ligase were inactivated by incubation of the reaction at 70 deg for 15 min. To digest the gene with Xba I, to the reaction was added 50 ul of 2x TA

containing BSA at 200 ug/ml and DTT at 1 mM, 43 ul of water, and 50 u of Xba I in 5 ul. The reaction was incubated for 3 hr at 37 deg, and run on a gel. The 431 bp Xba I fragment was purified from a gel and cloned into the Xba I site of the plasmid pUC19 by standard methods. Four plasmid isolates were purified and sequenced using the dideoxy method. One of these had the correct sequence (Figure 3).

5 To synthesize the light chain, four oligonucleotides JFD1, JFD2, JFD3, JFD4 (Figure 6A) were synthesized. Two of the oligonucleotides are part of each strand of the light chain, and each oligonucleotide overlaps the next one by about 20 nucleotides to allow annealing (Figure 6B). Together, the oligonucleotides cover the entire humanized light chain (Figure 4) with a few extra nucleotides at each end to allow cutting at the Xba I sites. The oligonucleotides were purified from polyacrylamide gels.

10 The light chain gene was synthesized from these oligonucleotides in two parts. 0.5 ug each of JFD1 and JFD2 were combined in 20 ul sequenase buffer (40 mM Tris-HCl, pH 7.5, 20 mM magnesium chloride, 50 mM sodium chloride), heated at 70 deg for 3 min and allowed to cool slowly to 23 deg in order for the oligonucleotides to anneal. JFD3 and JFD4 were treated in the same way. Each reaction was made 10 mM in DTT and 0.5 mM in each deoxyribonucleotide and 6.5 u of sequenase (US Biochemicals) was added, in a
15 final volume of 24 ul, and incubated for 1 hr at 37 deg to synthesize the opposite strands of the oligonucleotides. Xba I and Hind III were added to each reaction to digest the DNA (there is a Hind III site in the region where JFD2 and JFD3 overlap and therefore in each of the synthesized DNAs; Figure 6B). The reactions were run on polyacrylamide gels, and the Xba I - Hind III fragments were purified and cloned into pUC18 by standard methods. Several plasmid isolates for each fragment were sequenced by the dideoxy
20 method, and correct ones chosen.

Construction of plasmids to express humanized light and heavy chains

25 The heavy chain Xba I fragment was isolated from the pUC19 plasmid in which it had been inserted and then inserted into the Xba I site of the vector pV γ 1 (see, commonly assigned U.S.S.N. 223,037) in the correct orientation by standard methods, to produce the plasmid pHuGTAC1 (Figure 7). This plasmid will express high levels of a complete heavy chain when transfected into an appropriate host cell.

The two light chain Xba I - Hind III fragments were isolated from the pUC18 plasmids in which they had been inserted. The vector plasmid pV \times 1 (see, commonly assigned U.S.S.N. 223,037) was cut with Xba I,
30 dephosphorylated and ligated with the two fragments by standard methods. The desired reaction product has the circular form: vector - Xba I - fragment 1 - Hind III - fragment 2 - Xba I - vector. Several plasmid isolates were analyzed by restriction mapping and sequencing, and one with this form chosen. This plasmid, pHuLTAC (Figure 8), therefore contains the complete humanized light chain (Figure 4) and will express high levels of the light chain when transfected into an appropriate host cell.

Synthesis and affinity of humanized antibody

35 The plasmids pHuGTAC1 and pHuLTAC were transfected into mouse Sp2/0 cells, and cells that integrated the plasmids were selected on the basis of resistance to mycophenolic acid and/or hygromycin B conferred by the gpt and hyg genes on the plasmids (Figures 7,8) by standard methods. To verify that these cells secreted antibody that binds to the IL-2 receptor, supernatant from the cells was incubated with HUT-102 cells that are known to express the IL-2 receptor. After washing, the cells were incubated with fluorescein-conjugated goat anti-human antibody, washed, and analyzed for fluorescence on a FACSCAN
45 cytofluorometer. The results (Figure 9A), clearly show that the humanized antibody binds to these cells, but not to Jurkat T-cells that do not express the IL-2 receptor (Figure 9D). As controls, the original mouse anti-Tac antibody was also used to stain these cells (Figure 9B,C), giving similar results.

For further experiments, cells producing the humanized antibody were injected into mice, and the resultant ascites collected. Humanized antibody was purified to substantial homogeneity from the ascites by passage through an affinity column of goat anti-human immunoglobulin antibody, prepared on an Affigel-10
50 support (Bio-Rad Laboratories, Inc., Richmond, CA) according to standard techniques. To determine the affinity of the humanized antibody relative to the original anti-Tac antibody, a competitive binding experiment was performed. About 5×10^5 HUT-102 cells were incubated with known quantities (10 - 40 ng) of the anti-Tac antibody and the humanized anti-Tac antibody for 10 min at 4 deg. Then 100 ng of biotinylated anti-Tac was added to the cells and incubated for 30 min at 4 deg. This quantity of anti-Tac had previously
55 been determined to be sufficient to saturate the binding sites on the cells, but not to be in large excess. Then the cells were washed twice with 2 ml of phosphate buffered saline (PBS) containing 0.1% sodium azide. The cells were then incubated for 30 min at 4 deg with 250 ng of phycoerythrin-conjugated avidin, which bound to the biotinylated anti-Tac already bound to the cells. The cells were washed again as above,

fixed in PBS containing 1% paraformaldehyde, and analyzed for fluorescence on a FACSCAN cytofluorometer.

Use of increasing amounts (10 - 40 ng) of the anti-Tac antibody as competitor in the first step decreased the amount of biotinylated anti-Tac that could bind to the cells in the second step, and therefore the amount of phycoerythrin-conjugated avidin that bound in the last step, thus decreasing fluorescence (Figure 10A). Equivalent amounts (20 ng) of anti-Tac, and humanized anti-Tac used as competitor decreased the fluorescence to approximately the same degree (Figure 10B). This shows that these antibodies have approximately the same affinity (within 3 to 4 fold), because if one had much greater affinity, it would have more effectively competed with the biotinylated anti-Tac, thus decreasing fluorescence more.

Biological properties of the humanized antibody

For optimal use in treatment of human disease, the humanized antibody should be able to destroy T-cells in the body that express the IL-2 receptor. One mechanism by which antibodies may destroy target cells is antibody-dependent cell-mediated cytotoxicity, abbreviated ADCC (Fundamental Immunology, Paul, W., Ed., Raven Press, New York (1984), at pg. 681) in which the antibody forms a bridge between the target cell and an effector cell such as a macrophage that can lyse the target. To determine whether the humanized antibody and the original mouse anti-Tac antibody can mediate ADCC, a chromium release assay was performed by standard methods. Specifically, human leukemia HUT-102 cells, which express the IL-2 receptor, were incubated with ⁵¹Cr to allow them to absorb this radionuclide. The HUT-102 cells were then incubated with an excess of either anti-Tac or humanized anti-Tac antibody. The HUT-102 cells were next incubated for 4 hrs with either a 30:1 or 100:1 ratio of effector cells, which were normal purified human peripheral blood mononuclear cells that had been activated by incubation for about 20 hrs with human recombinant IL-2. Release of ⁵¹Cr, which indicated lysis of the target HUT-102 cells, was measured and the background subtracted (Table 1). The results show that at either ratio of effector cells, anti-Tac did not lyse a significant number of the target cells (less than 5%), while the humanized antibody did (more than 20%). Hence, the humanized antibody is likely to be more efficacious than the original mouse antibody in treating T-cell leukemia or other T-cell mediated diseases.

TABLE 1

Percent ⁵¹ Cr release after ADCC		
Antibody	Effector: Target ratio	
	30:1	100:1
Anti-Tac	4%	< 1%
Humanized anti-Tac	24%	23%

From the foregoing, it will be appreciated that the human-like immunoglobulins of the present invention offer numerous advantages of other antibodies. For example, in comparison to anti-Tac mouse monoclonal antibodies, the present human-like IL-2 receptor immunoglobulins can be more economically produced and contain substantially less foreign amino acid sequences. This reduced likelihood of antigenicity after injection into a human patient represents a significant therapeutic improvement for immunoglobulins designed in accordance with the above criteria.

Although the present invention has been described in some detail by way of illustration and example for purposes of clarity and understanding, it will be apparent that certain changes and modifications may be practiced within the scope of the appended claims.

Claims

1. A method of producing a humanized immunoglobulin (Ig) chain having one or more complementarity determining regions (CDR's) from a donor Ig and a framework region from a human Ig, said method comprising: comparing the framework or variable region amino acid sequence of the donor Ig light or heavy chain with corresponding sequences in a collection of human Ig chains; and selecting, to provide the human Ig light or heavy chain framework, a sequence from the collection which has at least about 65% homology with the donor framework.

EP 0 682 040 A1

2. A method of producing a humanized immunoglobulin (Ig) heavy chain comprising the step of combining complementarity determining regions from a donor Ig heavy chain with the framework of a human acceptor Ig heavy chain selected so that the sequence of the humanized Ig heavy chain framework is 65% or more identical to the sequence of the donor Ig heavy chain framework.
- 5
3. A method of producing a humanized immunoglobulin (Ig) comprising the step of combining complementarity determining regions from a donor Ig with a framework that is a consensus sequence of frameworks of many human antibodies.
- 10
4. A humanized immunoglobulin chain obtainable by a method according to any one of claims 1 to 3.
5. A humanized immunoglobulin comprising a chain according to claim 4.
6. A polynucleotide comprising a first sequence coding for a human-like immunoglobulin framework region and a second sequence coding for one or more CDR's, wherein upon expression said polynucleotide encodes an immunoglobulin chain of claim 4.
- 15
7. A cell line transfected with a polynucleotide of claim 6.
- 20
8. The use of an immunoglobulin of claim 5 in the manufacture of a medicament.

25

30

35

40

45

50

55

1	Q	V	Q	L	Q	Q	S	G	A	E	L	A	K	P	G	A	S	V	K	M
1	Q	V	Q	L	V	Q	S	G	A	E	V	K	K	P	G	S	S	V	K	V
21	S	C	K	A	S	G	Y	T	F	T	S	Y	R	M	H	W	V	K	Q	R
21	S	C	K	A	S	G	G	T	F	S	R	S	A	I	I	W	V	R	Q	A
						*		*												
41	P	G	Q	G	L	E	W	I	G	Y	I	N	P	S	T	G	Y	T	E	Y
41	P	G	Q	G	L	E	W	M	G	G	I	V	P	M	F	G	P	P	N	Y
						*														
61	N	Q	K	F	K	D	K	A	T	L	T	A	D	K	S	S	S	T	A	Y
61	A	Q	K	F	Q	G	R	V	T	I	T	A	D	E	S	T	N	T	A	Y
						*	*													
81	M	Q	L	S	S	L	T	F	E	D	S	A	V	Y	Y	C	A	R	G	
81	M	E	L	S	S	L	R	S	E	D	T	A	F	Y	F	C	A	G	G	Y
									*		*				*					
100	G	G	V	F	D	Y	W	G	Q	G	T	T	L	T	V	S	S			
101	G	I	Y	S	P	E	E	Y	N	G	G	L	V	T	V	S	S			
						*	*	*		*										

FIG. 1.

1	Q	I	V	L	T	Q	S	P	A	I	M	S	A	S	P	G	E	K	V	T
1	D	I	Q	M	T	Q	S	P	S	T	L	S	A	S	V	G	D	R	V	T
21	I	T	C	S	A	S	S	S	I		S	Y	M	H	W	F	Q	Q	K	P
21	I	T	C	R	A	S	O	S	I	N	T	W	L	A	W	Y	Q	Q	K	P
40	G	T	S	P	K	L	W	I	Y	T	T	S	N	L	A	S	G	V	P	A
41	G	K	A	P	K	L	L	M	Y	K	A	S	S	L	E	S	G	V	P	S
							*													*
60	R	F	S	G	S	G	S	G	T	S	Y	S	L	T	I	S	R	M	E	A
61	R	F	I	G	S	G	S	G	T	E	F	T	L	T	I	S	S	L	Q	P
			*																	
80	E	D	A	A	T	Y	Y	C	H	Q	R	S	T	Y	P	L	T	F	G	S
81	D	D	F	A	T	Y	Y	C	O	Q	Y	N	S	D	S	K	M	F	G	Q
100	G	T	K	L	E	L	K													
101	G	T	K	V	E	V	K													

FIG. 2.

10 20 30 40 50 60
 TCTAGATGGGATGGAGCTGGATCTTTCTTCTCCTCCTGTCAGGTACCGCGGGCGTGGACT
 M G W S W I F L F L L S G T A G V H
 70 80 90 100 110 120
 CTCAGGTCAGCTTGTCAGTCTGGGGCTGAAGTCAAGAACCTGGCTCGAGCGTGAAGG
 S Q V Q L V Q S G A E V K K P G S S V K
 130 140 150 160 170 180
 TCTCCTGCAAGGCTTCTGGCTACACCTTTACTAGCTACAGGATGCACTGGGTAAGGCAGG
 V S C K A S G Y T F T S Y R M H W V R Q
 190 200 210 220 230 240
 CCCCTGGACAGGCTCTGGAATGGATTGGATATATTAATCCGTCGACTGGGTATACTGAAT
 A P G Q G L E W I G Y I N P S T G Y T E
 250 260 270 280 290 300
 ACAATCAGAAGTTCAAGGACAAGGCAACAATTACTGCAGACGAATCCACCAATAAGGCT
 Y N Q K F K D K A T I T A D E S T N T A
 310 320 330 340 350 360
 ACATGGAAGTGAAGCAGCCTGAGATCTGAGGACACCGCAGTCTATTACTGTGCAAGAGGGG
 Y M E L S S L R S E D T A V Y Y C A R G
 370 380 390 400 410 420
 GGGGGTCTTTGACTACTGGGGCAAGGAACCTGGTCACAGTCTCCTCAGGTGAGTCCT
 G G V F D Y W G Q G T L V T V S S
 430
 TAAACCTCTAGA

FIG. 3.

10 20 30 40 50 60
 TCTAGATGGAGACGGATACCCCTCCTGCTATGGGTCCCTCCTGCTATGGGTCCAGGATCAA
 M E T D T L L L W V L L L W V P G S

70 80 90 100 110 120
 CCGGAGATATTCAGATGACCCAGTCTCCATCTACCCTCTCTGCTAGCGTCGGGGATAGGG
 T G D I Q M T Q S P S T L S A S V G D R

130 140 150 160 170 180
 TCACCATAACCTGCTCTGCCAGCTCAAGTATAAGTTACATGCACTGGTACCAGCAGAAGC
 V T I T C S A S S S I S Y M H W Y Q Q K

190 200 210 220 230 240
 CAGGCAAAGCTCCCAAGCTTCTAATTTATACCACATCCAACCTGGCTTCTGGAGTCCCTG
 P G K A P K L L I Y T T S N L A S G V P

250 260 270 280 290 300
 CTCGCTTCAGTGGCAGTGGATCTGGGACCGAGTTCACCCCTCACAATCAGCTCTCTGCAGC
 A R F S G S G S G T E F T L T I S S L Q

310 320 330 340 350 360
 CAGATGATTTCCGCCTTATTACTGCCATCAAAGGAGTACTTACCCACTCACGTTCCGGTC
 P D D F A T Y Y C H Q R S T Y P L T F G

370 380 390 400
 AGGGGACCAAGGTGGAGGTCAAACGTAAGTACACTTTTCTAGA
 Q G T K V E V K

FIG. 4.

A

HES12 AGCTTCTAGATGGGATGGAGCTGGATCTTTCTCTTCCTCCTGTCAGGTACCGC666CGTG
 CACTCTCAGGTCCAGCTTGTCCAGTCTGGGGCTGAAGTCAAAGAAACCTGGCTCGAGCGTG
 AAGGTC

HES13 CCCAGTCGACGGATTAATATA TCCAATCCATTCCAGACCCTGTCCAGGGGCTGCCTTAC
 CCAGTGCATCCTGTAGCTAGTAAAGGTGTAGCCAGAAGCCTTG CAGGAGACCTTCACGCT
 CGAGCCAGG

HES14 TATATTAATCCGTCGACTGGGTATACTGAATACAATCAGAAGTTCAAGGACAAGGCAACA
 ATTACTGCAGACGAATCCACCAATACAGCCTACATGGAAC TGAGCAGCCTGAGATCTGAG
 GACA

HES15 ATATCGTCTAGAGGTTTTAAGGACTCACCTGAGGAGACTGTGACCAGGGTTTCCTTGGCCC
 CAGTAGTCAAAGACCCCCCTCTTGCA CAGTAATAGACTGCGGTGTCTCAGATCTC
 AGGCTGCT

B

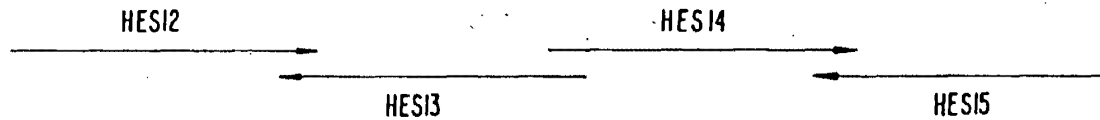

FIG. 5.

A

JFD1 CAAATCTAGATGGAGACCGATACCCTCCTGCTATGGGTCCTCCTGCTATGGGTCCCAGGA
TCAACCGGAGATATTCAGATGACCCAGTCTCCATCTACCCTCTCTGCTAGCGTCGGGGAT

JFD2 ATAAATTAGAAGCTTGGGAGCTTTGCCTGGCTTCTGCTGGTACCAAGTGCATGTAACCTTAT
ACTTGAGCTGGCAGAGCAGGTTATGGTGACCCTATCCCCGACGCTAGCAGAGAG

JFD3 GCTCCCAAGCTTCTAATTTATACCAATCCAACCTGGCTTCTGGAGTCCCTGCTCGCTTC
AGTGGCAGTGGATCTGGACCGAGTTCAACCTCACAATCAGCTCTCTGCAGCCAGATGAT
TTC

JFD4 TATACTAGAAAAGTGACTTACGTTTTGACCTCCACCTTGGTCCCCTGACCGAACGTGAG
TGGGTAAGTACTCCTTTGATGGCAGTAATAAGTGGCGAAATCATCTGGCTGCAGAGAGCT
GA

B

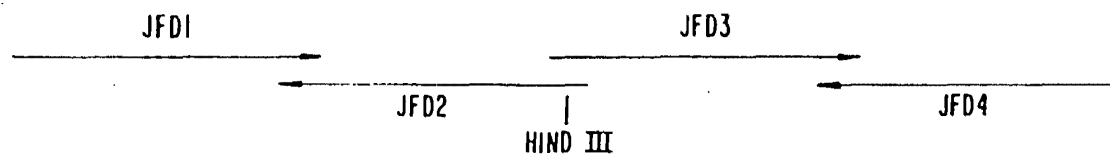

FIG._6.

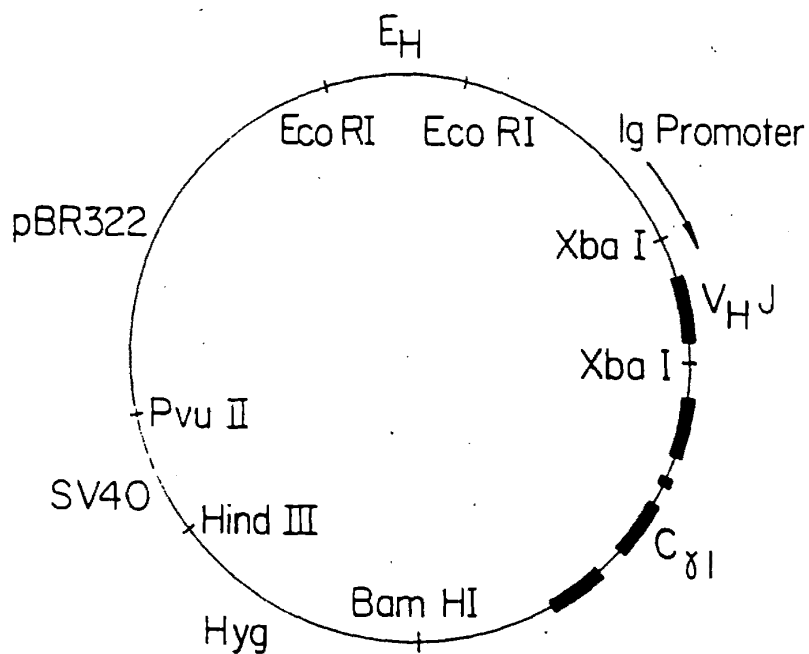

FIG. 7.

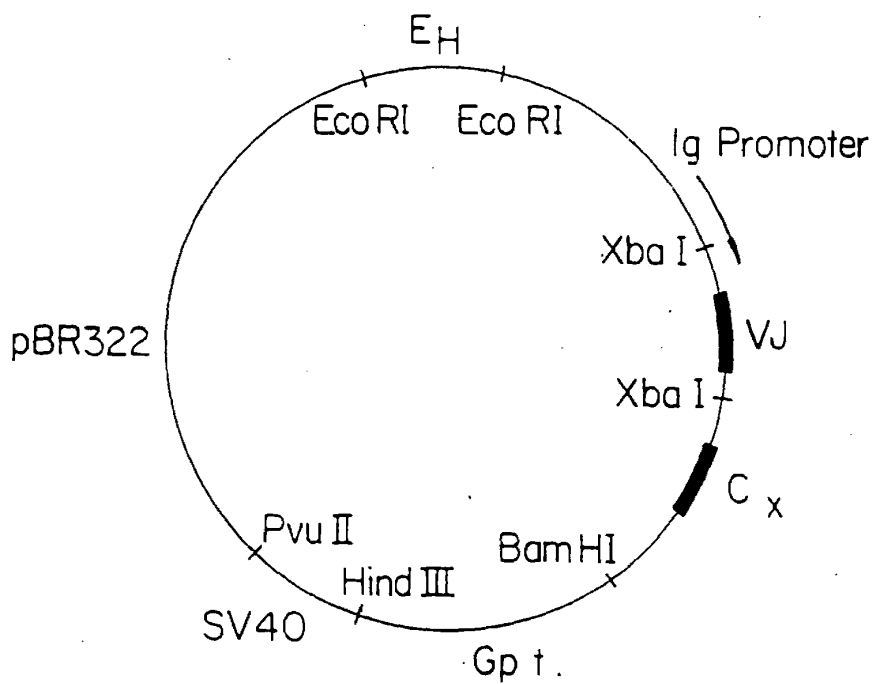

FIG. 8.

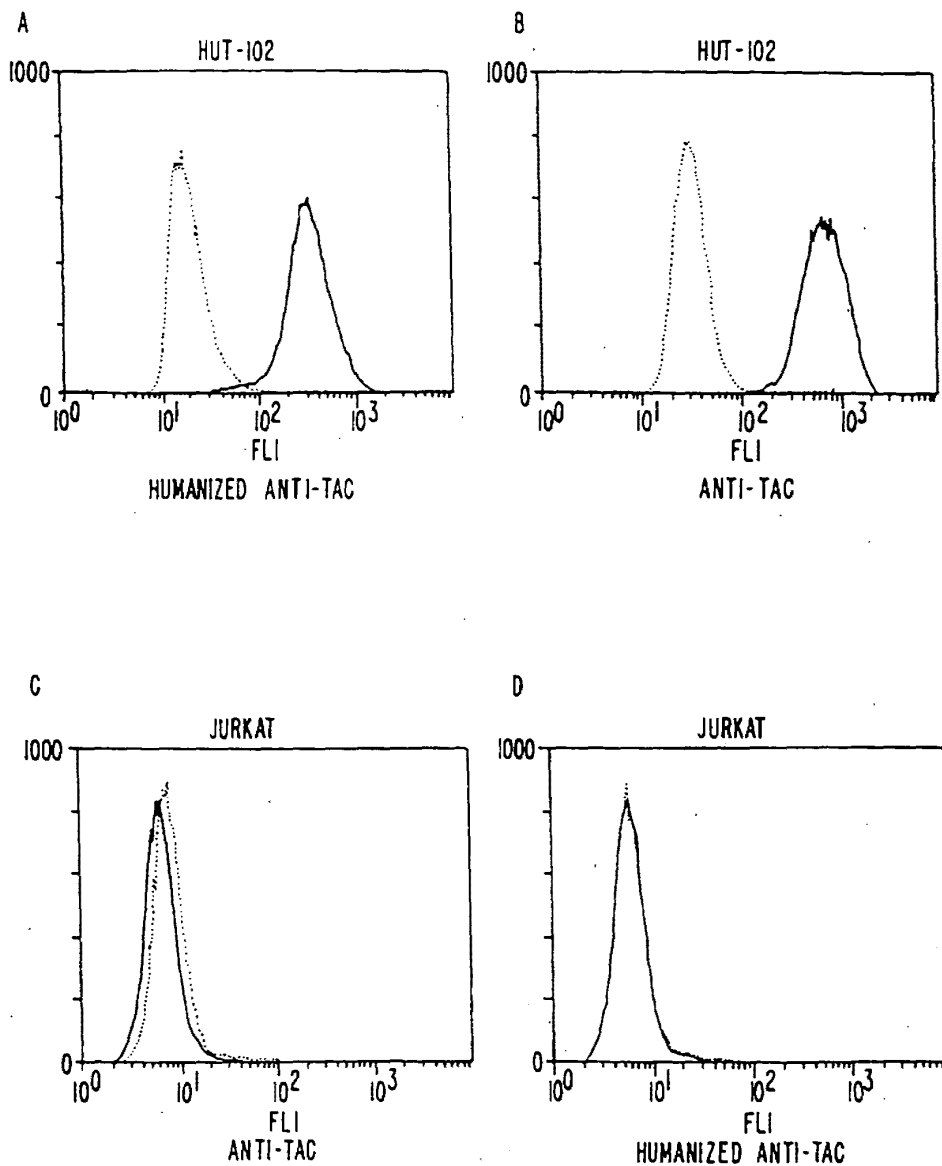

FIG. 9.

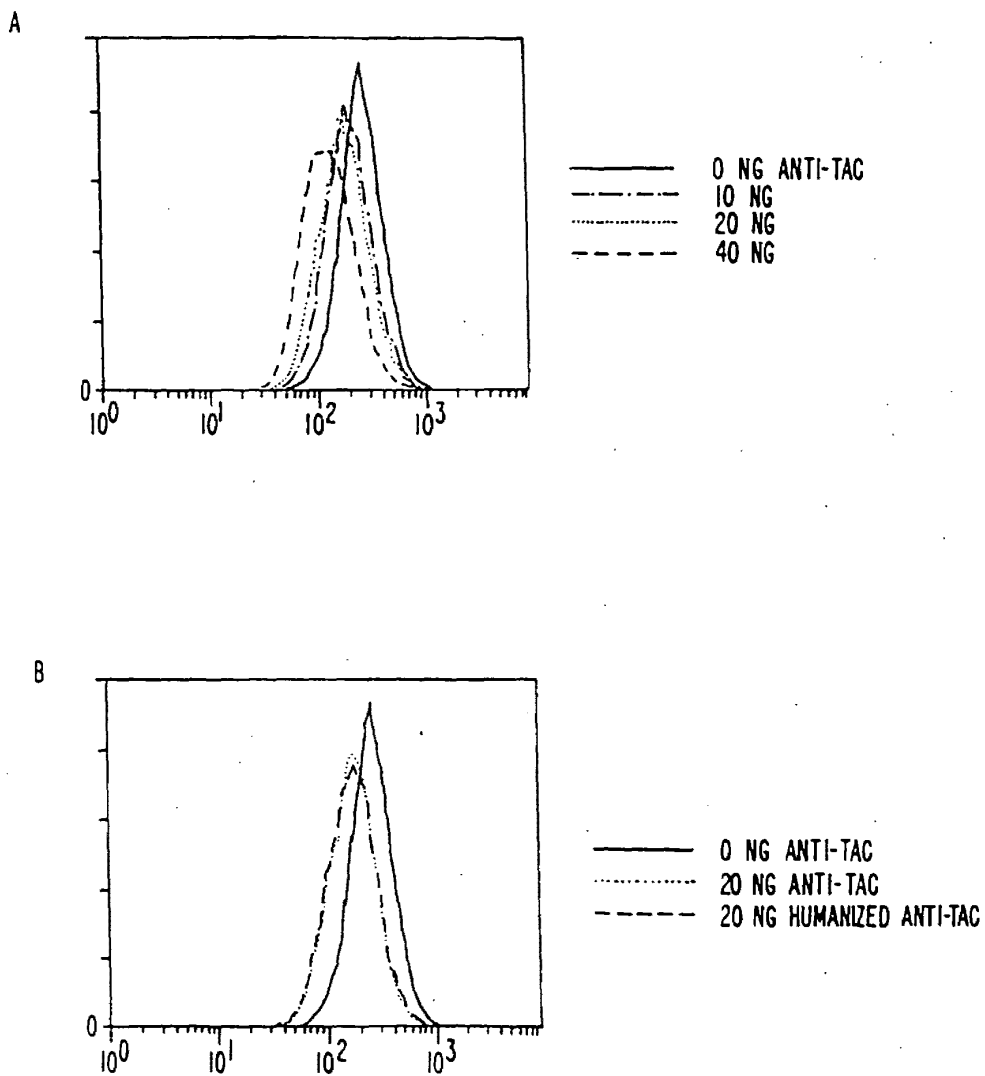

FIG. 10.



European Patent
Office

EUROPEAN SEARCH REPORT

Application Number
EP 95 10 5609

DOCUMENTS CONSIDERED TO BE RELEVANT			
Category	Citation of document with indication, where appropriate, of relevant passages	Relevant to claim	CLASSIFICATION OF THE APPLICATION (Int. Cl.5)
X,P	EP-A-0 328 404 (MEDICAL RESEARCH COUNCIL) 16 August 1989 * page 5-6; example 1 * * page 9, line 40 - line 55 * ---	3-8	C07K16/46 A61K39/395
X	NATURE, vol. 332, February 1988 LONDON GB, pages 323-327, RIECHMANN L. ET AL 'Reshaping human antibodies for therapy' * page 326, column 1 * ---	3-8	
T	PROCEEDINGS OF THE NATIONAL ACADEMY OF SCIENCES OF USA, vol. 86, December 1989 WASHINGTON US, pages 10029-10033, QUEEN C. ET AL 'A humanised antibody that binds to the interleukin 2 receptor' * the whole document * -----	1-8	
			TECHNICAL FIELDS SEARCHED (Int. Cl.5)
			C07K
The present search report has been drawn up for all claims			
Place of search	Date of completion of the search	Examiner	
THE HAGUE	31 August 1995	Fernandez y Branas, F	
CATEGORY OF CITED DOCUMENTS			
X : particularly relevant if taken alone Y : particularly relevant if combined with another document of the same category A : technological background O : non-written disclosure P : intermediate document		T : theory or principle underlying the invention E : earlier patent document, but published on, or after the filing date D : document cited in the application L : document cited for other reasons & : member of the same patent family, corresponding document	

EPO FORM 1502 (04/92) (P/OCI)



INTERNATIONAL APPLICATION PUBLISHED UNDER THE PATENT COOPERATION TREATY (PCT)

<p>(51) International Patent Classification⁴ : C07H 15/12, C12P 21/00 C12N 15/00, C07K 13/00</p>	<p>A1</p>	<p>(11) International Publication Number: WO 87/ 02671 (43) International Publication Date: 7 May 1987 (07.05.87)</p>
<p>(21) International Application Number: PCT/US86/02269 (22) International Filing Date: 27 October 1986 (27.10.86) (31) Priority Application Number: 793,980 (32) Priority Date: 1 November 1985 (01.11.85) (33) Priority Country: US (60) Parent Application or Grant (63) Related by Continuation US 793,980 (CIP) Filed on 1 November 1985 (01.11.85) (71) Applicant (for all designated States except US): INTERNATIONAL GENETIC ENGINEERING, INC. [US/US]; 1545 - 17th Street, Santa Monica, CA 90404 (US).</p>	<p>(72) Inventors; and (75) Inventors/Applicants (for US only) : ROBINSON, Randy, R. [US/US]; 5606 W. 79th Street, Los Angeles, CA 90045 (US). LIU, Alvin, Y. [US/US]; 807 - 8th Street, Apt. 6, Santa Monica, CA 90403 (US). HORWITZ, Arnold, H. [US/US]; 7529 Midfield Avenue, Los Angeles, CA 90045 (US). WALL, Randolph [US/US]; 5106 Van Noord, Sherman Oaks, CA 91423 (US). (74) Agents: GOLDSTEIN, Jorge, A. et al.; Saidman, Sterne, Kessler & Goldstein, 1225 Connecticut Ave., Suite 300, Washington, DC 20036 (US). (81) Designated States: AT (European patent), AU, BE (European patent), CH (European patent), DE (European patent), DK, FI, FR (European patent), GB (European patent), IT (European patent), JP, KR, LU (European patent), NL (European patent), NO, SE (European patent), SU, US. Published With international search report.</p>	

(54) Title: MODULAR ASSEMBLY OF ANTIBODY GENES, ANTIBODIES PREPARED THEREBY AND USE

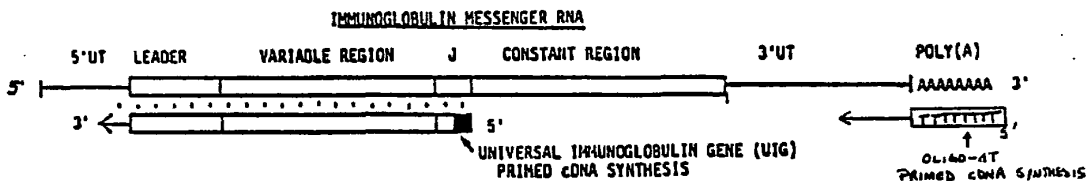

(57) Abstract

Chimeric immunoglobulin molecules are produced by cloning cDNA sequences encoding human constant regions together with non-human variable regions.

FOR THE PURPOSES OF INFORMATION ONLY

Codes used to identify States party to the PCT on the front pages of pamphlets publishing international applications under the PCT.

AT	Austria	FR	France	ML	Mali
AU	Australia	GA	Gabon	MR	Mauritania
BB	Barbados	GB	United Kingdom	MW	Malawi
BE	Belgium	HU	Hungary	NL	Netherlands
BG	Bulgaria	IT	Italy	NO	Norway
BJ	Benin	JP	Japan	RO	Romania
BR	Brazil	KP	Democratic People's Republic of Korea	SD	Sudan
CF	Central African Republic	KR	Republic of Korea	SE	Sweden
CG	Congo	LI	Liechtenstein	SN	Senegal
CH	Switzerland	LK	Sri Lanka	SU	Soviet Union
CM	Cameroon	LU	Luxembourg	TD	Chad
DE	Germany, Federal Republic of	MC	Monaco	TG	Togo
DK	Denmark	MG	Madagascar	US	United States of America
FI	Finland				

-1-

TITLE OF THE INVENTION

**MODULAR ASSEMBLY OF ANTIBODY GENES,
ANTIBODIES PREPARED THEREBY AND USE**

BACKGROUND OF THE INVENTION

This application is a continuation in part of Application Serial No. 793,980, filed November 1, 1985, the contents of which are herein fully incorporated by reference.

Field of the Invention

This invention relates to recombinant DNA methods of preparing immunoglobulins, genetic sequences coding therefor, as well as methods of obtaining such sequences.

Background Art

The application of cell-to-cell fusion for the production of monoclonal antibodies by Kohler and Milstein (Nature (London), 256: 495, 1975) has spawned a revolution in biology equal in impact to the invention of recombinant DNA cloning. Hybridoma-produced monoclonal antibodies are already widely used in clin-

-2-

ical diagnoses and basic scientific studies. Applications of human B cell hybridoma-produced monoclonal antibodies hold great promise for the clinical treatment of cancer, viral and microbial infections, B cell immunodeficiencies with diminished antibody production, and other diseases and disorders of the immune system.

Unfortunately, yields of monoclonal antibodies from human hybridoma cell lines are relatively low (1 ug/ml in human x human compared to 100 ug/ml in mouse hybridomas), and production costs are high for antibodies made in large scale human tissue culture. Mouse x mouse hybridomas, on the other hand, are useful because they produce abundant amounts of protein, and these cell lines are more stable than the human lines. However, repeated injections of "foreign" antibodies, such as a mouse antibody, in humans, can lead to harmful hypersensitivity reactions.

There has therefore been recent exploration of the possibility of producing antibodies having the advantages of monoclonals from mouse-mouse hybridomas, yet the species specific properties of human monoclonal antibodies.

Another problem faced by immunologists is that most human monoclonal antibodies (i.e., antibodies having human recognition properties) obtained in cell culture are of the IgM type. When it is desirable to obtain human monoclonals of the IgG type, however, it has been necessary to use such techniques as cell sorting, to separate the few cells which have switched to producing antibodies of the IgG or other type from the majority producing antibodies of the IgM type. A

-3-

need therefore exists for a more ready method of switching antibody classes, for any given antibody of a predetermined or desired antigenic specificity.

The present invention bridges both the hybridoma and monoclonal antibody technologies and provides a quick and efficient method, as well as products derived therefrom, for the improved production of chimeric human/non-human antibodies, or of "class switched" antibodies.

INFORMATION DISCLOSURE STATEMENT*

Approaches to the problem of producing chimeric antibodies have been published by various authors.

Morrison, S. L. et al., Proc. Natl. Acad. Sci., USA, 81: 6851-6855 (November 1984), describe the production of a mouse-human antibody molecule of defined antigen binding specificity, produced by joining the variable region genes of a mouse antibody-producing myeloma cell line with known antigen binding specificity to human immunoglobulin constant region genes using recombinant DNA techniques. Chimeric genes were constructed, wherein the heavy chain variable region exon from the myeloma cell line S107 well joined to human IgG1 or IgG2 heavy chain constant region exons, and the light chain variable region exon from the same myeloma to the human kappa light chain exon. These genes were transfected into mouse myeloma cell lines

* Note: The present Information Disclosure Statement is subject to the provisions of 37 C.F.R. 1.97(b). In addition, Applicants reserve the right to demonstrate that their invention was made prior to any one or more of the mentioned publications.

-4-

and. Transformed cells producing chimeric mouse-human antiphosphocholine antibodies were thus developed.

Morrison, S. L. et al., European Patent Publication No. 173494 (published March 5, 1986), disclose chimeric "receptors" (e.g. antibodies) having variable regions derived from one species and constant regions derived from another. Mention is made of utilizing cDNA cloning to construct the genes, although no details of cDNA cloning or priming are shown. (see pp 5, 7 and 8).

Boulianne, G. L. et al., Nature, 312: 643 (December 13, 1984), also produced antibodies consisting of mouse variable regions joined to human constant regions. They constructed immunoglobulin genes in which the DNA segments encoding mouse variable regions specific for the hapten trinitrophenyl (TNP) were joined to segments encoding human mu and kappa constant regions. These chimeric genes were expressed as functional TNP binding chimeric IgM.

For a commentary on the work of Boulianne et al. and Morrison et al., see Munro, Nature, 312: 597 (December 13, 1984), Dickson, Genetic Engineering News, 5, No. 3 (March 1985), or Marx, Science, 229: 455 (August 1985).

Neuberger, M. S. et al., Nature, 314: 268 (March 25, 1985), also constructed a chimeric heavy chain immunoglobulin gene in which a DNA segment encoding a mouse variable region specific for the hapten 4-hydroxy-3-nitrophenacetyl (NP) was joined to a segment encoding the human epsilon region. When this chimeric gene was transfected into the J558L cell line, an antibody was produced which bound to the NP hapten and had human IgE properties.

-5-

Neuberger, M.S. et al., have also published work showing the preparation of cell lines that secrete hapten-specific antibodies in which the Fc portion has been replaced either with an active enzyme moiety (Williams, G. and Neuberger, M.S. Gene 43:319, 1986) or with a polypeptide displaying c-myc antigenic determinants. (Nature, 312:604, 1984).

Neuberger, M. et al., PCT Publication WO 86/01533, (published March 13, 1986) also disclose production of chimeric antibodies (see p. 5) and suggests, among the technique's many uses the concept of "class switching" (see p. 6).

Taniguchi, M., in European Patent Publication No. 171 496 (published February 19, 1985) discloses the production of chimeric antibodies having variable regions with tumor specificity derived from experimental animals, and constant regions derived from human. The corresponding heavy and light chain genes are produced in the genomic form, and expressed in mammalian cells.

Takeda, S. et al., Nature, 314: 452 (April 4, 1985) have described a potential method for the construction of chimeric immunoglobulin genes which have intron sequences removed by the use of a retrovirus vector. However, an unexpected splice donor site caused the deletion of the V region leader sequence. Thus, this approach did not yield complete chimeric antibody molecules.

Cabilly, S. et al., Proc. Natl. Acad. Sci., USA, 81: 3273-3277 (June 1984), describe plasmids that direct the synthesis in E. coli of heavy chains and/or light chains of anti-carcinoembryonic antigen (CEA)

-6-

antibody. Another plasmid was constructed for expression of a truncated form of heavy chain (Fd') fragment in E. coli. Functional CEA-binding activity was obtained by in vitro reconstitution, in E. coli extracts, of a portion of the heavy chain with light chain.

Cabilly, S., et al., European Patent Publication 125023 (published November 14, 1984) describes chimeric immunoglobulin genes and their presumptive products as well as other modified forms. On pages 21, 28 and 33 it discusses cDNA cloning and priming.

Boss, M. A., European Patent Application 120694 (published October 3, 1984) shows expression in E. coli of non-chimeric immunoglobulin chains with 4-nitrophenyl specificity. There is a broad description of chimeric antibodies but no details (see p. 9).

Wood, C. R. et al., Nature, 314: 446 (April, 1985) describe plasmids that direct the synthesis of mouse anti-NP antibody proteins in yeast. Heavy chain mu antibody proteins appeared to be glycosylated in the yeast cells. When both heavy and light chains were synthesized in the same cell, some of the protein was assembled into functional antibody molecules, as detected by anti-NP binding activity in soluble protein prepared from yeast cells.

Alexander, A. et al., Proc. Nat. Acad. Sci. USA, 79: 3260-3264 (1982), describe the preparation of a cDNA sequence coding for an abnormally short human Ig gamma heavy chain (OMM gamma³ HCD serum protein) containing a 19- amino acid leader followed by the first 15 residues of the V region. An extensive internal deletion removes the remainder of the V and the entire C_H1 domain. This is cDNA coding for an internally deleted molecule.

-7-

Dolby, T. W. et al., Proc. Natl. Acad. Sci., USA, 77: 6027-6031 (1980), describe the preparation of a cDNA sequence and recombinant plasmids containing the same coding for mu and kappa human immunoglobulin polypeptides. One of the recombinant DNA molecules contained codons for part of the CH₃ constant region domain and the entire 3' noncoding sequence.

Seno, M. et al., Nucleic Acids Research, 11: 719-726 (1983), describe the preparation of a cDNA sequence and recombinant plasmids containing the same coding for part of the variable region and all of the constant region of the human IgE heavy chain (epsilon chain).

Kurokawa, T. et al., ibid, 11: 3077-3085 (1983), show the construction, using cDNA, of three expression plasmids coding for the constant portion of the human IgE heavy chain.

Liu, F. T. et al., Proc. Nat. Acad. Sci., USA, 81: 5369-5373 (September 1984), describe the preparation of a cDNA sequence and recombinant plasmids containing the same encoding about two-thirds of the CH₂, and all of the C_{H3} and C_{H4} domains of human IgE heavy chain.

Tsujimoto, Y. et al., Nucleic Acids Res., 12: 8407-8414 (November 1984), describe the preparation of a human V lambda cDNA sequence from an Ig lambda-producing human Burkitt lymphoma cell line, by taking advantage of a cloned constant region gene as a primer for cDNA synthesis.

Murphy, J., PCT Publication WO 83/03971 (published November 24, 1983) discloses hybrid proteins made of fragments comprising a toxin and a cell-specific ligand (which is suggested as possibly being an antibody).

-8-

Tan, et al., J. Immunol. 135:8564 (November, 1985), obtained expression of a chimeric human-mouse immunoglobulin genomic gene after transfection into mouse myeloma cells.

Jones, P. T., et al., Nature 321:552 (May 1986) constructed and expressed a genomic construct where CDR domains of variable regions from a mouse monoclonal antibody were used to substitute for the corresponding domains in a human antibody.

Sun, L.K., et al., Hybridoma 5 suppl. 1 S17 (1986), describes a chimeric human/mouse antibody with potential tumor specificity. The chimeric heavy and light chain genes are genomic constructs and expressed in mammalian cells.

Sahagan et al., J. Immun. 137:1066-1074 (August 1986) describe a chimeric antibody with specificity to a human tumor associated antigen, the genes for which are assembled from genomic sequences.

For a recent review of the field see also Morrison, S.L., Science 229: 1202-1207 (September 20, 1985) and Oi, V. T., et al., BioTechniques 4:214 (1986).

The Oi, et al., paper is relevant as it argues that the production of chimeric antibodies from cDNA constructs in yeast and/or bacteria is not necessarily advantageous.

See also Commentary on page 835 in Biotechnology 4 (1986).

SUMMARY OF THE INVENTION

The invention provides a novel approach for producing genetically engineered antibodies of desired variable region specificity and constant region properties through gene cloning and expression of light and heavy chains. The cloned immunoglobulin gene products can be produced by expression in genetically engineered organisms.

The application of chemical gene synthesis, recombinant DNA cloning, and production of specific immunoglobulin chains in various organisms provides an effective solution for the efficient large scale production of human monoclonal antibodies with the antigen specificities of either human or non-human, especially rodent, monoclonal antibodies. The invention also provides a solution to the problem of class switching antibody molecules, so as to readily prepare immunoglobulins of a certain binding specificity of any given class.

The invention provides cDNA sequences coding for immunoglobulin chains comprising a constant human region and a variable, either human or non-human, region. The immunoglobulin chains can either be heavy or light.

The invention also provides gene sequences coding for immunoglobulin chains comprising a cDNA variable region of either human or non-human origin and a genomic constant region of human origin.

The invention also provides sequences as above, present in recombinant DNA molecules, especially in vehicles such as plasmid vectors, capable of expression in desired prokaryotic or eukaryotic hosts.

The invention also provides consensus sequences and specific oligonucleotide sequences useful as probes for hybridization and priming cDNA synthesis of any hybridoma mRNA coding for variable regions of any desired specificity.

The invention provides hosts capable of producing, by culture, chimeric antibodies and methods of using these hosts.

-10-

The invention also provides chimeric immunoglobulin individual chains and whole assembled molecules having human constant regions and non-human variable regions, wherein both variable regions have the same binding specificity.

Among other immunoglobulin chains and/or molecules provided by the invention are:

- (a) a complete functional, immunoglobulin molecule comprising:
 - (i) two identical chimeric heavy chains comprising a non-human variable region and human constant region and
 - (ii) two identical all (i.e. non-chimeric) human light chains.
- (b) a complete, functional, immunoglobulin molecule comprising:
 - (i) two identical chimeric heavy chains comprising a non-human variable region and a human constant region, and
 - (ii) two identical all (i.e. non-chimeric) non-human light chains.
- (c) a monovalent antibody, i.e., a complete, functional immunoglobulin molecule comprising:
 - (i) two identical chimeric heavy chains comprising a non-human variable region and a human constant region, and
 - (ii) two different light chains, only one of which has the same specificity as the variable region of the heavy chains. The resulting antibody molecule binds only to one end thereof and is therefore incapable of divalent binding;

-11-

(d) an antibody with two different specificities, i.e., a complete, functional immunoglobulin molecule comprising:

- (i) two different chimeric heavy chains, the first one of which comprises a non-human variable region and a human constant region and the second comprises a different non-human variable region, and a human constant region, and
- (ii) two different chimeric light chains, the first one of which comprises a non-human variable region having the same specificity as the first heavy chain variable region, and a human constant region, and the second comprises a non-human variable region having the same specificity as the second heavy chain variable region, and a human constant region.

The resulting antibody molecule binds to two different antigens.

Genetic sequences, especially cDNA sequences, coding for the aforementioned combinations of chimeric chains or of non-chimeric chains are also provided herein.

The invention also provides for a genetic sequence, especially a cDNA sequence, coding for the variable region of an antibody molecule heavy and/or light chain, operably linked to a sequence coding for a polypeptide different than an immunoglobulin chain (e.g., an enzyme). These sequences can be assembled by the methods of the invention, and expressed to yield mixed-function molecules.

-12-

The use of cDNA sequences is particularly advantageous over genomic sequences (which contain introns), in that cDNA sequences can be expressed in bacteria or other hosts which lack RNA splicing systems.

Among preferred specific antibodies are those having specificities to cancer-related antigens.

BRIEF DESCRIPTION OF THE FIGURES

FIGURE 1 shows the DNA rearrangements and the expression of immunoglobulin mu and gamma heavy chain genes. This is a schematic representation of the human heavy chain gene complex, not shown to scale. Heavy chain variable V region formation occurs through the joining of V_H , D and J_H gene segments. This generates an active mu gene. A different kind of DNA rearrangement called "class switching" relocates the joined V_H , D and J_H region from the mu constant C region to another heavy chain C region (switching to gamma is diagrammed here). The scheme emphasizes that the J region is a common feature of all expressed heavy chain genes. The J region is also a common feature of expressed light chain genes.

FIGURE 2 shows the known nucleotide sequences of human and mouse J regions. Consensus sequences for the J regions are shown below the actual sequences. The oligonucleotide sequence below the mouse kappa J region consensus sequence is a Universal Immunoglobulin Gene (UIG) oligonucleotide which is used in the present invention.

-13-

FIGURE 3 shows a scheme noting the use of the UIG oligonucleotide primer for the synthesis of cDNA complementary to the variable region of immunoglobulin messenger RNA, or the use of oligo-dT as a primer for cDNA synthesis, followed by in vitro mutagenesis.

FIGURE 4 shows the synthesis and analysis of human IgG1 genes, including three isolated clones (A.b), one of which (pGMH-6) is utilized as a cloning vector (B). A 1.5 kb deletion of pBR322 sequence between Bam HI and PvuII is marked. Not to scale.

FIGURE 5 shows the cloning vector pQ23, a modified pBR322, useful for cDNA cloning at the KpnI site. This vector also contains the useful restriction enzyme sites BglIII plus SalI. Not to scale.

FIGURE 6 shows in A. the synthesis and analysis of human light chain kappa genes. The Figure also shows in B. (not to scale) construction of a human C_K region cloning vector pING2001.

FIGURE 7 shows primers designed for immunoglobulin V region synthesis. (A) shows the heavy chain J-C regions and primers. A DNA version of each mouse J heavy region is shown directly above primers designed from that sequence. Mouse J regions are 5' to 3', left to right, while primers are 3' to 5', left to right. Primer names are included in brackets, and numbers of nucleotides (N) and number of mismatches with each J_H region are listed to the right. Primers which introduce a BstEII site are underlined. (B) shows the light chain J regions and primers. The same as for (A) except for light chains. Primers designed to introduce a BglIII site are underlined, as is the BclI site present in pING2016E. (C) shows mouse vari-

-14-

able region consensus UIG primers. The actual primer sequence is shown below that consensus sequence. The human C_K HindIII vector pGML60 is shown below. (D) shows a mouse gamma 2a J/C junction primer.

FIGURE 8 shows the synthesis of heavy chain V region module genes using oligonucleotide primed cDNA synthesis. Not to scale.

FIGURE 9 shows the construction of hybrid mouse-human immunoglobulin genes. Panel A shows construction of a heavy chain gene. Stippled regions show C region modules, while hatched or black regions show V region modules. Not to scale.

FIGURE 10 shows the construction of cDNA cloning-expression shuttle vectors for mammalian cells. The vectors pING2003 and pING2003E are derived from pL1, pUC12, pSV2-neo and M8-alphaRX12. Stippled regions indicate mouse heavy chain enhancer DNA, hatched regions indicate SV-40 DNA from pL1, and cross-hatched regions indicate SV-40 DNA from pSV2-neo. In the vectors pING2003 and pING2003E, thick lines represent pBR322 DNA from pSV2-neo, while thin lines represent pUC12 DNA. Arrows indicate the locations and directions of SV-40 early region promoters, and indicates a complete SV-40 intron sequence. Not to scale.

FIGURE 11 shows the construction of the heavy chain expression plasmid pING2006E. Arrows show SV-40 promoter locations and directions of transcription. Hatched and black areas show mouse V region modules, while stippled areas show human C region modules. Not to scale.

-15-

FIGURE 12 shows the structure of the chimeric anti-hepatitis heavy chain genes in the expression plasmids pING2006E and pING2012E. Panel A shows the structure of mouse-human chimeric anti-hepatitis heavy chain genes. The structure of human IgG1 mRNA and cDNA is shown in A.a. The human heavy chain constant region cDNA clone pGMH-6 and the mouse heavy chain variable region cDNA clones pBS13-1 and pJ3-11 were used to make the hybrid gene used in pING2006E. Hatched gene blocks indicate mouse variable region sequences, while open gene blocks show human IgG1 constant region sequences. Panel B shows the nucleotide sequence of the anti-hepatitis B heavy chain variable region in pING2006E and pING2012E. pING2012E was constructed by first inserting a BglII site at the SalI site of pING1202 (See Figure 16) to form pING1202BglII. The chimeric heavy chain gene from this plasmid was inserted into the expression vector pING2003E, resulting in pING2012E. pING2012E differs from pING 2006E in the region immediately upstream of the initiator ATG. Underlined nucleotides denote human J region sequences from the cDNA clone pGMH-6. Asterisked amino acid 117 indicates a single change at this site from mouse to human sequence (Ala to Ser) introduced in the chimeric gene J region. Sequencing was by the Sanger method on plasmid (open circle) and M13 (closed circle) templates.

FIGURE 13 shows in panel A the J-C junction region nucleotide sequence in light chain clones derived from pING2001 (pMACK-3, pING2013E, pING2007E, pING2010E-gpt and pING2014E-gpt). The J region sequence originating from pK2-3 is marked human JK4. The G nucleotide

-16-

not predicted by genomic sequencing is marked with an asterisk. The oligonucleotide primer (K2-4BCLI) used to modify this sequence is shown below the human JK4 sequence. Panel B diagrams the method of site-directed mutagenesis used to make pING2016E-gpt. Not to scale.

FIGURE 14 Gene copy number of the transfected sequences in two transformants. nDNA from 2AE9, 2BH10 were digested with the enzymes indicated. The concentration of DNA is titrated down across the lanes with the amount indicated above them. The probe contains human C gamma 1 sequences (pmvHc24 ApaI-BamHI). The reference is germ-line or GM2146 nDNA digested with ApaI. The 3' ApaI site is 2 bp beyond the site of poly(A) addition (3).

FIGURE 15 shows the nucleotide sequence of the V region of the L6 V_H cDNA clone pH3-6a. The sequence was determined by the dideoxytermination method using M13 subclones of gene fragments (shown below). Open circles denote amino acid residues confirmed by peptide sequence. A sequence homologous to D_{Sp.2} in the CDR3 region is underlined.

FIGURE 16 shows the nucleotide sequence of the V region of the L6 V_K cDNA clone pL3-12a. The oligonucleotide primer used for site-directed mutagenesis is shown below the J_K5 segment. Open circles denote amino acid residues confirmed by peptide sequence.

FIGURE 17 shows the construction of chimeric L6-V_H plus human C gamma 1 expression plasmids. Panel (a) shows the sequences of the BAL-31 deletion clones M13mpl9-C1-delta 4 (C1-delta 4) and M13mpl9-C1-delta 21 (C1-delta 21). The 5' end of the cDNA clone,

-17-

pH3-6a, is denoted with an arrow. M13 sequences are underlined. The oligonucleotide primer used for this experiment is H3-6a (5'- GACTGCACCAACTGG-3'), which primes in FRI near the mature N terminus. Panel (b) shows the strategy for site-directed mutagenesis of 1 μ g of clones Cl-delta 4 and Cl-delta 21, each annealed to 20 ng of the 31-mer oligonucleotide MJH2-ApaI. Complementary strand synthesis with the Klenow fragment of DNA polymerase was at room temperature for 30 min, then 15°C for 72 hours. Transfected phage plaques were adsorbed to nitrocellulose, fixed with NaOH, and hybridized to ³²P-labelled MJH2-ApaI oligonucleotide at 65°C, 18 hours, in 4xTBS (0.6 M NaCl, 0.04 M Tris-HCl (pH 7.4), 0.004 M EDTA) plus 10% dextran sulfate. Final wash of the filters was at 65°C, 4xSSPE, 0.1% SDS for 15 min. (Maniatis, T., et al., Molecular Cloning: A Laboratory Manual, 1982). Positive plaques were detected by overnight exposure to Kodak XAR film, and were directly picked for growth and restriction enzyme analysis of RF DNA. Mismatches of the MJH2-ApaI oligonucleotide to the mouse C_H1 are denoted, resulting in the coding changes shown below the oligonucleotide. Panel (c) shows the strategy of the substitution of each of the mutagenized L6-V_H modules for the resident V_H of the chimeric expression plasmid pING2012 to generate pING2111 and pING2112.

FIGURE 18 shows the construction of the chimeric L6 expression plasmid pING2119. The SalI to BamHI fragment from pING2100 is identical to the SalI to BamHI A fragment from pING2012E.

FIGURE 19 shows the modification of the V_K gene and its use in constructing light chain and heavy plus light chain expression plasmids.

-18-

(a) Deletion of the oligo d[GC] segment 5' of V_K of L6. The oligonucleotide is a 22-mer and contains a SalI site. The 3 mismatches are shown. The V_K gene, after mutagenesis, is joined as a SalI-HindIII fragment to the human C K module. The expression plasmid thus formed is pING2119.

(b) pING2114, a heavy plus light chain expression plasmid. The expression plasmid pING2114 contains the L6 heavy chain chimeric gene from pING2111 and the chimeric light chain from pING2119 (bold line).

FIGURE 20 shows a summary of the sequence alterations made in the construction of the L6 chimeric antibody expression plasmids. Residues underlined in the 5' untranslated region are derived from the cloned mouse kappa and heavy-chain genes. Residues circled in the V/C boundary result from mutagenesis operations to engineer restriction enzyme sites in this region. Residues denoted by small circles above them in the L6 heavy-chain chimera also result from mutagenesis. They are silent changes.

FIGURE 21 shows the 2H7 V_H sequence. The V_H gene contains J_H1 sequences and DSP.2 sequence elements. Small circles above the amino acid residues are those that matched to peptide sequences.

FIGURE 22 shows the 2H7 V_L sequence. The V_K gene contains J_K5 sequences. A 22-mer oligonucleotide was used to place a SalI site 5' of the ATG initiator codon. Small circles above the amino acid residues are those that matched to peptide sequences.

-19-

FIGURE 23 shows the chimeric immunoglobulin gene expression plasmids of the 2H7 specificity. One gene plasmids are pING2101 (V_H ,neo), pING2106 (V_K ,neo) and pING2107 (V_K ,gpt). The others are two-gene plasmids. Their construction involved the ligation of the larger NdeI fragments of pING2101 and pING2107 to linearized pING2106 partially digested with NdeI. pHL2-11 and pHL2-26 were obtained from pING2101 and pING2106; pLL2-25 was obtained from pING2107 and pING2106.

FIGURE 24 shows a summary of the nucleotide changes introduced in the V_H and V_K in the construction of the chimeric plasmids. The cognate V_H and V_K nucleotide residues in the 5' end are underlined. Circles residues in the J-C junctions are derived from the human C modules.

DESCRIPTION OF THE PREFERRED EMBODIMENTS

INTRODUCTION

Generally, antibodies are composed of two light and two heavy chain molecules. Light and heavy chains are divided into domains of structural and functional homology. The variable regions of both light (V_L) and heavy (V_H) chains determine recognition and specificity. The constant region domains of light (C_L) and heavy (C_H) chains confer important biological properties such as antibody chain association, secretion, transplacental mobility, complement binding, and the like.

A complex series of events leads to immunoglobulin gene expression in B cells. The V region gene sequences conferring antigen specificity and binding are located in separate germ line gene segments called V_H , D and J_H ; or V_L and J_L . These gene segments are joined by DNA rearrangements to form the complete V

-20-

regions expressed in heavy and light chains respectively (Figure 1). The rearranged, joined (V_L - J_L and V_H - D - J_H) V segments then encode the complete variable regions or antigen binding domains of light and heavy chains, respectively.

DEFINITIONS

Certain terms and phrases are used throughout the specification and claims. The following definitions are provided for purposes of clarity and consistency.

1. Expression vector - a plasmid DNA containing necessary regulatory signals for the synthesis of mRNA derived from gene sequences, which can be inserted into the vector.
2. Module vector - a plasmid DNA containing a constant or variable region gene module.
3. Expression plasmid - an expression vector that contains an inserted gene, such as a chimeric immunoglobulin gene.
4. Gene cloning - synthesis of a gene, insertion into DNA vectors, and identification by hybridization and the like.
5. Transfection - the transfer of DNA into mammalian cells.

GENETIC PROCESSES AND PRODUCTS

The invention provides a novel approach for the cloning and production of human antibodies with desired specificity. Generally, the method combines five elements:

- (1) Isolation of messenger RNA (mRNA) from B cell hybridoma lines producing monoclonal anti-

-21-

- bodies against specific antigens, cloning and cDNA production therefrom;
- (2) Preparation of Universal Immunoglobulin Gene (UIG) oligonucleotides, useful as primers and/or probes for cloning of the variable region gene segments in the light and heavy chain mRNA from specific human or non-human hybridoma cell lines, and cDNA production therefrom;
 - (3) Preparation of constant region gene segment modules by cDNA preparation and cloning, or genomic gene preparation and cloning;
 - (4) Construction of complete heavy or light chain coding sequences by linkage of the cloned specific immunoglobulin variable region gene segments of part (2) above to cloned human constant region gene segment modules;
 - (5) Expression and production of light and heavy chains in selected hosts, including prokaryotic and eukaryotic hosts, either in separate fermentations followed by assembly of antibody molecules in vitro, or through production of both chains in the same cell.

The invention employs cloned hybridoma B cell lines producing monoclonal antibodies of defined specificity for the isolation of mRNA for cDNA cloning. Because many lymphoid cell lines contain highly active nucleases which degrade mRNA during isolation, the invention uses mRNA preparation methods specifically developed for the isolation of intact mRNA from cells and tissues containing active nucleases. One such method yields total RNA preparations by cell or tissue

-22-

disruption in an ethanol-perchlorate dry ice mixture which reduces nuclease action (Lizardi, P. M. et al., Anal. Biochem., 98: 116 (1979)). This method gives intact translatable mRNA.

Other methods that have been used for this invention include extraction of cells with lithium chloride plus urea (Auffray, C., and Rougeon, F., Eur. J. Biochem., 107: 303 (1980)) or guanidine thiocyanate (Chirgwin, J. M. et al., Biochemistry, 18: 5294 (1979)) to prepare total RNA.

One universal feature of all expressed immunoglobulin light and heavy chain genes and messenger RNAs is the so-called J region (i.e. joining region, see Figure 1). Heavy and light chain J regions have different sequences, but a high degree of sequence homology exists (greater than 80%) within the heavy J_H regions or the kappa light chain J regions. The invention provides consensus sequences of light and heavy chain J regions useful in the design of oligonucleotides (designated herein as UIGs) for use as primers or probes for cloning immunoglobulin light or heavy chain mRNAs or genes (Figures 2 or 7). Depending on the nature of design of a particular UIG, it may be capable of hybridizing to all immunoglobulin mRNAs or genes containing a single specific J sequence, such as UIG-MJH3 which detects only mouse J_H 3 sequences (Figure 7).

Another utility of a particular UIG probe may be hybridization to light chain or heavy chain mRNAs of a specific constant region, such as UIG-MJK which detects all mouse J_K containing sequences (Figure 7). UIG design can also include a sequence to introduce a

-23-

restriction enzyme site into the cDNA copy of an immunoglobulin gene (see Figure 7). The invention may, for example, utilize chemical gene synthesis to generate the UIG probes for the cloning of V regions in immunoglobulin mRNA from hybridoma cells making monoclonal antibodies of desired antigen specificities.

A multi-stage procedure is utilized for generating complete V+C region cDNA clones from hybridoma cell light and heavy chain mRNAs. In the first stage, the invention utilizes UIG probes as "primers" for reverse transcriptase copying of the complete V region and leader coding sequences of heavy and light chain mRNAs (Figure 3). The complementary strand of the primer extended cDNA is then synthesized, and this double-stranded cDNA is cloned in appropriate cDNA cloning vectors such as pBR322 (Gubler and Hoffman, Gene, 25: 263 (1983)) or pQ23 (Figure 5; Maniatis, T. et al., Molecular Cloning: A Laboratory Manual, Cold Spring Harbor Laboratory Publications, New York, page 224 (1982)). Clones are screened for specific hybridization with UIG oligonucleotide probes. Positive heavy and light chain clones identified by this screening procedure are mapped and sequenced to select those containing V region and leader coding sequences.

An alternative method is to make cDNA clones using oligo-dT as a primer, followed by selection of light and heavy chain clones by standard hybridization methods.

A second stage utilizes cloning of C region gene segments to form heavy and light chain module vectors. In one method cDNA clones of human heavy and light chain immunoglobulin mRNA are prepared. These cDNA

-24-

clones are then converted into C region module vectors by site-directed mutagenesis to place a restriction site at a desired location near a boundary of the constant region. An alternative method utilizes genomic C region clones as the source for C region module vectors.

A third stage of cDNA cloning involves the generation of complete light and heavy chain coding sequences with linked V and C regions. The cloned V region segments generated as above are excised and ligated to light or heavy chain C region module vectors. For example, one can clone the complete human kappa light chain C region and the complete human gamma₁ C region. In addition, one can modify a human gamma 1 region and introduce a termination codon, thereby obtain a gene sequence which encodes the heavy chain portion of an Fab molecule.

The coding sequences having operationally linked V and C regions are then transferred into appropriate expression systems for expression in appropriate hosts, prokaryotic or eukaryotic. Operationally linked means in-frame joining of coding sequences to derive a continuously translatable gene sequence without alterations or interruptions of the triplet reading frame.

One particular advantage of using cDNA genetic sequences in the present invention is the fact that they code continuously for immunoglobulin chains, either heavy or light. By "continuously" is meant that the sequences do not contain introns (i.e. are not genomic sequences, but rather, since derived from mRNA by reverse transcription, are sequences of contiguous exons). This characteristic of the cDNA sequences provided by the invention allows them to be

-25-

expressible in prokaryotic hosts, such as bacteria, or in lower eukaryotic hosts, such as yeast.

Another advantage of cDNA cloning methods is the ease and simplicity of obtaining V region gene modules.

The term "non-human" as used in the invention is meant to include any animal other than a human, wherein an immune response can be generated which then leads to usable B cells resulting in corresponding hybridomas or B cell clones obtained by viral transformation and the like. Such animals commonly include rodents such as the mouse or the rat. Because of ease of preparation and great availability, the mouse is at present the preferred, non-human animal. Mouse-mouse hybridomas are thus utilized as the preferred sources for heavy and light chain variable regions.

Preferably, the invention provides entire V and/or C region cDNA sequences. This means that the sequences code for substantially operable V and/or C regions, without lacking any major structural portions thereof.

The terms "constant" and "variable" are used functionally to denote those regions of the immunoglobulin chain, either heavy or light chain, which code for properties and features possessed by the variable and constant regions in natural non-chimeric antibodies. As noted, it is not necessary for the complete coding region for variable or constant regions to be present, as long as a functionally operating region is present and available.

A wide range of source hybridomas are available for the preparation of mRNA. For example, see the catalogue ATCC CELL LINES AND HYBRIDOMAS, December, 1984, American Type Culture Collection, 12301 Parklawn Drive, Rockville, Maryland 20852, U.S.A., pages 5-9 and the ECACC Catalogue, 2nd Edition; PHLs CAMR Porton

-26-

Down, Salisbury, Wills; SP40JG, U.K. pages 30-35 and 40-46. Hybridomas secreting monoclonal antibodies reactive to a wide variety of antigens are listed therein, are available from the collection, and usable in the invention. Of particular interest are hybridomas secreting antibodies which are reactive with viral antigens, including Dengue complex specific (ATCC HB 114); Dengue type 1 virus (ATCC HB 47), Dengue type 2 virus (ATCC HB 46), Dengue type 3 virus (ATCC HB 49), Dengue type 4 virus (ATCC HB 48), Epstein-Barr receptor (ATCC HB 135), Flavivirus group (ATCC HB 112), hepatitis B surface antigen (ATCC CRL 8017 and 8018), herpes simplex type I (ATCC HB 8068), herpes simplex type II (ATCC HB 8067), influenza virus (ATCC CL 189), influenza A virus, matrix protein (ATCC HB 64), influenza A virus, nucleoprotein (ATCC HB 65), influenza A Bangkok/L/79HA (ATCC HB 66), influenza AWSN NP (ATCC HB 67), SV40 large T antigen (ATCC TIB 115), SV40 large T antigen, C-terminal end (ATCC TIB 117), and SV40 nonviral T antigen (ATCC TIB 116). Examples of other hybridomas include those secreting antibodies to tumor associated antigens or to human lymphocyte antigens, such as those reactive to human tumor-associated CEA, high mw (ATCC CRL 8019); human tumor-associated alpha-fetoprotein, IgG₁K (ATCC HB 134); human B lymphocyte HLA-DR, monomorphic, IgG_{2b} (ATCC HB 104); human T lymphocyte T cell precursors, IgG₁ (ATCC CRL 8022); human T lymphocyte T cell subset, helper, IgG_{2b} (ATCC CRL 8002); T subset, suppressor/cytotoxic, human, IgG₁ (ATCC CRL 8013); T cell subset, suppressor/cytotoxic, human, IgG_{2a} (ATCC CRL 8014); T cells, peripheral, human, IgG₁ (ATCC CRL 8000); T cells, peripheral, human, IgG_{2a} (ATCC CRL 8001); thymocytes, "common," human, IgG₁ (ATCC CRL 8020).

-27-

These lines and others of similar nature can be utilized to copy the mRNA coding for variable region, using the UIG probes. Of particular interest are antibodies with specificity to human tumor antigens.

Expression vehicles include plasmids or other vectors. Preferred among these are vehicles carrying a functionally complete human constant heavy or light chain sequence having appropriate restriction sites engineered so that any variable heavy or light chain sequence with the appropriate cohesive ends can be easily inserted thereinto. Human constant heavy or light chain sequence-containing vehicles are thus an important embodiment of the invention. These vehicles can be used as intermediates for the expression of any desired complete heavy or light chain in any appropriate host.

One preferred host is yeast. Yeast provides substantial advantages for the production of immunoglobulin light and heavy chains. Yeasts carry out post-translational peptide modifications including glycosylation. A number of recombinant DNA strategies now exist which utilize strong promoter sequences and high copy number plasmids which can be used for overt production of the desired proteins in yeast. Yeast recognizes leader sequences on cloned mammalian gene products and secretes peptides bearing leader sequences (i.e. prepeptides) (Hitzman, et al., 11th International Conference on Yeast, Genetics and Molecular Biology, Montpellier, France, September 13-17, 1982).

-28-

1 Yeast gene expression systems can be routinely evaluated for the level of heavy and light chain production, protein stability, and secretion. Any of a series of yeast gene expression systems incorporating promoter and termination elements from the actively expressed genes coding for glycolytic enzymes produced in large quantities when yeasts are grown in mediums rich in glucose can be utilized. Known glycolytic genes can also provide very efficient transcription control signals. For example, the promoter and terminator signals of the iso-1-cytochrome C (CYC-1) gene can be utilized.

The following approach can be taken for evaluating optimal expression plasmids for the expression of cloned immunoglobulin cDNAs in yeast.

- (1) The cloned immunoglobulin DNA linking V and C regions is attached to different transcription promoters and terminator DNA fragments;
- (2) The chimeric genes are placed on yeast plasmids used for protein overproduction (see, for example, Beggs, J. D., Molecular Genetics and Yeast, Alfred Benzon Symposium, 16, Copenhagen (1981));
- (3) Additional genetic units such as a yeast leader peptide may be included on immunoglobulin DNA constructs to obtain antibody secretion.
- (4) A portion of the sequence, frequently the first 6 to 20 codons of the gene sequence may be modified to represent preferred yeast codon usage.

-29-

- (5) The chimeric genes are placed on plasmids used for integration into yeast chromosomes.

The following approaches can be taken to simultaneously express both light and heavy chain genes in yeast.

- (1) The light and heavy chain genes are each attached to a yeast promoter and a terminator sequence and placed on the same plasmid. This plasmid can be designed for either autonomous replication in yeast or integration at specific sites in the yeast chromosome.
- (2) The light and heavy chain genes are each attached to a yeast promoter and terminator sequence on separate plasmids containing different selective markers. For example, the light chain gene can be placed on a plasmid containing the trp1 gene as a selective marker, while the heavy chain gene can be placed on a plasmid containing ura3 as a selective marker. The plasmids can be designed for either autonomous replication in yeast or integration at specific sites in yeast chromosomes. A yeast strain defective for both selective markers is either simultaneously or sequentially transformed with the plasmid containing light chain gene and with the plasmid containing heavy chain gene.
- (3) The light and heavy chain genes are each attached to a yeast promoter and terminator sequence on separate plasmids each containing different selective markers as described in

-30-

(2) above. A yeast mating type "a" strain defective in the selective markers found on the light and heavy chain expression plasmids (trp1 and ura3 in the above example) is transformed with the plasmid containing the light chain gene by selection for one of the two selective markers (trp1 in the above example). A yeast mating type "alpha" strain defective in the same selective markers as the "a" strain (i.e. trp1 and ura3 as examples) is transformed with a plasmid containing the heavy chain gene by selection for the alternate selective marker (i.e. ura3 in the above example). The "a" strain containing the light chain plasmid (phenotype: Trp⁺ Ura⁻ in the above example) and the strain containing the heavy chain plasmid (phenotype: Trp⁻ Ura⁺ in the above example) are mated and diploids are selected which are prototrophic for both of the above selective markers (Trp⁺ Ura⁺ in the above example).

Among bacterial hosts which may be utilized as transformation hosts, E. coli K12 strain 294 (ATCC 31446) is particularly useful. Other microbial strains which may be used include E. coli X1776 (ATCC 31537). The aforementioned strains, as well as E. coli W3110 (ATCC 27325) and other enterobacteria such as Salmonella typhimurium or Serratia marcescens, and various Pseudomonas species may be used.

In general, plasmid vectors containing replicon and control sequences which are derived from species compatible with a host cell are used in connection

-31-

with these hosts. The vector ordinarily carries a replication site, as well as specific genes which are capable of providing phenotypic selection in transformed cells. For example, E. coli is readily transformed using pBR322, a plasmid derived from an E. coli species (Bolivar, et al., Gene, 2: 95 (1977)). pBR322 contains genes for ampicillin and tetracycline resistance, and thus provides easy means for identifying transformed cells. The pBR322 plasmid or other microbial plasmids must also contain, or be modified to contain, promoters which can be used by the microbial organism for expression of its own proteins. Those promoters most commonly used in recombinant DNA construction include the beta-lactamase (penicillinase) and lactose (beta-galactosidase) promoter systems (Chang et al., Nature, 275: 615 (1978); Itakura et al., Science, 198:1056 (1977)); and tryptophan promoter systems (Goeddel et al., Nucleic Acids Research, 8: 4057 (1980); EPO Publication No. 0036776). While these are the most commonly used, other microbial promoters have been discovered and utilized.

For example, a genetic construct for any heavy or light chimeric immunoglobulin chain can be placed under the control of the leftward promoter of bacteriophage lambda (P_L). This promoter is one of the strongest known promoters which can be controlled. Control is exerted by the lambda repressor, and adjacent restriction sites are known.

The expression of the immunoglobulin chain sequence can also be placed under control of other regulatory sequences which may be "homologous" to the organism in its untransformed state. For example,

-32-

lactose dependent E. coli chromosomal DNA comprises a lactose or lac operon which mediates lactose digestion by elaborating the enzyme beta-galactosidase. The lac control elements may be obtained from bacteriophage lambda pLAC5, which is infective for E. coli. The lac promoter-operator system can be induced by IPTG.

Other promoter/operator system or portions thereof can be employed as well. For example, arabinose, colicine EL, galactose, alkaline phosphatase, tryptophan, xylose, tac, and the like can be used.

Other preferred hosts are mammalian cells, grown in vitro in tissue culture, or in vivo in animals. Mammalian cells provide post-translational modifications to immunoglobulin protein molecules including leader peptide removal, correct folding and assembly of heavy and light chains, glycosylation at correct sites, and secretion of functional antibody protein from the cell as H₂L₂ molecules.

Mammalian cells which may be useful as hosts for the production of antibody proteins include cells of fibroblast origin, such as Vero (ATCC CRL 81) or CHO-K1 (ATCC CRL 61), or cells of lymphoid origin, such as the hybridoma Sp2/0-Ag14 (ATCC CRL 1581) or the myeloma P3X63Ag8 (ATCC TIB 9), and its derivatives.

Several possible vector systems are available for the expression of cloned heavy chain and light chain genes in mammalian cells. One class of vectors utilizes DNA elements which provide an autonomously replicating extrachromosomal plasmid, derived from animal viruses, such as bovine papillomavirus (Sarver, N. et al., Proc. Natl. Acad. Sci., USA, 79: 7147 (1982)),

-33-

polyoma virus (Deans, R. J. et al., Proc. Natl. Acad. Sci., USA, 81: 1292 (1984)), or SV40 virus (Lusky, M. and Botchan, M., Nature, 293: 79 (1981)). A second class of vectors relies upon the integration of the desired gene sequences into the host cell chromosome. Cells which have stably integrated the introduced DNA into their chromosomes can be selected by also introducing drug resistance genes such as E. coli gpt (Mulligan, R. C. and Berg, P., Proc. Natl. Acad. Sci., USA, 78: 2072 (1981)) or Tn5 neo (Southern, P. J. and Berg, P., J. Mol. Appl. Genet., 1: 327 (1982)). The selectable marker gene can be either directly linked to the DNA gene sequences to be expressed, or introduced into the same cell by co-transfection (Wigler, M. et al., Cell, 16: 77 (1979)).

Since an immunoglobulin cDNA is comprised only of sequences representing the mature mRNA encoding an antibody protein or its precursor, additional gene expression elements regulating transcription of the gene and processing of the RNA are required for optimal synthesis of immunoglobulin mRNA. These elements may include splice signals, as well as transcription promoters including inducible promoters, enhancers, and termination signals. cDNA expression vectors incorporating such elements include those described by Okayama, H. and Berg, P., Mol. Cell Biol., 3: 280 (1983); Cepko, C. L. et al., Cell, 37: 1053 (1984); and Kaufman, R. J., Proc. Natl. Acad. Sci., USA, 82: 689 (1985).

An approach to evaluate optimal vectors for the expression of immunoglobulin cDNA in mammalian cells involves first placing the immunoglobulin DNA sequences into vectors capable of stably integrating

-34-

into the cell genome, or replicating autonomously as an extrachromosomal plasmid. The vectors can be used to evaluate different gene expression elements for optimal immunoglobulin synthesis.

An additional advantage of mammalian cells as hosts is their ability to express chimeric immunoglobulin genes which are derived from genomic sequences. Thus, mammalian cells may express chimeric immunoglobulin genes which are comprised of a variable region cDNA module plus a constant region which is composed in whole or in part of genomic sequences. Several human constant region genomic clones have been described (Ellison, J. W. et al., Nucl. Acids Res., 10: 4071 (1982), or Max, E. et al., Cell, 29: 691 (1982)). The use of such genomic sequences may be convenient for the simultaneous introduction of immunoglobulin enhancers, splice signals, and transcription termination signals along with the constant region gene segment.

Different approaches can be followed to obtain complete H₂L₂ antibodies.

First, one can separately express the light and heavy chains followed by in vitro assembly of purified light and heavy chains into complete H₂L₂ IgG antibodies. The assembly pathways used for generation of complete H₂L₂ IgG molecules in cells have been extensively studied (see, for example, Scharff, M., Harvey Lectures, 69: 125 (1974)). In vitro reaction parameters for the formation of IgG antibodies from reduced isolated light and heavy chains have been defined by Beychok, S., Cells of Immunoglobulin Synthesis, Academic Press, New York, page 69, 1979.

-35-

Second, it is possible to co-express light and heavy chains in the same cells to achieve intracellular association and linkage of heavy and light chains into complete H₂L₂ IgG antibodies. The co-expression can occur by using either the same or different plasmids in the same host.

The methods described herein can also be used to switch the class of any antibody of a given specificity and class to an antibody of the same specificity but of a different class, whether human or non-human. For example, human IgM antibodies can be transmuted to human IgG antibodies by preparing constructs containing human constant IgG cDNA or genomic sequences, linked to variable human cDNA sequences obtained from a cell producing the original IgM antibody. These constructs are then introduced into appropriate hosts and expressed.

POLYPEPTIDE PRODUCTS

The invention provides "chimeric" immunoglobulin chains, either heavy or light. A chimeric chain contains a constant region substantially similar to that present in the heavy chain of a natural human immunoglobulin, and a variable region having any desired antigenic specificity. The variable region is either from human or non-human origin.

The invention also provides immunoglobulin molecules having heavy and light chains associated so that the overall molecule exhibits desired binding and recognition properties. Various types of immunoglobulin molecules are provided: monovalent, divalent, dispecific (i.e., with different variable regions), molecules

-36-

with chimeric heavy chains and non-chimeric light chains, or molecules with variable binding domains attached to peptide moieties carrying desired functions.

Antibodies having chimeric heavy chains of the same or different variable region binding specificity and non-chimeric (i.e., all human or all non-human) light chains, can be prepared by appropriate association of the needed polypeptide chains. These chains are individually prepared by the modular assembly methods of the invention.

USES

The antibodies of the invention having human constant region can be utilized for passive immunization, especially in humans, without negative immune reactions such as serum sickness or anaphylactic shock. The antibodies can, of course, also be utilized in prior art immunodiagnostic assays and kits, in labelled form for in vivo imaging, wherein the label can be a radioactive emitter, or an NMR contrasting agent such as a carbon-13 nucleus, or an X-ray contrasting agent, such as a heavy metal nucleus. The antibodies can also be used for in vitro localization of antigens by appropriate labelling.

The antibodies can be used for therapeutic purposes by themselves in complement mediated lysis or can be coupled to toxins or other therapeutic moieties.

Class switching of antibodies is useful when it is desired to change the association, aggregation or other properties of antibodies obtained from cell fusion or hybridoma technology. For example, most human-human monoclonals are of the IgM class, which are known for their ease of reduction and aggregation. Changing such antibodies to other antibody types, such as IgG, IgA or IgE, is thus of great benefit.

-37-

Mixed antibody-enzyme molecules can be used for immunodiagnostic methods, such as ELISA. Mixed antibody-peptide effector conjugates can be used for targeted delivery of the effector moiety with a high degree of efficacy and specificity.

Having now generally described the invention, the same will be further understood by reference to certain specific examples which are included herein for purposes of illustration only and are not intended to be limiting unless otherwise specified.

EXPERIMENTAL

Materials and Methods

Tissue Culture Cell Lines

The human cell lines GM2146 and GM1500 were obtained from the Human Mutant Cell Repository (Camden, New Jersey) and cultured in RPMI1640 plus 10% fetal bovine serum (M. A. Bioproducts). The cell lines Sp2/0 and CRL 8017 were obtained from the American Type Culture Collection and grown in Dulbecco's Modified Eagle Medium (DMEM) plus 4.5 g/l glucose (M. A. Bioproducts) plus 10% fetal bovine serum (Hyclone, Sterile Systems, Logan, Utah). Media were supplemented with penicillin/streptomycin (Irvine Scientific, Irvine, California).

Recombinant Plasmid and Bacteriophage DNAs

The plasmids pBR322, pL1 and pUC12 were purchased from Pharmacia P-L Biochemicals (Milwaukee, Wisconsin). The plasmids pSV2-neo and pSV2-gpt were obtained from BRL (Gaithersburg, Maryland), and are available from the American Type Culture Collection (Rockville, Maryland). pHu-gamma-1 is a subclone of the

-38-

8.3 Kb HindIII to BamHI fragment of the human IgG1 chromosomal gene. A separate isolation of the human IgG1 chromosomal gene is described by Ellison, J. W. et al., Nucl. Acids Res., 10: 4071 (1982). M8alphaRX12 contains the 0.7 Kb XbaI to EcoRI fragment containing the mouse heavy chain enhancer from the J-C intron region of the M603 chromosomal gene (Davis, M. et al., Nature, 283: 733) inserted into M13mp10. G-tailed pUC9 was purchased from Pharmacia P-L. DNA manipulations involving purification of plasmid DNA by buoyant density centrifugation, restriction endonuclease digestion, purification of DNA fragments by agarose gel electrophoresis, ligation and transformation of E. coli were as described by Maniatis, T. et al., Molecular Cloning: A Laboratory Manual, (1982). Restriction endonucleases and other DNA/RNA modifying enzymes were purchased from Boehringer-Mannheim (Indianapolis, Indiana), BRL, New England Biolabs (Beverly, Massachusetts) and Pharmacia P-L.

Oligonucleotide Preparation

Oligonucleotides were either synthesized by the triester method of Ito et al. (Nucl. Acids Res., 10: 1755 (1982)), or were purchased from ELESSEN, Los Angeles, California. Tritylated, deblocked oligonucleotides were purified on Sephadex-G50, followed by reverse-phase HPLC with a 0-25% gradient of acetonitrile in 10mM triethylamine-acetic acid, pH 7.2, on a C18 uBondapak column (Waters Associates). Detritylation was in 80% acetic acid for 30 min., followed by evaporation thrice. Oligonucleotides were labeled with [γ -³²P]ATP plus T4 polynucleotide kinase.

RNA Preparation and Analysis

-39-

Total cellular RNA was prepared from tissue culture cells by the method of Auffray, C. and Rougeon, F. (Eur. J. Biochem., 107: 303 (1980)) or Chirgwin, J. M. et al. (Biochemistry, 18: 5294 (1979)). Preparation of poly(A)⁺ RNA, methyl-mercury agarose gel electrophoresis, and "Northern" transfer to nitrocellulose were as described by Maniatis, T. et al., supra. Total cellular RNA or poly(A)⁺ RNA was directly bound to nitrocellulose by first treating the RNA with formaldehyde (White, B. A. and Bancroft, F. C., J. Biol. Chem., 257: 8569 (1982)). Hybridization to filterbound RNA was with nick-translated DNA fragments using conditions described by Margulies, D. H. et al. (Nature, 295: 168 (1982)) or with ³²P-labelled oligonucleotide using 4xSSC, 10X Denhardt's, 100 ug/ml salmon sperm DNA at 37°C overnight, followed by washing in 4xSSC at 37°C.

cdNA Preparation and Cloning

Oligo-dT primed cdNA libraries were prepared from poly(A)⁺ RNA from GM1500 and GM2146 cells by the methods of Land, H. et al. (Nucl. Acids Res., 9: 2251 (1981)) and Gubler, V. and Hoffman, B. J., Gene, 25: 263 (1983), respectively. The cdNA libraries were screened by in situ hybridization (Maniatis, T., supra) with ³²P-labelled oligonucleotides using the conditions shown above, or with nick-translated DNA fragments using the conditions of de Lange et al. (Cell, 34: 891 (1983)).

Oligonucleotide Primer Extension and Cloning

Poly(A)⁺ RNA (20 ug) was mixed with 1.2 ug primer in 40 ul of 64mM KCl. After denaturation at 90°C for 5 min. and then chilling in ice, 3 units Human Placen-

-40-

tal Ribonuclease Inhibitor (BRL) was added in 3 ul of 1M Tris-HCl, pH 8.3. The oligonucleotide was annealed to the RNA at 42°C for 15 minutes, then 12 ul of .05M DTT, .05M MgCl₂, and 1 mM each of dATP, dTTP, dCTP, and dGTP was added. 2 ul of alpha-³²P-dATP (400 Ci/mmol, New England Nuclear) was added, followed by 3 ul of AMV reverse transcriptase (19 units/ul, Life Sciences).

After incubation at 42°C for 105 min., 2 ul 0.5 M EDTA and 50 ul 10mM Tris, 1mM EDTA, pH 7.6 were added. Unincorporated nucleotides were removed by Sephadex G-50 spun column chromatography, and the RNA-DNA hybrid was extracted with phenol, then with chloroform, and precipitated with ethanol. Second strand synthesis, homopolymer tailing with dGTP or dCTP, and insertion into homopolymer tailed vectors was as described by Gubler and Hoffman, supra.

Site-Directed Mutagenesis

Single stranded M13 subclone DNA (1 ug) was combined with 20 ng oligonucleotide primer in 12.5 ul of Hin buffer (7 mM Tris-HCl, pH 7.6, 7 mM MgCl₂, 50 mM NaCl). After heating to 95°C in a sealed tube, the primer was annealed to the template by slowly cooling from 70°C to 37°C for 90 minutes. 2 ul dNTPs (1 mM each), 1 ul ³²P-dATP (10 uCi), 1 ul DTT (0.1 M) and 0.4 ul Klenow DNA PolI (2u, Boehringer Mannheim) were added and chains extended at 37°C for 30 minutes. To this was added 1 ul (10 ng) M13 reverse primer (New England Biolabs), and the heating/annealing and chain extension steps were repeated. The reaction was stopped with 2 ul of 0.5M EDTA, pH 8, plus 80 ul of 10 mM Tris-HCl, pH 7.6, 1 mM EDTA. The products were

-41-

phenol extracted and purified by Sephadex G-50 spun column chromatography and ethanol precipitated prior to restriction enzyme digestion and ligation to the appropriate vector.

Transfection of Myeloma Tissue Culture Cells

A variation of the method of Ochi, A. et al. (Nature, 302: 340 (1983)) was used for protoplast fusion. 50 ml. of bacteria at A_{600} of 0.7 were converted to protoplasts by the method of Sandri-Goldin, R. M. et al. (Mol. Cell. Biol., 1: 743 (1981)), then diluted with 20 ml DMEM plus 10% FBS (final volume is 25 ml). Sp2/0 cells were harvested, pelleted at 2,200 x g, washed, repelleted and resuspended in DMEM at $2-5 \times 10^6$ /ml. Bacterial protoplasts (10 ml) were mixed with 10×10^6 Sp2/0 cells and pelleted by centrifugation at 4,000 x g at 22°C for 20 min. After pipetting off the supernatant, the pellet was suspended in the remaining drop of medium by flicking the tube. 2ml of 10% DMSO, 37% (w/v) PEG6000 (Kodak) in DMEM was added dropwise with mixing over 45 sec. After 15 sec., 2 ml of 42% PEG6000 in DMEM was added over 45 sec. Complete DMEM (45 ml) was slowly added with mixing. Cells were pelleted at 2500 x g, then washed and pelleted thrice.

The electroporation method of Potter, H. et al. (Proc. Natl. Acad. Sci., USA, 81: 7161 (1984)) was used. After transfection, cells were allowed to recover in complete DMEM for 48-72 hours, then were seeded at 10,000 to 50,000 cells per well in 96-well culture plates in the presence of selective medium. G418 (GIBCO) selection was at 0.8 mg/ml, mycophenolic acid (Calbiochem) was at 6 ug/ml plus 0.25 mg/ml xan-

-42-

thine, and HAT (Sigma) was at the standard concentration.

Assays for Immunoglobulin Synthesis and Secretion

Secreted immunoglobulin was measured directly from tissue culture cell supernatants. Cytoplasmic protein extract was prepared by vortexing 1×10^6 cells in 160 μ l of: 1% NE40, 0.15 M NaCl, 10 mM Tris, 1 mM EDTA, pH 7.6 at 0°C , 15 minutes, followed by centrifugation at 10,000 \times g to remove insoluble debris.

Double antibody sandwich ELISA (Voller, A. et al., in Manual of Clinical Immunology, 2nd Ed., Eds. Rose, N. and Friedman, H., pp. 359-371, 1980) using affinity purified antisera was used to detect specific immunoglobulins. For detection of human IgG, the plate-bound antiserum is goat anti-human IgG (KPL, Gaithersburg, Maryland) at 1/1000 dilution, while the peroxidase-bound antiserum is goat anti-human IgG (KPL or Tago, Burlingame) at 1/4000 dilution. For detection of human immunoglobulin kappa, the plate-bound antiserum is goat anti-human kappa (Tago) at 1/500 dilution, while the peroxidase-bound antiserum is goat anti-human kappa (Cappel) at 1/1000 dilution.

Antibodies binding hepatitis B surface antigen were detected using a commercial (Abbott, AUSAB) assay.

-43-

EXAMPLES

The following examples show the preparation of chimeric antibodies each having a human constant region and a non-human variable region. These examples outline the step-by-step process of preparing the chimeric antibodies.

EXAMPLE I: Human Antibody Constant Region Gene Modules and cDNA Expression Vectors

- (1) Preparation of cDNA Clones, and Vehicles Containing Same, for Heavy Chain Human Constant Region

The cell line GM2146 was used as the source in mRNA preparation and cDNA cloning. This cell line secretes IgG1 (Simmons, J. G. *et al.*, Scand. J. Immunol., 14: 1-13, 1981). Tests of this cell line indicated that it secretes IgA as well as IgG.

The cell line was cloned, and results indicated that five of six subclones secreted IgG only, while one of six subclones secreted IgA only. Poly(A)⁺ RNA was prepared from the cell line and a cDNA library was prepared from the poly(A)⁺ RNA by the method of Gubler, U. and Hoffman, B. J., Gene, 25: 263-269 (1983). An initial plating of the cDNA transformed into E. coli strains HB101 and RR1 yielded a total of 1500 colonies, which were screened by hybridization to a HindIII to BamHI fragment of a genomic clone of human IgG1 (pHu-gamma-1). Four positive clones were found. A fragment containing the CH3 coding region of one of these clones, pGMH-3 (Figure 4), was used to rescreen the original library plus a new transformation of approximately 5000 colonies. Two of the lar-

-44-

gest clones, pGMH-6 and pGMH-15, were analyzed by restriction enzyme digestion (Figure 4). Both clones contained the entire constant region of human IgG1, although it was discovered that pGMH-6 had deleted approximately 1500 base pairs of pBR322 DNA, apparently without affecting the IgG1 cDNA sequences.

Clone pGMH-6 provided the IgG1 constant region module in the construction of cloning vectors for heavy chain variable region cloning.

(2) Preparation of cDNA Clones, and Vehicles
Containing Same, for Light Chain Human
Constant Region

A human cell line (GM1500) producing IgG₂K was selected for the initial cloning phase. Poly(A)⁺ RNA prepared from GM1500 is active in in vitro translation using rabbit reticulocyte extracts. A cDNA library was prepared from this RNA by the method of Land et al., Nucl. Acids Res., 9: 2251-2266 (1981), utilizing KpnI digested and dG-tailed pQ23 as the cloning vector (Figure 5). This vector contains BglII, KpnI and SstI sites inserted between the BamHI and SalI sites of pBR322.

In order to identify the cDNA clones generated from GM1500 RNA which correspond to light chain mRNA, a DNA probe, UIG-HuK, was synthesized and purified. The UIG-HuK oligonucleotide has the sequence 5'-AGCCACAGTTCGTTT-3', and is designed to hybridize to all functional human kappa mRNA species at the J-C junction. This probe was used to prime cDNA synthesis on GM1500 RNA in the presence of dideoxynucleotides and reverse transcriptase. From 1.2 ug of total

-45-

GM1500 poly(A)⁺ RNA was used in this experiment, the entire J sequence and some of the V region was read, demonstrating that (1) GM1500 RNA is intact, (2) the kappa probe is of the correct sequence, and (3) GM1500 light chain mRNA contains J_K4 sequences.

cDNA clones positive for hybridization to the light chain probe were selected. Since the probe hybridizes to the J-C junction, the most important point was to determine if the clones had complete constant region sequence in addition to the J region.

Insert sizes for the two largest kappa cDNA clones were 0.6 and 0.9 kb; restriction enzyme mapping indicated that the entire constant region coding sequence was present in both clones (Figure 6). The human kappa cDNA clone pK2-3 was used to make the light chain constant region vector pING2001 by inserting the Sau3A fragment comprising the human kappa constant and J regions into the BclI site of pBR325 (Figure 6B).

A variant of the human kappa cDNA clone was made by placing a HindIII site in the J region. This was carried out by in vitro mutagenesis using a J_KHINDIII oligonucleotide primer (Figure 7c). The resultant plasmid is pGML60.

A vector, pING2003, was constructed for the transfer and expression of cDNA sequences in mammalian cells (Figure 10). This vector was constructed from pUC12 and two plasmids containing SV40 sequences. pL1 provides an SV40 early region promoter and an SV40 late region splice sequence. pSV2-neo sequences provide a selectable marker for mammalian cell transformation and SV40 polyadenylation signal sequences. pUC12 provides a multiple cloning site for cDNA insertion.

-46-

The pING2003 vector has several useful restriction sites for modifications. These include a HindIII site useful for the insertion of enhancer sequences, and a HindIII to XhoI fragment useful for the insertion of alternate promoter sequences. This vector is useful in the expression of cDNA genes in mammalian cells.

Addition of Enhancer Element to pING2003

Immunoglobulin enhancer elements have been shown to enhance transcription of genes in their vicinity in stably transformed mouse myeloma cells by several hundred fold (Gillies, S. D. et al., Cell, 33: 717, 1983; and Banerji, J. et al. Cell, 33: 729, 1983). To facilitate expression of the mouse-human immunoglobulin genes in mouse myeloma cells, the mouse immunoglobulin heavy chain enhancer element was added to the cDNA expression vector pING2003 (Figure 10). The mouse heavy chain enhancer region DNA was isolated from an M13 subclone of mouse heavy chain genomic DNA (M8-alpha-RX12, Deans, R. J., unpublished). DNA isolated from a SalI plus EcoRI digestion of this subclone was modified with HindIII linkers and inserted into the HindIII site of pING2003, resulting in the new cDNA expression vector pING2003E. This vector is useful in the efficient expression of cDNA genes in mammalian cells, particularly mouse myeloma or hybridoma cell lines.

-47-

EXAMPLE II: Human-Mouse Chimeric Anti-HBsAg Antibody Chain

(1) Preparation of cDNA Clones and Vehicles Containing Same, for Heavy Chain Mouse Anti-HBsAg Variable Region.

The cell line CRL8017 was obtained from the ATCC and subcloned. Subclones were grown and tested for mouse IgG anti-hepatitis B binding activity using a commercially available anti-HBsAg detection kit. Three positive subclones were found. Poly(A)⁺ RNA was prepared from one of these subclones, and was fractionated on a methylmercury agarose gel. The RNA contained intact light chain and heavy chain mRNA's as inferred from specific hybridization to kappa UIG-MJK primer, and to the mouse heavy chain UIG-MJH3 probe (see Figure 7). In addition, the UIG-MJK primer was used for specific priming of anti-HBsAg poly(A)⁺ RNA in a dideoxy sequencing reaction. Sufficient sequence was read to show that a major kappa RNA of the anti-HBsAg cell line contains the J_K2 sequence.

The conditions for variable region cDNA synthesis were optimized by using heavy and light chain UIG primers on anti-HBsAg poly(A)⁺ RNA. Dideoxy chain extension experiments demonstrated that the mouse UIG-MJK primer and UIG-JH3 primer correctly primed kappa and heavy chain RNAs. When the reverse transcription was carried out in the absence of dideoxynucleotides, the main product using the kappa UIG-MJK primer was a 410_±20 nucleotide fragment, while the main product using the heavy chain UIG-JH3 primer was a 430_±30 nucleotide fragment. These correspond to the expected lengths of the variable and 5' untranslated regions of kappa and heavy chain immunoglobulin mRNAs. The conditions for the optimal priming of poly(A)⁺ RNA from

-48-

CRL8017 cells should work well for poly(A)⁺ RNA isolated from any cell line producing a monoclonal antibody.

After determining optimal conditions for priming hybridoma mRNA with oligonucleotide primers, two oligonucleotides were designed and used for heavy chain V region cDNA synthesis. These two oligonucleotides are UIG-MJHBSTEII(13) and UIG-MJH3 (Figures 7 and 8). It should be noted that the primer sequence was designed to introduce a BstEII recognition site (GGTGACC) in the clone so that it could be joined at this site to the human IgG1 constant module at the analogous position at the latter's J region. In this case, the primer had a single G to U mismatch with the mouse mRNA sequence that uses the J_H3 coding sequence. The UIG-MJHBSTEII(13) primer was 13 bases long and the mismatched residue was flanked by 7 matches 5' and 5 matches 3' of it. This was the 13-mer BstEII primer. To assess the priming efficiency of the 13-mer BstEII oligonucleotide, a 21-mer primer specific for mouse J_H3 (UIG-MJH3) was used. This primer had a perfect match for the 17 nucleotides on its 3' end.

These two primers and the J_H3 coding sequences are shown in Figure 8. The first strand cDNA products made via the 13-mer BstEII and the 21-mer J_H3 primers included bands of approximately 430 nucleotides, which represented the entire V_H region. Under the standard priming conditions used, the priming efficiency of the 13-mer BstEII was much less than that of the 21-mer J_H3. Accordingly, a cDNA library was generated from the first strand synthesis from each of these primers, using the method of Gubler and Hoffman, supra.

-49-

First, the 21-mer J_H3 library was screened with the 21-mer J_H3 oligonucleotide. Filter hybridization was done at 30° , overnight, according to de Lange, T. et al., Cell, 34: 891-900 (1983). The filters were then washed at 51° in $6 \times \text{SSC}$, 0.1% SDS. Five colonies were selected. The largest had an insert of approximately 460 bp. More significantly, it contained three restriction sites predicted from the known J_H3 sequence, which are present upstream of the primer sequence. This clone, pJ3-11, was sequenced using the J_H3 primer by the chain-termination method (Wallace, R. B. et al., Gene, 16: 21-26 (1981)). The sequence obtained has the remaining J_H3 coding segment. Just upstream, a 13-nucleotide segment matched to a published D segment sequence (Dsp 2.2) (Kurosawa, Y. et al., J. Exp. Med., 155: 201 (1982), and Tonegawa, S., Nature, 302: 575 (1983)). A nonapeptide predicted from this area showed characteristic homology to the published mouse heavy chain V subgroups at amino acid residues 86 to 94, comprising the FR3 of heavy chain molecules. Plasmid pJ3-11 represented a rearranged VDJ sequence, and apparently contained the anti-hepatitis V_H sequence produced by the cell line.

In order to isolate a V_H region cDNA clone that had a BstEII site in the J region, an AluI to Sau96I, 265 nucleotide long, probe from pJ3-11 was next used to screen the cDNA library generated from the 13-mer BstEII primer. Six positive clones were isolated. The largest, pBs13-1, was further analyzed. The insert was 280 nucleotides long and its restriction map agreed with that of pJ3-11 except for the introduced BstEII site. Figure 9 illustrates how these two in-

-50-

serts were recombined to generate pMVHca-13, a V_H clone with the module-joining BstEII site. Three additional V_H cDNA clones were isolated from a cDNA library generated from the 21-mer oligonucleotide UIG-MJH3BSTEII primer containing a BstEII site. These clones may provide alternate V_H cDNA sequences to join to human C_H sequences.

(2) Preparation of cDNA Clones, and Vehicles
Containing Same, for Light Chain Mouse Anti-
HBsAg Variable Region

Since the J_K2 sequence is present in mRNA prepared from the anti-hepatitis hybridoma cell line, the oligonucleotide UIG-JK2BGLII (Figure 7B), was designed to introduce a BglII site into the J_K2 region. Digestion with BglII would then allow direct insertion of a V_K cDNA coding region into the BclI site of the previously noted human C_K vector, pING2001. This insertion would result in the precise joining of a mouse variable region segment (including the J region) to a human kappa constant region segment, each in the proper coding frame and with no alteration in amino acid sequence for either mouse variable or human constant region.

The JK2BGLII oligonucleotide was used to prime anti-HBsAg mRNA to form a cDNA library as for heavy chain, supra, in pUC9. The cDNA was size-selected by polyacrylamide gel electrophoresis prior to cloning, and 80% of the cDNA clones were shown to have insert sizes between 300 and 750 nucleotides in length. Replica filters of this library were screened with two oligonucleotides, the original primer and a second probe complementary to J_K2 sequence 5' to the original primer.

-51-

It was discovered that the anti-hepatitis B monoclonal cell line CRL 8017 secretes immunoglobulins with at least two different light chains. One of them is derived from the myeloma NS-1, which was used as a fusion partner in generating the anti-hepatitis B cell line. Since NS-1 is derived from the myeloma MOPC21, the possibility was investigated that MOPC21 V_K mRNA may be present in the V_K cDNA library from the anti-hepatitis monoclonal cell line. Indeed, one cDNA clone (p6D4B) analyzed has an identical restriction enzyme map to that of MOPC21 V_K cDNA, except for the inserted BglIII site.

Two conclusions can be drawn from these results. The first is that it is possible to effectively use an oligonucleotide to introduce a restriction enzyme site while cloning a V_K region from a hybridoma cell line. The second is that one must carefully monitor hybridoma cell lines for the presence of multiple V region sequences, only one of which is the desired sequence.

In order to further characterize the kappa light chain J regions present in the cell line mRNA, poly(A)⁺ RNA was bound to nitrocellulose by the formaldehyde "Dot blot" procedure of White and Bancroft, J. Biol. Chem., 257: 8569 (1982). The RNA was hybridized to ³²P-labeled oligonucleotide probes specific for each functional kappa J region. These probes are shown in Figure 7B as the UIG probes 5JK1, MJK, 5JK4, and 5JK5. The results showed that the mRNA hybridized strongly to both MJK and 5JK4 oligonucleotide probes, indicating that both J_{K2} and J_{K4} sequences were present. Since J_{K2} mRNA had been previously identified as the one derived from the parental hybridoma partner

-52-

NS-1, it was concluded that the J_K4 mRNA encoded the anti-hepatitis binding specificity of the CRL 8017 cells.

Two different cDNA libraries were screened to isolate V region clones encoding J_K4 sequences. The first was primed by JK2BGLII, supra. The second was made by using the oligonucleotide primer, JK4BGLII, which is specific for J_K4 mRNA and introduces a BglII site into the J region of cloned V regions. The JK4BGLII primer was used to prime first strand cDNA synthesis to construct a cDNA library by the same method used to construct a JK2BGLII primed cDNA library, except that cDNA was not size selected prior to cloning.

Figure 7B tabulates the mismatches that each primer has with other functional mouse kappa J region sequences. Note that J_K4 has five mismatches in 21 nucleotides when compared with the JK2BGLII primer, and 3 in 23 with the JK4BGLII primer.

Both libraries were screened for V region clones containing J_K4 sequences by hybridizing to an oligonucleotide probe specific for J_K4 sequences (5JK4). The results of this screen are shown in Table 1.

-53-

Table 1*

Library	Probe Specificity	
	J _K 2	J _K 4
JK2BGLII	2% (30/1500)	0.15% (2/1500)
JK4BGLII	N/D	3.5% (31/875)

* Percentage of clones containing J_K2 or J_K4 sequence plus a V region. The probes used were the oligonucleotide 5JK4 (J_K4 specificity, Figure 7) and p6D4B, which contains the NS-1 (MOPC21) V region sequence. N/D, not done.

Several J_K4 V region cDNA clones isolated from both libraries were characterized. These clones have identical restriction enzyme maps, including the engineered BglII site resulting from the oligonucleotide primed cDNA cloning procedure. The restriction map and sequence of one clone, pV17, show that pV17 contains V region gene sequences.

These results show that the JK2BGLII primer could correctly, although inefficiently, prime J_K4 mRNA sequences. Since the JK2BGLII primer had less mismatches with any other J_K region mRNA than with J_K4 mRNA (Figure 7B), it is expected that the other J_K mRNAs can be primed at the correct location with better efficiency using the JK2BGLII primer. Thus, efficient cDNA cloning of any functional mouse kappa V region may be obtained by using a mixture of the JK2BGLII and JK4BGLII primers.

-54-

The placement of a BglIII site into the J region during cDNA cloning of the V regions allows joining of the cloned mouse V region gene module to the human kappa constant region gene module (Figure 9B).

After the aforementioned experiments were carried out it was found that the cDNA clone pV17 lacked a complete 5' coding region. Nucleotide sequencing showed that the A of the initiator codon ATG was not copied in pV17. This was not a random cDNA cloning artifact because two other cDNA clones had the same defect. Two approaches were devised to obtain a light chain gene with a complete 5' coding region.

First, a new cDNA library was constructed by first priming with an oligonucleotide (5'-ATATTTGCTGATGCTCT-3') complementary to pV17 sequences 155 bases from the 5' end. From this library, clones hybridizing to a pV17 DNA fragment probe were selected, and some of these new cDNA clones have the initiator ATG plus about 20 nucleotides of 5' untranslated region. One of these clones, p2-12, supplies a 5' untranslated region of 23 nucleotides and a complete ATG initiator codon. When p2-12 was combined with pV17 derived sequences, a variable region with a complete 5' end was formed (pING2013E).

Second, site-directed mutagenesis on the existing light chain clone was used to simultaneously remove the poly-G tract and place a ribosome recognition sequence adjacent to the initiator ATG. The PstI fragment from pV17 was subcloned into M13mp18. An oligonucleotide (V17-IVM; 5'-GTTGTCGACTCAGCATGAGGTTCAGGTTC-3') was then used as a primer to mutate the pV17 sequence to include a SalI site and an initiator

-55-

ATG into the pV17 sequence. The resultant plasmid pV17-IVM provided an alternate mouse variable region for joining to human constant region modules.

The complete nucleotide sequence of the variable region from pV17 was then determined. The sequence shows that pV17 contains a V_K - J_K junction region, containing several conserved amino acids, and the hybrid J_{K2}/J_{K4} region formed by priming the J_{K4} RNA with the UIG-JK2BGLII oligonucleotide. However, the V_K region in pV17 is non-functional, because the V_K and J_K regions are not in the same coding frame. Translation of the pV17 V region would thus result in an abnormal immunoglobulin light chain where the J region is translated in an incorrect frame. This defect may be caused by aberrant V-J joining, resulting in a non-functional kappa mRNA, as has been observed by Kelley, D.E. *et al.*, Mol. Cell. Biol., 5:1660-1675 (1985).

Since the pV17 V region encodes an abnormal immunoglobulin, it is highly unlikely that this light chain is part of a functional anti-hepatitis antibody molecule. These results show the importance of monitoring hybridoma cells for the presence of multiple RNA species encoding V regions, only one of which is the desired sequence.

Further screening of CRL 8017 cDNA libraries was done to search for V_K cDNA clones which are not from either of the two V_K cDNA classes found so far (MOPC21-p6D4B, pV17). First an oligo-dT primed cDNA library made from CRL8017 RNA was screened with a DNA fragment probe specific for the kappa constant region, and separately with probes specific for MOPC21 and

-56-

pV17 V_K regions. A cDNA clone (pIE9L-81) that contains the kappa constant region, but has a different V_K region than that of MOPC21 or pV17 was discovered. This method of screening oligo-dT primed cDNA libraries is a useful alternative to oligonucleotide screening of cDNA libraries, because nick-translated probes of high specific activity are used. Also, this method allows the simultaneous isolation of several classes of V region clones, such as all V_K clones, by appropriate probe choice. Second, the UIG-JK2BGLII-primed cDNA library made from CRL 8017 RNA was screened with the UIG-5JK2 oligonucleotide probe (see Figure 7). A new class of V_K cDNA clones was found whose members are homologous to pIE9L-81 and hybridize to the UIG-5JK2 probe, but not to a MOPC21 V_K probe. The restriction endonuclease site maps and nucleotide sequences of these clones also differ from MOPC21-homologous V_K cDNA clones from CRL8017 cells. These clones, however, have an aberrant V-J joint which results in a nonfunctional mRNA, and appear to be identical to one described by Cabilly and Riggs (Gene, 40:157 (1985)).

It was therefore concluded that the anti-hepatitis B cell line CRL8017 has at least three classes of V_K mRNA corresponding to the above described cDNA clones p6D4B (MOPC21), pIE9L, and pV17. The pIE9L and pV17 clones are derived from mRNA from aberrantly rearranged Kappa genes, while the p6D4B clone is derived from the parent hybridoma fusion partner NS-1. None of these clones appear to encode the desired anti-hepatitis light chain.

-57-

(3) Preparation and Expression of Heavy Chain
Containing Human Constant/Mouse Variable Regions

The V region sequences in pMVHCa-13 were joined to the human IgG1 constant (C) region clone pGMH-6. Due to the presence of a second BstEII site within the IgG1 CH1 region of pGMH-6, a multi-step ligation was required. First, the 220 nucleotide BstEII fragment from the J-CH1 region of pGMH-6 was ligated to the 1100 nucleotide IgG region BstEII to BamHI fragment of pGMH-6. In a separate ligation, the 420 nucleotide BstEII to BamHI fragment of pMVHCa-13, which comprises the mouse V region, was joined to a calf intestine phosphatase treated BamHI plasmid vector. The two ligations were then combined, ligase was added, and the products were transformed into HBl01, resulting in the chimeric mouse V-human C clone pMVHCc-24 (Figure 9A).

The V region of the hybrid heavy chain gene in pMVHCc-24 was further analyzed by partial sequence analysis. This analysis showed that the cloned V region contained a D sequence which matches a known D sequence, DSP2.2 (Kurosawa and Tonegawa, *supra*). The sequence also predicted a 19 amino acid leader peptide similar to known mouse V heavy chain leader peptide sequences, and a 5' untranslated region of at least 3 nucleotides.

The BamHI fragment containing the mouse-human hybrid heavy chain gene of pMVHCc-24 was cloned into BamHI digested pING2003E vector, resulting in the expression plasmid pING2006E (Figure 11). The pING2006E plasmid should have an increased probability of effi-

-58-

cient expression of the mouse-human chimeric immunoglobulin gene in B lymphoid cells because of the presence of the mouse heavy chain enhancer region.

A modification of the chimeric heavy chain gene present in pMVHCC-24 was done to provide an alternate heavy chain gene which lacks the oligo-dC region preceding the initiator ATG. The pING2012E and pING2006E vectors are identical except for the nucleotides immediately preceding the ATG, as shown in Figure 12.

Bacteria harboring the pING2006E and pSV2-neo plasmids were converted into protoplasts by the method of Sandri-Goldin, R. M. et al., Mol. Cell. Biol., 1: 743 (1981). The protoplasts were then separately fused to SP2/0-Ag14 hybridoma cells (ATCC CRL 1581) by treatment with polyethyleneglycol (Ochi, A. et al., Nature, 302: 340, 1983). The fused cells were allowed to recover for 72 hours in complete medium before plating at 10,000 or 50,000 cells per well in a 96-well tissue culture plate. The cells were selected with G418 at 0.8 mg/ml for two weeks, when growth in some wells was clearly evident. Under these selection conditions, Sp2/0 cells were completely killed within 4-7 days by G418. Only cells which have integrated and expressed the neo gene present in the vectors will grow under G418 selection. The number of wells positive for growth by these integrative transfectants are shown in Table 2.

-59-

Table 2*

Strain/ Plasmid	10,000 cells/well	50,000 cells/well
MC1061/pING2006E	3 (13%)	12 (50%)
MC1061/pSV2-neo	7 (29%)	4 (17%)
MC1061/none	0	0

* Percentage of wells showing positive growth out of 24 wells.

Cells transfected with pING2006E and pSV2-neo were tested for immunoglobulin gene expression at the RNA and protein level. Total cell RNA was prepared from transfected cells, bound to nitrocellulose and hybridized to nick-translated probes specific for the mouse-human hybrid heavy chain gene. Two clones were found which have a strong signal, representing expression of the gene at the RNA level. The amount of total cellular RNA hybridizing to the mouse-human probe appeared to be approximately 1/10 the level of heavy chain RNA in the original hybridoma cells. This probably represented about 1% of the total mRNA of the transfected cell.

The transfected mouse cells were also tested for production of cytoplasmic human heavy chain protein by an ELISA assay. It was found that 3 out of 7 pING-2006E transfected cell lines produced detectable levels of human heavy chain protein. The mouse cell transformant producing the most mouse-human heavy chain protein gave a signal in the ELISA assay comparable to that of a 1/100 dilution of a human B cell

-60-

line producing intact human immunoglobulin IgG1. This modest level of detected mouse-human heavy chain protein may be due to several factors, including instability of heavy chains in the absence of light chains in hybridoma cells, or incorrect processing of the chimeric gene transcript.

(4) ~~Gene~~ Amplification of the Integrated Chimeric Gene

Southern blot analysis showed that multiple copies of the pING2006E DNA sequences were integrated in tandem in the mouse genome. Restriction enzymes ApaI and BglII both cleave pING2006E singly. In the transformant, 2AE9, a band, from an ApaI or BglII digestion, of the expected size (8.2kb) was found to hybridize to the human C gamma 1 sequences (data not shown). An a BamHI band of the correct size (1.6kb) was found to hybridize to the human as well as the 1E9 V_H sequences. Gene-copy titration experiment (Fig. 14) indicated that there are about 5 copies of pING2006E in the 2AE9 genome. That fact that only a single band was detected in the ApaI or BglII lane indicates that these individual copies are in a tandemly arranged array. A set of double digestions showed that pING2006E sequences suffered no rearrangement in their introduction into the mouse DNA (data not shown).

We next transfected the 2AE9 cells with a plasmid that contains a different selectable marker, the gpt gene, and selected clones growing out in DMEM-HAT. One clone, 2BH10, has about 38 ng soluble human gamma

-61-

1 protein per 10^6 cells. Southern analysis showed that 2BH10 has about 30 copies of pING2006E (Fig. 14). They were amplified from the 5 copies in 2AE9 without rearrangement of the DNA sequences. (Compare the 2AE9 panel to the 2BH10). S1 data (data not shown) revealed that this increase in template led to a higher amount of IgG gene transcripts. We believe that these sequences were co-amplified with contiguous cellular sequences as a result of the second selection.

EXAMPLE III: A Human-Mouse Chimeric Antibody with Cancer Antigen Specificity

(1) Antibody L6

L6 monoclonal antibody (MAb) was obtained from a mouse which had been immunized with cells from a human lung carcinoma, after which spleen cells were hybridized with NS-1 mouse myeloma cells. The antibody binds to a previously not identified carbohydrate antigen which is expressed in large amounts at the surface of cells from most human carcinomas, including lung carcinomas (adeno, squamous), breast carcinomas, colon carcinomas and ovarian carcinomas, while the antigen is only present at trace levels in normal cells from the adult host. MAb L6 is an IgG2a and can mediate antibody dependent cellular cytotoxicity, ADCC, in the presence of human peripheral blood leukocytes as a source of effector cells, so as to lyse L6 positive tumor cells, and it can lyse L6 positive tumor cells in the presence of human serum as a source of complement; the lysis is detected as the release of ^{51}Cr from labelled cells over a 4 hour incubation

-62-

period. MAb L6 can localize to L6 positive tumors xenotransplanted onto nude mice, and it can inhibit the outgrowth of such tumors. MAb L6 is described in Cancer Res. 46:3917-3923, 1986 (on MAb specificity) and in Proc. Natl. Acad. Sci. 83:7059-7063, 1986 (on MAb function).

(2) Identification of J Sequences in the Immunoglobulin mRNA of L6.

Frozen cells were thawed on ice for 10 minutes and then at room temperature. The suspension was diluted with 15 ml PBS and the cells were centrifuged down. They were resuspended, after washes in PBS, in 16 ml 3M LiCl, 6M urea and disrupted in a polytron shear. The preparation of mRNA and the selection of the poly(A+) fraction were carried out according to Auf-ray, C. and Rougeon, F., Eur. J. Biochem. 107:303, 1980.

The poly (A+) RNA from L6 was hybridized individually with labeled J_H1 , J_H2 , J_H3 and J_H4 oligonucleotides under conditions described by Nobrega et al. Anal. Biochem 131:141, 1983). The products were then subjected to electrophoresis in a 1.7% agarose-TBE gel. The gel was fixed in 10% TCA, blotted dry and exposed for autoradiography. The result showed that the L6 v_H contains J_H2 sequences.

For the analysis of the V_K mRNA, the dot-blot method of White and Bancroft J. Biol. Chem. 257:8569, (1982) was used. Poly (A+) RNA was immobilized on nitrocellulose filters and was hybridized to labeled probe-oligonucleotides at 40° in 4xSSC. These experiments show that L6 contains J_K5 sequences. A faint hybridization to J_K2 was observed.

-63-

(3) V Region cDNA Clones.

A library primed by oligo (dT) on L6 poly (A+) RNA was screened for kappa clones with a mouse C_K region probe. From the L6 library, several clones were isolated. A second screen with a 5' J_K5 specific probe identified the L6 (J_K5) light-chain clones. Heavy chain clones of L6 were isolated by screening with the J_H2 oligonucleotide.

The heavy and light chain genes or gene fragments from the cDNA clones, pH3-6a and pL3-12a were inserted into M13 bacteriophage vectors for nucleotide sequence analysis. The complete nucleotide sequences of the variable region of these clones were determined (FIGURES 15 and 16) by the dideoxy chain termination method. These sequences predict V region amino acid compositions that agree well with the observed compositions, and predict peptide sequences which have been verified by direct amino acid sequencing of portions of the V regions.

The nucleotide sequences of the cDNA clones show that they are immunoglobulin V region clones as they contain amino acid residues diagnostic of V domains (Kabat et al., Sequences of Proteins of Immunological Interest; U.S. Dept of HHS, 1983).

The L6 V_H belongs to subgroup II. The cDNA predicts an N-terminal sequence of 24 amino acid residues identical to that of a known V_H (45-165 CRI; Margolies et al. Mol. Immunol. 18:1065, 1981). The L6 V_H has the J_H2 sequence. The L6 V_L is from the V_K-KpnI family (Nishi et al. Proc. Nat. Acad. Sci. USA 82:6399, 1985), and uses J_K5. The cloned L6 V_L predicts an amino acid sequence which was confirmed by amino acid sequencing of peptides from the L6 light chain corresponding to residues 18-40 and 80-96.

-64-

(4) In Vitro Mutagenesis to Engineer Restriction Enzyme Sites in the J Region for Joining to a Human C-Module, and to Remove Oligo (dC) Sequences 5' to the V Modules.

Both clones generated from priming with oligo (dT) L6 V_K and L6 V_H need to be modified. For the L6 V_K, the J-region mutagenesis primer J_KHindIII, as shown in FIGURE 17B, was utilized. A human C_K module derived from a cDNA clone was mutagenized to contain the HindIII sequence (see Figure 17A). The mutagenesis reaction was performed on M13 subclones of these genes. The frequency of mutant clones ranged from 0.5 to 1% of the plaques obtained.

It had been previously observed that the oligo (dC) sequence upstream of the AUG codon in a V_H chimeric gene interferes with proper splicing in one particular gene construct. It was estimated that perhaps as much as 70% of the RNA transcripts had undergone the mis-splicing, wherein a cryptic 3' splice acceptor in the leader sequence was used. Therefore the oligo (dC) sequence upstream of the initiator AUG was removed in all of the clones.

In one approach, an oligonucleotide was used which contains a SalI restriction site to mutagenize the L6 V_K clone. The primer used for this oligonucleotide-directed mutagenesis is a 22-mer which introduces a SalI site between the oligo (dC) and the initiator met codon (FIGURE 19).

In a different approach, the nuclease BAL-31 was used to chew away the oligo (dC) in the L6 V_H clone pH3-6a. The size of the deletion in two of the mutants obtained was determined by nucleotide sequencing

-65-

and is shown in FIGURE 17. In both of these mutants (delta 4 and delta 21), all of the oligo (dC) 5' to the coding region were deleted.

These clones were then modified by oligonucleotide-directed mutagenesis with the MJH2-ApaI primer (FIGURE 17). This 31-base primer introduces an ApaI site in the mouse C_H gene at a position analogous to an existing ApaI site in human C_{gamma}1 cDNA gene module. The primer introduces the appropriate codons for the human C gamma 1 gene. The chimeric heavy chain gene made by joining the mutagenized mouse V_H gene module to a human C_H module thus encodes a chimeric protein which contains no human amino acids for the entire V_H region.

The human C gamma 1 gene module is a cDNA derived from GM2146 cells (Human Genetic Mutant Cell Repository, Newark, New Jersey). This C gamma 1 gene module was previously combined with a mouse V_H gene module to form the chimeric expression plasmid pING2012E.

(5) L6 Chimeric Expression Plasmids.

L6 chimeric heavy chain expression plasmids were derived from the replacement of the V_H module pING2012E with the V_H modules of mutants delta 21 and delta 4 to give the expression plasmids pING2111 and pING2112 (FIGURE 17). These plasmids direct the synthesis of chimeric L6 heavy chain when transfected into mammalian cells.

For the L6 light chain chimeric gene, the SalI to HindIII fragment of the mouse V_K module was joined to the human C_K module by the procedure outlined in FIGURE 18, forming pING2119. Replacement of the neo sequence with the E. coli gpt gene derived from pSV2-

-66-

gpt resulted in pING2120, which expressed L6 chimeric light chain and confers mycophenolic acid resistance when transfected into mammalian cells.

The inclusion of both heavy and light chain chimeric genes in the same plasmid allows for the introduction into transfected cells of a 1:1 gene ratio of heavy and light chain genes leading to a balanced gene dosage. This may improve expression and decrease manipulations of transfected cells for optimal chimeric antibody expression. For this purpose, the DNA fragments derived from the chimeric heavy and light chain genes of pING2111 and pING2119 were combined into the expression plasmid pING2114 (FIGURE 19). This expression plasmid contains a selectable neo^R marker and separate transcription units for each chimeric gene, each including a mouse heavy chain enhancer.

The modifications and V-C joint regions of the L6 chimeric genes are summarized in FIGURE 20.

(6) Stable Transfection of Mouse Lymphoid Cells for the Production of Chimeric Antibody.

Electroporation was used (Potter et al. *supra*; Toneguzzo et al. *Mol. Cell Biol.* 6:703 1986) for the introduction of L6 chimeric expression plasmid DNA into mouse Sp2/0 cells. The electroporation technique gave a transfection frequency of 1-10 x 10⁻⁵ for the Sp2/0 cells.

The two gene expression plasmid pING2114 was linearized by digestion with AatII restriction endonuclease and transfected into Sp2/0 cells, giving approximately fifty G418 resistant clones which were screened for human heavy and light chain synthesis.

-67-

The levels of chimeric antibody chain synthesis from the two producers, D7 and 3E3, are shown in Table 3. Chimeric L6 antibody was prepared by culturing the D7 transfectant cells for 24 hours at 2×10^6 cells/ml in 5 l. DMEM supplemented with HEPES buffer and penicillin and streptomycin. The supernatant was concentrated over an Amicon YM30 membrane in 10mM sodium phosphate buffer, pH8.0. The preparation was loaded over a DEAE-Cellulose column, which separated the immunoglobulin into unbound and bound fractions. Samples from the DEAE-unbound, DEAE-bound and the pre-DEAE preparations (from 1.6 ul of medium) was separately purified by affinity chromatography on a Protein-A Sepharose column, eluting with 0.1 M sodium citrate, pH 3.5. The eluted antibody was neutralized and concentrated by Amicon centricon filtration, in phosphate-buffered saline. The yields for the three preparations were 12ug (DEAE unbound), 6ug (DEAE bound), and 9ug (pre-DEAE column). Western analysis of the antibody chains indicated that they were combined in an H_2L_2 tetramer like native immunoglobulins.

(7) A second purification for Chimeric L6 Antibody Secreted in Tissue Culture.

a. Sp2/0.pING2114.D7 cells were grown in culture medium [DMEM (Gibco #320-1965), supplemented with 10% Fetal Bovine Serum (Hyclone #A-1111-D), 10mM HEPES, 1x Glutamine-Pen-Strep (Irvine Scientific #9316) to 1×10^6 cell/ml.

b. The cells were then centrifuged at 400xg and resuspended in serum-free culture medium at 2×10^6 cell/ml for 18-24 hr.

-68-

c. The medium was centrifuged at 4000 RPM in a JS-4.2 rotor (3000xg) for 15 min.

d. 1.6 liter of supernatant was then filtered through a 0.45 micron filter and then concentrated over a YM30 (Amicon Corp.) filter to 25ml.

e. The conductance of the concentrated supernatant was adjusted to 5.7-5.6 mS/cm and the pH was adjusted to 8.0.

f. The supernatant was centrifuged at 2000xg, 5 min., and then loaded onto a 40 ml DEAE column, which was preequilibrated with 10mM sodium phosphate, pH8.0.

g. The flow through fraction was collected and loaded onto a 1ml protein A-Sepharose (Sigma) column preequilibrated with 10mM sodium phosphate, pH8.0.

h. The column was washed first with 6ml 10mM sodium phosphate buffer pH=8.0, followed by 8ml 0.1M sodium citrate pH=3.5, then by 6ml 0.1M citric acid (pH=2.2). Fractions of 0.5ml were collected in tubes containing 50ul 2M Tris base (Sigma).

i. The bulk of the IgG was in the pH=3.5 elution and was pooled and concentrated over Centricon 30 (Amicon Corp.) to approximately .06ml.

j. The buffer was changed to PBS (10mM sodium phosphate pH=7.4, 0.15M NaCl) in Centricon 30 by repeated diluting with PBS and reconcentrating.

k. The IgG solution was then adjusted to 0.10ml and bovine serum albumin (Fraction V, U.S. Biochemicals) was added to 1.0% as a stabilizing reagent.

-69-

(8) Production and Purification of Chimeric L6 Antibody Secreted in Ascites Fluid.

a. The ascites was first centrifuged a 2,000 xg for 10 min.

b. The conductance of the supernatant was adjusted to 5.7-5.6 mS/cm and its pH adjusted to 8.0.

c. Supernatant was then loaded onto a 40 ml DEAE-cellulose column pre-equilibrated with 10 mM $\text{Na}_2\text{PO}_4\text{H}$ pH 8.0.

d. The flow through from the DEAE column was collected and its pH was adjusted to 7.4, and then loaded onto a 1.0 ml goat anti-human IgG (H+L) - sepharose column.

e. The column was washed first with 6 ml of 10 mM sodium phosphate, 0.5 M sodium chloride, followed by 8 ml of 0.5 M NH_4OH , and 3 M sodium thiocyanate.

f. The sodium thiocyanate eluate was pooled and dialyzed against 2L PBS overnight.

The antibody can be further concentrated by steps j. and k. of the previous procedure.

70

TABLE 3

Levels of Secreted Chimeric L6
Chains from Sp2/0 Transfectants^a

<u>Culture Condition</u>	Sp2/0.D7		Sp2/0.3E3		
	<u>FBS</u>	<u>Kappa^b</u>	<u>Gamma^c</u>	<u>Kappa^b</u>	<u>Gamma^c</u>
1. 20 ml, 2d, seed @ 2×10^5 /ml	+	17	77	100	700
2. 200 ml, 2d, seed @ 2.5×10^5 /ml	+	0.9	6	80	215
3. 200 ml, 1d, seed @ 2×10^6 /ml	-	1.9	3.8	97	221
4. Balb/c ascites	-	5,160	19,170	ND	ND

^a - Sp2/0 cells transfected by electroporation with pING2114(pL6HL)

^b - ug/l measured by ELISA specific for human Kappa - human Bence-Jones protein standard.

^c - ug/l measured by ELISA specific for human gamma - human IgG standard.

ND - Not determined.

FBS: Fetal Bovine Serum

-71-

(9) Studies Performed on the Chimeric L6 Antibody.

First, the samples were tested with a binding assay, in which cells of both an L6 antigen-positive and an L6 antigen-negative cell line were incubated with standard mouse monoclonal antibody L6, chimeric L6 antibody derived from the cell culture supernatants, and chimeric L6 antibody derived from ascites (as previously described) followed by a second reagent, fluorescein-isothiocyanate (FITC)-conjugated goat antibodies to human (or mouse, for the standard) immunoglobulin.

Since the binding assay showed strong reactivity of the chimeric L6 on the L6 antigen positive cell line and total lack of reactivity on the negative cell line, the next step was to test for the ability of the chimeric L6 to inhibit the binding of mouse L6 to antigen positive cells; such inhibition assays are used routinely to establish the identity of two antibodies' recognition of antigen. These data are discussed below ("Inhibition of binding"). As part of these studies, a rough estimate of antibody avidity was made.

Finally, two aspects of antibody function were studied, the ability to mediate ADCC in the presence of human peripheral blood leukocytes, and the ability to kill L6 positive tumor cells in the presence of human serum as a source of complement (see "Functional Assays" below).

Binding Assays. Cells from a human colon carcinoma line, 3347, which had been previously shown to express approximately 5×10^5 molecules of the L6 anti-

-72-

gen at the cell surface, were used as targets. Cells from the T cell line HSB2 was used as a negative control, since they, according to previous testing, do not express detectable amounts of the L6 antigen. The target cells were first incubated for 30 min at 4°C with either the chimeric L6 or with mouse L6 standard, which had been purified from mouse ascites. This was followed by incubation with a second, FITC-labelled reagent, which for the chimeric antibody was goat-anti-human immunoglobulin, obtained from TAGO (Burlingame, CA), and used at a dilution of 1:50. For the mouse standard, it was goat-anti-mouse immunoglobulin, also obtained from TAGO and used at a dilution of 1:50. Antibody binding to the cell surface was determined using a Coulter Model EPIC-C cell sorter.

As shown in Table 4 and Table 4A, both the chimeric and the mouse standard L6 bound significantly, and to approximately the same extent, to the L6 positive 3347 line. They did not bind above background to the L6 negative HSB2 line.

In view of the fact that the three different chimeric L6 samples presented in Table 4 behaved similarly in the binding assays, they were pooled for the inhibition studies presented below. The same inhibition studies were performed for chimeric L6 derived from ascites fluid presented in Table 4A.

Inhibition of Binding. As the next step was studied the extent to which graded doses of the chimeric L6 antibody, or the standard mouse L6, could inhibit the binding of an FITC-labelled mouse L6 to the surface of antigen positive 3347 colon carcinoma cells.

-73-

Both the chimeric and mouse standard L6 inhibited the binding of the directly labelled L6 antibody, with the binding curves being parallel. The chimeric antibody was slightly less effective than the standard, as indicated by the results which showed that 3.4 ug/ml of the pooled chimeric L6 MAb, as compared to 2.0 ug/ml of the standard mouse L6 MAb was needed for 50% inhibition of the binding, and that 5.5 ug/ml of the chimeric L6 (derived from ascites) as compared to 2.7 ug/ml of the standard mouse L6 MAb was needed for 50% inhibition of binding.

As part of these studies, a rough estimate was made of antibody avidity. The avidity of the standard mouse L6 had been previously determined to be approximately 4×10^8 . The data indicated that there were no significant differences in avidity between the chimeric and the mouse L6.

Functional Assays. A comparison was made between the ability of the chimeric L6 and standard mouse L6 to lyse L6 antigen positive cells in the presence of human peripheral blood leukocytes as a source of effector cells (mediating Antibody Dependent Cellular Cytotoxicity, ADCC) or human serum as a source of complement (mediating Complement-Dependent Cytolysis, CDC).

As shown in Table 5 and Tables 5A-5D, the chimeric L6 was superior to the simultaneously tested sample of mouse L6 in causing ADCC, as measured by a 4 hr ^{51}Cr release test.

Tables 6 and 6A-6B present the data from studies on complement-mediated target cell lysis. In this case, a high cytolytic activity was observed with both the mouse and the chimeric L6 antibodies.

-74-

Conclusions.

The results presented above demonstrate a number of important, unexpected qualities of the chimeric L6 monoclonal antibody of the invention. Firstly, the chimeric L6 antibody binds to L6 antigen positive tumor cells to approximately the same extent as the mouse L6 standard and with approximately the same avidity. This is significant for the following reasons: the L6 antibody defines (a) a surface carbohydrate antigen, and (b) a protein antigen of about 20,000 daltons, each of which is characteristic of non-small cell lung carcinoma (NSCLC) and certain other human carcinomas. Significantly, the L6 antibody does not bind detectably to normal cells such as fibroblasts, endothelial cells, or epithelial cells in the major organs. Thus the chimeric L6 monoclonal antibody defines an antigen that is specific for carcinoma cells and not normal cells.

In addition to the ability of the chimeric L6 monoclonal antibodies of the present invention to bind specifically to malignant cells and localize tumors, the chimeric L6 exerts profound biological effects upon binding to its target, which make the chimeric antibody a prime candidate for tumor immunotherapy. The results presented herein demonstrate that chimeric L6 is capable of binding to tumor cells and upon binding kills the tumor cells, either by ADCC or CDC. Such tumor killing activity was demonstrated using concentrations of chimeric L6 antibody as low as 0.01 ug/ml (10ng/ml).

Although the prospect of attempting tumor therapy using monoclonal antibodies is attractive, with some partial tumor regressions being reported, to date such

-75-

monoclonal antibody therapy has been met with limited success (Houghton, February 1985, Proc. Natl. Acad. Sci. 82:1242-1246). The therapeutic efficacy of mouse monoclonal antibodies (which are the ones that have been tried so far) appears to be too low for most practical purposes. The discovery of the profound biological activity of chimeric L6 coupled with its specificity for a carcinoma antigen makes the chimeric L6 antibody a choice therapeutic agent for the treatment of tumors in vivo. Moreover, because of the "human" properties which will make the chimeric L6 monoclonal antibodies more resistant to clearance in vivo, the chimeric L6 monoclonal antibodies will be advantageously used not only for therapy with unmodified chimeric antibodies, but also for development of various immunoconjugates with drugs, toxins, immunomodulators, isotopes, etc., as well as for diagnostic purposes such as in vivo imaging of tumors using appropriately labelled chimeric L6 antibodies. Such immunoconjugation techniques are known to those skilled in the art and can be used to modify the chimeric L6 antibody molecules of the present invention.

Two illustrative cell lines secreting chimeric L6 antibody were deposited prior to the filing date of this application at the ATCC, Rockville Maryland. These are transfected hybridoma C255 (corresponds to 3E3 cells, supra), ATCC HB 9240 and transfected hybridoma C256 (C7 cells, supra), ATCC HB 9241.

(10) Expression in Yeast of L6 Chains

Genetic sequence codings for Chimeric L6 antibody heavy and light chains were prepared and introduced into vectors. Yeast cells were transformed therewith

-76-

and expression of separate heavy and light antibody chains for L6 antibody was detected.

The present invention is not to be limited in scope by the cell lines deposited since the deposited embodiment is intended as a single illustration of one aspect of the invention and all cell lines which are functionally equivalent are within the scope of the invention. Indeed, various modifications of the invention in addition to those shown in the art from the foregoing description and accompanying drawings. Such modifications are intended to fall within the scope of the appended claims.

⁷⁷
TABLE 4

Binding Assays Of Chimeric L6 Antibody and Mouse L6
Monoclonal Antibody on an L6 Antigen Positive and L6 Antigen
Negative Cell Line.

<u>Antibody</u>	<u>Batch</u>	<u>Binding Ratio For*</u> <u>H3347 Cells (L6 +)</u>	
		<u>GAM</u>	<u>GAH</u>
Standard L6		56.6	4.2
Chimeric L6	a	1.3	110.3
	b	1.3	110.3
	c	1.3	110.3
		<u>Binding Ratio For*</u> <u>HSB-2 Cells (L6 -)</u>	
		<u>GAM</u>	<u>GAH</u>
Standard L6		1.1	1.1
Chimeric L6	a	1.0	1.0
	b	1.0	1.1
	c	1.0	1.1

* All assays were conducted using an antibody concentration of 10 ug/ml. The binding ratio is the number of times brighter a test sample is than a control sample treated with GAM (FITC conjugated goat-anti-mouse) or GAH (FITC conjugated goat anti-human) alone. A ratio of 1 means that the test sample is just as bright as the control; a ratio of 2 means the test sample is twice as bright as the control, etc.

78 TABLE 4A

Binding Assays Of Chimeric L6 Antibody and Mouse Monoclonal Antibody on an L6 Antigen Positive and L6 Antigen Negative Cell Line.

<u>Antibody</u>	<u>Antibody Concentration (ug/ml)</u>	<u>Binding Ratio For*</u>	
		<u>H3347 Cells (L6 +)</u>	
		<u>GAM</u>	<u>GAM</u>
Standard L6	30	38	4
	10	49	4
	3	40	3
Chimeric L6 (Ascites)	30	2	108
	10	2	108
	3	1	42
Chimeric L6 (Cell Culture)	30	1	105
	10	1	86
	3	1	44
		<u>Binding Ratio For**</u>	
		<u>HSB-2 Cells (L6 -)</u>	
		<u>GAM</u>	<u>GAM</u>
Standard L6	10	1	1
Chimeric L6 (Ascites)	10	1	1
Chimeric L6 (Cell Culture)	10	1	1

* The binding ratio is the number of times brighter a test sample is than a control sample treated with GAM (FITC conjugated goat anti-human) alone. A ratio of 1 means that the test sample is just as bright as the control; a ratio of 2 means the test sample is twice as bright as the control, etc.

TABLE 5

ADCC of Chimeric L6 (Mouse) L6 Antibodies On Colon Carcinoma Cell Line 3347.

<u>Antibody</u>	<u>Antibody Concentration (ug/ml)</u>	<u>PBL per Target Cell</u>	<u>% Cytolysis*</u>
Chimeric L6	10	100	64
	5	100	70
	10	0	2
Standard L6	10	100	24
	5	100	17
	10	0	2
None	0	100	1

* The target cells had been labelled with ^{51}Cr and were exposed for 4 hours to a combination of MAb and human peripheral blood leukocytes (PBL), and the release of ^{51}Cr was measured subsequently. The release of ^{51}Cr (after corrections of values for spontaneous release from untreated cells) is a measure of the percent cytotoxicity.

80

TABLE 5A

ADCC of Chimeric L6 and Standard (Mouse) L6 Antibodies On
Colon Carcinoma Cell Line 3347.

<u>Antibody</u>	<u>Antibody Concentration (ug/ml)</u>	<u>PBL per Target Cell</u>	<u>% Cytolysis*</u>
Chimeric L6 (Ascites)	20	100	80
	10	100	74
	5	100	71
	2.5	100	71
	20	0	0
Chimeric L6 (Cell Culture)	10	100	84
	5	100	74
	2.5	100	67
	10	0	3
Standard L6	20	100	32
	10	100	26
	20	0	0

* The target cells had been labelled with ^{51}Cr and were exposed for 4 hours to a combination of MAb and human peripheral blood leukocytes (PBL), and the release of ^{51}Cr was measured subsequently. The release of ^{51}Cr (after corrections of values for spontaneous release from untreated cells) is a measure of the percent cytolysis.

⁸¹TABLE 5B

ADCC of Chimeric L6 and Standard (Mouse) L6 Antibodies On Colon Carcinoma Cell Line 3347.

<u>Antibody</u>	<u>Antibody Concentration (ug/ml)</u>	<u>PBL per Target Cell</u>	<u>% Cytolysis*</u>
Chimeric L6 (Ascites)	5	100	84
	2.5	100	78
	1.25	100	85
	0.63	100	81
	0.31	100	80
	0.16	100	71
	0.08	100	65
	5	0	0
Standard L6	5	100	32
	5	0	0
None	0	100	19

* The target cells had been labelled with ⁵¹Cr and were exposed for 4 hours to a combination of MAb and human peripheral blood leukocytes (PBL), and the release of ⁵¹Cr was measured subsequently. The release of ⁵¹Cr (after corrections of values for spontaneous release from untreated cells) is a measure of the percent cytotoxicity.

82

TABLE 5C

ADCC of Chimeric L6 and Standard (Mouse) L6 Antibodies On Lung Carcinoma Cell Line H2669.

<u>Antibody</u>	<u>Antibody Concentration (ug/ml)</u>	<u>PEL per Target Cell</u>	<u>% Cytolysis*</u>
Chimeric L6 (Ascites)	10	100	35
	1	100	31
	0.1	100	27
	0.01	100	15
	0.001	100	13
	0.0001	0	15
Standard L6	10	100	9
	1	100	15
None	0	100	9
Chimeric L6 (Ascites)	10	10	19
	1	10	15
	0.1	10	11
	0.01	10	13
	0.001	10	22
	0.0001	10	11
Standard L6	10	10	7
	1	10	6
None	0	10	8

83
TABLE 5C (cont'd)

<u>Antibody</u>	<u>Antibody Concentration (ug/ml)</u>	<u>PBL per Target Cell</u>	<u>% Cytolysis*</u>
Chimeric L6: (Ascites)	10	0	4
Standard L6	10	0	9

* The target cells had been labelled with ^{51}Cr and were exposed for 4 hours to a combination of MAb and Human peripheral blood leukocytes (PBL), and the release of ^{51}Cr was measured subsequently. The release of ^{51}Cr (after corrections of values for spontaneous release from untreated cells) is a measure of the percent cytolysis.

TABLE 5D

ADCC of Chimeric L6 and Standard (Mouse) L6 Antibodies On
Colon Carcinoma Cell Line H3347.

<u>Antibody</u>	<u>Antibody Concentration (ug/ml)</u>	<u>PBL per Target Cell</u>	<u>% Cytolysis*</u>
Chimeric L6 (Ascites)	10	100	62
	1	100	66
	0.1	100	69
	0.01	100	26
	0.001	100	8
	0.0001	0	3
	10	0	0
Standard L6	10	100	19
	1	100	24
		0	0
None	0	100	8

* The target cells had been labelled with ^{51}Cr and were exposed for 4 hours to a combination of MAb and Human peripheral blood leukocytes (PBL), and the release of ^{51}Cr (after corrections of values for spontaneous release from untreated cells) is a measure of the percent cytolysis.

TABLE ⁸⁵
6

Complement-dependent cytotoxic effect of chimeric and standard (mouse) L6 on colon carcinoma cells from line 3347, as measured by a 4-hr ⁵¹Cr-release assay. Human serum from a healthy subject was used as the source of complement.

Antibody	Human complement	% Cytolysis
L6 Standard 10 ug/ml	Yes	90
L6 chimeric 10 ug/ml	Yes	89
L6 Standard 10 ug/ml	No	0
L6 chimeric 10 ug/ml	No	1

86

TABLE 6A

Complement Dependent Cytotoxic Effect of Chimeric L6 and
Standard (Mouse) L6 Antibodies on Colon Carcinoma Cell Line 3347

<u>Antibody</u>	<u>Antibody Concentration (ug/ml)</u>	<u>PBL per Target Cell</u>	<u>% Cytolysis*</u>
Chimeric L6 (Ascites)	20	+	29
	10	+	23
	5	+	18
	2.5	+	8
	20	Inactivated	0
	10	0	0
Chimeric L6 (Cell Culture))	20	+	29
	5	+	26
	2.5	+	18
	20	+	4
	10	0	4
Standard L6	20	+	55
	10	+	37
	20	Inactivated	0
	20	0	1
None	0	+	0

* Complement mediated cytolysis was measured by a 4 hour ⁵¹Cr-release assay. Human serum from a healthy subject was used as the source of complement.

TABLE 6B

Complement Dependent Cytotoxic Effect of Chimeric L6 and
Standard (Mouse) L6 Antibodies on Colon Carcinoma Cell Line 3347

<u>Antibody:</u>	<u>Antibody Concentration (ug/ml)</u>	<u>PBL per Target Cell</u>	<u>% Cytolysis*</u>
Chimeric L6 (Ascites)	10	+	209
	5	+	155
	2.5	+	166
	1.25	+	114
	0.6	+	63
	0.3	+	17
	10	0	0
Standard L6	10	+	96
	5	+	83
	2.5	+	48
	1.25	+	18
	0.6	+	7
	0.3	+	4
	10	0	2
None	0	+	0

* Complement mediated cytolysis was measured by a 4 hour ⁵¹Cr-release assay. Human serum from a healthy subject was used as the source of complement.

-88-

EXAMPLE IV: A Human-Mouse Chimeric Antibody with Specificity for Human B-Cell Antigen

The 2H7 mouse monoclonal antibody (gamma 2bK) recognizes a human B-cell surface antigen, Bp35 (Clark, E. A. et al., Proc. Nat. Acad. Sci. USA, 82:1766 (1985)). The Bp35 molecule plays a role in B-cell activation. mRNA was prepared from the 2H7 cell line. Two cDNA libraries were generated - one using the heavy chain UIG-H primer and the other, oligo(dT). One V_H clone, pH2-11, was isolated upon screening with the same UIG-H oligonucleotide. To isolate the light-chain clone, a mouse kappa-specific DNA fragment was used to screen the oligo(dT) library. Candidate clones were further screened with a mouse J_K5 sequences. One V_K clone, pL2-12, was thus isolated. The light chain UIG-K was then used to engineer a restriction enzyme site in the J region.

The two cDNA clones were also modified at the 5' end to remove the artificial oligo d[C] sequence. In pH2-11 this was carried out by using the restriction enzyme NcoI which cuts one nucleotide residue 5' of the ATG initiator codon. In pL2-12 this was achieved by an oligonucleotide in vitro mutagenesis using a 22-mer containing a SalI site.

The DNA sequences of these two clones are shown in Figures 21, 22. To construct the chimeric heavy chain plasmid the V_H module was joined to the human C gamma 1 module (pGMH6) at the J_H BstEII site, and the chimeric light chain the V_K module was joined to the human C_K module (pGML60) at the J_K HindIII site. The expression vector sequences were derived from

-89-

pING2012-neo as well as pING2016-gpt. The constructed plasmids are pING2101 ($V_H C$ gamma 1-neo), pING2106 ($V_K C_K$ -neo), pING2107 ($V_K C_K$ -gpt). pING2101 and pING2106 were also used to generate plasmids containing both genes. They are pHL2-11 and pHL2-26. In addition, pING2106 and pING2014 were combined to a two light-chain plasmid, pLL2-25, to compensate for the poorer (compared to heavy chain) steady-state accumulation of light chain protein in transfected cells. (See Fig. 23) Fig. 24 shows the changes made to the variable region sequences during the construction.

The plasmid, pHL2-11, was linearized by AatII; and the DNA was used to transfect Sp2/0 cells by electroporation. Transformants were selected in G418-DMEM. One transformant, 1C9, produces 9.3 ng/ml chimeric kappa and 33-72 ng/ml chimeric gamma 1 protein as assayed by ELISA. Southern analysis of 1C9 DNA showed that there is one copy of the plasmid integrated in Sp2/0 genome.

89/1

ANNEX M3

International Application No: PCT/

MICROORGANISMS	
Optional Sheet in connection with the microorganism referred to on page <u>75</u> , line <u>26</u> of the description ¹	
A. IDENTIFICATION OF DEPOSIT ¹	
Further deposits are identified on an additional sheet <input checked="" type="checkbox"/> ²	
Name of depository institution ³ American Type Culture Collection	
Address of depository institution (including postal code and country) ⁴ 12301 Parklawn Drive Rockville, Maryland 20852, United States of America	
Date of deposit ⁵ 24 October 1986	Accession Number ⁶ HB 9240
B. ADDITIONAL INDICATIONS ⁷ (leave blank if not applicable). This information is continued on a separate attached sheet <input type="checkbox"/>	
Hybridoma C255 (Chimeric L6 Antibody)	
C. DESIGNATED STATES FOR WHICH INDICATIONS ARE MADE ⁸ (if the indications are not for all designated States)	
D. SEPARATE FURNISHING OF INDICATIONS ⁹ (leave blank if not applicable)	
The indications listed below will be submitted to the International Bureau later ⁹ (Specify the general nature of the indications e.g., "Accession Number of Deposit")	
E. <input type="checkbox"/> This sheet was received with the international application when filed (to be checked by the receiving Office)	
(Authorized Officer)	
<input checked="" type="checkbox"/> The date of receipt (from the applicant) by the International Bureau is	
was	(Authorized Officer)
REC'D 21 NOV 1986 WIPO PCT	

Form PCT/RO/34 (January 1981)

January 1985

89/2

ANNEX M3

International Application No: PCT/

MICROORGANISMS	
Optional Sheet in connection with the microorganism referred to on page <u>75</u> , line <u>27</u> of the description ¹	
A. IDENTIFICATION OF DEPOSIT ¹	
Further deposits are identified on an additional sheet <input type="checkbox"/> ²	
Name of depository institution ³ American Type Culture Collection	
Address of depository institution (including postal code and country) ⁴ 12301 Parklawn Drive Rockville, Maryland 20852, United States of America	
Date of deposit ⁵ 24 October 1986	Accession Number ⁶ HB 9241
B. ADDITIONAL INDICATIONS ⁷ (leave blank if not applicable). This information is continued on a separate attached sheet <input type="checkbox"/>	
Hybridoma C256 (Chimeric L6 Antibody)	
C. DESIGNATED STATES FOR WHICH INDICATIONS ARE MADE ⁸ (if the indications are not for all designated States)	
D. SEPARATE FURNISHING OF INDICATIONS ⁹ (leave blank if not applicable)	
The indications listed below will be submitted to the International Bureau later ⁹ (Specify the general nature of the indications e.g., "Accession Number of Deposit")	
E. <input type="checkbox"/> This sheet was received with the international application when filed (to be checked by the receiving Office)	
(Authorized Officer)	
<input type="checkbox"/> The date of receipt (from the applicant) by the International Bureau ¹⁰	
was	(Authorized Officer)
<div style="border: 2px solid black; padding: 5px; display: inline-block;"> <p>REC'D 21 NOV 1986</p> <p>WIPO PCT</p> </div>	

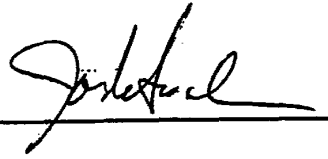

January 1985

Form PCT/RO/134 (January 1981)

-90-

WHAT IS NEW AND INTENDED TO BE COVERED BY LETTERS PATENT OF THE UNITED STATES IS:

1. A polynucleotide molecule comprising a cDNA sequence coding for the variable region of a non-human immunoglobulin chain.

2. A polynucleotide molecule comprising a cDNA ~~sequence~~ coding for the entire variable region of an immunoglobulin chain.

3. The molecule of any of claims 1 or 2 wherein said chain is a heavy chain.

4. The molecule of any of claims 1 or 2 wherein said chain is a light chain.

5. The molecule of any of claims 1 or 2 which further comprises an additional sequence coding for the constant region of a human immunoglobulin chain, both said sequences in operable linkage with each other.

6. The molecule of claim 5 wherein said additional sequence is a cDNA sequence.

7. The molecule of claim 5 wherein said additional sequence is a genomic sequence.

8. The molecule of claim 5 wherein said non-human is a rodent.

-91-

9. The molecule of any of claims 1 or 2 which is a recombinant DNA molecule.

10. The molecule of claim 9 which is in double-stranded DNA form.

11. The molecule of claim 9 which is an expressible vehicle.

12. The molecule of claim 11 wherein said vehicle is a plasmid.

13. A prokaryotic host transformed with the molecule of claim 5.

14. The host of claim 13 which is a bacterium.

15. A eukaryotic host transfected with the molecule of claim 5.

16. The host of claim 15 which is yeast or a mammalian cell.

17. A heavy immunoglobulin chain comprising a constant human region and a variable non-human region.

18. A light immunoglobulin chain comprising a constant human region and a variable non-human region.

19. A chimeric antibody molecule comprising two light chains and two heavy chains, each of said chains comprising a constant human region and a variable non-human region.

-92-

20. The molecule of claim 19 wherein both said heavy chains have the same binding specificity in their variable region.

21. The molecule of claim 19 wherein each of said heavy chains has a different binding specificity in its variable region.

22. An antibody molecule comprising (i) two chimeric heavy chains having the same binding specificity in their variable regions, and (ii) two all-human or all non-human light chains having the same binding specificity in their variable regions as that of the variable regions of the chimeric heavy chains.

23. An antibody molecule comprising (i) two chimeric heavy chains having the same binding specificity in their variable regions, and (ii) two all-human or non-human light chains having different binding specificities in their variable regions, wherein the binding specificity of the variable region of one of said light chains is the same as the binding specificity of the variable region of said chimeric heavy chains.

24. A process of preparing an immunoglobulin heavy chain having a constant human region and a variable non-human region which comprises:

 culturing a host capable of expressing said chain under culturing conditions and

 recovering from said culture said heavy chain.

-93-

25. A process of preparing an immunoglobulin light chain having a constant human region and a variable non-human region which comprises:

culturing a host capable of expressing said chain under culturing conditions; and

recovering from said culture said light chain..

26. A process of preparing a chimeric immunoglobulin containing a heavy chain and a light chain, each of said heavy and light chains having a constant human region and a variable non-human region, which comprises:

culturing a host capable of expressing said heavy chain, or said light chain, or both, under culturing conditions; and

recovering from said culture said chimeric immunoglobulin molecule.

27. The process of any of claims 24, 25 or 26 wherein said host is prokaryotic.

28. The process of any of claims 24, 25 or 26 wherein said host is eukaryotic.

29. A polynucleotide molecule comprising a consensus sequence for the J region of a heavy chain immunoglobulin molecule.

30. The molecule of claim 29 wherein said sequence is for a human heavy chain J region.

-94-

31. The molecule of claim 29 wherein said sequence is for a mouse heavy chain J region.

32. A polynucleotide molecule comprising a consensus sequence for the J region of a light chain immunoglobulin molecule.

33. The molecule of claim 32 wherein said sequence is for a human Kappa J region.

34. The molecule of claim 32 wherein said sequence is for a mouse Kappa J region.

35. The molecule of claim 32 wherein said sequence is for a mouse Lambda J region.

36. A process of switching the class of an antibody chain molecule from a first class to a second class which comprises:

obtaining a cDNA sequence coding for the variable region of said chain;

operably linking said cDNA sequence to a genetic sequence coding for the constant region of an antibody chain having the characteristics of said second class;

transforming with said linked sequence a host capable of expressing said sequences;

culturing said host under culturing conditions; and

recovering from said culture said heavy chain having the characteristics of said second class.

-95-

37. The process of claim 34 wherein said first class is IgM and said second class is IgG.

38. The process of claim 36 wherein said chain is a heavy chain.

39. The process of claim 36 wherein said chain is a light chain.

40. A method of preparing a genetic sequence coding for a chimeric immunoglobulin chain having a constant human region and a variable non-human region of any desired specificity, which comprises:

- (a) providing mRNA coding for said variable region from a cell secreting monoclonal antibodies of said desired specificity;
- (b) priming the formation, by reverse transcription using said mRNA as a template, of cDNA derived therefrom, with a polynucleotide molecule comprising a consensus genetic sequence for the J region of said immunoglobulin chain;
- (c) providing a genetic sequence coding for said human constant region; and
- (d) operably linking said cDNA sequence of step (b) to said sequence of step (c).

41. The method of claim 40 wherein step (d) comprises operably linking said cDNA sequence to said sequence of step (c) in an expression vehicle.

-96-

42. The method of claim 41 wherein said vehicle is a plasmid.

43. The method of claim 42 which further comprises transforming said plasmid into a host capable of expressing said plasmid.

44. The method of any of claims 40-43 wherein said chain is a heavy chain.

45. The method of any of claims 40-43 wherein said chain is a light chain.

46. The method of claim 40 wherein said consensus genetic sequence is selected from the group consisting of:

- (i) human heavy chain J region;
- (ii) mouse heavy chain J region;
- (iii) human Kappa J region;
- (iv) mouse Kappa J region; and
- (v) mouse Lambda J region.

47. The method of claim 40 wherein said consensus genetic sequence is selected from the group consisting of those denoted as MJH1, MJH2, MJH3, MJH3-BSTEII, MJH-BSTEII(13), MJH4, 5JK1, 5JK2, JK2BGLII, 5JK4, JK4BGLIII, 5JK5 and MJK in Figure 7.

48. The method of claim 40 wherein said consensus sequence further comprises the sequence coding for the recognition site of a restriction endonuclease enzyme.

-97-

49. cDNA expression vectors which have restriction endonuclease site maps substantially similar to the vectors pING2003 and pING2003E in Figure 10, useful for the expression of cDNA in mammalian cells.

50. The method of claim 40 wherein said consensus genetic sequence is selected from the group consisting of those denoted as UIGH, UIGK, and MJ_H²-ApaI in Figure 7.

FIG. 1

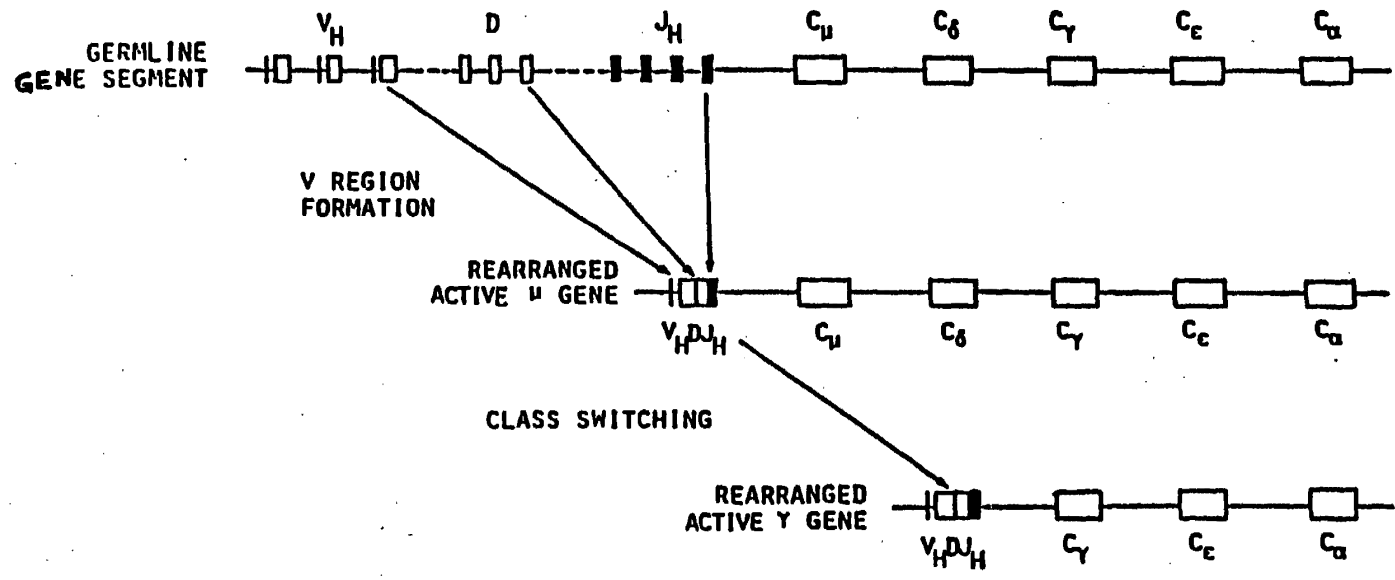

1/25

SUBSTITUTE SHEET

2/25

FIG. 2

Ig heavy chain J-C region

human heavy chain J regions

J | CH1

JH1 GCTGAATACTTCCAGCACTGGGGCCAGGGCACCCTGGTCACCGTCTCCTCAG
 JH2 CTACTGGTACTTCGATCTCTGGGGCCGTGGCACCCTGGTCACGTCTCCTCAG
 JH3 ATGCTTTTGATGTCTGGGGCCAAGGGACAATGGTCACCGTCTCTTCAG
 JH4 ACTACTTTGACTACTGGGGCCAAGGAACCCTGGTCACCGTCTCCTCAG
 JH5 ACACTGGTTCGACTCCTGGGGCCAAGGAACCCTGGTCACCGTCTCCTCAG
 JH6 AT(TAC)₅GGTATGGACGTCTGGGGCCAAGGGACCACGGTCACCGTCTCCTCAG
Consensus TCGACCTCTGGGGCCAAGGAACCCTGGTCACCGTCTCCTCAG

mouse heavy chain J regions

J | CH1

JH1 TACTGGTACTTCGATGTCTGGGGCCAGGGACCACGGTCACCGTCTCCTCAG
 JH2 TACTTTGACTACTGGGGCCAAGGCACCCTCTCACAGTCTCCTCAG
 JH3 CCTGGTTTGCTTACTGGGGCCAAGGGACTCTGGTCACGTCTCTGCAG
 JH4 TACTATGCTATGGACTACTGGGGTCAAGGAACCTCAGTCACCGTCTCCTCAG
Consensus TTTGACTACTGGGGCCAAGGGACCACGGTCACCGTCTCCTCAG

Ig light chain J-C region

human Kappa J region

J | C

JK1 GGACGTTCCGGCCAAGGGACCAAGGTGGAAATCAAAC
 JK2 ACACTTTTGGCCAGGGGACCAAGCTGGAGATCAAAC
 JK3 TCACTTTCGGCCCTGGGACCAAGTGGATATCAAAC
 JK4 TCACTTTCGGCGGAGGGACCAAGGTGGAGATCAAAC
 JK5 TCACCTTCGGCCAAGGGACACGACTGGAGATTAAC
Consensus TTCGGCCAAGGGACCAAGGTGGAGATCAAAC

mouse Kappa J region

J | C

JK1 TGGACGTTCCGGTGGAGGCACCAAGCTGGAAATCAAAC
 JK2 TACACGTTCCGAGGGGGGACCAAGCTGGAAATAAAAC
 JK3 TTCACATTCACTGATGGGACCAAGCTGGAAATAAAAC
 JK4 TTCACGTTCCGGCTCGGGGACCAAGTGGAAATAAAAC
 JK5 CTCACGTTCCGGTGTCTGGGACCAAGCTGGAGCTGAAAC
Consensus TTCGGTGGGGGACCAAGCTGGAAATAAAAC
 UIG[MJK] ₃TGGTTCGACCTTTATTTG₅

human Lambda pseudo J region

J | C

JPSL1 CACATGTTTGGCAGCAAGACCCAGCCACTGTCTTAG

mouse Lambda J region

J | C

JL1 TGGGTGTTCCGGTGGAGGAACCAAACTGACTGTCTCCTAG
 JL2 TATGTTTTGGCGGTGGAACCAAGGTCACTGTCTCCTAG
 JL3 TTTATTTTCGGCAGTGGAAACCAAGGTCACTGTCTCCTAG
Consensus TTCGGCGGTGGAACCAAGGTCACTGTCTCCTAG

SUBSTITUTE SHEET

FIG. 3

SUBSTITUTE SHEET

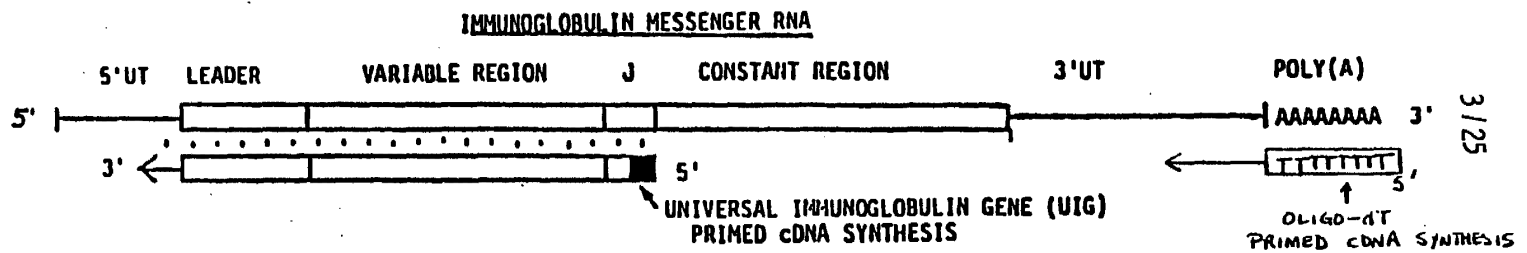

4/25

FIG. 4

A. Synthesis of Human IgG1 Genes

a. Human IgG1 Heavy Chain Structure

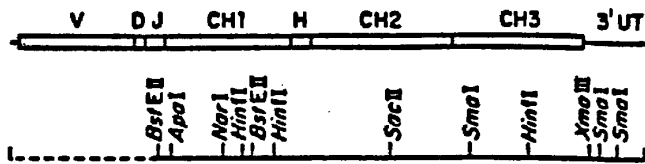

b. cDNA Clones

100 b

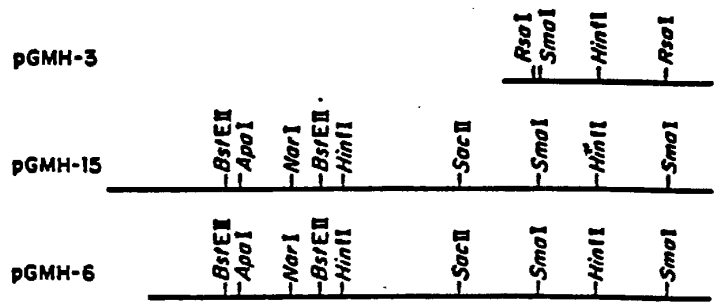

B. A Human IgG1 Constant Region Cloning Vector for V Region Module Insertion

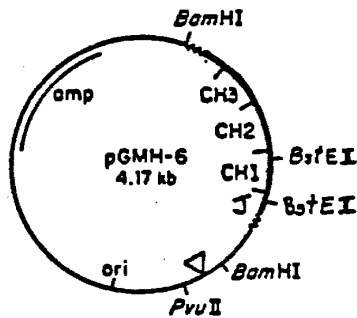

SUBSTITUTE SHEET

5/25

FIG. 5

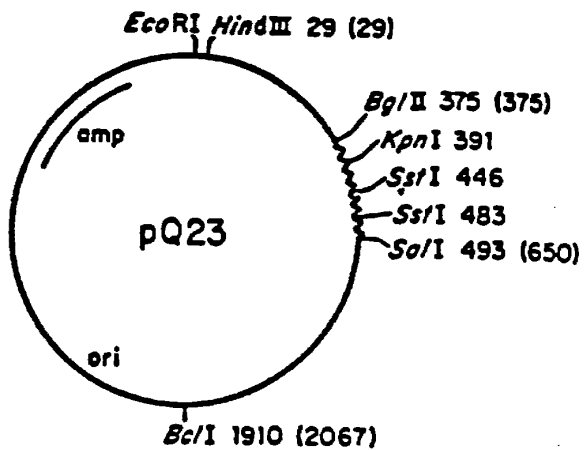

SUBSTITUTE SHEET

6/25

FIG. 6

A. Synthesis of Human IgK Genes

a. Human IgK Light Chain Structure

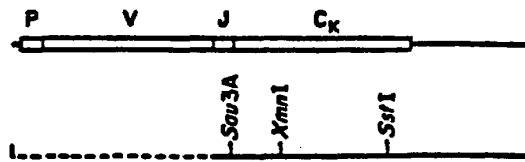

b. cDNA Clones

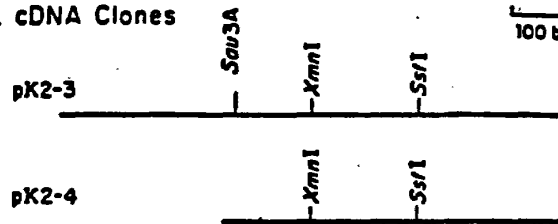

B. Construction of a Human C_κ Region Cloning Vector

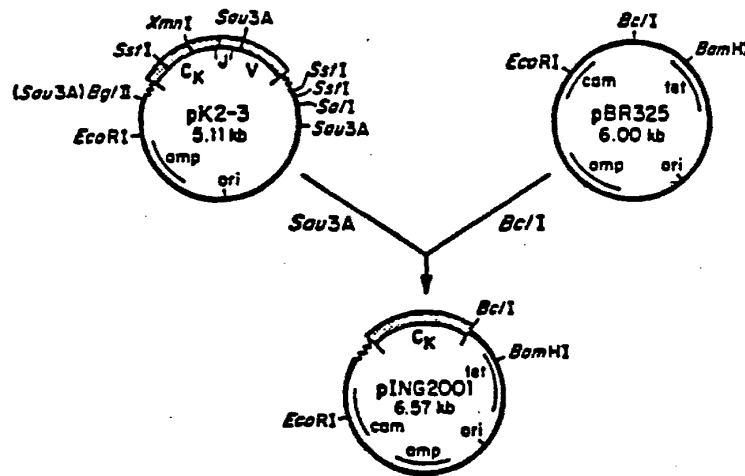

7/25

Fig. 7

Primers Designed for Ig V Region Synthesis

A. Ig Heavy Chain J-C Region

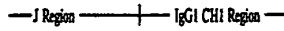

Human IgG1 pGMH-6-

GGTCACCGTCTCCTCAG CCTCCACCAAGGGCCCATC
Bst EI

Mouse Heavy Chain J Regions and Primers:

		Mismatches				
		N	JH1	JH2	JH3	JH4
JH1 (MJH1)	TACTGGTACTTCGATGCTGGGGCGCAGGGACACGGTCACCGTCTCCTCAG GCCAGTGGCAGAGGAGTCGGT	21	0	4	4	1
JH2 (MJH2)	TACTTTGACTACTGGGGCCAAGGCACCACTCTCACAGTCTCCTCAG GAGAGTGCAGACGAGTCGGT	21	4	1	7	4
JH3 (MJH3)	CCTGGTTTGCTTACTGGGGCCAAGGACTCTGGTCACGTCTCTGCAG ACCACTGACAGAGACGTCGGT	21	4	7	0	5
(MJH-BSTEII)	TCCCTGAGACCAAGTGGCAGAG	21	3	7	1	5
(MJH-BSTEII (B))	ACCACTGTCAGAG	13	1	4	1	2
(MJH-BSTEII (U))	Bst EI					
JH4 (MJH4)	TACTATGCTATGGACTACTGGGGTCAAGGAACCTCAGTCACCGTCTCCTCAG GTCAGTGGCAGAGGAGTCGGT	21	1	4	5	0

B. Ig Kappa Chain J-C Region

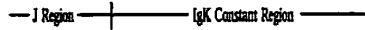

Human Kappa pK2-3
pINGMUSE

CTGAGATGAAC GAACTGTGGCTGCACCACTGTCTTCATCTTCCC
TGATCAAC GAACTGTGGCTGCACCACTGTCTTCATCTTCCC
Bcl

Mouse Heavy Kappa J Regions and Primers

		Mismatches				
		N	JK1	JK2	JK4	JK5
JK1 (SJK1)	TGGACGTCGGTGGAGGCACCAAGCTGGAAATCAAAC GCAAGCCACCTCCGTGG	17	0	3	6	3
JK2 (JK2BGLII)	TACACGTTCCGAGGGGGACCAAGCTGGAAATAAAC CCCTGGTTCGACCTTAGATT	21	3	3	5	3
(SJK2)	GTGCAAGCCCTCCCCCTGG BglII					
JK4 (SJK4)	TTCACGTTCCGCTCGGGGACAAAGTTGGAAATAAAC GCAAGCCGAGCCCTGT	17	6	4	0	4
(JK4BGLII)	GCCCCGTTCACACCTTAGATT BglII	13	7	6	3	6
JK5 (SJK5)	CTCACGTTCCGCTGGGACCAAGCTGGAGCTGAAAC GCAAGCCACGACCTGG	17	3	3	4	0
(SJK)	TGGTTCGACCTTATTTTG	19	1	0	2	3

SUBSTITUTE SHEET

8/25

FIG. 7B

C. Mouse Variable Region Consensus Primers

mouse heavy chain J segments

```

JH1  TACTGGTACTTCGATGTCTGGGGCGCAGGGACCAC GGCACC GTCTCCTCA
JH2      TACTTTGACTACTGGGGCCAAGGACCAC GGCACC GTCTCCTCA
JH3      CCTGGTTTGCTTACTGGGGCCAAGGGACCC GGCACC GTCTCTGCA
JH4      TACTATGCTATGGACTACTGGGGTCAAGGACC GGCACC GTCTCCTCA
    
```

```

consensus primer:  UIG-H      AGGGACCAC GGCACC GTCTC
                                     BstEII
                                     CCAGTGG CAGAG
3'                                     5'
    
```

mouse light chain J segments

```

JK1      TGGACGTTCCGGTGGAGGACC AAGCTG GAATCAAA
JK2      TACACGTTCCGGAGGGGGACC AAGCTG GAATAAAA
JK4      TTCACGTTCCGGCTCGGGGACC AAGCTG GAATAAAA
JK5      CTCACGTTCCGGTGCTGGGACC AAGCTG GAGCTGAAA
    
```

```

consensus primer:  UIG-K      GGGACC AAGCTT GAG
                                     HindIII
                                     CCTGG TTCGAA CTC
3'                                     5'
    
```

```

pGML60      GGAGGGACC AAGGTG GAGATGAAA
               -----C-T-----
               HindIII
    
```

D. Mouse γ 2a J/C Junction Primer

```

MJH2-ApaI      TGTCAGAGGAGTCGGTCTGTGTTCCCGGGTA
3'                                     ApaI 5'
    
```

SUBSTITUTE SHEET

FIG. 9A

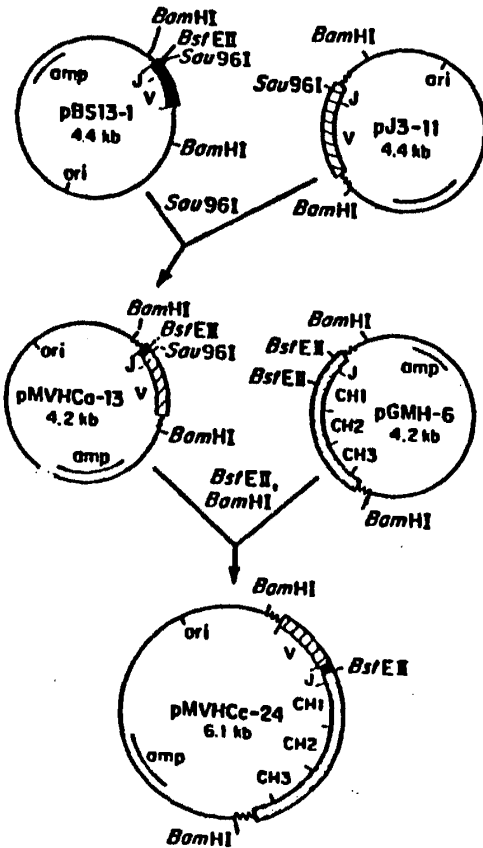
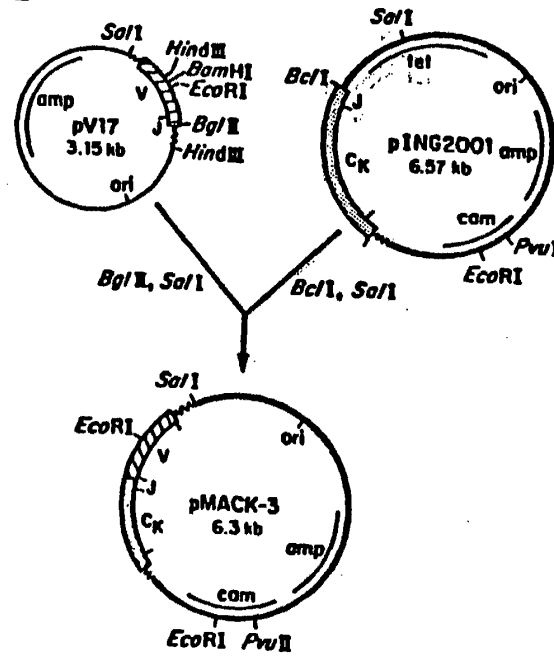

FIG. 9B



9/25

10 / 25

FIG. 8

Heavy Chain V Region Module Gene Synthesis

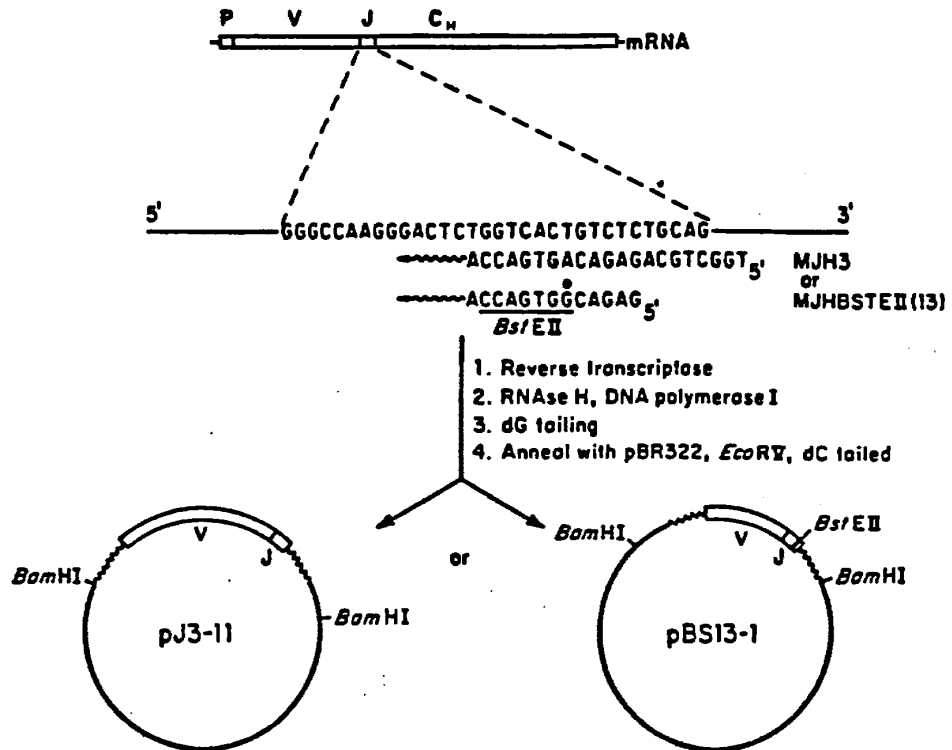

SUBSTITUTE SHEET

11/25

FIG. 10

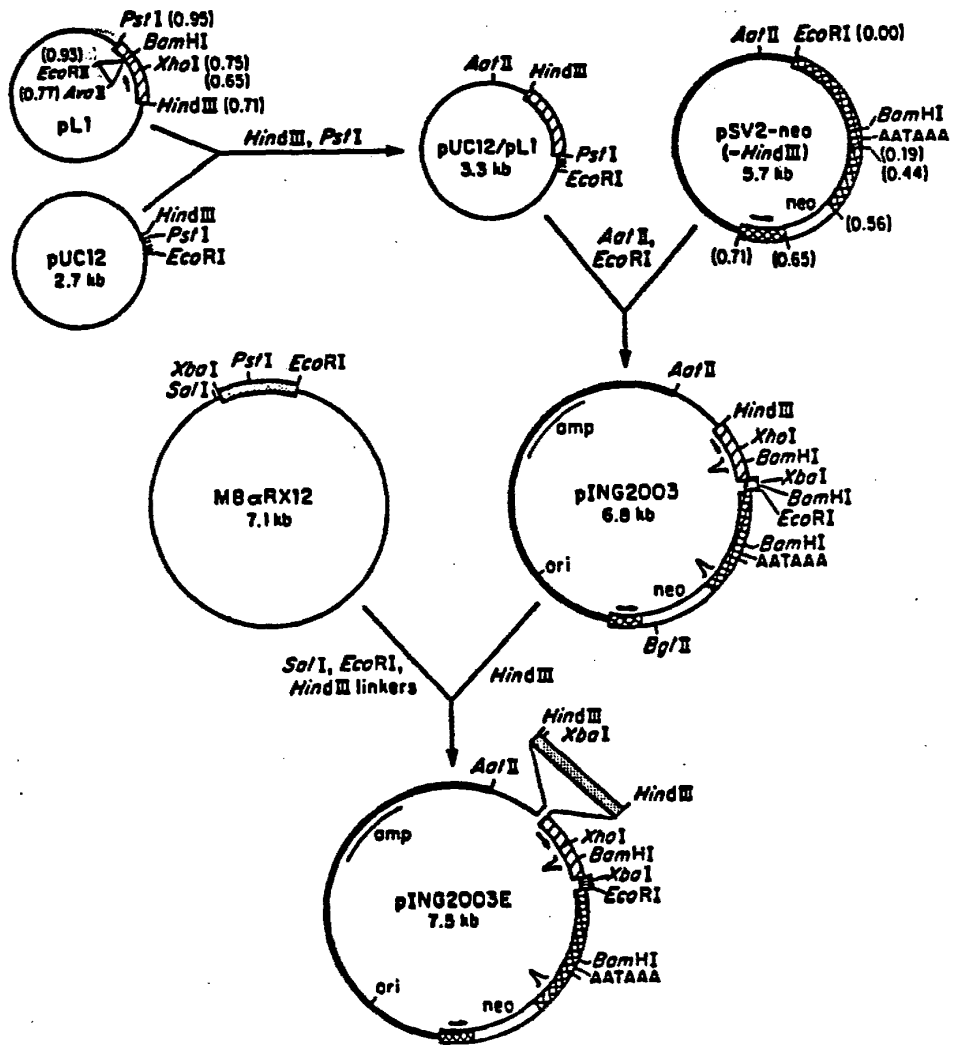

SUBSTITUTE SHEET

12/25

FIG. 11

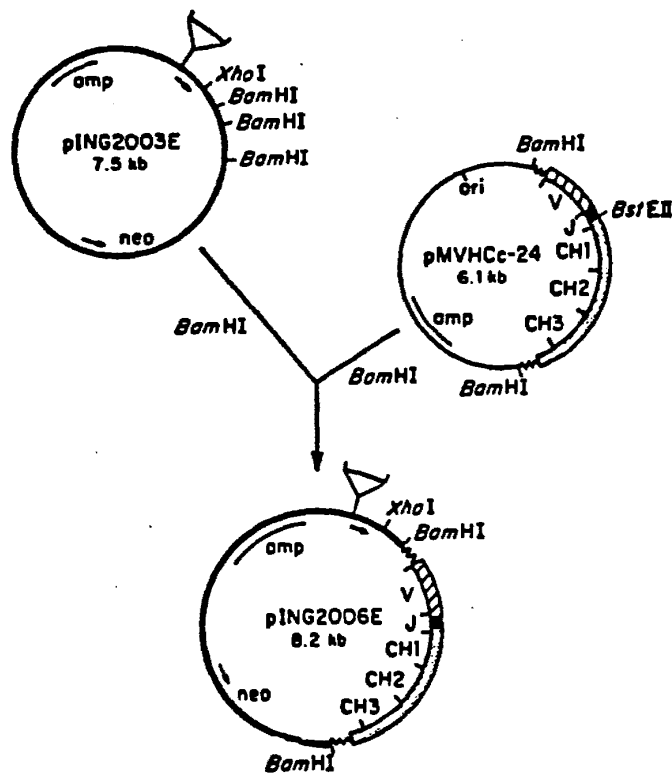

SUBSTITUTE SHEET

14 / 25

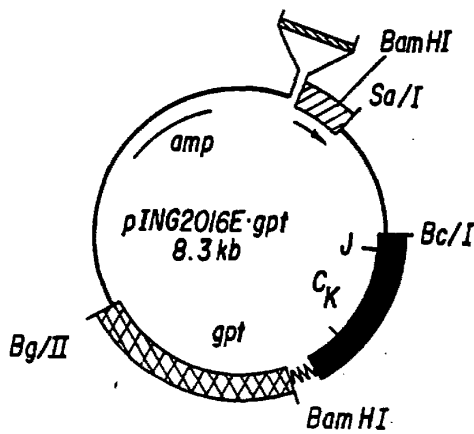
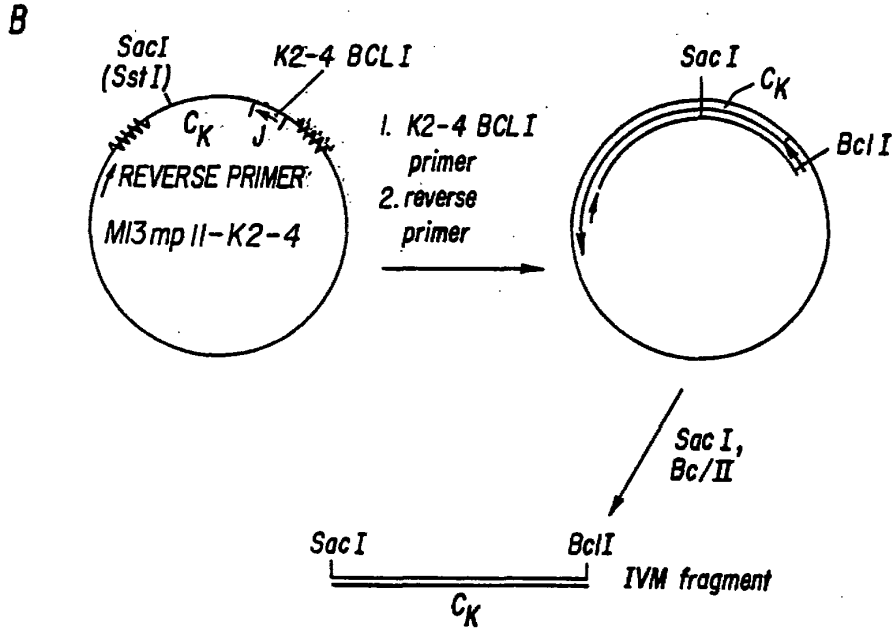
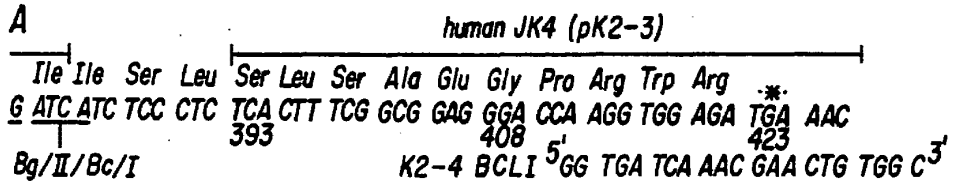
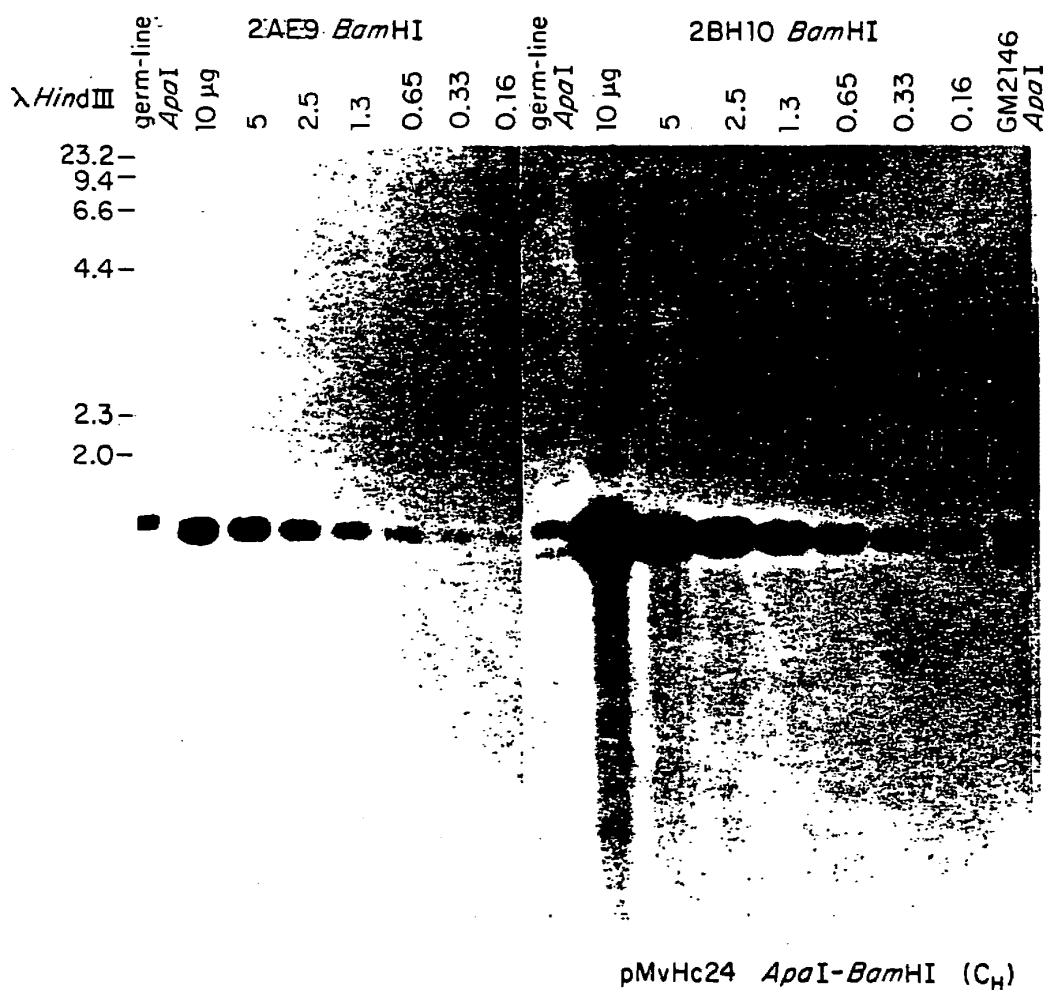

FIG. 13

SUBSTITUTE SHEET

15/25



SUBSTITUTE SHEET

FIG. 15

16 / 25

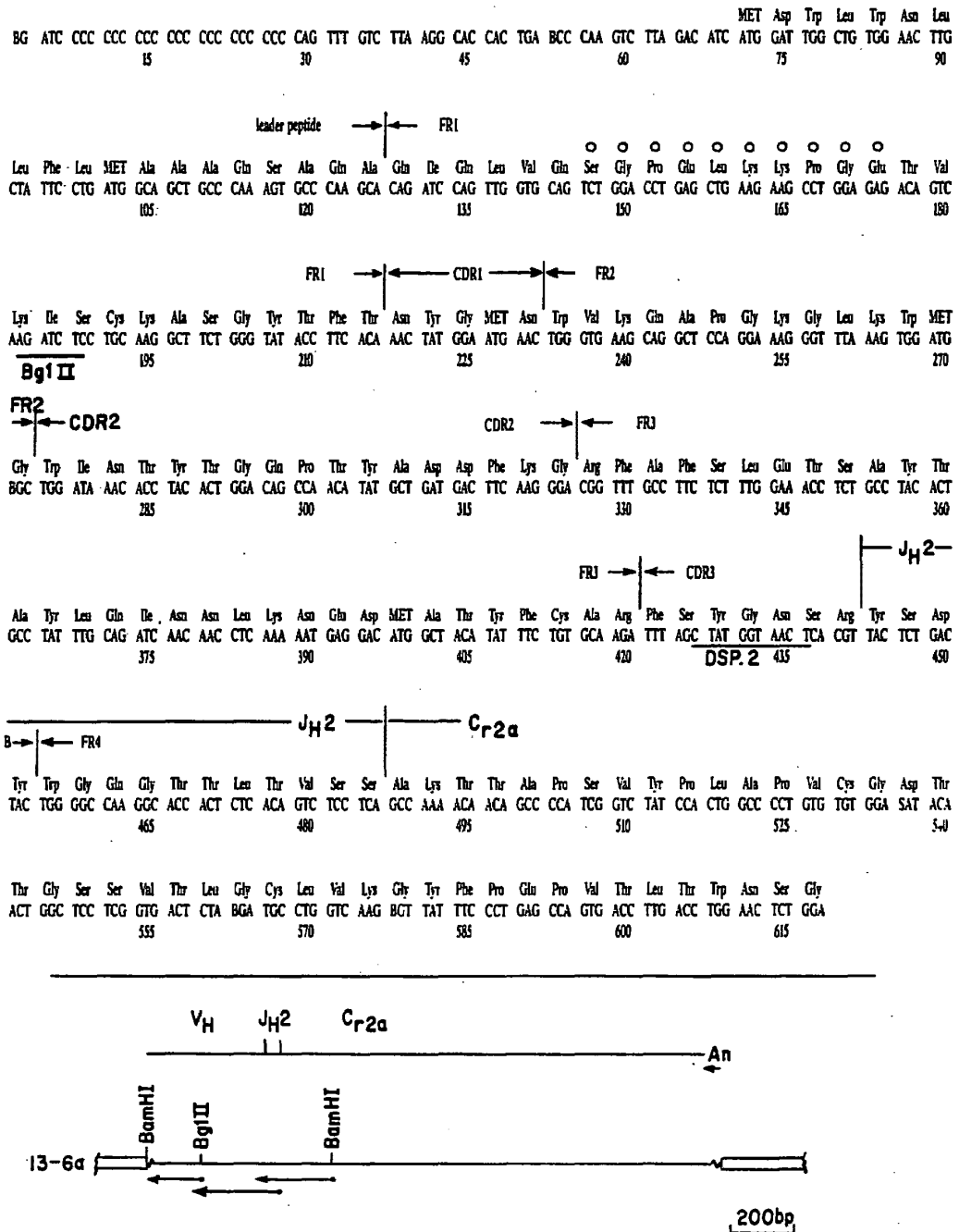

SUBSTITUTE SHEET

Fig. 16

17/25

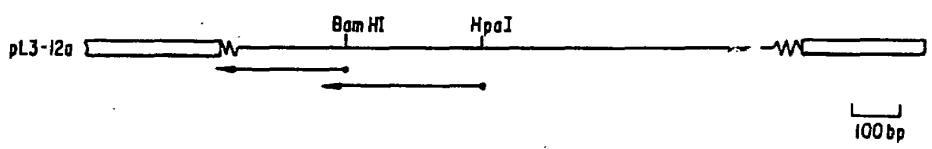
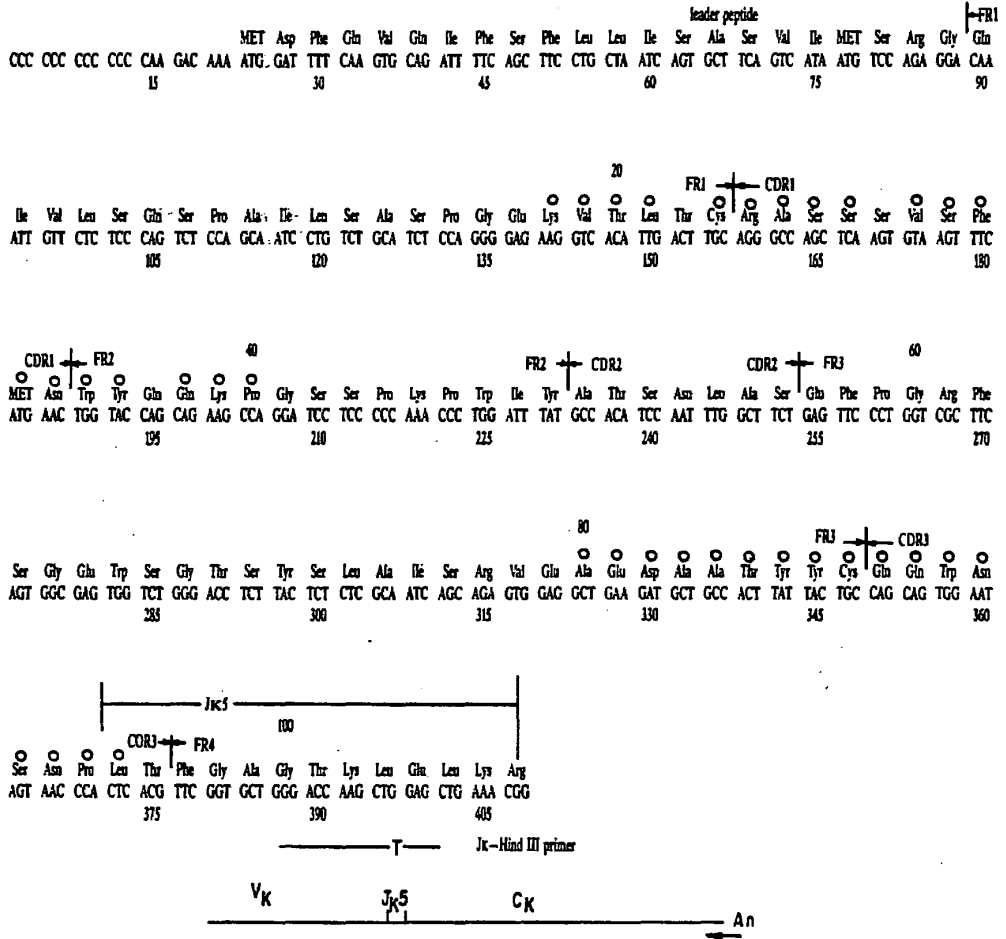

SUBSTITUTE SHEET

19 / 25

FIG.18

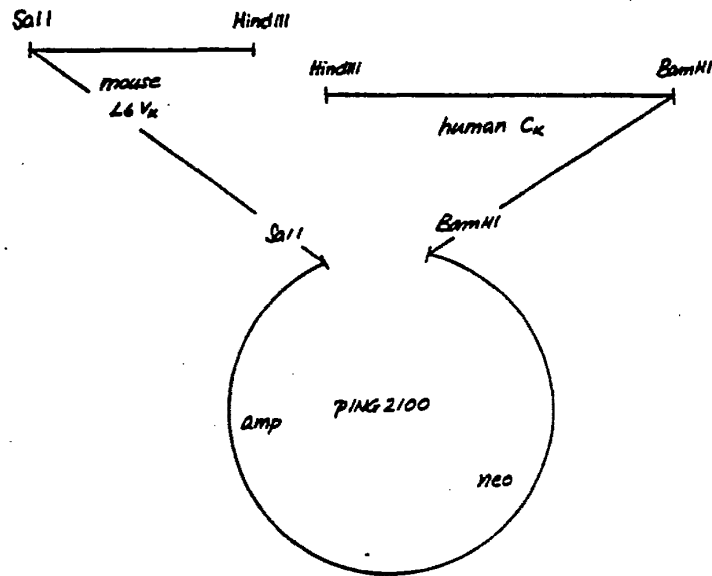

SUBSTITUTE SHEET

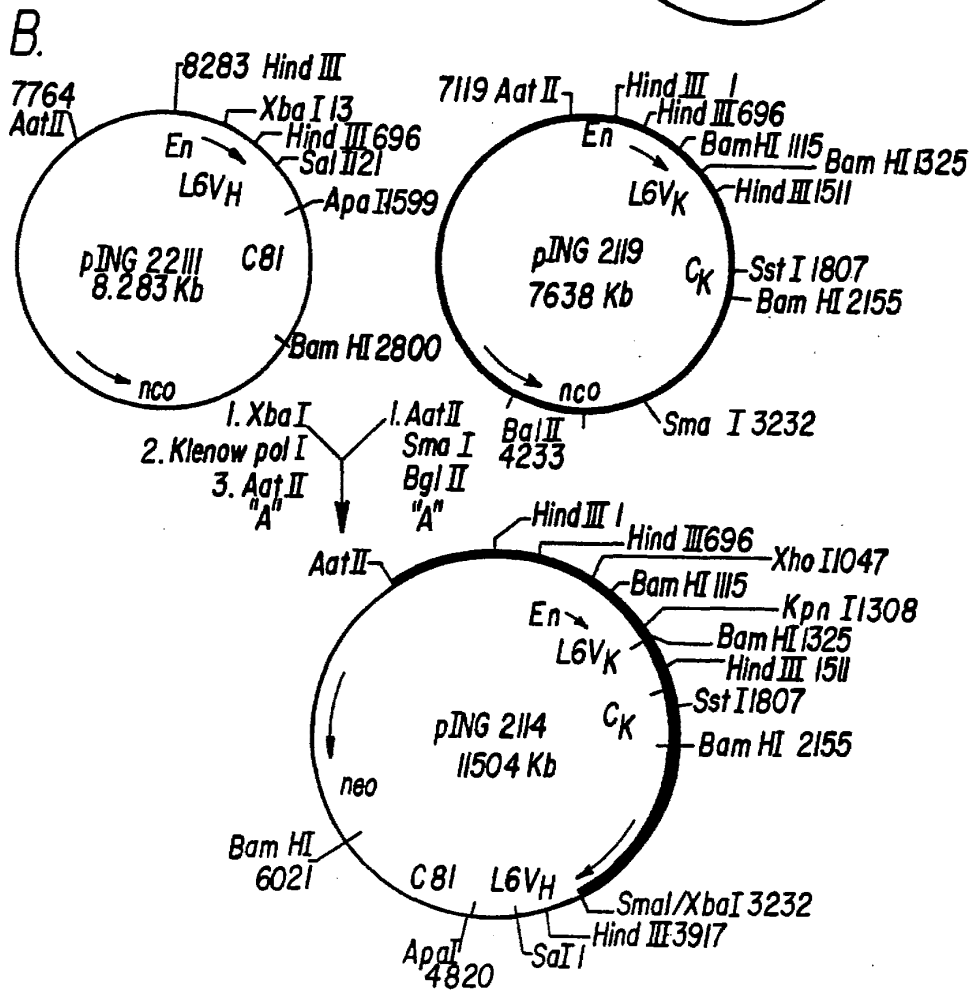
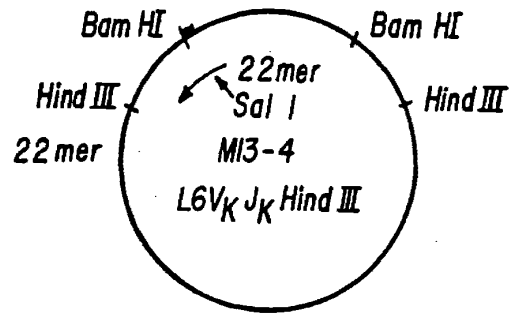
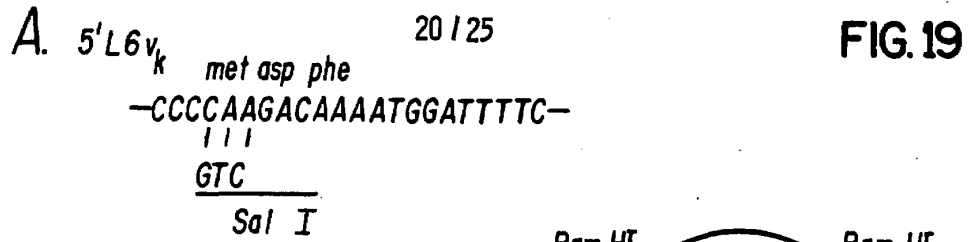

SUBSTITUTE SHEET

FIG. 20

L6 chimeras

VH pN3-66 (Sw) oligo(dT) clone, BAL-31 deletions 5', C₂IAPN mutagenesis → PING 2111 neo

PING 2112 neo

Sall PING 2111 PING 2112
 5' GTC GAC TCT AG TTT GTCTTAA GGC ACC ACT GAG CCC AAG
 met
TCTTAGACATCATGGAT

joint ACC ACT CTC ACA GTC TCC TCA | GCC AGC ACA AAG GGC
 ApaI
 CCA T

VH p13-12a (Jas) oligo(dT) clone, J_KNINDII mutagenesis, 5' JAL mutagenesis → PING 2119 neo

PING 2120 gpc

Sall met
 5' GTC GAC AAA ATG GAT

joint ACC AAG CT GAG A TG AAA | CGA ACT
 mo hu C_K

21/25

SUBSTITUTE SHEET

23/25

FIG. 22

2H7 light chain variable sequence

leader peptide

met asp phe gln val gln ile phe ser phe leu leu
 C₂₃CCCAAATTCAAAGACAAAATG GAT TTT CAA GTG CAG ATT TTC AGC TTC CTG CTA
 ————GTC————— *Sal I primer*

ile ser ala ser val ile ile ala arg gly | *FR1* | gln ile val leu ser gln ser
 ATC AGT GCT TCA GTC ATA ATT GCC AGA GGA CAA ATT GTT CTC TCC CAG TCT

pro ala ile leu ser ala ser pro gly glu lys val thr met thr cys arg | *FR1* |
 CCA GCA ATC CTG TCT GCA TCT CCA GGG GAG AAG GTC ACA ATG ACT TGC AGG

CDR1 | *FR2* | *FR3*
 ala ser ser ser val ser tyr met his trp tyr gln gln lys pro gly ser
 GCC AGC TCA AGT GTA AGT TAC ATG CAC TGG TAC CAG CAG AAG CCA GGA TCC
 † *Kpn I* † † *Bam HI*

FR2 | *CDR2* | *CDR2* | *FR3*
 ser pro lys pro trp ile tyr ala pro ser asn leu ala ser gly val pro
 TCC CCC AAA CCC TGG ATT TAT GCC CCA TCC AAC CTG GCT TCT GGA GTC CCT

ala arg phe ser gly ser gly ser gly thr ser tyr ser leu thr ile ser
 GCT CGC TTC AGT GGC AGT GGG TCT GGG ACC TCT TAC TCT CTC ACA ATC AGC

arg val glu ala glu asp ala ala thr tyr tyr cys | *FR3* | *CDR3* | gln gln trp ser phe
 AGA GTG GAG GCT GAA GAT GCT GCC ACT TAT TAC TGC CAG CAG TGG AGT TTT

CDR3 | *FR4* | *FR4*
 asn pro pro thr phe gly ala gly thr lys leu glu leu lys
 AAC CCA CCC ACG TTC GGT GCT GGG ACC AAG CTG GAG CTG AAA
 —————T————— *Jκ Hind III primer*

SUBSTITUTE SHEET

24/25

FIG. 23

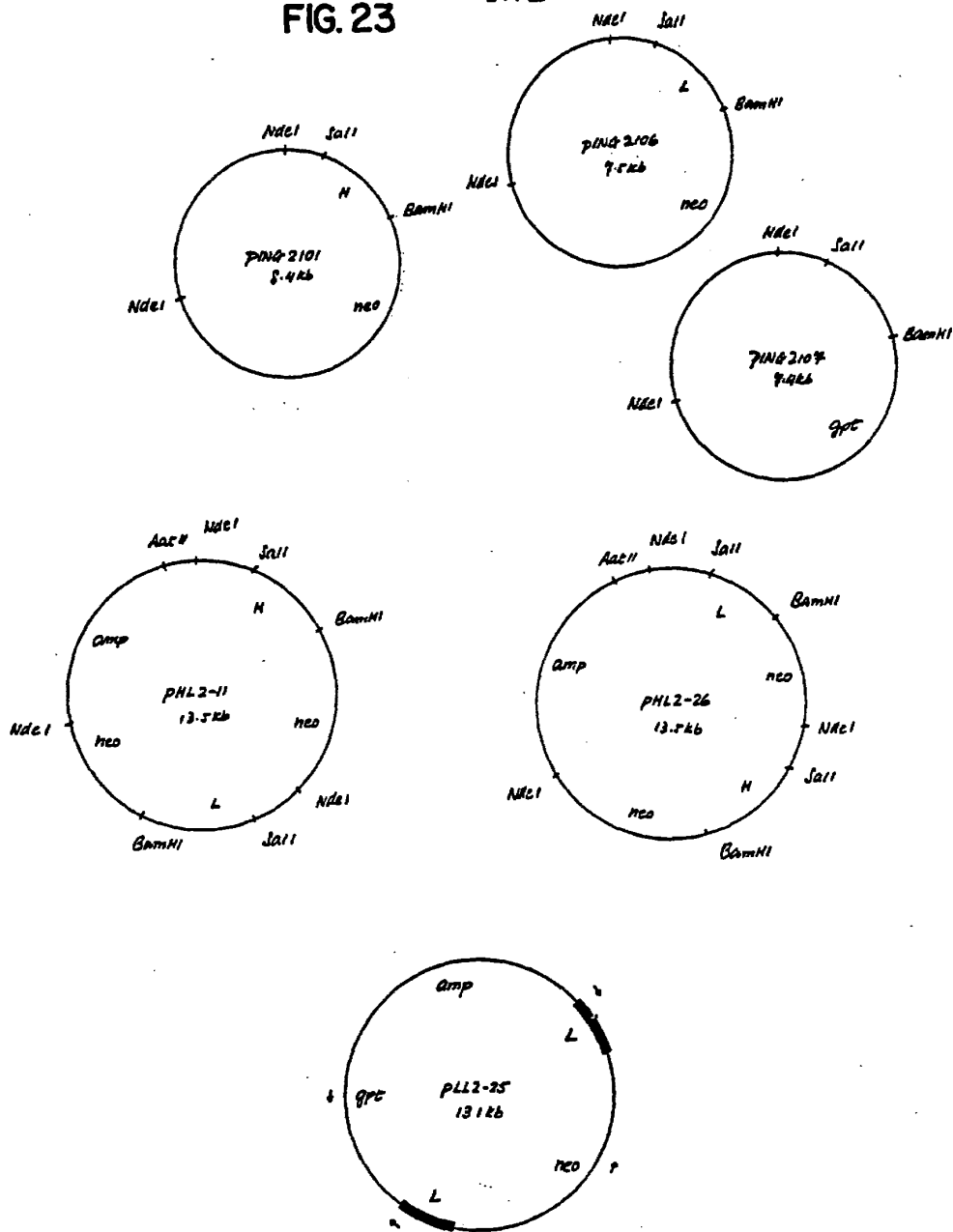

SUBSTITUTE SHEET

FIG. 24

2H7 Chimerae

V_H pM2-7 (JH1) JH BstEII clone, NcoI cut 5' ATC → pING 2101 neo

5' ^{SaI I}
_↓ G T C C A C A T G G G A ^{met}

joint ^{mo, hu} A C G G T C A C C G T C T C ⊕ T C A | ^{Cy1} G C C T C C

V_K pL2-12 (Jh+) oligo(dT) clone, Jk HindIII mutagenesis, 5' SAL mutagenesis → pING 2106 neo
 pING 2107 gat

5' ^{SaI I}
_↓ G T C G A C A A A A T G G A T ^{met}

joint ^{mo + hu} A C C A A G C T ⊕ G A G ⊕ A T G A A A | ^{Cx} C G A A C T

25/25

SUBSTITUTE SHEET

INTERNATIONAL SEARCH REPORT

International Application No **PCT/US86/02269**

I. CLASSIFICATION OF SUBJECT MATTER (If several classification symbols apply, indicate all) ³		
According to International Patent Classification (IPC) or to both National Classification and IPC		
I.P.C. 4: C07H 15/12; C12P 21/00; C12N 15/00; C07K 13/00		
U.S. 536/27; 435/68; 435/172.3; 530/388		
II. FIELDS SEARCHED		
Minimum Documentation Searched ⁴		
Classification System	Classification Symbols	
U.S.	536/27 435/68, 70, 172.3, 243, 253, 255, 317 935/15; 539/388	
Documentation Searched other than Minimum Documentation to the Extent that such Documents are Included in the Fields Searched ⁵		
Chemical Abstracts Data Base (CAS) 1967-1987; Biological Abstracts Data Base (BIOSIS) 1967-1987; Key Words: Immunoglobulin, hybrid, constant, variable, plasmid and recombinant DNA		
III. DOCUMENTS CONSIDERED TO BE RELEVANT ¹⁴		
Category ⁶	Citation of Document, ¹⁰ with indication, where appropriate, of the relevant passages ¹⁷	Relevant to Claim No. ¹⁸
K,P Y	EP, A, 173, 494 (MORRISON) 05 March 1986. See pages 14-21, particularly, pages 14-17.	<u>1-28</u> 29-50
K,P Y	EP, A, 171,496 (TANIGUCHI) 19 February 1986. See pages 5-15.	<u>1-28</u> 1-50
Y	<u>PROCEEDINGS OF THE NATIONAL ACADEMY OF SCIENCES, (USA)</u> (Washington, D.C) Volume 77 Issued October 1980 (DOLBY ET AL) "Cloning and Partial Nucleotide Sequence of Human Immunoglobulin μ chain cDNA from B cells and Mouse-Human Hybridomas". See pages 6027-6031.	1-50
<p>¹⁵ Special categories of cited documents:</p> <p>"A" document defining the general state of the art which is not considered to be of particular relevance</p> <p>"E" earlier document but published on or after the international filing date</p> <p>"L" document which may throw doubts on priority claim(s) or which is cited to establish the publication date of another citation or other special reason (as specified)</p> <p>"O" document referring to an oral disclosure, use, exhibition or other means</p> <p>"P" document published prior to the international filing date but later than the priority date claimed</p> <p>"T" later document published after the international filing date or priority date and not in conflict with the application but cited to understand the principle or theory underlying the invention</p> <p>"X" document of particular relevance; the claimed invention cannot be considered novel or cannot be considered to involve an inventive step</p> <p>"Y" document of particular relevance; the claimed invention cannot be considered to involve an inventive step when the document is combined with one or more other such documents, such combination being obvious to a person skilled in the art.</p> <p>"&" document member of the same patent family</p>		
IV. CERTIFICATION		
Date of the Actual Completion of the International Search ²	Date of Mailing of this International Search Report ³	
12 January 1987	22 JAN 1987	
International Searching Authority ¹	Signature of Authorized Officer ²⁰	
ISA/US	Thomas D. Mays	

Form PCT/ISA/210 (second sheet) (October 1981)

III. DOCUMENTS CONSIDERED TO BE RELEVANT (CONTINUED FROM THE SECOND SHEET)		
Category *	Citation of Document, ¹⁶ with indication, where appropriate, of the relevant passages ¹⁷	Relevant to Claim No. ¹⁸
<u>Y</u>	<u>NATURE</u> (London) Volume 314 Issued 21 March 1985 (NEUBERGER ET AL) "A Hapten-Specific Chimaeric IgE Antibody with Human Physiological Effector Function" See pages 268-270.	1-50
<u>X</u> <u>Y</u>	<u>NATURE</u> (London) Volume 309 Issued 24 May 1984 (SHARON ET AL) "Expression of a V _H C _K Chimaeric Protein in Mouse Myeloma Cells" See pages 364-367.	<u>1-28</u> 29-50
<u>X</u> <u>Y</u>	<u>PROCEEDINGS OF THE NATIONAL ACADEMY OF SCIENCES, (USA), (Washington, D.C.)</u> Volume 81 Issued November 1984 (MORRISON ET AL) "Chimeric Human Antibody Molecules: Mouse Antigen Binding Domains with Human Constant Region Domains" See pages 6851-6855.	<u>1-28</u> 29-50
<u>X</u> <u>Y</u>	EP,A, 125,023 (CABILLY) 14 November 1984. See pages 20-54, particularly pages 20-29.	<u>1-28</u> 29-50
<u>X</u> <u>Y</u>	GB,A, 2,137,631 (BOSS) 10 October 1984 See pages 1-16, particularly pages 5-14.	<u>1-28</u> 29-50

FURTHER INFORMATION CONTINUED FROM THE SECOND SHEET

<u>X</u> Y	NATURE (London) Volume 314 Issued 4 April 1985 (TAKEDA ET AL) "Construction of Chimaeric Processed Immunoglobulin Genes Containing Mouse Variable and Human Constant Region Sequences" See pages 452-454.	<u>1-28</u> <u>29-50</u>
<u>X</u> Y	NATURE (London) Volume 312 Issued 13 December 1984 (BOULIANNE ET AL) "Production of Functional Chimaeric Mouse/ Human Antibody" See pages 643- 646.	<u>1-28</u> <u>29-50</u>

V. OBSERVATIONS WHERE CERTAIN CLAIMS WERE FOUND UNSEARCHABLE ¹⁰

This international search report has not been established in respect of certain claims under Article 17(2) (a) for the following reasons:

1. Claim numbers because they relate to subject matter ¹² not required to be searched by this Authority, namely:

2. Claim numbers because they relate to parts of the international application that do not comply with the prescribed requirements to such an extent that no meaningful international search can be carried out ¹², specifically:

VI. OBSERVATIONS WHERE UNITY OF INVENTION IS LACKING ¹¹

This international Searching Authority found multiple inventions in this international application as follows:

1. As all required additional search fees were timely paid by the applicant, this international search report covers all searchable claims of the international application.

2. As only some of the required additional search fees were timely paid by the applicant, this international search report covers only those claims of the international application for which fees were paid, specifically claims:

3. No required additional search fees were timely paid by the applicant. Consequently, this international search report is restricted to the invention first mentioned in the claims; it is covered by claim numbers:

4. As all searchable claims could be searched without effort justifying an additional fee, the International Searching Authority did not invite payment of any additional fee.

Remark on Protest

The additional search fees were accompanied by applicant's protest.

No protest accompanied the payment of additional search fees.



INTERNATIONAL APPLICATION PUBLISHED UNDER THE PATENT COOPERATION TREATY (PCT)

(51) International Patent Classification ⁴ : C07K 13/00, C12P 21/00 C12N 15/00, C07H 15/12	A1	(11) International Publication Number: WO 88/ 09344 (43) International Publication Date: 1 December 1988 (01.12.88)
(21) International Application Number: PCT/US88/01737 (22) International Filing Date: 19 May 1988 (19.05.88) (31) Priority Application Number: 052,800 (32) Priority Date: 21 May 1987 (21.05.87) (33) Priority Country: US (60) Parent Application or Grant (63) Related by Continuation US 052,800 (CIP) Filed on 21 May 1987 (21.05.87) (71) Applicant (for all designated States except US): CREA- TIVE BIOMOLECULES, INC. [US/US]; 35 South Street, Hopkinton, MA 01748 (US).	(72) Inventors; and (75) Inventors/Applicants (for US only) : HUSTON, James, S. [US/US]; 41 Whittemore Road, Newton, MA 02158 (US). OPFERMANN, Hermann [US/US]; 25 Summerhill Road, Medway, MA 02053 (US). (74) Agent: PITCHER, Edmund, R.; Lahive & Cockfield, 60 State Street, Boston, MA 02109 (US). (81) Designated States: AT (European patent), AU, BE (Euro- pean patent), CH (European patent), DE (Euro- pean patent), DK, FI, FR (European patent), GB (European patent), IT (European patent), JP, LU (European patent), NL (European patent), NO, SE (European patent), US. Published <i>With international search report.</i>	
(54) Title: TARGETED MULTIFUNCTIONAL PROTEINS		
(57) Abstract <p>Disclosed are a family of synthetic proteins having binding affinity for a preselected antigen, and multifunctional proteins having such affinity. The proteins are characterized by one or more sequences of amino acids constituting a region which behaves as a biosynthetic antibody binding site (BABS). The sites comprise V_H-V_L or V_L-V_H-like single chains wherein the V_H and V_L-like sequences are attached by a polypeptide linker, or individual V_H or V_L-like domains. The binding domains comprise linked CDR and FR regions, which may be derived from separate immunoglobulins. The proteins may also include other polypeptide sequences which function, e.g., as an enzyme, toxin, binding site, or site for attachment to an immobilization media or radioactive atom. Methods are disclosed for producing the proteins, for designing BABS having any specificity that can be elicited by <i>in vivo</i> generation of antibody, for producing analogs thereof, and for producing multifunctional synthetic proteins which are self-targeted by virtue of their binding site region.</p>		

FOR THE PURPOSES OF INFORMATION ONLY

Codes used to identify States party to the PCT on the front pages of pamphlets publishing international applications under the PCT.

AT	Austria	FR	France	ML	Mali
AU	Australia	GA	Gabon	MR	Mauritania
BB	Barbados	GB	United Kingdom	MW	Malawi
BE	Belgium	HU	Hungary	NL	Netherlands
BG	Bulgaria	IT	Italy	NO	Norway
BJ	Benin	JP	Japan	RO	Romania
BR	Brazil	KP	Democratic People's Republic of Korea	SD	Sudan
CF	Central African Republic	KR	Republic of Korea	SE	Sweden
CG	Congo	LI	Liechtenstein	SN	Senegal
CH	Switzerland	LK	Sri Lanka	SU	Soviet Union
CM	Cameroon	LU	Luxembourg	TD	Chad
DE	Germany, Federal Republic of	MC	Monaco	TG	Togo
DK	Denmark	MG	Madagascar	US	United States of America
FI	Finland				

- 1 -

TARGETED MULTIFUNCTIONAL PROTEINS

The United States Government has rights in this application pursuant to small business innovation research grant numbers SSS-4 R43 CA39870-01 and SSS-4 2 R44 CA39870-02.

Reference to Related Applications

This application is a continuation-in-part of copending U.S. application serial number 052,800 filed May 21, 1987, the disclosure of which is incorporated herein by reference.

Background of the Invention

This invention relates to novel compositions of matter, hereinafter called targeted multifunctional proteins, useful, for example, in specific binding assays, affinity purification, biocatalysis, drug targeting, imaging, immunological treatment of various oncogenic and infectious diseases, and in other contexts. More specifically, this invention relates to biosynthetic proteins expressed from recombinant DNA as a single polypeptide chain comprising plural regions, one of which has a structure similar to an antibody binding site, and an affinity for a preselected antigenic determinant, and another of which has a separate function, and may be biologically active, designed to

- 2 -

bind to ions, or designed to facilitate immobilization of the protein. This invention also relates to the binding proteins per se, and methods for their construction.

There are five classes of human antibodies. Each has the same basic structure (see Figure 1), or multiple thereof, consisting of two identical polypeptides called heavy (H) chains (molecularly weight approximately 50,000 d) and two identical light (L) chains (molecular weight approximately 25,000 d). Each of the five antibody classes has a similar set of light chains and a distinct set of heavy chains. A light chain is composed of one variable and one constant domain, while a heavy chain is composed of one variable and three or more constant domains. The combined variable domains of a paired light and heavy chain are known as the Fv region, or simply "Fv". The Fv determines the specificity of the immunoglobulin, the constant regions have other functions.

Amino acid sequence data indicate that each variable domain comprises three hypervariable regions or loops, sometimes called complementarity determining regions or "CDRs" flanked by four relatively conserved framework regions or "FRs" (Kabat et. al., Sequences of Proteins of Immunological Interest [U.S. Department of Health and Human Services, third edition, 1983, fourth edition, 1987]). The hypervariable regions have been assumed to be responsible for the binding specificity of individual antibodies and to account for the diversity of binding of antibodies as a protein class.

- 3 -

Monoclonal antibodies have been used both as diagnostic and therapeutic agents. They are routinely produced according to established procedures by hybridomas generated by fusion of mouse lymphoid cells with an appropriate mouse myeloma cell line.

The literature contains a host of references to the concept of targeting bioactive substances such as drugs, toxins, and enzymes to specific points in the body to destroy or locate malignant cells or to induce a localized drug or enzymatic effect. It has been proposed to achieve this effect by conjugating the bioactive substance to monoclonal antibodies (see, e.g., Vogel, Immunoconjugates. Antibody Conjugates in Radioimaging and Therapy of Cancer, 1987, N.Y., Oxford University Press; and Ghose et al. (1978) J. Natl. Cancer Inst. 61:657-676,). However, non-human antibodies induce an immune response when injected into humans. Human monoclonal antibodies may alleviate this problem, but they are difficult to produce by cell fusion techniques since, among other problems, human hybridomas are notably unstable, and removal of immunized spleen cells from humans is not feasible.

Chimeric antibodies composed of human and non-human amino acid sequences potentially have improved therapeutic value as they presumably would elicit less circulating human antibody against the non-human immunoglobulin sequences. Accordingly, hybrid antibody molecules have been proposed which consist of amino acid sequences from different mammalian sources. The chimeric antibodies designed

- 4 -

thus far comprise variable regions from one mammalian source, and constant regions from human or another mammalian source (Morrison et al. (1984) Proc. Natl. Acad. Sci. U.S.A., 81:5851-6855; Neuberger et al. (1984) Nature 312:604-608; Sahagan et al. (1986) J. Immunol. 137:1066-1074; EPO application nos. 84302368.0, Genentech; 85102665.8, Research Development Corporation of Japan; 85305604.2, Stanford; P.C.T. application no. PCT/GB85/00392, Celltech Limited).

It has been reported that binding function is localized to the variable domains of the antibody molecule located at the amino terminal end of both the heavy and light chains. The variable regions remain noncovalently associated (as $V_H V_L$ dimers, termed Fv regions) even after proteolytic cleavage from the native antibody molecule, and retain much of their antigen recognition and binding capabilities (see, for example, Inbar et al., Proc. Natl. Acad. Sci. U.S.A. (1972) 69:2659-2662; Hochman et al. (1973) Biochem. 12:1130-1135; and (1976) Biochem. 15:2706-2710; Sharon and Givol (1976) Biochem. 15:1591-1594; Rosenblatt and Haber (1978) Biochem. 17:3877-3882; Ehrlich et al. (1980) Biochem. 19:4091-40996). Methods of manufacturing two-chain Fv substantially free of constant region using recombinant DNA techniques are disclosed in U.S. 4,642,334 and corresponding published specification EP 088,994.

- 5 -

Summary of the Invention

In one aspect the invention provides a single chain multifunctional biosynthetic protein expressed from a single gene derived by recombinant DNA techniques. The protein comprises a biosynthetic antibody binding site (BABS) comprising at least one protein domain capable of binding to a preselected antigenic determinant. The amino acid sequence of the domain is homologous to at least a portion of the sequence of a variable region of an immunoglobulin molecule capable of binding the preselected antigenic determinant. Peptide bonded to the binding site is a polypeptide consisting of an effector protein having a conformation suitable for biological activity in a mammal, an amino acid sequence capable of sequestering ions, or an amino acid sequence capable of selective binding to a solid support.

In another aspect, the invention provides biosynthetic binding site protein comprising a single polypeptide chain defining two polypeptide domains connected by a polypeptide linker. The amino acid sequence of each of the domains comprises a set of complementarity determining regions (CDRs) interposed between a set of framework regions (FRs), each of which is respectively homologous with at least a portion of the CDRs and FRs from an immunoglobulin molecule. At least one of the domains comprises a set of CDR amino acid sequences and a set of FR amino acid sequences at least partly homologous to different immunoglobulins. The two polypeptide

- 6 -

domains together define a hybrid synthetic binding site having specificity for a preselected antigen, determined by the selected CDRs.

In still another aspect, the invention provides biosynthetic binding protein comprising a single polypeptide chain defining two domains connected by a polypeptide linker. The amino acid sequence of each of the domains comprises a set of CDRs interposed between a set of FRs, each of which is respectively homologous with at least a portion of the CDRs and FRs from an immunoglobulin molecule. The linker comprises plural, peptide-bonded amino acids defining a polypeptide of a length sufficient to span the distance between the C terminal end of one of the domains and N terminal end of the other when the binding protein assumes a conformation suitable for binding. The linker comprises hydrophilic amino acids which together preferably constitute a hydrophilic sequence. Linkers which assume an unstructured polypeptide configuration in aqueous solution work well. The binding protein is capable of binding to a preselected antigenic site, determined by the collective tertiary structure of the sets of CDRs held in proper conformation by the sets of FRs. Preferably, the binding protein has a specificity at least substantially identical to the binding specificity of the immunoglobulin molecule used as a template for the design of the CDR regions. Such structures can have a binding affinity of at least 10^6 , M^{-1} , and preferably 10^8 M^{-1} .

In preferred aspects, the FRs of the binding protein are homologous to at least a portion of the FRs from a human immunoglobulin, the linker spans at

- 7 -

least about 40 angstroms; a polypeptide spacer is incorporated in the multifunctional protein between the binding site and the second polypeptide; and the binding protein has an affinity for the preselected antigenic determinant no less than two orders of magnitude less than the binding affinity of the immunoglobulin molecule used as a template for the CDR regions of the binding protein. The preferred linkers and spacers are cysteine-free. The linker preferably comprises amino acids having unreactive side groups, e.g., alanine and glycine. Linkers and spacers can be made by combining plural consecutive copies of an amino acid sequence, e.g., (Gly₄ Ser)₃. The invention also provides DNAs encoding these proteins and host cells harboring and capable of expressing these DNAs.

As used herein, the phrase biosynthetic antibody binding site or BABS means synthetic proteins expressed from DNA derived by recombinant techniques. BABS comprise biosynthetically produced sequences of amino acids defining polypeptides designed to bind with a preselected antigenic material. The structure of these synthetic polypeptides is unlike that of naturally occurring antibodies, fragments thereof, e.g., Fv, or known synthetic polypeptides or "chimeric antibodies" in that the regions of the BABS responsible for specificity and affinity of binding, (analogous to native antibody variable regions) are linked by peptide bonds, expressed from a single DNA, and may themselves be chimeric, e.g., may comprise amino acid sequences homologous to portions of at least two

- 8 -

different antibody molecules. The BABS embodying the invention are biosynthetic in the sense that they are synthesized in a cellular host made to express a synthetic DNA, that is, a recombinant DNA made by ligation of plural, chemically synthesized oligonucleotides, or by ligation of fragments of DNA derived from the genome of a hybridoma, mature B cell clone, or a cDNA library derived from such natural sources. The proteins of the invention are properly characterized as "binding sites" in that these synthetic molecules are designed to have specific affinity for a preselected antigenic determinant. The polypeptides of the invention comprise structures patterned after regions of native antibodies known to be responsible for antigen recognition.

Accordingly, it is an object of the invention to provide novel multifunctional proteins comprising one or more effector proteins and one or more biosynthetic antibody binding sites, and to provide DNA sequences which encode the proteins. Another object is to provide a generalized method for producing biosynthetic antibody binding site polypeptides of any desired specificity.

- 9 -

Brief Description of the Drawing

The foregoing and other objects of this invention, the various features thereof, as well as the invention itself, may be more fully understood from the following description, when read together with the accompanying drawings.

Figure 1A is a schematic representation of an intact IgG antibody molecule containing two light chains, each consisting of one variable and one constant domain, and two heavy chains, each consisting of one variable and three constant domains. Figure 1B is a schematic drawing of the structure of Fv proteins (and DNA encoding them) illustrating V_H and V_L domains, each of which comprises four framework (FR) regions and three complementarity determining (CDR) regions. Boundaries of CDRs are indicated, by way of example, for monoclonal 26-10, a well known and characterized murine monoclonal specific for digoxin.

Figure 2A-2E are schematic representations of some of the classes of reagents constructed in accordance with the invention, each of which comprises a biosynthetic antibody binding site.

Figure 3 discloses five amino acid sequences (heavy chains) in single letter code lined up vertically to facilitate understanding of the invention. Sequence 1 is the known native sequence

- 10 -

of V_H from murine monoclonal glp-4 (anti-lysozyme). Sequence 2 is the known native sequence of V_H from murine monoclonal 26-10 (anti-digoxin). Sequence 3 is a BABS comprising the FRs from 26-10 V_H and the CDRs from glp-4 V_H . The CDRs are identified in lower case letters; restriction sites in the DNA used to produce chimeric sequence 3 are also identified. Sequence 4 is the known native sequence of V_H from human myeloma antibody NEWM. Sequence 5 is a BABS comprising the FRs from NEWM V_H and the CDRs from glp-4 V_H , i.e., illustrates a "humanized" binding site having a human framework but an affinity for lysozyme similar to murine glp-4.

Figures 4A-4F are the synthetic nucleic acid sequences and encoded amino acid sequences of (4A) the heavy chain variable domain of murine anti-digoxin monoclonal 26-10; (4B) the light chain variable domain of murine anti-digoxin monoclonal 26-10; (4C) a heavy chain variable domain of a BABS comprising CDRs of glp-4 and FRs of 26-10; (4D) a light chain variable region of the same BABS; (4E) a heavy chain variable region of a BABS comprising CDRs of glp-4 and FRs of NEWM; and (4F) a light chain variable region comprising CDRs of glp-4 and FRs of NEWM. Delineated are FRs, CDRs, and restriction sites for endonuclease digestion, most of which were introduced during design of the DNA.

- 11 -

Figure 5 is the nucleic acid and encoded amino acid sequence of a host DNA (V_H) designed to facilitate insertion of CDRs of choice. The DNA was designed to have unique 6-base sites directly flanking the CDRs so that relatively small oligonucleotides defining portions of CDRs can be readily inserted, and to have other sites to facilitate manipulation of the DNA to optimize binding properties in a given construct. The framework regions of the molecule correspond to murine FRs (Figure 4A).

Figures 6A and 6B are multifunctional proteins (and DNA encoding them) comprising a single chain BABS with the specificity of murine monoclonal 26-10, linked through a spacer to the FB fragment of protein A, here fused as a leader, and constituting a binding site for Fc. The spacer comprises the 11 C-terminal amino acids of the FB followed by Asp-Pro (a dilute acid cleavage site). The single chain BABS comprises sequences mimicking the V_H and V_L (6A) and the V_L and V_H (6B) of murine monoclonal 26-10. The V_L in construct 6A is altered at residue 4 where valine replaces methionine present in the parent 26-10 sequence. These constructs contain binding sites for both Fc and digoxin. Their structure may be summarized as;

(6A) FB-Asp-Pro- V_H -(Gly₄-Ser)₃- V_L ,

and

(6B) FB-Asp-Pro- V_L -(Gly₄-Ser)₃- V_H ,

where (Gly₄-Ser)₃ is a polypeptide linker.

- 12 -

In Figures 4A-4E and 6A and 6B, the amino acid sequence of the expression products start after the GAATTC sequences, which codes for an EcoRI splice site, translated as Glu-Phe on the drawings.

Figure 7A is a graph of percent of maximum counts bound of radioiodinated digoxin versus concentration of binding protein adsorbed to the plate comparing the binding of native 26-10 (curve 1) and the construct of Figure 6A and Figure 2B renatured using two different procedures (curves 2 and 3). Figure 7B is a graph demonstrating the bifunctionality of the FB-(26-10) BABS adhered to microtiter plates through the specific binding of the binding site to the digoxin-BSA coat on the plate. Figure 7B shows the percent inhibition of ^{125}I -rabbit-IgG binding to the FB domain of the FB BABS by the addition of IgG, protein A, FB, murine IgG2a, and murine IgG1.

Figure 8 is a schematic representation of a model assembled DNA sequence encoding a multifunctional biosynthetic protein comprising a leader peptide (used to aid expression and thereafter cleaved), a binding site, a spacer, and an effector molecule attached as a trailer sequence.

Figure 9A-9E are exemplary synthetic nucleic acid sequences and corresponding encoded amino acid sequences of binding sites of different specificities: (A) FRs from NEWM and CDRs from 26-10 having the digoxin specificity of murine monoclonal 26-10; (B) FRs from 26-10, and CDRs from G-loop-4

- 13 -

(glp-4) having lysozyme specificity; (C) FRs and CDRs from MOPC-315 having dinitrophenol (DNF) specificity; (D) FRs and CDRs from an anti-CEA monoclonal antibody; (E) FRs in both V_H and V_L and CDR₁ and CDR₃ in V_H , and CDR₁, CDR₂, and CDR₃ in V_L from an anti-CEA monoclonal antibody; CDR₂ in V_H is a CDR₂ consensus sequence found in most immunoglobulin V_H regions.

Figure 10A is a schematic representation of the DNA and amino acid sequence of a leader peptide (MLE) protein with corresponding DNA sequence and some major restriction sites. Figure 10B shows the design of an expression plasmid used to express MLE-BABS (26-10). During construction of the gene, fusion partners were joined at the EcoRI site that is shown as part of the leader sequence. The pBR322 plasmid, opened at the unique SspI and PstI sites, was combined in a 3-part ligation with an SspI to EcoRI fragment bearing the *trp* promoter and MLE leader and with an EcoRI to PstI fragment carrying the BABS gene. The resulting expression vector confers tetracycline resistance on positive transformants.

Figure 11 is an SDS-polyacrylamide gel (15%) of the (26-10) BABS at progressive stages of purification. Lane 0 shows low molecular weight standards; lane 1 is the MLE-BABS fusion protein; lane 2 is an acid digest of this material; lane 3 is the pooled DE-52 chromatographed protein; lanes 4 and

- 14 -

5 are the same ouabain-Sepharose pool of single chain BABS except that lane 4 protein is reduced and lane 5 protein is unreduced.

Figure 12 shows inhibition curves for 26-10 BABS and 26-10 Fab species, and indicates the relative affinities of the antibody fragment for the indicated cardiac glycosides.

Figures 13A and 13B are plots of digoxin binding curves. (A) shows 26-10 BABS binding isotherm and Sips plot (inset), and (B) shows 26-10 Fab binding isotherm and Sips plot (inset).

Figure 14 is a nucleic acid sequence and corresponding amino acid sequence of a modified FB dimer leader sequence and various restriction sites.

Figure 15A-15H are nucleic acid sequences and corresponding amino acid sequences of biosynthetic multifunctional proteins including a single chain BABS and various biologically active protein trailers linked via a spacer sequence. Also indicated are various endonuclease digestion sites. The trailing sequences are (A) epidermal growth factor (EGF); (B) streptavidin; (C) tumor necrosis factor (TNF); (D) calmodulin; (E) platelet derived growth factor-beta (PDGF-beta); (F) ricin; and (G) interleukin-2, and (H) an FB-FB dimer.

- 15 -

Description

The invention will first be described in its broadest overall aspects with a more detailed description following.

A class of novel biosynthetic, bi or multifunctional proteins has now been designed and engineered which comprise biosynthetic antibody binding sites, that is, "BABS" or biosynthetic polypeptides defining structure capable of selective antigen recognition and preferential antigen binding, and one or more peptide-bonded additional protein or polypeptide regions designed to have a preselected property. Examples of the second region include amino acid sequences designed to sequester ions, which makes the protein suitable for use as an imaging agent, and sequences designed to facilitate immobilization of the protein for use in affinity chromatography and solid phase immunoassay. Another example of the second region is a bioactive effector molecule, that is, a protein having a conformation suitable for biological activity, such as an enzyme, toxin, receptor, binding site, growth factor, cell differentiation factor, lymphokine, cytokine, hormone, or anti-metabolite. This invention features synthetic, multifunctional proteins comprising these regions peptide bonded to one or more biosynthetic antibody binding sites, synthetic, single chain proteins designed to bind preselected antigenic determinants with high affinity and specificity, constructs containing multiple binding sites linked

- 16 -

together to provide multipoint antigen binding and high net affinity and specificity, DNA encoding these proteins prepared by recombinant techniques, host cells harboring these DNAs, and methods for the production of these proteins and DNAs.

The invention requires recombinant production of single chain binding sites having affinity and specificity for a predetermined antigenic determinant. This technology has been developed and is disclosed herein. In view of this disclosure, persons skilled in recombinant DNA technology, protein design, and protein chemistry can produce such sites which, when disposed in solution, have high binding constants (at least 10^6 , preferably 10^8 M^{-1} ,) and excellent specificity.

The design of the BABS is based on the observation that three subregions of the variable domain of each of the heavy and light chains of native immunoglobulin molecules collectively are responsible for antigen recognition and binding. Each of these subregions, called herein "complementarity determining regions" or CDRs, consists of one of the hypervariable regions or loops and of selected amino acids or amino acid sequences disposed in the framework regions or FRs which flank that particular hypervariable region. It has now been discovered that FRs from diverse species are effective to maintain CDRs from diverse other species in proper conformation so as to achieve true immunochemical binding properties in a biosynthetic protein. It has also been discovered that

- 17 -

biosynthetic domains mimicking the structure of the two chains of an immunoglobulin binding site may be connected by a polypeptide linker while closely approaching, retaining, and often improving their collective binding properties.

The binding site region of the multifunctional proteins comprises at least one, and preferably two domains, each of which has an amino acid sequence homologous to portions of the CDRs of the variable domain of an immunoglobulin light or heavy chain, and other sequence homologous to the FRs of the variable domain of the same, or a second, different immunoglobulin light or heavy chain. The two domain binding site construct also includes a polypeptide linking the domains. Polypeptides so constructed bind a specific preselected antigen determined by the CDRs held in proper conformation by the FRs and the linker. Preferred structures have human FRs, i.e., mimic the amino acid sequence of at least a portion of the framework regions of a human immunoglobulin, and have linked domains which together comprise structure mimicking a V_H-V_L or V_L-V_H immunoglobulin two-chain binding site. CDR regions of a mammalian immunoglobulin, such as those of mouse, rat, or human origin are preferred. In one preferred embodiment, the biosynthetic antibody binding site comprises FRs homologous with a portion of the FRs of a human immunoglobulin and CDRs homologous with CDRs from a mouse or rat immunoglobulin. This type of chimeric polypeptide displays the antigen binding specificity of the mouse or rat immunoglobulin, while its human framework

- 18 -

minimizes human immune reactions. In addition, the chimeric polypeptide may comprise other amino acid sequences. It may comprise, for example, a sequence homologous to a portion of the constant domain of an immunoglobulin, but preferably is free of constant regions (other than FRs).

The binding site region(s) of the chimeric proteins are thus single chain composite polypeptides comprising a structure which in solution behaves like an antibody binding site. The two domain, single chain composite polypeptide has a structure patterned after tandem V_H and V_L domains, but with the carboxyl terminal of one attached through a linking amino acid sequence to the amino terminal of the other. The linking amino acid sequence may or may not itself be antigenic or biologically active. It preferably spans a distance of at least about 40A, i.e., comprises at least about 14 amino acids, and comprises residues which together present a hydrophilic, relatively unstructured region. Linking amino acid sequences having little or no secondary structure work well. Optionally, one or a pair of unique amino acids or amino acid sequences recognizable by a site specific cleavage agent may be included in the linker. This permits the V_H and V_L -like domains to be separated after expression, or the linker to be excised after refolding of the binding site.

Either the amino or carboxyl terminal ends (or both ends) of these chimeric, single chain binding sites are attached to an amino acid sequence which itself is bioactive or has some other function

- 19 -

to produce a bifunctional or multifunctional protein. For example, the synthetic binding site may include a leader and/or trailer sequence defining a polypeptide having enzymatic activity, independent affinity for an antigen different from the antigen to which the binding site is directed, or having other functions such as to provide a convenient site of attachment for a radioactive ion, or to provide a residue designed to link chemically to a solid support. This fused, independently functional section of protein should be distinguished from fused leaders used simply to enhance expression in prokaryotic host cells or yeasts. The multifunctional proteins also should be distinguished from the "conjugates" disclosed in the prior art comprising antibodies which, after expression, are linked chemically to a second moiety.

Often, a series of amino acids designed as a "spacer" is interposed between the active regions of the multifunctional protein. Use of such a spacer can promote independent refolding of the regions of the protein. The spacer also may include a specific sequence of amino acids recognized by an endopeptidase, for example, endogenous to a target cell (e.g., one having a surface protein recognized by the binding site) so that the bioactive effector protein is cleaved and released at the target. The second functional protein preferably is present as a trailer sequence, as trailers exhibit less of a tendency to interfere with the binding behavior of the BABS.

- 20 -

The therapeutic use of such "self-targeted" bioactive proteins offers a number of advantages over conjugates of immunoglobulin fragments or complete antibody molecules: they are stable, less immunogenic and have a lower molecular weight; they can penetrate body tissues more rapidly for purposes of imaging or drug delivery because of their smaller size; and they can facilitate accelerated clearance of targeted isotopes or drugs. Furthermore, because design of such structures at the DNA level as disclosed herein permits ready selection of bioproperties and specificities, an essentially limitless combination of binding sites and bioactive proteins is possible, each of which can be refined as disclosed herein to optimize independent activity at each region of the synthetic protein. The synthetic proteins can be expressed in procaryotes such as E. coli, and thus are less costly to produce than immunoglobulins or fragments thereof which require expression in cultured animal cell lines.

The invention thus provides a family of recombinant proteins expressed from a single piece of DNA, all of which have the capacity to bind specifically with a predetermined antigenic determinant. The preferred species of the proteins comprise a second domain which functions independently of the binding region. In this aspect the invention provides an array of "self-targeted" proteins which have a bioactive function and which deliver that function to a locus determined by the binding site's specificity. It also provides biosynthetic binding proteins having attached

- 21 -

polypeptides suitable for attachment to immobilization matrices which may be used in affinity chromatography and solid phase immunoassay applications, or suitable for attachment to ions, e.g., radioactive ions, which may be used for in vivo imaging.

The successful design and manufacture of the proteins of the invention depends on the ability to produce biosynthetic binding sites, and most preferably, sites comprising two domains mimicking the variable domains of immunoglobulin connected by a linker.

As is now well known, Fv, the minimum antibody fragment which contains a complete antigen recognition and binding site, consists of a dimer of one heavy and one light chain variable domain in noncovalent association (Figure 1A). It is in this configuration that the three complementarity determining regions of each variable domain interact to define an antigen binding site on the surface of the V_H - V_L dimer. Collectively, the six complementarity determining regions (see Figure 1B) confer antigen binding specificity to the antibody. FRs flanking the CDRs have a tertiary structure which is essentially conserved in native immunoglobulins of species as diverse as human and mouse. These FRs serve to hold the CDRs in their appropriate orientation. The constant domains are not required for binding function, but may aid in stabilizing V_H - V_L interaction. Even a single variable domain (or half of an Fv comprising only three CDRs specific

- 22 -

for an antigen) has the ability to recognize and bind antigen, although at a lower affinity than an entire binding site (Painter et al. (1972) Biochem. 11:1327-1337).

This knowledge of the structure of immunoglobulin proteins has now been exploited to develop multifunctional fusion proteins comprising biosynthetic antibody binding sites and one or more other domains.

The structure of these biosynthetic proteins in the region which impart the binding properties to the protein is analogous to the Fv region of a natural antibody. It comprises at least one, and preferably two domains consisting of amino acids defining V_H and V_L-like polypeptide segments connected by a linker which together form the tertiary molecular structure responsible for affinity and specificity. Each domain comprises a set of amino acid sequences analogous to immunoglobulin CDRs held in appropriate conformation by a set of sequences analogous to the framework regions (FRs) of an Fv fragment of a natural antibody.

The term CDR, as used herein, refers to amino acid sequences which together define the binding affinity and specificity of the natural Fv region of a native immunoglobulin binding site, or a synthetic polypeptide which mimics this function. CDRs typically are not wholly homologous to hypervariable regions of natural Fvs, but rather also may include specific amino acids or amino acid sequences which flank the hypervariable region and have heretofore been considered framework not

- 23 -

directly determinative of complementarity. The term FR, as used herein, refers to amino acid sequences flanking or interposed between CDRs.

The CDR and FR polypeptide segments are designed based on sequence analysis of the Fv region of preexisting antibodies or of the DNA encoding them. In one embodiment, the amino acid sequences constituting the FR regions of the BABS are analogous to the FR sequences of a first preexisting antibody, for example, a human IgG. The amino acid sequences constituting the CDR regions are analogous to the sequences from a second, different preexisting antibody, for example, the CDRs of a murine IgG. Alternatively, the CDRs and FRs from a single preexisting antibody from, e.g., an unstable or hard to culture hybridoma, may be copied in their entirety.

Practice of the invention enables the design and biosynthesis of various reagents, all of which are characterized by a region having affinity for a preselected antigenic determinant. The binding site and other regions of the biosynthetic protein are designed with the particular planned utility of the protein in mind. Thus, if the reagent is designed for intravascular use in mammals, the FR regions may comprise amino acids similar or identical to at least a portion of the framework region amino acids of antibodies native to that mammalian species. On the other hand, the amino acids comprising the CDRs may be analogous to a portion of the amino acids from the hypervariable region (and certain flanking amino acids) of an antibody having a known affinity and specificity, e.g., a murine or rat monoclonal antibody.

- 24 -

Other sections of native immunoglobulin protein structure, e.g., C_H and C_L , need not be present and normally are intentionally omitted from the biosynthetic proteins. However, the proteins of the invention normally comprise additional polypeptide or protein regions defining a bioactive region, e.g., a toxin or enzyme, or a site onto which a toxin or a remotely detectable substance can be attached.

The invention thus can provide intact biosynthetic antibody binding sites analogous to V_H - V_L dimers, either non-covalently associated, disulfide bonded, or preferably linked by a polypeptide sequence to form a composite V_H - V_L or V_L - V_H polypeptide which may be essentially free of antibody constant region. The invention also provides proteins analogous to an independent V_H or V_L domain, or dimers thereof. Any of these proteins may be provided in a form linked to, for example, amino acids analogous or homologous to a bioactive molecule such as a hormone or toxin.

Connecting the independently functional regions of the protein is a spacer comprising a short amino acid sequence whose function is to separate the functional regions so that they can independently assume their active tertiary conformation. The spacer can consist of an amino acid sequence present on the end of a functional protein which sequence is not itself required for its function, and/or specific sequences engineered into the protein at the DNA level.

- 25 -

The spacer generally may comprise between 5 and 25 residues. Its optimal length may be determined using constructs of different spacer lengths varying, for example, by units of 5 amino acids. The specific amino acids in the spacer can vary. Cysteines should be avoided. Hydrophilic amino acids are preferred. The spacer sequence may mimic the sequence of a hinge region of an immunoglobulin. It may also be designed to assume a structure, such as a helical structure. Proteolytic cleavage sites may be designed into the spacer separating the variable region-like sequences from other pendant sequences so as to facilitate cleavage of intact BABS, free of other protein, or so as to release the bioactive protein in vivo.

Figures 2A-2E illustrate five examples of protein structures embodying the invention that can be produced by following the teaching disclosed herein. All are characterized by a biosynthetic polypeptide defining a binding site 3, comprising amino acid sequences comprising CDRs and FRs, often derived from different immunoglobulins, or sequences homologous to a portion of CDRs and FRs from different immunoglobulins. Figure 2A depicts a single chain construct comprising a polypeptide domain 10 having an amino acid sequence analogous to the variable region of an immunoglobulin heavy chain, bound through its carboxyl end to a polypeptide linker 12, which in turn is bound to a polypeptide domain 14 having an amino acid sequence analogous to

- 26 -

the variable region of an immunoglobulin light chain. Of course, the light and heavy chain domains may be in reverse order. Alternatively, the binding site may comprise two substantially homologous amino acid sequences which are both analogous to the variable region of an immunoglobulin heavy or light chain.

The linker 12 should be long enough (e.g., about 15 amino acids or about 40 Å) to permit the chains 10 and 14 to assume their proper conformation. The linker 12 may comprise an amino acid sequence homologous to a sequence identified as "self" by the species into which it will be introduced, if drug use is intended. For example, the linker may comprise an amino acid sequence patterned after a hinge region of an immunoglobulin. The linker preferably comprises hydrophilic amino acid sequences. It may also comprise a bioactive polypeptide such as a cell toxin which is to be targeted by the binding site, or a segment easily labelled by a radioactive reagent which is to be delivered, e.g., to the site of a tumor comprising an epitope recognized by the binding site. The linker may also include one or two built-in cleavage sites, i.e., an amino acid or amino acid sequence susceptible to attack by a site specific cleavage agent as described below. This strategy permits the V_H and V_L -like domains to be separated after expression, or the linker to be excised after folding while retaining the binding site structure in non-covalent association. The amino acids of the

- 27 -

linker preferably are selected from among those having relatively small, unreactive side chains. Alanine, serine, and glycine are preferred.

Generally, the design of the linker involves considerations similar to the design of the spacer, excepting that binding properties of the linked domains are seriously degraded if the linker sequence is shorter than about 20A in length, i.e., comprises less than about 10 residues. Linkers longer than the approximate 40A distance between the N terminal of a native variable region and the C-terminal of its sister chain may be used, but also potentially can diminish the BABS binding properties. Linkers comprising between 12 and 18 residues are preferred. The preferred length in specific constructs may be determined by varying linker length first by units of 5 residues, and second by units of 1-4 residues after determining the best multiple of the pentameric starting units.

Additional proteins or polypeptides may be attached to either or both the amino or carboxyl termini of the binding site to produce multifunctional proteins of the type illustrated in Figures 2B-2E. As an example, in Figure 2B, a helically coiled polypeptide structure 16 comprises a protein A fragment (FB) linked to the amino terminal end of a V_H-like domain 10 via a spacer 18. Figure 2C illustrates a bifunctional protein having an effector polypeptide 20 linked via spacer 22 to the carboxyl terminus of polypeptide 14 of binding protein segment 2. This effector polypeptide 20 may

- 28 -

consist of, for example, a toxin, therapeutic drug, binding protein, enzyme or enzyme fragment, site of attachment for an imaging agent (e.g., to chelate a radioactive ion such as indium), or site of selective attachment to an immobilization matrix so that the BABS can be used in affinity chromatography or solid phase binding assay. This effector alternatively may be linked to the amino terminus of polypeptide 10, although trailers are preferred. Figure 2D depicts a trifunctional protein comprising a linked pair of BABS 2 having another distinct protein domain 20 attached to the N-terminus of the first binding protein segment. Use of multiple BABS in a single protein enables production of constructs having very high selective affinity for multiepitopic sites such as cell surface proteins.

The independently functional domains are attached by a spacer 18 (Figs 2B and 2D) covalently linking the C terminus of the protein 16 or 20 to the N-terminus of the first domain 10 of the binding protein segment 2, or by a spacer 22 linking the C-terminus of the second binding domain 14 to the N-terminus of another protein (Figs. 2C and 2D). The spacer may be an amino acid sequence analogous to linker sequence 12, or it may take other forms. As noted above, the spacer's primary function is to separate the active protein regions to promote their independent bioactivity and permit each region to assume its bioactive conformation independent of interference from its neighboring structure.

- 29 -

Figure 2E depicts another type of reagent, comprising a BABS having only one set of three CDRs, e.g., analogous to a heavy chain variable region, which retains a measure of affinity for the antigen. Attached to the carboxyl end of the polypeptide 10 or 14 comprising the FR and CDR sequences constituting the binding site 3 through spacer 22 is effector polypeptide 20 as described above.

As is evidenced from the foregoing, the invention provides a large family of reagents comprising proteins, at least a portion of which defines a binding site patterned after the variable region of an immunoglobulin. It will be apparent that the nature of any protein fragments linked to the BABS, and used for reagents embodying the invention, are essentially unlimited, the essence of the invention being the provision, either alone or linked to other proteins, of binding sites having specificities to any antigen desired.

The clinical administration of multifunctional proteins comprising a BABS, or a BABS alone, affords a number of advantages over the use of intact natural or chimeric antibody molecules, fragments thereof, and conjugates comprising such antibodies linked chemically to a second bioactive moiety. The multifunctional proteins described herein offer fewer cleavage sites to circulating proteolytic enzymes, their functional domains are connected by peptide bonds to polypeptide linker or spacer sequences, and thus the proteins have improved stability. Because of their smaller size and efficient design, the multifunctional proteins

- 30 -

described herein reach their target tissue more rapidly, and are cleared more quickly from the body. They also have reduced immunogenicity. In addition, their design facilitates coupling to other moieties in drug targeting and imaging application. Such coupling may be conducted chemically after expression of the BABS to a site of attachment for the coupling product engineered into the protein at the DNA level. Active effector proteins having toxic, enzymatic, binding, modulating, cell differentiating, hormonal, or other bioactivity are expressed from a single DNA as a leader and/or trailer sequence, peptide bonded to the BABS.

Design and Manufacture

The proteins of the invention are designed at the DNA level. The chimeric or synthetic DNAs are then expressed in a suitable host system, and the expressed proteins are collected and renatured if necessary. A preferred general structure of the DNA encoding the proteins is set forth in Figure 8. As illustrated, it encodes an optimal leader sequence used to promote expression in procaryotes having a built-in cleavage site recognizable by a site specific cleavage agent, for example, an endopeptidase, used to remove the leader after expression. This is followed by DNA encoding a V_H -like domain, comprising CDRs and FRs, a linker, a V_L -like domain, again comprising CDRs and FRs, a spacer, and an effector protein. After expression,

- 31 -

folding, and cleavage of the leader, a bifunctional protein is produced having a binding region whose specificity is determined by the CDRs, and a peptide-linked independently functional effector region.

The ability to design the BABS of the invention depends on the ability to determine the sequence of the amino acids in the variable region of monoclonal antibodies of interest, or the DNA encoding them. Hybridoma technology enables production of cell lines secreting antibody to essentially any desired substance that produces an immune response. RNA encoding the light and heavy chains of the immunoglobulin can then be obtained from the cytoplasm of the hybridoma. The 5' end portion of the mRNA can be used to prepare cDNA for subsequent sequencing, or the amino acid sequence of the hypervariable and flanking framework regions can be determined by amino acid sequencing of the V region fragments of the H and L chains. Such sequence analysis is now conducted routinely. This knowledge, coupled with observations and deductions of the generalized structure of immunoglobulin Fvs, permits one to design synthetic genes encoding FR and CDR sequences which likely will bind the antigen. These synthetic genes are then prepared using known techniques, or using the technique disclosed below, inserted into a suitable host, and expressed, and the expressed protein is purified. Depending on the host cell, renaturation techniques may be required to attain proper conformation. The various proteins are then tested for binding ability, and one having

- 32 -

appropriate affinity is selected for incorporation into a reagent of the type described above. If necessary, point substitutions seeking to optimize binding may be made in the DNA using conventional cassette mutagenesis or other protein engineering methodology such as is disclosed below.

Preparation of the proteins of the invention also is dependent on knowledge of the amino acid sequence (or corresponding DNA or RNA sequence) of bioactive proteins such as enzymes, toxins, growth factors, cell differentiation factors, receptors, anti-metabolites, hormones or various cytokines or lymphokines. Such sequences are reported in the literature and available through computerized data banks.

The DNA sequences of the binding site and the second protein domain are fused using conventional techniques, or assembled from synthesized oligonucleotides, and then expressed using equally conventional techniques.

The processes for manipulating, amplifying, and recombining DNA which encode amino acid sequences of interest are generally well known in the art, and therefore, not described in detail herein. Methods of identifying and isolating genes encoding antibodies of interest are well understood, and described in the patent and other literature. In general, the methods involve selecting genetic material coding for amino acids which define the proteins of interest, including the CDRs and FRs of interest, according to the genetic code.

- 33 -

Accordingly, the construction of DNAs encoding proteins as disclosed herein can be done using known techniques involving the use of various restriction enzymes which make sequence specific cuts in DNA to produce blunt ends or cohesive ends, DNA ligases, techniques enabling enzymatic addition of sticky ends to blunt-ended DNA, construction of synthetic DNAs by assembly of short or medium length oligonucleotides, cDNA synthesis techniques, and synthetic probes for isolating immunoglobulin or other bioactive protein genes. Various promoter sequences and other regulatory DNA sequences used in achieving expression, and various types of host cells are also known and available. Conventional transfection techniques, and equally conventional techniques for cloning and subcloning DNA are useful in the practice of this invention and known to those skilled in the art. Various types of vectors may be used such as plasmids and viruses including animal viruses and bacteriophages. The vectors may exploit various marker genes which impart to a successfully transfected cell a detectable phenotypic property that can be used to identify which of a family of clones has successfully incorporated the recombinant DNA of the vector.

One method for obtaining DNA encoding the proteins disclosed herein is by assembly of synthetic oligonucleotides produced in a conventional, automated, polynucleotide synthesizer followed by ligation with appropriate ligases. For example, overlapping, complementary DNA fragments comprising 15 bases may be synthesized semi manually using

- 34 -

phosphoramidite chemistry, with end segments left unphosphorylated to prevent polymerization during ligation. One end of the synthetic DNA is left with a "sticky end" corresponding to the site of action of a particular restriction endonuclease, and the other end is left with an end corresponding to the site of action of another restriction endonuclease. Alternatively, this approach can be fully automated. The DNA encoding the protein may be created by synthesizing longer single strand fragments (e.g., 50-100 nucleotides long) in, for example, a Biosearch oligonucleotide synthesizer, and then ligating the fragments.

A method of producing the BABS of the invention is to produce a synthetic DNA encoding a polypeptide comprising, e.g., human FRs, and intervening "dummy" CDRs, or amino acids having no function except to define suitably situated unique restriction sites. This synthetic DNA is then altered by DNA replacement, in which restriction and ligation is employed to insert synthetic oligonucleotides encoding CDRs defining a desired binding specificity in the proper location between the FRs. This approach facilitates empirical refinement of the binding properties of the BABS.

This technique is dependent upon the ability to cleave a DNA corresponding in structure to a variable domain gene at specific sites flanking nucleotide sequences encoding CDRs. These restriction sites in some cases may be found in the native gene. Alternatively, non-native restriction sites may be engineered into the nucleotide sequence

- 35 -

resulting in a synthetic gene with a different sequence of nucleotides than the native gene, but encoding the same variable region amino acids because of the degeneracy of the genetic code. The fragments resulting from endonuclease digestion, and comprising FR-encoding sequences, are then ligated to non-native CDR-encoding sequences to produce a synthetic variable domain gene with altered antigen binding specificity. Additional nucleotide sequences encoding, for example, constant region amino acids or a bioactive molecule may then be linked to the gene sequences to produce a bifunctional protein.

The expression of these synthetic DNA's can be achieved in both prokaryotic and eucaryotic systems via transfection with an appropriate vector. In E. coli and other microbial hosts, the synthetic genes can be expressed as fusion protein which is subsequently cleaved. Expression in eucaryotes can be accomplished by the transfection of DNA sequences encoding CDR and FR region amino acids and the amino acids defining a second function into a myeloma or other type of cell line. By this strategy intact hybrid antibody molecules having hybrid Fv regions and various bioactive proteins including a biosynthetic binding site may be produced. For fusion protein expressed in bacteria, subsequent proteolytic cleavage of the isolated fusions can be performed to yield free BABS, which can be renatured to obtain an intact biosynthetic, hybrid antibody binding site.

- 36 -

Heretofore, it has not been possible to cleave the heavy and light chain region to separate the variable and constant regions of an immunoglobulin so as to produce intact Fv, except in specific cases not of commercial utility. However, one method of producing BABS in accordance with this invention is to redesign DNAs encoding the heavy and light chains of an immunoglobulin, optionally altering its specificity or humanizing its FRs, and incorporating a cleavage site and "hinge region" between the variable and constant regions of both the heavy and light chains. Such chimeric antibodies can be produced in transfectomas or the like and subsequently cleaved using a preselected endopeptidase.

The hinge region is a sequence of amino acids which serve to promote efficient cleavage by a preselected cleavage agent at a preselected, built-in cleavage site. It is designed to promote cleavage preferentially at the cleavage site when the polypeptide is treated with the cleavage agent in an appropriate environment.

The hinge region can take many different forms. Its design involves selection of amino acid residues (and a DNA fragment encoding them) which impart to the region of the fused protein about the cleavage site an appropriate polarity, charge distribution, and stereochemistry which, in the aqueous environment where the cleavage takes place, efficiently exposes the cleavage site to the cleavage agent in preference to other potential cleavage sites that may be present in the polypeptide, and/or to

- 37 -

improve the kinetics of the cleavage reaction. In specific cases, the amino acids of the hinge are selected and assembled in sequence based on their known properties, and then the fused polypeptide sequence is expressed, tested, and altered for refinement.

The hinge region is free of cysteine. This enables the cleavage reaction to be conducted under conditions in which the protein assumes its tertiary conformation, and may be held in this conformation by intramolecular disulfide bonds. It has been discovered that in these conditions access of the protease to potential cleavage sites which may be present within the target protein is hindered. The hinge region may comprise an amino acid sequence which includes one or more proline residues. This allows formation of a substantially unfolded molecular segment. Aspartic acid, glutamic acid, arginine, lysine, serine, and threonine residues maximize ionic interactions and may be present in amounts and/or in sequence which renders the moiety comprising the hinge water soluble.

The cleavage site preferably is immediately adjacent the Fv polypeptide chains and comprises one amino acid or a sequence of amino acids exclusive of any sequence found in the amino acid structure of the chains in the Fv. The cleavage site preferably is designed for unique or preferential cleavage by a specific selected agent. Endopeptidases are preferred, although non-enzymatic (chemical) cleavage agents may be used. Many useful cleavage agents, for instance, cyanogen bromide, dilute acid, trypsin,

- 38 -

Staphylococcus aureus V-8 protease, post proline cleaving enzyme, blood coagulation Factor Xa, enterokinase, and renin, recognize and preferentially or exclusively cleave particular cleavage sites. One currently preferred cleavage agent is V-8 protease. The currently preferred cleavage site is a Glu residue. Other useful enzymes recognize multiple residues as a cleavage site, e.g., factor Xa (Ile-Glu-Gly-Arg) or enterokinase (Asp-Asp-Asp-Asp-Lys). The principles of this selective cleavage approach may also be used in the design of the linker and spacer sequences of the multifunctional constructs of the invention where an exciseable linker or selectively cleavable linker or spacer is desired.

Design of Synthetic V_H and V_L Mimics

FRs from the heavy and light chain murine anti-digoxin monoclonal 26-10 (Figures 4A and 4B) were encoded on the same DNAs with CDRs from the murine anti-lysozyme monoclonal glp-4 heavy chain (Figure 3 sequence 1) and light chain to produce V_H (Figure 4C) and V_L (Figure 4D) regions together defining a biosynthetic antibody binding site which is specific for lysozyme. Murine CDRs from both the heavy and light chains of monoclonal glp-4 were encoded on the same DNAs with FRs from the heavy and light chains of human myeloma antibody NEWM (Figures 4E and 4F). The resulting interspecies chimeric antibody binding domain has reduced immunogenicity in humans because of its human FRs, and specificity for lysozyme because of its murine CDRs.

- 39 -

A synthetic DNA was designed to facilitate CDR insertions into a human heavy chain FR and to facilitate empirical refinement of the resulting chimeric amino acid sequence. This DNA is depicted in Figure 5.

A synthetic, bifunctional FB-binding site protein was also designed at the DNA level, expressed, purified, renatured, and shown to bind specifically with a preselected antigen (digoxin) and Fc. The detailed primary structure of this construct is shown in Figure 6; its tertiary structure is illustrated schematically in Figure 2B.

Details of these and other experiments, and additional design principles on which the invention is based, are set forth below.

GENE DESIGN AND EXPRESSION

Given known variable region DNA sequences, synthetic V_L and V_H genes may be designed which encode native or near native FR and CDR amino acid sequences from an antibody molecule, each separated by unique restriction sites located as close to FR-CDR and CDR-FR borders as possible. Alternatively, genes may be designed which encode native FR sequences which are similar or identical to the FRs of an antibody molecule from a selected species, each separated by "dummy" CDR sequences containing strategically located restriction sites. These DNAs serve as starting materials for producing BABS, as the native or "dummy" CDR sequences may be excised and replaced with sequences encoding the CDR

- 40 -

amino acids defining a selected binding site. Alternatively, one may design and directly synthesize native or near-native FR sequences from a first antibody molecule, and CDR sequences from a second antibody molecule. Any one of the V_H and V_L sequences described above may be linked together directly, via an amino acids chain or linker connecting the C-terminus of one chain with the N-terminus of the other.

These genes, once synthesized, may be cloned with or without additional DNA sequences coding for, e.g., an antibody constant region, enzyme, or toxin, or a leader peptide which facilitates secretion or intracellular stability of a fusion polypeptide. The genes then can be expressed directly in an appropriate host cell, or can be further engineered before expression by the exchange of FR, CDR, or "dummy" CDR sequences with new sequences. This manipulation is facilitated by the presence of the restriction sites which have been engineered into the gene at the FR-CDR and CDR-FR borders.

Figure 3 illustrates the general approach to designing a chimeric V_H ; further details of exemplary designs at the DNA level are shown in Figures 4A-4F. Figure 3, lines 1 and 2, show the amino acid sequences of the heavy chain variable region of the murine monoclonals glp-4 (anti-lysozyme) and 26-10 (anti-digoxin), including the four FR and three CDR sequences of each. Line 3 shows the sequence of a chimeric V_H which comprises 26-10 FRs and glp-4 CDRs. As illustrated, the hybrid protein of line 3 is identical to the native protein

- 41 -

of line 2, except that 1) the sequence TFTNYIIHWLK has replaced the sequence IFDFYMNWVR, 2) EWIGWIYPGNGNTKYNEFNFKG has replaced DYIGYISPYSGVTGYNQKFKG, 3) RYTHYYF has replaced GSSGNKWAM, and 4) A has replaced V as the sixth amino acid beyond CDR-2. These changes have the effect of changing the specificity of the 26-10 V_H to mimic the specificity of glp-4. The Ala to Val single amino acid replacement within the relatively conserved framework region of 26-10 is an example of the replacement of an amino acid outside the hypervariable region made for the purpose of altering specificity by CDR replacement. Beneath sequence 3 of Figure 3, the restriction sites in the DNA encoding the chimeric V_H (see Figures 4A-4F) are shown which are disposed about the CDR-FR borders.

Lines 4 and 5 of Figure 3 represent another construct. Line 4 is the full length V_H of the human antibody NEWM. That human antibody may be made specific for lysozyme by CDR replacement as shown in line 5. Thus, for example, the segment TFTNYIIHWLK from glp-4 replaces TFSNDYYTWVR of NEWM, and its other CDRs are replaced as shown. This results in a V_H comprising a human framework with murine sequences determining specificity.

By sequencing any antibody, or obtaining the sequence from the literature, in view of this disclosure one skilled in the art can produce a BABS of any desired specificity comprising any desired framework region. Diagrams such as Figure 3 comparing the amino acid sequence are valuable in suggesting which particular amino acids should be

- 42 -

replaced to determine the desired complementarity. Expressed sequences may be tested for binding and refined by exchanging selected amino acids in relatively conserved regions, based on observation of trends in amino acid sequence data and/or computer modeling techniques.

Significant flexibility in V_H and V_L design is possible because the amino acid sequences are determined at the DNA level, and the manipulation of DNA can be accomplished easily.

For example, the DNA sequence for murine V_H and V_L 26-10 containing specific restriction sites flanking each of the three CDRs was designed with the aid of a commercially available computer program which performs combined reverse translation and restriction site searches ("RV.exe" by Compugene, Inc.). The known amino acid sequences for V_H and V_L 26-10 polypeptides were entered, and all potential DNA sequences which encode those peptides and all potential restriction sites were analyzed by the program. The program can, in addition, select DNA sequences encoding the peptide using only codons preferred by *E. coli* if this bacterium is to be host expression organism of choice. Figures 4A and 4B show an example of program output. The nucleic acid sequences of the synthetic gene and the corresponding amino acids are shown. Sites of restriction endonuclease cleavage are also indicated. The CDRs of these synthetic genes are underlined.

- 43 -

The DNA sequences for the synthetic 26-10 V_H and V_L are designed so that one or both of the restriction sites flanking each of the three CDRs are unique. A six base site (such as that recognized by Bsm I or BspM I) is preferred, but where six base sites are not possible, four or five base sites are used. These sites, if not already unique, are rendered unique within the gene by eliminating other occurrences within the gene without altering necessary amino acid sequences. Preferred cleavage sites are those that, once cleaved, yield fragments with sticky ends just outside of the boundary of the CDR within the framework. However, such ideal sites are only occasionally possible because the FR-CDR boundary is not an absolute one, and because the amino acid sequence of the FR may not permit a restriction site. In these cases, flanking sites in the FR which are more distant from the predicted boundary are selected.

Figure 5 discloses the nucleotide and corresponding amino acid sequence (shown in standard single letter code) of a synthetic DNA comprising a master framework gene having the generic structure:

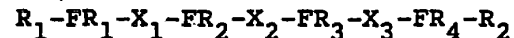

where R_1 and R_2 are restricted ends which are to be ligated into a vector, and X_1 , X_2 , and X_3 are DNA sequences whose function is to provide convenient restriction sites for CDR insertion. This particular DNA has murine FR sequences and unique, 6-base restriction sites adjacent the FR borders so

- 44 -

that nucleotide sequences encoding CDRs from a desired monoclonal can be inserted easily. Restriction endonuclease digestion sites are indicated with their abbreviations; enzymes of choice for CDR replacement are underscored. Digestion of the gene with the following restriction endonucleases results in 3' and 5' ends which can easily be matched up with and ligated to native or synthetic CDRs of desired specificity; KpnI and BstXI are used for ligation of CDR₁; XbaI and DraI for CDR₂; and BssHII and ClaI for CDR₃.

OLIGONUCLEOTIDE SYNTHESIS

The synthetic genes and DNA fragments designed as described above preferably are produced by assembly of chemically synthesized oligonucleotides. 15-100mer oligonucleotides may be synthesized on a Biosearch DNA Model 8600 Synthesizer, and purified by polyacrylamide gel electrophoresis (PAGE) in Tris-Borate-EDTA buffer (TBE). The DNA is then electroeluted from the gel. Overlapping oligomers may be phosphorylated by T4 polynucleotide kinase and ligated into larger blocks which may also be purified by PAGE.

CLONING OF SYNTHETIC OLIGONUCLEOTIDES

The blocks or the pairs of longer oligonucleotides may be cloned into E. coli using a suitable, e.g., pUC, cloning vector. Initially, this vector may be altered by single strand mutagenesis to

- 45 -

eliminate residual six base altered sites. For example, V_H may be synthesized and cloned into pUC as five primary blocks spanning the following restriction sites: 1. EcoRI to first NarI site; 2. first NarI to XbaI; 3. XbaI to SallI; 4. SallI to NcoI; 5. NcoI to BamHI. These cloned fragments may then be isolated and assembled in several three-fragment ligations and cloning steps into the pUC8 plasmid. Desired ligations selected by PAGE are then transformed into, for example, *E. coli* strain JM83, and plated onto LB Ampicillin + Xgal plates according to standard procedures. The gene sequence may be confirmed by supercoil sequencing after cloning, or after subcloning into M13 via the dideoxy method of Sanger.

PRINCIPLE OF CDR EXCHANGE

Three CDRs (or alternatively, four FRs) can be replaced per V_H or V_L . In simple cases, this can be accomplished by cutting the shuttle pUC plasmid containing the respective genes at the two unique restriction sites flanking each CDR or FR, removing the excised sequence, and ligating the vector with a native nucleic acid sequence or a synthetic oligonucleotide encoding the desired CDR or FR. This three part procedure would have to be repeated three times for total CDR replacement and four times for total FR replacement. Alternatively, a synthetic nucleotide encoding two consecutive CDRs separated by the appropriate FR can be ligated to a pUC or other plasmid containing a gene whose

- 46 -

corresponding CDRs and FR have been cleaved out. This procedure reduces the number of steps required to perform CDR and/or FR exchange.

EXPRESSION OF PROTEINS

The engineered genes can be expressed in appropriate prokaryotic hosts such as various strains of E. coli, and in eucaryotic hosts such as Chinese hamster ovary cell, murine myeloma, and human myeloma/transfectoma cells.

For example, if the gene is to be expressed in E. coli, it may first be cloned into an expression vector. This is accomplished by positioning the engineered gene downstream from a promoter sequence such as *trp* or *tac*, and a gene coding for a leader peptide. The resulting expressed fusion protein accumulates in refractile bodies in the cytoplasm of the cells, and may be harvested after disruption of the cells by French press or sonication. The refractile bodies are solubilized, and the expressed proteins refolded and cleaved by the methods already established for many other recombinant proteins.

If the engineered gene is to be expressed in myeloma cells, the conventional expression system for immunoglobulins, it is first inserted into an expression vector containing, for example, the Ig promoter, a secretion signal, immunoglobulin enhancers, and various introns. This plasmid may also contain sequences encoding all or part of a constant region, enabling an entire part of a heavy or light chain to be expressed. The gene is

- 47 -

transfected into myeloma cells via established electroporation or protoplast fusion methods. Cells so transfected can express V_L or V_H fragments, V_{L2} or V_{H2} homodimers, V_L-V_H heterodimers, V_H-V_L or V_L-V_H single chain polypeptides, complete heavy or light immunoglobulin chains, or portions thereof, each of which may be attached in the various ways discussed above to a protein region having another function (e.g., cytotoxicity).

Vectors containing a heavy chain V region (or V and C regions) can be cotransfected with analogous vectors carrying a light chain V region (or V and C regions), allowing for the expression of noncovalently associated binding sites (or complete antibody molecules).

In the examples which follow, a specific example of how to make a single chain binding site is disclosed, together with methods employed to assess its binding properties. Thereafter, a protein construct having two functional domains is disclosed. Lastly, there is disclosed a series of additional targeted proteins which exemplify the invention.

I EXAMPLE OF CDR EXCHANGE AND EXPRESSION

The synthetic gene coding for murine V_H and V_L 26-10 shown in Figures 4A and 4B were designed from the known amino acid sequence of the protein with the aid of Compugene, a software program. These genes, although coding for the native amino acid sequences, also contain non-native and

- 48 -

often unique restriction sites flanking nucleic acid sequences encoding CDR's to facilitate CDR replacement as noted above.

Both the 3' and 5' ends of the large synthetic oligomers were designed to include 6-base restriction sites, present in the genes and the pUC vector. Furthermore, those restriction sites in the synthetic genes which were only suited for assembly but not for cloning the pUC were extended by "helper" cloning sites with matching sites in pUC.

Cloning of the synthetic DNA and later assembly of the gene is facilitated by the spacing of unique restriction sites along the gene. This allows corrections and modifications by cassette mutagenesis at any location. Among them are alterations near the 5' or 3' ends of the gene as needed for the adaptation to different expression vectors. For example, a PstI site is positioned near the 5' end of the V_H gene. Synthetic linkers can be attached easily between this site and a restriction site in the expression plasmid. These genes were synthesized by assembling oligonucleotides as described above using a Biosearch Model 8600 DNA Synthesizer. They were ligated to vector pUC8 for transformation of E. coli.

Specific CDRs may be cleaved from the synthetic V_H gene by digestion with the following pairs of restriction endonucleases: HpHI and BstXI for CDR₁; XbaI and DraI for CDR₂; and BanII and BanI for CDR₃. After removal on one CDR, another CDR of desired specificity may be ligated directly

- 49 -

into the restricted gene, in its place if the 3' and 5' ends of the restricted gene and the new CDR contain complementary single stranded DNA sequences.

In the present example, the three CDRs of each of murine V_H 26-10 and V_L 26-10 were replaced with the corresponding CDRs of glp-4. The nucleic acid sequences and corresponding amino acid sequences of the chimeric V_H and V_L genes encoding the FRs of 26-10 and CDRs of glp-4 are shown in Figures 4C and 4D. The positions of the restriction endonuclease cleavage sites are noted with their standard abbreviations. CDR sequences are underlined as are the restriction endonucleases of choice useful for further CDR replacement.

These genes were cloned into pUC8, a shuttle plasmid. To retain unique restriction sites after cloning, the V_H -like gene was spliced into the EcoRI and HindIII or BamHI sites of the plasmid.

Direct expression of the genes may be achieved in E. coli. Alternatively, the gene may be preceded by a leader sequence and expressed in E. coli as a fusion product by splicing the fusion gene into the host gene whose expression is regulated by interaction of a repressor with the respective operator. The protein can be induced by starvation in minimal medium and by chemical inducers. The V_H - V_L biosynthetic 26-10 gene has been expressed as such a fusion protein behind the trp and tac promoters. The gene translation product of interest may then be cleaved from the leader in the fusion protein by e.g., cyanogen bromide degradation, tryptic digestion, mild acid cleavage, and/or

- 50 -

digestion with factor Xa protease. Therefore, a shuttle plasmid containing a synthetic gene encoding a leader peptide having a site for mild acid cleavage, and into which has been spliced the synthetic BABS gene was used for this purpose. In addition, synthetic DNA sequences encoding a signal peptide for secretion of the processed target protein into the periplasm of the host cell can also be incorporated into the plasmid.

After harvesting the gene product and optionally releasing it from a fusion peptide, its activity as an antibody binding site and its specificity for glp-4 (lysozyme) epitope are assayed by established immunological techniques, e.g., affinity chromatography and radioimmunoassay. Correct folding of the protein to yield the proper three-dimensional conformation of the antibody binding site is prerequisite for its activity. This occurs spontaneously in a host such as a myeloma cell which naturally expresses immunoglobulin proteins. Alternatively, for bacterial expression, the protein forms inclusion bodies which, after harvesting, must be subjected to a specific sequence of solvent conditions (e.g., diluted 20 X from 8 M urea 0.1 M Tris-HCl pH 9 into 0.15 M NaCl, 0.01 M sodium phosphate, pH 7.4 (Hochman et al. (1976) Biochem. 15:2706-2710) to assume its correct conformation and hence its active form.

Figures 4E and 4F show the DNA and amino acid sequence of chimeric V_H and V_L comprising human FRs from NEWM and murine CDRs from glp-4. The

- 51 -

CDRs are underlined, as are restriction sites of choice for further CDR replacement or empirically determined refinement.

These constructs also constitute master framework genes, this time constructed of human framework sequences. They may be used to construct BABS of any desired specificity by appropriate CDR replacement.

Binding sites with other specificities have also been designed using the methodologies disclosed herein. Examples include those having FRs from the human NEWM antibody and CDRs from murine 26-10 (Figure 9A), murine 26-10 FRs and G-loop CDRs (Figure 9B), FRs and CDRs from murine MOPC-315 (Figure 9C), FRs and CDRs from an anti-human carcinoembryonic antigen monoclonal antibody (Figure 9D), and FRs and CDRs 1, 2, and 3 from V_L and FRs and CDR 1 and 3 from the V_H of the anti-CEA antibody, with CDR 2 from a consensus immunoglobulin gene (Figure 9E).

II. Model Binding Site:

The digoxin binding site of the IgG_{2a,k} monoclonal antibody 26-10 has been analyzed by Mudgett-Hunter and colleagues (unpublished). The 26-10 V region sequences were determined from both amino acid sequencing and DNA sequencing of 26-10 H and L chain mRNA transcripts (D. Panka, J.N. & M.N.M., unpublished data). The 26-10 antibody exhibits a high digoxin binding affinity [$K_o = 5.4 \times 10^9 \text{ M}^{-1}$] and has a well-defined specificity profile, providing a baseline for comparison with the biosynthetic binding sites mimicking its structure.

- 52 -

Protein Design:

Crystallographically determined atomic coordinates for Fab fragments of 26-10 were obtained from the Brookhaven Data Bank. Inspection of the available three-dimensional structures of Fv regions within their parent Fab fragments indicated that the Euclidean distance between the C-terminus of the V_H domain and the N-terminus of the V_L domain is about 35 Å. Considering that the peptide unit length is approximately 3.8 Å, a 15 residue linker was selected to bridge this gap. The linker was designed so as to exhibit little propensity for secondary structure and not to interfere with domain folding. Thus, the 15 residue sequence (Gly-Gly-Gly-Gly-Ser)₃ was selected to connect the V_H carboxyl- and V_L amino-termini.

Binding studies with single chain binding sites having less than or greater than 15 residues demonstrate the importance of the prerequisite distance which must separate V_H from V_L ; for example, a (Gly₄-Ser)₁ linker does not demonstrate binding activity, and those with (Gly₄-Ser)₅ linkers exhibit very low activity compared to those with (Gly₄-Ser)₃ linkers.

Gene Synthesis:

Design of the 744 base sequence for the synthetic binding site gene was derived from the Fv protein sequence of 26-10 by choosing codons

- 53 -

frequently used in *E. coli*. The model of this representative synthetic gene is shown in Figure 8, discussed previously. Synthetic genes coding for the *trp* promoter-operator, the modified *trp* LE leader peptide (MLE), the sequence of which is shown in Figure 10A, and V_H were prepared largely as described previously. The gene coding for V_H was assembled from 46 chemically synthesized oligonucleotides, all 15 bases long, except for terminal fragments (13 to 19 bases) that included cohesive cloning ends. Between 8 and 15 overlapping oligonucleotides were enzymatically ligated into double stranded DNA, cut at restriction sites suitable for cloning (NarI, XbaI, SalI, SacII, SacI), purified by PAGE on 8% gels, and cloned in pUC which was modified to contain additional cloning sites in the polylinker. The cloned segments were assembled stepwise into the complete gene mimicking V_H by ligations in the pUC cloning vector.

The gene mimicking 26-10 V_L was assembled from 12 long synthetic polynucleotides ranging in size from 33 to 88 base pairs, prepared in automated DNA synthesizers (Model 6500, Biosearch, San Rafael, CA; Model 380A, Applied Biosystems, Foster City, CA). Five individual double stranded segments were made out of pairs of long synthetic oligonucleotides spanning six-base restriction sites in the gene (AatII, BstEII, PpnI, HindIII, BglII, and PstI). In one case, four long overlapping strands were combined and cloned. Gene fragments bounded by restriction sites for assembly that were absent from the pUC polylinker, such as AatII and BstEII, were flanked by EcoRI and BamHI ends to facilitate cloning.

- 54 -

The linker between V_H and V_L , encoding (Gly-Gly-Gly-Gly-Ser)₃, was cloned from two long synthetic oligonucleotides, 54 and 62 bases long, spanning SacI and AatII sites, the latter followed by an EcoRI cloning end. The complete single chain binding site gene was assembled from the V_H , V_L , and linker genes to produce a construct, corresponding to aspartyl-prolyl- V_H -<linker>- V_L , flanked by EcoRI and PstI restriction sites.

The trp promoter-operator, starting from its SspI site, was assembled from 12 overlapping 15 base oligomers, and the MLE leader gene was assembled from 24 overlapping 15 base oligomers. These were cloned and assembled in pUC using the strategy of assembly sites flanked by cloning sites. The final expression plasmid was constructed in the pBR322 vector by a 3-part ligation using the sites SspI, EcoRI, and PstI (see Figure 10B). Intermediate DNA fragments and assembled genes were sequenced by the dideoxy method.

Fusion Protein Expression:

Single-chain protein was expressed as a fusion protein. The MLE leader gene (Fig. 10A) was derived from E. coli trp LE sequence and expressed under the control of a synthetic trp promoter and operator. E. coli strain JM83 was transformed with the expression plasmid and protein expression was induced in M9 minimal medium by addition of indoleacrylic acid (10 µg/ml) at a cell density with $A_{600} = 1$. The high expression levels of the

- 55 -

fusion protein resulted in its accumulation as insoluble protein granules, which were harvested from cell paste (Figure 11, Lane 1).

Fusion Protein Cleavage:

The MLE leader was removed from the binding site protein by acid cleavage of the Asp-Pro peptide bond engineered at the junction of the MLE and binding site sequences. The washed protein granules containing the fusion protein were cleaved in 6 M guanidine-HCl + 10% acetic acid, pH 2.5, incubated at 37°C for 96 hrs. The reaction was stopped through precipitation by addition of a 10-fold excess of ethanol with overnight incubation at -20°C, followed by centrifugation and storage at -20°C until further purification (Figure 11, Lane 2).

Protein Purification:

The acid cleaved binding site was separated from remaining intact fused protein species by chromatography on DEAE cellulose. The precipitate obtained from the cleavage mixture was redissolved in 6 M guanidine-HCl + 0.2 M Tris-HCl, pH 8.2, + 0.1 M 2-mercaptoethanol and dialyzed exhaustively against 6 M urea + 2.5 mM Tris-HCl, pH 7.5, + 1 mM EDTA. 2-Mercaptoethanol was added to a final concentration of 0.1 M, the solution was incubated for 2 hrs at room temperature and loaded onto a 2.5 X 45 cm column of DEAE cellulose (Whatman DE 52), equilibrated with

- 56 -

6 M urea + 2.5 mM Tris-HCl + 1 mM EDTA, pH 7.5. The intact fusion protein bound weakly to the DE 52 column such that its elution was retarded relative to that of the binding protein. The first protein fractions which eluted from the column after loading and washing with urea buffer contained BABS protein devoid of intact fusion protein. Later fractions contaminated with some fused protein were pooled, rechromatographed on DE 52, and recovered single chain binding protein combined with other purified protein into a single pool (Figure 11, Lane 3).

Refolding:

The 26-10 binding site mimic was refolded as follows: the DE 52 pool, disposed in 6 M urea + 2.5 mM Tris-HCl + 1 mM EDTA, was adjusted to pH 8 and reduced with 0.1 M 2-mercaptoethanol at 37°C for 90 min. This was diluted at least 100-fold with 0.01 M sodium acetate, pH 5.5, to a concentration below 10 µg/ml and dialyzed at 4°C for 2 days against acetate buffer.

Affinity Chromatography:

Purification of active binding protein by affinity chromatography at 4°C on a ouabain-amine-Sepharose column was performed. The dilute solution of refolded protein was loaded directly onto a pair of tandem columns, each containing 3 ml of resin equilibrated with the 0.01 M acetate buffer, pH 5.5. The columns were washed

- 57 -

individually with an excess of the acetate buffer, and then by sequential additions of 5 ml each of 1 M NaCl, 20 mM ouabain, and 3 M potassium thiocyanate dissolved in the acetate buffer, interspersed with acetate buffer washes. Since digoxin binding activity was still present in the eluate, the eluate was pooled and concentrated 20-fold by ultrafiltration (PM 10 membrane, 200 ml concentrator; Amicon), reapplied to the affinity columns, and eluted as described. Fractions with significant absorbance at 280 nm were pooled and dialyzed against PBSA or the above acetate buffer. The amounts of protein in the DE 52 and ouabain-Sepharose pools were quantitated by amino acid analysis following dialysis against 0.01 M acetate buffer. The results are shown below in Table 1.

- 58 -

TABLE 1
Estimated Yields of BABS Protein During Purification

<u>Step</u>	<u>Wet wt. Per l</u>	<u>mg protein</u>	<u>Cleavage yield (%) prior step</u>	<u>Yield relative to fusion protein</u>
Cell paste	12.0 g	1440.0 mg ^a		
Fusion protein Granules	2.3 g	480.0 mg ^{a,b}	100.0%	100.0%
Acid Cleavage/ DE 52 pool		144.0 mg	38.0 ^c	38.0 ^e
Ouabain-Sepharose pool		18.1 mg	12.6 ^d	4.7 ^e

^aDetermined by Lowry protein analysis.

^bDetermined by absorbance measurements

^cDetermined by amino acid analysis

^dCalculated from the amount of BABS protein specifically eluted from ouabain-Sepharose relative to that applied to the resin; values were determined by amino acid analysis

^ePercentage yield calculated on a molar basis

- 59 -

Sequence Analysis of Gene and Protein:

The complete gene was sequenced in both directions using the dideoxy method of Sanger which confirmed the gene was correctly assembled. The protein sequence was also verified by protein sequencing. Automated Edman degradation was conducted on intact protein (residues 1-40), as well as on two major CNBr fragments (residues 108-129 and 140-159) with a Model 470A gas phase sequencer equipped with a Model 120A on-line phenylthiohydantoin-amino acid analyzer (Applied Biosystems, Foster City, CA). Homogeneous binding protein fractionated by SDS-PAGE and eluted from gel strips with water, was treated with a 20,000-fold excess of CNBr, in 1% trifluoroacetic acid-acetonitrile (1:1), for 12 hrs at 25° (in the dark). The resulting fragments were separated by SDS-PAGE and transferred electrophoretically onto an Immobilon membrane (Millipore, Bedford, MA), from which stained bands were cut out and sequenced.

Specificity Determination:

Specificities of anti-digoxin 26-10 Fab and the BABS were assessed by radioimmunoassay. Wells of microtiter plates were coated with affinity-purified goat anti-murine Fab fragment (ICN ImmunoBiologicals, Lisle, IL) at 10 µg/ml in PBSA overnight at 4°C. After the plates were washed and blocked with 1% horse serum in PBSA, solutions (50 µl) containing 26-10 Fab or the BABS in either PBSA or 0.01 M sodium acetate at pH 5.5 were added to the wells and

- 60 -

incubated 2-3 hrs at room temperature. After unbound antibody fragment was washed from the wells, 25 μ l of a series of concentrations of cardiac glycosides (10^{-4} to 10^{-11} M in PBSA) were added. The cardiac glycosides tested included digoxin, digitoxin, digoxigenin, digitoxigenin, gitoxin, ouabain, and acetyl strophanthidin. After the addition of 125 I-digoxin (25 μ l, 50,000 cpm; Cambridge Diagnostics, Billerica, MA) to each well, the plates were incubated overnight at 4°C, washed and counted. The inhibition curves are plotted in Figure 12. The relative affinities for each digoxin analogue were calculated by dividing the concentration of each analogue at 50% inhibition by the concentration of digoxin (or digoxigenin) that gave 50% inhibition. There is a displacement of inhibition curves for the BABS to lower glycoside concentrations than observed for 26-10 Fab, because less active BABS than 26-10 Fab was bound to the plate. When 0.25 M urea was added to the BABS in 0.01 M sodium acetate, pH 5.5, more active sFv was bound to the goat anti-murine Fab coating on the plate. This caused the BABS inhibition curves to shift toward higher glycoside concentrations, closer to the position of those for 26-10 Fab, although maintaining the relative positions of curves for sFv obtained in acetate buffer alone. The results, expressed as normalized concentration of inhibitor giving 50% inhibition of 125 I-digoxin binding, are shown in Table 2.

- 61 -

TABLE 2

26-10 Antibody Species	Normalizing Glycoside	D	DG	DO	DOG	A-S	G	O
Fab	Digoxin	1.0	1.2	0.9	1.0	1.3	9.6	15
	Digoxigenin	0.9	1.0	0.8	0.9	1.1	8.1	13
BABS	Digoxin	1.0	7.3	2.0	2.6	5.9	62	150
	Digoxigenin	0.1	1.0	0.3	0.4	0.8	8.5	21

D = Digoxin

DG = Digoxigenin

DO = Digitoxin

DOG = Digitoxigenin

A-S = Acetyl Strophanthidin

G = Gitoxin

O = Ouabain

Affinity Determination:

Association constants were measured by equilibrium binding studies. In immunoprecipitation experiments, 100 μ l of ^3H -digoxin (New England Nuclear, Billerica, MA) at a series of concentrations (10^{-7} M to 10^{-11} M) were added to 100 μ l of 26-10 Fab or the BABS at a fixed concentration. After 2-3 hrs of incubation at room temperature, the protein was precipitated by the addition of 100 μ l goat antiserum to murine Fab fragment (ICN Immuno-

- 62 -

Biologicals), 50 μ l of the IgG fraction of rabbit anti-goat IgG (ICN ImmunoBiologicals), and 50 μ l of a 10% suspension of protein A-Sepharose (Sigma). Following 2 hrs at 4°C, bound and free antigen were separated by vacuum filtration on glass fiber filters (Vacuum Filtration Manifold, Millipore, Bedford, MA). Filter disks were then counted in 5 ml of scintillation fluid with a Model 1500 Tri-Carb Liquid Scintillation Analyzer (Packard, Sterling, VA). The association constants, K_o , were calculated from Scatchard analyses of the untransformed radioligand binding data using LIGAND, a non-linear curve fitting program based on mass action. K_o s were also calculated by Sips plots and binding isotherms shown in Figure 13A for the BABS and 13B for the Fab. For binding isotherms, data are plotted as the concentration of digoxin bound versus the log of the unbound digoxin concentration, and the dissociation constant is estimated from the ligand concentration at 50% saturation. These binding data are also plotted in linear form as Sips plots (inset), having the same abscissa as the binding isotherm but with the ordinate representing $\log r/(n-r)$, defined below. The average intrinsic association constant (K_o) was calculated from the modified Sips equation (39), $\log (r/n-r) = a \log C - a \log K_o$, where r equals moles of digoxin bound per mole of antibody at an unbound digoxin concentration equal to C ; n is the number of moles of digoxin bound at saturation of the antibody binding site, and a is an index of heterogeneity which describes the distribution of association constants about the average intrinsic

- 63 -

association constant K_o . Least squares linear regression analysis of the data indicated correlation coefficients for the lines obtained were 0.96 for the BABS and 0.99 for 26-10 Fab. A summary of the calculated association constants are shown below in Table 3.

TABLE 3

Method of Data Analysis	Association Constant, K_o	
	K_o (BABS), M^{-1}	K_o (Fab), M^{-1}
Scatchard plot	$(3.2 \pm 0.9) \times 10^7$	$(1.9 \pm 0.2) \times 10^8$
Sips plot	2.6×10^7	1.8×10^8
Binding isotherm	5.2×10^7	3.3×10^8

III. Synthesis of a Multifunctional Protein

A nucleic acid sequence encoding the single chain binding site described above was fused with a sequence encoding the FB fragment of protein A as a leader to function as a second active region. As a spacer, the native amino acids comprising the last 11 amino acids of the FB fragment bonded to an Asp-Pro dilute acid cleavage site was employed. The FB binding domain of the FB consists of the immediately preceding 43 amino acids which assume a helical configuration (see Fig. 2B).

- 64 -

The gene fragments are synthesized using a Biosearch DNA Model 8600 Synthesizer as described above. Synthetic oligonucleotides are cloned according to established protocol described above using the pUC8 vector transfected into E. coli. The completed fused gene set forth in Figure 6A is then expressed in E. coli.

After sonication, inclusion bodies were collected by centrifugation, and dissolved in 6 M guanidine hydrochloride (GuHCl), 0.2 M Tris, and 0.1 M 2-mercaptoethanol (BME), pH 8.2. The protein was denatured and reduced in the solvent overnight at room temperature. Size exclusion chromatography was used to purify fusion protein from the inclusion bodies. A Sepharose 4B column (1.5 X 80 cm) was run in a solvent of 6 M GuHCl and 0.01 M NaOAc, pH 4.75. The protein solution was applied to the column at room temperature in 0.5-1.0 ml amounts. Fractions were collected and precipitated with cold ethanol. These were run on SDS gels, and fractions rich in the recombinant protein (approximately 34,000 D) were pooled. This offers a simple first step for cleaning up inclusion body preparations without suffering significant proteolytic degradation.

For refolding, the protein was dialyzed against 100 ml of the same GuHCl-Tris-BME solution, and dialysate was diluted 11-fold over two days to 0.55 M GuHCl, 0.01 M Tris, and 0.01 M BME. The dialysis sacks were then transferred to 0.01 M NaCl, and the protein was dialyzed exhaustively before being assayed by RIA's for binding of ¹²⁵I-labelled digoxin. The refolding procedure can be simplified by

- 65 -

making a rapid dilution with water to reduce the GuHCl concentration to 1.1 M, and then dialyzing against phosphate buffered saline (0.15 M NaCl, 0.05 M potassium phosphate, pH 7, containing 0.03% NaN₃), so that it is free of any GuHCl within 12 hours. Product of both types of preparation showed binding activity, as indicated in Figure 7A.

Demonstration of Bifunctionality:

This protein with an FB leader and a fused BABS is bifunctional; the BABS can bind the antigen and the FB can bind the Fc regions of immunoglobulins. To demonstrate this dual and simultaneous activity several radioimmunoassays were performed.

Properties of the binding site were probed by a modification of an assay developed by Mudgett-Hunter et al. (J. Immunol. (1982) 129:1165-1172; Molec. Immunol. (1985) 22:477-488), so that it could be run on microtiter plates as a solid phase sandwich assay. Binding data were collected using goat anti-murine Fab antisera (gAmFab) as the primary antibody that initially coats the wells of the plate. These are polyclonal antisera which recognize epitopes that appear to reside mostly on framework regions. The samples of interest are next added to the coated wells and incubated with the gAmFab, which binds species that exhibit appropriate antigenic sites. After washing away unbound protein, the wells are exposed to ¹²⁵I-labelled (radioiodinated) digoxin conjugates, either as ¹²⁵I-dig-BSA or ¹²⁵I-dig-lysine.

- 66 -

The data are plotted in Figure 7A, which shows the results of a dilution curve experiment in which the parent 26-10 antibody was included as a control. The sites were probed with ^{125}I -dig-BSA as described above, with a series of dilutions prepared from initial stock solutions, including both the slowly refolded (1) and fast diluted/quickly refolded (2) single chain proteins. The parallelism between all three dilution curves indicates that gAmFab binding regions on the BABS molecule are essentially the same as on the Fv of authentic 26-10 antibody, i.e., the surface epitopes appear to be the same for both proteins.

The sensitivity of these assays is such that binding affinity of the Fv for digoxin must be at least 10^6 . Experimental data on digoxin binding yielded binding constants in the range of 10^8 to 10^9 M^{-1} . The parent 26-10 antibody has an affinity of $5.4 \times 10^9 \text{ M}^{-1}$. Inhibition assays also indicate the binding of ^{125}I -dig-lysine, and can be inhibited by unlabelled digoxin, digoxigenin, digitoxin, digitoxigenin, gitoxin, acetyl strophanthidin, and ouabain in a way largely parallel to the parent 26-10 Fab. This indicates that the specificity of the biosynthetic protein is substantially identical to the original monoclonal.

In a second type of assay, Digoxin-BSA is used to coat microtiter plates. Renatured BABS (FB-BABS) is added to the coated plates so that only molecules that have a competent binding site can stick to the plate. ^{125}I -labelled rabbit IgG (radioligand) is mixed with bound FB-BABS on the

- 67 -

plates. Bound radioactivity reflects the interaction of IgG with the FB domain of the BABS, and the specificity of this binding is demonstrated by its inhibition with increasing amounts of FB, Protein A, rabbit IgG, IgG2a, and IgG1, as shown in Figure 7B.

The following species were tested in order to demonstrate authentic binding: unlabelled rabbit IgG and IgG2a monoclonal antibody (which binds competitively to the FB domain of the BABS); and protein A and FB (which bind competitively to the radioligand). As shown in Figure 7B, these species are found to completely inhibit radioligand binding, as expected. A monoclonal antibody of the IgG1 subclass binds poorly to the FB, as expected, inhibiting only about 34% of the radioligand from binding. These data indicate that the BABS domain and the FB domain have independent activity.

IV. OTHER CONSTRUCTS

Other BABS-containing protein constructed according to the invention expressible in E. coli and other host cells as described above are set forth in the drawing. These proteins may be bifunctional or multifunctional. Each construct includes a single chain BABS linked via a spacer sequence to an effector molecule comprising amino acids encoding a biologically active effector protein such as an enzyme, receptor, toxin, or growth factor. Some examples of such constructs shown in the drawing include proteins comprising epidermal growth factor (EGF) (Figure 15A), streptavidin (Figure 15B), tumor

- 68 -

necrosis factor (TNF) (Figure 15C), calmodulin (Figure 15D) the beta chain of platelet derived growth factor (B-PDGF) (15E) ricin A (15F), interleukin 2 (15G) and FB dimer (15H). Each is used as a trailer and is connected to a preselected BABS via a spacer (Gly-Ser-Gly) encoded by DNA defining a BamHI restriction site. Additional amino acids may be added to the spacer for empirical refinement of the construct if necessary by opening up the Bam HI site and inserting an oligonucleotide of a desired length having BamHI sticky ends. Each gene also terminates with a PstI site to facilitate insertion into a suitable expression vector.

The BABS of the EGF and PDGF constructs may be, for example, specific for fibrin so that the EGF or PDGF is delivered to the site of a wound. The BABS for TNF and ricin A may be specific to a tumor antigen, e.g., CEA, to produce a construct useful in cancer therapy. The calmodulin construct binds radioactive ions and other metal ions. Its BABS may be specific, for example, to fibrin or a tumor antigen, so that it can be used as an imaging agent to locate a thrombus or tumor. The streptavidin construct binds with biotin with very high affinity. The biotin may be labeled with a remotely detectable ion for imaging purposes. Alternatively, the biotin may be immobilized on an affinity matrix or solid support. The BABS-streptavidin protein could then be bound to the matrix or support for affinity chromatography or solid phase immunoassay. The interleukin-2 construct could be linked, for example, to a BABS specific for a T-cell surface antigen. The

- 69 -

FB-FB dimer binds to Fc, and could be used with a BABS in an immunoassay or affinity purification procedure linked to a solid phase through immobilized immunoglobulin.

Figure 14 exemplifies a multifunctional protein having an effector segment as a leader. It comprises an FB-FB dimer linked through its C-terminal via an Asp-Pro dipeptide to a BABS of choice. It functions in a way very similar to the construct of Fig. 15H. The dimer binds avidly to the Fc portion of immunoglobulin. This type of construct can accordingly also be used in affinity chromatography, solid phase immunoassay, and in therapeutic contexts where coupling of immunoglobulins to another epitope is desired.

In view of the foregoing, it should be apparent that the invention is unlimited with respect to the specific types of BABS and effector proteins to be linked. Accordingly, other embodiments are within the following claims.

What is claimed is:

Claims

1. A single chain multi-functional biosynthetic protein expressed from a single gene derived by recombinant DNA techniques, said protein comprising:

a biosynthetic antibody binding site capable of binding to a preselected antigenic determinant and comprising at least one protein domain, the amino acid sequence of said domain being homologous to at least a portion of the sequence of a variable region of an immunoglobulin molecule capable of binding said preselected antigenic determinant; and, peptide bonded thereto,

a polypeptide selected from the group consisting of effector proteins having a conformation suitable for biological activity in mammals, amino acid sequences capable of sequestering an ion, and amino acid sequences capable of selective binding to a solid support.

2. The protein of claim 1 wherein said binding site comprises at least two domains connected by peptide bonds to a polypeptide linker.

3. The protein of claim 2 wherein said two domains mimic a V_H and a V_L from a natural immunoglobulin.

- 71 -

4. The protein of claim 2 wherein the amino acid sequence of each of said domains comprises a set of CDRs interposed between a set of FRs, each of which is respectively homologous with at least a portion of CDRs and FRs from a said variable region of an immunoglobulin molecule capable of binding said preselected antigenic determinant.

5. The protein of claim 4 wherein at least one of said domains comprises a said set of CDRs homologous to a portion of the CDRs in a first immunoglobulin and a set of FRs homologous to a portion of the FRs in a second, distinct immunoglobulin.

6. The protein of claim 2 wherein said polypeptide linker spans a distance of at least 40 angstroms is hydrophilic.

7. The protein of claim 2 wherein said polypeptide linker comprises amino acids which together assume an unstructured polypeptide configuration in aqueous solution.

8. The protein of claim 2 wherein said polypeptide linker is cysteine-free.

9. The protein of claim 2 wherein said polypeptide linker comprises a plurality of glycine or alanine residues.

- 72 -

10. The protein of claim 2 wherein said polypeptide linker comprises plural consecutive copies of an amino acid sequence.
11. The protein of claim 2 wherein said polypeptide linker comprises one or a pair of amino acid sequences recognizable by a site specific cleavage agent.
12. The protein of claim 4 wherein said antibody binding site binds with said antigenic determinant with a specificity at least substantially identical to the binding specificity of said immunoglobulin molecule.
13. The protein of claim 4 wherein said antibody binding site binds said antigenic determinant with an affinity of at least about 10^6 M^{-1} .
14. The protein of claim 4 wherein said antibody binding site binds said antigenic determinant with an affinity no less than about two orders of magnitude less than the binding affinity of said immunoglobulin molecule.
15. The protein of claim 1 further comprising a polypeptide spacer incorporated therein interposed between said antibody binding site and said polypeptide.
16. The protein of claim 15 wherein said polypeptide spacer comprises amino acids selectively susceptible to cleavage.

- 73 -

17. The protein of claim 15 wherein said spacer is hydrophilic.

18. The protein of claim 15 wherein said spacer comprises amino acids which together assume an unstructured polypeptide configuration in aqueous solution.

19. The protein of claim 15 wherein said spacer is cysteine-free.

20. The protein of claim 15 wherein said spacer comprises a plurality of glycine or alanine residues.

21. The protein of claim 15 wherein said spacer comprises plural consecutive copies of an amino acid sequence.

22. The protein of claim 1 wherein said effector protein is an enzyme, toxin, receptor, binding site, biosynthetic antibody binding site, growth factor, cell-differentiation factor, lymphokine, cytokine, hormone, or anti-metabolite.

23. The protein of claim 1 wherein said sequence capable of sequestering an ion is calmodulin, metallothionein, a fragment thereof, or an amino acid sequence rich in at least one of glutamic acid, aspartic acid, lysine, and arginine.

- 74 -

24. The protein of claim 1 wherein said polypeptide sequence capable of selective binding to a solid support is a positively or negatively charged amino acid sequence, a cysteine-containing amino acid sequence, streptavidin, or a fragment of protein A.

25. The protein of claim 1 comprising a plurality of biosynthetic antibody binding sites.

26. The protein of claim 1 comprising an additional biofunctional domain.

27. A DNA encoding the protein of claim 1.

28. A host cell harboring and capable of expressing the DNA of claim 27.

29. A biosynthetic binding protein expressed from DNA derived by recombinant techniques
said binding protein comprising a single polypeptide chain comprising at least two polypeptide domains connected by a polypeptide linker, the amino acid sequence of each of said polypeptide domains comprising a set of CDRs interposed between a set of FRs, each of which is respectively homologous with at least a portion of CDRs and FRs from an immunoglobulin molecule,

at least one of said domains comprising a said set of CDR amino acid sequences homologous to a portion of the CDR amino acid sequences of a first immunoglobulin molecule, and a set of FR amino acid sequences homologous to a portion of the FR sequences of a second, distinct immunoglobulin molecule,

- 75 -

said polypeptide domains together defining a hybrid synthetic binding site having specificity for a preselected antigen.

30. The binding protein of claim 29 wherein said domains comprise FRs homologous to a portion of the FRs of a human immunoglobulin.

31. The binding protein of claim 29 wherein said polypeptide domains are peptide bonded to a biologically active amino acid sequence.

32. The binding protein of claim 29 further comprising a radioactive atom bound to said binding protein.

33. A DNA encoding the binding protein of claim 32.

34. A host cell harboring and capable of expressing the DNA of claim 33.

35. A biosynthetic binding protein expressed from DNA derived by recombinant techniques
said binding protein comprising a single polypeptide chain comprising at least two polypeptide domains connected by a polypeptide linker, the amino acid sequence of each of said polypeptide domains comprising a set of CDRs interposed between a set of FRs, each of which is respectively homologous with at least a portion of CDRs and FRs from an immunoglobulin molecule,

- 76 -

said polypeptide linker comprising plural, peptide-bonded amino acids defining a polypeptide of a length sufficient to span the distance between the C-terminal end of one of said domains and the N-terminal end of the other of said domains when said binding protein assumes a conformation suitable for binding, and comprising hydrophilic amino acids which together assume an unstructured polypeptide configuration in aqueous solution,

said binding protein being capable of binding to a preselected antigenic site, determined by the collective tertiary structure of said sets of CDRs held in proper conformation by said sets of FRs and said linker when disposed in aqueous solution.

36. The binding protein of claim 35 wherein said polypeptide linker spans a distance of at least about 40A when said binding protein is disposed in aqueous solution in a conformation suitable for binding said preselected antigen.

37. The binding protein of claim 35 wherein said polypeptide linker comprises a plurality of glycine or alanine residues.

38. The binding protein of claim 35 wherein said linker comprises plural consecutive copies of an amino acid sequence.

39. The binding protein of claim 35 wherein said linker comprises (Gly-Gly-Gly-Gly-Ser)₃.

- 77 -

40. The binding protein of claim 35 wherein at least one of said domains comprises a said set of CDRs homologous to a portion of the CDRs in a first immunoglobulin and a set of FRs homologous to a portion of the FRs of a second, distinct, human immunoglobulin.

41. The binding protein of claim 35 wherein at least one of said polypeptide domains is peptide bonded to a biologically active amino acid sequence.

42. The binding protein of claim 35 further comprising a radioactive atom bound to said polypeptide chain.

43. A biosynthetic binding protein expressed from DNA derived by recombinant techniques, said binding protein comprising a single polypeptide chain comprising at least two polypeptide domains connected by a polypeptide linker, the amino acid sequence of each of said polypeptide domains comprising a set of CDRs interposed between a set of FRs, each of which are respectively homologous with at least a portion of CDRs and FRs from an immunoglobulin molecule,

said binding protein being capable of binding to a preselected antigenic determinant, determined by the collective tertiary structure of said sets of CDRs held in proper conformation by said sets of FRs when disposed in aqueous solution, with a binding specificity at least substantially identical to the binding specificity of said immunoglobulin molecule comprising said homologous CDRs.

44. A biosynthetic binding protein expressed from DNA derived by recombinant techniques, said binding protein comprising a single polypeptide chain comprising at least two polypeptide domains connected by a polypeptide linker, the amino acid sequence of each of said polypeptide domains comprising a set of CDRs interposed between a set of FRs, each of which are respectively homologous with at least a portion of CDRs and FRs from an immunoglobulin molecule,

said binding protein being capable of binding to a preselected antigenic determinant, determined by the collective tertiary structure of said sets of CDRs held in proper information by said sets of FRs when disposed in aqueous solution, with a binding affinity at least 10^6 M^{-1} .

45. The binding protein of claim 43 or 44 having a binding affinity at least about 10^8 M^{-1} .

46. The binding protein of claim 43 or 44 having a binding affinity no less than two orders of magnitude less than the binding affinity of said immunoglobulin molecule comprising said homologous CDRs.

47. The binding protein of claim 43 or 44 wherein at least one of said polypeptide domains is peptide bonded to a biologically active amino acid sequence.

48. The binding protein of claim 43 or 44 further comprising a radioactive atom bound to said polypeptide chain.

1/31

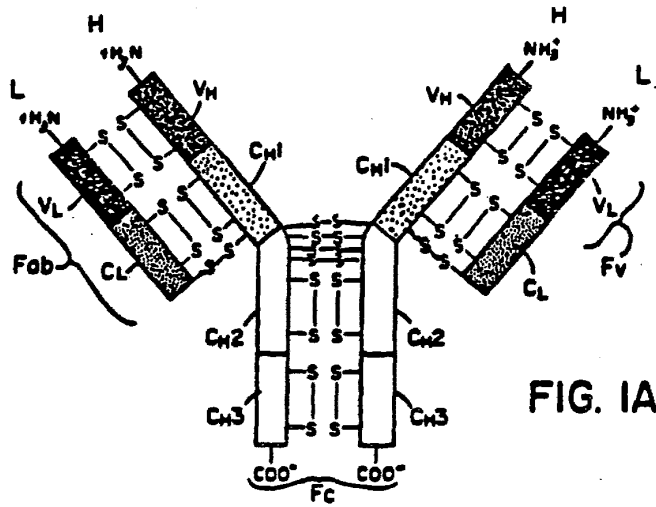

CDR1								26-IG GENES/ PROTEINS	
FR1	FR2	CDR2	FR3	CDR3	FR4			AMINO ACID SEQUENCE NO.	DNA BASE NO.
V _H									
31	35	50	64	100	106	119			
93	115	150	192	300	318	357			
CDR2									
CDR3									
FR1	CDR1	FR2	FR3	FR4					
V _L									
24	37	55	61	90	101	113			
72	111	165	183	288	303	339			

FIG. IB

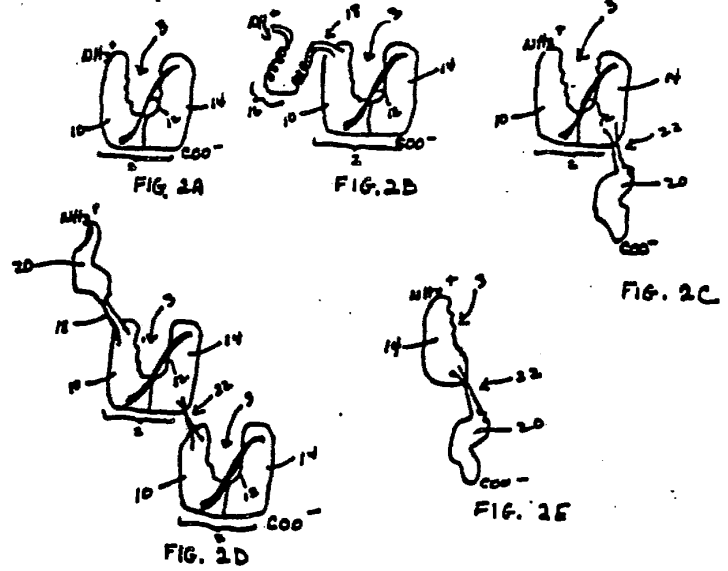

g-loop:

QVQLQQSGPELVEPGASVRISCTASGYTFTNYIIHWLQKRPQGQLEWIGWIYPGNGNTKYNEFKGKATLTADKSSSTAFNQISSLTSEDSAVYFCARYTHYYP DYWGQGTTLTVSSK*

26-10:

EVQLQQSGPELVKPGASVRMSCKSSGYIFTDFYMNWVRQSHGKSLDYIGYISPYSGVTCYNQKFKGKATLTVDKSSSTAYMELRSLTSEDSAVYYCAGSSGNKWAMDYWGHGASVTVSS*

26-10/g-loop hybrid:

EVQLQQSGPELVKPGASVRMSCKSSGYtftnyyihwLkQSHGKSLewigwiypgngntkynenfkGKATLTaDKSSSTAYMELRSLTSECSAVYYCarythyf DYWGHGASVTVSS*

(cdr1-----) (cdr2-----) (cdr3-----)

hphI bstXI xbaI draI hincII sacII nheI

2/31

newm/g-loop hybrid:

EVQLQQSGPGLVRPSQTLSLTCTVSGStftnyyihwLkQPPGRGLEwigwiypgngntkynenfkGRVTHLVDTSKNQFSLRLSSVTAADTAVYYCarythyf DVWGQGS LVTVSS*

[newm1.....] [newm2..] [newm3.....] [newm4]

avaII.....hphI bstXI...xbaI draI.....sacII

newm:

EVQLQQSGPGLVRPSQTLSLTCTVSGSTFNSNDYYTWRQPPGRGLEWIGYVFYHGTSDDTTPLRs RVTHLVDTSKNQFSLRLSSVTAADTAVYYCARNLIAGCIDVWGQGS LVTVSS*

FIG. 3

3/31

GAATTCCAAGTTCAACTGCCAGCAGTCTGGTCTGGAATTGGTTAAACCTGGCGCCTCTGTGCCCATGTCCCT	10	20	30	40	50	60	70
GluPheGluValGlnLeuGlnGlnSerGlyProGluLeuValLysProGlyAlaSerValArgMetSerC							
AsuII		BbvI	AvaII		AhaII	HhaI	
EcoRI		Fnu4HI	Sau96I		BanI	HinPI	
TaqI		PstI			EcoRII	HstINlaIII	
					HaeII	FspI	
					HhaI		
					HinPI		
					NarI		
					NlaIV		
					SerFI		
					AcyI		
GCAATCCTCTGGGTACATTTTCACCGACTTCTACATGAATTGGGTTCGCCAGTCTCATGGTAAGTCTCT	80	90	100	110	120	130	140
ysLysSerSerGlyTyrIlePheThrAspPheTyrMetAsnTrpValArgGlnSerHisGlyLysSerLe							
	RsaI	HphI	NlaIII		BstXI	NlaIII	Xba
							Ma
AGACTACATCGGGTACATTTCCCCATACTCTGGGGTTACCGGCTACAACCAGAAGTTTAAAGGTAAGGGC	150	160	170	180	190	200	210
uAspTyrIleGlyTyrIleSerProTyrSerGlyValThrGlyTyrAsnGlnLysPheLysGlyLysAla							
I	RsaI		BstEII			DraI	
eI			HpaII				
			MaeIII				
ACCCTTACTGTGACAAATCTTCCTCAACTGCTTACATGGAGCTGGCTTCTTTGACCTCTGAGGACTCCG	220	230	240	250	260	270	280
ThrLeuThrValAspLysSerSerSerThrAlaTyrMetGluLeuArgSerLeuThrSerGluAspSerA							
	AceI	MboII		AluI		DdeI	HinfIFn
	HincII			NlaIIBbvI			Sec
	SalI			Fnu4HI			
	TaqI						
CGGTACTACTATTGGCGGGCTCCTCTGGTAACAATAATGGGCCATGGATTACTGGGGTCTGGCCCTCTGT	290	300	310	320	330	340	350
laValTyrIyrCysAlaGlySerSerGlyAsnLysTrpAlaMetAspTyrTrpGlyHisGlyAlaSerVa							
uDII	HhaIBanII	MaeIII	HaeIII			AhaII	Ma
IIAecI	FnuDII		NcoI			BanI	
	HinPINlaIV		NlaIII			HaeII	
			Sau96I			HhaI	
			StyI			HinPI	
						NarI	
						NlaIII	
						NlaIV	
						AcyI	
TACTGTATCCTCATAGGATCC	360	370					
IThrValSerSer ^{am} Asp							
eIII	BamHI						
	NlaIV						
	Sau3A						
	XhoII						

FIG. 4A

4/31

```

      10      20      30      40      50      60      70
GAATTCGACCTCGTAATGACCCAGACTCCGCTGTCTCTGCCGGTTTCTCTGGGTGACCAGGCTTCTATTT
GluPheAspValValMetThrGlnThrProLeuSerLeuProValSerLeuGlyAspGlnAlaSerIleS
EcoRI AatII                      HinfI          HpaII          BstEII
      AhaII                      HphI EcoRII
      TaqI                      SerFI
      AcyI                      MaeIII
      MaeII

      80      90      100     110     120     130     140
CTTGCCCGCTCTTCCCACTCTCTGGTCCATTCTAATGGTAACACTTACCTGAACTCGGTACCTGCAAAAGGC
erCysArgSerSerGlnSerLeuValHisSerAsnGlyAsnThrTyrLeuAsnTrpTyrLeuGlnLysAl
Fnu4HI                      AvaII          MaeIII     HgiEII     BstXI
      MboII                      BstXI
      Sau96I
      KpnI
      NlaIV
      RsaI

      150     160     170     180     190     200     210
TGGTCAGTCTCCGAAGCTTCTGATCTACAAAGTCTCTAACCCTTCTCTGGTGTCCCGGATCGTTTCTCT
aGlyGlnSerProLysLeuLeuIleTyrLysValSerAsnArgPheSerGlyValProAspArgPheSer
AluI Sau3A                      HpaII
      HindIII                      NotISau3A
      SerFI

      220     230     240     250     260     270     280
GGTTCTGGTTCTGGTACTGACTTCACCCCTGAAGATCTCTCCTGTCGACGCCGAGGATCTGGGTATCTACT
GlySerGlySerGlyThrAspPheThrLeuLysIleSerArgValGluAlaGluAspLeuGlyIleTyrP
RsaI HphI                      BglII          TaqIHaeIII Sau3A
      MboII                      XhoII
      Sau3A
      XhoII

      290     300     310     320     330     340     350
TCTGCTCTCAGACTACTCATGTACCGCCGACCTTCGGCGGTGGCACCAAGCTCGAGATCAAACGTTGAGGATCC
heCysSerGlnThrThrHisValProProThrPheGlyGlyGlyThrLysLeuGluIleLysArg*op
DdeI                      NlaIII     HgiEII     BstXI AluI Sau3A MaeII BanHI
      RsaI                      NlaIV     AvaI                      NlaIV
      XhoI                      XhoI                      TaqI                      Sau3A
      XhoI                      XhoI
    
```

FIG. 4B

5/31

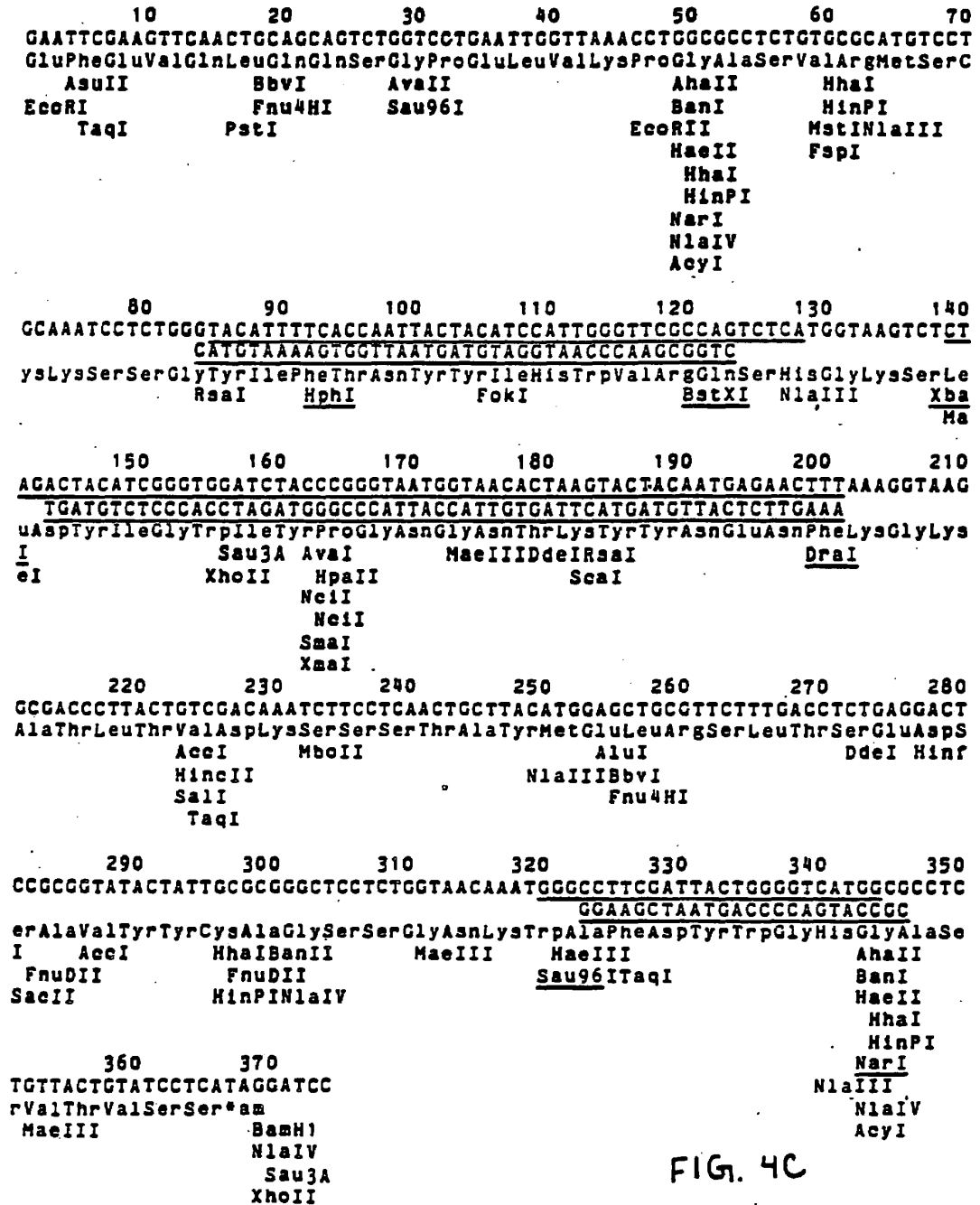

FIG. 4C

6/31

10 20 30 40 50 60 70
 GAATTCGACGTCGTAATGACCCAGACTCCGCTGTCTCTGCCGGTTTCTCTGGGTGACCAGGCTTCTATTT
 GluPheAspValValMetThrGlnThrProLeuSerLeuProValSerLeuGlyAspGlnAlaSerIleS
 EcoRI AatII HinfI HpaII BstEII
 AhaII HphI EcoRI
 TaqI SerFI
 AcyI MaeIII
 MaeII

80 90 100 110 120 130 140
 CTTGCCCTCTTCCCAGTCTATTGTGCACTCTAATGGTAACACTTACCTGGATTGGTACCTGCAAAAGGC
AACGGCGAGAAGGGTCAGATAACACGTGAGATTACCAATTGTGAATGGACCTAAC
 erCysArgSerSerGlnSerIleValHisSerAsnGlyAsnThrTyrLeuAspTrpTyrLeuGlnLysAl
 Fnu4HI HgiAI MaeIII EcoRI Bani
 MboII SerFI KpnI
 HgiEII NlaIV
 RsaI

150 160 170 180 190 200 210
 TGGTCAGTCTCCGAAAGCTTCTGATCTACAAAGTCTCTAACCGCTTCTCTGGTGTCCCGGATCGTTTCTCT
 aGlyGlnSerProLysLeuLeuIleTyrLysValSerAsnArgPheSerGlyValProAspArgPheSer
 AluI Sau3A HpaII
 HindIII NciISau3A
 SerFI

220 230 240 250 260 270 280
 GGTTCGTGTTCTGGTACTGACTTCACCCTGAAGATCTCTCGTGTCCGAGGCCGAGGATCTGGGTATCTACT
GGCTCCTAGACCCATAGATGA
 GlySerGlySerGlyThrAspPheThrLeuLysIleSerArgValGluAlaGluAspLeuGlyIleTyrT
 RsaI HphI BglII TaqIHaeIII Sau3A
 MboII XhoII
 Sau3A
 XhoII

290 300 310 320 330 340 350
 ACTGCTTCCAGGGGTCTCATGTACCGTGGACCTTCGGCGGTGGCACCAAGCTCGAGATCAAACGTTGAGGATCC
TGACGAAGGTCCCCAGAGTACATGGCACCTGGAAGCCGCCACCGTGGTTCCGAGCT
 yrCysPheGlnGlySerHisValProTrpThrPheGlyGlyGlyThrLysLeuGluIleLysArg*op
 EcoRI NlaIII AvaiI Bani AluI Sau3A MaeII BamHI
 SerFI RsaI Sau96I NlaIV AvaiI NlaIV NlaIV
 HgiEII TaqI Sau3A
 XhoI XhoII

FIG. 4D

7/31

10 20 30 40 50 60 70
 GAATTCATGGAAGTACAACCTGCAACAATCTGGGCCCCGGTCTCGGTACCTCCGTCTCAGACTCTGTCCCTGA
 GluPheMetGluValGlnLeuGlnGlnSerGlyProGlyLeuValArgProSerGlnThrLeuSerLeuT
 EcoRI NlaIII RsaI ApaI HpaII RsaI DdeI HinfI
 BanII MaeII Tth111I
 HaeIII
 NciI
 NlaIV
 Sau96I
 Sau96I
 SerFI

80 90 100 110 120 130 140
 CTTGTACCGTATCCGGATCCACCTTCTCTAACTACTACATCCATTGGGTCCGTCAACCGCCGGGTCGTGG
 hrCysThrValSerGlySerThrPheSerAsnTyrTyrIleHisTrpValArgGlnProProGlyArgG1
 RsaI BamHI FokI AvaII HincII HpaII
 HpaII NlaIV NlaIV Sau96I SerFI
 NlaIV
 Sau3A
 XhoII

150 160 170 180 190 200 210
 TCTCGAGTGGATCGGTTGGATTTACCCGGTAATGGTAACACTAAGTACTACAATGAGAAGCTTTAAAGGC
 yLeuGluTrpIleGlyTrpIleTyrProGlyAsnGlyAsnThrLysTyrTyrAsnGluAsnPheLysGly
 AvaI Sau3A AvaI MaeII DdeI RsaI DraI N
 TaqI HpaII ScaI SerFI SerFI
 XhoI NciI SmaI XmaI
 NciI
 SerFI
 SerFI

220 230 240 250 260 270 280
 ATGCTGGTCCGACACTTCTAAGAACCAATTCTCTCTCGCTCTCTTCTGTTACCCGGCTGATACTGCTG
 MetLeuValAspThrSerLysAsnGlnPheSerLeuArgLeuSerSerValThrAlaAlaAspThrAlaV
 laIII AccI DdeI XmaI HgaI MboII MaeIII Fnu4HI
 hI HincII BbvII FnuDII
 SaiI SacII
 TaqI

290 300 310 320 330 340 350
 TGTACTACTGCGCGGTTCCCTCCGGTAATAAGTGGGCATTTGATTACTGGGGCCAGGGCTCTCTGGTCAC
 alTyrTyrCysAlaArgSerSerGlyAsnLysTrpAlaPheAspTyrTrpGlyGlnGlySerLeuValTh
 RsaI BssHII HpaII NlaIV BanII BstEII
 FnuDII EcoRII HphI
 FnuDII HaeIII MaeIII
 HhaI Sau96I SerFI
 HhaI
 HinPI
 HinPI

360 370
 CGTATCCTCTTAAGTGCAG
 rValSerSer*ocLeuGln
 PstI

FIG. 4E

9/31

FR-1

10 20 30 40 50 60 70

GAAGTTCAACTGCAGCAGTCTGGTCTCTGAATTGGTTAAACCTGGCGCCTCTGTGCGCATGTCCTGCAAATCCTCT

E V Q L Q O S G P E L V K P G A S V R M S C K S S

BbvI+ AvaII AhaII MhaI MnlI+

Fnu4HI Sau96I BenIMnlI+ HinPI

PstI EcoRII PspIN11111

HaeII NspHI

HhaI

HinPI

NarI

NlaIV

SrfFI

X₁ FR-1 X₂

85 95 105 115 125 135 145

GGGTACCGCCAGTCTCATGGTAAGTCTCTAGACTTTAAAGGTAAGCGGACCCCTTACTGTGACAAATCTTCCTCA

G Y R Q S H G K S L D F K G K A T L T V D K S S S

BanI BstXI NlaIII XbaI DraI AcoI MboII-

KpnI NlaIV RsaI HincII MnlI+

SaiI TaqI

FR-3 X₃

160 170 180 190 200 210 220

ACTGCTTACATGGAGCTGCGTCTTTGACCTCTGAGGACTCCGGCGTATACTATTGGCGCGTATCGATTATTGG

T A Y M E L R S L T S E D S A V Y Y C A R I D Y W

AluI DdeI HinfI AccI AccII ClaI N1

NlaIII BbvI- MnlI+MnlI- AccII AccII TaqI S

Fnu4HI NspBII SacII BssHII

HhaI

HhaI

HinPI

HinPI

FR-4

235 245 255 265

GGCCATGGCGCTAGCGTTACCGTGAGCTCCTAAGGATCC

G H G A S V T V S S * G S

aIV HaeII AluI DdeI BamHI

su96I HhaI BaniIMstIINlaIV

HaeIII HinPI BspI286 Sau3A

NcoI NheI HqiAI XhoII

NlaIII SacI

StyI

FIG. 5

10/31

10 20 30 40 50 60 70
 GAATTCATGGCTGACAACAAATTCAACAAGGAACAGCAGAACCGGTTCTACGAGATCTTGACCTGCCGAACCTG
 E F M A D N K F N K E Q Q N A F Y E I L H L P N L
 EcoRI MluI BglII BspMI+
 XmnI

85 95 105 115 125 135 145
 AACGAAGAGCAGCGTAACGGCTTCATCCAAAGCTTGAAGACGACCCGCTCAGAGCGCTAACCTGCTGGCAGAG
 N E E Q R N G F I Q S L K D D P S Q S A N L L A E
 HindIII BspMI+
 Eco47III

160 170 180 190 200 210 220
 GCCAAGAAGCTGAACGACGCTCAGCGCGCCGAAGAGTGATCCCGAAGTCAACTGCAGCAGTCTGGTCTCGAATTG
 A K K L N D A Q A P K S D P E V Q L Q Q S G P E L
 NarI PstI

235 245 255 265 275 285 295
 GTTAAACCTGGCGCCTCTGTGCGCATGTCCTGCAAATCCTCTGGGTACATTTTCACCGACTTCTACATGAATTGG
 V K P G A S V R M S C K S S G Y I F T D F Y M N W
 NarI FspI

310 320 330 340 350 360 370
 GTTCGCCAGTCTCATGGTAAGTCTCTAGACTACATCGGGTACATTTCCCCATACTCTGGGGTTACCGGCTACAAC
 V R Q S H G K S L D Y I G Y I S P Y S G V T G Y N
 BstXI XbaI PflMI BstEII

385 395 405 415 425 435 445
 CAGAAGTTAAAGGTAAGGCGACCCCTTACTGTGACAAATCTTCTCAACTGCTTACATGGAGCTGCGTTCTTTG
 Q K F K G K A T L T V D K S S S T A Y M E L R S L
 DraI Sali

460 470 480 490 500 510 520
 ACCTCTGAGGACTCCGCGGTATACTATTGCGCGGGCTCCTCTGGTAACAAATGGGCCATGGATTATTGGGGTCAT
 T S E D S A V Y Y C A G S S G N K W A M D Y W G H
 SacII NcoI

535 545 555 565 575 585 595
 GGTGCTAGCGTTACTGTGAGCTCTGGTGGCGGTGGGTGCGGGCGGTGGTGGCTCGGGTGGCGCGGATCCGACGTC
 G A S V T V S S G G G G S G G G G S G G G S D V
 NheI SacI BamHI AatII

610 620 630 640 650 660 670
 GTTGTACCCAGACTCCGCTGTCTCTGCGGTTCTCTGGGTGACCAGGCTTCTATTCTTCCGCTCTTCCAG
 V V T Q T P L S L P V S L G D Q A S I S C R S S Q
 BstEII PflM

685 695 705 715 725 735 745
 TCTCTGGTCCATTCTAATGGTAACACTTACCTGAACTGGTACCTGCAAAAGGCTGGTCAGTCTCCGAAGCTTCTG
 S L V H S N G N T Y L N W Y L Q K A G Q S P K L L
 I BstXI BspMI+ HindIII
 KpnI

FIG. 6A-1

14/31

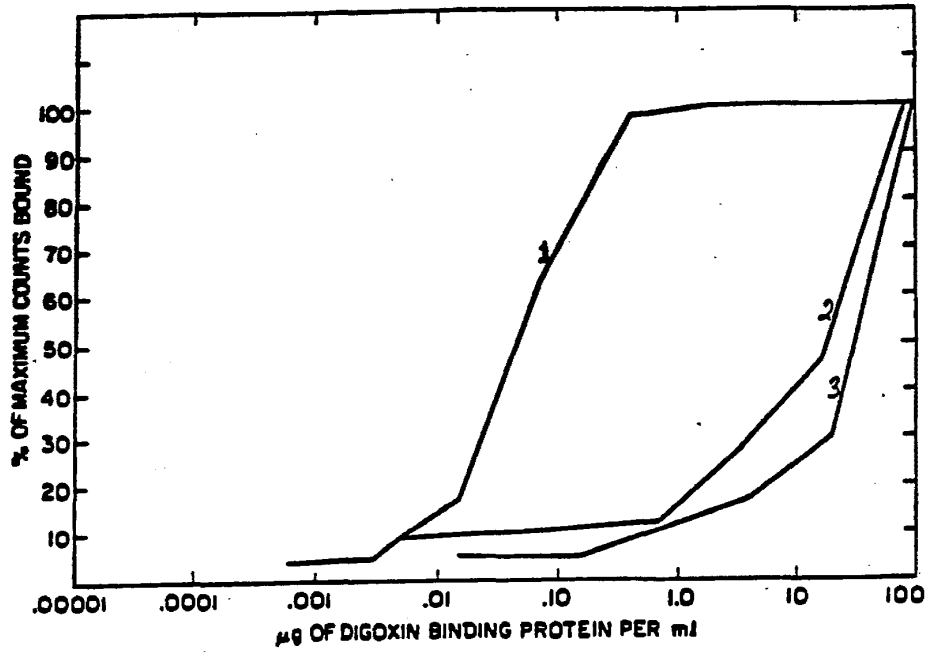

FIG. 7A

```

      760      770      780      790      800      810      820
ATCTACAAAGTCTCTAACCGCTTCTCTGGTGTCCCGGATCGTTTCTCTGGTTCTGGTACTGACTTCACC
I Y K V S N R F S G V P D R F S G S G S G T D F T

      835      845      855      865      875      885      895
CTGAAGATCTCTCGTGTCCGAGGCCGAAGACCTGGGTATCTACTTCTGCTCTCAGACTACTCATGTACCGCCGACT
L K I S R V E A E D L G I Y F C S Q T T H V P P T
      BglII

      910      920      930      940
TTTGGTGGTGGCACCAAGCTCGAGATTAACGTTAACTGCAG
F G G G T K L E I K R *
              XhoI      HpaI PstI
    
```

FIG. 6A-2

12/31

10 20 30 40 50 60
 GATCCTGACGTGTAATGACCCAGACTCCGCTGTCTCTGCCGTTTCTCTGGGTGACCAG
 D P D V V M T Q T P L S L P V S L G D Q
 AatII BstEII

70 80 90 100 110 120
 GCTTCTATTTCTTGCCGCTCTTCCCAGTCTCTGGTCCATTCTAATGGTAACACTTACCTG
 A S I S C R S S Q S L V H S N G N T Y L
 PflMI BstXI

130 140 150 160 170 180
 AACTGGTACCTGCAAAAGGCTGGTCCAGTCTCCGAAGCTTCTGATCTACAAAGTCTCTAAC
 N W Y L Q K A G Q S P K L L I Y K V S N
 BspMI+ HindIII
 KpnI

190 200 210 220 230 240
 CGCTTCTCTGGTGTCCCGGATCGTTTCTCTGGTCTGGTCTGGTACTGACTTCACCCCTG
 R F S G V P D R F S G S G S G T D F T L

250 260 270 280 290 300
 AAGATCTCTCGTGTGAGGCCGAAGACCTGGSTATCTACTTCTGCTCTCAGACTACTCAT
 K I S R V E A E D L G I Y F C S Q T T H
 BglII

310 320 330 340 350 360
 GTACCGCCGACTTTTGGTGGTGGCACCAAGCTCGAGATTAACCTGGATCTGGAGGTGGC
 V P P T F G G G T K L E I K R G S S G G G
 XhoI

370 380 390 400 410 420
 GGATCTGGTGGAGGTGGCTCTGGTGGCGGTGGATCCGAAGTTCAATTGCAGCAGTCTGGT
 G S G G G G S G G G G S E V Q L Q Q S G
 BamHI

430 440 450 460 470 480
 CCTGAATTGGTTAAACCTGGCGCCTCTGTGCGCATGTCTGCAAAATCCTCTGGGTACATT
 P E L V K P G A S V R M S C K S S G Y I
 NarI FspI

490 500 510 520 530 540
 TTCACCGACTTCTACATGAATTGGGTTCCGCGTCTCATGGTAAGTCTCTAGACTACATC
 F T D F Y M N W V R Q S H G K S L D Y I
 BstXI XbaI

550 560 570 580 590 600
 GGGTACATTTCCCATACTCTGGGGTTACCGGCTACAACCAGAAGTTTAAAGGTAAGGCG
 G Y I S P Y S G V T G Y N Q K F K G K A
 PflMI BstEII DraI

610 620 630 640 650 660
 ACCCTTACTGTGACAAATCTTCTCAACTGCTTACATGGAGCTGCGTTCTTTGACCTCT
 T L T V D K S S S T A Y M E L R S L T S
 Sall

670 680 690 700 710 720
 GAGGACTCCGCGGTATACTATTGCGCGGGCTCCTCTGGTAACAAATGGGCCATGGATTAT
 E D S A V Y Y C A G S S G N K W A M D Y
 SacII NcoI

730 740 750 760
 TGGGGTCATGGTGTGCTAGCGTTACTGTGAGCTCTTAACTGCAG
 W G H G A S V T V S S *

FIG. 6B

13/31

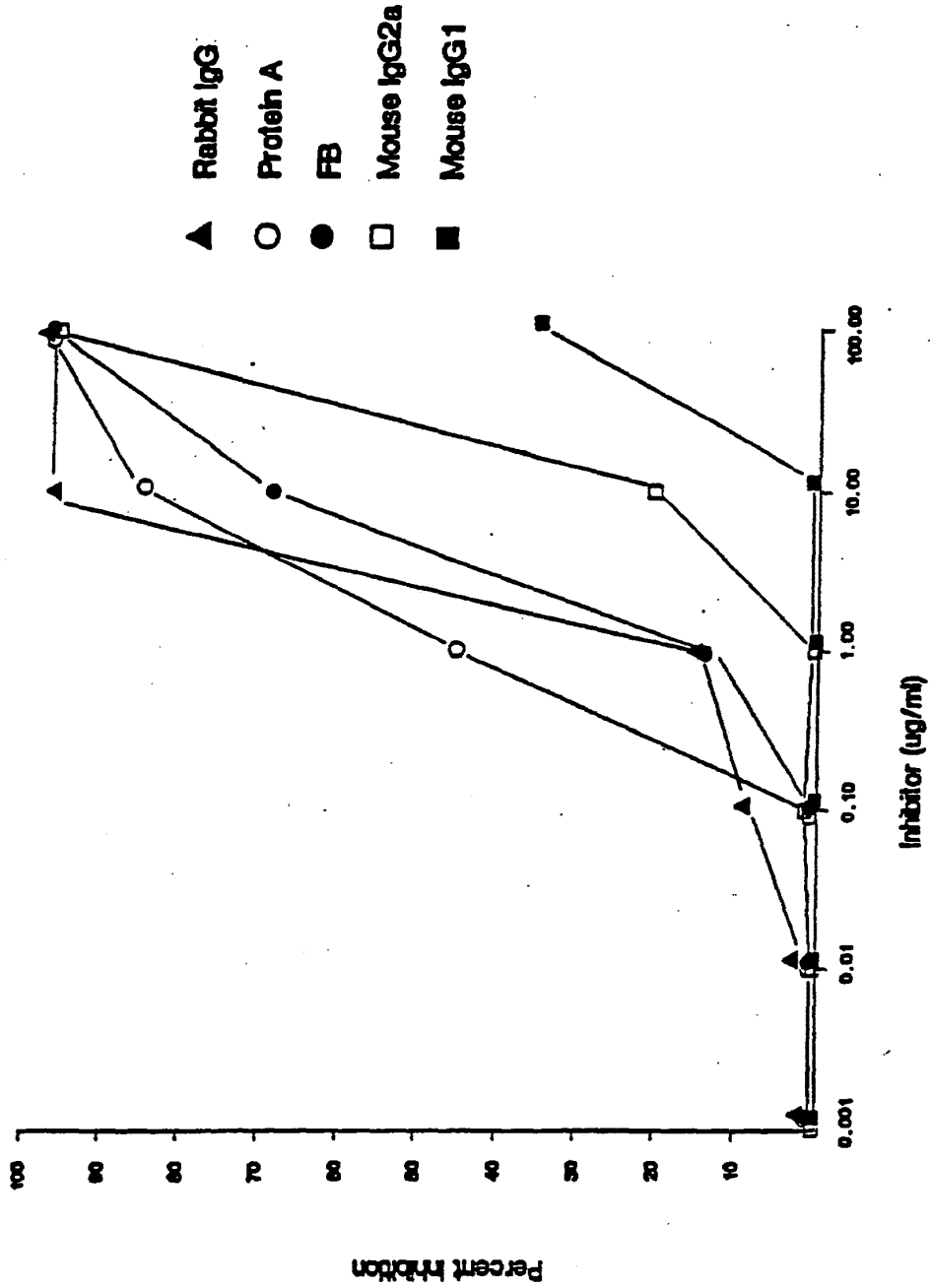

FIG. 7B

14/31

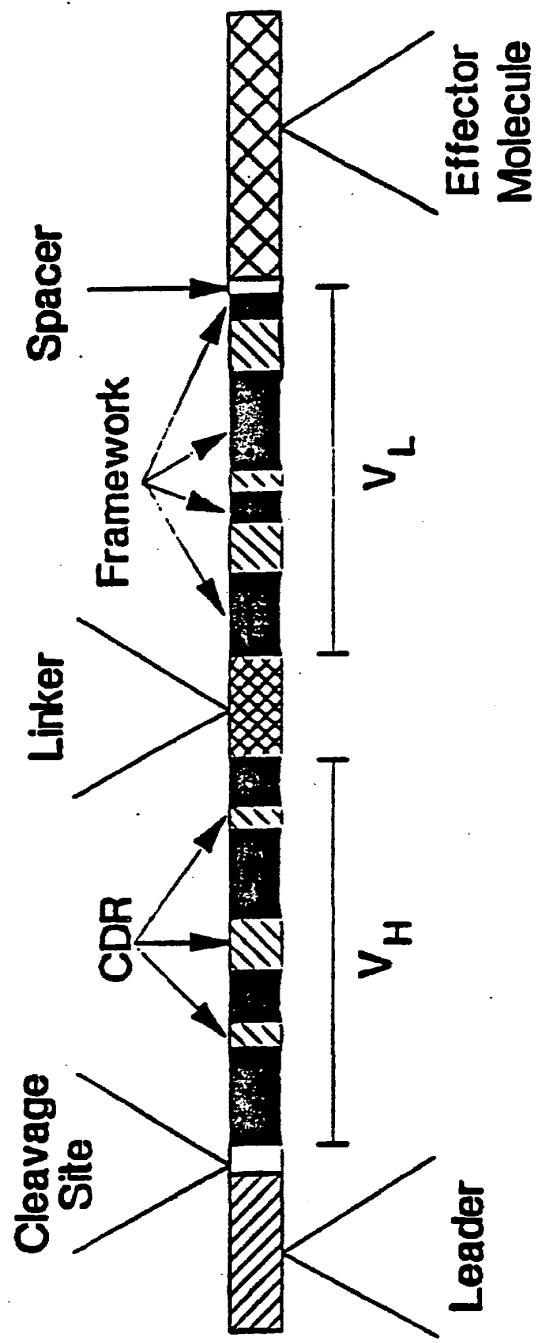

FIG. 8

15/31

10 20 30 40 50 60
 GAAGTTCAACTGGAGCAGTCTGGTCCTGGATTGGTTCGACCTTCCCAGACTCTGTCCCTG
 E V Q L E Q S G P G L V R P S Q T L S L

70 80 90 100 110 120
 ACCTGCACATCCTCTGGGTACATTTTCACCGACTTCTACATGAATTGGGGTTCGCCAGCCT
 T C T S S G Y I F T D F Y M N W V R Q P
 BspMI+ BstXI

130 140 150 160 170 180
 CCTGGTCCGGGCTAGACTACATCGGGTACATTTCCCCATACTCTGGGGTTACCGGGCTAC
 P G R G L D Y I G Y I S P Y S G V T G Y
 XbaI PflMI BstEII

190 200 210 220 230 240
 AACCAGAAGTTTAAAGGTAAGGCGACCCTTCTGGTCAACAAATCTAAGAACCAGGCTTCC
 N Q K F K G K A T L L V N K S K N Q A S
 DraI

250 260 270 280 290 300
 CTGCGGCTGTCTTCTGTGACCGCTGCGGACACCGCGGTATACTATTGCGCGGGCTCCTCT
 L R L S S V T A A D T A V Y Y C A G S S
 SacII

310 320 330 340 350 360
 GGTAACAAATGGGCCATGGATTATTGGGGTCAGGGTTCTCTGGTACTGTGAGCTCTGGT
 G N K W A M D Y W G Q G S L V T V S S G
 NcoI SacI

370 380 390 400 410 420
 GCGGGTGGTCCGGCGGTGGTGGCTCGGGTGGCGGGGATCCGACGTCGTTATGACCCAG
 G G G S G G G S G G G S D V V M T Q
 BamHI AatII

430 440 450 460 470 480
 CCTCCGTCGGTTTCGGGGCTCCTGGTCAGCGGGTACTATTCTTGCCGCTCTTCCCAG
 P P S V S G A P G Q R V T I S C R S S Q
 PflM

490 500 510 520 530 540
 TCTCTGGTCCATTCTAATGGTAACACTTACCTGAACTGGTACCAGCAACTGCCTGGTACG
 S L V H S N G N T Y L N W Y Q Q L P G T
 I BstXI KpnI

550 560 570 580 590 600
 GCTCCGAAGCTTCTGATCTACAAAGTCTCTAACCCTTCTCTGGTGTCCCGGATCGTTTC
 A P K L L I Y K V S N R F S G V P D R F
 HindIII

610 620 630 640 650 660
 TCTGGTCTGGTTCTGGTACTGACTTCACCCTGGCGATCACTGGTCTCCAGGCCGAAGAC
 S G S G S G T D F T L A I T G L Q A E D

670 680 690 700 710 720
 GAGGCTGACTACTTCTGCTCTCAGACTACTCATGTACCGCCGACTTTTGGTGGTGGCACC
 E A D Y F C S Q T T H V P P T F G G G T

730 740 750
 AAGCTCACGGTCTGCGTTAACTGCAG
 K L T V L R * L Q
 HpaI PstI

FIG. 9A

16/31

10 20 30 40 50 60
GAATTCGAAGTTCAACTGCAGCAGTCTGGTCCTGAATTGGTTAAACCTGGCGCCTCTGTG
E F E V Q L Q Q S G P E L V K P G A S V
A_{su}II PstI NarI Fb
EcoRI

70 80 90 100 110 120
CGCATGTCCTGCAAATCCTCTGGGTACACCTTCACCAACTATTACATCCACTGGCTTAAG
R M S C K S S G Y T F T N Y Y I H W L K
PI AflII

130 140 150 160 170 180
CAGTCTCATGGTAAGTCTCTAGAGTGGATCGGTTGGATTTACCCGGGTAATGGTAACACT
Q S H G K S L E W I G W I Y P G N G N T
XbaI SmaI

190 200 210 220 230 240
AAGTACAATGAGAACTTTAAAGGTAAGGCGACCTTACTGTCCGACAAATCTTCTCAACT
K Y N E N F K G K A T L T V D K S S S T
DraI Sall

250 260 270 280 290 300
GCTTACATGGAGCTGCGTTCTTTGACCTCTGAGGACTCCGGGGTATACTATTGGCGCCGT
A Y M E L R S L T S E D S A V Y Y C A R
SacII BssHII

310 320 330 340 350 360
TACACTCATTATTACTTCCGATTATTGGGGCCATGGCGCTAGCGTTACCGTGAGCTCTGGT
Y T H Y Y F D Y W G H G A S V T V S S G
NcoI NheI SacI

370 380 390 400 410 420
GGCGGTGGCTCGGGCGGTGGTGGGTGGCGGGGATCCGACGTCGTTATGACCCAG
G G G S G G G S G G G S D V V M T Q
BamHI AatII

430 440 450 460 470 480
ACTCCGCTGTCTCTGCCGGTTCTCTGGGTGACCAGGCTTCTATTCTTGGCGCTCTTCC
T P L S L P V S L G D Q A S I S C R S S
BstEII

490 500 510 520 530 540
CAGTCTATCGTCCATTCTAATGGTAACACTTACCTGGAGTGGTACCTGCAAAGGCTGGT
Q S I V H S N G N T Y L E W Y L Q K A G
BstXI BspMI+
KpnI

550 560 570 580 590 600
CAGTCTCCGAAGCTTCTGATCTACAAAGTCTCTAACCGCTTCTCTGGTGTCCCGGATCGT
Q S P K L L I Y K V S N R F S G V P D R
HindIII

610 620 630 640 650 660
TTCTCTGGTTCTGTTCTGGTACTGACTTCACCCCTGAAGATCTCTCGTCTCGAGGCCGAG
F S G S G S G T D F T L K I S R V E A E
BglII

670 680 690 700 710 720
GATCTGGGTACTACTGCTTCCAAGGTTCTCATGTACCGTGGACTTTCCGGCGGTGGG
D L G I Y Y C F Q G S H V P W T F G G G

730 740 750
ACCAAGCTCGAGATTAACGTTAACTGCAG
T K L E I K R * L Q
XhoI HpaI PstI

FIG. 9B

17/31

10 20 30 40 50 60
 GATCCCGAGGTTATGCTGGTTGAATCTGGTGGAGTACTGATGGAACCTGGTGGGTCCCTG
 D P E V M L V E S G G V L M E P G G S L
 ScaI EcoO

70 80 90 100 110 120
 AAGCTGAGCTGTGCTGCTAGCGGCTTCACGTTCTCTCGTTACGCCATGTCTGGGTCCCGT
 K L S C A A S G F T F S R Y A M S W V R
 EspI NheI PflMI

130 140 150 160 170 180
 CAGACTCCGGAGAAGCGTCTAGAGTGGGTCCGGACGATATCTTCTGGTGGTTCTCACACG
 Q T P E K R L E W V A T I S S G G S H T
 BspMII XbaI NruI EcoRV

190 200 210 220 230 240
 TTCCATCCAGACAGTGTGAAGGGTTCGATTCACGATCTCTCGAGACAACGCTAAGAACACG
 F H P D S V K G R F T I S R D N A K N T
 XhoI

250 260 270 280 290 300
 TTGTACCTGCAAATGTCTTCTACGTAGTGAAGATACTGCTATGCTACTACTGTGCACGT
 L Y L Q M S S L R S E D T A M Y Y C A R
 BspMI+ SnaBI ApaLI

310 320 330 340 350 360
 CCTCCACTGATCTCACTAGTTGCTGATTATGCCATGGATTATTGGGGTCATGGTGCTAGC
 P P L I S L V A D Y A M D Y W G H G A S
 SpeI NcoI NheI

370 380 390 400 410 420
 GTTACTGTGAGCTCTGGTGGCGGTGGGTCCGGGCGGTGGTGGCTCGGGTGGCGGGGATCG
 V T V S S G G G G S G G G G S G G G S
 SacI

430 440 450 460 470 480
 GATATCGTTATGACTCAGTCTCATAAGTTCATGTCCACTTCTGTTGGTGACCGTGTCTCT
 D I V M T Q S H K F M S T S V G D R V S
 EcoRV BstEII

490 500 510 520 530 540
 ATCACTTGTAAGGCCAGCCAGGATGTGGGTGCTGCTATCGCATGGTATCAGCAGAAGCCC
 I T C K A S Q D V G A A I A W Y Q Q K P
 PflMI Sma

550 560 570 580 590 600
 GGGCAGTCTCCTAAGCTGCTGATCTACTGGGCGTCCGACTCGTCATACTGGTGTCCCGGAT
 G Q S P K L L I Y W A S T R H T G V P D
 I Sall

610 620 630 640 650 660
 CGTTCACTGGGTCCGGATCAGGTACTGATTTCACTCTGACTATTCGAACGTTCACTCT
 R F T G S G S G T D F T L T I S N V Q S
 BspMII AsuII

670 680 690 700 710 720
 GATGACCTGGCTGATTACTTCTGCCAGCAATATTCGGGTACCCTCTGACTTTCCGGTGCC
 D D L A D Y F C Q Q Y S G Y P L T F G A
 SspI KpnI Nae

730 740 750
 GGCCTAAACTCGAGCTGAAGTAACTGCAG
 G T K L E L K *
 I XhoI PstI

FIG. 9D