

-48-

p γ CEAtrp207-1* which contained heavy chain as insoluble bodies, were
 lysed and centrifuged as above; the pellet was resuspended in the
 same buffer, sonicated and re-centrifuged. This pellet was washed
 once with buffer, then suspended in 6M guanidine HCl, 0.1M Tris HCl,
 5 pH 8, 1mM EDTA, 20 mg/ml sodium sulfite and 10 mg/ml sodium
 tetrathionate and allowed to react at 25° for about 16 hrs. The
 reaction mixture was dialyzed against 8M urea, 0.1M Tris HCl, pH 8,
 and stored at 4°, to give a 3 mg/ml solution of γ -SSO₃.

10 650 μ l of cell lysate from cells of various E. coli strains
 producing various IgG chains, was added to 500 mg urea. To this was
 added β -mercaptoethanol to 20mM, Tris-HCl, pH 8.5 to 50mM and EDTA
 to 1mM, and in some experiments, γ -SSO₃ was added to 0.1 mg/ml.
 After standing at 25° for 30-90 mins., the reaction mixtures were
 15 dialyzed at 4° against a buffer composed of 0.1M sodium glycinate,
 pH 10.8, 0.5M urea, 10mM glycine ethyl ester, 5mM reduced
 glutathione, 0.1mM oxidized glutathione. This buffer was prepared
 from N₂-saturated water and the dialysis was performed in a capped
 Wheaton bottle. After 16-48 hours, dialysis bags were transferred
 20 to 4° phosphate buffered saline containing 1mM PMSF and dialysis
 continued another 16-24 hrs. Dialysates were assayed by ELISA as
 described in paragraph E.2 for ability to bind CEA. The results
 below show the values obtained by comparison with the standard curve
 in x ng/ml anti-CEA. Also shown are the reconstitution efficiencies
 25 calculated from the ELISA responses, minus the background (108.
 ng/ml) of cells producing K chain only, and from estimates of the
 levels of γ and K chains in the reaction mixtures.

		ng/ml <u>anti-CEA</u>	<u>Percent recombination</u>
30	<u>E. coli</u> W3110 producing IFN- α A (control)	0	—
	<u>E. coli</u> (W3110/pKCEAtrp207-1*)	108	—
	<u>E. coli</u> (W3110/pKCEAtrp207-1*), plus γ -SSO ₃	848	0.33
	<u>E. coli</u> (W3110/pKCEAtrp207-1* Δ , p γ CEAInt2)	1580	0.76
35	Hybridoma anti-CEA K-SSO ₃ and γ -SSO ₃	540	0.40

0312L

E.4 Preparation of Chimeric Antibody

Figures 11 and 12 show the construction of an expression vector for a chimeric heavy (gamma) chain which comprises the murine anti CEA variable region and human γ -2 constant region.

5

A DNA sequence encoding the human gamma-2 heavy chain is prepared as follows: the cDNA library obtained by standard techniques from a human multiple myeloma cell line is probed with 5' GGGCACTCGACACAA 3' to obtain the plasmid containing the cDNA insert for human gamma-2 chain (Takahashi, et al., Cell, 29: 671 (1982), incorporated herein by reference), and analyzed to verify its identity with the known sequence in human gamma-2 (Ellison, J., et al., Proc. Natl. Acad. Sci. (USA), 79: 1984 (1982) incorporated herein by reference).

15

As shown in Figure 11, two fragments are obtained from this cloned human gamma 2 plasmid (p γ 2). The first fragment is formed by digestion with PvuII followed by digestion with Ava III, and purification of the smaller DNA fragment, which contains a portion of the constant region, using 6 percent PAGE. The second fragment is obtained by digesting the p γ 2 with any restriction enzyme which cleaves in the 3' untranslated region of γ 2, as deduced from the nucleotide sequence, filling in with Klenow and dNTPs, cleaving with Ava III, and isolating the smaller fragment using 6 percent PAGE. (The choice of a two step, two fragment composition to supply the PvuII-3' untranslated fragment provides a cleaner path to product due to the proximity of the AvaIII site to the 3 terminal end thus avoiding additional restriction sites in the gene sequence matching the 3' untranslated region site.) p γ CEA207-1* is digested with EcoR I, treated with Klenow and dNTPs to fill in the cohesive end, and digested with Pvu II, the large vector fragment containing promoter isolated by 6 percent PAGE.

25

30

35

The location and DNA sequence surrounding the PvuII site in the

0312L

-50-

mouse gamma-1 gene are identical to the location and DNA sequence surrounding the PvuII site in the human gamma-2 gene.

5 The plasmid resulting from a three way ligation of the foregoing fragments, pChim1, contains, under the influence of trp promoter, the variable and part of the constant region of murine anti-CEA gamma 1 chain, and a portion of the gamma 2 human chain. pChim1 will, in fact, express a chimeric heavy chain when transformed into E. coli, but one wherein the change from mouse to human does not
10 take place at the variable to constant junction.

Figure 12 shows modification of pChim1 to construct pChim2 so that the resulting protein from expression will contain variable region from murine anti CEA antibody and constant region from the
15 human γ -2 chain. First, a fragment is prepared from pChim1 by treating with Nco I, blunt ending with Klenow and dNTPs, cleaving with Pvu II, and isolating the large vector fragment which is almost the complete plasmid except for short segment in the constant coding
20 region for mouse anti CEA. A second fragment is prepared from the previously described p γ 2 by treating with Pvu II, followed by treating with any restriction enzyme which cleaves in the variable region, blunt ending with Klenow and dNTPs and isolating the short fragment which comprises the junction between variable and constant
25 regions of this chain.

Ligation of the foregoing two fragments produces an intermediate plasmid which is correct except for an extraneous DNA fragment which contains a small portion of the constant region of the murine anti CEA antigen, and a small portion of the variable region of the human
30 gamma chain. This repair can be made by excising the Xba I to Pvu II fragment and cloning into M13 phage as described by Messing et al., Nucleic Acids Res. 9: 309 (1981), followed by in vitro site directed deletion mutagenesis as described by Adelman, et al., DNA
35 2, 183 (1983) which is incorporated herein by reference. The

-51-

Xba I-Pvu II fragment thus modified is ligated back into the intermediate plasmid to form pChim2. This plasmid then is capable of expressing in a suitable host a cleanly constructed murine variable/human constant chimeric heavy chain.

5

In an analogous fashion, but using mRNA templates for cDNA construction for human kappa rather than γ chain, the expression plasmid for chimeric light chain is prepared.

10

The foregoing two plasmids are then double transformed into E. coli W3110, the cells grown and the chains reconstituted as set forth in paragraph E.1-E.3 supra.

E.5 Preparation of Altered Murine Anti-CEA Antibody

15

E.5.1 Construction of Plasmid Vectors for Direct Expression of Altered Murine Anti-CEA Heavy Chain Gene

The cysteine residues, and the resultant disulfide bonds in the region of amino acids 216-230 in the constant region of murine anti-CEA heavy chain are suspected to be important for complement fixation (Klein, et al., Proc. Natl. Acad. Sci., (USA), 78: 524 (1981)) but not for the antigen binding property of the resulting antibody. To decrease the probability of incorrect disulfide bond formation during reconstitution according to the process of the invention herein, the nucleotides encoding the amino acid residues 226-232 which includes codons for three cysteines, are deleted as follows:

20

A "deleter" deoxyoligonucleotide, 5' CTAACACCATGTCAGGGT is used to delete the relevant portions of the gene from p γ CEAtrp207-1* by the procedure of Wallace, et al., Science, 209: 1396 (1980) or of Adelman, et al., DNA 2, 183 (1983). Briefly, the "deleter" deoxyoligonucleotide is annealed with denatured p γ CEAtrp207-1* DNA,

25

n3121

-52-

and primer repair synthesis carried out in vitro, followed by screening by hybridization of presumptive deletion clones with P^{32} labelled deleter sequence.

5 E.5.2 Production of Cysteine Deficient Altered Antibody

The plasmid prepared in E.5.1 is transformed into an E. coli strain previously transformed with pKCEAtrp207-1* as described above. The cells are grown, extracted for recombinant antibody chains, and the altered antibody reconstituted as described in
10 E.1.10.

E.6 Preparation of Fab

15 E.6.1 Construction of a Plasmid Vector for Direct Expression
 of Murine Anti-CEA Gamma 1 Fab Fragment Gene
 p γ CEAFabtrp207-1*

Figure 13 presents the construction of p γ CEAFabtrp207-1*. 5 μ g of pBR322 was digested with Hind III, the cohesive ends made flush by treating with Klenow and dNTPs; digested with Pst I, and treated
20 with BAP. The large vector fragment, fragment I, was recovered using 6 percent PAGE followed by electroelution.

5 μ g of p γ CEAtrp207-1* was digested with both BamH I and Pst I and the ~1570 bp DNA fragment (fragment II) containing the trp promoter and the gene sequence encoding the variable region
25 continuing into constant region and further into the anti-CEA gamma 1 chain hinge region, was isolated and purified after electrophoresis.

30 Expression of the anti-CEA gamma 1 chain Fab fragment rather than complete heavy chain requires that a termination codon be constructed at the appropriate location in the gene. For this, the 260 bp Nco I - Nde I DNA fragment from 20 μ g of the p γ 298 was isolated and purified. A 13 nucleotide DNA primer, the complement

35

03121

-53-

of which encodes the last 3 C-terminal amino acids of the Fab gene and 2 bases of the 3 needed for the stop codon, was synthesized by the phosphotriester method (supra). The probe hybridizes to nucleotides 754 to 767 (Figure 4) which has the following sequence:

5

AspCysGlyStop

5' GGGATTGTGGTTG 3'

The third base of the stop codon is provided by the terminal nucleotide of the filled-in Hind III site from pBR322 cleavage described above. 500 ng of this primer was used in a primer repair reaction by phosphorylation at the 5' end in a reaction with 10 units T4 DNA kinase containing 0.5 mM ATP in 20 μ l, and mixing with ~200 ng of the Nco I-Nde I DNA fragment. The mixture was heat denatured for 3 minutes at 95° and quenched in dry-ice ethanol. The denatured DNA solution was made 60mM NaCl, 7mM MgCl₂, 7 mM Tris HCl (pH 7.4), 12 mM in each dNTP and 12 units DNA Polymerase I-Large Fragment was added. After 2 hours incubation at 37°C, this primer repair reaction was phenol/CHCl₃ extracted, ethanol precipitated, digested with BamH I and the reaction electrophoresed through a 6 percent polyacrylamide gel. ~50 ng of the 181 bp blunt end to BamH I DNA fragment, fragment III, was isolated and purified.

10

15

20

25

~100 ng of fragment I, ~100 ng each of fragments II and III were ligated overnight and transformed into E. coli K12 strain 294. Plasmid DNA from several tetracycline resistant transformants was analyzed for the proper construction and the nucleotide sequence through the repair blunt end filled-in Hind III junction was determined for verification of the TGA stop codon.

30

E.6.2 Production of Fab Protein

The plasmid prepared in E.6.1 is transformed into an E. coli strain previously transformed with pKCEatrp207-1* as described above. The cells are grown, extracted for recombinant antibody chains and the Fab protein reconstituted as described in E.1.10.

35

The appended claims set out the principal areas for which a monopoly is presently claimed. In addition, the following preferred features should be noted:

- the antibody of claim 3 which is directed against CEA;
- 5 the antibody of claim 3 wherein the heavy chain is of the gamma family;
- the antibody of claim 3 wherein the light chain is of the kappa family;
- the composition of matter of claim 8 which is
- 10 mammalian;
- the composition of matter of claim 8 which is immunoreactive against CEA;
- the sequence of claim 9 which is a mammalian heavy chain;
- 15 the sequence of claim 9 which is anti-CEA heavy chain;
- the sequence of claim 10 which is a mammalian light chain;
- the sequence of claim 10 which is anti-CEA light chain;
- 20 the recombinant host cells of claim 16 which are microbial host cells;
- the method of claim 17 wherein the vector of b) and the vector of d) are transformed into the same host cell culture, and
- 25 the sequence of a) and the sequence of c) are inserted into the same replicable expression vector;
- the method of claim 17 wherein the DNA sequence of a) encodes mammalian heavy chain, and the DNA sequence of c) encodes mammalian light chain; and wherein both DNA
- 30 fragments encode amino acid sequences of the same mammalian antibody;
- the method of claim 17 wherein the DNA fragment of a) encodes a chimeric hybrid heavy chain and the DNA sequence of c) encodes a chimeric light chain; and
- 35 the method of any one of claims 17 to 19 wherein said vectors are transformed into the same host cell culture.

CLAIMS

1. An immunoglobulin produced by recombinant host cells.
- 5 2. An immunoglobulin substantially free of other proteins with which it is normally associated in vertebrate cells.
3. The immunoglobulin of claim 1 or 2 which is a mammalian antibody, in that the amino acid sequences of all
10 four chains are homologous to the sequences in the corresponding chains in an antibody derived from a mammalian species.
4. The immunoglobulin of claim 1 or 2 which is a hybrid
15 antibody, a composite non-specific immunoglobulin, a chimeric antibody, or an altered antibody.
5. A chimeric antibody of claim 4 wherein the constant regions of all four chains are homologous to the
20 corresponding constant regions of an antibody of a first mammalian species, and the amino acid sequence of the variable regions of all four chains are homologous to the variable regions in an antibody derived from a second, different, mammalian species.
- 25 6. A composition of matter consisting essentially of a univalent antibody.
7. A composition of matter consisting essentially of Fab
30 protein.
8. A composition of matter of claim 6 or claim 7 which is produced by recombinant host cells.
- 35 9. A sequence of amino acids produced by recombinant host cells corresponding to immunoglobulin heavy chain.

10. A sequence of amino acids produced by recombinant host cells corresponding to immunoglobulin light chain.
11. A sequence of claim 9 or claim 10 which is a chimeric heavy chain or light chain, respectively.
12. A sequence of claim 11 wherein that portion of the sequence which corresponds to the constant region is homologous to corresponding sequence of an antibody derived from humans, and the amino acid sequence of the variable region is homologous to the corresponding amino acid sequence of an antibody derived from non-human mammalian species.
13. A DNA sequence which encodes for the immunoglobulin of claim 1 or 2, the composition of matter of claim 6 or the amino acid sequence of claim 9 or claim 10.
14. A replicable expression vector capable of expressing in a suitable host cell the DNA sequence of claim 13.
15. An expression plasmid which comprises the DNA sequence of claim 14 operably linked to a promoter compatible with a suitable host cell.
16. Recombinant host cells or host cell cultures transformed with the vector of claim 14 or 15.
17. A method for preparing immunoglobulins in recombinant host cells which method comprises
- a) preparing a DNA sequence encoding heavy chain,
 - b) inserting the sequence of a) into a replicable expression vector operably linked to a suitable promoter,
 - c) preparing a DNA sequence encoding light chain,
 - d) inserting the sequence of c) into a replicable expression vector operably linked to a suitable promoter,

- e) transforming host cell culture with the vector of
b) and host cell culture with the vector of d),
f) recovering light chain and heavy chain from cell
culture,
5 g) reconstituting light and heavy chain,
wherein steps f) and g) may be performed either
sequentially in either order, or simultaneously.

18. A method for preparing Fab protein in recombinant
10 host cells which method comprises
a) preparing a DNA sequence encoding the Fab region
of heavy chain,
b) inserting the sequence of a) into a replicable
expression vector operably linked to a suitable promoter,
15 c) preparing a DNA sequence encoding light chain,
d) inserting the sequence of c) into a replicable
expression vector operably linked to a suitable promoter,
e) transforming host cell culture with the vector of
b) and host cell culture with the vector of d),
20 f) recovering light chain and Fab protein of heavy
chain from cell culture,
g) reconstituting light and heavy Fab region chains;
wherein steps f) and g) may either be performed
sequentially in either order or simultaneously.

- 25 19. A method for preparing univalent antibody in
recombinant host cells which method comprises.
a) preparing a DNA sequence encoding heavy chain,
b) inserting the sequence of a) into a replicable
30 expression vector operably linked to a suitable promoter,
c) preparing a DNA sequence encoding light chain,
d) inserting the sequence of c) into a replicable
expression vector operably linked to a suitable promoter,
e) preparing a DNA sequence encoding the Fc portion
35 of heavy chain,

f) inserting the sequence of e) into a replicable expression vector operably linked to a suitable promoter,

g) transforming host cell culture with the vector of b), host cell culture with the vector of d), and host cell
5 culture with the vector of f),

h) recovering light chain, heavy chain, and Fc portion of heavy chain from cell culture,

i) reconstituting light chain, heavy chain, and Fc portion of heavy chain,

10 wherein steps h) and i) may be performed sequentially in either order or simultaneously.

20. A method for preparing heavy chain or light chain which method comprises

15 a) preparing a DNA sequence encoding heavy or light chain,

b) inserting said sequence into a replicable expression vector operably linked to a suitable promoter,

c) transforming host cell culture with the vector of
20 b), and

d) recovering heavy or light chain from cell culture.

21. A method for preparing Fab region of heavy chain as a polypeptide which method comprises

25 a) preparing a DNA sequence encoding Fab region of heavy chain,

b) inserting said sequence into a replicable expression vector operably linked to a suitable promoter,

d) transforming host cell culture with the vector of
30 b),

d) recovering Fab region of heavy chain from cell culture.

1/19

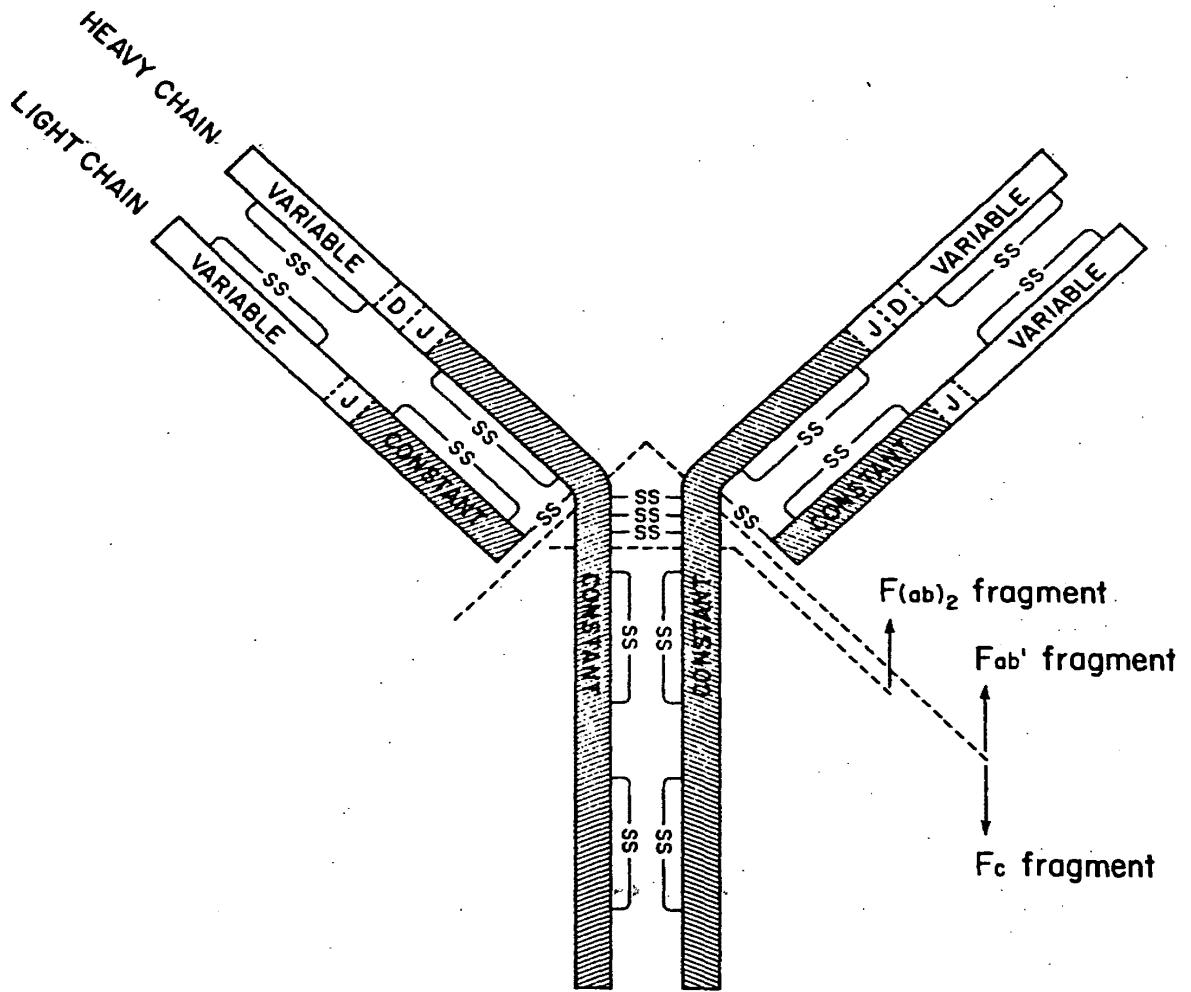

Fig. 1.

1 GTTGCTGTGG TTGCTGGTG TTGAAGGAGA CATTGTGATG ACCCAGTCTC ACAAATTCAT GTCCACATCA GTAGGAGACA GGGTCAGCAT CACCTGCAAG
 CAACGACACC AACAGACCAC AACTTCTCT GTAACACTAC TGGGTCAGAG TGTTAAGTA CAGGTGTAGT CATCCTCTGT CCCAGTCGTA GTGGACGTTT
 haeIII
 haeI
 tth111
 tth111
 hphI
 101 GCCAGTCAGG ATGTGGGTGC TGCTATAGCC TGGTATCAAC AGAAACCAGG ACAATCTCCT AAACACTGTA TTTACTGGGC ATCCACCCGG CACACTGGAG
 CGGTCAGTCC TACACCCAGG ACGATATCGG ACCATAGTTG TCTTTGGTCC TGTTAGAGGA TTTGATGACT AAATGACCCG TAGGTGGGCC GTGTGACCTC
 scrFI
 nciI
 hpaII
 hinfI
 foki
 sfaNI
 fnu4HI
 bbv
 scrFI
 ecorII
 scrFI
 ecorII
 201 TCCCTGATCG CTTACACAGGC AGTGGATCTG GGACAGATT CACTCTCACC ATTAGCAATG TGCAGTCTGA TGAATTGGCA GATTATTTCT GTCAACAATA
 AGGGACTAGC GAAGTGTCGG TCACCTAGAC CCTGTCTAAA GTGAGAGTGG TAATCGTTAC ACGTCAGACT ACTGAACCGT CTAATAAAGA CAGTTGTTAT
 xhoI
 sau3A
 dpnI
 sau3A
 dpnI
 hphI
 hincII
 301 TAGCGGGTAT CCTCTCACGT TCGGTGCTGG GACCAAGCTG GAGCTGAAAC GGGCTGATGC TGCACCAACT GTATCCATCT TCCCACCATC CAGTGAGCAG
 ATCGCCATA GGAGAGTGCA AGCCACGACC CTGGTTCGAC CTCGACTTTC CCCGACTAGC ACGTGGTTGA CATAGGTAGA AGGGTGGTAG GTCACTCGTC
 sau96
 avall
 aluI
 aluI
 sfaNI
 fnu4HI
 bbv
 mboII
 hpaI
 hincII
 foki
 401 TTAACATCTG GAGGTGCCTC AGTCGTGTGE TTCTTGAACA ACTTCTACCC CAAAGACATC AATGTCAAGT GGAAGATTGA TGGCAGTGAA CGACAAAATG
 AATTGTAGAC CTCCACGGAG TCAGCACACG AAGAACTTGT TGAAGATGGG GTTCTGTAG TTACAGTTCA CTTTCTAACT ACCGTCACCT GCTGTTTTAC
 mnlI
 ddeI
 xmnI
 mboII
 acyI

2/A

Fig. 2A.

0125023

sau3A
 dpnI
 fnu4HI
 bbv
 mnlI hincII
 aluI
 hgaI
 bclI
 501 GCGTCCTGAA CAGTTGGACT GATCAGGACA GCAAAGACAG CACCTACAGC ATGAGCAGCA CCCTCACGTT GACCAAGGAC GAGTATGAAC GACATAACAG
 CGCAGGACTT GTCAACCTGA CTAGTCCTGT CGTTTCTGTC GTGGATGTCG TACTCGTCGT GGGAGTGCAA CTGTTTCTG CTCATACTTG CTGTATTGTC

 mnlI
 haeIII
 haeI
 hphI
 aluI
 sau96 hgaI
 ddeI
 601 CTATACCTGT GAGGCCACTC ACAAGACATC AACTTCACCC ATTGTCAAGA GCTTCAACAG GAATGAGTGT TAGAGACAAA GGCCTGAGA CGCCACCACC
 GATATGGACA CTCCGGTGAG TGTTCTGTAG TTGAAGTGGG TAACAGTTCT CGAAGTTGTC CTTACTCACA ATCTCTGTTT CCAGGACTCT GCGGTGGTGG

 aluI aluI mboII ddeI mnlI hgfA mnlI mnlI
 701 AGCTCCCCAG CTCCATCCTA TCTTCGCTTC TAAGGTCTTG GAGGCTTCCC CACAAGCGAC CTACCACTGT TCGGGTGCTC CAAACCTCCT CCCCACCTCC
 TCGAGGGGTC GAGGTAGGAT AGAAGGGAAG ATTCCAGAAC CTCCGAAGGG GTGTTGCTG GATGGTGACA ACGCCACGAG GTTTGGAGGA GGGGTGGAGG
 fokI

 mnlI
 mnlI mnlI
 801 TTCTCCTCCT CCTCCCTTC CTGGCTTTT ATCATGCTAA TATTTGCAGA AAATATTCAA TAAAGTGAGT CTTTGCACCT GA
 AAGAGGAGGA GGAGGGAAG GAACCGAAAA TAGTACGATT ATAAACGTCT TTTATAAGTT ATTTCACTCA GAAACGTGAA CT

nucleotides: 882

Fig. 2B.

3/19

0125023

-9									1						10									20						
	leu	leu	trp	leu	ser	gly	val	glu	gly	asp	ile	val	met	thr	gln	ser	his	lys	phe	met	ser	thr	ser	val	gly	asp	arg	val	ser	
g	UUG	CUG	UGG	UUG	UCU	GGU	GUU	GAA	GGA	GAC	AUU	GUG	AUG	ACC	CAG	UCU	CAC	AAA	UUC	AUG	UCC	ACA	UCA	GUA	GGA	GAC	AGG	GUC	AGC	
									30										40											50
	ile	thr	cys	lys	ala	ser	gln	asp	val	gly	ala	ala	ile	ala	trp	tyr	gln	gln	lys	pro	gly	gln	ser	pro	lys	leu	leu	ile	tyr	trp
	AUC	ACC	UGC	AAG	GCC	AGU	CAG	GAU	GUG	GGU	GCU	GCU	AUA	GCC	UGG	UAU	CAA	CAG	AAA	CCA	GGA	CAA	UCU	CCU	AAA	CUA	CUG	AUU	UAC	UGG
									60										70											80
	ala	ser	thr	arg	his	thr	gly	val	pro	asp	arg	phe	thr	gly	ser	gly	ser	gly	thr	asp	phe	thr	leu	thr	ile	ser	asn	val	gln	ser
	GCA	UCC	ACC	CGG	CAC	ACU	GGA	GUC	CCU	GAU	CGC	UUC	ACA	GGC	AGU	GGA	UCU	GGG	ACA	GAU	UUC	ACU	CUC	ACC	AUU	AGC	AAU	GUG	CAG	UCU
									90										100											110
	asp	asp	leu	ala	asp	tyr	phe	cys	gln	gln	tyr	ser	gly	tyr	pro	leu	thr	phe	gly	ala	gly	thr	lys	leu	glu	leu	lys	arg	ala	asp
	GAU	GAC	UUG	GCA	GAU	UAU	UUC	UGU	CAA	CAA	UAU	AGC	GGG	UAU	CCU	CUC	ACG	UUC	GGU	GCU	GGG	ACC	AAG	CUG	GAG	CUG	AAA	CGG	GCU	GAU
									120										130											140
	ala	ala	pro	thr	val	ser	ile	phe	pro	pro	ser	ser	glu	gln	leu	thr	ser	gly	gly	ala	ser	val	val	cys	phe	leu	asn	asn	phe	tyr
	GCU	GCA	CCA	ACU	GUA	UCC	AUC	UUC	CCA	CCA	UCC	AGU	GAG	CAG	UUA	ACA	UCU	GGA	GGU	GCC	UCA	GUC	GUG	UGC	UUC	UUG	AAC	AAC	UUC	UAC
									150										160											170
	pro	lys	asp	ile	asn	val	lys	trp	lys	ile	asp	gly	ser	glu	arg	gln	asn	gly	val	leu	asn	ser	trp	thr	asp	gln	asp	ser	lys	asp
	CCC	AAA	GAC	AUC	AAU	GUC	AAG	UGG	AAG	AUU	GAU	GGC	AGU	GAA	CGA	CAA	AAU	GGC	GUC	CUG	AAC	AGU	UGG	ACU	GAU	CAG	GAC	AGC	AAA	GAC
									180										190											200
	ser	thr	tyr	ser	met	ser	ser	thr	leu	thr	leu	thr	lys	asp	glu	tyr	glu	arg	his	asn	ser	tyr	thr	cys	glu	ala	thr	his	lys	thr
	AGC	ACC	UAC	AGC	AUG	AGC	AGC	ACC	CUC	ACG	UUG	ACC	AAG	GAC	GAG	UAU	GAA	CGA	CAU	AAC	AGC	UAU	ACC	UGU	GAG	GCC	ACU	CAC	AAG	ACA
									210										214											
	ser	thr	ser	pro	ile	val	lys	ser	phe	asn	arg	asn	glu	cys	AM															
	UCA	ACU	UCA	CCC	AUU	GUC	AAG	AGC	UUC	AAC	AGG	AAU	GAG	UGU	UAG	AGACAAAGGUCCUGAGACGCCACCACCAGCUGCCCAAGCUCCCAUCCUUAUCUCCCCUUCUAA														

UAUUCAAUAAAGUGAGUCUUUGCACUUGA

Fig. 3.

41M

0125023

```

1      hinfI          sau96          ddeI          ahaIII          sfaNI
      GAGTCAGCAC TGAACACGGA CCCCTCACGA TGAACTTCGG GCTCAGCTTG ATTTACCTTG TCCTTGTTTT AAAAGTTGTC CAGTGTGAAG TGATGCTGGT
      CTCAGTCGTG ACTTGTGCCT GGGGAGTGT ACTTGAAGCC CGAGTCGAAC TAAATGGAAC AGGAACAAAA TTTTCAACAG GTCACACTTC ACTACGACCA

101     scrFI sau96          fnu4HI
          hinfI hinfI          ecorII avaII          bbv mnlI hinfI
      GGAGTCTGGG GGAGTCTTAA TGGAGCCTGG AGGGTCCCTG AAActCTCCT GTGCAGCCTC TGGATTCAC TTCAGTAGAT ATGCCATGTC TTGGGTTCCG
      CCTCAGACCC CCTCAGAATT ACCTCGGACC TCCCAGGGAC TTTGAGAGGA CACGTCGGAG ACCTAAGTGA AAGTCATCTA TACGGTACAG AACCCAAGCG

201     hpaII mnlI          hphI
          hinfI mboII
      CAGACTCCGG AGAAGAGGCT GGAGTGGGTC GCAACCATTA GTAGTGGTGG TAGTTCACAC CTTCCATCCA GACAGTGTGA AGGGCGATTC ACCATCTCCA
      GTCTGAGGCC TCTTCTCCGA CCTCACCCAG CGTTGGTAAT CATCACCACC ATCAAGTGTG GAAGGTAGGT CTGTCACACT TCCCCTAAG TGGTAGAGGT
          fokI

301     mnlI mnlI          haeIII          mnlI
          rsaI          ddeI ddeI          haeIII          mnlI
      GAGACAATGC CAAGAACACC CTGTACCTGC AAATGAGCAG TCTGAGGTCT GAGGACACGG CCATGTATTA CTGTGCAAGA CCCCCTCTTA TTTCGTTAGT
      CTCTGTTACG GTTCTTGTGG GACATGGACG TTTACTCGTC AGACTCCAGA CTCCTGTGCC GGTACATAAT GACACGTTCT GGGGGAGAAT AAAGCAATCA

401     mnlI          mnlI          xhoII
          ddeI hphI          ddeI          sau96 sau3A
          haeIII dpnI
      AGCGGACTAT GCTATGGACT ACTGGGGTCA AGGAACCTCA GTCACCGTCT CCTCAGCCAA AACGACACCC CCATCTGTCT ATCCACTGGC CCCTGGATCT
      TCGCCTGATA CGATACCTGA TGACCCAGT TCCTTGGAGT CAGTGGCAGA GGAGTCGGTT TTGCTGTGGG GGTAGACAGA TAGGTGACCG GGGACCTAGA

```

Fig. 4A.

5/19

0125023

```

                    scrFI
                    ncoI  sfaNI  fokI
fnu4HI                hphI  ecoRII  scrFI
bbv                   bstEII  ecoRII
501  GCTGCCAAA CTAAGTCCAT GGTGACCCTG GGATGCCTGG TCAAGGGCTA TTTCCCTGAG CCAGTGACAG TGACCTGGAA CTCTGGATCC CTGTCCAGCG
CGACGGGTTT GATTGAGGTA CCACTGGGAC CCTACGGACC AGTTCCCGAT AAAGGGACTC GGTCACTGTC ACTGGACCTT GAGACCTAGG GACAGGTCCG

                    fnu4HI
                    bbv  ddeI
                    sau96
                    mnI
601  hgIA                pvuII  pstI  mnI  ddeI  aluI  mnI  haeIII  hphI
GTGTGCACAC CTTCCCAGCT GTCCTGCAGT CTGACCTCTA CACTCTGAGC AGCTCAGTGA CTGTCCCCTC CAGCCCTCGG CCCAGCGAGA CCGTCACCTG
CACACGTGTG GAAGGGTCGA CAGGACGTC A GACTGGAGAT GTGAGACTCG TCGAGTCACT GACAGGGGAG GTCGGGAGCC GGGTCGCTCT GGCAGTGGAC

                    scrFI
                    haeIII
                    nciI  fnu4HI
                    bgII  hpaII  bbv
701  CAACGTTGCC CACCCGGCCA GCAGCACCAA GGTGGACAAG AAAATTGTGC CCAGGGATTG TGTTTGTAA G CTTTGCATAT GTACAGTCCC AGAAGTATCA
GTTGCAACGG GTGGGCCGGT CGTCGTGGTT CCACCTGTTT TTTAACAGC GGTCCCTAAC ACCAACATTC GGAACGTATA CATGTCAGGG TCTTCATAGT

                    mstII
                    hinfI
                    hphI
                    ddeI
                    accI  foki  sau3A
                    dpnI  mnI
801  TCTGTCTTCA TCTTCCCCC AAAGCCCCAAG GATGTGCTCA CCATTACTCT GACTCCTAAG GTCACGTGTG TTGTGGTAGA CATCAGCAAG GATGATCCCG
AGACAGAAGT AGAAGGGGGG TTTCCGGGTTT CTACACGAGT GGTAAATGAGA CTGAGGATTC CAGTGACAC AACACCATCT GTAGTCGTTT CTAAGTGGG

                    smaI
                    scrFI
                    scrFI
                    nciI
                    nciI
                    hpaII
                    sau96  pvuII  mnI  ddeI
                    ayaII  aluI  hgIA  aluI  hgaI  ayaI  mnI  ddeI
901  AGGTCCAGTT CAGCTGGTTT GTAGATGATG TGGAGGTGCA CACAGCTCAG ACGCAACCCC GGGAGGAGCA GTTCAACAGC ACTTCCGCT CAGTCAGTGA
TCCAGGTCAA GTCGACCAA CATCTACTAC ACCTCCACGT GTGTGAGTC TCGTGGGGG CCCTCCTCGT CAAGTTGTCTG TGAAAGGCGA GTCAGTCACT

```

6 | 19

0125023

Fig. 4B.

scrFI fnu4HI
 ecoRII bbv
 1001 ACTTCCATC ATGCACCAGG ACTGGCTCAA TGGCAAGGAG TTCAAATGCA GGGTCAACAG TGCAGCTTTC CCTGCCCCCA TCGAGAAAAC CATCTCCAAA
 TGAAGGGTAG TACGTGGTCC TGACCGAGTT ACCGTTCCCT AAGTTTACGT CCCAGTTGTC ACGTCGAAAG GGACGGGGGT AGCTCTTTTG GTAGAGGTTT
 hincII aluI taqI
 haeIII
 haeI
 1101 ACCAAAGGCA GACCGAAGGC TCCACAGGTG TACACCATT CACCTCCCAA GGAGCAGATG GCCAAGGATA AAGTCAGTCT GACCTGCATG ATAACAGACT
 TGGTTCCGT CTGGCTCCG AGGTGTCCAC ATGTGGTAAG GTGGAGGGTT CCTCGTCTAC CGGTTCTAT TTCAGTCAGA CTGGACGTAC TATTGTCTGA
 ball
 fnu4HI
 1201 mboII mboII ddeI
 TCTTCCCTGA AGACATTACT GTGGAGTGGC AGTGGAAATGG GCAGCCAGCG GAGAACTACA AGAACACTCA GCCATCATG AACACGAATG GCTCTTACTT
 AGAAGGGACT TCTGTAATGA CACCTCACCG TCACCTTACC CGTCGGTCCG CTCTTGATGT TCTTGTGAGT CGGGTAGTAC TTGTGCTTAC CGAGAATGAA
 sau96
 mnlI mboII
 1301 accI aluI mboII mnlI hphI haeIII ddeI
 CGTCTACAGC AAGCTCAATG TGCAGAAGAG CAACTGGGAG GCAGGAAATA CTTTCACCTG CTCTGTGTTA CATGAGGGCC TGCACAACCA CCATACTGAG
 GCAGATGTCG TTCGAGTTAC ACGTCTTCTC GTTGACCCTC CGTCCTTTAT GAAAGTGGAC GAGACACAAT GACTCCTCCG ACGTGTGGT GGTATGACTC
 mnlI scrFI sau3A sau96
 1401 mnlI ecoRII dpnI mnlI avaII hinfI mnlI mnlI
 AAGAGCCTCT CCCACTCTCC TGGTAAATGA TCCCAGTGTG CTTGGAGCCC TCTGGTCCTA CAGGACTCTG ACACCTACCT CCACCCCTCC CTGTATAAAT
 TTCTCGGAGA GGGTGAGAGG ACCATTTACT AGGGTCACAG GAACCTCGGG AGACCAGGAT GTCCTGAGAC TGTGGATGGA GGTGGGGAGG GACATATTTA
 1501 AAAGCACCCA GCACTGCCTT GGGAAAAA
 TTTCGTGGT CGTGACGGAA CCCTTTTT

Fig. 4C.

7/19

0125023

```

                                     -10                                     1
                                     met asn phe gly leu ser leu ile tyr leu val leu val leu lys val val gln cys glu
GAGUCAGCACUGAACACGGACCCUCACG AUG AAC UUC GGG CUC AGC UUG AUU UAC CUU GUC CUG GUU UUA AAA GUU GUC CAG UGU GAA

                                     10                                     20                                     30
val met leu val glu ser gly gly val leu met glu pro gly gly ser leu lys leu ser cys ala ala ser gly phe thr phe ser arg
GUG AUG CUG GUG GAG UCU GGG GGA GUC UUA AUG GAG CCU GGA GGG UCC CUG AAA CUC UCC UGU GCA GCC UCU GGA UUC ACU UUC AGU AGA

                                     40                                     50                                     60
tyr ala met ser trp val arg gln thr pro glu lys arg leu glu trp val ala thr ile ser ser gly gly ser ser his leu pro ser
UAU GCC AUG UCU UGG GUU CGC CAG ACU CCG GAG AAG AGG CUG GAG UGG GUC GCA ACC AUU AGU AGU GGU GGU AGU UCA CAC CUU CCA UCC

                                     70                                     80                                     90
arg gln cys glu gly arg phe thr ile ser arg asp asn ala lys asn thr leu tyr leu gln met ser ser leu arg ser glu asp thr
AGA CAG UGU GAA GGG CGA UUC ACC AUC UCC AGA GAC AAU GCC AAG AAC ACC CUG UAC CUG CAA AUG AGC AGU CUG AGG UCU GAG GAC ACG

                                     100                                    110                                    120
ala met tyr tyr cys ala arg pro pro leu ile ser leu val ala asp tyr ala met asp tyr trp gly gln gly thr ser val thr val
GCC AUG UAU UAC UGU GCA AGA CCC CCU CUU AUU UCG UUA GUA GCG GAC UAU GCU AUG GAC UAC UGG GGU CAA GGA ACC UCA GUC ACC GUC

                                     130                                    140                                    150
ser ser ala lys thr thr pro pro ser val tyr pro leu ala pro gly ser ala ala gln thr asn ser met val thr leu gly cys leu
UCC UCA GCC AAA ACG ACA CCC CCA UCU GUC UAU CCA CUG GCC CCU GGA UCU GCU GCC CAA ACU AAC UCC AUG GUG ACC CUG GGA UGC CUG

                                     160                                    170                                    180
val lys gly tyr phe pro glu pro val thr val thr trp asn ser gly ser leu ser ser gly val his thr phe pro ala val leu gln
GUC AAG GGC UAU UUC CCU GAG CCA GUG ACA GUG ACC UGG AAC UCU GGA UCC CUG UCC AGC GGU GUG CAC ACC UUC CCA GCU GUC CUG CAG

                                     190                                    200                                    210
ser asp leu tyr thr leu ser ser ser val thr val pro ser ser pro arg pro ser glu thr val thr cys asn val ala his pro ala
UCU GAC CUC UAC ACU CUG AGC AGC UCA GUG ACU GUC CCC UCC AGC CCU CGG CCC AGC GAG ACC GUC ACC UGC AAC GUU GCC CAC CCG GCC

                                     220                                    230                                    240
ser ser thr lys val asp lys lys ile val pro arg asp cys gly cys lys pro cys ile cys thr val pro glu val ser ser val phe
AGC AGC ACC AAG GUG GAC AAG AAA AUU GUG CCC AGG GAU UGU GGU UGU AAG CCU UGC AUA UGU ACA GUC CCA GAA GUA UCA UCU GUC UUC

```

8/19

0125023

Fig. 5A.

```

                250                                260                                270
ile phe pro pro lys pro lys asp val leu thr ile thr leu thr pro lys val thr cys val val val asp ile ser lys asp asp pro
AUC UUC CCC CCA AAG CCC AAG GAU GUG CUC ACC AUU ACU CUG ACU CCU AAG GUC ACG UGU GUU GUG GUA GAC AUC AGC AAG GAU GAU CCC

                280                                290                                300
glu val gln phe ser trp phe val asp asp val glu val his thr ala gln thr gln pro arg glu glu gln phe asn ser thr phe arg
GAG GUC CAG UUC AGC UGG UUU GUA GAU GAU GUG GAG GUG CAC ACA GCU CAG ACG CAA CCC CGG GAG GAG CAG UUC AAC AGC ACU UUC CGC

                310                                320                                330
ser val ser glu leu pro ile met his gln asp trp leu asn gly lys glu phe lys cys arg val asn ser ala ala phe pro ala pro
UCA GUC AGU GAA CUU CCC AUC AUG CAC CAG GAC UGG CUC AAU GGC AAG GAG UUC AAA UGC AGG GUC AAC AGU GCA GCU UUC CCU GCC CCC

                340                                350                                360
ile glu lys thr ile ser lys thr lys gly arg pro lys ala pro gln val tyr thr ile pro pro pro lys glu gln met ala lys asp
AUC GAG AAA ACC AUC UCC AAA ACC AAA GGC AGA CCG AAG GCU CCA CAG GUG UAC ACC AUU CCA CCU CCC AAG GAG CAG AUG GCC AAG GAU

                370                                380                                390
lys val ser leu thr cys met ile thr asp phe phe pro glu asp ile thr val glu trp gln trp asn gly gln pro ala glu asn tyr
AAA GUC AGU CUG ACC UGC AUG AUA ACA GAC UUC UUC CCU GAA GAC AUU ACU GUG GAG UGG CAG UGG AAU GGG CAG CCA GCG GAG AAC UAC

                400                                410                                420
lys asn thr gln pro ile met asn thr asn gly ser tyr phe val tyr ser lys leu asn val gln lys ser asn trp glu ala gly asn
AAG AAC ACU CAG CCC AUC AUG AAC ACG AAU GGC UCU UAC UUC GUC UAC AGC AAG CUC AAU GUG CAG AAG AGC AAC UGG GAG GCA GGA AAU

                430                                440                                447
thr phe thr cys ser val leu his glu gly leu his asn his his thr glu lys ser leu ser his ser pro gly lys OP
ACU UUC ACC UGC UCU GUG UUA CAU GAG GGC CUG CAC AAC CAC CAU ACU GAG AAG AGC CUC UCC CAC UCU CCU GGU AAA UGA UCCCAGUGUCCU

UGGAGCCUCUGGUCCUACAGGACUCUGACACCUACCUCACCUCUCCUGUAUAAAUAAGCACCCAGCACUGCCUUGGGAAAAA

```

9119

0125023

Fig. 5B.

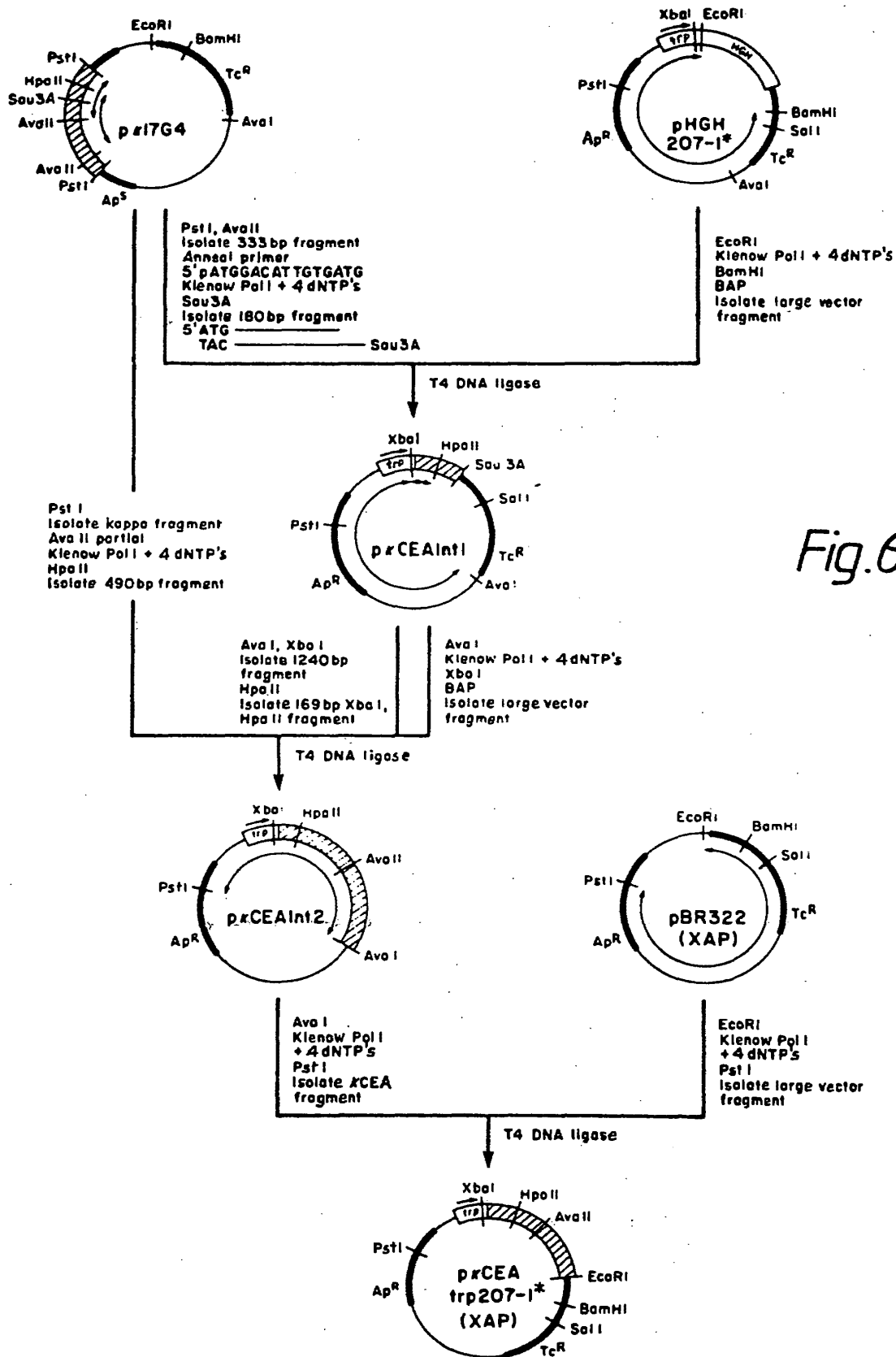

Fig. 6.

11/19

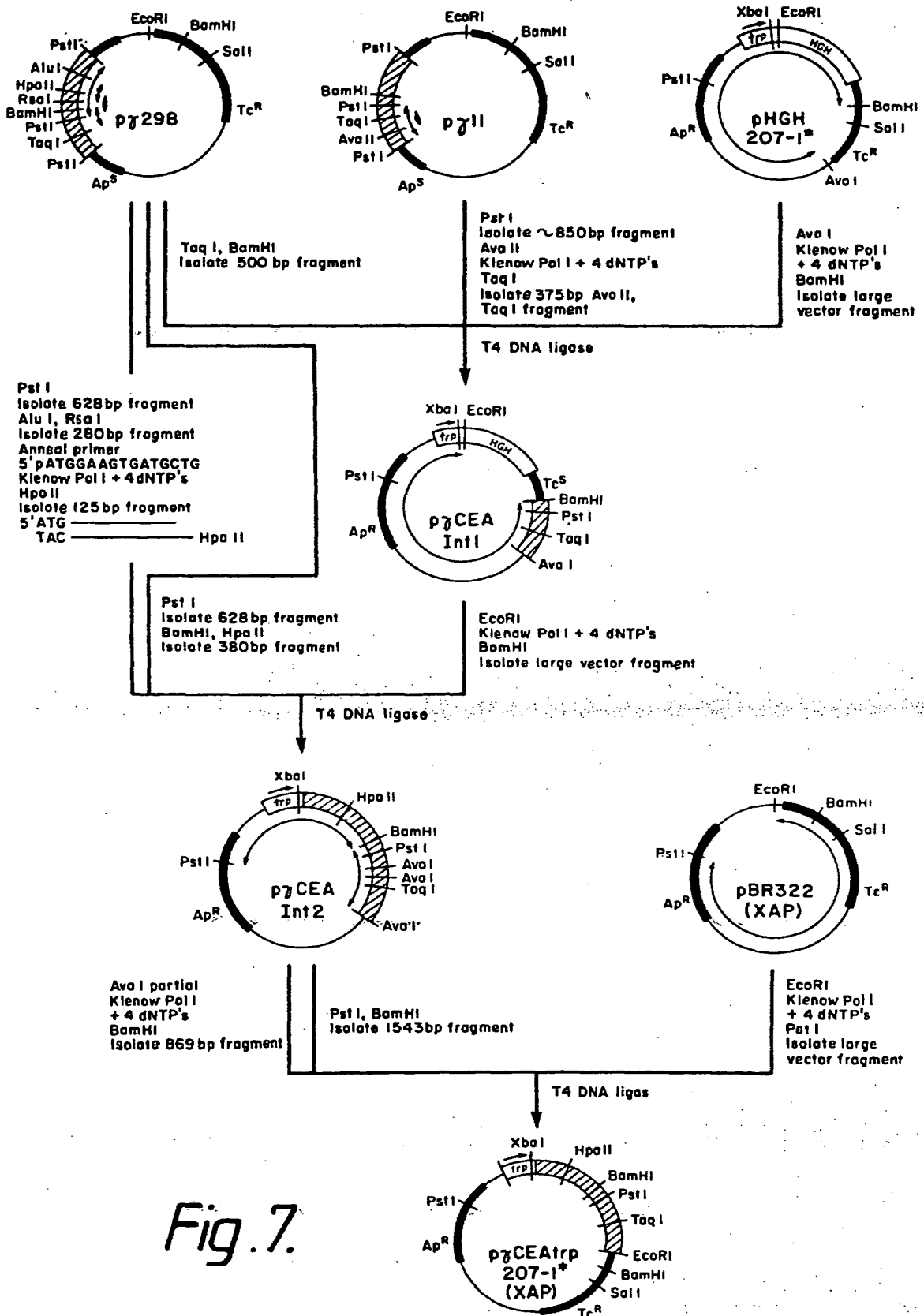

Fig. 7.

12/19

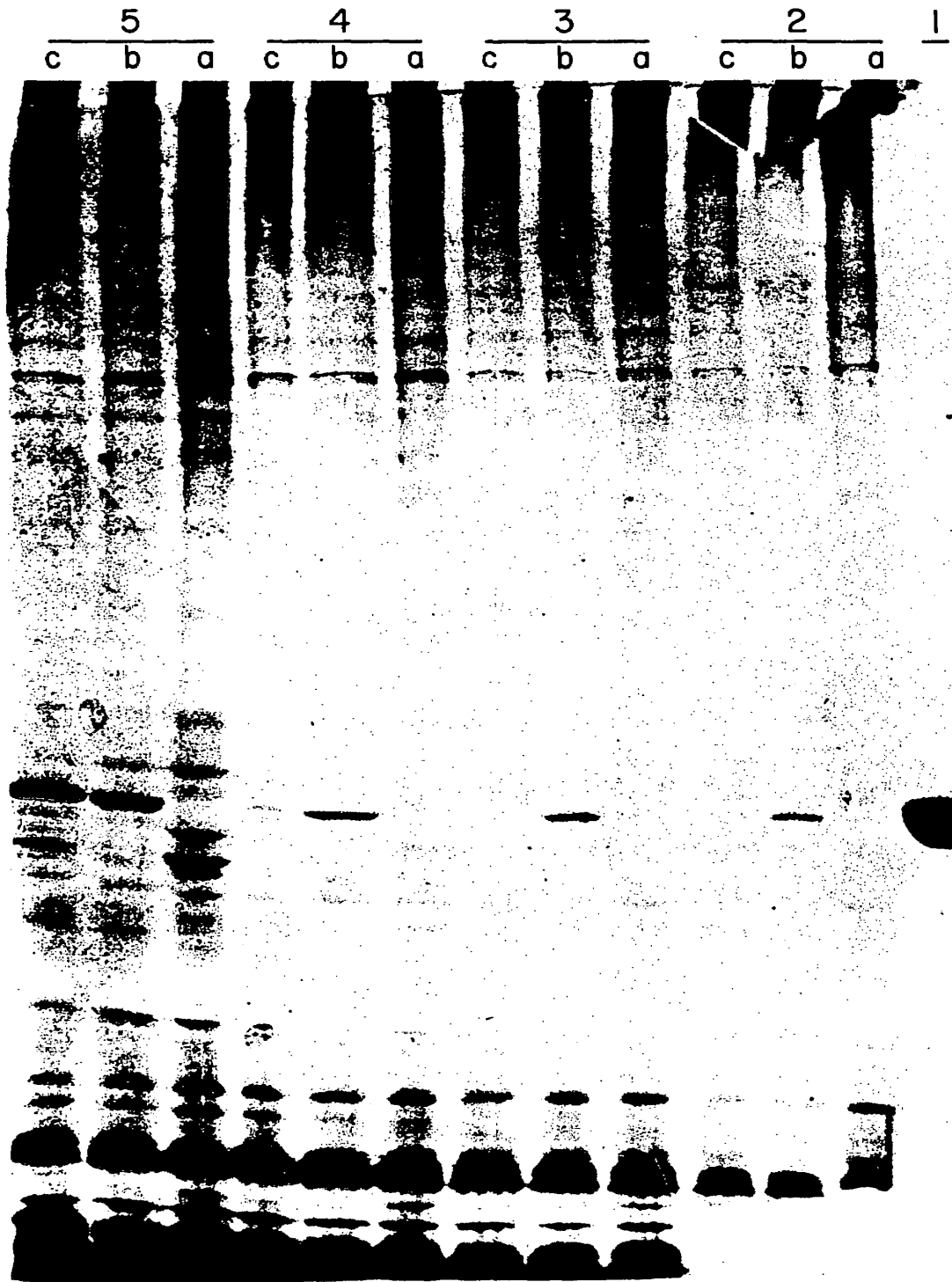

Fig. 8A.

13/19.



a b 1
a b 2
a b 3
a b 4
a b 5
a b 6
7 8 9 10

Fig. 8B.

14/19

0125023

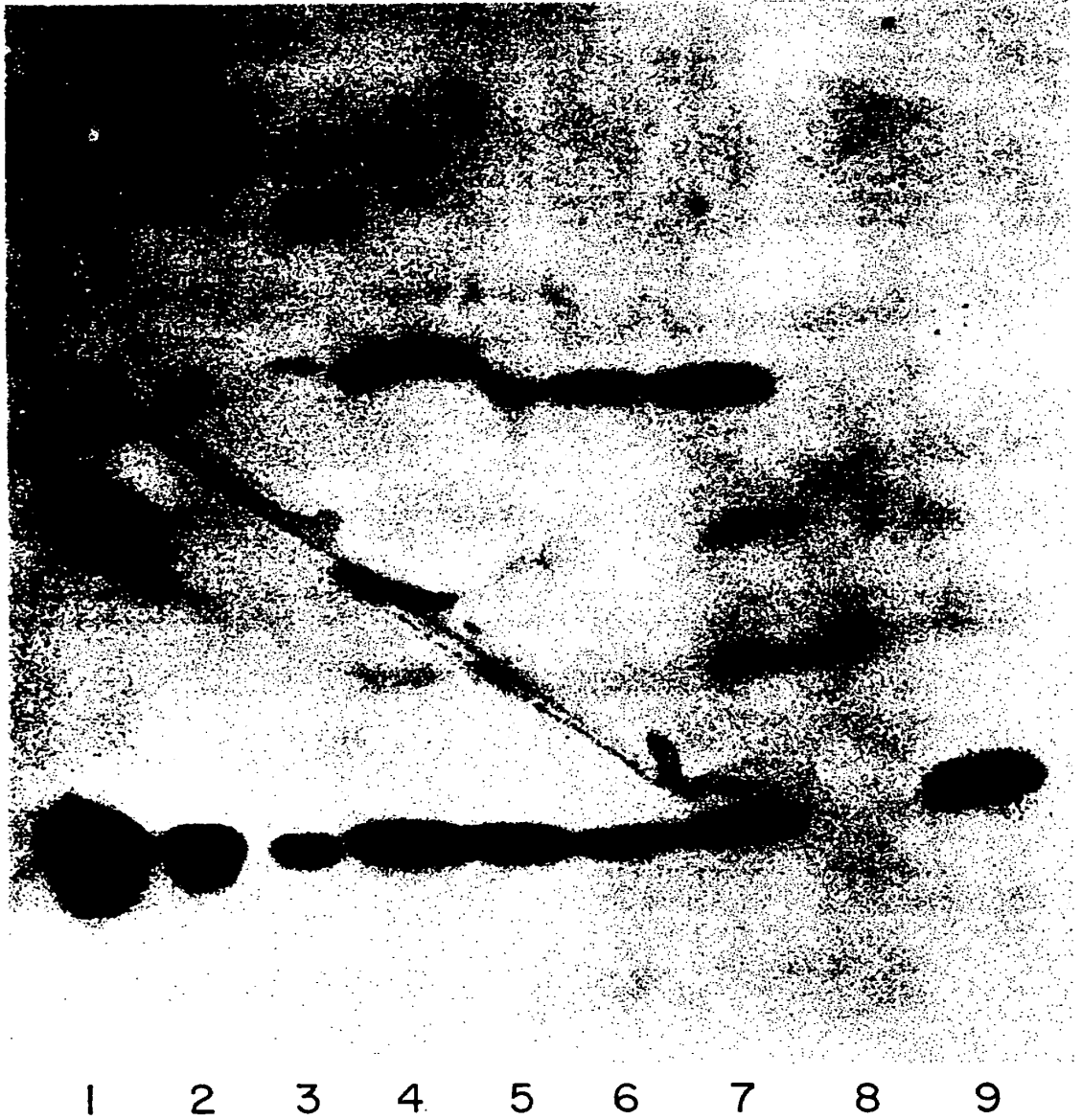

Fig. 8C.

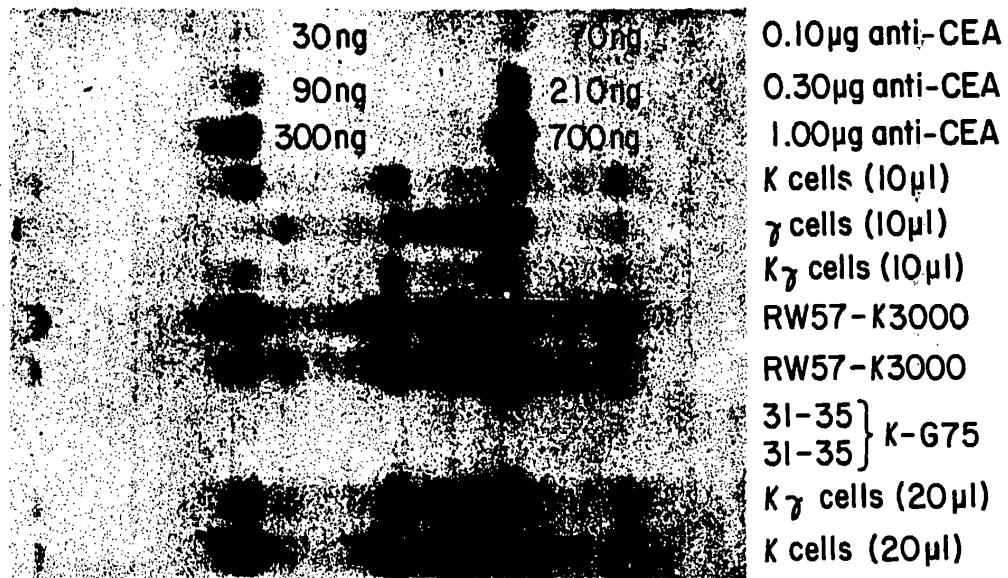

Fig. 9.

15/19.

0125023

11/19

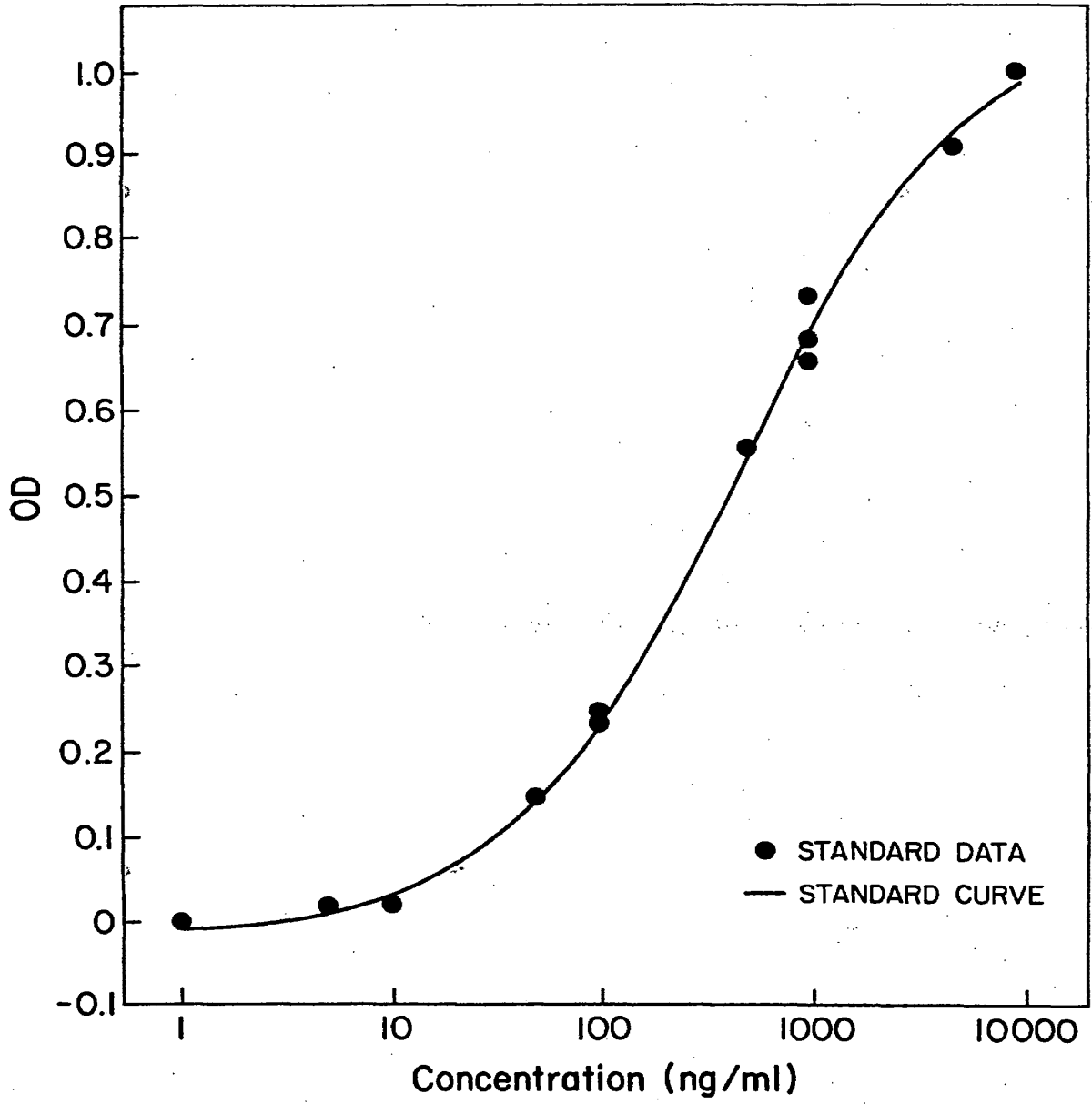

Fig. 10.

17/19

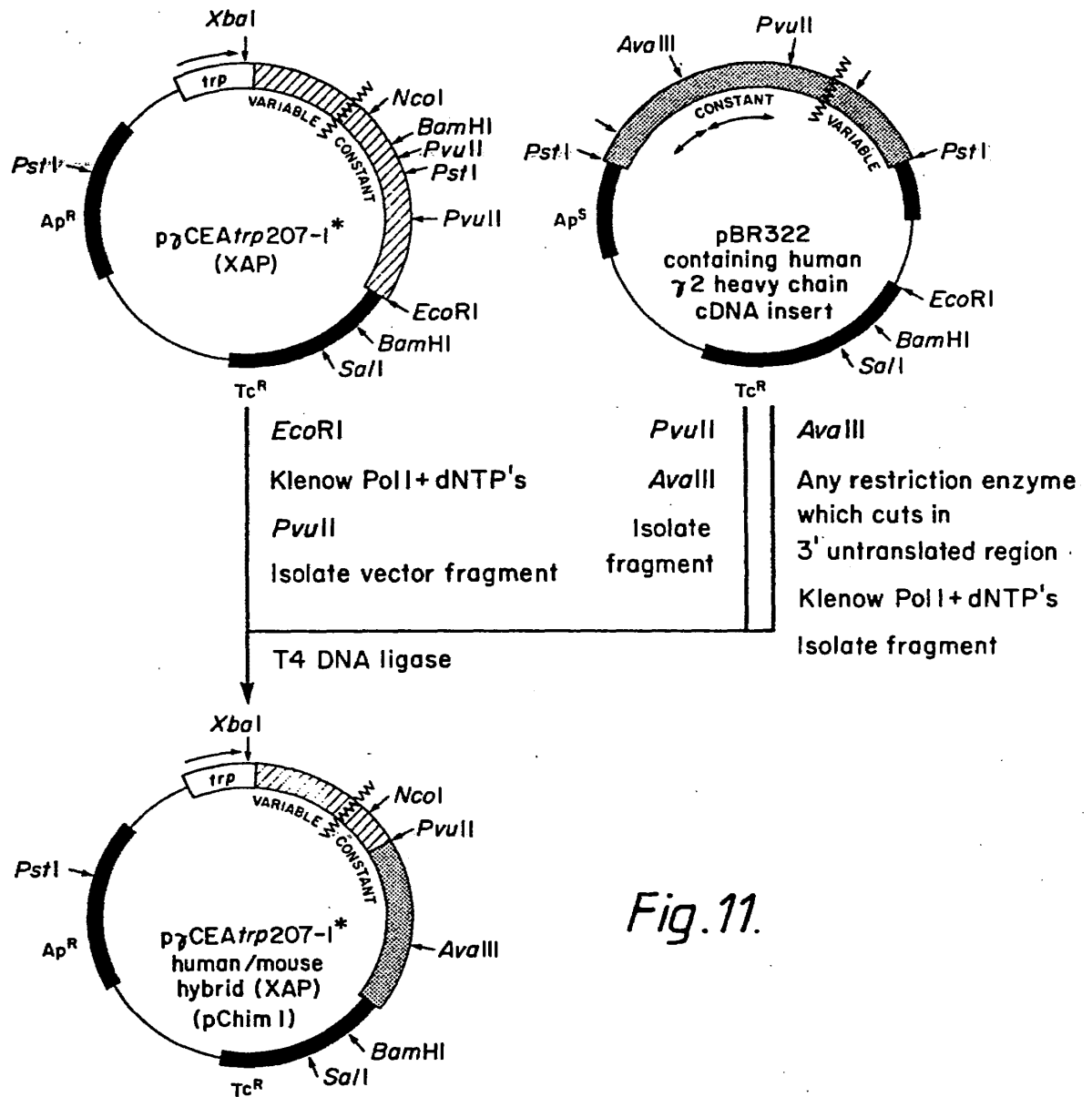

Fig. 11.

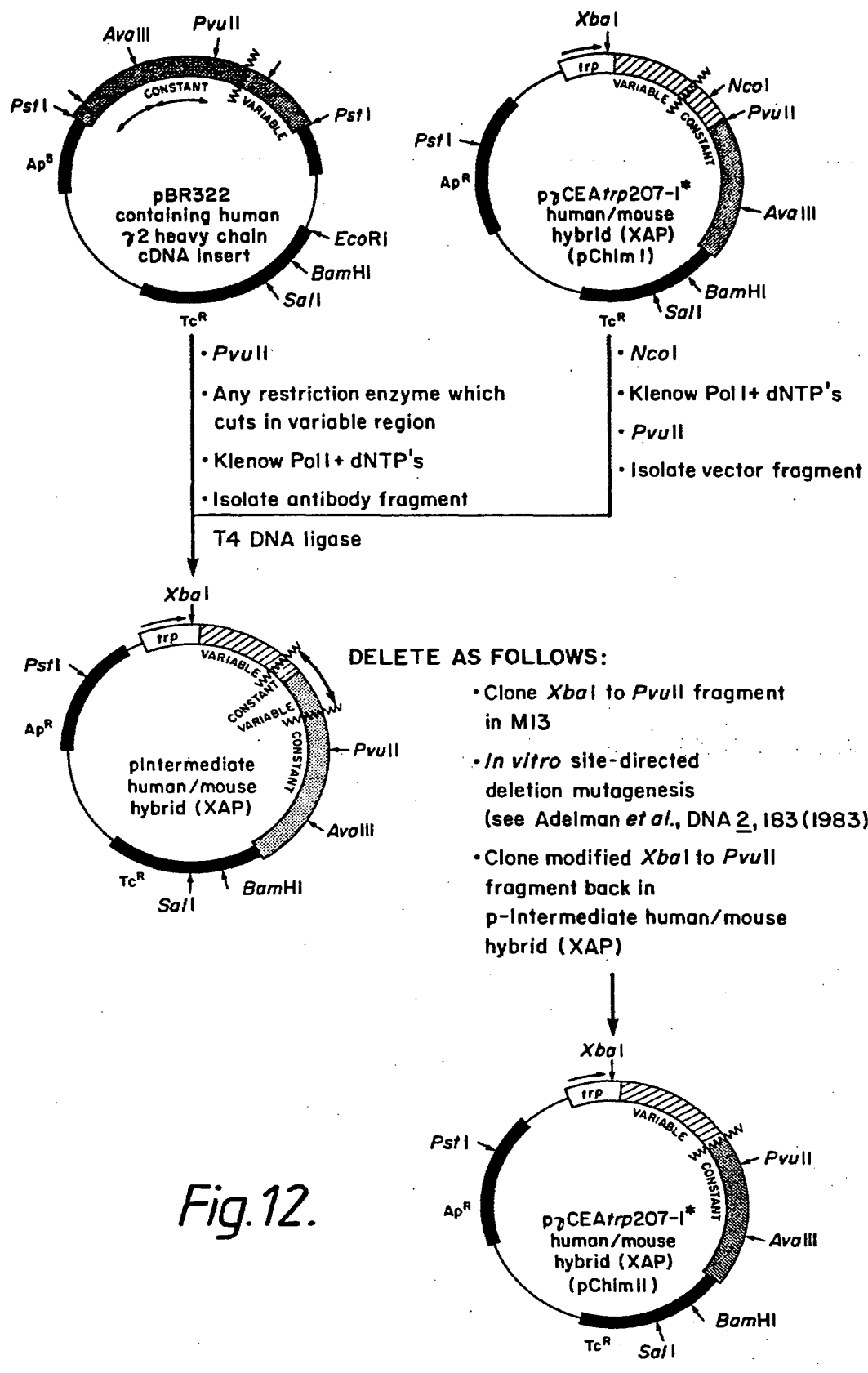

Fig.12.

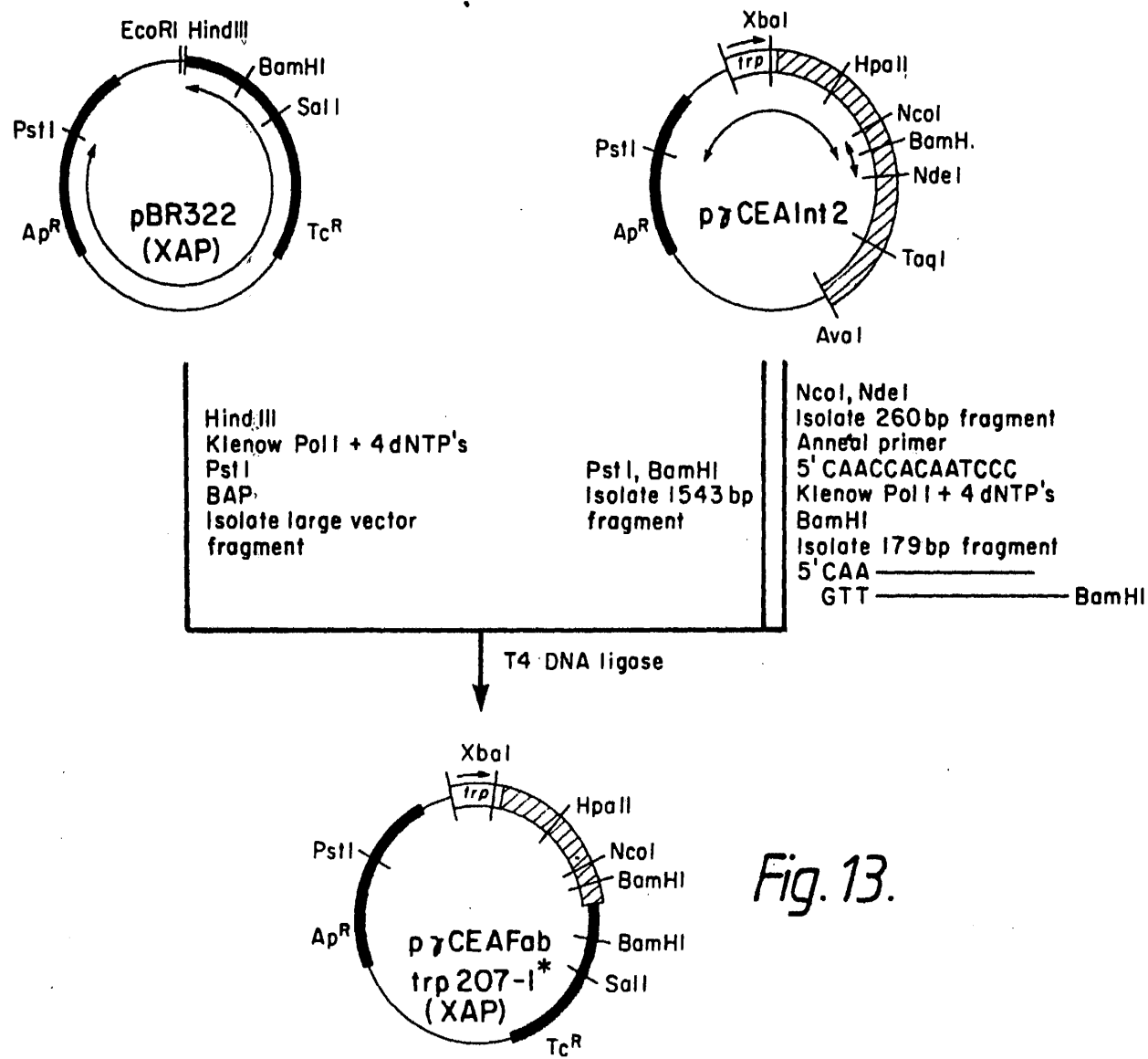

Fig. 13.

19/19
 0125023



DOCUMENTS CONSIDERED TO BE RELEVANT			EP 84302368.0
Category	Citation of document with indication, where appropriate, of relevant passages	Relevant to claim	CLASSIFICATION OF THE APPLICATION (Int. Cl. 7)
X	<p><u>EP - A2,A3 - O 068 763 (UNIVERSITY OF TEXAS)</u></p> <p>* Claims 1,10; page 4, line 15 - page 5, line 1 *</p> <p>--</p>	1,4,8-10	<p>C 12 N 15/00</p> <p>C 12 P 21/00</p> <p>A 61 K 39/395</p>
A,D	<p>TRENDS IN BIOCHEMICAL SCIENCES, vol. 6, no. 8, August 1981, North-Holland</p> <p>N. GOUGH "The rearrangements of immunoglobulin genes" pages 203-205</p> <p>--</p>		
A,D	<p>PROCEEDINGS OF THE NATIONAL ACADEMY OF SCIENCES OF THE UNITED STATES OF AMERICA, vol. 77, no. 4, April 1980</p> <p>G. KÖHLER "Immunoglobulin chain loss in hybridoma lines" page 2197-2199</p> <p>--</p>		<p>TECHNICAL FIELDS SEARCHED (Int. Cl. 7)</p> <p>C 12 N</p> <p>C 12 P</p> <p>A 61 K</p>
A,D	<p>THE JOURNAL OF IMMUNOLOGY, vol. 123, no. 2, August 1979, Baltimore, U.S.A</p> <p>S.L. MORRISON "Sequentially derived mutants of the constant region of the heavy chain of murine immunoglobulins" page 793-800</p> <p>--</p>		
A	<p><u>EP - A2 - O 057 107 (COATS PATONS)</u></p> <p>----</p>		
The present search report has been drawn up for all claims			
Place of search		Date of completion of the search	Examiner
VIENNA		11-07-1984	FARNIOK
CATEGORY OF CITED DOCUMENTS			
<p>X : particularly relevant if taken alone</p> <p>Y : particularly relevant if combined with another document of the same category</p> <p>A : technological background</p> <p>O : non-written disclosure</p> <p>P : intermediate document</p>		<p>T : theory or principle underlying the invention</p> <p>E : earlier patent document, but published on, or after the filing date</p> <p>D : document cited in the application</p> <p>L : document cited for other reasons</p> <hr/> <p>& : member of the same patent family, corresponding document</p>	

EPO Form 1500 (03.82)



Europäisches Patentamt
European Patent Office
Office européen des brevets

Publication number:

0 368 684
A1

EUROPEAN PATENT APPLICATION

(1) Application number: 89311731.7
(2) Date of filing: 13.11.89

(51) Int. Cl.⁵: C07K 13/00, C12N 15/10,
C12N 15/13, //C12Q1/68

(3) Priority: 11.11.88 GB 8826444
16.03.89 GB 8906034
22.04.89 GB 8909217
15.05.89 GB 8911047
02.06.89 GB 8912652
16.06.89 GB 8913900
15.08.89 GB 8918543

(43) Date of publication of application:
16.05.90 Bulletin 90/20

(64) Designated Contracting States:
AT BE CH DE ES FR GB GR IT LI LU NL SE

(71) Applicant: MEDICAL RESEARCH COUNCIL
20 Park Crescent
London W1N 4AL(GB)

(72) Inventor: Winter, Gregory Paul
64, Cavendish Avenue
Cambridge, CB1 4UT(GB)
Inventor: Güssow, Dettel
5, Linton Road
Abington Cambridge CB1 6AA(GB)
Inventor: Ward, Elizabeth Sally
Sidney Sussex College
Cambridge CB2 3HU(GB)

(74) Representative: Mercer, Christopher Paul et al
Carpmaels & Ransford 43, Bloomsbury
Square
London WC1A 2RA(GB)

(5) Single domain ligands, receptors comprising said ligands, methods for their production, and use of said ligands and receptors.

(57) The present invention relates to single domain ligands derived from molecules in the immunoglobulin (Ig) superfamily, receptors comprising at least one such ligand, methods for cloning, amplifying and expressing DNA sequences encoding such ligands, preferably using the polymerase chain reaction, methods for the use of said DNA sequences in the production of Ig-type molecules and said ligands or receptors, and the use of said ligands or receptors in therapy, diagnosis or catalysis.

EP 0 368 684 A1

Single Domain Ligands, Receptors comprising said Ligands, Methods for their Production, and Use of said Ligands and Receptors

The present invention relates to single domain ligands derived from molecules in the immunoglobulin (Ig) superfamily, receptors comprising at least one such ligand, methods for cloning, amplifying and expressing DNA sequences encoding such ligands, methods for the use of said DNA sequences in the production of Ig-type molecules and said ligands or receptors, and the use of said ligands or receptors in therapy, diagnosis or catalysis.

A list of references is appended to the end of the description. The documents listed therein are referred to in the description by number, which is given in square brackets [].

The Ig superfamily includes not only the Igs themselves but also such molecules as receptors on lymphoid cells such as T lymphocytes. Immunoglobulins comprise at least one heavy and one light chain covalently bonded together. Each chain is divided into a number of domains. At the N terminal end of each chain is a variable domain. The variable domains on the heavy and light chains fit together to form a binding site designed to receive a particular target molecule. In the case of Igs, the target molecules are antigens. T-cell receptors have two chains of equal size, the α and β chains, each consisting of two domains. At the N-terminal end of each chain is a variable domain and the variable domains on the α and β chains are believed to fit together to form a binding site for target molecules. In this case peptides presented by a histocompatibility antigen. The variable domains are so called because their amino acid sequences vary particularly from one molecule to another. This variation in sequence enables the molecules to recognise an extremely wide variety of target molecules.

Much research has been carried out on Ig molecules to determine how the variable domains are produced. It has been shown that each variable domain comprises a number of areas of relatively conserved sequence and three areas of hypervariable sequence. The three hypervariable areas are generally known as complementarity determining regions (CDRs).

Crystallographic studies have shown that in each variable domain of an Ig molecule the CDRs are supported on framework areas formed by the areas of conserved sequences. The three CDRs are brought together by the framework areas and, together with the CDRs on the other chain, form a pocket in which the target molecule is received.

Since the advent of recombinant DNA technology there has been much interest in the use of

such technology to clone and express Ig molecules and derivatives thereof. This interest is reflected in the numbers of patent applications and other publications on the subject.

The earliest work on the cloning and expression of full Igs in the patent literature is EP-A-0 120 694 (Boss). The Boss application also relates to the cloning and expression of chimeric antibodies. Chimeric antibodies are Ig-type molecules in which the variable domains from one Ig are fused to constant domains from another Ig. Usually, the variable domains are derived from an Ig from one species (often a mouse Ig) and the constant domains are derived from an Ig from a different species (often a human Ig).

A later European patent application, EP-A-0 125 023 (Genentech), relates to much the same subject as the Boss application, but also relates to the production by recombinant DNA technology of other variations of Ig-type molecules.

EP-A-0 194 276 (Neuberger) discloses not only chimeric antibodies of the type disclosed in the Boss application but also chimeric antibodies in which some or all of the constant domains have been replaced by non-Ig derived protein sequences. For instance, the heavy chain CH2 and CH3 domains may be replaced by protein sequences derived from an enzyme or a protein toxin.

EP-A-0 239 400 (Winter) discloses a different approach to the production of Ig molecules. In this approach, only the CDRs from a first type of Ig are grafted onto a second type of Ig in place of its normal CDRs. The Ig molecule thus produced is predominantly of the second type, since the CDRs form a relatively small part of the whole Ig. However, since the CDRs are the parts which define the specificity of the Ig, the Ig molecule thus produced has its specificity derived from the first Ig.

Hereinafter, chimeric antibodies, CDR-grafted Igs, the altered antibodies described by Genentech, and fragments, of such Igs such as $F(ab)_2$ and Fv fragments are referred to herein as modified antibodies.

One of the main reasons for all the activity in the Ig field using recombinant DNA technology is the desire to use Igs in therapy. It is well known that, using the hybridoma technique developed by Kohler and Milstein, it is possible to produce monoclonal antibodies (MAbs) of almost any specificity. Thus, MAbs directed against cancer antigens have been produced. It is envisaged that these MAbs could be covalently attached or fused to toxins to provide "magic bullets" for use in cancer therapy.

MABs directed against normal tissue or cell surface antigens have also been produced. Labels can be attached to these so that they can be used for *in vivo* imaging.

The major obstacle to the use of such MABs in therapy or *in vivo* diagnosis is that the vast majority of MABs which are produced are of rodent, in particular mouse, origin. It is very difficult to produce human MABs. Since most MABs are derived from non-human species, they are antigenic in humans. Thus, administration of these MABs to humans generally results in an anti-Ig response being mounted by the human. Such a response can interfere with therapy or diagnosis, for instance by destroying or clearing the antibody quickly, or can cause allergic reactions or immune complex hypersensitivity which has adverse effects on the patient.

The production of modified Igs has been proposed to ensure that the Ig administered to a patient is as "human" as possible, but still retains the appropriate specificity. It is therefore expected that modified Igs will be as effective as the MAB from which the specificity is derived but at the same time not very antigenic. Thus, it should be possible to use the modified Ig a reasonable number of times in a treatment or diagnosis regime.

At the level of the gene, it is known that heavy chain variable domains are encoded by a "rearranged" gene which is built from three gene segments: an "unrearranged" VH gene (encoding the N-terminal three framework regions, first two complete CDRs and the first part of the third CDR), a diversity (DH)-segment (DH) (encoding the central portion of the third CDR) and a joining segment (JH) (encoding the last part of the third CDR and the fourth framework region). In the maturation of B-cells, the genes rearrange so that each unrearranged VH gene is linked to one DH gene and one JH gene. The rearranged gene corresponds to VH-DH-JH. This rearranged gene is linked to a gene which encodes the constant portion of the Ig chain.

For light chains, the situation is similar, except that for light chains there is no diversity region. Thus light chain variable domains are encoded by an "unrearranged" VL gene and a JL gene. There are two types of light chains, kappa (κ) or lambda (λ), which are built respectively from unrearranged V κ genes and J κ segments, and from unrearranged V λ genes and J λ segments.

Previous work has shown that it is necessary to have two variable domains in association together for efficient binding. For example, the associated heavy and light chain variable domains were shown to contain the antigen binding site [1]. This assumption is borne out by X-ray crystallographic studies of crystallised antibody/antigen complexes [2-6] which show that both the heavy and light chains of the antibody's variable domains contact

the antigen. The expectation that association of heavy and light chain variable domains is necessary for efficient antigen binding underlies work to co-secrete these domains from bacteria [1], and to link the domains together by a short section of polypeptide as in the single chain antibodies [8, 9].

Binding of isolated heavy and light chains had also been detected. However the evidence suggested strongly that this was a property of heavy or light chain dimers. Early work, mainly with polyclonal antibodies, in which antibody heavy and light chains had been separated under denaturing conditions [10] suggested that isolated antibody heavy chains could bind to protein antigens [11] or hapten [12]. The binding of protein antigen was not characterised, but the hapten-binding affinity of the heavy chain fragments was reduced by two orders of magnitude [12] and the number of hapten molecules binding were variously estimated as 0.14 or 0.37 [13] or 0.26 [14] per isolated heavy chain. Furthermore binding of haptens was shown to be a property of dimeric heavy or dimeric light chains [14]. Indeed light chain dimers have been crystallised. It has been shown that in light chain dimers the two chains form a cavity which is able to bind to a single molecule of hapten [15].

This confirms the assumption that, in order to obtain efficient binding, it is necessary to have a dimer, and preferably a heavy chain/light chain dimer, containing the respective variable domains. This assumption also underlies the teaching of the patent references cited above, wherein the intention is always to produce dimeric, and preferably heavy/light chain dimeric, molecules.

It has now been discovered, contrary to expectations, that isolated Ig heavy chain variable domains can bind to antigen in a 1:1 ratio and with binding constants of equivalent magnitude to those of complete antibody molecules. In view of what was known up until now and in view of the assumptions made by those skilled in the art, this is highly surprising.

Therefore, according to a first aspect of the present invention, there is provided a single domain ligand consisting at least part of the variable domain of one chain of a molecule from the Ig superfamily.

Preferably, the ligand consists of the variable domain of an Ig light, or, most preferably, heavy chain.

The ligand may be produced by any known technique, for instance by controlled cleavage of Ig superfamily molecules or by peptide synthesis. However, preferably the ligand is produced by recombinant DNA technology. For instance, the gene encoding the rearranged gene for a heavy chain variable domain may be produced, for instance by cloning or gene synthesis, and placed into a suit-

able expression vector. The expression vector is then used to transform a compatible host cell which is then cultured to allow the ligand to be expressed and, preferably, secreted.

If desired, the gene for the ligand can be mutated to improve the properties of the expressed domain, for example to increase the yields of expression or the solubility of the ligand, to enable the ligand to bind better, or to introduce a second site for covalent attachment (by introducing chemically reactive residues such as cysteine and histidine) or non-covalent binding of other molecules. In particular it would be desirable to introduce a second site for binding to serum components, to prolong the residence time of the domains in the serum; or for binding to molecules with effector functions, such as components of complement, or receptors on the surfaces of cells.

Thus, hydrophobic residues which would normally be at the interface of the heavy chain variable domain with the light chain variable domain could be mutated to more hydrophilic residues to improve solubility; residues in the CDR loops could be mutated to improve antigen binding; residues on the other loops or parts of the β -sheet could be mutated to introduce new binding activities. Mutations could include single point mutations, multiple point mutations or more extensive changes and could be introduced by any of a variety of recombinant DNA methods, for example gene synthesis, site directed mutagenesis or the polymerase chain reaction.

Since the ligands of the present invention have equivalent binding affinity to that of complete Ig molecules, the ligands can be used in many of the ways as are Ig molecules or fragments. For example, Ig molecules have been used in therapy (such as in treating cancer, bacterial and viral diseases), in diagnosis (such as pregnancy testing), in vaccination (such as in producing anti-idiotypic antibodies which mimic antigens), in modulation of activities of hormones or growth factors, in detection, in biosensors and in catalysis.

It is envisaged that the small size of the ligands of the present invention may confer some advantages over complete antibodies, for example, in neutralising the activity of low molecular weight drugs (such as digoxin) and allowing their filtration from the kidneys with drug attached; in penetrating tissues and tumours; in neutralising viruses by binding to small conserved regions on the surfaces of viruses such as the "canyon" sites of viruses [16]; in high resolution epitope mapping of proteins; and in vaccination by ligands which mimic antigens.

The present invention also provides receptors comprising a ligand according to the first aspect of the invention linked to one or more of an effector

molecule, a label, a surface, or one or more other ligands having the same or different specificity.

A receptor comprising a ligand linked to an effector molecule may be of use in therapy. The effector molecule may be a toxin, such as ricin or pseudomonas exotoxin, an enzyme which is able to activate a prodrug, a binding partner or a radio-isotope. The radio-isotope may be directly linked to the ligand or may be attached thereto by a chelating structure which is directly linked to the ligand. Such ligands with attached isotopes are much smaller than those based on Fv fragments, and could penetrate tissues and access tumours more readily.

A receptor comprising a ligand linked to a label may be of use in diagnosis. The label may be a heavy metal atom or a radio-isotope, in which case the receptor can be used for *in vivo* imaging using X-ray or other scanning apparatus. The metal atom or radio-isotope may be attached to the ligand either directly or via a chelating structure directly linked to the ligand. For *in vitro* diagnostic testing, the label may be a heavy metal atom, a radio-isotope, an enzyme, a fluorescent or coloured molecule or a protein or peptide tag which can be detected by an antibody, an antibody fragment or another protein. Such receptors would be used in any of the known diagnostic tests, such as ELISA or fluorescence-linked assays.

A receptor comprising a ligand linked to a surface, such as a chromatography medium, could be used for purification of other molecules by affinity chromatography. Linking of ligands to cells, for example to the outer membrane proteins of *E. coli* or to hydrophobic tails which localise the ligands in the cell membranes, could allow a simple diagnostic test in which the bacteria or cells would agglutinate in the presence of molecules bearing multiple sites for binding the ligand(s).

Receptors comprising at least two ligands can be used, for instance, in diagnostic tests. The first ligand will bind to a test antigen and the second ligand will bind to a reporter molecule, such as an enzyme, a fluorescent dye, a coloured dye, a radio-isotope or a coloured, fluorescently- or radio-labelled protein.

Alternatively, such receptors may be useful in increasing the binding to an antigen. The first ligand will bind to a first epitope of the antigen and the second ligand will bind to a second epitope. Such receptors may also be used for increasing the affinity and specificity of binding to different antigens in close proximity on the surface of cells. The first ligand will bind to the first antigen and the second epitope to the second antigen: strong binding will depend on the co-expression of the epitopes on the surface of the cell. This may be useful in therapy of tumours, which can have elevated

expression of ~~several~~ surface markers. Further ligands could be added to further improve binding or specificity. Moreover, the use of strings of ligands, with the same or multiple specificities, creates a larger molecule which is less readily filtered from the circulation by the kidney.

For vaccination with ligands which mimic antigens, the use of strings of ligands may prove more effective than single ligands, due to repetition of the immunising epitopes.

If desired, such receptors with multiple ligands could include effector molecules or labels so that they can be used in therapy or diagnosis as described above.

The ligand may be linked to the other part of the receptor by any suitable means, for instance by covalent or non-covalent chemical linkages. However, where the receptor comprises a ligand and another protein molecule, it is preferred that they are produced by recombinant DNA technology as a fusion product. If necessary, a linker peptide sequence can be placed between the ligand and the other protein molecule to provide flexibility.

The basic techniques for manipulating Ig molecules by recombinant DNA technology are described in the patent references cited above. These may be adapted in order to allow for the production of ligands and receptors according to the invention by means of recombinant DNA technology.

Preferably, where the ligand is to be used for *in vivo* diagnosis or therapy in humans, it is humanised, for instance by CDR replacement as described in EP-A-0 239 400.

In order to obtain a DNA sequence encoding a ligand, it is generally necessary, firstly to produce a hybridoma which secretes an appropriate MAb. This can be a very time consuming method. Once an immunised animal has been produced, it is necessary to fuse separated spleen cells with a suitable myeloma cell line, grow up the cell lines thus produced, select appropriate lines, reclone the selected lines and reselect. This can take some long time. This problem also applies to the production of modified Igs.

A further problem with the production of ligands, and also receptors according to the invention and modified Igs, by recombinant DNA technology is the cloning of the variable domain encoding sequences from the hybridoma which produces the MAb from which the specificity is to be derived. This can be a relatively long method involving the production of a suitable probe, construction of a clone library from cDNA or genomic DNA, extensive probing of the clone library, and manipulation of any isolated clones to enable the cloning into a suitable expression vector. Due to the inherent variability of the DNA sequences encoding Ig variable domains, it has not previously been possible

to avoid such time consuming work. It is therefore a further aim of the present invention to provide a method which enables substantially any sequence encoding an Ig superfamily molecule variable domain (ligand) to be cloned in a reasonable period of time.

According to another aspect of the present invention therefore, there is provided a method of cloning a sequence (the target sequence) which encodes at least part of the variable domain of an Ig superfamily molecule, which method comprises:

(a) providing a sample of double stranded (ds) nucleic acid which contains the target sequence;

(b) denaturing the sample so as to separate the two strands;

(c) annealing to the sample, a forward and a back oligonucleotide primer, the forward primer being specific for a sequence at or adjacent the 3' end of the sense strand of the target sequence, the back primer being specific for a sequence at or adjacent the 3' end of the antisense strand of the target sequence, under conditions which allow the primers to hybridise to the nucleic acid at or adjacent the target sequence;

(d) treating the annealed sample with a DNA polymerase enzyme in the presence of deoxynucleoside triphosphates under conditions which cause primer extension to take place; and

(e) denaturing the sample under conditions such that the extended primers become separated from the target sequence.

Preferably, the method of the present invention further includes the step (f) of repeating steps (c) to (e) on the denatured mixture a plurality of times.

Preferably, the method of the present invention is used to clone complete variable domains from Ig molecules, most preferably from Ig heavy chains. In the most preferred instance, the method will produce a DNA sequence encoding a ligand according to the present invention.

In step (c) recited above, the forward primer becomes annealed to the sense strand of the target sequence at or adjacent the 3' end of the strand. In a similar manner, the back primer becomes annealed to the antisense strand of the target sequence at or adjacent the 3' end of the strand. Thus, the forward primer anneals at or adjacent the region of the ds nucleic acid which encodes the C terminal end of the variable region or domain. Similarly, the back primer anneals at or adjacent the region of the ds nucleic acid which encodes the N-terminal end of the variable domain.

In step (d), nucleotides are added onto the 3' end of the forward and back primers in accordance with the sequence of the strand to which they are annealed. Primer extension will continue in this manner until stopped by the beginning of the de-

naturing step (e). It must therefore be ensured that step (d) is carried out for a long enough time to ensure that the primers are extended so that the extended strands totally overlap one another.

In step (e), the extended primers are separated from the ds nucleic acid. The ds nucleic acid can then serve again as a substrate to which further primers can anneal. Moreover, the extended primers themselves have the necessary complementary sequences to enable the primers to anneal thereto.

During further cycles, if step (f) is used, the amount of extended primers will increase exponentially so that at the end of the cycles there will be a large quantity of cDNA having sequences complementary to the sense and antisense strands of the target sequence. Thus, the method of the present invention will result in the accumulation of a large quantity of cDNA which can form ds cDNA encoding at least part of the variable domain.

As will be apparent to the skilled person, some of the steps in the method may be carried out simultaneously or sequentially as desired.

The forward and back primers may be provided as isolated oligonucleotides, in which case only two oligonucleotides will be used. However, alternatively the forward and back primers may each be supplied as a mixture of closely related oligonucleotides. For instance, it may be found that at a particular point in the sequence to which the primer is to anneal, there is the possibility of nucleotide variation. In this case a primer may be used for each possible nucleotide variation. Furthermore it may be possible to use two or more sets of "nested" primers in the method to enhance the specific cloning of variable region genes.

The method described above is similar to the method described by Saiki et al. [17]. A similar method is also used in the methods described in EP-A-0 200 362. In both cases the method described is carried out using primers which are known to anneal efficiently to the specified nucleotide sequence. In neither of these disclosures was it suggested that the method could be used to clone Ig parts of variable domain encoding sequences, where the target sequence contains inherently highly variable areas.

The ds nucleic acid sequence used in the method of the present invention may be derived from mRNA. For instance, RNA may be isolated in known manner from a cell or cell line which is known to produce Igs. mRNA may be separated from other RNA by oligo-dT chromatography. A complementary strand of cDNA may then be synthesised on the mRNA template, using reverse transcriptase and a suitable primer, to yield an RNA/DNA heteroduplex. A second strand of DNA can be made in one of several ways, for example, by priming with RNA fragments of the mRNA

strand (made by incubating RNA/DNA heteroduplex with RNase H) and using DNA polymerase, or by priming with a synthetic oligodeoxynucleotide primer which anneals to the 3' end of the first strand and using DNA polymerase. It has been found that the method of the present invention can be carried out using ds cDNA prepared in this way.

When making such ds cDNA, it is possible to use a forward primer which anneals to a sequence in the CH1 domain (for a heavy chain variable domain) or the C λ or C κ domain (for a light chain variable domain). These will be located in close enough proximity to the target sequence to allow the sequence to be cloned.

The back primer may be one which anneals to a sequence at the N-terminal end of the VH1, V κ or V λ domain. The back primer may consist of a plurality of primers having a variety of sequences designed to be complementary to the various families of VH1, V κ or V λ sequences known. Alternatively the back primer may be a single primer having a consensus sequence derived from all the families of variable region genes.

Surprisingly, it has been found that the method of the present invention can be carried out using genomic DNA. If genomic DNA is used, there is a very large amount of DNA present, including actual coding sequences, introns and untranslated sequences between genes. Thus, there is considerable scope for non-specific annealing under the conditions used. However, it has surprisingly been found that there is very little non-specific annealing. It is therefore unexpected that it has proved possible to clone the genes of Ig-variable domains from genomic DNA.

Under some circumstances the use of genomic DNA may prove advantageous compared with use of mRNA, as the mRNA is readily degraded, and especially difficult to prepare from clinical samples of human tissue.

Thus, in accordance with an aspect of the present invention, the ds nucleic acid used in step (a) is genomic DNA.

When using genomic DNA as the ds nucleic acid source, it will not be possible to use as the forward primer an oligonucleotide having a sequence complementary to a sequence in a constant domain. This is because, in genomic DNA, the constant domain genes are generally separated from the variable domain genes by a considerable number of base pairs. Thus, the site of annealing would be too remote from the sequence to be cloned.

It should be noted that the method of the present invention can be used to clone both rearranged and unrearranged variable domain sequences from genomic DNA. It is known that in germ line genomic DNA the three genes, encoding

the VH, DH and JH respectively, are separated from one another by considerable numbers of base pairs. On maturation of the immune response, these genes are rearranged so that the VH, DH and JH genes are fused together to provide the gene encoding the whole variable domain (see Figure 1). By using a forward primer specific for a sequence at or adjacent the 3' end of the sense strand of the genomic "unrearranged" VH gene, it is possible to clone the "unrearranged" VH gene alone, without also cloning the DH and JH genes. This can be of use in that it will then be possible to fuse the VH gene onto pre-cloned or synthetic DH and JH genes. In this way, rearrangement of the variable domain genes can be carried out *in vitro*.

The oligonucleotide primers used in step (c) may be specifically designed for use with a particular target sequence. In this case, it will be necessary to sequence at least the 5' and 3' ends of the target sequence so that the appropriate oligonucleotides can be synthesised. However, the present inventors have discovered that it is not necessary to use such specifically designed primers. Instead, it is possible to use a species specific general primer or a mixture of such primers for annealing to each end of the target sequence. This is not particularly surprising as regards the 3' end of the target sequence. It is known that this end of the variable domain encoding sequence leads into a segment encoding JH which is known to be relatively conserved. However, it was surprisingly discovered that, within a single species, the sequence at the 5' end of the target sequence is sufficiently well conserved to enable a species specific general primer or a mixture thereof to be designed for the 5' end of the target sequence.

Therefore according to a preferred aspect of the present invention, in step (c) the two primers which are used are species specific general primers, whether used as single primers or as mixtures of primers. This greatly facilitates the cloning of any undetermined target sequence since it will avoid the need to carry out any sequencing on the target sequence in order to produce target sequence-specific primers. Thus the method of this aspect of the invention provides a general method for cloning variable region or domain encoding sequences of a particular species.

Once the variable domain gene has been cloned using the method described above, it may be directly inserted into an expression vector, for instance using the PCR reaction to paste the gene into a vector.

Advantageously, however, each primer includes a sequence including a restriction enzyme recognition site. The sequence recognised by the restriction enzyme need not be in the part of the primer which anneals to the ds nucleic acid, but

may be provided as an extension which does not anneal. The use of primers with restriction sites has the advantage that the DNA can be cut with at least one restriction enzyme which leaves 3' or 5' overhanging nucleotides. Such DNA is more readily cloned into the corresponding sites on the vectors than blunt end fragments taken directly from the method. The ds cDNA produced at the end of the cycles will thus be readily insertable into a cloning vector by use of the appropriate restriction enzymes. Preferably the choice of restriction sites is such that the ds cDNA is cloned directly into an expression vector, such that the ligand encoded by the gene is expressed. In this case the restriction site is preferably located in the sequence which is annealed to the ds nucleic acid.

Since the primers may not have a sequence exactly complementary to the target sequence to which it is to be annealed, for instance because of nucleotide variations or because of the introduction of a restriction enzyme recognition site, it may be necessary to adjust the conditions in the annealing mixture to enable the primers to anneal to the ds nucleic acid. This is well within the competence of the person skilled in the art and needs no further explanation.

In step (d), any DNA polymerase may be used. Such polymerases are known in the art and are available commercially. The conditions to be used with each polymerase are well known and require no further explanation here. The polymerase reaction will need to be carried out in the presence of the four nucleoside triphosphates. These and the polymerase enzyme may already be present in the sample or may be provided afresh for each cycle.

The denaturing step (e) may be carried out, for instance, by heating the sample, by use of chaotropic agents, such as urea or guanidine, or by the use of changes in ionic strength or pH. Preferably, denaturing is carried out by heating since this is readily reversible. Where heating is used to carry out the denaturing, it will be usual to use a thermostable DNA polymerase, such as Taq polymerase, since this will not need replenishing at each cycle.

If heating is used to control the method, a suitable cycle of heating comprises denaturation at about 95°C for about 1 minute, annealing at from 30°C to 65°C for about 1 minute and primer extension at about 75°C for about 2 minutes. To ensure that elongation and renaturation is complete, the mixture after the final cycle is preferably held at about 60°C for about 5 minutes.

The product ds cDNA may be separated from the mixture for instance by gel electrophoresis using agarose gels. However, if desired, the ds cDNA may be used in unpurified form and inserted directly into a suitable cloning or expression vector

by conventional methods. This will be particularly easy to accomplish if the primers include restriction enzyme recognition sequences.

The method of the present invention may be used to make variations in the sequences encoding the variable domains. For example this may be achieved by using a mixture of related oligonucleotide primers as at least one of the primers. Preferably the primers are particularly variable in the middle of the primer and relatively conserved at the 5' and 3' ends. Preferably the ends of the primers are complementary to the framework regions of the variable domain, and the variable region in the middle of the primer covers all or part of a CDR. Preferably a forward primer is used in the area which forms the third CDR. If the method is carried out using such a mixture of oligonucleotides, the product will be a mixture of variable domain encoding sequences. Moreover, variations in the sequence may be introduced by incorporating some mutagenic nucleotide triphosphates in step (d), such that point mutations are scattered throughout the target region. Alternatively such point mutations are introduced by performing a large number of cycles of amplification, as errors due to the natural error rate of the DNA polymerase are amplified, particularly when using high concentrations of nucleoside triphosphates.

The method of this aspect of the present invention has the advantage that it greatly facilitates the cloning of variable domain encoding sequences directly from mRNA or genomic DNA. This in turn will facilitate the production of modified Ig-type molecules by any of the prior art methods referred to above. Further, target genes can be cloned from tissue samples containing antibody producing cells, and the genes can be sequenced. By doing this, it will be possible to look directly at the immune repertoire of a patient. This "fingerprinting" of a patient's immune repertoire could be of use in diagnosis, for instance of autoimmune diseases.

In the method for amplifying the amount of a gene encoding a variable domain, a single set of primers is used in several cycles of copying via the polymerase chain reaction. As a less preferred alternative, there is provided a second method which comprises steps (a) to (d) as above, which further includes the steps of:

(g) treating the sample of ds cDNA with traces of DNase in the presence of DNA polymerase I to allow nick translation of the DNA; and

(h) cloning the ds cDNA into a vector.

If desired, the second method may further include the steps of:

(i) digesting the DNA of recombinant plasmids to release DNA fragments containing genes

encoding variable domains; and

(j) treating the fragments in a further set of steps (c) to (h).

Preferably the fragments are separated from the vector and from other fragments of the incorrect size by gel electrophoresis.

The steps (a) to (d) then (g) to (h) can be followed once, but preferably the entire cycle (c) to (d) and (g) to (j) is repeated at least once. In this way a priming step, in which the genes are specifically copied, is followed by a cloning step, in which the amount of genes is increased.

In step (a) the ds cDNA is derived from mRNA. For Ig derived variable domains, the mRNA is preferably be isolated from lymphocytes which have been stimulated to enhance production of mRNA.

In each step (c) the set of primers are preferably different from the previous step (c), so as to enhance the specificity of copying. Thus the sets of primers form a nested set. For example, for cloning of Ig heavy chain variable domains, the first set of primers may be located within the signal sequence and constant region, as described by Larrick et al., [18], and the second set of primers entirely within the variable region, as described by Orlandi et al., [19]. Preferably the primers of step (c) include restriction sites to facilitate subsequent cloning. In the last cycle the set of primers used in step (c) should preferably include restriction sites for introduction into expression vectors. In step (g) possible mismatches between the primers and the template strands are corrected by "nick translation". In step (h), the ds cDNA is preferably cleaved with restriction enzymes at sites introduced into the primers to facilitate the cloning.

According to another aspect of the present invention the product ds cDNA is cloned directly into an expression vector. The host may be prokaryotic or eukaryotic, but is preferably bacterial. Preferably the choice of restriction sites in the primers and in the vector, and other features of the vector will allow the expression of complete ligands, while preserving all those features of the amino acid sequence which are typical of the (methoded) ligands. For example, for expression of the rearranged variable genes, the primers would be chosen to allow the cloning of target sequences including at least all the three CDR sequences. The cloning vector would then encode a signal sequence (for secretion of the ligand), and sequences encoding the N-terminal end of the first framework region, restriction sites for cloning and then the C-terminal end of the last (fourth) framework region.

For expression of unrearranged VH genes as part of complete ligands, the primers would be chosen to allow the cloning of target sequences including at least the first two CDRs. The cloning

vector could then encode signal sequence, the N-terminal end of the first framework region, restriction sites for cloning and then the C-terminal end of the third framework region, the third CDR and fourth framework region.

Primers and cloning vectors may likewise be devised for expression of single CDRs, particularly the third CDR, as parts of complete ligands. The advantage of cloning repertoires of single CDRs would permit the design of a "universal" set of framework regions, incorporating desirable properties such as solubility.

Single ligands could be expressed alone or in combination with a complementary variable domain. For example, a heavy chain variable domain can be expressed either as an individual domain or, if it is expressed with a complementary light chain variable domain, as an antigen binding site. Preferably the two partners would be expressed in the same cell, or secreted from the same cell, and the proteins allowed to associate non-covalently to form an Fv fragment. Thus the two genes encoding the complementary partners can be placed in tandem and expressed from a single vector, the vector including two sets of restriction sites.

Preferably the genes are introduced sequentially: for example the heavy chain variable domain can be cloned first and then the light chain variable domain. Alternatively the two genes are introduced into the vector in a single step, for example by using the polymerase chain reaction to paste together each gene with any necessary intervening sequence, as essentially described by Yon and Fried [29]. The two partners could be also expressed as a linked protein to produce a single chain Fv fragment, using similar vectors to those described above. As a further alternative the two genes may be placed in two different vectors, for example in which one vector is a phage vector and the other is a plasmid vector.

Moreover, the cloned ds cDNA may be inserted into an expression vector already containing sequences encoding one or more constant domains to allow the vector to express Ig-type chains. The expression of Fab fragments, for example, would have the advantage over Fv fragments that the heavy and light chains would tend to associate through the constant domains in addition to the variable domains. The final expression product may be any of the modified Ig-type molecules referred to above.

The cloned sequence may also be inserted into an expression vector so that it can be expressed as a fusion protein. The variable domain encoding sequence may be linked directly or via a linker sequence to a DNA sequence encoding any protein effector molecule, such as a toxin, enzyme, label or another ligand. The variable domain se-

quences may also be linked to proteins on the outer side of bacteria or phage. Thus, the method of this aspect of the invention may be used to produce receptors according to the invention.

According to another aspect of the invention, the cloning of ds cDNA directly for expression permits the rapid construction of expression libraries which can be screened for binding activities. For Ig heavy and light chain variable genes, the ds cDNA may comprise variable genes isolated as complete rearranged genes from the animal, or variable genes built from several different sources, for example a repertoire of unrearranged VH genes combined with a synthetic repertoire of DH and JH genes. Preferably repertoires of genes encoding Ig heavy chain variable domains are prepared from lymphocytes of animals immunised with an antigen.

The screening method may take a range of formats well known in the art. For example Ig heavy chain variable domains secreted from bacteria may be screened by binding to antigen on a solid phase, and detecting the captured domains by antibodies. Thus the domains may be screened by growing the bacteria in liquid culture and binding to antigen coated on the surface of ELISA plates. However, preferably bacterial colonies (or phage plaques) which secrete ligands (or modified ligands, or ligand fusions with proteins) are screened for antigen binding on membranes. Either the ligands are bound directly to the membranes (and for example detected with labelled antigen), or captured on antigen coated membranes (and detected with reagents specific for ligands). The use of membranes offers great convenience in screening many clones, and such techniques are well known in the art.

The screening method may also be greatly facilitated by making protein fusions with the ligands, for example by introducing a peptide tag which is recognised by an antibody at the N-terminal or C-terminal end of the ligand, or joining the ligand to an enzyme which catalyses the conversion of a colourless substrate to a coloured product. In the latter case, the binding of antigen may be detected simply by adding substrate. Alternatively, for ligands expressed and folded correctly inside eukaryotic cells, joining of the ligand and a domain of a transcriptional activator such as the GAL4 protein of yeast, and joining of antigen to the other domain of the GAL4 protein, could form the basis for screening binding activities, as described by Fields and Song [21].

The preparation of proteins, or even cells with multiple copies of the ligands, may improve the avidity of the ligand for immobilised antigen, and hence the sensitivity of the screening method. For example, the ligand may be joined to a protein

subunit of a multimeric protein, to a phage coat protein or to an outer membrane protein of *E. coli* such as ompA or lamB. Such fusions to phage or bacterial proteins also offers possibilities of selecting bacteria displaying ligands with antigen binding activities. For example such bacteria may be precipitated with antigen bound to a solid support, or may be subjected to affinity chromatography, or may be bound to larger cells or particles which have been coated with antigen and sorted using a fluorescence activated cell sorter (FACS). The proteins or peptides fused to the ligands are preferably encoded by the vector, such that cloning of the ds cDNA repertoire creates the fusion product.

In addition to screening for binding activities of single ligands, it may be necessary to screen for binding or catalytic activities of associated ligands, for example, the associated Ig heavy and light chain variable domains. For example, repertoires of heavy and light chain variable genes may be cloned such that two domains are expressed together. Only some of the pairs of domains may associate, and only some of these associated pairs may bind to antigen. The repertoires of heavy and light chain variable domains could be cloned such that each domain is paired at random. This approach may be most suitable for isolation of associated domains in which the presence of both partners is required to form a cleft. Alternatively, to allow the binding of hapten. Alternatively, since the repertoires of light chain sequences are less diverse than those of heavy chains, a small repertoire of light chain variable domains, for example including representative members of each family of domains, may be combined with a large repertoire of heavy chain variable domains.

Preferably however, a repertoire of heavy chain variable domains is screened first for antigen binding in the absence of the light chain partner, and then only those heavy chain variable domains binding to antigen are combined with the repertoire of light chain variable domains. Binding of associated heavy and light chain variable domains may be distinguished readily from binding of single domains, for example by fusing each domain to a different C-terminal peptide tag which are specifically recognised by different monoclonal antibodies.

The hierarchical approach of first cloning heavy chain variable domains with binding activities, then cloning matching light chain variable domains may be particularly appropriate for the construction of catalytic antibodies, as the heavy chain may be screened first for substrate binding. A light chain variable domain would then be identified which is capable of association with the heavy chain, and "catalytic" residues such as cysteine or histidine (or prosthetic groups) would be introduced into the

CDRs to stabilise the transition state or attack the substrate, as described by Baldwin and Schultz [22].

Although the binding activities of non-covalently associated heavy and light chain variable domains (Fv fragments) may be screened, suitable fusion proteins may drive the association of the variable domain partners. Thus Fab fragments are more likely to be associated than the Fv fragments, as the heavy chain variable domain is attached to a single heavy chain constant domain, and the light chain variable domain is attached to a single light chain variable domain, and the two constant domains associate together.

Alternatively the heavy and light chain variable domains are covalently linked together with a peptide, as in the single chain antibodies, or peptide sequences attached, preferably at the C-terminal end which will associate through forming cysteine bonds or through non-covalent interactions, such as the introduction of "leucine zipper" motifs. However, in order to isolate pairs of tightly associated variable domains, the Fv fragments are preferably used.

The construction of Fv fragments isolated from a repertoire of variable region genes offers a way of building complete antibodies, and an alternative to hybridoma technology. For example by attaching the variable domains to light or suitable heavy chain constant domains, as appropriate, and expressing the assembled genes in mammalian cells, complete antibodies may be made and should possess natural effector functions, such as complement lysis. This route is particularly attractive for the construction of human monoclonal antibodies, as hybridoma technology has proved difficult, and for example, although human peripheral blood lymphocytes can be immortalised with Epstein Barr virus, such hybridomas tend to secrete low affinity IgM antibodies.

Moreover, it is known that immunological mechanisms ensure that lymphocytes do not generally secrete antibodies directed against host proteins. However it is desirable to make human antibodies directed against human proteins, for example to human cell surface markers to treat cancers, or to histocompatibility antigens to treat autoimmune diseases. The construction of human antibodies built from the combinatorial repertoire of heavy and light chain variable domains may overcome this problem, as it will allow human antibodies to be built with specificities which would normally have been eliminated.

The method also offers a new way of making bispecific antibodies. Antibodies with dual specificity can be made by fusing two hybridomas of different specificities, so as to make a hybrid antibody with an Fab arm of one specificity, and the

other Fab arm of a second specificity. However, the yields of the bispecific antibody are low, as heavy and light chains also find the wrong partners. The construction of Fv fragments which are tightly associated should preferentially drive the association of the correct pairs of heavy with light chains. (It would not assist in the correct pairing of the two heavy chains with each other.) The improved production of bispecific antibodies would have a variety of applications in diagnosis and therapy, as is well known.

Thus the invention provides a species specific general oligonucleotide primer or a mixture of such primers useful for cloning variable domain encoding sequences from animals of that species. The method allows a single pair or pair of mixtures of species specific general primers to be used to clone any desired antibody specificity from that species. This eliminates the need to carry out any sequencing of the target sequence to be cloned and the need to design specific primers for each specificity to be recovered.

Furthermore it provides for the construction of repertoires of variable genes, for the expression of the variable genes directly on cloning, for the screening of the encoded domains for binding activities and for the assembly of the domains with other variable domains derived from the repertoire.

Thus the use of the method of the present invention will allow for the production of heavy chain variable domains with binding activities and variants of these domains. It allows for the production of monoclonal antibodies and bispecific antibodies, and will provide an alternative to hybridoma technology. For instance, mouse splenic ds mRNA or genomic DNA may be obtained from a hyperimmunised mouse. This could be cloned using the method of the present invention and then the cloned ds DNA inserted into a suitable expression vector. The expression vector would be used to transform a host cell, for instance a bacterial cell, to enable it to produce an Fv fragment or a Fab fragment. The Fv or Fab fragment would then be built into a monoclonal antibody by attaching constant domains and expressing it in mammalian cells.

The present invention is now described, by way of example only, with reference to the accompanying drawings in which:

Figure 1 shows a schematic representation of the unrearranged and rearranged heavy and light chain variable genes and the location of the primers;

Figure 2 shows a schematic representation of the M13-VHPCR1 vector and a cloning scheme for amplified heavy chain variable domains;

Figure 3 shows the sequence of the Ig variable region derived sequences in M13-VHPCR1;

Figure 4 shows a schematic representation of the M13-VKPCR1 vector and a cloning scheme for light chain variable domains;

Figure 5 shows the sequence of the Ig variable region derived sequences in M13-VKPCR1;

Figure 6 shows the nucleotide sequences of the heavy and light chain variable domain encoding sequences of MAb MB1;

Figure 7 shows a schematic representation of the pSV-gpt vector (also known as α -Lys 30) which contains a variable region cloned as a HindIII-BamHI fragment, which is excised on introducing the new variable region. The gene for human IgG1 has also been engineered to remove a BamHI site, such that the BamHI site in the vector is unique;

Figure 8 shows a schematic representation of the pSV-hygro vector (also known as α -Lys 17). It is derived from pSV gpt vector with the gene encoding mycophenolic acid replaced by a gene coding for hygromycin resistance. The construct contains a variable gene cloned as a HindIII-BamHI fragment which is excised on introducing the new variable region. The gene for human C κ has also been engineered to remove a BamHI site, such that the BamHI site in the vector is unique;

Figure 9 shows the assembly of the mouse: human MB1 chimaeric antibody;

Figure 10 shows encoded amino acid sequences of 48 mouse rearranged VH genes;

Figure 11 shows encoded amino acid sequences of human rearranged VH genes;

Figure 12 shows encoded amino acid sequences of unrearranged human VH genes;

Figure 13 shows the sequence of part of the plasmid pSW1; essentially the sequence of a pectate lyase leader linked to VHLYS in pSW1 and cloned as an SphI-EcoRI fragment into pUC19 and the translation of the open reading frame encoding the pectate lyase leader-VHLYS polypeptide being shown;

Figure 14 shows the sequence of part of the plasmid pSW2; essentially the sequence of a pectate lyase leader linked to VHLYS and to VKLYS, and cloned as an SphI-EcoRI-EcoRI fragment into pUC19 and the translation of open reading frames encoding the pectate lyase leader-VHLYS and pectate lyase leader-VKLYS polypeptides being shown;

Figure 15 shows the sequence of part of the plasmid pSW1HPOLYMYC which is based on pSW1 and in which a polylinker sequence has replaced the variable domain of VHLYS, and acts as a cloning site for amplified VH genes, and a peptide tag is introduced at the C-terminal end;

Figure 16 shows the encoded amino acid sequences of two VH domains derived from mouse spleen and having lysozyme binding activity, and compared with the VH domain of the D1.3 anti-

body. The arrows mark the points of difference between the two VH domains;

Figure 17 shows the encoded amino acid sequence of a VH domain derived from human peripheral blood lymphocytes and having lysozyme binding activity;

Figure 18 shows a scheme for generating and cloning mutants of the VHLYS gene, which is compared with the scheme for cloning natural repertoires of VH genes;

Figure 19 shows the sequence of part of the vector pSW2HPOLY;

Figure 20 shows the sequence of part of the vector pSW3 which encodes the two linked VHLYS domains;

Figure 21 shows the sequence of the VHLYS domain and pelB leader sequence fused to the alkaline phosphatase gene;

Figure 22 shows the sequence of the vector pSW1VHLYSVKPOLYMYC for expression of a repertoire of V_κ light chain variable domains in association with the VHLYS domain; and

Figure 23 shows the sequence of VH domain which is secreted at high levels from *E. coli*. The differences with VHLYS domain are marked.

PRIMERS

In the Examples described below, the following oligonucleotide primers, or mixed primers were used. Their locations are marked on Figure 1 and sequences are as follows:

VH1FOR 5' TGAGGAGACGGTGACCGTGGTCCC-TTGGCCCCAG 3';
 VH1FOR-2 5' TGAGGAGACGGT-GACCGTGGTCCCTTGGCCCC 3';
 Hu1VHFOR 5' CTTGGTGGAGGCTGAGGAGACG-GTGACC 3';
 Hu2VHFOR 5' CTTGGTGGAGGCTGAGGAGACG-GTGACC 3';
 Hu3VHFOR 5' CTTGGTGGATGCTGAGGAGACG-GTGACC 3';
 Hu4VHFOR 5' CTTGGTGGATGCTGATGAGACGG-TGACC 3';
 MOJH1FOR 5' TGAGGAGACGGTGACCGTGGTCCCTGCGCCCCAG 3';
 MOJH2FOR 5' TGAGGAGACGGTGACCGTGGTGCCTTGGCCCCAG 3';
 MOJH3FOR 5' TGCAGAGACGGTGACCAGAGTCCCTTGGCCCCAG 3';
 MOJH4FOR 5' TGAGGAGACGGTGACCGAGGTTCCTTGACCCAG 3';
 HUJH1FOR 5' TGAGGAGACGGTGACCAGGGTGCCTGCCCCAG 3';
 HUJH2FOR 5' TGAGGAGACGGTGACCAGGGTGCACGGCCCCAG 3';
 HUJH4FOR 5' TGAGGAGACGGTGACCAGGGT-

TCCTTGGCCCCAG 3';
 VK1FOR 5' GTTAGATCTCCAGCTTGGTCCC 3';
 VK2FOR 5' CGTTAGATCTCCAGCTTGGTCCC 3';
 VK3FOR 5' CCGTTTCAGCTCGAGCTTGGTCCC 3';
 MOJK1FOR 5' CGTTAGATCTCCAGCTTGGTGCC 3';
 MOJK3FOR 5' GGTTAGATCTCCAGTCTGGTCCC 3';
 MOJK4FOR 5' CGTTAGATCTCCAACTTTGTCCC 3';
 HUJK1FOR 5' CGTTAGATCTCCACCTTGGTCCC 3';
 HUJK3FOR 5' CGTTAGATCTCCACTTTGGTCCC 3';
 HUJK4FOR 5' CGTTAGATCTCCACCTTGGTCCC 3';
 HUJK5FOR 5' CGTTAGATCTCCAGTCGTGTCCC 3';
 VH1BACK 5' AGGT(C/G)(C/A)A(G/A)CTGCAG-(G/C)AGTC(T/A)GG 3';
 Hu2VHIBACK: 5' CAGGTGCAGCTGCAG-CAGTCTGG 3';
 HuVHIIIBACK: 5' CAGGTGCAGCTGCAG-GAGTCTGG 3';
 Hu2VHIIIBACK: 5' GAGGTGCAGCTGCAG-GAGTCTGG 3';
 HuVHIVIBACK: 5' CAGGTGCAGCTGCAG-CAGTCTGG 3';
 MOVHIBACK 5' AGGTGCAGCTGCAGGAGTCAG 3';
 MOVHIIIBACK 5' AGGTCCAGCTGCAGCA(G/A)-TCTGG 3';
 MOVHIIIBACK: 5' AGGTCCAAGTGCAG-CAGCCTGG 3';
 MOVHIIIBACK 5' AGGTGAAGTGCAG-GAGTCTGG 3';
 VK1BACK 5' GACATTCAGCTGACCCAGTCTCCA 3';
 VK2BACK 5' GACATTGAGCTCACCCAGTCTCCA 3';
 MOVKIIIBACK 5' GATGTTGAGCTGACCCAAAC-TCCA 3';
 MOVKIIIBACK 5' GATATTCAGCTGACCCAGGAT-GAA 3';
 HuHep1FOR 5' C(A/G)(C/G)-TGAGCTCACTGTGTCTCTCGCACA 3';
 HuOcta1BACK 5' CGTGAATATGCAAATAA 3';
 HuOcta2BACK 5' AGTAGGAGACATGCAAAT 3';
 and
 HuOcta3BACK 5' CACCACCACATGCAAAT 3';
 VHMUT1 5' GGAGACGGTGACCGTGGTCCCTTG-GCCCCAGTAGTCAAG
 NNNNNNNNNNNNCTCTCTGGC 3' (where N is an equimolar mixture of T, C, G and A)
 M13 PRIMER 5' AACAGCTATGACCATG 3' (New England Biolabs *1201)

EXAMPLE 1

primer was used in place of the VH1FOR primer.

Cloning of Mouse Rearranged Variable region genes from hybridomas, assembly of genes encoding chimaeric antibodies and the expression of antibodies from myeloma cells

VH1FOR is designed to anneal with the 3' end of the sense strand of any mouse heavy chain variable domain encoding sequence. It contains a BstEII recognition site. VK1FOR is designed to anneal with the 3' end of the sense strand of any mouse kappa-type light chain variable domain encoding sequence and contains a BglII recognition site. VH1BACK is designed to anneal with the 3' end of the antisense strand of any mouse heavy chain variable domain and contains a PstI recognition site. VK1BACK is designed to anneal with the 3' end of the antisense strand of any mouse kappa-type light chain variable domain encoding sequence and contains a PvuII recognition site.

In this Example five mouse hybridomas were used as a source of ds nucleic acid. The hybridomas produce monoclonal antibodies (MAbs) designated MBr1 [23], BW431/26 [24], BW494/32 [25], BW250/183 [24,26] and BW704/152 [27]. MAb MBr1 is particularly interesting in that it is known to be specific for a saccharide epitope on a human mammary carcinoma line MCF-7 [28].

Cloning via mRNA

Each of the five hybridomas referred to above was grown up in roller bottles and about 5×10^6 cells of each hybridoma were used to isolate RNA. mRNA was separated from the isolated RNA using oligodT cellulose [29]. First strand cDNA was synthesised according to the procedure described by Maniatis et al. [30] as set out below.

In order to clone the heavy chain variable domain encoding sequence, a 50 μ l reaction solution which contains 10 μ g mRNA, 20 pmole VH1FOR primer, 250 μ M each of dATP, dTTP, dCTP and dGTP, 10 mM dithiothreitol (DTT), 100 mM Tris.HCl, 10 mM $MgCl_2$ and 140 mM KCl, adjusted to pH 8.3 was prepared. The reaction solution was heated at 70 $^\circ$ C for ten minutes and allowed to cool to anneal the primer to the 3' end of the variable domain encoding sequence in the mRNA. To the reaction solution was then added 46 units of reverse transcriptase (Anglian Biotec) and the solution was then incubated at 42 $^\circ$ C for 1 hour to cause first strand cDNA synthesis.

In order to clone the light chain variable domain encoding sequence, the same procedure as set out above was used except that the VK1FOR

Amplification from RNA/DNA hybrid

Once the ds RNA/DNA hybrids had been produced, the variable domain encoding sequences were amplified as follows. For heavy chain variable domain encoding sequence amplification, a 50 μ l reaction solution containing 5 μ l of the ds RNA/DNA hybrid-containing solution, 25 pmole each of VH1FOR and VH1BACK primers, 250 μ M of dATP, dTTP, dCTP and dGTP, 67 mM Tris.HCl, 17 mM ammonium sulphate, 10 mM $MgCl_2$, 200 μ g/ml gelatine and 2 units Taq polymerase (Cetus) was prepared. The reaction solution was overlaid with paraffin oil and subjected to 25 rounds of temperature cycling using a Techne PHC-1 programmable heating block. Each cycle consisted of 1 minute at 95 $^\circ$ C (to denature the nucleic acids), 1 minute at 30 $^\circ$ C (to anneal the primers to the nucleic acids) and 2 minutes at 72 $^\circ$ C (to cause elongation from the primers). After the 25 cycles, the reaction solution and the oil were extracted twice with ether, once with phenol and once with phenol/CHCl₃. Thereafter ds cDNA was precipitated with ethanol. The precipitated ds cDNA was then taken up in 50 μ l of water and frozen.

The procedure for light chain amplification was exactly as described above, except that the VK1FOR and VK1BACK primers were used in place of the VH1FOR and VH1BACK primers respectively.

5 μ l of each sample of amplified cDNA was fractionated on 2% agarose gels by electrophoresis and stained with ethidium bromide. This showed that the amplified ds cDNA gave a major band of the expected size (about 330 bp). (However the band for VK DNA of MBr1 was very weak. It was therefore excised from the gel and reamplified in a second round.) Thus by this simple procedure, reasonable quantities of ds DNA encoding the light and heavy chain variable domains of the five MAbs were produced.

Heavy Chain Vector Construction

A BstEII recognition site was introduced into the vector M13-HuVHNP [31] by site directed mutagenesis [32,33] to produce the vector M13-VHPCR1 (Figures 2 and 3).

Each amplified heavy chain variable domain encoding sequence was digested with the restriction enzymes PstI and BstEII. The fragments were phenol extracted, purified on 2% low melting point agarose gels and force cloned into vector M13-VHPCR1 which had been digested with PstI and

BstEII and purified on an 0.8% agarose gel. Clones containing the variable domain inserts were identified directly by sequencing [34] using primers based in the 3' non-coding variable gene in the M13-VHPCR1 vector.

There is an internal PstI site in the heavy chain variable domain encoding sequences of BW431:26. This variable domain encoding sequence was therefore assembled in two steps. The 3' PstI-BstEII fragment was first cloned into M13-VHPCR1, followed in a second step by the 5' PstI fragment.

Light Chain Vector Construction

Vector M13mp18 [35] was cut with PvuII and the vector backbone was blunt ligated to a synthetic HindIII-BamHI polylinker. Vector M13-HuV-KLYS [36] was digested with HindIII and BamHI to isolate the HuV-KLYS gene. This HindIII-BamHI fragment was then inserted into the HindIII-BamHI polylinker site to form a vector M13-VKPCR1 which lacks any PvuII sites in the vector backbone (Figures 4 and 5). This vector was prepared in *E. Coli* JM110 [22] to avoid dam methylation at the BclI site.

Each amplified light chain variable domain encoding sequence was digested with PvuII and BglII. The fragments were phenol extracted, purified on 2% low melting point agarose gels and force cloned into vector M13-VKPCR1 which had been digested with PvuII and BclI, purified on an 0.8% agarose gel and treated with calf intestinal phosphatase. Clones containing the light chain variable region inserts were identified directly by sequencing [34] using primers based in the 3' non-coding region of the variable domain in the M13-VKPCR1 vector.

The nucleotide sequences of the MBr1 heavy and light chain variable domains are shown in Figure 6 with part of the flanking regions of the M13-VHPCR1 and M13-VKPCR1 vectors.

Antibody Expression

The HindIII-BamHI fragment carrying the MBr1 heavy chain variable domain encoding sequence in M13-VHPCR1 was recloned into a pSV-gpt vector with human γ 1 constant regions [37] (Figure 7). The MBr1 light chain variable domain encoding sequence in M13-VKPCR1 was recloned as a HindIII-BamHI fragment into a pSV vector, pSV-hyg-HuCK with a hygromycin resistance marker and a human kappa constant domain (Figure 8). The assembly of the genes is summarised in Figure 9.

The vectors thus produced were linearised with

PvuII (in the case of the pSV-hygro vectors the PvuII digest is only partial) and cotransfected into the non-secreting mouse myeloma line NSO [38] by electroporation [39]. One day after cotransfection, cells were selected in 0.3 μ g/ml mycophenolic acid (MPA) and after seven days in 1 μ g/ml MPA. After 14 days, four wells, each containing one or two major colonies, were screened by incorporation of 14 C-lysine [40] and the secreted antibody detected after precipitation with protein-A Sepharose™ (Pharmacia) on SDS-PAGE [41]. The gels were stained, fixed, soaked in a fluorographic reagent, Amplify™ (Amersham), dried and autoradiographed on preflashed film at -70°C for 2 days.

Supernatant was also tested for binding to the mammary carcinoma line MCF-7 and the colon carcinoma line HT-29, essentially as described by Menard et al. [23], either by an indirect immunofluorescence assay on cell suspensions (using a fluorescein-labelled goat anti-human IgG (Amersham)) or by a solid phase RIA on monolayers of fixed cells (using 125 I-protein A (Amersham)).

It was found that one of the supernatants from the four wells contained secreted antibody. The chimeric antibody in the supernatant, like the parent mouse MBr1 antibody, was found to bind to MCF-7 cells but not the HT-29 cells, thus showing that the specificity had been properly cloned and expressed.

Example 2

Cloning of rearranged variable genes from genomic DNA of mouse spleen

Preparation of DNA from spleen.

The DNA from the mouse spleen was prepared in one of two ways (although other ways can be used).

Method 1.

A mouse spleen was cut into two pieces and each piece was put into a standard Eppendorf tube with 200 μ l of PBS. The tip of a 1 ml glass pipette was closed and rounded in the blue flame of a Bunsen burner. The pipette was used to squash the spleen piece in each tube. The cells thus produced were transferred to a fresh Eppendorf tube and the method was repeated three times until the connective tissue of the spleen appeared white. Any connective tissue which has been trans-

ferred with the cells was removed using a drawn-out Pasteur pipette. The cells were then washed in PBS and distributed into four tubes.

The mouse spleen cells were then sedimented by a 2 minute spin in a Microcentaur centrifuge at low speed setting. All the supernatant was aspirated with a drawn out Pasteur pipette. If desired, at this point the cell sample can be frozen and stored at -20° C

To the cell sample (once thawed if it had been frozen) was added 500 µl of water and 5 µl of a 10% solution of NP-40, a non-ionic detergent. The tube was closed and a hole was punched in the lid. The tube was placed on a boiling water bath for 5 minutes to disrupt the cells and was then cooled on ice for 5 minutes. The tube was then spun for 2 minutes at high speed to remove cell debris.

The supernatant was transferred to a new tube and to this was added 125 µl 5M NaCl and 30 µl 1M MOPS adjusted to pH 7.0. The DNA in the supernatant was absorbed on a Quiagen 5 tip and purified following the manufacturer's instructions for lambda DNA. After isopropanol precipitation, the DNA was resuspended in 500 µl water.

Method 2.

This method is based on the technique described in Maniatis et al. [30]. A mouse spleen was cut into very fine pieces and put into a 2 ml glass homogeniser. The cells were then freed from the tissue by several slow up and down strokes with the piston. The cell suspension was made in 500 µl phosphate buffered saline (PBS) and transferred to an Eppendorf tube. The cells were then spun for 2 min at low speed in a Microcentaur centrifuge. This results in a visible separation of white and red cells. The white cells, sedimenting slower, form a layer on top of the red cells. The supernatant was carefully removed and spun to ensure that all the white cells had sedimented. The layer of white cells was resuspended in two portions of 500 µl PBS and transferred to another tube.

The white cells were precipitated by spinning in the Microcentaur centrifuge at low speed for one minute. The cells were washed a further two times with 500 µl PBS, and were finally resuspended in 200 µl PBS. The white cells were added to 2.5 ml 25 mM EDTA and 10 mM Tris.Cl, pH 7.4, and vortexed slowly. While vortexing 25 µl 20% SDS was added. The cells lysed immediately and the solution became viscous and clear. 100 µl of 20 mg/ml proteinase K was added and incubated one to three hours at 50° C.

The sample was extracted with an equal volume of phenol and the same volume of chloroform, and vortexed. After centrifuging, the aqueous phase

was removed and 1/10 volume 3M ammonium acetate was added. This was overlaid with three volumes of cold ethanol and the tube rocked carefully until the DNA strands became visible. The DNA was spooled out with a Pasteur pipette, the ethanol allowed to drip off, and the DNA transferred to 1 ml of 10 mM Tris.Cl pH 7.4, 0.1 mM EDTA in an Eppendorf tube. The DNA was allowed to dissolve in the cold overnight on a roller.

Amplification from genomic DNA.

The DNA solution was diluted 1/10 in water and boiled for 5 min prior to using the polymerase chain reaction (PCR). For each PCR reaction, typically 50-200 ng of DNA were used.

The heavy and light chain variable domain encoding sequences in the genomic DNA isolated from the human PBL or the mouse spleen cells was then amplified and cloned using the general protocol described in the first two paragraphs of the section headed "Amplification from RNA/DNA Hybrid" in Example 1, except that during the annealing part of each cycle, the temperature was held at 65° C and that 30 cycles were used. Furthermore, to minimise the annealing between the 3' ends of the two primers, the sample was first heated to 95° C, then annealed at 65° C, and only then was the Taq polymerase added. At the end of the 30 cycles, the reaction mixture was held at 60° C for five minutes to ensure that complete elongation and renaturation of the amplified fragments had taken place.

The primers used to amplify the mouse spleen genomic DNA were VH1FOR and VH1BACK, for the heavy chain variable domain and VK2FOR and VK1BACK, for the light chain variable domain. (VK2FOR only differs from VK1FOR in that it has an extra C residue on the 5' end.)

Other sets of primers, designed to optimise annealing with different families of mouse VH and V_κ genes were devised and used in mixtures with the primers above. For example, mixtures of VK1FOR, MOJK1FOR, MOJK3FOR and MOJK4FOR were used as forward primers and mixtures of VK1BACK, MOVK1IBACK and MOVK1IBBACK as back primers for amplification of V_κ genes. Likewise mixtures of VH1FOR, MOJH1FOR, MOJH2FOR, MOJH3FOR and MOJH4FOR were used as forward primers and mixtures of VH1BACK, MOVH1IBACK, MOVH1IBBACK, MOVH1IBBACK, MOVH1IBBACK were used as backward primers for amplification of VH genes.

All these heavy chain FOR primers referred to above contain a BstEII site and all the BACK primers referred to above contain a PstI site. These light chain FOR and BACK primers referred to

above all contain BglII and PvuII sites respectively. Light chain primers (VK3FOR and VK2BACK) were also devised which utilised different restriction sites, SacI and XhoI.

Typically all these primers yielded amplified DNA of the correct size on gel electrophoresis, although other bands were also present. However, a problem was identified in which the 5' and 3' ends of the forward and backward primers for the VH genes were partially complementary, and this could yield a major band of "primer-dimer" in which the two oligonucleotides prime on each other. For this reason an improved forward primer, VH1FOR-2, was devised in which the two 3' nucleotides were removed from VH1FOR.

Thus, the preferred amplification conditions for mouse VH genes are as follows: the sample was made in a volume of 50-100 μ l, 50-100 ng of DNA, VH1FOR-2 and VH1BACK primers (25 pmole of each), 250 μ M of each deoxynucleotide triphosphate, 10 mM Tris.HCl, pH 8.6, 50 mM KCl, 1.5 mM MgCl₂, and 100 μ g/ml gelatine. The sample was overlaid with paraffin oil, heated to 95° C for 2 min, 65° C for 2 min, and then to 72° C: taq polymerase was added after the sample had reached the elongation temperature and the reaction continued for 2 min at 72° C. The sample was subjected to a further 29 rounds of temperature cycling using the Techne PHC-1 programmable heating block.

The preferred amplification conditions for mouse Vk genes from genomic DNA are as follows: the sample treated as above except with V_k primers, for example VK3FOR and VK2BACK, and using a cycle of 94° C for one minute, 60° C for one minute and 72° C for one minute.

The conditions which were devised for genomic DNA are also suitable for amplification from the cDNA derived from mRNA from mouse spleen or mouse hybridoma.

Cloning and analysis of variable region genes

The reaction mixture was then extracted twice with 40 μ l of water-saturated diethyl ether. This was followed by a standard phenol extraction and ethanol precipitation as described in Example 1. The DNA pellet was then dissolved in 100 μ l 10 mM Tris.Cl, 0.1 mM EDTA.

Each reaction mixture containing a light chain variable domain encoding sequence was digested with SacI and XhoI (or with PvuII and BglII) to enable it to be ligated into a suitable expression vector. Each reaction mixture containing a heavy chain variable domain encoding sequence was digested with PstI and BstEII for the same purpose.

The heavy chain variable genes isolated as

above from a mouse hyperimmunised with lysozyme were cloned into M13VHPCR1 vector and sequenced. The complete sequences of 48 VH gene clones were determined (Figure 10). All but two of the mouse VH gene families were represented, with frequencies of: VA (1), IIIC (1), IIIB (8), IIIA (3), IIB (17), IIA (2), IB (12), IA (4). In 30 clones, the D segments could be assigned to families SP2 (14), FL16 (11) and Q52 (5), and in 38 clones the JH minigenes to families JH1 (3), JH2 (7), JH3 (14) and JH4 (14). The different sequences of CDR3 marked out each of the 48 clones as unique. Nine pseudogenes and 16 unproductive rearrangements were identified. Of the clones sequenced, 27 have open reading frames.

Thus the method is capable of generating a diverse repertoire of heavy chain variable genes from mouse spleen DNA.

Example 3

Cloning of rearranged variable genes from mRNA from human peripheral blood lymphocytes

Preparation of mRNA.

Human peripheral blood lymphocytes were purified and mRNA prepared directly (Method 1), or mRNA was prepared after addition of Epstein Barr virus (Method 2).

Method 1.

20 ml of heparinised human blood from a healthy volunteer was diluted with an equal volume of phosphate buffered saline (PBS) and distributed equally into 50 ml Falcon tubes. The blood was then underlaid with 15ml Ficoll Hypaque (Pharmacia 10-A-001-07). To separate the lymphocytes from the red blood cells, the tubes were spun for 10 minutes at 1800 rpm at room temperature in an IEC Centra 3E table centrifuge. The peripheral blood lymphocytes (PBL) were then collected from the interphase by aspiration with a Pasteur pipette. The cells were diluted with an equal volume of PBS and spun again at 1500 rpm for 15 minutes. The supernatant was aspirated, the cell pellet was resuspended in 1 ml PBS and the cells were distributed into two Eppendorf tubes.

Method 2.

40 ml human blood from a patient with HIV in

the pre-AIDS condition was layered on Ficoll to separate the white cells (see Method 1 above). The white cells were then incubated in tissue culture medium for 4-5 days. On day 3, they were infected with Epstein Barr virus. The cells were pelleted (approx 2×10^7 cells) and washed in PBS.

The cells were pelleted again and lysed with 7 ml 5M guanidine isothiocyanate, 50 mM Tris, 10 mM EDTA, 0.1 mM dithiothreitol. The cells were vortexed vigorously and 7 volumes of 4M LiCl added. The mixture was incubated at 4 °C for 15-20 hrs. The suspension was spun and the supernatant resuspended in 3M LiCl and centrifuged again. The pellet was dissolved in 2ml 0.1 % SDS, 10 mM Tris HCl and 1 mM EDTA. The suspension was frozen at -20 °C, and thawed by vortexing for 20 s every 10 min for 45 min. A large white pellet was left behind and the clear supernatant was extracted with phenol chloroform, then with chloroform. The RNA was precipitated by adding 1/10 volume 3M sodium acetate and 2 vol ethanol and leaving overnight at -20 °C. The pellet was suspended in 0.2 ml water and reprecipitated with ethanol. Aliquots for cDNA synthesis were taken from the ethanol precipitate which had been vortexed to create a fine suspension.

100 μ l of the suspension was precipitated and dissolved in 20 μ l water for cDNA synthesis [30] using 10 pmole of a HUFOR primer (see below) in final volume of 50 μ l. A sample of 5 μ l of the cDNA was amplified as in Example 2 except using the primers for the human VH gene families (see below) using a cycle of 95 °C, 60 °C and 72 °C.

The back primers for the amplification of human DNA were designed to match the available human heavy and light chain sequences, in which the different families have, slightly different nucleotide sequences at the 5' end. Thus for the human VH genes, the primers Hu2VHIBACK, HuVHIIIBACK, Hu2VHIIIBACK and HuVH1VBACK were designed as back primers, and HUJH1FOR, HUJH2FOR and HUJH4FOR as forward primers based entirely in the variable gene. Another set of forward primers Hu1VHFOR, Hu2VHFOR, Hu3VHFOR, and Hu4VHFOR was also used, which were designed to match the human J-regions and the 5' end of the constant regions of different human isotopes.

Using sets of these primers it was possible to demonstrate a band of amplified ds cDNA by gel electrophoresis.

One such experiment was analysed in detail to establish whether there was a diverse repertoire in a patient with HIV infection. It is known that during the course of AIDS, that T-cells and also antibodies are greatly diminished in the blood. Presumably the repertoire of lymphocytes is also diminished. In this experiment, for the forward priming, an

equimolar mixture of primers Hu1VHFOR, Hu2VHFOR, Hu3VHFOR, and Hu4VHFOR (in PCR 25 pmole of primer 5' ends) was used. For the back priming, the primers Hu2VHIBACK, HuVHIIIBACK, Hu2VHIIIBACK and HuVH1VBACK were used separately in four separate primings. The amplified DNA from the separate primings was then pooled, digested with restriction enzymes PstI and BstEII as above, and then cloned into the vector M13VHPCR1 for sequencing. The sequences reveal a diverse repertoire (Fig. 11) at this stage of the disease.

For human V α genes the primers HuJK1FOR, HUJK3FOR, HUJK4FOR and HUJK5FOR were used as forward primers and VK1BACK as back primer. Using these primers it was possible to see a band of amplified ds cDNA of the correct size by gel electrophoresis.

Example 4

Cloning of unrearranged variable gene genomic DNA from human peripheral blood lymphocytes

Human peripheral blood lymphocytes of a patient with non-Hodgkins lymphoma were prepared as in Example 3 (Method 1). The genomic DNA was prepared from the PBL using the technique described in Example 2 (Method 2). The VH region in the isolated genomic DNA was then amplified and cloned using the general protocol described in the first two paragraphs of the section headed "Amplification from RNA/DNA hybrid" in Example 1 above, except that during the annealing part of each cycle, the temperature was held at 55 °C and that 30 cycles were used. At the end of the 30 cycles, the reaction mixture was held at 60 °C for five minutes to ensure that complete elongation and renaturation of the amplified fragments had taken place.

The forward primer used was HuHep1FOR, which contains a SacI site. This primer is designed to anneal to the 3' end of the unrearranged human VH region gene, and in particular includes a sequence complementary to the last three codons in the VH region gene and nine nucleotides downstream of these three codons.

As the back primer, an equimolar mixture of HuOcta1BACK, HuOcta2BACK and HuOcta3BACK was used. These primers anneal to a sequence in the promoter region of the genomic DNA VH gene (see Figure 1). 5 μ l of the amplified DNA was checked on 2% agarose gels in TBE buffer and stained with ethidium bromide. A double band was seen of about 620 nucleotides which corresponds to the size expected for the unrearranged VH gene.

The ds cDNA was digested with SacI and cloned into an M13 vector for sequencing. Although there are some sequences which are identical, a range of different unrearranged human VH genes were identified (Figure 12).

Example 5

Cloning Variable Domains with Binding Activities from a Hybridoma

The heavy chain variable domain (VHLYS) of the D1.3 (anti-lysozyme) antibody was cloned into a vector similar to that described previously [42] but under the control of the lac z promoter, such that the VHLYS domain is attached to a pelB leader sequence for export into the periplasm. The vector was constructed by synthesis of the pelB leader sequence [43], using overlapping oligonucleotides, and cloning into a pUC 19 vector [35]. The VHLYS domain of the D1.3 antibody was derived from a cDNA clone [44] and the construct (pSW1) sequenced (Figure 13).

To express both heavy and light chain variable domains together, the light chain variable region (VKLYS) of the D1.3 antibody was introduced into the pSW1 vector, with a pelB signal sequence to give the construct pSW2 (Figure 14).

A strain of *E. coli* (BMH71-18) [45] was then transformed [46,47] with the plasmid pSW1 or pSW2, and colonies resistant to ampicillin (100 µg/ml) were selected on a rich (2 x TY = per litre of water, 16g Bacto-tryptone, 10g yeast extract, 5g NaCl) plate which contained 1% glucose to repress the expression of variable domain(s) by catabolite repression.

The colonies were inoculated into 50 ml 2 x TY (with 1% glucose and 100 µg/ml ampicillin) and grown in flasks at 37 °C with shaking for 12-16 hr. The cells were centrifuged, the pellet washed twice with 50 mM sodium chloride, resuspended in 2 x TY medium containing 100 µg/ml ampicillin and the inducer IPTG (1 mM) and grown for a further 30 hrs at 37 °C. The cells were centrifuged and the supernatant was passed through a Nalgene filter (0.45 µm) and then down a 1 - 5 ml lysozyme-Sepharose affinity column. (The column was derived by coupling lysozyme at 10 mg/ml to CNBr activated Sepharose.) The column was first washed with phosphate buffered saline (PBS), then with 50 mM diethylamine to elute the VHLYS domain (from pSW1) or VHLYS in association with VKLYS (from pSW2).

The VHLYS and VKLYS domains were identified by SDS polyacrylamide electrophoresis as the correct size. In addition, N-terminal sequence

determination of VHLYS and VKLYS isolated from a polyacrylamide gel showed that the signal peptide had been produced correctly. Thus both the Fv fragment and the VHLYS domains are able to bind to the lysozyme affinity column, suggesting that both retain at least some of the affinity of the original antibody.

The size of the VHLYS domain was compared by FPLC with that of the Fv fragment on Superose 12. This indicates that the VHLYS domain is a monomer. The binding of the VHLYS and Fv fragment to lysozyme was checked by ELISA, and equilibrium and rapid reaction studies were carried out using fluorescence quench.

The ELISA for lysozyme binding was undertaken as follows:

(1) The plates (Dynatech Immulon) were coated with 200 µl per well of 300 µg/ml lysozyme in 50 mM NaHCO₃, pH 9.6 overnight at room temperature;

(2) The wells were rinsed with three washes of PBS, and blocked with 300 µl per well of 1% Sainsbury's instant dried skimmed milk powder in PBS for 2 hours at 37 °C;

(3) The wells were rinsed with three washes of PBS and 200 µl of VHLYS or Fv fragment (VHLYS associated with VKLYS) were added and incubated for 2 hours at room temperature;

(4) The wells were washed three times with 0.05% Tween 20 in PBS and then three times with PBS to remove detergent;

(5) 200 µl of a suitable dilution (1:1000) of rabbit polyclonal antisera raised against the Fv fragment in 2% skimmed milk powder in PBS was added to each well and incubated at room temperature for 2 hours;

(6) Washes were repeated as in (4);

(7) 200 µl of a suitable dilution (1:1000) of goat anti-rabbit antibody (ICN Immunochemicals) coupled to horse radish peroxidase, in 2% skimmed milk powder in PBS, was added to each well and incubated at room temperature for 1 hour;

(8) Washes were repeated as in (4); and

(9) 200 µl 2,2'-azino-bis(3-ethylbenzothiazolinesulphonic acid) [Sigma] (0.55 mg/ml, with 1 µl 20% hydrogen peroxide: water per 10 ml) was added to each well and the colour allowed to develop for up to 10 minutes at room temperature.

The reaction was stopped by adding 0.05% sodium azide in 50 mM citric acid pH 4.3. ELISA plates were read in a Titertek Multiscan plate reader. Supernatant from the induced bacterial cultures of both pSW1 (VHLYS domain) or pSW2 (Fv fragment) was found to bind to lysozyme in the ELISA.

The purified VHLYS and Fv fragments were titrated with lysozyme using fluorescence quench (Perkin Elmer LS5B Luminescence Spectrometer) to measure the stoichiometry of binding and the

affinity constant for lysozyme [48,49]. The titration of the Fv fragment at a concentration of 30 nM indicates a dissociation constant of 2.8 nM using a Scatchard analysis.

A similar analysis using fluorescence quench and a Scatchard plot was carried out for VHLYS, at a VHLYS concentration of 100 nM. The stoichiometry of antigen binding is about 1 mole of lysozyme per mole of VHLYS (calculated from plot). (The concentration of VH domains was calculated from optical density at 280 nM using the typical extinction coefficient for complete immunoglobulins.) Due to possible errors in measuring low optical densities and the assumption about the extinction coefficient, the stoichiometry was also measured more carefully. VHLYS was titrated with lysozyme as above using fluorescence quench. To determine the concentration of VHLYS a sample of the stock solution was removed, a known amount of nor-leucine added, and the sample subjected to quantitative amino acid analysis. This showed a stoichiometry of 1.2 mole of lysozyme per mole of VHLYS domain. The dissociation constant was calculated at about 12 nM.

The on-rates for VHLYS and Fv fragments with lysozyme were determined by stopped-flow analysis (Hi Tech Stop Flow SHU machine) under pseudo-first order conditions with the fragment at a ten fold higher concentration than lysozyme [50]. The concentration of lysozyme binding sites was first measured by titration with lysozyme using fluorescence quench as above. The on rates were calculated per mole of binding site (rather than amount of VHLYS protein). The on-rate for the Fv fragment was found to be $2.2 \times 10^6 \text{ M}^{-1} \text{ s}^{-1}$ at 25 °C. The on-rate for the VHLYS fragment found to be $3.8 \times 10^6 \text{ M}^{-1} \text{ s}^{-1}$ and the off-rate 0.075 s^{-1} at 20 °C. The calculated affinity constant is 19 nM. Thus the VHLYS binds to lysozyme with a dissociation constant of about 19 nM, compared with that of the Fv of 3 nM.

Example 6

Cloning complete variable domains with binding activities from mRNA or DNA of antibody-secreting cells

A mouse was immunised with hen egg white lysozyme (100 µg i.p. day 1 in complete Freund's adjuvant), after 14 days immunised i.p. again with 100 µg lysozyme with incomplete Freund's adjuvant, and on day 35 i.v. with 50 µg lysozyme in saline. On day 39, spleen was harvested. A second mouse was immunised with keyhole limpet haemocyanin (KLH) in a similar way. The DNA was

prepared from the spleen according to Example 2 (Method 2). The VH genes were amplified according to the preferred method in Example 2.

Human peripheral blood lymphocytes from a patient infected with HIV were prepared as in Example 3 (Method 2) and mRNA prepared. The VH genes were amplified according to the method described in Example 3, using primers designed for human VH gene families.

After the PCR, the reaction mixture and oil were extracted twice with ether, once with phenol and once with phenol/CHCl₃. The double stranded DNA was then taken up in 50 µl of water and frozen. 5 µl was digested with PstI and BstEII (encoded within the amplification primers) and loaded on an agarose gel for electrophoresis. The band of amplified DNA at about 350 bp was extracted.

Expression of anti-lysozyme activities

The repertoire of amplified heavy chain variable domains (from mouse immunised with lysozyme and from human PBLs) was then cloned directly into the expression vector pSW1HPOLYMYC. This vector is derived from pSW1 except that the VHLYS gene has been removed and replaced by a polylinker restriction site. A sequence encoding a peptide tag was inserted (Figure 15). Colonies were toothpicked into 1 ml cultures. After induction (see Example 5 for details), 10 µl of the supernatant from fourteen 1 ml cultures was loaded on SDS-PAGE gels and the proteins transferred electrophoretically to nitrocellulose. The blot was probed with antibody 9E10 directed against the peptide tag.

The probing was undertaken as follows. The nitrocellulose filter was incubated in 3% bovine serum albumin (BSA)/TBS buffer for 20 min (10 x TBS buffer is 100 mM Tris.HCl, pH 7.4, 9% w/v NaCl). The filter was incubated in a suitable dilution of antibody 9E10 (about 1/500) in 3% BSA/TBS for 1 - 4 hrs. After three washes in TBS (100 ml per wash, each wash for 10 min), the filter was incubated with 1:500 dilution of anti-mouse antibody (peroxidase conjugated anti-mouse Ig (Dakopats)) in 3% BSA/TBS for 1 - 2 hrs. After three washes in TBS and 0.1% Triton X-100 (about 100 ml per wash, each wash for 10 min), a solution containing 10 ml chloronaphthol in methanol (3 mg/ml), 40 ml TBS and 50 µl hydrogen peroxide solution was added over the blot and allowed to react for up to 10 min. The substrate was washed out with excess water. The blot revealed bands similar in mobility to VHLYSMYC on the Western blot, showing that other VH domains could be expressed.

Colonies were then toothpicked individually into

wells of an ELISA plate (200 μ l) for growth and induction. They were assayed for lysozyme binding with the 9E10 antibody (as in Examples 5 and 7). Wells with lysozyme-binding activity were identified. Two positive wells (of 200) were identified from the amplified mouse spleen DNA and one well from the human cDNA. The heavy chain variable domains were purified on a column of lysozyme-Sepharose. The affinity for lysozyme of the clones was estimated by fluorescence quench titration as >50 nM. The affinities of the two clones (VH3 and VH8) derived from the mouse genes were also estimated by stop flow analysis (ratio of k_{on}/k_{off}) as 12 nM and 27 nM respectively. Thus both these clones have a comparable affinity to the VHLYS domain. The encoded amino acid sequences of VH3 and VH8 are given in Figure 16, and that of the human variable domain in Figure 17.

A library of VH domains made from the mouse immunised with lysozyme was screened for both lysozyme and keyhole limpet haemocyanin (KLH) binding activities. Two thousand colonies were toothpicked in groups of five into wells of ELISA plates, and the supernatants tested for binding to lysozyme coated plates and separately to KLH coated plates. Twenty one supernatants were shown to have lysozyme binding activities and two to have KLH binding activities. A second expression library, prepared from a mouse immunised with KLH was screened as above. Fourteen supernatants had KLH binding activities and a single supernatant had lysozyme binding activity.

This shows that antigen binding activities can be prepared from single VH domains, and that immunisation facilitates the isolation of these domains.

Example 7

Cloning variable domains with binding activities by mutagenesis.

Taking a single rearranged VH gene, it may be possible to derive entirely new antigen binding activities by extensively mutating each of the CDRs. The mutagenesis might be entirely random, or be derived from pre-existing repertoires of CDRs. Thus a repertoire of CDRs might be prepared as in the preceding examples by using "universal" primers based in the flanking sequences, and likewise repertoires of the other CDRs (singly or in combination). The CDR repertoires could be stitched into place in the flanking framework regions by a variety of recombinant DNA techniques.

CDR3 appears to be the most promising region

for mutagenesis as CDR3 is more variable in size and sequence than CDRs 1 and 2. This region would be expected to make a major contribution to antigen binding. The heavy chain variable region (VHLYS) of the anti-lysozyme antibody D1.3 is known to make several important contacts in the CDR3 region.

Multiple mutations were made in CDR3. The polymerase chain reaction (PCR) and a highly degenerate primer were used to make the mutations and by this means the original sequence of CDR3 was destroyed. (It would also have been possible to construct the mutations in CDR3 by cloning a mixed oligonucleotide duplex into restriction sites flanking the CDR or by other methods of site-directed mutagenesis). Mutants expressing heavy chain variable domains with affinities for lysozyme were screened and those with improved affinities or new specificities were identified.

The source of the heavy chain variable domain was an M13 vector containing the VHLYS gene. The body of the sequence encoding the variable region was amplified using the polymerase chain reaction (PCR) with the mutagenic primer VHMUT1 based in CDR3 and the M13 primer which is based in the M13 vector backbone. The mutagenic primer hypermutates the central four residues of CDR3 (Arg-Asp-Tyr-Arg). The PCR was carried out for 25 cycles on a Techne PHC-1 programmable heat block using 100 ng single stranded M13mp19SW0 template, with 25 pmol of VHMUT1 and the M13 primer, 0.5 mM each dNTP, 67mM Tris.HCl, pH 8.8, 10 mM MgCl₂, 17 mM (NH₄)₂SO₄, 200 μ g/ml gelatine and 2.5 units Taq polymerase in a final volume of 50 μ l. The temperature regime was 95 $^{\circ}$ C for 1.5 min, 25 $^{\circ}$ C for 1.5 min and 72 $^{\circ}$ C for 3 min (However a range of PCR conditions could be used). The reaction products were extracted with phenol/chloroform, precipitated with ethanol and re-suspended in 10 mM Tris. HCl and 0.1 mM EDTA, pH 8.0.

The products from the PCR were digested with PstI and BstEII and purified on a 1.5% LGT agarose gel in Tris acetate buffer using GeneClean (Bio 101, LaJolla). The gel purified band was ligated into pSW2HPOLY (Figure 19). (This vector is related to pSW2 except that the body of the VHLYS gene has been replaced by a polylinker.) The vector was first digested with BstEII and PstI and treated with calf-intestinal phosphatase. Aliquots of the reaction mix were used to transform E. coli BMH 71-18 to ampicillin resistance. Colonies were selected on ampicillin (100 μ g/ml) rich plates containing glucose at 0.8% w/v.

Colonies resulting from transfection were picked in pools of five into two 96 well Corning microtitre plates, containing 200 μ l 2 x TY medium and 100 μ l TY medium, 100 μ g/ml ampicillin and 1%

glucose. The colonies were grown for 24 hours at 37 ° C and then cells were washed twice in 200 µl 50 mM NaCl, pelleting the cells in an IEC Centra-3 bench top centrifuge with microtitre plate head fitting. Plates were spun at 2,500 rpm for 10 min at room temperature. Cells were resuspended in 200 µl 2 x TY, 100 µg/ml ampicillin and 1 mM IPTG (Sigma) to induce expression, and grown for a further 24 hr.

Cells were spun down and the supernatants used in ELISA with lysozyme coated plates and anti-idiotypic sera (raised in rabbits against the Fv fragment of the D1.3 antibody). Bound anti-idiotypic serum was detected using horse radish peroxidase conjugated to anti-rabbit sera (ICN Immunochemicals). Seven of the wells gave a positive result in the ELISA. These pools were restreaked for single colonies which were picked, grown up, induced in microtitre plates and rescreened in the ELISA as above. Positive clones were grown up at the 50 ml scale and expression was induced. Culture supernatants were purified as in Example 5 on columns of lysozyme-Sepharose and eluates analysed on SDS-PAGE and staining with Page Blue 90 (BDH). On elution of the column with diethylamine, bands corresponding to the VHLYS mutant domains were identified, but none to the VKLYS domains. This suggested that although the mutant domains could bind to lysozyme, they could no longer associate with the VKYLS domains.

For seven clones giving a positive reaction in ELISA, plasmids were prepared and the VKLYS gene excised by cutting with EcoRI and religating. Thus the plasmids should only direct the expression of the VHLYS mutants. 1.5 ml cultures were grown and induced for expression as above. The cells were spun down and supernatant shown to bind lysozyme as above. (Alternatively the amplified mutant VKLYS genes could have been cloned directly into the pSW1HPOLY vector for expression of the mutant activities in the absence of VKLYS.)

An ELISA method was devised in which the activities of bacterial supernatants for binding of lysozyme (or KLH) were compared. Firstly a vector was devised for tagging of the VH domains at its C-terminal region with a peptide from the c-myc protein which is recognised by a monoclonal antibody 9E10. The vector was derived from pSW1 by a BstEII and SmaI double digest, and ligation of an oligonucleotide duplex made from

5' GTC ACC GTC TCC TCA GAA CAA AAA CTC
ATC TCA GAA GAG GAT CTG AAT TAA TAA 3'
and

5' TTA TTA ATT CAG ATC CTC TTC TGA GAT
GAG TTT TTG TTC TGA GGA GAC G 3'

The VHLYSMYC protein domain expressed after induction was shown to bind to lysozyme and to

the 9E10 antibody by ELISA as follows:

(1) Falcon (3912) flat bottomed wells were coated with 180 µl lysozyme (3 mg/ml) or KLH (50 µg/ml) per well in 50 mM NaHCO₃, pH 9.6, and left to stand at room temperature overnight;

(2) The wells were washed with PBS and blocked for 2 hrs at 37 ° C with 200 µl 2% Sainsbury's instant dried skimmed milk powder in PBS per well;

(3) The Blocking solution was discarded, and the wells washed out with PBS (3 washes) and 150 µl test solution (supernatant or purified tagged domain) pipetted into each well. The sample was incubated at 37 ° C for 2 hrs;

(4) The test solution was discarded, and the wells washed out with PBS (3 washes). 100 µl of 4 µg/ml purified 9E10 antibody in 2% Sainsbury's instant dried skimmed milk powder in PBS was added, and incubated at 37 ° C for 2 hrs;

(5) The 9E10 antibody was discarded, the wells washed with PBS (3 washes). 100 µl of 1/500 dilution of anti-mouse antibody (peroxidase conjugated anti-mouse Ig (Dakopatts)) was added and incubated at 37 ° C for 2 hrs;

(6) The second antibody was discarded and wells washed three times with PBS; and

(7) 100 µl 2,2'azino-bis(3-ethylbenz-thiazolinesulphonic acid) [Sigma] (0.55 mg/ml, with 1 µl 20% hydrogen peroxide: water per 10 ml) was added to each well and the colour allowed to develop for up to 10 minutes at room temperature.

The reaction was stopped by adding 0.05% sodium azide in 50 mM citric acid, pH 4.3. ELISA plates were read in an Titertek Multiscan plate reader.

The activities of the mutant supernatants were compared with VHLYS supernatant by competition with the VHLYSMYC domain for binding to lysozyme. The results show that supernatant from clone VHLYSMUT59 is more effective than wild type VHLYS supernatant in competing for VHLYSMYC. Furthermore, Western blots, of SDS-PAGE aliquots of supernatant from the VHLYS and VHLYSMUT59 domain (using anti-Fv antisera) indicated comparable amounts of the two samples. Thus assuming identical amounts of VHLYS and VHLYSMUT59, the affinity of the mutant appears to be greater than that of the VHLYS domain.

To check the affinity of the VHLYSMUT59 domain directly, the clone was grown at the 1l scale and 200-300 µg purified on lysozyme-Sepharose as in Example 5. By fluorescence quench titration of samples of VHLYS and VHLYSMUT59, the number of binding sites for lysozyme were determined. The samples of VHLYS and VHLYSMUT59 were then compared in the competition ELISA with VHLYSMYC over two orders of magnitude. In the competition assay each microtitre well contained a

constant amount of VHLYSMYC (approximately 0.6 µg VHLYSMYC). Varying amounts of VHLYS or VHLYSMUT59 (3.8 µM in lysozyme binding sites) were added (0.166 - 25 µl). The final volume and buffer concentration in all wells was constant. 9E10 (anti-myc) antibody was used to quantitate bound VHLYSMYC in each assay well. The % inhibition of VHLYSMYC binding was calculated for each addition of VHLYS or VHLYSMUT59, after subtraction of background binding. Assays were carried out in duplicate. The results indicate that VHLYSMUT59 has a higher affinity for lysozyme than VHLYS.

The VHLYSMUT59 gene was sequenced (after recloning into M13) and shown to be identical to the VHLYS gene except for the central residues of CDR3 (Arg-Asp-Tyr-Arg). These were replaced by Thr-Gln-Arg-Pro: (encoded by ACACAAAGGCCA).

A library of 2000 mutant VH clones was screened for lysozyme and also for KLH binding (toothpicking 5 colonies per well as described in Example 6). Nineteen supernatants were identified with lysozyme binding activities and four with KLH binding activities. This indicates that new specificities and improved affinities can be derived by making a random repertoire of CDR3.

Example 8

Construction and expression of double domain for lysozyme binding.

The finding that single domains have excellent binding activities should allow the construction of strings of domains (concatamers). Thus, multiple specificities could be built into the same molecule, allowing binding to different epitopes spaced apart by the distance between domain heads. Flexible linker regions could be built to space out the domains. In principle such molecules could be devised to have exceptional specificity and affinity.

Two copies of the cloned heavy chain variable gene of the D1.3 antibody were linked by a nucleotide sequence encoding a flexible linker Gly-Gly-Gly-Ala-Pro-Ala-Ala-Ala-Pro-Ala-Gly-Gly-Gly-

(by several steps of cutting, pasting and site directed mutagenesis) to yield the plasmid pSW3 (Figure 20). The expression was driven by a lacZ promoter and the protein was secreted into the periplasm via a pelB leader sequence (as described in Example 5 for expression of pSW1 and pSW2). The protein could be purified to homogeneity on a lysozyme affinity column. On SDS polyacrylamide gels, it gave a band of the right size (molecular weight about 26,000). The protein also bound strongly to lysozyme as detected by

ELISA (see Example 5) using anti-idiotypic antiserum directed against the Fv fragment of the D1.3 antibody to detect the protein. Thus, such constructs are readily made and secreted and at least one of the domains binds to lysozyme.

Example 9

Introduction of cysteine residue at C-terminal end of VHLYS

A cysteine residue was introduced at the C-terminus of the VHLYS domain in the vector pSW2. The cysteine was introduced by cleavage of the vector with the restriction enzymes BstI and SmaI (which excises the C-terminal portion of the J segment) and ligation of a short oligonucleotide duplex 5' GTC ACC GTC TCC TCA TGT TAA TAA 3' and 5' TTA TTA ACA TGA GGA GAC G 3'.

By purification on an affinity column of lysozyme Sepharose it was shown that the VHLYS-Cys domain was expressed in association with the VKLYS variable domain, but the overall yields were much lower than the wild type Fv fragment. Comparison of non-reducing and reducing SDS polyacrylamide gels of the purified Fv-Cys protein indicated that the two VH-Cys domains had become linked through the introduced cysteine residue.

Example 10

Linking of VH domain with enzyme

Linking of enzyme activities to VH domains should be possible by either cloning the enzyme on either the N-terminal or the C-terminal side of the VH domain. Since both partners must be active, it may be necessary to design a suitable linker (see Example 8) between the two domains. For secretion of the VH-enzyme fusion, it would be preferable to utilise an enzyme which is usually secreted. In Figure 21, there is shown the sequence of a fusion of a VH domain with alkaline phosphatase. The alkaline phosphatase gene was cloned from a plasmid carrying the *E. coli* alkaline phosphatase gene in a plasmid pEK48 [51] using the polymerase chain reaction. The gene was amplified with the primers

5' CAC CAC GGT CAC CGT CTC CTC ACG GAC ACC AGA AAT GCC TGT TCT G 3' and
5' GCG AAA ATT CAC TCC CGG GCG CGG TTT TAT TTC 3'. The gene was introduced into the vector pSW1 by cutting at BstEII and SmaI. The construction (Figure 21) was expressed in *E. coli*

strain BMH71-18 as in Example 5, and screened for phosphatase activity using 1 mg/ml p-nitrophenylphosphate as substrate in 10mM diethanolamine and 0.5 mM MgCl₂, pH 9.5) and also on SDS polyacrylamide gels which had been Western blotted (detecting with anti-idiotypic antiserum). No evidence was found for the secretion of the linked VHLYS-alkaline phosphatase as detected by Western blots (see Example 5), or for secretion of phosphatase activity.

However when the construct was transfected into a bacterial strain BL21DE3 [52] which is deficient in proteases, a band of the correct size (as well as degraded products) was detected on the Western blots. Furthermore phosphatase activity could now be detected in the bacterial supernatant. Such activity is not present in supernatant from the strain which had not been transfected with the construct.

A variety of linker sequences could then be introduced at the BstEII site to improve the spacing between the two domains.

Example 11

Coexpression of VH domains with Vk repertoire

A repertoire of V_x genes was derived by PCR using primers as described in Example 2 from DNA prepared from mouse spleen and also from mouse spleen mRNA using the primers VK3FOR and VK2BACK and a cycle of 94 °C for 1 min, 60 °C for 1 min, 72 °C for 2 min. The PCR amplified DNA was fractionated on the agarose gel, the band excised and cloned into a vector which carries the VHLYS domain (from the D1.3 antibody), and a cloning site (SacI and XhoI) for cloning of the light chain variable domains with a myc tail (pSW1VHLYS-VKPOLYMYC, Figure 22).

Clones were screened for lysozyme binding activities as described in Examples 5 and 7 via the myc tag on the light chain variable domain, as this should permit the following kinds of V_x domains to be identified:

- (1) those which bind to lysozyme in the absence of the VHLYS domain;
- (2) those which associate with the heavy chain and make no contribution to binding of lysozyme; and
- (3) those which associate with the heavy chain and also contribute to binding of lysozyme (either helping or hindering).

This would not identify those V_x domains which associated with the VHLYS domain and completely abolished its binding to lysozyme.

In a further experiment, the VHLYS domain was

replaced by the heavy chain variable domain VH3 which had been isolated from the repertoire (see Example 6), and then the V_x domains cloned into the vector. (Note that the VH3 domain has an internal SacI site and this was first removed to allow the cloning of the V_x repertoire as SacI-XhoI fragments.)

By screening the supernatant using the ELISA described in Example 6, bacterial supernatants will be identified which bind lysozyme.

Example 12

High expression of VH domains.

By screening several clones from a VH library derived from a mouse immunised with lysozyme via a Western blot, using the 9E10 antibody directed against the peptide tag, one clone was noted with very high levels of expression of the domain (estimated as 25 - 50 mg/l). The clone was sequenced to determine the nature of the sequence. The sequence proved to be closely related to that of the VHLYS domain, except with a few amino acid changes (Figure 23). The result was unexpected, and shows that a limited number of amino acid changes, perhaps even a single amino acid substitution, can cause greatly elevated levels of expression.

By making mutations of the high expressing domain at these residues, it was found that a single amino acid change in the VHLYS domain (Asn 35 to His) is sufficient to cause the domain to be expressed at high levels.

CONCLUSION

It can thus be seen that the present invention enables the cloning, amplification and expression of heavy and light chain variable domain encoding sequences in a much more simple manner than was previously possible. It also shows that isolated variable domains or such domains linked to effector molecules are unexpectedly useful.

It will be appreciated that the present invention has been described above by way of example only and that variations and modifications may be made by the skilled person without departing from the scope of the invention.

List of References

- [1] Inbar et al., PNAS-USA, 69, 2659-2662, 1972.

- [2] Amit et al., *Science*, 233, 747, 1986.
- [3] Satow et al., *J. Mol. Biol.*, 190, 593, 1986.
- [4] Colman et al., *Nature*, 326, 358, 1987.
- [5] Sheriff et al., *PNAS-USA*, 84, 8075-8079, 1987.
- [6] Padlan et al., *PNAS-USA*, 86, 5938-5942, 1989.
- [7] Skerra and Plücker, *Science*, 240, 1038-1041, 1988.
- [8] Bird et al., *Science*, 242, 423-426, 1988.
- [9] Huston et al., *PNAS-USA*, 85, 5879-5833, 1988.
- [10] Fleischman, *Arch. Biochem. Biophys. Suppl.*, 1, 174, 1966.
- [11] Porter and Weir, *J. Cell. Physiol. Suppl.*, 1, 51, 1967.
- [12] Jaton et al., *Biochemistry*, 7, 4185, 1968.
- [13] Rockey, *J. Exp. Med.*, 125, 249, 1967.
- [14] Stevenson, *Biochem. J.*, 133, 827-836, 1973.
- [15] Edmundson et al., *Biochemistry*, 14, 3953, 1975.
- [16] Rossman et al., *Nature*, 317, 145-153, 1985.
- [17] Saiki et al., *Science*, 230, 1350-1354, 1985.
- [18] Larrick et al., *Biochem. Biophys. Res. Comm.*, 160, 1250, 1989.
- [19] Orlandi et al., *PNAS-USA*, 86, 3833, 1989.
- [20] Yon and Fried, *Nuc. Acids Res.*, 17, 4895, 1989.
- [21] Fields and Song, *Nature*, 340, 245-246, 1989.
- [22] Baldwin and Schultz, *Science*, 245, 1104-1107, 1989.
- [23] Menard et al., *Cancer Res.*, 43, 1295-1300, 1983.
- [24] Bosslet et al., *Eur. J. Nuc. Med.*, 14, 523-528, 1988.
- [25] Bosslet et al., *Cancer Immunol. Immunother.*, 23, 185-191, 1986.
- [26] Bosslet et al., *Int. J. Cancer*, 36, 75-84, 1985.
- [27]
- [28] Bremer et al., *J. Biol. Chem.*, 259, 14773-14777, 1984.
- [29] Griffiths & Milstein, *Hybridoma Technology in the Biosciences and Medicine*, 103-115, 1985.
- [30] Maniatis et al., *Molecular Cloning: a Laboratory Manual*, Cold Spring Harbour Laboratory, 1982.
- [31] Jones et al., *Nature*, 321, 522-525, 1986.
- [32] Zoller & Smith, *Nuc. Acids Res.*, 10, 6457-6500, 1982.
- [33] Carter et al., *Nuc. Acids Res.*, 13, 4431-4443, 1985.
- [34] Sanger et al., *PNAS-USA*, 74, 5463-5467, 1977.
- [35] Yannisch-Perron et al., *Gene*, 33, 103-119, 1985.
- [36]
- [37] Riechmann et al., *Nature*, 332, 323-327, 1988.
- [38] Kearney et al., *J. Immunol.*, 123, 1548-1550, 1979.
- [39] Potter et al., *PNAS-USA*, 81, 7161-7163, 1984.
- [40] Galfre & Milstein, *Meth. Enzym.*, 73, 1-46, 1981.
- [41] Laemmli, *Nature*, 227, 680-685, 1970.
- [42] Better et al., *Science*, 240, 1041, 1988.
- [43] Lei et al., *J. Bacteriol.*, 169, 4379, 1987.
- [44] Verhoeyen et al., *Science*, 239, 1534, 1988.
- [45] Gronenborn, *Mol. Gen. Genet.*, 148, 243, 1976.
- [46] Dagert et al., *Gene*, 6, 23, 1974.
- [47] Hanahan, *J. Mol. Biol.*, 166, 557, 1983.
- [48] Jones et al., *Nature*, 321, 522, 1986.
- [49] Segal, *Enzyme Kinetics*, 73, Wiley, New York, 1975.
- [50] Gutfreund, *Enzymes, Physical Principles*, Wiley Interscience, London, 1972.
- [51] Chaidaroglou, *Biochem.*, 27, 8338, 1988.
- [52] Grodberg and Dunn, *J. Bacteriol.*, 170, 1245-1253, 1988.

35 Claims

1. A single domain ligand consisting of at least part of the variable domain of one chain of a molecule from the immunoglobulin (Ig) superfamily.
2. The ligand of claim 1, which consists of the variable domain of an Ig heavy chain.
3. The ligand of claim 1, which consists of the variable domain of an Ig chain with one or more point mutations from the natural sequence.
4. A receptor comprising a ligand of any one of claims 1 to 3 linked to one or more of an effector molecule, a prosthetic group, a label, a solid support or one or more other ligands having the same or different specificity.
5. The receptor of claim 4, comprising at least two ligands.
6. The receptor of claim 5, wherein the first ligand binds to a first epitope of an antigen and the second ligand binds to a second epitope.
7. The receptor of claim 6, which includes an effector molecule or label.
8. The receptor of any one of claims 5 to 7 which comprises a ligand and another protein mol-

ecule, produced by recombinant DNA technology as a fusion product.

9. The receptor of claim 8, wherein a linker peptide sequence is placed between the ligand and the other protein molecule.

10. A method of cloning a sequence (the target sequence) which encodes at least part of the variable domain of an Ig superfamily molecule, which method comprises:

(a) providing a sample of double stranded (ds) nucleic acid which contains the target sequence;

(b) denaturing the sample so as to separate the two strands;

(c) annealing to the sample a forward and a back oligonucleotide primer, the forward primer being specific for a sequence at or adjacent the 3' end of the sense strand of the target sequence, the back primer being specific for a sequence at or adjacent the 3' end of the antisense strand of the target sequence, under conditions which allow the primers to hybridise to the nucleic acid at or adjacent the target sequence;

(d) treating the annealed sample with a DNA polymerase enzyme in the presence of deoxynucleoside triphosphates under conditions which cause primer extension to take place; and

(e) denaturing the sample under conditions such that the extended primers become separated from the target sequence.

11. The method of claim 10, further including the step (f) of repeating steps (c) to (e) on the denatured mixture a plurality of times.

12. The method of claim 10 or claim 11, which is used to clone a complete variable domain from an Ig heavy chain.

13. The method of claim 10 or claim 11 which is used to produce a DNA sequence encoding a ligand according to any one of claims 1 to 3.

14. The method of any one of claims 10 to 13, wherein the forward and back primers are provided as single oligonucleotides.

15. The method of any one of claims 10 to 13, wherein the forward and back primers are each supplied as a mixture of closely related oligonucleotides.

16. The method of claim 14 or claim 15, wherein the primers which are used are species specific general primers.

17. The method of any one of claims 10 to 16, wherein the ds nucleic acid sequence is genomic DNA.

18. The method of any one of claims 10 to 17, wherein the ds nucleic acid is derived from a human.

19. The method of any one of claims 10 to 18, wherein the ds nucleic acid is derived from peripheral blood lymphocytes.

20. The method of any one of claims 10 to 18, wherein each primer includes a sequence encoding a restriction enzyme recognition site.

21. The method of claim 20, wherein the restriction enzyme recognition site is located in the sequence which is annealed to the ds nucleic acid.

22. The method of any one of claims 10 to 21, wherein the product ds cDNA is inserted into an expression vector and expressed alone.

23. The method of any one of claims 10 to 22, wherein the product ds cDNA is expressed in combination with a complementary variable domain.

24. The method of any one of claims 10 to 23, wherein the cloned ds cDNA is inserted into an expression vector already containing sequences encoding one or more constant domains to allow the vector to express Ig-type chains.

25. The method of any one of claims 10 to 24, wherein the cloned ds cDNA is inserted into an expression vector so that it can be expressed as a fusion protein.

26. The method of claim 10, wherein one or both of the primers comprises a mixture of oligonucleotides of hypervariable sequence, whereby a mixture of variable domain encoding sequences is produced.

27. A method of cloning a sequence (the target sequence) which encodes at least part of the variable domain of an Ig superfamily molecule, which method comprises:

(a) providing a sample of double stranded (ds) nucleic acid which contains the target sequence;

(b) denaturing the sample so as to separate the two strands;

(c) annealing to the sample a forward and a back oligonucleotide primer, the forward primer being specific for a sequence at or adjacent the 3' end of the sense strand of the target sequence, the back primer being specific for a sequence at or adjacent the 3' end of the antisense strand of the target sequence, under conditions which allow the primers to hybridise to the nucleic acid at or adjacent the target sequence;

(d) treating the annealed sample with a DNA polymerase enzyme in the presence of deoxynucleoside triphosphates under conditions which cause primer extension to take place;

(g) treating the sample of ds cDNA with traces of DNase in the presence of DNA polymerase I to allow nick translation of the DNA; and

(h) cloning the ds cDNA into a vector.

28. The method of claim 27, which further includes the steps of:

(i) digesting the DNA of recombinant plasmids to release DNA fragments containing genes encoding variable domains; and

(j) treating the fragments in a further set of

steps (c) to (h).

29. The method of either claim 27 or claim 28, wherein the fragments are separated from the vector and from other fragments of the incorrect size by gel electrophoresis.

30. The method of any one of claims 27 to 29, wherein the product ds cDNA is cloned directly into an expression vector.

31. A species specific general oligonucleotide primer or mixture of such primers useful for cloning at least part of a variable domain encoding sequence from an animal of that species.

32. A primer or mixture of primers according to claim 27, wherein each primer includes a restriction enzyme recognition site within the sequence which anneals to the coding part of the variable domain encoding sequence.

5

10

15

20

25

30

35

40

45

50

55

Rearranged heavy chain variable gene (DNA)

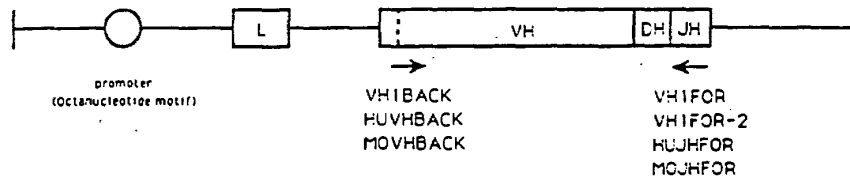

Unrearranged heavy chain variable gene (DNA)

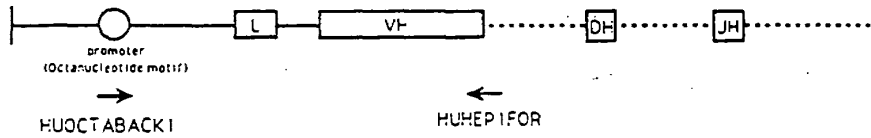

Rearranged heavy chain variable gene (mRNA)

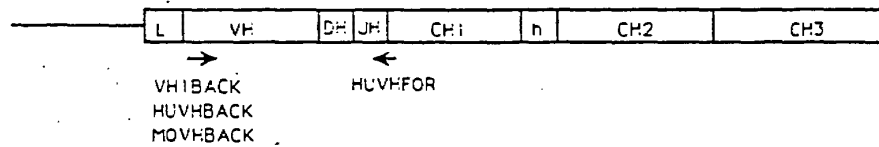

Rearranged light chain variable gene (DNA)

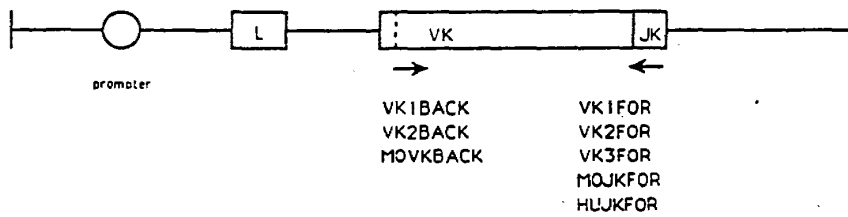

FIG. 1

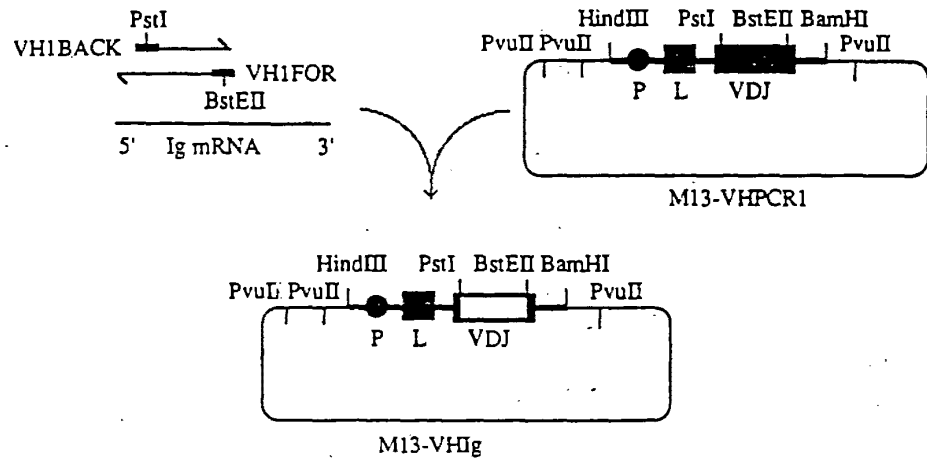

FIG. 2

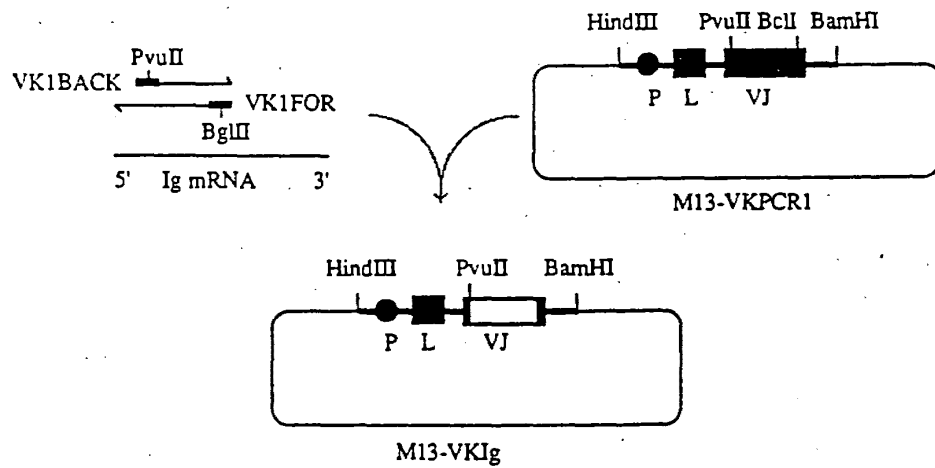

FIG. 4

M13 VHPCR1

Hind III⁽¹⁾

AGCTTATGAATATGCAAAATCCTCTGAATCTACATGGTAAATATAGGTTTGTCTATACCA
 10 20 30 40 50 60

CAAACAGAAAAACATGAGATCAGTCTCTCTACAGTTACTGAGCAGACAGGACCTCAC
 70 80 90 100 110 120

M G W S C I I L F L V A T A T
 CATGGGATGGAGCTGTATCATCCTCTCTTGGTAGCAACAGCTACAGSTAAGGGGCTCAC
 130 140 150 160 170 180

AGTAGCAGGCTTGAGGTCTGGACATATATATGGGTGACAATGACATCCACTTTGCCCTTC
 190 200 210 220 230 240

PstI
 51 10
 G V H S Q V Q L Q E S G P G L V R P
 TCTCCACAGGTGTCCACTCCCAGSTCCAACTTCAGGAGAGCGGTCCAGGTCTGTGAGAC
 250 260 270 280 290 300

CDR1
 15 20 25 30
 S O T L S L T C T V S G S T F S S Y W M
 CTAGCCAGACCCCTGAGCCTGACCTGCACCGTGTCTGGCAGCACCTTCAGCAGTACTGGA
 310 320 330 340 350 360

CDR2
 35 40 45 50
 H W V R Q P P G R G L E W I G R I D P N
 TGCACTGGGTGAGACAGCCACCTGGACGAGGTCTTGAGTGGATTGGAGGATTGATCCTA
 370 380 390 400 410 420

55 60 65 70
 S G G T K Y N E K F K S R V T M L V D T
 ATAGTGGTGGTACTAAGTACAATGAGAAGTCAAGAGCAGAGTGACAATGGTGGTAGACA
 430 440 450 460 470 480

75 80 85 90
 S K N Q F S L R L S S V T A A D T A V Y
 CCAGCAAGAACCACTTCAGCCTGAGACTCAGCAGCGTGACAGCCGCCGACACCCGGTCT
 490 500 510 520 530 540

CDR3
 95 100 105 110
 Y C A R Y D Y Y G S S Y F D Y W G Q G T
 ATTATTGTGCAAGATACGATTACTACGGTAGTAGCTACTTTGACTACTGGGGCCAAGGA
 550 560 570 580 590 600

BstEII
 115 120
 T V T V S S
 CCACCTCACCGTCTCTCCTCAGGTGAGTCTTACAACCTCTCTCTTATTAGCTTAAAT
 610 620 630 640 650 660

AGATTTTACTGCATTGTGGGGGGAAATGTGTGTAICTGAATTCAGGTATGAAGGA
 670 680 690 700 710 720

CTAGGGACACCTTGGGATCAGAAAGGTCATTTGGAGCCCGGGCTGATGCAGACAGACA
 730 740 750 760 770 780

BamHI
 TCTCAGCTCCAGACTTCATGGCCAGAGATTTATAG
 790 800 810

FIG. 3

M13 V_kPCR1

Hind III
 |
 AAGCTTATGAAATATGCAAAATCCTCTGAAATCTACATGGTAAATATAGGTTTGTCTATACCA
 38 48 58 68 78 88

CAAAACAGAAAAACATGAGATCACAGTTCTCTCTACAGTTACTGAGCACACAGGACCTCAC
 98 108 118 128 138 148

M G W S C I I L F L V A T A T
 CATGGGATGGAGCTGTATCATCCTCTCTGGTAGCAACAGCTACAGGTAAGGGGCTCAC
 158 168 178 188 198 208

AGTAGCAGCCTTGTAGCTGTGGACATATATATGGGTGACAATGACATCCACTTTGCCCTTC
 218 228 238 248 258 268

Pvu II
 |
 1 5 10
 G V H S D I Q L T Q S P S S L S A S
 TCTCCACAGGTGTCCACTCCGACATCCAGCTGACCCAGCCCAAGCAGCCTTGAGCGCCA
 278 288 298 308 318 328

CDR1
 15 20 25 30
 V G D R V T I T C R A S G N I H N Y L A
 GCGTGGGTGACAGAGTGACCATCACCTGTAGAGCCAGCGGTAACATCCCAACTACCTGG
 338 348 358 368 378 388

CDR2
 35 40 45 50
 W Y Q Q K P G K A P K L L I Y Y T T T L
 CTTGTACCAGCAGAGCCAGGTAAGGCTCCAAAGCTGCTGATCTACTACACCACCACCC
 398 408 418 428 438 448

55 60 65 70
 A D G V P S R F S G S G S G T D F T F T
 TGGCTGACGGTGTGCCAAGCAGATTCAGCGGTAGCGGTAGCGGTACCGACTTCACCTTCA
 458 468 478 488 498 508

CDR3
 75 80 85 90
 I S S L Q P E D I A T Y Y C Q H F W S T
 CCATCAGCAGCCTCCAGCCAGAGGACATCGCCACCTACTACTGCCAGCACTTCTGAGCA
 518 528 538 548 558 568

Bcl I (requires dam⁻ host)
 |
 95 100 105 108
 P R T F G Q G T K V V I K R
 CCCCAGGACGTTCCGCCAAGGGACCAAGGTGGTGTCAACGTGAGTAGAATTTAACT
 578 588 598 608 618 628

BamHI
 |
 TTGCTTCTCAGTTCCATCC
 638 648

FIG. 5

Sequence of MB1 VH

Splice -1
↓ G V H S
ASGTGTCCACTCC

1 PstI 10 20
Q V Q L Q E S G T E L A S P G A S V T L
CAGSTCCAACTGCAGGAGTCAGGAACCTGAGCTGGCGAGTCCCTGGGGCATCAGTGACACTG
VH1BACK SITE

30 CDR1 40
S C K A S G Y T F T D H I I N W V K K R
TCCTGCAAGGCTTCTGGCTACACATTTACTGACCATATTATAAATGGGTAAAAAGAGG
52a 53 CDR2

P G Q G L E W I G R I Y P V S G V T N Y
CCTGGACAGGGCCCTGAGTGGATTGGAAGGATTATCCAGTAAGTGGTSTAACACTACTAC
60 CDR2 65 70
N O K F M G K A T F S V D R S S N T V Y
AATCAAAAATTCATGGGCNAGGCCACATTTCTCGTAGACCGGTCCCTCCAACACAGTGATC
80 82A B C 83 90 CDR3
M V L N S L T S E D P A V Y Y C G R G F
ATGGTGTGGAACAGTCTGACATCTGAGGACCCCTGCTTATTACTGTGGAGGGGCTTT
CDR3 103 BstEII Splice
D F D Y W G Q G T T V T V S S ↓
GATTTTGACTACTGGGGCCAGGGACCCAGGTCCCGTCTCCTCAGST.....
VH1FOR SITE

Sequence of MB1 VK

Splice -1
↓ G V H S
ASGTGTCCACTCC

1 PvuII 10 20
D I Q L T Q S P P S L T V S V G E R V T
GACATTCAGGTGACCCAGTCTCCACCATCCCTGACTGTGTCTAGTAGGAGAGGGTCACT
VK1BACK SITE

27A B C D E F CDR1
I S C K S N O N L L W S G N R R Y C L G
ATCAGTTGCAAAATCCAATCAGAATCTTTTATGGAGTGGAAACCGAAGGTACTGTTTGGGC
35 40 50 CDR2
W H Q W K P G G Q T P T P L I T W T S D R
TGGCACCAAGTGGAAACCAAGGGCAACTCCTACACCGTTGATCACCTGGACATCTGATAGG
60 70
F S G V P D R F I G S G S V T D F T L T
TTCTCTGGAGTCCCTGATCGTTTCATAGGCAGTGGATCTGTGACAGATTTCACTCTGACC
80 90 CDR3
I S S V Q A E D V A V Y F C Q Q H L D L
ATCAGCAGTGTGCAGGCTGAAGATGTGGCAGTTTATTCTGTGACCAACATTTGGACCTT
95 100 BglII/BclI Splice
P Y T F G G G T K L E I K ↓
CCGTACACGTTCCGGAGGGGGACCAAGCTGGAGATCAAACGTGAG
VK1FOR SITE

FIG. 6

α -Lys 30

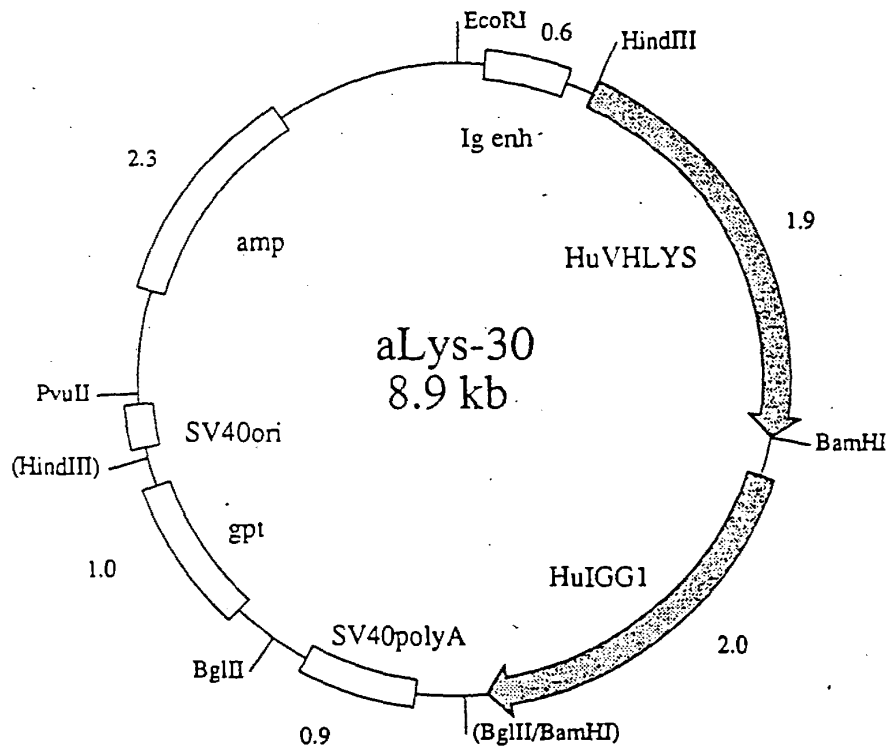

FIG. 7

α-Lys 17

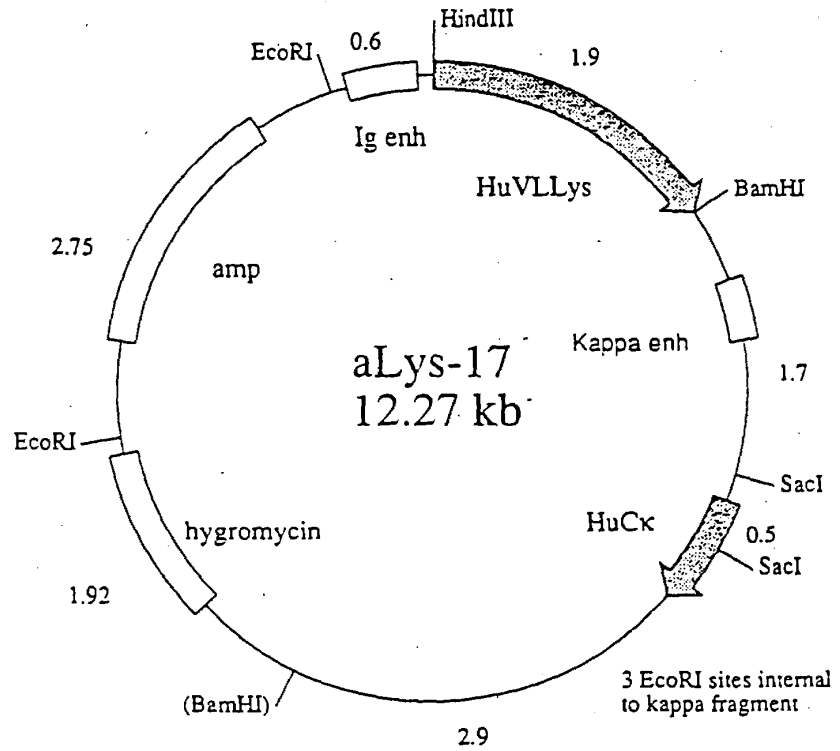

FIG. 8

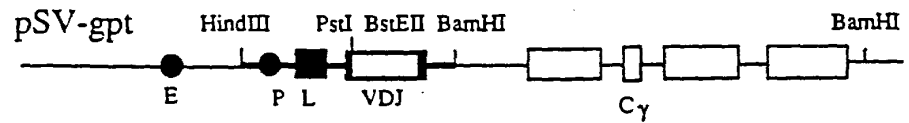
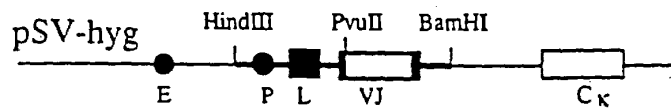

FIG. 9



	FR1	CDR 1	FR2	CDR 2
KABAT IA				
A07	PGLVKPQSLSLTCSTVGYST	SGYYNN	WIRQPPGNKLEWNG	YISYDGGNNYNPSLKN
A09	PGLVKPQSLSLTCSTVGYST	SGYYNI	WIRQSPGKLEWNG	YITHSGSTFYNPSLQS
E03	PGLVKPQSLSLTCSTVGYST	SGYYNN	WIRQPPGNKLEWNG	YISYDGGNNYNPSLKN
G01	PGLVKPQSLSLTCSTVGYST	SGYYNN	WIRQPPGNKLEWNG	YISYDGGNNYNPSLKN
KABAT IB				
A06	PVLVAPQSLSITCAVSDPSLT	NYGVL	WVRQPPGKLEWLG	VIWAGGISTNYNSALMS
25G07	PGLVQPSQSLSTCTVSGFSLT	SYGVH	WVRQSPGKLEWLG	VIWGGSTDYNAAFIS
B03	PGLVAPQSLSITCTVSGFSLT	SYGVD	WVRQPPGKLEWLG	VIWGGSTNYNSALMS
G03	PGLVQPSQSLSTCTVSGFSLT	SYGVH	WVRQSPGKLEWLG	VIWGGSTDYNAAFIS
H09	PVLVAPPQSLSITCTVSGFSLT	SYGVH	WVRQPPGKLEWLG	VIWAGGISTNYNSALMS
25C10	PGLVAPQSLSITCTVSGFSLT	SYAIS	WVRQPPGKLEWLG	VIWGGSTNYNSALKS
A12	PGLVAPQSLSITCTVSGFSLT	SYAIS	WVRQPPGKLEWLG	VIWGGSTNYNSALKS
A08	PGLVAPQSLSITCTVSGFSLT	SYGVH	WVRQPPGKLEW**	****GSTITYNSALKS
25G08	PGLVAPQSLSITCTVSGFSLT	SYGVD	WVRQSPGKLEWLG	VIWGGSTNYNSALKS
A03	PGLVQPSQSLSTCTVSGFSLT	SYGVH	WVRQSPGKLEWLG	VIWGGSTDYNAAFIS
C07	PVLVAPQSLSITCTVSGFSLT	SYGVH	WVRQPPGKLEWLG	VIWAGGISTNYNSALMS
H04	PGLVAPQSLSITCTVSGFSLT	SYGVD	WVRQSPGKLEWLG	VIWGGSTNYNSALKS
KABAT IIA				
E04	PELVRPQGVSVKISCKGSGYTF	DYAMH	WVKQSHAKSLEWIG	VISTYYGDASYNCKFKD
H07	PELVRPQGVSVKISCKGSGYTF	DYAMH	WVKQSHAKSLEWIG	VISTYYGDASYNCKFKD
KABAT IIB				
A02	AELVKPGASVKLSCKASGYTFF	SYMMH	WVKQRPQGGLEWIG	EIDPDSSTNYNCKFKG
B04	AELVKPGASVKLSCKASGYTFF	SYWIT	WVKQRPQGGLEWIG	DIYPGSGSTNYNEKFKS
C05	AELVKPGASVKLSCKASGYTFF	SYMMH	WVKQRPQGGLEWIG	RIDPNSGGTKYNEKFKS
C09	AELVKPGASVKLSCKASGYTFF	SYMMH	WVKQSPQGGLEWIG	EINPNSGGTNYNEKFKS
D06	ASLVKPGASVKMSCKASGYTFF	SYNIT	WVKQRPQGGLEWIG	DIYPGSGSTNYNEKFKS
D08	PELVKPGASVKLSCKASGYTFF	SYMMH	WVKQREGGLEWIG	EINPNSGGTNYNEKFKS
E07	AELVRRGASVKLSCKASGYTFF	DYEMH	WVKQTPVHGLEWIG	AIDPETGGTAYNCKFKG
G08	PELVKPGASVKLSCKASGYTFF	DYYIN	WVKQRPQGGLEWIG	WYIPGSGNTKYNEKFKG
G10	AELVKPGASVKLSCKASGYTFF	SYMMH	WVKQRPQGGLEWIG	RIDPDSSTNYNCKFKG
25G09	AELVKPGASVKMSCKASGYTFF	TYPEE	WVKQNHGKLEWIG	NFKPYNDDTKYNEKFKG
F04	TELVKPGASVKLSCKASGYTFF	SYMMH	WVKQRPQGGLEWIG	NINPNSGGTNYNCKFKG
H02	AELVKPGASVKLSCKASGYTFF	SYMMH	WVKQRPQGGLEWIG	WIDPDSSETHYNCKFKD
H01	AELVMEGASVKLSCKASGYTFF	SYMMH	WVKQRPQGGLEWIG	EIDPDSSTNYNCKFKG
25C05	PELVREPTSVKMSCKASGYTFF	NYMMK	WV*CRPGGLEWIG	QIFPAGSIIYNEMMKD
B01	AELVKPGASVKMSCKASGYTFF	SYWIT	WVKQRPQGGLEWIG	DIYPGSGSTNYNEKFKS
B05	AELVRRGASVKLSCKDSEYFAP	RHAMH	WVKQRPQGGLEWIG	SFTYYSDATSEYSENFKG
B11	AELVKPGASVKMSCKASGYTFF	SYWIT	WVKQRPQGGLEWIG	DIYPGSGSTNYNEKFKS
KABAT III A				
25G05	GGLVQPKGSLSLSCAASGTF	DYYMS	WVRQPPGKALEHLG	FIRNKANGYITTEYSASVKG
C10	GGLVQPGGSLSLSCAASGTF	DYYMN	WVRQPPGKALEHLA	LIRNKANGYITTEYSASVKG
B07	GGLVQPGGSLSLSCAASGTF	DYYMS	WVRQPPGKALEHLA	LIRNKANGYITTEYSASVKG
KABAT III B				
G05	GGLVKPQGSLLKLSCAASGTF	DYGMH	WVRQAPEKLELVA	YISSGSSITYYADTVKG
B12	GGLVQPGESLKLSCSESNVEYFP	SHDMS	WVR*****VA	AINSDDGGSTYYPDITER
D04	GGLVQPGGSLRLSCLASGTF	SYAMS	WVA*APGKLEWVS	AISGSGGSTYYADSVKG
D05	GGLVQPGGSLRLSCLASGTF	SYAMS	WVA*APGKLEWVS	AISGSGGSTYYADSVKG
F12	GGLVQPGESLKLSCSVIQ****	****	WVRO*PEKRLVA	AINSDDGGSTYYPDITER
F06	GGLVQPGGSLRLSCLASGTF	SYAMS	WVA*APGKLEWVS	AISGSGGSTYYADSAKG
D02	GGLVQPGESLKLSCSESNVEYVIP	*HDMS	WVRQDSE*LELVA	AINSDDGGSTYYPDITER
F09	GGLVQPGGSLKLSCLASGTF	SYGMS	WVRQTPDKRLVA	TISSGGSITYYPDSVKG
KABAT III C				
E06	GGLVQPGGSLKLSCLASGTF	DAKMD	WVRQSPGKLELVA	EIRNKANNHATYYAESVKG
KABAT V A				
C04	AELVKPGASVKLSCKASGYTFF	EYTIH	WVKQSPGKLEWIG	WYIPGSGSITKYNEKFKD

FIG. 10a

<u>CDR_2</u>	<u>FRAMEWORK_3</u>	<u>CDR_3</u>
KABAT HUMAN VH1		
	STSTAYMELRSLRSEDVAVYCAR	GEGWDHFDY
HAQKFOG	RVTIRREKSTSTAYMELSSLRSEDVAVYCAR	GSRYGDCSGYYL
GYAQKFOG	RVTMTRNTSISTATMELSSLRSEDVAVYCAR	LAHFSGSPVDWFDP
KABAT HUMAN VH2		
KHQLQPSLKS	RVTISVDTSKNQFSLKLSVTAADTAVYCAR	GGVPPAAMDV
KS	RVTISVDTSKNQFSLKLSVTAADTAVYCAR	MARYYDFWSGYSAYDY
SLKS	RLSISQOTSRNQFSLRSLSSVTAADTAVYCAR	HRNWGSPVHFDY
	ESTSTAYMELSSLRSEDVAVYCAR	DSYGDYGGHY
KABAT HUMAN VH3		
ISYITSSSSYTNVADSVKG	RFTISRDNKNSLYLQMNLSLRADDTAVYCAR	DGRFGTYSPSDY
SVKG	RFTISRDDSKSLAYLQVNSLKTEDTAVYYCTR	TIYYDSSGYPYW
YADSVKG	RFTISRDNKNSLFLQMNLSLRADDTAVYCAR	GIALDAFDI
YYADSVRD	RFTISRDNKNTLYLQMNLSLRADDTAVYCAR	53 NT. UNPROD PEARR
DSVKG	RFTISRDNKNSLYLQMNLSLRADDTAVYCAR	DHSGTGGGGSGSYF
VSAISGGGGSTYYADSVKG	RFTISRDNKNTLYLQMNLSLRADDTAVYCAR	KDNLWFDP
AVISYDGSNKYYADSVKG	RFTISRDNKNTLYLQMNLSLRADDTAVYCAR	DLGGRGVVVVWPAGGRSIYYGMDV
GAVISYDGSNKYYADSVKG	RFTISRDNKNTLYLQMNLSLRADDTAVYCAR	LEGIGTIYYGMDV
	AKNSLYLQMNLSLRADDTAVYCVR	DDSSSWPKHFQH
QYAASVKG	RFTISRDDSKNSLYLQMNLSLNTEDTAVYCVR	SGVVPYLDY
KNOWN FAMILY		
	AVYYCAR	DPRIAARPDYYYYMDV
	TAMYYCAR	GAEVVEPTARYYYGLNV

FIG. 11

	FR1	CDR1	FR2
	YTFT	SYGIS	WVTGPNTRDLRWMG
	GEKPGSSVAVSCKASGYTFT	DYFMN	WVRQAPGQRLWWMG
QVQLQEIGPRTGEASETSLICAVSGDSIS		SGNW*I	WVRQPPGKGLEWIG
QVQLQESGPGLVK*SETLSLTCTVSGGSIS		SYYS	WVRQPPGKGLEWIG
	GYTFT	NYCMH	WVRQDHAQGLEWWMG
QVQLQESGPGLVKpSETLSLYCAVSGDSIS		SGNW*I	WVRQPPGKGLEWIG
GPRLGEASETSLTCTVSGGSIS		SSSYW	WVRQPPGKGLEWIG
QVQLQESGPGLVKpSETLSLTCTVSGGSIS		SYYS	WVRQPPGKGLEWIG
	LSLICAVSGSSIS	SGNW*I	WVRQPPGKGLEWIG
	SETLSLTCAVYGGSF	GYYS	WVRQPPGKGLEWIG
QVQLVQSGAEVKPQASVAVSCKASGYTFT		NYCMH	WVRQVLAQGLEWWMG
	SETLSLICAVSGDSIS	SGNW*I	WVRQPPGKGLEWIG
SRAQTGEASETSLTCTVSGGSIS		SSSYWG	WVRQPPGKGLEWIG
	CPLTCTVSGGSVSSGS	YYWS	WVRQPPGKGLEWIG
GLVKPSETLSLTCTVSGGSIS		SYYS	WVRQPPGKGLEWIG
	SPETLSLICAVSGDSIS	SGNW*I	WVRQPPGKGLEWIG
QVQLVQSGAEVKPQSSVAVSCKASGGTFS		SYAIS	WVRQAPGGGLEWWMG
QVQLQVQSGAEVLPK*SETLSLTCAVYGGSF		GYYS	WVRQPPGKGLEWIG
QLQLQESGPGLVK*SETLSLTCTVSGGSIS		SSSYWG	WVRQPPGKGLEWIG
	GPGLVKP*SQTLTCTVSGGSIS	SGGYWS	WVRQPPGKGLEWIG

* indicates stop codon (unsure as sequence remains in frame)
 • sequence terminates due to internal restriction site
 lower case denotes frame shift

CDR2	FR3	CDR3
WISAYNGNTNYAQRKLG	RVTMTTDTSTSTAYMELRSLRSDDTAVYYCAR	DTVSS
WINAGNGNTKYQKLG	RVTITRDTASASTAYMQLSSLRSEDVAVYYCAR	DTVSS
EIHHSYSTYYP*SLKS	RITMSVDTSKNQFY*KLSS•	
RIYTSGSTNYNP*SLKS	RVTISVDTSKNQF*SLKLSVTAADTAVYYCAR	DTVSS
LVCPSDGS*SYAQKFOA	RVTITRDTSMSTAYMELSSLRSEDVAVYYCAR	DTVSS
EIHHSYSTYYP*SLKS	RITMSVDTSKNQFY*KLSS•	
EINHSGSTNYNP*SLKS	RVTISVDTSKNQF*SLKLS•	
YIYYSGSTNYNP*SLKS	RVTISVDTSKNQF*SLKLS•	
EIHHSYSTYYP*SLKS	RITMSVDTSKNQFY*KLSS•	
EINHSGSTNYNP*SLKS	RVTISVDTSKNQF*SLKLSVTAADTAVYYCAR	DTVSS
LVCPSDGS*SYAQKFOA	RVTITRDTSMSTAYMELSSLRSEDVAVYYCAR	DTVSS
EIHHSYSTYYP*SLKS	RITMSVDTSKNQFY*KLSS•	
SIYYSGSTYYP*SLKS	RVTIPVDTSKNQF*SLKLS•	
YIYYSGSTNYNP*SLKS	RVTISVDTSKNQF*SLKLSVTAADTAVYYCAR	DTVSS
RIYTSGSTNYNP*SLKS	RVTMSVDTSKNQF*SLKLS•	
EIHHSYSTYYP*SLKS	RITMSVDTSKNQFY*KLSS•	
RIIPILGIANYAQKFOG	RVTITADKSTSTAYMELSSLRSEDVAVYYCAR	DTVS
EINHSGSTNYNP*SLKS	RVTISVDTSKNQF*SLKLS•	
EINHSGSTNYNP*SLKS	RVTISVDTSKNQF*SLKLS•	
YIYYSGSTYYP*SLKS	RVTISVDTSKNQF*SLKLSVTAADTAVYYCAR	DTVSS

FIG. 12

pSW1

HindIII site AAGCTT

```

                                M K Y L L P T A A
GCATGCARATTCATTTC AAGGAGACAGTCATAATGAAATACCTATGCCTACGGCAGCC
  10          20          30          40          50          60

  A G L L L L A A Q P A M A Q V Q L Q E S
GCTGGATTGTTATTACTCGCTGCCCAACCAGCGATGGCCAGGTGCAGCTGCAGGAGTCA
  70          80          90          100         110         120

  G P G L V A P S Q S L S I T C T V S G F
GGACCTGGCCTGGTGGCGCCCTCACAGAGCCTGTCCATCACATGCACCCGCTCAGGGTTC
  130         140         150         160         170         180

  S L T G Y G V N W V R Q P P G K G L E W
TCATTAACCGGCTATGGTGTAAACTGGGTTCGCCAGCCTCCAGGAAGGGTCTGGAGTGG
  190         200         210         220         230         240

  L G M I W G D G N T D Y N S A L K S R L
CTGGGAATGATTGGGGTGTGGAACACAGACTATAATTCAGCTCTCAATCCAGACTG
  250         260         270         280         290         300

  S I S K D N S K S Q V F L K M N S L H T
AGCATCAGCAAGGACAACCTCCAAGAGCCAGTTTTCTTAAAAATGAACAGTCTGCACACT
  310         320         330         340         350         360

  D D T A R Y Y C A R E R D Y R L D Y W G
GATGACACAGCCAGGTACTACTGTGCCAGAGAGAGATTATAGGCTTGACTACTGGGGC
  370         380         390         400         410         420

  Q G T T V T V S S                                SmaI
CAAGGCACCACGGTCAACCGTCTCCTCATAATAAGAGCTATCCCGGCTAAGCTCGAATTC
  430         440         450         460         470         480

```

FIG. 13

pSK2

HindIII AAGCTT

```

                                M K Y L L P T A A
GCATGCAAAATTCATTTCAAGGAGACAGTCATATGAAATACCTATTGCCTACGGCAGCC
  10          20          30          40          50          60

  A G L L L L A A Q P A M A Q V Q L Q E S
GCTGGATTGTTATTACTCGCTGCCCAACCAGCGATGGCCAGGTGCAGCTGCAGGAGTCA
  70          80          90          100         110         120

  G P G L V A P S Q S L S I T C T V S G F
GGACCTGGCCTGGTGGCGCCCTCACAGAGCCTGTCCATCACATGCACCGTCTCAGGGTTC
  130         140         150         160         170         180

  S L T G Y G V N W V R Q P P G K G L E W
TCATTAACCGGCTATGGTGTAACTGGGTTCCGCCAGCCTCCAGGAAAGGTTCTGGAGTGG
  190         200         210         220         230         240

  L G M I W G D G N T D Y N S A L K S R L
CTGGGAATGATTTGGGGTGTGGAAACACAGACTATAATTCAGCTCTCAATCCAGACTG
  250         260         270         280         290         300

  S I S K D N S K S Q V F L K M N S L H T
AGCATCAGCAAGGACAACCTCCAAGGCCAAGTTTCTTAAAAATGAACAGTCTGCACACT
  310         320         330         340         350         360

  D D T A R Y Y C A R E R D Y R L D Y W G
GATGACACAGCCAGGTACTACTGTGCGCAGAGAGAGATTATAGGCTTGACTACTGGGGC
  370         380         390         400         410         420

  Q G T T V T V S S
CAAGGCACCACGGTCAACCGTCTCCCTCATAATAAGAGCTCGAATTCGCCAAGCTTGCATGC
  430         440         450         460         470         480

                                M K Y L L P T A A A G
AAATTCATTTCAAGGAGACAGTCATAATGAAATACCTATTGCCTACGGCAGCCGTGGA
  490         500         510         520         530         540

  L L L L A A Q P A M A D I V L T Q S P A
TTGTATTACTCGCTGCCCAACCAGCGATGGCCGACATCGTCTGACTCAGTCTCCAGCC
  550         560         570         580         590         600

  S L S A S V G E T V T I T C R A S G N I
TCCCTTTCTGGCTGTGGGAGAACTGTCACCATCACATGTCGAGCAAGTGGGAATATT
  610         620         630         640         650         660

  H N Y L A W Y Q Q K Q G K S P Q L L V Y
CACAAATTTAGCATGGTATCAGCAGAAACAGGGAAAATCTCCTCAGCTCCTGGTCTAT
  670         680         690         700         710         720

```

FIG. 14a

Y T T T L A D G V P S R F S G S G S G T
 TATACAACAACCTTAGCAGATGGTGTGCCATCAAGGTCAGTGGCAGTGGATCAGGAACA
 730 740 750 760 770 780

 Q Y S L K I N S L Q P E D F G S Y Y C Q
 CAATATTCTCTCAAGATCAACAGCCTGCAACCTGAAGATTTGGGAGTTATTACTGTCAA
 790 800 810 820 830 840

 H F W S T F R T F G G G T K L E I K R
 CATTTTGGAGTACTCCTCGGACGTTCCGGTGGAGGCACCAGCTGGAAATCAACGGTAA
 850 860 870 880 890 900

 TAAGAGCTCGAATTC
 910

FIG. 14 b

pSW1HPOLMYC
 HindIII site AAGCTT

 M K Y L L P T A A
 GCATGCAAATTCATTTCAAGGAGACAGTCATAATGAATACCTATTGCCTACGGCAGCC
 10 20 30 40 50 60

 A G L L L L A A Q P A M A Q V Q L Q
 GCTGGATTGTTATTACTCGCTGCCCAACCAGCGATGGCCCGAGTGCAGCTGCAG
 70 80 90 100 110 PstI

 Polylinker
 TCTAGA GTCGAC CTCGAG
 XbaI SalI XhoI

 MYC PEPTIDE
 V T V S S E O K L I S E E D L N * *
 GGTCCCGTCTCCTCAGAACAAAACTCATCTCAGAAGAGGATCTGAATTATAA
 BstEII

 GGGCTAAGCTCGAATTC

FIG. 15

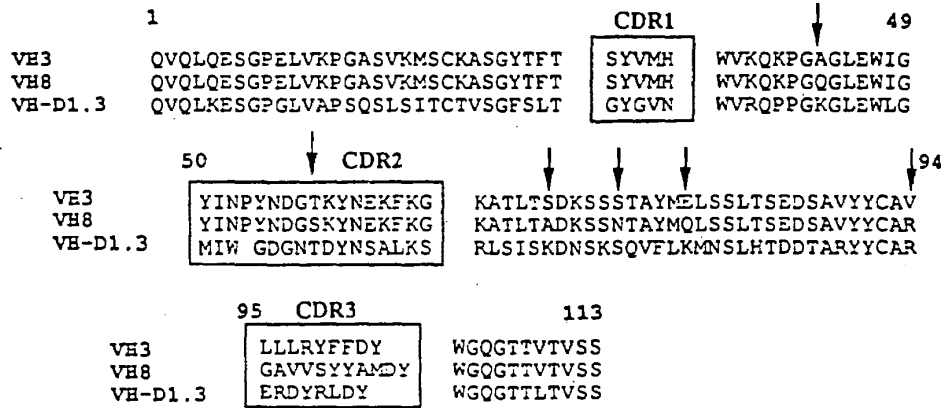

FIG. 16



FIG. 17

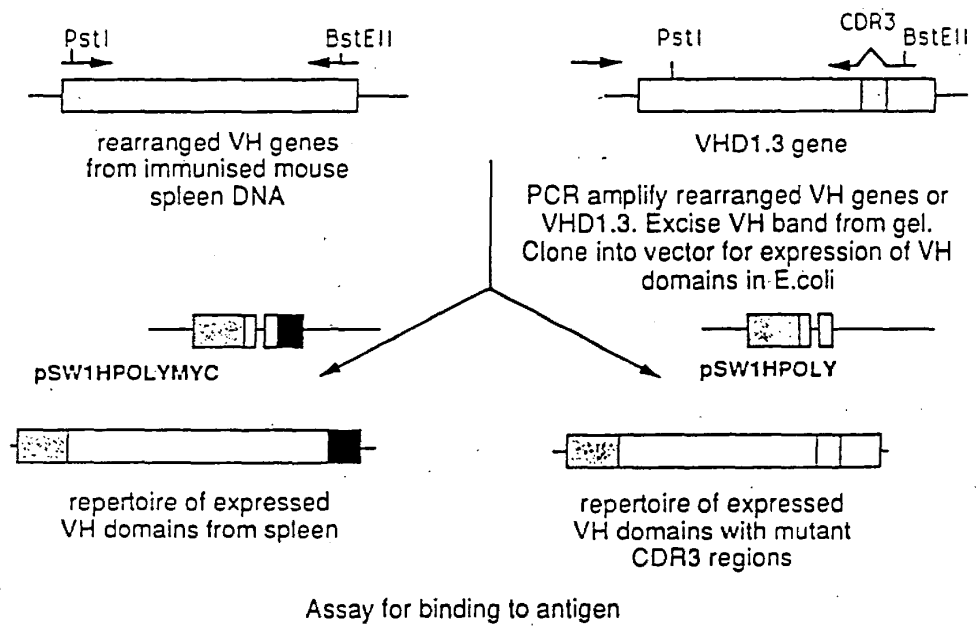

FIG. 18

pSW2HPOLY

HindIII AAGCTT

GCATGCAAATTCATTTCAAGGAGACAGTCATAATGAAATACCTATTGCCTACGGCAGCC
 10 20 30 40 50 60

AGLLLLAAQPAMAQVQLQ
 GCTGGATTGTTACTCTGCTGCCCAACCAGCGATGGCCAGGTGCAGTGCAG
 70 80 90 100 110 PstI

TCTAGA GTCGAC CTCGAG
 XbaI SalI XhoI

VTVSS
 GGTCACCGTCTCCTCATAATAAGAGCTCGAATTCGCCAAGCTTGCATGC
 BstEII 430 440 450 460 470 480

MKYLLPTAAG
 AAATTCATTTCAAGGAGACAGTCATAATGAAATACCTATTGCCTACGGCAGCCGCTGGA
 490 500 510 520 530 540

LLLLAAQPAMADIVLTQSPA
 TTGTTACTCTGCTGCCCAACCAGCGATGGCCGACATCGTCTGACTCAGTCTCCAGCC
 550 560 570 580 590 600

SLSA SVGETVTITCRASGNI
 TCCCTTCTGCGTCTGTGGGAGAACTGTCCACATCACATGTCGAGCAAGTGGGAATATT
 610 620 630 640 650 660

HNYLAWYQQKQKSPQLLVY
 CACAATTATTTAGCATGGTATCAGCAGAACAGGGAAAATCTCCTCAGCTCCTGGTCTAT
 670 680 690 700 710 720

YTTTLADGVPSRFSGSGSGT
 TATACAACAACCTTAGCAGATGGTGTGCCATCAAGGTTGAGTGGCAGTGGATCAGGAACA
 730 740 750 760 770 780

QYSLKINSLQPEDFGSYYCQ
 CAATATTCTCTCAAGATCAACAGCCTGCAACCTGAAGATTTGGGAGTTATTACTGTCAA
 790 800 810 820 830 840

HFWS TPTFGG GTKLEIKR
 CATTTTGGAGTACTCCTCGGACGTTCGGTGGAGGCCACCAAGCTGGAAATCAAACGGTAA
 850 860 870 880 890 900

TAAGAGCTCGAATTC
 910

FIG. 19

M K Y L L P T

AAGCTTGCATGCAAAATTCATTTCAAGGAGACAGTCATAATGAAATACCTATTGCCTACG
 10 20 30 40 50 60

A A A G L L L L A A Q P A M A Q V Q L Q
 GCAGCCGCTGGATTGTTACTCGCTGCCAACCCAGCGATGGCCAGGTGCAGCTGCAG
 70 80 90 100 110 120

E S G P G L V A P S Q S L S I T C T V S
 GAGTCAGGACCTGGCCTGGTGGCGCCCTCACAGAGCCTGTCCATCACATGCACCCGTCTCA
 130 140 150 160 170 180

G F S L T G Y G V N W V R Q P P G K G L
 GGGTTCTCATTAAACCGCTATGGTGTAACTGGGTTCGCCAGCCTCCAGGAAAGGGTCTG
 190 200 210 220 230 240

E W L G M I W G D G N T D Y N S A L K S
 GAGTGGCTGGGAATGATTTGGGGTGATGGAAACACAGACTATAATTCAGCTCTCAAATCC
 250 260 270 280 290 300

R L S I S K D N S K S Q V F L K M N S L
 AGACTGAGCATCAGCAAGGACAACCTCCAAGAGCCAAGTTTCTTAAAAATGAACAGTCTG
 310 320 330 340 350 360

H T D D T A R Y Y C A R E R D Y R L D Y
 CACACTGATGACACAGCCAGGTACTACTGTGCCAGAGAGAGATTATAGGCTTGACTAC
 370 380 390 400 410 420

W G Q G T T V T V S S G G G A P A A A P
 TGGGGCCAAGGCACCACCGTCCAGTCTCCTCAGTGGTGGTGTCCAGCAGCTGCACCT
 430 440 450 460 470 480

A G G G Q V Q L K E S G P G L V A P S Q
 GCTGGAGGAGACAGGTGCAGCTGAAGGAGTCAGGACCTGGCCTGGTGGCGCCCTCACAG
 490 500 510 520 530 540

S L S I T C T V S G F S L T G Y G V N W
 AGCCTGTCCATCACATGCACCGTCTCAGGGTCTCATTAAACCGGCTATGGTGTAACTGG
 550 560 570 580 590 600

V R Q P P G K G L E W L G M I W G D G N
 GTTCGCCAGCCTCCAGGAAAGGGTCTGGAGTGGCTGGGAATGATTGGGGTGATGGAAC
 610 620 630 640 650 660

T D Y N S A L K S R L S I S K D N S K S
 ACAGACTATAATTCAGCTCTCAAATCCAGACTGAGCATCAGCAAGGACAACCTCCAAGAGC
 670 680 690 700 710 720

Q V F L K M N S L H T D D T A R Y Y C A
 CAAGTTTTCTTAAAAATGAACAGTCTGCACACTGATGACACAGCCAGGTACTACTGTGCC
 730 740 750 760 770 780

R E R D Y R L D Y W G Q G T T V T V S S
 AGAGAGAGAGATTATAGGCTTGACTACTGGGGCCAAGGCACCAGGTCCAGTCTCCTCA
 790 800 810 820 830 840

* *
 TAATAAGAGCTC
 850

FIG. 20

M K Y L L P T A A
 GCATGCAAATTCTATTTCAAGGAGACAGTCATAATGAAATACCTATTCGCTACGGCAGCC
 10 20 30 40 50 60
 A G L L L L A A Q P A M A Q V Q L Q E S
 GCTGGATTGTTACTCGCTGCCCAACCAGCGATGGCCCGTGCAGTGCAGGAGTCA
 70 80 90 100 110 120
 G P G L V A P S Q S L S I T C T V S G F
 GGACCTGGCCTGGTGGCGCCCTCACAGAGCCTGTCCATCACATGCACCGTCTCAGGGTTC
 130 140 150 160 170 180
 S L T G Y G V N W V R Q P P G K G L E W
 TCATTAACCGGCTATGGTGAACTGGGTTCCGCGCCTCCAGGAAAGGCTCTGGAGTGG
 190 200 210 220 230 240
 L G M I W G D G N T D Y N S A L K S R L
 CTGGGAATGATTGGGGTGATGGAAACACAGACTATAATTCAGCTCTCAAATCCAGACTG
 250 260 270 280 290 300
 S I S K D N S K S Q V F L K M N S L H T
 AGCATCAGCAAGGACAACCTCCAAGAGCCCAAGTTTTCTTAAATGAACAGTCTGCACACT
 310 320 330 340 350 360
 D D T A R Y Y C A R E R D Y R L D Y W G
 GATGACACAGCCAGGTACTACTGTGCCAGAGAGAGATTATAGGCTTGACTACTGGGGC
 370 380 390 400 410 420
 Q G T T V T V S S R T P E M P V L E N R
 CAAGGCACCACGGTCAACCGTCTCCTCACGGACACCAGAAATGCCTGTCTGGAAACCGG
 430 440 450 460 470 480
 A A Q G D I T A P G G A R R R L T G D Q T
 GCTGCTCAGGGCGATATTACTGCACCCGCGGTGCTCGCCGTTTAAACGGGTGATCAGACT
 490 500 510 520 530 540
 A A L R D S L S D K P A K N I I L L I G
 GCCGCTCTGCGTGATTCTCTTAGCGATAAACCTGCAAAAAATATTATTTTGCTGATTGGC
 550 560 570 580 590 600
 D G M G D S E I T A A R N Y A E G A G G
 GATGGGATGGGGGACTCGGAAATTACTGCCGCACGTAATTATGCCGAAGSTGCGGGCGGC
 610 620 630 640 650 660
 F F K G I D A L P L T G Q Y T H Y A L N
 TTTTTAAAGGTATAGATGCCTTACCGCTTACCGGGCAATACACTCACTATGCGCTGAAT
 670 680 690 700 710 720
 K K T G K P D Y V T D S A A S A T A W S
 AAAAAACCGGCAACCGGACTACGTCACCGACTCGGCTGCATCAGCAACCGCCTGGTCA
 730 740 750 760 770 780

FIG. 21a

T G V K T Y N G A L G V D I H E K D H P
 ACCGGTGTCAAACCTATAACGGCGCGCTGGCGCTGCATATTCACGAAAGATCACCCA
 790 800 810 820 830 840

T I L E M A K A A G L A T G N V S T A E
 ACGATTCTGGAAATGGCAAAGCCGCAGGTCTGGCGACCGGTAACGTTTCTACCGCAGAG
 850 860 870 880 890 900

L Q D A T P A A L V A H V T S R K C Y G
 TTGCAGGATGCCACGCCCGCTGCGCTGGTGGCACATGTGACCTCGCGCAAATGTACGGT
 910 920 930 940 950 960

P S A T S E K C P G N A L E K G G K G S
 CCGAGCGCGACCACTGAAAAATGTCCGGGTAACGCTCTGAAAAAGCGGAAAAGGATCG
 970 980 990 1000 1010 1020

I T E Q L L N A R A D V T L G G G A K T
 ATTACCGAACAGCTGCTTAAACGCTCGTGCCGACGTTACGCTTGGCGCGCGCAAAAACC
 1030 1040 1050 1060 1070 1080

F A E T A T A G E W Q G K T L R E Q A Q
 TTTGCTGAAACGGCAACCGCTGGTGAATGGCAGGGAAAACGCTGCGTGAACAGGCACAG
 1090 1100 1110 1120 1130 1140

A R G Y Q L V S D A A S L N S V T E A N
 GCGCGTGGTTATCAGTTGGTGAGCGATGCTGCCTCACTGAATTCGGTGACGGAAAGCGAAT
 1150 1160 1170 1180 1190 1200

Q Q K P L L G L F A D G N M P V R W L G
 CAGCAAAACCCCTGCTTGGCCTGTTGCTGACGGCAATATGCCAGTGGCTGGCTAGGA
 1210 1220 1230 1240 1250 1260

P K A T Y H G N I D K P A V T C T P N P
 CCGAAAGCAACGTACCATGGCAATATCGATAAGCCCGCAGTCACCTGTACGCCAAATCCG
 1270 1280 1290 1300 1310 1320

Q R N D S V P T L A Q M T D K A I E L L
 CAACGTAATGACAGTGTACCAACCCCTGGCGCAGATGACCGACAAAGCCATTGAATTGTTG
 1330 1340 1350 1360 1370 1380

S K N E K G F F L Q V E G A S I D K Q D
 AGTAAAAATGAGAAAGGCTTTTTCCTGCAAGTTGAAGTTCGCTCAATCGATAAACAGGAT
 1390 1400 1410 1420 1430 1440

H A A N P C G Q I G E T V D L D E A V Q
 CATGCTGCGAATCCTTGTGGGCAATTTGGCGAGACGGTCCGATCTCGATGAAGCCGTACAA
 1450 1460 1470 1480 1490 1500

R A L E F A K K E G N T L V I V T A D H
 CGGGCGTGGAAATTCGCTAAAAAGGAGGTAACACGCTGGTTCATAGTCACCGCTGATCAC
 1510 1520 1530 1540 1550 1560

FIG. 21b

A H A S Q I V A P D T K A P G L T Q A L
 GCCCAGCCAGCCAGATTGTTGCGCCGGATACCAAAGCTCCGGGCCTCACCCAGGGCGTA
 1570 1580 1590 1600 1610 1620

N T K D G A V M V M S Y G N S E E D S Q
 AATACCAAASATGGCCGAGTGATGGTGATGAGTTACGGGAACCTCCGAAGAGGATTCACAA
 1630 1640 1650 1660 1670 1680

E H T G S Q L R I A A Y G P H A A N V V
 GAACATACCGGCAGTCAGTTGCGTATTGCGGCGTATGGCCCGCATGCCGCCAATGTTGTT
 1690 1700 1710 1720 1730 1740

G L T D Q T D L F Y T M K A A L G L K *
 GGACTGACCGACCAGACCGATCTCTTCTACACCATGAAAGCCGCTCTGGGGCTGAAATAA
 1750 1760 1770 1780 1790 1800

AACCGCGCCCGGGAGTGAATTTTCGCTGCCGGGTGGTTTTTTTTCGCTGTTAGC
 1810 1820 1830 1840 1850

FIG. 21c

M K Y L L P T A A
 GCATGCAAATTTCTATTTCAAGGAGACAGTCATAATGAAATACCTATTGCCTACGGCAGCC
 10 20 30 40 50 60

 A G L L L L A A Q P A M A Q V Q L Q E S
 GCTGGATTGTTATTACTCGCTGCCCAACCAGCGATGGCCAGGTGCAGGAGTCA
 70 80 90 100 110 120

 G P G L V A P S Q S L S I T C T V S G F
 GGACCTGGCCTGGTGGCGCCCTCACAGAGCCTGTCCATCACATGCACCGTCTCAGGGTTC
 130 140 150 160 170 180

 S L T G Y G V N W V R Q P P G K G L E W
 TCATTAACCGGCTATGGTGTAAACTGGGTTCCGACGCTCCAGGAAAGGGTCTGAGTGG
 190 200 210 220 230 240

 L G M I W G D G N T D Y N S A L K S R L
 CTGGGAATGATTTGGGGTGTGGAAACACAGACTATAATTCAGCTCTCAATCCAGACTG
 250 260 270 280 290 300

 S I S K D N S K S Q V F L K M N S L H T
 AGCATCAGCAAGGACAACCTCCAAGAGCCAAAGTTTTCTTAAAAATGAACAGTCTGCACACT
 310 320 330 340 350 360

 D D T A R Y Y C A R E R D Y R L D Y W G
 GATGACACAGCCAGGTACTACTGTGCCAGAGAGAGATTATAGGCTTGACTACTGGGGC
 370 380 390 400 410 420

 Q G T T V T V S S * *
 CAAGGCACCACGGTCCCGTCTCCTCATAATAAGAGCTATCCCGGGAGCTTGCATGCAAA
 430 440 450 460 470 480

 M K Y L L P T A A A G L
 TTCTATTTCAAGGAGACAGTCATAATGAAATACCTATTGCCTACGGCAGCCGCTGGATTG
 490 500 510 520 530 540

 L L L A A Q P A M A D I E L V D L E I K
 TTATTACTCGCTGCCCAACCAGCGATGGCCGACATCGAGCTCGTCCGCTCGAGATCAAA
 550 560 570 580 590 600

 R E Q K L I S E E D L N * *
 CGGGAACAAAACTCATCTCAGAAGAGGATCTGAATTAATAATGATCAAACGGTAATAAG
 610 620 630 640 650 660

 GATCCAGCTCGAATTC
 670

FIG. 22

Q V Q L Q E S G P G L V Q P S Q S L S I
 CAGGTGCAGCTGCAGSAGTCAGGACCTGGCCTAGTGCAGCCCTCACAGAGCCTGTCCATC
 10 20 30 40 50 60
 T C T V S G F S L T S Y G V H W V R Q S
 ACCTGCACAGTCTCTGGTTTCTCATTAACTAGCTATGGTGTACTACTGGGTTCCGCCAGTCT
 70 80 90 100 110 120
 P G K G L E W L G M I W G D G N T D Y N
 CCAGGAAAGGGTCTGGAGTGGCTGGGAATGATTTGGGGTGATGGAAACACAGACTATAAT
 130 140 150 160 170 180
 S A L K S R L S I S K D N S K S Q V F L
 TCAGCTCTCAAATCCAGACTGAGCATCAGCAAGGACAACCTCCAAGAGCCAAGTTTCTTA
 190 200 210 220 230 240
 K M N S L H T D D T A R Y Y C A R E R D
 AAAATGAAACAGTCTGCACACTGATGACACAGCCAGGTACTACTGTGCCAGAGAGAGAT
 250 260 270 280 290 300
 Y R L D Y W G Q G T T V T V S S
 TATAGGCTTGACTACTGGGGCCAAGGGACCACGGTCACCGTCTCCTCA
 310 320 330 340

FIG. 23



European Patent
Office

EUROPEAN SEARCH REPORT

Application Number

EP 89 31 1731

DOCUMENTS CONSIDERED TO BE RELEVANT			
Category	Citation of document with indication, where appropriate, of relevant passages	Relevant to claim	CLASSIFICATION OF THE APPLICATION (Int. Cl.5)
X	BIO ESSAYS, vol. 8, no. 2, February/March 1988, pages 74-78; M. VERHOEYEN AND L. RIECHMANN: "Engineering of antibodies" * The whole article especially figure 3 *	1-9	C 07 K 13/00 C 12 N 15/10 C 12 N 15/13 // C 12 Q 1/68
X	PROGRESS IN BIOTECHNOLOGY, vol. 5, February 1988: "In Vitro Immunization in Hybridoma Technology" (C.A.K. BORREBAECK, ed.), pages 231-246; J.W. LARRICK et al.: "Generation of specific human monoclonal antibodies by in vitro expansion of human B cells: A novel recombinant DNA approach" * Pages 241-244 *	10-32	
Y	SCIENCE, vol. 239, 25th March 1988, pages 1534-1536; M. VERHOEYEN et al.: "Reshaping human antibodies: Grafting an antilysozyme activity" * The whole article *	10-32	
Y	SCIENCE, vol. 239, 29th January 1988, pages 487-491; R.K. SAIKI et al.: "Primer-directed enzymatic amplification of DNA with a thermostable DNA polymerase" * The whole article *	10-32	C 12 N C 12 Q
P,X	PROCEEDINGS OF THE NATIONAL ACADEMY OF SCIENCES OF THE USA, vol. 86, no. 10, May 1989, pages 3833-3837; R. ORLANDI et al.: "Cloning immunoglobulin variable domains for expression by the polymerase chain reaction" * The whole article *	1-32	
The present search report has been drawn up for all claims			
Place of search THE HAGUE		Date of completion of the search 16-02-1990	Examiner CUPIDO M.
CATEGORY OF CITED DOCUMENTS		T : theory or principle underlying the invention E : earlier patent document, but published on, or after the filing date D : document cited in the application L : document cited for other reasons & : member of the same patent family, corresponding document	
X : particularly relevant if taken alone Y : particularly relevant if combined with another document of the same category A : technological background O : non-written disclosure P : intermediate document			

EPO FORM 1503 (01/87) (P/0401)

PCT

WORLD INTELLECTUAL PROPERTY ORGANIZATION
International Bureau

Document No. 93
EP-B1 0 451 216
Protein Design Labs, Inc.
ALBB Ref.: GFOP96504
Vossius Ref.: B 1060 EP

INTERNATIONAL APPLICATION PUBLISHED UNDER THE PATENT COOPERATION TREATY

<p>(51) International Patent Classification⁵ : C12N 15/13, C07K 15/28 G01N 33/574, C12N 15/62 A61K 39/395, C12P 21/08</p>	A2	<p>(11) International Publication Number: WO 94/11509 (43) International Publication Date: 26 May 1994 (26.05.94)</p>
<p>(21) International Application Number: PCT/US93/11445 (22) International Filing Date: 16 November 1993 (16.11.93) (30) Priority data: 07/977,696 16 November 1992 (16.11.92) US 08/129,930 30 September 1993 (30.09.93) US 08/134,346 8 October 1993 (08.10.93) US (71) Applicant (for all designated States except US): CANCER RESEARCH FUND OF CONTRA COSTA [US/US]; 2055 North Broadway, Walnut Creek, CA 94596 (US). (72) Inventors; and (75) Inventors/Applicants (for US only): DO COUTO, Fernando, J., R. [US/US]; 7710 Oak Creek Drive, Pleasanton, CA 94588 (US). CERIANI, Roberto, L. [US/US]; PETERSON, Jerry, A. [US/US]; 1089 Via Roble, Lafayette, CA 94549 (US). PADLAN, Eduardo, A. [US/US]; 4006 Simms Drive, Kensington, MD 20895 (US).</p>	<p>(74) Agent: AMZEL, Viviana; V. Amzel & Assoc., 2055 North Broadway, Walnut Creek, CA 94596 (US). (81) Designated States: AT, AU, BB, BG, BR, CA, CH, DE, DK, ES, FI, GB, HU, JP, KP, KR, LK, LU, MG, MN, MW, NL, NO, PL, RO, RU, SD, SE, US, European patent (AT, BE, CH, DE, DK, ES, FR, GB, GR, IE, IT, LU, MC, NL, PT, SE), OAPI patent (BF, BJ, CF, CG, CI, CM, GA, GN, ML, MR, NE, SN, TD, TG). Published <i>Without international search report and to be republished upon receipt of that report.</i></p>	
<p>(54) Title: PEPTIDES AND ANTI-SENSE PEPTIDES WITH BROAD NEOPLASTIC SPECIFICITY</p>		
<p>(57) Abstract</p> <p>An analogue peptide comprises the variable regions of the light or heavy chains of an antibody of a first species selectively binding to a tumor antigen, such as a carcinoma antigen, has 1 to 46 amino acids of the framework regions per chain substituted with amino acids such as those present in equivalent positions in antibodies of a species other than the first species, or fragments thereof comprising 1 to 3 variable region CDRs per chain and optionally flanking regions thereof of 1 to 10 or more amino acids, alone or with an N-terminal fragment of 1 to 10 or more amino acids, combinations or mixtures thereof. The polypeptide may also comprise an effector agent and/or be glycosylated, and is presented as a composition with a carrier. The analogue peptides are used in diagnostic kits for neoplasms such as carcinomas and methods for in vivo imaging and treating a primary or metastasized neoplasm such as a carcinoma, and in vitro diagnosing a neoplasm, ex vivo purging neoplastic cells from a biological fluid. RNAs and DNAs encode the analogue peptide, and a hybrid vector carrying the nucleotides and transfected cells express the peptides and a method produces the analogue peptide. An anti-idiotypic polypeptide comprises polyclonal antibodies raised against an antineoplastic antibody or the analogue peptide of this invention, monoclonal antibodies thereof, Fab, Fab', (Fab')₂, CDR, variable region, or analogues or fragments thereof, combinations thereof with an oligopeptide comprising a TRP trimer, tandem repeats thereof, or combination or mixtures thereof. An anti-idiotypic hybrid polypeptide with an effector agent and the anti-idiotypic polypeptide, an anti-neoplastic vaccine, an anti-neoplastic vaccination kit, a method of vaccinating against neoplasms such as carcinomas and a method of lowering the serum concentration of a circulating antibody or polypeptide are provided.</p>		

34

NOV 20 1990

FOR THE PURPOSES OF INFORMATION ONLY

Codes used to identify States party to the PCT on the front pages of pamphlets publishing international applications under the PCT.

AT	Austria	GB	United Kingdom	MR	Mauritania
AU	Australia	GE	Georgia	MW	Malawi
BB	Barbados	GN	Guinea	NE	Niger
BE	Belgium	GR	Greece	NL	Netherlands
BF	Burkina Faso	HU	Hungary	NO	Norway
BG	Bulgaria	IE	Ireland	NZ	New Zealand
BJ	Benin	IT	Italy	PL	Poland
BR	Brazil	JP	Japan	PT	Portugal
BY	Belarus	KE	Kenya	RO	Romania
CA	Canada	KG	Kyrgyzstan	RU	Russian Federation
CF	Central African Republic	KP	Democratic People's Republic of Korea	SD	Sudan
CG	Congo	KR	Republic of Korea	SE	Sweden
CH	Switzerland	KZ	Kazakhstan	SI	Slovenia
CI	Côte d'Ivoire	LJ	Liechtenstein	SK	Slovakia
CM	Cameroon	LK	Sri Lanka	SN	Senegal
CN	China	LU	Luxembourg	TD	Chad
CS	Czechoslovakia	LV	Latvia	TC	Togo
CZ	Czech Republic	MC	Monaco	TJ	Tajikistan
DE	Germany	MD	Republic of Moldova	TT	Trinidad and Tobago
DK	Denmark	MG	Madagascar	UA	Ukraine
ES	Spain	ML	Mali	US	United States of America
FI	Finland	MN	Mongolia	UZ	Uzbekistan
FR	France			VN	Viet Nam
GA	Gabon				

PEPTIDES AND ANTI-SENSE PEPTIDES WITH BROAD NEOPLASTIC
SPECIFICITY

BACKGROUND OF THE INVENTION

Field of the invention

This invention relates to the in vitro and in vivo diagnosis, immunization, and therapy of neoplastic tumors, particularly carcinomas, by means of specifically targeted analogue peptides comprising amino acid sequences encompassing the complementarity determining regions (CDRs) of a different species, and analogues of the variable (F_v) region of anti-carcinoma antibodies, among others. The carcinoma specific peptides for use in one species, e.g., humans, are provided as a single amino acid chain having the specificity of F_v regions obtained in different species, e.g., murine antibody F_v regions of the light or heavy chains, or as paired chains. These peptides are provided either by themselves or bound to other molecules such as synthetic polymers or oligopeptides resulting in sequences of mixed species, and more particularly analogues of human/non-human chimeric antibodies or other polymeric constructs. The analogue peptides comprise sequences derived from the variable regions of heterologous antibodies specific for, e.g., human carcinoma antigens that elicit a lesser immunological response in humans than the whole heterologous antibodies. The anti-idiotypic polypeptides and their analogues are suitable for immunizing humans or other animals against carcinoma. Polynucleotide segments encoding the analogue peptide and anti-idiotypic polypeptides, and hybrid vectors and transfected host cells carrying the segments are useful for preparing the peptides disclosed herein.

Description of the Background

Carcinomas result from the carcinogenic transformation of cells of different epithelia. Two of the most damaging characteristics of carcinomas are their uncontrolled growth and their ability to create metastases in distant sites of the host, particularly a human host. It is usually these distant metastases that cause serious consequences to the host, since frequently the primary carcinoma may be, in most cases, removed by surgery. The treatment of metastatic carcinomas, that are seldom removable, depends on irradiation therapy and systemic therapies of different natures. The systemic therapies currently include, but not fully comprise, chemotherapy, radiation, hormone therapy, different immunity-boosting medicines and procedures, hyperthermia and systemic monoclonal antibody treatment. The latter can be labeled with radioactive elements, immunotoxins and chemotherapeutic drugs.

Radioactively labeled monoclonal antibodies were initially used with success in lymphomas and leukemia, and recently in some carcinomas. The concept underlying the use of labeled antibodies is that the labeled antibody will specifically seek and bind to the carcinoma and, the radioactive element, through

its decay, will irradiate the tumor in situ. Since radioactive rays travel some distance in tumors it is not necessary that every carcinoma cell bind the labeled antibody. The specificity of the monoclonal antibodies will permit a selective treatment of the tumor while avoiding the irradiation of innocent by-stander
5 normal tissues, that could be dose limiting. Chemotherapy produces serious toxic effects on normal tissues, making the chemotherapy of carcinomas less than desirable, and the use of radiolabeled monoclonal antibodies a valid alternative.

Non-human antibodies raised against human epitopes have been used for
10 the diagnosis and therapy of carcinomas as is known in the art. Also known are the methods for preparing both polyclonal and monoclonal antibodies. Examples of the latter are BrE-2, BrE-3 and KC-4 (e.g., US patent Nos. 5,077,220; 5,075,219 and 4,708,930..

The KC-4 murine monoclonal antibody is specific to a unique antigenic
15 determinant, the "antigen", and selectively binds strongly to neoplastic carcinoma cells and not to normal human tissue (U.S. Patent No. 4,708,930 to Coulter). The antigen appears in two forms in carcinoma cells, only the smaller of these forms being expressed in the cell membrane. The larger form appears only in the cytoplasm and has an approximate 490 Kdalton molecular weight
20 (range of 480,000-510,000). The second form occurs at a higher density of expression, is found both in the cytoplasm and the membrane of carcinoma cells and has an approximate 438 Kdalton molecular weight (range of 390,000-450,000) as determined by gel electrophoresis with marker proteins of known molecular weights. Labeled KC-4 was applied to the diagnosis and medical
25 treatment of various carcinomas, particularly adenocarcinoma and squamous cell carcinoma regardless of the human organ site of origin.

The BrE-3 antibody (Peterson et al., Hybridoma 9:221 (1990); US patent
No. 5,075,219) was shown to bind to the tandem repeat of the polypeptide core
30 of human breast epithelial mucin. When the mucin is deglycosylated, the presence of more tandem repeat epitopes is exposed and the binding of the antibody increases. Thus, antibodies such as BrE-3 bind preferentially to neoplastic carcinoma tumors because these express an unglycosylated form of the breast epithelial mucin that is not expressed in normal epithelial tissue. This preferential binding combined with an observed low concentration of epitope for
35 these antibodies in the circulation of carcinoma patients, such as breast cancer patients, makes antibodies having specificity for a mucin epitope highly effective for carcinoma radioimmunotherapy. A ⁹⁰Y-BrE-3 radioimmunoconjugate proved highly effective against human breast carcinomas transplanted into nude mice. Human clinical studies showed the ⁹⁰Y-BrE-3 radioimmunoconjugate to

considerably reduce the size of breast tumor metastases without any immediate toxic side effects. Moreover, an ^{111}In -BrE-3 radioimmunoconjugate was successfully used for imaging 15 breast cancer patients, providing excellent tumor targeting in 13 out of 15 of the patients. Out of all the breast tumor
5 metastases occurring in another study, 86% were detected by ^{111}In -BrE-3. Unfortunately, 2 to 3 weeks after treatment, the patients developed a strong human anti-murine antibody (HAMA) response that prevented further administration of the radioimmunoconjugate. The HAMA response, which is
10 observed for numerous murine monoclonal antibodies, precludes any long-term administration of murine antibodies to human patients. Similarly, other heterologous antibodies, when administered to humans, elicited similar antibody responses. The anti-heterologous human response is, thus, a substantial limiting
15 factor hindering the successful use of heterologous monoclonal antibodies as therapeutic agents, which could, otherwise, specifically annihilate breast carcinomas, causing little or no damage to normal tissue and having no other toxic effects.

Chimeric antibodies are direct fusions between variable domains of one species and constant domains of another. Murine/human chimeric antibodies prepared from other types of B cells binding to other types of antigenic
20 determinants have been shown to be less immunogenic in humans than whole murine antibodies. These proved to be less immunogenic but still in some cases an immune response is mounted to the rodent variable region framework region (FR). A further reduction of the "foreign" nature of the chimeric antibodies was achieved by grafting only the CDRs from a rodent monoclonal into a human
25 supporting framework prior to its subsequent fusion with an appropriate constant domain, (European Patent Application, Publication No. 239,400 to Winter; Riechmann, et al., Nature 332:323-327 (1988)). However, the procedures employed to accomplish CDR-grafting often result in imperfectly "humanized" antibodies. That is to say, the resultant antibody loses avidity (usually 2-3 fold,
30 at best).

The ligand binding characteristics of an antibody combining site are determined primarily by the structure and relative disposition of the CDRs, although some neighboring residues also have been found to be involved in antigen binding (Davies, et al., Ann. Rev. Biochem. 59:439-473 (1990)).

35 The technologies of molecular biology have further expanded the utility of many antibodies by allowing for the creation of class switched molecules whose functionality has been improved by the acquisition or loss of complement fixation. The size of the bioactive molecule may also be reduced so as to increase the tissue target availability of the antibody by either changing the class

from an IgM to an IgG, or by removing most of the heavy and light chain constant regions to form an F₁ antibody. Common to all of these potentially therapeutic forms of antibody are the required complementary determining regions (CDRs), which guide the molecule to its ligand, and the framework residues (FRs) which support the CDRs and dictate their disposition relative to one another. The crystallographic analysis of numerous antibody structures revealed that the antigen combining site is composed almost entirely of the CDR residues arranged in a limited number of loop motifs. The necessity of the CDRs to form these structures, combined with the appreciated hypervariability of their primary sequence, leads to a great diversity in the antigen combining site, but one which has a finite number of possibilities. Thus, its hypermutability and the limited primary sequence repertoire for each CDR would suggest that the CDRs derived for a given antigen from one species of animal would be the same derived from another species. Hence, they should be poorly immunogenic, if at all, when presented to a recipient organism.

Accordingly, there is still need for a product of high affinity and/or specificity for carcinoma antigens suitable for the detection and therapy of carcinomas which elicits a lesser antibody response than whole non-human antibodies or chimeric antibodies containing, for instance the entire non-human variable region.

SUMMARY OF THE INVENTION

This invention relates to an analogue peptide and its glycosylated derivative which specifically and selectively bind to the human mammary fat globule (HMFG) antigen and to an antigen found on the surface or in the cytoplasm of tumor cells such as carcinoma cells or that is released by the cells, the analogue peptide consisting essentially of at least one variable region of the light or heavy chains of an antibody of a first species having affinity and specificity for an antigen found on the surface or the cytoplasm of a carcinoma cell or released by the cell, wherein preferably about 1 to at least 46 amino acids in the FR are substituted per chain with amino acids selected from the group consisting of amino acids present in equivalent positions in antibodies of a species other than the first species, or fragments thereof comprising 1 to 3 CDRs per chain or 1 to 3 CDRs plus flanking regions thereof, each of about 1 to at least 10 amino acids, alone or with an N-terminal fragment of about 1 to at least 10 amino acids, combinations thereof or combinations thereof with other variable regions or analogues thereof, wherein each analogue peptide is operatively linked to at least one other peptide or analogue thereof, or mixtures thereof.

Also provided herein are a fusion protein and a hybrid polymer comprising the analogue of the invention, the corresponding DNAs encoding them, hybrid vector thereof, transfected host thereof, and RNA.

This invention also encompasses a method of producing an analogue peptide or hybrid analogue peptide by recombinant technology, in vitro methods of diagnosing and immunohistochemistry of tissue slices, an ex vivo method of purging neoplastic cells, and in vivo methods for imaging and therapy of neoplasias such as carcinomas.

Also disclosed herein are anti-idiotypic polypeptides comprising polyclonal antibodies raised against the analogue peptide of this invention, analogues thereof, monoclonal antibodies thereof, fragments thereof selected from the group consisting of Fab, Fab', (Fab')₂, CDRs, variable regions and analogues thereof as described above, combinations thereof operatively linked to one another, an anti-carcinoma vaccine, a vaccination kit, a method of vaccinating against neoplasias including carcinomas, and a method of lowering the serum concentration of circulating anti-tumor antibody with the anti-idiotypic polypeptide of this invention.

Other objects, advantages and features of the present invention will become apparent to those skilled in the art from the following discussion.

20

DESCRIPTION OF THE PREFERRED EMBODIMENTS

This invention arose from a desire by the inventors to improve on antibody technology suitable for use in diagnostic, prognostic, vaccine and therapeutic applications in the field on neoplasmas and cancer. The present invention will be described for application to humans. However, it is also suitable for use in other species. The monoclonal antibodies obtained up to the present time have been prepared by fusing immortalized cell lines with B-cells of non-human origin such as murine, rat, rabbit, goat, and the like. Many of these hybridomas can produce large quantities of monoclonal antibodies that have desirable binding properties such as high affinity and/or specificity and selectivity for carcinoma antigens of a species, e.g., for human carcinoma antigens. However, in general, antibodies from other species, e.g., non-human antibodies, may only be administered once to a subject of a predetermined species, e.g., humans, due to the detrimental effects they produce. This is true for most heterologous antibodies being administered to mammalian animals. For example, the repeated administration of murine antibodies to a human subject elicits a strong human anti-murine antibody (HAMA) response, which precludes their further utilization as therapeutic agents in humans. These non-human antibodies initiate an immediate adverse reaction in many human patients and are, thus,

rendered ineffective for further administration as therapeutic agents. In some cases, non-human-human chimeric antibodies and non-human CDR "grafted"-human antibodies may have lower affinity and/or specificity for their antigens than the corresponding non-human antibody. On the other hand, human
5 monoclonal hybridoma cell lines have not been very stable and have, therefore, not been suitable for the large scale, repeated production of monoclonal antibodies.

The present invention is applicable to the manufacture of analogue peptides having a high number of amino acids in the respective positions found
10 in the endogenous antibodies, and where at least the CDRs are of another xenogeneic species.

The present inventors, thus, have undertaken the preparation of antitumor non-human CDRs and non-human variable regions of antibodies, having affinity and specificity for an antigen found on the surface or the
15 cytoplasm of a human neoplastic cell such as a carcinoma cell or that is released by the cell, wherein about 1 to 46 amino acids in the framework region (FR) are substituted per chain with amino acids present in equivalent positions in other human antibodies, or fragments thereof comprising 1 to 3 CDRs per chain or 1
20 to 3 CDRs per chain plus flanking regions thereof, each of about 1 to 10 or more amino acids, alone or plus an N-terminal fragment of about 1 to 10 or more amino acids, to lower or even circumvent the anti-xenogeneic response. To preserve substantial binding specificity in the molecules intended for use in
25 humans, the present invention utilizes CDRs and/or analogues of varying lengths of the variable regions of light and/or heavy chains of antibodies of other species such as murine, rat, rabbit, goat, equine, primate, bovine, and guinea pig antibodies, among others. Heterologous human CDRs and/or analogues of their variable regions may be utilized are intended for use in other species.

The present inventors have found, surprisingly, that these analogue antibody fragments substantially preserve the binding, specificity and selectively
30 characteristics of the whole non-human antibody while eliciting a lesser detrimental immunological response. However, the simple preservation of the binding region of an antibody does not by itself ensure that the binding characteristics of the antibody will be maintained. Antibodies are glycopolypeptides that are folded into specific conformations. When the
35 glycoside portion of the molecule or portions of the amino acid sequence are perturbed or excised, the folding pattern of the molecule may be perturbed. Thus, any deletion or modification of the sequence of an antibody must be made taking into consideration that its folding-dependent properties may be diminished or even obliterated if the folding is substantially affected, even though the amino

acid sequences involved in the binding of the antigen are preserved.

The present inventors selected the following strategy for the preparation and manufacture of the analogue and hybrid peptides of this invention. The cDNAs that encode the variable chains of an antibody may be obtained by
5 isolation of mRNA from a hybridoma cell and reverse transcription of the mRNA, amplification of the cDNA by polymerase chain reaction (PCR) and insertion of the DNA into a vector for optional sequencing, and for restriction enzyme cutting. The cDNAs encoding the CDRs or variable chain (F_v) region fragments of the light (V_L) and heavy (V_H) chains of an antibody having affinity and
10 specificity for a carcinoma cell antigen may be reverse transcribed from isolated mRNA. The cDNAs encoding the CDRs may then be ligated to other segments encoding neighboring sequences, and the variable region cDNAs may then be modified with predesigned primers used to PCR amplify them or synthesized de novo, cloned into a vector optionally carrying DNA sequences encoding, e.g.,
15 a constant region(s), optionally sequenced, and then transfected into a host cell for expression of the analogue gene product. The binding specificity characteristics of the analogue peptides may then be determined and compared to those of the whole antibodies.

X-ray crystallographic studies demonstrate that the framework
20 structures of the F_v of different antibodies assume a canonical structure regardless of the species of origin, amino acid sequence, or ligand specificity. This is generally taken as evidence that the ligand-binding characteristics of an antibody combining site are determined primarily by the structure and relative disposition of the CDRs, although some neighboring framework residues may
25 also be involved in antigen-binding. Thus, if the fine specificity of an antibody is to be preserved, its CDR structures, and probably some of the neighboring residues, their interaction with each other and with the rest of the variable domains, must also be maintained. These crystallographic studies point to the possible need for retaining most, if not all, of the many interior and inter-domain
30 contact residues since the structural effects of replacing only a few of them cannot be predicted.

While at first the necessity of keeping these amino acids might seem to defeat the goal of decreasing immunogenicity by "humanization", the actual number of amino acids that must be retained is usually small because of the
35 striking similarity between human and murine variable regions. Moreover, many, if not most, of the retained amino acids possess side chains that are not exposed on the surface of the molecule and, therefore, may not contribute to its antigenicity. Clearly, it is most of the exposed amino acids that are good candidates for substitution since it is these amino acids that are exposed to the

immunological environment of a mammal and may form epitopes of increased immunogenicity.

The challenge in humanizing the variable regions of a non-human antibody, e.g., a murine antibody, thus begins with the identification of the "important" xenogeneic amino acids. "Important" amino acids are those, for example, that are involved in antigen binding, contact the CDRs and the opposite chains, and have buried side-chains. Ideally, these residues might be identified from a well characterized three-dimensional structure. However, when direct structural data are not available, it is, fortunately, still possible to predict the location of these important amino acids by analyzing other related antibody structures, especially those whose variable light and heavy regions belong to the same class. The classes of variable regions can be determined from their amino acid sequence.

A method by which these important amino acids are identified has been described for the case of the amino acids with buried side chains by Padlan, E.A. (Padlan, E.A., "A Possible Procedure for Reducing the Immunogenicity of Antibody Variable Domains While Preserving Their Ligand-Binding Properties", *Molecular Immunology*, 28:489-494 (1991)). In the present case, various antibody variable region structures were compared using a computer program that determines the solvent accessibility of the framework residues as well as their contacts with the opposite domain as described by Padlan, E.A. (1991), supra. Surprisingly, a close examination of the fractional solvent accessibility reveals a very close similarity in the exposure patterns of the V_H and the V_L domains. Put in simple terms, regardless of the particular antibody in question, and of its amino acid sequence, the buried residues occupy similar relative positions in most antibodies.

A similar analysis can be done by computer modeling, to determine which amino acids contact the CDRs and which contact the opposite domain. At this point, the Fab structures that are currently in the Protein Data bank (Bernstein, F.C., et al., *J. Mol. Biol.* 112:535-542 (1977)) may be examined to determine which FRs are probably important in maintaining the structure of the combining site. Thus, after a close inspection of many high resolution three-dimensional structures of variable regions, the positions of all important framework amino acids, that is, those that contact the CDRs, the opposite domain, and those whose side chains are inwardly pointed, may be tabulated. Keeping these amino acids, as well as those from the CDRs, and finally those FR amino acids that may be involved in ligand binding, should insure to a great extent the preservation of affinity. The precise identification of FR amino acids that are involved in ligand-binding cannot be generalized since it varies for

different antibodies. Nevertheless, conservative decisions can be made to preserve the amino acids located in FR that have a high probability of contacting the antigen. These regions are located immediately adjacent to the CDRs and at the N-terminus of both chains, because the surfaces of these regions are contiguous with the CDR surfaces.

Surprisingly, it is possible to keep all of these important amino acids in a heterologous humanized antibody and still increase dramatically the similarity with a human consensus sequence. That is, the final number of amino acids with murine identities differing from human identities that are kept is typically small. This is usually possible because human frameworks that are similar to the murine frameworks, especially at the positions of the important amino acids, can be found. This is because many of the important amino acids have the same identities in both murine and human antibodies.

All the amino acids that are determined to be not important by the method described above may be completely replaced by their corresponding human counterparts. The surface of the finally humanized antibody should look very much like that of a human antibody except for the antigen binding surfaces. The original shape of those binding surfaces, however, is maintained by leaving the internal composition of the antibody intact, preserving inter-domain contacts and by keeping very few key amino acids that contact the CDRs.

a) **Choosing the Best Human Framework to Use in the "Humanization" of an Antibody When Its Structure is Known**
 At the present time, there are 11 Fab structures for which the atomic coordinates are known and have been placed in the Protein Data Bank as shown in Table 1 below, 2 from human and 9 from murine antibodies.

Table 1: Fab Structures for Which Coordinates are in the Protein Data Bank

	ANTIBODY	RESOLUTION (A)	R-VALUE	PDB CODE
HUMAN:	HEMH	2.0	0.46	3FAB
	KOL	1.9	0.189	2FB4
MURINE:	McPC603	2.7	0.225	1MCP
	JS39	1.95	0.194	2FBJ
	HyHEL-5	2.54	0.245	2HFL
	HyHEL-10	3.0	0.24	3NFH
	R19.9	2.8	0.30	1F19
	4-4-20	2.7	0.215	4FAB
	36-71	1.85	0.248	6FAB
	B1312	2.8	0.197	1IGF
	D1.3	2.5	0.184	1FOL

The contacts between side chains in the variable domains of the 11 Fabs have been collected and are presented in Tables 2 to 4 below. The framework (FR) amino acids (aa's) in the V_L domains that contact CDRs are listed in Table 2 below.

5 **Table 2:** V_L Framework Residues That Contact CDR Residues in Fabs of Known Three-Dimensional Structure

POSITION	ANTIBODY										
	J559	MCPC603	HYHEL-10	HYHEL-5	RLS-9	4-4-20	36-71	81312	D1.3	NEWM	KOL
1	GLU(2)	ASP(5)	ASP(10)	ASP(3)		ASP(8)	ASP(4)		ASP(11)		
2	ILE(11)	ILE(15)	ILE(17)	ILE(13)	ILE(5)	VAL(5)	ILE(20)	VAL(9)	ILE(10)	SER(3)	
3		VAL(3)	VAL(2)	VAL(2)	GLN(2)	VAL(2)	GLN(2)	LEU(5)		VAL(2)	
4	LEU(7)	MET(6)	LEU(6)	LEU(10)	MET(9)	MET(13)	MET(7)	MET(4)	MET(7)	LEU(4)	LEU(6)
5		THR(1)			THR(1)	THR(2)				THR(1)	
7								THR(4)			
22								SEA(5)			
23	CYS(1)	CYS(1)	CYS(2)	CYS(2)	CYS(1)	CYS(1)	CYS(1)				CYS(1)
35	TRP(3)	TRP(2)	TRP(4)		TRP(2)		TRP(6)	TRP(4)	TRP(4)	TRP(1)	TRP(2)
36	TYR(12)	TYR(16)	TYR(8)	TYR(10)	TYR(22)	TYR(13)	TYR(15)	TYR(8)	TYR(14)	TYR(13)	TYR(11)
45					LYS(22)	LYS(5)					
46	PRO(3)	LEU(6)	LEU(4)	ARG(15)	LEU(5)	VAL(14)	LEU(5)	LEU(10)	LEU(6)	LEU(2)	LEU(6)
48	ILE(1)	ILE(1)	ILE(1)				ILE(3)	ILE(2)	VAL(1)		ILE(1)
49	TYR(28)	TYR(29)	LYS(13)	TYR(12)	TYR(40)	TYR(22)	TYR(22)	TYR(16)	TYR(25)		TYR(25)
58	VAL(3)	VAL(3)	ILE(1)	VAL(6)	VAL(6)	VAL(5)	VAL(4)	VAL(5)	VAL(1)		VAL(6)
60		ASP(1)				ASP(2)		ASP(4)			ASP(2)
62											
66				PHE(1)		PHE(1)	PHE(1)			LYS(2)	LYS(11)
67		SER(3)							SER(1)		
69		THR(2)	THR(3)			THR(5)	THR(1)	THR(4)	THR(1)	SER(1)	
70		ASP(2)			ASP(1)		ASP(6)			SER(2)	
71	TYR(14)	PHE(23)	PHE(17)	TYR(17)	TYR(24)	PHE(17)	TYR(17)	PHE(19)	TYR(18)	ALA(2)	ALA(4)
88	CYS(1)		CYS(2)		CYS(1)	CYS(1)	CYS(1)	CYS(1)	CYS(2)		CYS(1)
98	PHE(8)	PHE(8)	PHE(10)	PHE(5)	PHE(8)	PHE(4)	PHE(8)	PHE(14)	PHE(14)	PHE(3)	PHE(7)

10 Those FR in the V_H domains that contact CDRs are listed in Table 3 below.

10 **Table 3:** V_H Framework Residues That Contact CDR Residues in Fabs of Known Three-Dimensional Structure

POSITION	ANTIBODY										
	J559	MCPC603	HYHEL-10	HYHEL-5	RLS-9	4-4-20	36-71	81312	D1.3	NEWM	KOL
1						GLU(2)					
2	VAL(11)	VAL(3)	VAL(6)		VAL(1)	VAL(7)	VAL(2)	VAL(12)		VAL(9)	
3	LEU(2)	LEU(5)	LEU(5)		LEU(1)	LEU(1)	LEU(1)	LEU(1)		LEU(1)	
4		THR(2)	VAL(6)			ALA(1)					
23	PHE(2)	PHE(2)		TYR(14)	TYR(11)	PHE(18)	TYR(4)	PHE(4)	PHE(4)	THR(1)	PHE(2)
24	ASP(1)	THR(5)		THR(2)	THR(5)	THR(4)	THR(2)	THR(2)		SEA(1)	ILE(2)
25	PHE(4)	PHE(4)		PHE(10)	PHE(7)	PHE(13)	PHE(4)	PHE(2)	LEU(1)		PHE(4)
30			THR(2)		THR(6)	SER(7)				ASP(4)	
34							TRP(2)				
35		VAL(1)			VAL(1)			VAL(2)	VAL(2)	VAL(1)	
36	ARG(1)	ARG(2)	ARG(4)	LYS(1)	LYS(1)	ARG(4)	LYS(2)	ARG(2)			ARG(2)
40					ARG(1)						
48	GLU(2)	GLU(4)	GLU(1)	GLU(27)	GLU(3)	GLU(4)	GLU(9)	GLU(1)		GLU(1)	GLU(1)
49	TRP(21)	TRP(29)	TYR(20)	TRP(21)	TRP(13)	TRP(10)	TRP(23)	TRP(23)	TRP(1)	TRP(2)	TRP(1)
48	ILE(1)	ILE(1)	MET(4)	ILE(13)	ILE(13)	VAL(1)	ILE(1)	VAL(2)	VAL(1)	ILE(1)	VAL(1)
49	ALA(1)					ALA(2)		ALA(2)			ALA(2)
64		ARG(1)				ARG(2)		ARG(2)		ARG(2)	ARG(1)
67	PHE(4)	PHE(10)	ILE(9)	ALA(1)		PHE(13)	TYR(9)	PHE(12)	LEU(4)	VAL(2)	PHE(10)
68	ILE(8)	ILE(8)	ILE(8)	PHE(13)	LEU(3)	ILE(10)	LEU(4)	ILE(1)	ILE(9)	MET(4)	ILE(9)
71	ARG(7)	ARG(18)	ARG(1)	ALA(1)	VAL(4)	ARG(8)	VAL(4)	ARG(1)	LYS(4)		ARG(9)
72	ASP(1)	THR(2)				ASP(2)					
74	LEU(4)	LEU(7)	TYR(5)	ALA(1)	ALA(1)	VAL(2)	ALA(1)	LEU(6)	VAL(4)	PHE(1)	LEU(1)
80						LEU(1)					
82						ASP(2)				MET(1)	LEU(1)
84											
92	ALA(4)	ALA(1)		CYS(1)		ASP(2)	CYS(1)	CYS(1)		ALA(1)	ALA(2)
93	ARG(28)	ARG(12)	ASN(1)	ASP(2)	ARG(10)	THR(2)	ALA(1)	THR(2)	ALA(1)	ARG(1)	ARG(1)
102	TRP(1)	TRP(1)				TRP(1)	TRP(1)	TRP(1)	TRP(1)	TRP(1)	TRP(1)

The FR amino acids that contact the opposite domain and which presumably are the ones mainly responsible for the quaternary structure of the V_H domains are listed in Table 4 below.

5 **Table 4:** Framework Residues That Contact Framework Residues in the Opposite Domain in Fabs of Known Three-Dimensional Structure

IN V_H :		ANTIBODY											
POSITION		J339	HP3C102	HYHEL-10	HYHEL-5	RI3.9	4-4-10	36-71	B1312	D1.3	MEMH	KOL	
36	TYR(3)	TYR(4)	TYR(3)	TYR(5)		TYR(11)	TYR(7)	TYR(11)	TYR(7)			TYR(9)	
38	GLN(10)	GLN(4)	GLN(8)	GLN(5)	GLN(5)	GLN(3)	GLN(6)	GLN(12)	GLN(4)			GLN(7)	GLN(8)
43	SEA(7)	PRO(11)	SEA(8)	SEA(8)	SEA(3)	TYR(3)		SEA(3)	SEA(2)	ALA(5)		ALA(1)	ALA(1)
44	PRO(10)	PRO(14)	PRO(8)	PRO(11)		PRO(3)	ILE(30)	PRO(14)	PRO(14)	PRO(7)		PRO(12)	PRO(12)
45	PRO(2)												
46													
47	TYR(6)	TYR(4)	PRO(6)	TYR(2)	THR(5)			PRO(3)	TYR(10)	TYR(8)	ASP(12)	TYR(4)	TYR(4)
58	PRO(11)	PRO(18)	PRO(7)	PRO(12)	PRO(12)	PRO(12)	PRO(8)	PRO(12)	PRO(12)	PRO(10)	PRO(10)	PRO(10)	PRO(12)
100		ALA(12)											

IN V_L :		ANTIBODY											
POSITION		J339	HP3C102	HYHEL-10	HYHEL-5	RI3.9	4-4-10	36-71	B1312	D1.3	MEMH	KOL	
37	VAL(4)		ILE(2)	VAL(2)	VAL(4)	VAL(2)	VAL(1)	VAL(2)	VAL(4)	VAL(1)	VAL(1)	VAL(4)	
39	GLN(10)	GLN(4)	LYS(8)	GLN(5)	GLN(5)	GLN(2)	GLN(6)	GLN(10)	GLN(6)	GLN(4)	GLN(4)	GLN(7)	
43			ASN(4)			GLN(7)				LYS(6)		ARG(10)	
44		ARG(2)											
45	LEU(12)	LEU(12)	LEU(8)	LEU(14)		LEU(8)	LEU(11)	LEU(13)	LEU(14)	LEU(11)	LEU(11)	LEU(14)	
47	TRP(1)		TYR(2)	TRP(2)						TRP(2)	TRP(2)	TRP(2)	
91	TYR(16)	TYR(4)	TYR(2)	TYR(8)	PRO(2)	TYR(2)	PRO(4)	TYR(2)	TYR(2)	TYR(2)	TYR(2)	TYR(2)	
102	TRP(11)	TRP(11)	TRP(18)	TRP(11)	TRP(4)	TRP(18)	TRP(24)	TRP(22)	TRP(19)	TRP(8)	TRP(19)	TRP(19)	
103	GLN(5)												

The buried, inward-pointing FR amino acids in the V_L domains, i.e., those which are located in the domain interior, are listed in Table 5 below.

10 **Table 5:** Inward-Pointing, Buried Framework Residues in the V_L of Fabs of Known Three-Dimensional Structure

POSITION		ANTIBODY											
		J339	HP3C102	HYHEL-10	HYHEL-5	RI3.9	4-4-10	36-71	B1312	D1.3	MEMH	KOL	
1	ILE	ILE	ILE	ILE	ILE	VAL	ILE	ILE	ILE	ILE			
4	LEU	MET	LEU	LEU	LEU	MET	MET	MET	MET	MET	LEU	LEU	
8	GLN	GLN	GLN	GLN	GLN	GLN	GLN	GLN	GLN	GLN	GLN	GLN	
11	THR	LEU	LEU	MET	LEU	LEU	LEU	LEU	LEU	LEU	VAL	ALA	
12	ALA	VAL	VAL	ALA	ALA	VAL	ALA	VAL	ALA	VAL	VAL	VAL	
13	VAL	VAL	VAL	VAL	VAL	VAL	VAL	VAL	VAL	VAL	VAL	VAL	
14	ILE	MET	LEU	MET	ILE	ILE	ILE	ILE	ILE	ILE	ILE	ILE	
22	CYS	CYS	CYS	CYS	CYS	CYS	CYS	CYS	CYS	CYS	CYS	CYS	
25	TRP	TRP	TRP	TRP	TRP	TRP	TRP	TRP	TRP	TRP	TRP	TRP	
27	GLN	GLN	GLN	GLN	GLN	LEU	GLN	LEU	GLN	GLN	GLN	GLN	
41	TRP	LEU	LEU	TRP	LEU	LEU	LEU	LEU	LEU	LEU	LEU	LEU	
49	ILE	ILE	ILE	ILE	VAL	ILE	ILE	ILE	ILE	VAL	PRO	ILE	
59	VAL	VAL	ILE	VAL	VAL	VAL	VAL	VAL	VAL	VAL	VAL	VAL	
61	ARG	ARG	ARG	ARG	ARG	ARG	ARG	ARG	ARG	ARG	ARG	ARG	
62	PRO	PRO	PRO	PRO	PRO	PRO	PRO	PRO	PRO	PRO	PRO	PRO	
71	TYR	PRO	PRO	TYR	TYR	PRO	TYR	PRO	TYR	TYR	ALA	ALA	
73	LEU	LEU	LEU	LEU	LEU	LEU	LEU	LEU	LEU	LEU	LEU	LEU	
74	ILE	ILE	ILE	ILE	ILE	ILE	ILE	ILE	ILE	ILE	ILE	ILE	
78	MET	VAL	VAL	MET	LEU	VAL	LEU	VAL	LEU	VAL	LEU	LEU	
81	ASP	ASP	ASP	ASP	ASP	ASP	ASP	ASP	ASP	ASP	ASP	ASP	
82											PRO		
83	ALA	ALA		ALA	ALA	ALA	ALA	ALA	ALA	ALA	ALA	THR	
84	TYR	TYR	TYR	TYR	TYR	TYR	TYR	TYR	TYR	TYR	TYR	TYR	
86	CYS	CYS	CYS	CYS	CYS	CYS	CYS	CYS	CYS	CYS	CYS	CYS	
101	THR	THR	THR	THR	THR	THR	THR	THR	THR	THR	THR	THR	
104	LEU	LEU	LEU	LEU	LEU	LEU	LEU	LEU	LEU	LEU	LEU	VAL	
106	LEU	ILE	ILE	ILE		ILE	ILE			VAL	VAL	VAL	

Those in the V_H domain are listed in Table 6 below.

Table Inward-Pointing, Empty Framework Residues in the V_H of Fabs of Known Three-Dimensional Structure

POSITION	J559	McPC603	HyREL-10	HyREL-5	RI9.3	4-4-20	34-71	B1312	D1.3	NEWB	KOL
2	VAL	VAL	VAL				VAL	VAL	VAL		VAL
4	LEU	LEU	LEU	LEU	LEU	LEU	LEU	LEU	LEU	LEU	LEU
6	GLU	GLU	GLU	GLN	GLU	GLU	GLN	GLU	GLU	GLN	GLN
5			PRO								
12	VAL	VAL	VAL	MET	VAL	VAL	VAL	VAL	VAL	VAL	VAL
18	LEU	LEU	LEU	VAL	VAL	MET	VAL	LEU	LEU	LEU	LEU
20	LEU	LEU	LEU	ILE	MET	LEU	MET	LEU	ILE	LEU	LEU
22	CYS	CYS	CYS	CYS	CYS	CYS	CYS	CYS	CYS	CYS	CYS
24	ALA	THR	VAL	ALA	ALA	ALA	ALA	ALA	VAL	VAL	SER
27	PHE	PHE	ASP	TYR	TYR	PHE	TYR	PHE	PHE	THR	PHE
29	PHE	PHE	ILE	PHE	PHE	PHE	PHE	PHE	LEU	PHE	PHE
34	TRP	TRP	TRP	TRP	TRP	TRP	TRP	TRP	TRP	TRP	TRP
38	ARG	ARG	ARG	LYS	LYS	ARG	LYS	ARG	ARG	ARG	ARG
40						SER					
48	ILE	GLU	GLU	GLU	ILE	VAL	ILE	VAL	LEU	ILE	VAL
48	ILE	ILE	MET	ILE	ILE	ALA	ILE	ALA		ALA	ALA
66	LYS	ARG	ARG	LYS				ARG	ARG	ARG	ARG
67	PHE	PHE	ILE	ALA	THR	PHE	THR	PHE	LEU	VAL	PHE
69	ILE	VAL	ILE	PHE	LEU	ILE	LEU	ILE	ILE	MET	ILE
71	ARG	ARG	ARG	ALA	VAL	ARG	VAL	ARG	LYS	VAL	ARG
78						SER					
78	LEU	LEU	TYR	ALA	ALA	VAL	ALA	LEU	VAL	PHE	LEU
80	LEU	LEU	LEU	MET	MET	LEU	MET	LEU	LEU	LEU	LEU
82	MET	MET	LEU	LEU	LEU	MET	LEU	MET	MET	LEU	MET
82C	VAL	LEU	VAL	LEU	LEU	LEU	LEU	LEU	VAL	VAL	VAL
88	ASP	ASP	ASP	ASP	ASP	ASP	ASP	ASP	ASP	ASP	ASP
88	ALA	ALA	ALA	ALA	ALA	ALA	ALA	ALA	ALA	ALA	ALA
90	TYR	TYR	TYR	TYR	TYR	TYR	TYR	TYR	TYR	TYR	TYR
92	CYS	CYS	CYS	CYS	CYS	CYS	CYS	CYS	CYS	CYS	CYS
94	ARG	ARG	ASN	VAL	ARG	ARG	ARG	ARG	ARG	ARG	ARG
107	THR	THR		THR	THR	THR	THR	THR	THR	SER	THR
109	VAL	VAL	VAL	LEU	LEU	VAL	LEU	LEU	VAL	VAL	VAL
111	VAL	VAL	VAL	VAL	VAL	VAL	VAL	VAL	VAL	VAL	VAL

5 From the above, it may be seen that
 (1) There are many FR amino acids that either contact the CDRs or the opposite domain, or are found in the domain interior.

(2) These FR amino acids, which could influence the structure of the combining site, and thus the antigen-binding characteristics of an antibody, are
 10 different from antibody to antibody.

It is obvious from these results that no one structure can serve as the perfect and sole basis of all "animalization", or in the present example "humanization", protocols. In fact, to "humanize" the 9 murine antibodies shown in Table 1 above by CDR-grafting with a view to preserving their ligand-
 15 binding properties, the FR amino acids listed in Table 2 to 6 above would have to be retained.

A search through the tables of immunoglobulin sequences (Kabat et al., "Sequences of Proteins of Immunological Interest", 5th Ed. US Dept. of Health and Human Service, NIH Publication No.91-3242 (1991)), shows that human
 20 variable domain sequences are known that already have most of the FR amino acids that need to be preserved as shown in Table 7 below.

Table 7: Human Antibodies that are Most Similar in Sequence to Murine Antibodies of Known Three-Dimensional Structure

ANTIBODY DOMAIN	MOST SIMILAR MURINE SEQUENCE
HYHEL-10 VH VH FRAMEWORK VH IMPT VL VL FRAMEWORK VL IMPT	58P2'CL (77/112) 15P1'CL, H11'CL (62/87) 58P2'CL, AD26'CL, C492'CL (28/38) IARC/BL41'CL (73/107) IARC/BL41'CL (59/80) IARC/BL41'CL (30/37)
HYHEL-5 VH VH FRAMEWORK VH IMPT VL VL FRAMEWORK VL IMPT	MD'CL (74/116) 783c'CL, X17115'CL (63/87) 21/28'CL, 51P1'CL, 783c'CL, 8E10'CL, AMD, KAS, NEI'CL, X17115'CL (25/37) HF2-1/17'CL, KAS (65/105) HF2-1/17'CL (57/80) BI, DEN, HF2-1/17'CL, KUE, REI, WALKER'CL, WIL(-) (27/36)
R19.9 VH VH FRAMEWORK VH IMPT VL VL FRAMEWORK VL IMPT	21/28'CL (73/119) 21/28'CL, 51P1'CL, AMD, LS2'CL, NEI'CL (60/87) 21/28'CL, 8E10'CL, LS2'CL (28/38) WALKER'CL (78/107) RZ (62/80) REI, WALKER'CL (33/36)
4-4-20 VH VH FRAMEWORK VH IMPT VL VL FRAMEWORK VL IMPT	30P1'CL (77/116) 2P1'CL, 3D6'CL (65/87) 484'CL, H26'CL (36/41) RPH1-6410'CL (91/112) GM-607-'CL (68/80) CDM, FR, NIK (33/36)
J539 VH VH FRAMEWORK VH IMPT VL VL FRAMEWORK VL IMPT	30P1'CL, Vh38C1.10'CL (81/118) 18/2'CL, 30P1'CL, M43 (71/87) 38P1'CL, 56P1'CL, M72, M74 (36/40) PA (62/105) LEN, WEA (53/80) BI, DEN, KUE, REI, WALKER'CL, WIL(-) (26/35)
McPC603 VH VH FRAMEWORK VH IMPT VL VL FRAMEWORK VL IMPT	M72 (81/120) 4G12'CL, Ab18'CL, M72 (70/87) 56P1'CL, M72, M74, RF-SJ2'CL (36/42) FK-001'CL, LEN (91/113) LEN (70/80) LEN (38/42)
36-71 VH VH FRAMEWORK VH IMPT VL VL FRAMEWORK VL IMPT	21/28'CL (74/119) 21/28'CL, 51P1'CL, 783c'CL, AMD'CL, NEI'CL, X17115'CL, (61/87) 21/28'CL, 8E10'CL (28/38) AG (76/105) RZ (63/80) REI, RZ, WALKER'CL (34/37)

Table

Human Antibodies that are Most Similar
Sequence to Murine Antibodies of Known
Three-Dimensional Structure (Cont'd)

B1312	VH	56P1'CL (83/119)
	VH FRAMEWORK	4B4'CL, 4G12'CL, M26'CL, H72, RF-SJ2'CL, VH38C1.10'CI (68/87)
	VH IMPT	56P1'CL, H72, H74, RF-SJ2'CL (37/39)
	VL	RFM1-6410'CL (86/112)
D1.3	VH	C6B2'CL (72/116)
	VH FRAMEWORK	C6B2'CL (62/87)
	VH IMPT	M60'CL (32/37)
	VL	BR (75/107)
D1.3	VH	H72-1/17'CL (64/80)
	VH FRAMEWORK	306'CL, BI, DEN, EU, KUE, PA, REI, WALKER'CL, WIL(-)
	VH IMPT	

5 These human sequences are not necessarily those which are most similar to the murine antibodies, overall or in the framework regions only, but rather, those that possess the largest number of important amino acids in common, the latter sequences being included in Table 7 above.

10 The number of murine amino acids that still need to be retained in order to have all the important FR amino acids in the "humanized" or analogue versions of the murine antibodies, as shown in Table 7 above, ranges from 21 (for HyHEL-5:12 in V_H and 9 in V_L) to 5 (for B1312:2 in V_H and 3 in V_L). These are not very many amino acids, considering that the resulting "humanized" or analogue molecules will probably retain most or all their ligand-binding

15 characteristics. It is possible that there exist other human sequences that are even more similar to these murine domains that are not included in the compilation of Kabat, et al. (1991), supra. When more sequences become available these may also be incorporated to improve the pool of basic data available.

- b) Choosing the best human framework to use in the "humanization" of an antibody when its structure is not known
- In the absence of a three-dimensional structure, the identification of the FR amino acids that are crucial to maintain the combining site structure is not easily done. Nevertheless, some proposals may be made from the data shown in Tables 2 to 6 above that have been collected in Tables 8 and 9 below for the V_L and V_H domains.

10 **Table 8:** Framework Residues in V_L That Probably Need to Be Preserved in Order to Reproduce the Ligand Properties of the Original Antibody

		CDR1			
J559	E I . L . Q T . A V . I . C	saas	-----	ewssib	WYQQ SP . FMIV
H2PC603	Q I V M T Q L . V V . M . C	ksaq	llsqnqkndla	WYQQ SP . LLIV	
HYNEL-10	Q I V L Q L . V V . L . C	ksaq	-----	sqnqalb	WYQQ SP . LLIK
HYNEL-5	Q I V L Q M . A V . M . C	saas	-----	ewnywy	WYQQ SP . AMIV
R19.9	. I Q M T Q L . A V . I . C	ksaq	-----	disnyla	WYQQ T . KLLIV
4-4-20	Q V M T Q L . V A . I . C	ksaq	slwbaqqntylr	WYIQ PKVLIY	
36-71	Q I Q M Q L . A V . I . C	ksaq	-----	dinnfln	WYQQ I . LLIV
R1312	. V L M Q T L . V A . I . C	ksaq	tkllsqdtyla	WYQQ SP . LLIV	
D1.3	D I . M . Q L . A V . I . C	ksaq	-----	nbnyla	WYQQ SP . LLIV

		CDR2		CDR3		
J559	eiaklas	. V R . F	Y . L . I M	D . A T . Y . C	qqcypylit	F T . L . I .
H2PC603	qaatrea	. V D . R . F	S . T . D . F . L . I	V D . A T . Y . C	qndhyyplit	F A . T . L . I .
HYNEL-10	yasqsla	. I R . F	T . F . L . I V	D M . I . T . C	qqaawpyt	F T . L . I .
HYNEL-5	etaklas	. V R . F	Y . L . I M	D . A T . Y . C	qqqatopt	F T . L . I .
R19.9	yeaslas	. V R . F	D . F . L . I L	D A . Y . T . C	qqqatopt	F T . L . I .
4-4-20	kvaaefa	. V D . R . F	T . F . L . I V	D T . Y . C	sqsthyopt	F T . L . I .
36-71	ftaaefa	. V R . F	T . D . Y . L . I L	D . A T . Y . C	qqqalopt	F T . L . I .
R1312	kvaaefa	. V D . R . F	T . F . L . I V	D T . Y . C	lqqaawpyt	F T . L . I .
D1.3	ycaatla	. V R . F	S . T . Y . L . I L	D T . Y . C	qqawopt	F T . L . I .

15 **Table 9:** Framework Residues in V_H That Probably Need to Be Preserved in Order to Reproduce the Ligand Properties of the Original Antibody

		CDR1			
J559	. V . A . L V	K . G . A F . R	h . y . m	h . y . m	h . y . m
H2PC603	. V . A . L V	K . G . A F . R	h . y . m	h . y . m	h . y . m
HYNEL-10	. V . A . L V	K . G . A F . R	h . y . m	h . y . m	h . y . m
HYNEL-5	. V . A . L V	K . G . A F . R	h . y . m	h . y . m	h . y . m
R19.9	. V . A . L V	K . G . A F . R	h . y . m	h . y . m	h . y . m
4-4-20	. V . A . L V	K . G . A F . R	h . y . m	h . y . m	h . y . m
36-71	. V . A . L V	K . G . A F . R	h . y . m	h . y . m	h . y . m
R1312	. V . A . L V	K . G . A F . R	h . y . m	h . y . m	h . y . m
D1.3	. V . A . L V	K . G . A F . R	h . y . m	h . y . m	h . y . m

		CDR2		CDR3	
J559	slap	-----	deqslwspabd	W . F	h . y . m
H2PC603	slap	-----	deqslwspabd	W . F	h . y . m
HYNEL-10	slap	-----	deqslwspabd	W . F	h . y . m
HYNEL-5	slap	-----	deqslwspabd	W . F	h . y . m
R19.9	slap	-----	deqslwspabd	W . F	h . y . m
4-4-20	slap	-----	deqslwspabd	W . F	h . y . m
36-71	slap	-----	deqslwspabd	W . F	h . y . m
R1312	slap	-----	deqslwspabd	W . F	h . y . m
D1.3	slap	-----	deqslwspabd	W . F	h . y . m

		CDR2		CDR3	
J559	slap	-----	deqslwspabd	W . F	h . y . m
H2PC603	slap	-----	deqslwspabd	W . F	h . y . m
HYNEL-10	slap	-----	deqslwspabd	W . F	h . y . m
HYNEL-5	slap	-----	deqslwspabd	W . F	h . y . m
R19.9	slap	-----	deqslwspabd	W . F	h . y . m
4-4-20	slap	-----	deqslwspabd	W . F	h . y . m
36-71	slap	-----	deqslwspabd	W . F	h . y . m
R1312	slap	-----	deqslwspabd	W . F	h . y . m
D1.3	slap	-----	deqslwspabd	W . F	h . y . m

15 From Tables 8 and 9 above, it may be seen that many of the important FR amino acids flank the CDRs. Among these flanking positions are most of the

FR amino acids that are involved in the contact with the opposite domain as shown in Table 4 above, and many of those which are in contact with the CDRs as shown in Tables 2 and 3 above. Moreover, almost all of the FR amino acids that have been observed to participate in the binding to antigen (Amit, A.G., et al., Science 233:747-753 (1986); Sheriff, et al., P.N.A.S. (USA) 82:1104-1107 (1987); Padlan, E.A., et al., P.N.A.S. (USA) 86:5938-5942 (1989); Tulip, et al., Cold Spring Harbor Symp. Quant. Biol. 54:257-263 (1989); Bentley, et al., Nature (London) 348: 254-257 (1990)), are in these flanking regions. Thus, during "animalization" or "humanization" or formation of the analogue peptides, not just the CDRs are retained, but also some of the residues immediately adjacent to the CDRs. This provides a better chance of retaining more of the ligand-binding properties of the original antibody. The likelihood of retaining the antigen binding properties of the original antibody is even greater if the first few amino acids in the NH₂-termini of both chains are also retained, since some of them are found to be in contact with CDRs as shown in Tables 2 and 3 above. Further, Tables 8 and 9 above also show many other framework positions that are deemed structurally important in all the cases examined here. The xenogeneic residues at those positions should probably be retained as well.

Alternatively, it may possible to reduce immunogenicity, while preserving antigen-binding properties, by simply replacing those exposed residues in the framework regions which differ from those usually found in human antibodies (Padlan, E.A. (1991), supra). This would "humanize" the surface of the xenogeneic antibody while retaining the interior and contacting residues which influence its antigen-binding characteristics. The judicious replacement of exterior residues should have little, or no, effect on the interior of the domains, or on the interdomain contacts. For example, the solvent accessibility patterns of the F_s of J539, a murine IgA (κ) and of KOL, a human IgG1 (λ) have been found to be very similar (Padlan, E.A. (1991), supra).

At present, more than 35 different Fab structures have been elucidated by X-ray diffraction analysis, although atomic coordinates for only 11 are currently in the Protein Data Bank as shown in Table 1 above. Most of the available structures have been analyzed to only medium resolution, some having been refined to only a limited extent. Eventually, atomic coordinates for more and better-refined structures will become available, so that the "important" FRs will be more easily assessed. This will improve the theoretical predictive record of the present method for determining the best mode for the analogue peptides.

As already indicated above, the specificity of an antibody depends on the CDR structures and sometimes, on some neighboring residues as well. These structures, in turn, depend on contacts with framework amino acids and on the

interaction of the V_L and V_H domains. Thus, to ensure the retention of binding affinity, not only the CDR residues must be preserved, but also those FRs that contact either the CDR's or the opposite domain, as well as all buried residues, which give shape to the variable domains.

5 This design of the humanized versions of murine antibodies is reached in stages as follows.

- 1- Choice of a xenogeneic model of known structure.
- 2- Choice of the target species FR.
- 10 3- Identification of xenogeneic/target species differences.
- 4- Identification of important xenogeneic amino acids.

(1) Choice of a xenogeneic model of known structure

The V_H and V_L domains of an antibody of desired specificity are classified according to Kabat et al. (1991), supra. Then, an antibody of the same species may be chosen, whose structure has been determined, and whose
15 variable regions belong to the same classes and subclasses. Modeling the xenogeneic antibody in question to such structure ensures maximal chance for success. This, however, is not absolutely necessary since the relative positions of the important amino acids do not vary considerably even in variable regions of different classes. Thus, with less than a perfect match this method may still
20 be applied to design the analogues of this invention. Once the xenogeneic model is chosen, it may be applied to identify the locations of important residues in the xenogeneic antibody to be animalized (humanized). Tables 2, 3, 4, 5, 6, 8 and 9 indicate the positions of the important amino acids in several antibodies whose structures have been determined to a high resolution level.

25 (2) Choice of the target species FR

The target species framework should, ideally, be a consensus framework. That is, one that has a maximum number of amino acids in common with all human frameworks of the same class. This is important, because, the goal of
30 humanization is to avoid an immunological response against the engineered analogue peptide.

The target species framework that is chosen is that which shares the greatest number of important amino acids with the original xenogeneic antibody. Thus, in choosing the target species (human) FR, the similarity between the important amino acids is more important than the overall similarity.

35 In practice, the sequences of the xenogeneic variable chains are aligned with the consensus sequences from all variable region classes of the target species and the number of differences in the amino acids that must be retained from the xenogeneic species are scored. The human consensus sequence(s) that

score(s) the lowest number of differences is (are) then chosen. These are the best analogue peptide candidates. Others with low numbers that are higher than the above may also be suitable, and are placed in a reserve pool, and so forth.

If there are too many differences in the chosen framework (e.g., more than 16),
5 then the same alignment procedure using all tabulated human sequences may be repeated in order to find a specific human framework whose similarity with the xenogeneic sequence is maximized at the positions of the important amino acids.

Thus, most preferably, the target species FR should be a consensus sequence. Next preferable would be a framework of a common target species (human)
10 antibody, and finally, the framework of any target species (human) antibody.

(3) Identification of xenogeneic target species differences

The xenogeneic sequences are then aligned with the target species sequences and the positions of all amino acids that differ in the murine and in the human frameworks are tabulated. Such a table contains the maximum
15 number of amino acids that can be changed toward the full "animalization" ("humanization") of the xenogeneic antibody (see, Tables 31 and 32 below). If all those changes were to be made, a so-called CDR-grafted antibody would be obtained. That is, only the original CDRs would be retained from the murine antibody. In some cases, possibly, such CDR-grafted antibody may maintain the
20 original binding affinity. In most instances, however, the affinity of a CDR-grafted antibody would be considerably less than that of the original xenogeneic antibody. In order to maximize the chances for conserving the original affinity, the identities of all important amino acids must be preserved.

(4) Identification of important xenogeneic amino acids

If the outlined approach to animalization (humanizing) an antibody is
25 followed strictly, the amino acids that are correspondingly important in the model xenogeneic antibody chosen in step 1 are retained. In a more preferred approach, however, the amino acids that have been shown to occupy important positions in other antibodies of the same species or of the target species may also be
30 retained and are therefore taken out from the group of candidates to be mutated. This preferred approach may be particularly appropriate when there is a chance that the amino acids in question could make contacts with the CDRs or with the opposite chains. Once the important xenogeneic amino acids are identified, the DNA sequence may be mutagenized to change all other amino acids, which for
35 the most part occupy exposed positions.

The present method is exemplified for a murine antibody humanized with the intent of diminishing or avoiding a HAMA response upon its administration

to humans. Murine and human antibodies, whose three-dimensional structures have been deduced to a high degree of resolution, were utilized as guidance in the choice of the amino acids to be substituted in order to humanize the particular murine antibody utilized. The method, however, may be applied more generally to transform antibodies from one species into a less immunogenic form to be administered to a second species, provided that adequate three-dimensional models are available for antibodies from those species. Information on other murine antibodies from a Data Bank was used in the exemplary disclosure provided below to modify the BrE-3 and anti-KC-4 murine-human chimeric antibodies with human amino acids. Similarly, antibodies of other species besides murine may also be utilized, their CDRs and other amino acids preserved and those amino acids not considered "important" replaced with human amino acids. Similarly, the above approach may be applied to the preparation of "animalized" antibodies for any animal species. This may be attained by substituting amino acids of the antibody target species into an antibody of another species in accordance with this invention.

Various peptide structures, such as CDRs, and analogue antibodies, Fab, Fab', (Fab')₂, and variable fragments having a desired specificity, may be constructed and optionally bridged via a linker. In addition, one or more of the peptides may be attached to one or more effector agent(s) or bridged via a linker. Multiple antibody, variable regions, Fab, Fab', (Fab')₂, CDRs and the like, and combinations thereof, may also be constructed and bridged via linkers or attached to one or more effector agents such as are described below.

The cDNAs encoding the analogue variable regions of an antibody of a desired specificity may be cloned into a vector, optionally containing sequences encoding constant regions or fragments thereof, enzymes, neuropeptides, other peptide transmitters, toxins, hormones, operative conjugation regions, cytokines, lymphokines and the like, optionally under the same promoter. Although this is the cloning strategy utilized in the exemplary disclosure of this invention, other methods known in the art may also be utilized such as co-expression and the like. In the exemplary disclosure provided herein, the anti-BrE-3 and anti-KC-4 murine-human chimeric antibodies specifically binding to human mammary mucin and carcinoma cells was constructed by joining the DNAs of the anti-BrE-3 or anti-KC-4 murine variable domain to a human constant domain (an effector agent) cloned into a hybrid vector, and the product expressed by transfecting the vector into myeloma cells. The variable regions of the chimeric antibody were modified at the DNA level to obtain an analogue or "humanized" chimeric polypeptide. The modifications to the variable regions of the peptides may either be conducted by PCR amplification with primers that are custom tailored to

produce the desired mutations, or by gene synthesis.

The analogue "humanized" peptides prepared and exemplified below comprise the "humanized" variable regions of the anti-BrE-3 or anti-KC-4 murine antibodies (U.S. Patent Nos. 5,075,219 and 4,708,930) and the kappa and gamma 1 constant region of a human antibody. These humanized antibodies were characterized by their molecular weights and binding specificities, and shown to compete well with or better than the respective parent murine and chimeric antibodies for the antigen. The analogue "humanized" peptides were shown to bind weakly to normal breast, lung, colon and endometrium, and strongly to carcinoma tissue sections by the ABC immunoperoxidase method. The portions of the CDR and FR regions of the non-modified peptides (murine F₁ regions) and effector agents (human F₁ regions) were shown in both cases to be substantially identical to those of the non-human and human antibodies from which they were obtained. The analogue peptides and hybrid derivatives of this invention lacking any non-human constant region sequences possess less foreign antigenic epitopes than the whole xenogeneic or chimeric antibodies from which they are derived. Accordingly, they are expected to elicit a less complex immunogenic response in animals such as humans than the corresponding non-human whole antibodies or even than the chimeric antibodies. However, to what extent a portion of the non-human FR amino acids may be replaced without altering the binding characteristics of the CDRs could not have been predicted prior to this invention because of the substantial conformational alterations in the interior regions that affect the binding of the CDRs to the antigen that may occur upon modification of amino acid sequences.

Thus, the substantially pure, isolated analogue peptide of the invention specifically and selectively binds to an antigen present on the surface or in the cytoplasm of a carcinoma cell or that is released by the cell. The polypeptide consists essentially of at least one CDR or variable region of the light or heavy chains of an antibody of a first species having affinity and specificity for an antigen found on the surface or the cytoplasm of a carcinoma cell of another species or that is released by the cell, wherein when the framework regions (FRs) are present, about 1 to at least 46 amino acids in the FRs are substituted per chain with amino acids, e.g., present in equivalent positions in antibodies of other species or similar amino acids, or fragments thereof comprising 1 to 3 CDRs per chain, or 1 to 3 CDRs per chain plus flanking regions thereof, each of about 1 to 10 or more amino acids, alone or plus an N-terminal fragment of about 1 to 10 or more amino acids, combinations thereof wherein each analogue peptide is operatively linked to at least one other analogue peptide, combinations thereof and mixtures thereof.

A single unit of the analogue peptide of the invention may be as short as the shortest CDR and as long as the longest combination of variable regions, antibodies, and the like, including non-peptide polymers of up to about 10⁶ molecular weight, and in some instances even larger. When several units are
5 linked or other combinations provided, the size of the analogue peptide increases accordingly. The smaller molecular weight analogue peptides are particularly suited for greater penetration of cells, the brain-blood barrier, and tumors, among others, and have a shorter half life, whereas the higher molecular weight polypeptides are suited for either in vitro or in vivo applications such as therapy,
10 imaging and diagnosis. The latter are generally cleared from the body over a longer period of time.

The analogue peptide of the invention may contain amino acid sequences derived from light and/or heavy chains of antibodies of a first or xenogeneic species raised against a variety of antigens and/or epitopes. For example, the
15 murine antibodies disclosed in the examples were raised against human mammary fat globule mucin (BrE-3) and the "KC-4" antigen in human carcinoma cells (KC-4). Other antigens comprising a variety of epitopes may also be utilized to generate the xenogeneic antibodies as long as the antibody contributing the variable region displays low affinity and specificity for normal cells and higher
20 affinity and specificity for human carcinomas that will permit their specific binding to carcinoma cells, preferably, in a variety of tissues. Similarly, the antibodies may be raised in animals of different xenogeneic species. The antibodies from which the polypeptide of the invention is derived may be a murine, rat, goat, birds including poultry, rabbit, guinea pig, equine, bovine, and
25 primate including human and simian, antibodies, among others. The preparation of the antibody and fragments thereof encompassed by the invention is similar, whether the origin of the antibody is human or non-human. The original variable region mRNA may be obtained from cells of any desired xenogeneic species and the remainder of the work-up is similar, utilizing a model antibody of the same
30 xenogeneic species and substituting amino acids from the target species.

The humanization procedure described here is designed to minimize potential losses in antigen binding affinity that may result from the introduced amino acids. In the case of the BrE-3 antibody exemplified below, eight amino acid changes were made in the variable region of the light chain and in the
35 variable region of the heavy chain. In the case of the anti-KC-4 antibody exemplified below, seven amino acid changes were introduced in the variable region of the light chain and twelve amino acid changes were made in the variable region of the heavy chain. Furthermore, to minimize the immunological response to the humanized antibody, target human amino acid sequences were

used that comprise the consensus sequences of all appropriate human variable regions. Nevertheless, neither the exemplified amino acid changes nor the exemplified human target sequences are the only choices encompassed by this invention. Many other individual amino acid changes and permutations thereof
 5 may be made without the expectation of significantly affecting either the affinity of the resulting antibody or its human immunogenicity, as taught herein.

The following Tables 10 and 11 indicate other possible amino acid changes for the variable regions of the BrE-3 and KC-4 sequences of the invention. The amino acid positions (or numbers) are as conventionally accepted
 10 (Kabat et al., 1991, supra). The most preferred changes are indicated under the heading "Most Preferred Analogue". For antibodies other than the BrE-3 and anti-KC-4 antibodies, the amino acids shown in the BrE-3 and KC-4 columns become also part of the group of most preferred choices. Amino acid changes
 15 that are not part of the most preferred group but that are still part of this invention are indicated in the next column under the heading "Preferred Analogue". In some instances, the "Preferred Analogue" choices become too numerous and the least acceptable choices are provided instead for that position. Clearly, all amino acids other than those listed under "Not Preferred Analogue" may be substituted at that position.

Table 10: Alternative Amino Acids for V_L Chain

V _L	BrE3	KC4	Most Preferred Analogue	Preferred Analogue	Not Preferred Analogue
FR1					
1	D	D			WIPLMCR
2	V	V	I	WKCRH	
3	V	L	L(V)		YC
4	M	M	LVI	PTQ	
5	T	T			
6	Q	Q			
7	T	T	IADS		WYMCGH
8	P	P	AE		WYFKCN
9	L	L	FP		WYMH
10	S	S	T		HDQ
11	L	L	NV		WYCRGH
12	P	P	S		WIKH
13	V	V			YKCRHN
14	S	T	T(S)		WMCE
15	L	P	PFIL		WYCGHDNEQ
16	G	G			
17	D	E	TEQ(D)		WIYFPMCR
18	Q	P	PS(Q)		WYFCAHDN
19	A	A	V		WPKMCRTHNQ
20	S	S			WPLCHD
21	I	I			WPKCGDEQ
22	S	S			WVMCHE
23	C	C			

Table 10: Alternative Amino Acids for V_L Chain (Cont.)

BrE3	KC4	Most Preferred Analogue	Preferred Analogue	Not Preferred Analogue
FR2				
35	W	W		
36	F	F	YL(F)	IVHN
37	L	L	Q	WLVKRTHDE
38	Q	Q		IFMCATSDN
39	K	K	R	WIPMCA
40	S	P	P(S)	FLKARTGQ
41G				
42	Q	Q		IYFPMCT
43	S	S	P	WYVCD
44	P	P		WYFKMHDNEQ
45	K	Q	EQR(K)	WYKCRGHDO
46	L	L	RV	YPCGHQ
47	L	L	V	KCD
48	I	I		WILMTSN
49	Y	Y	S	FPLVMTS
FR3				
57	G	G		WVTSGDNEQ
58	V	V		IYFLVMATQ
59	P	P	S	
60	D	D	N	WFMCR
61	R	R	T	
62	F	F		
63	S	S	T	IYPLKARSG
64	G	G	D	
65	S	S		
66	G	G		YCHDQ
67	S	S	A	VKMCRHN
68	E	G	GD(E)	VMCARSGQ
69	T	T		WPMCE
70	D	D		WIFPMCR
71	F	F		WKMTEQ
72	T	T		WLMCGHNEQ
73	L	L		
74	K	K	NLRE	WLMCHD
75	I	I	L	
76	S	S	IT	LVMC
77	R	R	S	WYFLKCHQ
78	V	V	ALI	WYFKCRHNE
79	E	E	KGQ	WVKM
80	A	A	P	WLKM
81	E	E		ILVKMAGDNE
82	D	D		
83	L	V	MV(L)	WCRH
84	G	G		LVARTSG
85	V	I	IM(V)	WFKCQ
86	Y	Y		
87	F	Y	YL(F)	IMSHE
88	C	C		

Table 10: Alternative Amino Acids for V_L Chain (Cont.)

BrE3	KC4	Most Preferred Analogue	Preferred Analogue	Not Preferred Analogue
FR4				
98	F	F		
99	G	G		
100	G	G	ASQ	IPVKRTG
101	G	G		
102	T	T		
103	K	K	NR	IYMATGHDEQ
104	L	L	V	LG
105	E	E		ILVTSGHNEQ
106	I	I		YLVKMRTD
106	a	a		PLVTI
107	K	K	R	ILVMATSGNE

Table 11: Alternative Amino Acids for V_H Chain

VL	BrE3	KC4	Most Preferred Analogue	Preferred Analogue	Not Preferred Analogue
FR1					
1	E	E	Q	PVLKARGHDEQ	
2	V	V	M		WYPKCRHV
3	K	Q	QR(K)	L	
4	L	M			WYKCRSN
5	E	V	VD(E)		WYCG
6	E	E	QD		WLYFMSH
7	S	S	T		IMCRHD
8	G	G	E		
9	G	G			WIYKCRNQ
10	G	G	DA		WIYFMCH
11	L	L	VF		WKCGHN
12	V	V	I		WYPTHQ
13	Q	Q	KE		WYFCD
14	P	P			WIYMCRDQ
15	G	G			IYCHN
16	G	G	RSE		WIYFMC
17	S	S	PA		WIYCHDNE
18	M				WYCD
19	K	R	R(K)		WIYPCH
20	L	L	V		WYFPKDNQ
21	S	S			WMH
22	C	C			
23	A	A	TSE		WFLMCH
24	A	A	V		WKMCRRHNEQ
25	S	S			WIVMRHDEQ
26	G	G			
27	F	F			WPMCR
28	T	A	AINS(I)		CHQ
29	F	F			WYKCRHONEQ
30	S	S			WLMCDQ

Table 11: Alternative Amino Acids for V_n Chain (Cont'd.)

VL	BrE3	KC4	Most Preferred Analogue	Preferred Analogue	Not Preferred Analogue
FR2					
36	W	W			
37	V	V		WIFLVMATGQ	
38	R	R			YFS
39	Q	Q			FPVMCA
40	S	A	VA(S)		WY
41	P	P	TS	PLVARTSHNEQ	
42	E	G	G(E)		YPLKMCTHN
43	K	K			WYLVCS
44	G	G	SR		WIFMCH
45	L	L			
46	E	E	Q		FPMCRTD
47	W	W			PMARNO
48	V	V	STG		YPKCARTHNO
49	A	A			WFPKCRHNO
FR3					
66	R	R			WYLVMCATSDE
67	F	F			WYPKMHNEQ
68	T	T	IS		WYPGE
69	I	I			WYKCHNQ
70	S	S	L		WVMCHDEQ
71	R	R			WYFCHDQ
72	D	D	N	VKRTSGHDE	
73	D	N	N(D)		WYFLC
74	S	S	A	FPLVTGDN	
75	K	K	EN		NPCGD
76	S	N	NTR(S)		WFPLMCE
77	R	T	TNIVSM(R)		WFC
78	V	L	LA(V)		WKCRNE
79	Y	Y	FH		WPG
80	L	L			
WYLKARGHEQ					
81	Q	Q	E		WYFPC
82	M	M			YPCTGHDEQ
82a	I	N	SDN(I)		WMO
82b	S	S	IR		WYFPLMHQ
82c	L	L		PLVMAGE	
83	R	R	EKT		WILCH
84	A	A	SPVTI		WKCDEQ
85	E	E	D	WYFPLMCRG	
86	D	D			
87	T	T	M		WLVMCNE
88	G	A	A(G)		WYPKGEQ
89	L	V	ITVM(L)		
90	Y	Y	HF		WIPLVKMAGO
91	Y	Y			
92	C	C			
93	T	A	ASHAV(T)		WIFR
94	G	R	R(G)	TSDQLAW	
FR4					
103	W	W	A		
104	G	G	YH		
105	Q	Q	THR		IYFLVMCDQ
106	G	G			
107	T	T	AQ		
108	L	L	STGM		WYCHDE

Table 11: Alternative Amino Acids for V_H Chain (Cont'd.)

VL	BrE3	KC4	Most Preferred Analogue	Preferred Analogue	Not Preferred Analogue
109	V	V	LT	IK	
110	T	T	SL		
111	V	V			
112	S	S	T		
113	A	S	S(A)	PLVATG	

Similar tables may be constructed for any and all amino acid sequences for other xenogeneic antibodies as taught herein.

In one particularly preferred embodiment of the invention, the humanized anti-carcinoma analogue peptide comprises the amino acid sequence ID No. 67 to 73 of Table 47, the sequence ID No. 75 to 81 of Table 48, the sequence ID No. 95 to 102 of Table 55 and/or the sequence ID No. 103 to 108 of Table 56, and the sequences wherein about 1 to 46 or more amino acids in the FR are substituted per chain with amino acids such as those present in equivalent positions in human antibodies, or fragments thereof comprising 1 to 3 CDRs per chain or 1 to 3 CDRs per chain plus flanking regions thereof, each of about 1 to 10 or more amino acids, alone or plus an N-terminal fragment of about 1 to 10 or more amino acids, or combinations thereof wherein each analogue peptide is operatively linked to at least one other analogue peptide, and mixtures thereof.

The present analogue peptide is provided either as a naked peptide or in glycosylated form. When provided in glycosylated form, the analogue peptide may be operatively linked to a glycosyl residue(s) provided by the eukaryotic cell where it is expressed, or it may be cloned and expressed in a prokaryotic cell as the naked polypeptide and the glycosyl residue(s) added thereafter, for example by means of glycosyl transferases as is known in the art. Examples of glycosyl residue(s) that may be added to the analogue peptide of the invention are N-glycosylated and O-glycosylated residues, among others. The glycosyl residues added to the naked analogue peptide may have a molecular weight of about 20 to 50,000 daltons, and more preferably about 100 to 20,000 daltons or greater, depending on the size and molecular weight of the peptide to which they are attached. However, other types of polysaccharides and molecular weights may also be present. The glycosyl residues may also be attached to the naked analogue peptide of the invention by chemical means as is known in the art.

A single CDR is the smallest part of an antibody known to be capable of binding to an antigen. The sequences of the V_L and V_H CDRs of the BrE-3 exemplary analogue is shown in Tables 47 and 48 below. Thus, small peptides that have the sequence of a single CDR can bind antigen and are, therefore,

suitable for imaging tumors in vivo. A CDR attached to an effector peptide may be synthesized chemically or recombinantly encoded in a DNA segment. Such small molecules have great tumor penetration and extremely rapid clearing properties when compared to larger antibody fragments. In some cases, it is more convenient to produce these small molecules by chemical synthesis, as is known in the art, rather than by fermentation. In many cases, these small peptides are completely non-immunogenic and an immune response, such as the HAMA response, is altogether avoided. Also preferred are 2 and 3 CDR units per chain operatively linked to one another by 1 to 10 or more amino acids and up to the entire inter-CDR segment length as positioned in the variable regions.

Heavy and light chain analogue variable regions may be obtained individually or in V_H/V_L pairs, or attached to an effector peptide such as a constant region(s) or portions thereof, a drug, an enzyme, a toxin, a whole antibody, or any other molecule or radioisotope. The fragments of the analogue variable regions may be synthesized chemically as is known in the art or from the DNA segments encoding the non-human variable regions. This may be attained by PCR amplification of the DNA with primers synthesized to contain the desired mutation(s) as is known in the art. Similarly, the fragments encoding analogue variable regions may be synthesized chemically or obtained by established cloning methods of restriction digestion, ligation, mutagenesis, and the like, as is known in the art.

There are advantages to using the different molecular variants of the analogue peptide depending on the specific applications for which they are intended, some of which are listed below.

- a) Smaller molecules penetrate target tissues more efficiently and are cleared from the body much more rapidly than larger molecules.
- b) Single chain molecules can be manipulated and synthesized more efficiently than multiple chain molecules.
- c) Many of these variants can be synthesized efficiently and inexpensively in bacteria, including the non-glycosylated analogues.
- d) Bi-functional or multifunctional molecules may carry polypeptide effectors, such as enzymes, toxins, radioisotopes, drugs, and other molecules, to a target tissue.

The following list encompasses exemplary analogue peptides of the invention engineered with molecules derived from antibodies or antibody fragments. These analogue peptides, among others, are suitable for the practice of this invention. A more extensive list of polypeptide constructs may be found in O'Kennedy, R., and Roben, P. (O'Kennedy, R., and Roben, P., "Antibody Engineering: an Overview", *Essays Biochem.* (England) 26:59-75 (1991)).

The analogue peptides and hybrid peptides of this invention encompass CDRs and/or analogue variable regions, monoclonal antibodies, antibody

fragments such as Fab, Fab', (Fab')₂, and fragments thereof, CDRs, constant regions, single or multiple-domain and catalytic fragments, bi-functional or multifunctional combinations thereof, enzymes, peptide hormones, molecules such as drugs and linkers, transmitters, and toxins, among others. These are
5 suitable for imaging, therapy, and diagnostics.

Single-Chain Antigen-Binding Polypeptides

A method for constructing single chain antigen-binding polypeptides has been described by Bird et al. (Bird, R.E., et al., Science 242:243-246 (1988); Bird, R.E., et al., Science 244:409 (1989)). Single Chain F_v (scF_v or sF_v) are
10 single chain analogue peptides containing both V_L and V_H with a linker such as a peptide connecting the two chains (V_L-linker-V_H). The engineering may be done at the DNA level, in which case knowledge of the sequence is required. These analogue peptides have the conformational stability, folding, and ligand-binding affinity of single-chain variable region immunoglobulin fragments and may be
15 expressed in E. coli. (Pantoliano, M.V., et al., Biochem. (US) 30:10117-25 (1991)). The peptide linker binding the two chains may be of variable length, for example, about 2 to 50 amino acid residues, and more preferably about 12 to 25 residues, and may be expressed in E. coli. (Pantoliano, M.V., et al. (1991),
20 supra). An analogue peptide such as an scF_v may be expressed and prepared from E. coli and used for tumor targeting. The clearance profiles for scF_v in some situations fragments are advantageous relative to those of normal antibodies, Fab, Fab' or (Fab')₂ fragments. (Colcher, D., et al., J. Natl. Cancer Inst. 82:1191-7 (1990)). Another type of analogue peptide comprises a V_H-linker-V_L and may have about 230 to 260 amino acids. A synthetic gene using E. coli
25 codons may be used for expression in E. coli. A leader peptide of about 20 amino acids, such that of Trp LE may be used to direct protein secretion into the periplasmic space or medium. If this leader peptide is not naturally cleaved, the sF_v analogue peptide may be obtained by acid cleavage of the unique asp-pro peptida bond placed between the leader peptide and the sF_v-encoding region
30 (Houston, J.S., et al., "Protein Engineering of Antibody Binding Sites: Recovery of Specific Activity in an Anti-Digoxin Single-Chain F_v Analogue Produced in E. coli.", PNAS (USA) 85 (16):5879-83 (1988)). The construction, binding properties, metabolism and tumor targeting of the single-chain F_v analogue peptides derived from monoclonal antibodies may be conducted as previously
35 described (Milenic, D.E., et al., Cancer Res. (US) 51 (23 pt1):6363-71 (1991); Yokota, et al., "Rapid Tumor Penetration of a single-chain F_v and Comparison with Other Immunoglobulin Forms", Cancer Res. (US) 52(12):3402-8 (1992)). This type of analogue peptide provides extremely rapid tumor penetration and

even distribution throughout tumor mass compared to IgG or Ig fragments Fab and F(ab')₂.

Bifunctional scF₂-Fxn or Fxn-scF₂

5 An example of this type of analogue peptide is a V_L-linker-V_H with an effector peptide such as a hormone, enzyme, transmitter, and the like. These hybrid analogue peptides may be prepared as described by McCarney et al. (McCarney, J.E. et al., "Biosynthetic Antibody Binding Sites: Development of a Single-Chain F₂ Model Based on Antidinitrophenol IgA Myeloma MOPC 315", J. Protein Chem. (US) 10 (6):669-83 (1991)). A bi-functional hybrid analogue
10 peptide containing an F₂-binding fragment B of staph protein A amino terminal to a single-chain analogue F₂ region of the present specificity is also encompassed and may be prepared as previously described. (Tai, M.S., et al., Biochem. 29 (35):8024-30 (1990)). In this example of a hybrid analogue peptide of this invention is a Staph. A fragment B (anti F₂) - scF₂ polypeptide. The order
15 is backward of normal cases. This FB-sF₂ may be encoded in a single synthetic gene and expressed as peptide in E. coli. This analogue peptide is a good example of a useful multifunctional targetable single-chain polypeptide. A hybrid analogue peptide also comprising antibodies to a human carcinoma receptor and angiogenin is also part of this invention. Angiogenin is a human homologue of
20 pancreatic RNAse. This is an (Fab')₂-like antibody-enzyme peptide effector. Another hybrid analogue peptide comprising a V_H-CH1 heavy chain-RNAse may be expressed in a cell that secretes a chimeric light chain of the same antibody. A secreted antibody of similar structure was shown to cause the inhibition of growth and of protein synthesis of K562 cells that express the human transferrin
25 receptor (Rybak, S.M., et al., "Humanization of Immunotoxins", PNAS 89:3165-3169 (1992)).

Bi-specific Antibodies

A monoclonal antibody or antibody fragment may be incorporated into a bi-specific analogue peptide as described, for example, by Greenman et al.
30 (Greenman, J., et al., Mol. Immunol. (England) 28 (11):1243-54 (1991)). In this example, a bi-specific F(ab')₂ comprising two (Fab'-(thioether-link)-Fab') was constructed. Bi-specific antibodies may also be obtained when two whole antibodies are attached. Another way to obtain bi-specific antibodies is by mixing chains from different antibodies or fragments thereof. In this manner the
35 "left" branch of the bi-specific antibody has one function while the "right" branch has another.

Phage Display Libraries

The analogue peptides in accordance with this invention may be screened with a filamentous phage system. This system may also be used for expressing any genes of antibodies or fragments thereof as well as for screening for mutagenized antibody variants as described by Marks et al. (Marks, J.D., et al., "Molecular Evolution of Proteins on Filamentous Phage. Mimicking the Strategy of the Immune System", *J.Mol. Biol. (England)* 267 (23):1607-10 (1992)). A library of V_H and V_L genes or analogue thereof may be cloned and displayed on the surface of a phage. Antibody fragments binding specifically to several antigens may be isolated as reported by Marks (Marks, J.D., "By-Passing Immunization. Human Antibodies from V-gene Libraries Displayed on Phage", *J. Mol. Biol. (England)* 222 (3):581-97 (1991)).

Covalent Oligosaccharide Modifications

The present analogue peptides alone or as hybrid peptides comprising antibodies and fragments thereof may be, e.g., covalently modified utilizing oxidized oligosaccharide moieties. The hybrid analogue peptides may be modified at the oligosaccharide residue with either a peptide labeled with a radioisotope such as ¹²⁵I or with a chelate such as a diethylenetriaminopentaacetic acid chelate with ¹¹¹In. The use of oligosaccharides provides a more efficient localization to a target than that obtained with antibodies radiolabeled either at the amino acid chain lysines or tyrosines (Rodwell, J.D. et al., "Site-Specific Covalent Modification of Monoclonal Antibodies: In Vitro and In Vivo Evaluations", *PNAS (USA)* 83:2632-6 (1986)).

Of the analogue peptides of this invention, preferred are those having the sequences ID Nos. 67 through 73, 75 through 81, 95, 96, and analogues thereof wherein about 1 to 42 amino acids in the FR are substituted per chain with amino acids such as those present in equivalent positions in antibodies of the species for which the analogue is intended, such as human, or fragments thereof comprising 1 to 3 CDRs per chain and flanking regions thereof, each of about 1 to 10 or more amino acids, alone or with an N-terminal fragment of about 1 to 10 amino acids, or up to the complete N-terminal region, or combinations thereof. Examples of possible substitute amino acids in all positions, including the most important positions are shown in Tables 10 and 11 above, and are indicated in the columns titled BrE-3 and KC-4, "Most Preferred Analogue and Preferred Analogue" amino acids substituents. Others are also suitable as may be deduced by the method described herein. These amino acid sequences may be bound by a peptide or non-peptide linker such as is known in the art.

Examples of peptide linkers are polylysines, leucine zippers, EGKSSGSGSEJL, and (GGGGS)x3, and non-peptide polymers, among others. Effector agents such as peptides and non-peptides may also be attached to the analogue peptides of the invention. These include non-peptide polymers, monomers, atoms, etc., which are discussed below.

Another preferred embodiment comprises a bi-functional analogue peptide having a pair of light and heavy chains of the same specificity attached to one another by a linker, such as those provided above. In another preferred embodiment, a bi-functional analogue peptide comprises one set of light and heavy chains comprising at least one xenogeneic CDR or variable region, e.g., the amino acid sequence ID No. 11 or 13 of Tables 15 and 16, sequence ID No. 95 or 96 from Tables 55 and 56 below, or the respective CDRs alone or separated by 1 to 10 amino acids and up to the entire amino acid segments of their flanking sequences, and optionally with 1 to 10 amino acids of each N-terminal region, sequence ID No. 68, 70 and/or 72, alone or with flanking sequences of varying length, or 76, 78 and/or 80, alone or with flanking sequences of varying length, with the modifications shown above, wherein about 1 to 42 amino acids in the FR are substituted per chain with amino acids such as those present in equivalent positions in antibodies of the target species, or fragments thereof comprising 1 to 3 CDRs per chain and flanking regions thereof, each of about 1 to 10 or more amino acids, alone or with an N-terminal fragment of about 1 to 10 or more amino acids, and one set of light and heavy chains comprising at least one xenogeneic CDR or analogue variable region, e.g., amino acid sequence ID No. 11, 13, 95, or 96 having a different set of substitute amino acids, wherein about 1 to 46 or more amino acids in the FR are substituted per chain with amino acids such as those present in equivalent positions in antibodies of the target species, or fragments comprising 1 to 3 CDRs per chain and flanking regions thereof, each of about 1 to 10 or more amino acids, alone or with an N-terminal fragment of about 1 to 10 or more amino acids, or fragments or combination thereof. Multi-functional hybrid analogue peptides may comprise several identical units or combinations of the above bi-functional analogue peptides of the same or different specificities or xenogeneic species. Preferred analogue peptides are those comprising murine CDRs and other regions substituted with human amino acids.

In another aspect, this invention provides a hybrid analogue polymer that comprises at least one anti-tumor analogue peptide and at least one effector agent operatively linked to the peptide, combinations thereof and mixtures thereof. The effector agent utilized in this invention comprises peptide polymers other than the constant region of an antibody of the same species as the CDRs.

non-peptide polymers, monomers, and atoms such as metals. In one particularly preferred embodiment, the effector agent may comprise an atom such as a radioisotope, an enzyme or a fluorescent label. These effector peptides are suited for in vivo and in vitro assays because they permit the identification of
5 complexes formed by the peptide of the invention. Radioisotopes are particularly preferred for in vivo imaging. Polypeptide labeling is known in the art (Greenwood, F.C., et al., Biochem. J. 89:114-123 (1963)). When a glycosylated polypeptide is utilized, the radiolabel may be attached to the glycosyl residue as is known in the art (Hay, G.W. et al, in Methods in Carbohydrate Chemistry, Vol
10 5:357, Whistler, R.L. Ed., Academic Press, NY and London (1965)). Effector agents comprising a monomer may be therapeutic, immunogenic or diagnostic agents, radioisotopes, DNA, or RNA monomers, chemical linkers, chemical chelators, transmitter molecules, combinations thereof, or combinations thereof with peptide and non-peptide polymers or copolymers and atoms. Examples of
15 therapeutic agents are anti-neoplastic drugs such as vincristine, intercalation drugs, adriamycin, enzymes, toxins and hormones, among others. Examples of immunogenic agents are other vaccines against tumors such as r carcinomas or for others purposes. Examples of diagnostic agents are radioisotopes and enzymes, among others. Examples of therapeutic, immunogenic and diagnostic
20 agents are toxins, vaccines, and radioisotopes, among others. Examples of radioisotopes are ^{111}In , ^{35}S , ^{90}Y , ^{188}Re , ^{225}Ac , ^{125}I and $^{99\text{m}}\text{Tc}$, among others. Examples of DNA and RNA monomers are A, T, U, G, C, among others. Examples of chemical linkers are dithiobis(succinimidyl)propionate and bis(sulfosuccinimidyl)suberate, among others. Examples of transmitter molecules
25 are cAMP and cGMP, among others. Examples of toxins are ricin A-chain and abrin A-chain, among others.

When the effector agent is a non-peptide polymer linked to the analogue peptide of the invention it may comprise an ester, ether, vinyl, amido, imido, alkylene, arylalkylene, cyanate, urethane, or isoprene polymers, DNA polymers,
30 RNA polymers, copolymers thereof and copolymers thereof with peptide polymers or monomers, or have labeled atoms attached thereto. Examples of these are polyesters, polyethers, polyethyleneglycols, polyvinyls, polyamido and polyimido resins, polyethylenes, polytetrafluoroethylene, poly(ethylene)terephthalate, polypropylene, silicone rubber, isoprenes and
35 copolymers thereof, copolymers of silicone and carbonated polylactic or polyglycolic acid or collagen, and the like. Particularly preferred are biodegradable and bioresorbable or bioabsorbable materials, which if detached from the polypeptide and left in the systemic circulation will not damage endogenous tissues. The effector agent being a peptide may comprise

antibodies such as IgA, IgG, IgM, IgE or IgC are constant regions of antibodies of a species different from the variable region or fragments thereof, and the CDRs, variable regions, Fab, Fab', (Fab')₂, fragments of antibodies of the classes described above, hormones, enzymes, peptide transmitters and whole antibodies, 5 combinations thereof, and combinations thereof with non-peptide polymers, copolymers, monomers and atoms such as radioisotopes. Examples of other antibodies, Fab, Fab', (Fab')₂, CDRs and variable regions thereof are those that specifically bind tumor epitopes such as those of carcinomas, including the murine BrE-3 and anti-KC-4 antibodies and others having specificities for different 10 tumor epitopes such as the BrE-1 (ATCC No. HB 9738), BrE-2 (ATCC No. HB 9795), and Mc5 antibodies, among others, and fragments thereof. All of the antibodies exemplified above selectively bind to the human mammary mucin, and more particularly to the human mammary fat globule (HMFG). However, antibodies with different specificities for antigens of the target species are also 15 encompassed. Examples of peptide transmitters and hormones suitable for use herein are insulin, growth hormone, FSH, LH, endorphins, and TNF, among others. Examples of enzymes are peroxidase, LDH, alkaline phosphatase and galactosidase, among others.

In a particularly preferred embodiment of the hybrid analogue, the 20 analogue peptide polymer of the invention comprises non-human CDRs and variable region sequences, and the effector peptide comprises the constant region of the light or heavy chains of a human antibody or fragments thereof capable of being bound by immunoglobulins of a different species selectively binding to the constant regions of antibodies, protein G or protein A, or 25 fragments having this binding capability. Also preferred is a half humanized/half chimeric or murine antibody (e.g., humanized light chain and murine or chimeric heavy chain and vice versa). In one of the most preferred embodiments, the analogue peptide(s) comprise(s) all CDRs, flanking sequences of 1 to 10 amino acids connecting them, and an N-terminal region of at least up to 10 amino 30 acids. One preferred embodiment comprises the fully humanized BrE-3HZ or HuBrE3V2, ATCC No. HB 11200 and the fully humanized HuKC-4HZ or HuKC4V2, ATCC No. HB 11455, both of which were deposited under the Budapest Treaty as an example of a best mode of this invention on November 13, 1992 and September 23, 1993, respectively. Other most preferred 35 embodiments are those having chimeric heavy chains and humanized light chains such as the HuBrE3V1, ATCC No. HB _____, deposited on November 10, 1993, and the HuKC4V1, ATCC No. HB 11454 deposited on September 23, 1993, and those having chimeric light chains and humanized heavy chains such as the HuBrE3V3, ATCC No. HB _____ deposited on November 10, 1993, and

HuKC4V3, ATCC No. HB 1-456 deposited on September 23, 1993, all of which deposited under the Budapest Treaty as an example of a best mode of this invention).

5 The hybrid analogue polymer may comprise two heavy and two light chains, each light and heavy chain comprising at least one CDR or analogue variable region polypeptide or fragments thereof of one species and the constant region and the substitute amino acids of an antibody of a different species such as human, at least one other CDR, analogue variable region, chimeric Fab, Fab' or (Fab')₂, fragments thereof, combinations thereof, and mixtures thereof. Still
10 more preferred is a hybrid analogue peptide comprising at least two "humanized" murine-human or chimeric antibody fragments thereof, Fab, Fab' or (Fab')₂, fragments thereof operatively linked to one another. The peptide fragments may be covalently attached to one another as is known in the art (Marchis-Mouren G., et al., "HT 29, a Model Cell Line: Stimulation by the Vasoactive Intestinal Peptide (VIP); VIP Receptor Structure and Metabolism", *Bioch. 70* (5):663-71 (1988)),
15 or they may be synthesized by methods known in the art (Allen, G., et al., "Production of Epidermal Growth Factor in Escherichia Coli from a Synthetic Gene", *J. Cell Sci. Suppl.* 3:29-38 (1985)).

20 The hybrid analogue polymer of the invention described above may have two heavy and two light analogue chains operatively linked to one another, where each pair of heavy and light chains, has specificity for a different epitope. One example of this analogue peptide is a pair of "humanized" variable region heavy and light chains of a BrE-3 analogue peptide and a pair of "humanized" variable region light and heavy chains of a KC-4 analogue peptide that are
25 covalently attached to one another by a peptide or non-peptide polymer or a disulfide bridge, or non-covalently by means of a leucine zipper or two helical structures, and the like. Non-peptide polymers may be covalently attached to peptides by methods known in the art (Duronio, V., et al., "Two Polypeptides Identified by Interleukin 3 Cross-Linking Represent Distinct Components of the
30 Interleukin 3 Receptor", *Exp. Hematol.* 20 (4):505-11 (1992)). In another embodiment, the invention provides a hybrid analogue peptide comprising at least one CDR or analogue variable region of the heavy chain of an antibody of a first species or fragments thereof, operatively linked to a first effector agent, and at least one CDR or analogue variable region of the light chain of an antibody
35 of a second species or fragments thereof operatively linked to a second effector agent and combinations thereof, wherein each pair of light and heavy chains has a predetermined specificity, combinations thereof, and mixtures thereof. In another preferred embodiment of the hybrid analogue peptide, at least one CDR or analogue variable region of the heavy chain of a murine antibody or fragments

thereof and at least one CDR or variable region of the light chain of a murine antibody or fragments thereof are linked to one another by a non-peptide polymer such as an isoprene polymer or monomer. In still another preferred embodiment, the hybrid analogue peptide of the invention is one wherein at least one pair of light and heavy chains comprising at least one murine CDR or analogue variable region or fragment thereof is linked to at least one other pair of light and heavy chains comprising at least one murine CDR or analogue variable region or fragment thereof. In another embodiment the two or more F₁ regions are covalently attached to one another by a peptide or non-peptide polymer or a disulfide bridge, or non-covalently by means of a leucine zipper or two helical structures, and the like. In a most preferred embodiment, the analogue peptides and hybrid polypeptides of the invention have affinity and specificity for an epitope located in the most hydrophilic region of a 20 amino acid tandem repeat that makes up a large part of the polypeptide core of mammary mucin, to hexamer fragments of the sequence APDTRPAPG or trimer TRP fragments shown to afford the strong binding of all five different monoclonal antibodies raised against the human mammary fat globule (Mc1, Mc5, BrE-1, BrE-2 and BrE-3). The monoclonal antibodies were shown to bind to different but overlapping polypeptide epitopes but to have different tissue and tumor specificities, to quantitatively differ in their binding to tumor cells such as breast carcinoma cell lines when observed by flow cytometry and have different competition patterns for binding to the native antigen on breast carcinoma cells. Also preferred amongst antibodies utilized for the preparation of the present analogue peptide and hybrid polypeptide are those that exhibit strong binding to the hexamer peptides described above or to fragments comprising a TRP trimer to tandem repeats thereof. In one most preferred embodiment, the analogue peptide comprises the humanized mutein antibody expressed by the hybridoma cell line having the ATCC Accession No. HB 11200 (BrE-3 HZ). This cell was deposited with the ATCC under the Budapest Treaty on November 13, 1992. In another most preferred embodiment, the analogue peptide comprises the humanized mutein antibody expressed by the hybridoma cell line having the ATCC Accession No. HB 11455 (HuKC-4V2), deposited under the Budapest Treaty on September 23, 1993. These were deposited as the best mode of the invention known to the inventors.

The anti-tumor analogue peptide and/or hybrid analogue polymer of the invention are also provided as an anti-tumor composition along with a carrier or diluent, preferably a pharmaceutically-acceptable carrier or diluent. The anti-tumor analogue peptide and the hybrid polymer provided herein may be present in the composition in an amount of about 0.001 to 99.99 wt%, more preferably

about 0.01 to 20 wt%, and still more preferably about 1 to 5 wt%. However, other amounts are also suitable. Carriers generally, and pharmaceutically-acceptable carriers in particular are known in the art and need not be further described herein. The carrier may be provided in a separate sterile container or
5 in admixture with the polypeptide. Typically, saline, aqueous alcoholic solutions, albumin-saline solutions, and propylene glycol solutions are suitable. However, others may also be utilized. When utilized for therapeutic purposes the proteic material must be of a purity suitable for human administration, and the composition may contain other ingredients as is known in the art. Examples of
10 these are other anti-neoplastic drugs such as adriamycin and mitomycin, cytoxan, PALA and/or methotrexate, among others. However, other therapeutic drugs, carriers or diluents, immunological adjuvants and the like may be also be added. When the composition described above is utilized for in vivo imaging, it may comprise about 0.001 to 99.9 wt% analogue peptide, and more preferably
15 about 0.01 to 25 wt% analogue peptide. Typically, when the composition is utilized for therapeutic purposes it may contain about 0.001 to 99.9 wt% analogue peptide, and more preferably about 0.01 to 30 wt% analogue peptide. When utilized for the ex vivo purging of neoplastic cells from bodily fluids such as spinal fluid, the composition may comprise about 0.0001 to 50wt%, and
20 preferably about 0.01 to 20wt% analogue peptide. When applied to the in vitro diagnosis of tumors such as carcinomas the composition of the invention may comprise about 0.001 to 35 wt% analogue peptide, and more preferably about 0.01 to 10 wt% analogue peptide. Other amounts, however, are also suitable.

Such products find one utility in the treatment of tumors such as
25 carcinomas, such as breast, lung, ovary, endometrial, pancreas, prostate and colon cancers, among others. The "humanized", "half humanized" and "partially humanized" analogue peptides may be used for the in vivo treatment or diagnosis of humans. The "animalized", "half animalized" and "partially animalized" analogue peptides of the invention may be utilized for the treatment of non-
30 human species such as were described above insofar as the amino acids of the species are substituted for those of the xenogeneic amino acids present at a specific location, and any constant region present in the analogue. The present analogue peptides are particularly suitable for repeated administration to a subject and for long term therapy, such as is the case of metastases and/or the
35 reoccurrence of tumors. Of all analogues described and encompassed herein, the ones most suitable for in vivo applications are those that exhibit low or no binding to serum antigens and to normal cells. Suitable for in vitro or ex vivo uses are those that exhibit good binding to tumor cell antigens such as the carcinoma cell antigen and weak or no binding to normal cells. Even though a

patient may have in circulation an interfering amount of a molecule that can bind the analogue peptide, the peptide may still be administered after removal of such serum molecule either by ex-vivo procedures or by administration of flush doses of the analogue peptide or fragments thereof.

5 A kit for the diagnosis of tumors such as carcinomas may comprise a composition comprising the anti-tumor analogue peptide of the invention, a solid support, anti-tumor antibody (positive control), immunoglobulins of a different species selectively binding the constant regions of the antibody, protein G or protein A, and instructions for its use. This diagnostic kit may be utilized by
10 covalently attaching the antigen or the analogue peptide of the invention or a fusion protein thereof to the solid support by means of a linker as is known in the art. In a particularly preferred embodiment, the support is coated with a polypeptide such as methylated albumin as described in US Patent No. 4,572,901, the relevant text of which is incorporated herein by reference. When
15 a biological sample is added to a well, the analogue peptide of the invention will bind any tumor antigen, such as a carcinoma antigen, present in the biological sample. If a competitive assay is utilized, to the solid supported antigen or hybrid peptide thereof are added a known amount of the analogue peptide and the sample. Thereafter, γ -globulin, protein G or protein A in labeled form may
20 be added for detection. Anti-tumor antibodies of a first species may be obtained by challenging a subject of another species with tumor cells such as carcinoma cells, the human milk fat globule mucin and the like, as is known in the art (Peterson, J.A., et al., *Hybridoma* 9:221 (1990); US Patent No. 4,708,930). Monoclonal antibodies may be prepared as described by Kohler and Milstein
25 (Kohler, G. and Milstein, C., "Continuous Culture of Fused Cell Secreting Antibody of Predefined Specificity", *Nature* 256:495-497 (1975)). Suitable for use in this invention are antibodies such as IgG, IgM, IgE, IgA, and IgD. Protein A, protein G and γ -globulin may be obtained commercially.

A diagnostic kit for detecting tumors such as carcinomas, and more
30 particularly human carcinomas is provided herein that comprises an anti-tumor composition comprising a hybrid analogue peptide and an effector agent comprising an enzyme, a radioisotope, a fluorescent label and/or a peptide comprising the constant region of an antibody of the species for which use it is intended, or fragments thereof capable of binding anti-constant region
35 immunoglobulins, protein G or A, anti-tumor antibody, anti-constant region immunoglobulins, protein G or protein A, a solid support having operatively linked thereto an antigen which specifically binds to the anti-tumor hybrid analogue peptide of the invention and the antibody, and instructions for its use. When the effector agent comprises a peptide, such as the constant region of an antibody

of the target species, the solid support may have operatively linked thereto an antibody which specifically binds to a portion of a fusion protein other than the antigen of the invention. This permits the binding of the anti-tumor analogue peptide to the antigen molecule now attached to the solid support. Any complex
5 formed between the hybrid analogue peptide of the invention and the supported tumor antigen will, thus, remain attached to the solid substrate. A competitive assay may then be conducted by addition to the solid supported antigen of a known amount of the hybrid antigen peptide and the sample. The amount of antigen present in the sample may be obtained from a dilution curve by addition
10 of anti-constant region immunoglobulins, protein G, protein A or other antibody binding molecules, e.g., labeled, to bind the hybrid analogue peptide that is now attached to the support. This kit may be used in a competitive assay where the supported antigen molecule competes with antigen in the sample for a known amount of the analogue peptide of the invention. The assay was described by
15 Ceriani, R.L., et al. (Ceriani, R.L., et al., Anal. Biochem. 201:178-184 (1992)), the relevant text thereof being incorporated herein by reference.

A tumor such as a carcinoma may be imaged in vivo and/or diagnosed by administering to a subject suspected of carrying a carcinoma the anti-tumor analogue peptide of the invention in radiolabeled form, in an amount effective to
20 reach the tumor cells and bind thereto, and detecting any localized binding of the labeled analogue peptide to the tumor. Typically, the analogue peptide of the invention may be administered in an amount of about 0.001 to 5000 mg/kg weight per treatment, more preferably about 0.01 to 5000 μ g/kg weight per treatment, and more preferably about 0.1 to 500 μ g/kg weight per treatment.
25 However, other amounts may also be utilized. Radiolabels that may be utilized are ^{111}In , ^{125}I , $^{99\text{m}}\text{Tc}$, and ^{131}I , among others. These radioisotopes may be detected with a PET scanner, NMR imaging, and radioactivity counting apparatus that are in wide use by the medical community.

The presence of a tumor such as a carcinoma may also be diagnosed in
30 vitro by contacting a biological sample with the anti-tumor analogue peptide or hybrid polypeptide of the invention to form an anti-tumor analogue peptide-antigen complex with any tumor antigen present in the sample, and detecting any complex formed. The biological sample is typically obtained from a subject such as a human suspected of being afflicted with the tumor. Suitable biological
35 samples are serum, blood, sputum, feces, lymph fluid, spinal fluid, lung secretions, and urine, among others. Clearly, any source of fluid, tissue and the like may be prepared for use in this method as is known in the art.

Neither the hybrid half chimeric/half humanized BrE-3 analogue peptide nor the chimeric BrE-3 polypeptide of the invention or the murine BrE-3 antibody

show substantially strong binding to normal tissue. The hybrid BrE-3 analogue peptide shows a binding pattern similar to the chimeric BrE-3 polypeptide and the murine BrE-3 antibody. The murine BrE-3 antibody was shown to bind with specificity to various tumors such as carcinomas of the breast, lung, ovary, bladder, and the endometrium, mesothelioma, colon, kidney, liver, pancreas, salivary glands, sarcomas and thyroid, among others. Weak binding was only shown to normal breast tissue, lung tissue, distal convoluted tubes of the kidney, acini of the pancreas and stomach mucosa (Peterson, J.A., et al. (1990), supra). The KC-4 hybrid murine peptide has tissue specificity similar to that of the murine KC-4 antibody. The KC-4 monoclonal antibody was shown to bind specifically and strongly to solid tumor tissue in the lung, colon, kidney, breast, stomach, prostate, pancreas, lymph node duct and lymphoma, and non-specifically and weakly to normal breast, kidney, and stomach tissue. KC-4 also showed some weak binding to normal tissue including spinal cord, uterus, thyroid, tongue, prostate, spleen, adrenal, lung, gall bladder, heart, lymph nodes, colon, liver, brain, testes, thymus, and placenta (U.S. Patent No. 4,708,930). In one preferred embodiment of the in vitro diagnostic method, the anti-carcinoma analogue peptide added to the biological sample comprises a labeled hybrid analogue peptide. Suitable labeling materials were described above. This method may be practiced, with the solid support containing kit described above, as a competitive assay as disclosed by Ceriani, R.L., et al. (Ceriani, R.L., et al. (1992), supra).

The present analogue peptides are also applicable to the purging of neoplastic cells, such as carcinoma cells, from biological samples, be it fluid or tissue samples. The purging of neoplastic cells from a fluid sample is part of the invention and may be practiced by contacting a biological fluid suspected of comprising neoplastic cells with the analogue peptide of the invention, which is capable of selectively binding to an antigen of the neoplastic cells and allowing the peptide to bind to the antigen, and separating the analogue peptide-cell complex from the remainder of the fluid.

This method may be utilized for purging unwanted cells *ex vivo* by extracting a biological sample from a patient, eliminating the neoplastic cells therefrom by separation of the analogue peptide-cell complexes or by further addition of an effector such as complement or a toxin or a radioactive label that can act upon the cell and then replenishing the purged sample to the patient. This is typically suitable for use with spinal taps where spinal fluid is rid of neoplastic cells such as carcinoma cells prior to reinjection. Other fluids may also be treated in this manner.

The present analogue peptides may also be applied to the histochemical

assessment of the presence of neoplastic cells such as carcinoma cells in a tissue obtained from a subject suspected of being afflicted by a carcinoma by methods that are standard in the art, like the preparation of tissue slices and fixation on a solid substrate to permit the application of the peptide and then the
5 assessment of any binding to neoplastic cells in the sample as indicated by the formation of complexes between the analogue peptide and antigens on or in the cells.

The growth or the size of a primary or metastasized tumor or neoplasia such as a carcinoma may be inhibited or reduced by administering to a subject
10 in a need of the treatment an effective amount of the anti-tumor hybrid analogue peptide of the invention. Typically, the hybrid analogue peptide may be administered in an amount of about 0.001 to 2000 $\mu\text{g}/\text{kg}$ body weight per dose, and more preferably about 0.01 to 500 mg/kg body weight per dose. Repeated doses may be administered as prescribed by the treating physician. However,
15 other amounts are also suitable. Generally, the administration of the hybrid analogue peptide is conducted by infusion so that the amount of radiolabel, toxin or other effector agent present that may produce a detrimental effect may be kept under control by varying the rate of administration. Typically, the infusion of one dose may last a few hours. However, also contemplated herein is the
20 constant infusion of a dose for therapeutic purposes that will permit the maintenance of a constant level of the hybrid polypeptide in serum. The infusion of the hybrid analogue peptide of the invention may be conducted as follows. Intravenous (I.V.) tubing may be pretreated, e.g., with 0.9 % NaCl and 5 % human serum albumin and placed for intravenous administration. The prescribed
25 dose of the analogue peptide may be infused as follows. Unlabeled analogue peptide may be infused initially. 30 minutes after completion of the unlabeled antibody infusion, ^{111}In -labeled and ^{90}Y labeled antibody may be co-infused. The I.V. infusion may comprise a total volume of 250 ml of 0.9 % NaCl and 5 % human serum albumin and be infused over a period of about 2 hours depending
30 on any rate-dependent side effects observed. Vital signs should be taken every, e.g., 15 minutes during the infusion and every one hour post infusion until stable. A thorough cardiopulmonary physical examination may be done prior to, and at the conclusion, of the infusion. Medications including acetaminophen, diphenhydramine, epinephrine, and corticosteroids may be kept at hand for
35 treatment of allergic reactions should they occur. The administration of the hybrid analogue peptide of the invention may be repeated as seen desirable by a practitioner. Typically, once a first dose has been administered and imaging indicates that there could be a reduction in the size of the tumor, whether primary or metastasized, repeated treatments may be administered every about

1 to 100, and more preferably about 2 to 60 days. These repeated treatments may be continued for a period of up to about 2 years, and in some circumstances even for longer periods of time or until complete disappearance of the tumor(s). The administration of the hybrid analogue peptides of this invention is typically
5 more useful for therapeutic purposes when a primary tumor has, for example, been excised. Thus, it is primarily, for mopping up after surgical intervention or in cases of cancerous metastases that the present method is of most use.

A pure, isolated analogue polydeoxyribonucleotide that comprises an analogue oligodeoxyribonucleotide encoding the analogue peptide or hybrid
10 peptide of this invention, including all redundant sequences may be applied to the preparation of the peptide. In one preferred embodiment, the analogue polydeoxyribonucleotide of the invention comprises a DNA sequence selected from the group consisting of DNA sequence ID No. 64 of Table 45, or DNA
15 sequence ID No. 65 of Table 46, or DNA segments encoding the CDR fragments sequence ID No. 68, 70 and/or 72, or 76, 78 and/or 80 flanked by 1 to 10 or more amino acids, and the N-terminal fragment of 1 to 10 or more amino acids
20 of human origin. The above DNA sequences may be cloned for expression under the same promoter. Similarly preferred are also the DNAs having the sequence ID No: 93 and/or 94 of Tables 52 and 53 and the segments encoding their CDR
fragments alone or separated by DNA segments encoding 1 to 10 or more flanking amino acids and/or terminated by DNA segments encoding 1 to 10 or more amino acids of the N-terminus.

Also provided herein is a hybrid vector that comprises a vector having the analogue polydeoxyribonucleotide of this invention operatively linked thereto.
25 Typically, vectors capable of replication both in eukaryotic and prokaryotic cells are suitable. When the preparation of a glycosylated analogue polypeptide is desired the vector should be suitable for transfection of eukaryotic host cells. In one preferred embodiment, the hybrid vector comprises the analogue polydeoxyribonucleotide and a polydeoxyribonucleotide comprising an
30 oligodeoxyribonucleotide encoding an effector peptide, the effector peptide-encoding polydeoxyribonucleotide being operatively linked to the vector. As already indicated, the various DNA sequences may be cloned for expression under the same promoter. In addition, the polydeoxyribonucleotide encoding the effector polypeptide may also be cloned for expression under the same promoter.

35 This invention also encompasses a host cell that has been transfected with the hybrid vector described above. Suitable hosts are prokaryotic and eukaryotic hosts such as bacteria, yeast, and mammalian cells such as insect cells and non-producing hybridoma cells, among others. Suitable vectors and/or plasmids for the transfection of each one of these types of hosts are known in

the art and need not be further described herein. Also known in the art are methods for cloning DNA sequences into each one of these types of vectors and for transfecting the different types of host cells. Particularly preferred is the cell line having the ATCC Accession No. HB 11200 (BrE-3 HZ).

5 Polyribonucleotides may be obtained by transcription of the polydeoxyribonucleotides described above as is known in the art. Provided herein are analogue polyribonucleotides comprising analogue oligoribonucleotides encoding at least one CDR or an analogue variable region or fragments thereof, combinations thereof, and combinations thereof with an effector peptide may be
10 prepared by cloning the desired DNA segments and then transcribing the thus obtained hybrid polydeoxyribonucleotide into the corresponding RNA sequences.

The analogue peptide which specifically binds to an antigen on the surface or in the cytoplasm of a neoplastic cell, or is released by the cell, may be produced by a method that comprises cloning the analogue
15 polydeoxyribonucleotide of the invention into a vector to form a hybrid vector, transfecting a host cell with the hybrid vector and allowing the expression of the anti-tumor analogue peptide, and isolating the anti-tumor polypeptide or mixtures thereof. The DNA segment encoding the analogue polypeptide may be obtained by chemical synthesis or by site-specific modification of the sequence encoding
20 the variable region of the xenogeneic species by PCR amplification with specifically designed primers as is known in the art. The fragment DNAs may also be prepared by PCR with primers that introduce a stop codon at a desired position as is known in the art. Preferably, the cloning and transfection steps are conducted by cloning polydeoxyribonucleotides encoding the analogue peptides
25 selected from the group comprising at least one CDR or analogue variable region of the heavy or light chains of the xenogeneic species, antibodies thereof, or fragments thereof. The method may further comprise allowing the expressed analogue peptides to interact with one another to form double chain analogue peptides, one or both analogue peptide chain comprising at least one xenogeneic
30 CDR or variable region of the light or heavy chain of the antibody or fragment thereof modified as described above. Still part of this invention is a method of producing a hybrid analogue peptide comprising an effector peptide and an analogue peptide which specifically binds to an antigen on the surface or in the cytoplasm of a tumor cell such as a carcinoma cell or that is released by the cell,
35 the method comprising transfecting a host cell with the hybrid vector of this invention carrying a DNA sequence encoding the hybrid analogue peptide, allowing the expression of the hybrid analogue peptide, and isolating the hybrid analogue peptide or mixtures thereof. The techniques for obtaining mRNA, conducting reverse transcription and PCR amplification of DNA, chemical

synthesis of primers, cloning DNA sequences into a vector, transfecting a host cell, and purifying polypeptides from a culture medium are known in the art and need not be further described herein.

Another aspect of this invention relates to an anti-idiotypic peptide that
5 comprises polyclonal antibodies raised against anti-tumor antibodies, the analogue peptide of the invention, monoclonal antibodies thereof, fragments thereof selected from the group consisting of CDRs, Fab, Fab', (Fab')₂, and variable region fragments and fragments thereof, analogues thereof selected from the group consisting of Fab, Fab', (Fab')₂, and variable regions thereof,
10 wherein about 1 to at least 46 amino acids in the FRs are substituted per chain with amino acids selected from the group consisting of amino acids present in equivalent positions in human antibodies, or fragments thereof comprising 1 to 3 CDRs per chain and flanking regions thereof, each of about 1 to 10 or more amino acids, alone or with an N-terminal fragment of about 1 to 10 or more
15 amino acids. The technique for obtaining anti-idiotypic polypeptides is known in the art and need not be further described herein (Nisonoff, A. and Lamoyi, "Implication of the Presence of an Internal Image of an Antigen in Anti-Idiotypic Antibodies: Possible Applications to Vaccine Production", Clin. Immunol. Immunopathol. 21:397-406 (1981)). Moreover, the technique for producing
20 hybridomas secreting monoclonal antibodies of a certain specificity is also known in the art (Kohler, G. and Milstein, C. (1975), supra). Techniques for obtaining different antibody fragments were described above or are known in the art and need not be further described herein (Wilbanks, T., et al., "Localization of Mammary Tumors In Vivo with ¹²⁵I-Labeled Fab Fragments of Antibodies Against
25 Murine Mammary Epithelial (MME) Antigens", Cancer 48:1768-1775 (1981)). The techniques for modifying peptides to obtain the analogue peptides of this invention have been described above or are known in the art.

The hybrid anti-idiotypic polymer may further comprise an effector agent operatively linked to the anti-idiotypic polypeptide. Effector agents suitable for
30 use herein were described above for the anti-tumor analogue polypeptide of the invention are also suitable for use with the anti-idiotypic polypeptide. Preferred hybrid polymers are polyclonal antibodies raised against the anti-tumor monoclonal antibodies or the analogue peptide of the invention, and a monoclonal antibody obtained by fusion of a B-cell producing an antibody having
35 specificity for the analogue peptide of the invention and an immortalized cell line. Also preferred are fragments of the monoclonal antibody such as Fab, Fab', (Fab')₂, and variable region fragments, analogues and fragments thereof as described above, and CDRs. Also, as described above for the anti-tumor polypeptide analogue, preferred are combinations of the above fragments and

analogues and combination: of the fragments with whole antibodies and analogues thereof. In another preferred embodiment, the anti-idiotypic polymer comprises an analogue variable region of a monoclonal antibody linked to a peptide comprising the hexamers or trimers described above or tandem repeats thereof.

DNA and RNA segments encoding the anti-idiotypic polymer and hybrid polymer, a hybrid vector having the DNA operatively linked thereto and a host cell transfected with the hybrid vector are also contemplated herein.

Also provided herein is an anti-tumor vaccine that comprises the anti-idiotypic polypeptide of the invention, and a pharmaceutically-acceptable carrier. Typically, the anti-idiotypic polypeptide is present in the composition in an amount of about 0.001 to 99.99 wt%, and more preferably about 0.01 to 50 wt% of the composition. However, other amounts are also suitable. Pharmaceutically-acceptable carriers are known in the art and need not be further described herein. The vaccine provided herein may further comprise other ingredients such as adjuvants, and the like. Examples of adjuvants are SAF-1 and Freund's, among others. Suitably, other ingredients typically used for the preparation of vaccines may also be utilized herein. In one embodiment, the vaccine of the invention may be provided in unit form as a powder or in a diluent. In another embodiment, it may be provided in powder form in a sterile container comprising a plurality of doses for preparation prior to utilization. Diluents that are suitable for the preparation of a formulation that may be administered to a patient by injection are known in the art. Examples were provided above.

An anti-tumor vaccination kit is also provided by this invention that comprises, the vaccine described above and a diluent in separate sterile containers, and instructions for its use.

An effective amount of the anti-idiotypic polypeptide or hybrid polypeptide described above may be administered to vaccinate a human. Typical amounts administered to vaccinate a human are about 0.001 to 5000 mg/kg body weight/dose, more preferably about 0.1 to 5000 μ g/kg body weight/dose. The anti-idiotypic vaccine of the invention may be administered repeatedly in order to boost the active immunization produced by the first dose. An anti-idiotypic antibody very likely resembles the epitope on the neoplastic cell to which the anti-tumor antibody binds. Thus, it may be utilized for the production of an immunological response by a subject such as a human or other mammals against its own neoplastic cells.

When an anti-idiotypic polypeptide of, e.g., non-human origin is administered to a, e.g., human, it may produce a somewhat detrimental

response. Accordingly, in theory, the smaller the non-human amino acid sequence the anti-idiotypic polypeptide contains, the lesser the immunogenic response to its xenogeneic sequences it will elicit in a human. Accordingly, preferred anti-idiotypic polypeptides are those containing at least one CDR or variable region of a non-human antibody binding specifically to the anti-tumor polypeptide described herein, optionally as a hybrid polypeptide. Also preferred are human anti-idiotypic antibodies, CDR and variable fragments thereof, and fragments thereof that are operatively linked to an effector agent comprising a human polypeptide that may include the constant region of a human antibody and fragments thereof, non-peptide polymers, monomers and atoms that may be radiolabeled as described above. Other types of constructs are also possible, several of which were described above.

Peptides comprising the sequence APDTRPAPG or fragments thereof comprising hexamers with the trimer TRP or TRP by itself or tandem repeats thereof may also be utilized for the preparation of the fusion protein, particularly as part of the antigenic peptide. The peptide comprising the hexapeptide or tripeptide sequences may be utilized as a tandem repeat comprising up to about 10,000 repeats of the basic unit, and in some instances up to about 500,000 repeats. In another embodiment, peptides comprising one or more hexapeptides or tripeptides may be operatively linked to other polypeptide sequences of related or unrelated function, which sequences provide bulk that aids the clearance through the liver and/or kidneys of the immunological complex formed between the circulating unbound or residual antibody or polypeptides utilized for the therapy of neoplasias such as carcinomas and the hexapeptide. The peptides comprising the hexapeptide or tripeptide may also be provided as a hybrid analogue peptide with other analogue peptides described above. In the absence of such treatment, the therapeutic antibody, which may carry a radioisotope, a toxin or other therapeutic molecules, may remain in the circulation for several days and in some instances weeks. This, in the case of a radioactively labeled antibody or analogue of the invention may produce extensive damage, which is highly detrimental to the health of the patient, and in some instances lethal.

Thus, the serum concentration of a circulating antibody or polypeptide that binds to an antigen on the surface or in the cytoplasm of tumor cells such as carcinoma cells or released by the cells may be lowered by administering to a subject the anti-idiotypic polypeptide described above, in an amount effective to bind the circulating polypeptide, to thereby accelerate its clearance. Typically, the anti-idiotypic polypeptide or hybrid polymer are administered in an amount of about 0.001 to 5000.00 mg/kg body weight/dose, more preferably about 0.01

to 500 mg/kg body weight/dose. However, other amounts may also be utilized. The administration of the anti-idiotypic polypeptide may be infusion as described above.

The growth or the size of a primary or metastasized tumor may be inhibited or reduced by administering to a subject in need of the treatment an effective amount of an antibody or an anti-tumor hybrid analogue peptide comprising an effector agent selected from the group consisting of radioisotopes, therapeutic drugs and vaccines, and an anti-tumor polypeptide which specifically binds to an antigen on the surface or in the cytoplasm of a tumor cell or released by the cell, allowing the hybrid polypeptide to reach the tumor and the polypeptide to bind thereto, and administering to the subject an amount of the anti-idiotypic polypeptide of the invention effective to bind residual or unbound circulating hybrid analogue peptide to thereby accelerate the clearance of the hybrid polypeptide.

Having now generally described this invention, the same will be better understood by reference to certain specific examples, which are included herein for purposes of illustration only and are not intended to be limiting of the invention or any embodiment thereof, unless so specified.

EXAMPLES

Example 1: Methods Utilized

The procedures utilized herein for the reverse-transcription (RT) of RNAs encoding the variable regions and the subsequent amplification of the cDNAs by the polymerase chain reaction (PCR) have been described (Orlandi, R., et al., "Cloning Immunoglobulin Variable Domains for Expression by the Polymerase Chain Reaction", PNAS (USA) 86:3833-3837 (1989); Coloma, M.J., et al., "Primer Design for the Cloning of Immunoglobulin Heavy-Chain Leader-Fvs from Murine Hybridoma Cells Using the PCR", Bio.Techniques 11:152-156 (1991); Gavilondo-Cowley, J.V., et al., "Specific Amplification of Rearranged Immunoglobulin Fv Genes from Murine Hybridoma Cells", Hybridoma 9:407-417 (1990)).

Total RNA is an adequate substrate for RT-PCR. Polyadenylated RNA was utilized herein, however, because it contains only minor levels of contaminating ribosomal RNA and practically no DNA. The polyadenylated RNA was isolated with a Fast Track mRNA isolation kit (Invitrogen Corporation, San Diego, CA).

The oligonucleotides were synthesized on a PCR-Mate EP DNA synthesizer model 391 (Applied Biosystems, Foster City, CA). A PCR murine Ig

primer set was purchased from Novagen (Madison, WI), and complementary DNA (cDNA) was prepared with an RNA PCR kit (Perkin Elmer-Cetus, Norwalk, CT).

5 PCR DNA fragments were cloned directly into pCR1000, using a TA cloning kit (Invitrogen Corporation, San Diego, CA). Plasmid DNA was isolated with a kit purchased from Qiagen (Tchapsworth, CA), and DNA sequencing was conducted with a Sequenase 2.0 DNA sequencing kit (United States Biochemical, Cleveland, Ohio) using aqueous 5'-³²SdATP at 600 mCi/mmol (Amersham Corporation, Arlington Heights, IL).

10 Sequence analyses were performed on a Macintosh computer using the program GeneWorks (IntelliGenetics, Inc, Mountain View, CA).

Example 2: Tissue Culture Media

SP2/O-Ag14 cells (Shulman, M., et al. (1978), below) were cultured either in Dulbecco's modified Eagle's medium (DME): fetal bovine serum (FBS), 90:10 (v/v) or in a mixture of DME:RPMI:FBS, 45:45:10 (v/v/v) or RPMI:FBS, 15 90:10 (v/v). Penicillin and streptomycin were added to prevent bacterial growth. When serum-free medium was utilized, it contained an HL-1 supplement as directed by the manufacturer (Ventrex Labs., Portland, ME). The freezing medium was 10% DMSO in bovine serum.

Example 3: PCR Primers

20 Primers and primer mixtures Mulg_xV_h5'-C, Mulg_hV_h3'-1, MulgV_h5'-C, MulgV_h5'-F, and MulgV_h3'-2 were part of a primer set purchased from Novagen. Their sequences may be obtained from Novagen. Other primers were synthesized by the inventors. These sequences are shown in Table 12 below.

Table 12: Synthetic Primers

25
 JO2- T GAA GCT TGC TCA CTG GAT GGT GGG AA (Seq. ID No: 1);
 JO3- AGA TGG GGG TGT CGT TTT GG (Seq. ID No: 2);
 JO4- GCT TGA ATT CCA GGG GCC AGT GGA TAG A (Seq. ID No: 3);
 30 V_h1BACK (*) - AG GT(CG) (CA)A(GA) CTG CAG (CG)AG TC(ITA) GG
 (Seq. ID No: 4);
 JO14- ATG TAC TTG GGA CTG AAC TAT GTC TT (Seq. ID No: 5).

35 * Orlandi, R., et al. (Orlandi, R., et al. "Cloning Immunoglobulin Variable Domains for Expression by the Polymerase Chain Reaction", PNAS (USA) 86: 3833-3837(1989)).

Example 4: Cloning of Chimeric BrE-3 Antibody Polydeoxyribonucleotide

Two expression vectors pAG4622 and pAH4604 were utilized herein (Coloma, M.J., et al., "Novel Vectors for the Expression of Antibody Molecules Using Variable Regions Generated by PCR", J. Immunol. Methods 152:89-104 (1992)). These were kindly provided by S.L. Morrison (Dept. of Microbiology and Molecular Genetics, UCLA). The construction and expression of chimeric genes was performed as described by Coloma et al. (Coloma, M.J., et al. (1992), supra).

Oligonucleotides were synthesized and used in a PCR mixture to produce variable heavy (V_H) and variable light (V_L) fragments with the correct ends for insertion into the pAG4622 and pAH4604 expression vectors. These sequences are shown in Table 13 below.

Table 13: Synthesized Oligonucleotides

15	JO16 (sense V_H leader) - GGG GATATC CACC ATG TAC TTG GGA CTG AAC TAT GTC TTC A (Seq. ID No: 6);
	JO17 (sense V_L leader) - GGG GATATC CACC ATG AAG TTG CCT GTT AGG CTG TTG GT (Seq. ID No: 7);
20	JO18 (anti-sense JH3) - GGG GCTAGC TGC AGA GAC AGT GAC CAG AGT CC (Seq. ID No: 8);
	JO19 (anti-sense Jk1) - GGG GTCGACTTAC G TTT GAT TTC CAG CTT GGT GCC TCC A (Seq. ID No: 9).

The original pCR1000 clones were utilized as the starting templates for the PCR. The new PCR products were cloned back into pCR1000 and their sequence confirmed. Correctly modified and amplified fragments were excised with either EcoR V and Sal I (for V_L) or with EcoR V and Nhe I (for V_H). These fragments were then ligated into the respective vectors, which had been cut open with the appropriate restriction enzymes. Both the vectors and the inserts were purified from an agarose gel prior to ligation, using the Bio101 GeneClean kit (glass beads) (La Jolla, CA).

Example 5: Expression of Murine-Human Chimeric BrE-3 Antibody

The V_H and V_L regions in the final murine-human chimeric antibody were sequenced once again to verify that their sequences were correct.

The non-producer myeloma cell line SP2/0-Ag14, (ATCC: CRL 1581, Shulman, M., et al., "A Better Cell Line for Making Hybridomas Secreting Specific Antibodies", Nature 276:269-270, (1978)) was transfected, and a chimeric antibody were isolated as described by Coloma, M.J. et al. (1992), with the following modification. The selection was only undertaken for the uptake of hisD by adding 5mM histidinol to the medium and readjusting the pH to 7.4 with

NaOH.

Example 6: Production of Transfected Hosts

After ten days, the stable transfectant colonies were clearly established at a frequency of approximately 10^6 . The colonies were transferred to a normal
5 medium (without histidinol) and the supernatants from stable transfectants were assayed for the presence of the murine-human chimeric BrE-3 antibody. This was done by capturing the secreted murine-human chimeric BrE-3 antibody with a plate-bound goat anti-human- κ antibody and developing with goat anti-human- γ antibody as described by Coloma et al. with the following modification. The
10 secondary antibody utilized herein was radiolabeled with ^{125}I .

Example 7: Confirmation of Murine-Human Chimeric BrE-3 Antibody Expression

The supernatants were assayed for binding to human milk fat globule (HMFG) as described by Ceriani et al. (Ceriani R.L., et al., Diagnostic Ability of
15 Different Human Milk Fat Globule Antigens in Breast Cancer", Breast Cancer Res. Treat. 15:161-174 (1990)). HMFG was bound to the microtiter plates as described previously (Ceriani R.L., "Solid Phase Identification and Molecular Weight Determination of Cell Membrane Antigens with Monoclonal Antibodies",
20 in: Monoclonal antibodies and functional cell lines. Progress and application, Bechtol, K.B., McKern, T.J., and Kennett, R., Eds., Plenum Press, New York, pp 398-402 (1984)).

Most colony supernatants were positive by both assays. The colonies that secreted the highest level of chimeric antibody into the supernatants, as determined by these assays, were subcloned and subsequently adapted to
25 serum-free medium for the purification of antibody.

Example 8: Determination of Affinity Constants

The antibody-antigen affinity constants for the murine-human chimeric antibody anti-human milk mucin and the whole murine antibody were determined by obtaining the reciprocal value of the concentration of competing unlabeled
30 monoclonal antibody giving 50% binding as described by Sheldon et al. (Sheldon, K., et al., "Characterization of Binding of Four Monoclonal Antibodies to the Human Ovarian Adenocarcinoma Cell Line HEY", Biochem. Cell Biol., 65: 423-428, (1987)). The protocol for the assay was as follows.

Microtiter plates (Dynatech, Chantilly, VA) were prepared using
35 successive layers of methylated BSA, glutaraldehyde, anti- β -galactosidase and the bacterial fusion protein 11-2 (a hybrid of β -galactosidase and human mammary mucin) as described in Ceriani et al. (Ceriani, R.L., et al., "A Novel

Serum Assay for Breast Cancer Epithelial Antigen Using a Fusion Protein". Anal. Biochem. 201:178-184 (1992). Each well contained 388ng of the 11-2 fusion protein. To each well were added 25 μ l ¹²⁵I-BrE-3 (ATCC No. HB 10028) in RIA buffer (10% bovine calf serum, 0.3% triton X-100, 0.05% sodium azide pH7.4, in phosphate buffered saline), and competed with 25 μ l of either unlabeled murine antibody or murine-human chimeric antibody in RIA buffer at final concentrations in the nanomolar range.

Iodinations were performed with ¹²⁵I (17 Ci/mg, Nordion International Inc., Kanata, Ontario, Canada). 50 micrograms of monoclonal antibody BrE-3 (Coulter, Hialeah, FL) were labeled at a specific activity of 9.56 mCi/mg using the chloramine T method as described by Ceriani, R.L. and Blank, E.W., (Ceriani, R.L., and Blank, E.W., "Experimental Therapy of Human Breast Tumors with ¹³¹I-Labeled Monoclonal Antibodies Prepared Against the Human Milk Fat Globule", Cancer Res. 48:4664-4672 (1988)). When the counts of bound radiolabeled anti-BrE-3 murine antibody were plotted on the Y axis and the logarithm of the nanomolar (nM) concentration of competing unlabeled anti-BrE-3 murine antibody or murine-human chimeric antibody were plotted in the X axis, both curves overlapped within 5% error (Figure not shown). This proves that the variable region's affinity characteristics have been preserved.

20 **Example 9: Affinity Binding Constants for BrE-3 Murine and Murine-Human Chimeric Antibody**

The purified murine-human chimeric BrE-3 antibody and purified murine BrE-3 antibody gave similar competition curves when tested against ¹²⁵I-labeled murine BrE-3 binding to its antigen. The affinity binding constants of the murine antibody and the murine-human chimeric antibody were determined in independent competition assays as described in Example 8 above. The values of the constants are 2.68x10⁸ M⁻¹ and 3.75x10⁸ M⁻¹ for the hybrid chimeric BrE-3 polypeptides and for the murine BrE-3 antibody, respectively. These values are not distinguishable at a 95% confidence interval.

30 **Example 10: Amplification of cDNAs Encoding BrE-3 Antibody Variable Regions**

The cDNAs that encode the anti-BrE-3 murine immunoglobulin variable domains (V_H and V_L) were prepared by reverse transcription and PCR amplification (RT-PCR) from polyadenylated RNA isolated from 10⁸ BrE-3 hybridoma cells by the following procedure. The JO2, JO3, JO4, JO14 and V_H1BACK primers were synthesized, and their sequences shown in Example 3 above. Other primers were purchased from Novagen. With the exception of V_H1BACK, which is a framework-specific primer, all sense primers are specific

for the leader peptide region. All anti-sense primers are specific for the constant regions. The degenerate λ chain of the specific primer Mulg λ V_L3'-1 (from Novagen), was used to isolate the κ chain cDNA clones because of the similarity of the λ and κ . An identical κ chain clone was isolated with primer JO2 which is specific for the κ chain constant domain. The V_H region cDNA could not be isolated with the available leader peptide primers. Thus, the V_H1BACK primer was used, which yielded the V_H cDNA γ 72. The leader-peptide primer JO14 was then designed by extrapolating from the framework sequence of γ 72, using cataloged nucleotide sequences (Kabat, E.A., et al., "Sequences of Proteins of Immunological Interest", U.S. Dept. Health and Human Services, NIH publication No. 91-3242, 5th Edition (1991). After sequential PCR reactions, this new primer yielded the complete V_H framework cDNA. This information is summarized in Table 14 below.

Table 14: Primer Combinations for PCR Amplification

	Clone No.	Sense Primers	Antisense Primers
V _L	152	Mulg κ V _L 5'-C	JO2
	164	Mulg κ V _L 5'-C	Mulg λ V _L 3'-1
V _H	γ 72	V _H 1BACK	(JO3 or JO4)
	1012	JO14(1 st PCR)	JO3
	1043	JO14(2 nd PCR)	JO4
		(MulgVH5'-C + MulgVH5'-F) (2 nd PCR)	JO3
			Mulg γ VH3'-2

Example 11: Isolation of Amplified BrE-3 V_L and V_H cDNA and Sequences

The PCR products were cloned without prior purification into pCR1000 (Invitrogen) and sequenced in both directions. Clones 152, 164, 1012, and 1043 were isolated independently during different RT-PCR runs. The sequences of V_L clones 152 and 164 were found to be identical, as were the sequences of the V_H clones 1012, 1043. The V_H and V_L DNA sequences and their derived protein sequences are shown in Tables 15 and 16 below.

Table 15: BrE-3 V_L Nucleotide and Derived Protein Sequences

DNA Sequence

ATG AAG TTG CCT GTT AGG CTG TTG GTG CTG TTG TTC TGG ATT CCT GCT TCC ATC AGT GAT GTT GTG ATG ACC CAA ACT CCA CTC TEC CTG
 CCT GTC AGT CTT GGA GAT CAA GCT TCC ATC TCT TGC AGA TGT AGT CAG AAC CTT GTA CAC AAC AAT GGA AAC ACC TAT TTA TAT TGG TTC
 CTG CAG AAG TCA GGC CAG TCT CCA AAG CTC CTG ATT TAT AGG GCT TCC ATC CGA TTT TCT GGG GTC CCA GAC AGG TTC AGT GGC AGT GGA
 TCA GAG ACA GAT TTC ACA CTC AAG ATC AGC AGA GTG GAG GCT GAG GAT CTG GGA GTT TAT TTC TGC TTT CAA GGT ACA CAT GTT CCG TGG
 ACC TTC GGT GGA GGC ACC AAG CTG GAA ATC AAA C (Seq. ID No: 10)

Amino Acid Sequence

M E I P V V I I V I L F W I P A S I S D I V V M T Q T P L S L
 P V S L G D Q A S I S C R S S O N L V M N N G N T V L Y W F
 L Q R S Q Q S P E L L I Y R A S I R F S G V P D R F S Q S Q
 S E T D F T L E I S R V E A E D L G V Y F C F Q Q T H V P W
 I P Q Q G T K L E I K (Seq. No: 11)

Table 16: BrE-3 V_H Nucleotide and Derived Protein Sequences

DNA Sequence

ATG TAC TTG GGA CTG AAC TAT GTC TTC ATA GTT TTT CTC TTA AAA GGT GTC CAG AGT GAA GTG AAG CTT GAG GAG TCT GGA GGA GGC TTG
 GTG CAA CCT GGA GGA TCC ATG AAA CTC TCT TGT GCT GCT TCT GGA TTC ACT TTT AGT GAT GCC TGG ATG GAC TGG GTC CGC CAG TCT CCA
 GAG AAG GGG CTT GAG TGG GTT GCT GAA ATT AGA AAC AAA GCC AAT AAT CAT GCA ACA TAT TAT GAT GAG TCT GTG AAA GGG AGG TTCACC
 ATC TCA AGA GAT GAT TCC AAA AGT AGA GTG TAC CTG CAA ATG ATA AGC TTA AGA GCT GAA GAC ACT GGC CTT TAT TAC TGT ACT GGG GAG
 TTT GCT AAC TGG GGC CAG GGG ACT CTG GTC ACT GTC TCT GCA G (Seq. ID No: 12)

Amino Acid Sequence

M Y I G I N Y V I I V F L L K G V Q S E I V K L E E S G G G L
 V Q P G G S M K L S C A A S G F T F S D A W M D W V R Q S P
 E K G L E W V A E I R N K A N N H A T Y Y D E S V K G R F T
 I S R D D S K S R V Y L Q M I S L R A E D T G L Y Y C T G E
F A N W G Q G T L V T V S A (Seq. ID No: 13)

The sequences were interpreted as described by Kabat et al. (1991). The residues that are shown in lower case correspond to PCR primers. The mature chains begin at D1 (V_L) and E1 (V_H), respectively. The amino-acids that are underlined are those corresponding to the CDRs. The underlined nucleotides indicate joining segments.

The framework and CDR polypeptide segments were identified according to Kabat et al. (1991), supra. V_L is a group IIX chain. Part of the CDR 3 and all of framework 4 (FR4) are encoded by J_{L1}. V_H belongs to group IIIc. CDR 3 and FR4 are encoded by J_{H2}. Little or nothing remains from an unidentified D minigene.

Thus, the CDR 3 is only 4 amino-acids long.

Example 12: Comparison of cDNA deduced Amino Acid Sequence with Directly Determined N-Terminal Fragment Sequence

5 Table 17 below shows a comparison between the cDNA-derived polypeptide sequence and the polypeptide sequence determined directly from purified murine BrE-3 monoclonal antibody.

Table 17: Comparison of cDNA-Deduced Protein Sequence with Directly Determined N-terminal Protein Sequence

10	VL	cDNA-deduced	DVVMTQTPLSLPVS LGDQASISCRS
	VL	Protein sequence	GVVMTQTPLSLPVV LGDQASIIXRX
15	VH	cDNA-deduced	EVKLEESGGGLVQPGGSMKLS CAAS
	VH	Protein sequence	EVKLEESGGVLVQPGGSMKLS SAAS

20 The murine BrE-3 antibody was reduced with 5% mercaptoethanol, separated on a 10% SDS polyacrylamide gel, and electroblotted onto a ProBlott membrane (Applied Biosystems, Foster City, CA). Amino acid sequencing was performed directly on the immobilized bands by the Biotechnology Instrumentation Facility, University of California, Riverside. The protein sequence given here is the sequencer's best guess.

25 Once the variable region cDNAs were cloned, it was confirmed that, in fact, they encoded the variable regions of the murine BrE-3 antibody and not those of another antibody by comparing the cDNA-derived amino acid sequences of the cloned murine BrE-3 antibody variable region with the N-terminal sequence of the purified anti-BrE-3 murine antibody directly determined by a single run of protein sequencing. The cDNA sequences were shown to be accurate by comparison with two independently reverse transcribed clones.

30 The general agreement between the predicted and the determined amino-acid sequences shows that the cloned cDNAs encode polypeptides of the same class and subclass as the variable regions of the murine BrE-3 antibody. This indicates that the cDNAs encode authentic variable regions. The authenticity of the variable region polypeptide and, therefore, that of the murine-
 35 human chimeric BrE-3 antibody is unquestionable given that the variable regions and the chimeric antibody affinity constant are indistinguishable from those of the murine BrE-3 antibody.

vectors were then electroporated (together) into SP2/O-Ag14 myeloma cells as described by Coloma et al. (1992), supra.

Example 14: Characterization of Murine-Human Chimeric BrE-3 Antibody

5 The supernatants from stable transfectants were assayed for the presence of the murine-human chimeric antibody as described in Examples 6 and 7 above. High producing transfectants were subcloned and subsequently adapted to grow in serum-free medium. The murine-human chimeric antibody produced by the myeloma cell line was then purified from the culture supernatant using a
 10 Sepharose 4B-protein A column (Bio-Rad, Richmond, CA) as described in Ey, P.L., et al. (Ey, P.L., et al., "Isolation of Pure IgG1, IgG2a and IgG2b Immunoglobulins from Murine Serum Using Protein A-Sepharose", *Immunochemistry* 15:429-436 (1978)). Antibody disulfide bonds were reduced to separate the light and heavy chains by heating for 10 min at 65° in Laemmli
 15 loading buffer containing 5% beta-mercaptoethanol. The separated chains were then chromatographed on a SDS polyacrylamide gel (10%). The reduced murine-human chimeric BrE-3 antibody and murine antibodies were electrophoresed in separate lanes next to 97.4, 66.2, 45.0, 31.0 and 2.5 Kdalton protein markers. Table 18 below shows the apparent molecular weights of the two bands
 20 obtained for both.

Table 18: Apparent Molecular Weights of Light and Heavy Chains of Murine and Chimeric BrE-3 Antibodies

	Chimeric Antibody		Murine Antibody	
	Heavy Chain (Kd)	Light Chain (Kd)	Heavy Chain (Kd)	Light Chain (Kd)
25	50	30	49	29

The heavy and light chains of the anti-BrE-3 chimeric antibody separate as expected when electrophoresed on a polyacrylamide gel.

Example 15: Tissue Binding Studies with Chimeric BrE-3 Antibody

30 Immunohistochemical staining using the immunoperoxidase technique of consecutive human breast carcinoma tissue sections was conducted with the murine-human chimeric BrE-3 antibody. A control was stained with the anti-human secondary antibody only. Positive staining resulted from the use of the murine-human chimeric BrE-3 antibody, followed by the anti-human antibody
 35 specific binding. (Pictures not shown).

The breast carcinoma tissue sections were stained with the supernatant

of the transfected cells using the Vectastain ABC method (Vector Labs, Burlingame, CA). The tissue stained with the goat anti-human Ig secondary antibody only shows background or non-specific staining of necrotic areas of the tissue section.

5 The tissue stained with murine-human chimeric BrE-3 antibody, followed by the secondary antibody, shows specific staining of the breast carcinoma cells in the breast tissue sections.

Example 16: Chimeric BrE-3 Antibody Imaging Studies

10 The anti-BrE-3 murine monoclonal antibody has been shown to be highly effective for imaging and for the radioimmunotherapy of breast cancers. For example, in a pharmacokinetic study of 15 breast cancer patients conducted with an ^{111}In -MXDTPA-BrE-3 radio-immunoconjugate (anti-BrE-3 antibody), the serum levels were low in most patients, the blood clearance correlated with the circulating antigen and the imaging results showed that about 86% of all sites
15 could be imaged (Liebes, L., et al., "Pharmacokinetics of ^{111}In -BrE-3 Monoclonal Antibody in Patients with Breast Carcinoma", Proc. Am. Assoc. Cancer Res. 33:216(Abs No. 1292) (1992)). A ^{90}Y -BrE-3 radioimmunoconjugate having similar pharmacokinetic characteristics and extrapolating the ^{111}In -BrE-3 dosimetry results provide a superior therapeutic agent, as well.

20 As with many other monoclonal antibodies, however, the clinical applications of the anti-BrE-3 murine antibody, a whole murine antibody, are limited by the HAMA response. A chimeric monoclonal antibody should give a more restricted HAMA response.

Example 17: Chimeric BrE-3 Antibody Immunogenicity

25 The BrE-3 variable region murine polypeptides have been cloned without the constant regions to produce less immunogenic polypeptides than the parent murine antibody. It has, moreover, been shown herein that the murine-human chimeric BrE-3 antibody lacking its original murine constant region preserves its antigen binding characteristics.

30 An BrE-3 antibody variable region alone or as a murine-human chimeric antibody also containing a constant human region or fragment thereof would be significantly less immunogenic to humans than the parent murine antibody. The hybrid polypeptide comprising the variable region of the BrE-3 antibody and the constant region of a human antibody was shown to preserve the original binding
35 affinity of the murine antibody. In this hybrid polypeptide, approximately 2/3 of its contiguous non-human immunogenic targets (C_L and C_H regions) were entirely replaced by human constant domains.

Example 18: PCR Primers used in First Isolation of Anti-KC-4 cDNAs

The PCR primers were purchased from Novagen (Madison, WI). Their sequences, reproduced from the booklet provided by Novagen, are shown in
5 Table 19 below.

Table 19: PCR Primer Sequences

-
- Mulg V_{κ} 5'-C: sense primer mix for kappa leader.
10 ACTAGTCGACATGAAGTTGCCTGTTAGGCTGTTGGTGCTG (Seq. ID No: 14)
ACTAGTCGACATGGAGWCAGACACACTCCTGYTATGGGT (Seq. ID No: 15)
ACTAGTCGACATGGATTTWCAGGTGCAGATTWTCAGCTTC (Seq. ID No: 16)
- Mulg V_{κ} 3'-1: antisense kappa constant region.
CCCAAGCTTACTGGATGGTGGGAAGATGGA (Seq. ID No: 17)
- 15 Mulg V_{μ} 5'-F: sense primer mix for heavy chain leader.
ACTAGTCGACATGRACCTTTGGGYTCAGCTTGRTTT (Seq. ID No: 18)
ACTAGTCGACATGAGAGTGCTGATTCTTTTGTG (Seq. ID No: 19)
ACTAGTCGACATGGATTTTGGGCTGATTTTTTTTATTG (Seq. ID No: 20)
- Mulg V_{γ} 3'-2: antisense gamma constant region.
20 CCCAAGCTTCCAGGGGCCARKGGATARACIGRTGG (Seq. ID No: 21)
-

Example 19: Cloning of Murine-Human Chimeric anti-KC-4 Antibody Ribonucleotide

The two expression vectors pAG4622 and pAH4604 described in
25 Example 4 were utilized. Oligonucleotides synthesized and used in a PCR to produce V_{κ} and V_{λ} fragments with the correct ends for insertion into the pAG4622 and pAH4604 expression vectors are shown in Table 20 below.

Table 20: PCR Primers Sequences

-
- 30 JO20 - sense kappa leader
GGG GATATC CACC ATG AAG TTG CCT GTT AGG CTG TTG (Seq. ID No: 22)
- JO21 - antisense JK2
CCC GTCGACTTAC G TTT TAT TTC CAG CTT GGT CCC CCC T (Seq. ID No: 23)
- 35 JO22 - sense V_{μ} leader
GGG GATATC CACC ATG GAC TTT GGG CTC AGC TTG GTT TT (Seq. ID No: 24)
- JO24 - antisense JH3
CCC GCTAGC TGC AGA GAC AGA GAC CAG AGT CC (Seq. ID No: 25)
-

The original pCR1000 clones were the starting templates for the PCR and the
40 rest of the procedures as described in Example 4 above.

Example 20: Expression of the anti-KC-4 Chimeric Antibody Gene

15 The V_H and V_L regions in the anti-KC-4 murine-human chimeric antibody were sequenced once again to verify that their sequences were correct. The transfection of the non-producer myeloma cell line SP2/O-Ag14, (ATCC: CRL 1581) and isolation of polypeptide was conducted as described in Example 5 above.

Example 21: Production of Transfected Hosts

20 After ten days, stable transfectant colonies were clearly established at a frequency of approximately 1/10,000. The colonies were transferred to normal medium and the assays conducted as described in Example 6 above.

Example 22: Confirmation of anti-KC-4 Murine-Human Chimeric Antibody Expression

25 The supernatants were assayed for binding to human milk fat globule (HMFG) and the breast epithelial mucin (BEM) as described previously in Example 7 above. HMFG and BEM were bound to the microtiter plates as described previously by Ceriani, R.L. (1990), supra. In this radioassay the bound anti-KC-4
30 chimeric antibody (HMFG and BEM) was detected by anti-human gamma chain conjugated to ^{125}I . Most colony supernatants were positive by both assays. The colonies that secreted the highest level of chimeric antibody in the supernatants, as determined by these assays, were subcloned.

Example 23: Western Blot

35 75 μ l of the culture supernatant was added to 20 μ l of 4x Laemmli buffer and 5 μ l β -mercaptoethanol and the mixture was heated at 65 °C for 15 min., in order to reduce antibody disulfide bonds and, thus, separate heavy from light chains. 20 μ l of the treated sample was chromatographed in duplicate lanes on a 10% SDS polyacrylamide gel together with other antibodies that were treated
40 similarly and that were loaded for comparison. Pre-stained size markers (BioRad, Richmond, CA) were also loaded.

5 The chromatographed proteins were electroblotted onto a ProBlott membrane (Applied Biosystems, Foster City, CA) in 90% 30 mM CAPS pH11, 10% methanol, for 1 hour at 25 V and at 4°C. The membrane was cut into 2 parts containing identical antibody samples. The 2 membranes were immersed in 20% bovine calf serum in PBS and shaken slowly at room temperature for
10 1 hour 35 min. ^{125}I -labeled goat anti-human κ chain antibody was added to one membrane and ^{125}I labeled goat anti-human γ chain antibody to the other

membrane. Antibodies were labeled at a specific activity of approximately 10 mCi/mg using the chloramin-T method as described by Ceriani, R.L. and Blank, E.W. (1988), the labeled antibodies were diluted to 4,000 cpm/ μ l in RIA buffer.

After incubating 3 hours at room temperature the blots were washed
5 twice in TBS for 10 min each time, once in TBST (50 mM TRIS pH7.5, 3 mM EDTA 25 mM NaCl) 10 min and once more in TBS (TBS with 0.05% Tween 20) for 10 min. The membranes were dried and exposed to Kodak XAR film.

Western blot analysis of culture supernatants revealed that three
10 antibody chains were expressed that corresponded to the three antibody chains seen in the original anti-KC-4 murine antibody. These were a heavy chain that stained with goat anti-human γ chain 125 I-labeled antibody, and two light chains that stained with goat anti-human κ chain 125 I-labeled antibody (Figure not shown).

The treatment of the original anti-KC-4 murine antibody with
15 N-glycosidase F (Boehringer Mannheim GmbH Germany) following the recommendations of the manufacturer, produced a noticeable decrease in the intensity of the "top" light chain and a concomitant increase in the intensity of the bottom light chain (Figure not shown).

The explanation for the existence of an extra light chain is that this chain
20 is glycosylated. Three lines of evidence substantiate this. First, the detection of an asparagine-linked glycosylation site in the amino acid sequence of the light chain. That is the triad NIS (Asn-Ile-Ser) in framework 3. Second, the decrease of the intensity in the putative glycosylated band after treatment with N-glycosidase F, while concomitantly the intensity of the non-glycosylated band
25 was increased. Finally, 2 corresponding light chain bands are seen in the chimeric antibody version. The extra light chain in the chimeric version cannot be a contaminant since it was specifically stained by goat anti-human κ chain antibody. It can only be a product expressed by pAG4622. Thus both light chains must have the same V_L amino acid sequence and the same human
30 constant region. These observations show that approximately half of the light chains of both the anti-KC-4 murine and chimeric antibodies are glycosylated at the asparagine-linked glycosylation site.

Example 24: Amplification of cDNAs Encoding anti-KC-4 Antibody F_c Regions

35 The cDNAs that encode the anti-KC-4 murine immunoglobulin V_H and V_L were prepared as described in Example 9 above from polyadenylated RNA isolated from 100 million KC-4 hybridoma cells. All clones were obtained from independent PCRs. The sequences of the primers are given in Example 19 and

20 above. All primers are specific for either the leader peptide region or for the constant regions. The primer combinations utilized herein are shown in Table 21 below.

Table 21: Primer Combination for PCR Amplifications

Clone No.	Primer combinations
5	
V_L	96 107 K1
	Mulg V_L 5'-C + Mulg V_L 3'-1 Mulg V_L 5'-C + Mulg V_L 3'-1 JO20 + JO21
10	
V_H	66 209 H3 H7
	Mulg V_H 5'-F + Mulg V_H 3'-2 Mulg V_H 5'-F + Mulg V_H 3'-2 JO22 + JO24 JO22 + JO24

Example 25: Isolation of Amplified anti-KC-4 F_{V_L} (V_L) and F_{V_H} (V_H) cDNA and Sequences

The PCR products were cloned, without prior purification, into pCR1000 (Invitrogen) and sequenced in both directions. The V_H and V_L DNA sequences and their derived protein sequences are shown in Tables 22 and 23 below.

Table 22: V_L Nucleotide Sequences anti-KC-4 V_L (kII-Jk2)

ATG AAG TTG CCT GTT AGG CTG TTG GTG CTG ATG TTC TGG ATT CCT
 GCT TCC AGC AGT GAT GTT TTG ATG ACC CAA ACT CCT CTC TCC CTG
 CCT GTC AGT CTT GGA GAT CAA GCC TCC ATC TCT TGC AGA TCT AGT
 CAG AGC ATT GTA CAT AGT AAT GGA AAC ACC TAT TTA GAA TGG TAC
 CTG CAG AAA CCA GGC CAG TCT CCA AAG CTC CTG ATC TAC AAA GTT
 TCC ATC CGA TTT TCT GGG GTC CCA GAC AAG TTC AGT GGC AGT GGA
 TCA GGG ACA GAT TTC ACA CTC AAT ATC AGC AGA GTG GAG GCT GAG
 GAT CTG GGA ATT TAT TAC TGC TTT CAA GGT TCA CAT GTT CCG TAC
 ACC TTC GGA GGG GGG ACC AAG CTG GAA ATA AAA c (Seq. ID No: 26)

Table 23: V_H Nucleotide Sequences anti-KC-4 V_H (IIID-D9-JH)

ATG GAC TTT GGG CTC AGC TTG GTT TTC CTT GTC CTT AAT TTA AAA
 GGT GTC CAG TGT GAA GTG CAG ATG GTG GAG TCT GGG GGA GTG AAG
 CCT GGA GGG TCC CTG AAA CTC TCC TGT GCA GCC TCT GGA TTC GCT
 TTC AGT AGC TAT GCC ATG TCT TGG GTT GGC CAG GAG AAG AAG CTG
 GAG TGG GTC GCA GAA ATT AGT AGT GGT GGT AAT TAC GCC TAC TAT
 CAA GAC ACT GTG ACC GGC CGA TTC ACC AGA GAC AAT GCC AAG AAC
 ACC CTG TAC CTG GAA ATG AGC AGT CTG AGG TCT GAG GAC ACC GCC
 ATG TAT TAC TGT GCA AGG GAG GGT ATC CCG GCC TGG TTT GCT TAC
 TGG GGC CAA GGG ACT CTG GTC TCT GTC TCT GCA g (Seq. ID No: 27)

**Example 26: Amino Acid Sequences of anti-KC-4
Chimeric Antibody Fv Regions**

5 After the anti-KC-4 F₁ region cDNAs were cloned, and sequenced, and their cDNA-derived amino acid sequence was compared with the N-terminus sequence directly determined by a single run of amino acid sequencing on purified anti-KC-4 antibody. The cDNA sequences were shown to be accurate since in both cases they were identical for clones that were prepared from
10 independent reverse transcription reactions. This confirms that the cloned cDNAs are authentic anti-KC-4 F₁ regions. The sequences are shown in Tables 24 and 25 below.

**Table 24: V_L Amino Acid Sequences
anti-KC-4V_L(kII-Jk2)**

15

MKLPVRLVLMFVIPASSS (Seq. ID No: 28)
FR1 DVLMTQTPLSLPVS LGDQASISC (Seq. ID No: 29)
CDR1 RSSQSIVHSNGNTYLE (Seq. ID No: 30)
FR2 WYLOKPGOSPKLLIY (Seq. ID No: 31)
20 CDR2 KVSIRFS (Seq. ID No: 32)
FR3 GVPDRFSGSGSGTDFTLNISRVEAEDLGIYYC (Seq. ID No: 33)
CDR3 FQGSHVPYT (Seq. ID No: 34)
FR4 FGGGTKLEIK (Seq. ID No: 35)

Table 25: V_H Amino Acid Sequences anti-KC-4V_H (IIID-D9-JH3)

25 MDFGLSLVFLVLILKGVQC (Seq. ID No: 36)
FR1 EVQMVESGGGLVKPGGSLKLSAASGFAFS (Seq. ID No: 37)
CDR1 SYAMS (Seq. ID No: 38)
FR2 WVRQSPEKRLEWVA (Seq. ID No: 39)
CDR2 EISSGGNYAYYQDTVTG (Seq. ID No: 40)
30 FR3 RFTISRDNKNTLYLEMSSLRSEDTAMYYCAR (Seq. ID No: 41)
CDR3 EGIPAWFAY (Seq. ID No: 42)
FR4 WGQGTLSVSA (Seq. ID No: 43)

The sequences were interpreted as described by Kabat et al. (1991), supra. The residues that are underlined correspond to PCR primers. The mature V_L and
35 V_H chains begin at amino-acids D and E of framework 1 (FR1), respectively.
Framework and CDR protein segments were identified according to Kabat et al. (1991), supra. V_L is a group II κ chain. Part of the CDR 3 and all of the

framework 4 (FR4) are encoded by Jk2. V_H belongs to group III d. CDR 3 and FR4 resulted from a genomic recombination involving minigenes D9 and JH3. There is an asparagine glycosylation site in the light chain in FR3. The site reads NIS (Asn Ile Ser).

5 **Example 27:** Comparison of cDNA-deduced Amino Acid Sequence with Directly Determined N-Terminal Fragment Sequence

A comparison between the cDNA-derived polypeptide sequence and the amino acid sequence determined directly on the purified anti-KC-4 monoclonal
10 antibody was undertaken. The results are shown in Table 26 below.

Table 26: Comparison of cDNA-deduced with Directly Determined N-Terminal Amino Acid Sequences

		FIRST BAND TOP
V _H , cDNA-deduced		EVQMVESGGGLVKPGGSLKLS (Seq. ID No: 44)
V _H , Protein sequence		EVQMVESGGGLVKPGGXKLS (Seq. ID No: 45)
		SECOND BAND
V _L , cDNA-deduced		DVLMTQTPLSLPVSLGDOASI (Seq. ID No: 46)
V _L , Protein sequence		DVLMTQTPLSLPVXXGDOASI (Seq. ID No: 47)
		THIRD BAND
V _L , cDNA-deduced		DVLMTQTPLSLPVSLGDOASI (Seq. ID No: 48)
V _L , Protein sequence		DVLMTQTPLSLPVSLGDOASI (Seq. ID No: 49)

X uncertain or alternative calls.

A sample of anti-KC-4 chimeric antibody (approximately 190 µg) was reduced with 5% beta-mercaptoethanol (65°C for 15 min.), separated on three lanes of a 10% SDS polyacrylamide gel, and electroblotted onto a ProBlott membrane (Applied Biosystems, Foster City, CA) in 90% 30 mM CAPS pH11.
5 10% methanol, for 1 hour at 25 V and at 4°C. The transferred protein species were stained with Comassie Brilliant Blue. 3 bands were seen in each lane, of which 2 migrated as expected for a heavy and light chain. The third band migrated above the light chain. Amino acid sequencing was performed directly on the immobilized bands by the Biotechnology Instrumentation Facility,
10 University of California, Riverside. The amino acid sequence given here is the sequencer's best guess.

Example 28: Construction of anti-KC-4 Murine-Human Chimeric Antibody Genes

The vector used were described in Example 1 above. Restriction ends were added to the cDNAs in a set of PCR reactions, using primers JO20, 21, 22, and 24.

The pAG4622 light chain vector and the pAH4604 heavy chain vector were described in Example 12 above.

The new V_H and V_L DNA fragments with appropriate restriction ends were integrated into pAH4604 and pAG4622 as described in Example 12 above. The vectors were then electroporated (together) also as described in Example 12 above.

Example 29: Tissue Binding Studies

The supernatants from stable transfectants were assayed for the presence of the anti-KC-4 murine-human chimeric antibody as described in Example 13 above. The chimeric antibody secreted in the supernatant bound both HMFG and BEM very strongly. In addition, the supernatants containing anti-KC-4 murine-human chimeric antibody were used to stain human breast carcinoma tissue sections by using the immunoperoxidase immunohistochemical staining technique. The intensity of the staining was comparable to that obtained with the original murine monoclonal antibody. The anti-KC-4 monoclonal antibody is known to bind the human milk fat globule and the breast epithelial mucin. This binding specificity of the anti-KC-4 murine monoclonal antibody was maintained even after the recombinant procedure. The anti-KC-4 chimeric antibody bound very strongly to HMFG and BEM as determined by a radioassay (Ceriani, et al., *Breast Cancer Res. Trent.* 15:161 (1990)). In addition, the anti-KC-4 chimeric antibody bound several human breast tumors in histopathological sections in a manner comparable to the anti-KC-4 murine monoclonal antibody, as detected by immunostaining described in Example 15 above. This specificity of binding demonstrated the retained binding reactivity of the variable regions of anti-KC-4 murine antibody by the polypeptide of the invention when attached to the human F_c fragment.

Example 30: Materials and Assays for Epitope Mapping

The specific details of the preparation of materials, cell lines, and techniques employed were disclosed by Peterson et al. (Peterson, J.A., et al., "Molecular Analysis of Epitope Heterogeneity of the Breast Mucin", *Breast Epithelial Antigens*, Ed. Ceriani, R.L., Plenum Press, NY (1991)), the relevant text of which is incorporated herein by reference.

Overlapping peptide hexamers were synthesized onto the ends of polyethylene pins using an Epitope Spinning Kit (Cambridge Research Biochemicals, Cambridge, UK), which is based on a method originally described by Geysen et al. (Geysen, H.L., et al., "Use of Peptide Synthesis to Probe Vital Antigens for Epitopes to a Resolution of a Single Amino Acid", PNAS (USA) 81:3998-4002 (1984)). The polyethylene pins were arranged in a 8x12 configuration that fits into a 96 well microtiter dish. The pins are supplied with an alanine attached to the ends to which the amino acids are added consecutively using pentafluorophenyl active esters of fluorophenyl-methyloxycarbonyl (Fmoc)-L-amino acids. Each consecutive overlapping hexamer differs from the previous one by a single amino acid and enough were synthesized to span the entire sequence of the peptide to be tested so that every combination of hexamer was present. Each monoclonal antibody was tested for binding to the synthetic peptides using an ELISA method with horseradish peroxidase-conjugated goat anti-murine IgG (Promega, Madison, WI) and color development with 2,2'-azino-bis (3-ethylbenzothiazoline-6-sulfonic acid (Sigma, St. Louis, MO).

The hexapeptides starting with A, P, D, and T bind well to the antibodies (Hexamers 1 to 3 and 20), whereas the hexamers starting between these positions did not. The hexamers that were prepared are shown in Table 27 below. The linear amino acid sequence essential for its binding to the antigen may be deduced from the hexamer that each monoclonal antibody binds. For example, the anti-BrE-3 antibody required the sequence TRP within the hexamer. Other monoclonal antibodies required other amino acid sequences (e.g., anti-Mc5, TRPAP; anti-Mc1, DTR; anti-BrE-1, DTRP). BrE-2 also required TRP but its different specificity for normal and tumor tissue indicates that its epitope on the native antigen is different from BrE-3.

Table 27: Epitope Mapping of Repeat Peptide Breast Mucin

Hexamer	GVTSA	PDTRPAPGSTAPPAHGVTS	APDTRP
1		PDTRPA	
2		DTRPAP	
3		TRPAPG	
4		RPAPGS	
5		PAPGST	
6		APGSTA	
7		PGSTAP	
8		GSTAPP	
9		STAPPA	
10		TAPPAH	
11		APPAHG	
12		PPAHGV	
13		PAHGV	
14		AHGVTS	
15		HGV TSA	
16		GVT SAP	
17		VTSAPD	
18		TSAPDT	
19		SAPDTR	
20		APDTRP	

Example 31: Epitope Mapping

5 Five different monoclonal antibodies (Mc1, Mc5, BrE1, BrE2 and BrE3) were prepared using HMFG for immunization. All identified epitopes on the highly glycosylated large molecular weight breast mucin. By immunohistochemistry they appeared to recognize different epitopes since each had different tissue and tumor specificities (Peterson, J.A., et al., "Biochemical and Histological

10 Characterization of Antigens Preferentially Expressed on the Surface and Cytoplasm of Breast Carcinomas Cells Identified by Monoclonal Antibodies Against the Human Milk Fat Globule", Hybridoma 9:221-235 (1990)). Each monoclonal antibody bound to a different spectrum of normal tissues and their specificities for different carcinomas were different. Anti-BrE2 and anti-BrE3,

15 however, were quite similar. In addition, by screening breast AgtII cDNA expression libraries with some of these monoclonal antibodies, cDNA clones were isolated that produced fusion proteins that bound all of them, while other cDNA clones bound just some (Larroca, D., et al., "High Level Expression in E. Coli of an Alternate Reading Frame of pS2 mRNA that Encodes a Mimotope of

20 Human Breast Epithelial Mucin Tandem Repeat" Hybridoma 11(2):191-201 (1992)). This binding to the fusion proteins indicated that the epitopes for these five monoclonal antibodies included the polypeptide portion of this glycoprotein. To confirm this the binding of these monoclonal antibodies to two synthetic polypeptide 20-mers (PDTRPAPGSTAPPAHGV TSA and

25 APPAHGVTSAPDTRPAPGST) that spanned the tandem repeat consensus sequence was tested (Gendler, S.J., et al., "Cloning of Partial cDNA Encoding

Differentiation and Tumor-Associated Mucin Glycoproteins Expressed by Human Mammary Epithelium", PNAS (USA) 84:6060-6064 (1987); Siddiqui, et al., "Isolation and Sequencing of a cDNA Coding for the Human DF3 Breast Carcinoma-Associated Antigen", PNAS (USA) 85:2320-2323 (1988).

5 One was started at the beginning of the published 20 amino acid repeat (Gendler, S.J., et al. (1987), supra) unit, and the other was started in the middle. All five monoclonal antibodies bound to both synthetic peptides, as did DF3, a monoclonal antibody against breast carcinoma cells produced by others (Hull, S.R., et al., "Oligosaccharide Differences in the DF3 Sialomucin Antigen from
10 Normal Human Milk and the BT-20 Human Breast Carcinoma Cell Line", Cancer Comm. 1:261-267 (1989)). Three other monoclonal antibodies against other components of the HMFG that do not cross-react with the breast mucin, Mc13, against a 70 KDa glycoprotein, and Mc3 and Mc8, against a 46 KDa glycoprotein do not bind to these synthetic peptides (data not shown) (Ceriani, R.L., et al., "Characterization of Cell Surface Antigens of Human Mammary
15 Epithelial Cells with Monoclonal Antibodies Prepared Against Human Milk Fat Globule", Somat. Cell Genet. 9:416-427 (1982); Peterson, J.A., et al., "Biochemical and Histological Characterization of Antigens Preferentially Expressed on the Surface and Cytoplasm of Breast Carcinoma Cells Identified by
20 Monoclonal Antibodies Against the Human Milk Fat Globule", Hybridoma 9:221-235 (1990)).

Example 32: Approach for Humanization of Antibodies

The present humanization approach is based on Padlan, E.A., "Choosing the Best Framework to Use in the Humanization of an Antibody by CDR-Grafting: Suggestions from 3-D Structural Data", Antibody Engineering 2nd. Annual Conf. San Diego, CA (Dec 16-17, 1991).
25

The fine specificity may be preserved in a "humanized" antibody only if the CDR structures, their interaction with each other, and their interaction with the rest of the variable domains can be maintained. (Padlan, E.A.(1991), supra).
30 This requires the preservation of residues of the FR amino acids which contact the CDRs, those which are involved in the V_L - V_H contact, and those which are buried and could influence the overall domain structure and the structure of the combining site.

By examination of murine Fab structures, for which atomic coordinates are available, the FR amino acids that are probably "important" in maintaining the structure of the combining site may be determined (Padlan, E.A., 8th International Congress of Immunol., Budapest, Hungary, Abstracts p. 19 (August 2-28, 1992)).
35

The specificity of an antibody depends on the CDR structures and sometimes, on some of its neighboring residues as well. These CDR structures, in turn, depend on contacts with framework amino acids and on the interaction of the V_L and V_H domains. Thus, to ensure the retention of binding affinity, not only the CDR residues must be preserved, but also those FR residues that contact either the CDRs or their opposite domains, as well as all buried residues, which give shape to the variable domains. The buried amino acids are placed in exactly the same positions in human and in murine frameworks (Padlan, E.A., "A Possible Procedure for Reducing the Immunogenicity of Antibody Variable Domains While Preserving Their Ligand-Binding Properties", *Molecular Immunology* 28:489-498 (1991)).

This approach was applied to design humanized analogues of the variable regions of the murine antibodies of the invention. The humanization or design of the exemplary analogue peptide provided herein was undertaken as follows. The identification of the residues, which are most probably "important" in preserving the combining site structure, permits the selection of the best human FR sequences to use in the "humanization" of each chimeric antibody of known structure or analogues peptides of the invention. The results of the analysis can be used also to predict which FR amino acids should probably be retained in those cases where no three-dimensional structural data are available.

The present procedure was designed to reduce the immunogenicity of the xenogeneic antibodies by preparation of their chimeric derivatives or fragments thereof while preserving their antigen-binding properties. In general, the antigen binding properties of an antibody are primarily determined by its CDRs. The CDRs of the murine antibody were "grafted" herein onto a human framework. In addition, the FR amino acids in the antibody, that are judged as probably important in maintaining the combining-site structure, may also be retained in the humanized molecule.

Example 33: Choice of a Murine Model of Known Structure for the Humanization of the BrE-3 Antibody

The classification of the V_H and V_L domains of an antibody such as the anti-BrE-3 antibody was done according to Kabat, E.A., et al. (Kabat, E.A., et al., "Sequences of Proteins of Immunological Interest" NIH (1991)). The anti-BrE-3 kappa chain V_L domain belongs to group II and the V_H domain belongs to group IIIc. A murine antibody was then found, whose structure had been determined, and whose variable regions belong to the same classes. The anti-fluorescein murine antibody 4-4-20 shown in Table 1 above (Herron, J.N., et al., "Three-Dimensional Structure of a Fluorescein-Fab Complex Crystallized in 2-Methyl-2,4-

Pentanediol", Proteins, 5:1-280 (1989) fits these requirements since, like BrE-3, it has V_L and V_H domains belonging to groups II and III C. Thus, the three-dimensional structures of antibodies BrE-3 and 4-4-20 should be similar, and BrE-3 may be modeled after 4-4-20.

5 **Example 34: Choice of Target Human Framework
for Humanization of BrE-3 Antibody**

The choice of the target human framework was not based on the similarity of the amino acid sequence of the entire framework, but strictly on the similarity at the residues that were judged to be structurally important according
10 to the 4-4-20 model. That is, only amino acids that could be involved in contacts with CDR of the opposite chain, or amino acids whose side-chains were predicted to be inwardly pointed. The positions of these amino acids are shown in Tables 8 and 9 and also in Tables 2, 3, 4, 5 and 6 above. These positions are as follows.

15 For the light chain variable region framework: 1, 2, 3, 4, 5, 6, 11, 13, 19, 21, 23, 35, 36, 37, 38, 44, 45, 46, 47, 48, 49, 58, 60, 61, 62, 69, 71, 73, 75, 78, 82, 86, 88, 98, 102, and 104.

For the heavy chain variable region framework: 4, 6, 12, 18, 20, 22, 24, 27, 28, 29, 30, 36, 37, 38, 39, 40, 45, 46, 47, 48, 49,
20 66, 67, 68, 69, 71, 73, 76, 78, 80, 82c, 86, 88, 90, 91, 92, 93, 94, 103, 107, 109 and 111.

The numbering system is conventionally accepted (Kabat, et al. (1991), supra) and shown in Tables 10 and 11 above. In this case, the consensus sequences of all human F_1 regions were selected as the target human framework
25 to minimize the immunogenicity of the product.

First, the sequences of the murine variable chains were aligned with consensus sequences from all known human variable region classes (Herron, J.N., (1989), supra) and the number of differences in the amino-acids that must be retained from the murine were scored. The positions of these amino acids
30 were obtained from those of murine monoclonal antibody 4-4-20, which was chosen to model the anti-BrE-3 antibody as shown in Tables 28 and 29 below.

Table 28: Choice of BrE-3 V_L Target Human Framework

BrE-3 V _L	
CDR1	CDR2
.....
BRE3K	DVVMTQTPLSLPVSLGDAQASISCRSSQNLVHN-NGNTYLY WFLQKSGSPKLLIY RASIRFS
HuKi-n	.IQ...S.S..SA.V..RVT.T..A..S..XXS-ISN..A..YQ..P.KA.....A..SLE
HuKi-ii	.I...S.....TP.EP.....S.L.SXD.....N.Y...P...Q....LV.N.A.
HuKi-iii	E.I.L.S.GT.SL.P.ER.TL...A..SVSSS...A..YQ..P..A.R....G..S.AT
HuKi-v	.I...S.D..A.....ER.T.N.K..SVLYSS.NKN..A..YQ...P..P.....W..T.E
CDR3	
.....
BRE3K	GVPDRFSGSGSETDFTLKISRVEAEDLGVYFC FQGTHTVPW-T FGGGTKLEK
HuKi-n	...S.....G.....T..SLQP..FAT.Y.Q.YNSL.EW..Q...V...
HuKi-iiG.....V...Y..M.ALOX.RX..Q...V...
HuKi-iii	.I.....G.....T..L.P..FA..Y.Q.YGSS.PL..Q...V...
HuKi-vG.....T..SLQ...VA..Y.Q.YYST..X..Q...V...

. identity with the murine sequence
 * the murine residues that are structurally important.

Table 29: Choice of BrE-3 V_H Target Human Framework

BrE-3 V _H	
CDR1	CDR2
..
BRE3VH	EVKLEESGGGLVQPGGSMKLSCAAAGFTFS DAWMD- WYRQSEPKGLEWVA
HuHI	Q.Q.VQ..AEVKK..A.V.V..K...Y..T SYAIS-A.GQ...MG
HuHII	Q.Q.Q...P...K.SQTL.S.T.TV..GSV. SYXWSWN .I..P.G.....IG
HuHIII	..Q.V.....LR..... SYA.S-A.G.....S
CDR2	
BRE3VH	EIRNKANNHATYDES VKG RFTISRDDSKSRVYLQMLSLRAEDTGLYCTG
HuHI	W.N-PYG.GD.N.AOKFQ. .V..TA.T.T.TA.MELS...S...AV...AR
HuHII	R.YYR.YSGS.X.NP.L.S .V...V.T..NQPS.KLS.VT.A..AV...AR
HuHIII	V.SG.TDGG...AD....N..NTL...N.....AV...AR
CDR3	
BRE3VH	EF-----AN WQGTLVTVSA
HuHI	APGYGGGGCYRGDYXFDYS
HuHII	ELPGGYXGDDYYXXGFDVS
HuHIII	GRXGXSLSGXYYHYFDYS

. identity with the murine sequence
 * the murine residues that are structurally important.

Based on these scores, the human frameworks belonging to groups V_HII and V_HIII were chosen to receive the anti-BrE-3 CDRs plus other important amino acids.

Example 35: Identification of BrE-3 Murine-Human Differences

5 The original murine sequences (BrE-3 V_L or V_H) were aligned with their closest human (Human KII or HIII) relatives that were chosen after comparing their sequences in Table 28 above. The alignment of these two sequences is shown in Table 30 below. The information in this table is also contained in Table

28 above, but is reproduced here for clarity. The CDRs are not shown, since their sequences were not changed during the humanization process. Thus, Table 30 shows the maximum number of amino acids that can be changed toward the humanization of the anti-BrE-3 antibody, based on the consensus human sequences obtained from the current databases (Kabat, E.A., et al. (1991), supra). If all these positions were to be replaced with the corresponding human amino acids, the corresponding CDR grafted antibody variable regions would be attained.

Table 30: Corresponding Amino Acid Sequences of VK BrE-3 and Human KII

	CDR1	CDR2
BrE-3 VK	DVVMTQTPLSLPVS LGDQASISC	WFLQKSGQSPKLLIY
Human KII	.I...S.....TP.EP.....Y...P....Q....
	CDR3	
BrE-3 VK	GVPDRFSGSGSETDFTLKISRVEAEDLGVYFC	FGGGTKLEIK
Human KIIG.....V...Y.....	..Q...V...
	CDR1	
BrE-3 VII	EVKLEESGGGLVOPGGSMKLSCAASGFTFS	WYRQSPEKGLEWVA
Human III	..Q.V.....LR.....A.G.....S
	CDR2	
BrE-3 VIIRFTISRDDSKSRVYLQMISLRAEDTGLYYCTG	
Human IIIN...NTL...N.....AV...AR	
	CDR3	
BrE-3 VIIWGQGLVTVSA	
Human IIIS	

Table 31 and 32 below contain the same information as Table 30 above in a different format. They show the numbers of the residues that would have to be changed in order to completely convert the original murine framework completely into a human consensus framework.

Table 31: BrE-3 V_L Amino Acid Candidates for Change into Human Consensus Sequences

V _L			
VI2		FY36	EG68
TS7		SP40	LV83
ST14		KQ45	FY87
DE17			LP15
QP18			

Table 32: BrE-3 V_H Amino Acid Candidates for Change into Human Consensus Sequences

	V _H		
	KQ3	SA40	DN73
5	AS113	EV5	EG42
	SN76	ML18	AS49
	RT77	KR19	VL78
	IN82a	GA88	LV89
10			TA93
			GR94

Example 36: Identification of Important Murine BrE-3 Amino Acids

The "important" murine amino acids that should be preserved were chosen based on the contacts of a particular amino acid with the CDRs, and with the opposite chains and/or whether their side chains are pointing inwardly or outwardly. The positions of these "important" amino acids were determined based on the examination of the known structures of other antibodies. This information is provided in Tables 33 and 34 below.

Table 33: Important V_L Amino Acid Positions to be Preserved

	V _L		
	V2	CDR contact	Buried
	F36	CDR contact	Contact with VH
	K45	CDR contact	
25	F87	Possible contact with VH	
	G100	Possible contact with VH	
	L104	Buried	

Table 34: Important V_H Amino Acid Positions to be Preserved

	V _H		
	M18	Buried	
	S40	Buried	
	A49	CDR contact	Buried
35	D73	CDR contact	
	S76		Buried
	V78	CDR contact	Buried
	L89	Might affect interaction with V _L	
40	T93	CDR contact	
	G94	CDR contact	Buried

Most of the "important" amino acids were selected on the basis of the structure of antibody 4-4-20 and according to Tables 2, 3, 4, 5, 6, 8 and 9 above. Two important amino acids out of each chain, however, were selected based on more general structural analysis, using other antibody structures. This was done to maximize the chances of conserving ligand binding properties. In particular the preservation of the Leu at 89-H was suggested in order to ensure the maintenance of, the $V_L:V_H$ contact. Although the residue at 89-H is usually not in contact with V_L and is only partly buried, it nonetheless contributes to the interface. A Val for Leu replacement at this position could very well create a "cavity" which could affect the contact. An Ile for Leu replacement would probably be fine since these amino acids have essentially the same side chain volume.

Finally, by comparing the position of all amino acids that are candidates for mutation, shown in Tables 31 and 32 above, with those that are "important" and should be preserved, shown in Tables 33 and 34, the final selection of amino acid positions for actual mutation was attained. Any "important" amino acid position was eliminated from the list of candidates. Table 35 below shows the amino acids that were selected for change from murine to human identities to obtain the present humanized analogue.

20 Table 35: Selected Amino Acids for Mutation

	V_L	V_H
	TS7	KQ3
25	ST14	EV5
	LP15	KR19
	DE17	EG42
	QP18	RT77
	SP40	IN82a
30	EG68	GA88
	LV83	AS113

Example 37: Introduction of Changes in BrE-3 Amino Acid Sequence

35 The changes were done at the DNA level in sequential manner. All but one of the codon mutations were performed using enzymatic inverse PCR (EIPCR), a mutagenesis technique developed by Stemmer and Morris (Stemmer, W.P.C and Morris, S.K., "Enzymatic Inverse Polymerase Chain Reaction: a Restriction Site Independent, Single Fragment Method for High Efficiency Site-Directed Mutagenesis", BioTechniques 13:146-220 (1992)).

First, the entire plasmid, containing the target cDNA was amplified by inverse PCR using terminal mutagenic oligonucleotides. Second, BsaI was used to cut the ends of the incorporated primers. This enzyme cuts at a site that is displaced from its recognition site. Thus, after digestion of the open amplified plasmid with BsaI, the BsaI recognition sequence was removed from the ends of the DNA. The DNA was left with complementary sticky ends and could be closed into a functional plasmid that contains the mutagenized region. The amino acid and DNA sequences of the non-mutated (wild-type) variable light and heavy chains of the anti-BrE-3 antibody are shown in Tables 15 and 16 above. The amino acid sequences of the anti-BrE-3 antibody frameworks and the mutations that were performed for the humanization, the oligonucleotide that was used for the mutagenesis, and the method of mutagenesis are shown in Tables 36 to 44 below.

Table 36: F_v, FR1 Mutation Sites

Position	FR1	Analogue 1 (8 Changes)	DNA Codon (FR1) (Analogue)	Method for Mutagenesis	Primers
Leader Peptide Not Shown					
		D			
		V			
		V			
		M			
		T			
7		Q	ACT TCT	EIPCR*	(JO37,JO38)
		T			
		P			
		L			
		S			
		L			
		P			
		V			
14		S	AGT ACT	EIPCR	(JO37,JO38)
15		L	CTT CCT	EIPCR	(JO37,JO38)
		G			
17		D	GAT GAG	EIPCR	(JO37,JO38)
18		Q	CAA CCA	EIPCR	(JO37,JO38)
		A			
		S			
		I			
		S			
		C			

* EIPCR: Enzymatic Inverse Polymerase Chain Reaction

Table 37: F_{VL} FR2 Mutation Sites

Position	FR2	Analogue 1 (8 Changes)	DNA Codon (FR2) (Analogue)	Method for Mutagenesis	Primers
CDR1 Not Shown					
	W				
	F				
	L				
	Q				
40	K	P	TCA CCA	EIPCR*	(JO39,JO40)
	S				
	G				
	Q				
	S				
	P				
	K				
	L				
	L				
	I				
	Y				

* EIPCR: Enzymatic Inverse Polymerase Chain Reaction

Table 38: F_{VL} FR3 Mutation Sites

Position	FR3	Analogue 1 (8 Changes)	DNA Codon (FR3) (Analogue)	Method for Mutagenesis	Primers
CDR2 Not Shown					
	G				
	V				
	P				
	D				
	R				
	F				
	S				
	G				
	S				
	G				
	S				
68	E	G	GAG GGG	EIPCR*	(JO41,JO42)
	T				
	D				
	F				
	T				
	L				
	K				
	I				
	S				
	R				
	V				
	E				
	A				
	E				
	D				
83	L	V	CTG GTG	EIPCR	(JO41,JO42)
	G				
	V				
	Y				
	F				
	C				

* EIPCR: Enzymatic Inverse Polymerase Chain Reaction

Table 39: F_{VL} FR4 Mutation Sites

Position	FR4	Analogue 1 (10 Changes)	Analogue 2 (6 Changes)	DNA Codon (FR4) (Analogue)	Method for Mutagenesis	Primers
CDR3 Not Shown						
	F	F	F			
	G	G	G			
	G	G	G			
	T	T	T			
	K	K	K			
	L	L	L			
	E	E	E			
	I	I	I			
	K	K	K			

Table 40: F_{VH} FR1 Mutation Sites

Position	FR1	Analogue 1 (8 Changes)	DNA Codon (FR1) (Analogue)	Method for Mutagenesis	Primers
Leader Peptide Not Shown					
	E				
	V				
3	K	Q	AAQ CAG	EIPCR*	(J057, J058)
	L				
5	E	V	GAG GTG	EIPCR	(J057, J058)
	S				
	G				
	G				
	L				
	V				
	D				
	P				
	G				
	S				
	M				
19	K	R	AAA AGA	EIPCR	(J057, J058)
	L				
	S				
	C				
	A				
	A				
	S				
	G				
	F				
	T				
	F				
	S				

* EIPCR: Enzymatic Inverse Polymerase Chain Reaction

Table 41: F_{VH} FR2 Mutation Sites

Position	FR2	Analogue 1 (8 Changes)	DNA Codon (FR2) (Analogue)	Method for Mutagenesis	Primers
CDR1 Not Shown					
	W V R S P E K G L E W V A				
42	Q	G	GAG GGG	EIPCR	(J055,J056)

* EIPCR: Enzymatic Inverse Polymerase Chain Reaction

Table 42: F_{VH} FR3 Mutation Sites

Position	FR2	Analogue 1 (8 Changes)	DNA Codon (FR2) (Analogue)	Method for Mutagenesis	Primers
CDR2 Not Shown					
	R F T I S R D D S K S R V Y L Q M I S L R A E D T G L Y Y C T G				
77		T	AGA ACT	EIPCR	(J053,J054)
82		N	ATA AAT	EIPCR	(J053,J054)
88		A	GGC GCC	EIPCR	(J053,J054)

* EIPCR: Enzymatic Inverse Polymerase Chain Reaction

Table 43: F_{VH} FR4 Mutation Sites

Position	FR2	Analogue 1 (8 Changes)	DNA Codon (FR2) (Analogue)	Method for Mutagenesis	Primers
CDR3 Not Shown					
	W				
	G				
	Q				
	G				
	T				
	L				
	V				
	T				
	V				
	S				
113	A	S	GCA TCT	PCR*	JO51, JO52*

*PCR: Polymerase Chain Reaction

Table 44: Sequences of Mutagenic Oligonucleotides

JO37	TCC CTG GGT CTC ACT CCT GGA GAG CCA GCT TCC ATC TCT TGC AGA TCT AGT (Seq. ID No. 50)
JO38	AGC TTG GGT CTC AGG AGT GAC AGG CAG GGA GAG TGG AGA TTG GGT CAT CAC AAC (Seq. ID No. 51)
JO39	G TTC CTG GTC TCG CCA GGC CAG TCT CCA AAG CTC CTG (Seq. ID No. 52)
JO40	T TGG AGG TCT CCC TGG CTT CTG CAG GAA CCA ATA TAA AT (Seq. ID No. 53)
JO41	TTC ACA GGT CTC ATC AGC AGA GTG GAG GCT GAG GAT GTG GGA GTT TAT TT (Seq. ID No. 54)
JO42	AGC CTC GGT CTC GCT GAT CTT GAG TGT GAA ATC TGT CCC TGA TCC ACT GC (Seq. ID No. 55)
JO51	CCT GGA GGA TCC ATG AGA CTC TCT TGT GCT (Seq. ID No. 56)
JO52	GTT GGG GCT AGC AGA AGA GAC AGT GAC CAG AGT (Seq. ID No. 57)
JO53	TAC CTG GGT CTC AAT AGC TTA AGA GCT GAA GAC ACT GCC CTT TAT TAC TGT (Seq. ID No. 58)
JO54	TTC AGC GGT CTC GCT ATT CAT TTG CAG GTA CAC AGT ACT TTT GGA ATC ATC (Seq. ID No. 59)
JO55	GTC CGC GGT CTC CCA GGG AAG GGG CTT GAG TGG GTT GCT GAA ATT AGA AA (Seq. ID No. 60)
JO56	CTC AAG GGT CTC CCC TGG AGA CTG GCG GAC CCA GTC CAT CCA GGC ATC A (Seq. ID No. 61)
JO57	T GAG GAG GTC TCA GGA GGC TTG GTG CAA CCT GGA GGA TCC ATG AGA CTC TCT (Seq. ID No. 62)
JO58	GG TTG CGG TCT CCC TCC TCC AGA CTC CAC AAG CTG CAC TTC ACT CTG GAC A (Seq. ID No. 63)

* note: Primer set JO51 and JO52 was originally intended for mutagenizing K19 to R (by JO51) and A113 to S (by JO52), as described below. Primer JO51, however, was somehow defective (it did not run as a single band on a polyacrylamide gel) and thus only the A113 to S mutagenesis was successful. Mutation K19 to R was accomplished at a later time with EIPCR, using primers JO57 and JO58.

Example 38: Synthesis of Primers

All primers except JO51 and JO52 were synthesized on a PCR-Mate EP DNA synthesizer model 391 (Applied Biosystems, Foster City CA). Primers JO51 and JO52 were purchased from Keystone Laboratories, Inc, Menlo Park, CA.

5. Both, the PCR method used with JO51 and JO52 and the EIPCR method used with all other primer sets, are described below.

The plasmid DNA template was extracted with a kit purchased from QIAGEN (Tchapsworth, CA) and diluted to 1ng/ μ l in 10mM TRIS 1mM EDTA pH 7.5 - 8. This plasmid is composed of vector pCR1000 (Invitrogen Corporation, San Diego, CA) into which the cDNA encoding the variable region to be humanized was inserted.

A mixture of PCR primers was made where each primer was present at a concentration of 10 pmole/ μ l in water.

The PCR amplification conditions were as follows. All reagents as well as the GeneAmp PCR system 9600 were purchased from Perkin Elmer Cetus. Optimal PCR conditions were determined empirically for each pair of mutagenic primers. A matrix of conditions varying the concentration of MgCl₂, mutagenic primers, and template plasmid DNA was set up. The annealing and extension temperatures during PCR may be varied.

Plasmid template (500 pg/ μ l), 0.5 μ M each mutagenic oligonucleotide, 1 mM MgCl₂, 10 mM TRIS pH 8.3, 50 mM KCl, 0.2 mM each nucleotide triphosphate (dGTP, dATP, TTP, dCTP), and Taq polymerase 1 unit/ 20 μ l reaction mixture.

Example 39: Hot Start PCR

All the components of the PCR mixture, with the exception of Taq polymerase, were mixed in a 95 μ l volume. The mixture was then dispensed in 19 μ l aliquots into 5 PCR tubes. The reason for performing five independent reactions was to decrease the odds that unwanted mutations be isolated as a result of nucleotide misincorporation during PCR. The tubes were heated to 95°C for 5 minutes and then cooled to 72°C. While at that temperature 1 μ l of an appropriate Taq polymerase dilution in 10 mM TRIS, pH 8.3, 50 mM KCl was added to the reaction tubes. The temperature cycling then proceeded as follows.

94°C, 3 min

[(94°C, 1 min) (50°C, 1 min) (72°C, 3.5 min)] 3 cycles

[(94°C, 1 min) (55°C, 1 min) (72°C, 3.5 min)] 25 cycles

72°C, 10 min

Example 40: Extra Final Extension

After cycling, the contents of the five tubes were mixed and an extra final extension reaction was carried out. Extra nucleotide triphosphates were added (to 125 μ M), 5 units of Taq polymerase were also added and the mixture was heated to 72°C for 10 minutes.

Example 41: Purification of PCR Products

The PCR products were then separated on a 0.8% agarose gel in 1XTAE buffer and 0.5 $\mu\text{g/ml}$ Ethidium Bromide. The correct DNA band was visualized with UV light (366 nm), excised from the gel and extracted with the GeneClean
5 kit purchased from Bio 101, La Jolla, CA.

Example 42: Restriction Digestion

The DNA was then digested with BsaI for two hours at 60 degrees celsius in 25 μl (20.5 μl of DNA, 2.5 μl 10 X buffer 4 (NEB) and 2 μl BsaI (NEB). BsaI sites were designed near the 5' end of the PCR primers. The primers
10 included 6 extra nucleotides 5' of the BsaI sites to facilitate digestion by BsaI. There were no BsaI sites elsewhere in the plasmid. Other restriction enzymes may be used as advised by Stemmer and Morris (Stemmer and Morris (1992), supra). This special class of restriction enzyme cuts at a site that is different
15 from its recognition site but, nevertheless, at a precise distance from it. Using this method, there was no need for having restriction sites in the sequence in order to perform the mutagenesis.

Example 43: Second Purification

The restricted products were then separated on a 0.8% agarose gel in 1XTAE buffer and 0.5 $\mu\text{g/ml}$ Ethidium Bromide. The correct DNA band was
20 visualized with UV light (366 nm), excised from the gel and extracted with the GeneClean kit purchased from Bio 101, La Jolla, CA.

Example 44: Ligation (Reclosure of Plasmid)

The ligation mixtures consisted of 5 μl extracted DNA, 2 μl 10x ligation buffer (NEB) 1 μl T4 DNA polymerase (NEB), 12 μl water. The amount of
25 plasmid DNA may be varied depending of the intensity of the band extracted from the Gel. Ligation was carried out at room temperature for 2 hrs., or alternatively at 14°C overnight.

Example 45: Transformation and Sequencing

The reclosed plasmids were then transformed into E. coli. We used Inv
30 alpha F' competent cells purchased from Invitrogen Corporation, San Diego CA.

Plasmid DNA was then prepared from a few transformants and sequenced to verify that mutagenesis was successful.

Example 46: Mutagenesis of BrE-3 Antibody using JO51 and JO52

These oligonucleotides were designed to mutagenize K19 to R (by JO51)

and A113 to S (by JO52), not by using EIPCR but using the normal PCR (with primers pointing to each other). Primer JO51 carried a BamHI site and primer JO52 carried an NheI site. After mutagenic PCR amplification the resulting amplified DNA cassette was inserted into the plasmid in lieu of the corresponding wild-type DNA fragment. There was no compelling reason to use this method over the EIPCR method except that conveniently placed restriction sites (BamHI and NheI) were available. This method, however, yielded only the A113 to S mutation. A subsequent analysis showed that the JO51 primer, which carried the K19 to R mutation ran aberrantly on a polyacrylamide gel.

The protocol for the mutagenic amplification step was as follows. Plasmid template (500 pg/ μ l), 0.75 μ M each mutagenic oligonucleotide, 2 mM $MgCl_2$, 10 mM TRIS pH 8.3, 50 mM KCl, 0.2 mM each nucleotide triphosphate (dGTP, dATP, TTP, dCTP), and Taq polymerase 1 unit/20 μ l reaction mixture..

The PCR was not started as described for EIPCR above. The temperature cycling conditions used were as follows.

94°C, 3 min

[(94°C, 1 min) (44°C, 1 min) (72°C, 1 min)] 3 cycles

[(94°C, 5 sec) (65°C, 1 min) (72°C, 1 min)] 32 cycles

72°C, 10 min

The extra final extension and purification of PCR products were conducted as described for EIPCR above.

The restriction digestion of the vector and the insert were conducted as follows. The PCR product was digested with BamHI and NheI for 1 hr. 50 min. at 37°C (19 μ l of DNA, 2.5 μ l 10Xbuffer 3 (NEB), 1.5 μ l BamHI (NEB), 1.5 μ l NheI (NEB). The vector, which is the starting plasmid described above, was digested under similar conditions (1 μ l plasmid (1 μ g), 2 μ l 10Xbuffer 3 (NEB), 1.5 μ l BamHI (NEB), 1.5 μ l NheI (NEB) 14 μ l water, 2 1/2 hrs. at 37°C).

The restricted products, vector and insert, were then purified once more as described above for EIPCR.

The ligation of the fragments was conducted as follows. The ligation mixtures consisted of 5 μ l vector, 5 μ l insert, 2 μ l 10x ligation buffer (NEB) 1 μ l T4 DNA polymerase (NEB), 7 μ l water. The amount of plasmid DNA may be varied depending of the intensity of the band extracted from the Gel. Ligation is carried out at 14°C overnight. A control ligation with vector only was carried out in parallel. The transformation of the host cells was conducted as described for EIPCR.

Example 47: Plasmid Preparation and Sequencing of Humanized BrE-3 V_H

Plasmid DNA was then prepared from several independent transformants. A few of the plasmids that were shown by restriction analysis to contain the insert were then sequenced to verify that the mutagenesis was successful. When one of the sequenced DNAs contained the desired mutation it was utilized for the next mutation cycle. The fully mutated humanized analogue BrE-3 DNA sequences for the V_H and V_L segments are shown in Tables 45 and 46 below.

Table 45: BrE-3 Antibody V_L Humanized Analogues DNA Sequences
BrE-3 V_L FR-HZ

10

ATG AAG TTG CCT GTT ACG CTG TTG CTG CTG TTG TTC TGG ATT CCT GCT TCC ATC AGT GAT GTT GTG
 ATG ACC CAA ~~TCT~~ CCA CTC TCC CTG CCT GTC ~~ACT~~ ~~GCT~~ GGA ~~GAG~~ ~~CCA~~ GCT TCC ATC TCT TCC AGA TCT
 AGT CAG AAC CTT GTA CAC AAC AAT GGA AAC ACC TAT TTA TAT TGG TTC CTG CAG AAG ~~CCA~~ GGC CAG
 TCT CCA AAG CTC CTG ATT TAT AGG GCT TCC ATC CGA TTT TCT GGG GTC CCA GAC AGG TTC AGT GGC
 15 AGT GGA TCA ~~GGG~~ ACA GAT TTC ACA CTC AAG ATC AGC AGA GTG GAG GCT GAG GAT ~~GTG~~ GGA GTT TAT
 TTC TGC TTT CAA GGT ACA CAT GTT CGG TGG ACC TTC GGT GGA GGC ACC AAG CTG GAA ATC AAA C
 (Seq. ID No. 64)

Table 46: BrE-3 Antibody V_H Humanized Analogue DNA Sequences

BrE-3 V_H FR-HZ

20

ATG TAC TTG GGA CTG AAC TAT GTC TTC ATA GTT TTT CTC TTA AAA GGT GTC CAG AGT GAA GTG ~~CAG~~
 CTT ~~GTC~~ GAG TCT GGA GGA GGC TTG GTG CAA CCT GGA GGA TCC ATG ~~AGA~~ CTC TCT TGT GCT GCT TCT
 GGA TTC ACT TTT AGT GAT GGC TGG ATG GAC TGG GTC GGC CAG TCT CCA ~~GGG~~ AAG GGC CTT GAG TGG
 GTT GCT GAA ATT AGA AAC AAA GGC AAT AAT CAT GCA ACA TAT TAT GAT GAG TCT GTG AAA GGG AGG
 TTC ACC ATC TCA AGA GAT GAT TCC AAA AGT ~~ACT~~ GTG TAC CTG CAA ATG ~~AAT~~ AGC TTA AGA GCT GAA
 25 GAC ACT ~~GGC~~ CTT TAT TAC TGT ACT GGG GAG TTT GCT AAC TGG GGC CAG GGG ACT CTG GTC ACT GTC
 TCT ~~TCT~~ G (Seq. ID No.: 65)

Example 48: Humanized BrE-3 Antibody Expression

Two expression vectors pAG4622 and pAH4604 (Coloma, M.J., et al. (1992), supra) were used that were developed and provided by S.L. Morrison (Dept. of Microbiology and Molecular Genetics, UCLA). Any cDNA encoding a signal peptide and either the variable heavy chain or the variable light chain can, in principle, be inserted into these vectors resulting in a construction that encodes an IgG1, K, antibody with human constant regions. Correctly modified cDNAs were excised from pCR1000 with EcoRV and Sal I and inserted into pAG4622. These encode the modified light chain. The wild-type heavy chain

was similarly excised from pCR1000 by digestion with EcoRV and NheI and inserted into pAH4604. The restriction and ligation reactions necessary to accomplish these operations were performed under the conditions stipulated by the enzyme manufacturers (New England Biolabs, Beverly, MA). Both the vectors and the inserts were purified from an agarose gel prior to ligation, using the Bio101 (La Jolla, CA) GeneClean kit (glass beads). The V_H and V_L regions in the final constructions were sequenced once again to verify that they are correct. The non-producer myeloma cell line SP2/0-Ag14, ATCC: CRL 1581, (Shulman M., et al. (1978), supra) was transfected with both plasmid constructions, and antibody producers were isolated following the recommendations outlined in (Coloma, M.J. et al. (1992), supra) except that selection was done only for the uptake of hisD (by adding 5 mM histidinol to the medium and readjusting the pH to 7.4 with NaOH). Usually after ten days, stable transfectant colonies were established at a frequency of approximately 10⁻⁸ to 10⁻⁶. Colonies were then transferred to normal medium (without histidinol). The culture media were either Dulbecco's modified Eagle's medium (DME): fetal bovine serum (FBS), 90:10, v/v, or a mixture of DME:RPMI:FBS, 45:45:10, v/v/v. Penicillin and streptomycin were added to prevent bacterial growth.

The supernatants from stable transfectants were assayed for the presence of the antibodies. This was done by capturing the secreted chimeric antibody with a plate-bound goat anti-human-kappa chain antibody and developing with goat anti-human-gamma chain antibody, essentially as described previously (Coloma, M.J. (1992), supra) except that the secondary antibody was radiolabeled with ¹²⁵I. The supernatants were also assayed for binding to human milk fat globule (HMFG) as described previously (Ceriani R.L., et al., "Diagnostic Ability of Different Human Milk Fat Globule Antigens in Breast Cancer", *Breast Cancer Res. Treat.*, 15:161-174 (1990)). HMFG is bound to the microtiter plates as described previously (Ceriani, R.I. (1984), supra). Usually most colony supernatants were positive by both assays. Colonies that secrete the highest level of antibody in the supernatants, as determined by these assays, were subcloned and subsequently adapted to serum-free medium for the purification of antibody. Serum free medium contains HL-1 supplement as directed by the manufacturer (Ventrex Labs., Portland, ME).

Example 49: Half Humanized-Half Chimeric BrE-3 Antibody

A BrE-3 humanized light chain was paired with an anti-BrE-3 non-humanized chimeric heavy chain by co-transfection of SP2/0 myeloma cells with hybrid plasmids carrying the respective DNA sequences and those of a human

F_c.

Example 50: Determination of Affinity Constants for Half Humanized and Fully Humanized BrE-3 Antibodies

The secreted half humanized-half chimeric and fully humanized antibodies
5 were purified from culture supernatants using a Sepharose 4B-protein A column (Bio-Rad, Richmond, CA.) as described by Ey et al. (Ey, P.L., et al. (1978), supra). Microtiter plates (Dynatech, Chantilly, VA) were prepared as described by Ceriani et al. (Ceriani, R.L., et al. (1992), supra) using successive layers of methylated BSA, glutaraldehyde, anti- β -galactosidase and the bacterial fusion
10 protein 11-2 (a hybrid of β -galactosidase and human mammary mucin). Each well contained 388 ng of the 11-2 fusion protein. To each well were added 25 μ l 125 I-BrE-3 in RIA buffer (10 % bovine calf serum, 0.3% triton X-100, 0.05 % sodium azide pH7.4, in phosphate buffer saline) and compete with 25 μ l of either unlabeled murine or chimeric antibody in RIA buffer at the final
15 concentrations of 130 pM, 850 pM, 1.3 nM, 4 nM, and 13 nM). Iodinations were performed with 125 I (17Ci/mg, Nordion International). Fifty micrograms of monoclonal antibody BrE-3 (Coulter, Hialeah, FL) were labeled at a specific activity of 9.56 mCi/mg using the chloramine T method as described previously by Ceriani et al. (Ceriani, R.L., et al. (1988), supra)

20 Antibody-antigen affinity constants were determined by taking the reciprocal of the concentration of competing unlabeled monoclonal antibody that produced 50 % binding as described by Sheldon et al. (Sheldon, K., et al. (1987), supra). The protocol used to determine affinity constants was as described above except that in each case, an unlabeled antibody competed for
25 binding to antigen against the same radiolabeled antibody. Both, the half humanized-half chimeric antibody and the fully humanized antibody competed about as well or better with the anti-BrE-3 murine antibody for the antigen.

30 Polyacrylamide gel electrophoresis was performed to insure that the antibody chains migrated as expected. The affinity binding constants of the murine, chimeric, half humanized and humanized antibodies were determined in independent competition assays.

Example 51: Histochemical Specificity of Half and Fully Humanized BrE-3 Antibodies

Immunohistochemical staining using the immunoperoxidase technique
35 of consecutive human breast carcinoma tissue sections was used as a test to verify that the analogue antibodies retain useful affinity for the carcinoma antigens. Breast carcinoma tissue sections were stained with the supernatant of the half humanized/half chimeric and fully humanized transfected cells using

the Vectastain ABC method (Vector Labs, Burlingame, CA). Both antibodies showed strong staining patterns.

Example 52: Gel Chromatography of Half Humanized-Half Chimeric and Fully Humanized BrE-3 Antibodies

5 Antibody disulfide bonds were reduced by heating for 10 min at 65°C in Laemmli loading buffer containing 5% beta-mercaptoethanol. The separated chains were then chromatographed on a SDS polyacrylamide gel (10%). Two bands were observed for both antibodies of similar migration pattern as the murine antibody. These data were also confirmed by Western blotting.

10 **Example 53: Deduced Amino Acid Sequences of Humanized BrE-3 Variable Light and Heavy Chains**

The amino acid sequences of the light and heavy chains of the analogue humanized antibody are shown in Tables 47 and 48 below. These amino acid sequences may be improved either to increase affinity for the antigen or to
15 decrease immunogenicity in humans. Numerous variants of this sequence may be engineered in accordance with the invention.

Table 47: Humanized BrE-3 V_L Analogue Amino Acid Sequence BrE-3 V_L FR-HZ

20	Leader	mkiprvllvILFWIPASIS (Seq. ID No: 66)
	FR1	DVVMTQSPLSLPVTPGEPASISC (Seq. ID No: 67)
	CDR1	RSSQNLVHNNGNTYLY (Seq. ID No: 68)
	FR2	WFLQKPGQSPKLLIY (Seq. ID No: 69)
	CDR2	RASIRFS (Seq. ID No: 70)
25	FR3	GVPDRFSGSGSGTDFTLKISRVEAEDVGVYFC (Seq. ID No: 71)
	CDR3	EQGTHVPWT (Seq. ID No: 72)
	FR4	FGGGTKLEIK (Seq. ID No: 73)

30 **Table 48: BrE-3 V_H Analogue Amino Acid Sequence BrE-3V_H FR-HZ**

	Leader	mylglnyvfIVFLLKGVQS (Seq. ID No: 74)
	FR1	EVQLVESGGGLVQPGGSMRLSCAASGFTFS (Seq. ID No: 75)
35	CDR1	DAWMD (Seq. ID No: 76)
	FR2	WVRQSPGKGLEWVA (Seq. ID No: 77)
	CDR2	FIRNKANNHATYYDESVKG (Seq. ID No: 78)
	FR3	RFTISRDDSKSTVYQLMNSLRAEDTALYYCTG (Seq. ID No: 79)
	CDR3	EFAN (Seq. ID No: 80)
40	FR4	WGQGLVTVSS (Seq. ID No: 81)

**Example 54: Choice of Murine Model of Known Structure
for Humanization of anti-KC-4 Antibody**

The classification of the V_H and V_L domains of an antibody such as the anti-KC-4 antibody was done according to Kabat et al. (Kabat, E.A., et al., "Sequences of Proteins of Immunological Interest" NIH (1991). The KC-4G3 kappa chain V_L domain belongs to group II and the V_H domain belongs to group IIIId. A murine antibody was then found, whose structure had been determined, and whose variable regions belong to the same classes. The anti-myohemerythrin peptide antibody B13I2 fits these requirements since, like the anti-KC-4 murine antibody, it has V_L and V_H domains belonging to groups II and IIIId (Stanfield, R.L., et al., "Crystal Structures of an Antibody to a Peptide and its complex with Peptide Antigen at 2.8 Å", Science 248:712-719 (1990)). Thus, the three-dimensional structures of antibodies the anti-KC-4 and B13I2 antibodies should be similar, and the humanization of the anti-KC-4 antibody may be modeled after B13I2.

**Example 55: Choice of Target Human Framework for
Humanization of Chimeric anti-KC-4 Antibody**

The choice of the target human framework was based strictly on the similarity at the residues that were judged to be structurally important according to the B13I2 model. That is, only amino acids that could be involved in contacts with CDRs of the opposite chain, or amino acids whose side-chains were predicted to be inwardly pointed. The positions of these amino acids are shown in Tables 49 below.

Table 49: Important Amino Acid Positions for anti-KC-4 Antibody

25

Light Chain Variable Region Framework

2, 3, 4, 6, 7, 11, 13, 19, 21, 22, 23, 35, 36, 37, 38, 43,
44, 46, 47, 48, 49, 58, 60, 61, 62, 69, 71, 73, 75, 78,
82, 85, 86, 87, 88, 98, 102, 104 and 106.

30 Heavy Chain Variable Region Framework

2, 4, 6, 12, 18, 20, 22, 24, 27, 28, 29, 36, 37, 38, 39, 43, 45, 46, 47, 48,
49, 66, 67, 69, 71, 78, 80, 82, 82c, 86, 88, 90, 91, 92, 93, 94, 103, 107,
109 and 111.

35 The numbering system is conventionally accepted (Kabat, et al. (1991), supra) and is shown in Tables 10 and 11 above. In this case, the consensus sequences of all human F_1 regions were selected as the target human framework to minimize the immunogenicity of the product.

First, the sequences of the murine variable chains were aligned with consensus sequences from all known human variable region classes (Herron, J.N., (1989), supra) and the number of differences in the amino-acids that must be retained from the murine were scored. The positions of these amino acids were obtained from those of the B1312 murine monoclonal antibody, which was chosen to model the humanization of the anti-KC-4 antibody.

Based on these scores, the consensus sequences human frameworks belonging to groups V_HII and V_HIII were chosen to receive the anti-KC-4 murine antibody CDRs plus other important amino acids.

10 **Example 56: Identification of Murine-Human anti-KC-4 Antibody Differences**

The original murine sequences (anti-KC-4 V_K or V_κ) were aligned with their closest human (Human KII or HIII) relatives that were chosen after comparing their sequences as described in Example 34 above. In the present example, it was intended to be substituted as many amino acids as possible in going from the murine to the humanized variable consensus sequences, leaving the important amino acids intact as described in Examples 55 and 57. The amino acids chosen to be preserved were a subset of those listed above. These were selected by analogy to the B1312 sequence. The single exception was the glycine (100) residue of the original framework of the variable region of the murine kappa chain, which was retained despite not being encompassed in Table 49 above since it was thought that it might contact the variable domain of the heavy chain. Such contacts were observed in at least three Fab that lack a gly at this position.

25 **Example 57: Identification of Important Murine anti-K-4 Antibody Amino Acids**

The "important" murine amino acids were chosen for preservation based on the contacts of a particular amino acid with the CDRs, and with the opposite chains and/or whether their side chains are pointing inwardly or outwardly. The positions of these "important" amino acids were determined based on the examination of the known structures of other antibodies.

Most of the "important" amino acids were selected on the basis of the structure of antibody B1312 and according to Tables 2, 3, 4, 5, 6, 8 and 9 above. The final selection of amino acid positions for actual mutation was attained by comparing the position of all amino acids that are candidates for mutation with those that are "important" and should be preserved. Any "important" amino acid position was eliminated from the list of candidates. Table 50 below shows the amino acids that were selected for change in the

murine sequence to attain the humanized sequence in the present exemplary analogue.

**Table 50: Anti-KC-4 Murine Antibody Variable Region
Amino Acids Selected for Mutation**

5	Position	KC-4G3 Murine Identity	→	Consensus Human Identity
	Light Chain Variable Region			
10	14			
	15			
	16			
	17			
	18			
	19			
	20			
	21			
	22			
	23			
	24			
	25			
	26			
	27			
	28			
	29			
	30			
	31			
	32			
	33			
	34			
	35			
	36			
	37			
	38			
	39			
	40			
	41			
	42			
	43			
	44			
	45			
	46			
	47			
	48			
	49			
	50			
	51			
	52			
	53			
	54			
	55			
	56			
	57			
	58			
	59			
	60			
	61			
	62			
	63			
	64			
	65			
	66			
	67			
	68			
	69			
	70			
	71			
	72			
	73			
	74			
	75			
	76			
	77			
	78			
	79			
	80			
	81			
	82			
	83			
	84			
	85			
	86			
	87			
	88			
	89			
	90			
	91			
	92			
	93			
	94			
	95			
	96			
	97			
	98			
	99			
	100			

The change N→K at position 74 in the variable light chain knowingly eliminated an N-linked glycosylation site, which was present in the original murine monoclonal antibody.

Example 58: Introduction of Changes in Amino Acid Sequence for Humanization of anti-KC-4 Antibody

The introduction of the changes in the amino acid sequence was not done as described in Example 37 above. Instead the DNA encoding each humanized variable region was synthesized in a single polymerase chain reaction (PCR) using overlapping oligonucleotides in accordance with the method described by Ye et al. (Ye, Q-Z, Johnson, L.L., and Baragi, V., "Gene Synthesis and Expression in E. coli for PUMP, a Human Matrix Metalloproteinase", BBRC 186(1):143-149 (1992)). The sequences of the mutagenic are shown in Table 51 below.

**Table 51: Primers for Humanization of anti-KC-4
Murine Antibody Variable Regions**

J059	CCCCGATCC	TTTAAAGGT	GTCCAGTGTG	AAGTCAGAT	GGTGGAG	TCTG	(SEQ. ID No.: 82)
5	J060	GAATCGGGC	TAGCACTAGA	GACACTEACC	AGACTCCCTT	GGCCCCAG	(SEQ. ID No.: 83)
J061	AGTGCAGATG	GTGGAGTCTG	GGGGAGGCTT	AGTGCAGCCT	GGAGGGTCCC	TGACACTCTC	
J062	CTTGATAGTA	GGGTAATTA	CCACCCTAC	TAATTTCTGC	GACCCACTCC	AGCCCCCTCC	
J063	CTGGAGCTTG	GGAACTCAA	GACATGGCAT	AGCTACTGAA	A	(SEQ. ID. No.: 85)	
10	J063	TAATTACGCC	TACTATCAAG	ACACTGTGAC	GGGCCAATC	ACCATCTCCA	GAGACAATTC
J064	CAAGAACC	CTGTACTTGC	AAATGAACAG	TCTGAGGGCT	G	(SEQ. ID. No.: 86)	
J064	CCAGATGCC	TTGGCCCCAG	TAAGCAAACC	AGGCGGGAT	ACCGTAGTCC	TCCCTTGAC	
J073	AGTAATAGAC	GGCCCTTCC	TCAGCCCTCA	GACTGTTCAI	T	(SEQ. ID. No.: 87)	
J073	GGGAGCTTG	ATATCCACCA	TGAAGTTC	TCTAGGCTG	TTGGTCTGA	TGTTCTGGAT	
15	J074	TCCTGC	(SEQ. ID No.: 88)				
J074	AAAGATTCC	TGCACTTACG	TTTTAATTC	AGCTGGTCC	CCCTCC	GAA	CGTGTACGGA
J075	ACATGT	(SEQ. ID. No.: 89)					
J075	CTGATGTTCT	GGATTCCTGC	TTCCAGCAAT	GATGTTTGA	TGACCC	AAAC	TCCTCTCTCC
J076	CTGCTGTCA	CTCCAGGAGA	GCCAGCTCC	ATCTCTTCCA	(SEQ. ID. No.: 90)		
20	J076	CTGTGAGAC	TGGCTGGTT	TCTGCAGGA	CCATTCTAAA	TAGTG	TTTC
J078	TACTACTATG	TGCAAGAGAT	GGAGCTGCC	(SEQ. ID. No.: 91)			
J078	CGAAGCTGA	CGGAACATG	GACCTTGA	AGCAATAA	AATTC	CACA	TCTCAGCCT
J078	CCACTCTCT	GATCTTGA	GTGAAATCTG	TCCTGATCC	(SEQ. ID. No.: 92)		

25 Example 59: Synthesis of Primers for Humanization of anti-KC-4 Antibody

All primers were synthesized on a PCR-Mate EP DNA synthesizer model 391 (Applied Biosystems, Foster City CA) using 40nmole columns, cycle 1:63, with Trityl off. None were purified before use. The EIPCR method was used for preparing all primer sets. Their sequences are shown in Table 51 above.

The plasmid DNA template was extracted with a kit purchased from QIAGEN (Tchapsworth, CA) and diluted to 1ng/ μ l in 10mM TRIS 1mM EDTA pH 7.5 - 8. This plasmid is composed of vector pCR1000 (Invitrogen Corporation, San Diego, CA) into which the cDNA encoding the variable region to be humanized was inserted.

Example 60: Synthesis of anti-KC-4 Humanized Heavy Chain Variable Regions

A mixture of PCR primers was made, where each primer was present at a concentration of 10 pmole/ μ l in water.

40 Four 101' mer oligonucleotides (J061, J062, J063 and J064), one 50' mer (J059), and one 49' mer (J060), were used for the synthesis of the humanized variable heavy chain. The oligonucleotides concentrations were

estimated using the formula

$$c = ((A_{260})/30)\mu\text{g}/\mu\text{l}$$

The PCR amplification conditions were as follows. All reagents as well as the GeneAmp PCR system 9600 were purchased from Perkin Elmer Cetus.

5 Optimal PCR conditions were determined empirically for each pair of mutagenic primers. A matrix of conditions varying the concentration of MgCl₂, mutagenic primers, and template plasmid DNA were set up as follows. However, the annealing and extension temperatures during PCR may be varied.

10 2 μ M primer JO59 150nM each of primers JO61, 62, 63 and 64.
 2 μ M primer JO60 200 μ M each of dGTP, dATP, TTP, and dCTP.
 10mM KCl 20mM Tris-HCl pH 8.8
 10mM (NH₄)₂SO₄ 2 units per 100 μ l reaction Vent DNA
 0.1% Triton X-100 polymerase (New England Biolabs)
 6mM MgSO₄

15 **Example 61: Hot Start PCR for Humanization of anti-KC-4 Antibody**

All the components of the PCR mixture, with the exception of Vent DNA polymerase, were mixed. The mixture was then dispensed in 19 μ l aliquots into 5 PCR tubes. The reason for performing five independent reactions was to decrease the odds that unwanted mutations be isolated as a result of nucleotide
 20 misincorporation during PCR. The tubes were heated to 95°C for 5 minutes and then cooled to 72°C. While at that temperature 1 μ l of an appropriate Vent DNA polymerase dilution in 1 x buffer was added to the reaction mixture (hot start). The temperature cycling then proceeds as follows.

25 [(96°C, 6 sec) (55°C, 10 sec) (72°C, 30 sec)] 3 cycles
 [(96°C, 5 sec) (60°C, 10 sec) (72°C, 30 sec)] 29 cycles
 72°C, 10 min

Example 62: Extra Final Extension for Humanized anti-KC-4 Antibody DNA

30 After cycling, one extra final extension reaction was carried out. Extra deoxyribonucleotide triphosphates (to 125 μ M) and 1 unit of Vent DNA polymerase were added, and the mixture was heated to 72°C for 10 minutes.

The resulting synthetic DNA fragment was digested with DraI and NheI and inserted into the same restriction sites a plasmid construct encoding the corresponding murine heavy chain variable region.

35 **Example 63: Synthesis of anti-KC-4 Humanized Light Chain Variable Regions**

The light chain variable region (V_L) genes were synthesized in a similar way as described in Examples 60 to 62 above for the heavy chain variable regions.

Example 64: Purification of Humanized anti-KC-4 PCR Products

The PCR products were then separated on a 0.8% agarose gel in 1XTAE buffer and 0.5 µg/ml ethidium bromide. The correct DNA band were visualized with UV light (366 nm), excised from the gels and extracted with the GeneClean kit (Bio 101, La Jolla, CA).

Example 65: Ligation of Humanized anti-KC-4 DNA to Plasmid (Reclosure of Plasmid)

The ligation mixtures consisted of 5 µl extracted DNA, 2 µl 10x ligation buffer (NEB), 1 µl T4 DNA polymerase (NEB), 12 µl water. The amount of plasmid DNA may be varied depending of the intensity of the band extracted from the Gel. Ligation into a pBluescript KS+ plasmid (Stratagene) was carried out at room temperature for 2 hrs., or alternatively at 14°C overnight.

Example 66: Transformation and Sequencing of Humanized anti-KC-4 DNA

The reclosed plasmids were then transformed into E. coli utilizing Inv alpha F' competent cells purchased from Invitrogen Corporation, San Diego CA. Plasmid DNA was then prepared from a few transformants and sequenced to verify that mutagenesis was successful.

Example 67: Hybrid Plasmid Preparation and Sequencing

Plasmid DNA was then prepared and sequenced to verify that the mutagenesis was successful. The mutated anti-KC-4 humanized analogue DNA sequences for the V_H and V_L segments are shown in Tables 52 and 53 below.

Table 52: Humanized anti-KC-4 Antibody V_L Analogue DNA Sequences

		anti-KC-4 V _L FR-HZ																			
		ATG	AAG	TIG	CCT	GTT	AGG	CTG	TTG	GTG	CTG	ATG	TTC	TGG	ATT	CCT	GCT				
		TCC	AGC	AGT	GAT	GTT	TTG	ATG	ACC	CAA	ACT	CCT	CTC	TCC	CTG	CCT	GTC				
30		ACT	CCA	GGA	GAG	CCA	GCC	TCC	ATC	TCT	TGC	AGA	TCT	AGT	CAG	AGC	ATT				
		GTA	CAT	AGT	AAT	GGA	AAC	ACC	TAT	TTA	GAA	TGG	TAC	CTG	CAG	AAA	CCA				
		GGC	CAG	TCT	CCA	CAG	CTC	CTG	ATC	TAC	AAA	GTT	TCC	ATC	CGA	TTT	TCT				
		GGG	GTC	CCA	GAC	AGG	TTC	AGT	GGC	AGT	GGA	TCA	GGG	ACA	GAT	TTC	ACA				
		CTC	AAG	ATC	AGC	AGA	GTG	GAG	GCT	GAG	GAT	GTG	GGA	ATT	TAT	TAC	TGC				
35		TTT	CAA	GGT	TCA	CAT	GTT	CCG	TAC	ACG	TTC	GGA	GGG	GGG	ACC	AAG	CTG				
		GAA	ATA	AAA	C	(SEQ. ID. No.: 93)															

Table 53: Humanized anti-KC-4 Antibody V_H Analogue DNA Sequences

		anti-KC-4 V _H FR-H2																	
5		ATG	GAC	TTT	GGG	CTC	AGC	TTG	GTT	TTC	CTT	GTC	CTT	ATT	TTA	AAA	GGT		
		GTC	CAG	TGT	GAA	GTG	CAG	ATG	GTG	GAG	TCT	GGG	GGA	GGC	TTA	GTG	CAG		
		CCT	GGA	GGG	TCC	CTG	AGA	CTC	TCC	TGT	GCA	GCC	TCT	GGA	TTC	GCT	TTC		
		AGT	AGC	TAT	GCC	ATG	TCT	TGG	GTT	CGC	CAG	GCT	CCA	GGG	AAG	GGG	CTG		
		GAG	TGG	GTC	GCA	GAA	ATT	AGT	AGT	GGT	GGT	AAT	TAC	GCC	TAC	TAT	CAA		
10		GAC	ACT	GTG	ACG	GSC	CGA	TTC	ACC	ATC	TCC	AGA	GAC	AAT	TCC	AAG	AAC		
		ACC	CTG	TAC	CTG	CAA	ATG	AAC	AGT	CTG	AGG	GCT	GAG	GAC	ACG	GCC	GTG		
		TAT	TAC	TGT	GCA	AGG	GAG	GAC	TAC	GGT	ATC	CCG	GCC	TTT	GCT	TAC			
		TGG	GGC	CAA	GGG	ACT	CTG	GTC	ACT	GTC	TCT	AGT	(SEQ. ID. No.: 94)						

Example 68: Expression of Anti-KC-4 Humanized Antibody

Two expression vectors pAG4622 and pAH4604 (Coloma, M.J., et al. (1992), supra) were used that were developed and provided by S.L. Morrison (Dept. of Microbiology and Molecular Genetics, UCLA). Any cDNA encoding a signal peptide and either the variable heavy chain or the variable light chain can, in principle, be inserted into these vectors resulting in a construction that encodes an IgG1, K, antibody with human constant regions. Correctly modified cDNAs were excised from pCR1000 with EcoRV and Sal I and inserted into pAG4622. These encode the modified light chain. The wild-type heavy chain was similarly excised from pCR1000 by digestion with EcoRV and NheI and inserted into pAH4604. The restriction and ligation reactions necessary to accomplish these operations were performed under the conditions stipulated by the enzyme manufacturers (New England Biolabs, Beverly, MA). Both the vectors and the inserts were purified from an agarose gel prior to ligation, using the Bio101 (La Jolla, CA) GeneClean kit (glass beads). The V_H and V_L regions in the final constructions were sequenced once again to verify that they were correct. The non-producer myeloma cell line SP2/O-Ag14, ATCC: CRL 1581, (Shulman M., et al. (1978), supra) was transfected with both plasmid constructions, and antibody producers were isolated following the recommendations outlined in Coloma et al. (Coloma, M.J. et al. (1992), supra) except that selection was done only for the uptake of hisD (by adding 5 mM histidinol to the medium and readjusting the pH to 7.4 with NaOH). Usually after ten days, stable transfectant colonies were established at a frequency of approximately 10⁻³ to 10⁻⁴. Colonies were then transferred to normal medium (without histidinol). The culture media were either Dulbecco's modified Eagle's medium (DME): fetal bovine serum (FBS), 90:10, v/v, or a mixture of DME:RPMI:FBS, 45:45:10; v/v/v. Penicillin and streptomycin were added to prevent bacterial growth.

The supernatants from stable transfectants were assayed for the presence of the antibodies. This was done by capturing the secreted chimeric

antibody with a plate-bound goat anti-human-kappa chain antibody and developing with goat anti-human-gamma chain antibody, essentially as described previously (Coloma, M.J. (1992), supra) except that the secondary antibody was radiolabeled with ¹²⁵I. The supernatants were also assayed for binding to human milk fat globule (HMFG) as described previously (Ceriani R.L., et al., "Diagnostic Ability of Different Human Milk Fat Globule Antigens in Breast Cancer", Breast Cancer Res. Treat., 15:161-174 (1990)). HMFG is bound to the microtiter plates as described previously (Ceriani, R.L. (1984), supra). Usually most colony supernatants were positive by both assays. Colonies that secrete the highest level of antibody in the supernatants, as determined by these assays, were subcloned and subsequently adapted to serum-free medium for the purification of antibody. Serum free medium contains HL-1 supplement as directed by the manufacturer (Ventrex Labs., Portland, ME).

Example 69: Half Humanized-Half Chimeric anti-KC-4 Antibody

An anti-KC-4 humanized light chain was paired with an anti-KC-4 non-humanized chimeric heavy chain by co-transfection of SP2/O-Ag14 myeloma cells with hybrid plasmids carrying the respective DNA sequences and those of a human F_c. The cell line obtained, HuKC-4V1 was deposited with the ATCC on September 23, 1993 and awarded an accession number HB 11454.

In addition, an anti-KC-4 humanized heavy chain was paired with an anti-KC-4 non-humanized chimeric light chain as described in Example 69 above. The thus obtained cell, HuKC-4V3 was deposited with the ATCC on September 23, 1993 and awarded an accession number HB 11456.

Example 70: Fully Humanized anti-KC-4 Antibody

An anti-KC-4 fully humanized antibody was prepared by pairing fully humanized anti-KC-4 light and heavy chains by co-transfection as described in Example 69 above. The cell line, HuKC-4V2, was deposited with the ATCC on September 23, 1993 and awarded the accession number HB 11455.

Example 71: Determination of Affinity Constants for Half and Fully Humanized anti-KC-4 Antibodies

The secreted half humanized antibodies and the fully humanized antibody were purified from culture supernatants using a Sepharose 4B-protein A column (Bio-Rad, Richmond, CA.) as described by Ey et al. (Ey, P.L., et al. (1978), supra). Microtiter plates (Dynatech, Chantilly, VA) were prepared as described by Ceriani et al. (Ceriani, R.L., et al. (1992), supra) using successive layers of

5 methylated BSA, glutaraldehyde, anti- β -galactosidase and the bacterial fusion protein 11-2 (a hybrid of β -galactosidase and human mammary mucin). Each well contained 388 ng of the 11-2 fusion protein. To each well were added 25 μ l 125 I-KC-4 in RIA buffer (10 % bovine calf serum, 0.3% triton X-100, 0.05 % sodium azide pH 7.4, in phosphate buffer saline) and compete with 25 μ l of either unlabeled murine or chimeric antibody in RIA buffer at the final concentrations of 130 pM, 850 pM, 1.3 nM, 4 nM, and 13 nM). Iodinations were performed with 125 I (17 Ci/mg, Nordion International). 50 μ g anti-KC-4 monoclonal antibody (Coulter, Hialeah, FL) were labeled at a specific activity of 9.56 mCi/mg using the chloramine T method as described previously by Ceriani et al. (Ceriani, R.L., et al. (1988), supra).

10 The antibody-antigen affinity constants were determined by taking the reciprocal of the concentration of competing unlabeled monoclonal antibody that produced 50 % binding as described by Sheldon et al. (Sheldon, K., et al. (1987), supra). The protocol used to determine affinity constants was as described above except that in each case, an unlabeled antibody competed for binding to the antigen against the same radiolabeled antibody. The fully humanized antibody was shown to compete about as well or better with the anti-KC-4 murine antibody for the KC-4G3 antigen.

20 Polyacrylamide gel electrophoresis was performed to insure that the antibody chains migrated as expected. The affinity binding constants of the murine, chimeric, half humanized and humanized antibodies were determined in independent competition assays.

25 **Example 72: Histochemical Specificity of Half and Fully Humanized anti-KC-4 Antibodies**

Immunohistochemical staining using the immunoperoxidase technique of consecutive human breast carcinoma tissue sections was used as a test to verify that the analogue antibodies retain the affinity for the KC-4G3 carcinoma antigen of the murine antibody. Breast carcinoma tissue sections were stained with the supernatant of the KC-4 murine and fully humanized transfected cells using the Vectastain ABC method (Vector Labs, Burlingame, CA). Both antibodies showed strong staining patterns.

35 The following Table 54 shows the results of the immunoperoxidase staining of five human breast carcinomas with either the standard anti-KC-4G3 murine or the fully humanized antibodies. Both stained the same tissues at a comparable level.

Table 54: Immunoperoxidase Staining of Human Breast Carcinoma Tissue Sections with Murine and Fully Humanized anti-KC-4 Antibodies

Breast Tumor	Murine Antibody	Fully Humanized Antibody
5 1	++	++
2	+++	+++
3	-	-
4	++	++
5	+++	+++

10 **Example 73:** Binding to HMFG of Half Humanized and Fully Humanized anti-KC-4 Antibodies
 Tissue culture supernatants from transfectants of all three anti-KC-4 variants of the humanized antibody were shown to bind the human milk fat globule (HMFG) as determined by radio-immunodetections.

15 **Example 74:** Half Humanized and Fully Humanized anti-KC-4 Antibodies Bind to Goat anti-Human κ or γ Antibodies
 Tissue culture supernatants from transfectants of all three variants of the anti-KC-4 humanized antibody were shown to bind in sandwich
 20 radioimmudetections to both goat anti-human kappa chain antibody bound to microtiterplate wells (750ng/well), and to radio-iodinated ¹²⁵I-labeled goat anti-human gamma chain antibodies.

The results of these sandwich assays demonstrate that both chains of the humanized antibodies indeed possess human kappa and gamma constant
 25 regions.

Example 75: Deduced Amino Acid Sequences of Humanized anti-KC-4 Variable Light and Heavy Chains

The amino acid sequences of the light and heavy chains of the analogue humanized antibody are shown in Tables 55 and 56 below. The actual amino
 30 acid sequences may be varied either to increase affinity for the antigen or to decrease immunogenicity in humans. Numerous variants of this sequence may be engineered in accordance with the invention.

Table 55: Humanized anti-KC-4 Antibody V_L Analogue Sequence

anti-KC-4 V_L FR-HZ

MKLPVRLVL MFWIPASSD VLMTQTPLSL PVTGPESAI SCRSSQSIHV
 SNGNTYLEWY LQKPGQSPQL LIYKVSIRFS GVPDRFSGSG SGTDFTLKIS
 5 RVEAEDVGIY YCFQGSHPY TFGGGTKLEI K (Seq. ID No: 95)

Table 56: Humanized anti-KC-4 Antibody V_H Analogue Sequence

anti-KC-4 V_H FR-HZ

MDFGLSLVFL VLILKGVQCE VQMVESGGGL VQPGGSLRLS CAASGFAFSS
 10 YAMSWVRQAP GKGLEWVAEI SSGGNYAYYQ DTVTGRFTIS RDNSKNTLYL
 QMNSLRAEDT AVYYCAREDY GIPAWFAYWG QGTLVTVSS (Seq. ID No: 96)

Example 76: Half Humanized-Half Chimeric anti-BrE-3 Antibodies

A humanized BrE-3 light chain was paired with a non-humanized chimeric
 15 BrE-3 heavy chain by co-transfection of SP2/O-Ag14 myeloma cells with hybrid
 plasmids carrying the respective DNA sequences and those of a human F_c . The
 cell line obtained, HuBrE3V1, was deposited with the ATCC on November 10,
 1993 and awarded an accession number HB _____.

In addition, a humanized BrE-3 heavy chain was paired with a non-
 20 humanized chimeric BrE-3 light chain as described in Example 69 above. The
 thus obtained cell, HuBrE3V3 was deposited with the ATCC on November 10,
 1993 and awarded an accession number HB _____.

Example 77: Fully Humanized BrE-3 Antibody

The fully humanized BrE-3 antibody was prepared by pairing fully humanized
 25 BrE-3 light and heavy chains by co-transfection as described in Example 69
 above. The thus obtained cell line, HuBrE3V2, was deposited with the ATCC on
 November 13, 1992 and awarded the accession number HB 1111200.

Example 78: Half Humanized and Fully Humanized
 BrE-3 Antibodies Bind to Goat
 anti-Human α or γ Antibodies

30

Tissue culture supernatants from transfectants of all three variants of the
 humanized BrE-3 antibody were shown to bind in sandwich
 radioimmunoassays to both goat anti-human kappa chain antibody bound to

microtiterplate wells (750ng/well), and to radio-iodinated ¹²⁵I-labeled goat anti-human gamma chain antibodies.

The results of these sandwich assays demonstrate that both chains of the humanized antibodies indeed possess human kappa and gamma constant regions.

Example 79: Binding to HMFG of Half Humanized and Fully Humanized BrE-3 Antibodies

Tissue culture supernatants from transfectants of all three BrE-3 variants of the humanized antibody were shown to bind the human milk fat globule (HMFG) as determined by radio-immunodetections.

Example 80: Competition Assays and Determination of Affinity Constants for Half Humanized BrE-3 Antibodies

The secreted half humanized antibodies were purified from culture supernatants using a Sepharose 4B-protein A column (Bio-Rad, Richmond, CA.) as described by Ey et al. (Ey, P.L., et al. (1978), supra). The fully humanized antibody (HuBrE3 V2) was not purified. Its concentration in the culture supernatant was determined by radioimmunodetection using a plate-bound goat anti-human kappa chain antibody as a capturing antibody and using radiolabeled goat anti-human gamma chain antibody as a detecting antibody. A parallel standard curve of human IgG_{1κ} was used to determine the unknown concentration of HuBrE3 V2. Microtiter plates (Dynatech, Chantilly, VA) were prepared as described by Ceriani et al. (Ceriani, R.L., et al. (1992), supra) using successive layers of methylated BSA, glutaraldehyde, anti-β-galactosidase and the bacterial fusion protein 11-2 (a hybrid of β-galactosidase and human mammary mucin). Each well contained 388 nanograms of the 11-2 fusion protein. To each well were added 25 μl ¹²⁵I -BrE-3 in RIA buffer (10 % bovine calf serum, 0.3% triton X-100, 0.05 % sodium azide pH 7.4, in phosphate buffer saline) and competed with 25 μl of either unlabeled murine or humanized antibody in RIA buffer at the final concentrations of 130 pM, 850 pM, 1.3 nM, 4 nM, and 13 nM). Iodinations were performed with ¹²⁵I (17 Ci/mg, Nordion International). 50 μg BrE-3 monoclonal antibody (Coulter, Hialeah, FL) were labeled at a specific activity of 9.56 mCi/mg using the chloramine T method as described previously by Ceriani et al. (Ceriani, R.L., et al. (1988), supra).

All humanized versions of the BrE-3 antibody were shown to compete about as well or better with the labeled murine BrE-3 antibody for the antigen as did the murine BrE3 antibody. The protocol used to determine affinity constants was as described above except that in each case, an unlabeled antibody competed for binding to the antigen against the same radiolabeled antibody. The antibody-antigen affinity constants were determined by taking the reciprocal of

the concentration of competing unlabeled monoclonal antibody that produced 50 % binding as described by Sheldon et al. (Sheldon, K., et al. (1987), supra).

Polyacrylamide gel electrophoresis was performed to insure that the antibody chains migrated as expected. The affinity binding constants of the murine, chimeric, half humanized and humanized antibodies were determined in independent competition assays.

Example B1: Histochemical Specificity of Half Humanized BrE-3 Antibodies

Immunohistochemical staining using the immunoperoxidase technique of consecutive human breast carcinoma tissue sections was used as a test to verify that the analogue antibodies retain the affinity for the carcinoma antigen of the murine BrE-3 antibody. Breast carcinoma tissue sections were stained with the supernatant of cells transfected with the HuBrE3 V1 humanized antibody using the Vectastain ABC method (Vector Labs, Burlingame, CA). Both antibodies showed strong staining patterns.

The following Table 57 shows the results of the immunoperoxidase staining of five human breast carcinomas with either the standard BrE-3 murine or the half humanized HuBrE3 V1 antibody. Both stained the same tissues at a comparable level.

Table 57: Immunoperoxidase Staining of Human Breast Carcinoma Tissue Sections with Murine and Half Humanized BrE-3 Antibodies

Breast Tumor	Murine Antibody	Half Humanized Antibodies
1	++	++
2	+++	+++
3	-	-
4	++	++
5	+++	+++

Example B2: Hybridoma Cell Deposits

The following cell lines were deposited as present examples of the best mode of the invention. The hybridoma cell lines expressing the murine-human fully chimeric BrE-3 and anti-KC4 antibodies and the fully humanized BrE-3 antibody were deposited with the ATCC on November 13, 1992 under the Budapest Treaty, and have been assigned Accession Nos. HB 11199 (Chimeric BrE-3 A1C10), HB 11201 (Chimeric anti-KC-4 1E8) and HB 11200 (Humanized BrE-3 A1C10). The hybridoma cell line expressing the anti-KC-4 humanized

antibody was deposited with the ATCC on September 23, 1993 and has been assigned Accession No. HB 11455 (Humanized HuKC-4 V2). The half chimeric/half humanized antibody cell lines deposited with the ATCC are as follows: ATCC No. HB 11454 (light humanized/ heavy chimeric chains, HuKC-4V1) and ATCC No. HB 11456 (Heavy humanized/ light chimeric chains, HuKC-4V3) were deposited on September 23, 1993, and ATCC No. HB _____ (light humanized/ heavy chimeric chains, BrE3V1) and ATCC No. HB _____ (heavy humanized/ light chimeric chains, BrE3V3) were deposited on November 10, 1993 under the Budapest Treaty as examples of the best mode of the invention known to the inventors.

The invention now being fully described, it will be apparent to one of ordinary skill in the art that many changes and modifications can be made thereto without departing from the spirit or scope of the invention as set forth herein.

**WHAT IS CLAIMED AS NOVEL AND UNOBLIVIOUS AND
DESIRED TO BE PATENTED IN LETTERS PATENT IS:**

1. A pure, isolated analogue peptide which selectively binds to an antigen that is present on the surface or in the cytoplasm of a neoplastic cell or that is released by the cell, the peptide being selected from the group consisting essentially of at least one CDR of the light or heavy chain of an antibody of a first species having affinity and specificity for the human mammary fat globule (HMFG) antigen and an antigen found on the surface or the cytoplasm of a neoplastic cell or that is released by the cell; at least one variable region of the light or heavy chains of an antibody of the first species having affinity and specificity for the HMFG antigen and an antigen found on the surface or the cytoplasm of a neoplastic cell or that is released by the cell, wherein about 1 to at least 46 amino acids in the FRs are substituted per chain with amino acids selected from the group consisting of amino acids present in equivalent positions in antibodies of a species other than the first species, or fragments thereof comprising 1 to 3 CDRs per chain and flanking regions thereof, each of about 1 to at least 10 amino acids, alone or with an N-terminal fragment of about 1 to at least 10 amino acids; combinations thereof, wherein each analogue peptide is operatively linked to at least one other variable region peptide or analogue thereof; and mixtures thereof.

2. The anti-neoplastic analogue peptide of claim 1, wherein the antibody of the first species is selected from the group consisting of murine, rat, goat, rabbit, canine, primate, guinea pig, bovine, equine, feline and porcine antibodies.

3. The anti-neoplastic analogue peptide of claim 1, being able to compete with the antibody secreted by the hybridoma cell ATCC No. HB 10028 for the human mammary fat globule antigen.

4. The antineoplastic analogue peptide of claim 1, having an amino acid sequence selected from the group consisting of amino acid Sequence ID Nos: 67 through 73; amino acid Sequence ID Nos: 75 through 81; fragments thereof comprising at least one CDR or one CDR and two flanking regions thereof per chain; combinations thereof, wherein

each analogue peptide is operatively linked to at least one other analogue peptide; and mixtures thereof.

5. A glycosylated analogue peptide selectively binding to an antigen present on the surface or in the cytoplasm of a neoplastic cell or that is released by the cell, comprising the analogue peptide of claim 1; and at least one glycosyl residue operatively linked to the peptide.

6. A composition of matter, comprising the analogue peptide of claim 1; and a carrier.

7. A diagnostic kit for the in vivo therapy of neoplasms, comprising the composition of claim 6 in pharmaceutically-acceptable form; and instructions for its use.

8. The kit of claim 7, further comprising a molecule capable of selectively binding the analogue peptide and comprising an effector agent operatively linked thereto.

9. The kit of claim 7, wherein the effector agent comprises a molecule selected from the group consisting of therapeutic, immunogenic and diagnostic agents, radioisotopes, DNA monomers, RNA monomers, chemical linkers, transmitter molecules, combinations thereof, and combinations thereof with peptide and non-peptide polymers or copolymers.

10. An in vitro carcinoma diagnostic kit, comprising the composition of claim 6; a solid support having operatively linked thereto an antigen which selectively binds to the analogue peptide; and instructions for its use.

11. The kit of claim 10, further comprising a molecule capable of selectively binding the analogue peptide and comprising an effector agent operatively linked thereto.

12. The diagnostic kit of claim 10, further comprising anti-constant region immunoglobulins, protein G, protein A, other antibody binding molecules or binding fragments thereof.

13. A hybrid analogue polymer, comprising at least one analogue peptide of claim 1 and at least one effector agent operatively linked to the

peptide; combinations thereof; and mixtures thereof.

14. The hybrid analogue polymer of claim 13, wherein the effector agent is selected from the group consisting of monomers, and non-peptide and peptide polymers other than the constant region of an antibody of the same species.

15. The hybrid analogue polymer of claim 13, wherein the effector agent comprises a radioisotope, an enzyme, or a phosphorescent or a fluorescent label.

16. The hybrid analogue polymer of claim 14, wherein the effector agent comprises a molecule selected from the group consisting of therapeutic, immunogenic and diagnostic agents, radioisotopes, phosphorescent and fluorescent agents, enzymes, DNA and RNA monomers, chemical linkers, transmitter molecules, combinations thereof, and combinations thereof with peptide and non-peptide polymers or copolymers.

17. The hybrid analogue polymer of claim 14, wherein the effector agent comprises a non-peptide polymer selected from the group consisting of ester, ether, vinyl, amido, imido, alkylene, arylalkylene, cyanate, urethane, and isoprene polymers, halogenated polymers, DNA and RNA polymers, copolymers thereof, and copolymers thereof with peptide polymers or monomers.

18. The hybrid analogue polymer of claim 14, wherein the effector agent comprises a peptide polymer selected from the group consisting of the constant region of antibodies or fragments thereof, the CDRs or variable regions of antibodies, whole antibodies, Fab and Fab', (Fab')₂, or antibody fragments of a species other than the first species, analogues thereof, hormones, enzymes, peptide transmitters, combinations thereof, and combination thereof with non-peptide polymers, copolymers or monomers.

19. The hybrid analogue polymer of claim 18, wherein the analogue peptide comprises amino acid sequences of non-human origin; and the peptide polymer comprises at least one constant region of the light or heavy chains of a human antibody or fragments thereof capable

of binding to anti-constant region immunoglobulins, protein G or protein A or other antibody binding molecules

20. The hybrid analogue polymer of claim 19, being selected from the group consisting of an analogue peptide comprising two heavy and two light chains, each light and heavy chain comprising at least one non-human CDR or analogue variable region peptide and at least one human constant region or fragment thereof; at least one human-non-human analogue Fab, Fab', or (Fab')₂ fragment thereof; fragments thereof; combinations thereof; and mixtures thereof.

21. The hybrid analogue polymer of claim 20, wherein each pair of the analogue heavy and light chains has a different predetermined specificity.

22. The hybrid analogue polymer of claim 13, wherein the analogue peptide and the effector agent are operatively linked by a polymer.

23. The hybrid analogue polymer of claim 13, being selected from the group consisting of at least one CDR or analogue variable region of the heavy chain of a first antibody of the first species or fragment thereof comprising at least one CDR and two flanking regions thereof and a first effector agent; at least one CDR or analogue variable region of the light chain of a second antibody of the first species or fragments thereof comprising at least one CDR and two flanking regions thereof, and a second effector agent, wherein each chain has a predetermined specificity; combinations thereof; and mixtures thereof.

24. The hybrid analogue polymer of claim 13, wherein at least one first pair of light and heavy chains comprising at least one CDR or analogue variable region or fragments thereof is linked to at least one second pair of the analogue light and heavy chains comprising at least one CDR or one analogue variable region or fragments thereof.

25. An anti-carcinoma composition, comprising the hybrid analogue polymer of claim 13; and a carrier.

26. An in vivo carcinoma therapy and diagnosis kit, comprising the anti-carcinoma composition of claim 25 in pharmaceutically-

acceptable form; and instructions for its use.

27. The kit of claim 26, further comprising a molecule capable of selectively binding the analogue peptide and comprising an effector agent operatively linked thereto.

28. The kit of claim 27, wherein the effector agent comprises a molecule selected from the group consisting of therapeutic, immunogenic and diagnostic agents, radioisotopes, DNA monomers, RNA monomers, chemical linkers, transmitter molecules, combinations thereof, and combinations thereof with peptide and non-peptide polymers and copolymers.

29. A diagnostic kit for carcinomas, comprising the anti-carcinoma composition of claim 25; a solid support having operatively linked thereto an antigen which specifically binds to the hybrid analogue peptide; and instructions for its use.

30. The kit of claim 29, further comprising a molecule capable of selectively binding to the hybrid analogue polymer, the molecule having an effector agent operatively linked thereto.

31. The diagnostic kit of claim 29, further comprising anti-constant region immunoglobulins, protein G, protein A, other antibody binding molecules or binding fragments thereof.

32. A method of determining the presence of neoplastic cells in a tissue, comprising contacting a tissue suspected of comprising neoplastic cells with the anti-neoplastic analogue peptide of claim 1 and allowing the analogue peptide to bind to antigen associated with any neoplastic cells present in the tissue to form an analogue peptide-cell antigen complex; and detecting the presence of any complexes formed.

33. An in vitro method of determining the presence of neoplastic cells in a tissue comprising the method of claim 32, wherein the tissue is excised from a subject prior to being contacted with the analogue peptide in vitro.

34. An in vitro method of diagnosing a neoplasm comprising the method of claim 33, and comparing the results with a standard cut-off

value determined by comparing results obtained for normal and neoplastic samples, wherein a result above the cut-off value is diagnostic of a neoplasm.

35. The in vitro method of diagnosing a neoplasm of claim 34, conducted by contacting a biological sample obtained from a subject suspected of having a neoplasm with a known amount of the anti-tumor analogue peptide of claim 1 in the presence of a solid supported antigen molecule that is selectively bound by the analogue peptide and allowing the formation of solid supported analogue peptide-antigen molecule complexes and analogue peptide-sample antigen complexes with any neoplastic cell antigen present in the sample; detecting any complex formed between the analogue peptide and the solid supported neoplastic antigen; and comparing the result obtained with the standard cut-off value.

36. An in vivo method of imaging a neoplasm present in a subject, comprising the method of claim 32, wherein a pharmaceutically-acceptable composition comprising an effective amount of the analogue peptide in radiolabeled form to reach the neoplasm and bind thereto is administered to a subject suspected of having a primary or metastasized neoplasm; and the detection is of any binding of the labeled analogue peptide to the antigen on the surface or in the cytoplasm of the neoplastic cells.

37. An in vivo method of diagnosing the presence of a neoplasm in a subject comprising the method of claim 36, and comparing the results with a standard cut-off value determined by comparing results obtained for normal and neoplastic samples, wherein a result above the cut-off value is diagnostic of a neoplasm.

38. A method of inhibiting the growth or reducing the size of a primary or metastasized neoplasm in a subject comprising administering to a subject in need of the treatment an effective amount of the anti-tumor composition of claim 25 in pharmaceutically-acceptable form, wherein the effector agent comprises a therapeutic agent.

39. The method of claim 38, further comprising administering to

the subject a molecule capable of selectively binding to the analogue peptide and having an effector agent operatively linked thereto.

40. A method of purging neoplastic cells from a biological fluid, comprising the method of claim 32; and separating any analogue peptide-cell complexes present from the remainder of the fluid.

41. An ex vivo method of purging neoplastic cells from a biological sample obtained from a subject, comprising obtaining a biological sample from a subject suspected of having a neoplasm; conducting the method of claim 40 with the biological sample; and replenishing the purged biological sample to the subject.

42. An in vitro histochemical method of assessing the presence of neoplastic cells in a tissue, comprising obtaining from a patient suspected of having a neoplasm a tissue sample and preparing therefrom a tissue substrate; contacting the tissue substrate with the analogue peptide of claim 1 and allowing the analogue peptide to bind to any neoplastic cells present therein; and detecting the presence of any complexes formed.

43. A hybridoma cell expressing the analogue peptide of claim 1.

44. The hybridoma cell of claim 43, having the ATCC No. HB 11200.

45. The hybridoma cell of claim 43, having the ATCC No. HB 11455.

46. The hybridoma cell of claim 43, having the ATCC No. HB 11454.

47. The hybridoma cell of claim 43, having the ATCC No. HB 11456.

48. The hybridoma cell of claim 43, having the ATCC No. HB _____ (HuBrE3V1).

49. The hybridoma cell of claim 43, having the ATCC No. HB _____ (HuBrE3V3).

50. A composition, comprising the hybridoma cell of claim 43, and a diluent or carrier.

51. A pure, isolated analogue polydeoxyribonucleotide, comprising an analogue oligodeoxyribonucleotide encoding the analogue peptide of

claim 1.

52. The analogue polydeoxyribonucleotide of claim 51, wherein the analogue oligodeoxyribonucleotide comprises a DNA sequence selected from the group consisting of DNA Sequence ID No: 64; DNA Sequence ID No: 65; fragments thereof encoding at least one CDR or one CDR and two flanking regions per chain; redundant DNA sequences thereof; combinations thereof; and mixtures thereof.

53. A hybrid vector, comprising a vector having the analogue polydeoxyribonucleotide of claim 51 operatively linked thereto.

54. The hybrid vector of claim 53, further comprising a polydeoxyribonucleotide comprising an oligodeoxyribonucleotide encoding an effector peptide, the effector peptide-encoding polydeoxyribonucleotide being operatively linked to the vector.

55. A transfected host cell, carrying the hybrid analogue vector of claim 53.

56. A pure, isolated analogue polyribonucleotide, comprising an analogue oligoribonucleotide encoding the analogue peptide of claim 1.

57. A method of producing an analogue peptide which specifically binds to an antigen on the surface or in the cytoplasm of neoplastic cell, or is released by the cell, comprising a) cloning the analogue polydeoxyribonucleotide of claim 40 into a vector to form a hybrid vector; b) transfecting a host cell with the hybrid vector and allowing the expression of the analogue peptide; and c) isolating the analogue peptide or mixtures thereof.

58. The method of claim 57, further comprising site-specifically modifying the codon of at least one amino acid in the framework region of a non-human antibody prior to step a) to obtain the analogue polydeoxyribonucleotide.

59. The method of claim 57, wherein steps a) and b) are conducted by cloning analogue polydeoxyribonucleotides encoding analogue peptides selected from the group consisting of at least one CDR or analogue variable region of the first species or fragments thereof comprising at least one CDR and two flanking regions of the heavy or

light chains of the antibody of the first species; and the method further comprises d) allowing the expressed analogue peptides to interact with one another to form double chains.

60. A method of producing a hybrid analogue peptide comprising an analogue peptide which specifically binds to an antigen on the surface or in the cytoplasm of a carcinoma cell or to an antigen released by the cell and an effector peptide, the method comprising a) transfecting a host cell with the hybrid analogue vector of claim 54 and allowing the expression of the anti-carcinoma hybrid analogue peptide; and b) isolating the anti-carcinoma hybrid analogue peptide or mixtures thereof.

61. An anti-idiotypic polymer, comprising polyclonal antibodies raised against anti-tumor antibodies or the analogue peptide of claim 1; monoclonal antibodies thereof capable of specifically binding the anti-neoplasm antibody; fragments thereof selected from the group consisting of CDRs, Fab, Fab', (Fab')₂, variable regions, and fragments thereof; analogues thereof selected from the group consisting of antibodies, Fab, Fab', (Fab')₂, and variable regions wherein about 1 to at least 46 amino acids in the FR are substituted per chain with amino acids selected from the group consisting of amino acids present in equivalent positions in antibodies of species other than the first species, or fragments thereof comprising 1 to 3 CDRs per chain and flanking regions thereof, each of about 1 to at least 10 amino acids, alone or with an N-terminal fragment of about 1 to at least 10 amino acids; combinations thereof, and combinations thereof with an oligopeptide comprising the amino acid sequence APDTRPAPG or fragments thereof comprising the TRP trimer hexamers thereof comprising the trimer, or tandem repeats thereof, wherein each analogue peptide is operatively linked to at least one other analogue peptide; and mixtures thereof.

62. A hybrid anti-idiotypic polymer, comprising the anti-idiotypic polypeptide of claim 61; and an effector agent operatively linked to the anti-analogue idiotypic polypeptide.

63. An anti-carcinoma vaccine, comprising the anti-idiotypic polypeptide of claim 61; and a pharmaceutically-acceptable carrier.

64. The anti-carcinoma vaccine of claim 63, in unit dose form.
65. A anti-tumor vaccination kit, comprising the vaccine of claim 63 and a diluent in separate sterile containers; and instructions for its use.
66. A method of vaccinating against neoplasms comprising administering to a subject an effective amount of the composition of claim 63.
67. The vaccination method of claim 66, wherein the anti-idiotypic polypeptide is administered in an amount of about 0.1 to 5000.00 $\mu\text{g}/\text{kg}$ body weight/dose.
68. A method of lowering the serum concentration of a circulating antibody or polypeptide that binds to an antigen on the surface or in the cytoplasm of a carcinoma cell or that is released by the cell, comprising administering to a subject in need of the treatment a pharmaceutically-acceptable composition comprising an amount of the anti-idiotypic polypeptide of claim 61 effective to bind the circulating antibody or polypeptide and accelerate its clearance.
69. The method of claim 68, wherein the anti-idiotypic peptide is administered in an amount of about 0.01 to 5.000.00 mg/kg body weight/dose.
70. A method of inhibiting the growth or reducing the size of a primary or metastasized carcinoma tumor in a subject, comprising administering to the subject an effective amount of a pharmaceutically-acceptable composition comprising an anti-carcinoma hybrid polymer comprising an effector agent selected from the group consist of radioisotopes and therapeutic drugs, and an anti-carcinoma polypeptide which specifically binds to an antigen on the surface or in the cytoplasm of a carcinoma cell or that is released by the cell; allowing the hybrid polymer to reach the tumor and the anti-carcinoma polypeptide to bind thereto; and administering to the subject a pharmaceutically-acceptable composition comprising an amount of the anti-idiotypic polypeptide of claim 61 effective to bind any residual or unbound circulating anti-carcinoma hybrid polypeptide and accelerate the clearance of the hybrid polymer.

PCT

WORLD INTELLECTUAL PROPERTY ORGANIZATION
International Bureau



INTERNATIONAL APPLICATION PUBLISHED UNDER THE PATENT COOPERATION TREATY (PCT)

<p>(51) International Patent Classification⁴ : A61K 39/395, C12N 15/00, 5/00 C07K 13/00, 15/04</p>	<p>A1</p>	<p>(11) International Publication Number: WO 89/09622 (43) International Publication Date: 19 October 1989 (19.10.89)</p>
<p>(21) International Application Number: PCT/US89/01578 (22) International Filing Date: 13 April 1989 (13.04.89) (30) Priority data: 181,862 15 April 1988 (15.04.88) US (71) Applicant: PROTEIN DESIGN LABS, INC. [US/US]; 3181 Port Drive, Palo Alto, CA 94304 (US). (72) Inventor: QUEEN, Cary, L. ; 886 Roble Avenue, Menlo Park, CA 94025 (US). (74) Agent: HANN, James, F.; Townsend and Townsend, One Market Plaza, 2000 Steuart Tower, San Francisco, CA 94105 (US). (81) Designated States: AT (European patent), AU, BE (Euro- pean patent), CH (European patent), DE (European pa- tent), DK, FI, FR (European patent), GB (European pa- tent), IT (European patent), JP, KR, LU (European pa- tent),</p>		<p>NL (European patent), NO, SE (European patent). Published <i>With international search report.</i></p>
<p>(54) Title: IL-2 RECEPTOR-SPECIFIC CHIMERIC ANTIBODIES</p>		
<p>(57) Abstract Chimeric antibodies specifically reactive with human IL-2 receptors are prepared employing recombinant DNA technology for use in, e.g., treatment of T-cell mediated disorders.</p>		

FOR THE PURPOSES OF INFORMATION ONLY

Codes used to identify States party to the PCT on the front pages of pamphlets publishing international applications under the PCT.

AT	Austria	FR	France	ML	Mali
AU	Australia	GA	Gabon	MR	Mauritania
BB	Barbados	GB	United Kingdom	MW	Malawi
BE	Belgium	HU	Hungary	NL	Netherlands
BG	Bulgaria	IT	Italy	NO	Norway
BJ	Benin	JP	Japan	RO	Romania
BR	Brazil	KP	Democratic People's Republic of Korea	SD	Sudan
CF	Central African Republic	KR	Republic of Korea	SE	Sweden
CG	Congo	LI	Liechtenstein	SN	Senegal
CH	Switzerland	LK	Sri Lanka	SU	Soviet Union
CM	Cameroon	LU	Luxembourg	TD	Chad
DE	Germany, Federal Republic of	MC	Monaco	TG	Togo
DK	Denmark	MG	Madagascar	US	United States of America
FI	Finland				

IL-2 RECEPTOR-SPECIFIC CHIMERIC ANTIBODIES

Field of the Invention

The present invention relates generally to the combination of recombinant DNA and monoclonal antibody technologies for developing novel therapeutic and other agents and, more particularly, to the production of chimeric antibodies specific for the human interleukin-2 receptor and the use of such chimeric antibodies in treating T-cell mediated human disorders.

Background of the Invention

In mammals, the immune response is mediated by two types of cells that interact specifically with foreign material, *i.e.*, antigens. One of these cell types, B-cells, are responsible for the production of antibodies. The second cell class, T-cells, include a wide variety of cellular subsets controlling the *in vivo* function of both B-cells and a wide variety of other hematopoietic cells, including T-cells.

One way in which T-cells exert this control is through the production of a lymphokine known as interleukin-2 (IL-2), originally named T-cell growth factor. IL-2's prime function appears to be the stimulation and maintenance of T-cells. Indeed, some immunologists believe that IL-2 may be at the center of the entire immune response (*see*, Farrar, J., et al., Immunol. Rev. 63:129-166 (1982), which is incorporated herein by reference).

To exert its biological effects, IL-2 interacts with a specific high-affinity membrane receptor (Greene, W., et al., Progress in Hematology XIV, E. Brown, ed., Grune and Statton, New York (1986), at pgs. 283 ff). The human IL-2 receptor is a complex glycoprotein, with one chain 55kD in size (Leonard, W. et al., J. Biol. Chem. 260:1872 (1985)). A gene encoding this protein has been isolated, and predicts a 272 amino acid peptide, including a 21 amino acid signal peptide, (*see*, Leonard, W. et al., Nature 311: 626 (1984)).

Much of the elucidation of the human IL-2 receptor's structure and function is due to the development of specifically reactive monoclonal antibodies. In particular, one monoclonal antibody, known as anti-Tac, (Uchiyama et al., J. Immunol. 126:1393 (1981)) has shown that
5 IL-2 receptors can be detected on T-cells, but also on cells of the monocyte-macrophage family, Kupffer cells of the liver, Langerhans' cells of the skin and, of course, activated T-cells. Importantly, resting T-cells, B-cells or circulating macrophages typically do not display the IL-2
10 receptor (Herrmann, et al., J. Exp. Med. 162:1111 (1985)).

The anti-Tac monoclonal antibody has also been used to define lymphocyte functions that require IL-2 interaction, and has been shown to inhibit various T-cell functions, including the generation of cytotoxic and suppressor T
15 lymphocytes in cell culture. Also, based on studies with anti-Tac, a variety of disorders are now associated with improper IL-2 receptor expression by T-cells, in particular adult T-cell leukemia.

More recently, the IL-2 receptor has been shown to
20 be an ideal target for novel therapeutic approaches to T-cell mediated diseases. The anti-Tac monoclonal antibody can be used either alone or as an immunoconjugate (e.g., with Ricin A, isotopes and the like) to effectively remove cells bearing the IL-2 receptor. These agents can, for example,
25 theoretically eliminate IL-2 receptor-expressing leukemic cells, certain B-cells, or activated T-cells involved in a disease state, yet allow the retention of mature normal T-cells and their precursors to ensure the capability of mounting a normal T-cell immune response as needed. In
30 general, other T-cell specific agents can destroy essentially all peripheral T-cells, which limits therapeutic efficacy. Overall, the use of monoclonal antibodies specific for the IL-2 receptor can be expected to have therapeutic utility in autoimmune diseases, organ transplantation and any unwanted
35 response by activated T-cells. Indeed, clinical trials have been initiated (see, generally, Waldman, T., Science 232:727-732 (1986), which is incorporated herein by reference).

Unfortunately, the use of the anti-Tac monoclonal antibody has certain drawbacks, particularly in repeated therapeutic regimens. As a mouse monoclonal, it does not fix human complement well, whereas a human equivalent may be more efficient.

5 More importantly, however, anti-Tac monoclonal antibody contains substantial murine amino acid sequences that will be antigenic when injected into a human patient. Numerous studies have shown that the immune response elicited by a patient against the nonbinding portion of an injected
10 mouse monoclonal antibody can be quite strong, essentially eliminating the antibody's therapeutic utility after an initial treatment. As increasing numbers of different mouse monoclonal antibodies can be expected to be developed to treat various diseases, after the first and second treatments
15 with different mouse monoclonal antibodies, subsequent treatments can be dangerous in themselves.

Thus, there is a need for improved forms of the anti-Tac monoclonal antibody that are substantially less antigenic, yet easily and economically produced in a manner
20 suitable for therapeutic formulation. The present invention fulfills these needs.

Summary of the Invention

The present invention provides novel compositions
25 useful in the treatment of T-cell mediated human disorders, the compositions containing a chimeric antibody specifically capable of binding to human IL-2 receptors, such as at the epitope bound by the anti-Tac monoclonal antibody. The IL-2
30 chimeric antibody can have two pairs of light chain/heavy chain complexes, wherein at least one pair has chains comprising mouse variable regions joined with human constant region segments, with or without naturally-associated J and D segments.

The chimeric antibodies, or binding fragments
35 thereof, of the present invention may be produced by a variety of recombinant DNA techniques, with ultimate expression in transfected cells, preferably immortalized

eukaryotic cells, such as myeloma or hybridoma cells. Polynucleotides comprising a first sequence coding for a human immunoglobulin constant region and a second sequence coding for the desired mouse immunoglobulin variable or hypervariable region can be produced synthetically or by
5 combining appropriate cDNA and genomic DNA segments.

When the chimeric antibodies are complexed with a cytotoxic agent, such as a radionuclide, a ribosomal inhibiting protein or a cytotoxic agent active at cell
10 surfaces, the compounds will be particularly useful in treating T-cell mediated disorders. These compounds can be provided in a pharmaceutically accepted dosage form, which will vary depending on the mode of administration.

15

20

25

30

35

BRIEF DESCRIPTION OF THE FIGURES

Figure 1 depicts the DNA coding sequence and putative amino acid sequence of the V and J regions of the anti-Tac light chain.

5 Figure 2 depicts the DNA coding sequence and putative amino acid sequence of the V and J regions of the anti-Tac heavy chain.

Figures 3-10 are schematic diagrams of the plasmids utilized to demonstrate the present invention.

10 Figure 11 represents an overview of a preferred strategy for preparation of V and J regions for insertion into plasmids.

15

20

25

30

35

DETAILED DESCRIPTION OF THE INVENTION

In accordance with the present invention, DNA sequences encoding mouse variable/human constant region chimeric antibodies capable of binding epitopes on human IL-2 receptors are provided. When placed in expression vectors and suitable hosts, large quantities of chimeric antibodies can be produced. Preferably, the chimeric antibodies will have substantially the same binding profile or characteristics as (e.g., be cross-reactive or capable of blocking) the binding of the anti-Tac monoclonal antibody, such as antibodies produced by the myeloma cell line deposited with the A.T.C.C. and designated accession number CRL 9688. These chimeric antibodies find use, for example, in the treatment of T-cell mediated disorders in human patients.

The basic immunoglobulin structural unit is known to comprise a tetramer. Each tetramer is composed of two identical pairs of polypeptide chains, each pair having one "light" (about 25kD) and one "heavy" chain (about 50-70kD). The NH₂-terminus of each chain begins a variable region of about 100 to 110 or more amino acids primarily responsible for antigen recognition. The COOH terminus of each chain defines a constant region primarily responsible for effector function.

Light chains are classified as either kappa or lambda. Heavy chains are classified (and subclassified) as gamma, mu, alpha, delta, or epsilon, and define the immunoglobulin's isotype as IgG, IgM, IgA, IgD and IgE, respectively. Within light and heavy chains, the variable and constant regions are joined by a "J" region of about 12 or more amino acids, with the heavy chain also including a "D" region of about 12 more amino acids. (See, generally, Fundamental Immunology, Ed. Paul, W. Chapter 7, pgs. 131-166, Raven Press, N.Y. (1984), which is incorporated herein by reference.)

Chimeric antibodies are antibodies whose light and heavy chain genes have been constructed, typically by genetic engineering, from immunoglobulin gene segments belonging to

different species. For example, the variable (V) segments of the genes for a mouse monoclonal antibody may be joined to human constant (C) segments, such as γ_1 , and γ_3 . A preferred therapeutic chimeric antibody is thus a hybrid protein consisting of the V or antigen-binding domain from a mouse antibody and the C or effector domain from a human antibody, although other mammalian species may be used.

Human chimeric antibodies have at least three potential advantages over mouse antibodies for use in human therapy:

- 1) Because the effector portion is human, it may interact better with the other parts of the human immune system (e.g., destroy the target cells more efficiently by complement-dependent cytotoxicity (CDC) or antibody-dependent cellular cytotoxicity (ADCC)).
- 2) The human immune system should not recognize the C region of the chimeric antibody as foreign, and therefore the antibody response against an injected chimeric antibody should be less than against a totally foreign mouse antibody.
- 3) Injected mouse antibodies have been reported to have a half-life in the human circulation much shorter than the half-life of normal antibodies (Shaw, D. et al., J. Immunol. 138:4534-4538 (1987)). It is possible that injected chimeric antibodies will have a half-life more like that of human antibodies, allowing smaller and less frequent doses to be given.

In one aspect, the present invention is directed to recombinant DNA segments encoding the heavy and/or light chain variable or hypervariable regions from the anti-Tac monoclonal antibody. The DNA segments encoding these regions will typically be joined to DNA segments encoding appropriate constant regions, such as human gamma heavy chain regions or human kappa light chain regions. The preferred variable region DNA sequences, which on expression code for the

polypeptide chains comprising the anti-Tac light and heavy chain variable regions (with naturally-associated J regions), are shown in Figures 1 and 2, respectively. Due to codon degeneracy and non-critical amino-acid substitutions, other DNA sequences can be readily substituted for those sequences, as detailed below.

The DNA segments will typically further include an expression control DNA sequence operably linked to the chimeric antibody coding sequences, including naturally-associated or heterologous promoter regions. Preferably, the expression control sequences will be eukaryotic promoter systems in vectors capable of transforming or transfecting eukaryotic host cells. Once the vector has been incorporated into the appropriate host, the host is maintained under conditions suitable for high level expression of the nucleotide sequences, and, as desired, the collection and purification of the light chains, heavy chains, light/heavy chain dimers or intact chimeric antibodies may follow.

It is well known that native forms of "mature" immunoglobulins will vary somewhat in terms of length by deletions, substitutions, insertions or additions of one or more amino acids in the sequences. Thus, both the variable and constant regions are subject to substantial natural modification, yet are "substantially identical" and still capable of retaining their respective activities. Human constant region DNA sequences can be isolated in accordance with well known procedures from a variety of human cells, but preferably immortalized B-cells. Suitable source cells for the DNA sequences and host cells for expression and secretion can be obtained from a number of sources, such as the American Type Culture Collection ("Catalogue of Cell Lines and Hybridomas," Fifth edition (1985) Rockville, Maryland, U.S.A., which is incorporated herein by reference).

In addition to these naturally-occurring forms of immunoglobulin chains, "substantially identical" modified heavy and light chains can be readily designed and manufactured utilizing various recombinant DNA techniques well known to those skilled in the art. For example, the

chains can vary from the naturally-occurring sequence at the primary structure level by several amino acid substitutions, terminal and intermediate additions and deletions, and the like. Alternatively, polypeptide fragments comprising only a portion (usually at least about 60-80%, typically 90-95%) of the primary structure may be produced, which fragments possess one or more immunoglobulin activities (e.g., complement fixation activity), while exhibiting lower immunogenicity. In particular, it is noted that like many genes, the immunoglobulin-related genes contain separate functional regions, each having one or more distinct biological activities. These may be fused to functional regions from other genes (e.g., enzymes, see, commonly assigned U.S.S.N. 132,387, filed Dec. 15, 1987, which is incorporated herein by reference) to produce fusion proteins (e.g., immunotoxins) having novel properties. In general, modifications of the genes may be readily accomplished by a variety of well-known techniques, such as site-directed mutagenesis (see, Gillman and Smith, Gene 8:81-97 (1979); Roberts, S. et al, Nature 328:731-734 (1987); and U.S. Patent no. 4,703,008, all of which are incorporated herein by reference). Preferred DNA segments encoding variable regions of the present invention will typically be substantially homologous to the sequences of Figures 1 and 2 (i.e., capable of hybridizing to the sequences under stringent conditions of low salt and high temperature), most preferably at least about 90-95% homologous or more.

The nucleic acid sequences of the present invention capable of ultimately expressing the desired chimeric antibodies can be formed from a variety of different polynucleotides (genomic or cDNA, RNA, etc.) and components (e.g., V, J, D, and C regions), as well as by a variety of different techniques. Joining appropriate genomic sequences is presently the most common method of production, but cDNA sequences may also be utilized (see, European Patent Application Nos. 85102655.8, 85305604.2, 84302368.0 and 85115311.4, as well as PCT Application Nos. GB85/00392 and US86/02269, all of which are incorporated herein by

reference).

As stated previously, the DNA sequences of the present invention (typically at least about 30 contiguous nucleotides encoding 10 amino acids from the sequences in Figures 1 and 2) will be expressed in hosts after the sequences have been operably linked to (*i.e.*, positioned to ensure the functioning of) an expression control sequence. These expression vectors are typically replicable in the host organisms either as episomes or as an integral part of the host chromosomal DNA. Commonly, expression vectors will contain selection markers, *e.g.*, tetracycline or neomycin, to permit detection of those cells transformed with the desired DNA sequences (*see, e.g.*, U.S. Patent 4,704,362, which is incorporated herein by reference).

E. coli is one prokaryotic host useful particularly for cloning the DNA sequences of the present invention. Other microbial hosts suitable for use include bacilli, such as *Bacillus subtilis*, and other enterobacteriaceae, such as *Salmonella*, *Serratia*, and various *Pseudomonas* species. In these prokaryotic hosts, one can also make expression vectors, which will typically contain expression control sequences compatible with the host cell (*e.g.*, an origin of replication). In addition, any number of a variety of well-known promoters will be present, such as the lactose promoter system, a tryptophan (*trp*) promoter system, a beta-lactamase promoter system, or a promoter system from phage lambda. The promoters will typically control expression, optionally with an operator sequence, and have ribosome binding site sequences and the like, for initiating and completing transcription and translation.

Other microbes, such as yeast may also be used for expression. *Saccharomyces* is a preferred host, with suitable vectors having expression control sequences, such as promoters, including 3-phosphoglycerate kinase or other glycolytic enzymes, and an origin of replication, termination sequences and the like as desired.

In addition to microorganisms, mammalian tissue cell culture may also be used to produce the polypeptides of

the present invention (see, Winnacker, "From Genes to Clones," VCH Publishers, N.Y., N.Y. (1987), which is incorporated herein by reference). Eukaryotic cells are actually preferred, because a number of suitable host cell lines capable of secreting intact immunoglobulins have been developed in the art, and include the CHO cell lines, various COS cell lines, HeLa cells, myeloma cell lines, etc, but preferably transformed B-cells or hybridomas. Expression vectors for these cells can include expression control sequences, such as an origin of replication, a promoter, an enhancer (Queen, C. et al., Immunol. Rev. 89:49-68 (1986), which is incorporated herein by reference), and necessary processing information sites, such as ribosome binding sites, RNA splice sites, polyadenylation sites, and transcriptional terminator sequences. Preferred expression control sequences are promoters derived from immunoglobulin genes, SV40, Adenovirus, Bovine Papilloma Virus, and the like.

The vectors containing the DNA segments of interest (e.g., the heavy and light chain encoding sequences and expression control sequences) can be transferred into the host cell by well-known methods, which vary depending on the type of cellular host. For example, calcium chloride transfection is commonly utilized for prokaryotic cells, whereas calcium phosphate treatment may be used for other cellular hosts. (See, generally, Maniatis et al., Molecular Cloning: A Laboratory Manual, Cold Spring Harbor Press, (1982), which is incorporated herein by reference.)

Once expressed, the whole chimeric antibodies, their dimers, or individual light and heavy chains of the present invention can be purified according to standard procedures of the art, including ammonium sulfate precipitation, fraction column chromatography, gel electrophoresis and the like. (See, generally, Scopes, R., Protein Purification, Springer-Verlag, N.Y. (1982).) Once purified, partially or to homogeneity as desired, the polypeptides may then be used therapeutically or in developing and performing assay procedures, immunofluorescent stainings, and the like. (See, generally, Immunological

Methods, Vols. I and II, Eds. Lefkovits and Pernis, Academic Press, New York, N.Y. (1979 and 1981).)

The chimeric antibodies of the present invention will typically find use individually in treating a T-cell mediated disease state. Generally, where the cell linked to a disease has been identified as IL-2 receptor bearing, then the chimeric antibodies are suitable (see, U.S.S.N. 7-085,707, entitled "Treating Human Malignancies and Disorders," which is incorporated herein by reference).

For example, typical disease states suitable for treatment graft versus host disease and most patients undergoing an organ transplant, such as heart, lungs, kidneys, liver, etc. Other diseases include Type I diabetes, multiple sclerosis, rheumatoid arthritis, Lupus erythematosus, and Myasthenia Gravis.

The antibodies of the present invention may also be used in combination with other antibodies, particularly human chimeric antibodies or human monoclonal antibodies reactive with other markers on cells responsible for the disease. For example, suitable T-cell markers can include those grouped into the so-called "Clusters of Differentiation," as named by the First International Leukocyte Differentiation Workshop, Leukocyte Typing, Eds. Bernard, et al., Springer-Verlag, N.Y. (1984), which is incorporated herein by reference.

The chimeric antibodies can also be used as separately administered compositions given in conjunction with chemotherapeutic or immunosuppressive agents. Typically, the agents will include a cephalosporin or a purine analog (e.g., methotrexate, 6-mercaptopurine, or the like), but numerous additional agents (e.g., cyclophosphamide, sulfa drugs, etc.) well-known to those skilled in the art may also be utilized.

A preferred pharmaceutical composition of the present invention comprises the use of the subject chimeric antibodies in immunotoxins. Immunotoxins are characterized by two components and are particularly useful for killing selected cells in vitro or in vivo. One component is a cytotoxic agent which is usually fatal to a cell when

attached or absorbed. The second component, known as the "delivery vehicle," provides a means for delivering the toxic agent to a particular cell type, such as cells comprising a carcinoma. The two components are commonly chemically bonded together by any of a variety of well-known chemical procedures. For example, when the cytotoxic agent is a protein and the second component is an intact immunoglobulin, such as a chimeric antibody, the linkage may be by way of heterobifunctional cross-linkers, e.g., SPDP, carbodiimide, glutaraldehyde, or the like. Production of various immunotoxins is well-known with the art, and can be found, for example in "Monoclonal Antibody-Toxin Conjugates: Aiming the Magic Bullet," Thorpe et al, Monoclonal Antibodies in Clinical Medicine, Academic Press, pp. 168-190 (1982), which is incorporated herein by reference.

A variety of cytotoxic agents are suitable for use in immunotoxins. Cytotoxic agents can include radionuclides, such as Iodine-131, Yttrium-90, Rhenium-188, and Bismuth-212; a number of chemotherapeutic drugs, such as vindesine, methotrexate, adriamycin, and cisplatinum; and cytotoxic proteins such as ribosomal inhibiting proteins, pokeweed antiviral protein, abrin and ricin (or their A-chains, diphtheria toxin A-chains, Pseudomonas exotoxin A, etc.) or an agent active at the cell surface, such as the phospholipase enzymes (e.g., phospholipase C). (See generally, "Chimeric Toxins," Olsnes and Phil, Pharmac. Ther., 25:355-381 (1982), and "Monoclonal Antibodies for Cancer Detection and Therapy," eds. Baldwin and Byers, pp. 159-179, 224-266, Academic Press (1985), both of which are incorporated herein by reference.)

The delivery component of the immunotoxin will include the chimeric antibodies of the present invention. Intact chimeric immunoglobulins or their binding fragments, such as Fab, F(ab₂), etc., are preferably used. Typically, the chimeric antibodies in the immunotoxins will be of the human IgM or IgG isotype, but other mammalian constant regions may be utilized as desired.

The chimeric antibodies and pharmaceutical

compositions thereof of this invention are particularly useful for parenteral administration, *i.e.*, subcutaneously, intramuscularly or intravenously. The compositions for parenteral administration will commonly comprise a solution of the antibody or a cocktail thereof dissolved in an acceptable carrier, preferably an aqueous carrier. A variety of aqueous carriers can be used, *e.g.*, water, buffered water, 0.4% saline, 0.3% glycine and the like. These solutions are sterile and generally free of particulate matter. These compositions may be sterilized by conventional, well known sterilization techniques. The compositions may contain pharmaceutically acceptable auxiliary substances as required to approximate physiological conditions such as pH adjusting and buffering agents, toxicity adjusting agents and the like, for example sodium acetate, sodium chloride, potassium chloride, calcium chloride, sodium lactate, etc. The concentration of antibody in these formulations can vary widely, *i.e.*, from less than about 0.5%, usually at or at least about 1% to as much as 15 or 20% by weight and will be selected primarily based on fluid volumes, viscosities, etc., in accordance with the particular mode of administration selected.

Thus, a typical pharmaceutical composition for intramuscular injection could be made up to contain 1 ml sterile buffered water, and 50 mg of antibody. A typical composition for intravenous infusion could be made up to contain 250 ml of sterile Ringer's solution, and 150 mg of antibody. Actual methods for preparing parenterally administrable compositions will be known or apparent to those skilled in the art and are described in more detail in, for example, Remington's Pharmaceutical Science, 15th Ed., Mack Publishing Company, Easton, Pennsylvania (1980), which is incorporated herein by reference.

The antibodies of this invention can be lyophilized for storage and reconstituted in a suitable carrier prior to use. This technique has been shown to be effective with conventional immune globulins and art-known lyophilization and reconstitution techniques can be employed. It will be

appreciated by those skilled in the art that lyophilization and reconstitution can lead to varying degrees of antibody activity loss (e.g., with conventional immune globulins, IgM antibodies tend to have greater activity loss than IgG antibodies) and that use levels may have to be adjusted to compensate.

5 The compositions containing the present human chimeric antibodies or a cocktail thereof can be administered for the prophylactic and/or therapeutic treatments. In therapeutic application, compositions are administered to a patient already, in an amount sufficient to cure or at least partially arrest the infection and its complications. An amount adequate to accomplish this is defined as a "therapeutically effective dose." Amounts effective for this use will depend upon the severity of the infection and the general state of the patient's own immune system, but generally range from about 1 to about 200 mg of antibody per dose, with dosages of from 5 to 25 mg per patient being more commonly used. It must be kept in mind that the materials of this invention may generally be employed in serious disease states, that is life-threatening or potentially life-threatening situations. In such cases, in view of the minimization of extraneous substances and the lower probability of "foreign substance" rejections which are achieved by the present human chimeric antibodies of this invention, it is possible and may be felt desirable by the treating physician to administer substantial excesses of these antibodies.

15
20
25
30
35 In prophylactic applications, compositions containing the present antibodies or a cocktail thereof are administered to a patient not already in a disease state to enhance the patient's resistance. Such an amount is defined to be a "prophylactically effective dose." In this use, the precise amounts again depend upon the patient's state of health and general level of immunity, but generally range from 0.1 to 25 mg per dose, especially 0.5 to 2.5 mg per patient.

Single or multiple administrations of the compositions can be carried out with dose levels and pattern being selected by the treating physician. In any event, the pharmaceutical formulations should provide a quantity of the antibody(ies) of this invention sufficient to effectively
5 treat the patient.

Chimeric antibodies of the present invention can further find a wide variety of utilities in vitro. By way of example, the chimeric antibodies can be utilized for T-cell typing, for isolating specific IL-2 receptor bearing cells or
10 fragments of the receptor, for vaccine preparation, or the like.

For diagnostic purposes, the chimeric antibodies may either be labeled or unlabeled. Unlabeled antibodies can be used in combination with other labeled antibodies (second
15 antibodies) that are reactive with the chimeric antibody, such as antibodies specific for human immunoglobulin constant regions. Alternatively, the chimeric antibodies can be directly labeled. A wide variety of labels may be employed, such as radionuclides, fluorescers, enzymes, enzyme
20 substrates, enzyme cofactors, enzyme inhibitors, ligands (particularly haptens), etc. Numerous types of immunoassays are available and are well known to those skilled in the art.

Kits can also be supplied for use with the subject antibodies in the protection against or detection of a
25 cellular activity or for the presence of a selected antigen. Thus, the subject antibody composition of the present invention may be provided, usually in a lyophilized form in a container, either alone or in conjunction with additional antibodies specific for the desired cell type. The
30 antibodies, which may be conjugated to a label or toxin, or unconjugated, are included in the kits with buffers, such as Tris, phosphate, carbonate, etc., stabilizers, biocides, inert proteins, e.g., serum albumin, or the like, and a set of instructions for use. Generally, these materials will be
35 present in less than about 5% wt. based on the amount of active antibody, and usually present in total amount of at least about 0.001% wt. based again on the antibody

concentration. Frequently, it will be desirable to include an inert extender or excipient to dilute the active ingredients, where the excipient may be present in from about 1 to 99% wt. of the total composition. Where a second antibody capable of binding to the chimeric antibody is employed in an assay, this will usually be present in a separate vial. The second antibody is typically conjugated to a label and formulated in an analogous manner with the antibody formulations described above.

The following examples are offered by way of illustration, not by limitation.

15

20

25

30

35

EXPERIMENTALConstruction of Plasmids

1. Construction began with the plasmid pKcath described in the literature (Garcia, J.V. et al., Nature 332:383-385 (1986); Fig. 3). This plasmid has the following parts; clockwise:
 - a. A 700 bp fragment containing the mouse immunoglobulin heavy chain enhancer (E_H in the Fig. 3).
 - b. An 1100 base pair (bp) fragment from the mouse immunoglobulin light chain kappa gene MOPC 41, containing its promoter. There is a Bgl II site 25 bp after the transcription startsite of this promoter.
 - c. The bacterial CAT gene (800 bp).
 - d. A splice and polyadenylation signal from the animal virus SV40 (850 bp).
 - e. Another part of SV40 containing its origin of replication (700 bp);
 - f. Part of the plasmid pBR322, extending from the Sph I site to the Eco RI site of the plasmid pML1 (Lusky, M and Botchan, M. Nature 293:79-81; 2300 bp) including the Amp gene and origin of replication.
2. pKcath was cut with Bgl II, and the ends filled in with Klenow polymerase. An Xba I linker, having the sequence GCTCTAGAGC, was inserted at the filled-in Bgl II site. The resulting plasmid is called pKcath - Xba.
3. pKcath - Xba was cut partially with Xho II, run on an agarose gel, and full-length linear plasmid (*i.e.*, plasmid cut exactly once with Xho II) was isolated. The DNA was cut with Bam HI, run on a gel and the 5600 bp fragment isolated. Because of its size, this fragment had to extend from the Bam site to the Xho II site at the end of the CAT gene (Fig. 3). The fragment was

ligated by itself. The resulting plasmid is called pKcatH - Xba - BX. It is similar to pKcatH but has an Xba I site in place of the Bgl II site and is missing the Xho II - Bam HI SV40 fragment (Fig. 4).

- 5 4. pKcatH - Xba - BX was cut partially with Eco RI, run on an agarose gel, and full-length linear plasmid was isolated. This DNA was cut with Bam HI, and the 2600 bp fragment isolated. This fragment extended from the Eco RI site before E_H to the Bam HI site. The plasmid
- 10 pSV2gpt, described in the literature (Mulligan, R.C. and Berg, P., Proc. Nat. Acad. Sci. USA 78:2072-2976 (1980)), was cut with Eco RI and Bam HI and the large Eco RI - Bam HI fragment ligated to the Eco RI - Bam HI fragment from pKcatH - Xba - BX. The resulting plasmid
- 15 is called pSV2gpt - E_H - κ, (Fig. 5).
- 20 5. The plasmid pSV2neo (Southern, P.J. and Berg, P. J. Mol. App. Genet. 1:327-341 (1982)), was cut with Eco RI and Bam HI, and the large Eco RI - Bam HI fragment ligated to the same Eco RI - Bam HI fragment from pKcatH - Xba - BX used in (4). The resulting plasmid is called pSV2neo - EH - κ, which is like pSV2gpt - EH - κ, but has the Neo gene in place of the Gpt gene.
- 25 6. pSV2gpt - E_H - κ was cut with Xba I and Bam HI and the ends filled in with Klenow polymerase. A fragment of the cloned human κ constant segment gene (Hieter, P.A. et al., Cell 22:197-207 (1980)) was purified, extending from a Hind III site 336 bp before the coding region, to
- 30 an Xba I site about 800 bp beyond the coding region, and the ends filled in. The two fragments were ligated together, and a plasmid selected in which the Hind III site of the second fragment was joined to the Xba I site and the Xba I site of the second fragment to the Bam HI
- 35 site. Because of the sequences of these sites, this recreated an Xba I site and a Bam HI site. The new plasmid is called pVκ1 (Fig. 6).

7. An Xba I fragment containing the VJ region of the cloned anti-Tac light chain gene was prepared by in vitro mutagenesis (see, below). pV κ 1 was cut with Xba I, treated with phosphatase, and ligated with the Xba I fragment. A plasmid was selected in which the VJ region had the same orientation as the following C region, and called pLTAC2 (Fig. 7).
8. pSV2neo - E_H - κ was cut with Xba I and Bam HI and the ends filled in with Klenow polymerase. A 2800 bp fragment containing the human C γ 1 gene was purified from the phage HG3A (Ellison, J.W. et al., Nucleic Acids Res. 10:4071-4079 (1982)), extending from a Hind III site 210 bp before the CH1 exon to a Pvu II site about 1100 bp after the CH3 exon, and the ends filled in. The two fragments were ligated together, and a plasmid selected in which the Hind III site of the second fragment was joined to the Xba I site and the Pvu II site of the second fragment to the Bam HI site. Because of the sequences of these sites, this recreated an Xba I site and a Bam HI site. The new plasmid is called pV γ 1neo (Fig. 8).
9. pSV2neo - E_H - κ was cut with Xba I and Bam HI and the ends filled in with Klenow polymerase. A 3600 bp fragment containing the human C γ 3 gene (Takahashi, N. et al., Cell 29:671-679 (1982)) was purified extending from a Hind III site 210 bp before the CH1 exon to a Pvu II site about 1100 bp after the CH3 exon, and the ends filled in. The two fragments were ligated together, and a plasmid selected in which the Hind III site of the second fragment was joined to the Xba I site and the Pvu II site of the second fragment to the Bam HI site. Because of the sequences of these sites, this recreated an Xba I site and a Bam HI site. The new plasmid is called pV γ 3neo and is identical to pV γ 1neo except it has the C γ 3 gene instead of C γ 1.

10. An Xba I fragment containing the VJ region of the cloned anti-Tac heavy china gene was prepared by in vitro mutagenesis (see, below). pV γ 1neo was cut with Xba I, treated with phosphatase, and ligated with the Xba I fragment. A plasmid was selected in which the VJ region had the same orientation as the following C region, and called pHTAC.
11. Three additional plasmids were prepared respectively from pV γ 1neo, pV γ 3neo and pHTAC, called respectively pV γ 1, pV γ 3 and pGTAC1. In each case, the original plasmid was cut with Hind III and Bam HI, and the large Hind III - Bam HI fragment purified. The plasmid pXBohph containing the Hyg gene (Blochlinger, K. and Diggelmann, H. Mol. Cell. Biol. 4:2929-2931 (1984)) was cut with Hind III and Bam HI and a 1600 bp fragment containing the Hyg gene purified. The fragments from the original plasmids were each ligated to the pXbohph fragment. pV γ 1 is shown in Fig. 9 and pGTAC1 in Fig. 10.
12. pHTAC was cut with Xba I and the small Xba I fragment, containing the heavy VJ region, purified. pV γ 3 was cut with Xba I, treated with phosphatase, and ligated with the small Xba I fragment. A plasmid was selected in which the VJ region had the same orientation as the following C region, and called pGTAC3. It is similar to pGTAC1, but has the C γ 3 region instead of the C γ 1 region.

Cloning of Light and Heavy Chain cDNA.

mRNA was extracted from approximately 10⁸ ascites cells of the anti-Tac hybridoma by the guanidium isothiocyanate method followed with poly A selection on Hybond-mAP paper (Amersham). cDNA was prepared by the method of Gubler and Hoffman (Gubler, U. and Hoffman, B.J. Gene 25:263-269 (1983)), treated with Eco RI methylase, ligated to Eco RI linkers, cloned into λ gt10 arms (Promega Biotec), packaged (Stratagene packaging extract) and plated on C600Hfl cells. Oligonucleotides respectively 43 and 37 nucleotides long that hybridized to the 5' ends of the mouse C κ and C γ 1 segments were synthesized (Applied Biosystems Model 380B DNA synthesizer). The oligonucleotides were 5' end-labelled and used to screen the plaques (Maniatis, et al., Molecular Cloning: A Laboratory Manual, Cold Spring Harbor Press, (1982), which is incorporated herein by reference).

Approximately 10,000 plaques were screened with the oligonucleotide probes. About 100 plaques were positive for the γ probe and 40 for the κ probe.

The cDNA inserts from 4 κ positive and 4 γ 2a positive phage were subcloned into the Eco RI sites of pUC19 and M13mp19. Partial sequencing by the dideoxy method (Sanger, F. et al., Proc. Nat. Acad. Sci. USA 74:5463-5467 (1977)) showed that two of the κ isolates had one sequence, and the other two had another sequence. In one pair, a κ V gene segment was joined to the JK2 segment out of its reading frame. In addition, the conserved Cys at position 23 was absent in this V segment, and the sequences of the two isolates differed slightly. Presumably, these clones were the result of an aberrant joining event in one κ allele, which continued to undergo somatic mutation after the formation of the hybridoma.

The VJ segments of the other pair of κ clones were sequences completely and were identical (Fig. 1). This light chain uses the JK5 segment and contains all the amino acid residues conserved in mouse κ light chains (Kabat, E. A. et al., Sequences of Proteins of Immunological Interest, particularly pg. 45 et seq, all of which is incorporated

herein by reference).

Partial sequencing of the four γ 2a clones showed they were from the same gene. The VJ segments of two were sequenced completely and had no differences. This heavy chain (Fig. 2) uses the JH2 segment and is of subgroup II (Kabat, E.A. et al., *supra*, at pgs. 121-127). The sequence is somewhat unusual because it contains no detectable D segment and has an N region containing 10 Gs. As both alleles of the κ light chain were accounted for and only one heavy chain sequence was detected, we tentatively assigned these sequences to the anti-Tac antibody genes.

Preparation of the Chimeric Genes

Plasmid vectors were prepared for the construction and expression of chimeric light and heavy chain genes as described above. The plasmid pV κ 1 (Fig. 6) contains the human κ genomic C segment, including 336 bp of the preceding intron and the poly A signal. It also contains a strong promoter sequence from the MOPC 41 κ gene, and the heavy chain enhancer sequence. There is a unique Xba I site between the promoter and the C intron. The plasmid also contains the gpt gene for selection. Two other very similar plasmids were prepared by using the human γ 1 and γ 3 C regions in place of the κ C region. In each case, the region inserted between the Xba I and Bam HI sites extended from about 210 bp 5' of the CH1 exon to about 1100 bp 3' of the CH3 exon. In addition, the gpt gene was replaced with the hyg gene to confer resistance to hygromycin.

Our strategy was to insert the VJ region from the anti-Tac κ cDNA, followed by a splice donor signal, at the Xba I site of pV κ 1. Doing so would create a chimeric κ gene, with a synthetic intron between the mouse VJ and human C κ segments. For this purpose, we devised a form of primer-directed mutagenesis (Fig. 11). The κ Eco R1 cDNA clone was moved into a variant of M13mp11, in which the Xba I and Eco R1 sites in the polylinker were abutting. An oligonucleotide was synthesized, of which the first 22 residues hybridized to the last 22 bp of the JK5 segment. The next 16 nucleotides

were the same as the sequence that follows JK5 in mouse genomic DNA, and therefore included a splice donor signal. The final nucleotides of the oligo consisted of an Xba I site followed by a short irrelevant sequence.

5 This oligonucleotide was hybridized to the M13
phage DNA containing the κ cDNA and extended with Klenow
polymerase (Fig. 3). The DNA was denatured and hybridized to
a "reverse primer," which represents M13 DNA 5' to the cDNA
insert. The reverse primer was extended, and the DNA cut
with Xba I. The Xba I fragment consisting of the extended VJ
10 segment of the cDNA was purified, and cloned in the
correction orientation into the Xba I site of pV κ 1 to obtain
the plasmid pLTAC2 (Fig. 7). Hence, the final chimeric κ
gen \acute{e} has a VJ-C intron, of which the first 14 bp and last 209
bp are respectively the same as in mouse and human genomic
15 DNA, as verified by direct sequencing of the construct. The
gene is transcribed from a κ promoter, stimulated by the
heavy chain enhancer. Based on results obtained with deleted
introns, we expected that the intron would be correctly
spliced from the transcribed RNA.

20 In an analogous manner, the VJ region from the
anti-Tac γ 2a heavy chain cDNA, followed by a splice donor
signal, was inserted into the Xba I site of pV γ 1neo. The
resulting plasmid pHTAC contains a chimeric heavy chain gene,
with a synthetic intron between the mouse VJ and human C γ 1
25 segments. The additional plasmids pGTAC1 and pGTAC3,
containing the Hyg gene and chimeric heavy genes with the
human C γ 1 C γ 3 constant regions respectively, were constructed
as described above (Fig. 10).

30

35

Details of Insertion of VJ cDNA Regions Into Plasmids

RF DNA of the phage M13mp11 was cut with Eco R1 and Xba I, the ends were filled-in, and the DNA ligated was ligated and transformed into JM101 cells. A plaque was picked and the DNA was sequenced to verify that the ends of the DNA had joined correctly, recreating the Eco R1 and Xba I sites with the intervening DNA segment deleted. This phage is designated M13mp11D. Eco R1 fragments containing the anti-Tac light and heavy chain cDNAs were separately cloned into the Eco R1 site of M13mp11, so that their 5' ends abuted the Xba I site. The resulting phage are respectively denoted M13mp11L and M13mp11H.

The following 48-nucleotide long primer was synthesized and gel-purified:
CCAGAAATTCTAGAAAAGTGTACTTACGTTTCAGCTCCAGCTTGGTCCC. From the 3' end, the first 22 residues of the primer are the same as the last 22 bp of the JK5 segment (non-coding strand). The next 16 nucleotides are the same as the sequence that follows JK5 in mouse genomic DNA and therefore includes a splice donor signal (abbreviated SD in Fig. 11). The final nucleotides of the oligo consist of an Xba I site followed by a short irrelevant sequence. Approximately 1 ug of single-stranded M13mp11L DNA was mixed with 50 ng of primer in 35 ul of 10 mM Tris, pH 7.4, 60 mM NaCl, 10 mM MgCl₂ and incubated for 15 min at 50°C and then 15 min at 23°C. 4 ul of a solution of 200 uM each dNTP was added, together with 5u Klenow polymerase. The solution was incubated for 30 minutes at 37°C. 50 ng of the "reverse primer" AACAGCTATGACCATG (New England Biolabs), which can hybridize to the newly synthesized strand upstream of the Xba I site (Fig. 11), was added. The solution was incubated at 95°C for 3 min and put on ice. An additional 4 ul of 200 uM each dNTP and 5u Klenow polymerase was added, and the solution incubated for 30 minutes at 37°C. The solution was extracted with phenol-chloroform, precipitated with ethanol, resuspended, and digested with 20u Xba I. The digested DNA was run on a 4% polyacrylamide gel and visualized with ethidium bromide. In addition to high molecular weight DNA, an approximately 400

bp fragment was visible, corresponding to the VJ region of the light chain cDNA with a "tail" (Fig. 11). The fragment was cloned directly into the Xba I site of pV κ 1 in the correct orientation.

The following 50-nucleotide long primer was synthesized and gel-purified:

5 CCAGAATTCTAGAGGTTTTAAGGACTCACCTGAGGAGACTGTGAGAGTGG. From the
3' end, the first 21 residues of the primer are the same as
the last 21 bp of the JH2 segment (non-coding strand). The
next 19 nucleotides are the same as the sequence that follows
10 JH2 in mouse genomic DNA and therefore includes a splice
donor signal. The final nucleotides of the oligo consist of
an Xba I site followed by a short irrelevant sequence. This
primer was hybridized to M13mp11H DNA following the same
protocol as above, in order to synthesize a fragment
15 containing the VJ region of the heavy chain cDNA. The
fragment was cloned directly into the Xba I site of pV γ 1neo
in the correct orientation.

Chimeric Antibody Specificity

20 CR2-2 and CEM cells are human T cell lines that are
respectively positive and negative for surface expression of
the IL2 receptor (IL2R). Whole CR2-2 cells were used to
demonstrate binding specificity of the chimeric antibody in
an ELISA assay, and CEM cells were used as a negative
25 control.

Antibody to be tested was prepared in several ways.
Anti-Tac monoclonal antibody, supplied by T. Waldmann, was
purified from mouse ascites by passage through a DEAE-dextran
column. The cell line L40H4, created by transfecting SP2/0
30 cells with the chimeric light and gamma 1 heavy chain
plasmids pLTAC2 and pGTAC1 (described above), was injected
into mice to form an ascites. From 3 mls of ascites fluid,
650 μ g of chimeric gamma 1 antibody was purified by passage
through a column of Baker Abx and a size exclusion column.
35 Also, to detect antibody production in tissue culture, 10^6
cells each of L40H4 and the cell lines 51.3 and L40H2 (which
had been created by transfecting SP2/0 with pLTAC2 and the

gamma 3 heavy chain plasmid pGTAC3 described before) and the non-producing line Sp2/0 itself, were plated in 1 ml of DME medium each. The media supernatant, containing any secreted chimeric antibodies, was harvested after 24 hr. and used directly in the assay,

5 Cultured cells of each type were washed in FACS buffer (0.1% BSA, .01% sodium azide in Dulbecco's phosphate buffered saline). 2×10^6 cells were mixed with either purified antibody in 20 μ l FACS buffer or 20 μ l media
10 supernatant from the transfected cell lines, and incubated on ice for 2 hr. The cells were washed 3 times with 1 μ l of FACS buffer (being collected by brief centrifugation after each wash). The cells that had been incubated with anti-Tac antibody (or no antibody as a control) were mixed with 0.5 μ l
15 peroxidase-conjugated goat anti-mouse antibody (Fab)'₂ fragment (Tago Immunologicals, Burlingame, California) in 20 μ l FACS buffer, and the cells that had been incubated with chimeric antibody were mixed with 0.5 μ l peroxidase-
20 conjugated goat anti-human gamma chain (Fab)'₂ fragment (Tago) in 20 μ l FACS buffer. The cells were incubated for 30 min on ice and then washed 3 times with FACS buffer. They were then mixed with 100 μ l peroxidase development solution and
25 incubated for 5 min at room temperature. The cells were spun out and the supernatants were transferred to a 96-well plate and the OD's determined in an ELISA reader. The OD's at 414 nm for the cells treated with each antibody are given in Table 1.

As expected the anti-Tac antibody itself bound to the IL2R+ CR2-2 cells but not to the IL2R- CEM cells. An
30 equal amount of purified gamma 1 chimeric antibody gave an equivalent amount of binding to the CR2-2 cells as the anti-Tac, and also failed to bind to the CEM cells. All the supernatants from both the chimeric antibody producing cells bound to the CR2-2 cells. As additional negative controls, the 51.3 supernatant did not bind to the CEM cells, and
35 supernatant from the parental SP2/0 cells did not bind the CR2-2 cells.

In combination with the derivation of the light and

heavy chain genes from the anti-Tac hybridoma, these results show that the chimeric antibodies retained specificity for the human IL2R.

5

10

15

20

25

30

35

TABLE 1

Whole-Cell ELISA Assay of Chimeric Antibodies

		CR2-2 cells (IL2R +)	CEM cells (IL2R -)
5			
	Mouse Gamma 2a		
10	none	.037	-
	anti-Tac (100ng)	.679	.024
	Human Gamma 1		
	none	.084	-
15	purified ascites (100ng)	.641	.044
	L40H4 (20 μ l sup.)	.481	-
	Human Gamma 3		
	51.3 (20 μ l sup.)	.381	.038
20	L40H2 (20 μ l sup.)	.932	-

25

30

35

To quantitate the rate of secretion of the chimeric antibodies, an ELISA assay was performed, using standard methods. The results are presented in Table 2. About 10^6 cells each of the chimeric gamma 1 secreting line L40H0 and the chimeric gamma 3 secreting line 51.3 were plated in 1 ml of DME medium with 5% fetal calf serum, and the supernatants collected after 24 hr. A 96-well plate was coated with goat anti-human antibodies (Tago Immunologicals). Different wells were incubated with increasing known amounts of gamma 1 chimeric antibody (purified from ascites) and with 1 μ l of the chimeric antibody supernatants. Briefly, the plate was washed, incubated with peroxidase-conjugated goat anti-human gamma chain antibody, washed again, incubated with peroxidase developing solution and the OD's at 414 nm determined in an ELISA reader. By comparison with the standard curve from the purified antibody, the media supernatants contained respectively about 8 and 7 ng per μ l, that is the cells secreted 8 and 7 μ g antibody per 10^6 cells per 24 hr.

20

25

30

35

TABLE 2

Rate of Chimeric Antibody Secretion

		OD ₄₁₄
5		
	Purified gamma 1 chimeric	
	3 ng	.426
10	4 ng	.535
	6 ng	.734
	8 ng	1.004
	L40H4 (1 μ l sup.)	1.014
15	51.3 (1 μ l sup.)	.845

20

25

30

35

The mixed lymphocyte reaction is a model for transplant rejection and was used to analyze the effectiveness of the chimeric anti-Tac antibodies. The experiments shown in Table 3 below were performed by standard methods (see, e.g., Strong, D.M. et al., In Vitro Stimulation of Murine Spleen Cells Using a Microculture System and a Multiple Automated Sample Harvester, J. Immunol. Meth., 2:279 (1973)). Briefly, human peripheral blood lymphocytes from two unrelated human donors were purified. The lymphocytes from the two donors were incubated in wells of a 96-well plate, either separately, mixed together, or mixed together with 1 μ g/ml of the indicated antibody added each day. When mixed together, the T-cells recognize each other as foreign, as T cells recognize an organ transplant as foreign. They therefore proliferate, as measured by uptake of 3H-labeled thymidine after three days. The numbers in Table 3 are the average thymidine uptake in cpm from triplicate wells \pm the standard deviation. Addition of either the original anti-Tac antibody or either of the chimeric antibodies strongly inhibits proliferation of the cells (percent inhibition shown in parentheses), by binding to the IL2R. This prevents IL2 from binding to the IL2R, which is required for T-cell proliferation. These experiments show that the chimeric antibody can be used to reduce the response of T-cells to foreign cells and may therefore have medical applications in preventing transplant rejection.

30

35

TABLE 3

Anti-IL2R Antibody Inhibition of Mixed Lymphocyte Reaction

	<u>Exp. 1</u>	<u>Exp. 2</u>
5		
Donor A	510 ± 292 .	151 ± 5
Donor B	901 ± 38	712 ± 29
A + B	11740 ± 1593	19806 ± 2034
10 A + B + anti-Tac	4262 ± 346 (73%)	7311 ± 461 (66%)
A + B + Human Gamma 1	4126 ± 370 (74%)	6721 ± 981 (69%)
A + B + Human Gamma 3	-	6423 ± 423 (71%)
15		
20		
25		
30		
35		

From the foregoing, it will be appreciated that the chimeric antibodies of the present invention offer numerous advantages of other human IL-2 receptor-specific antibodies. In comparison to anti-Tac mouse monoclonal antibodies, the present human chimeric antibodies can be
5 more economically produced and contain substantially less foreign amino acid sequences. This reduced likelihood of antigenicity after injection into a human patient represents a significant therapeutic improvement.

10 Although the present invention has been described in some detail by way of illustration and example for purposes of clarity and understanding, it will be apparent that certain changes and modifications may be practiced within the scope of the appended claims.

15

20

25

30

35

CLAIMS

1. A method of treating T-cell mediated disorders in a human patient, said method comprising administering to said patient a therapeutically effective dose of a mouse variable/human constant region chimeric antibody composition specifically reactive with IL-2 receptors on human T-cells.
2. A method according to Claim 1, wherein the mouse variable region comprises the entire variable region from heavy and light chains of an anti-Tac monoclonal antibody as produced by the cell line designated A.T.C.C. Accession No. CRL 9688.
3. A method according to Claim 1, wherein at least one of the mouse variable regions is joined with a naturally-associated mouse J segment.
4. A method according to Claim 1, wherein the human light chain constant region comprises a κ chain constant region.
5. A method according to Claim 1, wherein the human light chain constant region comprises a γ_1 or γ_3 chain constant region.
6. A method according to Claim 1, wherein the composition comprises the chimeric antibody complexed with a cytotoxic agent.
7. A method according to Claim 1, wherein the cytotoxic agent is a ribosomal inhibiting protein, a radionuclide or cytotoxic agent active at cell surfaces.

8. A chimeric antibody capable of binding to a human IL-2 receptor epitope, said antibody having two pairs of light chain/heavy chain complexes, wherein at least one pair has chains comprising mouse variable region and human constant region segments.

5

9. A chimeric antibody according to Claim 8, wherein the mouse variable region is adjacent to a naturally associated J segment.

10

10. A chimeric antibody according to Claim 8, which inhibits the binding of monoclonal antibodies secreted by the cell line designated A.T.C.C. Accession No. CRL 9688.

15

11. A chimeric antibody according to Claim 10, wherein at least one variable region comprises the amino acid sequence of a variable region of the anti-Tac monoclonal antibody.

20

12. A chimeric antibody according to Claim 8, which was produced in a myeloma or hybridoma cell.

25

13. A chimeric antibody according to Claim 8, which was expressed in a myeloma cell from a transfected DNA sequence comprising a mouse cDNA segment joined to a human genomic DNA segment.

14. A chimeric antibody according to Claim 8 complexed with a cytotoxic agent or signal agent.

30

15. A heavy immunoglobulin chain comprising a human heavy chain constant region and a variable chain region which is substantially identical to a monoclonal antibody heavy chain variable region secreted by the cell line designated A.T.C.C. Accession No. CRL 9688.

35

16. A heavy immunoglobulin chain according to Claim 15, wherein the variable and constant region are joined by a mouse J segment.

17. A light immunoglobulin chain comprising a human light chain constant region and a variable chain region which is substantially identical to a monoclonal antibody light chain variable region secreted by the cell line designated A.T.C.C. Accession No. CRL 9688.

18. A polynucleotide molecule comprising a first sequence coding for a human immunoglobulin constant region and a second sequence coding for a mouse immunoglobulin variable region, wherein said second sequence encodes substantially for one of the amino acid sequences of Figures 1 or 2.

19. A cell line transfected with a polynucleotide of Claim 18.

20. The cell line designated A.T.C.C. Accession No. CRL 9688.

21. A DNA segment encoding a portion of an immunoglobulin light chain, said segment comprising at least about 30 contiguous nucleotides from the sequence of Figure 1.

22. A DNA segment according to Claim 21, wherein the segment encodes a full length light chain variable region substantially homologous to the sequence in Figure 1.

23. A DNA segment encoding a portion of an immunoglobulin heavy chain, said segment comprising at least about 30 contiguous nucleotides from the sequence of Figure 2.

24. A DNA segment according to Claim 23, wherein the segment encodes a full length heavy chain variable region substantially homologous to the sequence in Figure 2.

5 25. An expression vector comprising a heterologous promoter operably linked to a DNA segment according to Claim 21 or 23.

10 26. An immortalized cell line transformed with an expression vector according to Claim 25.

15 27. A protein composition comprising at least about ten contiguous amino acids from the protein sequence of Figure 1 or Figure 2 fused to a heterologous polypeptide.

 28. A protein composition according to Claim 27, wherein the heterologous polypeptide is an immunoglobulin constant region.

20 29. A protein composition according to Claim 27, wherein the protein is glycosylated.

25 30. A recombinantly produced antibody exhibiting substantially the same antigen binding profile as an immunoglobulin secreted by a cell line designated A.T.C.C. Accession No. CRL 9688.

30

35

1/6

10 20 30 40 50 60
 AAATTCAAAGACAAAATGCATTTTCAAGTGCAGATTTT CAGCTTCCTGCTAATCAGTGCC
 Met His Phe Gln Val Gln Ile Phe Ser Phe Leu Leu Ile Ser Ala
 70 80 90 100 110 120
 TCAGTCATAATGTCCAGAGGACAAATTGTTCTCACCCAGTCTCCAGCAATCATGTCTGCA
 Ser Val Ile Met Ser Arg Gly Gln Ile Val Leu Thr Gln Ser Pro Ala Ile Met Ser Ala
 130 140 150 160 170 180
 TCTCCAGGGGAGAAGGTCACCATAACCTGCAGTGCCAGCTCAAGTATAAGTTACATGCAC
 Ser Pro Gly Glu Lys Val Thr Ile Thr Cys Ser Ala Ser Ser Ser Ile Ser Tyr Met His
 190 200 210 220 230 240
 TGGTTCCA6CAGAAGCCAGGCACTTCTCCAAAGTCTGGATTTATACCACATCCAACCTG
 Trp Phe Gln Gln Lys Pro Gly Thr Ser Pro Lys Leu Trp Ile Tyr Thr Thr Ser Asn Leu
 250 260 270 280 290 300
 GCTTCTGGAGTCCCTGCTCGCTTCAGTGGCAGTGGATCTGGGAGCTCTTACTCTCTCACA
 Ala Ser Gly Val Pro Ala Arg Phe Ser Gly Ser Gly Ser Gly Thr Ser Tyr Ser Leu Thr
 310 320 330 340 350 360
 ATCAGCCGAATGGAGGCTGAAGATGCTGCCACTTATTACTGCCATCAAAGGAGTACTTAC
 Ile Ser Arg Met Glu Ala Glu Asp Ala Ala Thr Tyr Tyr Cys His Gln Arg Ser Thr Tyr
 370 380 390 400
 CCACTCAG6TTC66TTC6GGACCAAGCTGGAGCTGAAAC
 Pro Leu Thr Phe Gly Ser Gly Thr Lys Leu Glu Leu Lys

FIG. 1.

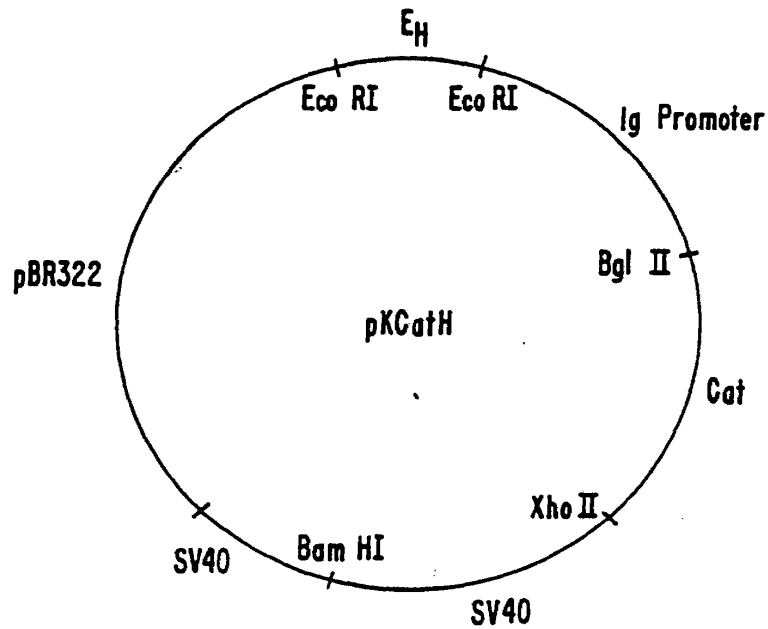

FIG. 3.

2/6

```

10      20      30      40      50      60
GCATCCTCTCCACAGACACTGAAAACCTCTGACTCACAATGGAAAGGCACTGGATCTTTCT
MetGluArgHisTrpIlePheLe

70      80      90      100     110     120
CTTCCTGTTTTTCAGTAACTGCAGGTGTCCACTCCCAGGTCCAGCTTCAGCAGTCTGGGGC
uPheLeuPheSerValThrAlaGlyValHisSerGlnValGlnLeuGlnGlnSerGlyAl

130     140     150     160     170     180
TGAAGTGGCAAACCTGGGGCCTCAGTGAAGATGTCCTGCAAGGCTTCTGGCTACACCTT
aGluLeuAlaLysProGlyAlaSerValLysMetSerCysLysAlaSerGlyTyrThrPh

190     200     210     220     230     240
TACTAGCTACAGGATGCACTGGGTAAAACAGAGGCCTGGACAGGGTCTGGAATGGATTGG
eThrSerTyrArgMetHisTrpValLysGlnArgProGlyGlnGlyLeuGluTrpIleGI

250     260     270     280     290     300
ATATATTAATCCTAGCACTGGGTATACTGAATACAATCAGAAGTTCAAGGACAAGGCCAC
yTyrIleAsnProSerThrGlyTyrThrGluTyrAsnGlnLysPheLysAspLysAlaTh

310     320     330     340     350     360
ATTGACTGCAGACAAATCCTCCAGCACAGCCTACATGCAACTGAGCAGCCTGACATTTGA
rLeuThrAlaAspLysSerSerSerThrAlaTyrMetGlnLeuSerSerLeuThrPheGI

370     380     390     400     410     420
GGACTCTGCAGTCTATTACTGTGCAAGAGGGGGGGGGTCTTTGACTACTGGGGCCAAGG
uAspSerAlaValTyrTyrCysAlaArgGlyGlyGlyValPheAspTyrTrpGlyGlnGI

430     440
AACCACTCTCACAGTCTCCTCAG
yThrThrLeuThrValSerSer
    
```

FIG. 2.

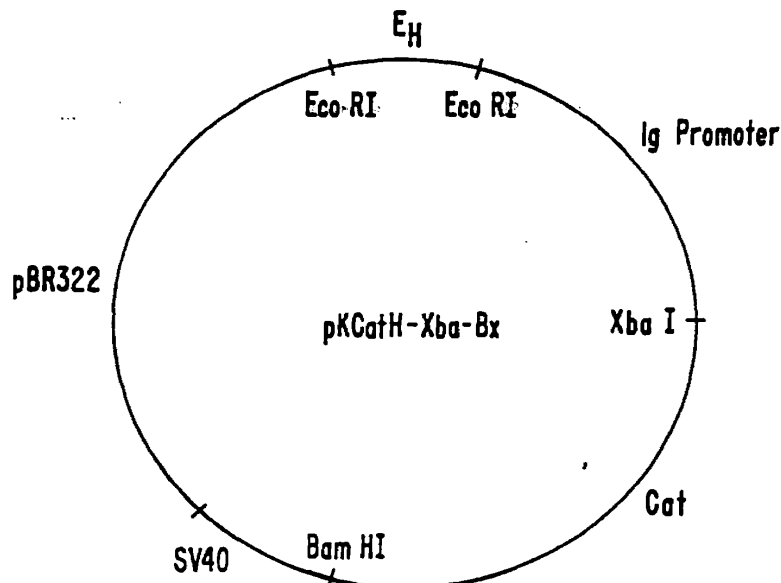

FIG. 4.

SUBSTITUTE SHEET

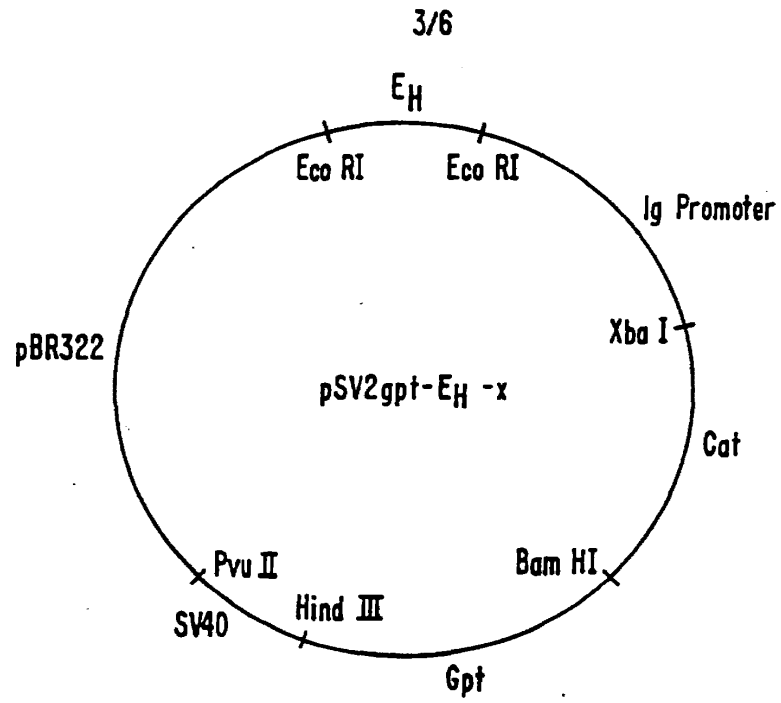

FIG. 5.

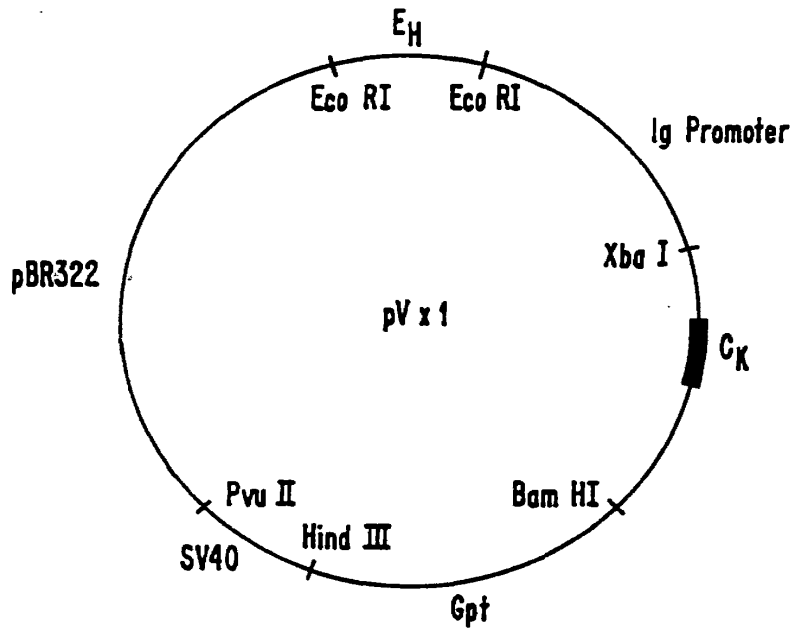

FIG. 6.

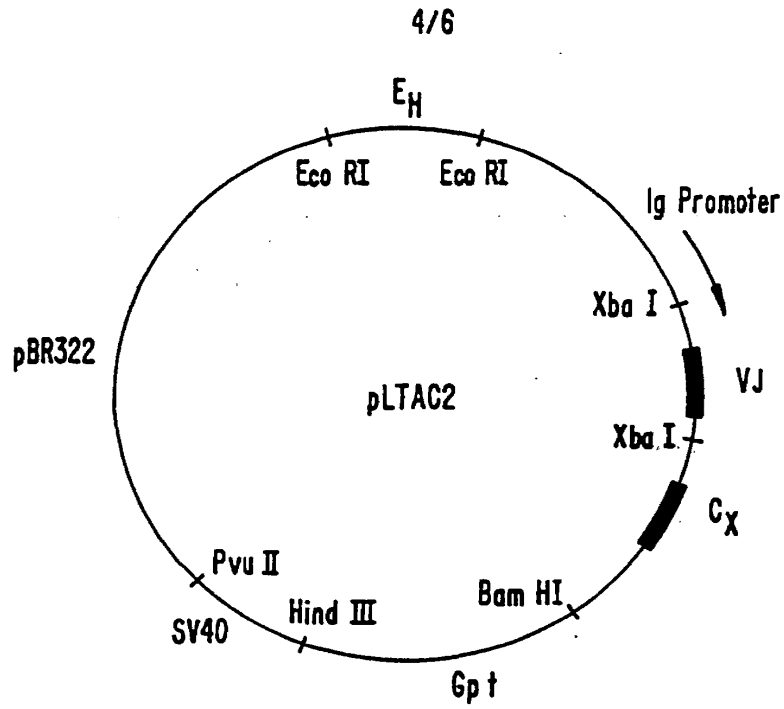

FIG. 7.

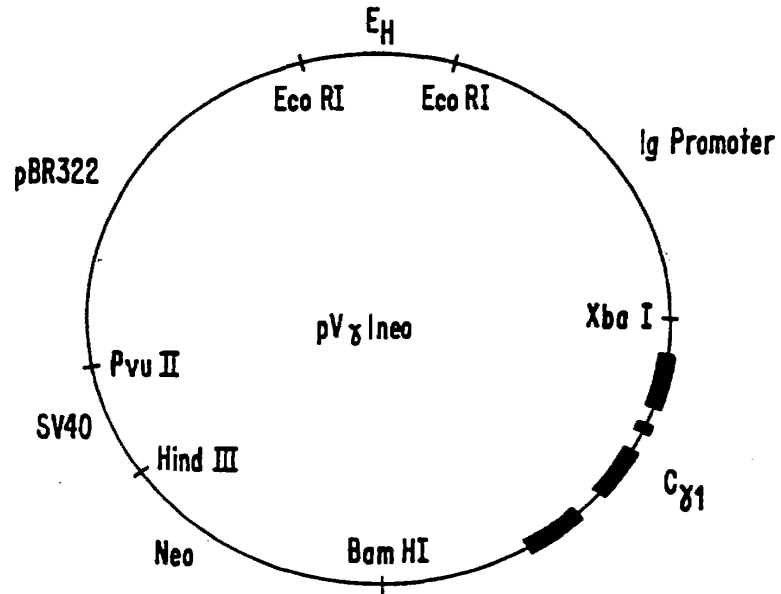

FIG. 8.

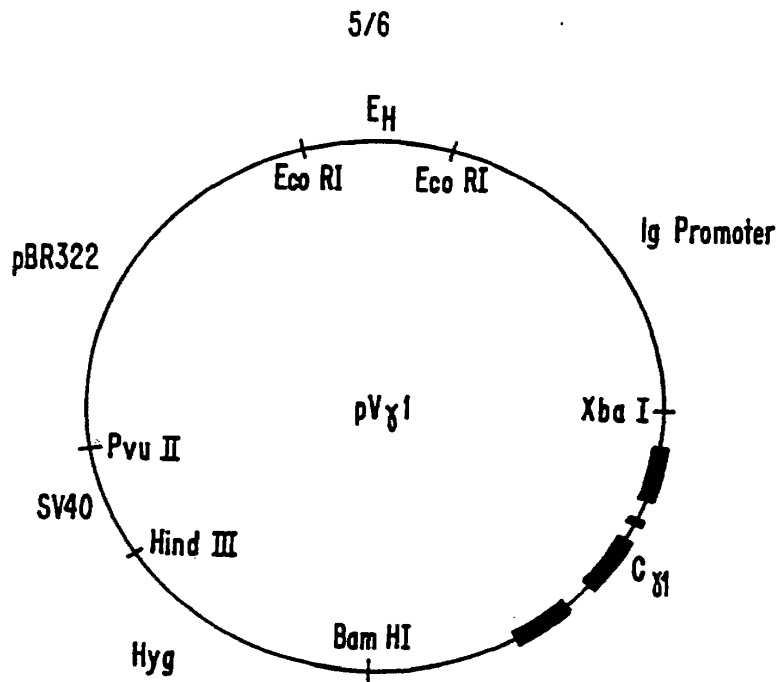

FIG. 9.

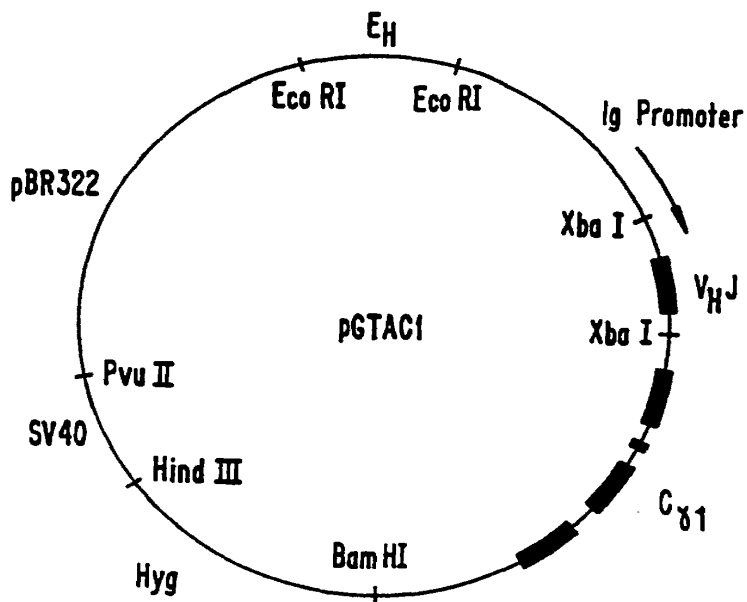

FIG. 10.

6/6

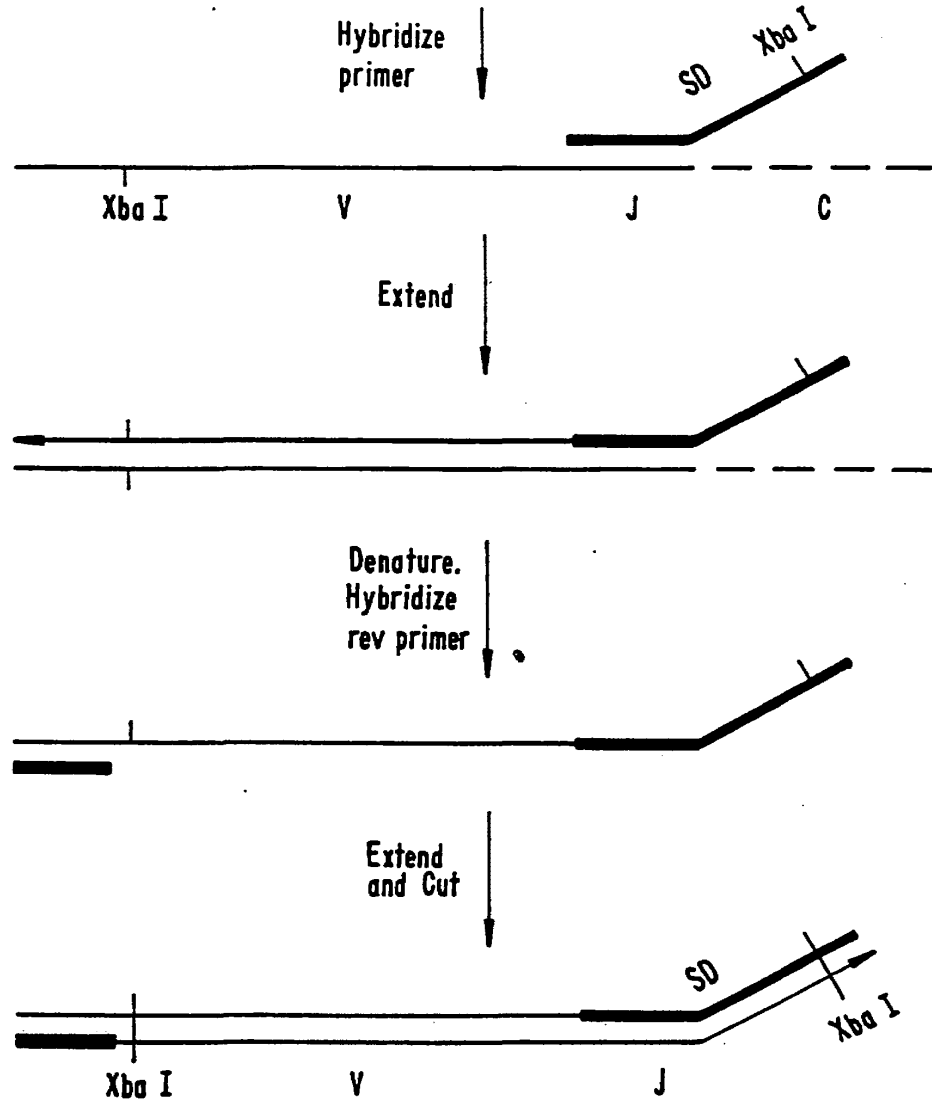

FIG. II.

SUBSTITUTE SHEET

INTERNATIONAL SEARCH REPORT

International Application **PCT/US89/01578**

I. CLASSIFICATION OF SUBJECT MATTER (if several classification symbols apply, indicate all) ⁶		
According to International Patent Classification (IPC) or to both National Classification and IPC		
IPC(4): A61K 39/395; C12N 15/00; C12N 5/00; C07K 13/00; C07K 15/04.		
U.S.: 424/85.91; 424/85.8; 530/387; 435/68; 435/172.2; 435/240.27; 536/27		
II. FIELDS SEARCHED		
Minimum Documentation Searched ⁷		
Classification System	Classification Symbols	
U.S.	424/85.8; 424/85.91; 530/387; 530/388; 530/391; 530/808; 530/821; 530/825; 435/68; 435/70; 435/172.2; 435/172.3; 435/240.27; 435/240.2; 536/27; 935/32; 935/15.	
Documentation Searched other than Minimum Documentation to the Extent that such Documents are Included in the Fields Searched ⁸		
Computer database searches on APS, Biosis.		
III. DOCUMENTS CONSIDERED TO BE RELEVANT ⁹		
Category ¹⁰	Citation of Document, ¹¹ with indication, where appropriate, of the relevant passages ¹²	Relevant to Claim No. ¹³
Y	US, A, 4,664,911 (UHR et al), 12 May 1987 (12.05.87), see columns 2 to 6.	6,7,14
Y	EP, A, 0125023 (GENENTECH et al), 14 November 1984 (14.11.84), see pages 16-25, 28, 29, and 31 to 43.	1-30
Y	EP,A, 0173494 (THE BOARD OF TRUSTEES OF THE LELAND STANFORD JUNIOR UNIVERSITY), 05 March 1986 (05.03.86), see pages 4-6 and 18-20.	1-30
Y	EP,A,0184187 (TELJIN LIMITED), 11 June 1986 (11.06.86) see pages 8 to 23.	1-30
Y	WO,A, 86/01533 (CELLTECH LIMITED), 13 March 1986 (13.03.86), see pages 3-8 and 19-22.	1-30
Y	The Journal of Immunology, Vol.126, No.4, issued April 1981 (USA), UCHIYAMA et al, "A Monoclonal Antibody (ANTI-Tac) Reactive with Activated and Functionally Mature Human T Cells," see pages 1393 to 1397.	1-30
<p>¹⁰ Special categories of cited documents:</p> <p>"A" document defining the general state of the art which is not considered to be of particular relevance</p> <p>"E" earlier document but published on or after the international filing date</p> <p>"L" document which may throw doubts on priority claim(s) or which is cited to establish the publication date of another citation or other special reason (as specified)</p> <p>"O" document referring to an oral disclosure, use, exhibition or other means</p> <p>"P" document published prior to the international filing date but later than the priority date claimed</p> <p>"T" later document published after the international filing date or priority date and not in conflict with the application but cited to understand the principle or theory underlying the invention</p> <p>"X" document of particular relevance; the claimed invention cannot be considered novel or cannot be considered to involve an inventive step</p> <p>"Y" document of particular relevance; the claimed invention cannot be considered to involve an inventive step when the document is combined with one or more other such documents, such combination being obvious to a person skilled in the art.</p> <p>"&" document member of the same patent family</p>		
IV. CERTIFICATION		
Date of the Actual Completion of the International Search		Date of Mailing of this International Search Report
10 July 1989		27 JUL 1989
International Searching Authority		Signature of Authorized Officer
ISA/US		Jeff P. Kushan

Form PCT/ISA/210 (second sheet) (Rev.11-87)



INTERNATIONAL APPLICATION PUBLISHED UNDER THE PATENT COOPERATION TREATY (PCT)

<p>(51) International Patent Classification ⁵ : C12P 21/08, C07K 15/28 C12N 15/13, 15/62, A61K 39/395</p>	A1	<p>(11) International Publication Number: WO 92/11383 (43) International Publication Date: 9 July 1992 (09.07.92)</p>
<p>(21) International Application Number: PCT/GB91/02300 (22) International Filing Date: 20 December 1991 (20.12.91)</p> <p>(30) Priority data: PCT/GB90/02017 21 December 1990 (21.12.90) WO (34) Countries for which the regional or international application was filed: GB et al. 9109645.3 3 May 1991 (03.05.91) GB</p> <p>(71) Applicant (for all designated States except US): CELLTECH LIMITED [GB/GB]; 216 Bath Road, Slough, Berkshire SL1 4EN (GB).</p> <p>(72) Inventors; and (75) Inventors/Applicants (for US only): ADAIR, John, Robert [GB/GB]; 23 George Road, Stokenchurch, High Wy- combe, Bucks HP14 3RN (GB). ATHWAL, Diljeet, Singh [GB/GB]; Flat 35, Knollys House, Tavistock Square, London WC1 7CHX (GB). EMTAGE, John, Spencer [GB/GB]; 49 Temple Mill Island, Temple, Mar- low, Bucks SL7 1SQ (GB). BODMER, Mark, William [GB/GB]; Rose Cottage, 5 Manor Road, South Hinksey, Oxford OX1 5AS (GB).</p>		<p>(74) Agent: MERCER, Christopher, Paul; Carpmaels & Rans- ford, 43 Bloomsbury Square, London WC1A 2RA (GB).</p> <p>(81) Designated States: AT, AT (European patent), AU, BB, BE (European patent), BF (OAPI patent), BG, BJ (OAPI patent), BR, CA, CF (OAPI patent), CG (OAPI patent), CH, CH (European patent), CI (OAPI patent), CM (OAPI patent), CS, DE, DE (European patent), DK, DK (European patent), ES, ES (European patent), FI, FR (European patent), GA (OAPI patent), GB, GB (Eu- ropean patent), GN (OAPI patent), GR (European pa- tent), HU, IT (European patent), JP, KP, KR, LK, LU, LU (European patent), MC (European patent), MG, ML (OAPI patent), MN, MR (OAPI patent), MW, NL, NL (European patent), NO, PL, RO, SD, SE, SE (European patent), SN (OAPI patent), SU*, TD (OAPI patent), TG (OAPI patent), US.</p> <p>Published With international search report.</p>
<p>(54) Title: RECOMBINANT ANTIBODIES SPECIFIC FOR TNFα</p>		
<p>(57) Abstract</p> <p>Recombinant, in particular humanised, e.g. humanised chimeric and CDR-grafted humanised, antibody molecules having specificity for human TNFα, are provided for use in diagnosis and therapy. In particular the antibody molecules have antigen binding sites derived from murine monoclonal antibodies CB0006, CB0010, hTNF3 or 101.4. Preferred CDR-grafted humanised anti-hTNFα antibodies comprise variable region domains comprising human acceptor framework and donor antigen binding regions and wherein the frameworks comprise donor residues at specific positions. The antibody molecules may be used for therapeutic treatment of human patients suffering from or at risk of disorders associated with undesirably high levels of TNF, in particular for treatment of immunoregulatory and inflammatory disorders or of septic, endotoxic or cardiovascular shock.</p>		

* See back of page

+ DESIGNATIONS OF "SU"

Any designation of "SU" has effect in the Russian Federation. It is not yet known whether any such designation has effect in other States of the former Soviet Union.

FOR THE PURPOSES OF INFORMATION ONLY

Codes used to identify States party to the PCT on the front pages of pamphlets publishing international applications under the PCT.

AT	Austria	ES	Spain	MG	Madagascar
AU	Australia	FI	Finland	ML	Mali
BB	Barbados	FR	France	MN	Mongolia
BE	Belgium	GA	Gabon	MR	Mauritania
BF	Burkina Faso	GB	United Kingdom	MW	Malawi
BG	Bulgaria	GN	Guinea	NL	Netherlands
BJ	Benin	GR	Greece	NO	Norway
BR	Brazil	HU	Hungary	PL	Poland
CA	Canada	IT	Italy	RO	Romania
CF	Central African Republic	JP	Japan	SD	Sudan
CG	Congo	KP	Democratic People's Republic of Korea	SE	Sweden
CH	Switzerland	KR	Republic of Korea	SN	Senegal
CI	Côte d'Ivoire	LI	Liechtenstein	SU*	Soviet Union
CM	Cameroon	LK	Sri Lanka	TD	Chad
CS	Czechoslovakia	LU	Luxembourg	TC	Togo
DE	Germany	MC	Monaco	US	United States of America
DK	Denmark				

RECOMBINANT ANTIBODIES SPECIFIC FOR TNF- α Field of the Invention

This invention relates to recombinant, in particular humanised, antibody molecules having specificity for antigenic determinants of tumour necrosis factor alpha (TNF- α), to processes for their production using recombinant DNA technology, and to their therapeutic uses.

For the purposes of the present description the term "recombinant antibody molecule" is used to describe an antibody molecule produced by any process involving the use of recombinant DNA technology, including any analogues of natural immunoglobulins or their fragments.

Also for the purposes of the present description the term "humanised antibody molecule" is used to describe a molecule having an antigen binding site derived from an immunoglobulin from a non-human species, and remaining immunoglobulin derived parts of the molecule being derived from a human immunoglobulin. Thus humanised antibody molecules include humanised chimeric antibody molecules comprising complete non-human heavy and/or light chain variable region domains linked to human constant region domains. Humanised antibody molecules also comprise CDR-grafted humanised antibody molecules comprising one or more CDRs from a non-human antibody grafted into a heavy and/or light chain human variable region framework.

The antigen binding specificity of antibodies is determined by their complementarily determining regions (CDRs) which are relatively short peptide sequences carried on the framework regions of the variable domains. There are 3CDRs, (CDR1, CDR2 and CDR3) in each of the heavy and light chain variable domains.

- 2 -

The abbreviation "MAB" is used to indicate a monoclonal antibody. In the present description reference is made to a number of publications by number, and these publications are listed in numerical order at the end of the description.

Background of the Invention

Natural immunoglobulins have been known for many years, as have the various fragments thereof, such as the Fab, Fv, (Fab')₂ and Fc fragments, which can be derived by enzymatic cleavage. Natural immunoglobulins comprise a generally Y-shaped molecule having an antigen-binding site towards the end of each upper arm. The remainder of the structure, and particularly the stem of the Y, mediates the effector functions associated with immunoglobulins.

Natural immunoglobulins have been used in assay, diagnosis and, to a more limited extent, therapy. However, such uses, especially in therapy, were hindered until recently by the polyclonal nature of natural immunoglobulins. A significant step towards the realisation of the potential of immunoglobulins as therapeutic agents was the discovery of procedures for the reproducible production of monoclonal antibodies (MAbs) of defined specificity (1).

However, most MAbs are produced by hybridomas which are fusions of rodent spleen cells with rodent myeloma cells. They are therefore essentially rodent proteins. There are very few reports of the production of human MAbs.

Since most available MAbs are of rodent origin, they are naturally antigenic in humans and thus can give rise to an undesirable immune response termed the HAMA (Human Anti-Mouse Antibody) response if the MAb is administered to a human. Therefore, the use of rodent MAbs as therapeutic agents in humans is inherently limited by the

- 3 -

fact that the human subject will mount an immunological response to the MAb and will either remove it entirely or at least reduce its effectiveness. In practice, MAbs of rodent origin may not be used in patients for more than one or a few treatments as a HAMA response soon develops rendering the MAb ineffective as well as giving rise to undesirable reactions. For instance, OKT3 a mouse IgG2a/k MAb which recognises an antigen in the T-cell receptor-CD3 complex has been approved for use in many countries throughout the world as an immunosuppressant in the treatment of acute allograft rejection [Chatenoud et al (2) and Jeffers et al (3)]. However, in view of the rodent nature of this and other such MAbs, a significant HAMA response which may include a major anti-idiotypic component, may build up on use. Clearly, it would be highly desirable to diminish or abolish this undesirable HAMA response and thus enlarge the areas of use of such antibodies.

Proposals have therefore been made to render non-human MAbs less antigenic in humans. Such techniques can be generically termed "humanisation" techniques. These techniques typically involve the use of recombinant DNA technology to manipulate DNA sequences encoding the polypeptide chains of the antibody molecule.

Early methods for humanising MAbs involved production of chimeric antibodies in which an antigen binding site comprising the complete variable domains of one antibody is linked to constant domains derived from another antibody. Methods for carrying out such chimerisation procedures are described in EP0120694 (Celltech Limited), EP0125023 (Genentech Inc. and City of Hope), EP-A-0 171496 (Res. Dev. Corp. Japan), EP-A-0 173 494 (Stanford University), and WO 86/01533 (Celltech Limited). These prior patent applications generally disclose processes for

- 4 -

preparing antibody molecules having the variable domains from a mouse MAb and the constant domains from a human immunoglobulin. Such humanised chimeric antibodies, however, still contain a significant proportion of non-human amino acid sequence, i.e. the complete non-human variable domains, and thus may still elicit some HAMA response, particularly if administered over a prolonged period [Begent et al (ref. 4)].

In an alternative approach, described in EP-A-0239400 (Winter), the complementarity determining regions (CDRs) of a mouse MAb have been grafted onto the framework regions of the variable domains of a human immunoglobulin by site directed mutagenesis using long oligonucleotides. Such CDR-grafted humanised antibodies are much less likely to give rise to a HAMA response than humanised chimeric antibodies in view of the much lower proportion of non-human amino acid sequence which they contain.

The earliest work on humanising MAbs by CDR-grafting was carried out on MAbs recognising synthetic antigens, such as the NP or NIP antigens. However, examples in which a mouse MAb recognising lysozyme and a rat MAb recognising an antigen on human T-cells were humanised by CDR-grafting have been described by Verhoeyen et al (5) and Riechmann et al (6) respectively. The preparation of CDR-grafted antibody to the antigen on human T cells is also described in WO 89/07452 (Medical Research Council).

In Riechmann et al/Medical Research Council it was found that transfer of the CDR regions alone [as defined by Kabat refs. (7) and (8)] was not sufficient to provide satisfactory antigen binding activity in the CDR-grafted product. Riechmann et al found that it was necessary to convert a serine residue at position 27 of the human heavy chain sequence to the corresponding rat phenylalanine

- 5 -

residue to obtain a CDR-grafted product having improved antigen binding activity. This residue at position 27 of the heavy chain is within the structural loop adjacent to CDR1. A further construct which additionally contained a human serine to rat tyrosine change at position 30 of the heavy chain did not have a significantly altered binding activity over the humanised antibody with the serine to phenylalanine change at position 27 alone. These results indicated that changes to residues of the human sequence outside the CDR regions, in particular in the structural loop adjacent to CDR1 of the heavy chain, may be necessary to obtain effective antigen binding activity for CDR-grafted antibodies which recognise more complex antigens. Even so the binding affinity of the best CDR-grafted antibodies obtained was still significantly less than the original MAb.

Recently Queen et al (9) have described the preparation of a humanised antibody that binds to an interleukin 2 receptor, by combining the CDRs of a murine MAb (anti-Tac) with human immunoglobulin framework and constant regions. The human framework regions were chosen to maximise homology with the anti-Tac MAb sequence. In addition computer modelling was used to identify framework amino acid residues which were likely to interact with the CDRs or antigen, and mouse amino acids were used at these positions in the humanised antibody.

In WO90/07861 Queen et al propose four criteria for designing humanised immunoglobulins. The first criterion is to use as the human acceptor the framework from a particular human immunoglobulin that is unusually homologous to the non-human donor immunoglobulin to be humanised, or to use a consensus framework from many human antibodies. The second criterion is to use the donor amino acid rather than the acceptor if the human acceptor

- 6 -

residue is unusual and the donor residue is typical for human sequences at a specific residue of the framework. The third criterion is to use the donor framework amino acid residue rather than the acceptor at positions immediately adjacent to the CDRs. The fourth criterion is to use the donor amino acid residue at framework positions at which the amino acid is predicted to have a side chain atom within about 3 Å of the CDRs in a three-dimensional immunoglobulin model and to be capable of interacting with the antigen or with the CDRs of the humanised immunoglobulin. It is proposed that the second, third or fourth criteria may be applied in addition or alternatively to the first criterion, and may be applied singly or in any combination.

WO90/07861 describes in detail the preparation of a single CDR-grafted humanised antibody, a humanised antibody having specificity for the p55 Tac protein of the IL-2 receptor. The combination of all four criteria, as above, were employed in designing this humanised antibody, the variable region frameworks of the human antibody EU (7) being used as acceptor. In the resultant humanised antibody the donor CDRs were as defined by Kabat *et al* (7 and 8) and in addition the mouse donor residues were used in place of the human acceptor residues, at positions 27, 30, 48, 66, 67, 89, 91, 94, 103, 104, 105 and 107 in the heavy chain and at positions 48, 60 and 63 in the light chain, of the variable region frameworks. The humanised anti-Tac antibody obtained is reported to have an affinity for p55 of $3 \times 10^9 \text{ M}^{-1}$, about one-third of that of the murine MAb.

We have further investigated the preparation of CDR-grafted humanised antibody molecules and have identified a hierarchy of positions within the framework of the variable regions (i.e. outside both the Kabat CDRs and

- 7 -

structural loops of the variable regions) at which the amino acid identities of the residues are important for obtaining CDR-grafted products with satisfactory binding affinity. This has enabled us to establish a protocol for obtaining satisfactory CDR-grafted products which may be applied very widely irrespective of the level of homology between the donor immunoglobulin and acceptor framework. The set of residues which we have identified as being of critical importance overlaps but does not coincide with the residues identified by Queen et al (9). Our copending International patent application WO91/09967 describes this protocol for the preparation of CDR-grafted, in particular humanised, antibody heavy and light chains and complete molecules of any desired specificity. The full disclosure of International patent application WO/91/09967 is incorporated in the present description by reference.

Tempest et al (10) have very recently described the preparation of a reshaped human monoclonal antibody for use in inhibiting human respiratory syncytial virus (RSV) infection in vivo. This reshaped antibody was prepared by grafting synthetic oligo nucleotides coding for the CDRs of a murine MAb, which neutralises RSV infection, by site - directed mutagenesis into DNA coding for the frameworks of a human IgG1, monoclonal antibody. However the simple reshaped antibody in which the CDRs alone had been transferred between mouse and human antibodies had only very poor binding for RSV which was not significantly above background. In order to partially restore binding ability it proved necessary to additionally convert human residues to mouse residues in a framework region adjacent to CDR3 of the heavy chain. Tempest et al did not convert human residues to mouse residues at important positions identified in the protocol of WO91/09967.

- 8 -

TNF α is a cytokine which is released by and interacts with cells of the immune system. Thus TNF α is released by macrophages which have been activated by lipopolysaccharide (LPS) of gram negative bacteria. As such TNF α appears to be an endogenous mediator of central importance involved in the development and pathogenesis of endotoxic shock associated with bacterial sepsis. Antibodies to TNF α has been proposed for the prophylaxis and treatment of endotoxic shock (Beutler et al (11)). However the antibodies to TNF α currently available for use in such treatment are typically murine MAb. As such these murine MAb are of only limited use for treatment of humans in view of the undesirable HAMA (Human Anti-Mouse Antibody) response which they can elicit if used for more than one or a few treatments. It is thus a highly desirable objective to prepare humanised anti-TNF α products for use in human therapy.

Our co-pending International patent application WO91/09967 describes, among other things, the preparation of humanised CDR-grafted antibody products which have specificity for TNF α . In particular WO91/09967 describes, in Example 5, preparation of specific humanised CDR grafted antibodies to human TNF α derived from the murine anti-human TNF α MAb identified as 61E71 (alternatively known as CB0006), hTNF1 (alternatively known as CB0010), hTNF3 and 101.4. The present application relates specifically to recombinant, in particular humanised antibodies to human TNF α , including those described in WO91/09967 and further improved humanised CDR-grafted antibodies to human TNF α based upon the hTNF1 (CB0010) and 101.4 murine MAb. Further studies of various anti-human TNF α murine MAb have revealed that hTNF1 and 101.4 have particularly desirable properties for use in anti-TNF therapy.

- 9 -

Summary of the Invention

Accordingly the present invention provides recombinant antibody molecules which have specificity for human TNF α .

The recombinant antibody molecules of the invention are preferably TNF neutralising, i.e. are capable of reducing or inhibiting a biological activity of human TNF α as measured by an in vitro or in vivo test.

Preferably the invention provides recombinant antibody molecules having antigen binding sites derived from the murine MAb CB0006, CB0010, hTNF3 or 101.4, especially from the murine MAb CB0010 or 101.4.

Preferably the recombinant antibody molecules of the invention are humanised antibody molecules including both chimeric humanised antibody molecules and CDR-grafted humanised antibody molecules.

For the purposes of the present description a "chimeric humanised antibody molecule" comprises complete non-human (e.g. murine MAb) variable domains linked to human constant domains, and a "CDR-grafted humanised antibody molecule" comprises an antibody heavy and/or light chain containing one or more CDRs from a non-human antibody (e.g. a murine MAb) grafted into a human heavy and/or light chain variable region framework.

The CDR-grafted humanised anti-TNF α antibody products of this invention include anti-human TNF α antibody heavy and light chain and molecule products as defined in the first, second, third and fourth aspects of the invention described in WO91/09967.

- 10 -

Detailed Description of the Invention

Thus in first preferred embodiments, the invention provides a CDR-grafted humanised anti-hTNF α antibody heavy chain having a variable region domain comprising human acceptor framework and donor antigen binding regions wherein the framework comprises donor residues at at least one of positions 6, 23 and/or 24, 48 and/or 49, 71 and/or 73, 75 and/or 76 and/or 78 and 88 and/or 91.

Preferably in these first preferred embodiments, the heavy chain framework comprises donor residues at positions 23, 24, 49, 71, 73 and 78 or at positions 23, 24 and 49. The residues at positions 71, 73 and 78 of the heavy chain framework are preferably either all acceptor or all donor residues.

Especially in these first preferred embodiments the heavy chain framework additionally comprises donor residues at one, some or all of positions 6, 37, 48 and 94. Also it is particularly preferred that residues at positions of the heavy chain framework which are commonly conserved across species, i.e. positions 2, 4, 25, 36, 39, 47, 93, 103, 104, 106 and 107, if not conserved between donor and acceptor, additionally comprise donor residues. Most preferably the heavy chain framework additionally comprises donor residues at positions 2, 4, 6, 25, 36, 37, 39, 47, 48, 93, 94, 103, 104, 106 and 107.

In addition the heavy chain framework optionally comprises donor residues at one, some or all of positions:

1 and 3,
72 and 76,
69 (if 48 is different between donor and acceptor),
38 and 46 (if 48 is the donor residue),
80 and 20 (if 69 is the donor residue),
67,

- 11 -

82 and 18 (if 67 is the donor residue),
91,
88, and
any one or more of 9, 11, 41, 87, 108, 110 and 112.

In the present description, typically the donor antibody is a non-human anti-hTNF α antibody, such as a rodent MAb, and the acceptor antibody is a human antibody.

In the CDR-grafted humanised anti-hTNF α antibodies of the present invention, the donor antigen binding region typically comprises at least one CDR from the donor antibody. Usually the donor antigen binding region comprises at least two and preferably all three CDRs of each of the heavy chain and/or light chain variable regions. The CDRs may comprise the Kabat CDRs, the structural loop CDRs or a composite of the Kabat and structural loop CDRs and any combination of any of these.

Preferably, the antigen binding regions of the CDR-grafted heavy chain variable domain comprise CDRs corresponding to the Kabat CDRs at CDR2 (residues 50-65) and CDR3 (residues 95-102) and a composite of the Kabat and structural loop CDRs at CDR1 (residues 26-35). These preferred CDR designations are preferably used for the CDR-grafted heavy chains of the first preferred embodiments, i.e. residues 26-30 are included within CDR1.

The residue designations given above and elsewhere in the present application are numbered according to the Kabat numbering [refs. (7) and (8)]. Thus the residue designations do not always correspond directly with the linear numbering of the amino acid residues. The actual linear amino acid sequence may contain fewer or additional amino acids than in the strict Kabat numbering corresponding to a shortening of, or insertion into, a

- 12 -

structural component, whether framework or CDR, of the basic variable domain structure. For example, the heavy chain variable region of the anti-Tac antibody described by Queen *et al* (9) contains a single amino acid insert (residue 52a) after residue 52 of CDR2 and a three amino acid insert (residues 82a, 82b and 82c) after framework residue 82, in the Kabat numbering. The correct Kabat numbering of residues may be determined for a given antibody by alignment at regions of homology of the sequence of the antibody with a "standard" Kabat numbered sequence.

It will be appreciated that when the CDR-grafted humanised antibody molecule embodiments of the invention, as described above and elsewhere in the present description, are applied to a particular donor/acceptor antibody pair, in some cases the donor and acceptor amino acid residues may be identical at a particular position identified for change to the donor residue, and thus no change or acceptor framework residue is required.

The invention also provides in second preferred embodiments a CDR-grafted humanised anti-hTNF α antibody light chain having a variable region domain comprising human acceptor framework and donor antigen binding regions wherein the framework comprises donor residues at at least one of positions 1 and/or 3 and 46 and/or 47.

Preferably the CDR grafted light chain of the second preferred embodiment comprises donor residues at positions 46 and/or 47.

The invention also provides in third preferred embodiments a CDR-grafted humanised anti-hTNF α antibody light chain having a variable region domain comprising human acceptor framework and donor antigen binding regions wherein the

- 13 -

framework comprises donor residues at at least one of positions 46, 48, 58 and 71.

In the third preferred embodiments, the framework preferably comprises donor residues at all of positions 46, 48, 58 and 71.

In particularly preferred embodiments of the second and third preferred embodiments, the framework additionally comprises donor residues at positions 36, 44, 47, 85 and 87. Similarly positions of the light chain framework which are commonly conserved across species, i.e. positions 2, 4, 6, 35, 49, 62, 64-69, 98, 99, 101 and 102, if not conserved between donor and human acceptor, additionally comprise donor residues. Most preferably the light chain framework additionally comprises donor residues at positions 2, 4, 6, 35, 36, 38, 44, 47, 49, 62, 64-69, 85, 87, 98, 99, 101 and 102.

In addition the framework of the second or third preferred embodiments optionally comprises donor residues at one, some or all of positions:

1 and 3,

63,

60 (if 60 and 54 are able to form a potential saltbridge),

70 (if 70 and 24 are able to form a potential saltbridge),

73 and 21 (if 47 is different between donor and acceptor),

37 and 45 (if 47 is different between donor and acceptor),

and

any one or more of 10, 12, 40, 80, 103 and 105.

Preferably, the antigen binding regions of the CDR-grafted light chain variable domain, including those of the second and third preferred embodiments described above, comprise CDRs corresponding to the Kabat CDRs at CDR1 (residue 24-34), CDR2 (residues 50-56) and CDR3 (residues 89-97).

- 14 -

The invention further provides in a fourth preferred embodiment a CDR-grafted antibody molecule comprising at least one CDR-grafted heavy chain and at least one CDR-grafted light chain according to the first and second or first and third preferred embodiments of the invention.

In a first particularly preferred embodiment, however, the invention provides a CDR-grafted humanised antibody heavy chain having a variable region domain comprising human acceptor framework (especially EU human acceptor framework) and hTNF1 donor antigen binding regions wherein the framework comprises hTNF1 donor residues at positions 12, 27, 30, 38, 46, 48, 66, 67, 69, 71, 73, 76, 83, 89, 91 and 94.

The EU heavy chain framework has residues in framework 4 (FR4) of the heavy chain which are anomalous for human heavy chain frameworks. Thus preferably human consensus residues are used in place of EU residues in FR4 of the heavy chain. In particular, the human consensus residue threonine (T) may be used at position 108. Fortuitously the murine hTNF1 residue at position 108 is also threonine.

In a second particularly preferred embodiment the invention provides a CDR-grafted humanised antibody light chain having a variable domain comprising human acceptor framework (especially EU human acceptor framework) and hTNF1 donor antigen binding regions wherein the framework comprises hTNF1 donor residues at positions 3, 42 and 49.

When the EU human framework is used for the light chain it is also desirable to change residues from EU residues at positions 48, 83, 106 and 108, as the EU residues at these positions are anomalous for human antibodies. Thus the human consensus residues may be used at some or preferably all of these residues, i.e. isoleucine (I) at position 48,

- 15 -

valine (V) at position 83, isoleucine (I) at position 106 and arginine (R) at position 108. Fortuitously the murine hTNF1 residues are the same as the human consensus residues at positions 48 (I), 106 (I) and 108 (R). However, the human consensus residue valine (V) at position 83 differs from both the EU residue (F) and the hTNF1 residue (L) at this position.

Especially the invention includes CDR-grafted humanised antibody molecules comprising at least one CDR-grafted humanised heavy chain according to the first particularly preferred embodiment and at least one CDR-grafted humanised light chain according to the second particularly preferred embodiment.

Also in a third particularly preferred embodiment the invention provides a CDR-grafted humanised antibody heavy chain having a variable region domain comprising human acceptor framework (especially KOL human acceptor framework) and 101.4 donor antigen binding regions wherein the framework comprises 101.4 donor residues at positions 4, 11, 23, 24, 28, 73, 77, 78, 79, 91, 93 and 94.

The KOL residue proline (P) at position 108 of the heavy chain is anomalous for human antibodies. Thus preferably the human consensus residue leucine (L) is at this position if KOL is used as the human acceptor framework. Fortuitously the murine 101.4 antibody has the human consensus residue (L) at this position.

Moreover in a fourth particularly preferred embodiment the invention provides a CDR-grafted humanised antibody light chain having a variable region domain comprising human acceptor framework (especially REI human acceptor framework) and 101.4 donor residues at positions 1, 3, 4 and 73.

- 16 -

The REI light chain human framework has residues which are anomalous for human antibodies at positions 39 (threonine, T), 104 (leucine, L), 105 (glutamine, Q), and 107 (threonine, T). Thus when REI is used as the light chain framework, human consensus residues are used at positions 39 (lysine, K), 104 (valine, V), 105 (glutamic acid, E) and 107 (lysine, K). Fortunately the murine 101.4 residues are the same as the human consensus residues at positions 39 (K), 105 (E) and 107 (K). However, the human consensus residue at position 104 (V) differs from the leucine (L) REI and murine 101.4 residues at this position.

Especially also the invention includes CDR grafted humanised antibody molecules comprising at least one CDR-grafted humanised heavy chain according to the third particularly preferred embodiment and at least one CDR-grafted humanised light chain according to the fourth particularly preferred embodiment.

Preferably the Kabat CDRs are used for all of the CDRs (CDR1, CDR2 and CDR3) of both the heavy and light chains of the first, second, third and fourth particularly preferred embodiments described above.

The recombinant and humanised antibody molecules and chains of the present invention may comprise: a complete antibody molecule, having full length heavy and light chains; a fragment thereof, such as a Fab, Fab', F(ab')₂ or Fv fragment; a light chain or heavy chain monomer or dimer; or a single chain antibody, e.g. a single chain Fv in which heavy and light chain variable regions are joined by a peptide linker; or any other recombinant, chimeric or CDR-grafted molecule with the same specificity as the original donor antibodies. Similarly the heavy and light chain variable region may be combined with other antibody domains as appropriate.

- 17 -

Also the heavy or light chains or recombinant or humanised complete antibody molecules of the present invention may have attached to them an effector or reporter molecule. For instance, it may have a macrocycle, for chelating a heavy metal atom, or a toxin, such as ricin, attached to it by a covalent bridging structure. Alternatively, the procedures of recombinant DNA technology may be used to produce an immunoglobulin molecule in which the Fc fragment or CH3 domain of a complete immunoglobulin molecule has been replaced by, or has attached thereto by peptide linkage, a functional non-immunoglobulin protein, such as an enzyme or toxin molecule.

The amino acid sequences of the heavy and light chain variable domains of the CB0010, 101.4, CB0006 and hTNF3 murine MAbs, CDR-grafted variants thereof and human acceptor antibodies are given in the accompanying diagrams Figures 1, 2, 3 and 4 respectively. The recombinant and humanised antibody products of the invention may be prepared using recombinant DNA techniques, for instance substantially as described in WO91/09967.

Any appropriate human acceptor variable region framework sequences may be used having regard to class/type of the donor antibody from which the antigen binding regions are derived. Preferably, the type of human acceptor framework used is of the same/similar class/type as the donor antibody. Conveniently, the framework may be chosen to maximise/ optimise homology with the donor antibody sequence particularly at positions close or adjacent to the CDRs. However, a high level of homology between donor and acceptor sequences is not critical for application of the present invention. The present invention identifies a hierarchy of framework residue positions at which donor residues may be important or desirable for obtaining a CDR-grafted antibody product

- 18 -

having satisfactory binding properties. The CDR-grafted products usually have binding affinities of at least 10^5 M^{-1} , preferably at least about 10^8 M^{-1} , or especially in the range 10^8 - 10^{12} M^{-1} . In principle, the present invention is applicable to any combination of anti-hTNF α donor and human acceptor antibodies irrespective of the level of homology between their sequences. Examples of human frameworks which may be used are KOL, NEWM, REI, EU, TUR, TEI, LAY and POM (refs. 7 and 8) and the like; for instance KOL and NEWM for the heavy chain and REI for the light chain and EU, LAY and POM for both the heavy chain and the light chain.

Also the constant region domains of the products of the invention may be selected having regard to the proposed function of the antibody in particular the effector functions which may be required. For example, the constant region domains may be human IgA, IgE, IgG or IgM domains. In particular, IgG human constant region domains may be used, especially of the IgG1 and IgG3 isotypes, when the humanised antibody molecule is intended for therapeutic uses, and antibody effector functions are required. Alternatively, IgG2 and IgG4 isotypes may be used when the humanised antibody molecule is intended for therapeutic purposes and antibody effector functions are not required, e.g. for simple blocking of TNF activity.

However, the remainder of the antibody molecules need not comprise only protein sequences from immunoglobulins. For instance, a gene may be constructed in which a DNA sequence encoding part of a human immunoglobulin chain is fused to a DNA sequence encoding the amino acid sequence of a functional polypeptide such as an effector or reporter molecule.

- 19 -

In further aspects the invention also includes DNA sequences coding for the recombinant and humanised antibody, e.g. CDR-grafted, heavy and light chains, cloning and expression vectors containing the DNA sequences, host cells transformed with the DNA sequences and processes for producing the recombinant and humanised, e.g. CDR-grafted, chains and antibody molecules comprising expressing the DNA sequences in the transformed host cells.

The general methods by which the vectors may be constructed, transfection methods and culture methods are well known per se. Such methods are shown, for instance, in references 12 and 13.

The DNA sequences which encode the anti-hTNF α antibody molecule amino acid sequences may be obtained by methods well known in the art. For example the anti-TNF coding sequences may be obtained by genomic cloning, or cDNA cloning from suitable anti-hTNF α producing hybridoma cell lines. Positive clones may be screened using appropriate probes for the heavy and light chain genes in question. Also PCR cloning may be used. DNA sequence coding for part or all of the antibody heavy and light chains may be synthesised as desired from the determined DNA sequence or on the basis of the corresponding amino acid sequence.

DNA coding for acceptor, e.g. human acceptor, sequences may be obtained in any appropriate way. For example DNA sequences coding for preferred human acceptor frameworks such as KOL, REI, EU and NEWM, are widely available to workers in the art, or may be readily synthesised on the basis of their known amino acid sequences (see refs. 7 & 8).

- 20 -

The standard techniques of molecular biology may be used to prepare DNA sequences coding for the chimeric and CDR-grafted humanised antibody products. Desired DNA sequences may be synthesised completely or in part using oligonucleotide synthesis techniques. Site-directed mutagenesis and polymerase chain reaction (PCR) techniques may be used as appropriate. For example oligonucleotide directed synthesis as described by Jones et al (ref. 14) may be used. Also oligonucleotide directed mutagenesis of a pre-existing variable region as, for example, described by Verhoeyen et al (ref. 5) or Riechmann et al (ref. 6) may be used. Also enzymatic filling in of gapped oligonucleotides using T₄ DNA polymerase as, for example, described by Queen et al (ref. 9) may be used.

Any suitable host cell/vector system may be used for expression of the DNA sequences coding for the recombinant, chimeric and CDR-grafted humanised antibody heavy and light chains. Bacterial e.g. E. coli, and other microbial systems may be used, in particular for expression of antibody fragments such as Fab and F(ab')₂ fragments, and especially Fv fragments and single chain antibody fragments e.g. single chain Fvs. Eucaryotic e.g. mammalian host cell expression systems may be used for production of larger CDR-grafted antibody products, including complete antibody molecules, and/or if glycosylated products are required. Suitable mammalian host cells include CHO cells and myeloma or hybridoma cell lines.

Thus, in a further aspect the present invention provides a process for producing a recombinant or humanised anti-hTNF α antibody product comprising:

- 21 -

- (a) producing in an expression vector an operon having a DNA sequence which encodes an anti-hTNF α antibody heavy chain;
- and/or
- (b) producing in an expression vector an operon having a DNA sequence which encodes a complementary anti-hTNF α antibody light chain;
 - (c) transfecting a host cell with the or each vector; and
 - (d) culturing the transfected cell line to produce the recombinant anti-hTNF α antibody product.

The recombinant or humanised anti-hTNF α product may comprise only heavy or light chain derived polypeptide, in which case only a heavy chain or light chain polypeptide coding sequence is used to transfect the host cells. For production of products comprising both heavy and light chains, the cell line may be transfected with two vectors, a first vector containing an operon encoding a light chain-derived polypeptide and a second vector containing an operon encoding a heavy chain-derived polypeptide. Preferably, the vectors are identical, except in so far as the coding sequences and selectable markers are concerned, so as to ensure as far as possible that each polypeptide chain is equally expressed. Alternatively, a single vector may be used, the vector including the sequences encoding both light chain- and heavy chain-derived polypeptides.

The DNA in the coding sequences for the light and heavy chains may comprise cDNA or genomic DNA or both.

The invention also includes therapeutic and diagnostic compositions comprising the recombinant and humanised antibody products of the invention and the uses of these products and the compositions in therapy and diagnosis.

- 22 -

Thus in a further aspect the invention provides a therapeutic or diagnostic composition comprising a recombinant or humanised antibody according to the invention in combination with a pharmaceutically acceptable excipient, diluent or carrier.

The invention also provides a process for the preparation of a therapeutic or diagnostic composition comprising admixing a recombinant or humanised antibody according to the invention together with a pharmaceutically acceptable excipient, diluent or carrier.

The recombinant or humanised antibody may be the sole active ingredient in the therapeutic or diagnostic composition or may be accompanied by one or more other active ingredients including other antibody ingredients, e.g. anti-T cell, anti-IFN γ or anti-LPS antibodies, or non-antibody ingredients such as xanthines. The therapeutic and diagnostic compositions may be in unit dosage form, in which case each unit dose comprises an effective amount of the recombinant or humanised antibody of the invention.

Furthermore, the invention also provides methods of therapy and diagnosis comprising administering an effective amount of a recombinant or humanised antibody according to the invention to a human or animal subject.

The antibodies and compositions may be utilised in any therapy where it is desired to reduce the level of TNF present in the human or animal body. The TNF may be in circulation in the body or present in an undesirably high level localised at a particular site in the body.

- 23 -

For example, elevated levels of TNF are implicated in immunoregulatory and inflammatory disorders and in septic, or endotoxic, and cardiovascular shock. The antibody or composition may be utilised in therapy of conditions which include sepsis, septic or endotoxic shock, cachexia, adult respiratory distress syndrome, AIDS, allergies, psoriasis, T.B., inflammatory bone disorders, blood coagulation disorders, burns, rejection episodes following organ or tissue transplant and autoimmune disease e.g. organ specific disease such as thyroiditis or non-specific organ diseases such as rheumatoid and osteo-arthritis.

Additionally, the antibody or composition may be used to ameliorate side effects associated with TNF generation during neoplastic therapy and also to eliminate or ameliorate shock related symptoms associated with the treatment or prevention of graft rejection by use of an antilymphocyte antibody, or may be used for treating multi-organ failure (MOF).

The recombinant and humanised antibodies and compositions of the invention are preferably for treatment of sepsis or septic/endotoxic shock.

The antibodies and compositions may be for administration in any appropriate form and amount according to the therapy in which they are employed. This may be for prophylactic use, for example where circumstances are such that an elevation in the level of TNF might be expected or alternatively, they may be for use in reducing the level of TNF after it has reached an undesirably high level or as the level is rising.

The therapeutic or diagnostic composition may take any suitable form for administration, and, preferably is in a form suitable for parenteral administration e.g. by

- 24 -

injection or infusion, for example by bolus injection or continuous infusion. Where the product is for injection or infusion, it may take the form of a suspension, solution or emulsion in an oily or aqueous vehicle and it may contain formulatory agents such as suspending, preservative, stabilising and/or dispersing agents.

Alternatively, the antibody or composition may be in dry form, for reconstitution before use with an appropriate sterile liquid.

If the antibody or composition is suitable for oral administration, e.g. in the case of antibody fragments, the formulation may contain, in addition to the active ingredient, additives such as: starch - e.g. potato, maize or wheat starch or cellulose - or starch derivatives such as microcrystalline cellulose; silica; various sugars such as lactose; magnesium carbonate and/or calcium phosphate. It is desirable that, if the formulation is for oral administration it will be well tolerated by the patient's digestive system. To this end, it may be desirable to include in the formulation mucus formers and resins. It may also be desirable to improve tolerance by formulating the antibody or compositions in a capsule which is insoluble in the gastric juices. It may also be preferable to include the antibody or composition in a controlled release formulation.

In a still further aspect of the invention, there is provided a method of treatment of a human or animal subject suffering from or at risk of a disorder associated with an undesirably high level of TNF, the method comprising administering to the subject an effective amount of the antibody or composition of the invention. In particular, the human or animal subject may be suffering from, or at risk from, sepsis, or septic or endotoxic shock.

The dose at which the antibody is administered depends on the nature of the condition to be treated, the degree to which the TNF to be neutralised is, or is expected to be, raised above a desirable level, and on whether the antibody is being used prophylactically or to treat an existing condition. The dose will also be selected according to the age and conditions of the patient.

Thus, for example, where the product is for treatment or prophylaxis of septic shock suitable doses of antibody to TNF lie in the range 0.001-30mg/kg/day, preferably 0.01-10mg/kg/day and particularly preferably 0.1-2mg/kg/day.

The antibody products may be used in diagnosis e.g. in in vivo diagnosis and imaging of disease states involving elevated TNF levels.

The invention is further described by way of illustration only in the following Examples which refers to the accompanying diagrams, Figures 1 - 6.

Brief Description of the Figures

Figure 1 shows amino acid sequences for the variable domains of the heavy and light chains for the human acceptor antibody EU (1EU), the murine MAb CB0010 (h t n f 1) and humanised CDR grafted light (gEU) and heavy (2hEUg) chains;

Figure 2 shows amino acid sequences for the variable region domains of the human acceptor antibodies REI (1 r e i) for the light chain and KOL (KOL) for the heavy chain, of the heavy and light chains of the murine MAb 101.4 (101/4) and humanised grafted light and heavy chains (both designated g1014);

- 26 -

Figure 3 shows amino acid sequences for the variable region domains of the human acceptor antibodies REI (REI) for the light chain and KOL (KOL) for the heavy chain, of the heavy and light chains of the murine MAb CB0006 (CB6) and humanised grafted light and heavy chains (both designated gCB6);

Figure 4 shows amino acid sequences for the variable region domains of the human acceptor antibodies REI (REI) for the light chain and KOL (KOL) for the heavy chain, of the heavy (HTNF3) and light (hTNF3) chains of the murine MAb HTNF3 and humanised grafted light (gHTNF3) and heavy (ghTNF3) chains;

Figure 5 shows a graph comparing the ability of murine CB0010 (hTNF1) and CDR-grafted CB0010 (GrhTNF1; CDP571) to compete with HRP-conjugated murine HTNF1 for binding to recombinant human TNF α , and

Figure 6 shows a graph comparing the ability of murine HTNF1 (CB0010) and CDR-grafted HTNF1 (CP571) to neutralise recombinant TNF α in the L929 bioassay.

Detailed Description of Embodiments of the InventionExample 1CDR-Grafting of murine anti-TNF α antibodies

A number of murine anti-human TNF α MAb were CDR-grafted substantially as described in detail in WO91/09967 for the CDR-grafting of the murine anti-CD3 antibody OKT3. In this and subsequent Examples, the chimeric and CDR-grafted humanised antibodies were prepared using human IgG4 constant region domains, substantially as described for preparation of γ 4 chimeric and CDR-grafted OKT3 antibodies in WO91/09967. It will be appreciated, however, that human constant region domains of other types and isotypes, e.g. IgG1, IgG2 and IgG3, could also have been used without significantly altering the procedures described.

These anti-hTNF α antibodies included the murine MAb designated CB0006 (also known as 61E71), CB0010 (also known as hTNF1), hTNF3 and 101.4. A brief summary of the CDR-grafting of each of these antibodies is given below.

CB0006

A similar analysis as described in Example 1, Section 12.1. of WO91/09967 was carried out for CB0006 and for the heavy chain 10 framework residues were identified at positions 23, 24, 48, 49, 68, 69, 71, 73, 75 and 88 as residues to potentially retain as murine. The human frameworks chosen for CDR-grafting of this antibody, and the hTNF3 and 101.4 antibodies were RE1 for the light chain and KOL for the heavy chain. The amino acid sequences of the murine CB0006 (CB6) (heavy and Light) RE1 (REI) light and KOL (KOL) heavy chain variable domains are given in Figure 3.

Three genes were built, the first of which coded for amino acid residues 23, 24, 48, 49, 71 and 73 [gH341(6)] as murine residues. The amino acid sequence of the variable

- 28 -

domain coded by this first gene is shown as gCB6 in the heavy chain summary in Figure 3. The second gene also had amino acid residues 75 and 88 as murine residues [gH341(8)] while the third gene additionally had amino acid residues 68, 69, 75 and 88 as murine residues [gH341(10)]. Each was co-expressed with gL221, the minimum grafted light chain (CDRs only) shown as gCB6 in the heavy chain summary in Figure 3. The gL221/gH341(6) and gL221/gH341(8) antibodies both bound as well to TNF as murine 61E71. The gL221/gH341(10) antibody did not express and this combination was not taken further.

Subsequently the gL221/gH341(6) antibody was assessed in an L929 cell competition assay in which the antibody competes against the TNF receptor on L929 cells for binding to TNF in solution. In this assay the gL221/gH341(6) antibody was approximately 10% as active as murine CB0006.

CB0010 (also known as hTNF1)

CB0010 is a monoclonal antibody which recognises an epitope of human TNF- α . The EU human framework was used for CDR-grafting of both the heavy and light variable domains. The amino acid sequences of the heavy and light variable domains of EU (EU), CB0010 (h t n f 1) and grafted versions of CB0010 (gEU, light; 2hEUg, heavy) are shown in Figure 1.

Heavy Chain

In the CDR-grafted heavy chain mouse CDRs were used at positions 26-35 (CDR1), 50-65 (CDR2) and 95-102 (CDR3). Mouse residues were also used in the frameworks at positions 48, 67, 69, 71, 73, 76, 89, 91, 94 and 108. Comparison of the TNF1 mouse and EU human heavy chain residues reveals that these are identical at positions 23, 24, 29 and 78.

- 29 -

Light Chain

In the CDR-grafted light chain mouse CDRs were used at positions 24-34 (CDR1), 50-56 (CDR2) and 89-97 (CDR3). In addition mouse residues were used in the frameworks at positions 3, 42, 48, 49, 83, 106 and 108. Comparison of the hTNF1 mouse and EU human light chain residues reveals that these are identical at positions 46, 58 and 71.

The grafted CB0010 heavy chain was co-expressed with the chimeric light chain and the binding ability of the product compared with that of the chimeric light chain/chimeric heavy chain product in a TNF binding assay. The grafted heavy chain product appeared to have binding ability for TNF slightly better than the fully chimeric product.

Similarly, a grafted heavy chain/grafted light chain product was co-expressed and compared with the fully chimeric product and found to have closely similar binding properties to the latter product. However when the grafted heavy chain/grafted light chain product was assayed in the L929 assay (see Example 4), it was found to have an activity only half that of the chimeric product. Thus further CDR-grafting experiments were carried out as described in Example 2.

hTNF3

hTNF3 recognises an epitope on human TNF- α . The sequence of hTNF3 shows only 21 differences compared to CB0006 in the light and heavy chain variable regions, 10 in the light chain (2 in the CDRs at positions 50, 96 and 8 in the framework at 1, 19, 40, 45, 46, 76, 103 and 106) and 11 in the heavy chain (3 in the CDR regions at positions 52, 60 and 95 and 8 in the framework at 1, 10, 38, 40, 67, 73, 87 and 105). The light and heavy chain variable domain amino acid sequences of hTNF3 (Htnf3, light;

- 30 -

hTNF3, heavy), CDR-grafted hTNF3 (gHTNF3, light; ghTNF3, heavy) and REI (REI, light) and KOL (KOL, heavy) are shown in Figure 4. The light and heavy chains of the CB0006 and hTNF3 chimeric antibodies can be exchanged without loss of activity in the direct binding assay. However CB0006 is an order of magnitude less able to compete with the TNF receptor on L929 cells for TNF- α compared to hTNF3. Based on the CB0006 CDR grafting data gL221 and gH341(+23, 24, 48, 49 71 and 73 as mouse) genes have been built for hTNF3 and tested and the resultant grafted antibody binds well to TNF- α , but competes very poorly in the L929 assay. The gL221 gene codes for the gHTNF3 and the gH341 etc. gene codes for the ghTNF3 variable domain sequences as shown in Figure 4. It is likely that in this case other framework residues may need to be changed to improve the competitive binding ability of this antibody.

101.4

101.4 is a further murine MAb able to recognise human TNF- α . The heavy chain of this antibody shows good homology to KOL and so the CDR-grafting has been based on REI for the light chain and KOL for the heavy chain. The heavy and light variable domain amino acid sequences of 101.4 (101/4) and a CDR-grafted version of 101.4 (g1014) and the REI light chain (*l r e i*) and KOL heavy chain (KOL) variable domains are given in Figure 2. Several grafted heavy chain genes have been constructed with conservative choices for the CDR's (gH341) and which have one or a small number of non-CDR residues at positions 73, 78 or 77-79 inclusive, as the mouse amino acids. These have been co-expressed with the chimeric light chain or the Kabat CDR-grafted light chain. In all cases binding to TNF equivalent to the chimeric antibody is seen and when co-expressed with cL the resultant antibodies are able to compete well in the L929 assay. However, with

- 31 -

gL221 the resultant antibodies are at least an order of magnitude less able to compete for TNF against the TNF receptor on L929 cells.

Mouse residues at other positions in the heavy chain, for example, at 23 and 24 together or at 76 have been demonstrated to provide no improvement to the competitive ability of the grafted antibody in the L929 assay.

- 32 -

Example 2Further CDR-Grafting of Murine anti-human TNF α Antibodies CB0010 and 101.4

Murine anti-human TNF α monoclonal antibodies CB0010 and 101.4 were further CDR-grafted substantially as described in WO91/09667.

CB0010

CB0010 is a monoclonal antibody which recognises an epitope on human TNF- α . The EU human framework was used for CDR-grafting of both the heavy and light variable domains.

The amino acid sequences of the heavy and light chain variable domains of the EU acceptor, CB0010 (h t n f 1) murine donor and CDR-grafted (gEU, light chain and 2hEUg, heavy chain) antibodies are given in Figure 1.

Heavy chain

In the CDR-grafted heavy chain (2hEUg), mouse CDRs were used at positions 31-35 (CDR1), 50-65 (CDR2) and 95-102 (CDR3).

Mouse residues were also used in the frameworks at positions 12, 27, 30, 38, 46, 48, 66, 67, 69, 71, 73, 76, 83, 89, 91, 94 and 108. Comparison of the CB0010 mouse and EU human heavy chain residues reveals that these are identical as positions 23, 24, 29 and 78.

Light chain

In the CDR-grafted light chain (gEU) mouse CDRs were used at positions 24-34 (CDR1), 50-65 (CDR2) and 89-97 (CDR3). In addition mouse residues were used in the frameworks at positions 3, 42, 48, 49, 106 and 108. The human consensus residue (valine) was used at position 83. Comparison of the CB0010 mouse and EU human light chain residues reveals that these are identical at positions 46, 58 and 71.

- 33 -

The grafted CB0010 heavy chain was co-expressed with the chimeric light chain and the binding ability of the product compared with that of the chimeric light chain/chimeric heavy chain product in a TNF binding assay. The grafted heavy chain product appeared to have binding ability for TNF slightly better than the fully chimeric product.

Similarly, a grafted heavy chain/grafted light chain product was co-expressed and compared with the fully chimeric product and found to have closely similar binding properties to the latter product. The specific combination of grafted light chain (gEU) and grafted heavy chain (2hEUg), as shown in Figure 1, provides the antibody known as CDP571. The murine CB0010 (CB0010), chimeric CB0010 (chimeric CB0010) and the grafted heavy chain/grafted light chain product (CDP571) were compared for binding to human TNF α in a standard assay. The results obtained are given in the table below in terms of the K_D (pM) measured for each antibody.

Antibody	K_D (pM)
CB0010	80
Chimeric CB0010	81
CDP571	87

The fully grafted antibody product (CDP571) is currently in pre-clinical development for treatment of sepsis syndrome and acute transplant rejection.

101.4

101.4 is a further murine MAb able to recognise human TNF- α . The heavy chain of this antibody shows good homology to KOL and so the CDR-grafting has been based on REI for the light chain and KOL for the heavy chain. An improved CDR-grafted product has been prepared. Variable

- 34 -

domain amino acid sequences for REI (rei, light chain), KOL (KOL, heavy chain) murine 101.4 (101/4, heavy and light chain) and fully grafted antibody (g1014, heavy and light chain) are shown in Figure 2.

Heavy chain

In the CDR-grafted heavy chain (g1014) mouse CDRs were used at position 31-35 (CDR1), 50-65 (CDR2) and 95-102 (CDR3). Mouse residues were also used in the framework at positions 4, 11, 23, 24, 28, 73, 77, 78, 79, 91, 93, 94 and 108.

Light chain

In the CDR-grafted light chain (g1014) mouse CDRs were used at positions 24-34 (CDR1), 50-56 (CDR2) and 89-97 (CDR3). In addition mouse residues were used in the framework at positions 1, 3, 4, 39, 73, 105 and 107. The human consensus residue (valine) was used at position 104.

The fully grafted heavy and light chain (g1014) were co-expressed and their binding to TNF compared with murine and chimeric 101.4 and also the fully grafted (gEU/2hEUg, CDP571) CB0010 antibody. The fully grafted 101.4 antibody was found to having binding properties for human TNF α similar to the murine, chimeric, and grafted CB0010 antibodies.

Example 3In vitro comparison of Murine and CDR-grafted AntibodiesA. Affinity Measurements for Murine CB0010 and CDP571Materials and MethodsMaterials:

PBS/BSA: Dulbeccos PBS + 1% (w/v) bovine serum albumin.

TNF: 50nM rec. human TNF-alpha (Bissendorf Biochemicals), 0.85µg/ml in PBS/BSA.

Stock ^{125}I -TNF: 5µCi, 185kBq (Amersham International) dissolved in 500µl water and stored at -70°C.

Working Solution ^{125}I -TNF: -62pM for titration curve and 124pM for Scatchard analysis, in PBS/BSA.

Antibodies: Purified murine CB0010 (mHTNF1) and CDP571 were quantified by A280nm ($E_{1\text{mg/ml}}, 280\text{nm}^{-1.4}$), and diluted to a concentration of 1µg/ml for titration, or 200ng/ml for Scatchard analysis.

Immunobeads: Goat anti-murine IgG whole molecule-agarose or goat anti-human IgG whole molecule-agarose (Sigma) were used undiluted.

Method:

Antibody titration: mHTNF1 and CDP571 were titrated in doubling dilutions (100µl each) to give a total of 16 samples and ^{125}I -TNF (100µl, 62pM) was added. The final top concentration of antibody was 500ng/ml and ^{125}I -TNF was 31pM. Control tubes (8) contained ^{125}I -TNF and PBS/BSA only. The samples were left to equilibrate overnight at room temperature, with shaking. After equilibration, 25µl goat anti-mouse-agarose was added to the mHTNF1 samples, and 50µl goat anti-human beads were added to the CDP571 samples except for the total ^{125}I -TNF controls. Non-specific absorption of ^{125}I -TNF to the agarose beads was corrected for by adding beads to

- 36 -

4 of the controls and comparing supernatant counts for these samples with those containing PBS/BSA instead of beads. After 1 hour equilibration at room temperature PBS/BSA (0.5ml) was added and the samples were centrifuged at 1500rpm for 10 mins at 20°C. The supernatant (0.5ml) was removed and radioactivity was counted in a gamma counter.

Confirmation that ^{125}I -TNF behaved similarly to the unlabelled material in this assay was made by performing the antibody titration in the presence of mixtures of ^{125}I -TNF and unlabelled TNF (at 25% and 75% ^{125}I -TNF) at the same total concentration.

Scatchard analysis: For both antibodies, unlabelled TNF (100 μl , 50nM) was titrated in duplicate, in 13 doubling dilutions. One sample containing PBS/BSA in place of TNF was included for each antibody. ^{125}I -TNF (50 μl , 124pM) was added to each sample. A constant amount of antibody, determined from the titration curve (50 μl , 200ng/ml) was then added.

This gave the following final concentrations: antibody, 50ng/ml; TNF, 25nM top concentration; ^{125}I -TNF, 31pM. The samples were left to equilibrate overnight and then treated exactly as for the antibody titration samples.

Calculations

Titration Curves

Bound ^{125}I -TNF cpm = NSB cpm - supernatant cpm

Bound ^{125}I -TNF cpm
 _____ = B/T

Total ^{125}I -TNF

NSB = non-specific absorption blank, supernatant cpm

Total = total counts for ^{125}I -TNF only

- 37 -

B/T was plotted against antibody concentration and the appropriate antibody concentration for use in Scatchard analyses was chosen at B/T = 0.6

Scatchard analysis

The mean of duplicate determination was used throughout

NSB = Total cpm - NSB supernatant cpm

Free cpm = sample cpm + NSB

$$\text{Proportion of free TNF} = \frac{\text{Free/Total (F/T)}}{\text{sample cpm} + \text{NSB cpm}} = \frac{1 - F/T}{\text{Total cpm}} = B/F = \frac{F/T}{\text{Total cpm}}$$

B/F was plotted against Bound TNF to give a slope of $-1/K_d$ from which K_d was calculated

RESULTS

Dissociation constants for murine CB0010 and CDP571

<u>Antibody</u>	<u>K_d.M</u>
Murine HTNF1	1.3×10^{-10}
CDP571	1.4×10^{-10}

- 38 -

B. Competition of murine CB0010 (Muhtnfl) and CDP571 (GrhTNF1) with HRP-conjugated in Murine CB0010 for binding to rhuTNF

Method

A 96 well microtitre plate (Nunc, Maxisorb) was coated with 100 μ l/well TNF at 0.5 μ g/ml.

Serial dilutions of murine or grafted antibody were prepared using PBS/1% BSA diluent, from 200 μ g/ml to 0.01 μ g/ml. 50 μ l of antibody was added to each well followed by 50 μ l HRP-murine CB0010 at 3 concentrations (0.625, 0.315 and 0.16 μ g/ml). Plates were incubated for 2 hours at room temperature with agitation, washed 4 times with PBS and 100 μ l of TMB substrate added.

Optical Density was measured and OD plotted against antibody concentration.

Conclusions

Curves for both murine antibody (MuhtNF1) and grafted antibody (GrhTNF1) are superimposable, indicating both antibodies compete with similar affinity for binding to TNF (see Figure 5).

Example 4Comparison of Murine CB0010 and CDR-grafted CDP571 Antibodies in Bioassay and Animal Model ExperimentsA. Neutralisation of TNF by CB0010 and CDP571 in the L929 Assay

The ability of the parent murine antibody CB0010 (hTNF1) and the CDR-grafted antibody CDP571 to neutralise recombinant human TNF was determined using the L929 bioassay. The assay uses the L929 mouse fibroblastoid cell line which is killed by TNF. The assay is performed in the presence of 1 ug/ml actinomycin D which renders the cells more sensitive to TNF. Serial dilution of the two antibodies were mixed with a constant amount of recombinant human TNF (100 pg/ml) and added to a L929 monolayer in 96 well flat bottomed plates. After a 16 hour incubation the cells which had not been killed by TNF were revealed using the stain crystal violet. The apparent amount of TNF not neutralised (residual TNF) was determined by comparison with a recombinant TNF standard curve. Results from a representative experiment where residual TNF is plotted against antibody concentration are shown in Figure 6. It can be seen that CB0010 and CDP571 have similar neutralisation activities.

B. Effect of CDP571 in Baboon Sepsis Model

In this study the effect of the prior treatment with CDP571 on the physiological consequences of severe sepsis (including death) was assessed. Baboons were chosen as a relevant species to study since CDP571 is known to neutralise baboon TNF.

Male adult baboons, Papio ursinus, weighting 20-25 kg were anaesthetised with ketamine hydrochloride and sodium pentobarbitone and instrumented for the measurement of blood pressure, cardiac index (by thermodilution), ECG and right atrial filling pressures. An infusion of either

- 40 -

saline only or antibody was then given for 120 min at a rate of 2.5 ml/kg/h following which they were given a further 120 min infusion of live E.coli at the same infusion rate. The bacterial strain used was Hinshaw's strain B7 ([086a:61], ATCC 33985) administered whilst in the log growth phase at a dose of 2×10^9 CFU/kg giving a plasma concentration of $2-2.5 \times 10^5$ CFU/ml at the end of the infusion. Following a further 120 min, animals were returned to their home cages, given free access to food and water and monitored for cardiovascular changes twice a day for 3 days. All animals were given constant fluid replacement infusion of 5 ml/kg/h which was adjusted, where necessary, to maintain adequate right heart filling pressures. Baboons that had died during treatment or that had survived the 72h experimental period, and then killed were post-mortemed. All major organs were assessed for gross macro-pathological damage according to semi-quantitative scale (+++ being the most severe).

Animals were randomly assigned to one of 4 treatment groups;

- saline only
- CDP571 0.1 mg/kg
- CDP571 1.0 mg/kg
- CB0010 0.1 mg/kg (parent murine antibody)

The survival and cumulative organ damage scores are shown in table 1. CDP571 at 1.0 mg/kg prevented death and significantly ($P < 0.005$) reduced the incidence of organ damage in this model; furthermore, these effects were dose-related ($P < 0.005$). In addition, the survival rate and organ damage score seen with CB0010 were similar to those seen with CDP571 at the same dose, indicating a maintained in vivo potency of CDP571 compared to its parent murine antibody.

BABOON SEPSIS STUDY

SURVIVAL FOLLOWING ADMINISTRATION OF 2×10^9 CFU E.Coli
GIVEN IV 2H AFTER SALINE OR CDP 571

<u>TREATMENT</u>	<u>No</u>	<u>DEAD</u>	<u>SURVIVED</u>	<u>PERCENT SURVIVAL</u>	<u>ORGAN PATHOL.</u>
SALINE	8	7	1	13	+++
CDP571 0.1 mg/kg	6	2	4	67	++
CDP571 1.0 mg/kg	6	0	6	100	+/-
CB0010 0.1 mg/kg	4	1	3	75	++

Table 1

WO 92/11383

- 41 -

PCT/GB91/02300

References

1. Kohler & Milstein, *Nature*, 265, 295-497, 1975.
2. Chatenoud et al, (1986), *J. Immunol.* 137, 830-838.
3. Jeffers et al, (1986), *Transplantation*, 41, 572-578.
4. Begent et al, *Br. J. Cancer* 62: 487 (1990).
5. Verhoeyen et al, *Science*, 239, 1534-1536, 1988.
6. Riechmann et al, *Nature*, 332, 323-324, 1988.
7. Kabat, E.A., Wu, T.T., Reid-Miller, M., Perry, H.M., Gottesman, K.S., 1987, in *Sequences of Proteins of Immunological Interest*, US Department of Health and Human Services, NIH, USA.
8. Wu, T.T., and Kabat, E.A., 1970, *J. Exp. Med.* 132 211-250.
9. Queen et al, (1989), *Proc. Natl. Acad. Sci. USA*, 86, 10029-10033 and WO 90/07861
10. Tempest et al, (1991), *Biotechnology*, 9, 266-271
11. Beutler et al, (1985), *Science*, 234, 470-474
12. Maniatis et al, *Molecular Cloning*, Cold Spring Harbor, New York, 1989.
13. Primrose and Old, *Principles of Gene Manipulation*, Blackwell, Oxford, 1980.
14. Jones et al, (1986), *Nature*, 321, 522.

CLAIMS

1. A recombinant antibody molecule which has specificity for human TNF α .
2. A recombinant antibody molecule according to Claim 1 having an antigen binding site derived from the murine monoclonal antibody CB0006 (alternatively known as 61E71), CB0010 (alternatively known as hTNF1), hTNF3 or 101.4.
3. A recombinant antibody molecule according to Claim 1 or 2 which is a humanised antibody molecule.
4. A humanised chimeric antibody molecule according to Claim 3.
5. A CDR-grafted humanised antibody according to Claim 3.
6. A CDR-grafted humanised antibody heavy chain according to Claim 5 having a variable region domain comprising human acceptor framework and donor antigen binding regions wherein the framework comprises donor residues at at least one of positions 6, 23 and/or 24, 48 and/or 49, 71 and/or 73, 75 and/or 76 and/or 78 and 88 and/or 91.
7. A CDR-grafted humanised heavy chain according to Claim 6 comprising donor residues at positions 23, 24, 49, 71, 73 and 78, or at positions 23, 24 and 49.
8. A CDR-grafted humanised heavy chain according to Claim 6 comprising donor residues at positions 2, 4, 6, 25, 36, 37, 39, 47, 48, 93, 94, 103, 104, 106 and 107.

- 44 -

9. A CDR-grafted humanised heavy chain according to Claim 7 or 8, comprising donor residues at one, some or all of positions:
1 and 3,
69 (if 48 is different between donor and acceptor),
38 and 46 (if 48 is the donor residue),
67,
82 and 18 (if 67 is the donor residue),
91, and
any one or more of 9, 11, 41, 87, 108, 110 and 112.
10. A CDR-grafted humanised heavy chain according to any of Claims 5-9 comprising donor CDRs at positions 26-35, 50-65 and 95-100.
11. A CDR-grafted humanised antibody light chain according to Claim 5 having a variable region domain comprising human acceptor framework and donor antigen binding regions wherein the framework comprises donor residues at at least one of positions 1 and/or 3 and 46 and/or 47.
12. A CDR-grafted light chain according to Claim 11 comprising donor residues at positions 46 and 47.
13. A CDR-grafted humanised antibody light chain according to Claim 5 having a variable region domain comprising human acceptor framework and donor antigen binding regions wherein the framework comprises donor residues at at least one of positions 46, 48, 58 and 71.
14. A CDR-grafted light chain according to Claim 13 comprising donor residues at positions 46, 48, 58 and 71.

- 45 -

15. A CDR-grafted light chain according to Claim 11 or 13, comprising donor residues at positions 2, 4, 6, 35, 36, 38, 44, 47, 49, 62, 64-69, 85, 87, 98, 99, 101 and 102.
16. A CDR-grafted light chain according to Claim 15, comprising donor residues at one, some or all of positions:
1 and 3,
63,
60 (if 60 and 54 are able to form a potential saltbridge),
70 (if 70 and 24 are able to form a potential saltbridge),
73 and 21 (if 47 is different between donor and acceptor),
37 and 45 (if 47 is different between donor and acceptor), and
any one or more of 10, 12, 40, 83, 103 and 105.
17. A CDR-grafted light chain according to any one of Claims 11-16, comprising donor CDRs at positions 24-34, 50-56 and 89-97.
18. A CDR-grafted antibody molecule comprising at least one CDR-grafted heavy chain according to any one of Claims 6-10 and at least one CDR-grafted light chain according to any one of Claims 11-17.
19. A CDR-grafted humanised antibody heavy chain having a variable region domain comprising human acceptor framework (especially EU human acceptor framework) and hTNF1 donor antigen binding regions wherein the framework comprises hTNF1 donor residues at positions 12, 27, 30, 38, 46, 48, 66, 67, 69, 71, 73, 76, 83, 89, 91 and 94.

- 46 -

20. A CDR-grafted humanised antibody light chain having a variable domain comprising human acceptor framework (especially EU human acceptor framework) and hTNF1 donor antigen binding regions wherein the framework comprises hTNF1 donor residues at positions 3, 42 and 49.
21. A CDR-grafted humanised antibody molecule comprising at least one CDR-grafted humanised heavy chain according to Claim 19 and at least one CDR-grafted humanised light chain according to Claim 20.
22. A CDR-grafted humanised antibody heavy chain having a variable region domain comprising human acceptor framework (especially KOL human acceptor framework) and 101.4 donor antigen binding regions wherein the framework comprises 101.4 donor residues at positions 4, 11, 23, 24, 28, 73, 77, 78, 79, 91, 93 and 94.
23. A CDR-grafted humanised antibody light chain having a variable region domain comprising human acceptor framework (especially REI human acceptor framework) and 101.4 donor residues at positions 1, 3, 4 and 73.
24. A CDR-grafted humanised antibody molecule comprising at least one CDR-grafted humanised heavy chain according to Claim 22 and at least one CDR-grafted humanised light chain according to Claim 23.
25. A DNA sequence which codes for a heavy or light chain antibody molecule which has specificity for human TNF α .
26. A DNA sequence which codes for a CDR-grafted heavy chain according to any one of Claims 6-10, 19 or 22, or a CDR-grafted light chain according to any one of Claims 11-17, 20 or 23.

- 47 -

27. A cloning or expression vector containing a DNA sequence according to Claim 26.
28. A host cell transformed with a DNA sequence according to Claim 27.
29. A process for the production of a CDR-grafted antibody comprising expressing a DNA sequence according to Claim 25 or Claim 26 in a transformed host cell.
30. A process for producing a recombinant or humanised anti-hTNF α antibody product comprising:
 - (a) producing in an expression vector an operon having a DNA sequence which encodes an anti-hTNF α antibody heavy chain.and/or
 - (b) producing in an expression vector an operon having a DNA sequence which encodes a complementary anti-hTNF α antibody light chain.
 - (c) transfecting a host cell with the or each vector; and
 - (d) culturing the transfected cell line to produce the anti-hTNF α antibody product.
31. A therapeutic or diagnostic composition comprising a recombinant antibody molecule according to Claim 1 in combination with a pharmaceutically acceptable carrier, diluent or excipient.
32. A process for the preparation of a therapeutic or diagnostic composition comprising admixing a recombinant antibody molecule according to Claim 1 together with a pharmaceutically acceptable excipient, diluent or carrier.

33. A method of therapy or diagnosis comprising administering an effective amount of a recombinant antibody molecule according to Claim 1 to a human or animal subject.
34. A recombinant antibody molecule according to Claim 1 or a therapeutic composition according to Claim 31 for use in the amelioration of side effects associated with TNF generation during neoplastic therapy.
35. A recombinant antibody molecule according to Claim 1 or a therapeutic composition according to Claim 31 for use in the elimination or amelioration of shock related symptoms associated with antilymphocyte therapy.
36. A recombinant antibody according to Claim 1 or a therapeutic composition according to Claim 31 for use in the treatment of multi organ failure.
37. A recombinant antibody according to Claim 1 or a therapeutic composition according to Claim 31 for use in the treatment of sepsis or septic/endotoxic shock.
38. A method of treatment of a human or animal subject, suffering from or at risk of a disorder associated with an undesirably high level of TNF, comprising administering to the subject an effective amount of a recombinant antibody according to Claim 1.
39. A method according to Claim 33 or 38 comprising administering doses of anti-TNF antibody product in the range 0.001-30mg/kg/day, preferably 0.01-10mg/kg/day, or particularly preferably 0.1-2mg/kg/day.

1/6

CDR GRAFTING OF hTNF-1Light Chain Data

1 Eu DIQMTQSPST LSASVGDRVT ITCRASQSI.NTWLA WYQQKPGKAPK
 htnf1 DIMMSQSPSS LAVSVGEKVTMS CKSSQSLLYSNNQKNYLA WYQQKPGQSPK
 g Eu DIMMTQSPST LSASVGDRVTIT CKSSQSLLYSNNQKNYLA WYQQKPGQAPK

Eu LLMYKASSLE SGVPSRFIS GSGTEFTLTI SSLQPD~~F~~AT YCQQYNSDS
 htnf1 LLISWASTRES GVPDRFTGS GSGTDFTLTI SSVKAED~~L~~AV YCQQYYDYP
 gEu LLISWASTRES GVPDRFTGS GSGTEFTLTI SSLQPD~~V~~AT YCQQYYDYP

3 Eu KMFGQG TKVEVRG..(KAPPA)
 htnf1 WTFGGG SKLEIK.....anti human TNF seq from
 g Eu WTFGGG TKVEIKR..(KAPPA)

framework residues changed (# = Kabat)

chgs 3/42/48/49/83/106/108

Heavy Chain Data

Eu QVQLVQSGAE VKKPGSSVKV SCKASGGTFPSRAII WVRQA PGQGLEWMGG
 htnf1 EVLLQDSGPE LYKPGASVKI PCKASGYTFTDYNVD WVKQS HGKSLQWIGN
 2hEug QVQLVQSGAE VYKPGSSVKV SCKASGYTFTDYNVD WVKQA PGQGLQWIGN

Eu IVPMFGPPNYAQKFG RVTITADESTNTAYMELSSLRSED TAFYFCAGGY
 htnf1 INPNNGGTIYNQKFKG KGTLTVDKSTSTAYMELSLTSED TAVYYCARSA
 2hEug INPNNGGTIYNQKFKG KGTLTVDKSTSTAYMELSSLTSED TAVYYCARSA

Eu GIYSPE WGQGLVTVSS.grp 1kabat cdr chg frwk4
 htnf1 FYNNYEYFDV WGAGTTVTVSS
 2hEug FYNNYEYFDV WGQGLVTVSS

framework residues changed (# = kabat)

chgs 12/27/30/38/46/48/66/67/69/71/73/76/83/89/91/94/108

Fig. 1

SUBSTITUTE SHEET

2/6

CDR GRAFTING OF 101-4LIGHT CHAIN SUMMARY

1 rei DIQMTQSPSS LSASVGDRVT ITCQASQDI.IKYLNW YQQTGPKAPK
 101/4 QIVLTQSPPI MSASPGEKVT MTCASASSVDFMY W YQKPGSSPR
 g1014 QIVLTQSPSS LSASVGDRVT ITCASASSVDFMY W YQKPGKAPK

2 rei LLIYEASNLQA GVPFRFSGS GSGTDYFTI SSLQPEDIAT YYCQQYQSLP
 101/4 LLIYDASILAS GVPFRFSGS GSGTBSYSLTI SRMEAEDVAT YYCQQWSDYS
 g1014 LLIYDASILAS GVPFRFSGS GSGTDYTLTI SSLQPEDIAT YYCQQWSDYS

3 rei YTFGQGTKLQ ITR..celltech rei
 101/4 PRTFGGGTKLE IKR.....THIS IS MOUSE(INSERTION IN CDR3)JSE
 g1014 PRTFGQGTKVE IKR..celltech rei

framework residues changed (# = Kabat)

1/3/4/39/73/104/105/107

HEAVY CHAIN SUMMARY

23 48
 KOL QVQLVESGGG VVQPGSRSLRL SCSSSGFIFSSYAMY WVRQA PGKGLEWVAI
 101/4 EVKIEESGGG WVQPGGSMKL SCIASGFTFSNYWMN WVRQS PEKGLEWVAE
 g1014 QVQIVESGGG WVQPGSRSLRL SCIASGFTFSNYWMN WVRQA PGKGLEWVAE

71 88
 KOL IWDDGSDQHYADSVKG RFTISRDNKNTLFLQMDSLRPED TGVYFCARDG
 101/4 VRLQSDNFTTHYAESVKGRFTISRDDSKSGVYLQMNNLGAED TGIYYCTPFA
 g1014 VRLQSDNFTTHYAESVKGRFTISRDDSKNGVYLQMDSLRPED TGVYICTPFA

KOL GHGFCSSASCFGPDY WGQGTPTVTVSS....HUMAN(kabat CDR defn)
 101/4 Y WGQGTLVTVSP...MOUSE seq
 g1014 Y WGQGTLVTVSS

framework residues changed (# = Kabat)

4/11/23/24/28/73/77/78/79/91/93/94/108

Fig. 2

SUBSTITUTE SHEET

3/6

61E71

LIGHT CHAIN SUMMARY

REI DIQMTQSPSS LSASVGDRVT ITCQASQDI.IKYLN WYQQTGKAPK
 CB6 SIVMTQTPKF LLVSAGDRVT ITCASQSVS NDVA WYQQKSGQSPK
 gCB6 DIQMTQSPSS LSASVGDRVT ITCASQSVS NDVA WYQQTGKAPK

REI LLIYEASNLQA GVPBRFSGS GSGTDYTFTI SSLQPEDIAT YYCQQVQSLP
 CB6 VLIYHVSNRYT GVPDRFTGS GYGTDFFTI TTVQAEDLAV YFCQQDYSSP
 gCB6 LLIYHVSNRYT GVPBRFSGS GSGTDYTFTI SSLQPEDIAT YYCQQDYSSP

REI YTFGQGTKLQ ITR... celltech rei(KAPPA)
 CB6 WTFGGGTELE IK.... MOUSE AB... REI (NO FWRKS)
 gCB6 WTFGQGTKLQ ITR... grafted AB sequence

HEAVY CHAIN SUMMARY

KOL QVQLVESGGG VVQPGRSLRL SCSSSGFIFSSYAMY WVRQA PGKGLEWVAI
 CB6 QIQLVQSGPD LKKPGETVKI SCKASGYTFTNYGMN WVKQT PGKGLKWMGW
 gCB6 QVQLVESGGG VVQPGRSLRL SCKASGYTFTNYGMN WVRQA PGKGLEWWMGW

KOL IWDDGSDQHYADSVKG RFTISRDNKNTLFLQMDSLRPED TGVYFCARDG
 CB6 INTYTGEPTYDDDFKG RPAFSLASASTAYLQINNPKNED MATFFCARQE
 gCB6 INTYTGEPTYDDDFKG RFTISLDASKNTLFLQMDSLRPED TGVYFCARQE

KOL GHGFCSSASCFGPDY WGQGTPTVTS.HUMAN grp3(kabat CDR defn)
 CB6 GFYAMDY WGQGTSLTVSS..MOUSE ANTI-TNF sequence
 gCB6 GFYAMDY WGQGTPTVTS.grafted AB sequence

Fig. 3

SUBSTITUTE SHEET

4/6

hTNF3

LIGHT CHAIN SUMMARY

REI DIQMTQSPSS LSASVGDRVT ITCQASQDI.IKYLN WYQQTGKAPK
 hTNF3 NIVMTQTPKF LLVSAGDRIT ITCKASQSVS NDVA WYQQKPGQSPR
 gHTNF3 DIQMTQSPSS LSASVGDRVT ITCKASQSVS NDVA WYQQTGKAPK

REI LLIYEASNLQA GVPDRFTGS GSGTDYFTTI SSLQPEDIAT YCQQDYSSP
 hTNF3 LLIYYVSNRYT GVPDRFTGS GSGTDYFTTI NTVQAEDLAY YCQQDYSSP
 gHTNF3 LLIYYVSNRYT GVPDRFTGS GSGTDYFTTI SSLQPEDIAT YCQQDYSSP

REI YTFGQGTKLQ ITR.. (KAPPA)
 hTNF3 YTFGGGTRLE VK.... MOUSE AB sequence
 gHTNF3 YTFGQGTKLQ ITR..grafted sequence

HEAVY CHAIN SUMMARY

KOL QVQLVESGGG VVQPRSLRL SCSSSGFIFSSYAMY WVRQA PGKGLEWVAI
 hTNF3 RIQLVQSGPE LKKPGETVKI SCKASGYTFTNYGMN WVTQA PGKGLKWMGW
 gHTNF3 QVQLVESGGG VVQPRSLRL SCKASGYTFTNYGMN WVRQA PGKGLEW~~MGW~~

KOL IWDDGSDQHYADSVKG RFTISRDNSKNTLFLQMDSLRPED TGVYFCARDG
 hTNF3 INTYTGEPTYADDFKG RFAFSLETSASTAYLQINNLKNEE TATYFCARKE
 gHTNF3 INTYTGEPTYADDFKG RFTISLDTSKNTLFLQMDSLRPED TGVYFCARKE

KOL GHGFCSSASC~~FG~~PDY WGQGT~~PTVS~~.HUMAN grp3
 hTNF3 GPYANDY WGQGT~~SVTVSS~~...MOUSE.ANTI-TNF sequence
 gHTNF3 GPYANDY WGQGT~~PTVS~~.grafted AB sequence

Fig. 4

SUBSTITUTE SHEET

5/6

hTNF1 COMP ASSAY MuhTNF1 / GrhTNF1

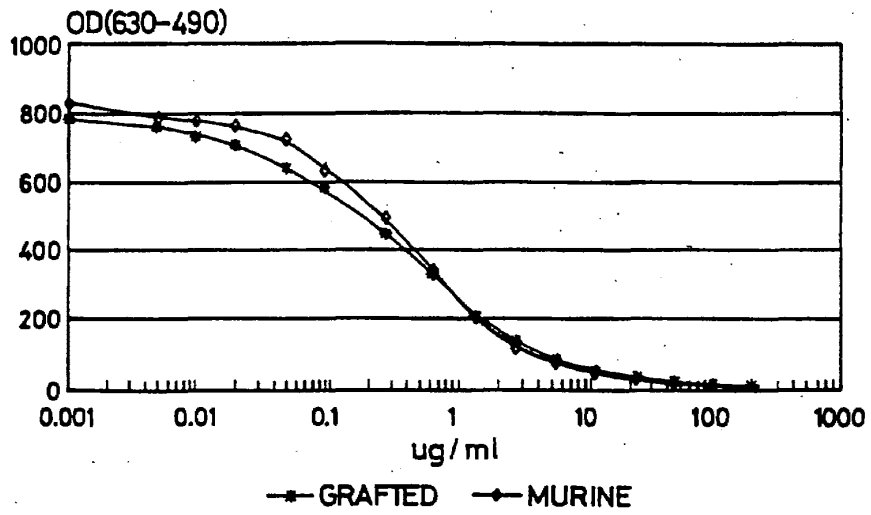

Fig. 5

SUBSTITUTE SHEET

6/6

NEUTRALISATION OF 100 pg/ml RECOMBINANT
TNF BY CB0010 AND CDP571

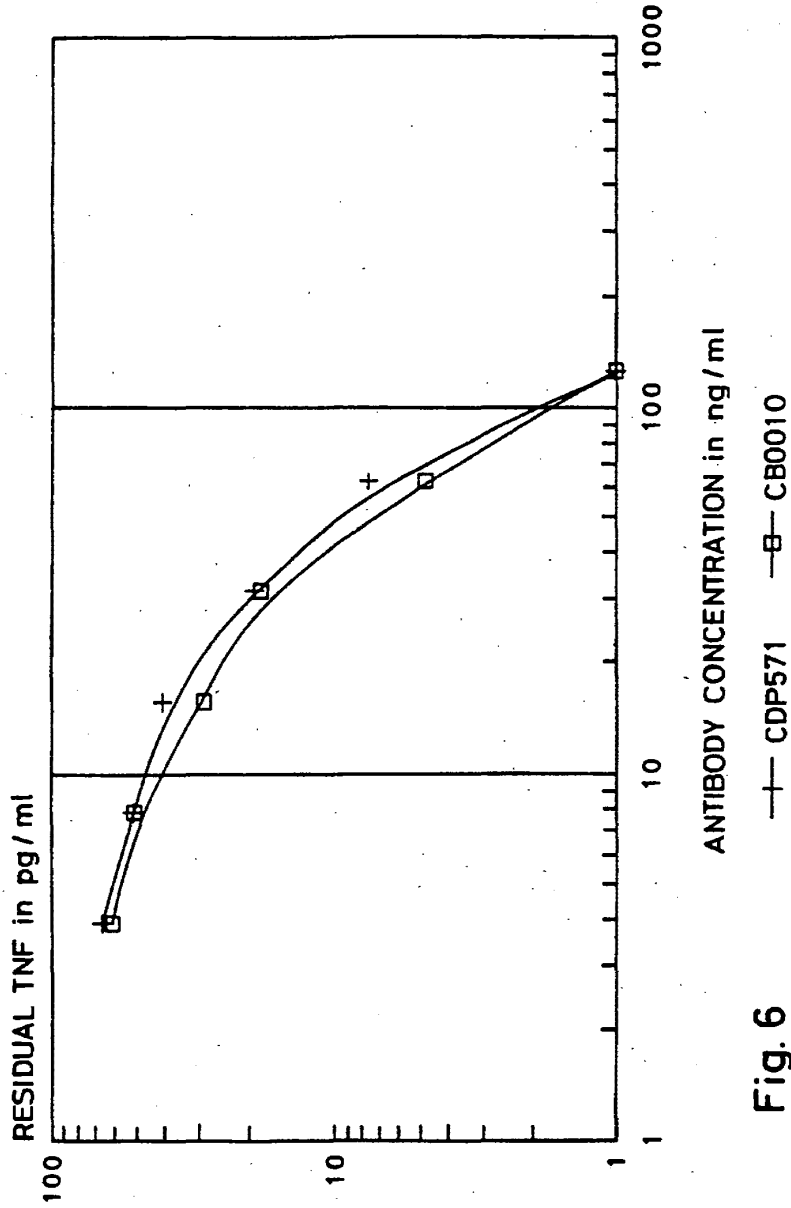
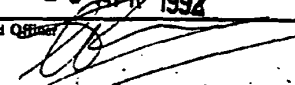

Fig. 6

SUBSTITUTE SHEET

INTERNATIONAL SEARCH REPORT

International Application No **PCT/GB 91/02300**

I. CLASSIFICATION OF SUBJECT MATTER (if several classification symbols apply, indicate all)*		
According to International Patent Classification (IPC) or to both National Classification and IPC		
Int. Cl. 5 C 12 N 15/62	C 12 P 21/08 A 61 K 39/395	C 07 K 15/28 C 12 N 15/13
II. FIELDS SEARCHED		
Minimum Documentation Searched ⁷		
Classification System	Classification Symbols	
Int. Cl. 5	C 12 P	C 12 N A 61 K
Documentation Searched other than Minimum Documentation to the extent that such Documents are included in the Fields Searched ⁸		
III. DOCUMENTS CONSIDERED TO BE RELEVANT⁹		
Category ⁹	Citation of Document, ¹¹ with indication, where appropriate, of the relevant passages ¹²	Relevant to Claim No. ¹³
X	EP, A, 0355067 (CELLTECH LTD) 21 February 1990, see the whole document	1, 2, 31- 38
Y	---	3-30
Y	EP, A, 0403156 (GENZYME CORP.) 19 December 1990, see example 12	3-30
X	Journal of Infectious Diseases, vol. 161, no. 6, June 1990, (Chicago, US), S. OPAL et al.: "Efficacy of a monoclonal antibody directed against tumor necrosis factor in protecting neutropenic rats from lethal infection with Pseudomonas aeruginosa", pages 1148-1152, see the whole article	1, 2, 31, 32, 37, 38
Y	---	3-30, 33 -36
---	-/-	
<p>⁹ Special categories of cited documents: ¹⁰</p> <p>"A" document defining the general state of the art which is not considered to be of particular relevance</p> <p>"E" earlier document but published on or after the international filing date</p> <p>"L" document which may throw doubts on priority claim(s) or which is cited to establish the publication date of another citation or other special reason (as specified)</p> <p>"O" document referring to an oral disclosure, use, exhibition or other means</p> <p>"P" document published prior to the international filing date but later than the priority date claimed</p> <p>"T" later document published after the international filing date or priority date and not in conflict with the application but cited to understand the principle or theory underlying the invention</p> <p>"X" document of particular relevance; the claimed invention cannot be considered novel or cannot be considered to involve an inventive step</p> <p>"Y" document of particular relevance; the claimed invention cannot be considered to involve an inventive step when the document is combined with one or more other such documents, such combination being obvious to a person skilled in the art.</p> <p>"&" document member of the same patent family</p>		
IV. CERTIFICATION		
Date of the Actual Completion of the International Search	Date of Mailing of this International Search Report	
26-03-1992	23 APR 1992	
International Searching Authority	Signature of Authorized Officer	
EUROPEAN PATENT OFFICE		

Form PCT/ISA/210 (second sheet) (January 1985)

III. DOCUMENTS CONSIDERED TO BE RELEVANT (CONTINUED FROM THE SECOND SHEET)		
Category	Citation of Document, with indication, where appropriate, of the relevant passages	Relevant to Claim No.
Y	Proceedings of the National Academy of Sciences of USA, vol. 86, no. 24, December 1989, (Washington, US), C. QUEEN et al.: "A humanized antibody that binds to the interleukin 2 receptor", pages 10029-10033, see page 10033, left-hand column, lines 10-45 (cited in the application) ---	3-30, 33 -36
X,P L	WO, A, 9109967 (CELLTECH LTD) 11 July 1990, see the whole document (cited in the application) (cited as L document since it may throw doubt on a priority claim) -----	1-38

FURTHER INFORMATION CONTINUED FROM THE SECOND SHEET		
V. <input checked="" type="checkbox"/> OBSERVATION WHERE CERTAIN CLAIMS WERE FOUND UNSEARCHABLE ¹		
This International search report has not been established in respect of certain claims under Article 17(2)(a) for the following reasons:		
1. <input checked="" type="checkbox"/> Claim numbers * Authority, namely:	because they relate to subject matter not required to be searched by this	
Remark: although claims 33 and 38 are directed to a method of treatment of the human/animal body, the search has been carried out and based on the alleged effects of the compound/composition.		
* claim not searched: 39 See PCT-Rule 39.1 (iv)		
2. <input type="checkbox"/> Claim numbers	because they relate to parts of the International application that do not comply with the prescribed requirements to such an extent that no meaningful international search can be carried out, specifically:	
3. <input type="checkbox"/> Claim numbers	because they are dependent claims and are not drafted in accordance with the second and third sentences of PCT Rule 6.4(a).	
VI. <input type="checkbox"/> OBSERVATIONS WHERE UNITY OF INVENTION IS LACKING ²		
This International Searching Authority found multiple inventions in this International application as follows:		
1. <input type="checkbox"/> As all required additional search fees were timely paid by the applicant, this International search report covers all searchable claims of the International application		
2. <input type="checkbox"/> As only some of the required additional search fees were timely paid by the applicant, this international search report covers only those claims of the International application for which fees were paid, specifically claims:		
3. <input type="checkbox"/> No required additional search fees were timely paid by the applicant. Consequently, this international search report is restricted to the invention first mentioned in the claims; it is covered by claim numbers:		
4. <input type="checkbox"/> As all searchable claims could be searched without effort justifying an additional fee, the International Searching Authority did not invite payment of any additional fee.		
Remark on Protest		
<input type="checkbox"/> The additional search fees were accompanied by applicant's protest.		
<input type="checkbox"/> No protest accompanied the payment of additional search fees.		

**ANNEX TO THE INTERNATIONAL SEARCH REPORT
ON INTERNATIONAL PATENT APPLICATION NO.**

GB 9102300
SA 54719

This annex lists the patent family members relating to the patent documents cited in the above-mentioned international search report. The members are as contained in the European Patent Office EDP file on 17/04/92. The European Patent Office is in no way liable for these particulars which are merely given for the purpose of information.

Patent document cited in search report	Publication date	Patent family member(s)	Publication date
EP-A- 0355067	21-02-90	AU-A- 4182289	23-03-90
		WO-A- 9001950	08-03-90
EP-A- 0403156	19-12-90	CA-A- 2018248	07-12-90
		JP-A- 3219896	27-09-91
WO-A- 9109967	11-07-91	AU-A- 6974091	24-07-91
		AU-A- 7033091	24-07-91
		AU-A- 7048691	24-07-91
		EP-A- 0460167	11-12-91
		EP-A- 0460171	11-12-91
		EP-A- 0460178	11-12-91
		WO-A- 9109966	11-07-91
		WO-A- 9109968	11-07-91
		GB-A- 2246781	12-02-92
GB-A- 2246570	05-02-92		

EPO FORM 1007

For more details about this annex : see Official Journal of the European Patent Office, No. 12/82

(12) **UK Patent Application** (19) **GB** (11) **2 188 941** (13) **A**

(43) Application published 14 Oct 1987

<p>(21) Application No 8609058</p> <p>(22) Date of filing 14 Apr 1986</p>	<p>(51) INT CL⁴ C12N 5/00 A61K 39/395 C12P 21/00</p> <p>(52) Domestic classification (Edition I): C6F HA2 U1S 1313 1337 2411 2419 C6F</p> <p>(56) Documents cited Microbiol, Immunol (1985) Vol 29 p. 959-972. Lymphokines (N.Y.) (1984) vol. 9 p. 127-52. J. of Immunology (U.S.) (1985) Vol. 134 p. 390 1-8 Molecular Immunology (1984) Vol. 21 No 12 p. 1229-36 Microbiology and Immunology (1985) Vol. 30 No. 4 p. 373-388.</p> <p>(58) Field of search C6F C3H Selected US specifications from IPC sub-classes A61K C12N C12P</p>
<p>(71) Applicant Bayen Aktiengesellschaft (Incorporated in FR Germany) 5090 Leverkusen-Bayerwerk, Federal Republic of Germany</p> <p>(72) Inventors Professor Dr. Tibor Diamantstein Dr. Hisao Osawa</p> <p>(74) Agent and/or Address for Service Carpmaels & Ransford, 43 Bloomsbury Square, London WC1A 2RA</p>	

(54) Monoclonal antibodies recognizing human interleukin-2-receptor

(57) Hybrid cell lines have been produced for the production of monoclonal antibody to an antigen found on activated human lymphocytes, the interleukin-2-receptor (iL-2-R) to the antibody so produced, and to therapeutic and diagnostic methods and compositions employing this antibody.

The antibody may be in the form of a chimeric animal-human antibody recognising iL-2-R wherein the F_C region is obtained from a human and the F_AB region is obtained from an animal.

GB 2 188 941 A

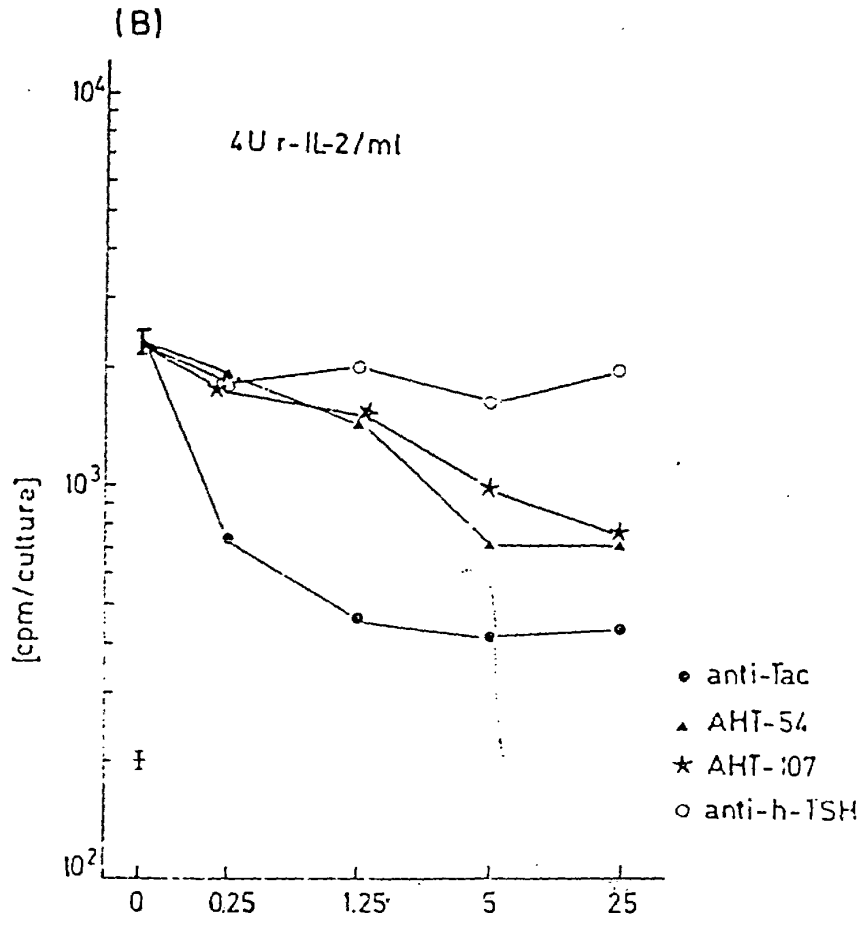

FIG. 1a

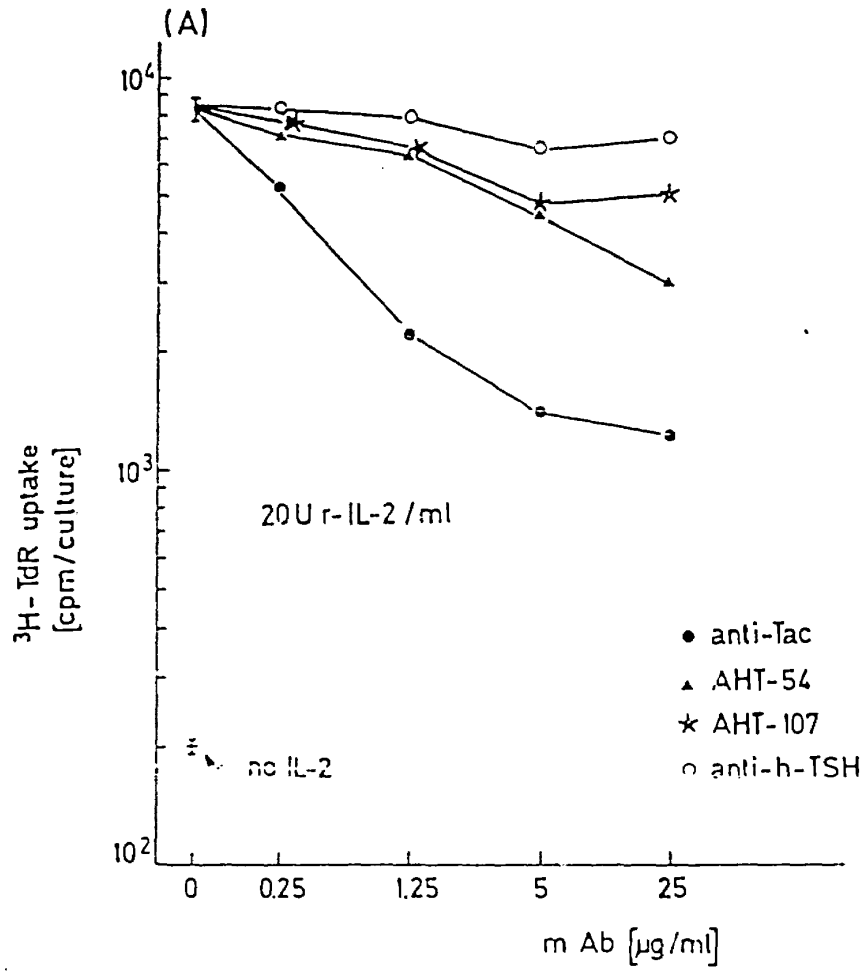

FIG. 1b

FIG. 2

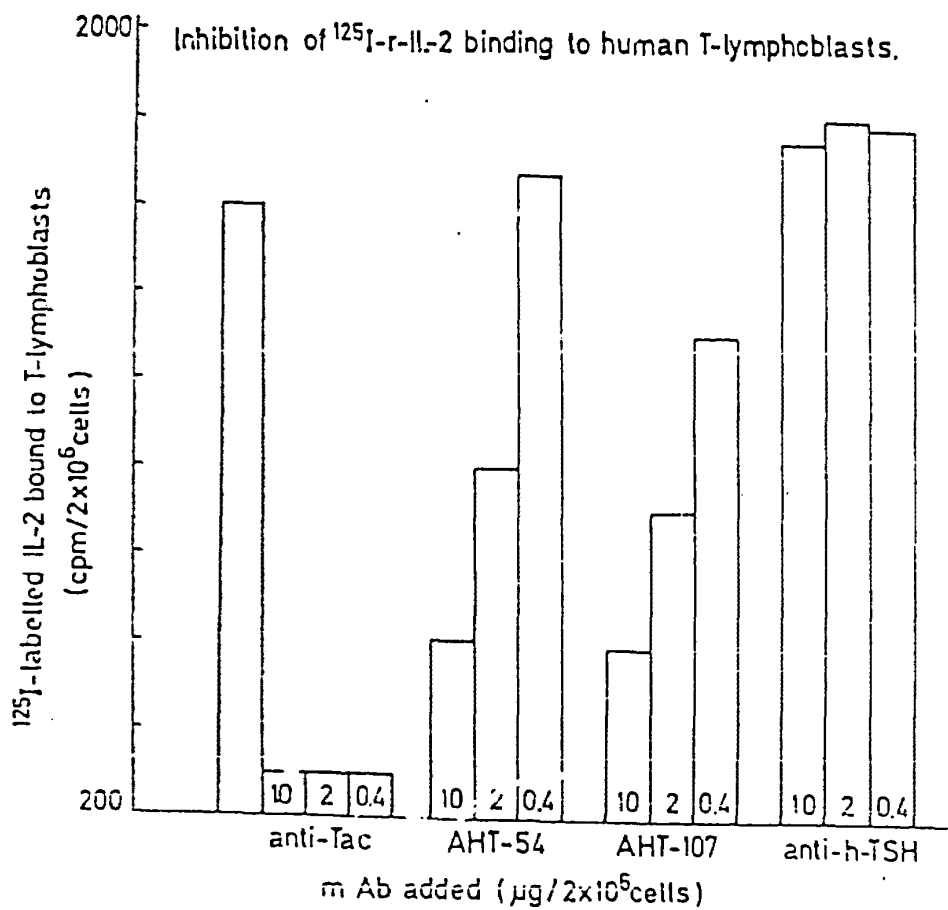
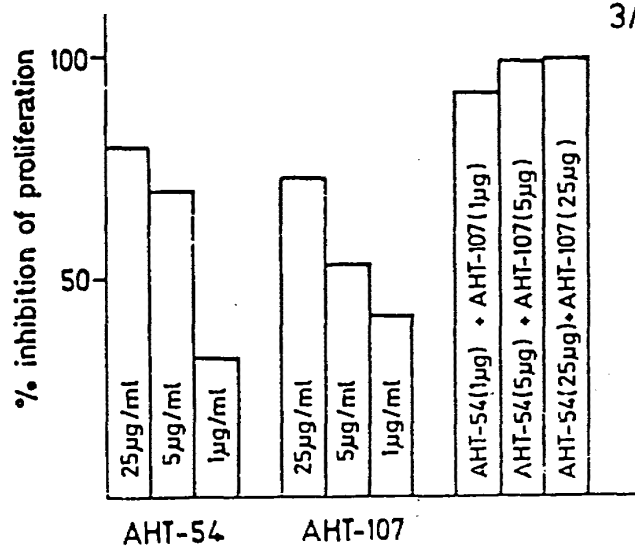

FIG. 4

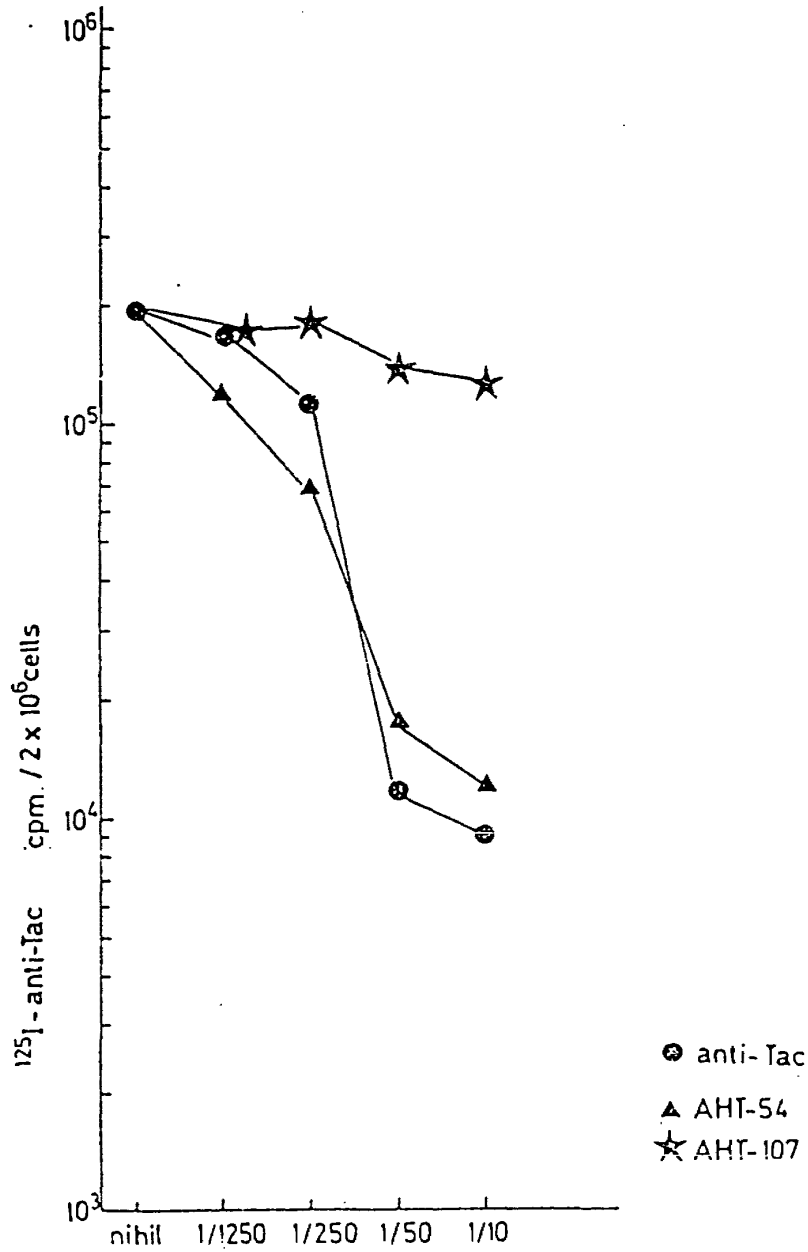

FIG. 3a

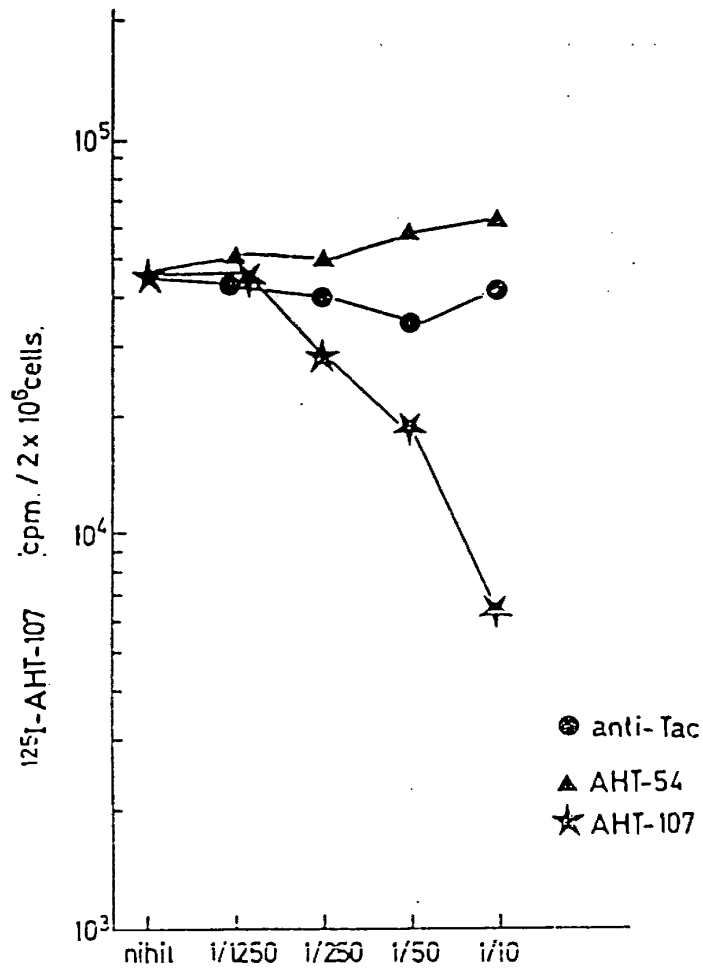

FIG. 3b

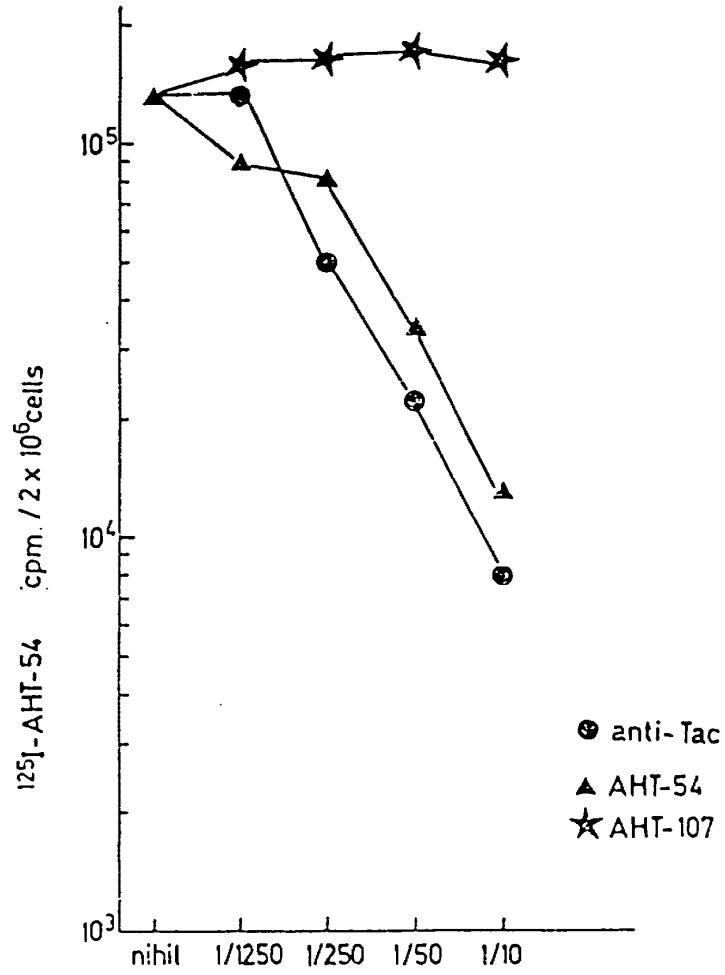

FIG. 3c

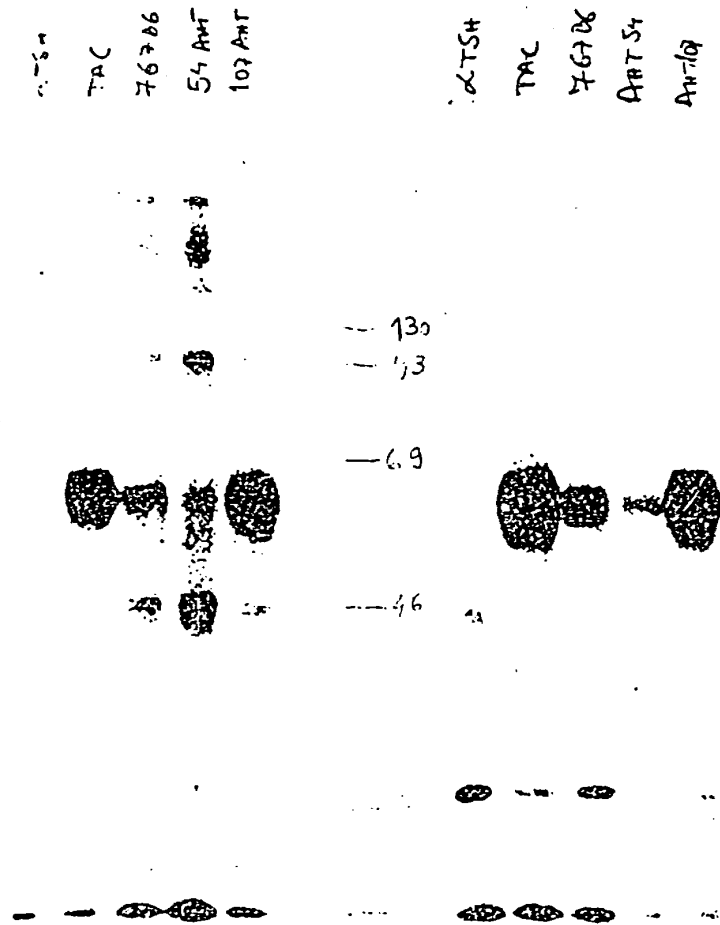

FIG. 5

FIG. 6

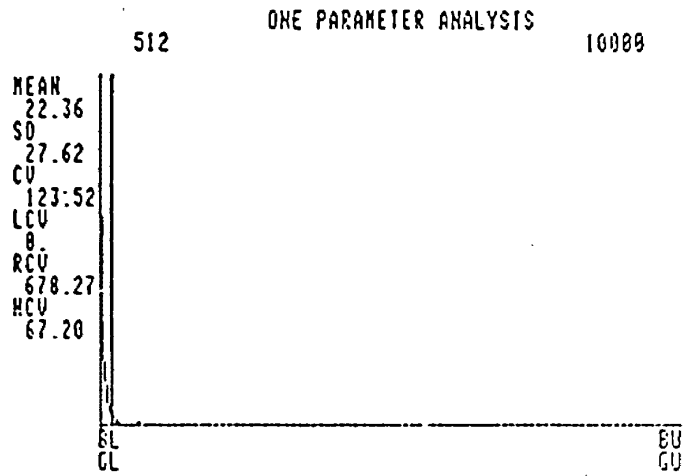

FIG. 7

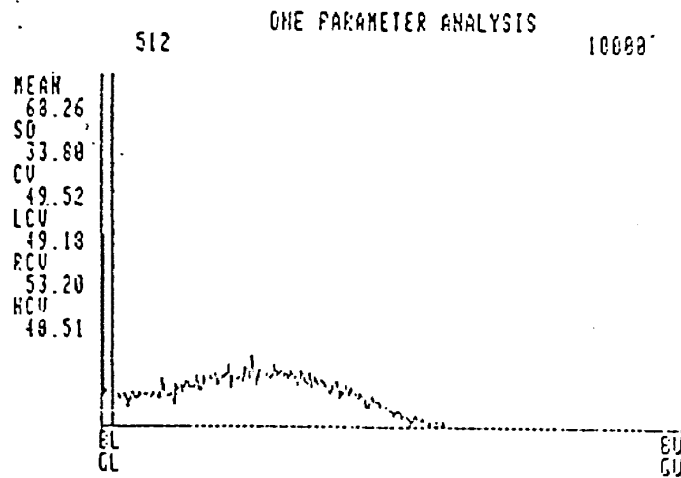

FIG. 8

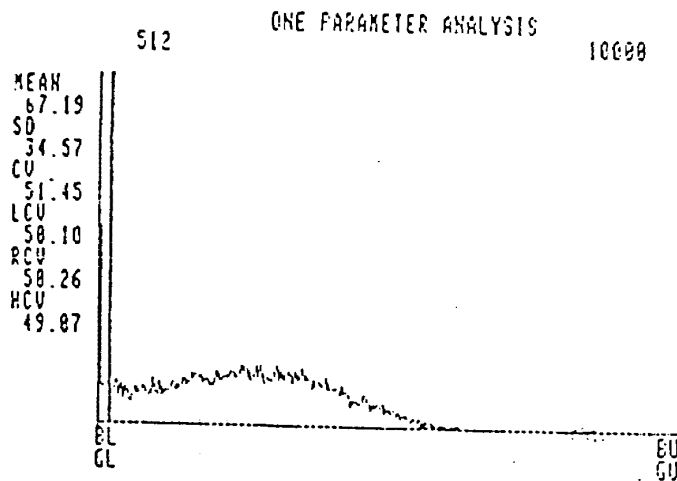

FIG. 9

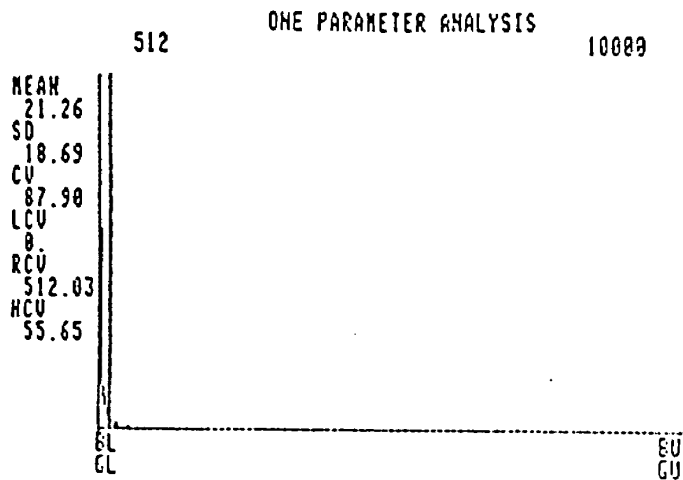

FIG. 10

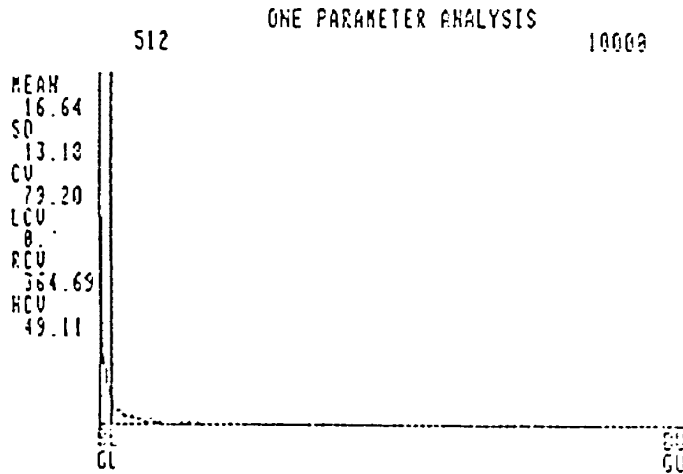
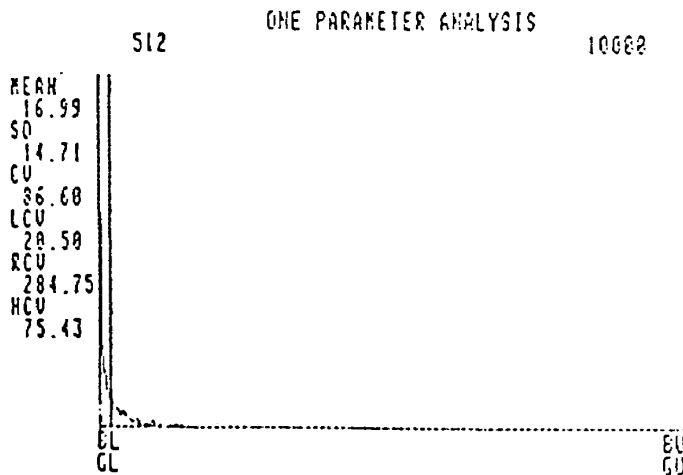

FIG. 11



SPECIFICATION

Monoclonal antibodies recognizing human interleukin-2-receptor

5 This invention relates generally to new hybrid cell lines and more specifically to hybrid cell lines for production of monoclonal antibody to an antigen found on activated human lymphocytes, the interleukin-2-receptor, to the antibody so produced, and to therapeutic and diagnostic methods and compositions employing this antibody.

15 INTRODUCTION

For many, if not all cells, the initial trigger for proliferation appears to be the interaction of growth factors with the cell surface growth factor receptor. Activation of the growth factor receptor leads in turn to yet undefined cytoplasmic signalling systems.

20 Resting T lymphocytes are long living cells in the G₀ phase of the cell cycle. They only enter proliferative cycles under antigenic stimulation in the presence of a T cell growth factor, interleukin 2 (IL-2). Receptors for IL-2 are not detectable on the surface of resting T cells. Expression of IL-2 receptors (IL-2R) is the consequence of interaction of antigen presenting cells with the antigen receptor. As shown recently, IL-2 receptor expression is a transient event and repeated restimulation by lectins (Cantrell, P.A., and K.A. Smith. (1984). *Science* (Wash. DC) 224:1312); (Osawa, H., and Diamantstein, T. (1984). *J. Immunol.* 132:2445) or the antigen (Reske-Kunz, A.B., D.v. Steldern, E. Rude, H. Osawa and T. Diamantstein, (1984). *J. Immunol.* 133:1356) is required for continuous IL-2 receptor expression and consequently for long term cell growth.

45 Since, IL-2-R are expressed exclusively on activated lymphocytes monoclonal antibody (mAb) that reacts with the IL-2-R may be useful as specific and selective immunosuppressive agent. Furthermore, such antibodies may serve as diagnostic reagents in order to detect qualitatively and quantitatively activated lymphocytes as well as neoplastic cells expressing IL-2-R.

SUMMARY OF THE INVENTION

55 An object of the present invention is to provide a composition of at least two monoclonal antibodies recognizing human interleukin-2-receptor capable to inhibit interleukin 2 induced lymphocyte proliferation. In an preferred embodiment one or more of the antibodies are of the IgG₁ class. In another preferred embodiment the antibody composition is capable to inhibit interleukin-2 binding to the receptor. The present invention provides monoclonal antibodies of the IgG₁ class recognizing human interleukin-2-receptor capable to inhibit interleukin-2 binding to the receptor and in particular

antibodies capable to inhibit interleukin-2 dependent lymphocyte proliferation. The antibodies of the present invention can be used for preparation of chimeric animal-human antibodies recognizing human interleukin-2-receptor wherein the constant F_c region of the immunoglobulin is obtained from human and the variance Fab region is obtained from an animal. Preferably the Fab region is obtained from mice.

70 The present invention further provides hybridoma cell lines, characterized by the production of monoclonal antibodies of the IgG₁ class recognizing human interleukin-2-receptor. Particular preferred are the hybridoma cell lines having the NTCC designation number ... and

80 Human T-lymphoblasts expressing IL-2-R were prepared by known methods (Osawa, H., and Diamantstein, T. (1983) *J. Immunol.* 130:51.) were used to produce a mouse monoclonal antibody against IL-2-R by the technique of Köhler and Milstein (Köhler, G., and C. Milstein, (1975) *Nature* 256:495). The fusion resulted in two hybrid clones AHT-54 and AHT-107 producing anti-IL-2-R antibodies of IgG₁ subclass. The hybrid clones secreting anti-IL-2-R antibodies were selected as preferred embodiment of the present invention.

95 Both mAb i) inhibit binding of 125J labelled IL-2 to IL-2-R positive human lymphocytes, ii) inhibit IL-2 dependent proliferation in vitro and iii) precipitates the identical cell surface molecule of 55KD, the IL-2 binding protein. Competitive binding of AHT-54 and AHT-107 revealed that they recognize different epitops of the IL-2-R molecule.

100 AHT-107 is different from anti-Tac (Uchiyama, T. et al., (1981) *J. Immunol.* 126:1398) because competitive inhibition studies revealed that they recognize two different epitops of the IL-2-R molecule; AHT-107 is also different from 7G7 B6, a recently published antihuman IL-2-R mAb (A. Rubin, C. Kurman, E. Biddison, D. Goldman, and L. Nelson (1985) *Hybridoma* Vol. 4:91), because in contrast to 7G7 B6 AHT-107 inhibits binding of IL-2 to the IL-2-R as well as IL-2 dependent proliferation of lymphocytes.

115 Both mAb react specifically with activated lymphocyte (T and B) but not with resting lymphocytes or other non-lymphoid cells. This statement is based on FACS-analysis data (Fig. 6-11).

120 According to previous studies in animal models such Ab reacting with the rat (ART-18) and with the mouse IL-2-R (AMT-13 and M7/20) has been shown to inhibit selectively and specifically i) local GVH-reaction (Diamantstein, T. and H. Osawa, (1986), *Immune Rev.* 92 in press.) ii) cardiac allograft rejection (L. Kirkman, E. Kelley, A. Koltun, J. Schoen, A. Ythier and B. Strom, (1985), *Transplantation* 40:719), (L. Kirkman, L.V. Barrett, N. Gaulton, E. Kelley, A. Ythier and B. Strom,

(1985), J. Exp. Med. 162: 358.) and iii) T-cell-mediated autoimmune reaction such as acute autoimmune encephalomyelitis and adjuvant arthritis induced by T-cell transfer (Wekerle, H. and T. Diamantstein, (1986), Autoimmunity: Experimental and Clinical Aspects Eds: R.S. Schwarz, N.R. Rose. Ann. New York Acad. Sci., In press.)

The anti-IL-2-R monoclonal antibodies of the present invention are also useful as therapeutic agents in clinical syndromes which are associated with pathological proliferation of IL-2 dependent cells. Thus, for example, hyperimmune syndromes such as Host versus Graft(HvG) Graft versus Host (GvH) diseases and autoimmune diseases (e.g. multiples sclerosis, autoimmune diabetes, Crohn's disease) may be treated. In a preferred embodiment of the present invention, the anti-IL-2-R monoclonal antibodies are used as therapeutic agents directly without further modification thereof. Furthermore, the invention includes preparation of anti IL-2-R chimeric antibodies using human heavy chain of different classes and subclasses in combination with the variable region of the AHT-54 and AHT-107 mAb, in order to optimise for therapeutic use.

Alternatively, the antibodies may be coupled to drugs including cytotoxic agents. The monoclonal antibodies of the present invention are capable of recognizing specifically cells expressing IL-2 receptors, inhibiting their function and of eliminating them selectively.

The monoclonal antibodies of the present invention are also useful diagnostic reagents for cells which contain IL-2-R either on the cell surface or within the cells and in body fluids. Thus by means of the present invention, cells containing IL-2-R may be identified in samples having different kinds of cells. Localization of IL-2-containing cells is possible in cultured cell colonies or in tissue specimens. When used in this manner the monoclonal antibodies are preferably coupled to fluorescent, color-forming substances such as an enzyme or chromophor, or a radioactive substance (ELISA, RIA).

DETAILED DESCRIPTION OF THE INVENTION

The following description is intended to illustrate this invention without limiting the same in any manner especially with respect to substantially functional equivalents of hybridomas and monoclonal antibodies as described herein.

55

I. Production of mAb

Source of IL-2-R

IL-2-R expressing cells were prepared as described using human-T-lymphoblast. Mixed human peripheral blood lymphocytes were stimulated with 3 mg/ml of concanavalin A (Con A) for 3 days. The cells were converted, treated with α -methyl mannoside (20 mg per ml), washed and used as immunogens in culture medium. Cultures were performed in Click's

RPMI medium (Seromed GmbH, München, F.R.G.) supplemented with 2×10^{-3} M L-glutamine, 5×10^{-5} M 2-mercaptoethanol, 100 U ml⁻¹ penicillin, 100 μ g ml⁻¹ streptomycin, and 5 to 10% (v/v) fetal calf serum (FCS; batch No. 104; Seromed GmbH).

Immunization, cell fusion, cloning, and production of monoclonal antibodies (mAb)

Ten-week-old BALB/c mice were primed with 2×10^7 T lymphoblasts. The cells were injected in 0,1 ml portions (10^6 cells) subcutaneously into the footpads and into the necks of the mice as well as i.v. (10^7 cells in 0.5 ml). Four weeks later, the mice were challenged i.v. with 10^7 T-lymphoblasts. Three days later, spleen cells from the immunized mice were fused with X63-Ag8.653 mouse myeloma cells in the presence of polyethylene glycol (Köhler and Milstein, (1975), Nature 256:495, as modified by Lemke H., G.J. Hämerling, C. Höhmann and K. Rajewsky, (1978), Nature 271:249). Fused cells suspended in HAT medium were distributed into each well of ten 24-well tissue culture plates (1 to 2×10^6 spleen cells/well). Supernatants of the wells in which vigorous growth was observed after 3 to 4 wk were screened for their capacity to bind a) human T lymphoblasts, b) mouse T lymphoblasts, and c) human thymocytes attached to the surface of the wells of microtiter plates. Cell-bound immunoglobulin was then detected by enzyme-linked immunosorbent assay (ELISA) as described (Kincade, P.W., G. Lee, L. Sun, and T. Watanabe, (1981), J. Immunol. Methods 42:17.) by using β -galactosidase-coupled sheep F(ab)₂ anti-mouse immunoglobulin (New England Nuclear, Dreieich, F.R.G.) as a second antibody. The hybridomas grown in HAT or RPMI medium that constantly produced antibodies binding specifically to human T lymphoblasts were selected. Supernatants of growing hybridomas were repeatedly tested and selected for hybridomas producing supernatants active in the functional assay (inhibition of the T-lymphoblast response to IL-2) as well as the absorption assay (inhibition of the capacity of T lymphoblasts to absorb IL 2 after preincubation). Positive hybridomas were cloned by limiting dilution with mouse thymocytes used as a feeder layer. The clones were retested and expanded. The supernatants of the relevant clones were used for isolation and purification of the mAb.

Purification of the mAb

As tested in the Ouchterlony double immunodiffusion test with rabbit anti-mouse IgM, IgA, IgG1, IgG2a, IgG2b, and IgG₃ sera (Miles Laboratories, Ltd., Slough, England), the hybridoma clone AHT-54 and AHT-107 were found to produce IgG1 antibodies. Excepting the initial screening experiments, in which unpurified culture supernatants were used, the

following experiments were performed with purified IgG1. Purification was achieved by successive binding/elution from protein A-Sepharose (Pharmacia Fine Chemicals) according to the method described by Ey et al. (Ey, P.L., S.J. Prowse and C.R. Jenkin, (1978), *Immunochimistry* 15:429). About 600 ml of the culture supernatants, brought to pH 8.0, were passed over a 5 ml protein A-Sepharose column equilibrated in 0.1 M sodium phosphate buffer (pH 8.0) IgG1 was eluted from the column with 0.1 M sodium citrate buffer (pH 6.0). The purified antibody was then dialyzed against a buffer containing 0.01 M HEPES (pH 7.4) and 0.9% NaCl. The purity of mAb was confirmed by sodium dodecyl sulfate (SDS) polyacrylamide gel electrophoresis performed in reducing conditions as described (Laemmli, U.K. 1970. Cleavage of structural proteins during the assembly of the head of bacteriophage T₄. *Nature* 227:429). The protein concentration of the purified IgG1 was determined by absorption of ultraviolet light at 280 nm, assuming an extinction coefficient (1% w/v:1cm) of 14, and by the method of Lowry et al, 1951 (Lowry, O.H., NJ. Rosebrogh, A.L. Farr, and R.J. Randall (1951). *J. Biol. Chem.* 193:265.) with bovine serum albumin (BSA) used as the standard.

30 Recombinant Interleukin-2 provided from Sanoles Mena was used. ¹²⁵I-labelled recombinant IL-2 was produced from NEN.

Labelling of the mAb with ¹²⁵I

35 MoAb were labelled with ¹²⁵I according to McConahey and Dixon (McConahey, P.J., and F.J. Dixon, (1980) *Methods Enzymol.* 70:210). Briefly, 20 µg of IgG1 dissolved in 50 µl of Na¹²⁵I (100 mCi ml⁻¹, carrier-free; Amersham Buchler). Ten microliters of chloramine-T (2.5 mg ml⁻¹ in 0.05 M Na-P) were added to the mixture. After 45 sec of incubation at room temperature, 20 µl of Na₂S₂O₃ (3 mg ml⁻¹ in 0.05 Na-P) were added to the tube. The mixture was immediately loaded onto a 15-m: Sephadex G-75 column (prewashed with 0.05 M Na-P containing 4% BSA and washed consecutively with 0.05 M Na-P until the eluate was protein-free), and the radiolabel in the excluded fraction was collected.

Detailed description of the drawings:

Figure 1

55 *Inhibition of IL-2 dependent human T-lymphoblast proliferation by different mAbs.*

2 × 10⁶ human T-lymphoblasts were incubated for 3 days in 0.2 ml of medium containing the indicated amounts of recombinant IL-2 (Fig. 1a, 20U/ml; Fig. 1b, 4U/ml) in the absence or presence of the different mAbs, anti-Tac (—O—), HT-54 (—Δ—), AHT-107 (—☆—) and of a control mAb anti-human-TSH (—○—). The cells were pulsed with ³H-thymidine for the last 4 h of the incubated period.

65 Incorporation of ³H-thymidine was measured

according to the standard procedure (Diamantstein et al, *Mol. Immunol.*, (1984), 21:1229.

70 Figure 2

Synergistic action of AHT-54 and AHT-107 mAbs on IL-2 dependent proliferation

T-lymphoblasts were cultured with 20U/ml of r-IL-2 for 3 days (for detail see Fig. 1) in the presence of either AHT-54 or AHT-107 mAb or in combination of both mAbs.

Figure 3

80 *Competition for the binding of ¹²⁵I-labelled antibodies*

2 × 10⁶ human T blasts were first suspended in 100 µl of a binding buffer (PBS=0.5% BSA/10 mM NaN₃) containing different dilutions of the mAbs anti-Tac (—O—), AHT-54 (—Δ—) and AHT-107 (—☆—). The suspensions were mixed with 100 µl of a 1:40 dilution of the ¹²⁵I-labelled mAb.

The mixture was incubated for 1h at 4°C. The relative amount of ¹²⁵I-labelled mAb (cpm) bound to the pelleted cells was measured by using a gamma-radiation counter after washing them twice with the binding buffer.

95 Figure 4

Inhibition of ¹²⁵I-IL-2 binding to human T blasts by different mAbs

2 × 10⁶ human T blasts were first incubated for 30 min. at 37°C in 0.25 ml of a buffer (RPMI/Hepes/BSA/NaN₃) containing the indicated amounts of different mAbs. The incubation was further continued at 37°C in the presence of ¹²⁵I-IL-2. After 40 min. the incubation mixture was centrifuged to pellet the cells and the pelleted cells were taken up in 100 µl of the buffer and overlaid on the oil phase consisting of dibutylphthalate/olive oil (10+3). After centrifugation the tips of the tube containing the cell pellets were cut out and counted in a gamma-radiation counter.

Figure 5

SDS-PAGE analysis of immunoprecipitates with different mAbs

115 2 × 10⁷ human T blasts were surface-iodinated with 0.5 mCi of Na [¹²⁵I] and lysed in 0.5 ml of the lysis buffer. The lysate was centrifuged and preabsorbed with 1/5 volume of protein A-sepharose beads (10 µl) through a bridge antibody rabbit anti-mouse IgG. After 1h at 4°C the beads were washed three times with a buffer containing 50mM Tris-HCL, pH 8.3, 450 mM NaCl, 5mM KI, 0.02% NaN₃ and 0.5 Nonidet P-40, and extracted with 100 µl of the sample buffer. 50 µl aliquots of the extracts were subjected to SDS-PAGE analysis either under non-reducing (lanes 1-6) or reducing (lanes 7-12) conditions. the mAbs used were control mouse UPC-10 ascites (lanes 1 & 7), anti Tac ascites (lanes 2 & 8).

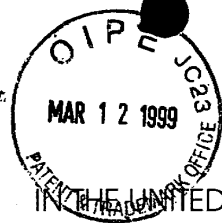

Handwritten notes: Paper # 47, P1642, and Patent Docket P0709P1

IN THE UNITED STATES PATENT AND TRADEMARK OFFICE

In re Application of Paul J. Carter et al. Serial No.: 08/146,206	Group Art Unit: 1642 Examiner: J. Reeves
Filed: November 17, 1993 For: METHOD FOR MAKING HUMANIZED ANTIBODIES	CERTIFICATE OF MAILING I hereby certify that this correspondence is being deposited with the United States Postal Service as First Class Mail with sufficient postage in an envelope addressed to: Assistant Commissioner of Patents, Washington, D.C. 20231 on March 9, 1999 <i>Ann Savelli</i>

SUPPLEMENTAL INFORMATION DISCLOSURE STATEMENT

Assistant Commissioner of Patents
 Washington, D.C. 20231
 03/26/1999 TGRAY1 00000003 070630 08146206
 01 FC:126 Sir: 240.00 CH

TERM CENTER 130 2030
 99 MAR 16 PM 24
 GROUP 180

Applicants submit herewith patents, publications or other information (attached hereto and listed on the attached Form PTO-1449) of which they are aware, which they believe may be material to the examination of this application and in respect of which there may be a duty to disclose in accordance with 37 CFR §1.56.

This Information Disclosure Statement:

- (a) accompanies the new patent application submitted herewith. 37 CFR §1.97(a).
- (b) is filed within three months after the filing date of the application or within three months after the date of entry of the national stage of a PCT application as set forth in 37 CFR §1.491.
- (c) as far as is known to the undersigned, is filed before the mailing date of a first Office action on the merits.
- (d) is filed after the first Office Action and more than three months after the application's filing date or PCT national stage date of entry filing but, as far as is known to the undersigned, prior to the mailing date of either a final rejection or a notice of allowance, whichever occurs first, and is accompanied by either the fee (\$240) set forth in 37 CFR §1.17(p) or a statement as specified in 37 CFR §1.97(e), as checked below. Should any fee be due, the U.S. Patent and Trademark Office is hereby authorized to charge Deposit Account No. 07-0630 in the amount of \$240.00 to cover

the cost of this Information Disclosure Statement. Any deficiency or overpayment should be charged or credited to this deposit account. A duplicate of this sheet is enclosed.

- (e) is filed after the mailing date of either a final rejection or a notice of allowance, whichever occurred first, and is accompanied by the fee (\$130) set forth in 37 CFR §1.17(f) and a statement as specified in 37 CFR §1.97(e), as checked below. This document is to be considered as a petition requesting consideration of the information disclosure statement. The U.S. Patent and Trademark Office is hereby authorized to charge Deposit Account No. 07-0630 in the amount of \$130.00 to cover the cost of this Information Disclosure Statement. Any deficiency or overpayment should be charged or credited to this deposit account. A duplicate of this sheet is enclosed.
- (f) (x) is filed after the mailing date of a final rejection, but a request to withdraw the finality thereof under 37 CFR § 1.129(a) was submitted on August 24, 1998. The U.S. Patent and Trademark Office is hereby authorized to charge Deposit Account No. 07-0630 to cover the cost of this Information Disclosure Statement in the event that any fees are due. A duplicate of this sheet is enclosed.

(If either of boxes (d) or (e) is checked above, the following statement under 37 CFR §1.97(e) may need to be completed.) The undersigned states that:

- Each item of information contained in the information disclosure statement was cited in a communication mailed from a foreign patent office in a counterpart foreign application not more than three months prior to the filing of this information disclosure statement.
- (x) No item of information contained in this information disclosure statement was cited in a communication mailed from a foreign patent office in a counterpart foreign application and, to the knowledge of the undersigned after making reasonable inquiry, was known to any individual designated in 37 CFR §1.56(c) more than three months prior to the filing of this information disclosure statement.

A list of the patent(s) or publication(s) is set forth on the attached Form PTO-1449 (Modified).
A copy of the items on PTO-1449 is supplied herewith:

(x) each none only those listed below:

A concise explanation of relevance of the items listed on PTO-1449 is:

- (x) not given
- given for each listed item
- given for only non-English language listed item(s) (Required)

- 0 in the form of an English language copy of a Search Report from a foreign patent office, issued in a counterpart application, which refers to the relevant portions of the references.

The Examiner is reminded that a "concise explanation of the relevance" of the submitted prior art "may be nothing more than identification of the particular figure or paragraph of the patent or publication which has some relation to the claimed invention," MPEP §609.

While the information and references disclosed in this Information Disclosure Statement may be "material" pursuant to 37 CFR §1.56, it is not intended to constitute an admission that any patent, publication or other information referred to therein is "prior art" for this invention unless specifically designated as such.

In accordance with 37 CFR §1.97(g), the filing of this Information Disclosure Statement shall not be construed to mean that a search has been made or that no other material information as defined in 37 CFR §1.56(a) exists. It is submitted that the Information Disclosure Statement is in compliance with 37 CFR §1.98 and MPEP §609 and the Examiner is respectfully requested to consider the listed references.

Respectfully submitted,

GENENTECH, INC.

By: 

Wendy M. Lee
Reg. No. 40,378

Date: March 9, 1999

1 DNA Way
So. San Francisco, CA 94080-4990
Phone: (650) 225-1994
Fax: (650) 952-9881



**UNITED STATES DEPARTMENT OF COMMERCE
Patent and Trademark Office**

Address: COMMISSIONER OF PATENTS AND TRADEMARKS
Washington, D.C. 20231

APPLICATION NO.	FILING DATE	FIRST NAMED INVENTOR	ATTORNEY DOCKET NO.
08/146,206	11/17/93	CARTER	P 709P1

HM22/0329

GENENTECH, INC.
1 DNA WAY
SOUTH SAN FRANCISCO CA 94080-4990

EXAMINER

REEVES, J

ART UNIT	PAPER NUMBER
1642	H8

DATE MAILED: 03/29/99

Please find below and/or attached an Office communication concerning this application or proceeding.

Commissioner of Patents and Trademarks

Office Action Summary

Application No. 08/146,206	Applicant(s) Carter et al
Examiner Julie E. Reeves, Ph.D.	Group Art Unit 1642



Responsive to communication(s) filed on Aug 26, 1998

This action is **FINAL**.

Since this application is in condition for allowance except for formal matters, prosecution as to the merits is closed in accordance with the practice under *Ex parte Quayle*, 1935 C.D. 11; 453 O.G. 213.

A shortened statutory period for response to this action is set to expire zero month(s), or thirty days, whichever is longer, from the mailing date of this communication. Failure to respond within the period for response will cause the application to become abandoned. (35 U.S.C. § 133). Extensions of time may be obtained under the provisions of 37 CFR 1.136(a).

Disposition of Claims

Claim(s) 43-128 is/are pending in the application.

Of the above, claim(s) _____ is/are withdrawn from consideration.

Claim(s) _____ is/are allowed.

Claim(s) _____ is/are rejected.

Claim(s) _____ is/are objected to.

Claims 43-128 are subject to restriction or election requirement.

Application Papers

See the attached Notice of Draftsperson's Patent Drawing Review, PTO-948.

The drawing(s) filed on _____ is/are objected to by the Examiner.

The proposed drawing correction, filed on _____ is approved disapproved.

The specification is objected to by the Examiner.

The oath or declaration is objected to by the Examiner.

Priority under 35 U.S.C. § 119

Acknowledgement is made of a claim for foreign priority under 35 U.S.C. § 119(a)-(d).

All Some* None of the CERTIFIED copies of the priority documents have been
 received.

received in Application No. (Series Code/Serial Number) _____

received in this national stage application from the International Bureau (PCT Rule 17.2(a)).

*Certified copies not received: _____

Acknowledgement is made of a claim for domestic priority under 35 U.S.C. § 119(e).

Attachment(s)

Notice of References Cited, PTO-892

Information Disclosure Statement(s), PTO-1449, Paper No(s). _____

Interview Summary, PTO-413 Paper # 43

Notice of Draftsperson's Patent Drawing Review, PTO-948

Notice of Informal Patent Application, PTO-152

--- SEE OFFICE ACTION ON THE FOLLOWING PAGES ---

Art Unit: 1642

1. Restriction is required under 35 U.S.C. 121 and 372.
2. This application contains claims directed to more than one species of the generic invention. These species are deemed to lack unity of invention because they are not so linked as to form a single general inventive concept under PCT Rule 13.1.

The species are as follows:

Species A: 4L

Species B: 38L

Species C: 43L

Species D: 44L

Species E: 46L

Species F: 58L

Species G: 62L

Species H: 65L

Species I: 66L

Species J: 67L

Species K: 68L

Species L: 69L

Species M: 73L

Species N: 85L

Species O: 98L

Art Unit: 1642

Species P: 2H

Species Q: 4H

Species R: 36H

Species S: 39H

Species T: 43H

Species U: 45H

Species V: 69H

Species W: 70H

Species X 74H

Species Y 75H

Species Z: 76H

Species AA: 78H

Species BB: 92H

Species CC: noncovalently binds antigen directly

Species DD: interacts with a CDR

Species EE: comprises a glycosylation site which affects the antigen binding or affinity
of the antibody

Species FF: participates in the VL-VH interface by affecting the proximity or
orientation of the VL and VH regions with respect to one another.

Species GG 24H

Art Unit: 1642

Species HH 73H

Species II 76H

Species JJ 78H

Species KK 93H

Applicant is required, in reply to this action, to elect a single species to which the claims shall be restricted if no generic claim is finally held to be allowable. The reply must also identify the claims readable on the elected species, including any claims subsequently added. An argument that a claim is allowable or that all claims are generic is considered non-responsive unless accompanied by an election.

Upon the allowance of a generic claim, applicant will be entitled to consideration of claims to additional species which are written in dependent form or otherwise include all the limitations of an allowed generic claim as provided by 37 CFR 1.141. If claims are added after the election, applicant must indicate which are readable upon the elected species. MPEP § 809.02(a).

3. The claims are deemed to correspond to the species A-BB listed above in the following manner: Claims 47-70 and claims 76-103 are limited to one of Species A-BB, respectively. Claims 107-110 are limited to one of the species CC-FF, respectively.

The following claim(s) are generic:

Claims 43-46, 71-75, 104-105 are generic for Species A-BB.

Claims 106, 111-114, 128 are generic for Species CC-FF.

Art Unit: 1642

Claims 115-118, 124-126 are generic for Species GG-KK

4. The species listed above do not relate to a single general inventive concept under PCT Rule 13.1 because, under PCT Rule 13.2, the species lack the same or corresponding special technical features for the following reasons: each of the particular amino acid substitution positions recited in Species A-BB or GG-KK or each of the functional definitions of amino acid substitution changes recited in Species CC-FF result in different primary amino acid structure which would result in different secondary, tertiary, and quaternary structure yielding a protein with different biological, physiological and immunological properties, including different immunogenicity and antigen binding functions. Further, species EE, for example, recites the addition of a glycosylation site, which would involve the presence of a carbohydrate moiety and its affect on amino acid structure. The examination of all species would require the consideration of different patentability issues.

Applicant is advised that the reply to this requirement to be complete must include an election of the invention to be examined even though the requirement be traversed (37 CFR 1.143).

5. Applicant is reminded that upon the cancellation of claims to a non-elected invention, the inventorship must be amended in compliance with 37 CFR 1.48(b) if one or more of the currently named inventors is no longer an inventor of at least one claim remaining in the application. Any amendment of inventorship must be accompanied by a petition under 37 CFR 1.48(b) and by the fee required under 37 CFR 1.17(i).

Art Unit: 1642

6. Any inquiry concerning this communication or earlier communications from the examiner should be directed to Julie E. Reeves, Ph.D. whose telephone number is (703) 308-7553.

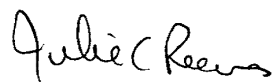

Julie E. Reeves, Ph.D.

**JULIE REEVES
PATENT EXAMINER**

Interview Summary

Application No.
08/146,206

Applicant(s)
Carter et al

Examiner
Julie E. Reeves, Ph.D.

Group Art Unit
1642



All participants (applicant, applicant's representative, PTO personnel):

(1) Julie E. Reeves, Ph.D. (3) _____

(2) Wendy Lee (4) _____

Date of Interview Jan 7, 1999

Type: Telephonic Personal (copy is given to applicant applicant's representative).

Exhibit shown or demonstration conducted: Yes No. If yes, brief description:

Agreement was reached. was not reached.

Claim(s) discussed: all pending

Identification of prior art discussed:
none

Description of the general nature of what was agreed to if an agreement was reached, or any other comments:
Applicant indicated that they intend to file a supplemental amdt.

(A fuller description, if necessary, and a copy of the amendments, if available, which the examiner agreed would render the claims allowable must be attached. Also, where no copy of the amendments which would render the claims allowable is available, a summary thereof must be attached.)

1. It is not necessary for applicant to provide a separate record of the substance of the interview.

Unless the paragraph above has been checked to indicate to the contrary, A FORMAL WRITTEN RESPONSE TO THE LAST OFFICE ACTION IS NOT WAIVED AND MUST INCLUDE THE SUBSTANCE OF THE INTERVIEW. (See MPEP Section 713.04). If a response to the last Office action has already been filed, APPLICANT IS GIVEN ONE MONTH FROM THIS INTERVIEW DATE TO FILE A STATEMENT OF THE SUBSTANCE OF THE INTERVIEW.

2. Since the Examiner's interview summary above (including any attachments) reflects a complete response to each of the objections, rejections and requirements that may be present in the last Office action, and since the claims are now allowable, this completed form is considered to fulfill the response requirements of the last Office action. Applicant is not relieved from providing a separate record of the interview unless box 1 above is also checked.

J. Reeves
JULIE REEVES
PATENT EXAMINER

Examiner Note: You must sign and stamp this form unless it is an attachment to a signed Office action.

#49

Official Document - GENENTECH, INC.

1 DNA Way, South San Francisco, CA 94080-4990 Tel: 650-225-7039 Fax: 650-952-9881

FAX TRANSMISSION COVER SHEET

Date: April 9, 1999

To: Examiner J. Reeves

Group Art Unit: 1642 of US PTO

Fax: (703)308-4426

Re: U.S. Ser. No 08/146,206 filed November 17, 1993 (Attorney Docket No.: P0709P1)

Sender: Wendy M. Lee

CERTIFICATION OF FACSIMILE TRANSMISSION

I hereby certify that this paper is being facsimile transmitted to the Patent and Trademark Office on the date shown below.

Ann Savelli

Type or print name of person signing certification

Ann Savelli

Signature

4/9/99

Date

YOU SHOULD RECEIVE 2 PAGES, INCLUDING THIS COVER SHEET. IF YOU DO NOT RECEIVE ALL THE PAGES, PLEASE CALL 650-225-7039

Comments:

CONFIDENTIALITY NOTE

The documents accompanying this facsimile transmission contain information from GENENTECH, INC. which is confidential or privileged. This information is intended only for the individual or entity named on this transmission sheet. If you are not the intended recipient, be aware that any disclosure, copying, distribution, or use of the contents of this facsimile information is strictly prohibited. If you have received this facsimile in error, please notify us by telephone immediately so that we can arrange for the return of the original documents to us and the retransmission of them to the intended recipient.

Off-...
4/9/99
9/2/92

Patent Docket P0709P1

IN THE UNITED STATES PATENT AND TRADEMARK OFFICE

49

In re Application of Paul J. Carter et al. Serial No.: 08/146,206 Filed: November 17, 1993 For: METHOD FOR MAKING HUMANIZED ANTIBODIES	Group Art Unit: 1642 Examiner: J. Reeves
--	---

Response to Restriction Requirement

Assistant Commissioner of Patents
Washington, D.C. 20231

Sir:

Responsive to the Office Action dated March 29, 1999 and pursuant to the telephonic conversation between the undersigned and Examiner Reeves of today's date, Applicants hereby elect the species 78H ("Species AA" and "Species JJ"), with traverse. Claims readable on the elected species include claims 72-75, 102, 104, 105, 115-118, 122 and 124-127. Applicants traverse the restriction requirement to the extent that 37 CFR 1.129(b)(1) states that in applications such as the present application (which had been pending for at least three years as of June 8, 1995 taking into account reference made in the application under 35 USC 120 to USSN 07715,272 filed June 14, 1991), "no requirement for restriction or for the filing of divisional applications shall be made or maintained in the application after June 8, 1995".

Respectfully submitted,
GENENTECH, INC.

Date: April 9, 1999

By: 
Wendy M. Lee
Reg. No. 40,378

1 DNA Way
So. San Francisco, CA 94080-4990
Phone: (650) 225-1994
Fax: (650) 952-9881

Page #50
6/11/99

Patent Docket P0709P1

IN THE UNITED STATES PATENT AND TRADEMARK OFFICE

<p>In re Application of Paul J. Carter et al. Serial No.: 08/146,206 Filed: November 17, 1993 For: METHOD FOR MAKING HUMANIZED ANTIBODIES</p>	<p>Group Art Unit: 1642 Examiner: Julie Burke</p>	<p>RECEIVED JUL 19 2001 TECH CENTER 1600/2900</p>
--	---	--

RECEIVED
TECH CENTER 1600/2900
99 JUN 11 AM 10:21

COMMUNICATION

Assistant Commissioner of Patents
Washington, D.C. 20231

Sir:

As requested by Examiner Julie Burke enclosed is the specification for USSN 07/715,272 (now abandoned) which is the priority document for the above-identified patent application.

Respectfully submitted,

GENENTECH, INC.

By: *Wendy M. Lee*
Wendy M. Lee
Reg. No. 40,378

Date: June 9, 1999

1 DNA Way
So. San Francisco, CA 94080-4990
Phone: (650) 225-1994
Fax: (650) 952-9881

Revised (10/11/95)

Interview Summary	Application No. 08/146,206	Applicant(s) Carter et al	
	Examiner Julie E. Burke, (Reeves), Ph.D.	Group Art Unit 1642	

All participants (applicant, applicant's representative, PTO personnel):

(1) Julie E. Burke, (Reeves), Ph.D. (3) _____

(2) Wendy Lee (4) _____

Date of Interview 16 Jul 1999

Type: Telephonic Personal (copy is given to applicant applicant's representative).

Exhibit shown or demonstration conducted: Yes No. If yes, brief description:

Agreement was reached. was not reached.

Claim(s) discussed: all pending

Identification of prior art discussed:
none in detail

Description of the general nature of what was agreed to if an agreement was reached, or any other comments:
Examiner phoned to say the claims 43-44, 46-73, 75-105, 115-127 are in condition for allowance; claims 45, 74, 117 are objected to for not further limiting the independent claims; claims 111-112 are double patenting with claims reciting the VH subgroup III heavy chain consensus region, as allowed in 08/437,642, accordingly a terminal disclaimer is necessary for the allowance of claims 111-112; claims 106-110, 113-114 and 128 need further prosecution. Applicant elected to not procede with the allowance at this time. A supplemental amdt will be filed today and an interview has been scheduled 23rd August.

(A fuller description, if necessary, and a copy of the amendments, if available, which the examiner agreed would render the claims allowable must be attached. Also, where no copy of the amendments which would render the claims allowable is available, a summary thereof must be attached.)

1. It is not necessary for applicant to provide a separate record of the substance of the interview.

Unless the paragraph above has been checked to indicate to the contrary, A FORMAL WRITTEN RESPONSE TO THE LAST OFFICE ACTION IS NOT WAIVED AND MUST INCLUDE THE SUBSTANCE OF THE INTERVIEW. (See MPEP Section 713.04). If a response to the last Office action has already been filed, APPLICANT IS GIVEN ONE MONTH FROM THIS INTERVIEW DATE TO FILE A STATEMENT OF THE SUBSTANCE OF THE INTERVIEW.

2. Since the Examiner's interview summary above (including any attachments) reflects a complete response to each of the objections, rejections and requirements that may be present in the last Office action, and since the claims are now allowable, this completed form is considered to fulfill the response requirements of the last Office action. Applicant is not relieved from providing a separate record of the interview unless box 1 above is also checked.

Examiner Note: You must sign and stamp this form unless it is an attachment to a signed Office action.

Julie Burke
JULIE BURKE
PRIMARY EXAMINER

7/16/99

Official Document - GENENTECH, INC.

#51

1 DNA Way, South San Francisco, CA 94080-4990 Tel: 650-225-7039 Fax: 650-952-9881

FAX TRANSMISSION COVER SHEET

Date: July 16, 1999

To: Examiner Julie Burke

Group Art Unit: 1642 of US PTO

Fax: (703) 308-4426

Re: U.S. Ser. No 08/146,206 filed November 17, 1993 (Attorney Docket No.: P0709P1)

Sender: Wendy M. Lee

CERTIFICATION OF FACSIMILE TRANSMISSION

I hereby certify that this paper is being facsimile transmitted to the Patent and Trademark Office on the date shown below.

Wendy Lee
Type or print name of person signing certification

W. Lee 7/16/99
Signature Date

YOU SHOULD RECEIVE 2 PAGE(S), INCLUDING THIS COVER SHEET. IF YOU DO NOT RECEIVE ALL THE PAGES, PLEASE CALL 650-225-7039

Comments:

CONFIDENTIALITY NOTE

The documents accompanying this facsimile transmission contain information from GENENTECH, INC., which is confidential or privileged. This information is intended only for the individual or entity named on this transmission sheet. If you are not the intended recipient, be aware that any disclosure, copying, distribution, or use of the contents of this facsimile information is strictly prohibited. If you have received this facsimile in error, please notify us by telephone immediately so that we can arrange for the return of the original documents to us and the retransmission of them to the intended recipient.

*Paper #51
Amdt K
7/16/99
JL*

Patent Docket P0709P1

IN THE UNITED STATES PATENT AND TRADEMARK OFFICE

In re Application of Paul J. Carter et al. Serial No.: 08/146,206 Filed: November 17, 1993 For: METHOD FOR MAKING HUMANIZED ANTIBODIES	Group Art Unit: 1642 Examiner: J. Burke
---	--

SUPPLEMENTAL AMENDMENT

Assistant Commissioner of Patents
Washington, D.C. 20231

Sir:

Further to the Supplemental Amendment dated January 15, 1999, please amend the present application as follows:

IN THE CLAIMS:

In line 3 of claims 43 and 115, please replace "further comprising an" with --further comprising a Framework Region (FR)--.

In line 4 of claim 72 please replace "further comprises an" with --further comprises a Framework Region (FR)--.

REMARKS

For claim precision, claims 43, 72 and 115 now refer to a Framework Region (FR) substitution, which provides antecedence for Framework Region (FR) in the claims which depend thereon.

Respectfully submitted,
GENENTECH, INC.

Date: July 16, 1999

By: 
Wendy M. Lee
Reg. No. 40,378

1 DNA Way
So. San Francisco, CA 94080-4990
Phone: (650) 225-1994
Fax: (650) 952-9881

Patent Docket PD70891

IN THE UNITED STATES PATENT AND TRADEMARK OFFICE

<p>Paul J. Carter et al. Serial No.: 09/146,206 Filed: November 17, 1993 For: METHOD FOR MAKING HUMANIZED ANTIBODIES</p>	<p>Group Art Unit: 1644 Examiner: Julie Burke</p>
<p>CERTIFICATE OF FACSIMILE TRANSMISSION <i>Aug. 30, 1999</i> Date of Transmission I hereby certify that this correspondence, consisting of a Supplemental Amendment, is being facsimile transmitted to the Assistant Commissioner of Patents, Washington, D.C. 20231. <i>Ann Savelli</i> Ann Savelli</p>	

Handwritten notes on the left margin of the form.

Handwritten notes on the top right margin of the form.

SUPPLEMENTAL AMENDMENT

Assistant Commissioner of Patents
Washington, D.C. 20231

Sir:

Further to the Supplemental Amendment dated July 16, 1999, please amend the present application as follows:

IN THE CLAIMS:

Please cancel claims 106-112, without prejudice.

In claim 113, line 9, after "one another", please insert -- wherein the humanized variant binds antigen up to about 3-fold more tightly than the parent antibody binds antigen--.

In claim 114, line 1, please delete "at least".

In claim 128, line 7, please insert --up to about 3-fold-- before "more tightly".

Handwritten notes on the left margin of the claims section.

Handwritten notes on the right margin of the claims section.

08/146,206

REMARKS

The undersigned confirms having met with Examiners Burke and Feisee in the interview August 23, 1999, and takes this opportunity to thank them for the courtesies extended in that interview.

As requested by Examiner Burke in the above interview, claims 113 and 128 have been revised, for claim precision, to refer to the humanized variant which binds antigen up to about 3-fold better than the parent antibody. Claims 113-114 and 128 have been revised herein in order to facilitate allowance of the present application and without acquiescing in any rejection. Basis for the revisions of these claims is found on at least page 70, lines 31-32 and in Table 3 on page 72. Aside from humanized anti-HER2 variants huMAb4D5-6 and huMAb4D5-8 in the present application, it is noted that humanized M195 has an affinity which is about 3-fold better than the parent antibody as recited in claim 128 (see first line on page 1153 of *Co et al. J. Immunol.* 148:1149-1154 (1992) (of record); and *Caron et al. Cancer Research* 52:6761-6767 (1992) (of record)).

To avoid the obviousness-type double patenting rejection of claim 111 over claim 47 of co-pending application USSN 08/437,642, Applicants have cancelled claims 111-112 herein, without prejudice to filing a continuing application directed thereto. In addition, in order to simplify prosecution, and without acquiescing in any objection or rejection, claims 106-110 have been cancelled. Applicants reserve the right to

08/146,206

file a continuing application directed to claims 106-110.

Examiner Burke suggested that claims 45, 74 and 117 be cancelled as not further limiting the independent claims on which they depend. The undersigned pointed out that, due to the use of the "comprising" language, claims 43, 72 and 115 clearly encompass humanized antibody variable domains or antibodies with one or more Framework Region (FR) substitutions, wherein at least one of those FR substitutions is set forth in the group of sites in the claims. Hence, claims 45, 74 and 117 are further limiting and need not be cancelled. The Examiner then asserted that, without an upper limit on the number of FR substitutions, independent claims 43, 72 and 115 could read on a prior art antibody with an intact murine variable domain. Applicants respectfully submit, in this regard, that given that these claims are directed to a "humanized" antibody variable domain or antibody, it is apparent that the claims cannot encompass antibodies with intact murine variable domains. This is apparent from page 2, lines 29-34 and page 10, lines 27-31.

Respectfully submitted,
GENENTECH, INC.

Date: August 30, 1999

By: 

Wendy M. Lee
Reg. No. 40,378

1 DNA Way
So. San Francisco, CA 94080-4990
Phone: (650) 225-1994
Fax: (650) 952-9881



**UNITED STATES DEPARTMENT OF COMMERCE
Patent and Trademark Office**

Address: COMMISSIONER OF PATENTS AND TRADEMARKS
Washington, D.C. 20231

APPLICATION NO.	FILING DATE	FIRST NAMED INVENTOR	ATTORNEY DOCKET NO.
08/146,206	11/17/93	CARTER	F 709P1

HM22/1124
GENENTECH, INC.
1 DNA WAY
SOUTH SAN FRANCISCO CA 94080-4990

EXAMINER

BURKE, J

ART UNIT PAPER NUMBER

1642

DATE MAILED: 11/24/99

Please find below and/or attached an Office communication concerning this application or proceeding.

Commissioner of Patents and Trademarks

08/146,206



UNITED STATES DEPARTMENT OF COMMERCE
Patent and Trademark Office
COMMISSIONER OF PATENTS AND TRADEMARKS
Washington, D.C. 20231

08/146,206 11/17/93

DEA/FCE-1994

F 709P1 VB

SERIAL NUMBER	FILING DATE	FIRST NAMED APPLICANT	ATTORNEY DOCKET NO.
		HM22/1124	

GENENTECH, INC.
1 DNA WAY
SOUTH SAN FRANCISCO CA 94080-4990

BURKE, J

EXAMINER	
1642	
ART UNIT	PAPER NUMBER
	1124799 SS

DATE MAILED:

Please find below a communication from the EXAMINER in charge of this application
Commissioner of Patents

1. Please see attachment.
2. Any inquiry concerning this communication should be directed to Examiner Julie E. Burke, née Reeves, Ph.D, Art Unit 1642, whose telephone number is (703) 308-7553.

J. Burke

JULIE BURKE
PRIMARY EXAMINER

Art Unit: 1642

Attachment
~~DETAILED ACTION~~

98

1. Since this application is eligible for the transitional procedure of 37 CFR 1.129(a), and the fee set forth in 37 CFR 1.17(r) has been timely paid, the finality of the previous Office action is hereby withdrawn pursuant to 37 CFR 1.129(a). Applicant's second submission after final filed on 8/26/98 has been entered.
2. The amendment to claim 113, filed 8/30/97 as Amendment L, Paper no 54 is not in compliance with 37 CFR 1.121 because more than five words are included in the amendment to the claim.
3. The application is not in compliance with the Sequence Requirements for the reasons set forth on the attached raw sequence listing error report. In brief, the application contains a new paper copy of the sequence listing containing 30 sequences, which was added by amendment G filed 10/7/97. The computer readable form of the sequences filed on the same day has only 26 sequences. Therefore the statements on page 3 of Paper no 32 filed 10/7/97 that the paper copy and computer readable form are the same is not sufficient. Additionally, it is not clear which new sequences have been added to the application, whether these sequences are new matter or whether the new sequences have unique SEQ ID NO:s.
4. Since the above-mentioned reply appears to be *bona fide*, and (1) in order to allow applicant the opportunity to amend the claims as they intend and (2) to complete the application with regards to Sequence Requirements, applicant is given a TIME PERIOD of **ONE (1) MONTH or THIRTY (30) DAYS**, from the mailing date of this notice, whichever is longer,

Art Unit: 1642

within which to supply the omission or correction in order to avoid abandonment.

EXTENSIONS OF THIS TIME LIMIT MAY BE GRANTED UNDER 37 CFR 1.136(a).

5. In an interest to complete the record of which papers have been entered in to the application, the following section is enclosed.

6. Claims 1-8, 10-12, 15 and 22-42 have been canceled and claims 43-114 added by Amendment H filed 9/26/98 as paper no 39 along with the Shak Declaration under 1.132.

7. Claims 43, 72, 104-106 and 112 have been amended by Amendment I, filed 11/6/98 as paper no 42.

8. Claims 43-44, 72-73, 104-106, 113-114 have been amended and claims 115-128 added by Amendment J filed 1/15/99 as Paper no 44.

9. Claims 43 and 72 have been amended By amendment K filed 7/16/99 as paper no 51.

10. Claims 106-112 have been canceled, claims 114 and 128 amended by amendment L filed 8/30/99 as paper no 54. Please note in view of the noncompliance with 37 CFR 1.121, the amendment to claim 113 has not been entered.

11. Claims 43-105, 113-128 are pending and under examination.

12. It is noted that the Restriction Requirement set forth in Paper no 48 mailed 3/29/99 has been withdrawn in view of the arguments set forth in Paper no 49 filed 4/9/99.

13. Once the application is in compliance with the Sequence Requirements and the claims are amended as applicant's intended, the claims will be examined for their merits.

Art Unit: 1642

14. Any inquiry concerning this communication or earlier communications from the examiner should be directed to Julie E. Burke, née Reeves, Ph.D, whose telephone number is (703) 308-7553. The examiner can normally be reached on Monday through Friday from 8:00 am to 5:30 pm, with alternate Fridays off. If attempts to reach the examiner by telephone are unsuccessful, the examiner's supervisor, Paula Hutzell, can be reached on (703) 308-4310. Any inquiry of a general nature or relating to the status of this application or proceeding should be directed to the Group receptionist whose telephone number is (703) 308-0196.

15. Papers related to this application may be submitted to Group 1600 by facsimile transmission. Papers should be faxed to Group 1600 via the PTO Fax Center located in Crystal Mall 1. The faxing of such papers must conform with the notice published in the Official Gazette, 1096 OG 30 (November 15, 1989). The CM1 Fax Center telephone number is (703) 305-7401.

Respectfully,



Julie E. Burke, née Reeves, Ph.D.

Primary Patent Examiner

(703) 308-7553

JULIE BURKE
PRIMARY EXAMINER

Please replace the existing sequence listing in the specification with the attached sequence listing (pages 90-105).

IN THE CLAIMS:

Please amend claim 113 as follows:

113. (Twice Amended) A humanized variant of a non-human parent antibody which binds an antigen with better affinity than the parent antibody and comprises a consensus human variable domain of a human heavy chain immunoglobulin subgroup wherein amino acid residues forming Complementarity Determining Regions (CDRs) thereof comprise non-human antibody amino acid residues, and further comprises a Framework Region (FR) substitution where the substituted FR residue: (a) noncovalently binds antigen directly; (b) interacts with a CDR; (c) introduces a glycosylation site which affects the antigen binding or affinity of the antibody; or (d) participates in the V_L - V_H interface by affecting the proximity or orientation of the V_L and V_H regions with respect to one another, wherein the humanized variant binds antigen up to about 3-fold more tightly than the parent antibody binds antigen.

REMARKS

In the above communication, the Examiner states that the amendment to claim 113 filed 8/30/99 (Paper # 54) was not in compliance with 37 CFR 1.121. Accordingly, claim 113 is amended herein in a manner which complies with 37 CFR 1.121. Comments in paragraph 2 on page 2 of the 8/30/99 amendment with respect to the amendment of claim 113 are incorporated herein.

The Examiner further states in the above communication that the substitute sequence listing filed 10/7/97 is not in compliance with the sequence requirements. Applicants submit that their records indicate that the content of the CRF of the sequence listing filed 10/7/97 was indeed the same as the paper copy of that sequence listing filed 10/7/97. Nevertheless, a replacement sequence listing (paper copy and CRF) are filed herewith. In accordance with 37 CFR §§ 1.821 (f) and (g), the undersigned hereby states (a) that the content of the paper and computer readable sequence listings submitted herewith is the same; and (b) that this submission includes no new matter.

With respect to the attached sequence listing, Applicants point out that due to the nonprejudicial cancellation of claim 41 (which referred to SEQ ID NO's 27-30) in the 8/24/98 amendment, SEQ ID NO's 27-30 have been removed from the sequence listing filed herewith.

For the Examiner's convenience, Applicants will summarize here the differences between the presently-filed sequence listing, and the originally-filed (11/17/93) sequence listing:

1. SEQ ID NO:4 was corrected 10/7/97 to correspond to the HUV_HIII sequence in Fig. 1B.
2. SEQ ID NO:19 was corrected 6/2/94 to correspond to the muxCD3 sequence in Fig. 5.
3. SEQ ID NO:23 was amended 6/2/94 to correspond to the pH52-8.0 sequence in Fig. 6A.
4. SEQ ID NO:26 was added 9/2/97 for the huxCD3v1 sequence in Fig. 5.

Corrections to the specification have been made hereinabove as follows: The symbols from Fig. 3 have been corrected on page 9; and the ATCC address has been updated on pages 62 and 84. Applicants submit that no new matter is added by these amendments.

Further prosecution on the merits is anxiously awaited. Should the Examiner have any questions concerning this submission, she is invited to call the undersigned at the number noted below.

Respectfully submitted,
GENENTECH, INC.

Date: December 22, 1999

By: Wm Lee
Wendy M. Lee
Reg. No. 40,378

1 DNA Way
So. San Francisco, CA 94080-4990
Phone: (650) 225-1994
Fax: (650) 952-9881



Sequence Listing

SEQUENCE LISTING

RECEIVED
JAN 03 2000
TECH CENTER 1600/29

(1) GENERAL INFORMATION:

71050

(i) APPLICANT: Carter, Paul J.
Presta, Leonard G.

(ii) TITLE OF INVENTION: Method for Making Humanized Antibodies

(iii) NUMBER OF SEQUENCES: 26

(iv) CORRESPONDENCE ADDRESS:
(A) ADDRESSEE: Genentech, Inc.
(B) STREET: 1 DNA Way
(C) CITY: South San Francisco
(D) STATE: California
(E) COUNTRY: USA
(F) ZIP: 94080

(v) COMPUTER READABLE FORM:
(A) MEDIUM TYPE: 3.5 inch, 1.44 Mb floppy disk
(B) COMPUTER: IBM PC compatible
(C) OPERATING SYSTEM: PC-DOS/MS-DOS
(D) SOFTWARE: WinPatin (Genentech)

(vi) CURRENT APPLICATION DATA:
(A) APPLICATION NUMBER: 08/146206
(B) FILING DATE: 17-Nov-1993
(C) CLASSIFICATION:

M

(vii) PRIOR APPLICATION DATA:
(A) APPLICATION NUMBER: 07/715272
(B) FILING DATE: 14-JUN-1991

(viii) ATTORNEY/AGENT INFORMATION:
(A) NAME: Lee, Wendy M.
(B) REGISTRATION NUMBER: 40,378
(C) REFERENCE/DOCKET NUMBER: P0709P1

(ix) TELECOMMUNICATION INFORMATION:
(A) TELEPHONE: 650/225-1994
(B) TELEFAX: 650/952-9881

(2) INFORMATION FOR SEQ ID NO:1:

(i) SEQUENCE CHARACTERISTICS:
(A) LENGTH: 109 amino acids
(B) TYPE: Amino Acid
(D) TOPOLOGY: Linear

(xi) SEQUENCE DESCRIPTION: SEQ ID NO:1:

Asp	Ile	Gln	Met	Thr	Gln	Ser	Pro	Ser	Ser	Leu	Ser	Ala	Ser	Val
1				5					10					15
Gly	Asp	Arg	Val	Thr	Ile	Thr	Cys	Arg	Ala	Ser	Gln	Asp	Val	Asn
				20					25					30

105

M

Thr Ala Val Ala Trp Tyr Gln Gln Lys Pro Gly Lys Ala Pro Lys
 35 40 45
 Leu Leu Ile Tyr Ser Ala Ser Phe Leu Glu Ser Gly Val Pro Ser
 50 55 60
 Arg Phe Ser Gly Ser Arg Ser Gly Thr Asp Phe Thr Leu Thr Ile
 65 70 75
 Ser Ser Leu Gln Pro Glu Asp Phe Ala Thr Tyr Tyr Cys Gln Gln
 80 85 90
 His Tyr Thr Thr Pro Pro Thr Phe Gly Gln Gly Thr Lys Val Glu
 95 100 105
 Ile Lys Arg Thr
 109

(2) INFORMATION FOR SEQ ID NO:2:

- (i) SEQUENCE CHARACTERISTICS:
 (A) LENGTH: 120 amino acids
 (B) TYPE: Amino Acid
 (D) TOPOLOGY: Linear

(xi) SEQUENCE DESCRIPTION: SEQ ID NO:2:

M!
cut

Glu Val Gln Leu Val Glu Ser Gly Gly Gly Leu Val Gln Pro Gly
 1 5 10 15
 Gly Ser Leu Arg Leu Ser Cys Ala Ala Ser Gly Phe Asn Ile Lys
 20 25 30
 Asp Thr Tyr Ile His Trp Val Arg Gln Ala Pro Gly Lys Gly Leu
 35 40 45
 Glu Trp Val Ala Arg Ile Tyr Pro Thr Asn Gly Tyr Thr Arg Tyr
 50 55 60
 Ala Asp Ser Val Lys Gly Arg Phe Thr Ile Ser Ala Asp Thr Ser
 65 70 75
 Lys Asn Thr Ala Tyr Leu Gln Met Asn Ser Leu Arg Ala Glu Asp
 80 85 90
 Thr Ala Val Tyr Tyr Cys Ser Arg Trp Gly Gly Asp Gly Phe Tyr
 95 100 105
 Ala Met Asp Val Trp Gly Gln Gly Thr Leu Val Thr Val Ser Ser
 110 115 120

(2) INFORMATION FOR SEQ ID NO:3:

- (i) SEQUENCE CHARACTERISTICS:
 (A) LENGTH: 109 amino acids
 (B) TYPE: Amino Acid
 (D) TOPOLOGY: Linear

(xi) SEQUENCE DESCRIPTION: SEQ ID NO:3:

Asp Ile Gln Met Thr Gln Ser Pro Ser Ser Leu Ser Ala Ser Val
1 5 10 15
Gly Asp Arg Val Thr Ile Thr Cys Arg Ala Ser Gln Asp Val Ser
20 25 30
Ser Tyr Leu Ala Trp Tyr Gln Gln Lys Pro Gly Lys Ala Pro Lys
35 40 45
Leu Leu Ile Tyr Ala Ala Ser Ser Leu Glu Ser Gly Val Pro Ser
50 55 60
Arg Phe Ser Gly Ser Gly Ser Gly Thr Asp Phe Thr Leu Thr Ile
65 70 75
Ser Ser Leu Gln Pro Glu Asp Phe Ala Thr Tyr Tyr Cys Gln Gln
80 85 90
Tyr Asn Ser Leu Pro Tyr Thr Phe Gly Gln Gly Thr Lys Val Glu
95 100 105
Ile Lys Arg Thr
109

(2) INFORMATION FOR SEQ ID NO:4:

- (i) SEQUENCE CHARACTERISTICS:
(A) LENGTH: 120 amino acids
(B) TYPE: Amino Acid
(D) TOPOLOGY: Linear

*M
cat*

(xi) SEQUENCE DESCRIPTION: SEQ ID NO:4:

Glu Val Gln Leu Val Glu Ser Gly Gly Gly Leu Val Gln Pro Gly
1 5 10 15
Gly Ser Leu Arg Leu Ser Cys Ala Ala Ser Gly Phe Thr Phe Ser
20 25 30
Asp Tyr Ala Met Ser Trp Val Arg Gln Ala Pro Gly Lys Gly Leu
35 40 45
Glu Trp Val Ala Val Ile Ser Glu Asn Gly Ser Asp Thr Tyr Tyr
50 55 60
Ala Asp Ser Val Lys Gly Arg Phe Thr Ile Ser Arg Asp Asp Ser
65 70 75
Lys Asn Thr Leu Tyr Leu Gln Met Asn Ser Leu Arg Ala Glu Asp
80 85 90
Thr Ala Val Tyr Tyr Cys Ala Arg Asp Arg Gly Gly Ala Val Ser
95 100 105
Tyr Phe Asp Val Trp Gly Gln Gly Thr Leu Val Thr Val Ser Ser
110 115 120

107

M

(2) INFORMATION FOR SEQ ID NO:5:

- (i) SEQUENCE CHARACTERISTICS:
(A) LENGTH: 109 amino acids
(B) TYPE: Amino Acid
(D) TOPOLOGY: Linear

(xi) SEQUENCE DESCRIPTION: SEQ ID NO:5:

Asp Ile Val Met Thr Gln Ser His Lys Phe Met Ser Thr Ser Val
1 5 10 15
Gly Asp Arg Val Ser Ile Thr Cys Lys Ala Ser Gln Asp Val Asn
20 25 30
Thr Ala Val Ala Trp Tyr Gln Gln Lys Pro Gly His Ser Pro Lys
35 40 45
Leu Leu Ile Tyr Ser Ala Ser Phe Arg Tyr Thr Gly Val Pro Asp
50 55 60
Arg Phe Thr Gly Asn Arg Ser Gly Thr Asp Phe Thr Phe Thr Ile
65 70 75
Ser Ser Val Gln Ala Glu Asp Leu Ala Val Tyr Tyr Cys Gln Gln
80 85 90
His Tyr Thr Thr Pro Pro Thr Phe Gly Gly Gly Thr Lys Leu Glu
95 100 105
Ile Lys Arg Ala
109

M!
cut

(2) INFORMATION FOR SEQ ID NO:6:

- (i) SEQUENCE CHARACTERISTICS:
(A) LENGTH: 120 amino acids
(B) TYPE: Amino Acid
(D) TOPOLOGY: Linear

(xi) SEQUENCE DESCRIPTION: SEQ ID NO:6:

Glu Val Gln Leu Gln Gln Ser Gly Pro Glu Leu Val Lys Pro Gly
1 5 10 15
Ala Ser Leu Lys Leu Ser Cys Thr Ala Ser Gly Phe Asn Ile Lys
20 25 30
Asp Thr Tyr Ile His Trp Val Lys Gln Arg Pro Glu Gln Gly Leu
35 40 45
Glu Trp Ile Gly Arg Ile Tyr Pro Thr Asn Gly Tyr Thr Arg Tyr
50 55 60
Asp Pro Lys Phe Gln Asp Lys Ala Thr Ile Thr Ala Asp Thr Ser
65 70 75

108

M

Ser Asn Thr Ala Tyr Leu Gln Val Ser Arg Leu Thr Ser Glu Asp
80 85 90
Thr Ala Val Tyr Tyr Cys Ser Arg Trp Gly Gly Asp Gly Phe Tyr
95 100 105
Ala Met Asp Tyr Trp Gly Gln Gly Ala Ser Val Thr Val Ser Ser
110 115 120

(2) INFORMATION FOR SEQ ID NO:7:

- (i) SEQUENCE CHARACTERISTICS:
 - (A) LENGTH: 27 base pairs
 - (B) TYPE: Nucleic Acid
 - (C) STRANDEDNESS: Single
 - (D) TOPOLOGY: Linear

(xi) SEQUENCE DESCRIPTION: SEQ ID NO:7:

TCCGATATCC AGCTGACCCA GTCTCCA 27

(2) INFORMATION FOR SEQ ID NO:8:

- (i) SEQUENCE CHARACTERISTICS:
 - (A) LENGTH: 31 base pairs
 - (B) TYPE: Nucleic Acid
 - (C) STRANDEDNESS: Single
 - (D) TOPOLOGY: Linear

(xi) SEQUENCE DESCRIPTION: SEQ ID NO:8:

mt
cut
GTTTGATCTC CAGCTTGGA CCHSCDCGA A 31

(2) INFORMATION FOR SEQ ID NO:9:

- (i) SEQUENCE CHARACTERISTICS:
 - (A) LENGTH: 22 base pairs
 - (B) TYPE: Nucleic Acid
 - (C) STRANDEDNESS: Single
 - (D) TOPOLOGY: Linear

(xi) SEQUENCE DESCRIPTION: SEQ ID NO:9:

AGGTSMARCT GCAGSAGTCW GG 22

(2) INFORMATION FOR SEQ ID NO:10:

- (i) SEQUENCE CHARACTERISTICS:
 - (A) LENGTH: 34 base pairs
 - (B) TYPE: Nucleic Acid
 - (C) STRANDEDNESS: Single
 - (D) TOPOLOGY: Linear

(xi) SEQUENCE DESCRIPTION: SEQ ID NO:10:

TGAGGAGACG GTGACCGTGG TCCCTTGCC CCAG 34

(2) INFORMATION FOR SEQ ID NO:11:

- (i) SEQUENCE CHARACTERISTICS:
 - (A) LENGTH: 36 base pairs
 - (B) TYPE: Nucleic Acid
 - (C) STRANDEDNESS: Single
 - (D) TOPOLOGY: Linear

(xi) SEQUENCE DESCRIPTION: SEQ ID NO:11:

GTAGATAAAT CCTCTAACAC AGCCTATCTG CAAATG 36

(2) INFORMATION FOR SEQ ID NO:12:

- (i) SEQUENCE CHARACTERISTICS:
 - (A) LENGTH: 36 base pairs
 - (B) TYPE: Nucleic Acid
 - (C) STRANDEDNESS: Single
 - (D) TOPOLOGY: Linear

(xi) SEQUENCE DESCRIPTION: SEQ ID NO:12:

GTAGATAAAT CCAAATCTAC AGCCTATCTG CAAATG 36

(2) INFORMATION FOR SEQ ID NO:13:

- (i) SEQUENCE CHARACTERISTICS:
 - (A) LENGTH: 36 base pairs
 - (B) TYPE: Nucleic Acid
 - (C) STRANDEDNESS: Single
 - (D) TOPOLOGY: Linear

(xi) SEQUENCE DESCRIPTION: SEQ ID NO:13:

GTAGATAAAT CCTCTTCTAC AGCCTATCTG CAAATG 36

(2) INFORMATION FOR SEQ ID NO:14:

- (i) SEQUENCE CHARACTERISTICS:
 - (A) LENGTH: 68 base pairs
 - (B) TYPE: Nucleic Acid
 - (C) STRANDEDNESS: Single
 - (D) TOPOLOGY: Linear

(xi) SEQUENCE DESCRIPTION: SEQ ID NO:14:

CTTATAAAGG TGTTTCCACC TATAACCAGA AATTCAAGGA TCGTTTCACG 50

ATATCCGTAG ATAAATCC 68

(2) INFORMATION FOR SEQ ID NO:15:

110

M

- (i) SEQUENCE CHARACTERISTICS:
 - (A) LENGTH: 30 base pairs
 - (B) TYPE: Nucleic Acid
 - (C) STRANDEDNESS: Single
 - (D) TOPOLOGY: Linear

(xi) SEQUENCE DESCRIPTION: SEQ ID NO:15:

CTATACCTCC CGTCTGCATT CTGGAGTCCC 30

(2) INFORMATION FOR SEQ ID NO:16:

- (i) SEQUENCE CHARACTERISTICS:
 - (A) LENGTH: 107 amino acids
 - (B) TYPE: Amino Acid
 - (D) TOPOLOGY: Linear

(xi) SEQUENCE DESCRIPTION: SEQ ID NO:16:

Asp Ile Gln Met Thr Gln Thr Thr Ser Ser Leu Ser Ala Ser Leu
 1 5 10 15
 Gly Asp Arg Val Thr Ile Ser Cys Arg Ala Ser Gln Asp Ile Arg
 20 25 30
 Asn Tyr Leu Asn Trp Tyr Gln Gln Lys Pro Asp Gly Thr Val Lys
 35 40 45
 Leu Leu Ile Tyr Tyr Thr Ser Arg Leu His Ser Gly Val Pro Ser
 50 55 60
 Lys Phe Ser Gly Ser Gly Ser Gly Thr Asp Tyr Ser Leu Thr Ile
 65 70 75
 Ser Asn Leu Glu Gln Glu Asp Ile Ala Thr Tyr Phe Cys Gln Gln
 80 85 90
 Gly Asn Thr Leu Pro Trp Thr Phe Ala Gly Gly Thr Lys Leu Glu
 95 100 105
 Ile Lys
 107

*M
C*

(2) INFORMATION FOR SEQ ID NO:17:

- (i) SEQUENCE CHARACTERISTICS:
 - (A) LENGTH: 107 amino acids
 - (B) TYPE: Amino Acid
 - (D) TOPOLOGY: Linear

(xi) SEQUENCE DESCRIPTION: SEQ ID NO:17:

Asp Ile Gln Met Thr Gln Ser Pro Ser Ser Leu Ser Ala Ser Val
 1 5 10 15
 Gly Asp Arg Val Thr Ile Thr Cys Arg Ala Ser Gln Asp Ile Arg
 20 25 30

96

///

M

Asn Tyr Leu Asn Trp Tyr Gln Gln Lys Pro Gly Lys Ala Pro Lys
 35 40 45
 Leu Leu Ile Tyr Tyr Thr Ser Arg Leu Glu Ser Gly Val Pro Ser
 50 55 60
 Arg Phe Ser Gly Ser Gly Ser Gly Thr Asp Tyr Thr Leu Thr Ile
 65 70 75
 Ser Ser Leu Gln Pro Glu Asp Phe Ala Thr Tyr Tyr Cys Gln Gln
 80 85 90
 Gly Asn Thr Leu Pro Trp Thr Phe Gly Gln Gly Thr Lys Val Glu
 95 100 105
 Ile Lys
 107

(2) INFORMATION FOR SEQ ID NO:18:

- (i) SEQUENCE CHARACTERISTICS:
 (A) LENGTH: 107 amino acids
 (B) TYPE: Amino Acid
 (D) TOPOLOGY: Linear

(xi) SEQUENCE DESCRIPTION: SEQ ID NO:18:

*M1
cont*

Asp Ile Gln Met Thr Gln Ser Pro Ser Ser Leu Ser Ala Ser Val
 1 5 10 15
 Gly Asp Arg Val Thr Ile Thr Cys Arg Ala Ser Gln Ser Ile Ser
 20 25 30
 Asn Tyr Leu Ala Trp Tyr Gln Gln Lys Pro Gly Lys Ala Pro Lys
 35 40 45
 Leu Leu Ile Tyr Ala Ala Ser Ser Leu Glu Ser Gly Val Pro Ser
 50 55 60
 Arg Phe Ser Gly Ser Gly Ser Gly Thr Asp Phe Thr Leu Thr Ile
 65 70 75
 Ser Ser Leu Gln Pro Glu Asp Phe Ala Thr Tyr Tyr Cys Gln Gln
 80 85 90
 Tyr Asn Ser Leu Pro Trp Thr Phe Gly Gln Gly Thr Lys Val Glu
 95 100 105
 Ile Lys
 107

(2) INFORMATION FOR SEQ ID NO:19:

- (i) SEQUENCE CHARACTERISTICS:
 (A) LENGTH: 122 amino acids
 (B) TYPE: Amino Acid
 (D) TOPOLOGY: Linear

112

M

(xi) SEQUENCE DESCRIPTION: SEQ ID NO:19:

Glu Val Gln Leu Gln Gln Ser Gly Pro Glu Leu Val Lys Pro Gly
1 5 10 15
Ala Ser Met Lys Ile Ser Cys Lys Ala Ser Gly Tyr Ser Phe Thr
20 25 30
Gly Tyr Thr Met Asn Trp Val Lys Gln Ser His Gly Lys Asn Leu
35 40 45
Glu Trp Met Gly Leu Ile Asn Pro Tyr Lys Gly Val Ser Thr Tyr
50 55 60
Asn Gln Lys Phe Lys Asp Lys Ala Thr Leu Thr Val Asp Lys Ser
65 70 75
Ser Ser Thr Ala Tyr Met Glu Leu Leu Ser Leu Thr Ser Glu Asp
80 85 90
Ser Ala Val Tyr Tyr Cys Ala Arg Ser Gly Tyr Tyr Gly Asp Ser
95 100 105
Asp Trp Tyr Phe Asp Val Trp Gly Ala Gly Thr Thr Val Thr Val
110 115 120
Ser Ser
122

(2) INFORMATION FOR SEQ ID NO:20:

- (i) SEQUENCE CHARACTERISTICS:
(A) LENGTH: 122 amino acids
(B) TYPE: Amino Acid
(D) TOPOLOGY: Linear

*M
cut*

(xi) SEQUENCE DESCRIPTION: SEQ ID NO:20:

Glu Val Gln Leu Val Glu Ser Gly Gly Gly Leu Val Gln Pro Gly
1 5 10 15
Gly Ser Leu Arg Leu Ser Cys Ala Ala Ser Gly Tyr Ser Phe Thr
20 25 30
Gly Tyr Thr Met Asn Trp Val Arg Gln Ala Pro Gly Lys Gly Leu
35 40 45
Glu Trp Val Ala Leu Ile Asn Pro Tyr Lys Gly Val Ser Thr Tyr
50 55 60
Asn Gln Lys Phe Lys Asp Arg Phe Thr Ile Ser Val Asp Lys Ser
65 70 75
Lys Asn Thr Ala Tyr Leu Gln Met Asn Ser Leu Arg Ala Glu Asp
80 85 90
Thr Ala Val Tyr Tyr Cys Ala Arg Ser Gly Tyr Tyr Gly Asp Ser
95 100 105

113

M

Asp Trp Tyr Phe Asp Val Trp Gly Gln Gly Thr Leu Val Thr Val
110 115 120

Ser Ser
122

(2) INFORMATION FOR SEQ ID NO:21:

- (i) SEQUENCE CHARACTERISTICS:
(A) LENGTH: 122 amino acids
(B) TYPE: Amino Acid
(D) TOPOLOGY: Linear

(xi) SEQUENCE DESCRIPTION: SEQ ID NO:21:

Glu Val Gln Leu Val Glu Ser Gly Gly Gly Leu Val Gln Pro Gly
1 5 10 15

Gly Ser Leu Arg Leu Ser Cys Ala Ala Ser Gly Phe Thr Phe Ser
20 25 30

Ser Tyr Ala Met Ser Trp Val Arg Gln Ala Pro Gly Lys Gly Leu
35 40 45

Glu Trp Val Ser Val Ile Ser Gly Asp Gly Gly Ser Thr Tyr Tyr
50 55 60

Ala Asp Ser Val Lys Gly Arg Phe Thr Ile Ser Arg Asp Asn Ser
65 70 75

Lys Asn Thr Leu Tyr Leu Gln Met Asn Ser Leu Arg Ala Glu Asp
80 85 90

Thr Ala Val Tyr Tyr Cys Ala Arg Gly Arg Val Gly Tyr Ser Leu
95 100 105

Ser Gly Leu Tyr Asp Tyr Trp Gly Gln Gly Thr Leu Val Thr Val
110 115 120

Ser Ser
122

(2) INFORMATION FOR SEQ ID NO:22:

- (i) SEQUENCE CHARACTERISTICS:
(A) LENGTH: 454 amino acids
(B) TYPE: Amino Acid
(D) TOPOLOGY: Linear

(xi) SEQUENCE DESCRIPTION: SEQ ID NO:22:

Gln Val Gln Leu Gln Gln Ser Gly Pro Glu Leu Val Lys Pro Gly
1 5 10 15

Ala Ser Val Lys Ile Ser Cys Lys Thr Ser Gly Tyr Thr Phe Thr
20 25 30

114

M

Glu	Tyr	Thr	Met	His	Trp	Met	Lys	Gln	Ser	His	Gly	Lys	Ser	Leu	35	40	45
Glu	Trp	Ile	Gly	Gly	Phe	Asn	Pro	Lys	Asn	Gly	Gly	Ser	Ser	His	50	55	60
Asn	Gln	Arg	Phe	Met	Asp	Lys	Ala	Thr	Leu	Ala	Val	Asp	Lys	Ser	65	70	75
Thr	Ser	Thr	Ala	Tyr	Met	Glu	Leu	Arg	Ser	Leu	Thr	Ser	Glu	Asp	80	85	90
Ser	Gly	Ile	Tyr	Tyr	Cys	Ala	Arg	Trp	Arg	Gly	Leu	Asn	Tyr	Gly	95	100	105
Phe	Asp	Val	Arg	Tyr	Phe	Asp	Val	Trp	Gly	Ala	Gly	Thr	Thr	Val	110	115	120
Thr	Val	Ser	Ser	Ala	Ser	Thr	Lys	Gly	Pro	Ser	Val	Phe	Pro	Leu	125	130	135
Ala	Pro	Ser	Ser	Lys	Ser	Thr	Ser	Gly	Gly	Thr	Ala	Ala	Leu	Gly	140	145	150
Cys	Leu	Val	Lys	Asp	Tyr	Phe	Pro	Glu	Pro	Val	Thr	Val	Ser	Trp	155	160	165
Asn	Ser	Gly	Ala	Leu	Thr	Ser	Gly	Val	His	Thr	Phe	Pro	Ala	Val	170	175	180
Leu	Gln	Ser	Ser	Gly	Leu	Tyr	Ser	Leu	Ser	Ser	Val	Val	Thr	Val	185	190	195
Pro	Ser	Ser	Ser	Leu	Gly	Thr	Gln	Thr	Tyr	Ile	Cys	Asn	Val	Asn	200	205	210
His	Lys	Pro	Ser	Asn	Thr	Lys	Val	Asp	Lys	Lys	Val	Glu	Pro	Lys	215	220	225
Ser	Cys	Asp	Lys	Thr	His	Thr	Cys	Pro	Pro	Cys	Pro	Ala	Pro	Glu	230	235	240
Leu	Leu	Gly	Gly	Pro	Ser	Val	Phe	Leu	Phe	Pro	Pro	Lys	Pro	Lys	245	250	255
Asp	Thr	Leu	Met	Ile	Ser	Arg	Thr	Pro	Glu	Val	Thr	Cys	Val	Val	260	265	270
Val	Asp	Val	Ser	His	Glu	Asp	Pro	Glu	Val	Lys	Phe	Asn	Trp	Tyr	275	280	285
Val	Asp	Gly	Val	Glu	Val	His	Asn	Ala	Lys	Thr	Lys	Pro	Arg	Glu	290	295	300
Glu	Gln	Tyr	Asn	Ser	Thr	Tyr	Arg	Val	Val	Ser	Val	Leu	Thr	Val	305	310	315

ml cut

115

M

Leu His Gln Asp Trp Leu Asn Gly Lys Glu Tyr Lys Cys Lys Val
 320 325 330
 Ser Asn Lys Ala Leu Pro Ala Pro Ile Glu Lys Thr Ile Ser Lys
 335 340 345
 Ala Lys Gly Gln Pro Arg Glu Pro Gln Val Tyr Thr Leu Pro Pro
 350 355 360
 Ser Arg Glu Glu Met Thr Lys Asn Gln Val Ser Leu Thr Cys Leu
 365 370 375
 Val Lys Gly Phe Tyr Pro Ser Asp Ile Ala Val Glu Trp Glu Ser
 380 385 390
 Asn Gly Gln Pro Glu Asn Asn Tyr Lys Thr Thr Pro Pro Val Leu
 395 400 405
 Asp Ser Asp Gly Ser Phe Phe Leu Tyr Ser Lys Leu Thr Val Asp
 410 415 420
 Lys Ser Arg Trp Gln Gln Gly Asn Val Phe Ser Cys Ser Val Met
 425 430 435
 His Glu Ala Leu His Asn His Tyr Thr Gln Lys Ser Leu Ser Leu
 440 445 450
 Ser Pro Gly Lys
 454

(2) INFORMATION FOR SEQ ID NO:23:

ml cont

- (i) SEQUENCE CHARACTERISTICS:
 (A) LENGTH: 469 amino acids
 (B) TYPE: Amino Acid
 (D) TOPOLOGY: Linear

(xi) SEQUENCE DESCRIPTION: SEQ ID NO:23:

Met Gly Trp Ser Cys Ile Ile Leu Phe Leu Val Ala Thr Ala Thr
 1 5 10 15
 Gly Val His Ser Glu Val Gln Leu Val Glu Ser Gly Gly Gly Leu
 20 25 30
 Val Gln Pro Gly Gly Ser Leu Arg Leu Ser Cys Ala Thr Ser Gly
 35 40 45
 Tyr Thr Phe Thr Glu Tyr Thr Met His Trp Met Arg Gln Ala Pro
 50 55 60
 Gly Lys Gly Leu Glu Trp Val Ala Gly Ile Asn Pro Lys Asn Gly
 65 70 75
 Gly Thr Ser His Asn Gln Arg Phe Met Asp Arg Phe Thr Ile Ser
 80 85 90

116

M

Val	Asp	Lys	Ser	Thr	Ser	Thr	Ala	Tyr	Met	Gln	Met	Asn	Ser	Leu
				95					100					105
Arg	Ala	Glu	Asp	Thr	Ala	Val	Tyr	Tyr	Cys	Ala	Arg	Trp	Arg	Gly
				110					115					120
Leu	Asn	Tyr	Gly	Phe	Asp	Val	Arg	Tyr	Phe	Asp	Val	Trp	Gly	Gln
				125					130					135
Gly	Thr	Leu	Val	Thr	Val	Ser	Ser	Ala	Ser	Thr	Lys	Gly	Pro	Ser
				140					145					150
Val	Phe	Pro	Leu	Ala	Pro	Cys	Ser	Arg	Ser	Thr	Ser	Glu	Ser	Thr
				155					160					165
Ala	Ala	Leu	Gly	Cys	Leu	Val	Lys	Asp	Tyr	Phe	Pro	Glu	Pro	Val
				170					175					180
Thr	Val	Ser	Trp	Asn	Ser	Gly	Ala	Leu	Thr	Ser	Gly	Val	His	Thr
				185					190					195
Phe	Pro	Ala	Val	Leu	Gln	Ser	Ser	Gly	Leu	Tyr	Ser	Leu	Ser	Ser
				200					205					210
Val	Val	Thr	Val	Thr	Ser	Ser	Asn	Phe	Gly	Thr	Gln	Thr	Tyr	Thr
				215					220					225
Cys	Asn	Val	Asp	His	Lys	Pro	Ser	Asn	Thr	Lys	Val	Asp	Lys	Thr
				230					235					240
Val	Glu	Arg	Lys	Cys	Cys	Val	Glu	Cys	Pro	Pro	Cys	Pro	Ala	Pro
				245					250					255
Pro	Val	Ala	Gly	Pro	Ser	Val	Phe	Leu	Phe	Pro	Pro	Lys	Pro	Lys
				260					265					270
Asp	Thr	Leu	Met	Ile	Ser	Arg	Thr	Pro	Glu	Val	Thr	Cys	Val	Val
				275					280					285
Val	Asp	Val	Ser	His	Glu	Asp	Pro	Glu	Val	Gln	Phe	Asn	Trp	Tyr
				290					295					300
Val	Asp	Gly	Met	Glu	Val	His	Asn	Ala	Lys	Thr	Lys	Pro	Arg	Glu
				305					310					315
Glu	Gln	Phe	Asn	Ser	Thr	Phe	Arg	Val	Val	Ser	Val	Leu	Thr	Val
				320					325					330
Val	His	Gln	Asp	Trp	Leu	Asn	Gly	Lys	Glu	Tyr	Lys	Cys	Lys	Val
				335					340					345
Ser	Asn	Lys	Gly	Leu	Pro	Ala	Pro	Ile	Glu	Lys	Thr	Ile	Ser	Lys
				350					355					360
Thr	Lys	Gly	Gln	Pro	Arg	Glu	Pro	Gln	Val	Tyr	Thr	Leu	Pro	Pro
				365					370					375

M!
cut

117

M

Ser Arg Glu Glu Met Thr Lys Asn Gln Val Ser Leu Thr Cys Leu
380 385 390

Val Lys Gly Phe Tyr Pro Ser Asp Ile Ala Val Glu Trp Glu Ser
395 400 405

Asn Gly Gln Pro Glu Asn Asn Tyr Lys Thr Thr Pro Pro Met Leu
410 415 420

Asp Ser Asp Gly Ser Phe Phe Leu Tyr Ser Lys Leu Thr Val Asp
425 430 435

Lys Ser Arg Trp Gln Gln Gly Asn Val Phe Ser Cys Ser Val Met
440 445 450

His Glu Ala Leu His Asn His Tyr Thr Gln Lys Ser Leu Ser Leu
455 460 465

Ser Pro Gly Lys
469

(2) INFORMATION FOR SEQ ID NO:24:

- (i) SEQUENCE CHARACTERISTICS:
 - (A) LENGTH: 214 amino acids
 - (B) TYPE: Amino Acid
 - (D) TOPOLOGY: Linear

(xi) SEQUENCE DESCRIPTION: SEQ ID NO:24:

my wt

Asp Val Gln Met Thr Gln Thr Thr Ser Ser Leu Ser Ala Ser Leu
1 5 10 15

Gly Asp Arg Val Thr Ile Asn Cys Arg Ala Ser Gln Asp Ile Asn
20 25 30

Asn Tyr Leu Asn Trp Tyr Gln Gln Lys Pro Asn Gly Thr Val Lys
35 40 45

Leu Leu Ile Tyr Tyr Thr Ser Thr Leu His Ser Gly Val Pro Ser
50 55 60

Arg Phe Ser Gly Ser Gly Ser Gly Thr Asp Tyr Ser Leu Thr Ile
65 70 75

Ser Asn Leu Asp Gln Glu Asp Ile Ala Thr Tyr Phe Cys Gln Gln
80 85 90

Gly Asn Thr Leu Pro Pro Thr Phe Gly Gly Gly Thr Lys Val Glu
95 100 105

Ile Lys Arg Thr Val Ala Ala Pro Ser Val Phe Ile Phe Pro Pro
110 115 120

Ser Asp Glu Gln Leu Lys Ser Gly Thr Ala Ser Val Val Cys Leu
125 130 135

118

M

Leu Asn Asn Phe Tyr Pro Arg Glu Ala Lys Val Gln Trp Lys Val
 140 145 150
 Asp Asn Ala Leu Gln Ser Gly Asn Ser Gln Glu Ser Val Thr Glu
 155 160 165
 Gln Asp Ser Lys Asp Ser Thr Tyr Ser Leu Ser Ser Thr Leu Thr
 170 175 180
 Leu Ser Lys Ala Asp Tyr Glu Lys His Lys Val Tyr Ala Cys Glu
 185 190 195
 Val Thr His Gln Gly Leu Ser Ser Pro Val Thr Lys Ser Phe Asn
 200 205 210
 Arg Gly Glu Cys
 214

(2) INFORMATION FOR SEQ ID NO:25:

- (i) SEQUENCE CHARACTERISTICS:
 - (A) LENGTH: 233 amino acids
 - (B) TYPE: Amino Acid
 - (D) TOPOLOGY: Linear

(xi) SEQUENCE DESCRIPTION: SEQ ID NO:25:

m' cut

Met Gly Trp Ser Cys Ile Ile Leu Phe Leu Val Ala Thr Ala Thr
 1 5 10 15
 Gly Val His Ser Asp Ile Gln Met Thr Gln Ser Pro Ser Ser Leu
 20 25 30
 Ser Ala Ser Val Gly Asp Arg Val Thr Ile Thr Cys Arg Ala Ser
 35 40 45
 Gln Asp Ile Asn Asn Tyr Leu Asn Trp Tyr Gln Gln Lys Pro Gly
 50 55 60
 Lys Ala Pro Lys Leu Leu Ile Tyr Tyr Thr Ser Thr Leu His Ser
 65 70 75
 Gly Val Pro Ser Arg Phe Ser Gly Ser Gly Ser Gly Thr Asp Tyr
 80 85 90
 Thr Leu Thr Ile Ser Ser Leu Gln Pro Glu Asp Phe Ala Thr Tyr
 95 100 105
 Tyr Cys Gln Gln Gly Asn Thr Leu Pro Pro Thr Phe Gly Gln Gly
 110 115 120
 Thr Lys Val Glu Ile Lys Arg Thr Val Ala Ala Pro Ser Val Phe
 125 130 135
 Ile Phe Pro Pro Ser Asp Glu Gln Leu Lys Ser Gly Thr Ala Ser
 140 145 150

119

M

Val Val Cys Leu Leu Asn Asn Phe Tyr Pro Arg Glu Ala Lys Val
155 160 165

Gln Trp Lys Val Asp Asn Ala Leu Gln Ser Gly Asn Ser Gln Glu
170 175 180

Ser Val Thr Glu Gln Asp Ser Lys Asp Ser Thr Tyr Ser Leu Ser
185 190 195

Ser Thr Leu Thr Leu Ser Lys Ala Asp Tyr Glu Lys His Lys Val
200 205 210

Tyr Ala Cys Glu Val Thr His Gln Gly Leu Ser Ser Pro Val Thr
215 220 225

Lys Ser Phe Asn Arg Gly Glu Cys
230 233

(2) INFORMATION FOR SEQ ID NO:26:

- (i) SEQUENCE CHARACTERISTICS:
 - (A) LENGTH: 122 amino acids
 - (B) TYPE: Amino Acid
 - (D) TOPOLOGY: Linear

Mx

(xi) SEQUENCE DESCRIPTION: SEQ ID NO:26:

Glu Val Gln Leu Val Glu Ser Gly Gly Gly Leu Val Gln Pro Gly
1 5 10 15

Gly Ser Leu Arg Leu Ser Cys Ala Ala Ser Gly Tyr Ser Phe Thr
20 25 30

Gly Tyr Thr Met Asn Trp Val Arg Gln Ala Pro Gly Lys Gly Leu
35 40 45

Glu Trp Val Ala Leu Ile Asn Pro Tyr Lys Gly Val Thr Thr Tyr
50 55 60

Ala Asp Ser Val Lys Gly Arg Phe Thr Ile Ser Val Asp Lys Ser
65 70 75

Lys Asn Thr Ala Tyr Leu Gln Met Asn Ser Leu Arg Ala Glu Asp
80 85 90

Thr Ala Val Tyr Tyr Cys Ala Arg Ser Gly Tyr Tyr Gly Asp Ser
95 100 105

Asp Trp Tyr Phe Asp Val Trp Gly Gln Gly Thr Leu Val Thr Val
110 115 120

Ser Ser
122

120

M

J. Burke

1642

PAGE: 1

RAW SEQUENCE LISTING
PATENT APPLICATION US/08/146,206C

DATE: 01/20/2000
TIME: 01:04:04

INPUT SET: S34518.raw

This Raw Listing contains the General
Information Section and up to the first 5 pages. **ENTERED**

1 SEQUENCE LISTING
2
3 (1) General Information:
4
5 (i) APPLICANT: Carter, Paul J.
6 Presta, Leonard G.
7
8 (ii) TITLE OF INVENTION: Method for Making Humanized Antibodies
9
10 (iii) NUMBER OF SEQUENCES: 26
11
12 (iv) CORRESPONDENCE ADDRESS:
13 (A) ADDRESSEE: Genentech, Inc.
14 (B) STREET: 1 DNA Way
15 (C) CITY: South San Francisco
16 (D) STATE: California
17 (E) COUNTRY: USA
18 (F) ZIP: 94080
19
20 (v) COMPUTER READABLE FORM:
21 (A) MEDIUM TYPE: 3.5 inch, 1.44 Mb floppy disk
22 (B) COMPUTER: IBM PC compatible
23 (C) OPERATING SYSTEM: PC-DOS/MS-DOS
24 (D) SOFTWARE: WinPatin (Genentech)
25
26 (vi) CURRENT APPLICATION DATA:
27 (A) APPLICATION NUMBER: 08/146206
28 (B) FILING DATE: 17-Nov-1993
29 (C) CLASSIFICATION:
30
31 (vii) PRIOR APPLICATION DATA:
32 (A) APPLICATION NUMBER: 07/715272
33 (B) FILING DATE: 14-JUN-1991
34
35 (viii) ATTORNEY/AGENT INFORMATION:
36 (A) NAME: Lee, Wendy M.
37 (B) REGISTRATION NUMBER: 40,378
38 (C) REFERENCE/DOCKET NUMBER: P0709P1
39
40 (ix) TELECOMMUNICATION INFORMATION:
41 (A) TELEPHONE: 650/225-1994
42 (B) TELEFAX: 650/952-9881
43 (2) INFORMATION FOR SEQ ID NO:1:
44
45 (i) SEQUENCE CHARACTERISTICS:
46 (A) LENGTH: 109 amino acids

RAW SEQUENCE LISTING
PATENT APPLICATION US/08/146,206C

DATE: 01/20/2000
 TIME: 01:04:04

INPUT SET: S34518.raw

```

47         (B) TYPE: Amino Acid
48         (D) TOPOLOGY: Linear
49
50     (xi) SEQUENCE DESCRIPTION: SEQ ID NO:1:
51
52     Asp Ile Gln Met Thr Gln Ser Pro Ser Ser Leu Ser Ala Ser Val
53         1             5             10             15
54
55     Gly Asp Arg Val Thr Ile Thr Cys Arg Ala Ser Gln Asp Val Asn
56             20             25             30
57
58     Thr Ala Val Ala Trp Tyr Gln Gln Lys Pro Gly Lys Ala Pro Lys
59             35             40             45
60
61     Leu Leu Ile Tyr Ser Ala Ser Phe Leu Glu Ser Gly Val Pro Ser
62             50             55             60
63
64     Arg Phe Ser Gly Ser Arg Ser Gly Thr Asp Phe Thr Leu Thr Ile
65             65             70             75
66
67     Ser Ser Leu Gln Pro Glu Asp Phe Ala Thr Tyr Tyr Cys Gln Gln
68             80             85             90
69
70     His Tyr Thr Thr Pro Pro Thr Phe Gly Gln Gly Thr Lys Val Glu
71             95             100            105
72
73     Ile Lys Arg Thr
74             109
75
76     (2) INFORMATION FOR SEQ ID NO:2:
77
78     (i) SEQUENCE CHARACTERISTICS:
79         (A) LENGTH: 120 amino acids
80         (B) TYPE: Amino Acid
81         (D) TOPOLOGY: Linear
82
83     (xi) SEQUENCE DESCRIPTION: SEQ ID NO:2:
84
85     Glu Val Gln Leu Val Glu Ser Gly Gly Gly Leu Val Gln Pro Gly
86         1             5             10             15
87
88     Gly Ser Leu Arg Leu Ser Cys Ala Ala Ser Gly Phe Asn Ile Lys
89             20             25             30
90
91     Asp Thr Tyr Ile His Trp Val Arg Gln Ala Pro Gly Lys Gly Leu
92             35             40             45
93
94     Glu Trp Val Ala Arg Ile Tyr Pro Thr Asn Gly Tyr Thr Arg Tyr
95             50             55             60
96
97     Ala Asp Ser Val Lys Gly Arg Phe Thr Ile Ser Ala Asp Thr Ser
98             65             70             75
99
  
```

RAW SEQUENCE LISTING
PATENT APPLICATION US/08/146,206C

DATE: 01/20/2000
 TIME: 01:04:04

INPUT SET: S34518.raw

```

100 Lys Asn Thr Ala Tyr Leu Gln Met Asn Ser Leu Arg Ala Glu Asp
101                               80                               85                               90
102
103 Thr Ala Val Tyr Tyr Cys Ser Arg Trp Gly Gly Asp Gly Phe Tyr
104                               95                               100                               105
105
106 Ala Met Asp Val Trp Gly Gln Gly Thr Leu Val Thr Val Ser Ser
107                               110                               115                               120
108

```

(2) INFORMATION FOR SEQ ID NO:3:

(i) SEQUENCE CHARACTERISTICS:

```

111
112 (A) LENGTH: 109 amino acids
113 (B) TYPE: Amino Acid
114 (D) TOPOLOGY: Linear
115

```

(xi) SEQUENCE DESCRIPTION: SEQ ID NO:3:

```

116
117
118 Asp Ile Gln Met Thr Gln Ser Pro Ser Ser Leu Ser Ala Ser Val
119   1                               5                               10                               15
120
121 Gly Asp Arg Val Thr Ile Thr Cys Arg Ala Ser Gln Asp Val Ser
122                               20                               25                               30
123
124 Ser Tyr Leu Ala Trp Tyr Gln Gln Lys Pro Gly Lys Ala Pro Lys
125                               35                               40                               45
126
127 Leu Leu Ile Tyr Ala Ala Ser Ser Leu Glu Ser Gly Val Pro Ser
128                               50                               55                               60
129
130 Arg Phe Ser Gly Ser Gly Ser Gly Thr Asp Phe Thr Leu Thr Ile
131                               65                               70                               75
132
133 Ser Ser Leu Gln Pro Glu Asp Phe Ala Thr Tyr Tyr Cys Gln Gln
134                               80                               85                               90
135
136 Tyr Asn Ser Leu Pro Tyr Thr Phe Gly Gln Gly Thr Lys Val Glu
137                               95                               100                               105
138
139 Ile Lys Arg Thr
140                               109
141

```

(2) INFORMATION FOR SEQ ID NO:4:

(i) SEQUENCE CHARACTERISTICS:

```

142
143
144 (A) LENGTH: 120 amino acids
145 (B) TYPE: Amino Acid
146 (D) TOPOLOGY: Linear
147
148

```

(xi) SEQUENCE DESCRIPTION: SEQ ID NO:4:

```

149
150
151 Glu Val Gln Leu Val Glu Ser Gly Gly Gly Leu Val Gln Pro Gly
152   1                               5                               10                               15

```

RAW SEQUENCE LISTING
PATENT APPLICATION US/08/146,206C

DATE: 01/20/2000
 TIME: 01:04:05

INPUT SET: S34518.raw

```

153
154 Gly Ser Leu Arg Leu Ser Cys Ala Ala Ser Gly Phe Thr Phe Ser
155                20                25                30
156
157 Asp Tyr Ala Met Ser Trp Val Arg Gln Ala Pro Gly Lys Gly Leu
158                35                40                45
159
160 Glu Trp Val Ala Val Ile Ser Glu Asn Gly Ser Asp Thr Tyr Tyr
161                50                55                60
162
163 Ala Asp Ser Val Lys Gly Arg Phe Thr Ile Ser Arg Asp Asp Ser
164                65                70                75
165
166 Lys Asn Thr Leu Tyr Leu Gln Met Asn Ser Leu Arg Ala Glu Asp
167                80                85                90
168
169 Thr Ala Val Tyr Tyr Cys Ala Arg Asp Arg Gly Gly Ala Val Ser
170                95                100               105
171
172 Tyr Phe Asp Val Trp Gly Gln Gly Thr Leu Val Thr Val Ser Ser
173                110               115               120
174
175 (2) INFORMATION FOR SEQ ID NO:5:
176
177   (i) SEQUENCE CHARACTERISTICS:
178       (A) LENGTH: 109 amino acids
179       (B) TYPE: Amino Acid
180       (D) TOPOLOGY: Linear
181
182   (xi) SEQUENCE DESCRIPTION: SEQ ID NO:5:
183
184 Asp Ile Val Met Thr Gln Ser His Lys Phe Met Ser Thr Ser Val
185   1                5                10                15
186
187 Gly Asp Arg Val Ser Ile Thr Cys Lys Ala Ser Gln Asp Val Asn
188                20                25                30
189
190 Thr Ala Val Ala Trp Tyr Gln Gln Lys Pro Gly His Ser Pro Lys
191                35                40                45
192
193 Leu Leu Ile Tyr Ser Ala Ser Phe Arg Tyr Thr Gly Val Pro Asp
194                50                55                60
195
196 Arg Phe Thr Gly Asn Arg Ser Gly Thr Asp Phe Thr Phe Thr Ile
197                65                70                75
198
199 Ser Ser Val Gln Ala Glu Asp Leu Ala Val Tyr Tyr Cys Gln Gln
200                80                85                90
201
202 His Tyr Thr Thr Pro Pro Thr Phe Gly Gly Gly Thr Lys Leu Glu
203                95                100               105
204
205 Ile Lys Arg Ala

```

PAGE: 1

SEQUENCE VERIFICATION REPORT
PATENT APPLICATION US/08/146,206C

DATE: 01/20/2000
TIME: 01:04:05

INPUT SET: S34518.raw

Line	Error	Original Text
27	Wrong application Serial Number	(A) APPLICATION NUMBER: 08/146206



**UNITED STATES DEPARTMENT OF COMMERCE
Patent and Trademark Office**

Address: COMMISSIONER OF PATENTS AND TRADEMARKS
Washington, D.C. 20231

APPLICATION NO.	FILING DATE	FIRST NAMED INVENTOR	ATTORNEY DOCKET NO.
08/146,206	11/17/93	CARTER	P 709P1

HM22/1025
 GENENTECH, INC.
 1 DNA WAY
 SOUTH SAN FRANCISCO CA 94080-4990

EXAMINER

DAVIS, M

ART UNIT	PAPER NUMBER
----------	--------------

1642
DATE MAILED: 10/25/00

Please find below and/or attached an Office communication concerning this application or proceeding.

Commissioner of Patents and Trademarks

Office Action Summary

Application No. 08/146,206	Applicant(s)
Examiner	Group Art Unit 1642

—The MAILING DATE of this communication appears on the cover sheet beneath the correspondence address—

Period for Reply

A SHORTENED STATUTORY PERIOD FOR REPLY IS SET TO EXPIRE 3 MONTH(S) FROM THE MAILING DATE OF THIS COMMUNICATION.

- Extensions of time may be available under the provisions of 37 CFR 1.136(a). In no event, however, may a reply be timely filed after SIX (6) MONTHS from the mailing date of this communication.
- If the period for reply specified above is less than thirty (30) days, a reply within the statutory minimum of thirty (30) days will be considered timely.
- If NO period for reply is specified above, such period shall, by default, expire SIX (6) MONTHS from the mailing date of this communication.
- Failure to reply within the set or extended period for reply will, by statute, cause the application to become ABANDONED (35 U.S.C. § 133).

Status

- Responsive to communication(s) filed on 8/30/99
- This action is FINAL.
- Since this application is in condition for allowance except for formal matters, prosecution as to the merits is closed in accordance with the practice under *Ex parte Quayle*, 1935 C.D. 11; 453 O.G. 213.

Disposition of Claims

- Claim(s) 43-105, 113-128 is/are pending in the application.
- Of the above claim(s) _____ is/are withdrawn from consideration.
- Claim(s) _____ is/are allowed.
- Claim(s) 43-105, 113-128 is/are rejected.
- Claim(s) _____ is/are objected to.
- Claim(s) _____ are subject to restriction or election requirement.

Application Papers

- See the attached Notice of Draftsperson's Patent Drawing Review, PTO-948.
- The proposed drawing correction, filed on _____ is approved disapproved.
- The drawing(s) filed on _____ is/are objected to by the Examiner.
- The specification is objected to by the Examiner.
- The oath or declaration is objected to by the Examiner.

Priority under 35 U.S.C. § 119 (a)-(d)

- Acknowledgment is made of a claim for foreign priority under 35 U.S.C. § 119(a)-(d).
 - All Some* None of the CERTIFIED copies of the priority documents have been received.
 - received in Application No. (Series Code/Serial Number) _____
 - received in this national stage application from the International Bureau (PCT Rule 1.7.2(a)).

*Certified copies not received: _____

Attachment(s)

- Information Disclosure Statement(s), PTO-1449, Paper No(s). _____
- Notice of Reference(s) Cited, PTO-892
- Notice of Draftsperson's Patent Drawing Review, PTO-948
- Interview Summary, PTO-413
- Notice of Informal Patent Application, PTO-152
- Other _____

Office Action Summary

Art Unit: 1642

Effective February 7, 1998, the Group Art Unit location has been changed, and the examiner of the application has been changed. To aid in correlating any papers for this application, all further correspondence regarding this application should be directed to Minh-Tam Davis, Group Art Unit 1642.

Since this application is eligible for the transitional procedure of 37 CFR 1.129(a), and the fee set forth in 37 CFR 1.17(r) has been timely paid, the finality of the previous office action has been withdrawn pursuant to 37 CFR 1.129(a). Applicant's amendment filed on 08/26/98 has been entered.

The text of those sections of Title 35, U.S. Code not included in this action can be found in a prior Office action.

Applicant cancels claims 106-112, and adds new claims 115-128, which are related to claims 43-105, and are not new matter.

Accordingly, claims 43-105, 113-128 are being examined.

The following are the remaining rejections.

REJECTION UNDER 35 USC 112 FIRST PARAGRAPH, SCOPE, NEW REJECTION

Claims 43-105, 113-128 are rejected under 35 U.S.C. 112, first paragraph, because the specification, while being enabling for humanized antibody muMAb4D5, and an anti-CD3 antibody, or variable domains thereof, comprising CDR amino acids which bind specifically to p185, or CD3, does not reasonably provide enablement for any humanized antibody, or variable

Art Unit: 1642

domain thereof, comprising CDR amino acids which binds non-specifically to any antigen, wherein the framework region amino acids are substituted at a site selected from the group consisting of 4L, 38L, 43L, 44L, 58L, 62L, 65L, 66L, 67L, 68L, 69L, 73L, 85L, 98L, 2H, 4H, 36H, 39H, 43H, 45H, 69H, 70H, 74H, and 92H, or of 24H, 73H, 76H, 78H and 93H, for treating any chronic diseases. The specification does not enable any person skilled in the art to which it pertains, or with which it is most nearly connected, to make and use the invention commensurate in scope with these claims.

Claims 43-105, 113-128 are drawn to a humanized antibody, or variable domain thereof, comprising CDR amino acids which bind an antigen, or which bind p185^{HER2}. The framework region amino acids of said antibody or variable domain are substituted at a site selected from the group consisting of 4L, 38L, 43L, 44L, 58L, 62L, 65L, 66L, 67L, 68L, 69L, 73L, 85L, 98L, 2H, 4H, 36H, 39H, 43H, 45H, 69H, 70H, 74H, and 92H, or of 24H, 73H, 76H, 78H and 93H. Claim 105 is further drawn to a humanized antibody which lacks immunogenicity upon repeated administration for treating a chronic disease, and wherein its non-human CDR amino acids bind an antigen.

The specification discloses examples of humanized antibody muMAB4D5, anti-CD3, and anti-CD18 antibody, or variable domain thereof, comprising CDR amino acids which bind specifically to p185, CD3, and CD18, respectively. The substituted framework residues for the heavy chain of antibody muMAB4D5 are amino acids number 71, 73, 78, 93, and for the light chains are amino acid number 66 (table 3, and p.68). Only one humanized antibody, huMab4D5-8,

Art Unit: 1642

with all of the above five substitutions in the framework region binds to p185 3-fold more tightly than the murine counterpart. The humanized antibodies, huMab4D5-2 and huMab4D5-3, with one and four substitutions in the framework region, respectively, are, however, at least 10-fold less potent than the murine counterpart, having a K_d of 4.7nM and 4.4nM, respectively, as compared to a K_d value of 0.30nM of the murine counterpart. The substituted framework residues for the heavy chain of antibody anti-CD3 are amino acids number 75 and 76. Although the specification discloses that humanized anti-CD3 antibody enhances the cytotoxic effects of cytotoxic T cells 4-fold against tumor cells expressing p185^{HER2}, there is no disclosure in the specification concerning the binding affinity of the humanized anti-CD3 or anti-CD18 as compared to the murine counterpart. The claims however encompass any humanized antibody, without any specificity, binding to p185^{HER2} or any antigen, with just any one of substitution at a site selected from the group consisting of 4L, 38L, 43L, 44L, 58L, 62L, 65L, 66L, 67L, 68L, 69L, 73L, 85L, 98L, 2H, 4H, 36H, 39H, 43H, 45H, 69H, 70H, 74H, and 92H, of 24H, 73H, 76H, 78H and 93H. The claims further encompass any humanized antibody for treating any chronic disease.

One cannot extrapolate from humanizing one antibody, which binds to p185^{HER2} 3-fold more tightly than the murine counterpart, to humanizing any antibody, wherein its affinity would be up to 3-fold or at least 3-fold more tightly than the murine counterpart, or wherein its affinity would be still intact for therapeutic purposes. In addition, one cannot extrapolate from humanizing an anti-p185 antibody by substitution at all five framework amino acids number H71, H73, H78, H93 and L66 in an anti-p185 antibody, or from humanizing an anti-CD3 antibody by

Art Unit: 1642

substitution at both framework amino acids number H75 and H76 in an anti-CD3 antibody, with humanizing any antibody by substitution at only any one amino acid selected from the group consisting of 4L, 38L, 43L, 44L, 58L, 62L, 65L, 66L, 67L, 68L, 69L, 73L, 85L, 98L, 2H, 4H, 36H, 39H, 43H, 45H, 69H, 70H, 74H, and 92H, or of 24H, 73H, 76H, 78H and 93H. Patent '101 teach that different antibodies require different combinations of different substitutions in the light chain and heavy chain (table 1). Even the specification discloses that only one variant, huMab4D5-8, wherein all five framework amino acids number H71, H73, H78, H93 and L66 are substituted, binds to p185 3-fold more tightly than the murine counterpart. Other variants, with only one or even four substitutions have much less binding affinity than the murine counterpart(table 3). Thus it is unpredictable that substitution at only one framework amino acid in any antibody, or any kind of combination of framework amino acid substitutions would result in a humanized antibody that binds to its antigen 3-fold more tightly than its murine counterpart, or retains adequate affinity for therapeutic purposes. The specification does not disclose whether substitution at only one of the claimed amino acid positions would produce a humanized antibody that has 3-fold more in affinity as the murine counterpart, or retains adequate affinity for therapeutic purposes. The specification does not disclose which combination of what substituted framework amino acids, other than H71, H73, H78, H93 and L66 for anti-p185 antibody, and H75 and H76 in anti-CD3 antibody would produce a humanized antibody that has 3-fold more in affinity as the murine counterpart, or retains adequate affinity for therapeutic purposes. It is well known in the art that not any substitution at any amino acids would produce a humanized

Art Unit: 1642

antibody having an affinity similar to the murine counterpart, unless it is tested by binding assays. The specification provides insufficient guidance with regard to the issues raised above and provides no working examples which would provide guidance to one skilled in the art and no evidence has been provided which would allow one of skill in the art to make the claimed humanized antibodies with a reasonable expectation of success. In view of the above, one of skill in the art would be forced into undue experimentation to practice the claimed invention.

Moreover, a humanized antibody that does not have a specificity for a particular antigen is of little practical use for treating a chronic disease, because said antibody would not target to the target tissues. In addition, although the specification discloses that murine anti-p185^{HER2} antibody has been successfully used in treating tumor cell growth in culture (p.5), p185^{HER2} and CD-3 are not specific for any tissues responsible for chronic disease, e.g. chronic headache, chronic lung inflammation, or chronic kidney disease. The specification does not disclose how to treat any chronic disease using the claimed humanized antibody. In the absence of a teaching of a method of treating any chronic disease, using the claimed humanized antibody, one of skill in the art would be forced into undue experimentation to practice the claimed invention.

REJECTION UNDER 35 USC 102, NEW REJECTION

1. New claims 115-117, 123, 127 are rejected under 35 USC 102(e) or 102(b) pertaining to anticipation by PN=5,530,101 or Queen et al, 1989, PNAS, USA, 86: 10029-10033.

Art Unit: 1642

Claims 115-117, 123, 127 are drawn to a humanized antibody or its heavy chain variable domain comprising non-human CDR amino acids, and a framework region amino acid wherein amino acid position 93H is substituted, utilizing the numbering system of Kabat, and wherein the substituted residue is the residue found in the corresponding location of the non-human antibody.

PN=5,530,101, teach humanized anti-Tac antibody, wherein amino acid 93 is substituted in heavy chain, using the aligned Kabat Eu sequence to provide the framework for the humanized antibody (column 45).

Queen et al, PNAS, teach humanized anti-Tac antibody, wherein amino acid 93 is substituted in heavy chain, using the aligned Kabat Eu sequence to provide the framework for the humanized antibody (figure 2).

Since anti-Tac antibody is a mouse antibody, its inherent heavy chain variable domain would comprise non-human CDR amino acids. Thus the humanized antibody and its heavy chain variable domain taught by patent '101 or Queen et al is the same as the claimed invention.

2. Claims 43, 44, 48, 55, 67, 71, 105, 115-117, 120, 127 are rejected under 35 USC 102(e) pertaining to anticipation by PN=5,530,101.

It is noted that PN=5,530,101 is filed on Sept, 1990, which is within a year before the claimed filing date of 06/14/91.

Claims 43, 44, 48, 55, 67, 71, 105, 115-117, 120, 127 are drawn to a humanized antibody or its heavy chain variable domain comprising non-human CDR amino acids, and a framework region amino acid wherein amino acid position 38L, 67L, 69H, 73H or 93H is substituted,

Art Unit: 1642

utilizing the numbering system of Kabat, and wherein the substituted residue is the residue found in the corresponding location of the non-human antibody. Claim 105 is further drawn to said humanized antibody which lacks immunogenicity compared to a non-human parent antibody upon repeated administration to a human patient.

PN=5,530,101 teaches humanized antibodies, wherein amino acid 38 or 67 are substituted in light chain (table 1, antibody Fd79 and M195, respectively), and amino acid 69, 73 or 93 is substituted in heavy chain (table 1, antibody CMV5, mik-beta-1, and Fd138-80, respectively), using the aligned Kabat Eu sequence to provide the framework for the humanized antibody. The humanized antibodies in table 1 would comprise non-human CDR amino acids (Summary). Patent '101 further teaches that the humanized antibodies will be substantially non-immunogenic in humans (Abstract). Thus the humanized antibody taught by patent '101 and its variable domain is the same as the claimed invention.

REJECTION UNDER 35 USC 102

1. Claim 128 is rejected under 35 USC 102(e) as being anticipated by PN=5,530,101, for the same reasons set forth in paper No.27 for the rejection of previous claims 23-24.

Applicant amends the claim 128 to read that the humanized antibody binds the antigen up to about 3-fold more tightly than the parent antibody. The language "up to" 3-fold reads on anything below 3-fold. Thus the structure and binding affinity of the claimed humanized antibody is the same as that of the humanized antibody taught by '101.

Art Unit: 1642

2. Claim 113 is rejected under 35 USC 102(e) as being anticipated by PN=5,693,762, for the same reasons set forth in paper No.27 for the rejection of previous claims 22-25, 38 and 39.

Applicant argues that the "consensus sequence" in '762 is the most homologous sequence from a single human immunoglobulin, and is thus different from the consensus sequence of the claimed invention.

Applicant's arguments set forth in paper No. 39 have been considered but are not deemed to be persuasive for the following reasons:

Although '762 uses the most homologous sequence from a single human immunoglobulin as an example, '762 also teach that as a principle, a framework is used from either a human immunoglobulin which is unusually homologous to the donor immunoglobulin, or a consensus framework from many human antibodies is used (column 13, first paragraph, lines 4-7). Thus the consensus sequence taught by '762 is the same as the claimed consensus sequence, as defined by the specification, i.e. the most frequently occurring amino acids, based on immunoglobulin of a particular species (p.14).

REJECTION UNDER 35 USC 103

Claims 113, 115-118, 123, 127-128 are rejected under 35 USC 103 as being unpatentable over US PN=5,693,762 in view of Kabat et al, for the same reasons set forth in paper No:27, for the rejection of previous claims 26-36 and 40-41.

Applicant argues as follows:

Art Unit: 1642

The rejection is made using hindsight reconstruction of the present invention. Patent '762 actually teaches away from the invention. The term "consensus framework" from '762 patent was not intended to refer to a sequence representing the most frequently occurring amino acids in the present invention. Furthermore, Kabat et al do not use the term "consensus", but rather "occurrences of most common amino acid". Thus there is no motivation to combine "consensus framework" from '762 patent with "occurrences of most common amino acid", especially the term "consensus framework" from '762 patent was not intended to refer to a sequence representing the most frequently occurring amino acids. Moreover, the present invention produces humanized antibodies with unexpected results, such as 1) lack of significant immunogenicity, as disclosed in the Declaration by Dr. Shak, 2) higher increase in binding affinity as compared to that of humanized antibodies known in the art, and 3) the same consensus sequence could be used to generate many different strong affinity humanized antibodies.

Applicant's arguments set forth in paper No. 39 have been considered but are not deemed to be persuasive for the following reasons:

Although '762 uses the most homologous sequence from a single human immunoglobulin as an example, '762 also teach that **as a principle**, a framework is used from either a human immunoglobulin which is unusually homologous to the donor immunoglobulin, **or** use a consensus framework **from many human antibodies** is used (column 13, first paragraph, lines 4-7). Thus the consensus sequence taught by '762 is the same as the claimed consensus sequence, as defined by the specification, i.e. the most frequently occurring amino acids, based on immunoglobulin of a

Art Unit: 1642

particular species (p.14). It is only Applicant's interpretation that the term "consensus framework" from '762 patent was not intended to refer to a sequence representing the most frequently occurring amino acids in the present invention. Furthermore, although Kabat et al do not use the term "consensus", but rather "occurrences of most common amino acid", one of ordinary skill in the art would readily understand that "a consensus sequence" from many antibodies is a sequence that occurs most frequently.

In addition, In re Kerkhoven (205 USPQ 1069, CCPA 1980) summarizes:

"It is prima facie obvious to combine two compositions each of which is taught by prior art to be useful for same purpose in order to form third composition that is to be used for very same purpose: idea of combining them flows logically from their having been individually taught in prior art."

Applicant asserts that the claimed humanized antibodies are not obvious in view of the cited references because the cited prior art does not suggest such a combination. However, the instant situation is amenable to the type of analysis set forth in In re Kerkhoven, 205 USPQ 1069 (CCPA 1980) wherein the court held that it is prima facie obvious to combine two compositions each of which is taught by the prior art to be useful for the same purpose in order to for a third composition that is to be used for the very same purpose since the idea of combining them flows logically from their having been individually taught in the prior art. Applying the same logic to the instant claims, given the teaching of the prior art that as a principle, a framework is used from either a human immunoglobulin which is unusually

Art Unit: 1642

homologous to the donor immunoglobulin, or a consensus framework from many human antibodies is used, and the structures of sequences that are most commonly occurred among many antibodies, it would have been obvious to humanize antibodies as taught by patent '762, using the most commonly occurred sequences taught by Kabat et al, because the idea of doing so would have logically followed from their having been individually taught in the prior art, and because patent '762 teaches the use of "consensus sequence", for the same purpose of producing humanized monoclonal antibodies for therapeutic purposes. One of ordinary skill in the art would have motivated to make humanized antibodies using the methods taught by '762 and the sequences taught by Kabat et al with a reasonable expectation of success. In addition, the arguments that the claimed invention is unexpected are not applicable, because the claims are broad, and drawn to any antibodies, and not specifically the claimed antibodies, wherein their specific target antigens, and their binding properties are not disclosed in the claims.

Any inquiry concerning this communication or earlier communications from the examiner should be directed to Minh-Tam B. Davis whose telephone number is (703) 305-2008. The examiner can normally be reached on Monday-Friday from 9:30am to 3:30pm, except on Wednesday.

If attempts to reach the examiner by telephone are unsuccessful, the examiner's supervisor, Tony Caputa, can be reached on (703) 308-3995. The fax phone number for this Group is (703) 308-4227.

Application/Control Number: 08/146206

Page 13

Art Unit: 1642

Any inquiry of a general nature or relating to the status of this application or proceeding should be directed to the Group receptionist whose telephone number is (703) 308-0916.

Minh-Tam B. Davis

October 13, 2000

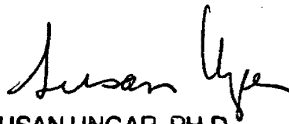

SUSAN UNGAR, PH.D
PRIMARY EXAMINER

Notice of References Cited

Application No. 58/146,206 Applicant(s) Carter et al.
 Examiner M. T. Davis Group Art Unit 1642 Page 1 of 1

U.S. PATENT DOCUMENTS

* A	DOCUMENT NO.	DATE	NAME	CLASS	SUBCLASS
B					
C					
D					
E					
F					
G					
H					
I					
J					
K					
L					
M					

FOREIGN PATENT DOCUMENTS

* N	DOCUMENT NO.	DATE	COUNTRY	NAME	CLASS	SUBCLASS
O						
P						
Q						
R						
S						
T						

NON-PATENT DOCUMENTS

* U	DOCUMENT (Including Author, Title, Source, and Pertinent Pages)	DATE
	Queen et al. PNAS, USA, 86:10029-10033	1989
V		
W		
X		

* A copy of this reference is not being furnished with this Office action.
 (See Manual of Patent Examining Procedure, Section 707.05(a).)

M. T. Davis

1642



Patent Docket P0709P1

IN THE UNITED STATES PATENT AND TRADEMARK OFFICE

TECH CENTER 1600/2900

APR 27 2001

RECEIVED

<p>In re Application of Paul J. Carter et al. Serial No.: 08/146,206 Filed: November 17, 1993 For: METHOD FOR MAKING HUMANIZED ANTIBODIES</p>	<p>Group Art Unit: 1642 Examiner: M. Davis</p> <p>CERTIFICATE OF MAILING I hereby certify that this correspondence is being deposited with the United States Postal Service with sufficient postage as first class mail in an envelope addressed to: Assistant Commissioner of Patents, Washington, D.C. 20231 on</p> <p>April 25, 2001 <i>[Signature]</i> Wendy M. Lee</p>
---	--

59/10 10 5201

AMENDMENT UNDER 37 C.F.R. §1.111

Assistant Commissioner of Patents
Washington, D.C. 20231

Sir:

Responsive to the Office Action dated 10/25/00, reconsideration of the present application is respectfully requested in view of the following amendments and remarks. A request for a 3 month extension of time and the requisite fee accompany this amendment.

IN THE CLAIMS:

(Please amend claims 113 and 114 as follows:)

Sub
O'
N'

113. (Amended) A humanized variant of a non-human parent antibody which binds an antigen and comprises a consensus human variable domain of a human heavy chain immunoglobulin subgroup wherein amino acid residues forming Complementarity Determining Regions (CDRs) thereof comprise non-human antibody amino acid residues, and further comprises a Framework Region (FR) substitution where the substituted FR residue: (a) noncovalently binds antigen directly; (b) interacts with a CDR; (c) introduces a glycosylation site which affects the antigen binding or affinity of the antibody; or (d) participates in the V_L-V_H interface by affecting the proximity or orientation of the V_L and V_H regions with

2

N1
cut

respect to one another.

N2
cut

65
114. (Amended) The humanized variant of claim 128 which binds the antigen
up to about 3-fold more tightly than the parent antibody binds antigen.
in the binding affinity

63
74

Q

121

N

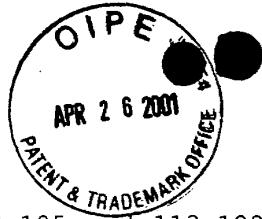

RECEIVED

APR 27 2001

TECH CENTER 1600/2900

REMARKS

Claims 43-105 and 113-128 are in the application. Claims 113 and 114 have been amended. Attached hereto is a marked-up version of the changes made to the claims by the current amendment. The attached page is captioned "Version with Markings to Show Changes Made".

Claim 113 no longer requires that the humanized variant bind antigen with better affinity than the parent antibody, up to about 3-fold tighter binding than the parent antibody. Hence, claim 114 has been amended herein to depend on claim 128, which claim requires that the humanized variant bind antigen more tightly than the parent antibody.

Prosecution History of the Present Application

Applicants first wish to express their concern about the undue prejudice to them due to the repeated transfer of this case from patent examiner to patent examiner, and to explain that this is a case which has thrice previously been indicated to be in condition for allowance.

The case was originally with Examiner Adams, then was transferred to Examiner Nolan. In the 8/13/98 interview, Examiner Nolan indicated that unexpected results would overcome the 103 rejection based on Queen Patent 5,693,762 (hereinafter "the '762 patent"). An amendment was filed 8/24/98 presenting the unexpected results. Shortly thereafter, the case was transferred to the present Examiner. Pending claims 43-114 were discussed in an interview on 10/16/98 between the undersigned, the present Examiner and Examiner Feisee at which time the only outstanding issue in the case related to the clarity of the terms "binding of CDR" and "significant immunogenicity". An amendment was filed 11/6/98 addressing those issues. The case was then transferred to Examiner Reeves, who issued a restriction requirement 3/29/99 at that late stage in prosecution. In an 8/23/99 interview, Examiners Reeves/Burke and Feisee indicated that the case would be in order for allowance with the filing of a terminal disclaimer for claim 111 and addition of an upper limit to affinity in claims 113 and 128. Claims 113 and 128 were amended as suggested by the Examiners and claim 111 was canceled to avoid the

obviousness-type double patenting rejection (see 8/30/99 amendment). Now the case has been transferred yet again to the present Examiner and prosecution has been re-opened on a case that was indicated to be in condition for allowance three times previously.

To the extent that any issues remain following entry of this amendment, Applicants specifically request an interview with the present Examiner and her supervisor to discuss this case so as to ensure speedy resolution of the issues and allowance of the application. It is noted that this is a pre-GATT case and two 129(a) responses have previously been filed.

Section 112, first paragraph, Scope, New Rejection

Claims 43-105 and 113-128 are rejected under 35 USC Section 112, first paragraph on the basis that the specification, while being enabling for humanized antibody muMAb4D5 and an anti-CD3 antibody, or variable domains thereof, "does not reasonably provide enablement for any humanized antibody, or variable domain thereof, comprising CDR amino acids which binds non-specifically to any antigen, wherein the framework region amino acids are substituted at a site selected from the group consisting of 4L, 38L, 43L, 44L, 58L, 62L, 65L, 66L, 67L, 68L, 69L, 73L, 85L, 98L, 2H, 4H, 36H, 39H, 43H, 45H, 69H, 70H, 74H and 92H, or of 24H, 73H, 76H, 78H and 93H, for treating any chronic disease."

The Examiner contends that the specification discloses examples of humanized muMAb4D5, anti-CD3 and anti-CD18 antibodies or variable domains thereof; that the substituted FR residues for muMAb4D5 are 71H, 73H, 78H, 93H and 66L; and that only one humanized antibody (huMAb4D5-8) with all the above five substitutions binds to p185 3-fold more tightly than the murine counterpart. The Examiner further contends that the substituted framework residues for the heavy chain of antibody anti-CD3 are FR residues 75 and 76, and that there is no disclosure concerning the binding affinity of the humanized anti-CD3 or anti-CD18 as compared to the murine counterpart. The Examiner contends that one cannot extrapolate from humanizing one antibody, which binds to p185^{HER2} 3-fold more tightly than the murine counterpart, to humanizing any antibody,

wherein its affinity would be up to 3-fold or at least 3-fold tighter than the murine counterpart, or wherein its affinity would still be intact for therapeutic purposes. The Examiner further argues that one cannot extrapolate from humanizing an anti-p185 antibody by substitution of all five FR residues at positions 71H, 73H, 78H, 93H and 66L in an anti-p185 antibody, or from humanizing an anti-CD3 antibody by substitution at both framework residues 75H and 76H, with humanizing any antibody by substitution at only one amino acid residue selected from the group consisting of 4L, 38L, 43L, 44L, 58L, 62L, 65L, 66L, 67L, 68L, 69L, 73L, 85L, 98L, 2H, 4H, 36H, 39H, 43H, 45H, 69H, 70H, 74H and 92H, or of 24H, 73H, 76H, 78H and 93H. The Examiner opines that the specification does not disclose whether substitution at only one of the claimed amino acid positions would produce a humanized antibody that has 3-fold more affinity, or which combination of what substituted FR residues (other than 71H, 73H, 78H, 93H and 66L for an anti-p185 antibody or 75H and 76H in an anti-CD3 antibody) would produce a humanized antibody that has 3-fold more affinity than the murine counterpart, or retains adequate affinity for therapeutic purposes. The Examiner contends that a humanized antibody that does not have specificity for a particular antigen is of little practical use for treating a chronic disease and that the specification does not disclose how to treat any chronic disease using the claimed humanized antibody.

Applicants submit that claims 43-105 and 113-128 are enabled by the present application.

First, Applicants point out that none of the claims (other than claim 114) require that the humanized antibody bind antigen about 3-fold more tightly than the parent antibody binds antigen, as the Office Action seems to imply. The independent claims herein merely recite that the humanized antibody variable domain comprises CDR residues which bind an antigen (claims 43, 104 and 115); the antibody comprising the humanized antibody variable domain binds p185^{HER2} (claim 72); the humanized antibody comprises CDR residues which bind an antigen (claim 105); the humanized variant bind antigen (claim 113 herein); or the humanized variant bind

antigen more tightly than the parent antibody - up to about 3-fold more tightly than the parent antibody (claim 128).

Second, Applicants submit that the claims herein encompass the humanized variable domain or antibody having at least one of the FR substitutions specified, but optionally having further FR substitution(s) in order to improve affinity to a level at which an antibody comprising the variable domain is able to bind antigen.

Finally, Applicants wish to clarify some issues concerning the Office's characterization of the working examples. First, it is noted that Example 1 actually describes several humanized anti-p185^{HER2} variants with FR substitution(s) as set forth in the claims herein: huMab4D5-2, huMab4D5-3, huMab4D5-4, huMab4D5-5, huMab4D5-6, huMab4D5-7, huMab4D5-8 (Table 3 on page 72). Thus, it is clear that this example teaches humanized variants which do not include substitution of all of FR residues 71H, 73H, 78H, 93H and 66L. Each of these FR substitution variants bound antigen with better affinity than the initial antibody (huMab4D5-1) comprising non-human CDR amino acid residues, but lacking any FR substitution(s). Two of the humanized anti-p185^{HER2} variants surprisingly bound antigen better than the murine parent antibody muMab4D5, i.e. huMab4D5-6 and huMab4D5-8. With regard to Example 3 concerning the humanized anti-CD3 variants, aside from the 75H and 76H FR substitutions noted by the Office, this Example further teaches the following FR substitutions: L71, 71H, 73H and 78H. See, e.g., Fig. 5 which aligns the murine anti-CD3 "muxCD3" sequences, the humanized variant "huxCD3v1" sequences, and the human sequences, "huxI" and "huIII".

The specification clearly teaches how to make humanized antibody variable domains and antibodies comprising such domains, and identifies FR residues that can be substituted to improve the binding affinity of an antibody comprising the humanized variable domain. See, e.g. pages 12-13, 20-26 and 28-29; Example 1 on pages 63-74; Example 3 on pages 79-88; and Example 4 on page 89. The specification teaches FR substitution(s)

individually or in combination. Based on the disclosure of the present application, one is able to make an antibody comprising a humanized antibody variable domain which binds antigen. The Office has provided no evidence that the humanized antibody variable domains or humanized antibodies comprising the FR substitution(s) claimed herein would not be functional, beyond speculating that the affinity might not be about 3-fold better than the parent antibody (and, as noted above, the claims other than claim 114 do not require this improvement in affinity). Hence, Applicants submit that the presently claimed variable domains and antibodies are enabled by the specification.

Reconsideration and withdrawal of the enablement rejection is respectfully requested in view of the above.

Section 102 - Claims 115-117, 123 and 127

Claims 115-117, 123 and 127 are rejected under 35 USC Section 102(e) or 102(b) as anticipated by US Patent No. 5,530,101 (hereinafter "the '101 patent") or Queen *et al.* *PNAS (USA)* 86:10029-10033 (1989) (hereinafter "Queen *et al.*"). The Examiner contends that the '101 patent and Queen *et al.* teach a humanized anti-Tac antibody wherein amino acid 93 is substituted in the heavy chain, using the aligned Kabat Eu sequence to provide the framework for the humanized antibody.

Applicants point out that - as explained earlier in prosecution - the substituted 93 FR residue in the cited references is not 93H "utilizing the numbering system set forth in Kabat" (see page 13, line 33 through to line 22 on page 14 of the present application) as required by claims 115-117, 123 and 127 of the present application. In particular, as noted on page 6 of the amendment hand carried to the Office on 10/7/97, residue no. 93 in the heavy chain of the anti-Tac antibody in the cited references, is actually 89H utilizing the numbering system set forth in Kabat. The cited references use a sequential numbering system, rather than the Kabat numbering system claimed herein.

Reconsideration of the 102(e) and 102(b) rejections based on the '101

patent and Queen *et al.* is respectfully requested in view of the above.

Section 102 - Claims 43, 44, 48, 55, 67, 71, 105, 115-117, 120 and 127
Claims 43, 44, 48, 55, 67, 71, 105, 115-117, 120 and 127 are rejected under 35 USC Section 102(e) as being anticipated by the '101 patent. The Examiner urges that FR substitutions 38L, 67L, 69H, 73H and 93H are taught by the '101 patent. Specifically, the Examiner contends that amino acids 38 or 67 are substituted in the light chain of the Fd79 and M195 antibodies, respectively, and amino acids 69, 73 or 93 are substituted in the heavy chains of the CMV5, mik- β 1 and Fd138-80 antibodies, respectively. The '101 patent is further alleged to teach (in the abstract thereof) that the humanized antibodies therein will be substantially non-immunogenic in humans.

Applicants submit that the presently claimed FR 38L, 67L, 69H and 93H substitutions are different from those in the '101 patent to which the Examiner refers, since the numbering of the presently claimed FR substitutions utilizes the numbering system set forth in Kabat, whereas the '101 patent uses sequential numbering for the residues. In particular, VL residue 38 of Fd79 is a CDR residue, as opposed to a FR residue (note Table 1 in column 43 of the '101 patent which states that residue 38 is in "Category 1" and therefore is a CDR residue; see lines 66-67 in column 13 of the '101 patent); VL residue 67 of M195 is FR residue 63L utilizing the numbering system set forth in Kabat (see page 8 of Applicants' 10/7/97 amendment); VH residue 69 of CMV5 is 68H utilizing the numbering system set forth in Kabat (see page 9 of the 10/7/97 amendment); and VH residue 93 of Fd138-80 is FR residue 89H utilizing the numbering system set forth in Kabat (see page 7 of the 10/7/97 amendment).

As to the FR 73H substitution (utilizing the numbering system set forth in Kabat) claimed herein, Applicants submit that the disclosure of the humanized mik- β 1 antibody is too late to qualify as Section 102 prior art to claim 115 which recites that substitution. See page 11, first full paragraph of Applicants' 1/15/99 amendment.

Finally, as to the recitation in claim 105 herein that the humanized antibody "lacks immunogenicity compared to a non-human parent antibody upon repeated administration to a human patient in order to treat a chronic disease in that patient", Applicants have shown that antibodies humanized according to one preferred embodiment of the present invention possess this property. See the Shak Declaration filed 8/24/99. The '101 patent merely states that the humanized antibodies will be "substantially non-immunogenic" in humans, but fails to disclose that the humanized antibodies lack substantial immunogenicity upon repeated administration to a human patient in order to treat a chronic disease in that patient.

Reconsideration and withdrawal of the Section 102(e) rejection is respectfully requested in view of the above.

Section 102(e) - Claim 128

Claim 128 is rejected under 35 USC Section 102(e) as being anticipated by the '101 patent. The Examiner states that the language "up to" 3-fold reads on anything below 3-fold.

Claim 128 pertains to a humanized antibody which binds antigen more tightly than the parent antibody (up to about 3-fold more tightly). The Queen patents state that the humanized antibodies therein bind the target antigen with the same affinity, or bind less tightly, than the parent antibody. See pages 21-22 of Applicants' amendment filed 8/24/98. While humanized M195 was later discovered to bind antigen up to about 3-fold more tightly than the parent antibody bound antigen (see paragraph 2 on page 2 of the 8/30/99 amendment), this property of the humanized M195 antibody is not described in the '101 patent (see lines 28-29 in column 60 of the '101 patent).

Reconsideration and withdrawal of the Section 102(e) rejection of claim 128 is respectfully requested.

Section 102(e) - Claim 113

Claim 113 is rejected under 35 USC Section 102(e) as being anticipated

by US Patent 5,693,762 ("the '762 patent") for the same reasons set forth in paper No. 27 for the rejection of previous claims 22-25, 38 and 39.

The Examiner contends that the '762 patent teaches "as a principle, a framework is used from either a human immunoglobulin which is unusually homologous to the donor immunoglobulin, or a consensus framework from many human antibodies is used".

Applicants submit that this disclosure in the '762 patent simply fails to anticipate the presently claimed "consensus human variable domain" in claim 113 as defined by the present specification. See the discussion of the '762 patent on pages 13-14 of the 8/24/98 amendment. The Examiner states on page 11 of the above Office Action that it 'is only Applicant's interpretation that the term "consensus framework" from '762 patent was not intended to refer to a sequence representing the most frequently occurring amino acids in the present invention'. Applicants respectfully disagree. Indeed the Office initially suggested the alternative interpretation for the term "consensus framework" as it was used by Queen *et al.* See page 4 of the Office Action dated 12/23/96 in which Examiner Nolan stated:

"Regarding the consensus sequence, the combination of references teach the human framework regions having a significantly high degree of sequence homology (conservative regions). Queen *et al.* in particular point to Kabat as demonstrating that this was known in the art well in advance of applicant's filing date, see reference 38, cited by Queen *et al.*" (Emphasis added).

The Queen *PNAS* paper to which Examiner Nolan referred, was concerned with using a human framework region from a human immunoglobulin which was unusually homologous to the donor immunoglobulin, and failed to mention a consensus human variable domain as that expression is used in the present application. Hence, the Office has previously used the expression "consensus sequence" to describe the highly homologous approach taught by Queen *et al.*

Notwithstanding this, Applicants note that in order to anticipate a claimed invention, the reference alone much teach each and every element of the claim. Even if it were the case that the "consensus framework" in the '762 patent was intended to refer to an amino acid sequence which comprises the most frequently occurring amino acid residues at each location in all human immunoglobulins (see page 14, lines 29-31 of the present application), which is denied, the Office has not shown that the '762 patent unambiguously disclosed the selection invention recited in claim 113 herein pertaining to a "consensus human variable domain of a human heavy chain immunoglobulin subgroup". The Office has combined the '762 patent with Kabat *et al.* (see Section 103 discussion below) in an attempt to show that this particular consensus sequence had been disclosed previously. Hence, Applicants submit that claim 113 is novel over the '762 patent. Applicants will demonstrate in the following section how the invention set forth in claim 113 is also nonobvious over the '762 patent, due to the unexpected results attributable thereto.

Reconsideration and withdrawal of the Section 102 rejection based on the '762 patent is respectfully requested in view of the above.

Section 103

Claims 113, 115-118, 123 and 127-128 are rejected under 35 USC Section 103 as being unpatentable over the '762 patent in view of Kabat *et al.*

First, it is noted that the Examiner relies on the rejection based on the '762 patent in view of Kabat *et al.* for the same reasons as set forth in paper no. 27 (Applicants assume paper no. 34 - Examiner Nolan's Office Action dated 12/23/97 is intended). Examiner Nolan previously indicated that the unexpected results would overcome the 103 rejection based on the '762 patent combined with Kabat *et al.* (see Paper no. 37; 8/13/98 Interview Summary).

Applicants rely on the unexpected results attributable to the consensus human variable domain of a human heavy chain immunoglobulin subgroup as demonstrating that the presently claimed antibodies are not obvious over

the '762 patent combined with Kabat et al. See pages 18-23 of the 8/24/98 amendment and the Shak declaration attached thereto.

The Examiner urges that "the arguments that the claimed invention is unexpected are not applicable, because the claims are broad, and drawn to any antibodies, and not specifically the claimed antibodies, wherein their specific target antigens, and their binding properties are not disclosed in the claims."

Applicants submit that the Examiner's basis for ignoring the evidence of unexpected results is legally flawed - at least with respect to (1) the lack of significant immunogenicity of the claimed humanized antibodies upon repeated administration to a human patient, e.g. to treat a chronic disease in that patient and (2) the ability to make many strong affinity antibodies, thus avoiding tailoring each human framework to each non-human antibody to be humanized. Those unexpected results provide objective evidence of non-obviousness. *Specialty Composites v. Cabot Corp.*, 845 F. 2d 981, 6 USPQ 2d 1601 (Fed. Cir. 1988).

As to unexpected result (1), Applicants have demonstrated that antibodies humanized using a consensus human variable domain of a human heavy chain immunoglobulin subgroup as set forth in claim 113 herein lack significant immunogenicity upon repeated administration to a human patient in order to treat a chronic disease in that patient. This was shown in the Shak Declaration for humanized anti-HER2, anti-IgE, anti-VEGF and anti-CD11a antibodies. See pages 18-21 of the 8/24/98 amendment and the Shak Declaration attached thereto. Hence, this unexpected property is not linked to certain antibodies or specific target antigens, but is generally applicable and the claims are commensurate in scope with the unexpected result relied upon.

Turning now to unexpected result (2), Applicants have shown that a consensus human variable domain of a human heavy chain immunoglobulin subgroup as set forth in claim 113 can be used to generate many different strong affinity humanized antibodies, including anti-HER2, anti-CD3,

anti-CD18, anti-IgE, anti-CD11a and anti-VEGF humanized antibodies (see pages 22-23 of the 8/24/98 amendment). Again, this further unexpected property is not dependent on the antibody or target antigen, and hence should be considered with respect to the non-obviousness of the presently claimed antibodies.

Hence, Applicants submit that claim 113 directed to a humanized variant comprising a consensus human variable domain of a human heavy chain immunoglobulin subgroup is non-obvious over the cited art, because of unexpected results (1) and (2) noted above.

As to the other rejected claims, Applicants point out that claim 115 recites FR substitutions at one or more of positions 24H, 73H, 76H, 78H and 93H, utilizing the numbering system set forth in Kabat. The Office has not shown how the cited art disclosed or suggested substitution of FR residues 24H, 76H, 78H and 93H, utilizing the numbering system set forth in Kabat; and, as noted above, the disclosure concerning substitution of 73H in the mik- β 1 antibody is too late to qualify as Section 102 prior art to the invention set forth in claim 115 herein. With regard to claim 117, the Office fails to teach a humanized antibody with FR substitution(s) limited to positions 24H, 73H, 76H, 78H and 93H, utilizing the numbering system set forth in Kabat. As to claim 118, the Office has not demonstrated how the art would have taught combining the listed FR substitution(s) in claim 115 with a consensus human variable domain. With regard to claim 123, as noted previously, substituted 93 FR residue in Queen's anti-Tac or Fd138-80 antibodies is not the same as FR substitution 93H "utilizing the numbering system set forth in Kabat." Finally, with respect to claim 128, as noted above, the Queen patents state that the humanized antibodies therein bind the target antigen with the same affinity, or bind less tightly, than the parent antibody. See pages 21-22 of Applicants' amendment filed 8/24/98. While humanized M195 was later discovered to bind antigen up to about 3-fold more tightly than the parent antibody bound antigen (see paragraph 2 on page 2 of the 8/30/99 amendment), this property of the humanized M195 antibody is not described in the '101 patent (see lines 28-29 in column 60 of the '101

Serial No.: 08/146,206

patent). The ability to bind antigen more tightly than the parent antibody was a further unexpected result observed with respect to certain humanized antibodies of the present application.

Reconsideration and withdrawal of the Section 103 rejection of claims 113, 115-118, 123 and 127-128 is respectfully requested in view of the above.

Respectfully submitted,

GENENTECH, INC.

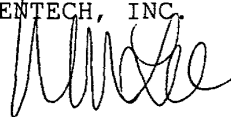
By: 
Wendy M. Lee
Reg. No. 40,378
Telephone: (650) 225-1994



09157

PATENT TRADEMARK OFFICE

Serial No.: 08/146,206

VERSION WITH MARKINGS TO SHOW CHANGES MADE

Claims 113 and 114 have been amended as follows:

113. (Three Times Amended) A humanized variant of a non-human parent antibody which binds an antigen [with better affinity than the parent antibody] and comprises a consensus human variable domain of a human heavy chain immunoglobulin subgroup wherein amino acid residues forming Complementarity Determining Regions (CDRs) thereof comprise non-human antibody amino acid residues, and further comprises a Framework Region (FR) substitution where the substituted FR residue: (a) noncovalently binds antigen directly; (b) interacts with a CDR; (c) introduces a glycosylation site which affects the antigen binding or affinity of the antibody; or (d) participates in the V_L - V_H interface by affecting the proximity or orientation of the V_L and V_H regions with respect to one another [, wherein the humanized variant binds antigen up to about 3-fold more tightly than the parent antibody binds antigen].

114. (Amended) The humanized variant of claim [113] 128 which binds the antigen about 3-fold more tightly than the parent antibody binds antigen.

Handwritten:
4-25-01

IN THE UNITED STATES PATENT AND TRADEMARK OFFICE

<p>In re Application of Paul J. Carter et al. Serial No.: 08/146,206 Filed: November 17, 1993 For: METHOD FOR MAKING HUMANIZED ANTIBODIES</p>	<p>Group Art Unit: 1642 Examiner: M. Davis</p> <hr/> <p style="text-align: center;">CERTIFICATE OF MAILING I hereby certify that this correspondence is being deposited with the United States Postal Service with sufficient postage as first class mail in an envelope addressed to: Assistant Commissioner of Patents, Washington, D.C. 20231 on</p> <p style="text-align: center;">April 25, 2001 <i>Wendy M. Lee</i> Wendy M. Lee</p>
---	---

Handwritten:
#108
80
5-201

PETITION AND FEE FOR THREE MONTH EXTENSION OF TIME
(37 CFR 1.136(a))

Assistant Commissioner of Patents
Washington, D.C. 20231

Sir:

Applicants petition the Commissioner of Patents and Trademarks to extend the time for response to the Office Action dated October 25, 2000 for three months from January 25, 2001 to April 25, 2001. The extended time for response does not exceed the statutory period.

Please charge Deposit Account No. 07-0630 in the amount of \$890.00 to cover the cost of the extension. Any deficiency or overpayment should be charged or credited to this deposit account. A duplicate of this sheet is enclosed.

Respectfully submitted,
GENENTECH, INC.

Date: April 25, 2001

By: *Wendy M. Lee*
Wendy M. Lee
Reg. No. 40,378
Telephone No. (650) 225-1994



05/02/2001 KDOWNING 00000001 07090
08 48206
890.00 CH
01 FC=117

Interview Summary	Application No. 08/146,206	Applicant(s) Carter et al	
	Examiner Minh-Tam Davis	Group Art Unit 1642	

All participants (applicant, applicant's representative, PTO personnel):

(1) Minh-Tam Davis (3) _____

(2) Ewndy Lee (4) _____

Date of Interview Apr 26, 2001

Type: a) Telephonic b) Video Conference
 c) Personal [copy is given to 1) applicant 2) applicant's representative]

Exhibit shown or demonstration conducted: d) Yes e) No. If yes, brief description:

Claim(s) discussed: _____

Identification of prior art discussed:

Agreement with respect to the claims f) was reached. g) was not reached. h) N/A.

Substance of Interview including description of the general nature of what was agreed to if an agreement was reached, or any other comments:

Applicant requests an interview if the case is not ready for allowance following entry of the amendment to be filed today.

(A fuller description, if necessary, and a copy of the amendments which the examiner agreed would render the claims allowable, if available, must be attached. Also, where no copy of the amendments that would render the claims allowable is available, a summary thereof must be attached.)

i) It is not necessary for applicant to provide a separate record of the substance of the interview (if box is checked).

Unless the paragraph above has been checked, THE FORMAL WRITTEN REPLY TO THE LAST OFFICE ACTION MUST INCLUDE THE SUBSTANCE OF THE INTERVIEW. (See MPEP section 713.04). If a reply to the last Office action has already been filed, APPLICANT IS GIVEN ONE MONTH FROM THIS INTERVIEW DATE TO FILE A STATEMENT OF THE SUBSTANCE OF THE INTERVIEW. See Summary of Record of Interview requirements on reverse side or on attached

Examiner Note: You must sign this form unless it is an Attachment to a signed Office action.

7/13/01

Patent Docket P0709P1

#6
7/13/01

IN THE UNITED STATES PATENT AND TRADEMARK OFFICE

In re Application of Paul J. Carter et al. Serial No.: 08/146,206 Filed: November 17, 1993 For: METHOD FOR MAKING HUMANIZED ANTIBODIES	Group Art Unit: 1642 Examiner: M. Davis
	<p style="text-align: center;"><small>Certificate of Facsimile Transmission Under 37 CFR § 1.8</small></p> <p style="text-align: center;"><small>In accordance with CFR § 1.6(d), this correspondence addressed to Examiner Minh-Tam Davis, The Patent and Trademark Office, Washington, DC 20231 is being transmitted to facsimile No. (703) 308-4426 on</small></p> <p style="text-align: center;">  July 3, 2001 Wendy M. Lee </p>

AMENDMENT TRANSMITTAL

Assistant Commissioner of Patents
Washington, D.C. 20231

Sir:

Transmitted herewith is an amendment in the above-identified application.

The fee has been calculated as shown below.

	Claims Remaining After Amendment		Highest No. Previously Paid For	Present Extra	Rate	Additional Fees
Total	82	-	86	0	18	\$0.00
Independent	8	-	9	0	80	\$0.00
___ 0 Multiple dependent claim(s), if any					270	\$0.00
Total Fee Calculation						\$0.00

 X
 X

No additional fee is required.
The reference O'Connor *et al.* *Protein Engineering* 11(4):321-328 (1998) is attached.

The Commissioner is hereby authorized to charge any additional fees required under 37 CFR 1.16 and 1.17, or credit overpayment to Deposit Account No. 07-0630.

Respectfully submitted,
GENENTECH, INC.

Date: July 13, 2001

By:

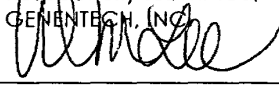
Wendy M. Lee
Reg. No. 40,378
Telephone No. (650) 225-1994



09157

PATENT TRADEMARK OFFICE

0

61
0 C/

Patent Docket P0709P1

IN THE UNITED STATES PATENT AND TRADEMARK OFFICE

7/13/01

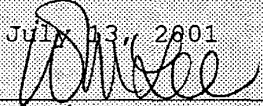
<p>In re Application of Paul J. Carter et al. Serial No.: 08/146,206 Filed: November 17, 1993 For: METHOD FOR MAKING HUMANIZED ANTIBODIES</p>	<p>Group Art Unit: 1642 Examiner: M. Davis</p>
<p style="text-align: center;">Certificate of Facsimile Transmission Under 37 CFR § 1.9</p> <p style="text-align: center;">In accordance with CFR § 1.6(d), this correspondence addressed to Examiner Minh-Tam Davis, The Patent and Trademark Office, Washington, DC 20231 is being transmitted to facsimile No. (703) 308-4426 on</p> <p style="text-align: center;">July 13, 2001  Wendy M. Lee</p>	

SUPPLEMENTAL AMENDMENT

Assistant Commissioner of Patents
Washington, D.C. 20231

Sir:

IN THE CLAIMS:

Please amend claims 113 and 128 as indicated below:

64 / 113. (Three times amended) A humanized variant of a non-human parent antibody which binds an antigen and comprises a human variable domain comprising the most frequently occurring amino acid residues at each location in all human immunoglobulins of a human heavy chain immunoglobulin subgroup wherein amino acid residues forming Complementarity Determining Regions (CDRs) thereof comprise non-human antibody amino acid residues, and further comprises a Framework Region (FR) substitution where the substituted FR residue: (a) noncovalently binds antigen directly; (b) interacts with a CDR; (c) introduces a glycosylation site which affects the antigen binding or affinity of the antibody; or (d) participates in the V_L-V_H interface by affecting the proximity or orientation of the V_L and V_H regions with respect to one another.

122

0

128. (Twice Amended) A humanized variant of a non-human parent antibody which binds an antigen, wherein the humanized variant comprises Complementarity Determining Region (CDR) amino acid residues of the non-human parent antibody incorporated into a human antibody variable domain, and further comprises a Framework Region (FR) substitution where the substituted FR residue: (a) noncovalently binds antigen directly; (b) interacts with a CDR; or (c) participates in the V_L - V_H interface by affecting the proximity or orientation of the V_L and V_H regions with respect to one another, and wherein the humanized variant binds the antigen more tightly than and up to about 3-fold more tightly than the parent antibody binds antigen.

Please add the following claims:

~~80~~ --129. A humanized antibody variable domain comprising non-human Complementarity Determining Region (CDR) amino acid residues which bind an antigen incorporated into a human antibody variable domain, and further comprising a Framework Region (FR) amino acid substitution where the substituted FR residue:

(a) noncovalently binds antigen directly;
(b) interacts with a CDR; or
(c) participates in the V_L - V_H interface by affecting the proximity or orientation of the V_L and V_H regions with respect to one another, and wherein the substituted FR residue is at a site selected from the group consisting of: 4L, 38L, 43L, 44L, 58L, 62L, 65L, 66L, 67L, 68L, 69L, 73L, 85L, 98L, 2H, 4H, 24H, 36H, 39H, 43H, 45H, 69H, 70H, 73H, 74H, 76H, 78H, 92H and 93H, utilizing the numbering system set forth in Kabat.

~~81~~ 130. The humanized variable domain of claim ~~129~~ ⁸¹⁰ wherein the substituted residue is the residue found at the corresponding location of the non-human antibody from which the non-human CDR amino acid residues are obtained.

~~82~~ 131. The humanized variable domain of claim ~~129~~ ⁸²⁰ wherein no human Framework Region (FR) residue other than those set forth in the group has been substituted.--

REMARKS

Applicants wish to thank Examiners Davis and Caputa for granting an interview to the representatives of Applicants on July 3, 2001. It is noted that the interview was terminated before its completion due to a fire alarm and evacuation of the building. The response herein reflects points raised by the Office during the interview. To the extent that issues remain in the case following entry of this and the previous amendment, Applicants respectfully request a further interview given the protracted prosecution of the case as discussed in the interview.

The pending claims

In the above-noted interview Examiner Caputa asked how the framework in claim 113 differed from the "consensus framework from many human antibodies" as in column 13 of the cited Queen '762 patent. In the interests of expediting prosecution, Applicants have amended claim 113 herein to recite the language found on page 14, lines 29-31 of the present application. The differences between the disclosure of the '762 patent and the invention set forth in claim 113 will be discussed below.

As discussed in the interview, claim 128 is amended herein to emphasize that the humanized antibody of this claim is one with better affinity than the non-human parent. This amendment obviates the §102 rejection over the disclosure of the '101 patent.

Claims 129-131 have been added herein. Claim 129 represents a combination of claims 43 and 115 and includes the FR substitution language from claim 128. Claims 130-131 employ language from claims 44 and 45, respectively.

Attached hereto is a marked-up version of the changes made to the claims by the current amendment. The attached page is captioned "Version with markings to show changes made." Applicants submit that the amendments do not introduce new matter and therefore should be entered. Following entry of this amendment, claims 43-105 and 113-131 will be pending in the present application.

As was pointed out in the interview, the present application contains three different types of independent claims: (1) claims 43, 72, 104, 105 and 115 encompassing humanized antibody variable domains or antibodies comprising FR substitution(s) including one or more FR substitutions from a specified selection of FR positions; (2) claim 128 directed to a humanized variant which binds the antigen more tightly than the parent antibody binds antigen (up to about 3-fold more tightly); and (3) claim 113 directed to a humanized antibody comprising non-human CDR and FR residue(s) incorporated into a human variable domain comprising the most frequently occurring amino acid residues at each location in all human immunoglobulins of a human heavy chain immunoglobulin subgroup.

Section 102

A comprehensive reply to the outstanding Section 102 rejections can be found in the amendment dated April 25, 2001. As discussed in the interview, it is believed that the Section 102 rejections should be withdrawn.

With respect to claims 43, 72, 104, 105 and 115, Applicants pointed out that Queen used sequential numbering, rather than Kabat numbering, for the FR residues, such that the 93H, 38H, 67L and 69H FR substitutions according to Kabat herein were not disclosed by Queen. As to the 73H FR substitution claimed herein, Applicants will submit shortly a swearing behind declaration showing completion of the invention of a humanized variable domain or antibody comprising that FR substitution, prior to cited Queen patent.

As to claim 128, Applicants pointed out that Queen did not describe humanized antibodies with improved affinity - affinity was either about the same or worse than the rodent antibody. The amendment herein clarifies that claim 128 pertains to antibodies with better affinity than the non-human parent antibody.

Finally, Applicants submit that recitation of "a human variable domain comprising the most frequently occurring amino acid residues at each

location in all human immunoglobulins of a human heavy chain immunoglobulin subgroup" in claim 113 renders the humanized antibody therein novel over the cited Queen '762 patent. The Section 103 rejection will be addressed below.

Withdrawal of the outstanding Section 102 rejections is respectfully requested.

Section 112, first paragraph, scope

A full and complete response to the outstanding rejection of claims 43-105 and 113-128 may be found in the communication to the Office dated April 25, 2001.

In the outstanding Office Action, the Examiner maintains that each of the claims presented is not enabled by the disclosure. The basis for the assertion of the Examiner is that she believes the practice of the invention as reflected in each of the claims presented would constitute undue experimentation. Based on the points raised by the Examiner in the July 3 interview and the outstanding Office Action, Applicants believe this conclusion is based on misunderstandings of the law governing enablement, particularly as it pertains to the issue of undue experimentation, and a mischaracterization of the claims at issue and the disclosure. Moreover, Applicants will summarize hereinbelow relevant evidence which demonstrates the reproducibility of the methods disclosed in the present application for generating useful humanized antibody variable domains and antibodies encompassed by the claims herein.

Enablement must be measured in relation to the claims, the disclosure and what is known to a person skilled in the art. See, *United States v. Telectronics, Inc.*, 857 F.2d 778, 785, 8 USPQ2d 1217, 1223 (Fed. Cir. 1988) ("The test of enablement is whether one reasonably skilled in the art could make or use the invention from the disclosures in the patent coupled with information known in the art without undue experimentation."). Undue experimentation, in turn, is a conclusion based on a number of discrete factual determinations. *In re Wands*, 858

F.2d 731, 737 (wherein the court listed eight factors that must be considered as a group when determining an issue of undue experimentation). In the present rejection, the only factors that apparently have been considered by the Examiner are the breadth of the claims and unpredictability in the art.

With respect to the scope of the claims, it is respectfully submitted that the Examiner has not accurately construed the claim scope, either in the rejections set forth in the outstanding Office Action or as characterized during the interview of July 3.

First, as has been noted in previous communications, only one claim (claim 114) specifically requires a three-fold increase in affinity of the humanized antibody relative to the non-human parent antibody. Claim 128, as amended, requires a binding affinity greater than the parent antibody, up to about three times the parent antibody affinity. Claims 43 to 105, 113 and 115 to 127 each contain no reference to minimum binding affinity relative to the parent antibody. Assertions that it would not have been possible to produce a humanized antibody subject to these claims having a three-fold increase in binding affinity are simply irrelevant to all but one claim.

Second, a requirement in each claim presented is that the variable domain retain the functional capacity to bind the antigen bound by the parent antibody. Thus, claims are not directed to single amino acid substitutions in an abstract sense that result in polypeptides that are inoperative as antibody binding domains. Instead, each of the claims presented requires the resulting humanized antibody variable domain or antibody to retain the antibody binding specificity of the parent antibody, and certain of the claims require the binding affinity to be greater than the parent antibody. Omitting the antibody binding limitation present in each claim improperly changes the scope of the claim.

Third, each of the independent claims is further limited in respect of one or more specific and objectively defined physical attributes of the resulting humanized antibody variable domain or antibody. For example, claim 43 identifies -- and thereby limits the claimed invention to -- a finite number of species of antibody binding domains which comprise amino acid substitutions in said binding domain selected from a finite range of substitutions in the framework region. If this physical characteristic of the humanized antibody variable domain is not present, it is outside the scope of this claim. Similarly, the claims do not encompass alterations of a human antibody variable domain that do not result in antibodies that bind to the antigen bound by the parent antibody.

Thus, it is respectfully submitted that the specific physical and functional characteristics of the claimed antibody variable regions must be given weight in determining the scope of the claims. The failure of the Examiner to do so has resulted in an improper characterization of the claimed invention, which is fundamental to the determination of enablement.

The second issue upon which the Examiner has not given sufficient weight are the extensive teachings in the disclosure, in view of what was known in the art as of the time of filing of the present application. The present disclosure provides more than ample direction to a person skilled in the art to rely upon in producing the variable domains and antibodies falling within the scope of the present claims. In particular, the present disclosure provides specific guidance to a person skilled in the art to produce, alter and select variants falling within the scope of the claims without the exercise of undue experimentation.

For example, the disclosure at pages 10-16, 20-29 and in the working examples recites a summary of the process to be used to produce the claimed humanized antibody domains and antibodies. As noted therein, steps for identifying and producing the variant sequences are described,

as are a variety of physical attributes of the resulting variants that are to be selected for through the process described therein (e.g., the substituted FR residue interacts with a CDR, non-covalently binds antigen directly or participates in the V_L - V_H interface). A person reasonably skilled in this field would face no difficulty in taking any parent antibody having a particular binding specificity and, following the explicit and comprehensive teachings of the present disclosure, construct and select humanized antibody domains and antibodies as defined in the claims.

The third basis of the Examiner's rejection appears to be the belief that the claims cannot be practiced without undue experimentation. Undue experimentation is a conclusion that must be reached after considering a number of discrete factors. Two of these, claim scope and the teachings of the disclosure, have been addressed above and in the earlier response to the outstanding Office Action. In addition, the Examiner appears have relied on an assumption that there is an abnormally high level of unpredictability in the field of the invention. In particular, the Examiner is apparently asserting that there is such an inherent degree of unpredictability in the art that no claim to a humanized antibody could ever issue if it were not limited to a specifically defined amino acid sequence associated with a specific antibody specificity. This is an inaccurate characterization of the level of unpredictability in the field of the invention at the time the present application was filed, and is used in an improper manner by the Examiner in light of law governing lack of enablement due to undue experimentation.

Unpredictability in the art, standing alone, is not a conclusion that can support a rejection on the basis of lack of enablement. *In re Wands*, 858 F.2d 731, 737 (Fed. Cir. 1988). Instead, it is a factor whose significance must be assessed in making the legal determination of whether practice of the claimed invention would involve undue experimentation. Moreover, the fact that an art has unpredictability

associated with it does not condemn any claim that goes beyond a specific working example. As §2164.03 of the MPEP provides:

The "predictability or lack thereof" in the art refers to the ability of one skilled in the art to extrapolate the disclosed or known results to the claimed invention. If one skilled in the art can readily anticipate the effect of a change within the subject matter to which the claimed invention pertains, then there is predictability in the art. On the other hand, if one skilled in the art cannot readily anticipate the effect of a change within the subject matter to which that claimed invention pertains, then there is lack of predictability in the art.

In the present case, neither the Examiner's characterization of unpredictability nor the assessment of the significance of unpredictability in light of the present disclosure is accurate.

As to the former issue, and as noted in the earlier response to the outstanding Office Action, the number of examples of successful modifications (*i.e.*, modifications resulting in functional humanized antibody binding domains) made according to the teachings of the present disclosure far exceeds the number suggested by the Examiner. For example, for one target antigen (HER2), eight successful variants were constructed using the procedures of the present invention. Each of these variants preserved binding affinity of a nature to make it a useful humanized binding domain.

Examiner Davis explained in the interview her opinion that variants (*e.g.* huMAB4D5-2 and huMAB4D5-3) without all 5 FR substitutions of the huMAB4D5-8 variant were not able to bind antigen with appropriate affinity.

With respect to the huMAB4D5-2 variant in Table 3, it was acknowledged that the variant with the single FR substitution did not appear to have growth inhibitory activity in the SK-BR-3 assay used. However, the

undersigned explained that even the 4.7nM Kd of this variant rendered it useful, e.g., for diagnostic uses (see pages 55-57), as an immunotoxin (see pages 58-59), and/or for killing cells *in vivo* via Antibody Dependent Cellular Cytotoxicity (ADCC, see pages 59-60). Indeed, the affinity of the huMab4D5-2 variant significantly surpasses the affinity of the murine and humanized anti-gD antibodies in column 45 of the cited Queen '762 patent, for instance. There is nothing in the art to indicate that 4.7nM is not a useful Kd. The other variant relied on by the Examiner as supporting her view that the claims were not enabled (huMab4D5-3 in Table 3 with 4.4nM Kd) would also have the above-noted uses in addition to its ability to inhibit the proliferation of breast cancer cells as assessed by the SK-BR-3 assay. Hence, it was emphasized that the antibodies of the present invention need not have superior binding affinities in order to be useful.

Examiner Caputa asked what evidence was available to demonstrate that the teachings of the present application could be applied to other useful humanized antibodies.

Applicants are able to demonstrate that humanized antibody variants that bind at least seven distinct antigens have been made based on the teachings in the above patent application. For each antigen, several humanized antibody variants with the claimed FR substitution(s) could be made. In particular:

1. Example 1 on pages 63-74 describes several humanized variants which bound HER2 comprising the presently claimed FR substitution(s). Each of those variants was able to bind HER2 antigen (see Table 3 on page 72).
2. Example 3 on pages 79-88 describes eight humanized anti-CD3 antibody variants (BsF(ab')₂v1 as well as variants v6-12) which comprised the presently claimed FR substitutions. That example describes the BsF(ab')₂v1 variant (see huxCD3v1 in Fig. 5) and the other variants which were useful for retargeting the cytotoxic activity of human CD3+

CTL against HER2 overexpressing breast cancer cells (see, page 79, first paragraph, and Shalaby et al. *J. Exp. Med.* 175:217-225 (1992), of record). The FR substitutions in the BsF(ab')₂v1 variant (71L, 71H, 73H and 78H) were those which (a) non-covalently bound antigen directly; (b) interacted with a CDR; or (c) participated in the V_L-V_H interface, such FR substitutions being described and enabled by the present specification. Example 3 describes how the affinity of the humanized antibody BsF(ab')₂v1 was further improved by incorporating additional rodent CDR amino acid residues in the humanized antibody to generate BsF(ab')₂v9. In addition, that example describes variants with further FR substitutions at positions 75H and/or 76H.

3. Example 4 on page 89 describes yet a further example of the presently claimed humanized antibody variable domains/antibodies. The humanized anti-CD18 antibody included the presently claimed FR substitutions that (a) non-covalently bound antigen directly; (b) interacted with a CDR; or (c) participated in the V_L-V_H interface, and were identified using molecular modeling as taught in the present application.

4. Presta et al. *Cancer Research* 57:4593-4599 (1997) (of record) describes nine humanized anti-VEGF variants that were generated following the enabling disclosure of the present application.

5. Various humanized anti-Protein C variants are described in O'Connor et al. *Protein Engineering* 11(4):321-328 (1998) (copy attached), those variants being enabled by the present application.

6. Humanized antibody variants which bind the IgE antigen covered by certain claims herein have also been made (see Presta et al. *J. Immunol.* 151(5): 2623-2632 (1993) (of record)).

7. Werther et al. *J. Immunol.* 157(11): 4986-4995 (1996) (of record) is concerned with the humanization of anti-LFA-1 antibodies and describes several humanized antibody variants encompassed by the present claims.

These facts suggest that the "unpredictability" in the art is in fact much lower than suggested by the Examiner. When this actual level of unpredictability is then considered in view of the claim scope and the breadth of the disclosure, it becomes clear that unpredictability in the present application is not a factor that can support an assertion of undue experimentation. Indeed, through the teachings of the present disclosure, the moderate degree of unpredictability that exists in the art does not operate as a barrier to practice of the claimed invention, particularly in light of the teachings of the disclosure as to how to produce, identify and select variants falling within the scope of the claims.

As a consequence, it is respectfully submitted that the basis of the Examiner's belief that there is a lack of enablement due to undue experimentation is misplaced and should be withdrawn. Moreover, it is respectfully submitted that unless the Examiner can provide specific evidence demonstrating that the procedures disclosed in the present application will not yield success in producing humanized antibody variable domains as claimed, to counter the evidence provided in the specification and the specific responses, the maintenance of this rejection is improper. *In re Wright*, 999 F.2d 1557, 1562 (Fed. Cir. 1993); *In re Marzocchi*, 439 F.2d 220, 224 (CCPA 1971). Accordingly, Applicants respectfully request that the Examiner reconsider and withdraw the rejections based on lack of enablement.

Section 103 rejection

Claims 113, 115-118, 123 and 127-128 are rejected under Section 103 as being unpatentable over the Queen '762 patent in view of Kabat et al. Applicants responded to the rejection in the amendment dated April 25, 2001 and that response is supplemented hereinbelow.

At the outset, it is noted that the 103 rejection as to 115-118, 123, 127-128 should fall with the withdrawal of the Section 102 rejections of these claims, since the Office has not advanced any reason why one would substitute the presently recited FR residues, or why one would

have thought it would be possible to make a humanized antibody with improved affinity compared to the rodent antibody based on the cited art.

With regard to claim 113, now reciting "a human variable domain comprising the most frequently occurring amino acid residues at each location in all human immunoglobulins of a human heavy chain immunoglobulin subgroup", Applicants pointed out that it is believed that a *prima facie* case for obviousness of this invention has not been established; and even if it had, unexpected results provide objective evidence as to the patentability of the presently claimed invention.

Applicants' representatives explained in the interview that the term "consensus framework from many human antibodies" was used in the Queen patent synonymously with "a framework from a particular human immunoglobulin that is unusually homologous to the donor immunoglobulin to be humanized" - the position also taken by a former Patent Examiner (see page 10 of the amendment dated April 25, 2001). This is abundantly clear from a reading of the relied upon reference to a "consensus framework from many human antibodies" in the '762 patent. Immediately after this phrase in column 13, first full paragraph, the '762 patent states "For example, comparison of the sequence of a mouse heavy (or light) chain variable region against human heavy (or light) variable regions in a data bank (for example, the National Biomedical Research Foundation Protein Identification Resource) shows that the extent of homology to different human regions varies greatly, typically from about 40% to about 60-70%. By choosing as the acceptor immunoglobulin one of the human heavy (respectively light) chain variable regions that is most homologous to the heavy (respectively light) chain variable region of the donor immunoglobulin, fewer amino acids will be changed in going from the donor immunoglobulin to the humanized immunoglobulin. Thus, it is clear from the '762 patent that what it intended by the "consensus framework from many human antibodies" was indeed the "most homologous" human framework region as selected in the quoted paragraph of the '762 patent above. Thus, Applicants submit that the rejection based on the

combination of the '762 patent and Kabat *et al.* has been made with the benefit of hindsight of the present invention, which is impermissible.

Aside from the lack of teaching or motivation in the '762 patent to use a human variable domain comprising the most frequently occurring amino acid residues at each location in all human immunoglobulins of a human heavy chain immunoglobulin subgroup, the '762 patent teaches away from this approach. Indeed, Queen taught the importance of selecting an unusually homologous human framework in order to avoid distorting the CDRs (column 13, lines 19-27). Applicants have shown previously how antibodies humanized with the human variable domain in claim 113 lack the unusually high homology to the non-human variable domain (paragraph bridging pages 17-18 of the amendment filed August 24, 1998), but nonetheless bind antigen extremely well. For instance, Applicants referenced the humanized anti-CD18 antibody with only 53% homology between the rodent and human framework sequences; humanized anti-IgE antibody with only 58% homology; humanized anti-CD11a with only 57% homology etc. These homologies were much lower than the homologies considered by Queen to be critical to avoid distorting the CDRs and for retaining affinity. The present application goes beyond the Queen method and discloses the benefits of using a human variable domain comprising the most frequently occurring amino acid residues at each location in all human immunoglobulins of a human heavy chain immunoglobulin subgroup for humanizing many different antibodies. This was not possible based on Queen's work which required that the human variable domain be tailored to each new rodent variable domain sequence to be humanized.

Applicants believe that the above arguments make out a strong case for patentability of the presently claimed invention over the cited combination of the '762 patent and Kabat *et al.* Moreover, Applicants are able to demonstrate that the presently claimed invention is patentable over the cited art due to the unexpected results attributable thereto. In particular, Applicants have demonstrated through the Shak declaration that antibodies directed against four different antigens humanized with

Serial No.: 08/146,206

the presently claimed human variable domain in claim 113 display the unexpected property of lack of significant immunogenicity upon repeated administration to a human patient. This was not predictable in view of art such as Isaacs *et al.* *The Lancet* 340:748-752 (1992) (of record) in which 3/4 patients developed inhibitory antiglobulins upon repeated administration of the prior art humanized antibody thereto.

The Examiner had indicated that the unexpected results are not applicable because "the claims are broad, and drawn to any antibodies, and not specifically the claimed antibodies, wherein their specific target antigens, and their binding properties are not disclosed in the claims". Applicants submit that the Shak declaration filed demonstrates that the unexpected result applies regardless of the antigen or binding properties of the antibodies; the unexpected result was shown for humanized anti-HER2, anti-IgE, anti-CD11a and anti-VEGF antibodies. Hence, Applicants submit that the unexpected results are commensurate in scope with the invention recited in claim 113.

Thus, Applicants submit that the presently claimed invention is patentable over the cited art.

Applicants believe that this application is now in order for allowance and look forward to early notification to that effect.

Respectfully submitted,

GENENTECH, INC.

By: 

Wendy M. Lee

Reg. No. 40,378

Telephone: (650) 225-1994

Date: July 13, 2001



09157

PATENT TRADEMARK OFFICE

Serial No.: 08/146,206

Part / #61
7/13/01

VERSION WITH MARKINGS TO SHOW CHANGES MADE

In the claims:

Please amend claims 113 and 128 as follows:

113. (Three times amended) A humanized variant of a non-human parent antibody which binds an antigen and comprises a [consensus] human variable domain comprising the most frequently occurring amino acid residues at each location in all human immunoglobulins of a human heavy chain immunoglobulin subgroup wherein amino acid residues forming Complementarity Determining Regions (CDRs) thereof comprise non-human antibody amino acid residues, and further comprises a Framework Region (FR) substitution where the substituted FR residue: (a) noncovalently binds antigen directly; (b) interacts with a CDR; (c) introduces a glycosylation site which affects the antigen binding or affinity of the antibody; or (d) participates in the V_L - V_H interface by affecting the proximity or orientation of the V_L and V_H regions with respect to one another.

¹²⁹
~~128~~. (Twice Amended) A humanized variant of a non-human parent antibody which binds an antigen, wherein the humanized variant comprises Complementarity Determining Region (CDR) amino acid residues of the non-human parent antibody incorporated into a human antibody variable domain, and further comprises a Framework Region (FR) substitution where the substituted FR residue: (a) noncovalently binds antigen directly; (b) interacts with a CDR; or (c) participates in the V_L - V_H interface by affecting the proximity or orientation of the V_L and V_H regions with respect to one another, and wherein the humanized variant binds the antigen more tightly than and up to about 3-fold more tightly than the parent antibody binds antigen.

Please add the following claims:

129. A humanized antibody variable domain comprising non-human Complementarity Determining Region (CDR) amino acid residues which bind an antigen incorporated into a human antibody variable domain, and further comprising a Framework Region (FR) amino acid substitution where the substituted FR residue:
(a) noncovalently binds antigen directly;
(b) interacts with a CDR; or
(c) participates in the V_L - V_H interface by affecting the proximity or orientation of the V_L and V_H regions with respect to one another, and wherein the substituted FR residue is at a site selected from the group consisting of: 4L, 38L, 43L, 44L, 58L, 62L, 65L, 66L, 67L, 68L, 69L, 73L, 85L, 98L, 2H, 4H, 24H, 36H, 39H, 43H, 45H, 69H, 70H, 73H, 74H, 76H, 78H, 92H and 93H, utilizing the numbering system set forth in Kabat.

130. The humanized variable domain of claim 129 wherein the substituted residue is the residue found at the corresponding

Serial No.: 08/146,206

location of the non-human antibody from which the non-human CDR amino acid residues are obtained.

131. The humanized variable domain of claim 129 wherein no human Framework Region (FR) residue other than those set forth in the group has been substituted.

Genentech, Inc.
Genentech, Inc.
Genentech, Inc.
Genentech, Inc.
Genentech, Inc.

FACSIMILE TRANSMITTAL

#62

1 DNA WAY
South San Francisco, CA 94080
(650) 225-1994
Facsimile: (650) 952-9881

DATE: July 30, 2001

Please deliver the following Amendment to:

NAME: Examiner Minh-Tam Davis
U.S. Patent and Trademark office
Washington, DC 20231

Fax No.:(703) 308-4426

FROM: Wendy M. Lee
Registration No.: 40,378

RE: U.S. Serial No.: 08/146,206
Our Docket No.: P0709P1

Number of Pages including this cover sheet - 13

Certificate of Facsimile Transmission Under 37 CFR § 1.8

In accordance with CFR § 1.6(d), this Amendment and Zenapax product information is addressed to Examiner Minh-Tam Davis, The Patent and Trademark Office, Washington, DC 20231 and is being transmitted to facsimile No. (703) 308-4426.

CONFIDENTIAL NOTE

The documents accompanying this facsimile transmission contain information from GENENTECH, INC. which is confidential or privileged. The information is intended only for the individual or entity named on this transmission sheet. If you are not the intended recipient, be aware that any disclosure, copying, distribution, or use of the contents of this faxed information is strictly prohibited. If you have received this facsimile in error, please notify us by telephone immediately so that we can arrange for the return of the original documents to us and the retransmission of them to the intended recipient.

If you do not receive all pages, please notify Wendy Lee at (650) 225-1994.

P

*Received
7/30/01*

Patent Docket P0709P1

IN THE UNITED STATES PATENT AND TRADEMARK OFFICE

<p>In re Application of Paul J. Carter et al. Serial No.: 08/146,206 Filed: November 17, 1993 For: METHOD FOR MAKING HUMANIZED ANTIBODIES</p>	<p>Group Art Unit: 1642 Examiner: Minh-Tam Davis</p> <hr/> <p>Certificate of Facsimile Transmission Under 37 CFR § 1.8 In accordance with CFR § 1.6(d), this correspondence addressed to Examiner Minh-Tam Davis, The Patent and Trademark Office, Washington, DC 20231 is being transmitted to facsimile No. (703) 308-4426 on July 30, 2001 <i>[Signature]</i> Wendy M. Lee</p>
---	---

*# 624
KD
8-16-01*

SUPPLEMENTAL AMENDMENT

Assistant Commissioner of Patents
Washington, D.C. 20231

Sir:

IN THE CLAIMS:

Please amend claim 128 as follows:

*Official
Davis
7/31/01*

*79
D*

128. (Three Times Amended) A humanized variant of a non-human parent antibody which binds an antigen, wherein the humanized variant comprises Complementarity Determining Region (CDR) amino acid residues of the non-human parent antibody incorporated into a human antibody variable domain, and further comprises Framework Region (FR) substitutions at heavy chain positions 71H, 73H, 78H and 93H, utilizing the numbering system set forth in Kabat.

REMARKS

Applicants confirm having discussed the above application with Examiner Davis in the telephonic interview of July 25, 2001. In that interview, Examiner Davis indicated that on reconsideration the Section 112, first paragraph rejection would be withdrawn except with respect to claim 128. The Examiner considers the claim to antibodies with improved affinity to be enabled only for variants with FR substitutions at all the positions

124

for the exemplified better-binding variants. Applicants strongly disagree with the rejection of claim 128 for all the reasons previously elaborated. Nonetheless, in order to expedite allowance of the case, claim 128 is amended herein to recite the FR substitutions in the heavy chain variable region of the huMAb4D5-8 and huMAb4D5-6 variants which bound antigen more tightly than the parent antibody. Support for the claim language can be found on page 72, for instance. Due to the recitation of the FR substitutions, the functional language concerning the improved binding has been removed from the claim. The Examiner indicated that such an amendment would address the maintained Section 112 rejection.

The Examiner further stated in the above interview that the previous Section 103 rejection of claims 113, 115-118, 123 and 127-128 would be maintained unless Applicants could demonstrate the unexpected results through a side-by-side comparison of the antibody described in the cited Queen prior art and the antibodies of the present application. Applicants are now able to provide that comparison. In particular, Applicants attach the Physicians' Desk Reference ® (PDR) entry for the humanized anti-Tac antibody (ZENAPAX®) of the Queen prior art. Applicants note that the other humanized antibodies added to the Queen patents by way of CIP applications are not prior art to Applicants' invention set forth in the rejected claims herein.

As noted in section entitled "PRECAUTIONS" in the PDR entry for ZENAPAX®, when patients received multiple doses of that humanized antibody, anti-idiotypic antibodies to ZENAPAX® were detected in patients with an overall incidence of 8.4%. The presently disclosed antibodies produce unexpectedly lower immunogenicity compared to that of the Queen antibody. This is demonstrated in the Shak declaration previously submitted which explained that patients receiving multiple doses of the humanized anti-HER2 antibody (HERCEPTIN®) exemplified in the present application only developed an antibody response 0.1% of the time (1 of the 885 patients evaluated; see paragraph 4 of the Shak declaration); and 0% of the patients treated with an anti-IgE antibody humanized according to the

Serial No.: 08/146,206

teachings of the above patent specification developed a HAHA response (paragraph 7 of the Shak declaration). The total lack of an immune response in the patients treated with the humanized anti-IgE antibody is particularly unexpected, given that the allergic rhinitis and asthma patients treated therewith were hyper-sensitive to foreign antigens. Likewise, no significant immunogenicity upon repeated administration was observed for the anti-VEGF and anti-CD11a antibodies humanized according to the teachings in the present application. Paragraphs 8 and 9 of the Shak declaration. Applicants submit that this side-by-side comparison shows that the antibodies of the present application possess unexpected properties with respect to minimal or no immunogenicity upon repeated administration to human patients.

Reconsideration and withdrawal of the Section 103 rejection is respectfully requested in view of the above.

Applicants believe that this case is now in order for allowance and look forward to early notification of same.

Respectfully submitted,
GENENTECH, INC.

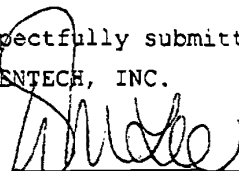
By: 
Wendy M. Lee
Reg. No. 40,378
Telephone: (650) 225-1994

Date: July 30, 2001



P

Serial No.: 08/146,206

VERSION WITH MARKINGS TO SHOW CHANGES MADE

In the claims:

Please amend claim 128 as follows:

128. (Three Times Amended) A humanized variant of a non-human parent antibody which binds an antigen, wherein the humanized variant comprises Complementarity Determining Region (CDR) amino acid residues of the non-human parent antibody incorporated into a human antibody variable domain, and further comprises [a] Framework Region (FR) substitutions at heavy chain positions 71H, 73H, 78H and 93H, utilizing the numbering system set forth in Kabat [where the substituted FR residue: (a) noncovalently binds antigen directly; (b) interacts with a CDR; or (c) participates in the V_L - V_H interface by affecting the proximity or orientation of the V_L and V_H regions with respect to one another, and wherein the humanized variant binds the antigen more tightly than and up to about 3-fold more tightly than the parent antibody binds antigen].



UNITED STATES DEPARTMENT OF COMMERCE
Patent and Trademark Office
 Address: COMMISSIONER OF PATENTS AND TRADEMARKS
 Washington, D.C. 20231

APPLICATION NUMBER	FILING DATE	FIRST NAMED APPLICANT	ATTORNEY DOCKET NO.
--------------------	-------------	-----------------------	---------------------

08/14/2006

EXAMINER

ART UNIT	PAPER NUMBER
----------	--------------

DATE MAILED: 8/29/01

INTERVIEW SUMMARY

All participants (applicant, applicant's representative, PTO personnel):

(1) MINH-TAM DAVIS (3) Wendy Lee
 (2) Anthony Caputo (4) _____

Date of Interview 08/29/01

Type: Telephonic Personal (copy is given to applicant applicant's representative).

Exhibit shown or demonstration conducted: Yes No If yes, brief description: _____

Agreement was reached. was not reached.

Claim(s) discussed: _____

Identification of prior art discussed: _____

Description of the general nature of what was agreed to if an agreement was reached, or any other comments: Applicant representative discusses prior art of record of pending claims

(A fuller description, if necessary, and a copy of the amendments, if available, which the examiner agreed would render the claims allowable must be attached. Also, where no copy of the amendments which would render the claims allowable is available, a summary thereof must be attached.)

1. It is not necessary for applicant to provide a separate record of the substance of the interview.

Unless the paragraph above has been checked to indicate to the contrary, A FORMAL WRITTEN RESPONSE TO THE LAST OFFICE ACTION IS NOT WAIVED AND MUST INCLUDE THE SUBSTANCE OF THE INTERVIEW. (See MPEP Section 713.04). If a response to the last Office action has already been filed, APPLICANT IS GIVEN ONE MONTH FROM THIS INTERVIEW DATE TO FILE A STATEMENT OF THE SUBSTANCE OF THE INTERVIEW.

2. Since the Examiner's interview summary above (including any attachments) reflects a complete response to each of the objections, rejections and requirements that may be present in the last Office action, and since the claims are now allowable, this completed form is considered to fulfill the response requirements of the last Office action. Applicant is not relieved from providing a separate record of the interview unless box 1 above is also checked.

Examiner Note: You must sign this form unless it is an attachment to another form.

FORM PTOL-413 (REV. 1-96)

Minh Tam Davis

Manual of Patent Examining Procedure, Section 713.04 Substance of Interview must Be Made of Record

A complete written statement as to the substance of any face-to-face or telephone interview with regard to an application must be made of record in the application, whether or not an agreement with the examiner was reached at the interview.

§1.133 Interviews
* * * * *

(b) In every instance where reconsideration is requested in view of an interview with an examiner, a complete written statement of the reasons presented at the interview as warranting favorable action must be filed by the applicant. An interview does not remove the necessity for response to Office action as specified in §§ 1.111, 1.135. (35 U.S.C. 132)

§ 1.2. Business to be transacted in writing. All business with the Patent or Trademark Office should be transacted in writing. The personal attendance of applicants or their attorneys or agents at the Patent and Trademark Office is unnecessary. The action of the Patent and Trademark Office will be based exclusively on the written record in the Office. No attention will be paid to any alleged oral promise, stipulation, or understanding in relation to which there is disagreement or doubt.

The action of the Patent and Trademark Office cannot be based exclusively on the written record in the Office if that record is itself incomplete through the failure to record the substance of interviews.

It is the responsibility of the applicant or the attorney or agent to make the substance of an interview of record in the application file, unless the examiner indicates he or she will do so. It is the examiner's responsibility to see that such a record is made and to correct material inaccuracies which bear directly on the question of patentability.

Examiners must complete a two-sheet carbon interleaf interview Summary Form for each interview held after January 1, 1978 where a matter of substance has been discussed during the interview by checking the appropriate boxes and filling in the blanks in neat handwritten form using a ball point pen. Discussions regarding only procedural matters, directed solely to restriction requirements for which interview recordation is otherwise provided for in Section 812.01 of the Manual of Patent Examining Procedure, or pointing out typographical errors or unreadable script in Office actions or the like, are excluded from the interview recordation procedures below.

The Interview Summary Form shall be given an appropriate paper number, placed in the right hand portion of the file, and listed on the "Contents" list on the file wrapper. The docket and serial register cards need not be updated to reflect interviews. In a personal interview, the duplicate copy of the Form is removed and given to the applicant (or attorney or agent) at the conclusion of the interview. In the case of a telephonic interview, the copy is mailed to the applicant's correspondence address either with or prior to the next official communication. If additional correspondence from the examiner is not likely before an allowance or if other circumstances dictate, the Form should be mailed promptly after the telephonic interview rather than with the next official communication.

The Form provides for recordation of the following information:

- Serial Number of the application
- Name of applicant
- Name of examiner
- Date of interview
- Type of interview (personal or telephonic)
- Name of participant(s) (applicant, attorney or agent, etc.)
- An indication whether or not an exhibit was shown or a demonstration conducted
- An identification of the claims discussed
- An identification of the specific prior art discussed
- An indication whether an agreement was reached and if so, a description of the general nature of the agreement (may be by attachment of a copy of amendments or claims agreed as being allowable). (Agreements as to allowability are tentative and do not restrict further action by the examiner to the contrary.)
- The signature of the examiner who conducted the interview
- Names of other Patent and Trademark Office personnel present.

The Form also contains a statement reminding the applicant of his responsibility to record the substance of the interview.

It is desirable that the examiner orally remind the applicant of his obligation to record the substance of the interview in each case unless both applicant and examiner agree that the examiner will record same. Where the examiner agrees to record the substance of the interview, or when it is adequately recorded on the Form or in an attachment to the Form, the examiner should check a box at the bottom of the Form informing the applicant that he need not supplement the Form by submitting a separate record of the substance of the interview.

It should be noted, however, that the Interview Summary Form will not normally be considered a complete and proper recordation of the interview unless it includes, or is supplemented by the applicant or the examiner to include, all of the applicable items required below concerning the substance of the interview:

A complete and proper recordation of the substance of any interview should include at least the following applicable items:

- 1) A brief description of the nature of any exhibit shown or any demonstration conducted,
- 2) an identification of the claims discussed,
- 3) an identification of specific prior art discussed,
- 4) an identification of the principal proposed amendments of a substantive nature discussed, unless these are already described on the Interview Summary Form completed by the examiner,
- 5) a brief identification of the general thrust of the principal arguments presented to the examiner. The identification of arguments need not be lengthy or elaborate. A verbatim or highly detailed description of the arguments is not required. The identification of the arguments is sufficient if the general nature or thrust of the principal arguments made to the examiner can be understood in the context of the application file. Of course, the applicant may desire to emphasize and fully describe those arguments which he feels were or might be persuasive to the examiner,
- 6) a general indication of any other pertinent matters discussed, and
- 7) if appropriate, the general results or outcome of the interview unless already described in the Interview Summary Form completed by the examiner.

Examiners are expected to carefully review the applicant's record of the substance of an interview. If the record is not complete or accurate, the examiner will give the applicant one month from the date of the notifying letter or the remainder of any period for response, whichever is longer, to complete the response and thereby avoid abandonment of the application (37 CFR 1.135(c)).

Examiner to Check for Accuracy

Applicant's summary of what took place at the interview should be carefully checked to determine the accuracy of any argument or statement attributed to the examiner during the interview. If there is an inaccuracy and it bears directly on the question of patentability, it should be pointed out in the next Office letter. If the claims are allowable for other reasons of record, the examiner should send a letter setting forth his or her version of the statement attributed to him. If the record is complete and accurate, the examiner should place the indication "Interview record OK" on the paper recording the substance of the interview along with the date and the examiner's initials.



Patent Docket P0709P1

1642
#

THE UNITED STATES PATENT AND TRADEMARK OFFICE

RECEIVED

In re Application of Paul J. Carter et al. Serial No.: 08/146,206	Group Art Unit: 1642 Examiner: Minh-Tam Davis SEP 06 2001 TECH CENTER 1600/2900
Filed: November 17, 1993 For: METHOD FOR MAKING HUMANIZED ANTIBODIES	CERTIFICATE OF MAILING I hereby certify that this correspondence is being deposited with the United States Postal Service with sufficient postage as first class mail in an envelope addressed to: Assistant Commissioner of Patents, Washington, D.C. 20231 on August 30, 2001 <i>Anna Kan</i> Anna Kan

6 #
KD
10/10/01

SUPPLEMENTAL INFORMATION DISCLOSURE STATEMENT

Assistant Commissioner of Patents
Washington, D.C. 20231

Sir:

Applicants submit herewith patents, publications or other information (attached hereto and listed on the attached revised Form PTO-1449) of which they are aware, which they believe may be material to the examination of this application and in respect of which there may be a duty to disclose in accordance with 37 CFR §1.56.

This Information Disclosure Statement is filed in accordance with the provisions of:

37 CFR §1.97(b)

- within three months of the filing date of the application other than a continued prosecution application under 37 CFR §1.53(d); or
- within three months of the date of entry of the national stage of a PCT application as set forth in 37 CFR §1.491, or
- before the mailing of the first Office action on the merits; or
- before the mailing of the first Office action after the filing of a request for a continued examination under 37 CFR §1.114.

37 CFR §1.97(c)

- by the applicant after the period specified in 37 CFR §1.97(b), but prior to the mailing date of any of a final action under 37 CFR §1.113, or a notice of allowance under 37 CFR §1.311, or an action that otherwise closes prosecution in the application, and is accompanied by either the fee set forth in 37 CFR §1.17(p) or a statement as specified in 37 CFR §1.97(e), as checked below.

37 CFR §1.97(d)

- after the period specified in CFR §1.97(c), and is accompanied by the fee set

09/06/2001 09:00:00 00000141 070000 00010000

01 10:15 100.00 00

forth in 37 CFR §1.17(p) **and** a statement as specified in 37 CFR §1.97(e), as checked below.

[If either of boxes 37 CFR §1.97(c) or 37 CFR §1.97(d) is checked above, the following statement under 37 CFR §1.97(e) may need to be completed.]

- 37 CFR §1.97(e)** Each item of information contained in the information disclosure statement was first cited in any communication from a foreign patent office in a counterpart foreign application not more than three months prior to the filing of this information disclosure statement.
- 37 CFR §1.704(d)** Each item of information contained in the information disclosure statement was cited in a communication from a foreign patent office in a counterpart foreign application and the communication was not received by any individual designated in §1.56(c) more than thirty days prior to the filing of this information disclosure statement. Therefore, in accordance with the provisions of 37 CFR §1.704(d), the filing of this information disclosure statement will not be considered a failure to engage in reasonable efforts to conclude prosecution under 37 CFR §1.704.
- The U.S. Patent and Trademark Office is hereby authorized to charge Deposit Account No. 07-0630 in the amount of \$180.00 to cover the cost of this Information Disclosure Statement under 37 CFR §1.17(p). Any deficiency or overpayment should be charged or credited to this deposit account.

A list of the patent(s) or publication(s) is set forth on the attached revised Form PTO-1449 (Modified). A copy of the items on PTO-1449 is supplied herewith.

Those patent(s) or publication(s) which are marked with an asterisk (*) in the attached PTO-1449 form are not supplied because they were previously cited by or submitted to the Office in a prior application Serial No. 07/715,272, filed 14 June 1991 and relied upon in this application for an earlier filing date under 35 USC §120.

A concise explanation of relevance of the items listed on PTO-1449 is:

- not given
- given for each listed item
- given for only non-English language listed item(s) [Required]
- in the form of an English language copy of a Search Report from a foreign patent office, issued in a counterpart application, which refers to the relevant portions of the references.

In accordance with 37 CFR §1.97(g), the filing of this information disclosure statement shall not be construed as a representation that a search has been made.

In accordance with 37 CFR §1.97(h), the filing of this information disclosure statement shall not be construed to be an admission that the information cited in the statement is, or is considered to be, material to patentability as defined in 37 CFR § 1.56(b).

In the event that the Office determines a fee to be due where none is specifically authorized in this paper, the U.S. Patent and Trademark Office is hereby authorized to charge Deposit Account No. 07-0630 in the amount of \$180.00 to cover the cost of this Information Disclosure Statement under 37 CFR §1.17(p).

Respectfully submitted,

GENENTECH, INC.

Date: August 30, 2001

By: Steven X. Cui
By: Steven X. Cui Reg. No. 44,637
for Wendy M. Lee Reg. No. 40,378
Telephone No. (650) 225-1994



09157

PATENT TRADEMARK OFFICE

9/4/01

File History Report

Paper number(s) _____ is/are missing from the United States Patent and Trademark Office's original copy of the file history.

The following page(s) 1 of paper number 64 is/are missing from the United States Patent and Trademark Office's original copy of the file history.

The following checked item(s) of paper number _____ is/are missing from the United States Patent and Trademark Office's original copy of the file history.

PTO-892 Form

PTO-1449 Form

PTO-948 Form

Other _____

to this declaration which represent excerpts from our laboratory notebooks with dates obscured.

4. Exhibit A provides the amino acid sequences of humanized 4D5 (anti-HER2) antibody variable domain sequences. A humanized antibody (Hu4D5 Fab) comprising the Hum4D5a V_L and Hum4D5a V_H sequences from Exhibit A (the variable domain sequences of the variant called "huMAb4D5-5" in the above application) was recombinantly produced and found to bind the HER2 antigen as evidenced by the laboratory notebook entries in Exhibit B attached hereto. Hu4D5 Fab comprised a heavy chain variable domain comprising non-human CDR amino acid residues which bound antigen incorporated into a human antibody variable domain, and further comprised a FR amino acid substitution at site 73H. The experimental work in Exhibits A and B was completed prior to September 28, 1990.

We declare further that all statements made herein of our own knowledge are true and that all statements made on information and belief are believed to be true; and further that these statements were made with the knowledge that willful false statements and the like so made are punishable by fine or imprisonment or both, under Section 1001 of Title 18 of the United States Code and that willful false statements may jeopardize the validity of the application or any patent issued thereon.

Date: _____

Paul J. Carter

Date: Sept. 4, 2001

Leonard G. Presta
Leonard G. Presta

Genentech, Inc.
Genentech, Inc.
Genentech, Inc.
Genentech, Inc.
Genentech, Inc.

#63

FACSIMILE TRANSMITTAL

1 DNA WAY
South San Francisco, CA 94080
(650) 225-1994
Facsimile: (650) 952-9881

DATE: October 2, 2001

Please deliver the following Supplemental Amendment, Vincenti et al. reference, and Declaration under 37 CFR §1.131 with attached Exhibits A and B to:

NAME: Examiner Minh-Tam Davis - Group 1642
U.S. Patent and Trademark office
Washington, DC 20231

Fax No.: (703) 308-4426

FROM: Wendy M. Lee
Registration No.: 40,378

RE: U.S. Serial No.: 08/146,206
Our Docket No.: P0709P1

Number of Pages including this cover sheet - 20

Certificate of Facsimile Transmission Under 37 CFR § 1.8

In accordance with CFR § 1.6(d), this correspondence addressed to The Patent and Trademark Office, Box: Assignments, Washington, DC 20231 is being transmitted to facsimile No. (703) 308-4426

CONFIDENTIAL NOTE

The documents accompanying this facsimile transmission contain information from GENENTECH, INC. which is confidential or privileged. The information is intended only for the individual or entity named on this transmission sheet. If you are not the intended recipient, be aware that any disclosure, copying, distribution, or use of the contents of this faxed information is strictly prohibited. If you have received this facsimile in error, please notify us by telephone immediately so that we can arrange for the return of the original documents to us and the retransmission of them to the intended recipient.

If you do not receive all pages, please notify Wendy Lee at (650) 225-1994.

Patent Docket P0709P1
IN THE UNITED STATES PATENT AND TRADEMARK OFFICE

<p>In re Application of Paul J. Carter et al. Serial No.: 08/146,206 Filed: November 17, 1993 For: METHOD FOR MAKING HUMANIZED ANTIBODIES</p>	<p>Group Art Unit: 1642 Examiner: Minh-Tam Davis</p> <hr/> <p>Certificate of Facsimile Transmission Under 37 CFR § 1.8 In accordance with CFR § 1.8(d), this correspondence addressed to Examiner Minh-Tam Davis at the Patent and Trademark Office, Washington, DC 20231 is being transmitted to facsimile No. (703) 308-4426</p> <p>October 2, 2001 <i>[Signature]</i> Wendy M. Lee</p>
---	---

63
10/10/01

SUPPLEMENTAL SUBMISSION

Assistant Commissioner of Patents
Washington, D.C. 20231

Sir:

The undersigned confirms having discussed the present application with Examiners Caputa and Davis in the interview on August 29, 2001. Based on and responsive to that discussion, Applicants wish to provide the following additional observations and information.

Official
Davis
10/04/01

Status of Previous Rejections

During the most recent interviews, Examiner Davis indicated that the Section 112 and 102 rejections would likely be withdrawn, but that certain of the claims may continue to be rejected under Section 103. The following comments address the 103 rejection.

Additional Information on ZENAPAX®

Examiner Caputa requested that evidence be presented to demonstrate that ZENAPAX® - for which Applicants provided the side-by-side comparison in the July 30, 2001 amendment - was the same as the antibody in the cited Queen references. To confirm that ZENAPAX® (Daclizumab) is the humanized anti-IL2 receptor antibody described in the cited Queen patents and Queen, PNAS (1989) paper, Applicants direct the Examiner's attention to the attached copy of Vincenti et al. N. Engl. J. Med. 338:161-165 (1998). Vincenti et al. refers to Daclizumab (the generic

name for the ZENAPAX® antibody - see PDR entry attached to the July 30, 2001 amendment) and states in column 2 on page 161 that it is a molecularly engineered human IgG1 incorporating the antigen-binding regions of the parent, murine monoclonal antibody. There, Vincenti cross-references the Queen et al. PNAS (1989) paper (ref. no. 14 in Vincenti et al.) as describing Daclizumab. Hence, Applicants submit that ZENAPAX®/Daclizumab is the humanized anti-IL2 receptor antibody described in the cited Queen references.

Rejection of Claim 113 under 35 USC 103 based on Queen in view of Kabat

The Office Action dated October 25, 2000 (hereinafter, "Action") includes a rejection of claims 113, 115-118, 123, and 127-128 made under 35 USC 103 as being obvious over Queen in view of Kabat. Applicants submit this response to supplement and clarify their previous remarks.

Applicants have previously explained why the Action's conclusions of obviousness made against claim 113 are formed through improper use of hindsight in interpreting the words of the disclosure of Queen. Applicants have also pointed out functional attributes of the humanized antibodies of claim 113 of the present invention that reflect unexpected results, thus providing a distinct and separate basis for overcoming the rejection imposed under §103. Through this supplemental amendment, Applicants respond to points made by Examiner in the Action, and as suggested in personal and telephonic interviews conducted earlier this year. On the basis of each of these points, Applicants respectfully submit that the Examiner has not presented and cannot sustain a *prima facie* showing of obviousness of the claimed inventions. In particular, the Queen disclosure fails to disclose the requisite motivation to combine it with Kabat to set forth a *prima facie* case of obviousness of claim 113.

It is well established that in order for a combination of references to render an invention obvious, there must be a clear motivation in the references that their teachings can be combined. *In re Avery*, 518 F.2d 1228 (1975, CCPA). The mere fact that references address issues within the same field of the invention does not render the resultant combination obvious unless the prior art also suggests the desirability of the combination. *ACS Hospital Systems Inc. v. Montefiore Hospital*, 732 F.2d 1572 (Fed. Cir. 1984). In fact, "[t]he references, viewed by themselves and not in retrospect must suggest doing what applicant has done" *In re Skoll*, 523 F.2d 1392 (1975 CCPA). Furthermore, the Federal Circuit and the PTO have made it clear that where a modification must be made to the

prior art to reject or invalidate a claim under 35 USC §103, there must be a showing of proper motivation to do so. In order to establish obviousness, there must be suggestion or motivation in the references. *In re Gordon*, 733 F.2d 900 (Fed. Cir. 1984).

The Action asserts that combining the references to provide the advantages of the present invention would be obvious. However, it identifies nothing within the applied references that would suggest combining those references to arrive at the claimed invention. Rather, the Action improperly cites the findings of *In re Kerkhoven*, 626 F.2d 846 (C.C.P.A. 1980) to support the conclusion of obviousness. Specifically, the Action states that combining the references "would have logically flowed from their having been individually taught in the prior art, and because patent '762 teaches the use of 'consensus sequence', for the same purpose of producing humanized monoclonal antibodies for therapeutic purposes." Applicants contend, however, that the use of *Kerkhoven* in the present case to support a finding of obviousness is improper as the facts of that case are distinguishable from those at hand.

In *Kerkhoven*, the Appellant's claimed a process for producing a detergent containing a mixture of anionic and nonionic detergent materials. In that method, the Appellant's combined two compositions, each taught by the prior art to be useful for the same purpose, in order to form a third composition that was also useful for the same purpose. The patent examiner rejected the method as obvious in light of the prior art under 35 U.S.C. §103. The Court of Patent Appeals affirmed the rejection and stated that the idea of combining two compositions taught by the prior art to be useful for the same purpose in order to form a third composition to be used for same purpose as the individual components is *prima facie* obvious. *Id* at 850.

The holding in *Kerkhoven* cannot be applied to the instant situation. Most significantly, the disclosure of Queen does not teach the usefulness of a sequence "comprising the most frequently occurring amino acid residues at each location in all human immunoglobulins of a human heavy chain immunoglobulin subgroup" for the purpose of humanizing antibodies, which concept is disclosed and claimed in the present application. In contrast, the Queen patent merely refers to using a "consensus framework from many human antibodies" for humanizing antibodies (column 13, line 7). One of skill in the art interpreting the phrase "many human antibodies" as recited in Queen would construe the phrase to refer to an arbitrarily selected group of human antibodies, with the specification

guiding that such an arbitrarily selected group should consist of sequences that are "unusually homologous to the donor immunoglobulin to be humanized" (column 13, line 6).

There is no specific teaching, suggestion or motivation found in the Queen disclosure that would direct a person of ordinary skill to select sets of consensus sequences that correspond to what is disclosed and claimed in the present application. Specifically, in contrast to Queen, the term "consensus" is used in the present application to refer to the relationship among a well-defined group of human antibody subgroups. See, page 14, lines 29 to 35 and page 15, lines 1-25 of disclosure.

The lack of any specific teaching or motivation in Queen is not cured by the disclosure of Kabat. The Action's analysis of Kabat does not provide any suggestion that the frequency of occurrence of amino acid residues in the immunoglobulin chains can be exploited or used for any particular purpose related to humanizing antibodies.

Indeed, nothing in the '762 patent or in Kabat teaches that a human variable domain comprising the most frequently occurring amino acid residues at each location in all human immunoglobulins of a human heavy chain immunoglobulin subgroup is useful for producing humanized monoclonal antibodies for therapeutic purposes. Therefore, regardless of what usefulness may be ascribed to the "consensus framework from many human antibodies" taught in the '762 patent, the sequences taught by Kabat could not have been, and were not, identified in the cited art as being useful for producing humanized monoclonal antibodies for therapeutic purposes. Because the prior art had not equated the potential use of the "consensus framework from many human antibodies" taught in the '762 patent with the potential use of the sequences taught by Kabat, the cited art does not provide motivation to substitute the sequences identified by Kabat for the sequences referred to in the '762 patent.

In summary, in *Kerkhoven*, both components had been taught by the prior art to be useful for the same purpose, and, in addition, the resulting component was also useful for the same purpose. However, in the instant situation only one of the prior art components, namely the "consensus framework from many human antibodies" as recited in the '762 patent, had been referred to for "producing humanized monoclonal antibodies for therapeutic purposes." Therefore, *Kerkhoven* does not control the facts of the present application, and a *prima facie* case of

obviousness on the basis of Queen in view of Kabat is improper because there is no suggestion or motivation to combine the cited references.

Applicants respectfully request that the rejection of claim 113 on the basis of Queen in view of Kabat be withdrawn.

Rejection of Claims 115-118, 123 and 127-128 under 35 USC 103 on the basis of Queen in view of Kabat

Claims 115-118, 123 and 127-128 have also been rejected under 35 USC 103 on the basis of Queen in view of Kabat. Since the rationale for this rejection and the facts that control its disposition are distinct from those related to claim 113, Applicants are separately addressing the basis of the rejection of these claims.

Each of the rejected claims recite substitutions at specific FR positions. Applicants have explained that the Queen '762 patent relied on in the Section 103 rejection did not describe a humanized antibody having these specific FR substitution(s), except for antibodies comprising a 73H FR substitution as claimed herein. With respect to the 73H substitution, Applicants provide herewith a swearing behind declaration showing a completion of that invention by the inventors of the present application prior to September 28, 1990 - the 2nd Queen CIP filing date, after which time the disclosure concerning the 73H substitution was added.

The Office has not advanced any reasons why substituting the specifically identified FR positions recited in the claims would have been obvious in view of Queen. The previous 103 rejection was based on the sequential numbering of the FR residues, rather than the Kabat numbering as presently claimed - see the April 25, 2001 amendment which clarifies this distinction at pages 8 and 13. In this regard, Examiner Caputa asked that Applicants emphasize the selection invention claimed herein by contrasting the specifically recited FR substitutions to the disclosure in the Queen patent. Aside from the specific FR substitutions for the exemplified humanized antibodies, Queen refers to FR substitutions in Categories 2-4 (columns 13-15 of the '762 patent). Thus, according to Queen, any one of the approximately 80 V_L FR residues or approximately 87 V_H FR residues can be substituted according to those criteria. This would not provide a specific teaching as to the selection invention set forth in claims herein which recite specific FR positions to be substituted.

In considering the appropriateness of the rejection of these claims on the basis of Queen in view of Kabat, the Examiner's attention is directed to the Federal Circuit decision of *In re Baird*, 16 F.3d 380. In *Baird* the court held that a reference, which discloses a generic formula that encompasses a species claimed by applicant did not render the species obvious because there was no motivation provided to select the particular species that applicant claimed. Moreover, the vast number of species encompassed by the reference's generic disclosure, and the fact that the preferred species of the reference were different from the applicant's species led the court to conclude that the reference did not fairly suggest the selection of the particular species claimed by applicants.

Baird controls the question of non-obviousness of claims 115-118, 123 and 127 in the present situation. As Applicants have previously indicated, the Queen disclosure reveals a genus that encompasses a vast number of species. According to Queen, any one of the approximately 80 V_H FR residues or approximately 87 V_H FR residues can be substituted according to their criteria. This would not provide a specific teaching as to the selection invention set forth in claims herein which recite specifically identified substitutions in FR positions. Further, as explained at the interview, the present case is entitled to a 1991 filing date and, as such, represents one of the early disclosures concerning humanized antibodies. Applicants submit that this should be taken into account when reconsidering the patentability of the present invention over the prior art.

For these reasons, Applicants respectfully request that the rejection of claims 115-118, 123 and 127-128 be withdrawn.

Conclusions

In light of the above and previous amendments and remarks, Applicants respectfully submit that all pending claims as currently presented are in condition for allowance.

Applicants believe that is application is now in condition for allowance, and look forward to early notification that effect. If however, there are outstanding issues, the Examiner is invited to call the undersigned to discuss those.

Respectfully submitted,
GENENTECH, INC.

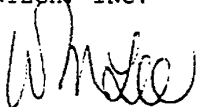

Date: October 2, 2001

By: _____
Wendy M. Lee
Reg. No. 40,378
Telephone: (650) 225-1994



09157

PATENT TRADEMARK OFFICE

Patent Docket P0709P1

IN THE UNITED STATES PATENT AND TRADEMARK OFFICE

In re Application of Paul J. Carter et al. Serial No.: 08/146,206	Group Art Unit: 1642 Examiner: Minh-Tam Davis
Filed: November 17, 1993 For: Method for Making Humanized Antibodies	

DECLARATION UNDER 37 CFR §1.131

Assistant Commissioner of Patents
Washington, D.C. 20231

*Official
Date
10/04/01*

Sir:

We, Paul J. Carter and Leonard G. Presta, do hereby declare and say as follows:

1. We are inventors of the subject matter of the above-identified patent application. All work described hereinafter was performed by us or on our behalf in the Unites States of America.
2. Prior to September 28, 1990, we conceived of and reduced to practice a humanized antibody heavy chain variable domain comprising non-human Complementarity Determining Region (CDR) amino acid residues which bind antigen incorporated into a human antibody variable domain, and further comprising a Framework Region (FR) amino acid substitution at site 73H, utilizing the numbering system set forth in Kabat, as well as an antibody comprising that humanized variable domain.
3. Evidence of the reduction to practice of the claimed invention is set forth in the exhibits attached

to this declaration which represent excerpts from our laboratory notebooks with dates obscured.

4. Exhibit A provides the amino acid sequences of humanized 4D5 (anti-HER2) antibody variable domain sequences. A humanized antibody (Hu4D5 Fab) comprising the Hum4D5a V_L and Hum4D5a V_H sequences from Exhibit A (the variable domain sequences of the variant called "huMAb4D5-5" in the above application) was recombinantly produced and found to bind the HER2 antigen as evidenced by the laboratory notebook entries in Exhibit B attached hereto. Hu4D5 Fab comprised a heavy chain variable domain comprising non-human CDR amino acid residues which bound antigen incorporated into a human antibody variable domain, and further comprised a FR amino acid substitution at site 73H. The experimental work in Exhibits A and B was completed prior to September 28, 1990.

We declare further that all statements made herein of our own knowledge are true and that all statements made on information and belief are believed to be true; and further that these statements were made with the knowledge that willful false statements and the like so made are punishable by fine or imprisonment or both, under Section 1001 of Title 18 of the United States Code and that willful false statements may jeopardize the validity of the application or any patent issued thereon.

Date: 9/5/01

Paul J. Carter
Paul J. Carter

Date: _____

Leonard G. Presta

Project No. _____

Book No. _____

TITLE Humanized 4D5

22

From Page No. _____

Dennis and Paul,
here are the human consensus sequences and the proposed
humanized 4D5 sequences.

VARIABLE LIGHT
HuLys has 83% similarity to human kappa subgroup I even when the
CDR sequences are included. The sequences inside the CDR boxes
(Chothia/Lesk definition) can be taken from HuLys or humkapi --
those outside the boxes should be taken from humkapi.

(Kabat/Wu CDR in capital letters; Chothia/Lesk CDR in boxes)

1 10
humkapi asp ile gln met thr gln ser pro ser ser leu ser ala ser val gly
HuLys

20 30
humkapi asp arg val thr ile thr cys ARG ALA SER GLN ASP ILE SER SER TYR
HuLys GLY ASN HIS ASN

40
humkapi LEU ASN trp tyr gln gln lys pro gly lys ala pro lys leu leu ile
HuLys ALA

50 60
humkapi tyr ALA ALA SER SER LEU GLU SER gly val pro ser arg phe ser gly
HuLys TYR THR THR THR ALA ASP

70 80
humkapi ser gly ser gly thr asp phe thr leu thr ile ser ser leu gln pro
HuLys phe

90
humkapi glu asp phe ala thr tyr tyr cys GLN GLN TYR ASN SER LEU PRO TYR
HuLys ile HIS PHE TRP THR ARG

100
humkapi THR phe gly gln gly thr lys val glu ile lys arg thr
HuLys

VARIABLE HEAVY
The sequences inside the CDR boxes (Chothia/Lesk definition) can be taken
from KOL or humIII -- those outside the boxes should be taken from humIII.

(Kabat/Wu CDR in capital letters; Chothia/Lesk CDR between bars)

1 10
humiii glu val gln leu val glu ser gly gly gly leu val gln pro gly gly
kol gln val arg

20 30
humiii ser leu arg leu ser cys ala ala ser GLY PHE THR PHE SER ASP TYR
kol ser ser ILE SER

40
humiii ALA MET SER trp val arg gln ala pro gly lys gly leu glu trp val
kol TYR

50 52 52a 53 60
humiii ala VAL ILE SER GLU ASN GLY SER ASP THR TYR TYR ALA ASP SER VAL
kol ILE TRP ASP ASP GLN HIS

To Page No. 23

Witnessed & Understood by me,

Date

Invented by

Date

Recorded by

Leonard Presta

EXHIBIT A

TITLE Humanized HDS

Project No. _____

Book No. _____

23

From Page No. 22

```

              70
humiii  LYS GLY arg phe thr ile ser arg asp asp ser lys asn thr leu tyr
kol     isn phe

              80      82 82a 82b 82c 83      90
humiii  leu gln met asn ser leu arg ala glu asp thr ala val tyr tyr cys
kol     asp pro gly phe

humiii  ala arg ASP ARG GLY GLY ALA VAL SER TYR CLY PHE PHE GLY TYR GLY
kol     GLY HIS GLY PHE CYS SER SER ALA SER CYS PHE GLY

              100  a  b  c  d  e  f  g  h
humiii  ARG GLY GLY ALA VAL SER TYR CLY PHE PHE GLY TYR GLY
kol     HIS GLY PHE CYS SER SER ALA SER CYS PHE GLY

              i  j  k  l01      110
humiii  GLY PHE PHE ASP VAL trp gly gln gly thr leu val thr val ser ser
kol     PRO --- --- TYR pro

```

The following are proposed humanized 405 sequences; changes in Hum4D5b and Hum4D5c from Hum4D5a are followed by an asterisk

VL

```

              1      10
humkapi  asp ile gln met thr gln ser pro ser ser leu ser ala ser val gly
Hum4D5a
Hum4D5b
Hum4D5c

```

```

              20      30
humkapi  asp arg val thr ile thr cys ARG ALA SER GLN ASP ILE SER SER TYR
Hum4D5a  VAL ASN THR ALA VAL ASN THR ALA
Hum4D5b  VAL ASN THR ALA
Hum4D5c  VAL ASN THR ALA

```

```

              40
humkapi  LEU ASN trp tyr gln gln lys pro gly lys ala pro lys leu leu ile
Hum4D5a  VAL ALA
Hum4D5b  VAL ALA
Hum4D5c  VAL ALA

```

```

              50      60
humkapi  tyr ALA ALA SER SER LEU GLU SER gly val pro ser arg phe ser gly
Hum4D5a  SER PHE
Hum4D5b  SER PHE
Hum4D5c  SER PHE TYR*

```

```

              70      80
humkapi  ser gly ser gly thr asp phe thr leu thr ile ser ser leu gln pro
Hum4D5a  arg
Hum4D5b  gly*
Hum4D5c  arg

```

```

              90
humkapi  glu asp phe ala thr tyr tyr cys GLN GLN TYR ASN SER LEU PRO TYR
Hum4D5a  HIS TYR THR THR PRO
Hum4D5b  HIS TYR THR THR PRO
Hum4D5c  HIS TYR THR THR PRO

```

```

              100
humkapi  THR phe gly gln gly thr lys val glu ile lys arg thr
Hum4D5a
Hum4D5b
Hum4D5c

```

To Page No. 24

Witnessed & Understood by me,

Date

Invented by

Date

Recorded by

Leonard Presto

Project No. _____

Book No. _____

TITLE Humanized 4DS

24

From Page No. 23

VH

1 10
 hum111 glu val gln leu val glu ser gly gly gly leu val gln pro gly gly
 Hum4D5a
 Hum4D5b
 Hum4D5c

20 30
 hum111 ser leu arg leu ser cys ala ala ser GLY PHE THR PHE SER ASP TYR
 Hum4D5a ASN ILE LYS THR
 Hum4D5b TYR ILE HIS THR
 Hum4D5c ASN ILE LYS THR

40
 hum111 ALA MET SER trp val arg gln ala pro gly lys gly leu glu trp val
 Hum4D5a TYR ILE HIS
 Hum4D5b TYR ILE HIS
 Hum4D5c TYR ILE HIS

50 52 52a 53 60
 hum111 ala val ile ser glu asn gly ser asp thr tyr tyr ala asp ser val
 Hum4D5a ARG TYR PRO THR ASN GLY TYR ARG
 Hum4D5b ARG TYR PRO THR ASN GLY TYR ARG
 Hum4D5c ARG TYR PRO THR ASN GLY TYR ARG

70
 hum111 LYS GLY arg phe thr ile ser arg asp asp ser lys asn thr leu tyr
 Hum4D5a ala thr ala
 Hum4D5b ala thr leu
 Hum4D5c ala thr ala

80 82 82a 82b 82c 83 90
 hum111 leu gln met asn ser leu arg ala glu asp thr ala val tyr tyr cys
 Hum4D5a
 Hum4D5b
 Hum4D5c

100 a b c 101
 hum111 ala arg asp ARG GLY GLY ALA VAL SER TYR GLY ASP VAL trp gly gln
 Hum4D5a ser TRP GLY GLY ASP GLY PHE TYR ALA MET ASP
 Hum4D5b ser TRP GLY GLY ASP GLY PHE TYR ALA MET ASP
 Hum4D5c ser TRP GLY GLY ASP GLY PHE TYR ALA MET ASP TYR

hum111 gly thr leu val thr val ser ser
 Hum4D5a
 Hum4D5b
 Hum4D5c

To Page No. 25

Witnessed & Understood by me,	Date	Invented by <i>Leonard Presta</i>	Date
		Recorded by <i>Leonard Presta</i>	

Her2 binding

TITLE #313 Activity of Hu4D5 Fab

Project No. _____
Book No. _____

63

From Page No. _____

AIM: To investigate the activity of Hu4D5 for inhibiting the binding of 4D5 to the cell line SKBR3 which over-expresses Her2

PROTOCOL

Assay performed by Jay Sartup + Kathy King

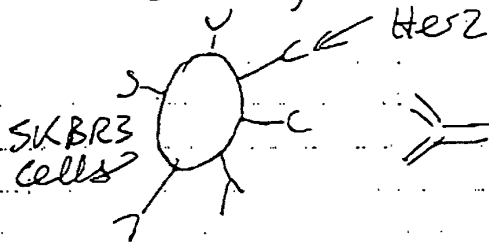

Vassay = 400n

+ Varying amounts of Hu4D5 Fab (2/2 A shockate) corrected for non-specific binding (477cpm).

Total counts	11665, 11567, 11603	11612	11365	} 0.1nM
Test buffer (200mM Tris-HCl, pH 8.0; 80mM glycine)	10862, 11473	1168	10921	
Hu4D5 (200n)		2482	2235	} [125I]-4D5
Hu4D5 (100n)		4052	3805	
Test buffer	12746, 13147	12947	12700	} 0.1nM
Hu4D5 (200n)	9044, 9583	9314	9067	
Hu4D5 (100n)	10938, 9918	10428	10181	} [125I]-6E9

Interpretation

another mab which binds her2 ↑

- Hu4D5 specifically inhib the interaction of 4D5 with the Her2 expressing cell line ~~SKBR3~~ SKBR3, but does not interfere with the interaction between this cell line and the antibody 6E9

- Order of Magnitude estimate of Kd (10 - 100 pM) ^{above} from gel (opposite) - estimate that sample contains ~1.6ng of Hu4D5 Fab

To Page No. _____

Witnessed & Understood by me,	Date	Invented by <u>Paul Cooper</u>	Date
		Recorded by	EXHIBIT B

INTERLEUKIN-2-RECEPTOR BLOCKADE WITH DACLIZUMAB TO PREVENT REJECTION IN RENAL TRANSPLANTATION

INTERLEUKIN-2-RECEPTOR BLOCKADE WITH DACLIZUMAB TO PREVENT ACUTE REJECTION IN RENAL TRANSPLANTATION

FLAVIO VINCENTI, M.D., ROBERT KIRKMAN, M.D., SUSAN LIGHT, M.D., GINNY BUMGARDNER, M.D., PH.D., MARK PESCOVITZ, M.D., PHILIP HALLORAN, M.D., PH.D., JOHN NEYLAN, M.D., ALAN WILKINSON, M.D., HENRIK EKBERG, M.D., PH.D., ROBERT GASTON, M.D., LARS BACKMAN, M.D., PH.D., AND JAMES BURDICK, M.D., FOR THE DACLIZUMAB TRIPLE THERAPY STUDY GROUP*

ABSTRACT

Background Monoclonal antibodies that block the high-affinity interleukin-2 receptor expressed on alloantigen-reactive T lymphocytes may cause selective immunosuppression. Daclizumab is a genetically engineered human IgG1 monoclonal antibody that binds specifically to the α chain of the interleukin-2 receptor and may thus reduce the risk of rejection after renal transplantation.

Methods We administered daclizumab (1.0 mg per kilogram of body weight) or placebo intravenously before transplantation and once every other week afterward, for a total of five doses, to 260 patients receiving first cadaveric kidney grafts and immunosuppressive therapy with cyclosporine, azathioprine, and prednisone. The patients were followed at regular intervals for 12 months. The primary end point was the incidence of biopsy-confirmed acute rejection within six months after transplantation.

Results Of the 126 patients given daclizumab, 28 (22 percent) had biopsy-confirmed episodes of acute rejection, as compared with 47 of the 134 patients (35 percent) who received placebo ($P=0.03$). Graft survival at 12 months was 95 percent in the daclizumab-treated patients, as compared with 90 percent in the patients given placebo ($P=0.08$). The patients given daclizumab did not have any adverse reactions to the drug, and at six months, there were no significant differences between the two groups with respect to infectious complications or cancers. The serum half-life of daclizumab was 20 days, and its administration resulted in prolonged saturation of interleukin-2 α receptors on circulating lymphocytes.

Conclusions Daclizumab reduces the frequency of acute rejection in kidney-transplant recipients. (N Engl J Med 1998;338:161-5.)

©1998, Massachusetts Medical Society.

ACUTE rejection is a strong risk factor for chronic rejection in recipients of renal grafts from cadaveric donors.¹ This fact has prompted the development of new immunosuppressive agents designed to reduce the incidence and severity of acute rejection.²⁻⁶ All these agents, however, achieve reductions in the frequency and severity of acute rejection at the price of generalized immunosuppression, with its attendant risks of opportunistic infection and cancer.

One potential target for more specific immunosuppressive therapy with monoclonal antibodies is

the interleukin-2 receptor.⁷ The high-affinity interleukin-2 receptor is composed of three noncovalently bound chains: a 55-kd α chain (also referred to as CD25 or Tac), a 75-kd β chain, and a 64-kd γ chain.⁷ This receptor is present on nearly all activated T cells but not on resting T cells. The interaction of interleukin-2 with this high-affinity receptor is required for the clonal expansion and continued viability of activated T cells. A variety of rodent monoclonal antibodies directed against the α chain of the receptor have been used in animals and humans to achieve selective immunosuppression by targeting only T-cell clones responding to the allograft.⁸⁻¹³ Daclizumab, a molecularly engineered human IgG1 incorporating the antigen-binding regions of the parent murine monoclonal antibody, offers the potential for greater therapeutic use of interleukin-2-receptor blockade.^{14,17} We compared the efficacy of daclizumab with placebo for the prevention of acute rejection in renal-transplant recipients.

METHODS

Study Design

We performed a randomized, double-blind, placebo-controlled trial at 11 transplantation centers in the United States, 3 in Canada, and 3 in Sweden. Adults receiving first renal allografts from cadaveric donors were eligible for the study. Patients were excluded if they were receiving multiple organ transplants or had a positive crossmatch for T-cell lymphocytes. The protocol was approved by the institutional review board or ethics committee at each participating center, and all patients gave written informed consent.

Immunosuppressive Treatment

All patients received cyclosporine, azathioprine, and prednisone. The first dose of cyclosporine was given during the period from 12 hours before to 24 hours after transplantation.

Daclizumab (Zenapax, Hoffmann-LaRoche) or placebo was

From the University of California, San Francisco (F.V.); Brigham and Women's Hospital, Boston (R.K.); Hoffmann-LaRoche, Nutley, N.J. (S.L.); Ohio State University, Columbus (G.B.); Indiana University, Indianapolis (M.P.); the University of Alberta, Edmonton, Alta., Canada (P.H.); Emory University, Atlanta (J.N.); the University of California, Los Angeles (A.W.); Malmö University Hospital, Malmö, Sweden (H.E.); the University of Alabama, Birmingham (R.G.); Sahlgrenska Hospital, Gothenburg, Sweden (L.B.); and Johns Hopkins University, Baltimore (J.B.). Address reprint requests to Dr. Vincenti at the Transplant Service, University of California, San Francisco, 505 Parnassus Ave., Rm. M884, Box 0116, San Francisco, CA 94143-0116.

*Other members of the Daclizumab Triple Therapy Study Group are listed in the Appendix.

administered intravenously over a period of 15 minutes. Each patient received five doses of either daclizumab (1 mg per kilogram of body weight, to a maximum of 100 mg per dose) or placebo (0.2 mg of polysorbate 80 per milliliter in 67 mM phosphate buffer). The first dose was administered within 24 hours before transplantation, with subsequent doses given two, four, six, and eight weeks after transplantation.

Primary and Secondary End Points

The primary end point of the study was the incidence of biopsy-confirmed acute rejection within the first six months after transplantation. All patients with an unexplained rise in the serum creatinine concentration or one or more symptoms of acute rejection (fever, pain over the graft, or a decrease in urinary volume) were required to undergo a renal biopsy within 24 hours after the initiation of antirejection therapy, which consisted initially of intravenous methylprednisolone (7 mg per kilogram per day) for three days. The histologic diagnosis of rejection was based on the presence of acute tubulitis or vasculitis and was made by the pathologist at each institution. Patients were considered to have presumptive rejection if they received a course of antirejection therapy in the absence of histologic confirmation of rejection. The diagnosis of any subsequent episodes of rejection in patients presenting with renal dysfunction was based on clinical criteria, such as the absence of evidence of nephrotoxicity or of urinary tract obstruction or infection, with a biopsy for confirmation performed at the investigator's discretion.

Secondary end points included patient survival and graft survival at one year, the time to the first episode of acute rejection, the number of acute rejection episodes per patient, the need for antilymphocyte therapy (OKT3 or polyclonal antithymocyte globulin) because of glucocorticoid-resistant rejection (defined as the absence of a response to intravenous methylprednisolone pulse therapy), graft function (as indicated by the serum creatinine concentration and glomerular filtration rate), and the cumulative dose of prednisone in the first six months after transplantation.

Pharmacokinetic Measurements

Blood samples were collected immediately before and after (for trough and peak concentrations, respectively) the first and fifth infusions of daclizumab or placebo and on days 70 and 84 after transplantation. A sandwich enzyme-linked immunosorbent assay was used to measure daclizumab in serum.¹⁸

In 20 consecutive patients at one U.S. center (University of California, San Francisco), lymphocyte analysis was performed to determine the saturation of the interleukin-2-receptor α chain, with the use of methods reported previously.¹⁷

Glomerular Filtration Rate

The glomerular filtration rate was measured in all patients with functioning grafts six months after transplantation. Measurements were based on iohexol, radioisotope, or inulin clearance.

Statistical Analysis

Differences in categorical variables between the two groups were determined with the use of the Mantel-Haenszel test (with stratification according to center). Differences in the time to the first biopsy-confirmed episode of rejection were determined with the use of the log-rank test (with stratification according to center). The log-rank test was also used to analyze the time to graft failure (or death with a functioning graft) because of the small number of events reported. Kaplan-Meier estimates of the probability of patient survival and graft survival and the cumulative probability of biopsy-confirmed rejection were plotted over time. Differences in the number of presumptive or biopsy-confirmed rejection episodes per patient in the first six months were analyzed with a normal regression model. The serum creatinine concentrations, glomerular filtration rates, and cumulative doses of prednisone administered during the first six months after trans-

plantation in the two groups were compared with the use of the Wilcoxon rank-sum test. Logistic-regression analysis was used to determine the effects of various factors on the probability of biopsy-confirmed rejection. Proportional-hazards analysis was used to determine the effects of various factors on the time to biopsy-confirmed rejection. The results of lymphocyte and interleukin-2-receptor assays were compared with the use of Student's *t*-test. All statistical tests were two-sided.

All patients randomly assigned to a treatment group were included in the primary analyses of efficacy and safety, according to the intention-to-treat principle. Values are reported as means \pm SD.

RESULTS

A total of 260 patients were enrolled in the study: 134 patients were assigned to the placebo group, and 126 to the daclizumab group. The two groups were similar with respect to age, sex, race, cause of end-stage renal disease, presence or absence of panel-reactive anti-HLA antibodies, number of HLA-DR mismatches between donor and recipient, and duration of cold ischemia for the graft (Table 1).

All patients received at least one dose of the study drug, and 107 of the patients in the placebo group (80 percent) and 107 of those in the daclizumab group (85 percent) received all five doses. Graft function was delayed in 39 patients in the placebo group (29 percent) and 27 patients in the daclizumab group (21 percent). The early use of prophylactic antilymphocyte therapy for delayed graft function led to the discontinuation of the study drug in nine patients in the placebo group (7 percent) and nine in the daclizumab group (7 percent).

Efficacy

Daclizumab prophylaxis resulted in a significant reduction in the incidence of biopsy-documented acute rejection during the first six months after transplantation (22 percent, vs. 35 percent in the placebo group; $P=0.03$; odds ratio, 0.5; 95 percent confidence interval, 0.3 to 0.9) (Table 2). The proportion of patients with presumptive or biopsy-confirmed acute rejection and the number of rejection episodes per patient were also lower in the daclizumab group, and the time to the first rejection was longer. There was a trend toward a reduction in the number of patients with two or more rejection episodes and the number receiving antilymphocyte preparations for severe rejection in the daclizumab group. The beneficial effect of daclizumab was not influenced by delayed graft function, initial use of other antilymphocyte therapies, or exclusion of patients who did not receive all five infusions of the study drug (data not shown).

The patient-survival rates at one year were 98 percent in the daclizumab group and 96 percent in the placebo group (Table 3). The graft-survival rates in the daclizumab and placebo groups were 95 and 90 percent, respectively. None of the patients in the daclizumab group but three of those in the placebo group died of infections: one each of aspergillosis,

INTERLEUKIN-2-RECEPTOR BLOCKADE WITH DACLIZUMAB TO PREVENT REJECTION IN RENAL TRANSPLANTATION

TABLE 1. BASE-LINE CHARACTERISTICS OF RENAL-ALLOGRAFT RECIPIENTS.*

CHARACTERISTIC	PLACEBO (N=134)	DACLIZUMAB (N=126)
Age — yr	47±13	47±13
Sex — no. of patients (%)		
Male	81 (60)	74 (59)
Female	53 (40)	52 (41)
Race or ethnic group — no. of patients (%)		
White	81 (60)	84 (67)
Black	27 (20)	24 (19)
Other	26 (19)	18 (14)
Cause of renal failure — no. of patients (%)		
Glomerulonephritis	40 (30)	33 (26)
Diabetes mellitus	29 (22)	32 (25)
Hereditary or polycystic kidney disease	20 (15)	24 (19)
Hypertension	19 (14)	18 (14)
Other	26 (19)	19 (15)
Panel-reactive serum antibodies — no. of patients (%)†		
0-10%	121 (90)	113 (89)
11-49%	10 (7)	12 (10)
50-100%	3 (2)	1 (1)
No. of HLA-DR mismatches — no. of patients (%)‡		
0	22 (16)	19 (15)
1	62 (46)	49 (39)
2	40 (30)	50 (40)
Graft cold-ischemia time — hr	21±9	22±8

*Plus-minus values are means ±SD. Percentages may not sum to 100 because of rounding.

†Panel-reactive antibodies are anti-HLA antibodies that have a cytotoxic effect on lymphocytes obtained from a panel of donors from the general population.

‡Data were missing for some patients.

TABLE 2. ACUTE REJECTION EPISODES IN THE FIRST SIX MONTHS AFTER RENAL TRANSPLANTATION IN THE PLACEBO AND DACLIZUMAB GROUPS.

REJECTION	PLACEBO (N=134)	DACLIZUMAB (N=126)	P VALUE
One or more biopsy-confirmed episodes — no. of patients (%)	47 (35)	25 (22)	0.03
One or more biopsy-confirmed or presumptive episodes — no. of patients (%)	52 (39)	32 (25)	0.04
Two or more biopsy-confirmed or presumptive episodes — no. of patients (%)	18 (13)	9 (7)	0.08
Mean no. of episodes/patient	0.6	0.3	0.01
Time to first episode — days*	30±27	73±59	0.006
Episode requiring antilymphocyte therapy — no. of patients (%)†	19 (14)	10 (8)	0.09

*Plus-minus values are means ±SD.

†Antilymphocyte therapy consisted of OKT3 or polyclonal antilymphocyte globulin.

TABLE 3. CAUSES OF DEATH AND RENAL-GRAFT FAILURE AT ONE YEAR IN THE PLACEBO AND DACLIZUMAB GROUPS.

CAUSE	PLACEBO (N=134)	DACLIZUMAB (N=126)
	no. of patients (%)	
Death	5 (4)	3 (2)
Infection or lymphoma	3 (2)	1 (1)
Cardiovascular cause	1 (1)	0
Pulmonary embolism	1 (1)	0
Intracerebral bleeding	0	1 (1)
Suicide	0	1 (1)
Graft failure	13 (10)	6 (5)
Death	5 (4)	3 (2)
Rejection	3 (2)	1 (1)
Technical cause	4 (3)	2 (2)
Primary nonfunction	1 (1)	0

coccidioidomycosis, and pseudomonas sepsis. One patient in the daclizumab group died of lymphoma.

The mean serum creatinine concentrations six months after transplantation were the same in the two groups (1.7±0.7 mg per deciliter [150±60 μmol per liter]). The mean glomerular filtration rate was 55±23 ml per minute in the daclizumab group and 52±22 ml per minute in the placebo group. The average daily doses of prednisone and cyclosporine did not differ between the groups at any time during the study, nor was there a difference in the mean trough whole-blood cyclosporine concentrations at any time.

Adverse Events

The administration of daclizumab was not associated with any immediate side effects. There was no significant difference in reported adverse events between the two groups (Table 4). One patient in the placebo group and two patients in the daclizumab group had lymphoma during the first year after transplantation.

Pharmacokinetic Data

Pharmacokinetic data were available for 92 patients in the daclizumab group. The mean serum half-life of daclizumab was 20 days.

Circulating Peripheral-Blood Lymphocytes and Interleukin-2 α-Chain Receptor

There were no differences in absolute lymphocyte numbers between the placebo and daclizumab groups before transplantation or for six months afterward. Circulating CD3+ cell concentrations and T-cell subgroups were not measured, because they were not affected by daclizumab therapy in an earlier study.¹⁷ There was a significant decrease in the percentage of circulating lymphocytes that stained with anti-

TABLE 4. ADVERSE EVENTS AT SIX MONTHS IN THE PLACEBO AND DACLIZUMAB GROUPS.

ADVERSE EVENTS	PLACEBO	DACLIZUMAB
	(N = 134)	(N = 126)
	no. of patients (%)	
Serious event*	15 (10)	6 (5)
Fever	16 (12)	11 (9)
Sepsis and bacteremia	9 (7)	4 (3)
Pneumonia	4 (3)	3 (2)
Fungal infection	27 (20)	21 (17)
Fungemia	2 (1)	0
Local infection	25 (19)	21 (17)
Local infection†	70 (52)	59 (47)
Cellulitis and wound infection	4 (3)	7 (6)
Urinary tract infection	44 (33)	34 (27)
Other	38 (28)	36 (29)
Any viral infection†	32 (24)	29 (23)
Viremia	12 (9)	12 (10)
Local infection	21 (16)	20 (16)
Cytomegalovirus infection	14 (10)	15 (12)
Viremia	10 (7)	12 (10)
Tissue infection	4 (3)	3 (2)

*Serious adverse events were defined as complications other than death or rejection that prolonged or required hospitalization and were possibly or probably related to the study drug.

†Some patients had more than one type of infection.

CD25 antibody starting 10 hours after transplantation and lasting up to four months in the daclizumab group (data not shown). Similarly, there was a significant decrease in the percentage of circulating lymphocytes that stained with the fluorescein-conjugated antibody 7g7, which binds to an interleukin-2 α -chain-receptor epitope distinct from the epitope recognized by daclizumab and reflects total interleukin-2 α -receptor expression (data not shown).

DISCUSSION

We found that the patients receiving daclizumab in addition to maintenance therapy with three immunosuppressive agents had a lower frequency of biopsy-confirmed acute rejection in the first six months after transplantation than the patients receiving placebo with the three immunosuppressive agents. In addition, the time to the first episode of acute rejection was significantly prolonged, and the mean number of episodes per patient significantly reduced in the daclizumab group. These results were obtained without a concomitant increase in infectious complications or cancers. The efficacy of daclizumab is probably related to its selective target, the α -chain component of the high-affinity interleukin-2 receptor, which is present almost exclusively

on activated T cells. Use of the drug thus spares other immunocompetent cells.⁷

Only 10 percent of daclizumab is composed of murine sequences, which are from the antigen-binding regions of the parent antibody. These sequences are inserted into human immunoglobulin with the use of molecular biologic techniques.¹⁴ Our study highlights the advantages of this type of antibody, including its prolonged serum half-life, approaching that of human IgG, and the absence of functional immunogenicity associated with its use.^{15,16,19,20}

The exact mechanism or mechanisms of action of daclizumab are not known. A likely mechanism is that it binds to circulating lymphocytes with interleukin-2 α -chain receptors but does not activate the receptors, and the cells therefore have no free interleukin-2 α -chain receptors available for activation by interleukin-2. In addition, the decline in the percentage of circulating lymphocytes expressing CD25 (measured by staining with 7g7 antibody) without an accompanying decrease in the absolute number of lymphocytes suggests that the expression of interleukin-2 receptors is down-regulated or the shedding of the daclizumab-bound interleukin-2 α chain is increased.

In conclusion, when added to therapy with cyclosporine, azathioprine, and prednisone, daclizumab reduces the frequency of acute rejection and improves short-term graft survival in renal-transplant recipients.

Supported by a grant from Hoffmann-La Roche.

We are indebted to Dr. Thomas A. Waldmann for his contribution to the development of daclizumab, and to Ms. Peggy Millar for her assistance in the preparation of the manuscript.

APPENDIX

In addition to the authors, the following investigators participated in the Daclizumab Triple Therapy Study Group: Victoria General Hospital, Halifax, N.S., Canada — B. Kiberu; Hudlings Hospital, Hudtings, Sweden — G. Tyden; University of Minnesota, Minneapolis — A. Matas; Beil Israel Denton Medical Center, Boston — M. Shapiro; Tampa General Hospital, Tampa, Fla. — G. Chan; Vancouver General Hospital, Vancouver, B.C., Canada — P. Keown; University of California, San Francisco — M. Lantz; University of Alberta, Edmonton, Alta., Canada — K. Solez; and Hoffmann-La Roche, Nutley, N.J. — A. Lin, I. Patel, K. Nieforth, A. Wolitzky, and J. Hakim.

REFERENCES

1. Ferguson R. Acute rejection episodes — best predictor of long-term primary cadaveric renal transplant survival. *Clin Transplant* 1994;8:328-31.
2. Sollinger HW. Mycophenolate mofetil for the prevention of acute rejection in primary cadaveric renal allograft recipients. *Transplantation* 1995;60:225-32.
3. Vincenti F, Laskow DA, Neylan JF, Mendez R, Matas AJ. One-year follow-up from an open-label trial of FK506 in primary kidney transplantation: a report of the U.S. Multicenter FK506 Kidney Transplantation Group. *Transplantation* 1996;61:1576-81.
4. Morris RE. Mechanisms of action of new immunosuppressive drugs. *Kidney Int Suppl* 1996;53:S-26-S-38.
5. Kalan BD. Sirolimus: a new agent for clinical renal transplantation. *Transplant Proc* 1997;29:48-50.
6. Gruber SA, Chan GLC, Canafax DM, Matas AJ. Immunosuppression in renal transplantation. II. Corticosteroids, antilymphocyte globulin, and OKT3. *Clin Transplant* 1991;5:219-32.

63

INTERLEUKIN-2-RECEPTOR BLOCKADE WITH DACLIZUMAB TO PREVENT REJECTION IN RENAL TRANSPLANTATION

7. Taniguchi T, Minami Y. The IL-2/IL-2 receptor system: a current overview. *Cell* 1993;73:5-8.
8. Kupiec-Weglinski JW, Diamantstein T, Tilney NL, Strom TB. Therapy with monoclonal antibody to interleukin 2 receptor spares suppressor T cells and prevents or reverses acute allograft rejection in rats. *Proc Natl Acad Sci U S A* 1986;83:2624-7.
9. Reed MH, Shapiro ME, Strom TB, et al. Prolongation of primate renal allograft survival by anti-Tac, an anti-human IL-2 receptor monoclonal antibody. *Transplantation* 1989;47:55-9.
10. Souillou J-P, Cantarovich D, Le Mauff B, et al. Randomized controlled trial of a monoclonal antibody against the interleukin-2 receptor (3B3.1) as compared with rabbit antilymphocyte globulin for prophylaxis against rejection of renal allografts. *N Engl J Med* 1990;322:1175-82.
11. Kirkman RL, Shapiro ME, Carpenter CB, et al. A randomized prospective trial of anti-Tac monoclonal antibody in human renal transplantation. *Transplantation* 1991;51:107-13.
12. van Gelder T, Zietse R, Mulder AH, et al. A double-blind, placebo-controlled study of monoclonal anti-interleukin-2 receptor antibody (BT565) administration to prevent acute rejection after kidney transplantation. *Transplantation* 1995;60:248-52.
13. Reding R, Vraux H, de Ville de Goyet J, et al. Monoclonal antibodies in prophylactic immunosuppression after liver transplantation: a randomized controlled trial comparing OKT3 and anti-IL-2 receptor monoclonal antibody LO-Tact-1. *Transplantation* 1993;55:534-41.
14. Queen C, Schucider WP, Selick HE, et al. A humanized antibody that binds to the interleukin 2 receptor. *Proc Natl Acad Sci U S A* 1989;86:10029-33.
15. Hakimi J, Mould D, Waldmann TA, Queen C, Anasetti C, Light S. Development of Zenapax: a humanized anti-Tac antibody. In: Harris WJ, Adair JR, eds. *Antibody therapeutics*. New York: CRC Press, 1997:277-300.
16. Hakimi J, Chizzonite R, Luke DR, et al. Reduced immunogenicity and improved pharmacokinetics of humanized anti-Tac in cynomolgus monkeys. *J Immunol* 1991;147:1352-9.
17. Vincenti F, Lantz M, Birnbaum J, et al. A phase I trial of humanized anti-interleukin 2 receptor antibody in renal transplant recipients. *Transplantation* 1997;63:33-8.
18. Fayer BE, Soti PP, Binger MH, Mould DR, Satoh H. Determination of humanized anti-Tac in human serum by a sandwich enzyme linked immunosorbent assay. *J Immunol Methods* 1995;186:47-54.
19. Brown PS Jr, Parenteau GL, Dirbas FM, et al. Anti-Tac-H, a humanized antibody to the interleukin 2 receptor, prolongs primate cardiac allograft survival. *Proc Natl Acad Sci U S A* 1991;88:2663-7.
20. Anasetti C, Hansen JA, Waldmann TA, et al. Treatment of acute graft-versus-host disease with humanized anti-Tac: an antibody that binds to the interleukin-2 receptor. *Blood* 1994;84:1320-7.

Interview Summary

Application No. 08/146,206	Applicant(s) Carter et al
Examiner MINH TAM DAVIS	Group Art Unit 1642



All participants (applicant, applicant's representative, PTO personnel):

- (1) MINH TAM DAVIS (3) _____
(2) Wendy Lee (4) _____

Date of Interview Dec 11, 2001

Type: a) Telephonic b) Video Conference
c) Personal [copy is given to 1) applicant 2) applicant's representative]

Exhibit shown or demonstration conducted: d) Yes e) No. If yes, brief description:

Claim(s) discussed: _____

Identification of prior art discussed: _____

Agreement with respect to the claims f) was reached. g) was not reached. h) N/A.

Substance of Interview including description of the general nature of what was agreed to if an agreement was reached, or any other comments:

Pending claims 43-105, 113-131 are allowable.

(A fuller description, if necessary, and a copy of the amendments which the examiner agreed would render the claims allowable, if available, must be attached. Also, where no copy of the amendments that would render the claims allowable is available, a summary thereof must be attached.)

i) It is not necessary for applicant to provide a separate record of the substance of the interview (if box is checked).

Unless the paragraph above has been checked, THE FORMAL WRITTEN REPLY TO THE LAST OFFICE ACTION MUST INCLUDE THE SUBSTANCE OF THE INTERVIEW. (See MPEP section 713.04). If a reply to the last Office action has already been filed, APPLICANT IS GIVEN ONE MONTH FROM THIS INTERVIEW DATE TO FILE A STATEMENT OF THE SUBSTANCE OF THE INTERVIEW. See Summary of Record of Interview requirements on reverse side or on attached

Examiner Note: You must sign this form unless it is an Attachment to a signed Office action.

M-T DAVIS

Re-Perm

1600

RAW SEQUENCE LISTING DATE: 12/11/2001
PATENT APPLICATION: US/08/146,206C TIME: 13:58:59

Input Set : A:\p0709p1.txt
Output Set: N:\CRF3\12112001\H146206C.raw

SEQUENCE LISTING

W--> 3 SEQUENCE LISTING

5 (1) GENERAL INFORMATION:

7 (i) APPLICANT: Carter, Paul J.
8 Presta, Leonard G.

10 (ii) TITLE OF INVENTION: Method for Making Humanized Antibodies

12 (iii) NUMBER OF SEQUENCES: 26

14 (iv) CORRESPONDENCE ADDRESS:

15 (A) ADDRESSEE: Genentech, Inc.
16 (B) STREET: 1 DNA Way
17 (C) CITY: South San Francisco
18 (D) STATE: California
19 (E) COUNTRY: USA
20 (F) ZIP: 94080

22 (v) COMPUTER READABLE FORM:

23 (A) MEDIUM TYPE: 3.5 inch, 1.44 Mb floppy disk
24 (B) COMPUTER: IBM PC compatible
25 (C) OPERATING SYSTEM: PC-DOS/MS-DOS
26 (D) SOFTWARE: WinPatin (Genentech)

28 (vi) CURRENT APPLICATION DATA:

C--> 29 (A) APPLICATION NUMBER: US/08/146,206C
C--> 30 (B) FILING DATE: 17-Nov-1993
31 (C) CLASSIFICATION:

33 (vii) PRIOR APPLICATION DATA:

34 (A) APPLICATION NUMBER: 07/715272
35 (B) FILING DATE: 14-JUN-1991

37 (viii) ATTORNEY/AGENT INFORMATION:

38 (A) NAME: Lee, Wendy M.
39 (B) REGISTRATION NUMBER: 40,378
40 (C) REFERENCE/DOCKET NUMBER: P0709P1

42 (ix) TELECOMMUNICATION INFORMATION:

43 (A) TELEPHONE: 650/225-1994
44 (B) TELEFAX: 650/952-9881

45 (2) INFORMATION FOR SEQ ID NO: 1:

47 (i) SEQUENCE CHARACTERISTICS:

48 (A) LENGTH: 109 amino acids
49 (B) TYPE: Amino Acid
50 (D) TOPOLOGY: Linear

52 (xi) SEQUENCE DESCRIPTION: SEQ ID NO: 1:

54 Asp Ile Gln Met Thr Gln Ser Pro Ser Ser Leu Ser Ala Ser Val
55 1 5 10 15
57 Gly Asp Arg Val Thr Ile Thr Cys Arg Ala Ser Gln Asp Val Asn
58 20 25 30
60 Thr Ala Val Ala Trp Tyr Gln Gln Lys Pro Gly Lys Ala Pro Lys
61 35 40 45
63 Leu Leu Ile Tyr Ser Ala Ser Phe Leu Glu Ser Gly Val Pro Ser
64 50 55 60

67
ES
12-1-99 ✓

ENTERED

RAW SEQUENCE LISTING

DATE: 12/11/2001

PATENT APPLICATION: US/08/146,206C

TIME: 13:58:59

Input Set : A:\p0709pl.txt

Output Set : N:\CRF3\12112001\H146206C.raw

```

139           95           100           105
141 Ile Lys Arg Thr
142           109
144 (2) INFORMATION FOR SEQ ID NO: 4:
146   (i) SEQUENCE CHARACTERISTICS:
147       (A) LENGTH: 120 amino acids
148       (B) TYPE: Amino Acid
149       (D) TOPOLOGY: Linear
151   (xi) SEQUENCE DESCRIPTION: SEQ ID NO: 4:
153 Glu Val Gln Leu Val Glu Ser Gly Gly Gly Leu Val Gln Pro Gly
154   1           5           10           15
156 Gly Ser Leu Arg Leu Ser Cys Ala Ala Ser Gly Phe Thr Phe Ser
157           20           25           30
159 Asp Tyr Ala Met Ser Trp Val Arg Gln Ala Pro Gly Lys Gly Leu
160           35           40           45
162 Glu Trp Val Ala Val Ile Ser Glu Asn Gly Ser Asp Thr Tyr Tyr
163           50           55           60
165 Ala Asp Ser Val Lys Gly Arg Phe Thr Ile Ser Arg Asp Asp Ser
166           65           70           75
168 Lys Asn Thr Leu Tyr Leu Gln Met Asn Ser Leu Arg Ala Glu Asp
169           80           85           90
171 Thr Ala Val Tyr Tyr Cys Ala Arg Asp Arg Gly Gly Ala Val Ser
172           95           100          105
174 Tyr Phe Asp Val Trp Gly Gln Gly Thr Leu Val Thr Val Ser Ser
175          110          115          120
177 (2) INFORMATION FOR SEQ ID NO: 5:
179   (i) SEQUENCE CHARACTERISTICS:
180       (A) LENGTH: 109 amino acids
181       (B) TYPE: Amino Acid
182       (D) TOPOLOGY: Linear
184   (xi) SEQUENCE DESCRIPTION: SEQ ID NO: 5:
186 Asp Ile Val Met Thr Gln Ser His Lys Phe Met Ser Thr Ser Val
187   1           5           10           15
189 Gly Asp Arg Val Ser Ile Thr Cys Lys Ala Ser Gln Asp Val Asn
190           20           25           30
192 Thr Ala Val Ala Trp Tyr Gln Gln Lys Pro Gly His Ser Pro Lys
193           35           40           45
195 Leu Leu Ile Tyr Ser Ala Ser Phe Arg Tyr Thr Gly Val Pro Asp
196           50           55           60
198 Arg Phe Thr Gly Asn Arg Ser Gly Thr Asp Phe Thr Phe Thr Ile
199           65           70           75
201 Ser Ser Val Gln Ala Glu Asp Leu Ala Val Tyr Tyr Cys Gln Gln
202           80           85           90
204 His Tyr Thr Thr Pro Pro Thr Phe Gly Gly Gly Thr Lys Leu Glu
205           95           100          105
207 Ile Lys Arg Ala
208           109
210 (2) INFORMATION FOR SEQ ID NO: 6:
212   (i) SEQUENCE CHARACTERISTICS:

```

RAW SEQUENCE LISTING

DATE: 12/11/2001

PATENT APPLICATION: US/08/146,206C

TIME: 13:58:59

Input Set : A:\p0709pl.txt

Output Set: N:\CRF3\12112001\H146206C.raw

288 (D) TOPOLOGY: Linear
290 (xi) SEQUENCE DESCRIPTION: SEQ ID NO: 10:
293 TGAGGAGACG GTGACCGTGG TCCCTTGGCC CCAG 34
295 (2) INFORMATION FOR SEQ ID NO: 11:
297 (i) SEQUENCE CHARACTERISTICS:
298 (A) LENGTH: 36 base pairs
299 (B) TYPE: Nucleic Acid
300 (C) STRANDEDNESS: Single
301 (D) TOPOLOGY: Linear
303 (xi) SEQUENCE DESCRIPTION: SEQ ID NO: 11:
306 GTAGATAAAT CCTCTAACAC AGCCTATCTG CAAATG.36
308 (2) INFORMATION FOR SEQ ID NO: 12:
310 (i) SEQUENCE CHARACTERISTICS:
311 (A) LENGTH: 36 base pairs
312 (B) TYPE: Nucleic Acid
313 (C) STRANDEDNESS: Single
314 (D) TOPOLOGY: Linear
316 (xi) SEQUENCE DESCRIPTION: SEQ ID NO: 12:
319 GTAGATAAAT CCAAATCTAC AGCCTATCTG CAAATG 36
321 (2) INFORMATION FOR SEQ ID NO: 13:
323 (i) SEQUENCE CHARACTERISTICS:
324 (A) LENGTH: 36 base pairs
325 (B) TYPE: Nucleic Acid
326 (C) STRANDEDNESS: Single
327 (D) TOPOLOGY: Linear
329 (xi) SEQUENCE DESCRIPTION: SEQ ID NO: 13:
332 GTAGATAAAT CCTCTTCTAC AGCCTATCTG CAAATG 36
334 (2) INFORMATION FOR SEQ ID NO: 14:
336 (i) SEQUENCE CHARACTERISTICS:
337 (A) LENGTH: 68 base pairs
338 (B) TYPE: Nucleic Acid
339 (C) STRANDEDNESS: Single
340 (D) TOPOLOGY: Linear
342 (xi) SEQUENCE DESCRIPTION: SEQ ID NO: 14:
345 CTTATAAAGG TGTTCCACC TATAACCAGA AATTCAAGGA TCGTTTCACG 50
347 ATATCCGTAG ATAAATCC 68
349 (2) INFORMATION FOR SEQ ID NO: 15:
351 (i) SEQUENCE CHARACTERISTICS:
352 (A) LENGTH: 30 base pairs
353 (B) TYPE: Nucleic Acid
354 (C) STRANDEDNESS: Single
355 (D) TOPOLOGY: Linear
357 (xi) SEQUENCE DESCRIPTION: SEQ ID NO: 15:
360 CTATACCTCC CGTCTGCATT CTGGAGTCCC 30
362 (2) INFORMATION FOR SEQ ID NO: 16:
364 (i) SEQUENCE CHARACTERISTICS:
365 (A) LENGTH: 107 amino acids
366 (B) TYPE: Amino Acid
367 (D) TOPOLOGY: Linear

VERIFICATION SUMMARY

DATE: 12/11/2001

PATENT APPLICATION: US/08/146,206C

TIME: 13:59:00

-Input Set : A:\p0709pl.txt

Output Set: N:\CRF3\12112001\H146206C.raw

L:3 M:244 W: Invalid beginning of sequence listing, Data=[SEQUENCE LISTING], Duplicate Sequence Listing Title!

L:29 M:220 C: Keyword misspelled or invalid format, [(A) APPLICATION NUMBER:]

L:30 M:220 C: Keyword misspelled or invalid format, [(B) FILING DATE:]

Genentech, Inc.
Genentech, Inc.
Genentech, Inc.
Genentech, Inc.
Genentech, Inc.

Anna S. Kan
Legal Department

(650) 225-2830
Fax (650) 952-9881
kan@gene.com

To: Examiner Minh-Tam Davis
From: Wendy Lee

This is the priority document
for 08/146,206.

12/12/2001

Genentech Legal Department

1 DNA Way
South San Francisco, CA 94080
650-225-2830
Fax: 650-952-9881/9882

FAX TRANSMISSION COVER SHEET

Date: December 12, 2001
To: Examiner Minh-Tam Davis
Group Art 1642
Fax: (703) 746-7145
Re: U.S. Ser. No 09/146,206
filed August 1, 1995
Attorney Docket No.: P0709P1
Sender: Anna Kan for Wendy Lee

YOU SHOULD RECEIVE 12 PAGE(S), INCLUDING THIS COVER SHEET. IF YOU DO NOT RECEIVE ALL THE PAGES, PLEASE CALL 650-225-2830.

CONFIDENTIALITY NOTE

The documents accompanying this facsimile transmission contain information from GENENTECH, INC. which is confidential or privileged. This information is intended only for the individual or entity named on this transmission sheet. If you are not the intended recipient, be aware that any disclosure, copying, distribution, or use of the contents of this faxed information is strictly prohibited. If you have received this facsimile in error, please notify us by telephone immediately so that we can arrange for the return of the original documents to us and the retransmission of them to the intended recipient.

Dear Examiner Davis,

Pursuant to your request, attached are courtesy copies of the IDS Transmittals and PTO-1449 Forms filed on August 1, 1995 and February 1, 1999. We understand that you have the cited references but, if not, let us know and we will be happy to provide further copies.

Kindly send us initialed copies of the PTO-1449 Forms for the IDSs filed on the following dates. The reference nos. are noted below in parentheses.

- 09/02/97 (refs. 100-207)
- 08/24/98 (refs. 215-224)
- 02/01/99 (refs. 225-262)
- 03/09/99 (ref. 263)
- 08/30/01 (ref. 264-265)

Very truly yours,
Genentech, Inc.



Anna Kan for Wendy Lee

12-12-01

11:50am

From-Genentech Legal

+1 650 952 9881

T-282 P.008/012 F-366

WL/LS
L

Patent Docket P0709P1

IN THE UNITED STATES PATENT AND TRADEMARK OFFICE

<p>In re Application of Paul J. Carter et al. Serial No.: 08/146,206 Filed: November 17, 1993 For: METHOD FOR MAKING HUMANIZED ANTIBODIES</p>	<p>Group Art Unit: 1642 Examiner: J. Reeves</p> <p>CERTIFICATE OF HAND DELIVERY I hereby certify that this correspondence is being hand delivered in an envelope addressed to: Assistant Commissioner of Patents, Washington, D.C. 20231 on February 13, 1999 <i>R. H. Mitchell</i></p>
---	---

SUPPLEMENTAL INFORMATION DISCLOSURE STATEMENT

*official
idea
12/13/01*

Assistant Commissioner of Patents
Washington, D.C. 20231

Sir:

Applicants submit herewith patents, publications or other information (attached hereto and listed on the attached Form PTO-1449) of which they are aware, which they believe may be material to the examination of this application and in respect of which there may be a duty to disclose in accordance with 37 CFR § 1.56.

This Information Disclosure Statement:

- (a) accompanies the new patent application submitted herewith. 37 CFR § 1.97(a).
- (b) is filed within three months after the filing date of the application or within three months after the date of entry of the national stage of a PCT application as set forth in 37 CFR § 1.491.
- (c) as far as is known to the undersigned, is filed before the mailing date of a first Office action on the merits.
- (d) is filed after the first Office Action and more than three months after the application's filing date or PCT national stage date of entry filing but, as far as is known to the undersigned, prior to the mailing date of either a final rejection or a notice of allowance, whichever occurs first, and is accompanied by either the fee (\$240) set forth in 37 CFR § 1.17(p) or a statement as specified in 37 CFR § 1.97(e), as checked below. Should any fee be due, the U.S. Patent and Trademark Office is hereby authorized to charge Deposit Account No. 07-0630 in the amount of \$240.00 to cover the cost of this Information Disclosure Statement. Any deficiency or overpayment

Received from <+16509529881 > at 12/12/01 2:55:22 PM [Eastern Standard Time]

08/146,206

Page 2

should be charged or credited to this deposit account. A duplicate of this sheet is enclosed.

(e) is filed after the mailing date of either a final rejection or a notice of allowance, whichever occurred first, and is accompanied by the fee (\$130) set forth in 37 CFR §1.17(i) and a statement as specified in 37 CFR §1.97(e), as checked below. This document is to be considered as a petition requesting consideration of the information disclosure statement. The U.S. Patent and Trademark Office is hereby authorized to charge Deposit Account No. 07-0630 in the amount of \$130.00 to cover the cost of this Information Disclosure Statement. Any deficiency or overpayment should be charged or credited to this deposit account. A duplicate of this sheet is enclosed.

(f) (x) is filed after the mailing date of a final rejection, but a request to withdraw the finality thereof under 37 CFR § 1.129(a) was submitted on August 24, 1998. The U.S. Patent and Trademark Office is hereby authorized to charge Deposit Account No. 07-0630 to cover the cost of this Information Disclosure Statement in the event that any fees are due. A duplicate of this sheet is enclosed.

(If either of boxes (d) or (e) is checked above, the following statement under 37 CFR §1.97(e) may need to be completed.) The undersigned states that:

Each item of information contained in the information disclosure statement was cited in a communication mailed from a foreign patent office in a counterpart foreign application not more than three months prior to the filing of this information disclosure statement.

No item of information contained in this information disclosure statement was cited in a communication mailed from a foreign patent office in a counterpart foreign application and, to the knowledge of the undersigned after making reasonable inquiry, was known to any individual designated in 37 CFR §1.56(c) more than three months prior to the filing of this Information disclosure statement.

A list of the patent(s) or publication(s) is set forth on the attached Form PTO-1449 (Modified).

A copy of the items on PTO-1449 is supplied herewith:

each none only those listed below:

A concise explanation of relevance of the items listed on PTO-1449 is:

not given

given for each listed item

given for only non-English language listed item(s) (Required)

In the form of an English language copy of a Search Report from a foreign patent

08/146,206

Page 3

office, issued in a counterpart application, which refers to the relevant portions of the references.

The Examiner is reminded that a "concise explanation of the relevance" of the submitted prior art "may be nothing more than identification of the particular figure or paragraph of the patent or publication which has some relation to the claimed invention," MPEP §609.

While the information and references disclosed in this Information Disclosure Statement may be "material" pursuant to 37 CFR §1.56, it is not intended to constitute an admission that any patent, publication or other information referred to therein is "prior art" for this invention unless specifically designated as such.

In accordance with 37 CFR §1.97(g), the filing of this Information Disclosure Statement shall not be construed to mean that a search has been made or that no other material information as defined in 37 CFR §1.56(a) exists. It is submitted that the Information Disclosure Statement is in compliance with 37 CFR §1.98 and MPEP §609 and the Examiner is respectfully requested to consider the listed references.

Respectfully submitted,

GENENTECH, INC.



By: _____

Wendy M. Lee
Reg. No. 40,378

Date: January 29, 1999

1 DNA Way
So. San Francisco, CA 94080-4990
Phone: (650) 225-1994
Fax: (650) 952-9881

12-12-01

11:48am

From-Genentech Legal

+1 650 852 9881

T-282 P.002/012 F-366

In re Application of: Paul J. Carter et al.
Serial No.: 08/146,206
Filed On: 17 November 1993
Mailed On: 1 August 1995

Docket No.: 709P1
By: Wendy M. Lee
Reg. No.:

The following has been received in the U.S. Patent Office on the date stamped:

- | | | | |
|-------------------------------------|---|--------------------------|---|
| <input type="checkbox"/> | Amendment/Response | <input type="checkbox"/> | U.S. Patent Application |
| <input type="checkbox"/> | Extension of Time Request (dup) | <input type="checkbox"/> | Rule 60 <input type="checkbox"/> Rule 62 |
| <input type="checkbox"/> | Communication/Transmittal Letter (dup) | <input type="checkbox"/> | Declaration/Power of Atty |
| <input type="checkbox"/> | Notice of Appeal (dup) | <input type="checkbox"/> | Assignment |
| <input type="checkbox"/> | Issue Fee Transmittal Form | <input type="checkbox"/> | <input type="checkbox"/> Recordation Form/Fee |
| <input checked="" type="checkbox"/> | Information Disclosure Statement (Supplemental) | <input type="checkbox"/> | Drawings: <input type="checkbox"/> Sheets |
| <input checked="" type="checkbox"/> | Form 1449 with <u>3</u> References | <input type="checkbox"/> | <input type="checkbox"/> Informal <input type="checkbox"/> Formal |
| <input checked="" type="checkbox"/> | Certificate of Mailing | <input type="checkbox"/> | <input type="checkbox"/> Sequence Listing & Diskette |
| <input type="checkbox"/> | Certificate of Express Mailing | <input type="checkbox"/> | <input type="checkbox"/> PCT Patent Application |
| <input type="checkbox"/> | Express Mail Label No.: | | |
| <input checked="" type="checkbox"/> | Other: Limited Recognition | | |

In re Application of: Paul J. Carter et al.
Serial No.: 08/146,206
Filed On: 17 November 1993
Mailed On: 1 August 1995

Docket No.: 709P1
By: Wendy M. Lee
Reg. No.:

The following has been received in the U.S. Patent Office on the date stamped:

- | | | | |
|-------------------------------------|---|--------------------------|---|
| <input type="checkbox"/> | Amendment/Response | <input type="checkbox"/> | U.S. Patent Application |
| <input type="checkbox"/> | Extension of Time Request (dup) | <input type="checkbox"/> | Rule 60 <input type="checkbox"/> Rule 62 |
| <input type="checkbox"/> | Communication/Transmittal Letter (dup) | <input type="checkbox"/> | Declaration/Power of Atty |
| <input type="checkbox"/> | Notice of Appeal (dup) | <input type="checkbox"/> | Assignment |
| <input type="checkbox"/> | Issue Fee Transmittal Form | <input type="checkbox"/> | <input type="checkbox"/> Recordation Form/Fee |
| <input checked="" type="checkbox"/> | Information Disclosure Statement (Supplemental) | <input type="checkbox"/> | Drawings: <input type="checkbox"/> Sheets |
| <input checked="" type="checkbox"/> | Form 1449 with <u>3</u> References | <input type="checkbox"/> | <input type="checkbox"/> Informal <input type="checkbox"/> Formal |
| <input checked="" type="checkbox"/> | Certificate of Mailing | <input type="checkbox"/> | <input type="checkbox"/> Sequence Listing & Diskette |
| <input type="checkbox"/> | Certificate of Express Mailing | <input type="checkbox"/> | <input type="checkbox"/> PCT Patent Application |
| <input type="checkbox"/> | Express Mail Label No.: | | |
| <input checked="" type="checkbox"/> | Other: Limited Recognition | | |

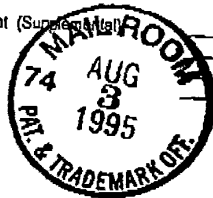

Received from <+16509529881> at 12/12/01 2:55:22 PM [Eastern Standard Time]

12-12-01

11:49am

From: Genentech Legal

copy

+1 650 952 9881

T-282

P.003/012

F-366

PATENT DOCKET 709P1

IN THE UNITED STATES PATENT AND TRADEMARK OFFICE

In re Application of

Paul J. Carter et al.

Serial No. 08/146,206

Filed: 17 November 1993

For: METHOD FOR MAKING HUMANIZED
ANTIBODIES

) Group Art Unit: 1806

) Examiner: D. Adams

CERTIFICATE OF MAILING	
I hereby certify that this correspondence is being deposited with the United States Postal Service as first class mail in an envelope addressed to: Commissioner of Patents and Trademarks, Washington, D.C. 20231 on	
8/1/95	
(Date of Deposit)	
Duane Alexander Vick	
Name of Depositing Party	
Duane Alexander Vick	
Signature of Depositing Party	
8/1/95	
Date of Signature	

SUPPLEMENTAL INFORMATION DISCLOSURE STATEMENT

BOX DD
Honorable Commissioner of Patents
and Trademarks
Washington, D.C. 20231

*Official
Dis
12/13/01*

Sir:

Applicants submit herewith patents, publications or other information (attached hereto and listed on the attached Form PTO-1449) of which they are aware, which they believe may be material to the examination of this application and in respect of which there may be a duty to disclose in accordance with 37 CFR §1.56.

This Information Disclosure Statement:

- (a) accompanies the new patent application submitted herewith. 37 CFR §1.97(a).
- (b) is filed within three months after the filing date of the application or within three months after the date of entry of the national stage of a PCT application as set forth in 37 CFR §1.491.
- (c) as far as is known to the undersigned, is filed before the mailing date of a first Office action on the merits.
- (d) is filed after the first Office Action and more than three months after the application's filing date or PCT national stage date of entry filing but, as far as is known to the undersigned, prior to the mailing date of either a final rejection or a notice of allowance, whichever occurs first, and is accompanied by either the fee (\$210) set forth in 37 CFR §1.17(p) or a certification as specified in 37 CFR §1.97(e), as checked below. Should any fee be due, the U.S. Patent and Trademark Office is hereby authorized to charge Deposit Account No. 07-0630 in the amount of \$210.00 to cover the cost of this

Received from <+16509529881> at 12/12/01 2:55:22 PM [Eastern Standard Time]

08/146,206

Page 2

Information Disclosure Statement. Any deficiency or overpayment should be charged or credited to this deposit account. A duplicate of this sheet is enclosed.

- (e) is filed after the mailing date of either a final rejection or a notice of allowance, whichever occurred first, and is accompanied by the fee (\$130) set forth in 37 CFR §1.17(i)(1) and a certification as specified in 37 CFR §1.97(e), as checked below. **This document is to be considered as a petition requesting consideration of the information disclosure statement.** The U.S. Patent and Trademark Office is hereby authorized to charge Deposit Account No. 07-0630 in the amount of \$130.00 to cover the cost of this Information Disclosure Statement. Any deficiency or overpayment should be charged or credited to this deposit account. A duplicate of this sheet is enclosed.

[If either of boxes (d) or (e) is checked above, the following "certification" under 37 CFR §1.97(e) may need to be completed.] The undersigned certifies that:

- Each item of information contained in the information disclosure statement was cited in a communication mailed from a foreign patent office in a counterpart foreign application not more than three months prior to the filing of this information disclosure statement.
- No item of information contained in this information disclosure statement was cited in a communication mailed from a foreign patent office in a counterpart foreign application or, to the knowledge of the undersigned after making reasonable inquiry, was known to any individual designated in 37 CFR §1.56(c) more than three months prior to the filing of this information disclosure statement.

A list of the patent(s) or publication(s) is set forth on the attached Form PTO-1449 (Modified).

A copy of the items on PTO-1449 is supplied herewith:

each none only those listed below:

Those patent(s) or publication(s) which are marked with an asterisk (*) in the attached PTO-1449 form are not supplied because they were previously cited by or submitted to the Office in a prior application Serial No. , filed and relied upon in this application for an earlier filing date under 35 USC §120.

A concise explanation of relevance of the items listed on PTO-1449 is:

- not given
- given for each listed item
- given for only non-English language listed item(s) [Required]
- in the form of an English language copy of a Search Report from a foreign patent office, issued in a counterpart application, which refers to the relevant portions of the references.

08/146,206

Page 3

The Examiner is reminded that a "concise explanation of the relevance" of the submitted prior art "may be nothing more than identification of the particular figure or paragraph of the patent or publication which has some relation to the claimed invention," MPEP §609.

While the information and references disclosed in this Information Disclosure Statement may be "material" pursuant to 37 CFR §1.56, it is not intended to constitute an admission that any patent, publication or other information referred to therein is "prior art" for this invention unless specifically designated as such.

In accordance with 37 CFR §1.97(g), the filing of this Information Disclosure Statement shall not be construed to mean that a search has been made or that no other material information as defined in 37 CFR §1.56(a) exists. It is submitted that the Information Disclosure Statement is in compliance with 37 CFR §1.98 and MPEP §609 and the Examiner is respectfully requested to consider the listed references.

A copy of a document pursuant to 37 C.F.R. § 10.9(b) is attached as proof of the authorization of the undersigned to prosecute the above-mentioned application. The original of this document is on file in the Office of Enrollment and Discipline.

Respectfully submitted,
GENENTECH, INC.

Date: August 1, 1995

By: 

Wendy M. Lee

460 Pt. San Bruno Blvd.
So. San Francisco, CA 94080-4990
Phone: (415) 225-1994
Fax: (415) 952-9881

12-12-01 11:50am From-Genentech Legal

+1 650 952 9881

T-282 P.007/012 F-366

In re Application of: Paul J. Carter et al.
Serial No.: 08/146,206
Filed On: November 17, 1993
Hand Delivered On: ___ February 1999

Docket No.: P0709P1
By: Wendy M. Lee
Reg. No.: 40,378

The following has been received in the U.S. Patent Office on the date stamped:

- Information Disclosure Statement
- Form 1449 with 38 References
- Communication with Exhibit A and two priority documents
- Certificate of Hand Delivery

In re Application of: Paul J. Carter et al.
Serial No.: 08/146,206
Filed On: November 17, 1993
Hand Delivered On: ___ February 1999

Docket No.: P0709P1
By: Wendy M. Lee
Reg. No.: 40,378

The following has been received in the U.S. Patent Office on the date stamped:

- Information Disclosure Statement
- Form 1449 with 38 References
- Communication with Exhibit A and two priority documents
- Certificate of Hand Delivery

RECEIVED
TSCM-CRITER 1800/2900
59 FEB -1 PM 12:21

Received from <+16509529881> at 12/12/01 2:55:22 PM [Eastern Standard Time]

Copy

page # 46

FORM PTO-1449		U.S. Dept. of Commerce Patent and Trademark Office		Atty Docket No. P0709P1	Serial No. 08/146,206	
LIST OF DISCLOSURES CITED BY APPLICANT (Use several sheets if necessary)				Applicant Carter et al.		
				Filing Date 17 Nov 1993	Group 1806	
U.S. PATENT DOCUMENTS						
Examiner Initials	Document Number	Date	Name	Class	Subclass	Filing Date
	225	5,714,350	03.02.98	Co et al.		13.01.95
	226	5,821,337	13.10.98	Carter et al.		
FOREIGN PATENT DOCUMENTS						
Examiner Initials	Document Number	Date	Country	Class	Subclass	Translation Yes No
	227	0 460 167 B1	11.12.91	EPO		
	228	0 519 596 A1	23.12.92	EPO		
	229	0 592 106 A1	13.04.94	EPO		
	230	120,694	03.10.84	EPO		
	231	125,023 A1	14.11.84	EPO		
	232	368,684	16.05.90	EPO		
	233	94/11509	26.05.94	PCT		
	234	WO 89/09622		PCT		
	235	WO 92/11383	09.07.92	PCT		
	236	2 188941	14.10.87	UNITED KINGDOM		
OTHER DISCLOSURES (Including Author, Title, Date, Pertinent Pages, etc.)						
	237	"Biosym Technologies" in New Products, Chemical Design Automation 3" (December 1988)				
	238	"Polygen Corporation" in New Products, Chemical Design Automation 3" (November 1988)				
	239	Adair et al., "Humanization of the murine anti-human CD3 monoclonal antibody OKP3" <u>Hum. Antibod. Hybridomas</u> 5:41-47 (1994)				
	240	Chocthia et al., "Principles of protein-protein recognition" <u>Nature</u> 256:705-708 (1975)				
	241	Chocthia et al., "Transmission of conformational change in insulin" <u>Nature</u> 302:500-505 (1983)				
	242	Corti et al., "Idiotope Determining Regions of a Mouse Monoclonal Antibody and Its Humanized Versions" <u>J. Mol. Biol.</u> 235:53-60 (1994)				
	243	Couto et al., "Anti-BA46 Monoclonal Antibody Mc3 Humanization Using a Novel Positional Consensus and in Vivo and in Vitro Characterization" <u>Cancer Research Supplement</u> 55:1717-1722 (1995)				
	244	Couto et al., "Humanization of KC4G3, an Anti-Human Carcinoma Antibody" <u>Hybridoma</u> 13:215-219 (1994)				
	245	Ellis et al., "Engineered Anti-CD38 Monoclonal Antibodies for Immunotherapy of Multiple Myeloma" <u>The Journal of Immunology</u> pps. 925-937 (1995)				
	246	Hieter et al., "Evolution of Human Immunoglobulin K J Region Genes" <u>The Journal of Biological Chemistry</u> 257:1516-1522 (1982)				
	247	Lesk, Arthur M., "How Different Amino Acid Sequences Determine Similar Protein Structures: The Structure and Evolutionary Dynamics of the Globins" <u>J. Mol. Biol.</u> 136:225-270 (1980)				
Examiner			Date Considered			
*Examiner. Initial if reference considered, whether or not citation is in conformance with MPEP 609; draw line through citation if not in conformance and not considered. Include copy of this form with next communication to applicant.						

Copy

FORM PTO-1449		U.S. Dept. of Commerce Patent and Trademark Office		Atty Docket No. P0709P1	Serial No. 08/146,206
LIST OF DISCLOSURES CITED BY APPLICANT (Use several sheets if necessary)				Applicant Carter et al.	
				Filing Date 17 Nov 1993	
OTHER DISCLOSURES (Including Author, Title, Date, Pertinent Pages, etc.)					
248	Matsumura et al., "Hydrophobic stabilization in T4 lysozyme determined directly by multiple substitutions of Ile 3" <u>Nature</u> 334:406-410 (1988)				
249	Morrison, S. L., "Transfectomas Provide Novel Chimeric Antibodies" <u>Science</u> 229:1202-1207 (September 20, 1985)				
250	Nakatani et al., "Humanization of mouse anti-human IL-2 receptor antibody B-B10" <u>Protein Engineering</u> 7:435-443 (1994)				
251	Ohtomo et al., "Humanization of Mouse ONS-M21 Antibody with the Aid of Hybrid Variable Regions" <u>Molecular Immunology</u> 32:407-416 (1995)				
252	Padlan et al., "Model-Building Studies of Antigen-Binding Sites: The Hapten-Binding Site of MOFC-315" <u>C.S. Harbor Symp. Quant. Biol.</u> 41:627-637 (1977)				
253	Rodrigues et al., "Engineering a humanized bispecific F(ab') ₂ fragment for improved binding to T cells" <u>Int. J. Cancer (Suppl.)</u> 7:45-50 (1992)				
254	Shu et al., "A Heavy-Chain Grafted Antibody that Recognizes the Tumor-Associated TAG72 Antigen" <u>Cancer Biotherapy</u> 9:341-349 (1994)				
255	Tempest et al., "Identification of framework residues required to restore antigen binding during reshaping of a monoclonal antibody against the glycoprotein gB of human cytomegalovirus" <u>Int. J. Biol. Macromol.</u> 17:37-42 (1995)				
256	Tramontano, "Structural Determinants of the Conformations of Medium-Sized Loops in Proteins" <u>Proteins</u> 6:382-394 (1989)				
257	Uchiyama et al., "A Monoclonal Antibody (ANTI-Tac) Reactive with Activated and Functionally Mature Human T Cells" <u>Journal of Immunology</u> 126:1393-1397 (1981)				
258	Vincenti et al., "Interleukin-2-Receptor Blockade with Daclizumab to Prevent Acute Rejection in Renal Transplantation" <u>New Engl. J. Med.</u> 338:161-165 (1998)				
259	Vitetta et al., "Redesigning Nature's Poisons to Create Anti-Tumor Reagents" <u>Science</u> 238:1098-1104 (1987)				
260	Waldmann et al., "Interleukin 2 Receptor (Tac Antigen) Expression in HTLV-1-associated Adult T-Cell Leukemia" <u>Cancer Research</u> 45:4559s-4562s (1985)				
261	Waldmann, Thomas A., "The Structure, Function, and Expression of Interleukin-2 Receptors on Normal and Malignant Lymphocytes" <u>Science</u> 232:727-732 (1986)				
262	Wu et al., "An Analysis of the Sequences of the Variable Regions of Bence Jones Proteins and Myeloma Light Chains and Their Implications for Antibody Complementarity" <u>Journal of Experimental Medicine</u> 132:211-250 (1970)				
Examiner			Date Considered		
*Examiner: Initial if reference considered, whether or not citation is in conformance with MPEP 609; draw line through citation if not in conformance and not considered. Include copy of this form with next communication to applicant.					

USCOMM-DC 80-398.

Received from <+16509529881> at 12/12/01 2:55:22 PM [Eastern Standard Time]



UNITED STATES PATENT AND TRADEMARK OFFICE

UNITED STATES DEPARTMENT OF COMMERCE
United States Patent and Trademark Office
Address: COMMISSIONER OF PATENTS AND TRADEMARKS
Washington, D.C. 20231
www.uspto.gov

NOTICE OF ALLOWANCE AND FEE(S) DUE

7590 12/18/2001
GENENTECH, INC.
1 DNA WAY
SOUTH SAN FRANCISCO, CA 940804990

EXAMINER

DAVIS, MINH TAM B

ART UNIT CLASS-SUBCLASS

1642

530-387300

DATE MAILED: 12/18/2001

Table with 5 columns: APPLICATION NO., FILING DATE, FIRST NAMED INVENTOR, ATTORNEY DOCKET NO., CONFIRMATION NO.
08/146,206 11/17/1993 PAUL J. CARTER 709P1 3992

TITLE OF INVENTION: METHOD FOR MAKING HUMANIZED ANTIBODIES

Table with 7 columns: TOTAL CLAIMS, APPLN. TYPE, SMALL ENTITY, ISSUE FEE, PUBLICATION FEE, TOTAL FEE(S) DUE, DATE DUE
82 nonprovisional NO \$1280 \$0 \$1280 03/18/2002

THE APPLICATION IDENTIFIED ABOVE HAS BEEN EXAMINED AND IS ALLOWED FOR ISSUANCE AS A PATENT.

PROSECUTION ON THE MERITS IS CLOSED. THIS NOTICE OF ALLOWANCE IS NOT A GRANT OF PATENT RIGHTS. THIS APPLICATION IS SUBJECT TO WITHDRAWAL FROM ISSUE AT THE INITIATIVE OF THE OFFICE OR UPON PETITION BY THE APPLICANT. SEE 37 CFR 1.313 AND MPEP 1308.

THE ISSUE FEE AND PUBLICATION FEE (IF REQUIRED) MUST BE PAID WITHIN THREE MONTHS FROM THE MAILING DATE OF THIS NOTICE OR THIS APPLICATION SHALL BE REGARDED AS ABANDONED. THIS STATUTORY PERIOD CANNOT BE EXTENDED. SEE 35 U.S.C. 151.

HOW TO REPLY TO THIS NOTICE:

I. Review the SMALL ENTITY status shown above. If the SMALL ENTITY is shown as YES, verify your current SMALL ENTITY status:

A. If the status is changed, pay the PUBLICATION FEE (if required) and twice the amount of the ISSUE FEE shown above and notify the United States Patent and Trademark Office of the change in status, or

B. If the status is the same, pay the TOTAL FEE(S) DUE shown above.

If the SMALL ENTITY is shown as NO:

A. Pay TOTAL FEE(S) DUE shown above, or

B. If applicant claimed SMALL ENTITY status before, or is now claiming SMALL ENTITY status, check the box below and enclose the PUBLICATION FEE and 1/2 the ISSUE FEE shown above.

[] Applicant claims SMALL ENTITY status. See 37 CFR 1.27.

II. PART B - FEE(S) TRANSMITTAL should be completed and returned to the United States Patent and Trademark Office (USPTO) with your ISSUE FEE and PUBLICATION FEE (if required). Even if the fee(s) have already been paid, Part B - Fee(s) Transmittal should be completed and returned. If you are charging the fee(s) to your deposit account, section "4b" of Part B - Fee(s) Transmittal should be completed and an extra copy of the form should be submitted.

III. All communications regarding this application must give the application number. Please direct all communications prior to issuance to Box ISSUE FEE unless advised to the contrary.

IMPORTANT REMINDER: Utility patents issuing on applications filed on or after Dec. 12, 1980 may require payment of maintenance fees. It is patentee's responsibility to ensure timely payment of maintenance fees when due.

PART B - FEE(S) TRANSMITTAL

Complete and mail this form, together with applicable fee(s), to:

Box ISSUE FEE
Assistant Commissioner for Patents
Washington, D.C. 20231

MAILING INSTRUCTIONS: This form should be used for transmitting the ISSUE FEE and PUBLICATION FEE (if required). Blocks 1 through 4 should be completed where appropriate. All further correspondence including the Patent, advance orders and notification of maintenance fees will be mailed to the current correspondence address as indicated unless corrected below or directed otherwise in Block 1, by (a) specifying a new correspondence address; and/or (b) indicating a separate "FEE ADDRESS" for maintenance fee notifications.

CURRENT CORRESPONDENCE ADDRESS (Note: Legibly mark-up with any corrections or use Block 1)

7590 12/18/2001
GENENTECH, INC.
 1 DNA WAY
 SOUTH SAN FRANCISCO, CA 940804990

Note: The certificate of mailing below can only be used for domestic mailings of the Fee(s) Transmittal. This certificate cannot be used for any other accompanying papers. Each additional paper, such as an assignment or formal drawing, must have its own certificate of mailing.

Certificate of Mailing

I hereby certify that this Fee(s) Transmittal is being deposited with the United States Postal Service with sufficient postage for first class mail in an envelope addressed to the Box Issue Fee address above on the date indicated below.

_____ (Depositor's name)
_____ (Signature)
_____ (Date)

APPLICATION NO.	FILING DATE	FIRST NAMED INVENTOR	ATTORNEY DOCKET NO.	CONFIRMATION NO.
08/146,206	11/17/1993	PAUL J. CARTER	709P1	3992

TITLE OF INVENTION: METHOD FOR MAKING HUMANIZED ANTIBODIES

TOTAL CLAIMS	APPLN. TYPE	SMALL ENTITY	ISSUE FEE	PUBLICATION FEE	TOTAL FEE(S) DUE	DATE DUE
82	nonprovisional	NO	\$1280	\$0	\$1280	03/18/2002

EXAMINER	ART UNIT	CLASS-SUBCLASS
DAVIS, MINH TAM B	1642	530-387300

<p>1. Change of correspondence address or indication of "Fee Address" (37 CFR 1.363). Use of PTO form(s) and Customer Number are recommended, but not required.</p> <p><input type="checkbox"/> Change of correspondence address (or Change of Correspondence Address form PTO/SB/122) attached.</p> <p><input type="checkbox"/> "Fee Address" indication (or "Fee Address" Indication form PTO/SB/47) attached.</p>	<p>2. For printing on the patent front page, list (1) the names of up to 3 registered patent attorneys or agents OR, alternatively, (2) the name of a single firm (having as a member a registered attorney or agent) and the names of up to 2 registered patent attorneys or agents. If no name is listed, no name will be printed.</p> <p>1 _____</p> <p>2 _____</p> <p>3 _____</p>
--	---

3. ASSIGNEE NAME AND RESIDENCE DATA TO BE PRINTED ON THE PATENT (print or type)

PLEASE NOTE: Unless an assignee is identified below, no assignee data will appear on the patent. Inclusion of assignee data is only appropriate when an assignment has been previously submitted to the USPTO or is being submitted under separate cover. Completion of this form is NOT a substitute for filing an assignment.

(A) NAME OF ASSIGNEE _____ (B) RESIDENCE: (CITY and STATE OR COUNTRY) _____

Please check the appropriate assignee category or categories (will not be printed on the patent) individual corporation or other private group entity government

<p>4a. The following fee(s) are enclosed:</p> <p><input type="checkbox"/> Issue Fee</p> <p><input type="checkbox"/> Publication Fee</p> <p><input type="checkbox"/> Advance Order - # of Copies _____</p>	<p>4b. Payment of Fee(s):</p> <p><input type="checkbox"/> A check in the amount of the fee(s) is enclosed.</p> <p><input type="checkbox"/> Payment by credit card. Form PTO-2038 is attached.</p> <p><input type="checkbox"/> The Commissioner is hereby authorized by charge the required fee(s), or credit any overpayment, to Deposit Account Number _____ (enclose an extra copy of this form).</p>
---	---

The COMMISSIONER OF PATENTS AND TRADEMARKS is requested to apply the Issue Fee and Publication Fee (if any) to the application identified above.

<p>(Authorized Signature) _____</p>	<p>(Date) _____</p>
<p>NOTE: The Issue Fee and Publication Fee (if required) will not be accepted from anyone other than the applicant; a registered attorney or agent; or the assignee or other party in interest as shown by the records of the United States Patent and Trademark Office.</p> <p>Burden Hour Statement: This form is estimated to take 0.2 hours to complete. Time will vary depending on the needs of the individual case. Any comments on the amount of time required to complete this form should be sent to the Chief Information Officer, United States Patent and Trademark Office, Washington, D.C. 20231. DO NOT SEND FEES OR COMPLETED FORMS TO THIS ADDRESS. SEND FEES AND THIS FORM TO: Box Issue Fee, Assistant Commissioner for Patents, Washington, D.C. 20231</p> <p>Under the Paperwork Reduction Act of 1995, no persons are required to respond to a collection of information unless it displays a valid OMB control number.</p>	



UNITED STATES PATENT AND TRADEMARK OFFICE

UNITED STATES DEPARTMENT OF COMMERCE
United States Patent and Trademark Office
Address: COMMISSIONER OF PATENTS AND TRADEMARKS
Washington, D.C. 20231
www.uspto.gov

APPLICATION NO.	FILING DATE	FIRST NAMED INVENTOR	ATTORNEY DOCKET NO.	CONFIRMATION NO.
08/146,206	11/17/1993	PAUL J. CARTER	709P1	3992
	7590 12/18/2001		EXAMINER	
GENENTECH, INC. 1 DNA WAY SOUTH SAN FRANCISCO, CA940804990			DAVIS, MINH TAM B	
			ART UNIT	PAPER NUMBER
			1642	
DATE MAILED: 12/18/2001				

Determination of Patent Term Extension or Adjustment under 35 U.S.C. 154 (b)
(application filed prior to June 8, 1995)

This patent application was filed prior to June 8, 1995, thus no Patent Term Extension or Adjustment applies.

Applicant will be able to obtain more detailed information by accessing the Patent Application Information Retrieval (PAIR) system. (<http://pair.uspto.gov>)

Notice of Allowability

Application No. 08/146,206	Applicant(s) Carter et al	
Examiner MINH TAM DAVIS	Art Unit 1642	

--The MAILING DATE of this communication appears on the cover sheet with the correspondence address--

All claims being allowable, PROSECUTION ON THE MERITS IS (OR REMAINS) CLOSED in this application. If not included herewith (or previously mailed), a Notice of Allowance and Issue Fee Due or other appropriate communication will be mailed in due course. **THIS NOTICE OF ALLOWABILITY IS NOT A GRANT OF PATENT RIGHTS.** This application is subject to withdrawal from issue at the initiative of the Office or upon petition by the applicant. See 37 CFR 1.313 and MPEP 1308.

- 1. This communication is responsive to interview on 12/11/01.
- 2. The allowed claim(s) is/are 43-105, 113-128, renumbered as 1-82.
- 3. The drawings filed on _____ are acceptable as formal drawings.
- 4. Acknowledgement is made of a claim for foreign priority under 35 U.S.C. § 119(a)-(d).
 - a) All b) Some* c) None of the:
 - 1. Certified copies of the priority documents have been received.
 - 2. Certified copies of the priority documents have been received in Application No. _____.
 - 3. Copies of the certified copies of the priority documents have been received in this national stage application from the International Bureau (PCT Rule 17.2(a)).
- *Certified copies not received: _____
- 5. Acknowledgement is made of a claim for domestic priority under 35 U.S.C. § 119(e).

Applicant has THREE MONTHS FROM THE "MAILING DATE" of this communication to file a reply complying with the requirements noted below. Failure to timely comply will result in ABANDONMENT of this application. **THIS THREE-MONTH PERIOD IS NOT EXTENDABLE FOR SUBMITTING NEW FORMAL DRAWINGS, OR A SUBSTITUTE OATH OR DECLARATION.** ~~This three-month period for complying with the REQUIREMENT FOR THE DEPOSIT OF BIOLOGICAL MATERIAL is extendable under 37 CFR 1.136(a).~~

- 6. Note the attached EXAMINER'S AMENDMENT or NOTICE OF INFORMAL APPLICATION (PTO-152) which gives reason(s) why the oath or declaration is deficient. A SUBSTITUTE OATH OR DECLARATION IS REQUIRED.
- 7. Applicant MUST submit NEW FORMAL DRAWINGS
 - (a) including changes required by the Notice of Draftsperson's Patent Drawing Review (PTO-948) attached
 - 1) hereto or 2) to Paper No. 12.
 - (b) including changes required by the proposed drawing correction filed _____, which has been approved by the examiner.
 - (c) including changes required by the attached Examiner's Amendment/Comment or in the Office action of Paper No. _____.

Identifying indicia such as the application number (see 37 CFR 1.84(c)) should be written on the drawings. The drawings should be filed as a separate paper with a transmittal letter addressed to the Official Draftsperson.

- 8. Note the attached Examiner's comment regarding REQUIREMENT FOR THE DEPOSIT OF BIOLOGICAL MATERIAL.

Any reply to this letter should include, in the upper right hand corner, the APPLICATION NUMBER (SERIES CODE/SERIAL NUMBER). If applicant has received a Notice of Allowance and Issue Fee Due, the ISSUE BATCH NUMBER and DATE of the NOTICE OF ALLOWANCE should also be included.

Attachment(s)

- 1 Notice of References Cited (PTO-892)
- 2 Notice of Informal Patent Application (PTO-152)
- 3 Notice of Draftsperson's Patent Drawing Review (PTO-948)
- 4 Interview Summary (PTO-413), Paper No. _____
- 5 Information Disclosure Statement(s) (PTO-1449), Paper No(s). 10 sheets
- 6 Examiner's Amendment/Comment
- 7 Examiner's Comment Regarding Requirement for Deposit of Biological Material
- 8 Examiner's Statement of Reasons for Allowance
- 9 Other

EXAMINER'S AMENDMENT

An examiner's amendment to the record appears below. Should the changes and/or additions be unacceptable to applicant, an amendment may be filed as provided by 37 CFR 1.312. To ensure consideration of such an amendment, it MUST be submitted no later than the payment of the issue fee.

Authorization for this examiner's amendment was given in a telephone interview with Wendy Lee on 12/13/01.

The application has been amended as follows:

In the claims:

Claim 114. Delete "about", and replace it with --- up to ---

Delete "tightly", and replace it with --- in the binding affinity ---

Any inquiry concerning this communication or earlier communications from the examiner should be directed to MINH-TAM DAVIS whose telephone number is 703-305-2008. The examiner can normally be reached on 9:30AM-4:00PM.

If attempts to reach the examiner by telephone are unsuccessful, the examiner's supervisor, ANTHONY CAPUTA can be reached on 703-308-3995. The fax phone numbers for the organization where this application or proceeding is assigned are 703-308-4426 for regular communications and 703-308-4426 for After Final communications.

Application/Control Number: 08/146,206
Art Unit: 1642

Page 3

Any inquiry of a general nature or relating to the status of this application or proceeding should be directed to the receptionist whose telephone number is 703-308-0916.

MINH TAM DAVIS
December 14, 2001

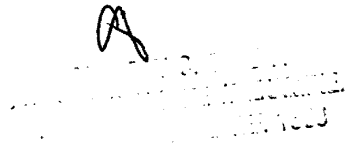
A handwritten signature in black ink is positioned above a faint, rectangular stamp. The stamp contains illegible text, likely a date or administrative marking.

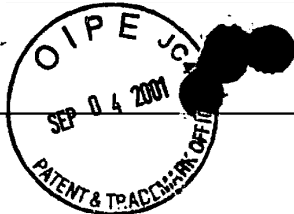

A. Hackett # 64

Sheet 1 of 1

FORM PTO-1449	U.S. Dept. of Commerce Patent and Trademark Office	Atty Docket No. P0709P1	Serial No. 08/146,206
LIST OF DISCLOSURES CITED BY APPLICANT (Use several sheets if necessary)		Applicant Carter et al.	
		Filing Date 17 Nov 1993	Group 1642

U.S. PATENT DOCUMENTS

Examiner Initials	Document Number	Date	Name	Class	Subclass	Filing Date
AS	264 5,834,598	10/11/98	Lowman et al.	530	399	

OTHER DISCLOSURES (Including Author, Title, Date, Pertinent Pages, etc.)

AS	265	Rhodes, P., "Recombinant antibodies from CHO cells" ABSTR PAP AM CHEM SOC (Abstract No. 60 from the 199th American Chemical Society National Meeting held in Boston, MA April 22-27, 1990) 199(1-2):BIOT 60 (Apr 1990)				
----	-----	--	--	--	--	--

RECEIVED

SEP 06 2001

TECH CENTER 1600/2900

Examiner <i>M.T. Davis</i>	Date Considered <i>12/05/01</i>
-------------------------------	------------------------------------

*Examiner: Initial if reference considered, whether or not citation is in conformance with MPEP 609; draw line through citation if not in conformance and not considered. Include copy of this form with next communication to applicant.

USCOMM-DC 80-398.

Attachment to Paper #47
 Sheet 1 of 1

FORM PTO-1449	U.S. Dept. of Commerce Patent and Trademark Office	Atty Docket No. P0709P1	Serial No. 08/146,206
LIST OF DISCLOSURES CITED BY APPLICANT (Use several sheets if necessary)		Applicant Carter et al.	
		Filing Date 17 Nov 1993	Group 1642

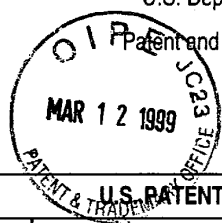

U.S. PATENT DOCUMENTS

Examiner Initials	Document Number	Date	Name	Class	Subclass	Filing Date
MS GR	263 5,859,205	12.01.99	Adair et al.	530	387.3	07.09.94

Examiner <i>Julie Kevs, PLD</i>	Date Considered <i>3/25/99</i>
------------------------------------	-----------------------------------

*Examiner: Initial if reference considered, whether or not citation is in conformance with MPEP 609; draw line through citation if not in conformance and not considered. Include copy of this form with next communication to applicant.

M. J. Davis 12/05/01

USCOMM-DC 80-398.

#46a then
 Sheet 1 of 2

FORM PTO-1449	U.S. Dept. of Commerce Patent and Trademark Office	Atty Docket No. P0709P1	Serial No. 08/146,206
LIST OF DISCLOSURES CITED BY APPLICANT (Use several sheets if necessary)		Applicant Carter et al.	
		Filing Date 17 Nov 1993	Group 1806

U.S. PATENT DOCUMENTS

Examiner Initials	Document Number	Date	Name	Class	Subclass	Filing Date
TK L	225 5,714,350	03.02.98	Co et al.	435	69.6	13.01.95
	226 5,821,337	13.10.98	Carter et al.	530	387.3	

FOREIGN PATENT DOCUMENTS

Examiner Initials	Document Number	Date	Country	Class	Subclass	Translation	
						Yes	No
TK MS	227 0 460 167 B1	11.12.91	EPO				
	228 0 519 596 A1	23.12.92	EPO				
	229 0 592 106 A1	13.04.94	EPO				
	230 120,694	03.10.84	EPO				
	231 125,023 A1	14.11.84	EPO				
	232 368,684	16.05.90	EPO				
	233 94/11509	26.05.94	PCT				
	234 WO 89/09622	10/1984	PCT				
	235 WO 92/11383	09.07.92	PCT				
	236 2 188941	14.10.87	UNITED KINGDOM				

OTHER DISCLOSURES (Including Author, Title, Date, Pertinent Pages, etc.)

237	"Biosym Technologies" in New Products, Chemical Design Automation 3" (December 1988)
238	"Polygen Corporation" in New Products, Chemical Design Automation 3" (November 1988)
239	Adair et al., "Humanization of the murine anti-human CD3 monoclonal antibody OKT3" <u>Hum. Antibod. Hybridomas</u> 5:41-47 (1994)
240	Chothia et al., "Principles of protein-protein recognition" <u>Nature</u> 256:705-708 (1975)
241	Chothia et al., "Transmission of conformational change in insulin" <u>Nature</u> 302:500-505 (1983)
242	Corti et al., "Idiotope Determining Regions of a Mouse Monoclonal Antibody and Its Humanized Versions" <u>J. Mol. Biol.</u> 235:53-60 (1994)
243	Couto et al., "Anti-BA46 Monoclonal Antibody Mc3 Humanization Using a Novel Positional Consensus and in Vivo and in Vitro Characterization" <u>Cancer Research Supplement</u> 55:1717-1722 (1995)
244	Couto et al., "Humanization of KC4G3, an Anti-Human Carcinoma Antibody" <u>Hybridoma</u> 13:215-219 (1994)
245	Ellis et al., "Engineered Anti-CD38 Monoclonal Antibodies for Immunotherapy of Multiple Myeloma" <u>The Journal of Immunology</u> pps. 925-937 (1995)
246	Hieter et al., "Evolution of Human Immunoglobulin K J Region Genes" <u>The Journal of Biological Chemistry</u> 257:1516-1522 (1982)
247	Lesk, Arthur M., "How Different Amino Acid Sequences Determine Similar Protein Structures: The Structure and Evolutionary Dynamics of the Globins" <u>J. Mol. Biol.</u> 136:225-270 (1980)

Examiner M.T. Davis	Date Considered 12/05/01
------------------------	-----------------------------

*Examiner: Initial if reference considered, whether or not citation is in conformance with MPEP 609; draw line through citation if not in conformance and not considered. Include copy of this form with next communication to applicant.

FORM PTO-1449		U.S. Dept. of Commerce Patent and Trademark Office		Atty Docket No. P0709P1	Serial No. 08/146,206
LIST OF DISCLOSURES CITED BY APPLICANT (Use several sheets if necessary)				Applicant Carter et al.	
				Filing Date 17 Nov 1993	
OTHER DISCLOSURES (Including Author, Title, Date, Pertinent Pages, etc.)					
248	✓	Matsumura et al., "Hydrophobic stabilization in T4 lysozyme determined directly by multiple substitutions of Ile 3" <u>Nature</u> 334:406-410 (1988)			
249		Morrison, S. L., "Transfectomas Provide Novel Chimeric Antibodies" <u>Science</u> 229:1202-1207 (September 20, 1985)			
250		Nakatani et al., "Humanization of mouse anti-human IL-2 receptor antibody B-B10" <u>Protein Engineering</u> 7:435-443 (1994)			
251		Ohtomo et al., "Humanization of Mouse ONS-M21 Antibody with the Aid of Hybrid Variable Regions" <u>Molecular Immunology</u> 32:407-416 (1995)			
252		Padlan et al., "Model-Building Studies of Antigen-Binding Sites: The Hapten-Binding Site of MOPC-315" <u>C.S. Harbor Symp. Quant. Biol.</u> 41:627-637 (1977) <i>Inqul.</i>			
253		Rodrigues et al., "Engineering a humanized bispecific F(ab') ₂ fragment for improved binding to T cells" <u>Int. J. Cancer</u> (Suppl.) 7:45-50 (1992)			
254		Sha et al., "A Heavy-Chain Grafted Antibody that Recognizes the Tumor-Associated TAG72 Antigen" <u>Cancer Biotherapy</u> 9:341-349 (1994)			
255		Tempest et al., "Identification of framework residues required to restore antigen binding during reshaping of a monoclonal antibody against the glycoprotein gB of human cytomegalovirus" <u>Int. J. Biol. Macromol.</u> 17:37-42 (1995)			
256		Tramontano, "Structural Determinants of the Conformations of Medium-Sized Loops in Proteins" <u>Proteins</u> 6:382-394 (1989)			
257		Uchiyama et al., "A Monoclonal Antibody (ANTI-Tac) Reactive with Activated and Functionally Mature Human T Cells" <u>Journal of Immunology</u> 126:1393-1397 (1981)			
258		Vincenti et al., "Interleukin-2-Receptor Blockade with Daclizumab to Prevent Acute Rejection in Renal Transplantation" <u>New Engl. J. Med.</u> 338:161-165 (1998)			
259		Vitetta et al., "Redesigning Nature's Poisons to Create Anti-Tumor Reagents" <u>Science</u> 238:1098-1104 (1987)			
260		Waldmann et al., "Interleukin 2 Receptor (Tac Antigen) Expression in HTLV-1-associated Adult T-Cell Leukemia" <u>Cancer Research</u> 45:4559s-4562s (1985)			
261		Waldmann, Thomas A., "The Structure, Function, and Expression of Interleukin-2 Receptors on Normal and Malignant Lymphocytes" <u>Science</u> 232:727-732 (1986)			
262	✓	Wu et al., "An Analysis of the Sequences of the Variable Regions of Bence Jones Proteins and Myeloma Light Chains and Their Implications for Antibody Complementarity" <u>Journal of Experimental Medicine</u> 132:211-250 (1970)			
Examiner		M.T. Davis		Date Considered	
				12/04/01	
*Examiner: Initial if reference considered, whether or not citation is in conformance with MPEP 609; draw line through citation if not in conformance and not considered. Include copy of this form with next communication to applicant.					

12-12-01 11:50am From-Genentech Legal

copy.

+1 650 952 9881

T-282 P.006/012 F-366

Attachment # 15 (17)

Sheet 1 of 1

FORM PTO-1449	U.S. Dept. of Commerce Patent and Trademark Office	Atty Docket No. P0709P1	Serial No. 08/146,206
LIST OF DISCLOSURES CITED BY APPLICANT (Use several sheets if necessary)		Applicant Carter et al.	
		Filing Date 17 Nov 1993	Group 1806

FOREIGN PATENT DOCUMENTS

Examiner Initials	Document Number	Date	Country	Class	Subclass	Translation	
						Yes	No
<i>JDS</i> ↓	79 WO 92/04381	19.03.92	PCT				
	80 WO 92/05274	02.04.92	PCT				
	81 WO 92/15683	17.09.92	PCT				

Examiner <i>M. T. Davis</i>	Date Considered <i>12/05/01</i>
--------------------------------	------------------------------------

*Examiner: Initial if reference considered, whether or not citation is in conformance with MPEP 809; draw line through citation if not in conformance and not considered. Include copy of this form with next communication to applicant.

USCOMM-DC 80-398.

copy

Received from <+16509529881> at 12/12/01 2:55:22 PM [Eastern Standard Time]

FORM PTO-1449	U.S. Dept. of Commerce Patent and Trademark Office	Any Docket No. P0709P1	Serial No. 08/146,206
LIST OF DISCLOSURES CITED BY APPLICANT (Use several sheets if necessary)		Applicant Carter et al.	
		Filing Date 17 Nov 1993	Group 1806

U.S. PATENT DOCUMENTS

Examiner Initials	Document Number	Date	Name	Class	Subclass	Filing Date
PA	81 5,225,539 7-6-93	06-07-93	Winter, G.	530/387.3	C07K	15/38 25-10-92/025/91
PN	82 5,530,101 6-25-94	25-06-96	Queen et al.	530/387.3	A61K	39/395 19-12-90, 21/10/90

FOREIGN PATENT DOCUMENTS

Examiner Initials	Document Number	Date	Country	Class	Subclass	Translation Yes No
PA	83 85058/91 3-30-92	30-03-92	AUSTRALIA	C07K	15/12	
	84 328,404 A1 8-16-89	16-08-89	EPO	A61K	39/395	
	85 451,216 B1 1-24-96	24-01-96	EPO	C12P	21/08	
	86 WO 91/09966 7-11-91	11-07-91	PCT	C12P	21/08	
	87 WO 91/09968 7-11-91	11-07-91	PCT	C12P	21/08	
PN	88 WO 92/11018 7-7-92	07-09-92	PCT	A61K	35/14	

OTHER DISCLOSURES (Including Author, Title, Date, Pertinent Pages, etc.)

PA	89	Carter et al., "High level escherichia coli expression and production of a bivalent humanized antibody fragment" <u>Bio/Technology</u> 10:163-167 (1992)				
	90	Foote et al., "Antibody Framework Residues Affecting the Conformation of the Hypervariable Loops" <u>J. Mol. Biol.</u> 224:487-499 (1992)				
	91	Foote, J., "Humanized Antibodies" <u>Nova acta Leopoldina</u> 61(269):103-110 (1989)				
	92	Kabat et al., "Sequences of Proteins of Immunological Interest", Bethesda, MD:National Institute of Health pps. 14-32 (1983)				
	93	Kettleborough et al., "Humanization of a Mouse Monoclonal Antibody by CDR-grafting: the Importance of Framework Residues on Loop Conformation" <u>Protein Engineering</u> 4(7):773-783 (1991)				
	94	Maeda et al., "Construction of Reshaped Human Antibodies with HIV-neutralizing Activity" <u>Hum. Antibod. Hybridomas</u> 2:124-134 (July 1991)				
	95	Riechmann et al., "Expression of an Antibody Fv Fragment in Myeloma Cells" <u>J. Mol. Biol.</u> 203:825-828 (1988)				
	96	Routledge et al., "A Humanized Monovalent CD3 Antibody which Can Activate Homologous Complement" <u>European Journal of Immunology</u> 21:2717-2725 (1991)				
	97	Shearman et al., "Construction, Expression and Characterization of Humanized Antibodies Directed Against the Human α/β T Cell Receptor" <u>J. Immunol.</u> 147(12):4366-4373 (December 15, 1991)				
PA	98	Tempest et al., "Reshaping a Human Monoclonal Antibody to Inhibit Human Respiratory Syncytial Virus Infection In Vivo" <u>Bio/Technology</u> 9:266-271 (March 1991)				

Examiner <i>Patrick NDR</i>	Date Considered 12-16-96
--------------------------------	-----------------------------

*Examiner: Initial if reference considered, whether or not citation is in conformance with MPEP 609; draw line through citation if not in conformance and not considered. Include copy of this form with next communication to applicant.

M. T. DAVIS

12/05/01

USCOMM-DC 80-398.

Attached ~~1/8/96~~

FORM PTO-1449

U.S. Dept. of Commerce
Patent and Trademark Office

Atty Docket No.
P0709P1

Serial No.
08/146,206

LIST OF DISCLOSURES CITED BY APPLICANT
(Use several sheets if necessary)

Applicant
Carter et al.

Filing Date
17 Nov 1993

Group
~~1000~~ 1816

FOREIGN PATENT DOCUMENTS

Examiner Initials	Document Number	Date	Country	Class	Subclass	Translation	
						Yes	No
TBS ↓ PN	208 403,156 A1	19.12.90	EPO	_____	_____	_____	_____
	209 438,310 A2	24.07.91	EPO	_____	_____	_____	_____
	210 438,312 A2	24.07.91	EPO	_____	_____	_____	_____
	211 440,351 A2	07.08.91	EPO	_____	_____	_____	_____
	212 WO 91/07492	30.05.91	PCT	_____	_____	_____	_____
	213 WO 92/16562*	01.10.92	PCT	_____	_____	_____	_____
	214 WO 94/12214	09.06.94	PCT	_____	_____	_____	_____

Examiner *Patricia f-Nol*

Date Considered
12/22/97

*Examiner: Initial if reference considered, whether or not citation is in conformance with MPEP 609; draw line through citation if not in conformance and not considered. Include copy of this form with next communication to applicant.

M. T. Davis

12/05/01



03-19-02

25

Patent Docket P0709P1

THE UNITED STATES PATENT AND TRADEMARK OFFICE

<p>In re Application of Paul J. Carter et al. Serial No.: 08/146,206 Filed: November 17, 1993 For: METHOD FOR MAKING HUMANIZED ANTIBODIES</p>	<p>Group Art Unit: 1642 Examiner: Minh-Tam Davis <i>#69mm</i> Date of Mailing of PTOL 85 entitled "Notice of Allowance and Issue Fee Due" December 18, 2001</p> <p>CERTIFICATE OF MAILING I hereby certify that this correspondence is being deposited with the United States Postal Service "Express Mail Post Office to Addressee" service under 37 CFR 1.10 on the date indicated below and is addressed to: U.S. Patent and Trademark Office, Washington, D.C. 20231-8999 Express Mail Label No. EL 889 330 529 US March 18, 2002 <i>Wendy M. Lee</i> Wendy M. Lee</p>
--	--

**TRANSMITTAL OF NEW DRAWINGS TO CORRECT INFORMALITIES
WITHIN THREE MONTH PERIOD OF RESPONSE SET IN NOTICE
OF ALLOWABILITY (PTOL 37)**

BOX ISSUE FEE
Assistant Commissioner of Patents
Washington, D.C. 20231

Sir:

- To correct the informalities in the drawings as noted in the Draftsman's objections on PTO-948 applicant submits herewith new drawings for this application. Number of sheets of drawings submitted: 9.
- The three month period of response set in the Notice of Allowability (PTOL 37) expires on March 18, 2002 and this submission is on or before this expiry date.

Respectfully submitted,
GENENTECH, INC.

Wendy M. Lee

Date: March 18, 2002

By: _____

Wendy M. Lee
Reg. No. 40,378
Telephone No. (650) 225-1994



09157

PATENT TRADEMARK OFFICE

12-01

FIG. 1A

	10	20	30	40	50
4D5	DIVMTQSHKFMSTSVGDRVSITCKASQDVNTAVAWYQQKPGHSPKLLIYSASFRYT				
HU4D5	DIQMTQSPSSLSASVGDRVTITCRASQDVNTAVAWYQQKPGKAPKLLIYSASFLES				
HUV _L κI	DIQMTQSPSSLSASVGDRVTITCRASQDVSSYLAWYQQKPGKAPKLLIYAASSLES				
	-----			-----	
	-----			---	
	V _L -CDR1			V _L -CDR2	

	60	70	80	90	100
4D5	GVPDRFTGNRSGTDFFTISSVQAEDLAVYYCQQHYTTPPTFGGGTKLEIKRA				
HU4D5	GVPSRFSGSRSGTDFTLTISLQPEDFATYYCQQHYTTPPTFGQGTKVEIKRT				
HUV _L κI	GVPSRFSGSGSGTDFTLTISLQPEDFATYYCQQYNSLPYTFGQGTKVEIKRT				

	V _L -CDR3				

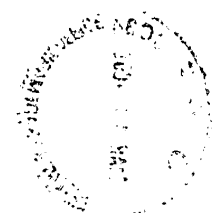

FIG. 1B

	10	20	30	40	50	A
4D5	EVQLQQSGPELVKPGASLKL	SCTASGFNIKDTYIHWVKQRPEQGLEWIGRIYPTN				
HU4D5	EVQLVESGGGLVQPGGSLRLS	CAASGFNIKDTYIHWVRQAPGKGLEWVARIYPTN				
HUV _H III	EVQLVESGGGLVQPGGSLRLS	CAASGFTFSDYAMSWVRQAPGKGLEWVAVISENG				
			-----			-----
			-----			-----
			V_H-CDR1			V_H-CDR2
	60	70	80	ABC	90	100ABC
4D5	GYTRYDPKFQDKATITADTSS	NAYLQVSRLTSEDTAVYYCSRWGGDGFYAMDYW				
HU4D5	GYTRYADSVKGRFTISADTS	KNTAYLQMNSLRAEDTAVYYCSRWGGDGFYAMDVW				
HUV _H III	SDTYYADSVKGRFTISRDDS	KNTLYLQMNSLRAEDTAVYYCARDRGGAVSYFDVW				
	-----					-----
						V_H-CDR3
	110					
4D5	GQGASVTVSS					
HU4D5	GQGLTVTVSS					
HUV _H III	GQGLTVTVSS					



Anneal huV_L or huV_H oligomers to pAK1 template



1. Ligate
2. Isolate assembled oligomers
3. Anneal to pAK1 template (*XhoI*⁻, *StuI*⁺)
4. Extend and ligate

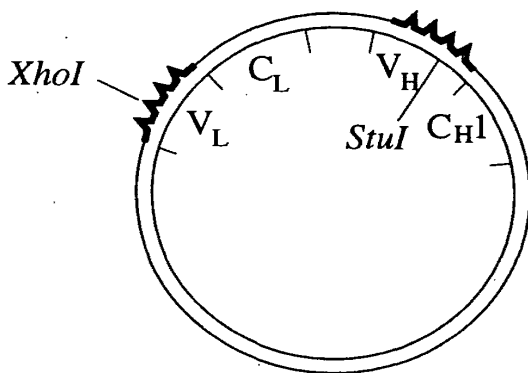

1. Transform *E. coli*
2. Isolate phagemid pool
3. Enrich for huV_L and huV_H (*XhoI*⁺, *StuI*⁻)
4. Sequence verify

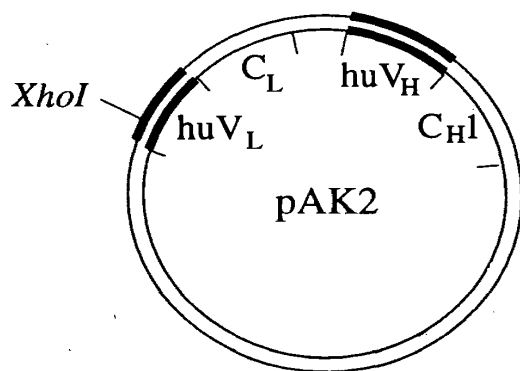

FIG. 2

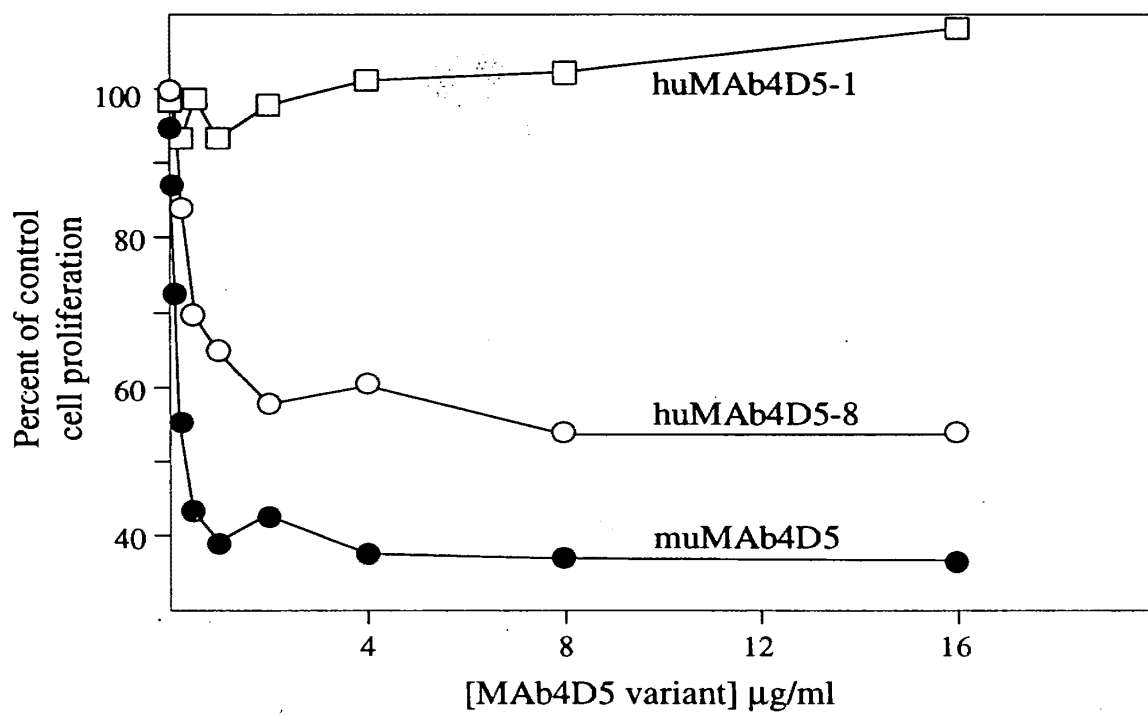

FIG. 3

4/1

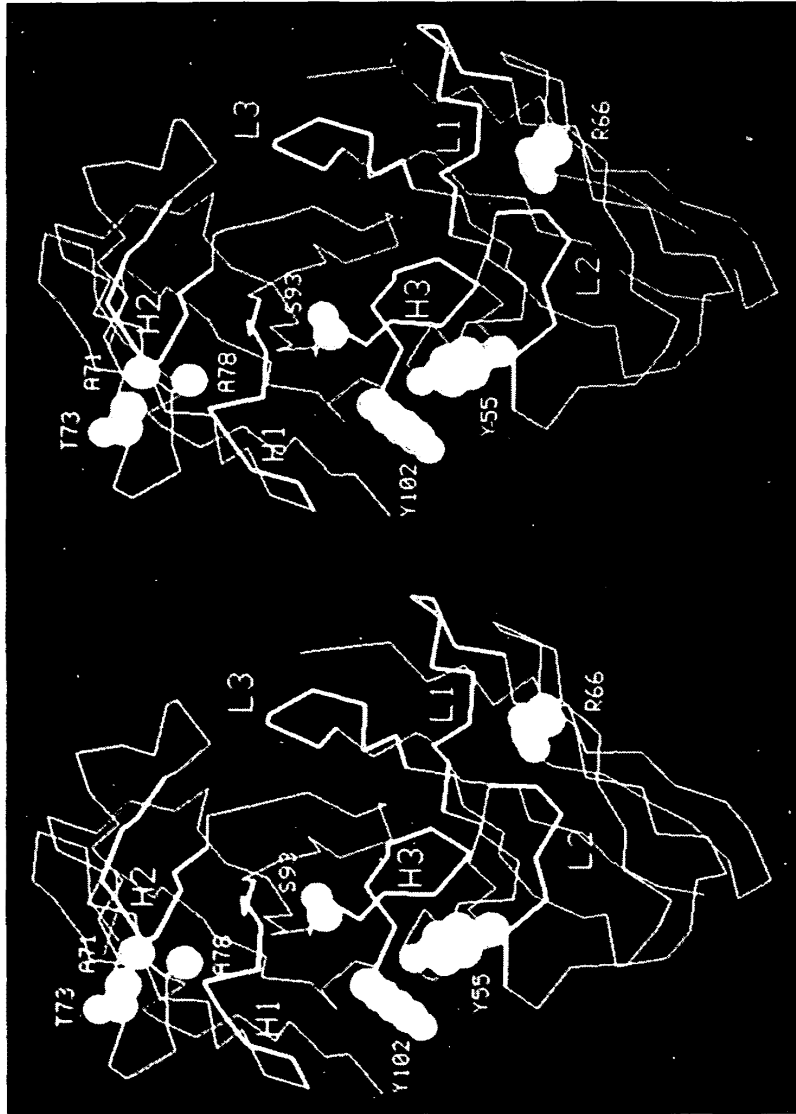

FIG. 4

FIG. 6A-1

H52H4-160	10	20	30	
	QVQLQQSGPELVKPGASVKISCKTSGYTFTE			
pH52-8.0	10	20	30	40
	MGWSCIIILFLVATATGVHSEVQLVESGGGLVQPGGSLRLSCATSGYTFTE			
H52H4-160	40	50	60	70
	YTMHWMKQSHGKSLEWIGGFNPKNGGSSHNQRFMDKATLAVDKSTSTAYM			
pH52-8.0	60	70	80	90
	YTMHWMRQAPGKGLEWVAGINPKNGGTSHNQRFMDRFTISVDKSTSTAYM			
H52H4-160	90	100	110	120
	ELRSLTSEDSGIYYCARWRGLNYGFDVRYFDVWGAGTTVTVSSASTKGPS			
pH52-8.0	110	120	130	140
	QMNSLRAEDTAVYYCARWRGLNYGFDVRYFDVWGQGLVTVSSASTKGPS			
H52H4-160	140	150	160	170
	VFPLAPSSKSTSGGTAALGCLVKDYFPEPVTVSWNSGALTSGVHTFPAVL			
pH52-8.0	160	170	180	190
	VFPLAPCSRSTSESTAALGCLVKDYFPEPVTVSWNSGALTSGVHTFPAVL			
H52H4-160	190	200	210	230
	QSSGLYSLSSVVTVPSSSLGTQTYICNVNHKPSNTKVDKKEPKSCDKTH			
pH52-8.0	210	220	230	240
	QSSGLYSLSSVVTVTSSNFGTQTYTCNVDHKPSNTKVDKTVKCC---V			
H52H4-160	240	250	260	270
	TCPPCPAPELLGGPSVFLFPPKPKDTLMISRTPEVTCVVVDVSHEDPEVK			
pH52-8.0	250	260	270	280
	ECPPCPAPP-VAGPSVFLFPPKPKDTLMISRTPEVTCVVVDVSHEDPEVQ			

7

FIG. 6A-2

290 300 310 320 330
H52H4-160 FNWYVDGVEVHNAKTKPREEQYNSTYRVVSVLTVLHQDWLNGKEYKCKVS
*****.*****.***.*****.*****
pH52-8.0 FNWYVDGMEVHNAKTKPREEQFNSTFRVVSVLTVVHQDWLNGKEYKCKVS
300 310 320 330 340

340 350 360 370 380
H52H4-160 NKALPAPIEKTISKAKGQPREPQVYTLPPSREEMTKNQVSLTCLVKGFYP
.*.***.*****
pH52-8.0 NKGLPAPIEKTISKTKGQPREPQVYTLPPSREEMTKNQVSLTCLVKGFYP
350 360 370 380 390

390 400 410 420 430
H52H4-160 SDIAVEWESNGQPENNYKTPPVLDSDGSFFLYSKLTVDKSRWQQGNVFS
*****.*****
pH52-8.0 SDIAVEWESNGQPENNYKTPPMLDSDGSFFLYSKLTVDKSRWQQGNVFS
400 410 420 430 440

440 450
H52H4-160 CSVMEALHNHYTQKSLSLSPGK

pH52-8.0 CSVMEALHNHYTQKSLSLSPGK
450 460

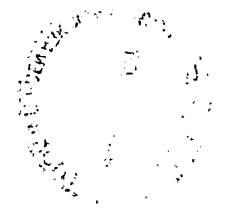

FIG. 6B

		10	20	30
H52L6-158		DVQMTQTTSSLSASLGDRVTINCRASQDINN		
		*.****.*****.*****.*****.*****		
pH52-9.0	MGWSCIIILFLVATATGVHSDIQMTQSPSSLSASVGDRTITCRASQDINN			
		10	20	30
		40	50	60
H52L6-158	YLNWYQQKPNGTVKLLIYYTSTLHSGVPSRFSGSGSGTDYSLTISNLDQE			
		*****.*****.*****.*****.*.*		
pH52-9.0	YLNWYQQKPGKAPKLLIYYTSTLHSGVPSRFSGSGSGTDYTLTISSLQPE			
		60	70	80
		90	100	110
H52L6-158	DIATYFCQQGNTLPPTFGGQTKVEIKRTVAAPSVFIFPPSDEQLKSGTAS			
		*.***.*****.*****.*****.*****.*****.*****		
pH52-9.0	DFATYYCQQGNTLPPTFGGQTKVEIKRTVAAPSVFIFPPSDEQLKSGTAS			
		110	120	130
		140	150	160
H52L6-158	VVCLLNNFYPPREAKVQWKVDNALQSGNSQESVTEQDSKDYSLSTLTL			
		*****.*****.*****.*****.*****.*****.*****.*****		
pH52-9.0	VVCLLNNFYPPREAKVQWKVDNALQSGNSQESVTEQDSKDYSLSTLTL			
		160	170	180
		190	200	210
H52L6-158	SKADYEKHKVYACEVTHQGLSSPVTKSFNRGEC			
		*****.*****.*****.*****.*****.*****.*****.*****		
pH52-9.0	SKADYEKHKVYACEVTHQGLSSPVTKSFNRGEC			
		210	220	230



03-19-02

Handwritten initials/signature

PART B - FEE(S) TRANSMITTAL

Complete this form together with applicable fee(s), to:

Box ISSUE FEE
Assistant Commissioner for Patents
Washington, D.C. 20231

MAILING INSTRUCTIONS: This form should be used for transmitting the ISSUE FEE and PUBLICATION FEE (if required). Blocks 1 through 4 should be completed where appropriate. All further correspondence including the Patent, advance orders and notification of maintenance fees will be mailed to the current correspondence address indicated unless corrected below or directed otherwise in Block 1, by (a) specifying a new correspondence address; and/or (b) indicating a separate "FEE ADDRESS" for maintenance fee notifications.

CURRENT CORRESPONDENCE ADDRESS (Please Legibly mark-up with any corrections or use Block 1)

7590 12/18/2001
GENENTECH, INC.
1 DNA WAY
SOUTH SAN FRANCISCO, CA 940804990

Note: The certificate of mailing below can only be used for domestic mailings of the Fee(s) Transmittal. This certificate cannot be used for any other accompanying papers. Each additional paper, such as an assignment or formal drawing, must have its own certificate of mailing.

Certificate of Mailing
I hereby certify that this Fee(s) Transmittal is being deposited with the United States Postal Service with sufficient postage for delivery to the envelope addressed to the Box issue fee address indicated below.
Wendy Maria Lee
3/18/02

Table with 5 columns: APPLICATION NO., FILING DATE, FIRST NAMED INVENTOR, ATTORNEY DOCKET NO., CONFIRMATION NO.
Values: 06/146,206; 11/17/1993; PAUL J. CARTER; 70921; 3992

TITLE OF INVENTION: METHOD FOR MAKING HUMANIZED ANTIBODIES

Table with 7 columns: TOTAL CLAIMS, APPLN. TYPE, SMALL ENTITY, ISSUE FEE, PUBLICATION FEE, TOTAL FEE(S) DUE, DATE DUE
Values: 82; nonprovisional; NO; \$1280; \$0; \$1280; 03/18/2002

Table with 3 columns: EXAMINER, ART UNIT, CLASS-SUBCLASS
Values: DAVIS, MINH TAM B; 1642; 550-387300

1. Change of correspondence address or indication of "Fee Address" (37 CFR 1.363). Use of PTO form(s) and Customer Number are recommended, but not required.

- Change of correspondence address (or Change of Correspondence Address form PTO/SB/122) attached.
"Fee Address" indication (or "Fee Address" Indication form PTO/SB/47) attached.

2. For printing on the patent front page, list (1) the names of up to 3 registered patent attorneys or agents OR, alternatively, (2) the name of a single firm (having as a member a registered attorney or agent) and the names of up to 2 registered patent attorneys or agents. If no name is listed, no name will be printed.

1 Wendy M. Lee
2
3

3. ASSIGNEE NAME AND RESIDENCE DATA TO BE PRINTED ON THE PATENT (print or type)

PLEASE NOTE: Unless an assignee is identified below, no assignee data will appear on the patent. Inclusion of assignee data is only appropriate when an assignment has been previously submitted to the USPTO or is being submitted under separate cover. Completion of this form is NOT a substitute for filing an assignment.

(A) NAME OF ASSIGNEE: Genentech, Inc.
(B) RESIDENCE: (CITY and STATE OR COUNTRY): South San Francisco, California

Please check the appropriate assignee category or categories (will not be printed on the patent): Individual Corporation or other private group entity government

4a. The following fee(s) are enclosed:

- Issue Fee
Publication Fee
Advance Order - # of Copies 4

4b. Payment of Fee(s):

- A check in the amount of the fee(s) is enclosed.
Payment by credit card. Form PTO-2038 is attached.

The Commissioner is hereby authorized by check the required fee(s), or credit any overpayment, to deposit Account Number 87-3837 (enclose an extra copy of this form).

The COMMISSIONER OF PATENTS AND TRADEMARKS is requested to apply the Issue Fee and Publication Fee (if any) to the application identified above.

(Authorized Signature) Wendy M. Lee - No. 40,378 3/18/02

NOTE: The Issue Fee and Publication Fee (if required) will not be accepted from anyone other than the applicant, a registered attorney or agent, or the assignee or other party in interest as shown by the records of the United States Patent and Trademark Office.

Burden Hour Statement: This form is estimated to take 0.2 hours to complete. Time will vary depending on the needs of the individual case. Any comments on the amount of time required to complete this form should be sent to the Chief Information Officer, United States Patent and Trademark Office, Washington, D.C. 20231. DO NOT SEND FEES OR COMPLETED FORMS TO THIS ADDRESS. SEND FEES AND THIS FORM TO: Box Issue Fee, Assistant Commissioner for Patents, Washington, D.C. 20231

Under the Paperwork Reduction Act of 1995, no persons are required to respond to a collection of information unless it displays a valid OMB control number.

03/28/2002 SEARCHED 00000176 070630 06146206
01 FC:140 1000.00 CH
02 FC:051 12.00 CH

TRANSMIT THIS FORM WITH FEE(S)

Page 2 of 3



Patent Docket P0709P1

C9C
70
DGO
R
9-25-02

IN THE UNITED STATES PATENT AND TRADEMARK OFFICE

<p>In re Application of Paul J. Carter et al. U.S. Patent No.: 6,407,213 B1 Issued: June 18, 2002 For: METHOD FOR MAKING HUMANIZED ANTIBODIES</p>	<p>CERTIFICATE OF MAILING I hereby certify that this correspondence is being deposited with the United States Postal Service as first class mail in an envelope addressed to: Assistant Commissioner of Patents, Washington, D.C. 20231 on August 12, 2002 <i>W.M. Lee</i> Wendy M. Lee</p>
---	--

REQUEST FOR CERTIFICATE OF CORRECTION UNDER 37 CFR 1.322

Assistant Commissioner of Patents
Washington, D.C. 20231

Certificate

AUG 27 2002

Sir:

of Correction

Enclosed is a Certificate of Correction for the above-referenced patent. Because the mistake occurred in the printing of the patent, it is not believed that any fee is required. However, if this is not the case, the Commissioner is hereby authorized to charge the required fee to Deposit Account No. 07-0630. Acceptance of this Certificate of Correction is respectfully requested.

Respectfully submitted,
GENENTECH, INC.

Date: August 12, 2002

By: *W.M. Lee*
Wendy M. Lee
Reg. No. 40,378
Telephone No. (650) 225-1994



09157

PATENT TRADEMARK OFFICE

AUG 27 2002

UNITED STATES PATENT AND TRADEMARK OFFICE
CERTIFICATE OF CORRECTION

PATENT NO. : U.S. 6,407,213 B1

DATED : June 18, 2002

INVENTOR(S) : Carter et al.

It is certified that error appears in the above-identified patent and that said Letters Patent is hereby corrected as shown below:

In column 88, claim ~~65~~, line 63, please delete "63" and insert therefor --79--.

MAILING ADDRESS OF SENDER:

PATENT NO. U.S. 6,407,213

Wendy M. Lee



09157

PATENT TRADEMARK OFFICE

NOTICE RE: CERTIFICATES OF CORRECTION

DATE : 9-25-02

Paper No.: 71

TO : Supervisor, Art Unit 1642

SUBJECT : Certificate of Correction Request in Patent No.: 6,407,213

A response to the following question is requested with respect to the accompanying request for a certificate of correction.

With respect to the change(s) requested, correcting Office and/or Applicant's errors, should the patent read as shown in the certificate of correction? No new matter should be introduced, nor should the scope or meaning of the claims be changed.

See red tags.

D. G. Olson

PLEASE COMPLETE THIS FORM AND RETURN WITH FILE, WITHIN 7 DAYS, TO CERTIFICATES OF CORRECTION BRANCH - PK 3-915/922 PALM LOCATION 7580 - TEL. NO. 305-8309

THANK YOU FOR YOUR ASSISTANCE!

Note your decision, regarding the changes requested in the Request for Certificate of Correction, placing a check mark (+) in the box that reflects your decision, which corresponds to the question checked above.

YES NO Comments below

Comments: Please enter the correction
Ex: Microw - TAM DAVIS

ANTHONY B. CORNER
SUPERVISORY PATENT EXAMINER
TECHNOLOGY CENTER

Supervisor

DL1642

Art Unit

UNITED STATES PATENT AND TRADEMARK OFFICE
CERTIFICATE OF CORRECTION

PATENT NO. : 6,407,213 B1
DATED : June 18, 2002
INVENTOR(S) : Carter et al.

Page 1 of 1

It is certified that error appears in the above-identified patent and that said Letters Patent is hereby corrected as shown below:

Column 88.

Line 63, please delete "63" and insert therefor -- 79 --.

Signed and Sealed this

Third Day of December, 2002

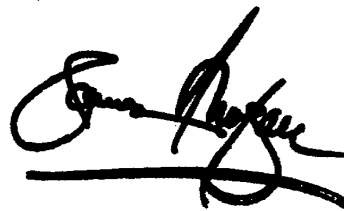

JAMES E. ROGAN
Director of the United States Patent and Trademark Office

DAC

#45



IN THE UNITED STATES PATENT AND TRADEMARK OFFICE

In re Patent of: Paul J. Carter *et al.* -- § 156

Patent No.: 6,407,213

Issued: June 18, 2002

Application No: 08/146,206

For: METHOD FOR MAKING HUMANIZED ANTIBODIES – Application for § 156 Patent Term Extension

Mail Stop Patent Ext.
Commissioner for Patents
P.O. Box 1450
Alexandria, VA 22313-1450

Docket No: 22338-80060

Assignee: Genentech, Inc.

Unit: OPLA

RECEIVED

SEP 12 2006

TECH CENTER 1600/2900

CERTIFICATE OF MAILING - 37 C.F.R. § 1.10
EXPRESS MAIL LABEL NO. ER 736919973 US

I hereby certify this correspondence is being deposited with the U.S. Postal Service with sufficient postage as "Express Mail – Post Office to Addressee" addressed to: Mail Stop Patent Ext., Commissioner for Patents, U.S. Patent and Trademark Office, P.O. Box 1450, Alexandria, VA 22313-1450, on the date shown below.

[Signature] David Devenoe Aug. 25, 2006
Signature Printed Name Date

APPLICATION FOR EXTENSION OF PATENT TERM UNDER 35 U.S.C. § 156

Dear Sir:

Applicant, Genentech, Inc., hereby submits this application for extension of the term of United States Letters Patent 6,407,213 under 35 U.S.C. § 156 by providing the following information in accordance with the requirements specified in 37 C.F.R. § 1.740.

Applicant represents that it is the assignee of the entire interest in and to United States Letters Patent No. 6,407,213, granted to Paul J. Carter and Leonard G. Presta (Carter *et al.*) by virtue of an assignment of such patent to Genentech, Inc., recorded June 28, 1994, at Reel 7035, Frame 0272.

1. Identification of the Approved Product [§ 1.740(a)(1)]

The name of the approved product is LUCENTIS™. The name of the active ingredient of LUCENTIS™ is ranibizumab. Ranibizumab is a recombinant humanized monoclonal IgG₁ antibody antigen-binding fragment (Fab) based on a humanized framework with complementarity-determining regions (CDRs) derived from a murine monoclonal antibody that binds to human Vascular Endothelial Growth Factor (VEGF).

**2. Federal Statute Governing Regulatory Approval of the Approved Product
[§ 1.740(a)(2)]**

The approved product was subject to regulatory review under, *inter alia*, the Public Health Service Act (42 U.S.C. § 201 *et seq.*) and the Federal Food, Drug and Cosmetic Act (21 U.S.C. § 355 *et seq.*).

3. Date of Approval for Commercial Marketing [§ 1.740(a)(3)]

LUCENTIS™ was approved for commercial marketing or use under § 351 of the Public Health Service Act on **June 30, 2006**.

4. Identification of Active Ingredient and Certifications Related to Commercial Marketing of Approved Product [§ 1.740(a)(4)]

- (a) The active ingredient of LUCENTIS™ is ranibizumab. Ranibizumab is a humanized monoclonal IgG₁ antibody antigen-binding fragment produced by an *E. coli* expression system. It contains human framework regions (FRs) and the complementarity-determining regions (CDRs) derived from a murine antibody that binds to VEGF.
- (b) Applicant certifies that ranibizumab had not been approved for commercial marketing or use under the Federal Food, Drug and Cosmetic Act, the Public Health Service Act or the Virus-Serum-Toxin Act prior to the approval granted on June 30, 2006 to the present Applicant.
- (c) Ranibizumab has been approved for the treatment of patients with neovascular (wet) age-related macular degeneration. *See* LUCENTIS™ product label, provided as Attachment A.
- (d) LUCENTIS™ was approved for commercial marketing pursuant to § 351 of the Public Health Service Act (42 U.S.C. § 262) under Genentech's existing Department of Health and Human Services (DHHS) U.S. License No. 1048. *See* LUCENTIS™ approval letter, provided as Attachment B.

**5. Statement Regarding Timeliness of Submission of Patent Term Extension Request
[§ 1.740(a)(5)]**

Applicant certifies that this application for patent term extension is being timely submitted within the sixty (60) day period permitted for submission specified in 35 U.S.C. § 156(d)(1) and 37 C.F.R. § 1.720(f). The last date on which this application may be submitted is August 28, 2006.

6. Complete Identification of the Patent for Which Extension Is Being Sought [§ 1.740(a)(6)]

The complete identification of the patent for which an extension is being sought is as follows:

- (a) Names of the inventors: Paul J. Carter and Leonard G. Presta.
- (b) Patent Number: 6,407,213 (“the ’213 patent”)
- (c) Date of Issue: June 18, 2002
- (d) Date of Expiration: June 18, 2019

7. Copy of the Patent for Which an Extension is Being Sought [§ 1.740(a)(7)]

A copy of U.S. Patent No. 6,407,213 is provided as Attachment C to the present application.

8. Copies of Disclaimers, Certificates of Correction, Receipt of Maintenance Fee Payment, or Reexamination Certificate [§ 1.740(a)(8)]

- (a) U.S. Patent No. 6,407,213 is not subject to a terminal disclaimer.
- (b) A Certificate of Correction was issued for U.S. Patent No. 6,407,213 on December 3, 2002. A copy of the Certificate of Correction is provided in Attachment D to the present application.
- (c) The first maintenance fee for U.S. Patent No. 6,407,213 has been paid and there are no maintenance fees currently due, as provided in Attachment E.
- (d) U.S. Patent No. 6,407,213 has not been the subject of a reexamination proceeding.

9. Statement Regarding Patent Claims Relative to Approved Product [§ 1.740(a)(9)]

The statements below are made solely to comply with the requirements of 37 C.F.R. § 1.740(a)(9). Applicant notes that, as the M.P.E.P. acknowledges, § 1.740(a)(9) does not require an applicant to show whether or how the listed claims would be infringed, and that this question cannot be answered without specific knowledge concerning acts performed by third parties. As such, these comments are not an assertion or an admission of Applicant as to the scope of the listed claims, or whether or how any of the listed claims would be infringed, literally or under the doctrine of equivalents, by the manufacture, use, sale, offer for sale or the importation of any product.

- (a) At least claims 1-2, 4-5, 25, 29, 62-64, 66-67, 69, 71-73, 75-78, and 80-81 of U.S. Patent No. 6,407,213 claim the active pharmaceutical ingredient in the approved product or a method that may be used to make or use that ingredient.
- (b) Pursuant to M.P.E.P. § 2753 and 37 C.F.R. § 1.740(a)(9), the following explanation is provided which shows how at least one of the above-listed claims of the '213 patent claim the approved product.

(1) *Description of the approved product*

The approved product is described in Section 11 of the approved label for LUCENTIS™ as follows, a copy of which is provided as Attachment A.

LUCENTIS™ (ranibizumab injection) is a recombinant humanized IgG1 kappa isotype monoclonal antibody fragment designed for intraocular use. Ranibizumab binds to and inhibits the biologic activity of human vascular endothelial growth factor A (VEGF-A). Ranibizumab has a molecular weight of approximately 48 kilodaltons and is produced by an *E. coli* expression system in a nutrient medium containing the antibiotic tetracycline. Tetracycline is not detectable in the final product.

LUCENTIS™ is a sterile, colorless to pale yellow solution in a single-use glass vial. LUCENTIS™ is supplied as a preservative-free, sterile solution in a single-use glass vial designed to deliver 0.05 mL of 10 mg/mL LUCENTIS™ aqueous solution with 10 mM histidine HCL, 10% α, α-trehalose dihydrate, 0.01% polysorbate 20, pH 5.5.

Ranibizumab is further characterized in a scientific reference, Chen *et al.* published in 1999 in the Journal of Molecular Biology (JMB) entitled "Selection and Analysis of an Optimized Anti-VEGF Antibody: Crystal Structure of an Affinity-matured Fab in Complex with Antigen."¹ The Chen *et al.* article discusses the lineage of the ranibizumab antibody fragment. In this respect, the article states that "[a] murine monoclonal antibody, A.4.6.1, was found to block VEGF-dependent cell proliferation *in vitro* and to antagonize tumor growth *in vivo*. [Citation omitted]. The murine mAb was previously humanized in Fab form to yield a variant known as Fab-12." [Citation omitted] See p. 866, left col., ¶1. The abstract explains that the authors affinity-matured Fab-12 and obtained Fab fragment Y0317, now known as ranibizumab. According to the article, ranibizumab was derived from the humanization and affinity-maturation of a non-human, murine monoclonal antibody that binds to VEGF. The Chen *et al.* article also describes the humanized structure of ranibizumab. See, e.g., Figure 1.

¹ 293:865-881 (1999) (Attachment F)

WO 98/45331 (Figures 1A, 1B, 10A, 10B, provided as Attachment G) also provides sequence data for the heavy and light chain variable domains of Y0317, together with the heavy and light chain variable domains of murine A.4.6.1, the heavy and light chain variable domains of humanized variant Fab-12, and the Kabat human consensus framework, humIII. WO 98/45331 confirms that, in addition to non-human CDRs derived from the sequence of the murine antibody, ranibizumab comprises framework substitutions in the variable domains at positions 4 and 46 in the light chain (V_L) and positions 49, 69, 71, 73, 76, 78, and 94 in the heavy chain (V_H).²

(2) *Explanation Regarding Claim 29 of the '213 Patent Relative to Ranibizumab*

As explained below, the active pharmaceutical ingredient of the approved product, ranibizumab, is a humanized Fab fragment that is covered by at least claim 29.

Claim 29 of the '213 patent reads as follows:

29. An antibody comprising the humanized variable domain of claim 1.

Claim 29 depends from claim 1, which reads as follows:

1. A humanized antibody variable domain comprising non-human Complementarity Determining Region (CDR) amino acid residues which bind an antigen incorporated into a human antibody variable domain, and further comprising a Framework Region (FR) amino acid substitution at a site selected from the group consisting of: 4L, 38L, 43L, 44L, 58L, 62L, 65L, 66L, 67L, 68L, 69L, 73L, 85L, 98L, 2H, 4H, 36H, 39H, 43H, 45H, 69H, 70H, 74H, and 92H, utilizing the numbering system set forth in Kabat.

The term "antibody," as defined in the '213 patent specification includes, in addition to full-length antibodies, antibody fragments such as Fab, Fab', F(ab)₂ and Fv so long as those fragments retain the desired biological activity, *i.e.*, binding to VEGF (*See, e.g.*, '213 at col. 8, lines 11-17; col. 24, lines 13-18). As recited in the '213 specification – "FAB fragments with specificity for the antigen are specifically encompassed within the term 'antibody' as it is defined, discussed, and claimed herein." '213 at col. 24, lines 13-18. Ranibizumab, being

² Compare sequence data for the heavy and light chain variable domains of Y0317 (Figs. 10A-10B), A.4.6.1 (Figs. 1A-1B) and humIII (Figs. 1A-1B) as set forth in WO 98/45331, provided as Attachment G.

a Fab fragment that binds VEGF, falls within the scope of the term “antibody” as used in Claims 1 and 29.

The amino acid sequences of the V_L and V_H domains of ranibizumab include human framework substitutions at positions 4L, 46L, 49H, 69H, 71H, 73H, 76H, 78H and 94H.³ Of these, substitutions at positions 4L and 69H are among those recited in the Markush group of claim 1. Figures 1A-1B of WO 98/45331, provided as Attachment G, show the heavy and light chain variable domains of sequences of the same import antibody (“A4.6.1”) used to design ranibizumab on the lines above the variable domains of the Fab-12 sequence and the Kabat consensus sequences (“humIII”).⁴ The A4.6.1 antibody is a murine monoclonal antibody; its sequence is therefore “non-human.” *See, e.g.,* Chen *et al.* Figures 10A-10B of WO 98/45331, provided as Attachment G (and Figure 1 of Chen *et al.*), show the variable domains of the Y0317 sequence. When the heavy and light chain variable domains of A4.6.1, Y0317 and humIII are aligned, the framework substitutions noted above are apparent utilizing the Kabat numbering system.

In each of the V_L and V_H domains of ranibizumab, “substantially less than an intact human variable domain has been substituted by the corresponding sequence from a non-human species” (*i.e.*, the murine antibody A4.6.1). *See, e.g.,* ’213 at col. 2, lines 27-31. Ranibizumab is therefore “humanized” within the meaning of claims 1 and 29 of the ’213 patent.

As also required in claim 1, ranibizumab includes non-human amino acid residues in its CDRs. The CDRs in ranibizumab are also functional to “bind an antigen” – here, the VEGF protein. *See* LUCENTIS™ label, provided as Attachment A.

Ranibizumab thus meets the limitations of dependent claim 29.

³ *See* WO 98/45331 at Figures 1A-1B (humIII) and 10A-10B (Y0317).

⁴ The residues in a human Ig sequence that are substituted with residues from an “import antibody” are identified according to standard numbering conventions published by Kabat. *See* ’213 at col. 10, line 45 through col. 11, line 26. The Kabat sequences represent consensus amino acid sequences for various human antibodies in each subclass. *See id.*

10. Relevant Dates Under 35 U.S.C. § 156 for Determination of Applicable Regulatory Review Period [§ 1.740(a)(10)]

(a) *Patent Issue Date*

U.S. Patent No. 6,407,213 was issued on June 18, 2002.

(b) *IND Effective Date [35 U.S.C. § 156(g)(1)(B)(i); 37 C.F.R. § 1.740(a)(10)(i)(A)]*

The date that an exemption under § 505(i) of the Federal Food, Drug and Cosmetic Act became effective (*i.e.*, the date that an investigational new drug application (“IND”) became effective) for LUCENTIS™ (referred to as “Humanized Monoclonal Antibody Fragment (rhuFab V2)(E. coli, Genentech) to Vascular Endothelial Growth Factor (VEGF), Intravitreal) was October 7, 1999. The IND was assigned number BB-IND # 8633. A copy of the letter from the FDA reflecting the effective date of the IND is provided in Attachment H. The application date for this IND was October 6, 1999.

(c) *BLA Submission Date [35 U.S.C. § 156(g)(1)(B)(i); 37 C.F.R. § 1.740(a)(10)(i)(B)]*

The BLA was submitted by Genentech to the FDA on December 29, 2005. The BLA was assigned number BL# 125156/0. A copy of the letter from the FDA acknowledging receipt of the BLA and reflecting the BLA submission date is provided in Attachment I.

(d) *BLA Issue Date [35 U.S.C. § 156(g)(1)(B)(ii); 37 C.F.R. § 1.740(a)(10)(i)(C)]*

The FDA approved biologic license application 125156/0 authorizing the marketing of LUCENTIS™ on June 30, 2006. LUCENTIS™ was approved under Department of Health and Human Services (DHHS) U.S. License No. 1048. A copy of the approval letter from the FDA is provided as Attachment B.

11. Summary of Significant Events During Regulatory Review Period [§ 1.740(a)(11)]

Pursuant to 37 C.F.R. § 1.740(a)(11), the following provides a brief description of the activities of Genentech, Inc. before the FDA in relation to the regulatory review of LUCENTIS™. The brief description lists the significant events that occurred during the regulatory review period for the approved product. In several instances, communications to or from the FDA are referenced. Pursuant to 37 C.F.R. § 1.740(a)(11), 21 C.F.R. § 60.20(a), and M.P.E.P. § 2753, copies of all such communications are not provided in this application, but can be obtained from records maintained by the FDA.

- On October 6, 1999, Genentech submitted to FDA (See Attachment H) an investigational new drug application for a recombinant humanized monoclonal antibody fragment (rhuFab V2, now known as Ranibizumab) against Vascular Endothelial Growth Factor (VEGF). The antibody was developed as a potential new therapeutic in treating patients with the exudative (wet or neovascular) form of age-related macular degeneration (AMD).
- On October 7, 1999 FDA made BB-IND #8633 effective via a communication mailed to Genentech on October 13, 1999 (*See* Attachment H). According to the FDA, initiation of trials could begin 30 days after October 7, 1999.
- The first human clinical trial (Phase I) was initiated on February 8, 2000 followed by Phase II human trials and Phase III human trials, some of which remain ongoing at the time of this application.
- On February 5, 2002, representatives of Genentech and the FDA (CBER and CDER) participated in a Type C meeting to discuss the proposed clinical development plan for ranibizumab in AMD.
- On October 31, 2002 representatives of Genentech and FDA (CBER and CDER) participated in an Type B End-of-Phase II meeting.
- Beginning in approximately March 2003, and continuing at the time of this application, Phase III studies have been conducted. The three Phase III trials forming the basis of the Biologics License Application (BLA), FVF2598g, FVF2587g, and FVF3192g are studies of two year duration with primary endpoints of one year. FVF2587g and FVF3192g, along with extension study FVF3426g and safety study FVF3689g, remain ongoing at the time of this application.
- On September 21, 2005 representatives of Genentech and CDER participated in a Type B Pre-BLA submission meeting to discuss information requirements for the BLA.

- Genentech submitted a BLA for ranibizumab for the treatment of patients with wet AMD on December 29, 2005 (*See Attachment I*).
- FDA acknowledged receipt of the BLA for ranibizumab via a communication mailed to Genentech dated January 27, 2006. The letter indicated that FDA had assigned the Submission Tracking Number (STN) of BL #125156/0 to the BLA (*See Attachment I*).
- By way of a communication mailed to Genentech on March 14, 2006 FDA made Genentech aware that the BLA for ranibizumab was filed on February 28, 2006 and that FDA had assigned a user fee goal date of June 30, 2006 (*See Attachment J*).
- On June 30, 2006 FDA approved BLA 125156/0, issuing marketing authorization for LUCENTIS™ (*See Attachment B*).

12. Statement Concerning Eligibility for and Duration of Extension Sought Under 35 U.S.C. § 156 [37 C.F.R. § 1.740(a)(12)]

- (a) In the opinion of the Applicant, U.S. Patent No. 6,407,213 is eligible for an extension under § 156 because:
- (i) one or more claims of the '213 patent claim the approved product or a method of making or using the approved product;
 - (ii) the term of the '213 patent has not been previously extended on the basis of § 156;
 - (iii) the '213 patent has not expired;
 - (iv) no other patent has been extended pursuant to § 156 on the basis of the regulatory review process associated with the approved product, LUCENTIS™;
 - (v) there is an eligible period of regulatory review by which the patent may be extended pursuant to § 156;
 - (vi) the applicant for marketing approval exercised due diligence within the meaning of § 156(d)(3) during the period of regulatory review;
 - (vii) the present application has been submitted within the 60-day period following the approval date of the approved product, pursuant to § 156(c); and
 - (viii) this application otherwise complies with all requirements of 35 U.S.C. § 156 and applicable rules and procedures.
- (b) The period by which the term of the '213 patent is requested by Applicant to be extended is **378 days**.
- (c) The requested period of extension of term for the '213 patent corresponds to the regulatory review period that is eligible for extension pursuant to § 156, based on the facts and circumstances of the regulatory review associated with the approved product LUCENTIS™ and the issuance of the '213 patent. The period was determined as follows.
- (i) The relevant dates for calculating the regulatory review period, based on the events discussed in the section above, are the following.