

AO 120 (Rev. 08/10)

TO: Mail Stop 8 Director of the U.S. Patent and Trademark Office P.O. Box 1450 Alexandria, VA 22313-1450	REPORT ON THE FILING OR DETERMINATION OF AN ACTION REGARDING A PATENT OR TRADEMARK
---	--

In Compliance with 35 U.S.C. § 290 and/or 15 U.S.C. § 1116 you are hereby advised that a court action has been filed in the U.S. District Court Eastern District of Texas on the following

Trademarks or Patents. (the patent action involves 35 U.S.C. § 292.);

DOCKET NO. 2:17-cv-0214-JRG	DATE FILED 3/20/2017	U.S. DISTRICT COURT Eastern District of Texas
PLAINTIFF Uniloc USA, Inc. and Uniloc Luxembourg S.A.		DEPENDANT Google, Inc.
PATENT OR TRADEMARK NO.	DATE OF PATENT OR TRADEMARK	HOLDER OF PATENT OR TRADEMARK
1 8,724,622	5/13/2014	Uniloc Luxembourg S.A.
2 8,995,433	5/31/2015	Uniloc Luxembourg S.A.
3 7,535,890	5/19/2009	Uniloc Luxembourg S.A.
4 8,199,747	6/12/2012	Uniloc Luxembourg S.A.
5		

In the above—entitled case, the following patent(s)/ trademark(s) have been included:

DATE INCLUDED	INCLUDED BY <input type="checkbox"/> Amendment <input type="checkbox"/> Answer <input type="checkbox"/> Cross Bill <input type="checkbox"/> Other Pleading	
PATENT OR TRADEMARK NO.	DATE OF PATENT OR TRADEMARK	HOLDER OF PATENT OR TRADEMARK
1		
2		
3		
4		
5		

In the above—entitled case, the following decision has been rendered or judgement issued:

DECISION/JUDGEMENT

CLERK	(BY) DEPUTY CLERK	DATE

Copy 1—Upon initiation of action, mail this copy to Director Copy 3—Upon termination of action, mail this copy to Director
 Copy 2—Upon filing document adding patent(s), mail this copy to Director Copy 4—Case file copy

AO 120 (Rev. 08/10)

TO: Mail Stop 8 Director of the U.S. Patent and Trademark Office P.O. Box 1450 Alexandria, VA 22313-1450	REPORT ON THE FILING OR DETERMINATION OF AN ACTION REGARDING A PATENT OR TRADEMARK
---	--

In Compliance with 35 U.S.C. § 290 and/or 15 U.S.C. § 1116 you are hereby advised that a court action has been filed in the U.S. District Court Eastern District of Texas on the following

Trademarks or Patents. (the patent action involves 35 U.S.C. § 292.);

DOCKET NO. 2:17-cv-0224-JRG	DATE FILED 3/22/2017	U.S. DISTRICT COURT Eastern District of Texas
PLAINTIFF Uniloc USA, Inc. and Uniloc Luxembourg S.A.		DEPENDANT Google, Inc.
PATENT OR TRADEMARK NO.	DATE OF PATENT OR TRADEMARK	HOLDER OF PATENT OR TRADEMARK
1 8,724,622	5/13/2014	Uniloc Luxembourg S.A.
2 8,995,433	5/31/2015	Uniloc Luxembourg S.A.
3 7,535,890	5/19/2009	Uniloc Luxembourg S.A.
4		
5		

In the above—entitled case, the following patent(s)/ trademark(s) have been included:

DATE INCLUDED	INCLUDED BY <input type="checkbox"/> Amendment <input type="checkbox"/> Answer <input type="checkbox"/> Cross Bill <input type="checkbox"/> Other Pleading
PATENT OR TRADEMARK NO.	DATE OF PATENT OR TRADEMARK
1	
2	
3	
4	
5	

In the above—entitled case, the following decision has been rendered or judgement issued:

DECISION/JUDGEMENT

CLERK	(BY) DEPUTY CLERK	DATE
-------	-------------------	------

Copy 1—Upon initiation of action, mail this copy to Director Copy 3—Upon termination of action, mail this copy to Director
 Copy 2—Upon filing document adding patent(s), mail this copy to Director Copy 4—Case file copy

AO 120 (Rev. 08/10)

TO: Mail Stop 8 Director of the U.S. Patent and Trademark Office P.O. Box 1450 Alexandria, VA 22313-1450	REPORT ON THE FILING OR DETERMINATION OF AN ACTION REGARDING A PATENT OR TRADEMARK
---	---

In Compliance with 35 U.S.C. § 290 and/or 15 U.S.C. § 1116 you are hereby advised that a court action has been filed in the U.S. District Court Eastern District of Texas, Marshall Division on the following

Trademarks or Patents. (the patent action involves 35 U.S.C. § 292.);

DOCKET NO. 2:16-cv-640	DATE FILED 6/14/2016	U.S. DISTRICT COURT Eastern District of Texas, Marshall Division
PLAINTIFF UNILOC USA, INC., and UNILOC LUXEMBOURG, S.A.		DEFENDANT KAKAO CORPORATION
PATENT OR TRADEMARK NO.	DATE OF PATENT OR TRADEMARK	HOLDER OF PATENT OR TRADEMARK
1 7,535,890	5/19/2009	UNILOC LUXEMBOURG, S.A.
2 8,199,747	6/12/2012	UNILOC LUXEMBOURG, S.A.
3 8,724,622	5/13/2014	UNILOC LUXEMBOURG, S.A.
4 8,995,433	3/31/2015	UNILOC LUXEMBOURG, S.A.
5 8,243,723	8/14/2012	UNILOC LUXEMBOURG, S.A.

In the above—entitled case, the following patent(s)/ trademark(s) have been included:

DATE INCLUDED	INCLUDED BY <input type="checkbox"/> Amendment <input type="checkbox"/> Answer <input type="checkbox"/> Cross Bill <input type="checkbox"/> Other Pleading
PATENT OR TRADEMARK NO.	DATE OF PATENT OR TRADEMARK
1	
2	
3	
4	
5	

In the above—entitled case, the following decision has been rendered or judgement issued:

DECISION/JUDGEMENT Kakao Corp. ("Kakao") should be DISMISSED WITH PREJUDICE

CLERK 	(BY) DEPUTY CLERK ch	DATE 3/17/17
--	-------------------------	-----------------

Copy 1—Upon initiation of action, mail this copy to Director Copy 3—Upon termination of action, mail this copy to Director
 Copy 2—Upon filing document adding patent(s), mail this copy to Director Copy 4—Case file copy

AO 120 (Rev. 08/10)

TO: Mail Stop 8 Director of the U.S. Patent and Trademark Office P.O. Box 1450 Alexandria, VA 22313-1450	REPORT ON THE FILING OR DETERMINATION OF AN ACTION REGARDING A PATENT OR TRADEMARK
---	---

In Compliance with 35 U.S.C. § 290 and/or 15 U.S.C. § 1116 you are hereby advised that a court action has been filed in the U.S. District Court Eastern District of Texas, Marshall Division on the following

Trademarks or Patents. (the patent action involves 35 U.S.C. § 292.);

DOCKET NO. 2:16-cv-643	DATE FILED 6/14/2016	U.S. DISTRICT COURT Eastern District of Texas, Marshall Division
PLAINTIFF UNILOC USA, INC., and UNILOC LUXEMBOURG, S.A.		DEFENDANT VIBER MEDIA S.A.R.L.,
PATENT OR TRADEMARK NO.	DATE OF PATENT OR TRADEMARK	HOLDER OF PATENT OR TRADEMARK
1 8,724,622	5/13/2014	UNILOC LUXEMBOURG, S.A.
2 8,995,433	3/31/2015	UNILOC LUXEMBOURG, S.A.
3 7,535,890	5/19/2009	UNILOC LUXEMBOURG, S.A.
4 8,199,747	6/12/2012	UNILOC LUXEMBOURG, S.A.
5 8,243,723	8/14/2012	UNILOC LUXEMBOURG, S.A.

In the above—entitled case, the following patent(s)/ trademark(s) have been included:

DATE INCLUDED	INCLUDED BY <input type="checkbox"/> Amendment <input type="checkbox"/> Answer <input type="checkbox"/> Cross Bill <input type="checkbox"/> Other Pleading
PATENT OR TRADEMARK NO.	DATE OF PATENT OR TRADEMARK
1	
2	
3	
4	
5	

In the above—entitled case, the following decision has been rendered or judgement issued:

DECISION/JUDGEMENT Having considered the Stipulation, the Court finds that the case should be DISMISSED under Federal Rule of Civil Procedure 41.
--

CLERK 	(BY) DEPUTY CLERK M. Martin	DATE 1/19/17
-----------	--------------------------------	-----------------

Copy 1—Upon initiation of action, mail this copy to Director Copy 3—Upon termination of action, mail this copy to Director
 Copy 2—Upon filing document adding patent(s), mail this copy to Director Copy 4—Case file copy

AO 120 (Rev. 08/10)

TO: Mail Stop 8 Director of the U.S. Patent and Trademark Office P.O. Box 1450 Alexandria, VA 22313-1450	REPORT ON THE FILING OR DETERMINATION OF AN ACTION REGARDING A PATENT OR TRADEMARK
---	---

In Compliance with 35 U.S.C. § 290 and/or 15 U.S.C. § 1116 you are hereby advised that a court action has been filed in the U.S. District Court Eastern District of Texas, Marshall Division on the following

Trademarks or Patents. (the patent action involves 35 U.S.C. § 292.);

DOCKET NO. 2:16-cv-733	DATE FILED 7/5/2016	U.S. DISTRICT COURT Eastern District of Texas, Marshall Division
PLAINTIFF UNILOC USA, INC., and UNILOC LUXEMBOURG, S.A.		DEFENDANT TANGOME, INC. d/b/a TANGO
PATENT OR TRADEMARK NO.	DATE OF PATENT OR TRADEMARK	HOLDER OF PATENT OR TRADEMARK
1 7,535,890	5/19/2009	UNILOC LUXEMBOURG, S.A.
2 8,199,747	6/12/2012	UNILOC LUXEMBOURG, S.A.
3 8,243,723	8/14/2012	UNILOC LUXEMBOURG, S.A.
4 8,724,622	5/13/2014	UNILOC LUXEMBOURG, S.A.
5 8,995,433	3/31/2015	UNILOC LUXEMBOURG, S.A.

In the above—entitled case, the following patent(s)/ trademark(s) have been included:

DATE INCLUDED	INCLUDED BY <input type="checkbox"/> Amendment <input type="checkbox"/> Answer <input type="checkbox"/> Cross Bill <input type="checkbox"/> Other Pleading		
PATENT OR TRADEMARK NO.	DATE OF PATENT OR TRADEMARK	HOLDER OF PATENT OR TRADEMARK	
1			
2			
3			
4			
5			

In the above—entitled case, the following decision has been rendered or judgement issued:

DECISION/JUDGEMENT ORDER OF DISMISSAL WITH PREJUDICE OF ALL CLAIMS BY UNILOC AGAINST TANGOME, INC. d/b/a TANGO
--

CLERK <i>David A. O'Loole</i>	(BY) DEPUTY CLERK Nakisha Love	DATE 1/11/17
----------------------------------	-----------------------------------	-----------------

Copy 1—Upon initiation of action, mail this copy to Director Copy 3—Upon termination of action, mail this copy to Director
 Copy 2—Upon filing document adding patent(s), mail this copy to Director Copy 4—Case file copy

AO 120 (Rev. 08/10)

TO: Mail Stop 8 Director of the U.S. Patent and Trademark Office P.O. Box 1450 Alexandria, VA 22313-1450	REPORT ON THE FILING OR DETERMINATION OF AN ACTION REGARDING A PATENT OR TRADEMARK
---	---

In Compliance with 35 U.S.C. § 290 and/or 15 U.S.C. § 1116 you are hereby advised that a court action has been filed in the U.S. District Court Eastern District of Texas, Marshall Division on the following
 Trademarks or Patents. (the patent action involves 35 U.S.C. § 292.);

DOCKET NO. 2:16-cv-994	DATE FILED 9/6/2016	U.S. DISTRICT COURT Eastern District of Texas, Marshall Division
PLAINTIFF UNILOC USA, INC., and UNILOC LUXEMBOURG, S.A.		DEFENDANT HUAWEI DEVICE USA, INC. and HUAWEI TECHNOLOGIES USA, INC.,
PATENT OR TRADEMARK NO.	DATE OF PATENT OR TRADEMARK	HOLDER OF PATENT OR TRADEMARK
1 7,535,890	5/19/2009	UNILOC LUXEMBOURG, S.A.
2 8,995,433	3/31/2015	UNILOC LUXEMBOURG, S.A.
3 8,724,622	5/13/2014	UNILOC LUXEMBOURG, S.A.
4 8,199,747	6/12/2012	UNILOC LUXEMBOURG, S.A.
5		

In the above—entitled case, the following patent(s)/ trademark(s) have been included:

DATE INCLUDED	INCLUDED BY <input type="checkbox"/> Amendment <input type="checkbox"/> Answer <input type="checkbox"/> Cross Bill <input type="checkbox"/> Other Pleading	
PATENT OR TRADEMARK NO.	DATE OF PATENT OR TRADEMARK	HOLDER OF PATENT OR TRADEMARK
1		
2		
3		
4		
5		

In the above—entitled case, the following decision has been rendered or judgement issued:

DECISION/JUDGEMENT

CLERK	(BY) DEPUTY CLERK	DATE
-------	-------------------	------

Copy 1—Upon initiation of action, mail this copy to Director Copy 3—Upon termination of action, mail this copy to Director
 Copy 2—Upon filing document adding patent(s), mail this copy to Director Copy 4—Case file copy

AO 120 (Rev. 08/10)

TO: Mail Stop 8 Director of the U.S. Patent and Trademark Office P.O. Box 1450 Alexandria, VA 22313-1450	REPORT ON THE FILING OR DETERMINATION OF AN ACTION REGARDING A PATENT OR TRADEMARK
---	---

In Compliance with 35 U.S.C. § 290 and/or 15 U.S.C. § 1116 you are hereby advised that a court action has been filed in the U.S. District Court Eastern District of Texas, Marshall Division on the following
 Trademarks or Patents. (the patent action involves 35 U.S.C. § 292.):

DOCKET NO. 2:16-cv-993	DATE FILED 9/6/2016	U.S. DISTRICT COURT Eastern District of Texas, Marshall Division
PLAINTIFF UNILOC USA, INC., and UNILOC LUXEMBOURG, S.A.		DEFENDANT ZTE (USA), INC. and ZTE (TX), INC.,
PATENT OR TRADEMARK NO.	DATE OF PATENT OR TRADEMARK	HOLDER OF PATENT OR TRADEMARK
1 7,535,890	5/19/2009	UNILOC LUXEMBOURG, S.A.
2 8,199,747	6/12/2012	UNILOC LUXEMBOURG, S.A.
3 8,724,622	5/13/2014	UNILOC LUXEMBOURG, S.A.
4 8,995,433	3/31/2015	UNILOC LUXEMBOURG, S.A.
5		

In the above—entitled case, the following patent(s)/ trademark(s) have been included:

DATE INCLUDED	INCLUDED BY <input type="checkbox"/> Amendment <input type="checkbox"/> Answer <input type="checkbox"/> Cross Bill <input type="checkbox"/> Other Pleading		
PATENT OR TRADEMARK NO.	DATE OF PATENT OR TRADEMARK	HOLDER OF PATENT OR TRADEMARK	
1			
2			
3			
4			
5			

In the above—entitled case, the following decision has been rendered or judgement issued:

DECISION/JUDGEMENT

CLERK	(BY) DEPUTY CLERK	DATE
-------	-------------------	------

Copy 1—Upon initiation of action, mail this copy to Director Copy 3—Upon termination of action, mail this copy to Director
 Copy 2—Upon filing document adding patent(s), mail this copy to Director Copy 4—Case file copy

AO 120 (Rev. 08/10)

TO: Mail Stop 8 Director of the U.S. Patent and Trademark Office P.O. Box 1450 Alexandria, VA 22313-1450	REPORT ON THE FILING OR DETERMINATION OF AN ACTION REGARDING A PATENT OR TRADEMARK
---	---

In Compliance with 35 U.S.C. § 290 and/or 15 U.S.C. § 1116 you are hereby advised that a court action has been filed in the U.S. District Court Eastern District of Texas, Marshall Division on the following

Trademarks or Patents. (the patent action involves 35 U.S.C. § 292.):

DOCKET NO. 2:16-cv-992	DATE FILED 9/6/2016	U.S. DISTRICT COURT Eastern District of Texas, Marshall Division
PLAINTIFF UNILOC USA, INC., and UNILOC LUXEMBOURG, S.A.		DEFENDANT MOTOROLA MOBILITY LLC
PATENT OR TRADEMARK NO.	DATE OF PATENT OR TRADEMARK	HOLDER OF PATENT OR TRADEMARK
1 7,535,890	5/19/2009	UNILOC LUXEMBOURG, S.A.
2 8,199,747	6/12/2012	UNILOC LUXEMBOURG, S.A.
3 8,724,622	5/13/2014	UNILOC LUXEMBOURG, S.A.
4 8,995,433	3/31/2015	UNILOC LUXEMBOURG, S.A.
5		

In the above—entitled case, the following patent(s)/ trademark(s) have been included:

DATE INCLUDED	INCLUDED BY <input type="checkbox"/> Amendment <input type="checkbox"/> Answer <input type="checkbox"/> Cross Bill <input type="checkbox"/> Other Pleading		
PATENT OR TRADEMARK NO.	DATE OF PATENT OR TRADEMARK	HOLDER OF PATENT OR TRADEMARK	
1			
2			
3			
4			
5			

In the above—entitled case, the following decision has been rendered or judgement issued:

DECISION/JUDGEMENT

CLERK	(BY) DEPUTY CLERK	DATE
-------	-------------------	------

Copy 1—Upon initiation of action, mail this copy to Director Copy 3—Upon termination of action, mail this copy to Director
 Copy 2—Upon filing document adding patent(s), mail this copy to Director Copy 4—Case file copy

AO 120 (Rev. 08/10)

TO: Mail Stop 8 Director of the U.S. Patent and Trademark Office P.O. Box 1450 Alexandria, VA 22313-1450	REPORT ON THE FILING OR DETERMINATION OF AN ACTION REGARDING A PATENT OR TRADEMARK
---	---

In Compliance with 35 U.S.C. § 290 and/or 15 U.S.C. § 1116 you are hereby advised that a court action has been filed in the U.S. District Court Eastern District of Texas, Marshall Division on the following

Trademarks or Patents. (the patent action involves 35 U.S.C. § 292.);

DOCKET NO. 2:16-cv-893	DATE FILED 8/11/2016	U.S. DISTRICT COURT Eastern District of Texas, Marshall Division
PLAINTIFF UNILOC USA, INC., and UNILOC LUXEMBOURG, S.A.		DEFENDANT VONAGE HOLDINGS CORP. & VONAGE AMERICAS, INC.
PATENT OR TRADEMARK NO.	DATE OF PATENT OR TRADEMARK	HOLDER OF PATENT OR TRADEMARK
1 8,724,622	5/31/2014	UNILOC LUXEMBOURG, S.A.
2 8,995,433	3/31/2015	UNILOC LUXEMBOURG, S.A.
3 8,243,723	8/14/2012	UNILOC LUXEMBOURG, S.A.
4 7,535,890	5/19/2009	UNILOC LUXEMBOURG, S.A.
5		

In the above—entitled case, the following patent(s)/ trademark(s) have been included:

DATE INCLUDED	INCLUDED BY <input type="checkbox"/> Amendment <input type="checkbox"/> Answer <input type="checkbox"/> Cross Bill <input type="checkbox"/> Other Pleading
PATENT OR TRADEMARK NO.	DATE OF PATENT OR TRADEMARK
1	
2	
3	
4	
5	

In the above—entitled case, the following decision has been rendered or judgement issued:

DECISION/JUDGEMENT Defendants Vonage Holdings Corp. and Vonage Americas, Inc. are dismissed with prejudice
--

CLERK <i>David A. O'Toole</i>	(BY) DEPUTY CLERK ch	DATE 11/17/16
----------------------------------	-------------------------	------------------

Copy 1—Upon initiation of action, mail this copy to Director Copy 3—Upon termination of action, mail this copy to Director
 Copy 2—Upon filing document adding patent(s), mail this copy to Director Copy 4—Case file copy



UNITED STATES PATENT AND TRADEMARK OFFICE

UNITED STATES DEPARTMENT OF COMMERCE
United States Patent and Trademark Office
Address: COMMISSIONER FOR PATENTS
P.O. Box 1450
Alexandria, Virginia 22313-1450
www.uspto.gov

APPLICATION NUMBER	FILING OR 371(C) DATE	FIRST NAMED APPLICANT	ATTY. DOCKET NO./TITLE
10/740,030	12/18/2003	Michael J. Rojas	UN-NP-IT-192

CONFIRMATION NO. 1731

POA ACCEPTANCE LETTER

96051
Uniloc USA Inc.
Legacy Town Center
7160 Dallas Parkway
Suite 380
Plano, TX 75024



Date Mailed: 09/21/2016

NOTICE OF ACCEPTANCE OF POWER OF ATTORNEY

This is in response to the Power of Attorney filed 09/15/2016.

The Power of Attorney in this application is accepted. Correspondence in this application will be mailed to the above address as provided by 37 CFR 1.33.

Questions about the contents of this notice and the requirements it sets forth should be directed to the Office of Data Management, Application Assistance Unit, at (571) 272-4000 or (571) 272-4200 or 1-888-786-0101.

/rmtturner myles/



UNITED STATES PATENT AND TRADEMARK OFFICE

UNITED STATES DEPARTMENT OF COMMERCE
United States Patent and Trademark Office
Address: COMMISSIONER FOR PATENTS
P.O. Box 1450
Alexandria, Virginia 22313-1450
www.uspto.gov

APPLICATION NUMBER	FILING OR 371(C) DATE	FIRST NAMED APPLICANT	ATTY. DOCKET NO./TITLE
10/740,030	12/18/2003	Michael J. Rojas	UN-NP-IT-192

67050
KASHA LAW LLC
14532 Dufief Mill Road
North Potomac, MD 20878

CONFIRMATION NO. 1731
POWER OF ATTORNEY NOTICE



Date Mailed: 09/21/2016

NOTICE REGARDING CHANGE OF POWER OF ATTORNEY

This is in response to the Power of Attorney filed 09/15/2016.

- The Power of Attorney to you in this application has been revoked by the applicant. Future correspondence will be mailed to the new address of record(37 CFR 1.33).

Questions about the contents of this notice and the requirements it sets forth should be directed to the Office of Data Management, Application Assistance Unit, at (571) 272-4000 or (571) 272-4200 or 1-888-786-0101.

/rmtturner myles/

AO 120 (Rev. 08/10)

TO: Mail Stop 8 Director of the U.S. Patent and Trademark Office P.O. Box 1450 Alexandria, VA 22313-1450	REPORT ON THE FILING OR DETERMINATION OF AN ACTION REGARDING A PATENT OR TRADEMARK
---	---

In Compliance with 35 U.S.C. § 290 and/or 15 U.S.C. § 1116 you are hereby advised that a court action has been filed in the U.S. District Court Eastern District of Texas, Marshall Division on the following

Trademarks or Patents. (the patent action involves 35 U.S.C. § 292.);

DOCKET NO. 2:16-cv-989	DATE FILED 9/6/2016	U.S. DISTRICT COURT Eastern District of Texas, Marshall Division
PLAINTIFF UNILOC USA, INC., and UNILOC LUXEMBOURG, S.A.		DEFENDANT HTC AMERICA, INC.
PATENT OR TRADEMARK NO.	DATE OF PATENT OR TRADEMARK	HOLDER OF PATENT OR TRADEMARK
1 7,535,890	5/19/2009	UNILOC LUXEMBOURG, S.A.
2 8,199,747	6/12/2012	UNILOC LUXEMBOURG, S.A.
3 8,724,622	5/13/2014	UNILOC LUXEMBOURG, S.A.
4 8,995,433	3/31/2015	UNILOC LUXEMBOURG, S.A.
5		

In the above—entitled case, the following patent(s)/ trademark(s) have been included:

DATE INCLUDED	INCLUDED BY <input type="checkbox"/> Amendment <input type="checkbox"/> Answer <input type="checkbox"/> Cross Bill <input type="checkbox"/> Other Pleading		
PATENT OR TRADEMARK NO.	DATE OF PATENT OR TRADEMARK	HOLDER OF PATENT OR TRADEMARK	
1			
2			
3			
4			
5			

In the above—entitled case, the following decision has been rendered or judgement issued:

DECISION/JUDGEMENT

CLERK	(BY) DEPUTY CLERK	DATE
-------	-------------------	------

Copy 1—Upon initiation of action, mail this copy to Director Copy 3—Upon termination of action, mail this copy to Director
 Copy 2—Upon filing document adding patent(s), mail this copy to Director Copy 4—Case file copy

AO 120 (Rev. 08/10)

TO: Mail Stop 8 Director of the U.S. Patent and Trademark Office P.O. Box 1450 Alexandria, VA 22313-1450	REPORT ON THE FILING OR DETERMINATION OF AN ACTION REGARDING A PATENT OR TRADEMARK
---	---

In Compliance with 35 U.S.C. § 290 and/or 15 U.S.C. § 1116 you are hereby advised that a court action has been filed in the U.S. District Court Eastern District of Texas, Marshall Division on the following

Trademarks or Patents. (the patent action involves 35 U.S.C. § 292.);

DOCKET NO. 2:16-cv-990	DATE FILED 9/6/2016	U.S. DISTRICT COURT Eastern District of Texas, Marshall Division
PLAINTIFF UNILOC USA, INC., and UNILOC LUXEMBOURG, S.A.		DEFENDANT KYOCERA AMERICA, INC. and § KYOCERA COMMUNICATIONS, INC.,
PATENT OR TRADEMARK NO.	DATE OF PATENT OR TRADEMARK	HOLDER OF PATENT OR TRADEMARK
1 7,535,890	5/19/2009	UNILOC LUXEMBOURG, S.A.
2 8,199,747	6/12/2012	UNILOC LUXEMBOURG, S.A.
3 8,724,622	5/13/2014	UNILOC LUXEMBOURG, S.A.
4 8,995,433	3/31/2015	UNILOC LUXEMBOURG, S.A.
5		

In the above—entitled case, the following patent(s)/ trademark(s) have been included:

DATE INCLUDED	INCLUDED BY <input type="checkbox"/> Amendment <input type="checkbox"/> Answer <input type="checkbox"/> Cross Bill <input type="checkbox"/> Other Pleading	
PATENT OR TRADEMARK NO.	DATE OF PATENT OR TRADEMARK	HOLDER OF PATENT OR TRADEMARK
1		
2		
3		
4		
5		

In the above—entitled case, the following decision has been rendered or judgement issued:

DECISION/JUDGEMENT

CLERK	(BY) DEPUTY CLERK	DATE
-------	-------------------	------

Copy 1—Upon initiation of action, mail this copy to Director Copy 3—Upon termination of action, mail this copy to Director
 Copy 2—Upon filing document adding patent(s), mail this copy to Director Copy 4—Case file copy

AO 120 (Rev. 08/10)

TO: Mail Stop 8 Director of the U.S. Patent and Trademark Office P.O. Box 1450 Alexandria, VA 22313-1450	REPORT ON THE FILING OR DETERMINATION OF AN ACTION REGARDING A PATENT OR TRADEMARK
---	---

In Compliance with 35 U.S.C. § 290 and/or 15 U.S.C. § 1116 you are hereby advised that a court action has been filed in the U.S. District Court Eastern District of Texas, Marshall Division on the following

Trademarks or Patents. (the patent action involves 35 U.S.C. § 292.);

DOCKET NO. 2:16-cv-991	DATE FILED 9/6/2016	U.S. DISTRICT COURT Eastern District of Texas, Marshall Division
PLAINTIFF UNILOC USA, INC., and UNILOC LUXEMBOURG, S.A.		DEFENDANT LG ELECTRONICS U.S.A., INC.,
PATENT OR TRADEMARK NO.	DATE OF PATENT OR TRADEMARK	HOLDER OF PATENT OR TRADEMARK
1 7,535,890	5/19/2009	UNILOC LUXEMBOURG, S.A.
2 8,199,747	6/12/2012	UNILOC LUXEMBOURG, S.A.
3 8,724,622	5/13/2014	UNILOC LUXEMBOURG, S.A.
4 8,995,433	3/31/2015	UNILOC LUXEMBOURG, S.A.
5		

In the above—entitled case, the following patent(s)/ trademark(s) have been included:

DATE INCLUDED	INCLUDED BY <input type="checkbox"/> Amendment <input type="checkbox"/> Answer <input type="checkbox"/> Cross Bill <input type="checkbox"/> Other Pleading	
PATENT OR TRADEMARK NO.	DATE OF PATENT OR TRADEMARK	HOLDER OF PATENT OR TRADEMARK
1		
2		
3		
4		
5		

In the above—entitled case, the following decision has been rendered or judgement issued:

DECISION/JUDGEMENT

CLERK	(BY) DEPUTY CLERK	DATE
-------	-------------------	------

Copy 1—Upon initiation of action, mail this copy to Director Copy 3—Upon termination of action, mail this copy to Director
 Copy 2—Upon filing document adding patent(s), mail this copy to Director Copy 4—Case file copy

“FEE ADDRESS” INDICATION FORM

Address to:
 Mail Stop M Correspondence
 Commissioner for Patents
 P.O. Box 1450
 Alexandria, VA 22313-1450

- OR -

Fax to:
 571-273-6500

INSTRUCTIONS: The issue fee must have been paid for application(s) listed on this form. In addition, only an address represented by a Customer Number can be established as the fee address for maintenance fee purposes (hereafter, fee address). A fee address should be established when correspondence related to maintenance fees should be mailed to a different address than the correspondence address for the application. **When to check the first box below:** If you have a Customer Number to represent the fee address. **When to check the second box below:** If you have no Customer Number representing the desired fee address, in which case a completed Request for Customer Number (PTO/SB/125) must be attached to this form. For more information on Customer Numbers, see the Manual of Patent Examining Procedure (MPEP) § 403.

For the following listed application(s), please recognize as the “Fee Address” under the provisions of 37 CFR 1.363 the address associated with:

Customer Number: 96051

OR

The attached Request for Customer Number (PTO/SB/125) form.

PATENT NUMBER <small>(if known)</small>	APPLICATION NUMBER
7,535,890	10/740,030

Completed by (check one):

Applicant/Inventor

Attorney or Agent of record 51,513
(Reg. No.)

Assignee of record of the entire interest. See 37 CFR 3.71.
 Statement under 37 CFR 3.73(b) is enclosed.
(Form PTO/SB/96)

Assignee recorded at Reel _____ Frame _____

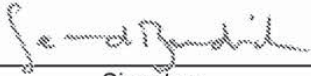

 Signature

Sean D. Burdick

 Typed or printed name

972-905-9580 x227

 Requester's telephone number

September 15, 2016

 Date

NOTE: Signatures of all the inventors or assignees of record of the entire interest or their representative(s) are required. Submit multiple forms if more than one signature is required, see below*.

* Total of 1 forms are submitted.

This collection of information is required by 37 CFR 1.363. The information is required to obtain or retain a benefit by the public which is to file (and by the USPTO to process) an application. Confidentiality is governed by 35 U.S.C. 122 and 37 CFR 1.11 and 1.14. This collection is estimated to take 5 minutes to complete, including gathering, preparing, and submitting the completed application form to the USPTO. Time will vary depending upon the individual case. Any comments on the amount of time you require to complete this form and/or suggestions for reducing this burden, should be sent to the Chief Information Officer, U.S. Patent and Trademark Office, U.S. Department of Commerce, P.O. Box 1450, Alexandria, VA 22313-1450. DO NOT SEND COMPLETED FORMS TO THIS ADDRESS. SEND TO: Mail Stop M Correspondence, Commissioner for Patents, P.O. Box 1450, Alexandria, VA 22313-1450.
 If you need assistance in completing the form, call 1-800-PTO-9199 and select option 2.

STATEMENT UNDER 37 CFR 3.73(b)Applicant/Patent Owner: Uniloc Luxembourg S.A.Application No./Patent No.: 7,535,890Filed/Issue Date: May 19, 2009Titled: SYSTEM AND METHOD FOR INSTANT VOIP MESSAGINGUniloc Luxembourg S.A., a corporation

(Name of Assignee)

(Type of Assignee, e.g., corporation, partnership, university, government agency, etc.)

states that it is:

1. the assignee of the entire right, title, and interest in;
2. an assignee of less than the entire right, title, and interest in
(The extent (by percentage) of its ownership interest is _____ %); or
3. the assignee of an undivided interest in the entirety of (a complete assignment from one of the joint inventors was made)

the patent application/patent identified above, by virtue of either:

- A. An assignment from the inventor(s) of the patent application/patent identified above. The assignment was recorded in the United States Patent and Trademark Office at Reel _____, Frame _____, or for which a copy therefore is attached.

OR

- B. A chain of title from the inventor(s), of the patent application/patent identified above, to the current assignee as follows:

1. From: Michael J. ROJASTo: Ayalogic, Inc.

The document was recorded in the United States Patent and Trademark Office at

Reel 014827, Frame 0059, or for which a copy thereof is attached.2. From: Ayalogic, Inc.To: Empire IP LLC

The document was recorded in the United States Patent and Trademark Office at

Reel 030922, Frame 0335, or for which a copy thereof is attached.3. From: Empire IP LLCTo: Uniloc Luxembourg S.A.

The document was recorded in the United States Patent and Trademark Office at

Reel 038963, Frame 0343, or for which a copy thereof is attached.

- Additional documents in the chain of title are listed on a supplemental sheet(s).

- As required by 37 CFR 3.73(b)(1)(i), the documentary evidence of the chain of title from the original owner to the assignee was, or concurrently is being, submitted for recordation pursuant to 37 CFR 3.11.

[NOTE: A separate copy (i.e., a true copy of the original assignment document(s)) must be submitted to Assignment Division in accordance with 37 CFR Part 3, to record the assignment in the records of the USPTO. See MPEP 302.08]

The undersigned (whose title is supplied below) is authorized to act on behalf of the assignee.

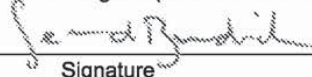

Signature

September 15, 2016

Date

Sean D. Burdick

Printed or Typed Name

IP Counsel for Uniloc Luxembourg S.A.

Title

This collection of information is required by 37 CFR 3.73(b). The information is required to obtain or retain a benefit by the public which is to file (and by the USPTO to process) an application. Confidentiality is governed by 35 U.S.C. 122 and 37 CFR 1.11 and 1.14. This collection is estimated to take 12 minutes to complete, including gathering, preparing, and submitting the completed application form to the USPTO. Time will vary depending upon the individual case. Any comments on the amount of time you require to complete this form and/or suggestions for reducing this burden, should be sent to the Chief Information Officer, U.S. Patent and Trademark Office, U.S. Department of Commerce, P.O. Box 1450, Alexandria, VA 22313-1450. DO NOT SEND FEES OR COMPLETED FORMS TO THIS ADDRESS. SEND TO: Commissioner for Patents, P.O. Box 1450, Alexandria, VA 22313-1450.

If you need assistance in completing the form, call 1-800-PTO-9199 and select option 2.

Electronic Acknowledgement Receipt

EFS ID:	26942493
Application Number:	10740030
International Application Number:	
Confirmation Number:	1731
Title of Invention:	SYSTEM AND METHOD FOR INSTANT VOIP MESSAGING
First Named Inventor/Applicant Name:	Michael J. Rojas
Customer Number:	67050
Filer:	Sean Dylan Burdick/Kris Pangan
Filer Authorized By:	Sean Dylan Burdick
Attorney Docket Number:	EMP0021-US
Receipt Date:	15-SEP-2016
Filing Date:	18-DEC-2003
Time Stamp:	18:48:50
Application Type:	Utility under 35 USC 111(a)

Payment information:

Submitted with Payment	no
------------------------	----

File Listing:

Document Number	Document Description	File Name	File Size(Bytes)/ Message Digest	Multi Part /.zip	Pages (if appl.)
1	Power of Attorney	IT-192_Executed_POA.pdf	37608 208cf9b8f86571561a5aeb145b2f29ef8b91 edec	no	1

Warnings:

Information:					
2	Change of Address	IT-192_Fee_Address_Indication_Form.pdf	317687 ff1497553406466285f0680a188858ab53804385	no	1
Warnings:					
Information:					
3	Assignee showing of ownership per 37 CFR 3.73	IT-192_Statement_Under_37_CFR.pdf	4209259 d6adb4ec1c162c850ce2b6ee0a0dd3737e024c4d	no	1
Warnings:					
Information:					
Total Files Size (in bytes):			4564554		
<p>This Acknowledgement Receipt evidences receipt on the noted date by the USPTO of the indicated documents, characterized by the applicant, and including page counts, where applicable. It serves as evidence of receipt similar to a Post Card, as described in MPEP 503.</p> <p><u>New Applications Under 35 U.S.C. 111</u> If a new application is being filed and the application includes the necessary components for a filing date (see 37 CFR 1.53(b)-(d) and MPEP 506), a Filing Receipt (37 CFR 1.54) will be issued in due course and the date shown on this Acknowledgement Receipt will establish the filing date of the application.</p> <p><u>National Stage of an International Application under 35 U.S.C. 371</u> If a timely submission to enter the national stage of an international application is compliant with the conditions of 35 U.S.C. 371 and other applicable requirements a Form PCT/DO/EO/903 indicating acceptance of the application as a national stage submission under 35 U.S.C. 371 will be issued in addition to the Filing Receipt, in due course.</p> <p><u>New International Application Filed with the USPTO as a Receiving Office</u> If a new international application is being filed and the international application includes the necessary components for an international filing date (see PCT Article 11 and MPEP 1810), a Notification of the International Application Number and of the International Filing Date (Form PCT/RO/105) will be issued in due course, subject to prescriptions concerning national security, and the date shown on this Acknowledgement Receipt will establish the international filing date of the application.</p>					

Under the Paperwork Reduction Act of 1995 no persons are required to respond to a collection of information unless it displays a valid OMB control number

PATENT - POWER OF ATTORNEY OR REVOCATION OF POWER OF ATTORNEY WITH A NEW POWER OF ATTORNEY AND CHANGE OF CORRESPONDENCE ADDRESS	Patent Number	7,535,890
	Issue Date	May 19, 2009
	First Named Inventor	Michael J. ROJAS
	Title	SYSTEM AND METHOD FOR INSTANT VOIP MESSAGING
	Attorney Docket No.	UN-NP-IT-192

I hereby revoke all previous powers of attorney given in the above-identified patent.

A Power of Attorney is submitted herewith.

OR

I hereby appoint Practitioner(s) associated with the Customer Number identified in the box at right as my/our attorney(s) or agent(s) with respect to the patent identified above, and to transact all business in the United States Patent and Trademark Office connected therewith: 96051

OR

I hereby appoint Practitioner(s) named below as my/our attorney(s) or agent(s) with respect to the patent identified above, and to transact all business in the United States Patent and Trademark Office connected therewith:

Practitioner(s) Name	Registration Number

Please recognize or change the correspondence address for the above-identified patent to:

The address associated with the above-identified Customer Number.

OR

The address associated with the Customer Number identified in the box at right:

OR

<input type="checkbox"/> Firm or Individual Name			
Address			
City	State	Zip	
Country			
Telephone	Email		

I am the:

Applicant.

OR

Patent owner.
 Statement under 37 CFR 3.73(c) (Form PTO/AIA/96) submitted herewith or filed on _____

SIGNATURE of Applicant or Patent Owner	
Signature 	Date
Name: Craig S. Elchegoyen	Telephone
Title and Company: CEO of Uniloc Luxembourg S.A.	

NOTE: Signatures of all the applicants or patent owners of the entire interest or their representative(s) are required. If more than one signature is required, submit multiple forms, check the box below, and identify the total number of forms submitted in the blank below.

A total of 1 forms are submitted.

This collection of information is required by 37 CFR 1.31, 1.32, and 1.33. The information is required to obtain or retain a benefit by the public, which is to update (and by the USPTO to process) the file of a patent or reexamination proceeding. Confidentiality is governed by 35 U.S.C. 122 and 37 CFR 1.14. This collection is estimated to take 3 minutes to complete, including gathering, preparing, and submitting the completed application form to the USPTO. Time will vary depending upon the individual case. Any comments on the amount of time you require to complete this form and/or suggestions for reducing this burden, should be sent to the Chief Information Officer, U.S. Patent and Trademark Office, U.S. Department of Commerce, P.O. Box 1450, Alexandria, VA 22313-1450. DO NOT SEND FEES OR COMPLETED FORMS TO THIS ADDRESS. SEND TO: Commissioner for Patents, P.O. Box 1450, Alexandria, VA 22313-1450.

If you need assistance in completing the form, call 1-800-PTO-9199 and select option 2.

AO 120 (Rev. 08/10)

TO: Mail Stop 8 Director of the U.S. Patent and Trademark Office P.O. Box 1450 Alexandria, VA 22313-1450	REPORT ON THE FILING OR DETERMINATION OF AN ACTION REGARDING A PATENT OR TRADEMARK
---	---

In Compliance with 35 U.S.C. § 290 and/or 15 U.S.C. § 1116 you are hereby advised that a court action has been filed in the U.S. District Court Eastern District of Texas, Marshall Division on the following

Trademarks or Patents. (the patent action involves 35 U.S.C. § 292.);

DOCKET NO. 2:16-cv-638	DATE FILED 6/14/2016	U.S. DISTRICT COURT Eastern District of Texas, Marshall Division
PLAINTIFF UNILOC USA, INC., and UNILOC LUXEMBOURG, S.A.		DEFENDANT APPLE INC.
PATENT OR TRADEMARK NO.	DATE OF PATENT OR TRADEMARK	HOLDER OF PATENT OR TRADEMARK
1 7,535,890	5/19/2009	UNILOC LUXEMBOURG, S.A.
2 8,995,433	3/31/2015	UNILOC LUXEMBOURG, S.A.
3 8,724,622	5/31/2014	UNILOC LUXEMBOURG, S.A.
4 8,243,723	8/14/2012	UNILOC LUXEMBOURG, S.A.
5		

In the above—entitled case, the following patent(s)/ trademark(s) have been included:

DATE INCLUDED	INCLUDED BY <input type="checkbox"/> Amendment <input type="checkbox"/> Answer <input type="checkbox"/> Cross Bill <input type="checkbox"/> Other Pleading	
PATENT OR TRADEMARK NO.	DATE OF PATENT OR TRADEMARK	HOLDER OF PATENT OR TRADEMARK
1		
2		
3		
4		
5		

In the above—entitled case, the following decision has been rendered or judgement issued:

DECISION/JUDGEMENT

CLERK	(BY) DEPUTY CLERK	DATE
-------	-------------------	------

Copy 1—Upon initiation of action, mail this copy to Director Copy 3—Upon termination of action, mail this copy to Director
 Copy 2—Upon filing document adding patent(s), mail this copy to Director Copy 4—Case file copy

AO 120 (Rev. 08/10)

TO: Mail Stop 8 Director of the U.S. Patent and Trademark Office P.O. Box 1450 Alexandria, VA 22313-1450	REPORT ON THE FILING OR DETERMINATION OF AN ACTION REGARDING A PATENT OR TRADEMARK
---	--

In Compliance with 35 U.S.C. § 290 and/or 15 U.S.C. § 1116 you are hereby advised that a court action has been filed in the U.S. District Court Eastern District of Texas, Marshall Division on the following

Trademarks or Patents. (the patent action involves 35 U.S.C. § 292.):

DOCKET NO. 2:16-cv-722	DATE FILED 7/5/2016	U.S. DISTRICT COURT Eastern District of Texas, Marshall Division
PLAINTIFF UNILOC USA, INC., and UNILOC LUXEMBOURG, S.A.		DEFENDANT AOL INC.
PATENT OR TRADEMARK NO.	DATE OF PATENT OR TRADEMARK	HOLDER OF PATENT OR TRADEMARK
1 7,535,890	5/19/2009	UNILOC LUXEMBOURG, S.A.
2 8,199,747	6/12/2012	UNILOC LUXEMBOURG, S.A.
3 8,243,723	8/14/2012	UNILOC LUXEMBOURG, S.A.
4 8, 724,622	5/13/2014	UNILOC LUXEMBOURG, S.A.
5 8,995,433	3/31/2015	UNILOC LUXEMBOURG, S.A.

In the above—entitled case, the following patent(s)/ trademark(s) have been included:

DATE INCLUDED	INCLUDED BY <input type="checkbox"/> Amendment <input type="checkbox"/> Answer <input type="checkbox"/> Cross Bill <input type="checkbox"/> Other Pleading	
PATENT OR TRADEMARK NO.	DATE OF PATENT OR TRADEMARK	HOLDER OF PATENT OR TRADEMARK
1		
2		
3		
4		
5		

In the above—entitled case, the following decision has been rendered or judgement issued:

DECISION/JUDGEMENT

CLERK	(BY) DEPUTY CLERK	DATE
-------	-------------------	------

Copy 1—Upon initiation of action, mail this copy to Director Copy 3—Upon termination of action, mail this copy to Director
 Copy 2—Upon filing document adding patent(s), mail this copy to Director Copy 4—Case file copy

AO 120 (Rev. 08/10)

TO: Mail Stop 8 Director of the U.S. Patent and Trademark Office P.O. Box 1450 Alexandria, VA 22313-1450	REPORT ON THE FILING OR DETERMINATION OF AN ACTION REGARDING A PATENT OR TRADEMARK
---	---

In Compliance with 35 U.S.C. § 290 and/or 15 U.S.C. § 1116 you are hereby advised that a court action has been filed in the U.S. District Court Eastern District of Texas, Marshall Division on the following
 Trademarks or Patents. (the patent action involves 35 U.S.C. § 292.);

DOCKET NO. 2:16-cv-725	DATE FILED 7/5/2016	U.S. DISTRICT COURT Eastern District of Texas, Marshall Division
PLAINTIFF UNILOC USA, INC., and UNILOC LUXEMBOURG, S.A.		DEFENDANT BEETALK PRIVATE LTD.
PATENT OR TRADEMARK NO.	DATE OF PATENT OR TRADEMARK	HOLDER OF PATENT OR TRADEMARK
1 7,535,890	5/19/2009	UNILOC LUXEMBOURG, S.A.
2 8,199,747	6/12/2012	UNILOC LUXEMBOURG, S.A.
3 8,243,723	8/14/2012	UNILOC LUXEMBOURG, S.A.
4 8,724,622	5/13/2014	UNILOC LUXEMBOURG, S.A.
5 8,995,433	3/31/2015	UNILOC LUXEMBOURG, S.A.

In the above—entitled case, the following patent(s)/ trademark(s) have been included:

DATE INCLUDED	INCLUDED BY <input type="checkbox"/> Amendment <input type="checkbox"/> Answer <input type="checkbox"/> Cross Bill <input type="checkbox"/> Other Pleading	
PATENT OR TRADEMARK NO.	DATE OF PATENT OR TRADEMARK	HOLDER OF PATENT OR TRADEMARK
1		
2		
3		
4		
5		

In the above—entitled case, the following decision has been rendered or judgement issued:

DECISION/JUDGEMENT

CLERK	(BY) DEPUTY CLERK	DATE
-------	-------------------	------

Copy 1—Upon initiation of action, mail this copy to Director Copy 3—Upon termination of action, mail this copy to Director
 Copy 2—Upon filing document adding patent(s), mail this copy to Director Copy 4—Case file copy

AO 120 (Rev. 08/10)

TO: Mail Stop 8 Director of the U.S. Patent and Trademark Office P.O. Box 1450 Alexandria, VA 22313-1450	REPORT ON THE FILING OR DETERMINATION OF AN ACTION REGARDING A PATENT OR TRADEMARK
---	---

In Compliance with 35 U.S.C. § 290 and/or 15 U.S.C. § 1116 you are hereby advised that a court action has been filed in the U.S. District Court Eastern District of Texas, Marshall Division on the following

Trademarks or Patents. (the patent action involves 35 U.S.C. § 292.):

DOCKET NO. 2:16-cv-893	DATE FILED 8/11/2016	U.S. DISTRICT COURT Eastern District of Texas, Marshall Division
PLAINTIFF UNILOC USA, INC., and UNILOC LUXEMBOURG, S.A.		DEFENDANT VONAGE HOLDINGS CORP. & VONAGE AMERICAS, INC.
PATENT OR TRADEMARK NO.	DATE OF PATENT OR TRADEMARK	HOLDER OF PATENT OR TRADEMARK
1 8,724,622	5/31/2014	UNILOC LUXEMBOURG, S.A.
2 8,995,433	3/31/2015	UNILOC LUXEMBOURG, S.A.
3 8,243,723	8/14/2012	UNILOC LUXEMBOURG, S.A.
4 7,535,890	5/19/2009	UNILOC LUXEMBOURG, S.A.
5		

In the above—entitled case, the following patent(s)/ trademark(s) have been included:

DATE INCLUDED	INCLUDED BY <input type="checkbox"/> Amendment <input type="checkbox"/> Answer <input type="checkbox"/> Cross Bill <input type="checkbox"/> Other Pleading	
PATENT OR TRADEMARK NO.	DATE OF PATENT OR TRADEMARK	HOLDER OF PATENT OR TRADEMARK
1		
2		
3		
4		
5		

In the above—entitled case, the following decision has been rendered or judgement issued:

DECISION/JUDGEMENT

CLERK	(BY) DEPUTY CLERK	DATE
-------	-------------------	------

Copy 1—Upon initiation of action, mail this copy to Director Copy 3—Upon termination of action, mail this copy to Director
 Copy 2—Upon filing document adding patent(s), mail this copy to Director Copy 4—Case file copy

AO 120 (Rev. 08/10)

TO: Mail Stop 8 Director of the U.S. Patent and Trademark Office P.O. Box 1450 Alexandria, VA 22313-1450	REPORT ON THE FILING OR DETERMINATION OF AN ACTION REGARDING A PATENT OR TRADEMARK
---	--

In Compliance with 35 U.S.C. § 290 and/or 15 U.S.C. § 1116 you are hereby advised that a court action has been filed in the U.S. District Court Eastern District of Texas, Marshall Division on the following

Trademarks or Patents. (the patent action involves 35 U.S.C. § 292.):

DOCKET NO. 2:16-cv-892	DATE FILED 8/11/2016	U.S. DISTRICT COURT Eastern District of Texas, Marshall Division
PLAINTIFF UNILOC USA, INC., and UNILOC LUXEMBOURG, S.A.		DEFENDANT TELEGRAM MESSENGER, LLP
PATENT OR TRADEMARK NO.	DATE OF PATENT OR TRADEMARK	HOLDER OF PATENT OR TRADEMARK
1 8,724,622	5/13/2014	UNILOC LUXEMBOURG, S.A.
2 8,995,433	3/31/2015	UNILOC LUXEMBOURG, S.A.
3 7,535,890	5/19/2009	UNILOC LUXEMBOURG, S.A.
4 8,199,747	6/12/2012	UNILOC LUXEMBOURG, S.A.
5 8,243,723	8/14/2012	UNILOC LUXEMBOURG, S.A.

In the above—entitled case, the following patent(s)/ trademark(s) have been included:

DATE INCLUDED	INCLUDED BY <input type="checkbox"/> Amendment <input type="checkbox"/> Answer <input type="checkbox"/> Cross Bill <input type="checkbox"/> Other Pleading		
PATENT OR TRADEMARK NO.	DATE OF PATENT OR TRADEMARK	HOLDER OF PATENT OR TRADEMARK	
1			
2			
3			
4			
5			

In the above—entitled case, the following decision has been rendered or judgement issued:

DECISION/JUDGEMENT

CLERK	(BY) DEPUTY CLERK	DATE

Copy 1—Upon initiation of action, mail this copy to Director Copy 3—Upon termination of action, mail this copy to Director
 Copy 2—Upon filing document adding patent(s), mail this copy to Director Copy 4—Case file copy

AO 120 (Rev. 08/10)

TO: Mail Stop 8 Director of the U.S. Patent and Trademark Office P.O. Box 1450 Alexandria, VA 22313-1450	REPORT ON THE FILING OR DETERMINATION OF AN ACTION REGARDING A PATENT OR TRADEMARK
---	---

In Compliance with 35 U.S.C. § 290 and/or 15 U.S.C. § 1116 you are hereby advised that a court action has been filed in the U.S. District Court Eastern District of Texas, Marshall Division on the following

Trademarks or Patents. (the patent action involves 35 U.S.C. § 292.);

DOCKET NO. 2:16-cv-645	DATE FILED 6/14/2016	U.S. DISTRICT COURT Eastern District of Texas, Marshall Division
PLAINTIFF UNILOC USA, INC., and UNILOC LUXEMBOURG, S.A.		DEFENDANT WHATSAPP, INC.
PATENT OR TRADEMARK NO.	DATE OF PATENT OR TRADEMARK	HOLDER OF PATENT OR TRADEMARK
1 7,535,890	5/19/2009	UNILOC LUXEMBOURG, S.A.
2 8,199,747	6/12/2012	UNILOC LUXEMBOURG, S.A.
3 8,243,723	8/14/2012	UNILOC LUXEMBOURG, S.A.
4 8,724,622	5/13/2014	UNILOC LUXEMBOURG, S.A.
5 8,995,433	3/31/2015	UNILOC LUXEMBOURG, S.A.

In the above—entitled case, the following patent(s)/ trademark(s) have been included:

DATE INCLUDED	INCLUDED BY <input type="checkbox"/> Amendment <input type="checkbox"/> Answer <input type="checkbox"/> Cross Bill <input type="checkbox"/> Other Pleading	
PATENT OR TRADEMARK NO.	DATE OF PATENT OR TRADEMARK	HOLDER OF PATENT OR TRADEMARK
1		
2		
3		
4		
5		

In the above—entitled case, the following decision has been rendered or judgement issued:

DECISION/JUDGEMENT

CLERK	(BY) DEPUTY CLERK	DATE
-------	-------------------	------

Copy 1—Upon initiation of action, mail this copy to Director Copy 3—Upon termination of action, mail this copy to Director
 Copy 2—Upon filing document adding patent(s), mail this copy to Director Copy 4—Case file copy

AO 120 (Rev. 08/10)

TO: Mail Stop 8 Director of the U.S. Patent and Trademark Office P.O. Box 1450 Alexandria, VA 22313-1450	REPORT ON THE FILING OR DETERMINATION OF AN ACTION REGARDING A PATENT OR TRADEMARK
---	---

In Compliance with 35 U.S.C. § 290 and/or 15 U.S.C. § 1116 you are hereby advised that a court action has been filed in the U.S. District Court Eastern District of Texas, Marshall Division on the following

Trademarks or Patents. (the patent action involves 35 U.S.C. § 292.);

DOCKET NO. 2:16-cv-641	DATE FILED 6/14/2016	U.S. DISTRICT COURT Eastern District of Texas, Marshall Division
PLAINTIFF UNILOC USA, INC., and UNILOC LUXEMBOURG, S.A.		DEFENDANT LINE EURO-AMERICAS CORP. & LINE CORPORATION
PATENT OR TRADEMARK NO.	DATE OF PATENT OR TRADEMARK	HOLDER OF PATENT OR TRADEMARK
1 8,724,622	5/13/2014	UNILOC LUXEMBOURG, S.A.
2 8,995,433	3/31/2015	UNILOC LUXEMBOURG, S.A.
3 7,535,890	5/19/2009	UNILOC LUXEMBOURG, S.A.
4 8,199,747	6/12/2012	UNILOC LUXEMBOURG, S.A.
5 8,243,723	8/14/2012	UNILOC LUXEMBOURG, S.A.

In the above—entitled case, the following patent(s)/ trademark(s) have been included:

DATE INCLUDED	INCLUDED BY <input type="checkbox"/> Amendment <input type="checkbox"/> Answer <input type="checkbox"/> Cross Bill <input type="checkbox"/> Other Pleading	
PATENT OR TRADEMARK NO.	DATE OF PATENT OR TRADEMARK	HOLDER OF PATENT OR TRADEMARK
1		
2		
3		
4		
5		

In the above—entitled case, the following decision has been rendered or judgement issued:

DECISION/JUDGEMENT

CLERK	(BY) DEPUTY CLERK	DATE
-------	-------------------	------

Copy 1—Upon initiation of action, mail this copy to Director Copy 3—Upon termination of action, mail this copy to Director
 Copy 2—Upon filing document adding patent(s), mail this copy to Director Copy 4—Case file copy

AO 120 (Rev. 08/10)

TO: Mail Stop 8 Director of the U.S. Patent and Trademark Office P.O. Box 1450 Alexandria, VA 22313-1450	REPORT ON THE FILING OR DETERMINATION OF AN ACTION REGARDING A PATENT OR TRADEMARK
---	---

In Compliance with 35 U.S.C. § 290 and/or 15 U.S.C. § 1116 you are hereby advised that a court action has been filed in the U.S. District Court Eastern District of Texas, Marshall Division on the following

Trademarks or Patents. (the patent action involves 35 U.S.C. § 292.);

DOCKET NO. 2:16-cv-639	DATE FILED 6/14/2016	U.S. DISTRICT COURT Eastern District of Texas, Marshall Division
PLAINTIFF UNILOC USA, INC., and UNILOC LUXEMBOURG, S.A.		DEFENDANT BLACKBERRY CORPORATION & BLACKBERRY LIMITED
PATENT OR TRADEMARK NO.	DATE OF PATENT OR TRADEMARK	HOLDER OF PATENT OR TRADEMARK
1 8,724,622	5/13/2014	UNILOC LUXEMBOURG, S.A.
2 8,995,433	3/31/2015	UNILOC LUXEMBOURG, S.A.
3 7,535,890	5/19/2009	UNILOC LUXEMBOURG, S.A.
4 8,199,747	6/12/2012	UNILOC LUXEMBOURG, S.A.
5 8,243,723	8/14/2012	UNILOC LUXEMBOURG, S.A.

In the above—entitled case, the following patent(s)/ trademark(s) have been included:

DATE INCLUDED	INCLUDED BY <input type="checkbox"/> Amendment <input type="checkbox"/> Answer <input type="checkbox"/> Cross Bill <input type="checkbox"/> Other Pleading	
PATENT OR TRADEMARK NO.	DATE OF PATENT OR TRADEMARK	HOLDER OF PATENT OR TRADEMARK
1		
2		
3		
4		
5		

In the above—entitled case, the following decision has been rendered or judgement issued:

DECISION/JUDGEMENT

CLERK	(BY) DEPUTY CLERK	DATE
-------	-------------------	------

Copy 1—Upon initiation of action, mail this copy to Director Copy 3—Upon termination of action, mail this copy to Director
 Copy 2—Upon filing document adding patent(s), mail this copy to Director Copy 4—Case file copy

AO 120 (Rev. 08/10)

TO: Mail Stop 8 Director of the U.S. Patent and Trademark Office P.O. Box 1450 Alexandria, VA 22313-1450	REPORT ON THE FILING OR DETERMINATION OF AN ACTION REGARDING A PATENT OR TRADEMARK
---	---

In Compliance with 35 U.S.C. § 290 and/or 15 U.S.C. § 1116 you are hereby advised that a court action has been filed in the U.S. District Court Eastern District of Texas, Marshall Division on the following
 Trademarks or Patents. (the patent action involves 35 U.S.C. § 292.):

DOCKET NO. 2:16-cv-728	DATE FILED 7/5/2016	U.S. DISTRICT COURT Eastern District of Texas, Marshall Division
PLAINTIFF UNILOC USA, INC., and UNILOC LUXEMBOURG, S.A.		DEFENDANT FACEBOOK, INC.
PATENT OR TRADEMARK NO.	DATE OF PATENT OR TRADEMARK	HOLDER OF PATENT OR TRADEMARK
1 7,535,890	5/19/2009	UNILOC LUXEMBOURG, S.A.
2 8,199,747	6/12/2012	UNILOC LUXEMBOURG, S.A.
3 8,243,723	8/14/2012	UNILOC LUXEMBOURG, S.A.
4 8,724,622	5/13/2014	UNILOC LUXEMBOURG, S.A.
5 8,995,433	3/31/2015	UNILOC LUXEMBOURG, S.A.

In the above—entitled case, the following patent(s)/ trademark(s) have been included:

DATE INCLUDED	INCLUDED BY <input type="checkbox"/> Amendment <input type="checkbox"/> Answer <input type="checkbox"/> Cross Bill <input type="checkbox"/> Other Pleading		
PATENT OR TRADEMARK NO.	DATE OF PATENT OR TRADEMARK	HOLDER OF PATENT OR TRADEMARK	
1			
2			
3			
4			
5			

In the above—entitled case, the following decision has been rendered or judgement issued:

DECISION/JUDGEMENT

CLERK	(BY) DEPUTY CLERK	DATE
-------	-------------------	------

Copy 1—Upon initiation of action, mail this copy to Director Copy 3—Upon termination of action, mail this copy to Director
 Copy 2—Upon filing document adding patent(s), mail this copy to Director Copy 4—Case file copy

AO 120 (Rev. 08/10)

TO: Mail Stop 8 Director of the U.S. Patent and Trademark Office P.O. Box 1450 Alexandria, VA 22313-1450	REPORT ON THE FILING OR DETERMINATION OF AN ACTION REGARDING A PATENT OR TRADEMARK
---	---

In Compliance with 35 U.S.C. § 290 and/or 15 U.S.C. § 1116 you are hereby advised that a court action has been filed in the U.S. District Court Eastern District of Texas, Marshall Division on the following

Trademarks or Patents. (the patent action involves 35 U.S.C. § 292.);

DOCKET NO. 2:16-cv-644	DATE FILED 6/14/2016	U.S. DISTRICT COURT Eastern District of Texas, Marshall Division
PLAINTIFF UNILOC USA, INC., and UNILOC LUXEMBOURG, S.A.		DEFENDANT VOXERNET LLC
PATENT OR TRADEMARK NO.	DATE OF PATENT OR TRADEMARK	HOLDER OF PATENT OR TRADEMARK
1 8,724,622	5/13/2014	UNILOC LUXEMBOURG, S.A.
2 8,995,433	3/31/2015	UNILOC LUXEMBOURG, S.A.
3 7,535,890	5/19/2009	UNILOC LUXEMBOURG, S.A.
4 8,199,747	6/12/2012	UNILOC LUXEMBOURG, S.A.
5 8,243,723	8/14/2012	UNILOC LUXEMBOURG, S.A.

In the above—entitled case, the following patent(s)/ trademark(s) have been included:

DATE INCLUDED	INCLUDED BY <input type="checkbox"/> Amendment <input type="checkbox"/> Answer <input type="checkbox"/> Cross Bill <input type="checkbox"/> Other Pleading	
PATENT OR TRADEMARK NO.	DATE OF PATENT OR TRADEMARK	HOLDER OF PATENT OR TRADEMARK
1		
2		
3		
4		
5		

In the above—entitled case, the following decision has been rendered or judgement issued:

DECISION/JUDGEMENT

CLERK	(BY) DEPUTY CLERK	DATE
-------	-------------------	------

Copy 1—Upon initiation of action, mail this copy to Director Copy 3—Upon termination of action, mail this copy to Director
 Copy 2—Upon filing document adding patent(s), mail this copy to Director Copy 4—Case file copy

AO 120 (Rev. 08/10)

TO: Mail Stop 8 Director of the U.S. Patent and Trademark Office P.O. Box 1450 Alexandria, VA 22313-1450	REPORT ON THE FILING OR DETERMINATION OF AN ACTION REGARDING A PATENT OR TRADEMARK
---	---

In Compliance with 35 U.S.C. § 290 and/or 15 U.S.C. § 1116 you are hereby advised that a court action has been filed in the U.S. District Court Eastern District of Texas, Marshall Division on the following

Trademarks or Patents. (the patent action involves 35 U.S.C. § 292.);

DOCKET NO. 2:16-cv-643	DATE FILED 6/14/2016	U.S. DISTRICT COURT Eastern District of Texas, Marshall Division
PLAINTIFF UNILOC USA, INC., and UNILOC LUXEMBOURG, S.A.		DEFENDANT VIBER MEDIA S.A.R.L.,
PATENT OR TRADEMARK NO.	DATE OF PATENT OR TRADEMARK	HOLDER OF PATENT OR TRADEMARK
1 8,724,622	5/13/2014	UNILOC LUXEMBOURG, S.A.
2 8,995,433	3/31/2015	UNILOC LUXEMBOURG, S.A.
3 7,535,890	5/19/2009	UNILOC LUXEMBOURG, S.A.
4 8,199,747	6/12/2012	UNILOC LUXEMBOURG, S.A.
5 8,243,723	8/14/2012	UNILOC LUXEMBOURG, S.A.

In the above—entitled case, the following patent(s)/ trademark(s) have been included:

DATE INCLUDED	INCLUDED BY <input type="checkbox"/> Amendment <input type="checkbox"/> Answer <input type="checkbox"/> Cross Bill <input type="checkbox"/> Other Pleading	
PATENT OR TRADEMARK NO.	DATE OF PATENT OR TRADEMARK	HOLDER OF PATENT OR TRADEMARK
1		
2		
3		
4		
5		

In the above—entitled case, the following decision has been rendered or judgement issued:

DECISION/JUDGEMENT

CLERK	(BY) DEPUTY CLERK	DATE
-------	-------------------	------

Copy 1—Upon initiation of action, mail this copy to Director Copy 3—Upon termination of action, mail this copy to Director
 Copy 2—Upon filing document adding patent(s), mail this copy to Director Copy 4—Case file copy

AO 120 (Rev. 08/10)

TO: Mail Stop 8 Director of the U.S. Patent and Trademark Office P.O. Box 1450 Alexandria, VA 22313-1450	REPORT ON THE FILING OR DETERMINATION OF AN ACTION REGARDING A PATENT OR TRADEMARK
---	---

In Compliance with 35 U.S.C. § 290 and/or 15 U.S.C. § 1116 you are hereby advised that a court action has been filed in the U.S. District Court Eastern District of Texas, Marshall Division on the following

Trademarks or Patents. (the patent action involves 35 U.S.C. § 292.);

DOCKET NO. 2:16-cv-642	DATE FILED 6/14/2016	U.S. DISTRICT COURT Eastern District of Texas, Marshall Division
PLAINTIFF UNILOC USA, INC., and UNILOC LUXEMBOURG, S.A.		DEFENDANT SAMSUNG ELECTRONICS AMERICA, INC.
PATENT OR TRADEMARK NO.	DATE OF PATENT OR TRADEMARK	HOLDER OF PATENT OR TRADEMARK
1 8,724,622	5/31/2014	UNILOC LUXEMBOURG, S.A.
2 8,995,433	3/31/2015	UNILOC LUXEMBOURG, S.A.
3 8,243,723	8/14/2012	UNILOC LUXEMBOURG, S.A.
4 7,535,890	5/19/2009	UNILOC LUXEMBOURG, S.A.
5		

In the above—entitled case, the following patent(s)/ trademark(s) have been included:

DATE INCLUDED	INCLUDED BY <input type="checkbox"/> Amendment <input type="checkbox"/> Answer <input type="checkbox"/> Cross Bill <input type="checkbox"/> Other Pleading	
PATENT OR TRADEMARK NO.	DATE OF PATENT OR TRADEMARK	HOLDER OF PATENT OR TRADEMARK
1		
2		
3		
4		
5		

In the above—entitled case, the following decision has been rendered or judgement issued:

DECISION/JUDGEMENT

CLERK	(BY) DEPUTY CLERK	DATE
-------	-------------------	------

Copy 1—Upon initiation of action, mail this copy to Director Copy 3—Upon termination of action, mail this copy to Director
 Copy 2—Upon filing document adding patent(s), mail this copy to Director Copy 4—Case file copy

AO 120 (Rev. 08/10)

TO: Mail Stop 8 Director of the U.S. Patent and Trademark Office P.O. Box 1450 Alexandria, VA 22313-1450	REPORT ON THE FILING OR DETERMINATION OF AN ACTION REGARDING A PATENT OR TRADEMARK
---	--

In Compliance with 35 U.S.C. § 290 and/or 15 U.S.C. § 1116 you are hereby advised that a court action has been filed in the U.S. District Court Eastern District of Texas, Marshall Division on the following
 Trademarks or Patents. (the patent action involves 35 U.S.C. § 292.):

DOCKET NO. 2:16-cv-779	DATE FILED 7/15/2016	U.S. DISTRICT COURT Eastern District of Texas, Marshall Division
PLAINTIFF UNILOC USA, INC., and UNILOC LUXEMBOURG, S.A.		DEFENDANT SHORETEL, INC.
PATENT OR TRADEMARK NO.	DATE OF PATENT OR TRADEMARK	HOLDER OF PATENT OR TRADEMARK
1 7,535,890	5/19/2009	UNILOC LUXEMBOURG, S.A.
2 8,995,433	3/31/2015	UNILOC LUXEMBOURG, S.A.
3 8,724,622	5/13/2014	UNILOC LUXEMBOURG, S.A.
4 8,243,723	8/14/2012	UNILOC LUXEMBOURG, S.A.
5		

In the above—entitled case, the following patent(s)/ trademark(s) have been included:

DATE INCLUDED	INCLUDED BY <input type="checkbox"/> Amendment <input type="checkbox"/> Answer <input type="checkbox"/> Cross Bill <input type="checkbox"/> Other Pleading	
PATENT OR TRADEMARK NO.	DATE OF PATENT OR TRADEMARK	HOLDER OF PATENT OR TRADEMARK
1		
2		
3		
4		
5		

In the above—entitled case, the following decision has been rendered or judgement issued:

DECISION/JUDGEMENT

CLERK	(BY) DEPUTY CLERK	DATE
-------	-------------------	------

Copy 1—Upon initiation of action, mail this copy to Director Copy 3—Upon termination of action, mail this copy to Director
 Copy 2—Upon filing document adding patent(s), mail this copy to Director Copy 4—Case file copy

AO 120 (Rev. 08/10)

TO: Mail Stop 8 Director of the U.S. Patent and Trademark Office P.O. Box 1450 Alexandria, VA 22313-1450	REPORT ON THE FILING OR DETERMINATION OF AN ACTION REGARDING A PATENT OR TRADEMARK
---	--

In Compliance with 35 U.S.C. § 290 and/or 15 U.S.C. § 1116 you are hereby advised that a court action has been filed in the U.S. District Court Eastern District of Texas, Marshall Division on the following
 Trademarks or Patents. (the patent action involves 35 U.S.C. § 292.);

DOCKET NO. 2:16-cv-777	DATE FILED 7/15/2016	U.S. DISTRICT COURT Eastern District of Texas, Marshall Division
PLAINTIFF UNILOC USA, INC., and UNILOC LUXEMBOURG, S.A.		DEFENDANT AVAYA INC.,
PATENT OR TRADEMARK NO.	DATE OF PATENT OR TRADEMARK	HOLDER OF PATENT OR TRADEMARK
1 7,535,890	5/19/2009	UNILOC LUXEMBOURG, S.A.
2 8,995,433	3/31/2015	UNILOC LUXEMBOURG, S.A.
3 8,724,622	5/13/2014	UNILOC LUXEMBOURG, S.A.
4 8,243,723	8/14/2012	UNILOC LUXEMBOURG, S.A.
5 8,199,747	6/12/2012	UNILOC LUXEMBOURG, S.A.

In the above—entitled case, the following patent(s)/ trademark(s) have been included:

DATE INCLUDED	INCLUDED BY <input type="checkbox"/> Amendment <input type="checkbox"/> Answer <input type="checkbox"/> Cross Bill <input type="checkbox"/> Other Pleading	
PATENT OR TRADEMARK NO.	DATE OF PATENT OR TRADEMARK	HOLDER OF PATENT OR TRADEMARK
1		
2		
3		
4		
5		

In the above—entitled case, the following decision has been rendered or judgement issued:

DECISION/JUDGEMENT

CLERK	(BY) DEPUTY CLERK	DATE
-------	-------------------	------

Copy 1—Upon initiation of action, mail this copy to Director Copy 3—Upon termination of action, mail this copy to Director
 Copy 2—Upon filing document adding patent(s), mail this copy to Director Copy 4—Case file copy

AO 120 (Rev. 08/10)

TO: Mail Stop 8 Director of the U.S. Patent and Trademark Office P.O. Box 1450 Alexandria, VA 22313-1450	REPORT ON THE FILING OR DETERMINATION OF AN ACTION REGARDING A PATENT OR TRADEMARK
---	--

In Compliance with 35 U.S.C. § 290 and/or 15 U.S.C. § 1116 you are hereby advised that a court action has been filed in the U.S. District Court Eastern District of Texas, Marshall Division on the following

Trademarks or Patents. (the patent action involves 35 U.S.C. § 292.):

DOCKET NO. 2:16-cv-733	DATE FILED 7/5/2016	U.S. DISTRICT COURT Eastern District of Texas, Marshall Division
PLAINTIFF UNILOC USA, INC., and UNILOC LUXEMBOURG, S.A.		DEFENDANT TANGOME, INC. d/b/a TANGO
PATENT OR TRADEMARK NO.	DATE OF PATENT OR TRADEMARK	HOLDER OF PATENT OR TRADEMARK
1 7,535,890	5/19/2009	UNILOC LUXEMBOURG, S.A.
2 8,199,747	6/12/2012	UNILOC LUXEMBOURG, S.A.
3 8,243,723	8/14/2012	UNILOC LUXEMBOURG, S.A.
4 8, 724,622	5/13/2014	UNILOC LUXEMBOURG, S.A.
5 8,995,433	3/31/2015	UNILOC LUXEMBOURG, S.A.

In the above—entitled case, the following patent(s)/ trademark(s) have been included:

DATE INCLUDED	INCLUDED BY <input type="checkbox"/> Amendment <input type="checkbox"/> Answer <input type="checkbox"/> Cross Bill <input type="checkbox"/> Other Pleading	
PATENT OR TRADEMARK NO.	DATE OF PATENT OR TRADEMARK	HOLDER OF PATENT OR TRADEMARK
1		
2		
3		
4		
5		

In the above—entitled case, the following decision has been rendered or judgement issued:

DECISION/JUDGEMENT

CLERK	(BY) DEPUTY CLERK	DATE
-------	-------------------	------

Copy 1—Upon initiation of action, mail this copy to Director Copy 3—Upon termination of action, mail this copy to Director
 Copy 2—Upon filing document adding patent(s), mail this copy to Director Copy 4—Case file copy

AO 120 (Rev. 08/10)

TO: Mail Stop 8 Director of the U.S. Patent and Trademark Office P.O. Box 1450 Alexandria, VA 22313-1450	REPORT ON THE FILING OR DETERMINATION OF AN ACTION REGARDING A PATENT OR TRADEMARK
---	---

In Compliance with 35 U.S.C. § 290 and/or 15 U.S.C. § 1116 you are hereby advised that a court action has been filed in the U.S. District Court Eastern District of Texas, Marshall Division on the following

Trademarks or Patents. (the patent action involves 35 U.S.C. § 292.):

DOCKET NO. 2:16-cv-731	DATE FILED 7/5/2016	U.S. DISTRICT COURT Eastern District of Texas, Marshall Division
PLAINTIFF UNILOC USA, INC., and UNILOC LUXEMBOURG, S.A.		DEFENDANT GREEN TOMATO LIMITED
PATENT OR TRADEMARK NO.	DATE OF PATENT OR TRADEMARK	HOLDER OF PATENT OR TRADEMARK
1 7,535,890	5/19/2009	UNILOC LUXEMBOURG, S.A.
2 8,199,747	6/12/2012	UNILOC LUXEMBOURG, S.A.
3 8,243,723	8/14/2012	UNILOC LUXEMBOURG, S.A.
4 8,724,622	5/13/2014	UNILOC LUXEMBOURG, S.A.
5 8,995,433	3/31/2015	UNILOC LUXEMBOURG, S.A.

In the above—entitled case, the following patent(s)/ trademark(s) have been included:

DATE INCLUDED	INCLUDED BY <input type="checkbox"/> Amendment <input type="checkbox"/> Answer <input type="checkbox"/> Cross Bill <input type="checkbox"/> Other Pleading		
PATENT OR TRADEMARK NO.	DATE OF PATENT OR TRADEMARK	HOLDER OF PATENT OR TRADEMARK	
1			
2			
3			
4			
5			

In the above—entitled case, the following decision has been rendered or judgement issued:

DECISION/JUDGEMENT

CLERK	(BY) DEPUTY CLERK	DATE
-------	-------------------	------

Copy 1—Upon initiation of action, mail this copy to Director Copy 3—Upon termination of action, mail this copy to Director
 Copy 2—Upon filing document adding patent(s), mail this copy to Director Copy 4—Case file copy

AO 120 (Rev. 08/10)

TO: Mail Stop 8 Director of the U.S. Patent and Trademark Office P.O. Box 1450 Alexandria, VA 22313-1450	REPORT ON THE FILING OR DETERMINATION OF AN ACTION REGARDING A PATENT OR TRADEMARK
---	---

In Compliance with 35 U.S.C. § 290 and/or 15 U.S.C. § 1116 you are hereby advised that a court action has been filed in the U.S. District Court Eastern District of Texas, Marshall Division on the following

Trademarks or Patents. (the patent action involves 35 U.S.C. § 292.);

DOCKET NO. 2:16-cv-777	DATE FILED 7/15/2016	U.S. DISTRICT COURT Eastern District of Texas, Marshall Division
PLAINTIFF UNILOC USA, INC., and UNILOC LUXEMBOURG, S.A.		DEFENDANT AVAYA INC.,
PATENT OR TRADEMARK NO.	DATE OF PATENT OR TRADEMARK	HOLDER OF PATENT OR TRADEMARK
1 7,535,890	5/19/2009	UNILOC LUXEMBOURG, S.A.
2 8,995,433	3/31/2015	UNILOC LUXEMBOURG, S.A.
3 8,724,622	5/13/2014	UNILOC LUXEMBOURG, S.A.
4 8,243,723	8/14/2012	UNILOC LUXEMBOURG, S.A.
5 8,199,747	6/12/2012	UNILOC LUXEMBOURG, S.A.

In the above—entitled case, the following patent(s)/ trademark(s) have been included:

DATE INCLUDED	INCLUDED BY <input type="checkbox"/> Amendment <input type="checkbox"/> Answer <input type="checkbox"/> Cross Bill <input type="checkbox"/> Other Pleading	
PATENT OR TRADEMARK NO.	DATE OF PATENT OR TRADEMARK	HOLDER OF PATENT OR TRADEMARK
1		
2		
3		
4		
5		

In the above—entitled case, the following decision has been rendered or judgement issued:

DECISION/JUDGEMENT

CLERK	(BY) DEPUTY CLERK	DATE
-------	-------------------	------

Copy 1—Upon initiation of action, mail this copy to Director Copy 3—Upon termination of action, mail this copy to Director
 Copy 2—Upon filing document adding patent(s), mail this copy to Director Copy 4—Case file copy

AO 120 (Rev. 08/10)

TO: Mail Stop 8 Director of the U.S. Patent and Trademark Office P.O. Box 1450 Alexandria, VA 22313-1450	REPORT ON THE FILING OR DETERMINATION OF AN ACTION REGARDING A PATENT OR TRADEMARK
---	---

In Compliance with 35 U.S.C. § 290 and/or 15 U.S.C. § 1116 you are hereby advised that a court action has been filed in the U.S. District Court Eastern District of Texas, Marshall Division on the following

Trademarks or Patents. (the patent action involves 35 U.S.C. § 292.);

DOCKET NO. 2:16-cv-779	DATE FILED 7/15/2016	U.S. DISTRICT COURT Eastern District of Texas, Marshall Division
PLAINTIFF UNILOC USA, INC., and UNILOC LUXEMBOURG, S.A.		DEFENDANT SHORETEL, INC.
PATENT OR TRADEMARK NO.	DATE OF PATENT OR TRADEMARK	HOLDER OF PATENT OR TRADEMARK
1 7,535,890	5/19/2009	UNILOC LUXEMBOURG, S.A.
2 8,995,433	3/31/2015	UNILOC LUXEMBOURG, S.A.
3 8,724,622	5/13/2014	UNILOC LUXEMBOURG, S.A.
4 8,243,723	8/14/2012	UNILOC LUXEMBOURG, S.A.
5		

In the above—entitled case, the following patent(s)/ trademark(s) have been included:

DATE INCLUDED	INCLUDED BY <input type="checkbox"/> Amendment <input type="checkbox"/> Answer <input type="checkbox"/> Cross Bill <input type="checkbox"/> Other Pleading	
PATENT OR TRADEMARK NO.	DATE OF PATENT OR TRADEMARK	HOLDER OF PATENT OR TRADEMARK
1		
2		
3		
4		
5		

In the above—entitled case, the following decision has been rendered or judgement issued:

DECISION/JUDGEMENT

CLERK	(BY) DEPUTY CLERK	DATE
-------	-------------------	------

Copy 1—Upon initiation of action, mail this copy to Director Copy 3—Upon termination of action, mail this copy to Director
 Copy 2—Upon filing document adding patent(s), mail this copy to Director Copy 4—Case file copy



UNITED STATES PATENT AND TRADEMARK OFFICE

UNITED STATES DEPARTMENT OF COMMERCE
United States Patent and Trademark Office
Address: COMMISSIONER FOR PATENTS
P.O. Box 1450
Alexandria, Virginia 22313-1450
www.uspto.gov

APPLICATION NUMBER	FILING OR 371(C) DATE	FIRST NAMED APPLICANT	ATTY. DOCKET NO./TITLE
10/740,030	12/18/2003	Michael J. Rojas	EMP0021-US

67050
KASHA LAW LLC
14532 Dufief Mill Road
North Potomac, MD 20878

CONFIRMATION NO. 1731
POA ACCEPTANCE LETTER



OC000000063664372

Date Mailed: 09/10/2013

NOTICE OF ACCEPTANCE OF POWER OF ATTORNEY

This is in response to the Power of Attorney filed 08/27/2013.

The Power of Attorney in this application is accepted. Correspondence in this application will be mailed to the above address as provided by 37 CFR 1.33.

/sharris/

Office of Data Management, Application Assistance Unit (571) 272-4000, or (571) 272-4200, or 1-888-786-0101



UNITED STATES PATENT AND TRADEMARK OFFICE

UNITED STATES DEPARTMENT OF COMMERCE
United States Patent and Trademark Office
Address: COMMISSIONER FOR PATENTS
P.O. Box 1450
Alexandria, Virginia 22313-1450
www.uspto.gov

APPLICATION NUMBER	FILING OR 371(C) DATE	FIRST NAMED APPLICANT	ATTY. DOCKET NO./TITLE
10/740,030	12/18/2003	Michael J. Rojas	17188

CONFIRMATION NO. 1731

POWER OF ATTORNEY NOTICE

23389
SCULLY SCOTT MURPHY & PRESSER, PC
400 GARDEN CITY PLAZA
SUITE 300
GARDEN CITY, NY 11530



Date Mailed: 09/10/2013

NOTICE REGARDING CHANGE OF POWER OF ATTORNEY

This is in response to the Power of Attorney filed 08/27/2013.

- The Power of Attorney to you in this application has been revoked by the assignee who has intervened as provided by 37 CFR 3.71. Future correspondence will be mailed to the new address of record(37 CFR 1.33).

/sharris/

Office of Data Management, Application Assistance Unit (571) 272-4000, or (571) 272-4200, or 1-888-786-0101

Under the Paperwork Reduction Act of 1995, no persons are required to respond to a collection of information unless it displays a valid OMB control number.

**POWER OF ATTORNEY
OR
REVOCAION OF POWER OF ATTORNEY
WITH A NEW POWER OF ATTORNEY
AND
CHANGE OF CORRESPONDENCE ADDRESS**

Application Number	10740090
Filing Date	2009-12-19
First Named Inventor	Michael J. Rojas
Title	System and Method for Instant VoIP Message
Art Unit	2814
Examiner Name	Creighton H. Smith
Attorney Docket Number	EMPU021-LIS

I hereby revoke all previous powers of attorney given in the above-identified application.

A Power of Attorney is submitted herewith.

OR

I hereby appoint Practitioner(s) associated with the following Customer Number as my/our attorney(s) or agent(s) to prosecute the application identified above, and to transact all business in the United States Patent and Trademark Office connected therewith:

67050

OR

I hereby appoint Practitioner(s) named below as my/our attorney(s) or agent(s) to prosecute the application identified above, and to transact all business in the United States Patent and Trademark Office connected therewith:

Practitioner(s) Name	Registration Number

Please recognize or change the correspondence address for the above-identified application to:

The address associated with the above-mentioned Customer Number.

OR

The address associated with Customer Number:

OR

Firm or Individual Name

Address:

City

State

Zip

Country

Telephone

Email

I am the:

Applicant/Inventor.

OR

Assignee of record of the entire interest. See 37 CFR 3.71.

Statement under 37 CFR 3.73(b) (Form PTO/SB/96) submitted herewith or filed on _____

SIGNATURE of Applicant or Assignee of Record

Signature		Date	8-23-2010
Name	Daniel Mitry	Telephone	
Title and Company	Principal, Empire IP LLC		

NOTE: Signatures of all the inventors or assignees of record of the entire interest or their representative(s) are required. Submit multiple forms if more than one signature is required, see below.

Total of 1 forms are submitted.

This collection of information is required by 37 CFR 1.31, 1.32 and 1.33. The information is required to obtain or retain a benefit by the public which is to be filed by the USPTO to process an application. Confidentiality is governed by 35 U.S.C. 122 and 37 CFR 1.11 and 1.14. This collection is estimated to take 3 minutes to complete, including gathering, preparing, and submitting the completed application form to the USPTO. Time will vary depending upon the individual case. Any comments on the amount of time you require to complete this form and/or suggestions for reducing this burden, should be sent to the Chief Information Officer, U.S. Patent and Trademark Office, U.S. Department of Commerce, P.O. Box 1450, Alexandria, VA 22313-1450. DO NOT SEND FEES OR COMPLETED FORMS TO THIS ADDRESS. SEND TO: Commissioner for Patents, P.O. Box 1450, Alexandria, VA 22313-1450.

If you need assistance in completing the form, call 1-800-PTO-9199 and select option 2.

Under the Paperwork Reduction Act of 1995, no persons are required to respond to a collection of information unless it displays a valid OMB control number.

STATEMENT UNDER 37 CFR 3.73(b)Applicant/Patent Owner: Empire IP LLCApplication No./Patent No.: 7,535,890Filed/Issue Date: 2009-05-19Titled: System and Method for Instant VoIP Messaging

Empire IP LLC, a Corporation

(Name of Assignee)

(Type of Assignee, e.g., corporation, partnership, university, government agency, etc.)

states that it is:

1. the assignee of the entire right, title, and interest in;
2. an assignee of less than the entire right, title, and interest in
(The extent (by percentage) of its ownership interest is _____ %), or
3. the assignee of an undivided interest in the entirety of (a complete assignment from one of the joint inventors was made)

the patent application/patent identified above, by virtue of either:

- A. An assignment from the inventor(s) of the patent application/patent identified above. The assignment was recorded in the United States Patent and Trademark Office at Reel _____, Frame _____, or for which a copy therefore is attached.

OR

- B. A chain of title from the inventor(s), of the patent application/patent identified above, to the current assignee as follows:

1. From: Rojas, Michael J. To: Ayalogic, Inc.The document was recorded in the United States Patent and Trademark Office at
Reel 014827, Frame 0359, or for which a copy thereof is attached.2. From: Ayalogic, Inc. To: Empire IP LLCThe document was recorded in the United States Patent and Trademark Office at
Reel 030922, Frame 0335, or for which a copy thereof is attached.

3. From: _____ To: _____

The document was recorded in the United States Patent and Trademark Office at
Reel _____, Frame _____, or for which a copy thereof is attached. Additional documents in the chain of title are listed on a supplemental sheet(s). As required by 37 CFR 3.73(b)(1)(i), the documentary evidence of the chain of title from the original owner to the assignee was, or concurrently is being, submitted for recordation pursuant to 37 CFR 3.11.

(NOTE: A separate copy (i.e., a true copy of the original assignment document(s)) must be submitted to Assignment Division in accordance with 37 CFR Part 3, to record the assignment in the records of the USPTO. See MPEP 302.06)

The undersigned (whose title is supplied below) is authorized to act on behalf of the assignee.

Signature

Date

Daniel Mitry

Principal

Printed or Typed Name

Title

This collection of information is required by 37 CFR 3.73(b). The information is required to obtain or retain a benefit by the public which is to file (and by the USPTO to process) an application. Confidentiality is governed by 35 U.S.C. 122 and 37 CFR 1.11 and 1.14. This collection is estimated to take 12 minutes to complete, including gathering, preparing, and submitting the completed application form to the USPTO. Time will vary depending upon the individual case. Any comments on the amount of time you require to complete this form and/or suggestions for reducing this burden, should be sent to the Chief Information Officer, U.S. Patent and Trademark Office, U.S. Department of Commerce, P.O. Box 1480, Alexandria, VA 22313-1480. DO NOT SEND FEES OR COMPLETED FORMS TO THIS ADDRESS. SEND TO: Commissioner for Patents, P.O. Box 1480, Alexandria, VA 22313-1480.

If you need assistance in completing the form, call 1-800-PTO-9198 and select option 2.

Electronic Acknowledgement Receipt

EFS ID:	16696004
Application Number:	10740030
International Application Number:	
Confirmation Number:	1731
Title of Invention:	SYSTEM AND METHOD FOR INSTANT VOIP MESSAGING
First Named Inventor/Applicant Name:	Michael J. Rojas
Customer Number:	23389
Filer:	John Kasha
Filer Authorized By:	
Attorney Docket Number:	17188
Receipt Date:	27-AUG-2013
Filing Date:	18-DEC-2003
Time Stamp:	13:36:56
Application Type:	Utility under 35 USC 111(a)

Payment information:

Submitted with Payment	no
------------------------	----

File Listing:

Document Number	Document Description	File Name	File Size(Bytes)/ Message Digest	Multi Part /.zip	Pages (if appl.)
1	Power of Attorney	EMP0021-US_poa_signed1.pdf	384208 <small>c7dc5435967b29f44f0fd86261e8559f5cd868</small>	no	2

Warnings:

Information:

This Acknowledgement Receipt evidences receipt on the noted date by the USPTO of the indicated documents, characterized by the applicant, and including page counts, where applicable. It serves as evidence of receipt similar to a Post Card, as described in MPEP 503.

New Applications Under 35 U.S.C. 111

If a new application is being filed and the application includes the necessary components for a filing date (see 37 CFR 1.53(b)-(d) and MPEP 506), a Filing Receipt (37 CFR 1.54) will be issued in due course and the date shown on this Acknowledgement Receipt will establish the filing date of the application.

National Stage of an International Application under 35 U.S.C. 371

If a timely submission to enter the national stage of an international application is compliant with the conditions of 35 U.S.C. 371 and other applicable requirements a Form PCT/DO/EO/903 indicating acceptance of the application as a national stage submission under 35 U.S.C. 371 will be issued in addition to the Filing Receipt, in due course.

New International Application Filed with the USPTO as a Receiving Office

If a new international application is being filed and the international application includes the necessary components for an international filing date (see PCT Article 11 and MPEP 1810), a Notification of the International Application Number and of the International Filing Date (Form PCT/RO/105) will be issued in due course, subject to prescriptions concerning national security, and the date shown on this Acknowledgement Receipt will establish the international filing date of the application.



UNITED STATES PATENT AND TRADEMARK OFFICE

UNITED STATES DEPARTMENT OF COMMERCE
United States Patent and Trademark Office
Address: COMMISSIONER FOR PATENTS
P.O. Box 1450
Alexandria, Virginia 22313-1450
www.uspto.gov

Table with 5 columns: APPLICATION NO., ISSUE DATE, PATENT NO., ATTORNEY DOCKET NO., CONFIRMATION NO.
Row 1: 10/740,030, 05/19/2009, 7535890, 17188, 1731

23389 7590 04/29/2009
SCULLY SCOTT MURPHY & PRESSER, PC
400 GARDEN CITY PLAZA
SUITE 300
GARDEN CITY, NY 11530

ISSUE NOTIFICATION

The projected patent number and issue date are specified above.

Determination of Patent Term Adjustment under 35 U.S.C. 154 (b)
(application filed on or after May 29, 2000)

The Patent Term Adjustment is 799 day(s). Any patent to issue from the above-identified application will include an indication of the adjustment on the front page.

If a Continued Prosecution Application (CPA) was filed in the above-identified application, the filing date that determines Patent Term Adjustment is the filing date of the most recent CPA.

Applicant will be able to obtain more detailed information by accessing the Patent Application Information Retrieval (PAIR) WEB site (http://pair.uspto.gov).

Any questions regarding the Patent Term Extension or Adjustment determination should be directed to the Office of Patent Legal Administration at (571)-272-7702. Questions relating to issue and publication fee payments should be directed to the Customer Service Center of the Office of Patent Publication at (571)-272-4200.

APPLICANT(s) (Please see PAIR WEB site http://pair.uspto.gov for additional applicants):

Michael J. Rojas, North Canton, OH;



UNITED STATES PATENT AND TRADEMARK OFFICE

UNITED STATES DEPARTMENT OF COMMERCE
United States Patent and Trademark Office
Address: COMMISSIONER FOR PATENTS
P.O. Box 1450
Alexandria, Virginia 22313-1450
www.uspto.gov

Table with 5 columns: APPLICATION NO., FILING DATE, FIRST NAMED INVENTOR, ATTORNEY DOCKET NO., CONFIRMATION NO.

10/740,030 12/18/2003 Michael J. Rojas 17188 1731

23389 7590 04/22/2009
SCULLY SCOTT MURPHY & PRESSER, PC
400 GARDEN CITY PLAZA
SUITE 300
GARDEN CITY, NY 11530

Table with 1 column: EXAMINER

SMITH, CREIGHTON H

Table with 2 columns: ART UNIT, PAPER NUMBER

2614

Table with 2 columns: MAIL DATE, DELIVERY MODE

04/22/2009 PAPER

Please find below and/or attached an Office communication concerning this application or proceeding.

The time period for reply, if any, is set in the attached communication.

Notice of Allowability	Application No.	Applicant(s)	
	10/740,030	ROJAS, MICHAEL J.	
	Examiner	Art Unit	
	CREIGHTON SMITH	2614	

-- The MAILING DATE of this communication appears on the cover sheet with the correspondence address--

All claims being allowable, PROSECUTION ON THE MERITS IS (OR REMAINS) CLOSED in this application. If not included herewith (or previously mailed), a Notice of Allowance (PTOL-85) or other appropriate communication will be mailed in due course. **THIS NOTICE OF ALLOWABILITY IS NOT A GRANT OF PATENT RIGHTS.** This application is subject to withdrawal from issue at the initiative of the Office or upon petition by the applicant. See 37 CFR 1.313 and MPEP 1308.

1. This communication is responsive to *ids filed on 02.27.09.*
2. The allowed claim(s) is/are 1-5,7-20,22-35,37-45,47-57,59-69 and 71-76.
3. Acknowledgment is made of a claim for foreign priority under 35 U.S.C. § 119(a)-(d) or (f).
 - a) All b) Some* c) None of the:
 1. Certified copies of the priority documents have been received.
 2. Certified copies of the priority documents have been received in Application No. _____ .
 3. Copies of the certified copies of the priority documents have been received in this national stage application from the International Bureau (PCT Rule 17.2(a)).

* Certified copies not received: _____.

Applicant has THREE MONTHS FROM THE "MAILING DATE" of this communication to file a reply complying with the requirements noted below. Failure to timely comply will result in ABANDONMENT of this application.
THIS THREE-MONTH PERIOD IS NOT EXTENDABLE.

4. A SUBSTITUTE OATH OR DECLARATION must be submitted. Note the attached EXAMINER'S AMENDMENT or NOTICE OF INFORMAL PATENT APPLICATION (PTO-152) which gives reason(s) why the oath or declaration is deficient.
5. CORRECTED DRAWINGS (as "replacement sheets") must be submitted.
 - (a) including changes required by the Notice of Draftsperson's Patent Drawing Review (PTO-948) attached
 - 1) hereto or 2) to Paper No./Mail Date _____.
 - (b) including changes required by the attached Examiner's Amendment / Comment or in the Office action of Paper No./Mail Date _____.

Identifying indicia such as the application number (see 37 CFR 1.84(c)) should be written on the drawings in the front (not the back) of each sheet. Replacement sheet(s) should be labeled as such in the header according to 37 CFR 1.121(d).
6. DEPOSIT OF and/or INFORMATION about the deposit of BIOLOGICAL MATERIAL must be submitted. Note the attached Examiner's comment regarding REQUIREMENT FOR THE DEPOSIT OF BIOLOGICAL MATERIAL.

Attachment(s)

- | | |
|--|--|
| <ol style="list-style-type: none"> 1. <input type="checkbox"/> Notice of References Cited (PTO-892) 2. <input type="checkbox"/> Notice of Draftsperson's Patent Drawing Review (PTO-948) 3. <input checked="" type="checkbox"/> Information Disclosure Statements (PTO/SB/08),
Paper No./Mail Date <u>02.27.09</u> 4. <input type="checkbox"/> Examiner's Comment Regarding Requirement for Deposit of Biological Material | <ol style="list-style-type: none"> 5. <input type="checkbox"/> Notice of Informal Patent Application 6. <input type="checkbox"/> Interview Summary (PTO-413),
Paper No./Mail Date _____ . 7. <input type="checkbox"/> Examiner's Amendment/Comment 8. <input type="checkbox"/> Examiner's Statement of Reasons for Allowance 9. <input type="checkbox"/> Other _____. |
|--|--|

/CREIGHTON SMITH/
Primary Examiner, Art Unit 2614

15 APR '09

Form PTO-1449 U.S. DEPARTMENT OF COMMERCE (REV. 7-80) PATENT AND TRADEMARK OFFICE		Atty. Docket No. (Optional) 17188		Application Number 10/740,030				
INFORMATION DISCLOSURE CITATION (Use several sheets if necessary)								
Applicant(s) Michael Rojas								
Filing Date December 18, 2003				Group Art Unit 2614				
U.S. PATENT DOCUMENTS								
EXAMINER INITIAL*		DOCUMENT NUMBER	DATE	NAME	CLASS	SUBCLASS	FILING DATE (if appropriate)	
	AA							
	AB							
	AC							
FOREIGN PATENT DOCUMENTS								
	REF	DOCUMENT NUMBER	DATE	COUNTRY	CLASS	SUBCLASS	TRANSLATION	
							YES	NO
OTHER DOCUMENTS (Including Author, Title, Date, Pertinent Pages, Etc.)								
		http://www.cisco.com/warp/public/cc/pd/nemnsw/callmn/prodlit/cm33_ds.htm ; "Data Sheet Cisco CallManager Version 3.3", November 22, 2002.						
		http://www.cisco.com/en/US/products/hw/switches/ps1925/products_data_sheet_09186_a00800a3c3d.html ; "Data Sheet Cisco MGX 8000 Series" (date unknown).						
		http://www.hsteliann.com/english/?zone=3100-V21P ; "Telephone 3100-V21P", 2003.						
		http://www.linuxdevices.com/articles/AT5199947519.html ; "Device Profile: snom 100 VoIP phone", May 15, 2002.						
		http://www.pingtel.com/pr_xpressa.jsp ; "No limits with the advanced industry standard SIP phone; December 8, 2003.						
		AudioCoded Enabling Technology Products, TPM-1100 VoP Media Gateway Modules, copyright 2003.						
EXAMINER /Creighton Smith/			DATE CONSIDERED 04/15/2009					
* EXAMINER: Initial if reference considered, whether or not citation is in conformance with MPEP 609; draw line through citation if not in conformance and not considered. Include copy of this form with next communication to applicant.								



UNITED STATES PATENT AND TRADEMARK OFFICE

UNITED STATES DEPARTMENT OF COMMERCE
United States Patent and Trademark Office
Address: COMMISSIONER FOR PATENTS
P.O. Box 1450
Alexandria, Virginia 22313-1450
www.uspto.gov

Table with 5 columns: APPLICATION NO., FILING DATE, FIRST NAMED INVENTOR, ATTORNEY DOCKET NO., CONFIRMATION NO.

10/740,030 12/18/2003 Michael J. Rojas 17188 1731

23389 7590 04/16/2009
SCULLY SCOTT MURPHY & PRESSER, PC
400 GARDEN CITY PLAZA
SUITE 300
GARDEN CITY, NY 11530

Table with 1 column: EXAMINER

SMITH, CREIGHTON H

Table with 2 columns: ART UNIT, PAPER NUMBER

2614

Table with 2 columns: MAIL DATE, DELIVERY MODE

04/16/2009 PAPER

Please find below and/or attached an Office communication concerning this application or proceeding.

The time period for reply, if any, is set in the attached communication.

supplemental Notice of Allowability	Application No.	Applicant(s)	
	10/740,030	ROJAS, MICHAEL J.	
	Examiner	Art Unit	
	CREIGHTON SMITH	2614	

-- The MAILING DATE of this communication appears on the cover sheet with the correspondence address--

All claims being allowable, PROSECUTION ON THE MERITS IS (OR REMAINS) CLOSED in this application. If not included herewith (or previously mailed), a Notice of Allowance (PTOL-85) or other appropriate communication will be mailed in due course. **THIS NOTICE OF ALLOWABILITY IS NOT A GRANT OF PATENT RIGHTS.** This application is subject to withdrawal from issue at the initiative of the Office or upon petition by the applicant. See 37 CFR 1.313 and MPEP 1308.

1. This communication is responsive to *ids filed on 27 FEB '09*.
2. The allowed claim(s) is/are 1-5,7-20,22-35,37-45,47-57,59-69 and 71-76.
3. Acknowledgment is made of a claim for foreign priority under 35 U.S.C. § 119(a)-(d) or (f).
 - a) All b) Some* c) None of the:
 1. Certified copies of the priority documents have been received.
 2. Certified copies of the priority documents have been received in Application No. _____ .
 3. Copies of the certified copies of the priority documents have been received in this national stage application from the International Bureau (PCT Rule 17.2(a)).

* Certified copies not received: _____.

Applicant has THREE MONTHS FROM THE "MAILING DATE" of this communication to file a reply complying with the requirements noted below. Failure to timely comply will result in ABANDONMENT of this application.
THIS THREE-MONTH PERIOD IS NOT EXTENDABLE.

4. A SUBSTITUTE OATH OR DECLARATION must be submitted. Note the attached EXAMINER'S AMENDMENT or NOTICE OF INFORMAL PATENT APPLICATION (PTO-152) which gives reason(s) why the oath or declaration is deficient.
5. CORRECTED DRAWINGS (as "replacement sheets") must be submitted.
 - (a) including changes required by the Notice of Draftsperson's Patent Drawing Review (PTO-948) attached
 - 1) hereto or 2) to Paper No./Mail Date _____.
 - (b) including changes required by the attached Examiner's Amendment / Comment or in the Office action of Paper No./Mail Date _____.

Identifying indicia such as the application number (see 37 CFR 1.84(c)) should be written on the drawings in the front (not the back) of each sheet. Replacement sheet(s) should be labeled as such in the header according to 37 CFR 1.121(d).
6. DEPOSIT OF and/or INFORMATION about the deposit of BIOLOGICAL MATERIAL must be submitted. Note the attached Examiner's comment regarding REQUIREMENT FOR THE DEPOSIT OF BIOLOGICAL MATERIAL.

Attachment(s)

- | | |
|--|---|
| 1. <input type="checkbox"/> Notice of References Cited (PTO-892) | 5. <input type="checkbox"/> Notice of Informal Patent Application |
| 2. <input type="checkbox"/> Notice of Draftsperson's Patent Drawing Review (PTO-948) | 6. <input type="checkbox"/> Interview Summary (PTO-413),
Paper No./Mail Date _____ . |
| 3. <input checked="" type="checkbox"/> Information Disclosure Statements (PTO/SB/08),
Paper No./Mail Date <u>02.27.09</u> | 7. <input type="checkbox"/> Examiner's Amendment/Comment |
| 4. <input type="checkbox"/> Examiner's Comment Regarding Requirement for Deposit
of Biological Material | 8. <input type="checkbox"/> Examiner's Statement of Reasons for Allowance |
| | 9. <input type="checkbox"/> Other _____. |

/CREIGHTON SMITH/
Primary Examiner, Art Unit 2614

15 APR '09

Form PTO-1449 U.S. DEPARTMENT OF COMMERCE (REV. 7-80) PATENT AND TRADEMARK OFFICE		Atty. Docket No. (Optional) 17188		Application Number 10/740,030				
INFORMATION DISCLOSURE CITATION (Use several sheets if necessary)								
Applicant(s) Michael Rojas								
Filing Date December 18, 2003				Group Art Unit 2614				
U.S. PATENT DOCUMENTS								
EXAMINER INITIAL*		DOCUMENT NUMBER	DATE	NAME	CLASS	SUBCLASS	FILING DATE (if appropriate)	
	AA							
	AB							
	AC							
FOREIGN PATENT DOCUMENTS								
	REF	DOCUMENT NUMBER	DATE	COUNTRY	CLASS	SUBCLASS	TRANSLATION	
							YES	NO
OTHER DOCUMENTS (Including Author, Title, Date, Pertinent Pages, Etc.)								
		http://www.cisco.com/warp/public/cc/pd/nemnsw/callmn/prodlit/cm33_ds.htm ; "Data Sheet Cisco CallManager Version 3.3", November 22, 2002.						
		http://www.cisco.com/en/US/products/hw/switches/ps1925/products_data_sheet_09186a00800a3c3d.html ; "Data Sheet Cisco MGX 8000 Series" (date unknown).						
		http://www.hsteliann.com/english/?zone=3100-V21P ; "Telephone 3100-V21P", 2003.						
		http://www.linuxdevices.com/articles/AT5199947519.html ; "Device Profile: snom 100 VoIP phone", May 15, 2002.						
		http://www.pingtel.com/pr_xpressa.jsp ; "No limits with the advanced industry standard SIP phone; December 8, 2003.						
		AudioCoded Enabling Technology Products, TPM-1100 VoP Media Gateway Modules, copyright 2003.						
EXAMINER /Creighton Smith/				DATE CONSIDERED 03/04/2009				
* EXAMINER: Initial if reference considered, whether or not citation is in conformance with MPEP 609; draw line through citation if not in conformance and not considered. Include copy of this form with next communication to applicant.								

Please enter this IDS.

CHS 04 MAR '09

J:\Work\1732\17188\Misc\supplemental1449.doc

ALL REFERENCES CONSIDERED EXCEPT WHERE LINED THROUGH. /C.S./

PART B - FEE(S) TRANSMITTAL

Complete and send this form, together with applicable fee(s), to: **Mail** Mail Stop ISSUE FEE
Commissioner for Patents
P.O. Box 1450
Alexandria, Virginia 22313-1450
or Fax (571)-273-2885

INSTRUCTIONS: This form should be used for transmitting the ISSUE FEE and PUBLICATION FEE (if required). Blocks 1 through 5 should be completed where appropriate. All further correspondence including the Patent, advance orders and notification of maintenance fees will be mailed to the current correspondence address as indicated unless corrected below or directed otherwise in Block 1, by (a) specifying a new correspondence address; and/or (b) indicating a separate "FEE ADDRESS" for maintenance fee notifications.

CURRENT CORRESPONDENCE ADDRESS (Note: Use Block 1 for any change of address)

Note: A certificate of mailing can only be used for domestic mailings of the Fee(s) Transmittal. This certificate cannot be used for any other accompanying papers. Each additional paper, such as an assignment or formal drawing, must have its own certificate of mailing or transmission.

23389 7590 12/05/2008
SCULLY SCOTT MURPHY & PRESSER, PC
400 GARDEN CITY PLAZA
SUITE 300
GARDEN CITY, NY 11530

Certificate of Mailing or Transmission

I hereby certify that this Fee(s) Transmittal is being deposited with the United States Postal Service with sufficient postage for first class mail in an envelope addressed to the Mail Stop ISSUE FEE address above, or being facsimile transmitted to the USPTO (571) 273-2885, on the date indicated below.

_____ (Depositor's name)
_____ (Signature)
_____ (Date)

APPLICATION NO.	FILING DATE	FIRST NAMED INVENTOR	ATTORNEY DOCKET NO.	CONFIRMATION NO.
10/740,030	12/18/2003	Michael J. Rojas	17188	1731

TITLE OF INVENTION: SYSTEM AND METHOD FOR INSTANT VOIP MESSAGING

APPLN. TYPE	SMALL ENTITY	ISSUE FEE DUE	PUBLICATION FEE DUE	PREV. PAID ISSUE FEE	TOTAL FEE(S) DUE	DATE DUE
nonprovisional	YES	\$755	\$300	\$0	\$1055	03/05/2009

EXAMINER	ART UNIT	CLASS-SUBCLASS
SMITH, CREIGHTON H	2614	370-352000

1. Change of correspondence address or indication of "Fee Address" (37 CFR 1.363).
 Change of correspondence address (or Change of Correspondence Address form PTO/SB/122) attached.
 "Fee Address" indication (or "Fee Address" Indication form PTO/SB/47; Rev 03-02 or more recent) attached. Use of a Customer Number is required.

2. For printing on the patent front page, list
 (1) the names of up to 3 registered patent attorneys or agents OR, alternatively,
 (2) the name of a single firm (having as a member a registered attorney or agent) and the names of up to 2 registered patent attorneys or agents. If no name is listed, no name will be printed.

1 Scully, Scott, Murphy
 2 & Presser, P.C.
 3 _____

3. ASSIGNEE NAME AND RESIDENCE DATA TO BE PRINTED ON THE PATENT (print or type)
 PLEASE NOTE: Unless an assignee is identified below, no assignee data will appear on the patent. If an assignee is identified below, the document has been filed for recordation as set forth in 37 CFR 3.111. Completion of this form is NOT a substitute for filing an assignment.

(A) NAME OF ASSIGNEE (B) RESIDENCE: (CITY and STATE OR COUNTRY)
Ayalogic, Inc. **Akron, Ohio**

Please check the appropriate assignee category or categories (will not be printed on the patent) : Individual Corporation or other private group entity Government

4a. The following fee(s) are submitted:
 Issue Fee
 Publication Fee (No small entity discount permitted)
 Advance Order - # of Copies _____

4b. Payment of Fee(s): (Please first reapply any previously paid issue fee shown above)
 A check is enclosed.
 Payment by credit card. Form PTO-2038 is attached.
 The Director is hereby authorized to charge the required fee(s), any deficiency, or credit any overpayment, to Deposit Account Number _____ (enclose an extra copy of this form).

5. Change in Entity Status (from status indicated above)
 a. Applicant claims SMALL ENTITY status. See 37 CFR 1.27. b. Applicant is no longer claiming SMALL ENTITY status. See 37 CFR 1.27(g)(2).

NOTE: The Issue Fee and Publication Fee (if required) will not be accepted from anyone other than the applicant; a registered attorney or agent; or the assignee or other party in interest as shown by the records of the United States Patent and Trademark Office.

Authorized Signature _____ Date March 5, 2009
 Typed or printed name Paul J. Esatto, Jr. Registration No. 30,749

This collection of information is required by 37 CFR 1.311. The information is required to obtain or retain a benefit by the public which is to file (and by the USPTO to process) an application. Confidentiality is governed by 35 U.S.C. 122 and 37 CFR 1.14. This collection is estimated to take 12 minutes to complete, including gathering, preparing, and submitting the completed application form to the USPTO. Time will vary depending upon the individual case. Any comments on the amount of time you require to complete this form and/or suggestions for reducing this burden, should be sent to the Chief Information Officer, U.S. Patent and Trademark Office, U.S. Department of Commerce, P.O. Box 1450, Alexandria, Virginia 22313-1450. DO NOT SEND FEES OR COMPLETED FORMS TO THIS ADDRESS. SEND TO: Commissioner for Patents, P.O. Box 1450, Alexandria, Virginia 22313-1450.

Under the Paperwork Reduction Act of 1995, no persons are required to respond to a collection of information unless it displays a valid OMB control number.

Electronic Patent Application Fee Transmittal

Application Number:	10740030			
Filing Date:	18-Dec-2003			
Title of Invention:	SYSTEM AND METHOD FOR INSTANT VOIP MESSAGING			
First Named Inventor/Applicant Name:	Michael J. Rojas			
Filer:	Paul J. Esatto/Roseann Gallo			
Attorney Docket Number:	17188			
Filed as Small Entity				
Utility under 35 USC 111(a) Filing Fees				
Description	Fee Code	Quantity	Amount	Sub-Total in USD(\$)
Basic Filing:				
Pages:				
Claims:				
Miscellaneous-Filing:				
Petition:				
Patent-Appeals-and-Interference:				
Post-Allowance-and-Post-Issuance:				
Utility Appl issue fee	2501	1	755	755
Publ. Fee- early, voluntary, or normal	1504	1	300	300

Description	Fee Code	Quantity	Amount	Sub-Total in USD(\$)
Extension-of-Time:				
Miscellaneous:				
Total in USD (\$)				1055

Electronic Acknowledgement Receipt

EFS ID:	4910739
Application Number:	10740030
International Application Number:	
Confirmation Number:	1731
Title of Invention:	SYSTEM AND METHOD FOR INSTANT VOIP MESSAGING
First Named Inventor/Applicant Name:	Michael J. Rojas
Customer Number:	23389
Filer:	Paul J. Esatto/Roseann Gallo
Filer Authorized By:	Paul J. Esatto
Attorney Docket Number:	17188
Receipt Date:	05-MAR-2009
Filing Date:	18-DEC-2003
Time Stamp:	14:46:57
Application Type:	Utility under 35 USC 111(a)

Payment information:

Submitted with Payment	yes
Payment Type	Deposit Account
Payment was successfully received in RAM	\$1055
RAM confirmation Number	210
Deposit Account	191013
Authorized User	

The Director of the USPTO is hereby authorized to charge indicated fees and credit any overpayment as follows:

Charge any Additional Fees required under 37 C.F.R. Section 1.16 (National application filing, search, and examination fees)

Charge any Additional Fees required under 37 C.F.R. Section 1.17 (Patent application and reexamination processing fees)

File Listing:					
Document Number	Document Description	File Name	File Size(Bytes)/ Message Digest	Multi Part /.zip	Pages (if appl.)
1	Issue Fee Payment (PTO-85B)	17188ISSUEFEE.pdf	110917	no	1
			e29ffedc3b5caca2f2525898457f5155a55a1b48		
Warnings:					
Information:					
2	Fee Worksheet (PTO-06)	fee-info.pdf	31539	no	2
			54cde0d55e656e647b7e751ab3273ed08b297f6b		
Warnings:					
Information:					
Total Files Size (in bytes):			142456		
<p>This Acknowledgement Receipt evidences receipt on the noted date by the USPTO of the indicated documents, characterized by the applicant, and including page counts, where applicable. It serves as evidence of receipt similar to a Post Card, as described in MPEP 503.</p> <p><u>New Applications Under 35 U.S.C. 111</u> If a new application is being filed and the application includes the necessary components for a filing date (see 37 CFR 1.53(b)-(d) and MPEP 506), a Filing Receipt (37 CFR 1.54) will be issued in due course and the date shown on this Acknowledgement Receipt will establish the filing date of the application.</p> <p><u>National Stage of an International Application under 35 U.S.C. 371</u> If a timely submission to enter the national stage of an international application is compliant with the conditions of 35 U.S.C. 371 and other applicable requirements a Form PCT/DO/EO/903 indicating acceptance of the application as a national stage submission under 35 U.S.C. 371 will be issued in addition to the Filing Receipt, in due course.</p> <p><u>New International Application Filed with the USPTO as a Receiving Office</u> If a new international application is being filed and the international application includes the necessary components for an international filing date (see PCT Article 11 and MPEP 1810), a Notification of the International Application Number and of the International Filing Date (Form PCT/RO/105) will be issued in due course, subject to prescriptions concerning national security, and the date shown on this Acknowledgement Receipt will establish the international filing date of the application.</p>					

TRANSMITTAL OF FORMAL DRAWINGS

Docket No.

17188

In Re Application Of: **Michael J. Rojas**

Application No.	Filing Date	Examiner	Customer No.	Group Art Unit	Confirmation No.
10/740,030	December 18, 2003	Creighton H. Smith	23389	2614	1731

Invention: **SYSTEM AND METHOD FOR INSTANT VOIP MESSAGING**

Address to:
**Commissioner for Patents
P.O. Box 1450
Alexandria, VA 22313-1450**

Transmitted herewith are:

9 sheets of formal drawing(s) for this application.

Each sheet of drawing indicates the identifying indicia suggested in 37 CFR Section 1.84(c).

Signature

Seth Weinfeld
Registration No.: 50,929
Scully, Scott, Murphy & Presser, P.C.
400 Garden City Plaza - Suite 300
Garden City, New York 11530
(516) 742-4343

Dated: **March 4, 2009**

I hereby certify that this correspondence is being deposited with the United States Postal Service with sufficient postage as first class mail in an envelope addressed to "Commissioner for Patents, P.O. Box 1450, Alexandria, VA 22313-1450" [37 CFR 1.8(a)] on

(Date)

Signature of Person Mailing Correspondence

Typed or Printed Name of Person Mailing Correspondence

P23B/REV03

Electronic Acknowledgement Receipt

EFS ID:	4905745
Application Number:	10740030
International Application Number:	
Confirmation Number:	1731
Title of Invention:	SYSTEM AND METHOD FOR INSTANT VOIP MESSAGING
First Named Inventor/Applicant Name:	Michael J. Rojas
Customer Number:	23389
Filer:	Seth Weinfeld/Roseann Gallo
Filer Authorized By:	Seth Weinfeld
Attorney Docket Number:	17188
Receipt Date:	04-MAR-2009
Filing Date:	18-DEC-2003
Time Stamp:	18:20:16
Application Type:	Utility under 35 USC 111(a)

Payment information:

Submitted with Payment	no
------------------------	----

File Listing:

Document Number	Document Description	File Name	File Size(Bytes)/ Message Digest	Multi Part /.zip	Pages (if appl.)
1	Drawings-only black and white line drawings	17188formaldrawings.pdf	529689 <small>3e39aeaac05cc875d8c9b440a417396ccdf3d8d</small>	no	9

Warnings:

Information:

2	Miscellaneous Incoming Letter	17188Transmittal.pdf	38729 <small>15edf4f36260aee585dd293d42104d4aceb b790</small>	no	1
Warnings:					
Information:					
Total Files Size (in bytes):				568418	
<p>This Acknowledgement Receipt evidences receipt on the noted date by the USPTO of the indicated documents, characterized by the applicant, and including page counts, where applicable. It serves as evidence of receipt similar to a Post Card, as described in MPEP 503.</p> <p><u>New Applications Under 35 U.S.C. 111</u> If a new application is being filed and the application includes the necessary components for a filing date (see 37 CFR 1.53(b)-(d) and MPEP 506), a Filing Receipt (37 CFR 1.54) will be issued in due course and the date shown on this Acknowledgement Receipt will establish the filing date of the application.</p> <p><u>National Stage of an International Application under 35 U.S.C. 371</u> If a timely submission to enter the national stage of an international application is compliant with the conditions of 35 U.S.C. 371 and other applicable requirements a Form PCT/DO/EO/903 indicating acceptance of the application as a national stage submission under 35 U.S.C. 371 will be issued in addition to the Filing Receipt, in due course.</p> <p><u>New International Application Filed with the USPTO as a Receiving Office</u> If a new international application is being filed and the international application includes the necessary components for an international filing date (see PCT Article 11 and MPEP 1810), a Notification of the International Application Number and of the International Filing Date (Form PCT/RO/105) will be issued in due course, subject to prescriptions concerning national security, and the date shown on this Acknowledgement Receipt will establish the international filing date of the application.</p>					

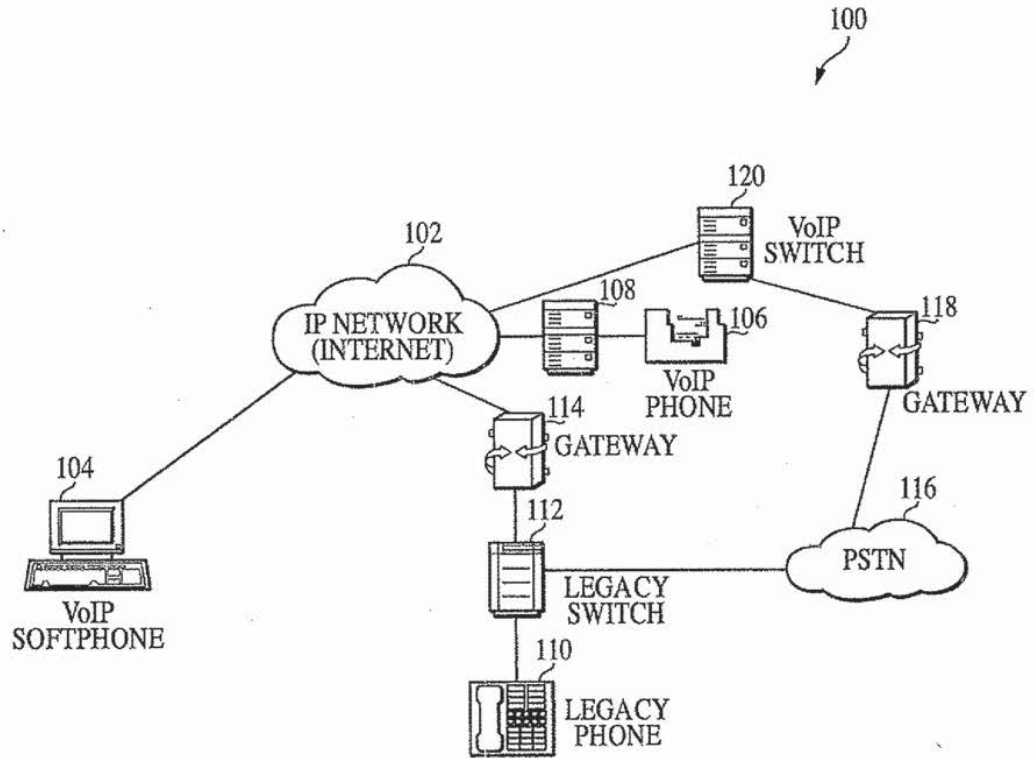

FIG. 1
(PRIOR ART)

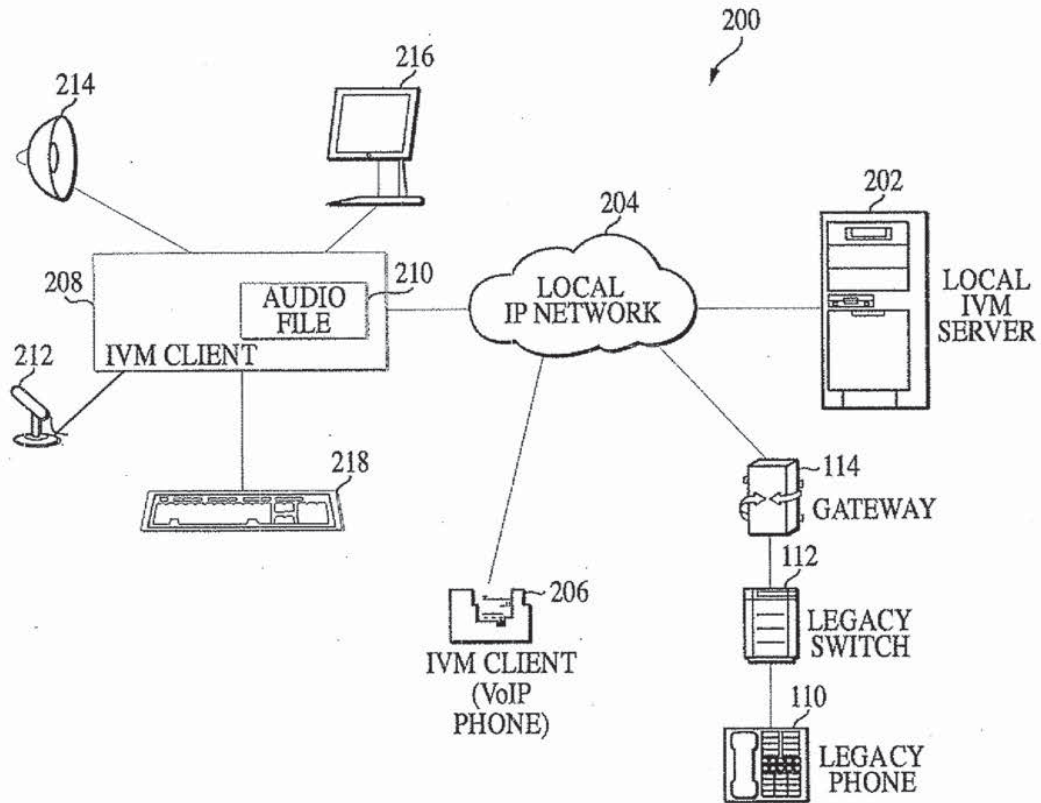

FIG. 2

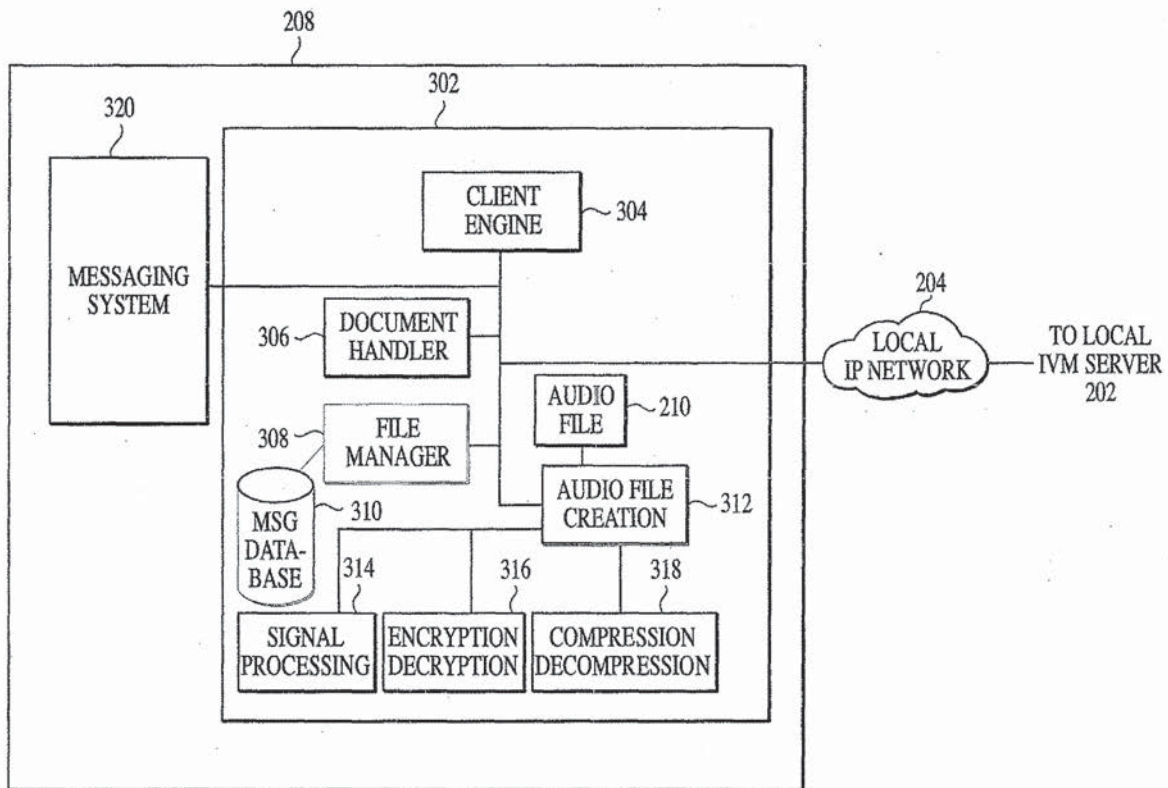

FIG. 3

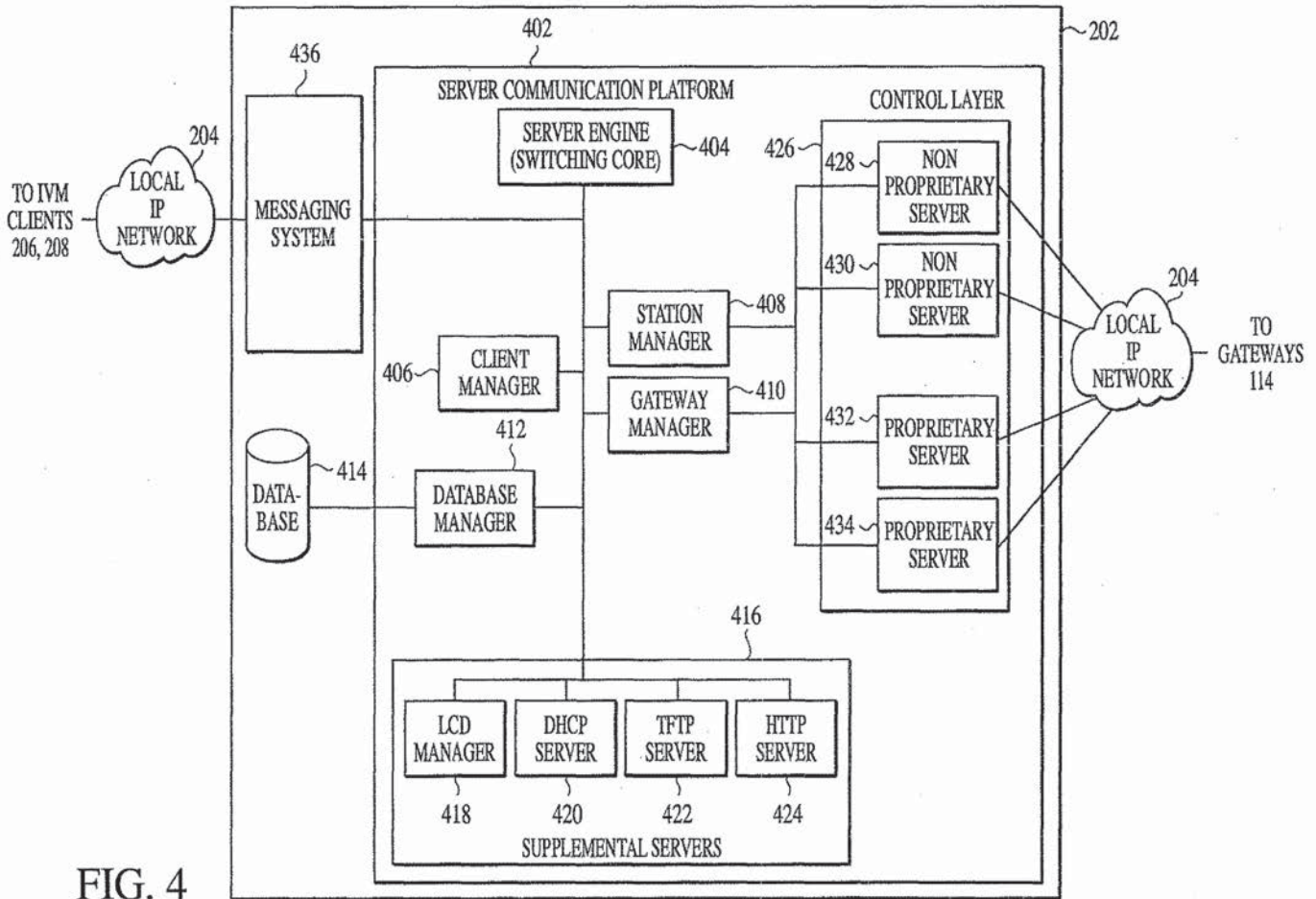
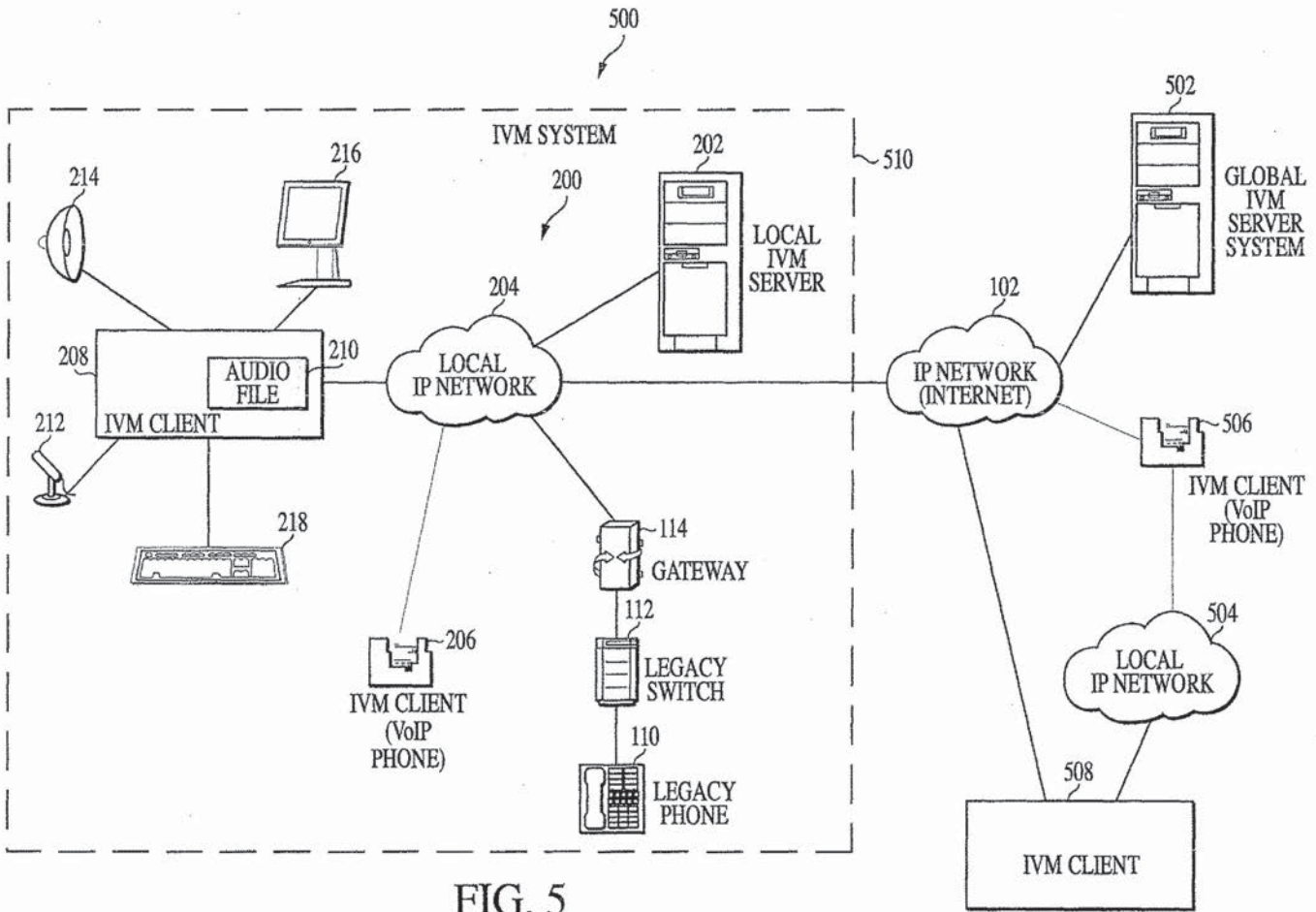

FIG. 4



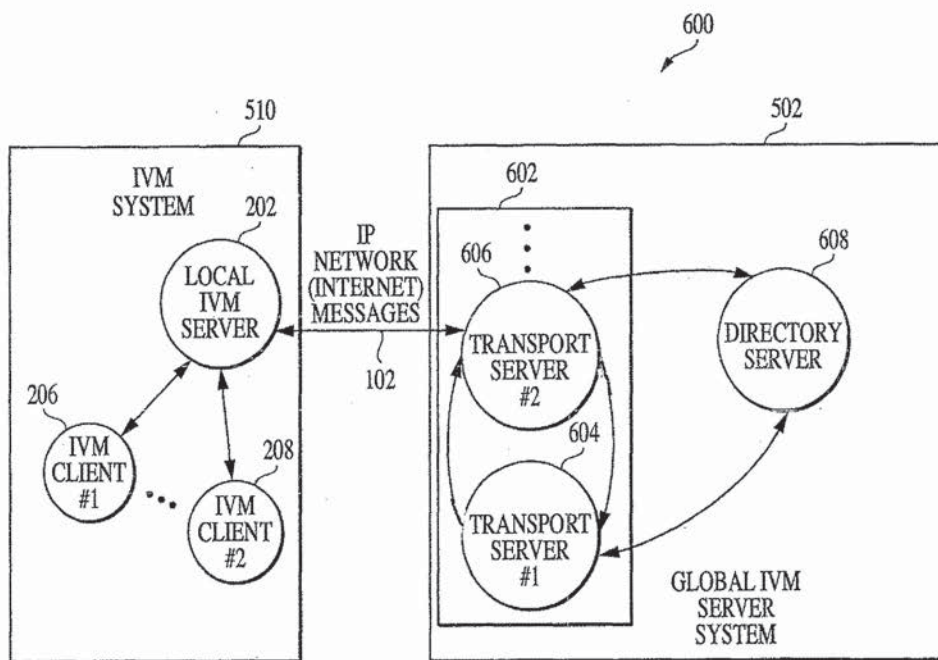

FIG. 6

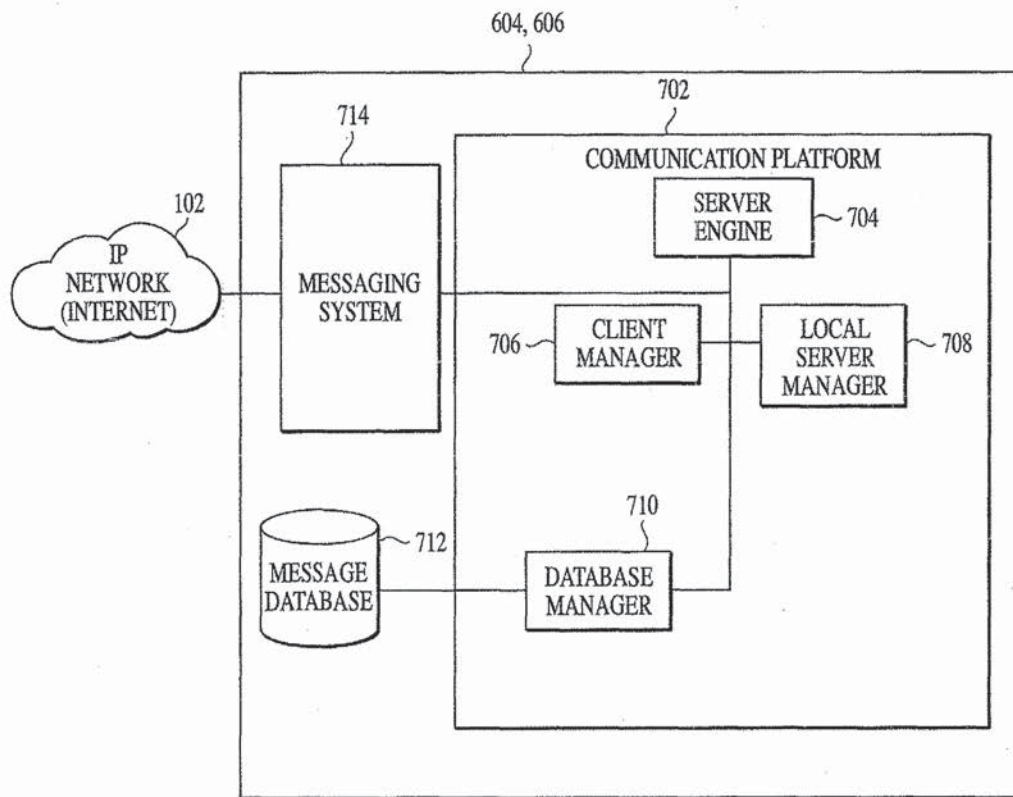

FIG. 7

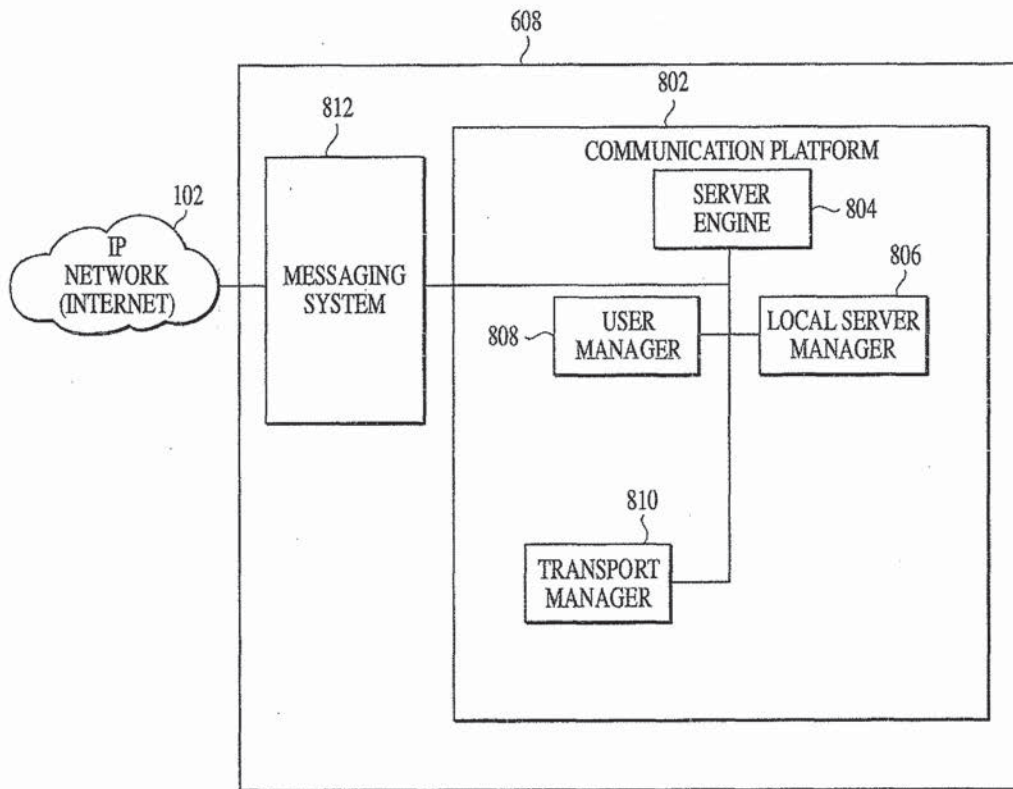

FIG. 8

SYSTEM AND METHOD FOR INSTANT VOIP MESSAGING

Michael J. Rojas
 U.S. Serial No.: 10/740,030
 Replacement Sheet

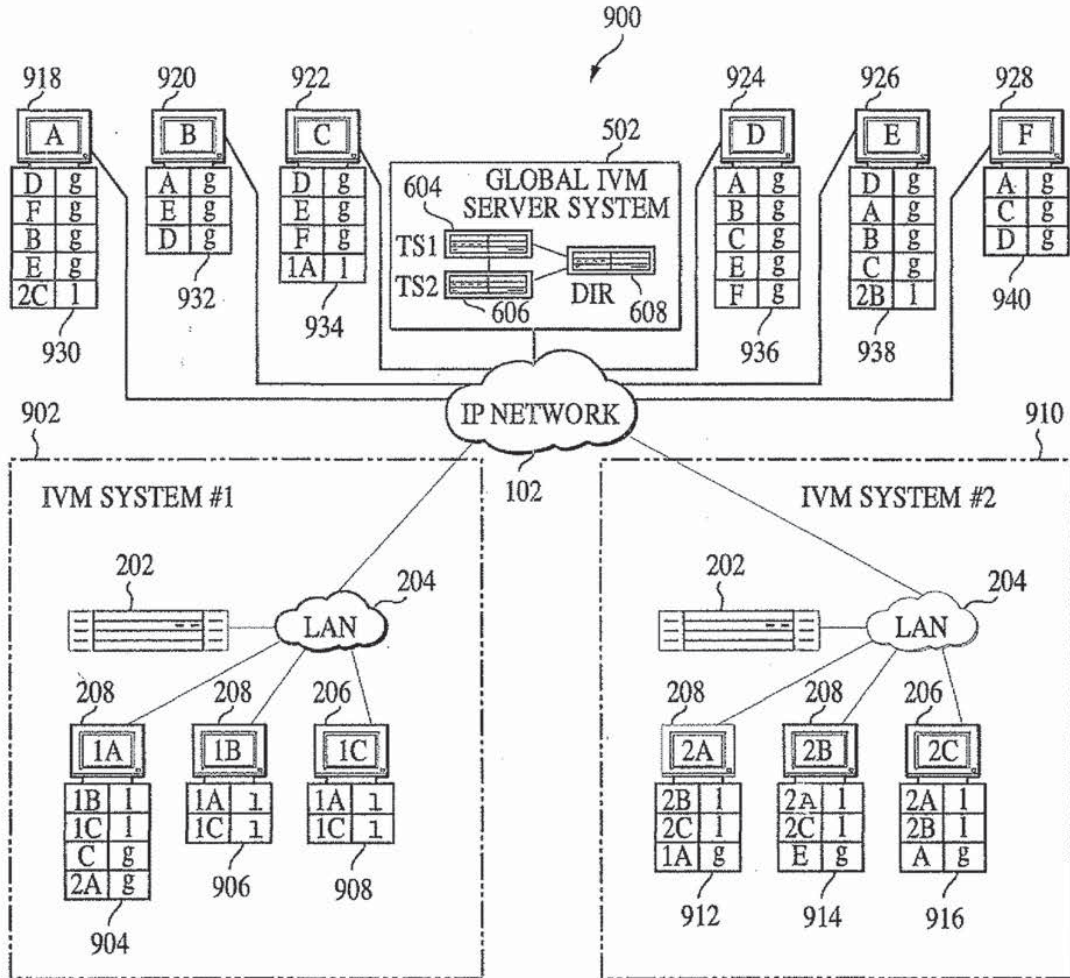

FIG. 9

IN THE UNITED STATES PATENT AND TRADEMARK OFFICE

Applicant:	Michael J. Rojas	Examiner:	Creighton H. Smith
Serial No:	10/740,030	Art Unit:	2614
Filed:	December 18, 2003	Docket:	17188
For:	SYSTEM AND METHOD FOR INSTANT VoIP MESSAGING	Dated:	February 27, 2009

Confirmation No. 1731

Mail Stop Amendment
Commissioner for Patents
P. O. Box 1450
Alexandria, VA 22313-1450

SUBMISSION

Sir:

Applicant respectfully submits a supplemental Information Disclosure Statement herewith. An Information Disclosure Statement was filed on August 19, 2004 in the above-identified application. The Information Disclosure Statement was filed with 6 references. Applicant submitted copies of the references with the Information Disclosure Statement along with PTO Form 1449. On September 18, 2007, Examiner Smith attached an initialized PTO

CERTIFICATE OF ELECTRONIC TRANSMISSION

I hereby certify that this document is being electronically filed in the United States Patent and Trademark Office on the date shown below.

Dated: February 27, 2009

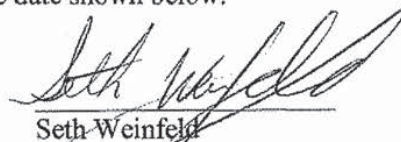
Seth Weinfeld

J:\Work\1732\17188\Amend\17188.submission.doc

Form 1449 to the First Office Action on the Merits indicating that all of the references were considered. The First Office Action did not include any of the references submitted in the Information Disclosure Statement in any of the rejections of the claims.

Subsequently, Examiner Smith attached the same PTO Form 1449 to the Notice of Allowability, however, the PTO Form 1449 had all of the references crossed off, indicating that the references were not considered. Applicant's representative conducted a series of Examiner interviews with both Examiner Smith and Examiner Fsang (Examiner Smith's Supervisor). The Examiners notified Applicant's representative that the PTO Form 1449 did not include a date for each of the references identified.

Applicant maintains that the Information Disclosure Statement should be considered, since the Examiner did in fact consider the Information Disclosure Statement during the prosecution of the application, and, therefore, the references should be listed on the face of the patent.

However, to expedite the issuance of the patent, Applicant is submitting the supplemental Information Disclosure Statement which includes the best available dates for the references, if known, with a replacement PTO Form 1449.

An archive website indicates that Reference 1 was posted on November 22, 2002. Attached herewith is a copy of a document printed from an archive web site evidencing the post date.

An archive website indicates that Reference 3 was copyrighted in 2003. Attached herewith is a copy of a document printed from an archive website indicating a copyright date.

Reference 4 bears a date of May 15, 2002 on the reference.

Reference 5 was archived by a website on December 8, 2003. Attached herewith is a copy of a document printed from an archive website indicating the archive date for Reference 5.

Reference 6 bears a copyright date of 2003.

Applicant respectfully requests consideration of the Supplemental Information Disclosure Statement pursuant to the Examiner interview with Examiner Fsang.

The Director is hereby authorized to charge Deposit Account No. 19-1013/SSMP any additional fees if required.

Respectfully submitted,

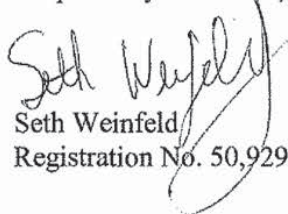

Seth Weinfeld
Registration No. 50,929

Scully, Scott, Murphy & Presser
400 Garden City Plaza
Garden City, New York 11530
(516) 742-4343

SW:reg
Enclosures

IN THE UNITED STATES PATENT AND TRADEMARK OFFICE

Applicant(s): Michael J. Rojas	Examiner: Creighton H. Smith
Serial No: 10/740,030	Art Unit: 2614
Filed: December 18, 2003	Docket: 17188
For: SYSTEM AND METHOD FOR INSTANT VoIP MESSAGING	Dated: February 27, 2009

Confirmation No. 1731

Mail Stop Amendment
Commissioner for Patents
P. O. Box 1450
Alexandria, VA 22313-1450

SUPPLEMENTAL INFORMATION DISCLOSURE STATEMENT

Sir:

In accordance with 37 C.F.R. §§ 1.97 and 1.98, it is requested that the following references, which are also listed on the attached replacement Form PTO-1449, be made of record in the above-identified case.

1. http://www.cisco.com/warp/public/cc/pd/nemnsw/callmn/prodlit/cm33_ds.htm; "Data Sheet Cisco CallManager Version 3.3", November 22, 2002;
2. http://www.cisco.com/en/US/products/hw/switches/ps1925/products_data_sheet_09186_a00800a3c3d.html; "Data Sheet Cisco MGX 8000 Series" (Date unknown).

CERTIFICATE OF ELECTRONIC TRANSMISSION

I hereby certify that this document is being electronically filed in the United States Patent and Trademark Office on the date shown below.

Dated: February 27, 2009

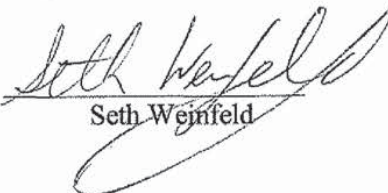
Seth Weinfeld

3. <http://www.hsteliann.com/english/?zone=3100-V21P>; "Telephone 3100-V21P", 2003;
4. <http://www.linuxdevices.com/articles/AT5199947519.html>; "Device Profile: snom 100 VoIP phone", (May 15, 2002);
5. http://www.pingtel.com/pr_xpressa.jsp; "No limits with the advanced industry standard SIP phone, December 8, 2003; and
6. AudioCoded Enabling Technology Products, TPM-1100 VoP Media Gateway Modules; 2003.

The above-identified references were previously submitted in an Information Disclosure Statement dated August 19, 2004. Therefore, Applicant is not submitting copies of the references. This Supplemental Information Disclosure Statement includes the best available dates for the references, if known.

Respectfully submitted,

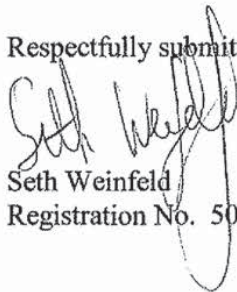

Seth Weinfeld
Registration No. 50,929

Scully, Scott, Murphy & Presser
400 Garden City Plaza
Garden City, New York 11530
(516) 742-4343

SW:reg

Form PTO-1449 U.S. DEPARTMENT OF COMMERCE (REV. 7-80) PATENT AND TRADEMARK OFFICE		Atty. Docket No. (Optional) 17188			Application Number 10/740,030					
INFORMATION DISCLOSURE CITATION (Use several sheets if necessary)								Applicant(s) Michael Rojas		
								Filing Date December 18, 2003		
U.S. PATENT DOCUMENTS										
EXAMINER INITIAL*		DOCUMENT NUMBER	DATE	NAME	CLASS	SUBCLASS	FILING DATE (if appropriate)			
	AA									
	AB									
	AC									
FOREIGN PATENT DOCUMENTS										
	REF	DOCUMENT NUMBER	DATE	COUNTRY	CLASS	SUBCLASS	TRANSLATION			
							YES NO			
OTHER DOCUMENTS (Including Author, Title, Date, Pertinent Pages, Etc.)										
		http://www.cisco.com/warp/public/cc/pd/nemnsw/callmn/prodlit/cm33_ds.htm ; "Data Sheet Cisco CallManager Version 3.3", November 22, 2002.								
		http://www.cisco.com/en/US/products/hw/switches/ps1925/products_data_sheet_09186_a00800a3c3d.html ; "Data Sheet Cisco MGX 8000 Series" (date unknown).								
		http://www.hsteliann.com/english/?zone=3100-V21P ; "Telephone 3100-V21P", 2003.								
		http://www.linuxdevices.com/articles/AT5199947519.html ; "Device Profile: snom 100 VoIP phone", May 15, 2002.								
		http://www.pingtel.com/pr_xpressa.jsp ; "No limits with the advanced industry standard SIP phone; December 8, 2003.								
		AudioCoded Enabling Technology Products, TPM-1100 VoP Media Gateway Modules, copyright 2003.								
EXAMINER				DATE CONSIDERED						
* EXAMINER: Initial if reference considered, whether or not citation is in conformance with MPEP 609; draw line through citation if not in conformance and not considered. Include copy of this form with next communication to applicant.										

Electronic Acknowledgement Receipt

EFS ID:	4876766
Application Number:	10740030
International Application Number:	
Confirmation Number:	1731
Title of Invention:	SYSTEM AND METHOD FOR INSTANT VOIP MESSAGING
First Named Inventor/Applicant Name:	Michael J. Rojas
Customer Number:	23389
Filer:	Seth Weinfeld/Roseann Gallo
Filer Authorized By:	Seth Weinfeld
Attorney Docket Number:	17188
Receipt Date:	27-FEB-2009
Filing Date:	18-DEC-2003
Time Stamp:	16:28:44
Application Type:	Utility under 35 USC 111(a)

Payment information:

Submitted with Payment	no
------------------------	----

File Listing:

Document Number	Document Description	File Name	File Size(Bytes)/ Message Digest	Multi Part /.zip	Pages (if appl.)
1	Miscellaneous Incoming Letter	17188submission.pdf	1067171 aa63f7b4e93171cf0812aaa48dd799474ab28431	no	20

Warnings:

Information:

This Acknowledgement Receipt evidences receipt on the noted date by the USPTO of the indicated documents, characterized by the applicant, and including page counts, where applicable. It serves as evidence of receipt similar to a Post Card, as described in MPEP 503.

New Applications Under 35 U.S.C. 111

If a new application is being filed and the application includes the necessary components for a filing date (see 37 CFR 1.53(b)-(d) and MPEP 506), a Filing Receipt (37 CFR 1.54) will be issued in due course and the date shown on this Acknowledgement Receipt will establish the filing date of the application.

National Stage of an International Application under 35 U.S.C. 371

If a timely submission to enter the national stage of an international application is compliant with the conditions of 35 U.S.C. 371 and other applicable requirements a Form PCT/DO/EO/903 indicating acceptance of the application as a national stage submission under 35 U.S.C. 371 will be issued in addition to the Filing Receipt, in due course.

New International Application Filed with the USPTO as a Receiving Office

If a new international application is being filed and the international application includes the necessary components for an international filing date (see PCT Article 11 and MPEP 1810), a Notification of the International Application Number and of the International Filing Date (Form PCT/RO/105) will be issued in due course, subject to prescriptions concerning national security, and the date shown on this Acknowledgement Receipt will establish the international filing date of the application.



NOTICE OF ALLOWANCE AND FEE(S) DUE

23389 7590 12/05/2008

SCULLY SCOTT MURPHY & PRESSER, PC
400 GARDEN CITY PLAZA
SUITE 300
GARDEN CITY, NY 11530

EXAMINER

SMITH, CREIGHTON H

ART UNIT PAPER NUMBER

2614

DATE MAILED: 12/05/2008

Table with 5 columns: APPLICATION NO., FILING DATE, FIRST NAMED INVENTOR, ATTORNEY DOCKET NO., CONFIRMATION NO.

10/740,030 12/18/2003 Michael J. Rojas 17188 1731

TITLE OF INVENTION: SYSTEM AND METHOD FOR INSTANT VOIP MESSAGING

Table with 7 columns: APPLN. TYPE, SMALL ENTITY, ISSUE FEE DUE, PUBLICATION FEE DUE, PREV. PAID ISSUE FEE, TOTAL FEE(S) DUE, DATE DUE

nonprovisional YES \$755 \$300 \$0 \$1055 03/05/2009

THE APPLICATION IDENTIFIED ABOVE HAS BEEN EXAMINED AND IS ALLOWED FOR ISSUANCE AS A PATENT. PROSECUTION ON THE MERITS IS CLOSED. THIS NOTICE OF ALLOWANCE IS NOT A GRANT OF PATENT RIGHTS. THIS APPLICATION IS SUBJECT TO WITHDRAWAL FROM ISSUE AT THE INITIATIVE OF THE OFFICE OR UPON PETITION BY THE APPLICANT. SEE 37 CFR 1.313 AND MPEP 1308.

THE ISSUE FEE AND PUBLICATION FEE (IF REQUIRED) MUST BE PAID WITHIN THREE MONTHS FROM THE MAILING DATE OF THIS NOTICE OR THIS APPLICATION SHALL BE REGARDED AS ABANDONED. THIS STATUTORY PERIOD CANNOT BE EXTENDED. SEE 35 U.S.C. 151. THE ISSUE FEE DUE INDICATED ABOVE DOES NOT REFLECT A CREDIT FOR ANY PREVIOUSLY PAID ISSUE FEE IN THIS APPLICATION. IF AN ISSUE FEE HAS PREVIOUSLY BEEN PAID IN THIS APPLICATION (AS SHOWN ABOVE), THE RETURN OF PART B OF THIS FORM WILL BE CONSIDERED A REQUEST TO REAPPLY THE PREVIOUSLY PAID ISSUE FEE TOWARD THE ISSUE FEE NOW DUE.

HOW TO REPLY TO THIS NOTICE:

I. Review the SMALL ENTITY status shown above.

If the SMALL ENTITY is shown as YES, verify your current SMALL ENTITY status:

- A. If the status is the same, pay the TOTAL FEE(S) DUE shown above.
B. If the status above is to be removed, check box 5b on Part B - Fee(s) Transmittal and pay the PUBLICATION FEE (if required) and twice the amount of the ISSUE FEE shown above, or

If the SMALL ENTITY is shown as NO:

- A. Pay TOTAL FEE(S) DUE shown above, or
B. If applicant claimed SMALL ENTITY status before, or is now claiming SMALL ENTITY status, check box 5a on Part B - Fee(s) Transmittal and pay the PUBLICATION FEE (if required) and 1/2 the ISSUE FEE shown above.

II. PART B - FEE(S) TRANSMITTAL, or its equivalent, must be completed and returned to the United States Patent and Trademark Office (USPTO) with your ISSUE FEE and PUBLICATION FEE (if required). If you are charging the fee(s) to your deposit account, section "4b" of Part B - Fee(s) Transmittal should be completed and an extra copy of the form should be submitted. If an equivalent of Part B is filed, a request to reapply a previously paid issue fee must be clearly made, and delays in processing may occur due to the difficulty in recognizing the paper as an equivalent of Part B.

III. All communications regarding this application must give the application number. Please direct all communications prior to issuance to Mail Stop ISSUE FEE unless advised to the contrary.

IMPORTANT REMINDER: Utility patents issuing on applications filed on or after Dec. 12, 1980 may require payment of maintenance fees. It is patentee's responsibility to ensure timely payment of maintenance fees when due.

PART B - FEE(S) TRANSMITTAL

**Complete and send this form, together with applicable fee(s), to: Mail Mail Stop ISSUE FEE
 Commissioner for Patents
 P.O. Box 1450
 Alexandria, Virginia 22313-1450
 or Fax (571)-273-2885**

INSTRUCTIONS: This form should be used for transmitting the ISSUE FEE and PUBLICATION FEE (if required). Blocks 1 through 5 should be completed where appropriate. All further correspondence including the Patent, advance orders and notification of maintenance fees will be mailed to the current correspondence address as indicated unless corrected below or directed otherwise in Block 1, by (a) specifying a new correspondence address; and/or (b) indicating a separate "FEE ADDRESS" for maintenance fee notifications.

CURRENT CORRESPONDENCE ADDRESS (Note: Use Block 1 for any change of address)

23389 7590 12/05/2008

SCULLY SCOTT MURPHY & PRESSER, PC
 400 GARDEN CITY PLAZA
 SUITE 300
 GARDEN CITY, NY 11530

Note: A certificate of mailing can only be used for domestic mailings of the Fee(s) Transmittal. This certificate cannot be used for any other accompanying papers. Each additional paper, such as an assignment or formal drawing, must have its own certificate of mailing or transmission.

Certificate of Mailing or Transmission

I hereby certify that this Fee(s) Transmittal is being deposited with the United States Postal Service with sufficient postage for first class mail in an envelope addressed to the Mail Stop ISSUE FEE address above, or being facsimile transmitted to the USPTO (571) 273-2885, on the date indicated below.

(Depositor's name)
(Signature)
(Date)

APPLICATION NO.	FILING DATE	FIRST NAMED INVENTOR	ATTORNEY DOCKET NO.	CONFIRMATION NO.
10/740,030	12/18/2003	Michael J. Rojas	17188	1731

TITLE OF INVENTION: SYSTEM AND METHOD FOR INSTANT VOIP MESSAGING

APPLN. TYPE	SMALL ENTITY	ISSUE FEE DUE	PUBLICATION FEE DUE	PREV. PAID ISSUE FEE	TOTAL FEE(S) DUE	DATE DUE
nonprovisional	YES	\$755	\$300	\$0	\$1055	03/05/2009

EXAMINER	ART UNIT	CLASS-SUBCLASS
SMITH, CREIGHTON H	2614	370-352000

<p>1. Change of correspondence address or indication of "Fee Address" (37 CFR 1.363).</p> <p><input type="checkbox"/> Change of correspondence address (or Change of Correspondence Address form PTO/SB/122) attached.</p> <p><input type="checkbox"/> "Fee Address" indication (or "Fee Address" Indication form PTO/SB/47; Rev 03-02 or more recent) attached. Use of a Customer Number is required.</p>	<p>2. For printing on the patent front page, list</p> <p>(1) the names of up to 3 registered patent attorneys or agents OR, alternatively, 1 _____</p> <p>(2) the name of a single firm (having as a member a registered attorney or agent) and the names of up to 2 registered patent attorneys or agents. If no name is listed, no name will be printed. 2 _____</p> <p>3 _____</p>
---	---

3. ASSIGNEE NAME AND RESIDENCE DATA TO BE PRINTED ON THE PATENT (print or type)

PLEASE NOTE: Unless an assignee is identified below, no assignee data will appear on the patent. If an assignee is identified below, the document has been filed for recordation as set forth in 37 CFR 3.11. Completion of this form is NOT a substitute for filing an assignment.

(A) NAME OF ASSIGNEE _____ (B) RESIDENCE: (CITY and STATE OR COUNTRY) _____

Please check the appropriate assignee category or categories (will not be printed on the patent): Individual Corporation or other private group entity Government

<p>4a. The following fee(s) are submitted:</p> <p><input type="checkbox"/> Issue Fee</p> <p><input type="checkbox"/> Publication Fee (No small entity discount permitted)</p> <p><input type="checkbox"/> Advance Order - # of Copies _____</p>	<p>4b. Payment of Fee(s): (Please first reapply any previously paid issue fee shown above)</p> <p><input type="checkbox"/> A check is enclosed.</p> <p><input type="checkbox"/> Payment by credit card. Form PTO-2038 is attached.</p> <p><input type="checkbox"/> The Director is hereby authorized to charge the required fee(s), any deficiency, or credit any overpayment, to Deposit Account Number _____ (enclose an extra copy of this form).</p>
---	--

5. Change in Entity Status (from status indicated above)

a. Applicant claims SMALL ENTITY status. See 37 CFR 1.27. b. Applicant is no longer claiming SMALL ENTITY status. See 37 CFR 1.27(g)(2).

NOTE: The Issue Fee and Publication Fee (if required) will not be accepted from anyone other than the applicant; a registered attorney or agent; or the assignee or other party in interest as shown by the records of the United States Patent and Trademark Office.

Authorized Signature _____ Date _____

Typed or printed name _____ Registration No. _____

This collection of information is required by 37 CFR 1.311. The information is required to obtain or retain a benefit by the public which is to file (and by the USPTO to process) an application. Confidentiality is governed by 35 U.S.C. 122 and 37 CFR 1.14. This collection is estimated to take 12 minutes to complete, including gathering, preparing, and submitting the completed application form to the USPTO. Time will vary depending upon the individual case. Any comments on the amount of time you require to complete this form and/or suggestions for reducing this burden, should be sent to the Chief Information Officer, U.S. Patent and Trademark Office, U.S. Department of Commerce, P.O. Box 1450, Alexandria, Virginia 22313-1450. DO NOT SEND FEES OR COMPLETED FORMS TO THIS ADDRESS. SEND TO: Commissioner for Patents, P.O. Box 1450, Alexandria, Virginia 22313-1450.

Under the Paperwork Reduction Act of 1995, no persons are required to respond to a collection of information unless it displays a valid OMB control number.



UNITED STATES PATENT AND TRADEMARK OFFICE

UNITED STATES DEPARTMENT OF COMMERCE
United States Patent and Trademark Office
Address: COMMISSIONER FOR PATENTS
P.O. Box 1450
Alexandria, Virginia 22313-1450
www.uspto.gov

Table with 5 columns: APPLICATION NO., FILING DATE, FIRST NAMED INVENTOR, ATTORNEY DOCKET NO., CONFIRMATION NO. Includes application details for Michael J. Rojas and examiner information for SMITH, CREIGHTON H.

Determination of Patent Term Adjustment under 35 U.S.C. 154 (b)
(application filed on or after May 29, 2000)

The Patent Term Adjustment to date is 848 day(s). If the issue fee is paid on the date that is three months after the mailing date of this notice and the patent issues on the Tuesday before the date that is 28 weeks (six and a half months) after the mailing date of this notice, the Patent Term Adjustment will be 848 day(s).

If a Continued Prosecution Application (CPA) was filed in the above-identified application, the filing date that determines Patent Term Adjustment is the filing date of the most recent CPA.

Applicant will be able to obtain more detailed information by accessing the Patent Application Information Retrieval (PAIR) WEB site (http://pair.uspto.gov).

Any questions regarding the Patent Term Extension or Adjustment determination should be directed to the Office of Patent Legal Administration at (571)-272-7702. Questions relating to issue and publication fee payments should be directed to the Customer Service Center of the Office of Patent Publication at 1-(888)-786-0101 or (571)-272-4200.

Notice of Allowability	Application No.	Applicant(s)	
	10/740,030	ROJAS, MICHAEL J.	
	Examiner	Art Unit	
	CREIGHTON SMITH	2614	

-- The MAILING DATE of this communication appears on the cover sheet with the correspondence address--

All claims being allowable, PROSECUTION ON THE MERITS IS (OR REMAINS) CLOSED in this application. If not included herewith (or previously mailed), a Notice of Allowance (PTOL-85) or other appropriate communication will be mailed in due course. **THIS NOTICE OF ALLOWABILITY IS NOT A GRANT OF PATENT RIGHTS.** This application is subject to withdrawal from issue at the initiative of the Office or upon petition by the applicant. See 37 CFR 1.313 and MPEP 1308.

1. This communication is responsive to *remarks filed on 06 NOV '08*.
2. The allowed claim(s) is/are 1-5,7-20,22-35,37-45,47-57,59-69 and 71-76.
3. Acknowledgment is made of a claim for foreign priority under 35 U.S.C. § 119(a)-(d) or (f).
 - a) All b) Some* c) None of the:
 1. Certified copies of the priority documents have been received.
 2. Certified copies of the priority documents have been received in Application No. _____.
 3. Copies of the certified copies of the priority documents have been received in this national stage application from the International Bureau (PCT Rule 17.2(a)).

* Certified copies not received: _____.

Applicant has THREE MONTHS FROM THE "MAILING DATE" of this communication to file a reply complying with the requirements noted below. Failure to timely comply will result in ABANDONMENT of this application.
THIS THREE-MONTH PERIOD IS NOT EXTENDABLE.

4. A SUBSTITUTE OATH OR DECLARATION must be submitted. Note the attached EXAMINER'S AMENDMENT or NOTICE OF INFORMAL PATENT APPLICATION (PTO-152) which gives reason(s) why the oath or declaration is deficient.
5. CORRECTED DRAWINGS (as "replacement sheets") must be submitted.
 - (a) including changes required by the Notice of Draftsperson's Patent Drawing Review (PTO-948) attached
 - 1) hereto or 2) to Paper No./Mail Date _____.
 - (b) including changes required by the attached Examiner's Amendment / Comment or in the Office action of Paper No./Mail Date _____.

Identifying indicia such as the application number (see 37 CFR 1.84(c)) should be written on the drawings in the front (not the back) of each sheet. Replacement sheet(s) should be labeled as such in the header according to 37 CFR 1.121(d).
6. DEPOSIT OF and/or INFORMATION about the deposit of BIOLOGICAL MATERIAL must be submitted. Note the attached Examiner's comment regarding REQUIREMENT FOR THE DEPOSIT OF BIOLOGICAL MATERIAL.

Attachment(s)

- | | |
|--|--|
| <ol style="list-style-type: none"> 1. <input checked="" type="checkbox"/> Notice of References Cited (PTO-892) 2. <input type="checkbox"/> Notice of Draftsperson's Patent Drawing Review (PTO-948) 3. <input checked="" type="checkbox"/> Information Disclosure Statements (PTO/SB/08),
Paper No./Mail Date <u>8.23.04</u> 4. <input type="checkbox"/> Examiner's Comment Regarding Requirement for Deposit of Biological Material | <ol style="list-style-type: none"> 5. <input type="checkbox"/> Notice of Informal Patent Application 6. <input type="checkbox"/> Interview Summary (PTO-413),
Paper No./Mail Date _____. 7. <input type="checkbox"/> Examiner's Amendment/Comment 8. <input checked="" type="checkbox"/> Examiner's Statement of Reasons for Allowance 9. <input type="checkbox"/> Other _____. |
|--|--|

--	--

REASONS FOR ALLOWANCE

The following is an examiner's statement of reasons for allowance: The prior art fails to teach/disclose applicant's instant voice messaging system having a server that temporarily stores an instant voice message if a recipient is unavailable and delivers the stored instant voice message when the recipient becomes available. No obvious combination of references found would have taught one of ordinary skill in the art to use applicant's system and method as claimed.

Any comments considered necessary by applicant must be submitted no later than the payment of the issue fee and, to avoid processing delays, should preferably accompany the issue fee. Such submissions should be clearly labeled "Comments on Statement of Reasons for Allowance."

Any inquiry concerning this communication or earlier communications from the examiner should be directed to CREIGHTON SMITH whose telephone number is (571)272-7546. The examiner can normally be reached on 5-4-9.

If attempts to reach the examiner by telephone are unsuccessful, the examiner's supervisor, fan tsang can be reached on 27548. The fax phone number for the organization where this application or proceeding is assigned is 571-273-8300.

Application/Control Number: 10/740,030
Art Unit: 2614

Page 3

Information regarding the status of an application may be obtained from the Patent Application Information Retrieval (PAIR) system. Status information for published applications may be obtained from either Private PAIR or Public PAIR. Status information for unpublished applications is available through Private PAIR only. For more information about the PAIR system, see <http://pair-direct.uspto.gov>. Should you have questions on access to the Private PAIR system, contact the Electronic Business Center (EBC) at 866-217-9197 (toll-free). If you would like assistance from a USPTO Customer Service Representative or access to the automated information system, call 800-786-9199 (IN USA OR CANADA) or 571-272-1000.

02 DEC '08

/ creighton smith/
for Primary, Examiner of Art Unit
2614

Notice of References Cited	Application/Control No. 10/740,030	Applicant(s)/Patent Under Reexamination ROJAS, MICHAEL J.	
	Examiner CREIGHTON SMITH	Art Unit 2614	Page 1 of 1

U.S. PATENT DOCUMENTS

*		Document Number Country Code-Number-Kind Code	Date MM-YYYY	Name	Classification
*	A	US-6,763,226	07-2004	McZeal, Jr., Alfred	455/90.2
*	B	US-2004/0252679	12-2004	Williams et al.	370/356
*	C	US-2004/0122906	06-2004	Goodman et al.	709/206
*	D	US-2005/0053230	03-2005	Gierachf, Karl	379/406.06
*	E	US-2005/0105697	05-2005	Hollowell et al.	379/088.13
*	F	US-2003/0087632	05-2003	Sagi et al.	455/414
*	G	US-2006/0268750	11-2006	Weiner, Moshe	370/260
*	H	US-2004/0030046	02-2004	Schultes et al.	525/71
*	I	US-2007/0112925	05-2007	Malik, Dale W.	709/206
	J	US-			
	K	US-			
	L	US-			
	M	US-			

FOREIGN PATENT DOCUMENTS

*		Document Number Country Code-Number-Kind Code	Date MM-YYYY	Country	Name	Classification
	N					
	O					
	P					
	Q					
	R					
	S					
	T					

NON-PATENT DOCUMENTS

*		Include as applicable: Author, Title Date, Publisher, Edition or Volume, Pertinent Pages)
	U	
	V	
	W	
	X	

*A copy of this reference is not being furnished with this Office action. (See MPEP § 707.05(a).)
Dates in MM-YYYY format are publication dates. Classifications may be US or foreign.

Index of Claims 	Application/Control No. 10740030	Applicant(s)/Patent Under Reexamination ROJAS, MICHAEL J.
	Examiner CREIGHTON SMITH	Art Unit 2614

✓	Rejected
=	Allowed

-	Cancelled
÷	Restricted

N	Non-Elected
I	Interference

A	Appeal
O	Objected

Claims renumbered in the same order as presented by applicant
 CPA
 T.D.
 R.1.47

CLAIM		DATE							
Final	Original	08/05/2008	11/17/2008						
1	1	✓	=						
2	2	✓	=						
3	3	✓	=						
4	4	✓	=						
5	5	✓	=						
	6	✓	-						
6	7	✓	=						
7	8	✓	=						
8	9	✓	=						
9	10	✓	=						
10	11	✓	=						
11	12	✓	=						
12	13	✓	=						
13	14	✓	=						
14	15	✓	=						
15	16	✓	=						
16	17	✓	=						
17	18	✓	=						
18	19	✓	=						
19	20	✓	=						
	21	✓	-						
20	22	✓	=						
21	23	✓	=						
22	24	✓	=						
23	25	✓	=						
24	26	✓	=						
25	27	✓	=						
26	28	✓	=						
27	29	✓	=						
28	30	✓	=						
29	31	✓	=						
30	32	✓	=						
31	33	✓	=						
32	34	✓	=						
33	35	✓	=						
	36	✓	-						

Index of Claims 	Application/Control No. 10740030	Applicant(s)/Patent Under Reexamination ROJAS, MICHAEL J.
	Examiner CREIGHTON SMITH	Art Unit 2614

✓	Rejected
=	Allowed

-	Cancelled
÷	Restricted

N	Non-Elected
I	Interference

A	Appeal
O	Objected

Claims renumbered in the same order as presented by applicant
 CPA
 T.D.
 R.1.47

CLAIM		DATE							
Final	Original	08/05/2008	11/17/2008						
34	37	✓	=						
35	38	✓	=						
36	39	✓	=						
37	40	✓	=						
38	41	✓	=						
39	42	✓	=						
40	43	✓	=						
41	44	✓	=						
42	45	✓	=						
	46	✓	-						
43	47	✓	=						
44	48	✓	=						
45	49	✓	=						
46	50	✓	=						
47	51	✓	=						
48	52	✓	=						
49	53	✓	=						
50	54	✓	=						
51	55	✓	=						
52	56	✓	=						
53	57	✓	=						
	58	✓	-						
54	59	✓	=						
55	60	✓	=						
56	61	✓	=						
57	62	✓	=						
58	63	✓	=						
59	64	✓	=						
60	65	✓	=						
61	66	✓	=						
62	67	✓	=						
63	68	✓	=						
64	69	✓	=						
	70	✓	-						
65	71	✓	=						
66	72	✓	=						

<i>Index of Claims</i> 	Application/Control No. 10740030	Applicant(s)/Patent Under Reexamination ROJAS, MICHAEL J.
	Examiner CREIGHTON SMITH	Art Unit 2614

✓	Rejected	-	Cancelled	N	Non-Elected	A	Appeal
=	Allowed	÷	Restricted	I	Interference	O	Objected

Claims renumbered in the same order as presented by applicant
 CPA
 T.D.
 R.1.47

CLAIM		DATE							
Final	Original	08/05/2008	11/17/2008						
67	73	✓	=						
68	74	✓	=						
69	75	✓	=						
70	76	✓	=						

Issue Classification 	Application/Control No. 10740030	Applicant(s)/Patent Under Reexamination ROJAS, MICHAEL J.
	Examiner CREIGHTON SMITH	Art Unit 2614

ORIGINAL						INTERNATIONAL CLASSIFICATION														
CLASS			SUBCLASS			CLAIMED					NON-CLAIMED									
370			352			H	O	4	L	12 / 66 (2006.01.01)										
CROSS REFERENCE(S)																				
CLASS	SUBCLASS (ONE SUBCLASS PER BLOCK)																			
709	206																			

Claims renumbered in the same order as presented by applicant
 CPA
 T.D.
 R.1.47

Final	Original	Final	Original	Final	Original	Final	Original	Final	Original	Final	Original	Final	Original	Final	Original
1	1	16	17	31	33	45	49	60	65						
2	2	17	18	32	34	46	50	61	66						
3	3	18	19	33	35	47	51	62	67						
4	4	19	20		36	48	52	63	68						
5	5		21	34	37	49	53	64	69						
	6	20	22	35	38	50	54		70						
6	7	21	23	36	39	51	55	65	71						
7	8	22	24	37	40	52	56	66	72						
8	9	23	25	38	41	53	57	67	73						
9	10	24	26	39	42		58	68	74						
10	11	25	27	40	43	54	59	69	75						
11	12	26	28	41	44	55	60	70	76						
12	13	27	29	42	45	56	61								
13	14	28	30		46	57	62								
14	15	29	31	43	47	58	63								
15	16	30	32	44	48	59	64								

NONE	Total Claims Allowed:	
(Assistant Examiner)	(Date)	70
/CREIGHTON SMITH/ Primary Examiner.Art Unit 2614	11.17.08	O.G. Print Claim(s) O.G. Print Figure
(Primary Examiner)	(Date)	1 1

Search Notes 	Application/Control No. 10740030	Applicant(s)/Patent Under Reexamination ROJAS, MICHAEL J.
	Examiner Creighton H Smith	Art Unit 2614

SEARCHED			
Class	Subclass	Date	Examiner
370	352	17 NOV '08	

SEARCH NOTES		
Search Notes	Date	Examiner
EAST Search	05 AUG '08	chs
EAST	17 NOV '08	chs

INTERFERENCE SEARCH			
Class	Subclass	Date	Examiner
EAST interferences earch		17 NOV '08	chs

--	--

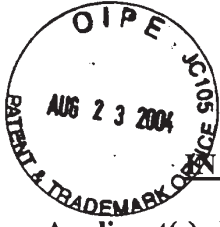

THE UNITED STATES PATENT AND TRADEMARK OFFICE

Applicant(s): Michael J. Rojas	Examiner: Unassigned
Serial No: 10/740,030	Art Unit: 2661
Filed: December 18, 2003	Docket: 17188
For: SYSTEM AND METHOD FOR INSTANT VoIP MESSAGING	Dated: August 19, 2004

Confirmation No. 1731

Mail Stop Amendment
Commissioner for Patents
P. O. Box 1450
Alexandria, VA 22313-1450

INFORMATION DISCLOSURE STATEMENT

Sir:

In accordance with 37 C.F.R. §§ 1.97 and 1.98, it is requested that the following references, which are also listed on the attached Form PTO-1449, be made of record in the above-identified case.

1. http://www.cisco.com/warp/public/cc/pd/nemnsw/callmn/prodlit/cm33_ds.htm; "Data Sheet Cisco CallManager Version 3.3".
2. http://www.cisco.com/en/US/products/hw/switches/ps1925/products_data_sheet_09186_a00800a3c3d.html; "Data Sheet Cisco MGX 8000 Series".
3. <http://www.hsteliann.com/english/?zone=3100-V21P>; "Telephone 3100-V21P".

CERTIFICATE OF MAILING UNDER 37 C.F.R. §1.8(a)

I hereby certify that this correspondence is being deposited with the United States Postal Service as first class mail in an envelope addressed to: Mail Stop Amendment, Commissioner of Patents, P. O. Box 1450, Alexandria, VA, 22313-1450 on August 19, 2004.

Dated: August 19, 2004

Paul J. Esatto, Jr.

4. <http://www.linuxdevices.com/articles/AT5199947519.html>; "Device Profile: snom 100 VoIP phone".

5. http://www.pingtel.com/pr_xpressa.jsp; "No limits with the advanced industry standard SIP phone.

6. AudioCoded Enabling Technology Products, TPM-1100 VoP Media Gateway Modules.

Applicant is submitting a copy of the above-cited references.

Inasmuch as this Information Disclosure Statement is being submitted in accordance with the schedule set out in 37 C.F.R. § 1.97(b), no statement or fee is required.

Respectfully submitted,



Paul J. Esatto, Jr.
Registration No. 30,749

Scully, Scott, Murphy & Presser
400 Garden City Plaza
Garden City, New York 11530
(516) 742-4343

PJE:ae

Form PTO-1449 (REV. 7-80) PATENT AND TRADEMARK OFFICE	U.S. DEPARTMENT OF COMMERCE	Atty. Docket No. (Optional) 17188	Application Number 10/740,030
INFORMATION DISCLOSURE CITATION (Use several sheets if necessary)		Applicant(s) Michael Rojas	
		Filing Date December 18, 2003	Group Art Unit 2661

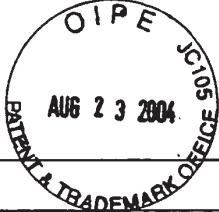

U.S. PATENT DOCUMENTS

EXAMINER INITIAL*	DOCUMENT NUMBER	DATE	NAME	CLASS	SUBCLASS	FILING DATE (if appropriate)
AA						
AB						
AC						

FOREIGN PATENT DOCUMENTS

REF	DOCUMENT NUMBER	DATE	COUNTRY	CLASS	SUBCLASS	TRANSLATION	
						YES	NO

OTHER DOCUMENTS (Including Author, Title, Date, Pertinent Pages, Etc.)

	http://www.cisco.com/warp/public/cc/pd/nemnsw/callmn/prodlit/cm33_ds.htm ; "Data Sheet Cisco CallManager Version 3.3"
	http://www.cisco.com/en/US/products/hw/switches/ps1925/products_data_sheet_09186_a00800a3c3d.html ; "Data Sheet Cisco MGX 8000 Series"
	http://www.hoteliann.com/english/?zone=3100_V21P ; "Telephone 3100 V21P"
	http://www.linuxdevices.com/articles/AT5199947519.html ; "Device Profile: snom 100 VoIP phone"
	http://www.pingtel.com/pr_xpressa_isp ; "No limits with the advanced industry standard SIP phone AudioCoded Enabling Technology Products, TPM-1100 VoP Media Gateway Modules"

EXAMINER /Creighton Smith/	DATE CONSIDERED 12/03/2008
--------------------------------------	--------------------------------------

* EXAMINER: Initial if reference considered, whether or not citation is in conformance with MPEP 609; draw line through citation if not in conformance and not considered. Include copy of this form with next communication to applicant.

J.F.W

**TRANSMITTAL OF INFORMATION DISCLOSURE STATEMENT
(Under 37 CFR 1.97(b) or 1.97(c))**

Docket No.
17188

In Re Application Of: **Michael J. Rojas**

Application No.	Filing Date	Examiner	Customer No.	Group Art Unit	Confirmation No.
10/740,030	December 18, 2003	Unassigned	23389	2661	1731

Title:

SYSTEM AND METHOD FOR INSTANT VoIP MESSAGING



Address to:
Commissioner for Patents
 P.O. Box 1450
 Alexandria, VA 22313-1450

37 CFR 1.97(b)

1. The Information Disclosure Statement submitted herewith is being filed within three months of the filing of a national application other than a continued prosecution application under 37 CFR 1.53(d); within three months of the date of entry of the national stage as set forth in 37 CFR 1.491 in an international application; before the mailing of a first Office Action on the merits, or before the mailing of a first Office Action after the filing of a request for continued examination under 37 CFR 1.114.

37 CFR 1.97(c)

2. The Information Disclosure Statement submitted herewith is being filed after the period specified in 37 CFR 1.97(b), provided that the Information Disclosure Statement is filed before the mailing date of a Final Action under 37 CFR 1.113, a Notice of Allowance under 37 CFR 1.311, or an Action that otherwise closes prosecution in the application, and is accompanied by one of:
- the statement specified in 37 CFR 1.97(e);
- OR**
- the fee set forth in 37 CFR 1.17(p).

TRANSMITTAL OF INFORMATION DISCLOSURE STATEMENT
(Under 37 CFR 1.97(b) or 1.97(c))

Docket No.
17188

In Re Application: **Michael J. Rojas**

Application No.	Filing Date	Examiner	Customer No.	Group Art Unit	Confirmation No.
10/740,030	December 18, 2003	Unassigned	23389	2661	1731

SYSTEM AND METHOD FOR INSTANT VoIP MESSAGING

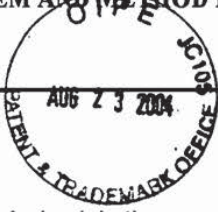

Payment of Fee

(Only complete if Applicant elects to pay the fee set forth in 37 CFR 1.17(p))

- A check in the amount of _____ is attached.
- The Director is hereby authorized to charge and credit Deposit Account **19-1013/SSMP** as described below.
 - Charge the amount of _____
 - Credit any overpayment.
 - Charge any additional fee required.

Certificate of Transmission by Facsimile*

I certify that this document and authorization to charge deposit account is being facsimile transmitted to the United States Patent and Trademark Office (Fax. No. _____)

(Date)

Signature

Typed or Printed Name of Person Signing Certificate

Certificate of Mailing by First Class Mail

I certify that this document and fee is being deposited on **8/19/04** with the U.S. Postal Service as first class mail under 37 C.F.R. 1.8 and is addressed to the Commissioner for Patents, P.O. Box 1450, Alexandria, VA 22313-1450.

Signature of Person Mailing Correspondence

Paul J. Esatto, Jr.
Typed or Printed Name of Person Mailing Certificate

*This certificate may only be used if paying by deposit account.

Dated: **August 19, 2004**

Signature
Paul J. Esatto, Jr.
Registration No. 30,749
Scully, Scott, Murphy & Presser
400 Garden City Plaza
Garden City, New York 11530
516-742-4343

cc:

UNITED STATES PATENT AND TRADEMARK OFFICE

Applicant(s): Michael J. Rojas	Examiner: Creighton H. Smith
Serial No: 10/740,030	Art Unit: 2614
Filed: December 18, 2003	Docket: 17188
For: SYSTEM AND METHOD FOR INSTANT VoIP MESSAGING	Dated: November 6, 2008

Confirmation No. 1731

Commissioner for Patents
P. O. Box 1450
Alexandria, VA 22313-1450

RESPONSE UNDER 37 C.F.R. § 1.111

Sir:

Applicant submits this Response in reply to the Official Action dated August 11, 2008. Applicant respectfully requests reconsideration of the application in view of the following remarks.

CERTIFICATE OF ELECTRONIC FILING

I hereby certify that this correspondence is being deposited with the United States Patent & Trademark Office via Electronic Filing through the United States Patent and Trademark Office e-business website, on November 6, 2008.

Dated: November 6, 2008

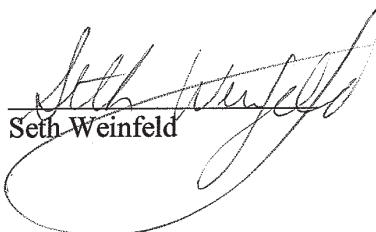
Seth Weinfeld

1

H:\work\1732\17188\Amend\17188.am3.doc

REMARKS

Applicant has filed the present Response in reply to the outstanding Official Action of August 11, 2008. Applicant believes the Response is fully responsive to the Official Action for at least the reasons set forth herein.

At the onset, Applicant would like to thank the Examiner for taking the time to have a telephone interview with Applicant's representative on October 31, 2008.

During the interview, Bernstein, Williams and Gierachf references were discussed.

With respect to the Bernstein reference, Applicant noted that the reference fails to teach (i) any consideration of **availability/unavailability**; (ii) **temporarily** storing the instant voice message; and (iii) **delivering** the stored instant voice message to the selected recipient once the selected recipient becomes **available**. The Examiner agreed to take another look at Bernstein and update the search using additional search terms.

With respect to Williams, Applicant noted that the reference fails to teach that the client requests a list of recipients associated with the client from the server and the server transmits the list of recipients to the client for selection of the one or more recipients. Williams only teaches transmitting the list of recipients if a voice command is not recognized.

With respect to Gierachf, Applicant noted that the reference is not prior art and referred the Examiner to the inventor declaration under 37 C.F.R. § 1.131.

Claims 1-3, 5, 11-18, 26-29, 43, 45, 51-54, 65 and 66 stand rejected under 35 U.S.C. § 103(a) as being unpatentable in view of McZeal (previously cited) and

Bernstein, U.S. Patent Publication No. 2004/00128356. Claims 4, 19, 20, and 44 stand rejected under 35 U.S.C. § 103(a) in view of McZeal, Bernstein and Williams. Claims 7, 22 and 47 stand rejected under 35 U.S.C. § 103(a) as being unpatentable in view of McZeal, Bernstein, and Sagi. Claims 8, 23 and 48 stand rejected under 35 U.S.C. § 103(a) as being unpatentable in view of McZeal, Bernstein and Goodman. Claims 9, 24 and 49 stand rejected under 35 U.S.C § 103(a) as being unpatentable in view of McZeal, Bernstein and Gierachf, U.S. Patent Publication No. 2005/0053230. Claims 10, 25 and 50 stand rejected under 35 U.S.C. § 103(a) as being unpatentable in view of McZeal, Bernstein and Creamer et al., U.S. Pat. Pub 2003/0126207.

Claims 30-33, 35, 41, 55, 57, 63, 64, 67, 69 and 75 stand rejected under 35 U.S.C. § 103(a) as being unpatentable in view of McZeal, Bernstein and Monroe, U.S. Patent No. 6,970,183. Claims 42 and 76 stand rejected under 35 U.S.C. § 103(a) as being unpatentable in view of McZeal, Bernstein, Monroe and Boukobza. Claims 34, 56 and 68 stand rejected under 35 U.S.C. § 103(a) as being unpatentable in view McZeal, Bernstein, Williams and Monroe. Claims 37, 59 and 71 were rejected under 35 U.S.C. § 103(a) as being unpatentable in view McZeal, Bernstein, Sagi and Monroe.

Claims 38, 60 and 72 stand rejected under 35 U.S.C. § 103(a) as being unpatentable in view of McZeal, Bernstein, Goodman and Monroe. Claims 39, 61 and 73 stand rejected under 35 U.S.C. § 103(a) as being unpatentable in view of McZeal, Bernstein, Gierachf and Monroe. Claims 40, 62 and 74 stand rejected under 35 U.S.C. § 103(a) as being unpatentable in view of McZeal, Bernstein, Creamer and Monroe.

Applicant respectfully disagrees with the rejection and traverses with at least the following remarks.

Applicant submits that all of the cited references, whether taken alone or in any combination thereof, fail to teach, suggest or render obvious the limitation of the server temporarily stores the instant voice message if a selected recipient is unavailable and delivers the stored instant voice message to the selected recipient once the selected recipient becomes available, as recited in each of the independent claims.

The Official Action asserts that Bernstein teaches this feature. Applicant respectfully disagrees. As noted above, the reference fails to teach (i) any consideration of **availability/unavailability**; (ii) **temporarily** storing the instant voice message; and (iii) **delivering** the stored instant voice message to the selected recipient once the selected recipient becomes **available**.

(I) **Storing only when unavailable**

At best, Bernstein teaches storing all of the IM messages in a remote server, i.e., communication history or database. Bernstein teaches that the IM messages are stored for an IM session. The IM session implies that two parties are already available and IMing, i.e., a session is a flow of instant messages between at least two users.

Bernstein states that the server program system performs a step of maintained a database referencing a history of the instant messaging session with the universally unique identifier for the audience collection. See paragraphs 0086 and 0088. The audience collection is a list of users that **accepted** an invitation to the session. When and if a recipient responds to the instant messaging invitation email message, it becomes a

member of the audience collection 138. The first user sends an email invitation for the IM session and at least one other user replies to the invitation. *See* Paragraphs 0078-81.

At paragraph 0090, the reference states a step of sending the processed communication from the first member as content in the areas associated with the first member to the history of the instant message session with the universally unique identifier. The database receives the transferred communication from the first member to create a history-received communication from the first member.

In embodiments when there is a database 150, it includes a history 154 of the instant messaging session 130. History 154 includes the universally unique identifier 132 of instant messaging session 130. History 154 also includes an audience list 162 based upon audience collection 138 and a communication history 166, which further references communications records 168, each of which may be based upon at least one of the received communication 142, processed communication 144, and transferred communication 146. Additionally, in an embodiment, the server 100 may retain the complete transcript 166 of the Instant Messaging session.

In other words, when the store feature is active, every message is stored, without a determination of whether the recipient is available. In fact, since a session is active, the recipient must be available and online (emphasis added).

In stark contrast, in the claimed invention the IVM is only stored in the server if the recipient (IVM client) is not currently connected to the local IVM server. In fact, the reference only suggests that the IM is not stored if confidentiality cannot be maintained. *See* paragraph 0094.

(II) Temporarily storing the instant voice message if a selected recipient is unavailable

Bernstein fails to teach that the IVM is temporarily stored.

Bernstein states that the *user whenever looking at that email at any time in the future*, will trigger the server 100 to attempt fetching all the Instant Messaging messages 168 has stored for that email. *See* paragraph 0100. At any time in the future implies that the messages are stored permanently.

(III) Pushing IMV to recipient when available.

Additionally, the reference does not teach that the stored IVM is delivered to the client when the client connects to the IVM (after not being initiately connected).

Bernstein states that the *user whenever looking at that email at any time in the future*, will trigger the server 100 to attempt fetching all the Instant Messaging messages 168 has stored for that email. *See* paragraph 0100. In Bernstein, the user initiates the fetching process by sending a request, i.e., pulling the message data. In stark contrast, in the claimed invention, the server pushes or delivers the message when the recipient is determined to be available.

The other cited references fail to cure these deficiencies.

Therefore, the cited references fail to teach, suggest or render obvious each and every limitation of the claims; the claims are patentable over the cited combination.

Applicant further submits that claims 9, 24, 39, 49, 61, and 73 are patentable over the cited references based at least upon the following additional analysis. The Official Action cites Gierachf in the rejection of these claims. Applicant submits the Gierachf is

not prior art. Notably, in Applicant's declaration pursuant to 1.131, Applicant at paragraph 3 stated that the Applicant conceived the claimed invention prior to August 15 2003. *See Declaration Pursuant to §1.131 ¶ 3.* Gierachf has a filing date of September 6, 2003. Therefore, Applicant completed the invention claimed in the instant application prior to the filing date of the reference.

Applicant further submits that claims 4, 19, 34, 44, 56 and 68 are patentable over the cited references based at least upon the following additional analysis. Each of these claims recites, *inter alia*, a limitation directed to requesting a list of recipients associated with the server from the server. Applicant submits that the cited references fail to teach this limitation. At best, Williams (cited as a teaching of this limitation) teaches that the server sends a list of potential recipients **after a voice command is not recognized**. Notably, Williams describes an embodiment, where if a first word of the voice message does not satisfy a predetermined condition, the message is saved and a list of recipients is transmitted to the local client. *See paragraph 0055.* Clearly, the client is not requesting the list; rather the server determines that a command is not understood and that all available options should be transmitted to the user. The client makes no request.

Additionally, Applicant notes that this function is not in the context of an instant voice message.

None of the other cited references cure the above-identified deficiency.

Therefore, claims 4, 19, 34, 44, 56 and 68 are patentable over the cited references, whether taken alone or in any combination thereof.

Applicant further submits that claims 7, 22, 37, 47, 59 and 71 are patentable over the cited references based at least upon the following additional analysis.

Applicant submits that the references, whether taken alone or in any combination thereof teach or suggest recording an instant voice message in an audio file, at the client, where the audio file is a instant voice message, as recited in each of these claims. At best, Sagi teaches that an audio file can be transmitted to a server. Sagi teaches that an instant text message is converted into an instant voice message and then transmitted (Steps 420 and 425). The server relays the voice message to a cellular telephone. Sagi then describes that at step 435, user b sends an instant message in a voice message format to user via the gateway. The voice message is converted into a text message. Notably, Sagi does not teach that the voice message from user B to user A is recorded on the user device. None of the other cited references cure the above-identified deficiency.

Therefore, claims 7, 22, 37, 47, 59 and 71 are patentable over the cited references, whether taken alone or in any combination thereof.

Based upon the foregoing, Applicant respectfully requests that the Examiner withdraw all of the pending rejections pursuant to 35 U.S.C. § 103(a).

In conclusion, the Applicant believes that the above-identified application is in condition for allowance and henceforth respectfully solicits the Examiner to allow the application. If the Examiner believes a telephone conference might expedite the

allowance of this application, the Applicant respectfully requests that the Examiner call the undersigned, Applicant's attorney, at the following telephone number: (516) 742-4343.

Respectfully submitted,



Seth Weinfeld

Registration No: 50,929

Scully, Scott, Murphy & Presser, P.C.
400 Garden City Plaza, Suite 300
Garden City, New York 11530
516-742-4343

SW:reg

TRANSMITTAL LETTER (General - Patent Pending)	Docket No. 17188
--	----------------------------

In Re Application Of: **Michael J. Rojas**

Application No.	Filing Date	Examiner	Customer No.	Group Art Unit	Confirmation No.
10/740,030	December 18, 2003	Creighton H. Smith	23389	2614	1731

Title: **SYSTEM AND METHOD FOR INSTANT VoIP MESSAGING**

COMMISSIONER FOR PATENTS:

Transmitted herewith is:

RESPONSE UNDER 37 C.F.R. § 1.111

in the above identified application.

- No additional fee is required.
- A check in the amount of _____ is attached.
- The Director is hereby authorized to charge and credit Deposit Account No. **19-1013/SSMP** as described below.
 - Charge the amount of _____
 - Credit any overpayment.
 - Charge any additional fee required.
- Payment by credit card. Form PTO-2038 is attached.

WARNING: Information on this form may become public. Credit card information should not be included on this form. Provide credit card information and authorization on PTO-2038.



Signature

Dated: **November 6, 2008**

Seth Weinfeld
Registration No: 50,929
Scully, Scott, Murphy & Presser, P.C.
400 Garden City Plaza, Suite 300
Garden City, New York 11530
516-742-4343
SW:reg

I hereby certify that this correspondence is being deposited with the United States Postal Service with sufficient postage as first class mail in an envelope addressed to the "Commissioner for Patents, P.O. Box 1450, Alexandria, VA 22313-1450" [37 CFR 1.8(a)] on _____
(Date)
<i>Signature of Person Mailing Correspondence</i>
<i>Typed or Printed Name of Person Mailing Correspondence</i>

cc:

Electronic Acknowledgement Receipt

EFS ID:	4244655
Application Number:	10740030
International Application Number:	
Confirmation Number:	1731
Title of Invention:	System and method for instant VoIP messaging
First Named Inventor/Applicant Name:	Michael J. Rojas
Customer Number:	23389
Filer:	Paul J. Esatto/Roseann Gallo
Filer Authorized By:	Paul J. Esatto
Attorney Docket Number:	17188
Receipt Date:	06-NOV-2008
Filing Date:	18-DEC-2003
Time Stamp:	15:20:12
Application Type:	Utility under 35 USC 111(a)

Payment information:

Submitted with Payment	no
------------------------	----

File Listing:

Document Number	Document Description	File Name	File Size(Bytes)/ Message Digest	Multi Part /.zip	Pages (if appl.)
1		17188AM3.pdf	422767 <small>c5ccea7930f25917cf0d3096e12360a11e803ab8</small>	yes	10

Multipart Description/PDF files in .zip description		
Document Description	Start	End
Amendment/Req. Reconsideration-After Non-Final Reject	1	1
Applicant Arguments/Remarks Made in an Amendment	2	9
Miscellaneous Incoming Letter	10	10

Warnings:

Information:

Total Files Size (in bytes):	422767
-------------------------------------	--------

This Acknowledgement Receipt evidences receipt on the noted date by the USPTO of the indicated documents, characterized by the applicant, and including page counts, where applicable. It serves as evidence of receipt similar to a Post Card, as described in MPEP 503.

New Applications Under 35 U.S.C. 111

If a new application is being filed and the application includes the necessary components for a filing date (see 37 CFR 1.53(b)-(d) and MPEP 506), a Filing Receipt (37 CFR 1.54) will be issued in due course and the date shown on this Acknowledgement Receipt will establish the filing date of the application.

National Stage of an International Application under 35 U.S.C. 371

If a timely submission to enter the national stage of an international application is compliant with the conditions of 35 U.S.C. 371 and other applicable requirements a Form PCT/DO/EO/903 indicating acceptance of the application as a national stage submission under 35 U.S.C. 371 will be issued in addition to the Filing Receipt, in due course.

New International Application Filed with the USPTO as a Receiving Office

If a new international application is being filed and the international application includes the necessary components for an international filing date (see PCT Article 11 and MPEP 1810), a Notification of the International Application Number and of the International Filing Date (Form PCT/RO/105) will be issued in due course, subject to prescriptions concerning national security, and the date shown on this Acknowledgement Receipt will establish the international filing date of the application.



UNITED STATES PATENT AND TRADEMARK OFFICE

UNITED STATES DEPARTMENT OF COMMERCE
United States Patent and Trademark Office
Address: COMMISSIONER FOR PATENTS
P.O. Box 1450
Alexandria, Virginia 22313-1450
www.uspto.gov

Table with 5 columns: APPLICATION NO., FILING DATE, FIRST NAMED INVENTOR, ATTORNEY DOCKET NO., CONFIRMATION NO.

10/740,030 12/18/2003 Michael J. Rojas 17188 1731

23389 7590 08/11/2008
SCULLY SCOTT MURPHY & PRESSER, PC
400 GARDEN CITY PLAZA
SUITE 300
GARDEN CITY, NY 11530

Table with 1 column: EXAMINER

SMITH, CREIGHTON H

Table with 2 columns: ART UNIT, PAPER NUMBER

2614

Table with 2 columns: MAIL DATE, DELIVERY MODE

08/11/2008 PAPER

Please find below and/or attached an Office communication concerning this application or proceeding.

The time period for reply, if any, is set in the attached communication.

Office Action Summary	Application No. 10/740,030	Applicant(s) ROJAS, MICHAEL J.	
	Examiner Creighton H. Smith	Art Unit 2614	

-- The MAILING DATE of this communication appears on the cover sheet with the correspondence address --
Period for Reply

A SHORTENED STATUTORY PERIOD FOR REPLY IS SET TO EXPIRE 3 MONTH(S) OR THIRTY (30) DAYS, WHICHEVER IS LONGER, FROM THE MAILING DATE OF THIS COMMUNICATION.

- Extensions of time may be available under the provisions of 37 CFR 1.136(a). In no event, however, may a reply be timely filed after SIX (6) MONTHS from the mailing date of this communication.
- If NO period for reply is specified above, the maximum statutory period will apply and will expire SIX (6) MONTHS from the mailing date of this communication.
- Failure to reply within the set or extended period for reply will, by statute, cause the application to become ABANDONED (35 U.S.C. § 133). Any reply received by the Office later than three months after the mailing date of this communication, even if timely filed, may reduce any earned patent term adjustment. See 37 CFR 1.704(b).

Status

- 1) Responsive to communication(s) filed on 07 JUL '08.
- 2a) This action is **FINAL**. 2b) This action is non-final.
- 3) Since this application is in condition for allowance except for formal matters, prosecution as to the merits is closed in accordance with the practice under *Ex parte Quayle*, 1935 C.D. 11, 453 O.G. 213.

Disposition of Claims

- 4) Claim(s) 1-76 is/are pending in the application.
 - 4a) Of the above claim(s) _____ is/are withdrawn from consideration.
- 5) Claim(s) _____ is/are allowed.
- 6) Claim(s) 1-76 is/are rejected.
- 7) Claim(s) _____ is/are objected to.
- 8) Claim(s) _____ are subject to restriction and/or election requirement.

Application Papers

- 9) The specification is objected to by the Examiner.
- 10) The drawing(s) filed on _____ is/are: a) accepted or b) objected to by the Examiner.
 Applicant may not request that any objection to the drawing(s) be held in abeyance. See 37 CFR 1.85(a).
 Replacement drawing sheet(s) including the correction is required if the drawing(s) is objected to. See 37 CFR 1.121(d).
- 11) The oath or declaration is objected to by the Examiner. Note the attached Office Action or form PTO-152.

Priority under 35 U.S.C. § 119

- 12) Acknowledgment is made of a claim for foreign priority under 35 U.S.C. § 119(a)-(d) or (f).
 - a) All b) Some * c) None of:
 - 1. Certified copies of the priority documents have been received.
 - 2. Certified copies of the priority documents have been received in Application No. _____.
 - 3. Copies of the certified copies of the priority documents have been received in this National Stage application from the International Bureau (PCT Rule 17.2(a)).
- * See the attached detailed Office action for a list of the certified copies not received.

Attachment(s)

- 1) Notice of References Cited (PTO-892)
- 2) Notice of Draftsperson's Patent Drawing Review (PTO-948)
- 3) Information Disclosure Statement(s) (PTO/SB/08)
 Paper No(s)/Mail Date _____.
- 4) Interview Summary (PTO-413)
 Paper No(s)/Mail Date. _____.
- 5) Notice of Informal Patent Application
- 6) Other: _____.

The following is a quotation of 35 U.S.C. 103(a) which forms the basis for all obviousness rejections set forth in this Office action:

(a) A patent may not be obtained though the invention is not identically disclosed or described as set forth in section 102 of this title, if the differences between the subject matter sought to be patented and the prior art are such that the subject matter as a whole would have been obvious at the time the invention was made to a person having ordinary skill in the art to which said subject matter pertains. Patentability shall not be negated by the manner in which the invention was made.

Claims 1-3, 5, 11-18, 26-29, 43, 45, 51-54, 65, 66 are rejected under 35 U.S.C. 103(a) as being unpatentable over McZeal, Jr. '226 in view of Bernstein et al, U.S. Pat. App. Pub. #2004/00128356.

McZeal discloses in col. 4, lines 18 et seq. that until his invention there was no device which could take full advantage of the Internet and IM for voice quality purposes, and which uses computer data networks for voice. In col. 28, lines 5 et seq. McZeal discloses that his invention provides customers with instant IM which uses VoIP. In col. 16, lines 39 et seq. McZeal discloses that his invention can use both the Internet and the PSTN. Bernstein et al disclose in P.0050 that each IM session has a universally unique identifier, which the server computer uses to identify and store individual Instant Messages. To have provided Bernstein et al teaching of storing IM in a server in McZeal's communication system would have been obvious to a person having ordinary skill in the art, because the skilled practitioner in this communication art will realize the need to store messages if the called party lacked the present ability to receive the IM.

For claims 2 & 3, McZeal discloses in cols. 1 & 16, lines 42-43 & 25-30 that his invention can be used in local or wide area networks - LAN/WAN.

Regarding claim 11, see McZeal @ col. 16, lines 42 & 59-60. Pertaining to claim 20, with McZeal's disclosure that his device that his device can be used in either a WAN

(Internet) or LAN (local area network). If the voice message is to be routed out beyond a LAN, then an external serving system will have to be employed until the message reaches the recipient inside of the LAN, whereupon the LAN and its associated server will route the message to the intended recipient.

Claims 4, 19, 20, 44 are rejected under 35 U.S.C. 103(a) as being unpatentable over McZeal in view of Bernstein et al as applied to claim 1 above, and further in view of Williams et al.

Williams et al disclose in P.0055 that a messaging server (105) will save a voice message and send a list of recipients to the user from an address book. To have provided Williams teaching of a server providing a user a calling list of recipients in McZeal's Instant Voice Messaging server system would have been obvious to a person having ordinary skill in the art because the skilled practitioner in the communications and server arts will readily realize that there are an unlimited amount of commands and information that a server can hold which can be communicated to anyone throughout the world that has proper equipment.

Claims 7, 22, 47 are rejected under 35 U.S.C. 103(a) as being unpatentable over McZeal in view of Bernstein et al as applied to claim 1 above, and further in view of Sagi et al.

Sagi et al disclose in claim 24 where a server will receive an audio file from a subscriber, and then in claim 29 Sagi et al disclose that the transmission is sent to a 2nd subscriber. To have similarly used Sagi et al disclosure of transmitting an audio file to a server in McZeal's device would have been obvious to a person having ordinary skill in

the art, because the skilled practitioner in communications art will realize that the sending party can either directly record a voice message or send an audio file. Either way, a called party will receive the voice message.

Claims 8, 23, 48 are rejected under 35 U.S.C. 103(a) as being unpatentable over McZeal in view of Bernstein et al as applied to claim 1 above, and further in view of Goodman et al.

Goodman et al disclose in P.0033 that an audio message can be transformed from any of encrypted, decrypted, compressed, or decompressed format. To have similarly provided Goodman's teaching of encrypting, decrypting, compressing, and decompressing audio into McZeal's device would have been obvious to a person having ordinary skill in the art, because by compressing the audio will take up less memory in the server.

Claims 9, 24, 49 are rejected under 35 U.S.C. 103(a) as being unpatentable over McZeal in view of Bernstein et al as applied to claim 1 above, and further in view of Gierachf.

Gierachf discloses in P.0044 in Step- 266 that the audio data or voice message is sent to audio buffer 19B'. To have similarly used Gierachf's method of buffering the audio data in McZeal's apparatus would have been obvious to a person having ordinary skill in the art.

Claims 10, 25, 50 are rejected under 35 U.S.C. 103(a) as being unpatentable over McZeal in view of Bernstein et al as applied to claim 1 above, and further in view of Creamer et al, U.S. Pat. App. Pub. #2003/0126207.

Creamer et al disclose in P.0006 that IM chat systems can also support the exchange of attachments. Attachments are electronic files such as images, documents, or binary objects which can be attached to an IM and transmitted therewith. To have used creamer et al teaching of attaching an electronic file to an IM in McZeal's instant voice messaging system would have been obvious to a person having ordinary skill in this art because the skilled practitioner will realize the efficiency of alerting a multitude of persons located throughout the world that an email/document from the sender is being sent to the recipients, such as the minutes of an important meeting.

Claims 30-33, 35, 41, 55, 57, 63, 64, 67, 69, 75 are rejected under 35 U.S.C. 103(a) as being unpatentable over McZeal in view of Bernstein et al as applied to claim 1 above, and further in view of Monroe.

Monroe discloses in col. 20, lines 28 et seq. and in Fig. 9 a local server (460) connected to a LAN, which provides a gateway to a WAN like the Internet. In col. 32, lines 11 et seq. Monroe discloses that pre-recorded voice messages can be delivered to a modem and then delivered throughout the network. To have used Monroe's teaching of connecting a local server to an Internet server in McZeal's device would have been obvious to a person having ordinary skill in the art because a local server will only reach a few, select individuals in close proximity to each other, whereas the Internet will have global reach, thus insuring connectivity to clients worldwide.

Claims 42 & 76 are rejected under 35 U.S.C. 103(a) as being unpatentable over McZeal in view of Bernstein et al and Monroe as applied to claim 30 above, and further in view of Boukobza, U.S. Pat. App. Pub. #2006/0167883.

Boukobza's method as disclosed in P.0020 is for load balancing databases within a network having a plurality of servers. To have provided Boukobza's method of load balancing servers in Monroe as applied to McZeal would have been obvious to a person having ordinary skill in the art, because the skilled practitioner would realize that as one server becomes filled with IM, or as one server is being inundated with high volume traffic, it would become necessary to route some of those IM to another server for storing.

Claims 34, 56, 68 are rejected under 35 U.S.C. 103(a) as being unpatentable over Mczeal in view of Bernstein et al and Monroe as applied to claim 30 above, and further in view of Williams et al.

Claims 37, 59, 71 are rejected under 35 U.S.C. 103(a) as being unpatentable over McZeal in view of Bernstein et al and Monroe as applied to claim 30 above, and further in view of Sagi et al.

Claims 38, 60, 72 are rejected under 35 U.S.C. 103(a) as being unpatentable over McZeal in view of Bernstein et al and Monroe as applied to claim 30 above, and further in view of Goodman et al.

Claims 39, 61, 73 are rejected under 35 U.S.C. 103(a) as being unpatentable over McZeal in view of Bernstein et al and Monroe as applied to claim 30 above, and further in view of Gierachf.

Claims 40, 62, 74 are rejected under 35 U.S.C. 103(a) as being unpatentable over McZeal in view of Bernstein et al and Monroe as applied to claim 30 above, and further in view of Creamer et al.

Application/Control Number: 10/740,030
Art Unit: 2614

Page 7

Any inquiry concerning this communication should be directed to Creighton H.
Smith at telephone number 571/272-7546.

04 AUG '08

/Creighton H Smith/
Primary Examiner, Art Unit 2614

Notice of References Cited	Application/Control No. 10/740,030	Applicant(s)/Patent Under Reexamination ROJAS, MICHAEL J.	
	Examiner Creighton H. Smith	Art Unit 2614	Page 1 of 1

U.S. PATENT DOCUMENTS

*	Document Number Country Code-Number-Kind Code	Date MM-YYYY	Name	Classification
*	A US-2004/0128356	07-2004	Bernstein et al.	709/206
*	B US-2003/0126207	07-2003	Creamer et al.	709/204
	C US-			
	D US-			
	E US-			
	F US-			
	G US-			
	H US-			
	I US-			
	J US-			
	K US-			
	L US-			
	M US-			

FOREIGN PATENT DOCUMENTS

*	Document Number Country Code-Number-Kind Code	Date MM-YYYY	Country	Name	Classification
	N				
	O				
	P				
	Q				
	R				
	S				
	T				

NON-PATENT DOCUMENTS

*	Include as applicable: Author, Title Date, Publisher, Edition or Volume, Pertinent Pages)
U	
V	
W	
X	

*A copy of this reference is not being furnished with this Office action. (See MPEP § 707.05(a).)
Dates in MM-YYYY format are publication dates. Classifications may be US or foreign.

Index of Claims 	Application/Control No. 10740030	Applicant(s)/Patent Under Reexamination ROJAS, MICHAEL J.
	Examiner Creighton H Smith	Art Unit 2614

✓	Rejected	-	Cancelled	N	Non-Elected	A	Appeal
=	Allowed	÷	Restricted	I	Interference	O	Objected

Claims renumbered in the same order as presented by applicant
 CPA
 T.D.
 R.1.47

CLAIM		DATE									
Final	Original	08/05/2008									
	1	✓									
	2	✓									
	3	✓									
	4	✓									
	5	✓									
	6	✓									
	7	✓									
	8	✓									
	9	✓									
	10	✓									
	11	✓									
	12	✓									
	13	✓									
	14	✓									
	15	✓									
	16	✓									
	17	✓									
	18	✓									
	19	✓									
	20	✓									
	21	✓									
	22	✓									
	23	✓									
	24	✓									
	25	✓									
	26	✓									
	27	✓									
	28	✓									
	29	✓									
	30	✓									
	31	✓									
	32	✓									
	33	✓									
	34	✓									
	35	✓									
	36	✓									

Index of Claims 	Application/Control No. 10740030	Applicant(s)/Patent Under Reexamination ROJAS, MICHAEL J.
	Examiner Creighton H Smith	Art Unit 2614

✓	Rejected	-	Cancelled	N	Non-Elected	A	Appeal
=	Allowed	÷	Restricted	I	Interference	O	Objected

Claims renumbered in the same order as presented by applicant
 CPA
 T.D.
 R.1.47

CLAIM		DATE									
Final	Original	08/05/2008									
	37	✓									
	38	✓									
	39	✓									
	40	✓									
	41	✓									
	42	✓									
	43	✓									
	44	✓									
	45	✓									
	46	✓									
	47	✓									
	48	✓									
	49	✓									
	50	✓									
	51	✓									
	52	✓									
	53	✓									
	54	✓									
	55	✓									
	56	✓									
	57	✓									
	58	✓									
	59	✓									
	60	✓									
	61	✓									
	62	✓									
	63	✓									
	64	✓									
	65	✓									
	66	✓									
	67	✓									
	68	✓									
	69	✓									
	70	✓									
	71	✓									
	72	✓									

<i>Index of Claims</i> 	Application/Control No. 10740030	Applicant(s)/Patent Under Reexamination ROJAS, MICHAEL J.
	Examiner Creighton H Smith	Art Unit 2614

✓	Rejected	-	Cancelled	N	Non-Elected	A	Appeal
=	Allowed	÷	Restricted	I	Interference	O	Objected

Claims renumbered in the same order as presented by applicant
 CPA
 T.D.
 R.1.47

CLAIM		DATE									
Final	Original	08/05/2008									
	73	✓									
	74	✓									
	75	✓									
	76	✓									

Search Notes 	Application/Control No. 10740030	Applicant(s)/Patent Under Reexamination ROJAS, MICHAEL J.
	Examiner Creighton H Smith	Art Unit 2614

SEARCHED			
Class	Subclass	Date	Examiner

SEARCH NOTES		
Search Notes	Date	Examiner
EAST Search	05 AUG '08	chs

INTERFERENCE SEARCH			
Class	Subclass	Date	Examiner

EAST Search History

Ref #	Hits	Search Query	DBs	Default Operator	Plurals	Time Stamp
L1	207	(@ad<="20021218") and (stor\$3 with (im or instant adj mesag\$3) with server\$1)	US-PGPUB; USPAT; USOCR; EPO; JPO; DERWENT; IBM_TDB	OR	OFF	2008/08/04 13:09
L2	411	(@ad<="20021218") and ((attach\$3 or fasten\$3 or affix \$3 or connect\$3 or join\$3 or add\$3) with email with (audio or voice))	US-PGPUB; USPAT; USOCR; EPO; JPO; DERWENT; IBM_TDB	OR	OFF	2008/08/04 14:43
L3	3411	(@ad<="20021218") and ((attach\$3 or fasten\$3 or affix \$3 or connect\$3 or join\$3 or add\$3) with (file\$1 or email) with (audio or voice))	US-PGPUB; USPAT; USOCR; EPO; JPO; DERWENT; IBM_TDB	OR	OFF	2008/08/04 14:44
L4	17	(@ad<="20021218") and ((attach\$3 or fasten\$3 or affix \$3 or connect\$3 or join\$3 or add\$3) with email with (im or instant adj mesag\$3))	US-PGPUB; USPAT; USOCR; EPO; JPO; DERWENT; IBM_TDB	OR	OFF	2008/08/04 14:48
L5	44	(@ad<="20021218") and ((attach\$3 or fasten\$3 or affix \$3 or connect\$3 or join\$3 or add\$3) with (email or file\$1) with (im or instant adj mesag \$3))	US-PGPUB; USPAT; USOCR; EPO; JPO; DERWENT; IBM_TDB	OR	OFF	2008/08/04 15:08

8/ 4/ 2008 3:48:57 PM

C:\Documents and Settings\csmith1\My Documents\EAST\Workspaces\10566778.wsp

UNITED STATES PATENT AND TRADEMARK OFFICE

Applicant(s):	Michael J. Rojas	Examiner:	Creighton H. Smith
Serial No:	10/740,030	Art Unit:	2614
Filed:	December 18, 2003	Docket:	17188
For:	SYSTEM AND METHOD FOR INSTANT VoIP MESSAGING	Dated:	July 7, 2008

Confirmation No. 1731

Commissioner for Patents
P. O. Box 1450
Alexandria, VA 22313-1450

RESPONSE UNDER 37 C.F.R. § 1.111

Sir:

Applicant submits this Response in reply to the Official Action dated March 6, 2008. Applicant respectfully requests reconsideration of the application in view of the following remarks.

CERTIFICATE OF ELECTRONIC FILING

I hereby certify that this correspondence is being deposited with the United States Patent & Trademark Office via Electronic Filing through the United States Patent and Trademark Office e-business website, on July 7, 2008.

Dated: July 7, 2008

Seth Weinfeld

REMARKS

Applicant has filed the present Response in reply to the outstanding Official Action of March 6, 2008, and the Applicant believes the Response to be fully responsive to the Official Action for at least the reasons set forth herein.

Claims 1-3, 5, 11-18, 26-29, 43, 45, 51-54, 65 and 66 stand rejected under 35 U.S.C. § 103(a) as being unpatentable in view of McZeal (previously cited) and Barry, U.S. Patent Publication No. 2007/0174403. Claims 4, 19, 20, and 44 stand rejected under 35 U.S.C. § 103(a) in view of McZeal, Barry and Williams. Claims 7, 22 and 47 stand rejected under 35 U.S.C. § 103(a) as being unpatentable in view of McZeal, Barry, and Sagi. Claims 8, 23 and 48 stand rejected under 35 U.S.C. § 103(a) as being unpatentable in view of McZeal, Barry and Goodman. Claims 9, 24 and 49 stand rejected under 35 U.S.C. § 103(a) as being unpatentable in view of McZeal, Barry and Gierachf, U.S. Patent Publication No. 2005/0053230. Claims 10, 25 and 50 stand rejected under 35 U.S.C. § 103(a) as being unpatentable in view of McZeal, Barry and Hollowell et al., U.S. Pat. Pub 2005/0105697.

Claims 30-33, 35, 41, 55, 57, 63, 64, 67, 69 and 75 stand rejected under 35 U.S.C. § 103(a) as being unpatentable in view of McZeal, Barry and Monroe, U.S. Patent No. 6,970,183. Claims 42 and 46 stand rejected under 35 U.S.C. § 103(a) as being unpatentable in view of McZeal, Barry, Monroe and Boukobza. Claims 34, 56 and 68 stand rejected under 35 U.S.C. § 103(a) as being unpatentable in view of McZeal, Barry, Williams and Monroe. Claims 37, 59 and 71 were rejected under 35 U.S.C. § 103(a) as being unpatentable in view of McZeal, Barry, Sagi and Monroe.

Claims 38, 60 and 72 stand rejected under 35 U.S.C. § 103(a) as being unpatentable in view of McZeal, Barry, Goodman and Monroe. Claims 39, 61 and 73 stand rejected under 35

U.S.C. § 103(a) as being unpatentable in view of McZeal, Barry, Gierachf and Monroe. Claims 40, 62 and 74 stand rejected under 35 U.S.C. § 103(a) as being unpatentable in view of McZeal, Barry, Hollowell and Monroe.

Applicant respectfully disagrees with the rejection and traverses with at least the following remarks and comments. Applicant submits that Barry and Hollowell are not prior art. Annexed hereto is a declaration pursuant to 37 C.F.R. § 1.131 attesting to Applicant's prior conception of the claimed invention. As asserted in paragraphs 2 and 3, Applicant completed the invention claimed in the instant application prior to the filing dates of both references. Applicant worked diligently with two different patent attorneys to file a patent application.

Based upon the foregoing, Applicant respectfully requests that the Examiner withdraw all of the pending rejections pursuant to 35 U.S.C. § 103(a).

In conclusion, the Applicant believes that the above-identified application is in condition for allowance and henceforth respectfully solicits the Examiner to allow the application. If the Examiner believes a telephone conference might expedite the allowance of this application, the Applicant respectfully requests that the Examiner call the undersigned, Applicant's attorney, at the following telephone number: (516) 742-4343.

Respectfully submitted,

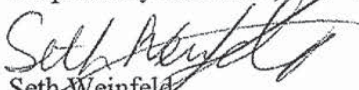
Seth Weinfeld
Registration No: 50,929

Scully, Scott, Murphy & Presser, P.C.
400 Garden City Plaza, Suite 300
Garden City, New York 11530
516-742-4343

SW:reg

COMBINED AMENDMENT & PETITION FOR EXTENSION OF TIME UNDER 37 CFR 1.136(a) (Small Entity)

Docket No.
17188

In Re Application Of: **Michael J. Rojas**

Application No. 10/740,030	Filing Date December 18, 2003	Examiner Creighton H. Smith	Customer No. 23389	Group Art Unit 2614	Confirmation No. 1731
-------------------------------	----------------------------------	--------------------------------	-----------------------	------------------------	--------------------------

Invention: **SYSTEM AND METHOD FOR INSTANT VoIP MESSAGIN**

COMMISSIONER FOR PATENTS:

This is a combined amendment and petition under the provisions of 37 CFR 1.136(a) to extend the period for filing a response to the Office Action of March 6, 2008 in the above-identified application.
Date

The requested extension is as follows (check time period desired):

One month Two months Three months Four months Five months

from: June 6, 2008 until: July 6, 2008 (Sunday)
Date *Date*

Applicant claims small entity status. See 37 CFR 1.27.

The fee for the amendment and extension of time has been calculated as shown below:

CLAIMS AS AMENDED

	CLAIMS REMAINING AFTER AMENDMENT	HIGHEST # PREV. PAID FOR	NUMBER EXTRA CLAIMS PRESENT	RATE	ADDITIONAL FEE
TOTAL CLAIMS	70 -	76 =	0	x \$25.00	\$0.00
INDEP. CLAIMS	14 -	14 =	0	x \$105.00	\$0.00
FEE FOR AMENDMENT					\$0.00
FEE FOR EXTENSION OF TIME					\$60.00
TOTAL FEE FOR AMENDMENT AND EXTENSION OF TIME					\$60.00

COMBINED AMENDMENT & PETITION FOR EXTENSION OF TIME UNDER 37 CFR 1.136(a) (Small Entity)

Docket No.
17188

The fee for the amendment and extension of time is to be paid as follows:

- A check in the amount of _____ for the amendment and extension of time is enclosed.
- Please charge Deposit Account No. **19-1013/SSMP** in the amount of **\$60.00**
- The Director is hereby authorized to charge payment of the following fees associated with this communication or credit any overpayment to Deposit Account No.
 - Any additional filing fees required under 37 C.F.R. 1.16.
 - Any patent application processing fees under 37 CFR 1.17.
- If an additional extension of time is required, please consider this a petition therefor and charge any additional fees which may be required to Deposit Account No. **19-1013/SSMP**
- Payment by credit card. Form PTO-2038 is attached.

WARNING: Information on this form may become public. Credit card information should not be included on this form. Provide credit card information and authorization on PTO-2038.



Signature

Seth Weinfeld
Registration No. 50,929
Scully, Scott, Murphy & Presser, P. C.
400 Garden City Plaza - Suite 300
Garden City, New York 11530
(516) 742-4343

Dated: July 7, 2008

I hereby certify that this correspondence is being deposited with the United States Postal Service with sufficient postage as first class mail in an envelope addressed to the "Commissioner for Patents, P.O. Box 1450, Alexandria, VA 22313-1450" [37 CFR 1.8(a)] on

(Date)

Signature of Person Mailing Correspondence

Typed or Printed Name of Person Mailing Correspondence

CC:

P28SMALL/REV06

UNITED STATES PATENT AND TRADEMARK OFFICE

Applicant:	Michael J. Rojas	Examiner:	Creighton H. Smith
Serial No:	10/740,030	Art Unit:	2614
Filed:	December 18, 2003	Docket:	17188
For:	SYSTEM AND METHOD FOR INSTANT VoIP MESSAGING		

Confirmation No. 1731

Commissioner for Patents
P. O. Box 1450
Alexandria, VA 22313-1450

DECLARATION PURSUANT TO 37 C.F.R. § 1.131

Sir:

I, MICHAEL ROJAS, hereby declare that:

1. I am the Applicant of United States Patent Application No. 10/740,030, filed on December 18, 2003.
2. I completed the invention disclosed and claimed in United States Patent Application No. 10/740,030, prior to November 14, 2003, which is the filing date of United States Publication No. 2005/0105697 A1, cited as a reference under 35 U.S.C. § 103, against the present application by the Examiner.
3. I completed the invention disclosed and claimed in United States Patent Application No. 10/740,030, prior to August 15, 2003, which is the filing date of United States Publication No. 2007/0174403 A1, cited as a reference under 35 U.S.C. § 103, against the present application by the Examiner.
4. The completion of the present invention consisted of the timely preparation of an invention disclosure outlining the subject matter of the invention. As evidence thereof

annexed hereto and made a part of this Declaration is Exhibit A, which is a redacted copy of the invention entitled "Instant Voice Communication" and comprising nineteen (19) pages of description.

5. All of the salient features of Applicant's United States Patent Application No. 10/740,030 are fully described in the annexed Exhibit A.
6. The material, as set forth in Exhibit A, fully and comprehensively describes the subject matter of the claims of the United States Patent Application No. 10/740,030, setting forth the features of the claimed invention.
7. The invention disclosure was timely submitted to outside counsel, Bradley C. Corsello (hereinafter "Corsello"), to prepare and file a provisional patent application.
8. A first draft of the provisional patent application was received from Corsello, prior to August 15, 2003.
9. On August 11, 2003, Corsello and Applicant had a teleconference regarding drafting the application and visit by Corsello to Applicant's office scheduled for August 19, 2003. Annexed herein as Exhibit B is a redacted email evidencing the teleconference.
10. On August 28, 2003, Corsello responded to a series of questions from Applicant regarding information needed to draft the application. Annexed herein as Exhibit C is a redacted email from Corsello.
11. On September 8, 2003, a representative of the assignee, Ayalogic, Neil Adams (hereinafter "Adams") inquired about the status of the application. Corsello informed Applicant that he was working on the revised draft. Annexed herein as Exhibit D is a redacted email regarding the inquiry and response.

12. On September 17, 2003, Adams emailed Applicant inquiring about information and material needed for the draft of the provisional application. Annexed herein as Exhibit E is a redacted email regarding the inquiry.
13. On September 22, 2003, Adams emailed Corsello information and material for the provisional application. The material is appended to the email as an attachment. Annexed herein as Exhibit F is a redacted email regarding the submission of material.
14. On October 3, 2003, assignee, Ayalogic (hereinafter "Ayalogic") decided to look for another law firm to file a patent application regarding the subject matter described in the invention disclosure.
15. Between October 3, 2003–October 27, 2003, Ayalogic searched for a law firm to preparing the patent application.
16. On October 28, 2003, Ayalogic engaging the firm Scully, Scott, Murphy and Presser, P.C., (hereinafter "Scully Scott") to preparing a patent application.
17. On October 30, 2003, Adams forwarded the latest draft of the provisional application to Scully Scott. Annexed herein as Exhibit G is a redacted email forwarding the document.
18. On November 4, 2003, Adams and Scully Scott conducted a teleconference regarding drafting of the application. Annexed herein as Exhibit H is a redacted email reflecting the teleconference.
19. On November 6, 2003, Adams emailed Applicant a revised draft and forwarded draft to Scully Scott. Annexed herein as Exhibit I is a redacted email evidencing the submission of the draft to Scully Scott.

20. Between November 6, 2003 and December 1, 2003, Adams inquired about the status of the application no less than three times.
21. Scully Scott prepared a draft of the application in timely manner. A first draft of the application was sent from Scully Scott to Applicant on December 2, 2003. Annexed herein as Exhibit J is a redacted email enclosing the draft. A series of revisions to the application were emailed to Applicant between December 3 and 4, after a teleconference with Applicant.
22. Applicant diligently reviewed the drafts of the application and provided comments thereto on December 9, 2003. Annexed herein as Exhibit K is a redacted email reflecting the comments.
23. A final draft of the application was sent to Applicant on December 16, 2003.
24. The United States Patent Application No. 10/740,030 was filed on December 18, 2003, after a timely and expedient review by the Applicant.
25. I further declare that all statements made herein of my own knowledge are true and that all statements made on information and belief are believed to be true; and further that these statements are made with knowledge that willful false statements and the like so made are punishable by fine or imprisonment or both, under Section 1001 of Title 18 of the United States Code and that such willful false statements may jeopardize the validity of the application or any patent issued thereon.

MICHAEL ROJAS

7-3-2008
Dated:

A



Instant Voice Communications

REDACTED

Michael Rojas
Executive Vice President

REDACTED

Ayalogic, Inc.
530 South Main Street, Suite 1732
Akron, Ohio 44311-1010
voice 330.253.2700
fax 330.253.3055

www.ayalogic.com

Instant Voice Communications

Abstract

This paper outlines the next step for communications systems – *instant voice communication* over internet protocol. With Ayalogic's™ new offering, QuickTalk™ business professionals will have the option to speak instantly with one another, revolutionizing the concept of telephone, voice mail and instant messaging. The IP technology behind QuickTalk will allow companies with this system to save dramatically on time, equipment and maintenance costs.

Instant Voice Messaging

QuickTalk™ offers instant connectedness – like an intercom that reaches everyone in the company, or a walkie talkie that spans the world. Touch a button and you can talk immediately with anyone anywhere the internet touches. The closest comparable technology is instant messaging – wildly popular, even with the significant handicap of using text instead of the clear, quality voice over IP that QuickTalk™ offers.

Instant messaging technology has been around in its most familiar form since 1996 and in recent years has become a common feature on PCs and cellular phones. It works like this: you create a “buddy list” of various people you may want to contact. When you want to communicate with a list member you simply type a message and it is instantly delivered to that person’s desktop (usually in a pop-up window). How popular is instant messaging? CNET.COM, a prominent downloads site, reported the number of ICQ instant messaging software downloads just in a single week at over 500,000.

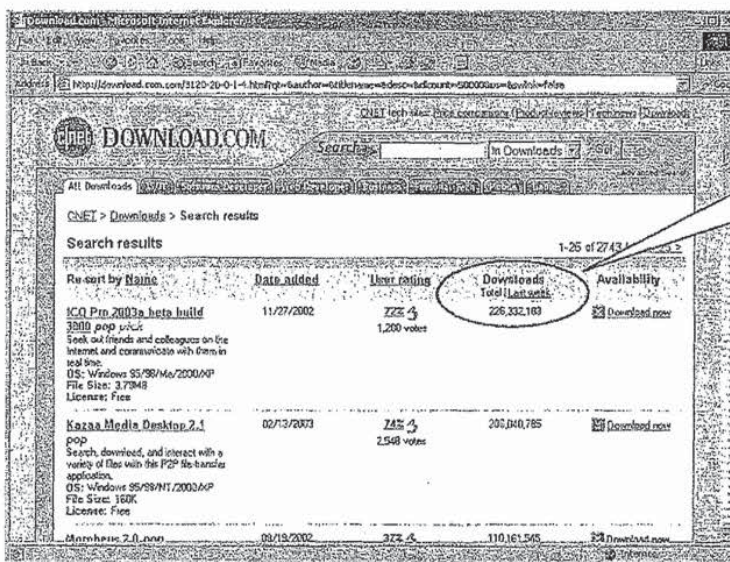

The screenshot shows a web browser window displaying search results on CNET Download.com. The search results table lists software items with columns for Name, Date added, User rating, Downloads, and Availability. A callout bubble points to the 'Downloads' column for the first item, 'ICQ Pm 2003a beta build', which shows 226,332,183 downloads.

Re-sort by Name	Date added	User rating	Downloads	Availability
ICQ Pm 2003a beta build 3800 pop Seek out friends and colleagues on the Internet and communicate with them in real time. OS: Windows 95/98/Me/2000/XP File Size: 3.73M License: Freeware	11/27/2002	2.25 1,200 votes	226,332,183	Download now
Kazaa Media Desktop 2.1 pop Search, download, and interact with a variety of files with this P2P file-sharing application. OS: Windows 95/98/NT/2000/XP File Size: 160K License: Freeware	02/13/2003	2.45 2,548 votes	200,040,785	Download now
Minihaptic 2.0.exe	09/19/2002	3.75 110,161,545	110,161,545	Download now

266,332,183
Downloads!

CNET.COM
Website
captured on
March 27, 2003

The substitution of voice for text makes QuickTalk™ infinitely more attractive. Nothing to type, just push a button and speak. Leave a voice mail message without dialing and check your own messages without lengthy punch pad scroll through. Ease of use and the comfort of voice communications set QuickTalk™ apart.

Innovation

No instant messaging vendor is concentrating on voice. We believe that by combining the best features of instant messaging with Voice over IP technology, we can provide a new form of communication – *instant voice*.

Messages are recorded, digitized, encrypted, and transmitted instantly to anywhere in the world. Since the digitization occurs at the time of recording, the voice quality will not suffer degradation as the message moves through the Internet. The voice quality will be superb every time – regardless of congestion on the global network.

New Levels of Privacy and Connectedness

QuickTalk™ promises to replace voice mail as we now know it with unprecedented levels of both connectedness and privacy. To leave a message with another user, simply push a button and speak. As for receiving messages, you may now choose *in advance* who can reach you instantly and which messages are sent automatically to voice mail – without screening. Change your preferences whenever you like, based on your schedule or specific project needs. Screen all your messages if you like, or send all messages to be stored for later pick up.

When you wish to reach others, a QuickTalk™ display on your PC screen – or a display on certain types of phones – will tell you whether they are “in” or “out,” again according to their preferences. This offers all of the connection of instant messaging with none of the productivity shattering intrusiveness.

Wherever You Go, There you Are

QuickTalk™ can reach you wherever you go, at whatever device you designate. Cellular phones, laptops, palm pilots – all can be used by the QuickTalk™ system whenever you designate that you wish to be reached somewhere other than at your desk. Using Ayalogic's™ proprietary gateway and software, you can now be reached (at whatever level of privacy you choose) instantly everywhere.

Voice over Internet Protocol (VoIP)

Telephone technology has changed very little since its inception. It is still primarily an analog modulated electrical voltage running on copper wires to each home – exactly how Alexander Graham Bell designed it. Now the Internet has is forcing a change in this 100-year-old technology. That change is called Voice over IP.

Voice over IP (or IP telephony) is a method of voice transmission in which analog speech is converted to digital information and transported across a computer network. This technology enables the transmission of speech to anywhere in the world that the Internet touches. When the digital voice information arrives, it is converted back into its analog form using technology built directly into the phone or receiving device.



Cisco 7960 VoIP Phone

The introduction of this technology, primarily by Cisco Systems, alarmed many traditional phone manufacturers. At first, they resisted the technology, citing that it was unreliable and of poor voice quality. However, as the technology's adoption rate grew, they began to incorporate it into their core products. Today, every vendor has some form of IP telephony offering.

Some manufacturers started from scratch creating new communication systems completely based on software, called *softswitches*. The philosophy was that once the voice was converted into digital packets, it could most easily be manipulated using computers and software. The goal was to speed the introduction of new phone services without having to upgrade expensive hardware. Cisco's CallManager product is an example of a softswitch.



Since Cisco had already cornered the Voice over IP *enterprise market*, the other softswitch vendors charged into the *service provider market*. Their customers were traditional phone companies, such as Verizon, and competitive local exchange carriers known as CLECs. However, when the telecommunication sector slumped, the service providers cut drastically back in capital expenditures, all but evaporating the Voice over IP market for service providers.

In reaction to this, every softswitch vendor did an about-face, and introduced an enterprise-version of their carrier-class products. This means that the enterprise market has over 50 softswitch vendors vying for position in a market dominated by Cisco. To compete, prices on this technology are dropping precipitously.

New Phones

Accelerating this price pressure is the weekly announcement of new devices that can leverage this technology. Companies such as Alcatel, Teliann, Lucent, Nortel, NEC, Cisco, Snom, Polycom, and Pingtel all offer VoIP phones. Up to now, the major growth inhibitor has been the cost the end device. In a normal communication system, the phones account for over 70% of the cost of the system.

Here is a sampling of the available phones as of March 27, 2003:



Vendor: PingTel
Model: expressa
Price: \$599

Description:

The PingTel phone is intelligent, has a built-in java processor and uses industry standard Session Initiation Protocol (SIP).



Vendor: Cisco Systems
Model: 7905
Price: \$230

Description:

This is Cisco's entry level IP phone based on the SIP standard.

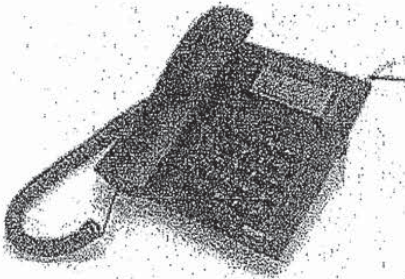

Vendor: Snom
Model: 100b
Price: \$240

Description:

Entry level VoIP Phone, supporting multiple standards such as SIP and H.323/H.450.

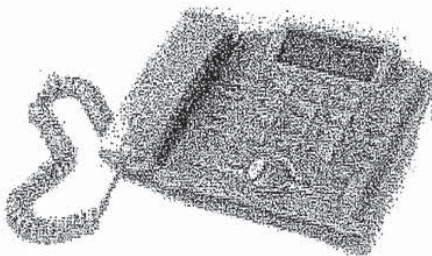

Vendor: Teliann
Model: HS Teliann IP Phone
Price: \$120

Description:

Korean-built, lowest cost VoIP phone on the market today – supports industry standard H.323 – SIP is planned.

The Teliann IP Phone was introduced at the Voice over Network conference (VON2002) in winter of 2002. Retailing at \$120, the phone has the potential of finally removing the price barrier to the market.

Phone-Speak

Every one of these devices requires a signaling protocol to make them function properly. This protocol is a series of commands and response messages that control every aspect of the phone. Call Hold, Call Forward, Answer, Hang-Up, and other basic features are handled by this protocol. Until recently, another large inhibitor of the market was the lack of agreement as to a standard for this signaling.

Here is a brief list of the competing signal standards:

- **H.323** - This is actually an umbrella standard that covers a number of other standards. This collection originated in the International Telecommunication Union (ITU) and like most telecommunication standards, is large and complex.
- **MGCP** (Media Gateway Control Protocol) - This standard was introduced by the Internet Engineering Task Force to control endpoint conversion devices, called gateways.
- **MEGACO** (MEdia GAteway COontrol Protocol) - Similar to MGCP, this protocol attempts to provide additional functionality in controlling endpoint gateways.
- **SIP** (Session Initiation Protocol) -- A simple text-based protocol which has its roots in HTTP (Hypertext Transport Protocol), the protocol that drives every web page of the Internet today.
- **SCCP** (Skinny Client Control Protocol) -- This is a proprietary protocol that every Cisco phone uses to provide advanced services beyond the standard protocols. Only the Cisco CallManager product supports this protocol.

For the past few years, the industry wrestled with each standard, slowing the adoption of the technology. Many products were introduced that could not communicate with each other because of these different standards.

As of this writing, the standards war is ending, with SIP becoming the winner. Microsoft, Cisco, Alcatel, Lucent, Nortel, and other vendors have all introduced SIP-based products. SIP is favored because of the simple and extensible nature of the protocol. With the adoption of SIP as a standard across all products, the Voice over IP market has removed one more inhibitor.

However, the most important standard that Voice over IP introduces is not the signaling standard, but the *network technology* for the phone itself -- Ethernet and TCP/IP.

The Real Voice over IP Standard - Ethernet

Every one of these devices shares a common characteristic. They all use TCP/IP protocol over Ethernet as the network standard to connect to the computer network.

This provides some very important benefits:

- **Flexibility** – Because Ethernet and TCP/IP are so prevalent, the devices can be deployed in many networking environments. They can be part of Wireless Local Area Networks (WLAN) such as 802.11b and connect over broadband connections such as cable modem, and DSL.
- **Cost** – Since Ethernet is widely available, the equipment to support such a network can enjoy the benefits of economies of scale. Networking gear is inexpensive, easy to obtain and install, allowing a wide audience to be reached.
- **Mobility** - All Ethernet devices have a unique number called the Media Access Control address (MAC). This number represents a unique piece of hardware and is never duplicated. This means that no matter where the phone connects to the network, that particular phone can be located and has the *same* identity.
- **Interoperability** – All the devices that deploy Ethernet inherently have the ability to communicate with one another. The devices may disagree on the *format* of the messages, but with additional software acting as a translator, these devices can communicate.

Flexibility

Ethernet provides for a wide variety of deployment possibilities. The networking standard can operate over twisted pair cabling, coax, and even wireless. Hundreds of network equipment manufacturers provide equipment for routing, switching, transporting, and configuring Ethernet-based systems.

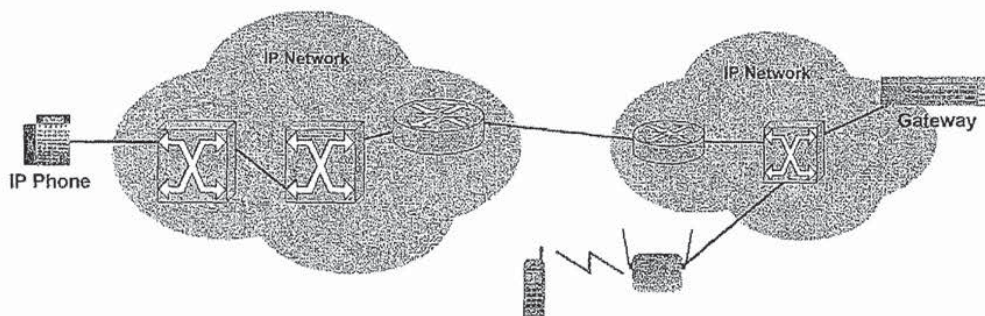

This allows the customer to choose best solutions for their particular business goals – while maintaining compatibility and interoperability.

Cost

With so many vendors offering compatible equipment, Voice over IP using Ethernet provides for significant cost savings. For example, a proprietary, 16-port station line card for a typical phone system costs \$1200. This allows the system to be expanded by 16 endpoints. In contrast, to add an additional 16 endpoints to a Voice over IP system, an Ethernet switch could be installed which retails for \$97.

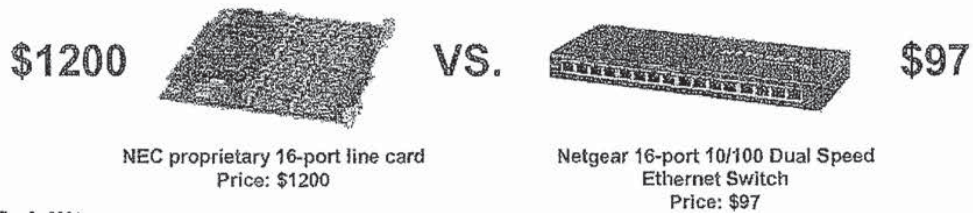

Mobility

In a traditional phone network, the typical business phone is a proprietary device using proprietary electrical signaling to connect to a central switching system. Even though the device may be located far from this system, its proprietary signaling limits where the device can be hooked up. It must be *directly connected*. This means that in order to move the device to a new location, the physical wiring must be changed.

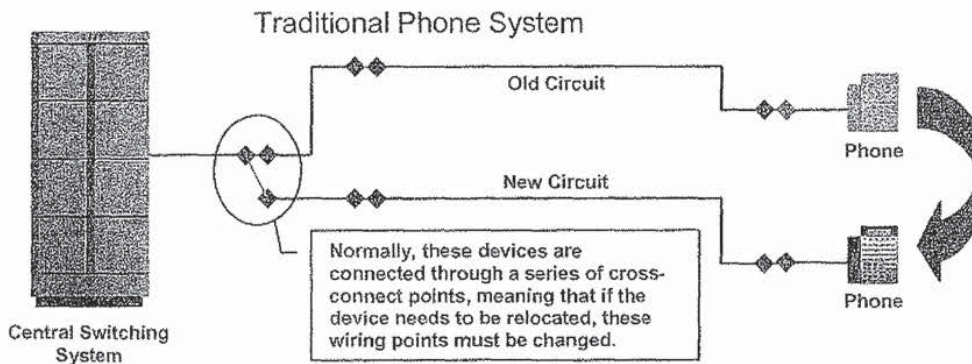

However, when the device employs Ethernet, the customer has complete flexibility in the location of the endpoint. All jacks can be provisioned identically regardless of which physical device will ultimately be connected.

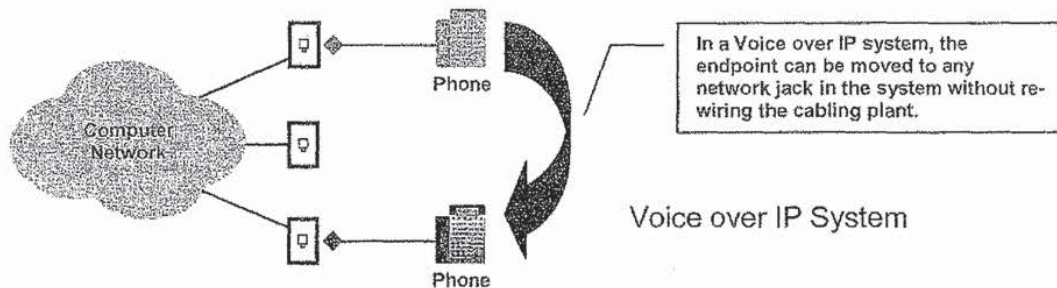

This is possible because each endpoint maintains its identity using the MAC address burned into the device. The *intelligence* in the system has been moved from a large

central device (PBX) into the endpoints itself. This give a Voice over IP system seamless *mobility* in relocating telephony equipment with a significant savings in administration costs.

Interoperability

Since the proprietary electrical signaling has been eliminated, it is possible to mix multiple vendor devices into the same network. This protects the customer's infrastructure investment and provides flexibility in determining the correct endpoint for a particular solution. Multiple systems can be combined into a single larger system regardless of whether the equipment is from the same vendor.

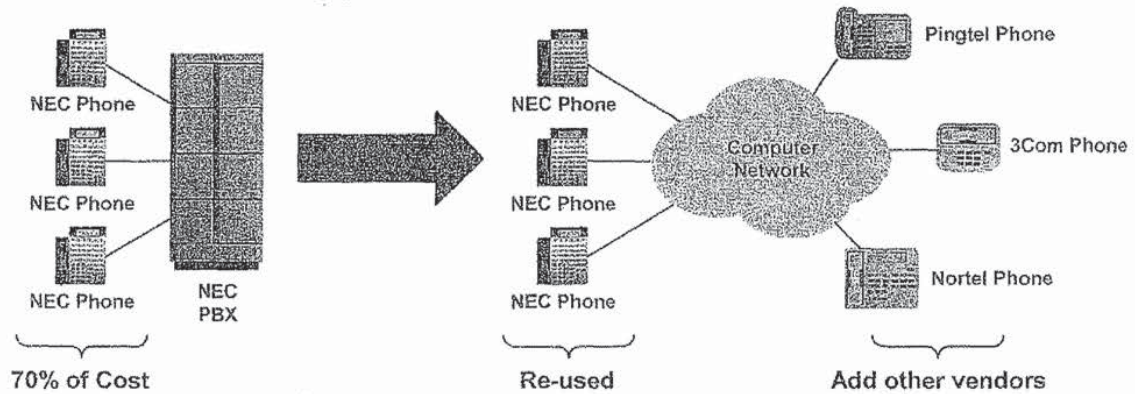

In the same way mainframes and *dumb* terminals gave way to personal computers and local area networks, the telecommunications industry can now move from cumbersome and costly switches and homogenous equipment to greater independence for end users and economical, as-needed equipment purchasing. All of this makes it possible to build a highly distributed and largely dispersed communication system that provides connectivity opportunities in ways that were not previously envisioned. We believe that this technology has paved the way to provide a new form of always-on, always-accessible, instant voice communications.

All that is required to connect one VoIP endpoint to another – instantly - is the software to control it.

Why the PC is not a Phone

Most proponents of Voice over IP technology always arrive at the conclusion that the PC should be used as a *replacement* for the phone. After all, a personal computer has a processor, network card, and a sound card, so all you need is software and - voila! - you have an IP phone. In the VoIP industry, this type of software is known as a *softphone*.

Softphones have been slow to catch on because of several reasons:

- **Reliability** – PCs are not always ready to receive calls, because of system reboots, lock-ups, and crashes. If the softphone software is not running at the time the call comes in, the call is lost.
- **Latency** – Not all users are running the latest Windows OS with the latest processor speeds, making it hard to predict whether the system will be able to support real-time two-way audio. In addition, most PCs are used for other daily activities. In some cases, even running Microsoft Word could deprive the softphone of the necessary resources to provide quality audio streaming.
- **Performance** – most audio needs real-time compression in order to be transmitted across the Internet. This compression can consume as much as 25% of most Pentium III processor cycles.
- **Ergonomics** – A personal computer is somewhat uncomfortable to use as a phone. You will need to use a microphone and speakers at a minimum, making it impossible to have a private conversation. If you use a headset, you have a feeling of being tethered to the workstation.
- **Interface** – Most softphones require dialing to be performed using the mouse or keyboard. This is an awkward situation at best. Even if you use the numeric keypad on the keyboard, the numbers are arranged upside-down of those on a telephone.
- **Financial** – Some implementations require the addition of cards into the PC. Many IT departments balk at the task of opening every PC just to deploy a phone system, making this logistically and financially difficult.

According to a recent IDC report, 94% of all users prefer to talk using an actual phone rather than their PC. Any new communication technology must be able to interoperate with new and existing telephony devices.

However, let's look at another growing communication technology – instant messaging.

Instant Messaging (IM) for the Business Market

While the consumer market is quite comfortable with instant messaging, the business market has viewed the technology with distrust, as problematic to manage and secure. Many corporations see the technology as *decreasing* productivity rather than enhancing it. However, whether individual IT groups sanction the use of the technology or not, instant messaging has invaded the workplace. The use of the technology can be broken down into several areas:

- **Personal** – While most companies have put into place strict phone abuse controls, instant messaging has effectively circumvented everything their IT groups have adopted. While most companies allow a reasonable amount of time for “calls to

home”, IM can quickly lead to abuse. If a corporation thinks IM decreases productivity, this is the most common reason provided.

- **Co-Worker** – Usually a very legitimate use, leading to greater productivity if deployed properly. A classic example is the use of the technology in customer service centers. The caller can be kept on the line talking with the service agent, while the agent chats with the problem specialist (co-worker) using instant messaging. This enables the customer to be served without a transfer or being put on-hold.
- **Customer** – Highly productive, convenient, low-cost way to serve your customer. Usually the biggest hurdle is getting the customer to use it.
- **Vendor** – Also productive. Easier to convince vendors to use the technology, since they have a sales motivation.

Since the invasion of IM technology into the enterprise, many large and small companies have rushed into the market. Almost all are focusing on security, manageability, and control in order to satisfy the business environment.

Current Instant Messaging Vendors

Vendors	Products
All Instant, Inc.	LiveGate, LiveStudio/Live Manager, Live Tracker, Live Archive 2.0
America Online, Inc.	AOL Instant Messenger (AIM) 4.7 ICQ
Bantu, Inc.	Bantu Instant Messaging & Presence Platform 1.5
Flypaper Inc.	Open Web Services Platform 3.0
IBM	Lotus Sametime Server 2.5
Ikimbo	Omniprise 1.3
Jabber, Inc.	Jabber Communications Platform 1.1
Microsoft Corp.	Microsoft MSN Messenger
Netscape Communications	Netscape Navigator Chat
Openwave Systems, Inc.	Openwave IM
PeopleLink	OnLine Community Solutions-Msg. Boards, Chat, Instant Messaging
Rockliffe, Inc.	MailSite DataCenter 4.5

Sonork S.R.L.	Sonork Instant Messaging Client 1.6 Sonork Instant Messaging Server 1.6
Wiredred Software	ie/pop - Real-time Communication Software for Corporations 3.0
Yahoo!, Inc.	Yahoo! Instant Messenger

The big players are, of course, AOL and Microsoft. IBM has the most aggressive growth because they integrated their instant messaging platform into Lotus Notes.

However, even though these companies say they support VoIP conferencing (usually via Microsoft NetMeeting), they are primarily a text-based messaging system. If they do support voice, the only option is full, real-time communications – the same communication method as a phone, but with a noticeable reduction in voice quality. In fact, they require the user to use the PC as a replacement for the phone. This approach has had very limited success, and *recently Microsoft has announced they are dropping support for voice in their instant messaging product (MSN Messenger).*

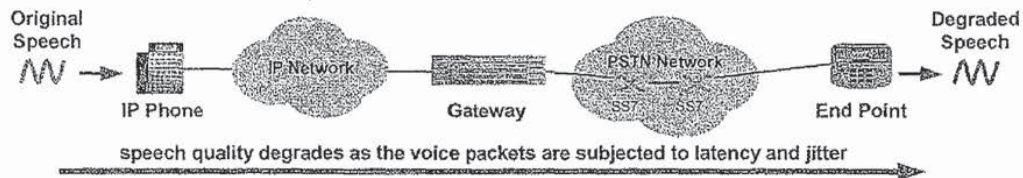

No instant messaging vendor is concentrating on voice. We believe that by combining the best features of instant messaging with Voice over IP technology, we can provide a new form of communication – *instant voice*. This technology allows the user to send and receive voice messages with a *push-to-talk* feel.

Messages are recorded, digitized, encrypted, and transmitted instantly to anywhere in the world. Since the digitization occurs at the time of recording, the voice quality will not suffer degradation as the message moves through the Internet. The voice quality will be superb every time – regardless of the currently congestion on the global network.

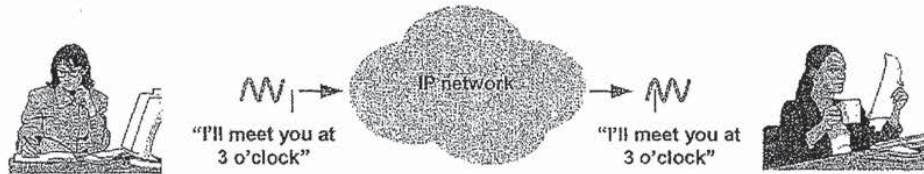

The user still has the option of controlling the *realtime-ness* of the communication – allowing instant messages, instant voice mails, paging, or full, two-way connections to be used.

Our Technology

Our product philosophy involves three key elements:

- **Simplicity in use** – Above everything else, the product will be easy for ordinary people to use everyday. The product can be received with very little training. It must be obvious to the casual user how the product can be put to use.
- **Powerful in function** – Through the creation of business enhancing features, the product will provide immediate, real-world productivity on a daily basis.
- **Business class software** – The software is designed from the ground up by business people for business.

Our flagship product, the QuickTalk Communication Platform™, is an enterprise class instant voice communication system designed to meet these goals. This system provides businesses with secure, manageable, and scalable instant voice communications. The product works with practically any existing phone system as an adjunct server providing advanced business-to-business collaborative communications.

Leveraging the latest software technologies, the server software is .NET managed code running on a Windows .NET Server platform with a Microsoft SQL Server database.

Client Server Architecture

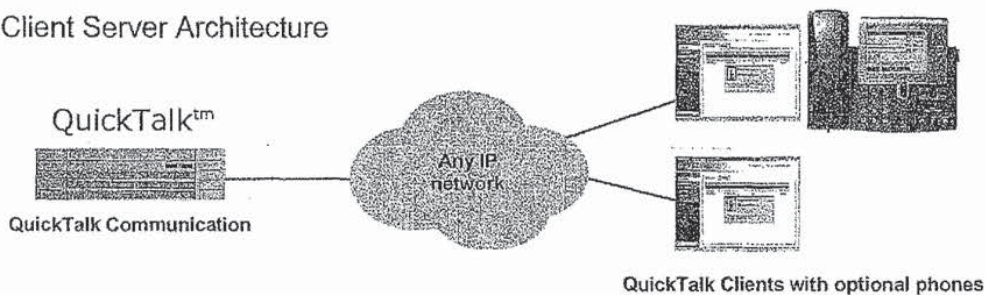

The entire software platform is installed on a rack-mountable industrial-grade server. This server features a front panel LCD which can control everything from assigning the network address, to rebooting the system.

Multiple servers may be deployed for system redundancy and load balancing.

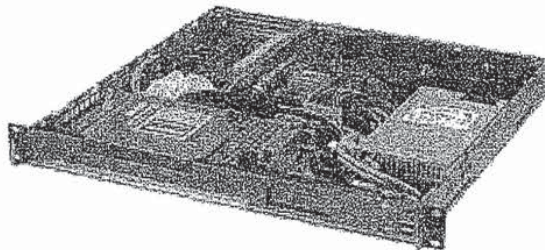

Instant Voice Communications

When using this form of communication, the end user simply designates a recipient, speaks the desired message and the audio is digitized, compressed, encrypted and immediately delivered using voice over IP technology. It is fast, easy and convenient. You can think of this as voice mail in reverse. No more waiting for the beep – just leave your message and go.

To see the benefit of using instant voice communication, look how an old-style voice mail message is delivered today:

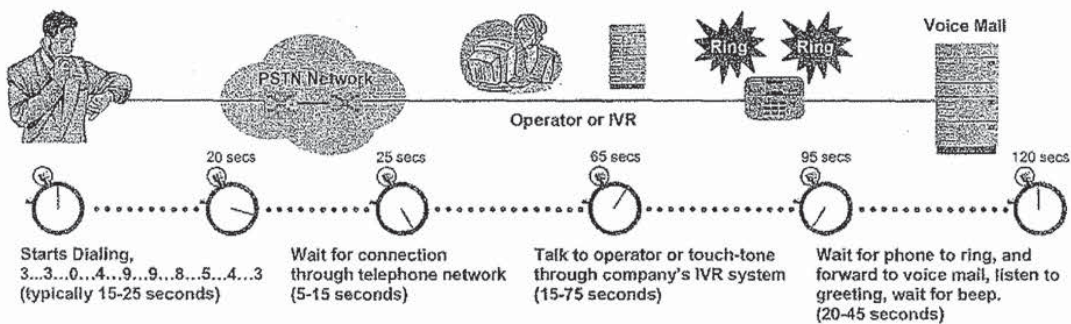

After dialing, connecting, transferring, ringing, and listening to the voice mail greeting, the caller has wasted over 1-2 minutes. This is the businessperson's typical waiting time *before* a voice message can begin. In addition to this waiting time, the caller must also spend time providing identification information in the voice mail message itself, further increasing the time of the entire effort.

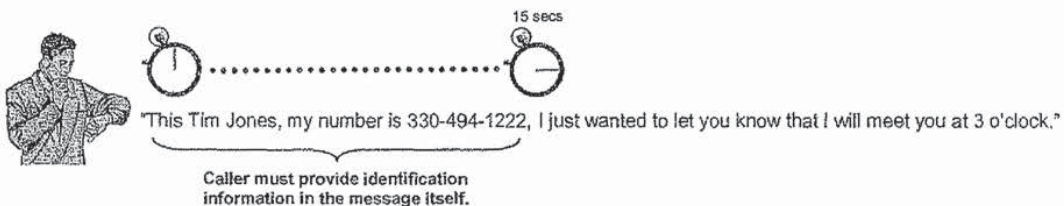

With instant voice communication, the caller simply presses a **push-to-talk** button on her PC keyboard or her phone and speaks her message. The message is delivered *instantly* via her telephone (which can be set directly on speaker or with a special ring signal).

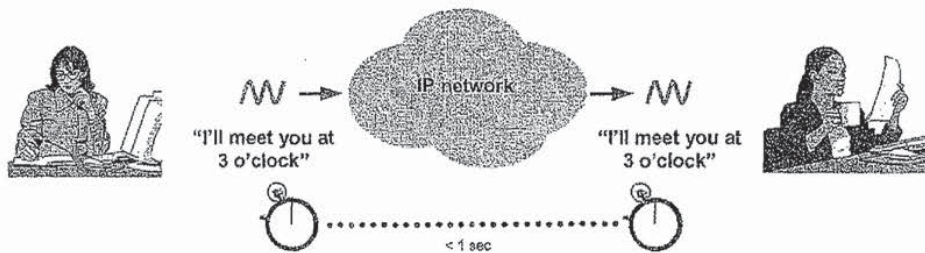

If the receiving party of the message wishes to reply, they can do so *instantly* by replying hands-free to the incoming message. The reply is delivered immediately to the sender.



All of this occurred without dialing, transferring, connecting, or most importantly – waiting. The productivity gains are enormous. Let’s look at a hypothetical ball bearing company.

Number of Employees	2000 employees
Average calls placed or received per day per employee (station-station and outside calls)	8 calls
Average salary of an employee	22.50 / hour
Percent of calls that reach voice mail or caller must wait for answer/callback	60% = 4.8 calls are "callbacks" or reach voice mail
Time wasted per call waiting to leave message	2 minutes
Total Time wasted in company per day	19,200 minutes per day
Total dollars saved using instant voice communications	\$7,200 / day = \$1,872,000 / year

Many companies spend hundreds of thousands of dollars on voice mail technologies so that they don't miss important messages. QuickTalk provides all the benefits of traditional voice messaging without the wait. The key to this technology is the patent-

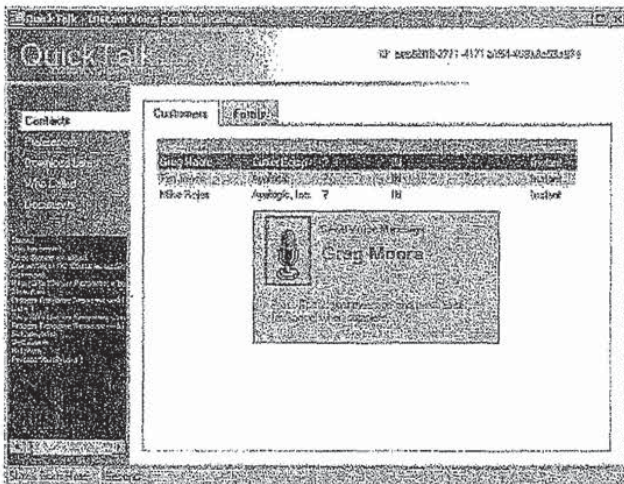

pending technology in the QuickTalk client software. This runs on Windows 95/98, 2000, NT, and XP and provides an easy-to-use interface to the product.

To use the technology, the user simply highlights the intended recipient, presses the space bar, and speaks the desired message. When the key is released, the message is instantly delivered to the intended contact.

If the user wishes to give or receive a more private conversation, the user may speak her message into a telephone instead of a PC microphone -- handoff is seamless between the client software and the physical telephony device.

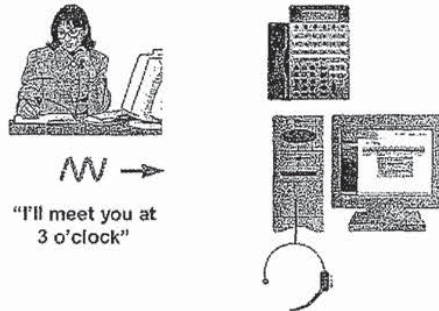

User has a choice of using the phone, PC microphone or headset for sending and receiving messages.

The client software provides a high-level view of all contacts using instant voice communications.

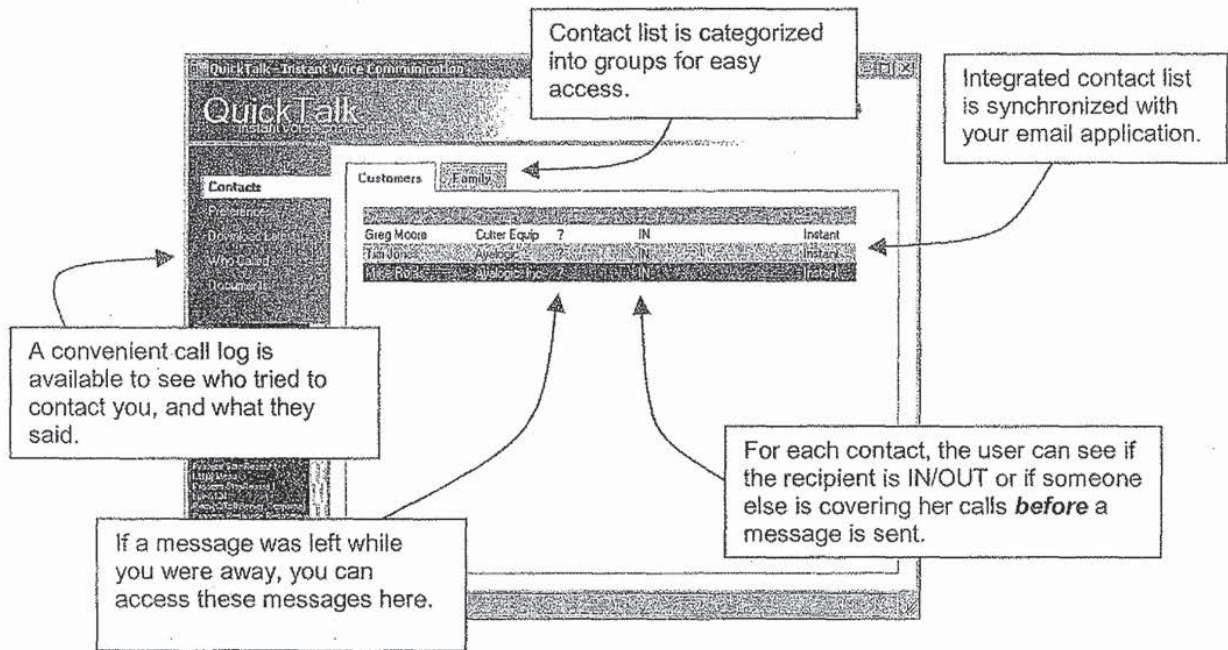

The client software can also be deployed on any system that utilizes the Microsoft .NET framework. This provides the flexibility to deploy the client onto a number of different computing devices: Pocket PCs, Laptops, Tablet PCs, and desktop computers.



When a wireless LAN card is added to the device, the client software can be configured for *cordless* instant voice communications providing mobility to the user.

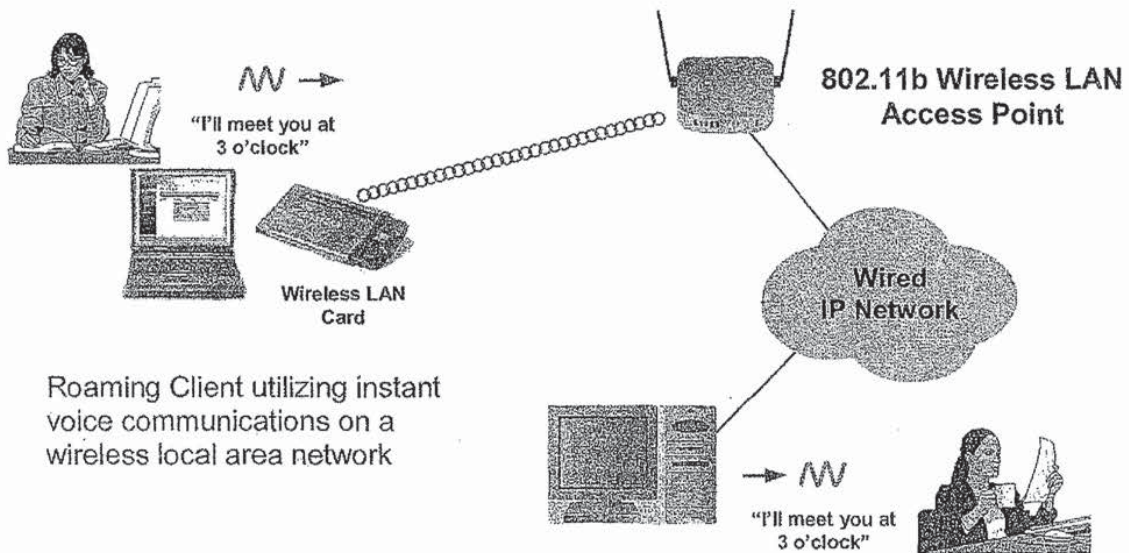

Roaming Client utilizing instant voice communications on a wireless local area network

Another important aspect of the client software is interoperability with the actual telephone infrastructure. When the client software is configured to utilize an actual phone, complete control of the software can be handled through the device itself.

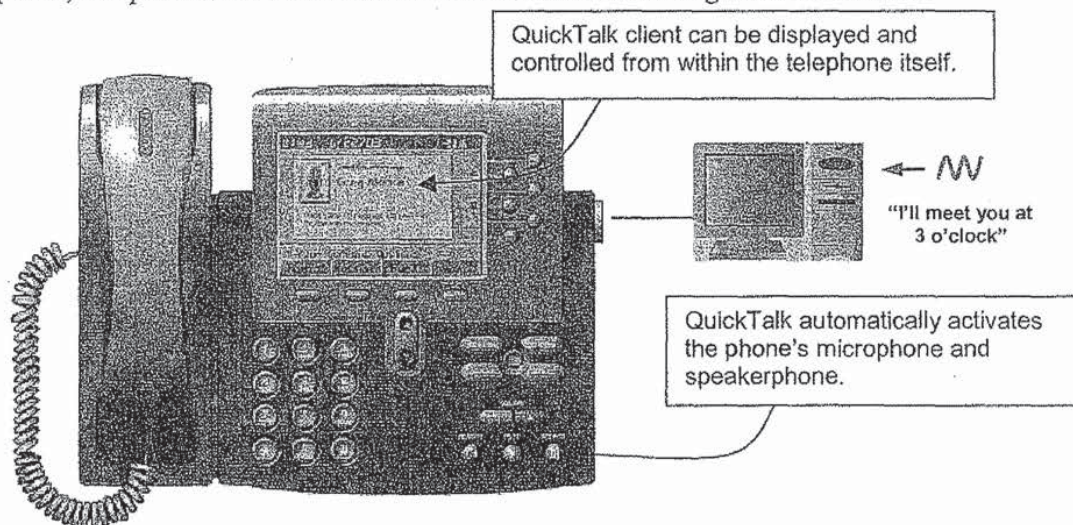

QuickTalk can support Voice over IP telephony hardware such as Cisco, Snom, Polycom, Teliann, and Pingtel, as well as legacy, circuit-based telephone infrastructure. This allows the product to provide instant voice communications on the customer's existing telephone system.

QuickTalk supports the following vendors:

- Avaya™ DEFINITY® ECS and MERLIN MAGIX®
- Nortel Meridian® and Norstar®
- NEC NEAX, Electra Elite and i-Series
- Toshiba Strata DK
- Ericsson MD110
- Alcatel 4200 and 4400
- Iwatsu ADIX APS
- Panasonic DBS 576 and 576HD

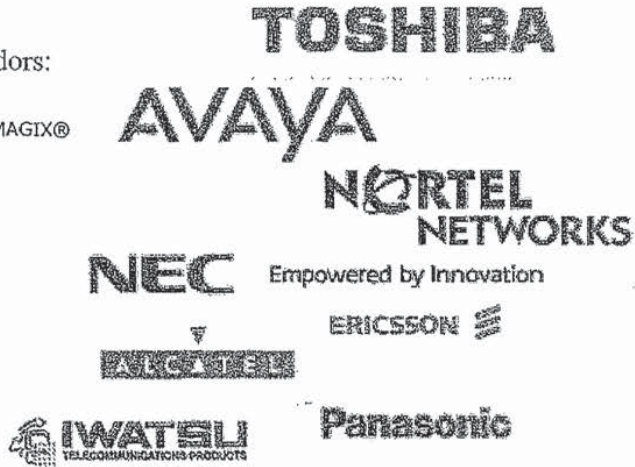

Here the allowable configuration modes of the client:

Stand-Alone (PC Only)



In this mode, communication is provided through the PC's speakers and microphone. The user can utilize an optional headset for a private conversation.



Stand-Alone with locally controlled VoIP phone

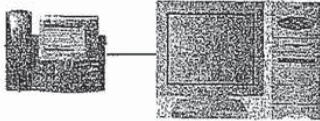

The user is free to use the phone and/or PC for instant voice communications. To transfer communication to the phone the user simply picks up the handset of the phone.

Remotely controlled VoIP phone



In this mode, the phone is remotely controlled from a virtual client on the *QuickTalk Communication Platform*. This allows the phone to be used independently from a PC.

Non-VoIP phone controlled by QuickTalk Server

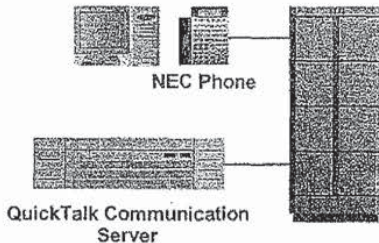

In this mode, the phone is remotely controlled by the *QuickTalk Communication Platform*. Control is accomplished by using integration technology to connect to the existing telephone system. This configuration allows existing infrastructure to be used for instant voice communications.

Wireless LAN IP devices

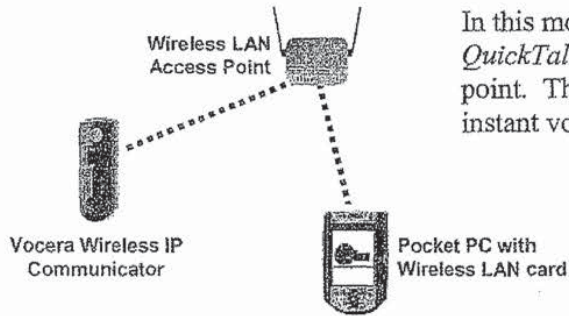

In this mode, the devices are remotely controlled by the *QuickTalk Communication Platform* via a wireless access point. This allows roaming clients to send and receive instant voice communications over a wireless network.

A Different Voice

QuickTalk™ offers a product unlike any other. No other company offers voice over IP technology in such a clear and convenient form. None works so completely with different machines (phones, PCs, Pocket PCs) and brands with such flexibility and mobility. Instant messaging is intrusive and voice mail as we know it can be cumbersome. QuickTalk™ with its patent pending *instant voice* technology promises to be the most convenient and cost-effective messaging solution for business people on the move.

B

REDACTED

REDACTED

-----Original Message-----

From: Brad Corsello

REDACTED

Sent: Monday, August 11, 2003 11:45 AM

To: Michael J. Rojas

Subject: Meeting on Tuesday, August 19

Mike, following up on our phone conversation today, I've booked a flight for Tuesday, August 19 arriving at 11:35 at Akron-Canton. I'll just drive up from the airport and arrive at about 12:00-12:15 (or at a later time if that is more convenient for you).

REDACTED

REDACTED

This email is a confidential and privileged attorney-client communication.

REDACTED

This email is a confidential and privileged attorney-client communication.

C

REDACTED

REDACTED

REDACTED

----- Original Message -----

From: "Brad Corsello" <
To: "Neil Adams" <nadams@ayalogic.com>
Sent: Thursday, August 28, 2003 12:08 PM
Subject: Re: CD with IMvox software

> Neil, '

REDACTED

>

REDACTED

>

REDACTED

But I think we will wrap things

> up next week.

>

> On Wed, 2003-08-27 at 16:26, neil adams wrote:

>> Brad,

>>

>>

>>

>>

REDACTED

>>

REDACTED

REDACTED

REDACTED

- >>
- >> Do you have examples of prior patent submittals that answer these type
- >> of questions?
- >>
- >> Neil
- >
- >
- >

REDACTED

- >
- > This email is a confidential and privileged attorney-client communication.
- >

D

REDACTED

REDACTED

-----Original Message-----

From: neil adams [mailto:nadams@ayalogic.com]
Sent: Monday, September 08, 2003 3:37 PM
To: mrojas@ayalogic.com
Subject: Patents - status, Brad

FYI

Neil

----- Original Message -----

From: "Brad Corsello" <bcorsello@corsello.com>
To: "Neil Adams" <nadams@ayalogic.com>
Sent: Monday, September 08, 2003 3:21 PM
Subject: Re: CD with IMvox software

> Neil, I am working on it now and will have it to you tonight or tomorrow
> morning.

>

> On Mon, 2003-09-08 at 10:04, neil adams wrote:

>> Brad,

>>

>> What's the status on changes to the patent app'n?

>>

>> Neil

>> ----- Original Message -----

>> From: "Brad Corsello" <bcorsello@corsello.com>

>> To: "Neil Adams" <nadams@ayalogic.com>

>> Sent: Thursday, August 28, 2003 12:08 PM

>> Subject: Re: CD with IMvox software

>>

>>

:

:

|

REDACTED

>>>

REDACTED

>>

REDACTED

REDACTED

REDACTED

>>>
>>>
!
>

REDACTED

REDACTED

>>>
>>>

>>> On Wed, 2003-08-27 at 16:26, neil adams wrote:

>>>> Brad,

>>>>

REDACTED

>>>>
>>
>>>
>>
>>>
>>>>
>>>>
>>

REDACTED

REDACTED

>>>>
>>>>
>>>> Neil

>>>>
>>>>

REDACTED

>>>>
>>>>

>>>> This email is a confidential and privileged attorney-client communication.

>>>>

>>>>

>>>>

>>>>

REDACTED

>>>>

>>>>

>>>>

>>>> This email is a confidential and privileged attorney-client communication.

>>>>

E

REDACTED

REDACTED

From: neil adams [mailto:nadams@ayalogic.com]
Sent: Wednesday, September 17, 2003 11:08 AM
To: mrojas@ayalogic.com; misha@ayalogic.com
Subject: CD for patents - questions

Mike,

Here's some additional information I need to add to the CD for Brad.

REDACTED

Questions

REDACTED

REDACTED

REDACTED

REDACTED

REDACTED

REDACTED

REDACTED -

Neil

F

REDACTED

REDACTED

From: neil adams [mailto:nadams@ayalogic.com]
Sent: Monday, September 22, 2003 12:29 PM
To: bcorsello@corsellolaw.com
Cc: mrojas@ayalogic.com
Subject: CD folders/files

Brad,

Attached is a compressed copy of the IMvox software and a Readme document that gives a brief overview of the software and hardware requirements.

REDACTED

REDACTED

Neil

G

REDACTED

REDACTED

From: neil adams [mailto:nadams@ayalogic.com]
Sent: Thursday, October 30, 2003 1:03 PM
To: mrojas@ayalogic.com; Herbert Breger (E-mail); jbreger@ayalogic.com;
bdiehl@ayalogic.com; misha@ayalogic.com
Subject: Prov patent forwarded to Paul Esatto at Scully et al.

The Provisional patent document was sent at 12:00 noon today.

REDACTED

Neil

H

REDACTED

REDACTED

From: neil adams [mailto:nadams@ayalogic.com]
Sent: Tuesday, November 04, 2003 1:50 PM
To: mrojas@ayalogic.com; Herbert Breger (E-mail)
Subject: Scully contact/discussions

I talked with the person at Scully who will be responsible for supporting our patent application. He is Alex Vodovozov.

REDACTED

Basically we went through a variety of questions about the patent draft

REDACTED

REDACTED

REDACTED

Neil

REDACTED

11/06/03

REDACTED

From: neil adams [mailto:nadams@ayalogic.com]
Sent: Thursday, November 06, 2003 2:28 PM
To: mrojas@ayalogic.com
Subject: Status - Patent Draft

Mike,

REDACTED

REDACTED

REDACTED

I am sending this version to Alex at Scully.

If you came up with a newer version please send it to me at nadams@sssnet.com.

I'll be back on Sunday and can review the changes prior to our 10:30 teleconference with Alex and Paul on Monday.

Neil

REDACTED

REDACTED

-----Original Message-----

From: Alex Vodovozov [mailto:avodovozov@ssmp.com]

Sent: Tuesday, December 02, 2003 5:09 PM

To: mrojas@ayalogic.com

Cc: Nadams@sssnet.com

Subject: IVM appl.

Dear Mike and Neil:

Please see a draft of the application.

REDACTED

Thank you for your assistance.

Regards,

Alexander G. Vodovozov, Esq.
Scully, Scott, Murphy & Presser
400 Garden City Plaza
Garden City, New York 11530
(516) 742-4343 (telephone)
(516) 742-4366 (facsimile)
avodovozov@ssmp.com (email)

THIS ELECTRONIC MESSAGE AND ATTACHMENTS, IF ANY, ARE INTENDED ONLY FOR THE INDIVIDUAL OR ENTITY NAMED ABOVE (OR THOSE PROPERLY ENTITLED TO ACCESS THE INFORMATION) AND MAY CONTAIN INFORMATION THAT IS PRIVILEGED, CONFIDENTIAL, ATTORNEY-WORK PRODUCT OR OTHERWISE EXEMPT FROM DISCLOSURE UNDER APPLICABLE LAW. IF THE READER OF THIS TRANSMISSION IS NOT THE INTENDED OR AN AUTHORIZED RECIPIENT, YOU ARE HEREBY NOTIFIED THAT ANY UNAUTHORIZED DISTRIBUTION, DISSEMINATION, OR COPYING OF THIS TRANSMISSION, IS PROHIBITED.

IF YOU HAVE RECEIVED THIS TRANSMISSION IN ERROR, PLEASE CONTACT THE SENDER IMMEDIATELY AND DELETE AND DESTROY ALL COPIES OF THIS TRANSMISSION

REDACTED

REDACTED

From: neil adams [mailto:nadams@ayalogic.com]
Sent: Tuesday, December 09, 2003 4:30 PM
To: 'Herbert Breger'; mrojas@ayalogic.com
Subject: Latest draft mods sent to Alex for review.

REDACTED

REDACTED

Neil

Electronic Patent Application Fee Transmittal

Application Number:	10740030			
Filing Date:	18-Dec-2003			
Title of Invention:	System and method for instant VoIP messaging			
First Named Inventor/Applicant Name:	Michael J. Rojas			
Filer:	Paul J. Esatto/Roseann Gallo			
Attorney Docket Number:	17188			
Filed as Small Entity				
Utility Filing Fees				
Description	Fee Code	Quantity	Amount	Sub-Total in USD(\$)
Basic Filing:				
Pages:				
Claims:				
Miscellaneous-Filing:				
Petition:				
Patent-Appeals-and-Interference:				
Post-Allowance-and-Post-Issuance:				
Extension-of-Time:				
Extension - 1 month with \$0 paid	2251	1	60	60

Description	Fee Code	Quantity	Amount	Sub-Total in USD(\$)
Miscellaneous:				
Total in USD (\$)				60

Electronic Acknowledgement Receipt

EFS ID:	3574061
Application Number:	10740030
International Application Number:	
Confirmation Number:	1731
Title of Invention:	System and method for instant VoIP messaging
First Named Inventor/Applicant Name:	Michael J. Rojas
Customer Number:	23389
Filer:	Paul J. Esatto/Roseann Gallo
Filer Authorized By:	Paul J. Esatto
Attorney Docket Number:	17188
Receipt Date:	07-JUL-2008
Filing Date:	18-DEC-2003
Time Stamp:	15:59:25
Application Type:	Utility under 35 USC 111(a)

Payment information:

Submitted with Payment	yes
Payment Type	Deposit Account
Payment was successfully received in RAM	\$60
RAM confirmation Number	1347
Deposit Account	191013
Authorized User	

The Director of the USPTO is hereby authorized to charge indicated fees and credit any overpayment as follows:

Charge any Additional Fees required under 37 C.F.R. Section 1.16 (National application filing, search, and examination fees)

Charge any Additional Fees required under 37 C.F.R. Section 1.17 (Patent application and reexamination processing fees)

File Listing:					
Document Number	Document Description	File Name	File Size(Bytes) /Message Digest	Multi Part /.zip	Pages (if appl.)
1		AMEND2EOT.pdf	272137 509df11695555820ed564ec18a03c5e9b91852a6	yes	5
Multipart Description/PDF files in .zip description					
		Document Description	Start	End	
		Amendment - After Non-Final Rejection	1	1	
		Applicant Arguments/Remarks Made in an Amendment	2	3	
		Extension of Time	4	5	
Warnings:					
Information:					
2	Rule 130, 131 or 132 Affidavits	1131EXHIBIT.pdf	2419512 343cb6c54645324fe787bcf9ad0412dc2dcd7dec	no	47
Warnings:					
Information:					
3	Fee Worksheet (PTO-06)	fee-info.pdf	8143 1290891803c33abbdad5ae675d70fcd01936076	no	2
Warnings:					
Information:					
Total Files Size (in bytes):			2699792		
<p>This Acknowledgement Receipt evidences receipt on the noted date by the USPTO of the indicated documents, characterized by the applicant, and including page counts, where applicable. It serves as evidence of receipt similar to a Post Card, as described in MPEP 503.</p> <p><u>New Applications Under 35 U.S.C. 111</u> If a new application is being filed and the application includes the necessary components for a filing date (see 37 CFR 1.53(b)-(d) and MPEP 506), a Filing Receipt (37 CFR 1.54) will be issued in due course and the date shown on this Acknowledgement Receipt will establish the filing date of the application.</p> <p><u>National Stage of an International Application under 35 U.S.C. 371</u> If a timely submission to enter the national stage of an international application is compliant with the conditions of 35 U.S.C. 371 and other applicable requirements a Form PCT/DO/EO/903 indicating acceptance of the application as a national stage submission under 35 U.S.C. 371 will be issued in addition to the Filing Receipt, in due course.</p> <p><u>New International Application Filed with the USPTO as a Receiving Office</u> If a new international application is being filed and the international application includes the necessary components for an international filing date (see PCT Article 11 and MPEP 1810), a Notification of the International Application Number and of the International Filing Date (Form PCT/RO/105) will be issued in due course, subject to prescriptions concerning national security, and the date shown on this Acknowledgement Receipt will establish the international filing date of the application.</p>					

Under the Paperwork Reduction Act of 1995, no persons are required to respond to a collection of information unless it displays a valid OMB control number.

PATENT APPLICATION FEE DETERMINATION RECORD Substitute for Form PTO-875	Application or Docket Number 10/740,030	Filing Date 12/18/2003	<input checked="" type="checkbox"/> To be Mailed

APPLICATION AS FILED – PART I				SMALL ENTITY <input checked="" type="checkbox"/> OR		OTHER THAN SMALL ENTITY	
(Column 1)		(Column 2)					
FOR	NUMBER FILED	NUMBER EXTRA	RATE (\$)	FEE (\$)	OR	RATE (\$)	FEE (\$)
<input type="checkbox"/> BASIC FEE (37 CFR 1.16(a), (b), or (c))	N/A	N/A	N/A			N/A	
<input type="checkbox"/> SEARCH FEE (37 CFR 1.16(k), (l), or (m))	N/A	N/A	N/A			N/A	
<input type="checkbox"/> EXAMINATION FEE (37 CFR 1.16(o), (p), or (q))	N/A	N/A	N/A			N/A	
TOTAL CLAIMS (37 CFR 1.16(j))	minus 20 =	*	X \$ =		OR	X \$ =	
INDEPENDENT CLAIMS (37 CFR 1.16(h))	minus 3 =	*	X \$ =			X \$ =	
<input type="checkbox"/> APPLICATION SIZE FEE (37 CFR 1.16(s))	If the specification and drawings exceed 100 sheets of paper, the application size fee due is \$250 (\$125 for small entity) for each additional 50 sheets or fraction thereof. See 35 U.S.C. 41(a)(1)(G) and 37 CFR 1.16(s).						
<input type="checkbox"/> MULTIPLE DEPENDENT CLAIM PRESENT (37 CFR 1.16(j))							
* If the difference in column 1 is less than zero, enter "0" in column 2.				TOTAL		TOTAL	

APPLICATION AS AMENDED – PART II					SMALL ENTITY OR		OTHER THAN SMALL ENTITY		
(Column 1)		(Column 2)		(Column 3)					
AMENDMENT	DATE	CLAIMS REMAINING AFTER AMENDMENT	HIGHEST NUMBER PREVIOUSLY PAID FOR	PRESENT EXTRA	RATE (\$)	ADDITIONAL FEE (\$)	OR	RATE (\$)	ADDITIONAL FEE (\$)
	07/07/2008								
	Total (37 CFR 1.16(i))	* 70	Minus	** 76	= 0	X \$25 =	0	OR	X \$ =
	Independent (37 CFR 1.16(h))	* 14	Minus	*** 14	= 0	X \$105 =	0	OR	X \$ =
	<input type="checkbox"/> Application Size Fee (37 CFR 1.16(s))								
	<input type="checkbox"/> FIRST PRESENTATION OF MULTIPLE DEPENDENT CLAIM (37 CFR 1.16(j))								
					TOTAL ADD'L FEE	0	OR	TOTAL ADD'L FEE	

APPLICATION AS AMENDED – PART II					SMALL ENTITY OR		OTHER THAN SMALL ENTITY		
(Column 1)		(Column 2)		(Column 3)					
AMENDMENT	DATE	CLAIMS REMAINING AFTER AMENDMENT	HIGHEST NUMBER PREVIOUSLY PAID FOR	PRESENT EXTRA	RATE (\$)	ADDITIONAL FEE (\$)	OR	RATE (\$)	ADDITIONAL FEE (\$)
	Total (37 CFR 1.16(i))	*	Minus	**	=	X \$ =		OR	X \$ =
	Independent (37 CFR 1.16(h))	*	Minus	***	=	X \$ =		OR	X \$ =
	<input type="checkbox"/> Application Size Fee (37 CFR 1.16(s))								
	<input type="checkbox"/> FIRST PRESENTATION OF MULTIPLE DEPENDENT CLAIM (37 CFR 1.16(j))								
					TOTAL ADD'L FEE		OR	TOTAL ADD'L FEE	

* If the entry in column 1 is less than the entry in column 2, write "0" in column 3.

** If the "Highest Number Previously Paid For" IN THIS SPACE is less than 20, enter "20".

*** If the "Highest Number Previously Paid For" IN THIS SPACE is less than 3, enter "3".

The "Highest Number Previously Paid For" (Total or Independent) is the highest number found in the appropriate box in column 1.

Legal Instrument Examiner:
/NICHELE PETERSON/

This collection of information is required by 37 CFR 1.16. The information is required to obtain or retain a benefit by the public which is to file (and by the USPTO to process) an application. Confidentiality is governed by 35 U.S.C. 122 and 37 CFR 1.14. This collection is estimated to take 12 minutes to complete, including gathering, preparing, and submitting the completed application form to the USPTO. Time will vary depending upon the individual case. Any comments on the amount of time you require to complete this form and/or suggestions for reducing this burden, should be sent to the Chief Information Officer, U.S. Patent and Trademark Office, U.S. Department of Commerce, P.O. Box 1450, Alexandria, VA 22313-1450. DO NOT SEND FEES OR COMPLETED FORMS TO THIS ADDRESS. SEND TO: Commissioner for Patents, P.O. Box 1450, Alexandria, VA 22313-1450.

If you need assistance in completing the form, call 1-800-PTO-9199 and select option 2.