



UNITED STATES PATENT AND TRADEMARK OFFICE

UNITED STATES DEPARTMENT OF COMMERCE
United States Patent and Trademark Office
Address: COMMISSIONER FOR PATENTS
P.O. Box 1450
Alexandria, Virginia 22313-1450
www.uspto.gov

Table with 5 columns: APPLICATION NO., ISSUE DATE, PATENT NO., ATTORNEY DOCKET NO., CONFIRMATION NO.

38933 7590 08/22/2007
GARMIN LTD.
C/O GARMIN INTERNATIONAL, INC.
ATTN: Legal - IP
1200 EAST 151ST STREET
OLATHE, KS 66062

ISSUE NOTIFICATION

The projected patent number and issue date are specified above.

Determination of Patent Term Adjustment under 35 U.S.C. 154 (b)
(application filed on or after May 29, 2000)

The Patent Term Adjustment is 71 day(s). Any patent to issue from the above-identified application will include an indication of the adjustment on the front page.

If a Continued Prosecution Application (CPA) was filed in the above-identified application, the filing date that determines Patent Term Adjustment is the filing date of the most recent CPA.

Applicant will be able to obtain more detailed information by accessing the Patent Application Information Retrieval (PAIR) WEB site (http://pair.uspto.gov).

Any questions regarding the Patent Term Extension or Adjustment determination should be directed to the Office of Patent Legal Administration at (571)-272-7702. Questions relating to issue and publication fee payments should be directed to the Customer Service Center of the Office of Patent Publication at (571)-272-4200.

APPLICANT(s) (Please see PAIR WEB site http://pair.uspto.gov for additional applicants):

Darrin W. Kabel, Overland Park, KS;
Steven J. Myers, Edgerton, KS;

**PART B - FEE(S) TRANSMITTAL**

**Complete and send this form, together with applicable fee(s), to: Mail Mail Stop ISSUE FEE  
 Commissioner for Patents  
 P.O. Box 1450  
 Alexandria, Virginia 22313-1450  
 or Fax (571)-273-2885**

**INSTRUCTIONS:** This form should be used for transmitting the ISSUE FEE and PUBLICATION FEE (if required). Blocks 1 through 5 should be completed where appropriate. All further correspondence including the Patent, advance orders and notification of maintenance fees will be mailed to the current correspondence address as indicated unless corrected below or directed otherwise in Block 1, by (a) specifying a new correspondence address; and/or (b) indicating a separate "FEE ADDRESS" for maintenance fee notifications.

CURRENT CORRESPONDENCE ADDRESS (Note: Use Block 1 for any change of address)

38933 7590 05/21/2007

GARMIN LTD.  
 C/O GARMIN INTERNATIONAL, INC.  
 ATTN: Legal - IP  
 1200 EAST 151ST STREET  
 OLATHE, KS 66062

Note: A certificate of mailing can only be used for domestic mailings of the Fee(s) Transmittal. This certificate cannot be used for any other accompanying papers. Each additional paper, such as an assignment or formal drawing, must have its own certificate of mailing or transmission.

**Certificate of Mailing or Transmission**

I hereby certify that this Fee(s) Transmittal is being deposited with the United States Postal Service with sufficient postage for first class mail in an envelope addressed to the Mail Stop ISSUE FEE address above, or being facsimile transmitted to the USPTO (571) 273-2885, on the date indicated below.

_____ (Depositor's name)
_____ (Signature)
_____ (Date)

APPLICATION NO.	FILING DATE	FIRST NAMED INVENTOR	ATTORNEY DOCKET NO.	CONFIRMATION NO.
10/667,026	09/18/2003	Darrin W. Kabel	702.254	9123

TITLE OF INVENTION: METHODS, SYSTEMS, AND DEVICES FOR CARTOGRAPHIC ALERTS

APPLN. TYPE	SMALL ENTITY	ISSUE FEE DUE	PUBLICATION FEE DUE	PREV. PAID ISSUE FEE	TOTAL FEE(S) DUE	DATE DUE
nonprovisional	NO	\$1400	\$0	\$0	\$1400	08/21/2007

EXAMINER	ART UNIT	CLASS-SUBCLASS
MEHMOOD, JENNIFER	2612	340-984000

1. Change of correspondence address or indication of "Fee Address" (37 CFR 1.363).  
 Change of correspondence address (or Change of Correspondence Address form PTO/SB/122) attached.  
 "Fee Address" indication (or "Fee Address" Indication form PTO/SB/47; Rev 03-02 or more recent) attached. Use of a Customer Number is required.

2. For printing on the patent front page, list  
 (1) the names of up to 3 registered patent attorneys or agents OR, alternatively,  
 (2) the name of a single firm (having as a member a registered attorney or agent) and the names of up to 2 registered patent attorneys or agents. If no name is listed, no name will be printed.

1 David L. Terrell  
 2 \_\_\_\_\_  
 3 \_\_\_\_\_

3. ASSIGNEE NAME AND RESIDENCE DATA TO BE PRINTED ON THE PATENT (print or type)  
 PLEASE NOTE: Unless an assignee is identified below, no assignee data will appear on the patent. If an assignee is identified below, the document has been filed for recordation as set forth in 37 CFR 3.11. Completion of this form is NOT a substitute for filing an assignment.

(A) NAME OF ASSIGNEE Garmin Ltd. (B) RESIDENCE: (CITY and STATE OR COUNTRY) Cayman Islands

Please check the appropriate assignee category or categories (will not be printed on the patent):  Individual  Corporation or other private group entity  Government

4a. The following fee(s) are submitted:  
 Issue Fee  
 Publication Fee (No small entity discount permitted)  
 Advance Order - # of Copies \_\_\_\_\_

4b. Payment of Fee(s): (Please first reapply any previously paid issue fee shown above)  
 A check is enclosed.  
 Payment by credit card. Form PTO-2038 is attached.  
 The Director is hereby authorized to charge the required fee(s), any deficiency, or credit any overpayment, to Deposit Account Number 561-791 (enclose an extra copy of this form).

5. Change in Entity Status (from status indicated above)  
 a. Applicant claims SMALL ENTITY status. See 37 CFR 1.27.  b. Applicant is no longer claiming SMALL ENTITY status. See 37 CFR 1.27(g)(2).

NOTE: The Issue Fee and Publication Fee (if required) will not be accepted from anyone other than the applicant; a registered attorney or agent; or the assignee or other party in interest as shown by the records of the United States Patent and Trademark Office.

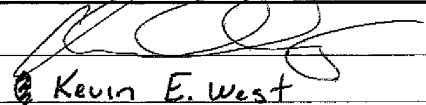
Authorized Signature  Date 8/3/07  
 Typed or printed name Kevin E. West Registration No. 43,983

This collection of information is required by 37 CFR 1.311. The information is required to obtain or retain a benefit by the public which is to file (and by the USPTO to process) an application. Confidentiality is governed by 35 U.S.C. 122 and 37 CFR 1.14. This collection is estimated to take 12 minutes to complete, including gathering, preparing, and submitting the completed application form to the USPTO. Time will vary depending upon the individual case. Any comments on the amount of time you require to complete this form and/or suggestions for reducing this burden, should be sent to the Chief Information Officer, U.S. Patent and Trademark Office, U.S. Department of Commerce, P.O. Box 1450, Alexandria, Virginia 22313-1450. DO NOT SEND FEES OR COMPLETED FORMS TO THIS ADDRESS. SEND TO: Commissioner for Patents, P.O. Box 1450, Alexandria, Virginia 22313-1450.

Under the Paperwork Reduction Act of 1995, no persons are required to respond to a collection of information unless it displays a valid OMB control number.

## Electronic Patent Application Fee Transmittal

<b>Application Number:</b>	10667026			
<b>Filing Date:</b>	18-Sep-2003			
<b>Title of Invention:</b>	METHODS, SYSTEMS, AND DEVICES FOR CARTOGRAPHIC ALERTS			
First Named Inventor/Applicant Name:	Darrin W. Kabel			
<b>Filer:</b>	Kevin E. West/Christine Terrell			
<b>Attorney Docket Number:</b>	702.254			
Filed as Large Entity				
<b>Utility Filing Fees</b>				
<b>Description</b>	<b>Fee Code</b>	<b>Quantity</b>	<b>Amount</b>	<b>Sub-Total in USD(\$)</b>
<b>Basic Filing:</b>				
<b>Pages:</b>				
<b>Claims:</b>				
<b>Miscellaneous-Filing:</b>				
<b>Petition:</b>				
<b>Patent-Appeals-and-Interference:</b>				
Post-Allowance-and-Post-Issuance:				
Utility Appl issue fee	1501	1	1400	1400
<b>Extension-of-Time:</b>				

Description	Fee Code	Quantity	Amount	Sub-Total in USD(\$)
<b>Miscellaneous:</b>				
<b>Total in USD (\$)</b>				<b>1400</b>

## Electronic Acknowledgement Receipt

<b>EFS ID:</b>	2047871
<b>Application Number:</b>	10667026
<b>International Application Number:</b>	
<b>Confirmation Number:</b>	9123
<b>Title of Invention:</b>	METHODS, SYSTEMS, AND DEVICES FOR CARTOGRAPHIC ALERTS
<b>First Named Inventor/Applicant Name:</b>	Darrin W. Kabel
<b>Customer Number:</b>	38933
<b>Filer:</b>	Kevin E. West/Christine Terrell
<b>Filer Authorized By:</b>	Kevin E. West
<b>Attorney Docket Number:</b>	702.254
<b>Receipt Date:</b>	03-AUG-2007
<b>Filing Date:</b>	18-SEP-2003
<b>Time Stamp:</b>	18:11:01
<b>Application Type:</b>	Utility under 35 USC 111(a)

### Payment information:

Submitted with Payment	yes
Payment was successfully received in RAM	\$ 1400
RAM confirmation Number	2386
Deposit Account	501791

The Director of the USPTO is hereby authorized to charge indicated fees and credit any overpayment as follows:  
Charge any Additional Fees required under 37 C.F.R. Section 1.16 and 1.17

### File Listing:

Document Number	Document Description	File Name	File Size(Bytes) /Message Digest	Multi Part /.zip	Pages (if appl.)
1	Issue Fee Payment (PTO-85B)	IssueFeeTransmittal.pdf	97145 ac23c8ec2e63d1a221dd38c61d37e901554a2774	no	1
<b>Warnings:</b>					
<b>Information:</b>					
2	Fee Worksheet (PTO-06)	fee-info.pdf	8168 a509a6339b766889922e4c1c7376c3619bd7cca1	no	2
<b>Warnings:</b>					
<b>Information:</b>					
<b>Total Files Size (in bytes):</b>			105313		
<p><b>This Acknowledgement Receipt evidences receipt on the noted date by the USPTO of the indicated documents, characterized by the applicant, and including page counts, where applicable. It serves as evidence of receipt similar to a Post Card, as described in MPEP 503.</b></p> <p><b><u>New Applications Under 35 U.S.C. 111</u></b>  If a new application is being filed and the application includes the necessary components for a filing date (see 37 CFR 1.53(b)-(d) and MPEP 506), a Filing Receipt (37 CFR 1.54) will be issued in due course and the date shown on this Acknowledgement Receipt will establish the filing date of the application.</p> <p><b><u>National Stage of an International Application under 35 U.S.C. 371</u></b>  If a timely submission to enter the national stage of an international application is compliant with the conditions of 35 U.S.C. 371 and other applicable requirements a Form PCT/DO/EO/903 indicating acceptance of the application as a national stage submission under 35 U.S.C. 371 will be issued in addition to the Filing Receipt, in due course.</p> <p><b><u>New International Application Filed with the USPTO as a Receiving Office</u></b>  If a new international application is being filed and the international application includes the necessary components for an international filing date (see PCT Article 11 and MPEP 1810), a Notification of the International Application Number and of the International Filing Date (Form PCT/RO/105) will be issued in due course, subject to prescriptions concerning national security, and the date shown on this Acknowledgement Receipt will establish the international filing date of the application.</p>					



UNITED STATES PATENT AND TRADEMARK OFFICE

*elen*

UNITED STATES DEPARTMENT OF COMMERCE  
United States Patent and Trademark Office  
Address: COMMISSIONER FOR PATENTS  
P.O. Box 1450  
Alexandria, Virginia 22313-1450  
www.uspto.gov

NOTICE OF ALLOWANCE AND FEE(S) DUE

38933 7590 05/21/2007

GARMIN LTD.  
C/O GARMIN INTERNATIONAL, INC.  
ATTN: Legal - IP  
1200 EAST 151ST STREET  
OLATHE, KS 66062

EXAMINER

MEHMOOD, JENNIFER

ART UNIT PAPER NUMBER

2612  
DATE MAILED: 05/21/2007

APPLICATION NO.	FILING DATE	FIRST NAMED INVENTOR	ATTORNEY DOCKET NO.	CONFIRMATION NO.
10/667,026	09/18/2003	Darrin W. Kabel	702.254	9123

TITLE OF INVENTION: METHODS, SYSTEMS, AND DEVICES FOR CARTOGRAPHIC ALERTS

APPLN. TYPE	SMALL ENTITY	ISSUE FEE DUE	PUBLICATION FEE DUE	PREV. PAID ISSUE FEE	TOTAL FEE(S) DUE	DATE DUE
nonprovisional	NO	\$1400	\$0	\$0	\$1400	08/21/2007

THE APPLICATION IDENTIFIED ABOVE HAS BEEN EXAMINED AND IS ALLOWED FOR ISSUANCE AS A PATENT. PROSECUTION ON THE MERITS IS CLOSED. THIS NOTICE OF ALLOWANCE IS NOT A GRANT OF PATENT RIGHTS. THIS APPLICATION IS SUBJECT TO WITHDRAWAL FROM ISSUE AT THE INITIATIVE OF THE OFFICE OR UPON PETITION BY THE APPLICANT. SEE 37 CFR 1.313 AND MPEP 1308.

THE ISSUE FEE AND PUBLICATION FEE (IF REQUIRED) MUST BE PAID WITHIN THREE MONTHS FROM THE MAILING DATE OF THIS NOTICE OR THIS APPLICATION SHALL BE REGARDED AS ABANDONED. THIS STATUTORY PERIOD CANNOT BE EXTENDED. SEE 35 U.S.C. 151. THE ISSUE FEE DUE INDICATED ABOVE DOES NOT REFLECT A CREDIT FOR ANY PREVIOUSLY PAID ISSUE FEE IN THIS APPLICATION. IF AN ISSUE FEE HAS PREVIOUSLY BEEN PAID IN THIS APPLICATION (AS SHOWN ABOVE), THE RETURN OF PART B OF THIS FORM WILL BE CONSIDERED A REQUEST TO REAPPLY THE PREVIOUSLY PAID ISSUE FEE TOWARD THE ISSUE FEE NOW DUE.

HOW TO REPLY TO THIS NOTICE:

I. Review the SMALL ENTITY status shown above.

If the SMALL ENTITY is shown as YES, verify your current SMALL ENTITY status:

A. If the status is the same, pay the TOTAL FEE(S) DUE shown above.

B. If the status above is to be removed, check box 5b on Part B - Fee(s) Transmittal and pay the PUBLICATION FEE (if required) and twice the amount of the ISSUE FEE shown above, or

If the SMALL ENTITY is shown as NO:

A. Pay TOTAL FEE(S) DUE shown above, or

B. If applicant claimed SMALL ENTITY status before, or is now claiming SMALL ENTITY status, check box 5a on Part B - Fee(s) Transmittal and pay the PUBLICATION FEE (if required) and 1/2 the ISSUE FEE shown above.

II. PART B - FEE(S) TRANSMITTAL; or its equivalent, must be completed and returned to the United States Patent and Trademark Office (USPTO) with your ISSUE FEE and PUBLICATION FEE (if required). If you are charging the fee(s) to your deposit account, section "4b" of Part B - Fee(s) Transmittal should be completed and an extra copy of the form should be submitted. If an equivalent of Part B is filed, a request to reapply a previously paid issue fee must be clearly made, and delays in processing may occur due to the difficulty in recognizing the paper as an equivalent of Part B.

III. All communications regarding this application must give the application number. Please direct all communications prior to issuance to Mail Stop ISSUE FEE unless advised to the contrary.

IMPORTANT REMINDER: Utility patents issuing on applications filed on or after Dec. 12, 1980 may require payment of maintenance fees. It is patentee's responsibility to ensure timely payment of maintenance fees when due.

**PART B - FEE(S) TRANSMITTAL**

**Complete and send this form, together with applicable fee(s), to: Mail Mail Stop ISSUE FEE  
 Commissioner for Patents  
 P.O. Box 1450  
 Alexandria, Virginia 22313-1450  
 or Fax (571)-273-2885**

**INSTRUCTIONS:** This form should be used for transmitting the ISSUE FEE and PUBLICATION FEE (if required). Blocks 1 through 5 should be completed where appropriate. All further correspondence including the Patent, advance orders and notification of maintenance fees will be mailed to the current correspondence address as indicated unless corrected below or directed otherwise in Block 1, by (a) specifying a new correspondence address; and/or (b) indicating a separate "FEE ADDRESS" for maintenance fee notifications.

CURRENT CORRESPONDENCE ADDRESS (Note: Use Block 1 for any change of address)

38933                      7590                      05/21/2007

**GARMIN LTD.  
 C/O GARMIN INTERNATIONAL, INC.  
 ATTN: Legal - IP  
 1200 EAST 151ST STREET  
 OLATHE, KS 66062**

Note: A certificate of mailing can only be used for domestic mailings of the Fee(s) Transmittal. This certificate cannot be used for any other accompanying papers. Each additional paper, such as an assignment or formal drawing, must have its own certificate of mailing or transmission.

**Certificate of Mailing or Transmission**

I hereby certify that this Fee(s) Transmittal is being deposited with the United States Postal Service with sufficient postage for first class mail in an envelope addressed to the Mail Stop ISSUE FEE address above, or being facsimile transmitted to the USPTO (571) 273-2885, on the date indicated below.

_____ (Depositor's name)
_____ (Signature)
_____ (Date)

APPLICATION NO.	FILING DATE	FIRST NAMED INVENTOR	ATTORNEY DOCKET NO.	CONFIRMATION NO.
10/667,026	09/18/2003	Darrin W. Kabel	702.254	9123

TITLE OF INVENTION: METHODS, SYSTEMS, AND DEVICES FOR CARTOGRAPHIC ALERTS

APPLN. TYPE	SMALL ENTITY	ISSUE FEE DUE	PUBLICATION FEE DUE	PREV. PAID ISSUE FEE	TOTAL FEE(S) DUE	DATE DUE
nonprovisional	NO	\$1400	\$0	\$0	\$1400	08/21/2007

EXAMINER	ART UNIT	CLASS-SUBCLASS
MEHMOOD, JENNIFER	2612	340-984000

<p>1. Change of correspondence address or indication of "Fee Address" (37 CFR 1.363).  <input type="checkbox"/> Change of correspondence address (or Change of Correspondence Address form PTO/SB/122) attached.  <input type="checkbox"/> "Fee Address" indication (or "Fee Address" Indication form PTO/SB/47; Rev 03-02 or more recent) attached. Use of a Customer Number is required.</p>	<p>2. For printing on the patent front page, list                  (1) the names of up to 3 registered patent attorneys or agents OR, alternatively, _____ 1                  (2) the name of a single firm (having as a member a registered attorney or agent) and the names of up to 2 registered patent attorneys or agents. If no name is listed, no name will be printed. _____ 2                  _____ 3</p>
--	---

3. ASSIGNEE NAME AND RESIDENCE DATA TO BE PRINTED ON THE PATENT (print or type)

PLEASE NOTE: Unless an assignee is identified below, no assignee data will appear on the patent. If an assignee is identified below, the document has been filed for recordation as set forth in 37 CFR 3.11. Completion of this form is NOT a substitute for filing an assignment.

(A) NAME OF ASSIGNEE \_\_\_\_\_ (B) RESIDENCE: (CITY and STATE OR COUNTRY) \_\_\_\_\_

Please check the appropriate assignee category or categories (will not be printed on the patent) :  Individual  Corporation or other private group entity  Government

<p>4a. The following fee(s) are submitted:  <input type="checkbox"/> Issue Fee  <input type="checkbox"/> Publication Fee (No small entity discount permitted)  <input type="checkbox"/> Advance Order - # of Copies _____</p>	<p>4b. Payment of Fee(s): (Please first reapply any previously paid issue fee shown above)  <input type="checkbox"/> A check is enclosed.  <input type="checkbox"/> Payment by credit card. Form PTO-2038 is attached.  <input type="checkbox"/> The Director is hereby authorized to charge the required fee(s), any deficiency, or credit any overpayment, to Deposit Account Number _____ (enclose an extra copy of this form).</p>
---	--

5. Change in Entity Status (from status indicated above)  
 a. Applicant claims SMALL ENTITY status. See 37 CFR 1.27.  b. Applicant is no longer claiming SMALL ENTITY status. See 37 CFR 1.27(g)(2).

NOTE: The Issue Fee and Publication Fee (if required) will not be accepted from anyone other than the applicant; a registered attorney or agent; or the assignee or other party in interest as shown by the records of the United States Patent and Trademark Office.

Authorized Signature \_\_\_\_\_ Date \_\_\_\_\_  
 Typed or printed name \_\_\_\_\_ Registration No. \_\_\_\_\_

This collection of information is required by 37 CFR 1.311. The information is required to obtain or retain a benefit by the public which is to file (and by the USPTO to process) an application. Confidentiality is governed by 35 U.S.C. 122 and 37 CFR 1.14. This collection is estimated to take 12 minutes to complete, including gathering, preparing, and submitting the completed application form to the USPTO. Time will vary depending upon the individual case. Any comments on the amount of time you require to complete this form and/or suggestions for reducing this burden, should be sent to the Chief Information Officer, U.S. Patent and Trademark Office, U.S. Department of Commerce, P.O. Box 1450, Alexandria, Virginia 22313-1450. DO NOT SEND FEES OR COMPLETED FORMS TO THIS ADDRESS. SEND TO: Commissioner for Patents, P.O. Box 1450, Alexandria, Virginia 22313-1450.

Under the Paperwork Reduction Act of 1995, no persons are required to respond to a collection of information unless it displays a valid OMB control number.





UNITED STATES PATENT AND TRADEMARK OFFICE

UNITED STATES DEPARTMENT OF COMMERCE
United States Patent and Trademark Office
Address: COMMISSIONER FOR PATENTS
P.O. Box 1450
Alexandria, Virginia 22313-1450
www.uspto.gov

Table with 5 columns: APPLICATION NO., FILING DATE, FIRST NAMED INVENTOR, ATTORNEY DOCKET NO., CONFIRMATION NO.
Row 1: 10/667,026, 09/18/2003, Darrin W. Kabel, 702.254, 9123
Row 2: 38933, 7590, 05/21/2007, (Empty), (Empty)
Text: GARMIN LTD., C/O GARMIN INTERNATIONAL, INC., ATTN: Legal - IP, 1200 EAST 151ST STREET, OLATHE, KS 66062
Text: EXAMINER: MEHMOOD, JENNIFER
Text: ART UNIT: 2612, PAPER NUMBER: (Empty)
Text: DATE MAILED: 05/21/2007

Determination of Patent Term Adjustment under 35 U.S.C. 154 (b)
(application filed on or after May 29, 2000)

The Patent Term Adjustment to date is 71 day(s). If the issue fee is paid on the date that is three months after the mailing date of this notice and the patent issues on the Tuesday before the date that is 28 weeks (six and a half months) after the mailing date of this notice, the Patent Term Adjustment will be 71 day(s).

If a Continued Prosecution Application (CPA) was filed in the above-identified application, the filing date that determines Patent Term Adjustment is the filing date of the most recent CPA.

Applicant will be able to obtain more detailed information by accessing the Patent Application Information Retrieval (PAIR) WEB site (http://pair.uspto.gov).

Any questions regarding the Patent Term Extension or Adjustment determination should be directed to the Office of Patent Legal Administration at (571)-272-7702. Questions relating to issue and publication fee payments should be directed to the Customer Service Center of the Office of Patent Publication at 1-(888)-786-0101 or (571)-272-4200.

<b>Notice of Allowability</b>	<b>Application No.</b>	<b>Applicant(s)</b>	
	10/667,026	KABEL ET AL.	
	<b>Examiner</b>	<b>Art Unit</b>	
	Jennifer A. Mehmood	2612	

**-- The MAILING DATE of this communication appears on the cover sheet with the correspondence address--**

All claims being allowable, PROSECUTION ON THE MERITS IS (OR REMAINS) CLOSED in this application. If not included herewith (or previously mailed), a Notice of Allowance (PTOL-85) or other appropriate communication will be mailed in due course. **THIS NOTICE OF ALLOWABILITY IS NOT A GRANT OF PATENT RIGHTS.** This application is subject to withdrawal from issue at the initiative of the Office or upon petition by the applicant. See 37 CFR 1.313 and MPEP 1308.

1.  This communication is responsive to amendment proposed by Applicant's representative on May 9, 2007.
2.  The allowed claim(s) is/are 1,5-10,19-23,27-34 and 38-67.
3.  Acknowledgment is made of a claim for foreign priority under 35 U.S.C. § 119(a)-(d) or (f).
  - a)  All    b)  Some\*    c)  None    of the:
    1.  Certified copies of the priority documents have been received.
    2.  Certified copies of the priority documents have been received in Application No. \_\_\_\_\_.
    3.  Copies of the certified copies of the priority documents have been received in this national stage application from the International Bureau (PCT Rule 17.2(a)).

\* Certified copies not received: \_\_\_\_\_.

Applicant has THREE MONTHS FROM THE "MAILING DATE" of this communication to file a reply complying with the requirements noted below. Failure to timely comply will result in ABANDONMENT of this application.  
**THIS THREE-MONTH PERIOD IS NOT EXTENDABLE.**

4.  A SUBSTITUTE OATH OR DECLARATION must be submitted. Note the attached EXAMINER'S AMENDMENT or NOTICE OF INFORMAL PATENT APPLICATION (PTO-152) which gives reason(s) why the oath or declaration is deficient.
5.  CORRECTED DRAWINGS ( as "replacement sheets") must be submitted.
  - (a)  including changes required by the Notice of Draftsperson's Patent Drawing Review ( PTO-948) attached
    - 1)  hereto or 2)  to Paper No./Mail Date \_\_\_\_\_.
  - (b)  including changes required by the attached Examiner's Amendment / Comment or in the Office action of Paper No./Mail Date \_\_\_\_\_.

Identifying indicia such as the application number (see 37 CFR 1.84(c)) should be written on the drawings in the front (not the back) of each sheet. Replacement sheet(s) should be labeled as such in the header according to 37 CFR 1.121(d).
6.  DEPOSIT OF and/or INFORMATION about the deposit of BIOLOGICAL MATERIAL must be submitted. Note the attached Examiner's comment regarding REQUIREMENT FOR THE DEPOSIT OF BIOLOGICAL MATERIAL.

**Attachment(s)**

- |   |   |
|---|---|
| <ol style="list-style-type: none"> <li>1. <input checked="" type="checkbox"/> Notice of References Cited (PTO-892)</li> <li>2. <input type="checkbox"/> Notice of Draftsperson's Patent Drawing Review (PTO-948)</li> <li>3. <input checked="" type="checkbox"/> Information Disclosure Statements (PTO/SB/08),<br/>Paper No./Mail Date <u>May 10, 2007</u></li> <li>4. <input type="checkbox"/> Examiner's Comment Regarding Requirement for Deposit of Biological Material</li> </ol> | <ol style="list-style-type: none"> <li>5. <input type="checkbox"/> Notice of Informal Patent Application</li> <li>6. <input checked="" type="checkbox"/> Interview Summary (PTO-413),<br/>Paper No./Mail Date <u>20070511</u></li> <li>7. <input checked="" type="checkbox"/> Examiner's Amendment/Comment</li> <li>8. <input checked="" type="checkbox"/> Examiner's Statement of Reasons for Allowance</li> <li>9. <input type="checkbox"/> Other _____.</li> </ol> |
|---|---|

***Examiner's Amendment***

1. An examiner's amendment to the record appears below. Should the changes and/or additions be unacceptable to applicant, an amendment may be filed as provided by 37 CFR 1.312. To ensure consideration of such an amendment, it MUST be submitted no later than the payment of the issue fee.

Authorization for this examiner's amendment was given in a telephone interview with Mr. David L. Terrell on May 9, 2007.

The application has been amended as follows:

For claim 54: Replace "wherein the line highlights where the water depth is expected to be less than a minimum water depth" with --wherein the line is displayed in a different manner where the water depth is expected to be less than a minimum water depth--.

***Allowable Subject Matter***

2. Claims 1, 5-10, 19-23, 27-34, and 38-67 are allowed.

The following is an examiner's statement of reasons for allowance:

For claim sets 1, 23, 34, 44, 45: A method for marine navigation where a marine route calculation algorithm is performed where a course to avoid preselected conditions by identifying one or more non-user selected waypoints is disclosed.

For claim set 19: A method for marine navigation is disclosed, comprising: receiving a user defined graphical filter area from the user; identifying the user defined

graphical filter area on a display; and analyzing cartographic data only within the user defined graphical filter area for the preselected conditions.

For claim sets 47, 48: A method for marine navigation discloses displaying a substantially straight line between a first location and the potential waypoint, wherein the line depicts both where the water depth is expected to be greater than the minimum water depth and where the water depth is expected to be less than the minimum water depth, and wherein the line highlights where the water depth is expected to be less than the minimum water depth.

For claim set 54: A method for marine navigation is disclosed, comprising: displaying marine cartographic data; receiving indication of a potential waypoint; and displaying a substantially straight line on the marine cartographic data between a first location and the potential waypoint, wherein the line is displayed in a different manner where the water depth is expected to be less than a minimum water depth.

Moreover, the prior art indicates that this particular method is novel and has not been published or patented by other entities.

Any comments considered necessary by applicant must be submitted no later than the payment of the issue fee and, to avoid processing delays, should preferably accompany the issue fee. Such submissions should be clearly labeled "Comments on Statement of Reasons for Allowance."

**Conclusion**

3. The prior art made of record and not relied upon is considered pertinent to applicant's disclosure: YOSHIMASA et al. (JP 2002-288800 A) discloses a marine navigation display that depicts substantially straight lines regarding waypoints and intersecting water depth lines.

4. Any inquiry concerning this communication or earlier communications from the examiner should be directed to Jennifer A Mehmood whose telephone number is (571) 272.2976. The examiner can normally be reached on M-F from 8:00am to 4:30pm.

If attempts to reach the examiner by telephone are unsuccessful, the examiner's supervisor, Mr. Daniel Wu, can be reached at (571) 272.2964. The fax phone number for the organization where this application or proceeding is assigned is (571) 273.8300.

Information regarding the status of an application may be obtained from the Patent Application Information Retrieval (PAIR) system. Status information for published applications may be obtained from either Private PAIR or Public PAIR. Status information for unpublished applications is available through Private PAIR only. For more information about the PAIR system, see <http://pair-direct.uspto.gov>. Should you have questions on access to the Private PAIR system, contact the Electronic Business Center (EBC) at 866-217-9197 (toll-free).

Jennifer A. Mehmood  
May 11, 2007

  
**BENJAMIN C. LEE**  
**PRIMARY EXAMINER**

<b>Examiner-Initiated Interview Summary</b>	Application No. 10/667,026	Applicant(s) KABEL ET AL.	
	Examiner Jennifer A. Mehmood	Art Unit 2612	

**All Participants:**

(1) Jennifer A. Mehmood.

(2) David Terrell.

**Status of Application:** allowance

(3) \_\_\_\_\_

(4) \_\_\_\_\_

**Date of Interview:** 9 May 2007

**Time:** 2pm

**Type of Interview:**

- Telephonic  
 Video Conference  
 Personal (Copy given to:  Applicant  Applicant's representative)

Exhibit Shown or Demonstrated:  Yes  No

If Yes, provide a brief description:

**Part I.**

Rejection(s) discussed:

*limitations of claim 54 regarding water depth lines and waypoints*

Claims discussed:

54

Prior art documents discussed:

*Japanese Patent # JP 2002-288800 A*

**Part II.**

**SUBSTANCE OF INTERVIEW DESCRIBING THE GENERAL NATURE OF WHAT WAS DISCUSSED:**

*Examiner agreed to amendment proposed by Applicant's representative to distinguish the limitations of claim 54 from the Japanese patent listed above. Examiner amends claim 54 based on attorney's suggestions.*

**Part III.**

- It is not necessary for applicant to provide a separate record of the substance of the interview, since the interview directly resulted in the allowance of the application. The examiner will provide a written summary of the substance of the interview in the Notice of Allowability.  
 It is not necessary for applicant to provide a separate record of the substance of the interview, since the interview did not result in resolution of all issues. A brief summary by the examiner appears in Part II above.

\_\_\_\_\_  
(Examiner/SPE Signature)

\_\_\_\_\_  
(Applicant/Applicant's Representative Signature – if appropriate)

IDS 07/25/2006

Under the Paperwork Reduction Act of 1995, no persons are required to respond to a collection of information unless it contains a valid OMB control number.

PTO/SB/08a (08-03 )  
 Approved for use through 07/31/2008. OMB 0851-0031  
 U.S. Patent and Trademark Office: U.S. DEPARTMENT OF COMMERCE

<b>INFORMATION DISCLOSURE STATEMENT BY APPLICANT</b> ( Not for submission under 37 CFR 1.99)	Application Number	<del>10677026</del> 10/66?, D216
	Filing Date	2003-09-18
	First Named Inventor	KABEL, DARIN W.
	Art Unit	2612
	Examiner Name	MEHMOOD, JENNIFER
	Attorney Docket Number	702.254

U.S. PATENTS							Remove	
Examiner Initial*	Cite No	Patent Number	Kind Code <sup>1</sup>	Issue Date	Name of Patentee or Applicant of cited Document	Pages, Columns, Lines where Relevant Passages or Relevant Figures Appear		
JM	1	5398188		1995-03-14	Maruyama			
JM	2	5872526		1999-02-16	Tognazzini			
If you wish to add additional U.S. Patent citation information please click the Add button.							Add	
U.S. PATENT APPLICATION PUBLICATIONS							Remove	
Examiner Initial*	Cite No	Publication Number	Kind Code <sup>1</sup>	Publication Date	Name of Patentee or Applicant of cited Document	Pages, Columns, Lines where Relevant Passages or Relevant Figures Appear		
	1							
If you wish to add additional U.S. Published Application citation information please click the Add button.							Add	
FOREIGN PATENT DOCUMENTS							Remove	
Examiner Initial*	Cite No	Foreign Document Number <sup>3</sup>	Country Code <sup>2</sup> j	Kind Code <sup>4</sup>	Publication Date	Name of Patentee or Applicant of cited Document	Pages, Columns, Lines where Relevant Passages or Relevant Figures Appear	T <sup>5</sup>
	1							<input type="checkbox"/>
If you wish to add additional Foreign Patent Document citation information please click the Add button							Add	
NON-PATENT LITERATURE DOCUMENTS							Remove	

<b>INFORMATION DISCLOSURE STATEMENT BY APPLICANT</b> ( Not for submission under 37 CFR 1.99)	Application Number		<del>10677826</del> 10/667,026
	Filing Date		2003-09-18
	First Named Inventor	KABEL, DARIN W.	
	Art Unit	2612	
	Examiner Name	MEHMOOD, JENNIFER	
	Attorney Docket Number	702.254	

Examiner Initials*	Cite No	Include name of the author (in CAPITAL LETTERS), title of the article (when appropriate), title of the item (book, magazine, journal, serial, symposium, catalog, etc), date, pages(s), volume-issue number(s), publisher, city and/or country where published.	T <sup>5</sup>
	1		<input type="checkbox"/>
If you wish to add additional non-patent literature document citation information please click the Add button <input type="button" value="Add"/>			
<b>EXAMINER SIGNATURE</b>			
Examiner Signature	/Jennifer Mehmood/		Date Considered 07/27/2006
*EXAMINER: Initial if reference considered, whether or not citation is in conformance with MPEP 609. Draw line through a citation if not in conformance and not considered. Include copy of this form with next communication to applicant.			
<small><sup>1</sup> See Kind Codes of USPTO Patent Documents at <a href="http://www.USPTO.GOV">www.USPTO.GOV</a> or MPEP 901.04. <sup>2</sup> Enter office that issued the document, by the two-letter code (WIPO Standard ST.3). <sup>3</sup> For Japanese patent documents, the indication of the year of the reign of the Emperor must precede the serial number of the patent document. <sup>4</sup> Kind of document by the appropriate symbols as indicated on the document under WIPO Standard ST.16 if possible. <sup>5</sup> Applicant is to place a check mark here if English language translation is attached.</small>			



FORM PTO-1449 (Rev. 2-32)  U.S. DEPARTMENT OF COMMERCE PATENT AND TRADEMARK OFFICE  INFORMATION DISCLOSURE STATEMENT BY APPLICANT	ATTORNEY DOCKET NO.: 702.254	SERIAL NUMBER: 10/667,026
	APPLICANT: KABEL, Darrin W.	
	FILING DATE: 09/18/2003	GROUP: <del>863</del> 2612

U.S. PATENT DOCUMENTS

EXAM. INITIAL	DOCUMENT NUMBER	INVENTOR NAME	CLASS	SUB-CLASS	ISSUE DATE (PATENT); PUBLICATION DATE (PUBLISHED APPLICATION); OR FILING DATE (NON-PUBLISHED APPLICATION)
JM	4646244	Bateman et al.	364	461	02/24/1987
	5339085	Katoh et al.	342	180	08/16/1994
	5470233	Fruchterman et al.	434	112	11/28/1995
	5592382	Colley	701	207	01/1997
	5684476	Anderson	340	988	11/1997
	5872526	Tognazzini	340	961	02/1999
	5999882	Simpson et al.	702	003	12/07/1999
	6055478	Heron	701	213	04/2000
	6198428	Sekine	342	176	03/06/2001
	6199015	Curtwright et al.	701	213	03/06/2001
	6279851	Huss et al.	244	3.15	08/28/2001
	6314370	Curtright	701	213	11/06/2001
	6356837	Yokota et al.	701	208	02/12/2002
	6385538	Yokota	701	211	05/07/2002
	6401038	Gia	701	301	06/04/2002
	6421603	Pratt et al.	701	206	07/16/2002
	6469664	Michaelson et al.	342	357.13	10/22/2002
	6556206	Benson et al.	345	473	04/29/2003
	6574551	Maxwell et al.	701	209	06/03/2003
	6653947	Dwyer et al.	340	970	11/25/2003
	6665630	Wei et al.	702	155	12/16/2003
	6750815	Michaelson et al.	342	357.13	06/15/2004
	6862501	He	701	003	03/01/2005

10/669, 026

EXAM. INITIAL	DOCUMENT NUMBER	INVENTOR NAME	CLASS	SUB-CLASS	ISSUE DATE (PATENT); PUBLICATION DATE (PUBLISHED APPLICATION); OR FILING DATE (NON-PUBLISHED APPLICATION)
JM	7035166	Zimmerman et al.	367	88	04/25/2006

**FOREIGN PATENT DOCUMENTS**

EXAM. INITIAL	DOCUMENT NUMBER	PUBLICATION DATE	COUNTRY OR PATENT OFFICE	CLASS	SUB-CLASS	TRANSLATION	
						YES	NO

**OTHER DOCUMENTS (Including Publisher, Author, Title, Date, Relevant Pages, and Place of Publication)**

JM	C-Series Display Reference Manual, Raymarine UK, March 2006.
JM	GPSMAP 3600C/3010C Color Chartplotter, Garmin Ltd., 2004.
JM	GPSMAP 206/2010 Chartplotters Owner's Manual and Reference Guide, Garmin Ltd., 2001.

EXAMINER	/Jennifer Mehmood/	DATE CONSIDERED	05/14/2007
EXAMINER: Initial citation if reference was considered. Draw line through citation if not in conformance to MPEP 609 and not considered. Include copy of this form with next communication to applicant.			

<b>Notice of References Cited</b>	Application/Control No. 10/667,026	Applicant(s)/Patent Under Reexamination KABEL ET AL.	
	Examiner Jennifer A. Mehmood	Art Unit 2612	Page 1 of 1

**U.S. PATENT DOCUMENTS**

*	Document Number Country Code-Number-Kind Code	Date MM-YYYY	Name	Classification
	A US-			
	B US-			
	C US-			
	D US-			
	E US-			
	F US-			
	G US-			
	H US-			
	I US-			
	J US-			
	K US-			
	L US-			
	M US-			

**FOREIGN PATENT DOCUMENTS**

*	Document Number Country Code-Number-Kind Code	Date MM-YYYY	Country	Name	Classification
	N 2002-288800 A	10-2002	Japan	YOSHIMASA et al.	G08G 3/00
	O				
	P				
	Q				
	R				
	S				
	T				

**NON-PATENT DOCUMENTS**

*	Include as applicable: Author, Title Date, Publisher, Edition or Volume, Pertinent Pages)
U	
V	
W	
X	

\*A copy of this reference is not being furnished with this Office action. (See MPEP § 707.05(a).)  
Dates in MM-YYYY format are publication dates. Classifications may be US or foreign.

[JP,2002-288800,A]

Japanese(PDF) File Wrapper Information

**FULL CONTENTS CLAIM + DETAILED DESCRIPTION TECHNICAL FIELD PRIOR ART EFFECT OF THE INVENTION TECHNICAL PROBLEM MEANS EXAMPLE DESCRIPTION OF DRAWINGS DRAWINGS**

[Translation done.]

**Disclaimer:**

This English translation is produced by machine translation and may contain errors. The JPO, the INPIT, and those who drafted this document in the original language are not responsible for the result of the translation.

**Notes:**

1. Untranslatable words are replaced with asterisks (\* \*\*).
2. Texts in the figures are not translated and shown as it is.

Translated: 00:52:03 JST 04/28/2007

Dictionary: Last updated 03/16/2007 / Priority: 1. Information communication technology (ICT) / 2. Business / 3. Finance and Law

**FULL CONTENTS**

**[Claim(s)]**

[Claim 1] The self-ship wake behind a sailing ship including a self-ship position, and the direction of movement or the direction of a bow of the present self-ship, It is the navigation equipment which enabled it to display the picture of the cruise related information containing a depth line, such as plurality, on the display screen. The navigation equipment characterized by providing a sea bed cross-section display means to display the picture of the sea bed cross section by the side of the front in said direction of movement or the direction of a bow on said display screen, based on each depth-sounding data corresponding to the every place point for displaying a depth line, such as said plurality.

[Claim 2] The navigation equipment according to claim 1 characterized by changing a part of picture of said cruise related information into the picture of said sea bed cross section, or replacing with the whole picture of said navigation related information, and displaying the picture of said sea bed cross section only when predetermined operation is performed.

[Claim 3] The navigation equipment according to claim 1 or 2 characterized by displaying the picture of said sea bed cross section covering the range of a predetermined distance from said self-ship position.

[Claim 4] A navigation equipment given in either of Claim 1 characterized by constituting said position measurement portion from satellite electric navigation equipment or amendment satellite electric navigation equipment to Claim 3.

[Claim 5] A navigation equipment given in either of Claim 1 characterized by using each depth-sounding data based on a depth line of the above included in the map data memorized beforehand as said each depth-sounding data, and each depth-sounding data obtained by the water depth measurement portion to Claim 3.

[Claim 6] The navigation equipment according to claim 5 characterized by constituting said water depth measurement portion from a shoal-of-fish

Drawing selection **Representative draw**

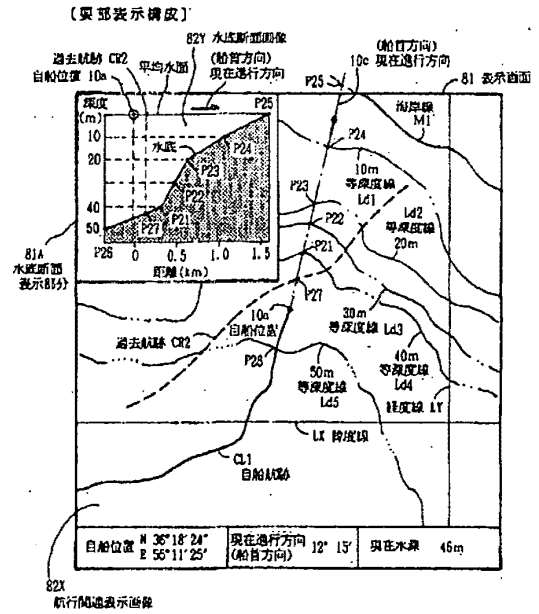

[Translation done.]

detection device while constituting said position measurement portion from satellite electric navigation equipment or amendment satellite electric navigation equipment.

[Claim 7] It is based on the position measurement data of the self-ship position obtained by a position measurement portion, and the water depth measurement data of the water depth value corresponding to said self-ship position obtained by a water depth measurement portion. While being the navigation equipment which enabled it to display the picture of said cruise related information containing \*\*\*\*\* on the display screen and setting up the water depth predetermined value for creating depth lines, such as the above The 1st storage portion which memorizes the predetermined depth-sounding position value corresponding to said water depth predetermined value is prepared. A predetermined depth-sounding position value storage means to memorize into said 1st storage portion by making into said predetermined depth-sounding position value the position value of said position measurement data obtained when said water depth measurement data reaches said predetermined depth-sounding value, A segment storage means to memorize the segment prepared data for creating the segment which connects between the points of said predetermined depth-sounding position value memorized into said 1st storage portion into the 2nd storage portion, The navigation equipment characterized by providing a depth line display means, such as displaying depth lines, such as the above, on said display screen based on each data obtained by reading each memory content of said 1st storage portion and said 2nd storage portion.

[Claim 8] While setting said water depth predetermined value as a different water depth value from the water depth value of a depth line (a map etc. is hereafter called depth line), such as being contained in the map data memorized beforehand, and creating depth lines, such as the above The navigation equipment according to claim 7 characterized by adding a merge display means to merge and display depth lines, such as the above, and depth lines, such as said map.

[Claim 9] By preparing the storage portion corresponding to said two or more water depth predetermined values in said 1st storage portion and said 2nd storage portion while making said water depth predetermined value into two or more water depth predetermined values and setting it up The navigation equipment according to claim 7 or 8 characterized by displaying depth lines, such as two or more above, on said display screen.

[Claim 10] A navigation equipment given in either of Claim 7 characterized by adding a segment elimination addition means to specify the figure which displays said point, or said segment, and to eliminate storage of said segment prepared data, or to add storage of said segment prepared data to Claim 9.

[Claim 11] A navigation equipment given in either of Claim 7 characterized by constituting said water depth measurement portion from a shoal-of-fish detection device while constituting said position measurement portion from satellite electric navigation equipment or amendment electric navigation equipment to Claim 10.

[Claim 12] It is based on the position measurement data of the self-ship position obtained by a position measurement portion, and the water depth measurement data of the water depth value corresponding to said self-ship position obtained by a water depth measurement portion. While being the navigation equipment which enabled it to display the picture of the cruise related information containing \*\*\*\*\* on the display screen and setting up the water depth predetermined value for creating depth lines, such as the above The 1st storage portion which memorizes the predetermined depth-sounding position value corresponding to said water depth predetermined value is prepared. A predetermined depth-sounding position value storage means to memorize into said 1st storage portion by making into said predetermined depth-sounding position value the position value of said position measurement data obtained when said water depth measurement data reaches said predetermined depth-

sounding value, A segment storage means to memorize the segment prepared data with which between the points of the predetermined depth-sounding position value memorized into said 1st storage portion creates the segment which connects between the following [ a predetermined distance value ] into the 2nd storage portion, The navigation equipment characterized by providing a depth line display means, such as displaying depth lines, such as the above, on said display screen based on each data obtained by reading each memory content of said 1st storage portion and said 2nd storage portion.

[Claim 13] The navigation equipment according to claim 12 characterized by displaying the figure which displays the point which is not connected by said segment with a large figure while displaying the figure which displays the point connected by said segment with a small figure.

[Claim 14] The navigation equipment according to claim 12 or 13 characterized for the figure which displays the point which is not connected by said segment while expressing the figure which displays the point connected by said segment as regular brightness by brightness brighter than regular brightness or the thing which it is made to blink and is displayed.

[Claim 15] While setting said water depth predetermined value as a different water depth value from the water depth value of a depth line (a map etc. is hereafter called depth line), such as being contained in the map data memorized beforehand, and creating depth lines, such as the above A navigation equipment given in either of Claim 12 characterized by adding a merge display means to merge and display depth lines, such as the above, and depth lines, such as said map, to Claim 14.

[Claim 16] By preparing the storage portion corresponding to said two or more water depth predetermined values in said 1st storage portion and said 2nd storage portion while making said water depth predetermined value into two or more water depth predetermined values and setting it up A navigation equipment given in either of Claim 12 characterized by displaying depth lines, such as two or more above, on said display screen to Claim 15.

[Claim 17] A navigation equipment given in either of Claim 12 characterized by adding a segment elimination addition means to specify the figure which displays said point, or said segment, and to eliminate storage of said segment prepared data, or to add storage of said segment prepared data to Claim 16.

[Claim 18] A navigation equipment given in either of Claim 12 characterized by constituting said water depth measurement portion from a shoal-of-fish detection device while constituting said position measurement portion from satellite electric navigation equipment or amendment satellite electric navigation equipment to Claim 17.

---

[Detailed Description of the Invention]

[0001]

[Field of the Invention] This invention relates to the navigation equipment which displays the picture of two or more information of the information relevant to the cruise of the cruise position of a vessel, a wake behind a sailing ship, a ~~cruise target point, a schedule route, depth of water~~, etc. (it is called ~~cruise related information~~ in this invention).

[0002]

[Description of the Prior Art] As such a navigation equipment, like drawing 13 - drawing 17, the cruise position of a self-ship, Namely, the position measurement portion which performs position measurement with the position measurement portion 10 which measures a self-ship position, for example, satellite electric navigation, loran C electric navigation, decca navigator electric navigation, etc., The composition (henceforth the 1st conventional technology) which used as another object a part for the cruise related information display 20 which displays the picture of cruise related information is common knowledge.

[0003] In addition, in each figure explained below, the portion shown with the same sign is a portion with the same function as the portion of the same sign explained in one of figures. moreover -- generally a point or a position has a latitude longitude value -- a listing -- a LOP value [ in / although the bottom considers it as a point or a position, when using the Lolland electric navigation and decca navigator electric navigation / the navigation ] -- a listing -- it is [ the bottom ] good also as a point or a position.

[0004] And generally the position measurement portion 10 by the above-mentioned electric navigation is also called electric navigation equipment of an electric navigation receiver, and, generally the part for the above-mentioned cruise related information display 20 is also called the wake-behind-a-sailing-ship recording device.

[0005] Furthermore, for example, when the electric navigation equipment by satellite electric navigation is used as the position measurement portion 10, based on the amount of change, the change direction, etc. of the self-ship position 10a, it is constituted so that degree of self-vessel speed 10b and the direction 10c of a present progressive can also be measured besides the self-ship position 10a.

[0006] In drawing 13 and drawing 14, [ the position measurement portion 10 for example, ~~GPS (Global Positioning System) electric navigation equipment,~~ ] The signal containing the data of self-ship position 10a, degree of self-vessel speed 10b, and the direction 10c of a present progressive is given to a part for the cruise related information display 20 as a part of cruise related information.

[0007] In addition, in this invention [ direction / of a present progressive / 10c ] The direction value which measured the direction in which the self-ship is running with electric navigation, i.e., a direction of movement, is said, and the direction which the bow of the self-ship measured [ the direction of a bow \*\*\*\* (ed) is ] like a postscript with the heading measurement portion, for example, a gyrocompass, or the magnetic compass has turned to is said.

[0008] The control processing part which the amount of [ 20 ] cruise related information display made into the subject the cruise Data Processing Division portion 70 with the control processing facility (henceforth CPU) 70A which makes a microcomputer a subject, for example, commercial CPU, and was constituted, It constitutes from a display-processing portion 80 with CPU80A which carries out a conjoint action to CPU70A, for example, the control processing part which made commercial IC for drawing processing the subject, and constituted it.

[0009] [ and the data of self-ship position 10a, degree of self-vessel speed 10b, and the direction 10c of a present progressive ] Through input/output port 71A, i.e., an I/O portion, it is taken into the cruise Data Processing Division portion 70, and [ the data of the self-ship position 10a ] Based on the setups operated and given, the part for the after-mentioned setting control unit 60 is taken in for every predetermined time and every predetermined distance interval, and is memorized in the memory 74 for wake-behind-a-sailing-ship data.

[0010] The amount of [ 60 ] setting control unit minds input/output port 71B, i.e., an I/O portion, for a necessary operation input, for example. The processing condition for being the control panel which has arranged parts for a control unit, such as an operation key for giving the cruise Data Processing Division portion 70, and acquiring necessary cruise related information by the cruise Data Processing Division portion 70, It is a part for the control unit which sets up the display condition for displaying necessary cruise related conditions on the display screen 81 of the display-processing portion 80. For example, each operation key for setting up or changing a display, elimination, etc. of a display and elimination of a display measure besides the taking-in conditions of the data of the above self-ship position 10a and latitude meridian lines, movement and zooming of a display rectangle, and a map is prepared.

[0011] The memory 73 for work which memorizes the setting data based on the setpoint signal 60a which took in the cruise Data Processing Division section

portion 70 from input/output port 71B, data required on the process of control processing, etc., The above-mentioned memory 74 for wake-behind-a-sailing-ship data, and the map data memory 75 which memorizes the map data for displaying a map, Each necessary data is taken in from the memory 72 for processing which memorized fixed figures, such as the clock circuit 76, and a mark, a menu for obtaining time data, and the the data of the screen element. The data of the cruise related information acquired by the program of the control processing flow memorized in the memory 72 for processing performing necessary processing is memorized in the memory 73 for work. In addition, the depth-lines Ld, such as coastline M1, etc. are contained in map data. And \*\*\*\*\* Ld is also called the isobath or the depth line.

[0012] The data of the cruise related information memorized in the memory 73 for work is given to the display-processing portion 80 if needed with the data of the cruise related information memorized by the memory 74 for wake-behind-a-sailing-ship data, and the data of the cruise related information memorized by the memory 75 for map data.

[0013] The data of the picture element for drawing with which CPU80A was memorized by the picture element memory 82 in the display-processing portion 80 in the data of each cruise related information given from the Data Processing Division portion 70, Like [ process / based on the program of the processing flow for control processing memorized in the memory 83 for processing ] the picture of the cruise related information made into the purpose, for example, drawing 16 Figures, such as the depth-lines Ld, such as self-ship wake-behind-a-sailing-ship CRl, plan route RT1, destination point DP1, the coastline M1, and latitude LX and meridian-lines LY-, the self-ship position 10a -- the numeric value of degree of - self-vessel speed 10b, direction of present progressive 10c, and destination point DP1. While memorizing serially the data showing the text TT, such as a numeric value of the difference angle theta 1 of the direction of movement 10c and plan route RT1, of a picture in the memory 84 for the display screens, making it update, the memory content of the memory 84 for the display screens is read, and it displays on the display screen 81.

[0014] In addition, the thing which displays the portion which displays the text TT on the proper corner part of the display screen 81 like drawing 16, What is displayed on the portion covering two or more [ two or more / 1// of the whole / of the width BB of the display screen 81 ], for example, about 1/4 lengthwise directions, at either of the right and left of the display screen 81, What is displayed on the portion covering two or more [ two or more / height HB / 1// of the whole / of the display screen 81 ], for example, about 1/5 longitudinal directions, and the thing to display combining two or more things of these displays are in either of the upper and lower sides of the display screen 81.

[0015] Memory 75, and picture element memory 72 and the memory for processing 82 for processing And ROM, [ memory 83 and the memory for map data ] Namely, while constituting from a read only memory and constituting memory 73, and memory 74 and the memory for the display screens 84 for wake-behind-a-sailing-ship data for work from RAM, i.e., the memory in which rewriting read-out is possible The battery for storage maintenance for holding the memory content of the necessary memory of such memory (not shown) is formed, and it constitutes. In addition, if needed, a necessary memory part may be used as a flash memory, and may be constituted.

[0016] In drawing 13, the display screens 81 are the display screens, such as a drop with the screen by a raster scan, for example, a Braun-tube drop, and a dot-matrix type liquid crystal display machine, and each figure of the picture to display is generated as follows, and they show it.

[0017] The picture of self-ship wake-behind-a-sailing-ship CRl connects the every place point of the data of the self-ship position 10a of the past memorized by the memory 74 for wake-behind-a-sailing-ship data, and the data of the present self-ship position 10a with the picture element for drawing memorized by the picture element memory 82, uses it as the figure of one wake-behind-a-

X

ways pts



~~sailing-ship line, and is displayed.~~ In addition, it can be carried out whether self-ship wake-behind-a-sailing-ship CR2 at the time of the past voyage, i.e., past wake-behind-a-sailing-ship CR2, change the kind of line, or a color is changed like a postscript, and can also display.

[0018] The point of two or more direction changed parts P1-P4 is connected with the picture element for drawing memorized by the picture element memory 82, the route to destination point JP1 is used as the figure of the route lines L1-L5 of the shape of a series of polygonal line, and the picture of plan route RT1 displays it.

[0019] Moreover, without setting up the point of the direction changed parts P1-P4, only destination point JP1 can be set up, and it can also constitute so that the figure of ~~only one straight line which~~ connects the self-ship position 10a in the time of performing the setup screen and destination point JP1 may be displayed. In addition, the direction changed parts P1-P4 are also called veering point.

[0020] The picture of the depth lines Ld, such as coastline M1-, connects the point of the fine interval memorized by the memory 75 for map data with the picture element for drawing memorized by the picture element memory 82, for example, ~~uses it as the figure of the depth lines Ld, with as a series of consecutive M1-, and is displayed. every [every water depth predetermined value which defined beforehand, for example, 100m, in addition,] etc. it is the depth line Ld.~~

[0021] The conditions which the picture of latitude LX and meridian lines LY defined beforehand, Or the number and interval by the conditions set up with the after-mentioned menu screen, for example, the horizontal line and vertical line covering the whole screen by the picture element for drawing memorized by the picture element memory 82 in the part of the point which calculated Latitude LX according to the conditions which make 2 and meridian lines LY three and make an interval the integral value of "" of latitude longitude, or "" -- for example, The figure made into the horizontal line and vertical line by a solid line is displayed.

[0022] [ cursor CLX-CLY in which movement for specifying the arbitrary points CP on the display screen 81 is possible ] The figure which made the part of the designated point CP which moves by the operation input from a part for the setting control unit 60 in the display screen 81 top the horizontal line and vertical line covering the whole screen, for example, the horizontal line and vertical line by a dotted line, with the picture element for drawing is displayed. In addition, cursor CLX-CLY may be changed into a figure with small + character figure, x character figure, etc., and the intersection portion of these figures may be displayed as a point CP.

[0023] Specifically, a part for the setting control unit 60 is constituted so that the input by the operation key which consists of contact operation keys by which a contact is closed, for example only while operating it, and operated each operation key may be changed into the signal of a predetermined sign in input/output port 71B and it may give a predetermined portion.

[0024] and [ in the case of the color display which classifies each cruise related information by color, and was displayed ] for example, drawing 15 -- like -- a part for setting control units, such as screen selection operation partial 61 and a destination, -- it constitutes from a part for control unit part 67 and the arbitrary directional movement control units 68, such as setting control unit part, such as 62, wake-behind-a-sailing-ship setting control unit part 63, mark setting control unit part 64, and numeric value, 65, screen setting control unit part 66, and a power supply, etc.

[0025] In the composition for the setting control unit 60 of drawing 15, the screen selection operation portion 61 is a part for the control unit which mainly chooses the display form of the display image of the cruise related information displayed on the display screen 81, and the "wake-behind-a-sailing-ship" key key "navigation" key "monitor" key "menu" etc. is prepared.

[0026] A "wake-behind-a-sailing-ship" key is an operation key which chooses

the wake behind a sailing ship of a self-ship as the displaying condition made into a subject, for example, the displaying condition of drawing 16 .

"Navigation" key is an operation key chosen as the displaying condition which makes navigation of a self-ship a subject. A "monitor" key is an operation key chosen as the state which displays cruise related information only in written form, and supervises it, i.e., a monitor state. A "menu" key is an operation key chosen as the displaying condition which displays the menu screen which sets up each details of the display conditions of cruise related information.

[0027] The amount of [ 62 ] setting control units, such as a destination, are parts for the control unit which mainly choose the display form relevant to the destination of the cruise related information displayed on the display screen 81 etc., and the "destination" key key "destination" key "root" key "alarm" etc. is prepared.

[0028] A "destination" key is an operation key made into the displaying condition which performs registration which attaches and memorizes to the destination set up while setting up the destination point made into the terminal point of a cruise, for example, destination point JP1 of drawing 16 , predetermined sign, for example, destination number.

[0029] A "destination" key is an operation key which makes any one of the destinations registered by operation by a "destination" key the displaying condition chosen as a destination. A "root" key is an operation key made into the plan route to a destination point, for example, plan route RT1 of drawing 16 , i.e., the displaying condition which performs a setup of the root.

[0030] An "alarm" key is an operation key made into the displaying condition which sets up the alarm condition which generates alarms, such as having arrived at the point of predetermined distance, from predetermined point, for example, destination point JPof drawing 16 , 1.

[0031] The amount of [ 63 ] wake-behind-a-sailing-ship setting control unit is a part for the control unit which mainly chooses the display form relevant to the wake behind a sailing ship of the cruise related information displayed on the display screen 81 etc., and the "map" key key "color" key "elimination" key "\*\*\*" etc. is prepared.

[0032] A "map" key is an operation key which chooses a display and un-displaying of a map in the displaying condition of a wake-behind-a-sailing-ship display. A "color" key is the figure of a wake behind a sailing ship, for example, the operation key which chooses each foreground color to self-ship wake-behind-a-sailing-ship CR1 and past wake-behind-a-sailing-ship CR2 of drawing 16 .

[0033] In addition, selection of the foreground color is constituted so that the number corresponding to each color which operated the "color" key, displayed the screen of the "color" selection menu, and was displayed on the "color" selection menu may be chosen by several character each key of after-mentioned "0" - "9."

[0034] "Elimination" key is an operation key which eliminates temporarily the picture of a route, for example, the picture of self-ship wake-behind-a-sailing-ship CR1 and past wake-behind-a-sailing-ship CR2 of drawing 16 . \*\* / "\*\*\*" key is selection of the interval value of the interval which takes the data of the self-ship position 10a into the memory 74 for wake-behind-a-sailing-ship data, and an operation key which switches the taking in, ON state, i.e., a "\*\*\*" state, and an OFF state, i.e., a "\*\*\*" state, in order to draw a wake behind a sailing ship.

[0035] [ in addition, the interval value of the interval which takes the data of the self-ship position 10a into the memory 74 for wake-behind-a-sailing-ship data in the "\*\*\*" state by \*\* / "\*\*\*" key ] the menu screen by the above-mentioned "menu" key -- a predetermined time interval -- for example, -- "-- it takes into every 20-second" -- as -- a distance interval predetermined in set \*\*\*\*, for example, movement, -- "-- it can be set up to take into every 100m."

[0036] The displaying condition of a wake-behind-a-sailing-ship display says the displaying condition which can perform a wake-behind-a-sailing-ship display here, and the displaying condition which has eliminated the picture of a wake behind a sailing ship is included as mentioned above.

[0037] A part for the mark setting control unit 64 is set mainly to the displaying condition of a wake-behind-a-sailing-ship display. The point 10a of a law, for example, the self-ship position of drawing 16, everywhere which accompanies cruise related information It is a part for the control unit which chooses the figure and color of the mark which displays consideration point EV1, EV2, etc. which performed destination point JP1 and the matter which should mind, for example, fish catching etc., and the "color" key key "O" key "\*\*\*" key "\*\*\*" etc. is prepared.

[0038] It is the operation key which performs selection soot \*\*\*\*\*, and selection of each foreground color chooses each foreground color for a "color" key to distinguish each mark figure to plurality further by the same operation as the "color" selection in a part for the wake-behind-a-sailing-ship setting control unit 63. The "O" key key "\*\*\*" key "\*\*\*" is operating the key of either of these, and chooses the operated figure of a key as a mark.

[0039] In addition, he is trying to unrlated always display these marks on "expansion" and "reduction" of the picture to display in a fixed size. Moreover, the mark which displays point EV1, EV2, etc. which performed the above-mentioned matter which should mind, for example, fish catching etc., is called event mark.

[0040] Mainly in the displaying condition of a menu screen, it is a part for the control unit which performs operation which inputs a necessary numeric value or chooses a necessary item, for example, the kind of "color" etc., and, as for a part for the setting control units 65, such as a numeric value, each sign key of several character each key [ of "0" - "9" ] - "+" and "-" etc. is prepared.

[0041] The amount of [ 66 ] screen setting control unit is a part for the control unit which operates change of the measure of a screen, a scroll, etc. mainly in the displaying condition of a wake-behind-a-sailing-ship display, and the "central" key key "\*\*\*" key "\*\*\*" key "->" key "<-" key "expansion" key "reduction" etc. is prepared.

[0042] A "central" key is an operation key which makes the self-ship position 10a the displaying condition positioned in the center of the screen of the display screen 81. "Expansion" key, i.e., the operation key which attached the arrow suitable for four slanting outsides, is an operation key to which the screen currently displayed is expanded in the shape of zoom. "Reduction" key, i.e., the operation key which attached the arrow suitable for four slanting inner sides, is an operation key which reduces the screen currently displayed in the shape of zoom.

[0043] [ the "\*\*\*" key key "\*\*\*" key "->" key "<-" ] While displaying cursor by the after-mentioned "cursor" key It operates as an operation key which moves the intersection CP of cursor CLX-CLY, i.e., a designated point, to either above, down, the left and the right which corresponds in the direction of an arrow. While not displaying cursor, it operates as an operation key which moves the whole screen to either above, down, the left and the right which corresponds in the direction of an arrow.

[0044] The amount of [ 67 ] control units, such as a power supply, are mainly parts for the control unit which perform adjustment of ON-OFF of the power supply of equipment, and the brightness of the display screen 81, and the "power supply" key key "brightness" etc. is prepared.

[0045] The "power supply" key 67A is an operation key which performs ON-OFF, i.e., the operation supplied or intercepted, for the power supply of equipment. A "brightness" key is an operation key which performs operation of changing the brightness of the display screen.

[0046] The amount of [ 68 ] arbitrary directional movement control unit is a part for the control unit which performs operation which moves the whole screen

currently displayed or cursor CLX-CLY in the arbitrary directions, for example, it consists of a track ball, a joystick, etc.

[0047] While [ and ] displaying cursor by the after-mentioned "cursor" key While operating as an operation key which moves the intersection CP of cursor CLX-CLY, i.e., a designated point, in the arbitrary directions and not displaying cursor, it operates as an operation key which moves in the arbitrary directions in the whole screen.

[0048] The amount of [ 69 ] setting control units, such as cursor, are parts for the control unit which mainly operate determination or cancellation of a condition and a numeric value chosen or inputted as a display and un-displaying of cursor, and the trend of the display screen, and the "cursor" key key "navigation change" key "determination" key "cancellation" etc. is prepared.

[0049] Whenever it carries out the key stroke of the "cursor" key, it is an operation key which switches cursor CLX-CLY to a displaying condition and a non-displaying condition every. "A display for north directions" which displays a display image every by making the right above [ the display screen 81 ] direction into "those for north directions" whenever it carries out the key stroke of the "navigation change" key, It is the operation key switched to the "direction display of a bow" which displays a display image by making the right above [ the display screen 81 ] direction into "the direction of a bow", and the "direction display of a destination point" which displays a display image for the right above [ the display screen 81 ] direction as "a direction of destination point JP1."

[0050] "Determination" key is an operation key "opts" for making it operate by the condition and numeric value which operated other operation keys, and chose or inputted them. "Cancellation" key is an operation key which cancels the above-mentioned condition and numeric value.

[0051] It replaces with a part for the setting control unit 60 of above drawing 15, and there is also a thing of composition of positioning a part for a setting control unit 60 like drawing 17 under the display screen 81, and preparing it. And only the "menu" key in the screen selection operation portion 61 of drawing 15 is arranged to a part for the setting control units 62X, such as a destination of drawing 17, and the operation by other keys consists of composition of drawing 17 so that selection operation may be carried out in the mcnu screen by the "menu" key 62A.

[0052] Moreover, only operation by the "destinations" key in a part for the setting control unit 62 is arranged to a part for the setting control units 62X, such as a destination of drawing 17. [ , such as a destination of drawing 15, ] The operation by other keys is changed so that selection operation may be carried out in the menu screen by the "menu" key 62A, and all operations in a part for the setting control units 65, such as a numeric value of drawing 15, are constituted so that selection operation may be carried out in the menu screen by the "menu" key 62A.

[0053] A part for the screen setting control unit 66 of drawing 15 like [ for the screen setting control unit / 66X / of drawing 17 ] The moving operation by "\*\*\*" key key "\*\*\*" key [ of drawing 15 ] "->" - "<-" is removed. In addition to the same "expansion" key 66Dand "center" key 66Eand "reduction" key 66F as drawing 15, it has newly changed so that "scale 1" key 66Aand "scale 2" key 66Band "scale 3" Key 66C may be formed.

[0054] In addition, beforehand, the measure by "scale 1" key 66Aand "scale 2" key 66Band "scale 3" Key 66C is constituted so that it can set up in the menu screen by the "menu" key 62A.

[0055] While changing a part for the wake-behind-a-sailing-ship setting control unit 63 of drawing 15 like [ for the wake-behind-a-sailing-ship setting control unit / 63X / of drawing 17 ] so that selection operation of the operation by the "map" key of drawing 15 may be carried out in the menu screen by the "menu"

key 62A It constitutes so that selection by the "color" key and a menu screen can be directly chosen by the "wake-behind-a-sailing-ship color" change-over switch 63A of drawing 17 .

[0056] Furthermore, to \*\* / "\*" key 63D, and "wake-behind-a-sailing-ship elimination" the key 63F of the same wake behind a sailing ship as drawing 15 [ with in addition "storage" key 63B and "a call" the key 63C of drawing 17 ]

Directly, a menu screen is displayed, and operation of attaching and memorizing a sign to the wake behind a sailing ship in the time, and operation of calling the memorized wake behind a sailing ship are constituted so that it can be operated on a menu screen.

[0057] A part for the mark setting control unit 64 of drawing 15 like [ for the mark setting control unit / 64X / of drawing 17 ] While arranging the "\*" key 64F which has arranged the "x" key 64E in addition to the same "O" key 64B and "\*" key 64C as drawing 15 , and used the "\*" key of drawing 17 as the reverse triangle figure It changes so that selection by the "color" key and a menu screen can be directly chosen by the "mark" change-over switch 64A of drawing 17 , and it constitutes so that the mark which arranges and specified "mark elimination" 64F can be eliminated further.

[0058] moreover, [ the destination of drawing 17 etc. / a part for the setting control unit 62X ] In addition to above-mentioned "menu" key 62A and "destination" key 62B and "cursor" key 62H, and the same "cancellation" key 62D and "determination" key 62F [ same ] and "navigation change" key 62G as drawing 15 , "\*" key 62C and "return" key 62J and "release" Key 62E are added.

[0059] The "\*" key 62C memorizes the self-ship position 10a of the point from which the self-ship took down the anchor, and a self-ship [ with a billow, a current, etc. ] From the point, use the distance, the direction, etc. which moved for displaying, and [ the "return" key 62J ] After carrying out moving operation of the screen currently displayed on the display screen 81, it uses for making it return to the displaying condition in the original position, and "release" key 62E is used for canceling a display, setup, etc. of a menu screen, the destination, and \*

[0060] In addition, a part for the arbitrary directional movement control unit 68 of drawing 17 is constituted from a joy stick type operation machine, and all of a screen, the moving operation of cursor, or the selection operation in a menu screen are constituted so that a part for the arbitrary directional movement control unit 68 may perform.

[0061] Furthermore, in above-mentioned drawing 13 - the composition of drawing 17 if needed as the dotted line showed to drawing 13 The composition (henceforth the 2nd conventional technology) which form the file memory portion 90 and its input/output port 91, take necessary data into the interior of equipment from the exterior, and memorize it, or the file memory portion 90, for example, an IC card, is made to memorize the data inside equipment, and is saved is common knowledge.

[0062] And while in the former composition removing the memory 75 for map data, making the file memory portion 90 into the IC card which memorized map data beforehand for example, and constituting By preparing and constituting the storage reading function of an IC card in input/output port 91, it constitutes so that map data may be read in the file memory portion 90 and may be displayed.

[0063] Moreover, while in the latter composition making it the IC card which memorizes the indicative data of the display screen [ in / for the file memory portion 90 / a wake-behind-a-sailing-ship displaying condition ] 81 for example, and constituting While saving the cruise related information in the past wake-behind-a-sailing-ship displaying condition by preparing and constituting the storage writing and read-out function of an IC card in input/output port 91, it constitutes if needed so that the past wake-behind-a-sailing-ship displaying condition may be indicated by reappearance.

[0064] Although displayed by the text TT with the [course gap display composition] of above-mentioned drawing 16 by considering the navigation state of a self-ship over plan route RT1 as the course gap theta 1 [ replace with the display of a such course gap and ] like the [distance width gap display composition] of drawing 16 The portion of the predetermined distance width B1, for example, the width of 100m each of right and left, centering on plan route RT1 is made into the predetermined route range, and there are some which were constituted so that the self-ship position 10a might display distance width B1a beyond the distance width B1 as an amount of course gaps.

[0065] Moreover, the composition (henceforth the 3rd conventional technology) which made one a part for the arithmetic part which obtains the data of the predetermined part 10c of the position measurement portion 10 in the above-mentioned 1st conventional technology and 2nd conventional technology, for example, self-ship position 10a, degree of self-vessel speed 10b, and the direction of a present progressive, and the cruise related information display 20 is common knowledge.

[0066] in addition, [ the electric navigation equipment by satellite electric navigation, for example, GPS (Global PositioningSystem) electric navigation, ] Above-mentioned degree of self-vessel speed 10b and direction 10c of a present progressive are measured based on the amount of Doppler shift of the frequency of the satellite electric wave from two or more move satellites around gone at the rate of 2 rounds/the degree of schedule. The composition of the amendment navigation which amends the error by change of the propagation property in an altitude radio-wave-propagation way etc., and raises measurement precision further is common knowledge.

[0067] Electric navigation equipment according to DGPS (Differential Global Positioning System) for example as such amendment navigation, The electric navigation equipment by WAAS/GPS (GPS augmented with the WideArea Augmentation System) is common knowledge, and these are called "amendment satellite electric navigation equipment" in this invention.

[0068] and [ the composition (henceforth the 4th conventional technology) of the amendment satellite electric navigation equipment by DGPS ] the error value of the position value 10a measured in the office of two or more dispersed measurement points, for example, a coast station, and the actual position value of the measurement point -- a basis -- [ the correction value of the amount data of Doppler shift based on \*\*\*\*\* each satellite / it transmits through radio and ] By amending the amount data of Doppler shift based on each satellite by the correction value obtained by receiving the transmitted electric wave of one station near the current position of a self-ship, it constitutes so that the precision of self-ship position 10a, degree of self-vessel speed 10b, and the direction 10c of a present progressive may be raised.

[0069] [ moreover, the composition (henceforth the 5th conventional technology) of the amendment satellite electric navigation equipment by WAAS/GPS ] Similitude carries out an electric wave to two or more satellite electric waves which measure each correction value which received and memorized the electric wave of the correction value from each office which distributed and prepared the coast station in above DGPS, and two or more offices which measure the same correction value by the geostationary satellite prepared separately from the above-mentioned move satellite gone around, and it transmits. By carrying out the same amendment as the case of above DGPS by the correction value obtained by receiving this electric wave, it constitutes so that the precision of self-ship position 10a, degree of self-vessel speed 10b, and the direction 10c of a present progressive may be raised.

[0070] Although the move satellite around gone as a satellite for measurement is used with the composition of the satellite electric navigation by the above-mentioned 1st conventional technology - the 5th conventional technology The composition (henceforth the 6th conventional technology) which replaces with such a move satellite and acquires self-ship position 10a, degree of self-vessel

speed 10b, and the direction 10c of a present progressive with the electric navigation using a geostationary satellite is also common knowledge.

[0071] [ degree of self-vessel speed 10b and the direction 10c of a present progressive acquired by each above electric navigation equipment ] The degree 10b of self-vessel speed [ a low speed, for example, speed of 5 knots or less, ] since precision worsens, as the dotted line showed to [drawing 13](#) , boil the heading measurement portion 15, for example, a gyrocompass, a magnetic compass, etc. -- while constituting so that it may acquire, the direction 15a of a bow of the present bow, i.e., direction, of the \*\*\*\*\* present In below the predetermined degree 10b of self-vessel speed, it replaces with in the direction 10c of a present progressive, and the composition (henceforth the 7th conventional technology) using the direction 15a of the present bow is common knowledge.

[0072] Furthermore, it adds to the composition of the above-mentioned 1st conventional technology - the 7th conventional technology like [drawing 18](#) and [drawing 19](#) . Prepare the water depth measurement portion by the water depth measurement portion 30, for example, echo-sounding equipment, or a shoal-of-fish detection device, and the water depth data of 30a obtained in the water depth measurement portion 30 is taken into the water depth memory 77 for data through input/output port 15a. While making the data of each depth of water 30a, and the self-ship position 10a where the depth of water was obtained correspond and memorizing them, the composition (henceforth the 8th conventional technology) which reads the memory content and displayed the figure of the sea bed cross section by the side of back from the self-ship position 10a in self-ship wake-behind-a-sailing-ship CRI of [drawing 16](#) is common knowledge.

[0073] In [drawing 19](#) , constitute the water depth measurement portion 30 from a shoal-of-fish detection device, and the sending signal from the transmitting portion (not shown) of the acoustic wave formed in the interior is underwater transmitted from the transducer 35 formed in the ship's bottom of the self-ship etc. By processing the signal amplified by the amplification portion (not shown) which amplifies the received signal acquired by receiving the reflected wave obtained from a shoal of fish, a sea bed, etc. with the transducer 35 to necessary signal strength by water depth Data Processing Division portion and display-processing portion (not shown), like the display screen 31 of [drawing 19](#) It constitutes so that the shoal-of-fish detection display image 31a with a shoal of fish and the picture of a sea bed can be displayed.

[0074] And it constitutes so that the data of the depth of water which is equivalent to the water depth portion of 31a now [ of the shoal-of-fish detection display image 31a ] may make it correspond through the input/output port 71A of [drawing 18](#) as the present water depth 30a with the self-ship position 10a where the water depth 30a was obtained and may memorize in the water depth memory 77 for data.

[0075] In addition, it cannot be overemphasized that a part for each control unit required for shoal-of-fish detection and water depth measurement is prepared in the water depth measurement portion 30 32 in this composition, a part for i.e., the setting control unit of a shoal-of-fish detection device.

[0076] Therefore, the data of the self-ship position 10a for every predetermined time Or while constituting so that it may take in for every predetermined distance and self-ship wake-behind-a-sailing-ship CRI may be created The figure of the above-mentioned sea bed cross section which formed the picture of the sea bed in the shoal-of-fish detection display image 31a in the figure of the letter of a crease can be displayed by taking the water depth data of 30a into every self-ship position 10a of the, and memorizing in the water depth memory 77 for data.

[0077] In addition, in composition of displaying this sea bed cross section, it constitutes so that the operation part for displaying a sea bed cross section may

be established in the proper part for the setting control unit 60 of drawing 15 and drawing 17 or the selection operation part for displaying a sea bed cross section may be established into a proper menu screen.

[0078] Moreover, the composition (henceforth the 9th conventional technology) which replaces the water depth measurement portion 30 in the composition of the 8th conventional technology of above-mentioned drawing 19 with a shoal-of-fish detection device, and forms echo-sounding equipment is also common knowledge.

[0079] And echo-sounding equipment is constituted so that a part for the display which constitutes, for example, without displaying the above-mentioned shoal-of-fish detection picture 31a so that water depth 31a may be outputted only as the present water depth 30a now [ above-mentioned ], and carries out character representation of the water depth 30a if needed may be prepared.

[0080] The composition (henceforth the 10th conventional technology) which prepared the portion except the transducer 35 of such echo-sounding equipment and the portion attached to it in the interior for a cruise related information 20 display is also common knowledge.

[0081] Furthermore, the composition of composition (henceforth the 11th conventional technology) of having made a part for the water depth measurement portion 30 in the composition of drawing 19, for example, the water depth measurement portion by a shoal-of-fish detection device, and the cruise related information display 20 into one body is common knowledge like drawing 20 and drawing 21.

[0082] In drawing 20, a cruise related information display part + depth-sounding measurement portion (20+30) is a portion which made one body a part for the water depth measurement portion 30 by the shoal-of-fish detection device of drawing 19, and the cruise related information display 20.

[0083] Moreover, the amount of (60+32) setting control unit makes a part for a part for the setting control unit 60 of drawing 19, and the setting control unit 32 into one body, and [ with operation for a setting control unit (60+32) ] It constitutes so that a cruise related information display image like drawing 16 and a shoal-of-fish detection display image like drawing 19 may be displayed on the display screen (81+31) in parallel, only a cruise related information display image may be displayed on it or only a shoal-of-fish detection display image may be displayed on it like drawing 20.

[0084] In addition, [ a part ] like drawing 21 although a part for a setting control unit (60+32) is constituted in the operated-by remote control type by wireless communications, such as an operated-by remote control type by cable splicing, or infrared transmission An operation part required in order to perform shoal-of-fish detection to a part for the setting control unit 60 by the composition of drawing 15 or drawing 17 is established, and it constitutes.

[0085] In drawing 21, the key to which the character sign the same as that of the character sign given to each key of drawing 15 and drawing 17 or similar is given is an operation key for making image display the same as that of the character sign given to each key of drawing 10 and drawing 12, or similar perform.

[0086] an operation key for "sensitivity" key to fluctuate the receiving sensitivity of shoal-of-fish detection -- "-- sounding -- an operation key for a range" key to set up the range which detects a shoal of fish and a sea bed -- An operation key for a "plotter" key to choose and display only a cruise related information display image like drawing 16 and a "\*\*\*\*" key are operation keys for choosing and displaying only a shoal-of-fish detection display image like drawing 19.

[0087] Moreover, PU / "fish" key is operation keys for displaying a cruise related information display image like drawing 16, and a shoal-of-fish detection display image like drawing 19 in parallel. When a "graph" key is a key for



choosing and displaying either of a water temperature graph and a sea bed graph, a "graph" key is operated and a water temperature graph is chosen. When the water temperature detected with the water temperature detector (not shown) attached to the transducer 35 is made into the shape of a line graph, and is displayed and a sea bed graph is chosen, the sea bed cross section in the composition of the above-mentioned 8th conventional technology and the sea bed cross section of the shape of same line graph are displayed.

[0088]

[Problem to be solved by the invention] The [1st technical problem] According to the composition of the above-mentioned 8th conventional technology and 11th conventional technology, the water depth position of 30a made into the purpose can be known by displaying the figure of a back sea bed cross section from the self-ship position 10a.

[0089] When [ and ] memorizing the wake-behind-a-sailing-ship data of self-ship wake-behind-a-sailing-ship CR1 in the memory 74 for wake-behind-a-sailing-ship data. If the data of the self-ship position 10a used as wake-behind-a-sailing-ship data and the water depth data of 30a are made to correspond, it memorizes in the water depth memory 77 for data and past wake-behind-a-sailing-ship CR2 are displayed based on this memory content. At the time of a next cruise, distance until it arrives at a front water depth situation and the water depth ocean space of 30a made into the purpose rather than the self-ship position 10a etc. can be known by following the past wake-behind-a-sailing-ship CR2.

[0090] However, with such composition, in cruising ocean space without past wake-behind-a-sailing-ship CR2, there is un-arranging [ that distance until it arrives at a front water depth situation and the water depth ocean space of 30a made into the purpose rather than the self-ship position 10a etc. cannot be known ].

[0091] The [2nd technical problem] With the composition of the above-mentioned 1st conventional technology - the 11th conventional technology, since \*\*\*\*\* Ld is displayed with the map data memorized by the memory 75 for map data, or the file memory portion 90, the ocean space where a self-ship cruises, or the ocean space of the depth of water made into the purpose can be known.

[0092] furthermore, the depth of the ocean space made into depth required as a self-ship, for example, a fishery, although not contained in map data etc. -- etc. -- if there is a depth line, it is convenient very much. And since the depth lines Ld, such as map data, are what the public organization tied the water depth data which measured the depth of water of the every place point of having divided ocean space in the shape of [ fine ] a grid, and created the point of depth, such as structure, if the same work is done by self-ship, they can make depth, such as necessary.

[0093] However, a depth line makes having carried out like this etc., and there is un-arranging [ of \*\*\*\*\* needing whether to be the size for it and needing a considerable investment etc. ] in a direction. For this reason, the technical problem that offer of such an inconvenient navigation equipment which is not is desired occurs.

[0094]

[Means for solving problem] This invention the picture of the cruise related information containing the self-ship wake behind a sailing ship which includes the above self-ship positions to the above-mentioned [1st technical problem], the direction of movement of the present self-ship or the direction of a bow, and a depth line, such as plurality, in the navigation equipment it enabled it to display on the display screen [0095] The 1st composition which establishes a sea bed cross-section display means to display the picture of the sea bed cross section by the side of the front in an above-mentioned direction of movement or the above-mentioned direction of a bow on the above-mentioned display screen, based on each depth-sounding data corresponding to the every place-point for

displaying a depth line, such as the above-mentioned plurality, and [0096] The 2nd composition which changes a part of picture of the above-mentioned cruise related information into the picture of the above-mentioned sea bed cross section, or replaces with the whole picture of the above-mentioned navigation related information, and displayed the picture of the above-mentioned sea bed cross section in this 1st composition only when predetermined operation was performed, and [0097] The 3rd composition which displayed the picture of the above-mentioned sea bed cross section covering the range of a predetermined distance from the above self-ship position in the 1st above-mentioned composition and 2nd composition, and [0098] The 4th composition which constituted the above-mentioned position measurement portion from satellite electric navigation equipment or amendment satellite electric navigation equipment in the 1st above-mentioned composition - the 3rd composition, and [0099] The 5th composition which used each depth-sounding data based on depth lines, such as the above contained in the map data memorized beforehand as each above-mentioned depth-sounding data in the 1st above-mentioned composition - the 3rd composition, and each depth-sounding data obtained by the water depth measurement portion, and [0100] In the 5th above-mentioned composition, while constituting the above-mentioned position measurement portion from satellite electric navigation equipment or amendment satellite electric navigation equipment, it solves by the 6th composition which constituted the above-mentioned water depth measurement portion from a shoal-of-fish detection device.

[0101] Moreover, the position measurement data of the self-ship position obtained by the above position measurement portions to the above-mentioned [2nd technical problem], [0102] being based on the water depth measurement data of the water depth value corresponding to the above self-ship position obtained by a water depth measurement portion -- etc. -- [ the picture of the cruise related information containing a depth line ] in the navigation equipment it enabled it to display on the display screen While setting up the water depth predetermined value for creating depth lines, such as the above The 1st storage portion which memorizes the predetermined depth-sounding position value corresponding to the above-mentioned water depth predetermined value is prepared. A predetermined depth-sounding position value storage means to memorize the position value of the above-mentioned position measurement data at the time of the above-mentioned water depth measurement data becoming the above-mentioned water depth predetermined value into the 1st above-mentioned storage portion as the above-mentioned predetermined depth-sounding position value, and [0103] A segment storage means to memorize the segment prepared data for creating the segment which connects between the points of the above-mentioned predetermined depth-sounding position value memorized into the 1st above-mentioned storage portion into the 2nd storage portion, The 7th composition which establishes a depth line display means, such as displaying depth lines, such as the above, on the above-mentioned display screen based on each data obtained by reading each memory content of the 1st above-mentioned storage portion and the 2nd above-mentioned storage portion, and [0104] While setting it as a different water depth value from the water depth value of depth lines, such as a depth line, i.e., a map etc., such as being contained in the map data which memorized the above-mentioned water depth predetermined value beforehand in this 7th composition, and creating depth lines, such as the above The 8th composition which added a merge display means to merge and display depth lines, such as the above, and depth lines, such as the above-mentioned map, and [0105] While making the above-mentioned water depth predetermined value into two or more water depth predetermined values and setting it up in the 7th above-mentioned composition and 8th composition The 9th composition which displayed depth lines, such as two or more above, on the above-mentioned display screen by preparing the storage portion corresponding to two or more above-mentioned water depth predetermined values in the 1st above-

mentioned storage portion and the 2nd above-mentioned storage portion, and [0106] The 10th composition which added a segment elimination addition means to have specified the figure or the above-mentioned segment which displays the above-mentioned point in the 7th above-mentioned composition - the 9th composition, and to have eliminated storage of the above-mentioned segment prepared data, or to add storage of the above-mentioned segment prepared data, and [0107] The 11th composition which constituted the above-mentioned water depth measurement portion from a shoal-of-fish detection device in the 7th above-mentioned composition - the 10th composition while constituting the above-mentioned position measurement portion from satellite electric navigation equipment or amendment electric navigation equipment, and [0108] [0109] being based on the position measurement data of the self-ship position obtained by a position measurement portion, and the water depth measurement data of the water depth value corresponding to the above self-ship position obtained by a water depth measurement portion -- etc. -- [ the picture of the cruise related information containing a depth line ] in the navigation equipment it enabled it to display on the display screen While setting up the water depth predetermined value for creating depth lines, such as the above The 1st storage portion which memorizes the predetermined depth-sounding position value corresponding to the above-mentioned water depth predetermined value is prepared. A predetermined depth-sounding position value storage means to memorize the position value of the above-mentioned position measurement data at the time of the above-mentioned water depth measurement data becoming the above-mentioned water depth predetermined value into the 1st above-mentioned storage portion as the above-mentioned predetermined depth-sounding position value, and [0110] A segment storage means to memorize the segment prepared data with which between the points of the predetermined depth-sounding position value memorized into the 1st above-mentioned storage portion creates the segment which connects between the following [ a predetermined distance value ] into the 2nd storage portion, and [0111] The 12th composition which establishes a depth line display means, such as displaying depth lines, such as the above, on the above-mentioned display screen based on each data obtained by reading each memory content of the 1st above-mentioned storage portion and the 2nd above-mentioned storage portion, and [0112] The 13th composition which displayed the figure which displays the point which is not connected by the above-mentioned segment while displaying the figure which displays the point connected by the above-mentioned segment in this 12th composition with a small figure with the large figure, and [0113] While expressing the figure which displays the point connected by the above-mentioned segment in the 12th above-mentioned composition and 13th composition as regular brightness The figure which displays the point which is not connected by the above-mentioned segment Brightness brighter than regular brightness or the 14th composition which is blinked and was displayed, and [0114] While setting it as a different water depth value from the water depth value of depth lines, such as a depth line, i.e., a map etc., such as being contained in the map data which memorized the above-mentioned water depth predetermined value beforehand in the 12th above-mentioned composition - the 14th composition, and creating depth lines, such as the above The 15th composition which added a merge display means to merge and display depth lines, such as the above, and depth lines, such as the above-mentioned map, and [0115] While making the above-mentioned water depth predetermined value into two or more water depth predetermined values and setting it up in the 12th above-mentioned composition - the 15th composition The 16th composition which displayed depth lines, such as two or more above, on the above-mentioned display screen by preparing the storage portion corresponding to two or more above-mentioned water depth predetermined values in the 1st above-mentioned storage portion and the 2nd above-mentioned storage portion, and [0116] The 17th composition which added a segment elimination addition means to have specified the figure or the

above-mentioned segment which displays the above-mentioned point in the 12th above-mentioned composition - the 16th composition, and to have eliminated storage of the above-mentioned segment prepared data, or to add storage of the above-mentioned segment prepared data, and [0117] In the 12th above-mentioned composition - the 17th composition, while constituting the above-mentioned position measurement portion from satellite electric navigation equipment or amendment satellite electric navigation equipment, it solves by the 18th composition which constituted the above-mentioned water depth measurement portion from a shoal-of-fish detection device.

[0118]

[Mode for carrying out the invention] The example which applied this invention to the composition of the above-mentioned 1st conventional technology - the 11th conventional technology as a form of this working of an invention is explained.

[0119]

[Working example] The [1st example] Drawing 1 - drawing 3 explain the 1st example hereafter. [ this 1st example / the composition of the 1st conventional technology explained by drawing 13 - drawing 17 - the 6th conventional technology ] A part which constitutes with the application of the composition which excepted the portion using the direction of a bow in the 1st above-mentioned composition - the 4th composition, and is different from the composition of the above-mentioned 1st conventional technology - the 6th conventional technology is the next part. In addition, there shall be no display of past wake-behind-a-sailing-ship CR2 in drawing 2 .

[0120] A depth line, such as plurality contained in the map data memorized by the 1st at the memory 75 for map data, or the file memory portion 90, For example, it is the part which displayed the sea bed cross-section picture 82Y by the side of the front in the direction 10c of a present progressive, for example, the front sea bed cross-section picture of drawing 2 , on the display screen 81 based on each depth-sounding data corresponding to the every place point for displaying the depth lines Ld1-Ld4, such as drawing 2 .

[0121] A part for the control unit for displaying a front sea bed cross section on the 2nd at a part for the setting control unit 60, for example, only when operation which displays a front sea bed cross section on drawing 15 and drawing 17 by the "front sea bed" key 69X shown by the dotted line is performed It is the part which displayed the picture which changed a part of cruise related information picture 82X in the display screen 81 of drawing 2 into the front sea bed cross-section picture 82Y, or replaced with the above-mentioned whole navigation related information picture 82X, and expanded the above-mentioned front sea bed cross-section picture 82Y.

[0122] It is the part which displayed the picture of the portion covering the range of a predetermined distance, for example, the range of 0-1.0km of the front sea bed cross-section picture 82Y of drawing 2 , for the front sea bed cross-section picture 82Y on the 3rd from the self-ship position 10a.

[0123] It is the part which constituted the position measurement portion 10 from satellite electric navigation equipment, for example, GPS electric navigation equipment, amendment satellite electric navigation equipment, i.e., DGPS electric navigation, or WAAS satellite electric navigation in the 4th.

[0124] That is, the composition of this 1st example generally Self-ship wake-behind-a-sailing-ship CR1 which includes the self-ship position 10a in the 1st, and the direction of movement 10c of a present progressive of the present self-ship, for example, direction, In the navigation equipment 100 it enabled it to display on the display screen 81, Picture 82X, for example, the cruise related information picture, of the cruise related information containing the depth lines Ld1-Ld4, such as being contained in a depth line, for example, map data, such as plurality, [0125] It is based on each depth-sounding data corresponding to the every place point for displaying the depth line Ld1-Ld4, for example, \*\*\*\*\*,

such as the above-mentioned plurality. The 1st above-mentioned composition which established a sea bed cross-section display means to display the picture 82Y of the sea bed cross section by the side of the front in the above-mentioned direction of movement 10c, for example, a front sea bed cross-section picture, on the above-mentioned display screen 81 is constituted.

[0126] moreover, only when predetermined operation is performed to the 2nd in the 1st above-mentioned composition for example, only when operation which displays a front sea bed cross section by the "front sea bed" key 69X is performed A part of picture 82X of the above-mentioned cruise related information, for example, cruise related information picture, is changed into the picture 82Y of the above-mentioned sea bed cross section, for example, a front sea bed cross-section picture. Or the 2nd above-mentioned composition which displayed the picture which replaced with the whole picture 82X of the above-mentioned navigation related information, for example, a cruise related information picture, and expanded the picture 82Y of the above-mentioned sea bed cross section, for example, a front sea bed cross-section picture, is constituted.

[0127] Furthermore, the picture of the above-mentioned sea bed cross section on the 1st composition and 2nd composition of the above [ 3rd / the ], and covering the range of a distance predetermined [ the above self-ship position 10a to ], For example, the 3rd above-mentioned composition which displayed the picture of the portion covering the range of 0-1.0km of the front sea bed cross-section picture 82Y is constituted.

[0128] To the 4th, the above-mentioned position measurement portion 10 in the 1st above-mentioned composition - the 3rd composition Moreover, satellite electric navigation equipment, for example, GPS electric navigation equipment, Or the 4th above-mentioned composition constituted from amendment satellite electric navigation equipment, i.e., DGPS electric navigation, or WAAS satellite electric navigation is constituted.

[0129] And by specifically memorizing beforehand the program of the control processing flow which removed the portions of step SP1 and step SP11 from the control processing flow of drawing 3 in the memory 72 for processing in the composition of drawing 1 , it constitutes so that the display by each above-mentioned composition can be performed.

[0130] In addition, this control processing flow is constituted as a subroutine of the main control manipulation routine for performing control processing of the whole in the cruise Data Processing Division portion 70, and for every second, it consists of main control manipulation routines, for example so that it may shift to this control processing flow.

[0131] [Explanation of a control processing flow] The control processing flow which removed the portions of step SP1 and step SP11 from the control processing flow of drawing 3 is explained hereafter. Therefore, a control processing flow here will be started from step SP2.

[0132] ⇨ In step SP2, take in the data of the position measurement portion 10 10c of a present progressive, for example, the direction given from satellite electric navigation equipment, for example, 12 degrees of direction of present progressive 15' of drawing 2 , and shift to the following step SP3.

[0133] Like this 1st example here [ only in the case of satellite electric navigation equipment or amendment satellite electric navigation equipment ] When the degree 10b of self-vessel speed is below a predetermined less than speed, for example, 5 knots Since it constitutes so that the data of the direction 10c of a present progressive may not be outputted, only when the degree 10b of self-vessel speed is over a predetermined speed and the data of the direction 10c of a present progressive is obtained, it will shift to the following step SP3.

[0134] ⇨ Distinguish whether there is a signal which performed operation which displays a front sea bed cross section by the "front sea bed" key 69X, i.e., a front sea bed cross-section display signal, in step SP3. When there is a front sea bed cross-section display signal, it shifts to the following step SP4, and

when that is not right, it returns to the predetermined step part of a main control manipulation routine.

[0135] ⇨ In step SP4, it is based in the map data and the direction 10c of a present progressive which are memorized by the memory 75 for map data. Data processing of the data of the positions P21-P26 of the point that each \*\*\*\*\* Ld1 - Ld5 and the coastline M1, and the direction 10c of a present progressive of drawing 2 cross is carried out, and after taking into the memory 73 for work and memorizing, it shifts to the following step SP5.

[0136] ⇨ [ step SP5 ] by calculating each distance from the self-ship position 10a to positions P21-P26 based on the data of the self-ship position 10a and positions P21-P26 Creation processing of the image data for breaking and displaying sea bed form by a line picture based on the data of each of this distance and the data of the depth value of each \*\*\*\*\* Ld1-Ld5, i.e., water depth data, like the front sea bed cross-section picture 82Y of drawing 2 , is carried out.

[0137] [ here ] so that the self-ship position 10a of the front sea bed cross-section picture 82Y, i.e., distance, (km) may be known from the part of 0 the depth before and behind the self-ship position 10a (m), and the value of distance (km) to proportional distribution etc. -- the self-ship position 10a -- being water depth -- that is, data processing of the 46 water depthm can be carried out now, for example, it can display like the lower right column of the display screen 81 like drawing 2 .

[0138] Furthermore, while taking the image data into the memory 73 for work and memorizing it, after giving the display-processing portion 80 and displaying the front sea bed cross-section picture 82Y on a part for the sea bed cross-section display 81A of drawing 2 , it shifts to the following step SP6.

[0139] In addition, the memory 78 for front sea bed data is formed, and you may make it memorize the data storage in above step SP4 and these step SP5, as the dotted line showed to drawing 2 .

[0140] Moreover, a part for the sea bed cross-section display 81A is constituted so that it may be made to move to the position where the image display of the viewing area of the direction of movement 10c of a self-ship is not checked, suitably, it may display on it and display processing may be carried out in the display-processing portion 80.

[0141] Furthermore, if needed, replace with the cruise related display screen 82X, and the front sea bed cross-section picture 82Y is displayed. Or you may constitute so that such a display and the display which prepares and displays a part for the sea bed cross-section display 81A on a proper corner like drawing 2 may be chosen with the menu screen displayed by operation of the "front sea bed" key 69X, for example.

[0142] Moreover, if needed, it constitutes so that it may set up beforehand, or it constitutes so that it may choose with a menu screen, so that the picture of a portion covering the range of a predetermined distance, for example, the range of 0-1.0km, for the front sea bed cross-section picture 82Y may be displayed from the self-ship position 10a.

[0143] ⇨ Distinguish whether there is a signal which eliminates a display, i.e., a front sea bed cross-section erasing signal, about a front sea bed cross section in step SP6 by the "front sea bed" key 69X or a proper operation key. When there is a front sea bed cross-section erasing signal, it shifts to the following step SP7, and when that is not right, it returns to step SP2. In addition, in this 1st example, since step SP1 is not to be prepared, it will return to step SP2 from step SP6.

[0144] ⇨ In step SP7, return to the predetermined step part of a main control manipulation routine after eliminating the front sea bed cross-section picture 82Y. That is, the portion of the cruise related information display image 82X which was hidden by the amount of [ 81A ] sea bed cross-section display, and was will be displayed on the display screen 81.

[0145] therefore, when predetermined operation, for example, the operation by

the "front sea bed" key 69X, is performed according to the composition of this 1st example since it will obtain if distance until it arrives at a front water depth situation and the water depth ocean space of 30a made into the purpose rather than the self-ship position 10a, even if it is not a case in the cruise state where past wake-behind-a-sailing-ship CR2 are followed etc. can be known, and the feature is acquired, it means that the above-mentioned [1st technical problem] was solved

[0146] The [2nd example] Drawing 1 - drawing 3 explain the 2nd example hereafter. A different part from the composition of the 1st example of the above [ the composition of this 2nd example ] is the next part.

[0147] In the 1st, like the composition of the above-mentioned 7th conventional technology, the heading measurement portion 15 For example, form the gyrocompass or the magnetic compass and [ predetermined degree 10b of self-vessel speed, at for example, the time of 5 knots or less, ] When displaying the front sea bed cross-section picture 82Y using the direction 15a of a bow acquired by the heading measurement portion 15 and exceeding the predetermined degree 10b of self-vessel speed, for example, 5 knots It is the part constituted so that the front sea bed cross-section picture 82Y might be displayed using the direction of movement 10c of a self-ship obtained by the position measurement portion 10, for example, satellite electric navigation equipment, or amendment satellite electric navigation equipment.

[0148] In order to make the above-mentioned display perform in the 2nd, it is the part constituted so that the program of the whole control processing flow of drawing 3 might be beforehand memorized in the memory 72 for processing in the composition of drawing 1 .

[0149] In addition, this control processing flow is constituted as the same subroutine as the case of the 1st above-mentioned example, and for every second, it consists of main control manipulation routines, for example so that it may shift to this control processing flow.

[0150] [Explanation of a control processing flow] The control processing flow of drawing 3 is explained hereafter.

◁ Distinguish whether it is the predetermined less than degree 10b of self-vessel speed, for example, 5 knots, in step SP1. It shifts to step SP11 at the time of below the predetermined degree 10b of self-vessel speed, and when that is not right, it shifts to the following step SP2.

[0151] ▷ In step SP2, perform the same control processing as the case of the 1st above-mentioned example, and shift to step SP3. In addition, since it is over the predetermined degree 10b of self-vessel speed, the direction of movement 10c of a self-ship will be obtained here.

[0152] ▷ In step SP11, take in the data of the direction 15a of a bow given from the heading measurement portion 15, for example, a gyrocompass, or the magnetic compass, for example, 12 degrees of direction of bow 15' of drawing 2 , and shift to step SP3. In addition, in fact, although the value of the direction of movement 10c of a self-ship and the direction 15a of a bow turns into a different value, it is made into the same value on account of Drawings here.

[0153] ▷ although the same control processing as the case of the 1st above-mentioned example is performed in step SP3 - step SP7 When it has gone via step SP11, it constitutes so that data processing of step SP4 and step SP5 may be replaced with the data of the direction of movement 10c of a self-ship and may be performed using the data of the direction 15a of a bow.

[0154] That is, the composition of this 2nd example generally In the navigation equipment it enabled it to display on the display screen, the picture of the cruise related information containing the self-ship wake behind a sailing ship which replaces with the 1st composition in the 1st above-mentioned example, and includes a self-ship position in the 1st, the direction of movement of the present self-ship or the direction of a bow, and a depth line, such as plurality, [0155]

The 1st composition which establishes a sea bed cross-section display means to

display the picture of the sea bed cross section by the side of the front in an above-mentioned direction of movement or the above-mentioned direction of a bow on the above-mentioned display screen, based on each depth-sounding data corresponding to the every place point for displaying a depth line, such as the above-mentioned plurality, and [0156] Self-ship wake-behind-a-sailing-ship CR1 including the self-ship position 10a and the direction of movement 10c of a present progressive of the present self-ship, for example, the direction, In the navigation equipment 100 it enabled it to display on the display screen 81, Picture 82X, for example, the cruise related information picture, of the cruise related information containing the direction 15a of a bow, and the depth lines Ld1-Ld4, such as being contained in a depth line, for example, map data, such as plurality, or [0157] It is based on each depth-sounding data corresponding to the every place point for displaying the depth line Ld1-Ld4, for example, \*\*\*\*\* , such as the above-mentioned plurality. The 1st above-mentioned composition which established a sea bed cross-section display means to display the picture 82Y of the sea bed cross section by the side of the front in the above-mentioned direction of movement 10c or the above-mentioned above-mentioned direction 15a of a bow, for example, a front sea bed cross-section picture, on the above-mentioned display screen 81 will be constituted.

[0158] Moreover, in the 2nd, the 2nd above-mentioned composition - the 4th composition will be constituted like the 1st above-mentioned example. And since the feature in the case of the 1st above-mentioned example and the same feature are acquired according to these 1st composition - the 4th composition, it means that the above-mentioned [1st technical problem] was solved.

[0159] The [3rd example] Drawing 2 , drawing 4 , and drawing 5 explain the 3rd example hereafter. A part which constitutes this 3rd example with the application of the composition which excepted the portion using the direction of a bow in the 1st above-mentioned composition - the 6th composition in the composition of the 7th conventional technology explained by drawing 18 - drawing 21 - the 11th conventional technology, and is different from the composition of the 1st above-mentioned example is the next part. In addition, past wake-behind-a-sailing-ship CR2 in drawing 2 shall be displayed.

[0160] A depth line, such as plurality contained in the map data memorized by the 1st at the memory 75 for map data, or the file memory portion 90, [ for example, each depth-sounding data corresponding to the every place point for displaying the depth lines Ld1-Ld4, such as drawing 2 , ] In addition, it is the part which displayed the sea bed cross-section picture 82Y by the side of the front in the direction 10c of a present progressive, for example, the front sea bed cross-section picture of drawing 2 , on the display screen 81 based on the water depth measurement portion 30, for example, each depth-sounding data which used the water depth data of 30a obtained by the shoal-of-fish detection device.

[0161] [ the 2nd ] as the above-mentioned water depth data of 30a when memorizing past wake-behind-a-sailing-ship CR2 in the memory 74 for wake-behind-a-sailing-ship data It is the part constituted so that it might use, the water depth data which the data of the position value used as wake-behind-a-sailing-ship data and the water depth data of 30a were made to correspond, and was memorized in the water depth memory 77 for data, and the water depth data of 30a in the self-ship position 10a, i.e., the data of the present depth of water. In addition, when the water depth data which measured water depth 30a to the predetermined point is only memorized, it constitutes so that the water depth data may also be included.

[0162] And by specifically memorizing beforehand the program of the control processing flow which removed the portions of step SP1 and step SP11 from the control processing flow of drawing 5 in the memory 72 for processing in the composition of drawing 4 , it constitutes so that the display by each above-mentioned composition can be performed.

[0163] In addition, this control processing flow is constituted as the same



subroutine as the case of the 1st above-mentioned example, and for every second, it consists of main control manipulation routines, for example so that it may shift to this control processing flow.

[0164] [Explanation of a control processing flow] The control processing flow which removed the portions of step SP1 and step SP11 from the control processing flow of drawing 5 is explained hereafter. Therefore, a control processing flow here will be started from step SP2.

[0165] ⇨ In step SP2 - step SP4, perform the same control processing as step SP2 of drawing 3 in the 1st example - step SP4, and shift to the following step SP5.

[0166] [ in addition, the front sea bed cross-section erasing signal distinguished by step SP3 ] For example, it constitutes so that a front sea bed cross-section erasing signal may be given to a part for a part for the setting control unit 60 of drawing 19 , and the setting control unit of drawing 21 (60+32) based on operation of the "front sea bed" key 69X prepared like the case of the 1st example, for example.

[0167] ⇨ The water depth data which accompanied storage of above past wake-behind-a-sailing-ship CR2, and the position data of the position used as wake-behind-a-sailing-ship data and the water depth data of 30a were made to correspond in step SP5, and was memorized in the water depth memory 77 for data, The water depth data of 30a in the self-ship position 10a, i.e., the data of the present depth of water, and the water depth data which measured [ as opposed to / further only / the predetermined point ] water depth 30a distinguish whether it memorizes to the direction of movement 10c of a self-ship. When water depth data is memorized to the direction of movement 10c of a self-ship, it shifts to the following step SP6, and when that is not right, it shifts to step SP7.

[0168] ⇨ The data and depth-sounding data of the position value of the point where each above-mentioned depth-sounding data and the data of the position of the point corresponding to it, for example, past wake-behind-a-sailing-ship CR2 and the direction 10c of a present progressive, cross in step SP6, The water depth data of the self-ship position 10a is taken into the memory 73 for work, and it shifts to the following step SP7.

[0169] ⇨ [ step SP7 / based on the position data of the self-ship position 10a and positions P21-P26, calculate each distance from the self-ship position 10a to positions P21-P26, and also ] like step SP5 When there is a position P27 of past wake-behind-a-sailing-ship CR2 taken in by step SP6 About that position P27, by calculating distance, similarly The data of the depth value of the data of each of this distance, each \*\*\*\*\* Ld1-Ld5, and the position P27 of past wake-behind-a-sailing-ship CR2, namely, -- replacing with the front sea bed cross-section picture 82Y of drawing 2 based on water depth data -- the [important section display composition] of drawing 5 -- creation processing of the image data for displaying the front sea bed cross-section picture [ like ] 82Y is carried out.

[0170] Furthermore, while taking the image data into the memory 73 for work and memorizing it, after giving the display-processing portion 80 and displaying the front sea bed cross-section picture 82Y of drawing 5 on a part for the sea bed cross-section display 81A of drawing 2 , it shifts to the following step SP8.

[0171] [ here / the front sea bed cross-section picture 82Y of drawing 5 / a different part from the front sea bed cross-section picture 82Y of drawing 2 ] [ the water depth data of the self-ship position 10a is expressed as the water depth data based on water depth 30a obtained by the water depth measurement portion 30, and ] between the water depth data 40m based on depth [ data / 46m / water depth ] line Ld4 now [ of the self-ship position 10a ] It is the part where the figure of the part based on the water depth data of the position P27 of past wake-behind-a-sailing-ship CR2, for example, 43m data, is displayed. In addition, when the water depth data of \*\*\*\*\* Ld5 differs from water depth

30a measured in the water depth measurement portion 30, you may make it display with the water depth water depth data of 30a.

[0172] Moreover, the memory 78 for front sea bed data is formed, and you may make it memorize the data storage in above step SP4, step SP6, and step SP7 like the case of the 1st example, as the dotted line showed to drawing 4.

[0173] <> Constitute from step SP8 and step SP9 so that control processing by step SP6 and step SP7 in the case of the 1st above-mentioned example by drawing 3 and same control processing may be performed.

[0174] That is, the composition of this 3rd example generally In the 1st, the 1st composition by the 1st above-mentioned example - the 4th composition will be constituted, and further [ the 2nd ] In the 1st composition by the composition of the 1st above-mentioned example - the 3rd composition, as each above-mentioned depth-sounding data Each depth-sounding data based on the depth lines Ld1-Ld5, for example, \*\*\*\*\*, such as the above contained in the map data memorized by the map data 75 memorized beforehand, for example, the memory for map data, and the file memory portion 90, Each depth-sounding data obtained by the water depth measurement portion 30, for example, the water depth data of the self-ship position 10a, i.e., data of the present depth of water, The 5th above-mentioned composition which used the water depth data memorized along with storage of past wake-behind-a-sailing-ship CR2 by the water depth memory 77 for data will be constituted.

[0175] Moreover, in the 3rd, in the 5th above-mentioned composition, while constituting the above-mentioned position measurement portion 10 from satellite electric navigation equipment or amendment satellite electric navigation equipment, the 6th above-mentioned composition which constituted the above-mentioned water depth measurement portion 10 from a shoal-of-fish detection device will be constituted.

[0176] And since the feature in the case of the 1st above-mentioned example and the same feature are acquired according to these 1st composition - the 6th composition, it means that the above-mentioned [1st technical problem] was solved.

[0177] The [4th example] Drawing 2, drawing 4, and drawing 5 explain the 4th example hereafter. A different part from the composition of the 3rd example of the above [ the composition of this 4th example ] is the next part.

[0178] In the 1st, like the case of the 2nd above-mentioned example, the heading measurement portion 15 For example, form the gyrocompass or the magnetic compass and [ predetermined degree 10b of self-vessel speed, at for example, the time of 5 knots or less, ] When displaying the front sea bed cross-section picture 82Y using the direction 15a of a bow acquired by the heading measurement portion 15 and exceeding the predetermined degree 10b of self-vessel speed, for example, 5 knots It is the part constituted so that the front sea bed cross-section picture 82Y might be displayed using the direction of movement 10c of a self-ship obtained by the position measurement portion 10, for example, satellite electric navigation equipment, or amendment satellite electric navigation equipment.

[0179] In order to make the above-mentioned display perform in the 2nd, it is the part constituted so that the program of the whole control processing flow of drawing 5 might be beforehand memorized in the memory 72 for processing in the composition of drawing 4.

[0180] In addition, this control processing flow is constituted as the same subroutine as the case of the 1st above-mentioned example, and for every second, it consists of main control manipulation routines, for example so that it may shift to this control processing flow.

[0181] [Explanation of a control processing flow] The control processing flow of drawing 5 is explained hereafter.

<> In step SP1, step SP2, and step SP11, perform the same control processing as the case of the 2nd example by above-mentioned drawing 3, and shift to the

following step SP3.

<> Constitute from step SP3 - step SP9 so that the same control processing as the case of the 3rd above-mentioned example may be performed.

[0182] That is, the composition of this 4th example generally In the 1st, the 1st composition by the 2nd above-mentioned example - the 4th composition will be constituted, and further [ the 2nd ] In the 1st composition by the composition of the 2nd above-mentioned example - the 3rd composition, the 5th above-mentioned composition and 6th composition by the 3rd above-mentioned example will be constituted.

[0183] And since the feature in the case of the 1st above-mentioned example and the same feature are acquired according to these 1st composition - the 6th composition, it means that the above-mentioned [1st technical problem] was solved.

[0184] The [5th example] Drawing 6 - drawing 9 explain the 5th example hereafter. A part which constitutes the composition of this 5th example with the application of the 7th above-mentioned composition - the 11th composition in the composition of the 7th conventional technology explained by above-mentioned drawing 18 - drawing 21 - the 11th conventional technology, and is different from the composition of the above-mentioned 7th conventional technology - the 11th conventional technology is the next part.

[0185] new to the 1st -- etc. -- a depth line, such as being contained in the depth line, i.e., the map data memorized by the memory 75 for map data, -- namely, -- while setting up the water depth predetermined value for creating depth line Ld, such as creation [ of a depth line, for example, drawing 7 , such as different different depth of water from depth line Ld, such as ready-made / of a depth line, for example, drawing 7 , //, such as ready-made/, 1, and Ld5, ], 11, for example, the water depth water depth value of 20m

[0186] It is the part constituted so that the data of these water depth values might be memorized into a storage portion at Storage 77Y, for example, the memory for setting depth-sounding data of drawing 6 . in addition, when the depth [ map data ] line is not included, it comes to resemble that the above-mentioned water depth value sets up the proper water depth value for which it wishes

[0187] The water depth predetermined value set as the 2nd, for example, the position where 20 water depthm was obtained, For example, the data of the ship position 10a is memorized into a storage portion as data of a predetermined depth-sounding position value each one obtained by the position measurement portion 10 in each position value of predetermined depth-sounding position LP1 of drawing 7 , i.e., the position. For example, it is the part constituted so that it might be made the shape of a table like drawing 8 for example, and might memorize in the memory 77Y for setting depth-sounding data of drawing 6 .

[0188] The data of the predetermined depth-sounding position value memorized by the 3rd at the memory 77Y for setting depth-sounding data, For example, sequence predetermined in latitude and a longitude value (A1) - (A6) each position value of predetermined depth-sounding position LP1, For example, it is the part constituted so that it might be made the shape of a table like drawing 8 for example, and might memorize into the storage portion which arranges and changes so that it may be made the sequence that a longitude value is small, for example, is equivalent to the "position data" column of the memory 79 for depth line data, such as drawing 6 .

[0189] In the memory 79 for \*\*\*\*\* data the 4th The point of the data of a predetermined depth-sounding position value, Namely, the segment prepared data for creating the segment which connects between the every place points of predetermined depth-sounding position LP1, for example, each association line part LL1 of drawing 7 , For example, it is the part constituted so that it might be made the shape of a table like drawing 8 for example, and might memorize into the storage portion equivalent to the "segment" column of the memory 79 for

depth [ data / of "\*" ] line data.

[0190] The memory content of the storage portion which is equivalent to the 3rd at the "position data" column of the memory 79 for "\*" data, it is the part constituted so that depth line Ld, such as creation/,11 might be displayed on the display screen 81 by giving and carrying out display processing of each data obtained by the storage portion equivalent to the "segment" column of the memory 79 for "\*" data carrying out memory content reading appearance to the display-processing portion 80.

[0191] When displaying depth line Ld, such as above-mentioned creation/,11 on the 4th and depth line Ld, such as each ready-made/,1 and Ld5 are contained in the map data beforehand memorized into the memory 75 for map data, or the file memory portion 90 It is the part constituted so that depth line Ld, such as these,11, Ld1, and Ld5 might be merged and displayed on the display screen 81 by giving and carrying out display processing of depth line Ld, such as depth line Ld11 and each ready-made/, such as creation/,1 and Ld5 to the display-processing portion 80.

[0192] The figure which displays the point of each predetermined depth-sounding positions LP1-LP3 currently displayed on the display screen 81 on the 5th, for example, the figure of O form, Or a segment LL1-LL3, parts for for example, an association line, is specified using the designated point CP by cursor CLX-CLY, for example. It is the part constituted so that the data storage of "\*" memorized by the "segment" column of the above-mentioned segment prepared data 79, for example, the memory for "\*" data, might be eliminated or the data storage of "\*" could be added.

[0193] [ the 6th / a water depth predetermined value ] while setting two or more water depth predetermined values, for example, the water depth water depth value of 20 m.30 m.40m, as the 6th The storage portion equivalent to the "position data" column of the memory 79 for depth line data, such as the above, [ the storage portion equivalent to the "segment" column of the memory 79 for depth line data, such as the above, ] It is the part constituted so that the storage portion corresponding to two or more water depth predetermined values, for example, the water depth water depth value of 20 m.30 m.40m, might be prepared and depth line Ld, such as two or more creation/, 11, Ld12, Ld13, etc. could be displayed on the display screen 81.

[0194] That is, the composition of this 5th example generally The position measurement data of the self-ship position 10a obtained by the position measurement portion 10 by the 1st, [0195] being based on the water depth measurement data 30a of the water depth value corresponding to the above self-ship position 10a obtained by the water depth measurement portion 30 -- etc. -- [ the picture of the cruise related information containing depth line Ld11 ] in the navigation equipment 100 it enabled it to display on the display screen 81 While setting up the water depth predetermined value for creating depth line Ld, such as the above,11, for example, 20 water depthm Prepare the 1st storage portion which memorizes the above-mentioned water depth predetermined value, for example, the predetermined depth-sounding position value corresponding to 20 water depthm, for example, the storage portion equivalent to the "position data" column of the memory 79 for "\*" data, and [0196] The position value 10a of the above-mentioned position measurement data at the time of the above-mentioned water depth measurement data 30a becoming the above-mentioned water depth predetermined value, for example, 20m, the above-mentioned predetermined depth-sounding position value, For example, a predetermined depth-sounding position value storage means to memorize as latitude longitude value (A1) - (A6) into the 1st above-mentioned storage portion, for example, the storage portion equivalent to the "position data" column of the memory 79 for "\*" data, and [0197] The above-mentioned predetermined depth-sounding position value memorized into the 1st above-mentioned storage portion, for example, the storage portion equivalent to the "position data" column of the memory 79 for "\*" data, For example, the segment which connects

between a latitude longitude value (A1) - (A6) points For example, a segment storage means to memorize the segment prepared data for creating association line part LL1, for example, the data of "\*\*\*", into the 2nd storage portion, for example, the storage portion equivalent to the "segment" column of the memory 79 for \*\*\*\*\* data, and [0198] The 1st above-mentioned storage portion, for example, the storage portion equivalent to the "position data" column of the memory 79 for \*\*\*\*\* data, Based on each data read and obtained, each memory content of the 2nd above-mentioned storage portion, for example, the storage portion equivalent to the "segment" column of the memory 79 for \*\*\*\*\* data, depth lines, such as the above, For example, the 7th above-mentioned composition which established the depth line display means, such as displaying \*\*\*\*\* Ld11 on the above-mentioned display screen 81, is constituted.

[0199] To the 2nd, in the 7th above-mentioned composition, moreover, the above-mentioned water depth predetermined value, For example, a depth line, such as being contained in the map data memorized by the map data 75 which memorized the water depth value of 20m beforehand, for example, the memory for map data, and the file memory portion, Namely, while setting to water depth values of depth line Ld1 and Ld5, such as depth lines, i.e., ready-made/etc., such as a map, for example, a water depth value which is different in water depth value 10 m.50m, and creating depth lines, for example, creation / depth line Ld11, such as the above The 8th above-mentioned composition which added depth lines, for example, a merge display means to merge and display a ready-made / depth line Ld1, and Ld5, such as depth lines, for example, creation / depth line Ld11, the above-mentioned map, etc., such as the above, is constituted.

[0200] Furthermore, while making the above-mentioned water depth predetermined value into two or more water depth predetermined values, for example, water depth 20 m.30 m.40m, and setting it as the 3rd in the 7th above-mentioned composition and 8th composition The 1st above-mentioned storage portion, for example, the storage portion equivalent to the "position data" column of the memory 79 for \*\*\*\*\* data, By preparing two or more above-mentioned water depth predetermined values, for example, the storage portion corresponding to water depth 20 m.30 m.40m, in the 2nd above-mentioned storage portion, for example, the storage portion equivalent to the "segment" column of the memory 79 for \*\*\*\*\* data The 9th above-mentioned composition which displayed the depth lines Ld11-Ld13, such as depth lines, for example, creation/etc., such as two or more above, on the above-mentioned display screen 81 is constituted.

[0201] Moreover, the figure which displays the above-mentioned point LP1-LP3, for example, each predetermined depth-sounding positions, on the 4th in the 7th above-mentioned composition - the 9th composition, for example, the figure of O form, Or specify the above-mentioned segment LL1-LL3, parts for for example, an association line, and the above-mentioned segment prepared data, for example, the data storage of "\*\*\*", is eliminated. Or the 10th above-mentioned composition which added a segment elimination addition means to add the above-mentioned segment prepared data, for example, the data storage of "\*\*\*", is constituted.

[0202] Furthermore, in the 5th, in the 7th above-mentioned composition - the 10th composition, while constituting the above-mentioned position measurement portion 10 from satellite electric navigation equipment or amendment electric navigation equipment, the 11th above-mentioned composition which constituted the above-mentioned water depth measurement portion 30 from a shoal-of-fish detection device is constituted.

[0203] And by memorizing the program of the control processing flow of drawing 9 beforehand in the memory 72 for processing of drawing 6, specifically, it constitutes so that the display by each above-mentioned composition can be performed.

[0204] In addition, this control processing flow is constituted as Zabol Ching, the main control manipulation routine for performing control processing of the whole in the cruise Data Processing Division portion 70 of drawing 6 , and for every second, it consists of main control manipulation routines, for example so that it may shift to this control processing flow.

[0205] [Explanation of a control processing flow] The control processing flow of drawing 9 is explained hereafter. In addition, control processing for creating and displaying depth line Ld, such as creation/, 11, Ld12, and Ld13 shall be performed here by setting a water depth predetermined value to 20 m.30 m.40m.

[0206] ⇨ Distinguish whether a depth setup of depth lines, such as creation/, i. e., a water depth predetermined value, is ending with a setting in step SP1. When it is ending with a setting, it shifts to step SP3, and when that is not right, it shifts to the following step SP2.

[0207] Here, since a setup of a water depth value may set up other water depth value 30 m.40m after setting up the water depth value of 20m first, it distinguishes whether there is any setting input at every setup of the, for example.

[0208] Moreover, the "grade depth line" key 69Y shown in a part for the control unit for creating a depth line, such as having prepared the setting input in a part for the setting control unit 60, a part for for example, the setting control unit of drawing 21 , (60+32) by the dotted line is operated. The menu screen for setting up the conditions of depth lines, such as creation/, is displayed, and a value setpoint signal input is carried out, and a necessary water depth value, for example, the signal which sets up water depth value 20 m.30 m.40m, is constituted so that whether this water depth value setpoint signal is memorized by the memory 73 for work may perform [ water depth ] the above-mentioned distinction.

[0209] ⇨ In step SP2, take in the above-mentioned water depth value setpoint signal, for example, memorize water depth predetermined value 20 m.30 m.40m like drawing 8 , for example in the memory 79 for depth [ memory / 77Y / for setting depth-sounding data ] line data.

[0210] each depth-sounding value 20m.30 [ and ] memorized -- the position data of the self-ship position 10a when the water depth value is acquired every m.40 m -- every place -- a law -- the data of depth-sounding position LP1, LP2, and LP3 -- For example, the storage portion equivalent to the "position data" column for making it the shape of a table as a latitude longitude value (A1) - (A6) - latitude longitude value (B1) - (B7) ....., and memorizing is made.

[0211] Furthermore, it corresponds to the data of each predetermined depth-sounding position LP1, LP2, and LP3 of the "position data" column of the memory 79 for \*\*\*\*\* data. The storage portion equivalent to the "segment" column for making the segment data for creating each association line LL1, LL2, and LL3 equivalent to each segment of depth line Ld, such as creation/, 11, Ld12, and Ld13, for example, "\*\*\*", into the shape of a table, and memorizing it is made.

[0212] ⇨ predetermined [ which the present water depth data of 30a set up in step SP3 ] -- each -- distinguish whether it became one water depth value of the depth-sounding value 20 m.30 m.40m. When it becomes one of the water depth values, it shifts to the following step SP4, and when that is not right, it returns to the predetermined step part of a main control manipulation routine.

[0213] A distinction value here distinguishes whether the water depth data of 30a is in agreement with either of the data of a water depth predetermined value as compared with water depth predetermined value 20 m.30 m.40m memorized by the memory 77Y for setting depth-sounding data.

[0214] ⇨ The time of being in agreement with either of the data of a water depth predetermined value in step SP4, For example, when in agreement with the water depth value of 20m, the data of the data of the obtained self-ship position 10a, i.e., a latitude longitude value, for example, a latitude longitude value, (A6) as data of a predetermined depth-sounding position value After

memorizing into the storage portion which is once equivalent to the column of the water depth value to which the memory 77Y for setting depth-sounding data corresponds, for example, the with a water depth value [ in the memory 77Y for setting depth-sounding data of drawing 8 ] of 20m "position data" column, it shifts to the following step SP5.

[0215] In addition, let the data of latitude longitude value (A1) - (A5) be data of the predetermined depth-sounding position value acquired by these step SP4 by last time on account of explanation here.

[0216] ⇨ The water depth value to which the memory 77Y for setting depth-sounding data once corresponds in step SP5, For example, the predetermined depth-sounding position value memorized into the storage portion equivalent to the with a water depth value of 20m "position data" column, For example, [ the data of a latitude longitude value (A6) ] as compared with the data of the position value memorized by the storage portion which is already equivalent to the "position data" column of the memory 79 for \*\*\*\*\* data so that it may become predetermined sequence, for example, the sequence that a longitude value is small For example, after replacing storage sequence and memorizing like the 20m "position data" column in the memory 79 for depth line data, such as drawing 8, it shifts to the following step SP6.

[0217] ⇨ memorizing in step SP6 in the "segment" column of the memory 79 for depth [ segment data /, for example, "\*\*\*" etc., ] line data -- etc. -- distinguish whether creation, for example, association line LL1, is created for the segment of a depth line. When creating a segment, it shifts to the following step SP7, and when that is not right, it shifts to step SP8.

[0218] Distinction here shall have memorized segment data, for example, "\*\*\*", when the predetermined depth-sounding position value is only memorized by the storage portion equivalent to the column of the order of the point in the "position data" column of the memory 79 for \*\*\*\*\* data.

[0219] that is, -- for example, -- since the latitude longitude value (A4) is memorized by the column of the order of the point of the data of a latitude longitude value (A6) if the data of the latitude longitude value (A6) was memorized in the "position data" column of the memory 79 for depth line data -- it can set to drawing 8 -- segment data -- \*\*\*\*\* -- \*\*\*\*\* -- it distinguishes.

[0220] ⇨ In step SP7, shift to the following step SP8 after memorizing segment data. Like the example of above step SP6, storage here memorizes the data of "\*\*\*" into the storage portion equivalent to the "segment" column corresponding to the data of a latitude longitude value (A6), when the latitude longitude value (A4) is memorized by the column of the order of the point of the data of a latitude longitude value (A6).

[0221] ⇨ Distinguish whether depth line Ld, such as creation/,11, Ld12, and Ld13 are displayed in step SP8. When displaying, it shifts to the following step SP9, and when that is not right, it returns to the predetermined step part of a main control manipulation routine.

[0222] Distinction here operates the "grade depth line" key 69Y shown in a part for the setting control unit of drawing 21 (60+32) by the dotted line, for example. The menu screen for setting up the conditions of depth lines, such as creation/, is displayed, and it constitutes so that it may distinguish by whether depth line display signals, such as the signal which chose "the display", i.e., creation/etc., are memorized by the memory 73 for work.

[0223] ⇨ Data required for the display of depth lines, such as creation/, at step SP9 for example, when [ which carry out data reading appearance and gives the display-processing portion 80 ] the "position data" column of the memory 79 for depth line data -- it can set to drawing 8 -- and the "segment" column memorize After displaying the portion memorized by the memory 79 for depth line data among depth line Ld, such as creation/,11, Ld12, and Ld13 etc. on the display screen 81, it shifts to the following step SP10.

[0224] ⇨ Distinguish whether the necessary segment of depth line Ld, such as creation/,11, Ld12, and Ld13, for example, either of association line part LL1, is

changed in step SP10. When changing, it shifts to the following step SP11, and when that is not right, it shifts to step SP12.

[0225] Distinction here operates the "grade depth line" key 69Y shown in a part for the setting control unit of drawing 21 (60+32) by the dotted line, for example. The menu screen for setting up the conditions of depth lines, such as creation/, is displayed, and it constitutes so that it may distinguish by whether depth line change signals, such as the signal which chose "change", i.e., creation/ etc., are memorized by the memory 73 for work.

[0226] <> The segment of depth line Ld, such as creation/currently displayed on the display screen 81 in step SP11,11, Ld12, and Ld13, Namely, the arbitrary things of association line part LL1, LL2, and LL3 are eliminated. Or the new segment which connects the arbitrary points of the predetermined depth-sounding positions LP1-LP3, a part for i.e., a new association line, is added, and manual change operation of changing the alignment of the arbitrary things of depth line Ld, such as creation/,11, Ld12, and Ld13 is performed.

[0227] [ "elimination operation" by manual change operation here / the designated point CP by cursor CLX-CLY of drawing 7 ] by operating a part for "cursor" key 62H and the arbitrary directional movement control unit 68 of drawing 21 It is made in agreement with the figure which displays the point of the predetermined depth-sounding positions LP1-LP3 of the part which wants to eliminate a segment, for example, the figure of O form, and the position for an association line LL1-LL3, and specifies.

[0228] In the state, by operating "elimination" key 64F of drawing 21 , the data storage of "\*\*\*" memorized by the "segment" column of the memory 79 for segment prepared data, for example, \*\*\*\*\* data, is eliminated, and the segment is eliminated.

[0229] Moreover, "add operation" is in the state which specified the figure which displays the point of the predetermined depth-sounding positions LP1-LP3 of a part to add a segment to by same operation, for example, the figure of O form. By operating the "setting" key 62F of drawing 21, the data storage of above "\*\*\*" is added and a new segment is added.

[0230] That is, by eliminating association line part LL1A of depth line Ld11, such as creation/, and specifically adding association line part LL1B shown by a dotted line as a new segment like the [segment change composition] of drawing 7 In order to coincide alignment of depth line Ld11, such as creation/, with actual alignment, it enables it to perform the above-mentioned "elimination operation" and "add operation."

[0231] <> Distinguish whether depth line Ld, such as creation/,11, Ld12, and Ld13 are eliminated in step SP12. When eliminating, it shifts to the following step SP13, and when that is not right, it returns to the predetermined step part of a main control manipulation routine.

[0232] Distinction here operates the "grade depth line" key 69Y of drawing 21, for example. The menu screen for setting up the conditions of depth lines, such as creation/, is displayed, and it constitutes so that it may distinguish by whether depth line erasing signals, such as the signal which chose "elimination", i.e., creation/etc., are memorized by the memory 73 for work.

<> In step SP13, return to the predetermined step part of a main control manipulation routine after eliminating depth line Ld, such as creation/,11, Ld12, and Ld13.

[0233] [ in that is, the menu screen on which the "grade depth line" key 69Y was operated and displayed according to the composition of this 5th example ] Water depth value 20 m.30 m.40m, such as depth line Ld, such as wanting to newly create, 11, Ld12, and Ld13, etc. is set up. The accumulation storage of the position data of predetermined depth position LP1, LP2, and LP3 and the segment prepared data of association line part LL1, LL2, and LL3 is carried out at the memory 79 for depth [ inside / where the self-ship is cruising through various routes ] line data. The feature that \*\*\*\*\*Ld11, Ld12, Ld13, etc. can be displayed now is acquired. therefore, new -- etc. -- since \*\*\*\*\* becomes



unnecessary specially for making a depth line in whether it is size, it means that the above-mentioned [2nd technical problem] was solved

[0234] The [6th example] Drawing 6 and drawing 10 - drawing 12 explain the 6th example hereafter. A different part from the composition of the 5th example of the above [ the composition of this 6th example ] is the next part.

[0235] the 1st -- drawing 11 -- like -- etc. -- to the position value (A8), for example, the latitude longitude value, of the point newly memorized by the "position data" column with a predetermined depth of 20m of the memory 79 for depth line data The position value of a point with a predetermined depth of 20m adjoining, i.e., the distance value between the position values memorized by the column of the order of the point, and the following order, for example, the distance value between a latitude longitude value (A8) and the latitude longitude value by the side of the order of the point (A1), [ a distance value ] although the distance value between a latitude longitude value (A8) and the latitude longitude value by the side of the following order (A6) will call it the distance value between the points of a position value with a predetermined depth of 20m Only when distinguishing these distance values separately and below the predetermined distance value  $d_s$  (not shown) has become 0.5km or less, it is the part changed so that the conditions of memorizing "\*\*\*" might be established.

[0236] That is, [ since the distance value between a latitude longitude value (A8) and the latitude longitude value by the side of the order of the point (A1) is over the predetermined distance value  $d_s$  in the case of drawing 11, the storage portion equivalent to the "segment" column corresponding to a latitude longitude value (A8) is made into "a null, i.e., a storage state without a segment," but ] Since the distance value between a latitude longitude value (A8) and the latitude longitude value by the side of the following order (A6) is below the predetermined distance value  $d_s$ , the storage portion equivalent to the "segment" column corresponding to a latitude longitude value (A6) is made into "\*\*", i.e., a storage state with a segment." In addition, it cannot be overemphasized that it is similarly processed to the storage portion equivalent to other columns of predetermined depth-sounding 30 m.40m.

[0237] The portion which only the portion for an association line LLX which depth line Ld, such as creation/11, Ld12, and Ld13 showed as the solid line was displayed on the 2nd by storage of "\*\*\*" by the above-mentioned conditions like drawing 10, and was shown by the dotted line is the part changed and constituted so that it might not be displayed.

[0238] It constitutes so that the point connected by the segment like drawing 10 if needed, for example, the figure which displays the part of the predetermined depth-sounding position LPX connected by a part for an association line LLX, may be displayed on the 3rd with a small figure, for example, the figure of small black -.

[0239] Furthermore, it constitutes so that the point which is not connected by a segment, for example, the figure which displays the part of the predetermined depth-sounding position LPX which is not connected by a part for an association line LLX, may be displayed with a large figure, for example, the figure of large O. It is the part constituted so that it could gaze at the point of a water depth predetermined value existing in the point which is not connected by the above-mentioned segment.

[0240] It constitutes so that the point connected by the segment if needed, for example, the figure which displays the part of the predetermined depth-sounding position LPX connected by a part for an association line LLX, for example, the figure of small black -, may be displayed on the 4th by regular brightness.

[0241] Furthermore, the point which is not connected by a segment, for example, the figure which displays the part of the predetermined depth-sounding position LPX which is not connected by a part for an association line LLX, For example, it is the part which constituted so that the figure of large O might be displayed, or might be blinked by brightness brighter than regular brightness, for

example, the brightness of regular double, and it might display, and was constituted so that it could gaze at the point of a water depth predetermined value existing in the point which is not connected by the above-mentioned segment.

[0242] That is, the composition of this 6th example generally The position measurement data of the self-ship position 10a obtained by the position measurement portion 10 by the 1st, [0243] being based on the water depth measurement data 30a of the water depth value corresponding to the above self-ship position 10a obtained by the water depth measurement portion 30 -- etc. -- [ the picture of the cruise related information containing depth line Ld1 ] in the navigation equipment 100 it enabled it to display on the display screen 81 While setting up the water depth predetermined value for creating depth line Ld, such as the above, 11, for example, 20 water depthm Prepare the 1st storage portion which memorizes the above-mentioned water depth predetermined value, for example, the predetermined depth-sounding position value corresponding to 20 water depthm, for example, the storage portion equivalent to the "position data" column of the memory 79 for \*\*\*\*\* data, and [0244] The position value 10a of the above-mentioned position measurement data at the time of the above-mentioned water depth measurement data 30a becoming the above-mentioned water depth predetermined value, for example, 20m, the above-mentioned predetermined depth-sounding position value, For example, a predetermined depth-sounding position value storage means to memorize as latitude longitude value (A1) - (A6) into the 1st above-mentioned storage portion, for example, the storage portion equivalent to the "position data" column of the memory 79 for \*\*\*\*\* data, and [0245] The above-mentioned predetermined depth-sounding position value memorized into the 1st above-mentioned storage portion, for example, the storage portion equivalent to the "position data" column of the memory 79 for \*\*\*\*\* data, For example, a latitude longitude value (A1) - (A6) below a distance value predetermined in between points [0246] for example, [ means / to memorize the segment prepared data for creating the segment LLX which connects between \*\* of 0.5km or less, a part for for example, an association line, for example, the data of "\*\*\*", into the 2nd storage portion for example, the storage portion equivalent to the "segment" column of the memory 79 for \*\*\*\*\* data, / segment storage ] The 1st above-mentioned storage portion, for example, the storage portion equivalent to the "position data" column of the memory 79 for \*\*\*\*\* data, Based on each data read and obtained, each memory content of the 2nd above-mentioned storage portion, for example, the storage portion equivalent to the "segment" column of the memory 79 for \*\*\*\*\* data, depth lines, such as the above, For example, the 12th above-mentioned composition which established the depth line display means, such as displaying \*\*\*\*\* Ld11 on the above-mentioned display screen 81, is constituted.

[0247] Moreover, while displaying the point connected by the above-mentioned segment, for example, the figure which displays the part of the predetermined depth-sounding position LPX connected by a part for an association line LLX, on the 2nd with a small figure, for example, the figure of small black -, in the 12th above-mentioned composition The 13th above-mentioned composition which displayed the point which is not connected by the above-mentioned segment, for example, the figure which displays the part of the predetermined depth-sounding position LPX which is not connected by a part for an association line LLX, with the large figure, for example, the figure of large O, is constituted.

[0248] Moreover, the point connected with the 3rd by the above-mentioned segment in the 12th above-mentioned composition and 13th composition, For example, while expressing the figure which displays the part of the predetermined depth-sounding position LPX connected by a part for an association line LLX, for example, the figure of small black -, as regular brightness The point which is not connected by the above-mentioned segment,

for example, the figure which displays the part of the predetermined depth-sounding position LPX which is not connected by a part for an association line LLX. For example, the 14th above-mentioned composition which the figure of large O is displayed, or is blinked by brightness brighter than regular brightness, for example, the brightness of regular double, and was displayed is constituted.

[0249] To the 4th, in the 12th above-mentioned composition - the 14th composition, furthermore, the above-mentioned water depth predetermined value, For example, a depth line, such as being contained in the map data memorized by the map data 75 which memorized the water depth value of 20m beforehand, for example, the memory for map data, and the file memory portion, Namely, while setting to water depth values of depth line Ld1 and Ld5, such as depth lines, i.e., ready-made/etc., such as a map, for example, a water depth value which is different in water depth value 10 m.50m, and creating depth lines, for example, creation / depth line Ld11, such as the above The 15th above-mentioned composition which added depth lines, for example, a merge display means to merge and display a ready-made / depth line Ld1, and Ld5, such as depth lines, for example, creation / depth line Ld11, the above-mentioned map, etc., such as the above, is constituted.

[0250] Moreover, while making the above-mentioned water depth predetermined value into two or more water depth predetermined values, for example, water depth 20 m.30 m.40m, and setting it as the 5th in the 12th above-mentioned composition - the 15th composition The 1st above-mentioned storage portion, for example, the storage portion equivalent to the "position data" column of the memory 79 for \*\*\*\*\* data, By preparing two or more above-mentioned water depth predetermined values, for example, the storage portion corresponding to water depth 20 m.30 m.40m, in the 2nd above-mentioned storage portion, for example, the storage portion equivalent to the "segment" column of the memory 79 for \*\*\*\*\* data The 16th above-mentioned composition which displayed the depth lines Ld11-Ld13, such as depth lines, for example, creation/etc., such as two or more above, on the above-mentioned display screen 81 is constituted.

[0251] Furthermore, the figure which displays the above-mentioned point LP1-LP3, for example, each predetermined depth-sounding positions, on the 6th in the 12th above-mentioned composition - the 16th composition, for example, the figure of O form, Or specify the above-mentioned segment LL1-LL3, parts for for example, an association line, and the above-mentioned segment prepared data, for example, the data storage of "\*\*\*", is eliminated. Or the 17th above-mentioned composition which added a segment elimination addition means to add the above-mentioned segment prepared data, for example, the data storage of "\*\*\*", is constituted.

[0252] Moreover, in the 7th, in the 12th above-mentioned composition - the 17th composition, while constituting the above-mentioned position measurement portion 10 from satellite electric navigation equipment or amendment electric navigation equipment, the 18th above-mentioned composition which constituted the above-mentioned water depth measurement portion 30 from a shoal-of-fish detection device is constituted.

[0253] And by memorizing the program of the control processing flow of drawing 12 beforehand in the memory 72 for processing of drawing 6, specifically, it constitutes so that the display by each above-mentioned composition can be performed.

[0254] In addition, this control processing flow is constituted as the same Zabul Ching as the control processing flow of drawing 9, and for every second, it consists of main control manipulation routines, for example so that it may shift to this control processing flow.

[0255] [Explanation of a control processing flow] The control processing flow of drawing 12 is explained hereafter. In addition, control processing for creating and displaying depth line Ld, such as creation/,11, Ld12, and Ld13 shall be performed here by setting a water depth predetermined value to 20 m.30 m.40m.

[0256] ⇨ In step SP1 - step SP5, perform the same control processing as step SP1 in the control processing flow of drawing 9 - step SP5, and shift to the following step SP6.

[0257] ⇨ step SP6 -- new -- etc. -- [ point / of the position value of the predetermined depth of water taken into the "position data" column of the memory 79 for depth line data ] The distance value between the points of the position value of the same predetermined depth of water which adjoins the point distinguishes whether below the predetermined distance value ds (not shown) is 0.5km or less. When having become below the predetermined distance value ds, it shifts to the following step SP7, and when that is not right, it shifts to step SP8.

[0258] Distinction here memorizes the data of the predetermined distance value ds in the "predetermined distance value" column of the memory 79 for \*\*\*\*\* data beforehand first. For example, the position value of the point which was newly taken in in the case of the "position data" column with a predetermined depth of 20m, For example, distance value dm1 to a position value (A1) with a predetermined depth of 20m which adjoins a latitude longitude value (A8), for example, a latitude longitude value, (not shown), Data processing of distance value dm2 to a latitude longitude value (A6) (not shown), i.e., each distance value dm1 and dm2 between the points of the position value of the adjoining same predetermined depth of water, is carried out, and they are calculated.

[0259] Next, either these distance value dm1 and dm2 distinguish by whether it has become below the predetermined distance value ds. [ each ] In addition, only distance value dm2 between the point of a latitude longitude value (A8) and the point of a latitude longitude value (A6) assume that it has become below the predetermined distance value ds here.

[0260] ⇨ In step SP7, shift to the following step SP8 after memorizing the segment prepared data for creating a segment between the points which have become below the predetermined distance value ds into a predetermined storage portion.

[0261] [ storage processing here ] as segment prepared data for, for example, displaying the segment LLX which connects between the point of a latitude longitude value (A8), and the points of a latitude longitude value (A6), a part for i.e., an association line Control processing which memorizes the data of "" into the storage portion equivalent to the "segment" column corresponding to the latitude longitude value (A6) of the "position data" column of the memory 79 for \*\*\*\*\* data is performed.

[0262] ⇨ In step SP8 - step SP13, perform the same control processing as step SP8 in the control processing flow of drawing 9 - step SP13, and shift to the predetermined step part of a main control manipulation routine.

[0263] [ in addition, "segment change" by step SP11 in this 6th example ] The part exceeding the predetermined distance values ds in depth line Ld12, such as with a predetermined depth of 30m creation/, i.e., the part of an excess of predetermined distance shown by the dotted line, is specifically judged from the actual condition, for example like the [segment change composition] of drawing 10. As the solid line showed, it constitutes so that a part for the new association line LLY may be displayed and change processing may be carried out.

[0264] [ in that is, the menu screen on which the "grade depth line" key 69Y was operated and displayed like the case of the 5th above-mentioned example according to the composition of this 6th example ] Water depth value 20 m.30 m.40m, such as depth line Ld, such as wanting to newly create, 11, Ld12, and Ld13, etc. is set up. the accumulation storage of the position data of the predetermined depth position LPX and the segment prepared data for an association line LLX is carried out at the memory 79 for depth [ inside / where the self-ship is cruising through various routes ] line data -- etc. -- the feature that depth line Ld11, Ld12, Ld13, etc. can be displayed now is acquired. therefore, new -- etc. -- since \*\*\*\*\* becomes unnecessary specially for making

a depth line in whether it is size, it means that the above-mentioned [2nd technical problem] was solved

[0265] [Deformation implementation] It includes this invention deforming as follows and carrying it out.

(1) Change and constitute the storage by memory parts other than memory 72 for processing in the composition of drawing 1, drawing 4, and drawing 6 so that it may memorize to the storage region which these memory parts were made to correspond and was classified into one memory.

[0266] (2) Prepare and constitute the heading measurement portion 15 in the composition of the 5th example and the 6th example by the composition of drawing 6.

(3) Remove and constitute the heading measurement portion 15 in the composition of the 5th example and the 6th example by the composition of drawing 6.

[0267] (4) Arrange and constitute a part for the setting control unit 60 in the 3rd operation - the composition of the 6th example in the lower part side of the display screen 81.

(5) Add and constitute a part for a control unit required for operation and the "grade depth line" key 69Y as a shoal-of-fish detection device [ in / for a part for the setting control unit 60 / a part for the setting control unit of drawing 21 (60 +32) ] in a part for a setting control unit 60 like drawing 17 in the composition of the above (4).

[0268] (6) Replace with the water depth data of 30a in the composition of drawing 4 and drawing 6, and constitute so that the depth of water in which the transducer 35 of the water depth measurement portion 30 is formed, i.e., the data which added the value of the depth from the water surface to the transducer 35 to the water depth data of 30a, may be used as data of a water depth value.

[0269]

[Effect of the Invention] it will obtain, if distance until it arrives at a front water depth situation and the ocean space of the depth of water made into the purpose rather than a self-ship position, even if it is not a case in the cruise state where a past wake behind a sailing ship is followed, when predetermined operation is performed above like according to this invention etc. can be known, and the feature is acquired.

[0270] Moreover, by setting up the water depth value of a depth line, such as wanting to newly create, by predetermined operation a depth line -- while the self-ship is cruising through various routes, accumulation storage is carried out and the data for creating the \*\*\*\*\* considers it as the purpose -- can be displayed now -- etc. -- there are effects -- the feature that \*\*\*\*\* becomes unnecessary in whether it is the size for creating a depth line is acquired.

---

#### [Brief Description of the Drawings]

Drawing 1 - drawing 12 show this example of working of an invention among Drawings, and drawing 13 - drawing 21 show the conventional technology, and the contents of each figure are as follows.

[Drawing 1] Whole block diagram

[Drawing 2] Important section display block diagram

[Drawing 3] Important section control processing block diagram

[Drawing 4] Whole block diagram

[Drawing 5] Important section control processing block diagram

[Drawing 6] Whole block diagram

[Drawing 7] Important section display block diagram

[Drawing 8] Important section storage block diagram

[Drawing 9] Important section control processing block diagram

[Drawing 10] Important section display block diagram

[Drawing 11] Important section storage block diagram

[Drawing 12] Important section control processing block diagram

[Drawing 13] Whole block block diagram  
[Drawing 14] Whole concrete composition perspective view  
[Drawing 15] Important section concrete composition front view  
[Drawing 16] Important section display block diagram  
[Drawing 17] Important section concrete composition front view  
[Drawing 18] Whole block block diagram  
[Drawing 19] Whole concrete composition perspective view  
[Drawing 20] Whole concrete composition perspective view  
[Drawing 21] Important section concrete composition front view  
[Explanations of letters or numerals]  
10 Position Measurement Portion  
20 A Part for Cruise Related Information Display  
10a Self-ship position  
10b The degree of self-vessel speed  
10c The direction of a present progressive  
15 Heading Measurement Portion  
15a The direction of a bow  
30 Water Depth Measurement Portion  
30a Depth of water  
31 Display Screen  
31d The present depth of water  
32 A Part for Setting Control Unit  
35 Transducer  
60 A Part for Setting Control Unit  
60a Setpoint signal  
61 Screen Selection Operation Portion  
62 A Part for Setting Control Units, Such as Destination  
62A "Menu" key  
62B "Destination" key  
62C "\*\*\*\*\*" key  
62D "Cancellation" key  
62F "Determination" key  
62G "Navigation change" key  
62H "Cursor" key  
62J "Return" key  
62X A part for setting control units, such as a destination  
63 A Part for Wake-behind-a-Sailing-Ship Setting Control Unit  
63X A part for a wake-behind-a-sailing-ship setting control unit  
63A "Wake-behind-a-sailing-ship color" change-over switch  
63B Wake-behind-a-sailing-ship "storage" key  
63C Wake-behind-a-sailing-ship "call" key  
63D Wake-behind-a-sailing-ship "\*\*\*/\*\* (ON/OFF)" key  
63E Wake-behind-a-sailing-ship "elimination" key  
64 A Part for Mark Setting Control Unit  
64A "Mark color" change-over switch  
64B-64E "Mark" key  
64F "Mark elimination" key  
65 A Part for Setting Control Units, Such as Numeric Value  
66 A Part for Screen Setting Control Unit  
66 A Part for Screen Setting Control Unit  
66A-66C "Scale rate" key  
66D Expansion" "key"  
66C "Central" key  
66F "Reduction" key  
66X A part for a picture setting control unit  
67 A Part for Setting Control Units, Such as Power Supply  
67B "Power supply" key  
67C "Brightness" key

68 A Part for Arbitrary Directional Movement Control Unit  
69 A Part for Setting Control Units, Such as Cursor  
69X "Front sea bed" key  
69Y "Grade depth line" key  
70 Cruise Data Processing Division Portion  
70A CPU  
71A Input/output port  
71B Input/output port  
72 Memory for Processing  
73 Memory for Work  
74 Memory for Wake-behind-a-Sailing-Ship Data  
75 Memory for Maps  
76 Clock Circuit  
77 Water Depth Memory for Data  
78 Memory for Front Sea Bed Data  
80 Display-Processing Portion  
80A CPU  
81 Display Screen  
82 Picture Element Memory  
82X Cruise related display image  
82Y Sea bed cross-section picture  
83 Memory for Processing  
84 Memory for Display Screens  
90 File Memory Portion  
91 Input/output Port  
100 Navigation Equipment  
B1 Distance width  
B1a Distance width  
CP Named point  
CLX-CLY Cursor line  
CR1 Self-ship wake behind a sailing ship  
CR2 Past wake behind a sailing ship  
EV1andEV2 Consideration point  
JP1 Destination point  
Ld etc. -- depth line  
L1-L5 Route line  
Ld1-Ld5 etc. -- depth line  
Ld 11-13 Depth lines, such as creation/  
LX Latitude  
LY Meridian lines  
M1 Coastline  
P1-P4 Direction changed part  
P21-P26 Intersection position  
RT1 Plan wake behind a sailing ship  
theta 1 Course gap

---

[Drawing 1]

〔全体ブロック構成〕

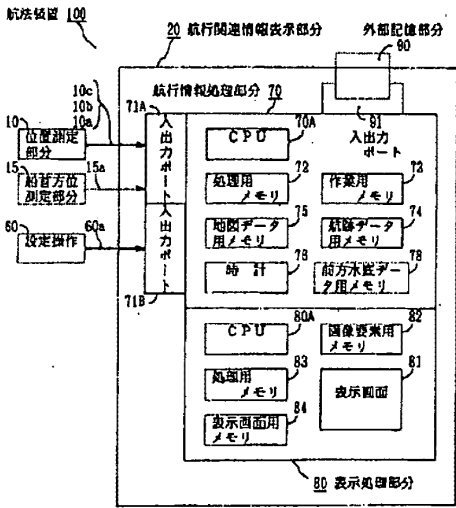

〔Drawing 2〕

〔要部表示構成〕

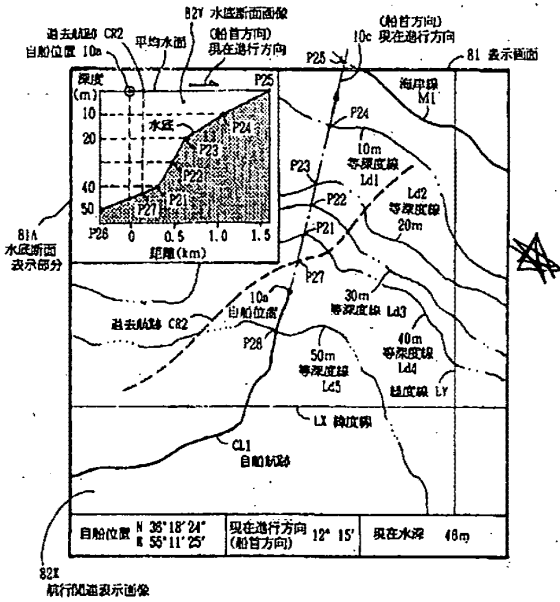

〔Drawing 3〕



〔要部制御処理構成〕

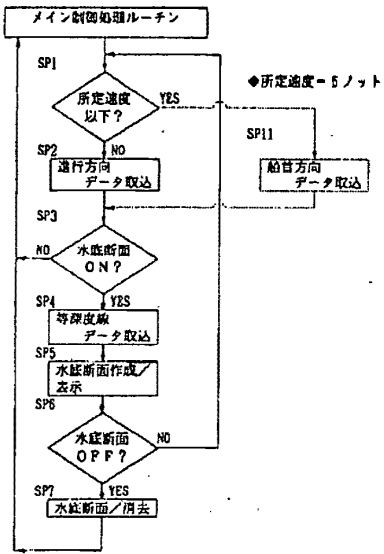

〔Drawing 4〕  
〔全体ブロック構成〕

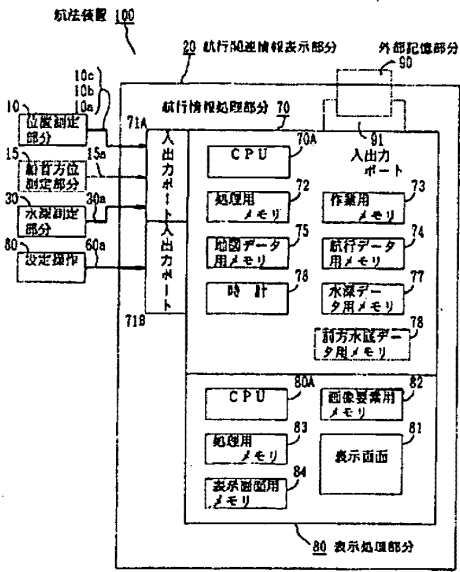

〔Drawing 5〕

(要部制御処理構成)

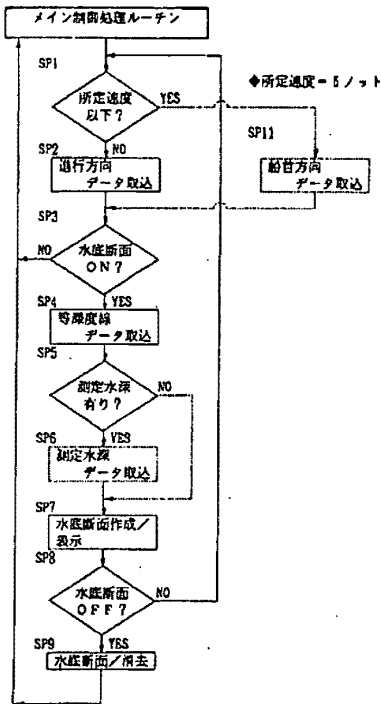

[Drawing 6]  
[全体ブロック構成]

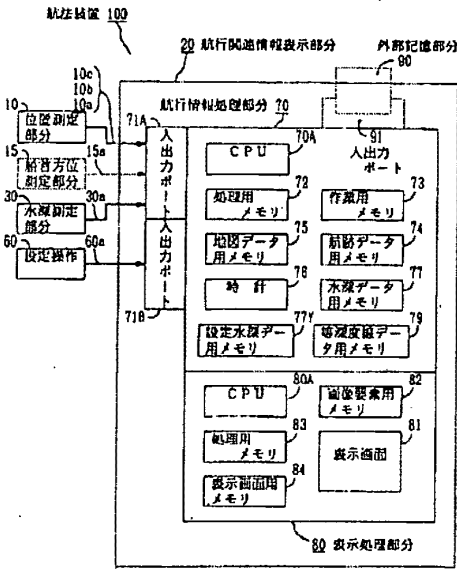

[Drawing 7]

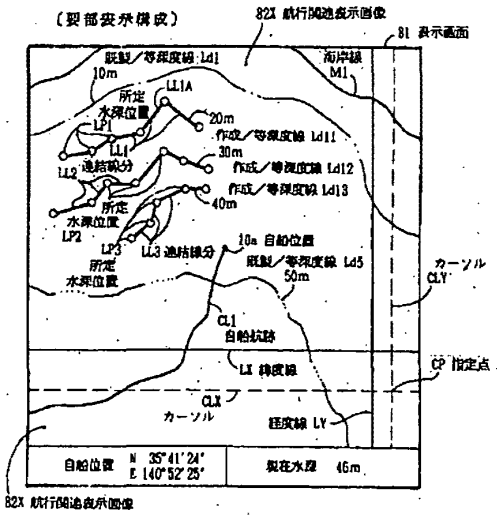

[Drawing 8]

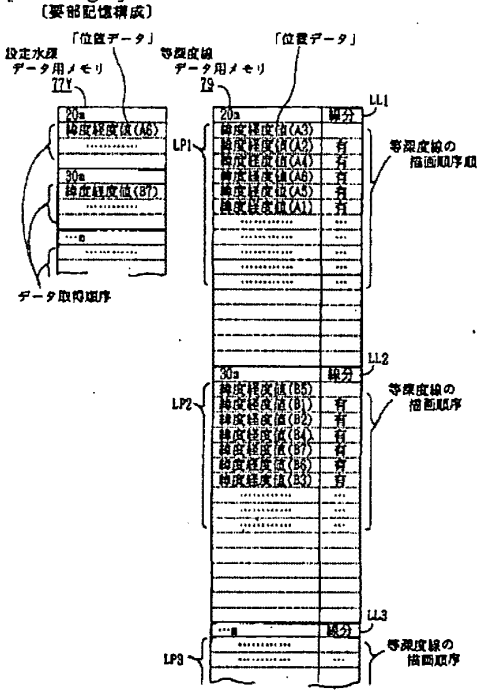

[Drawing 9]

(要部制御処理構成)

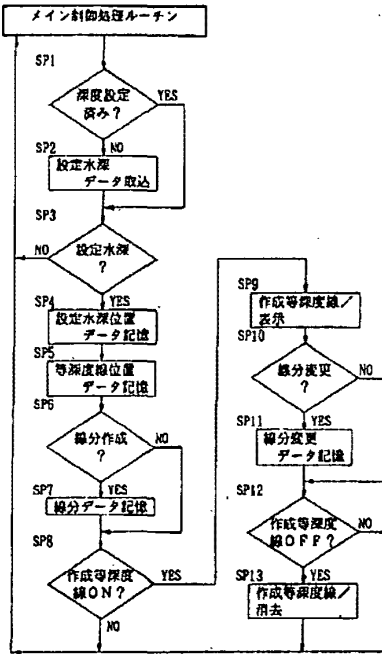

[Drawing 10]  
(要部表示構成)

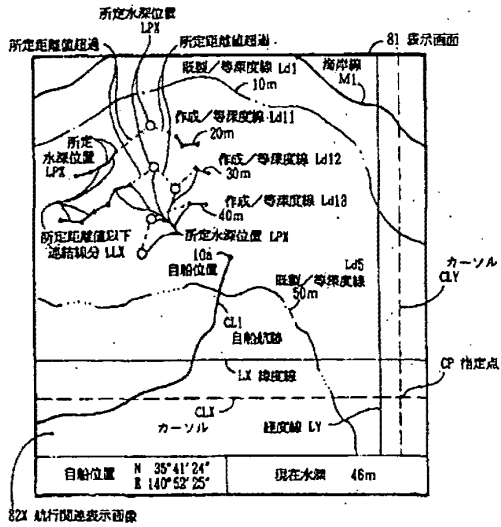

(線分変更構成)

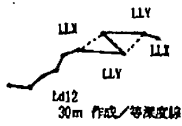

[Drawing 11]

Search Result

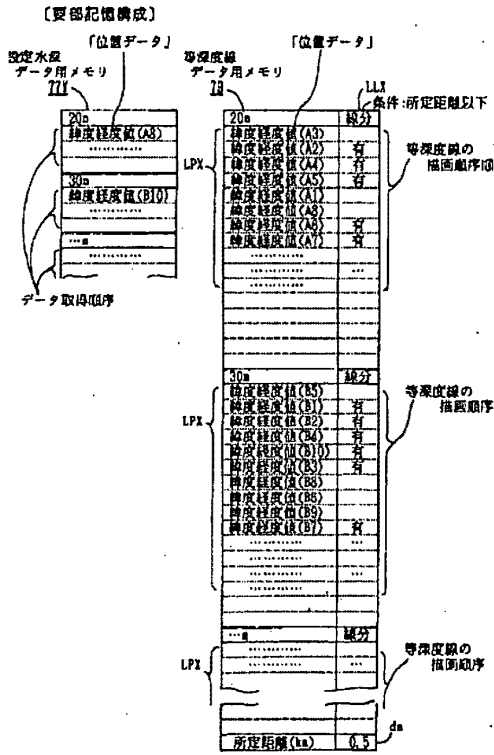

[Drawing 12]  
〔要部制御処理構成〕

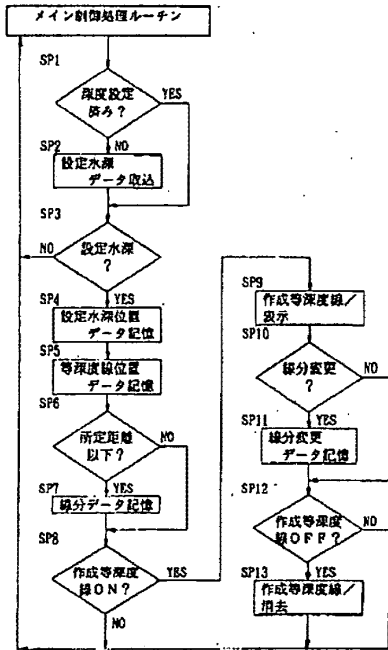

[Drawing 13]

Search Result

(全体ブロック構成)

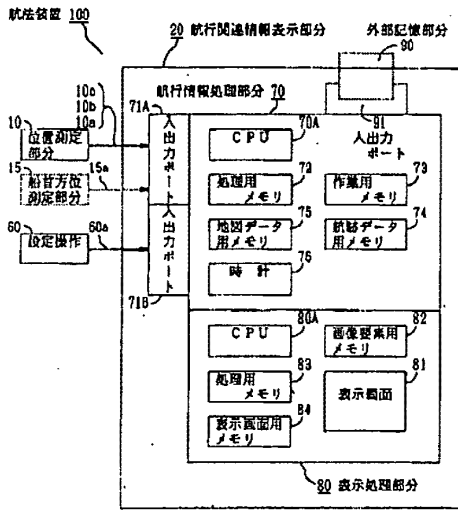

[Drawing 14]

(全体具体構成/斜視)

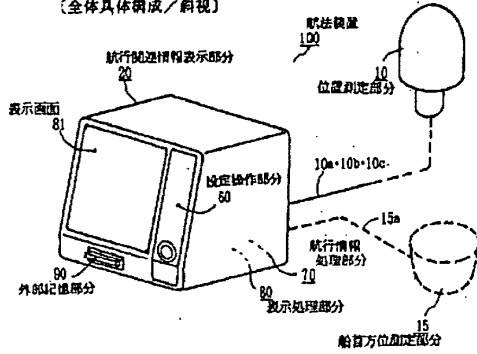

[Drawing 15]

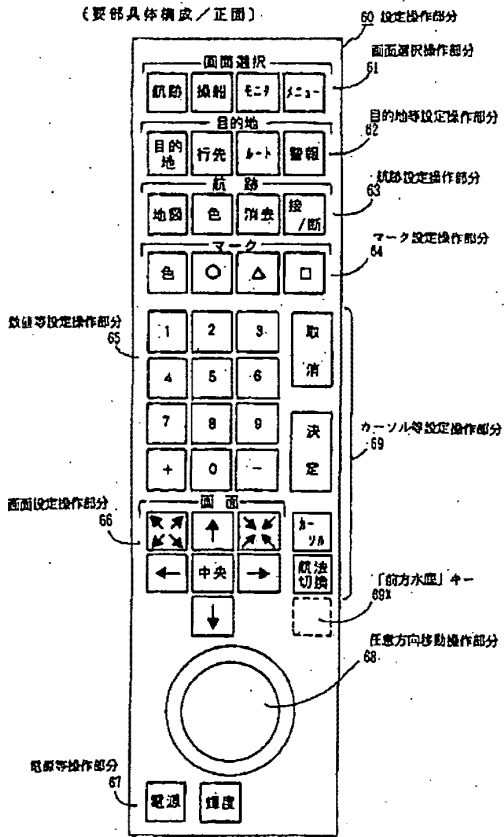

[Drawing 16]

(要部表示構成)

(遠路ずれ表示構成)

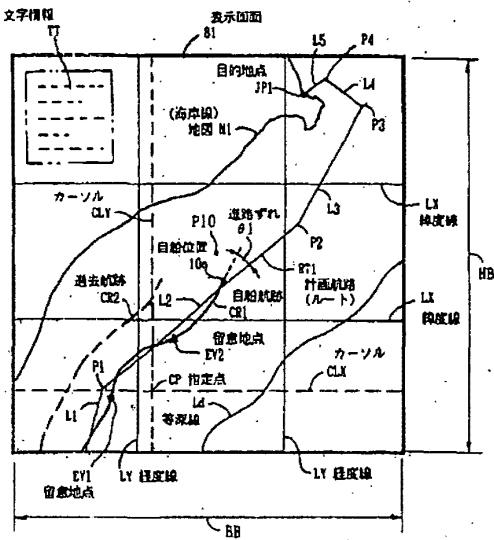

(距離補ずれ表示構成)

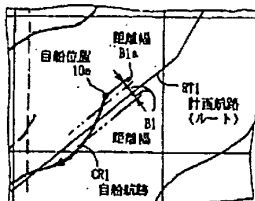

[Drawing 17]

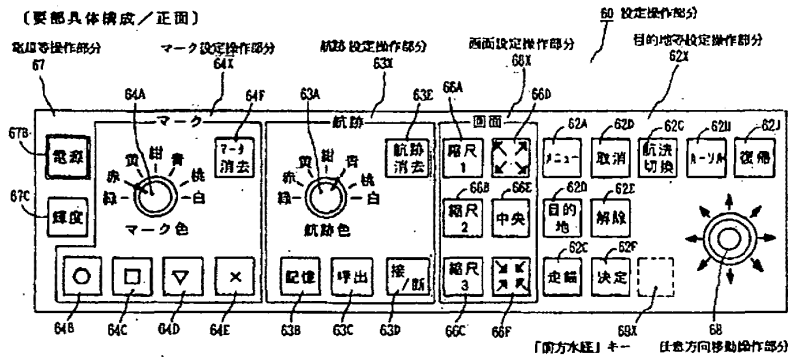

[Drawing 18]

(全体ブロック構成)

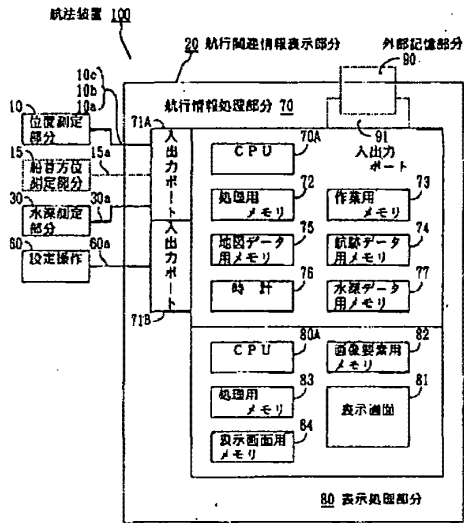

[Drawing 19]

(全体具体構成/斜視)

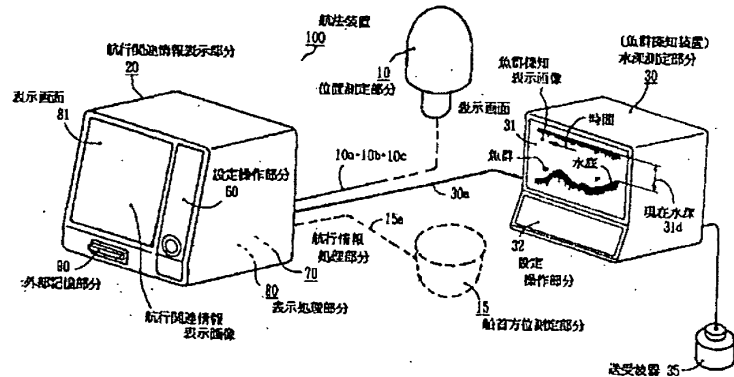

[Drawing 20]



Search Result

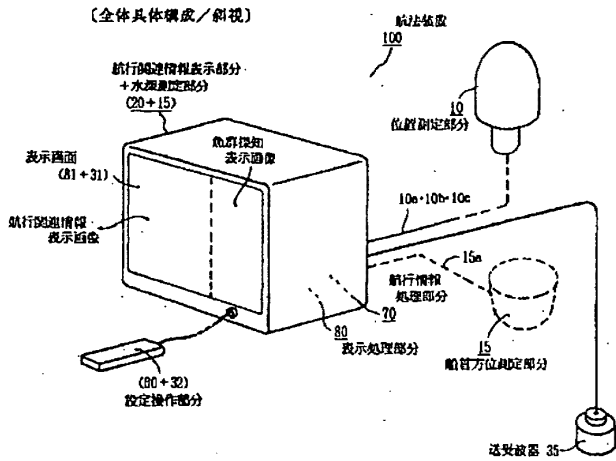

[Drawing 21]

【要部具体構成／正面】

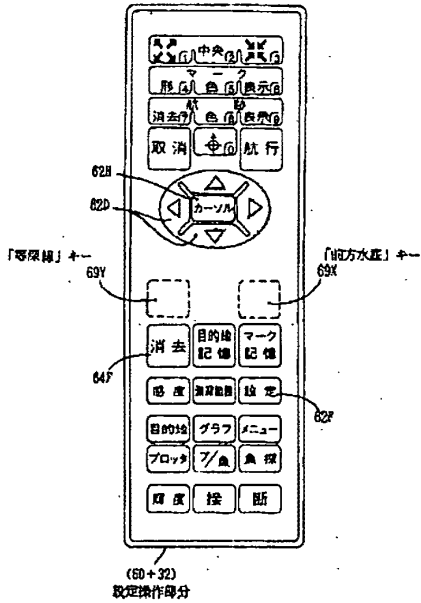

[Translation done.]

Report Mistranslation

Japanese (whole document in PDF)

<b>Issue Classification</b> 	Application/Control No.	Applicant(s)/Patent under Reexamination	
	10/667,026	KABEL ET AL.	
	Examiner	Art Unit	
	Jennifer A. Mehmood	2612	

ISSUE CLASSIFICATION										
ORIGINAL					CROSS REFERENCE(S)					
CLASS	SUBCLASS				CLASS	SUBCLASS (ONE SUBCLASS PER BLOCK)				
340	984				701	21	301			
INTERNATIONAL CLASSIFICATION										
B	6	0	L	3/00						
G	0	D	5	1/00						
G	0	6	F	7/00						
G	0	8	B	23/00						
G	0	6	F	17/10						

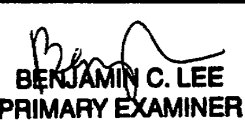
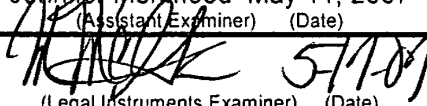
Jennifer Mehmood May 11, 2007 (Assistant Examiner) (Date)	 <b>BENJAMIN C. LEE</b> PRIMARY EXAMINER (Primary Examiner)	Total Claims Allowed: 50				
 (Legal Instruments Examiner) (Date)	5/14/07 (Date)	<table border="1" style="width: 100%;"> <tr> <td style="width: 50%;">O.G. Print Claim(s)</td> <td style="width: 50%;">O.G. Print Fig.</td> </tr> <tr> <td style="text-align: center;">1</td> <td style="text-align: center;">4A</td> </tr> </table>	O.G. Print Claim(s)	O.G. Print Fig.	1	4A
O.G. Print Claim(s)	O.G. Print Fig.					
1	4A					

<input checked="" type="checkbox"/> Claims renumbered in the same order as presented by applicant												<input type="checkbox"/> CPA		<input type="checkbox"/> T.D.		<input type="checkbox"/> R.1.47	
Final	Original	Final	Original	Final	Original	Final	Original	Final	Original	Final	Original	Final	Original	Final	Original		
	1		31		61		91		121		151		181		210		
	2		32		62		92		122		152		182				
	3		33		63		93		123		153		183				
	4		34		64		94		124		154		184				
	5		35		65		95		125		155		185				
	6		36		66		96		126		156		186				
	7		37		67		97		127		157		187				
	8		38		68		98		128		158		188				
	9		39		69		99		129		159		189				
	10		40		70		100		130		160		190				
	11		41		71		101		131		161		191				
	12		42		72		102		132		162		192				
	13		43		73		103		133		163		193				
	14		44		74		104		134		164		194				
	15		45		75		105		135		165		195				
	16		46		76		106		136		166		196				
	17		47		77		107		137		167		197				
	18		48		78		108		138		168		198				
	19		49		79		109		139		169		199				
	20		50		80		110		140		170		200				
	21		51		81		111		141		171		201				
	22		52		82		112		142		172		202				
	23		53		83		113		143		173		203				
	24		54		84		114		144		174		204				
	25		55		85		115		145		175		205				
	26		56		86		116		146		176		206				
	27		57		87		117		147		177		207				
	28		58		88		118		148		178		208				
	29		59		89		119		149		179		209				
	30		60		90		120		150		180		210				

**Search Notes**



Application No.

10/667,026

Applicant(s)

KABEL ET AL.

Examiner

Jennifer A Mehmood

Art Unit

2612

**SEARCHED**

Class	Subclass	Date	Examiner
340	686.6 995.1 984 985 851 539.13	12/28/2005	JS
340	539.2 961	12/28/2005	JS
340	539.22	12/28/2005	JS
340	7.56	12/28/2005	JS
340	825.36	12/28/2005	JS
340	995.11	12/28/2005	JS
367	909	12/28/2005	JS
342	357.13 41	12/28/2005	JS
701	21 201	12/28/2005	JS
701	301	12/28/2005	JS
340	850 851	9/27/2005	JS
367	87-116	4/21/2006	JM
701	211	7/25/2006	JM

**INTERFERENCE SEARCHED**

Class	Subclass	Date	Examiner
340	984	5/11/2007	JM
701	21 301	5/11/2007	JM

**SEARCH NOTES  
(INCLUDING SEARCH STRATEGY)**

	DATE	EXMR
Brent Swartout	1/5/2005	JS
East Search	12/28/2004	JS
Brent Swartout	5/24/2005	JS
Updated Search	5/20/2005	JS
Updated Search	9/27/2005	JS
Updated Search	12/27/2005	JS
Updated Search	4/21/2006	JM
Updated Search	7/25/2006	JM

*updated search*

*Jeff Johnson*

*5/9/2007 jm*

*5/8/2007 jm*

## EAST Search History

Ref #	Hits	Search Query	DBs	Default Operator	Plurals	Time Stamp
L1	533	"4646244" "5339085" "5470233" "5592382" "5684476" "5872526" "5999882" "6055478" "6198428" "6199015" "6279851" "6314370" "6356837" "6385538" "6401038" "6421603" "6469664" "6556206" "6574551" "6653947"	US-PGPUB; USPAT; USOCR	OR	ON	2007/05/11 10:08
L2	0	("4646244""5339085""5470233""559 2382""5684476""5872526""5999882 ""6055478""6198428""6199015""627 9851""6314370""6356837""6385538 ""6401038""6421603""6469664""655 6206""6574551""6653947").PN.	US-PGPUB; USPAT; EPO; JPO; DERWENT; IBM_TDB	OR	OFF	2007/05/11 10:59
L3	2	("2002288800").PN.	US-PGPUB; USPAT; EPO; JPO; DERWENT; IBM_TDB	OR	OFF	2007/05/11 10:59
S13 1	4	340/984-987.ccls. and (waypoint (way near3 point) (point near5 course)) and (water near5 (depth deep heigth))	US-PGPUB; USPAT; EPO; JPO; DERWENT	OR	ON	2007/04/26 09:07
S13 2	0	"6734808".pn. and "4590"	US-PGPUB; USPAT; EPO; JPO; DERWENT	OR	ON	2007/04/25 14:38
S13 3	1	"6734808".pn. and "4560"	US-PGPUB; USPAT; EPO; JPO; DERWENT	OR	ON	2007/04/25 14:38
S13 4	12	340/984-996.ccls. and (waypoint (way near3 point) (point near5 course)) and (water near5 (depth deep heigth))	US-PGPUB; USPAT; EPO; JPO; DERWENT	OR	ON	2007/04/26 11:54
S13 5	9	701/21.ccls. and (waypoint (way near3 point) (point near5 course)) and (water near5 (depth deep heigth))	US-PGPUB; USPAT; EPO; JPO; DERWENT	OR	ON	2007/04/26 10:10
S13 6	29	701/200-226,300-302.ccls. and (waypoint (way near3 point) (point near5 course)) and (water near5 (depth deep heigth))	US-PGPUB; USPAT; EPO; JPO; DERWENT	OR	ON	2007/04/26 10:37
S13 7	7	"5786849".uref.	US-PGPUB; USPAT; EPO; JPO; DERWENT	OR	ON	2007/04/26 10:36

## EAST Search History

S138	9	"6181302".uref.	US-PGPUB; USPAT; EPO; JPO; DERWENT	OR	ON	2007/04/26 10:36
S139	19	701/200-226,300-302.ccls. and (topograph\$4 and (water near5 (depth deep heighth)))	US-PGPUB; USPAT; EPO; JPO; DERWENT	OR	ON	2007/04/26 10:37
S140	8	340/984-996.ccls. and (topograph\$4 and (water near5 (depth deep heighth)))	US-PGPUB; USPAT; EPO; JPO; DERWENT	OR	ON	2007/04/26 10:47
S141	20	"342".clas. and (waypoint (way near3 point) (point near5 course)) and (water near5 (depth deep heighth))	US-PGPUB; USPAT; EPO; JPO; DERWENT	OR	ON	2007/04/26 12:28
S142	25	"342".clas. and (topograph\$4 and (water near5 (depth deep heighth)))	US-PGPUB; USPAT; EPO; JPO; DERWENT	OR	ON	2007/04/26 11:03
S143	4	(navigat\$4 and (waypoint (way near3 point)) and (indicat\$4 highlight\$3 (high near3 light\$4) emphasiz\$4 color\$4 bright\$4 illuminat\$4) near15 (water near5 (depth deep heighth)))	US-PGPUB; USPAT; EPO; JPO; DERWENT	OR	ON	2007/04/26 11:44
S144	32	(navigat\$4 and (point near5 (path course track destination end)) and (indicat\$4 highlight\$3 (high near3 light\$4) emphasiz\$4 color\$4 bright\$4 illuminat\$4) near15 (water near5 (depth deep heighth)))	US-PGPUB; USPAT; EPO; JPO; DERWENT	OR	ON	2007/04/26 11:23
S145	126	(navigat\$4 and (point near5 (path course)) and (water near5 (depth deep heighth)))	US-PGPUB; USPAT; EPO; JPO; DERWENT	OR	ON	2007/04/26 11:24
S146	583	((((high near3 light\$4) emphasiz\$4 color\$4 bright\$4 illuminat\$4) near15 (water near5 (depth deep heighth))))	US-PGPUB; USPAT; EPO; JPO; DERWENT	OR	ON	2007/04/26 11:46
S147	236	S146 and (ocean vessel ship sea marine cartograph\$4 navigat\$4 boat barge)	US-PGPUB; USPAT; EPO; JPO; DERWENT	OR	ON	2007/04/26 12:25
S148	19	S146 and (navigat\$4 and (ocean vessel ship sea marine cartograph\$4 navigat\$4 boat barge))	US-PGPUB; USPAT; EPO; JPO; DERWENT	OR	ON	2007/04/26 11:48

## EAST Search History

S149	490	((waypoint (way near3 point) (point near5 course)) and (water near5 (depth deep heigth)))	US-PGPUB; USPAT; EPO; JPO; DERWENT	OR	ON	2007/04/26 12:27
S150	924	((waypoint (way near3 point) (point near5 (course path))) and (water near5 (depth deep heigth)))	US-PGPUB; USPAT; EPO; JPO; DERWENT	OR	ON	2007/04/26 11:55
S151	296	((waypoint (way near3 point)) and (water near5 (depth deep heigth)))	US-PGPUB; USPAT; EPO; JPO; DERWENT	OR	ON	2007/04/26 12:15
S152	2	"6798378".pn.	US-PGPUB; USPAT; EPO; JPO; DERWENT	OR	ON	2007/04/26 12:15
S153	1	"20030200026".PN.	US-PGPUB	OR	ON	2007/04/26 12:16
S154	1	"20030176798".PN.	US-PGPUB	OR	ON	2007/04/26 12:16
S155	1	"20020017989".PN.	US-PGPUB	OR	ON	2007/04/26 12:16
S156	1	"20010049470".PN.	US-PGPUB	OR	ON	2007/04/26 12:16
S157	1	"6549756".PN.	USPAT; USOCR	OR	ON	2007/04/26 12:16
S158	1	"6542121".PN.	USPAT; USOCR	OR	ON	2007/04/26 12:17
S159	1	"6529827".PN.	USPAT; USOCR	OR	ON	2007/04/26 12:17
S160	1	"6198394".PN.	USPAT; USOCR	OR	ON	2007/04/26 12:17
S161	1	"5210540".PN.	USPAT; USOCR	OR	ON	2007/04/26 14:15
S162	1	"6611737".pn. and (depth deep)	US-PGPUB; USPAT; EPO; JPO; DERWENT	OR	ON	2007/04/26 12:25
S163	573	(display\$4 near8 (water near5 (depth deep heigth)))	US-PGPUB; USPAT; EPO; JPO; DERWENT	OR	ON	2007/04/26 12:28
S164	22	S163 and (waypoint (way near3 point) ((point path) near5 course))	US-PGPUB; USPAT; EPO; JPO; DERWENT	OR	ON	2007/04/26 12:37

## EAST Search History

S16 5	4	"4428052".pn.	US-PGPUB; USPAT; EPO; JPO; DERWENT	OR	ON	2007/04/26 12:32
S16 6	31	"4428052".uref.	US-PGPUB; USPAT; EPO; JPO; DERWENT	OR	ON	2007/04/26 12:35
S16 7	46	"4590569".uref.	US-PGPUB; USPAT; EPO; JPO; DERWENT	OR	ON	2007/04/26 12:35
S16 8	71	S163 and navigat\$4	US-PGPUB; USPAT; EPO; JPO; DERWENT	OR	ON	2007/04/26 12:37
S16 9	1	"4590569".PN.	USPAT; USOCR	OR	ON	2007/04/26 14:16
S17 0	46	"4590569".uref.	USPAT; USOCR	OR	ON	2007/04/26 14:16
S17 1	31	"4428052".uref.	USPAT; USOCR	OR	ON	2007/04/26 14:16

IN THE UNITED STATES PATENT AND TRADEMARK OFFICE

Application of:	)	Group Art Unit No. 2636
	)	
KABEL, Darrin W.	)	Examiner: MEHMOOD, J.
	)	
Serial No.: 10/667,026	)	Confirmation No.: 9123
	)	
Filed: 09/18/2003	)	Customer No.: 38933
	)	
	)	Docket No. 702.254

Commissioner of Patents  
P.O. Box 1450  
Alexandria, VA 22313-1450

Sir:

INFORMATION DISCLOSURE STATEMENT

Transmitted herewith is a list on Form PTO-1449 of patents, publications, or other information submitted by the applicants for consideration by the Office pursuant to the duty of disclosure under 37 CFR 1.56, together with legible copies of any non-patent or foreign patent publications to the extent clean copies are available.

The USPTO is authorized to charge the \$180.00 fee required by 37 C.F.R §1.17(p) to our deposit account number 501-791. Further, any additional fees which might be due in connection with the disclosure statement should be applied to our deposit account number 501-791.

It is respectfully submitted that the present invention as claimed is patentable over the listed references.

Respectfully submitted,

By         /David L. Terrell/          
David L. Terrell, Reg. No. 50,576  
Garmin International, Inc.  
1200 East 151st Street  
Olathe, KS 66062  
(913) 397-8200  
(913) 397-9079 - Facsimile



<b>FORM PTO-1449 (Rev. 2-32)</b>  <b>U.S. DEPARTMENT OF COMMERCE          PATENT AND TRADEMARK OFFICE</b>  <b>INFORMATION DISCLOSURE STATEMENT          BY APPLICANT</b>	<b>ATTORNEY DOCKET NO.: 702.254</b>	<b>SERIAL NUMBER: 10/667,026</b>	
	<b>APPLICANT: KABEL, Darrin W.</b>		
	<b>FILING DATE: 09/18/2003</b>	<b>GROUP: 2636</b>	<b>CONF. NO.: 9123</b>

### U.S. PATENT DOCUMENTS

EXAM. INITIAL	DOCUMENT NUMBER	INVENTOR NAME	CLASS	SUB-CLASS	ISSUE DATE (PATENT); PUBLICATION DATE (PUBLISHED APPLICATION); OR FILING DATE (NON-PUBLISHED APPLICATION)
	4646244	Bateman et al.	364	461	02/24/1987
	5339085	Katoh et al.	342	180	08/16/1994
	5470233	Fruchterman et al.	434	112	11/28/1995
	5592382	Colley	701	207	01/1997
	5684476	Anderson	340	988	11/1997
	5872526	Tognazzini	340	961	02/1999
	5999882	Simpson et al.	702	003	12/07/1999
	6055478	Heron	701	213	04/2000
	6198428	Sekine	342	176	03/06/2001
	6199015	Curtwright et al.	701	213	03/06/2001
	6279851	Huss et al.	244	3.15	08/28/2001
	6314370	Curtright	701	213	11/06/2001
	6356837	Yokota et al.	701	208	02/12/2002
	6385538	Yokota	701	211	05/07/2002
	6401038	Gia	701	301	06/04/2002
	6421603	Pratt et al.	701	206	07/16/2002
	6469664	Michaelson et al.	342	357.13	10/22/2002
	6556206	Benson et al.	345	473	04/29/2003
	6574551	Maxwell et al.	701	209	06/03/2003
	6653947	Dwyer et al.	340	970	11/25/2003
	6665630	Wei et al.	702	155	12/16/2003
	6750815	Michaelson et al.	342	357.13	06/15/2004
	6862501	He	701	003	03/01/2005

EXAM. INITIAL	DOCUMENT NUMBER	INVENTOR NAME	CLASS	SUB-CLASS	ISSUE DATE (PATENT); PUBLICATION DATE (PUBLISHED APPLICATION); OR FILING DATE (NON-PUBLISHED APPLICATION)
	7035166	Zimmerman et al.	367	88	04/25/2006

**FOREIGN PATENT DOCUMENTS**

EXAM. INITIAL	DOCUMENT NUMBER	PUBLICATION DATE	COUNTRY OR PATENT OFFICE	CLASS	SUB-CLASS	TRANSLATION	
						YES	NO

**OTHER DOCUMENTS (Including Publisher, Author, Title, Date, Relevant Pages, and Place of Publication)**

	C-Series Display Reference Manual, Raymarine UK, March 2006.
	GPSMAP 3600C/3010C Color Chartplotter, Garmin Ltd., 2004.
	GPSMAP 206/2010 Chartplotters Owner's Manual and Reference Guide, Garmin Ltd., 2001.

EXAMINER	DATE CONSIDERED
EXAMINER: Initial citation if reference was considered. Draw line through citation if not in conformance to MPEP 609 and not considered. Include copy of this form with next communication to applicant.	

## Electronic Patent Application Fee Transmittal

<b>Application Number:</b>	10667026			
<b>Filing Date:</b>	18-Sep-2003			
<b>Title of Invention:</b>	Methods, systems, and devices for cartographic alerts			
First Named Inventor/Applicant Name:	Darrin W. Kabel			
<b>Filer:</b>	David L. Terrell/Christine Terrell			
<b>Attorney Docket Number:</b>	702.254			
Filed as Large Entity				
<b>Utility Filing Fees</b>				
<b>Description</b>	<b>Fee Code</b>	<b>Quantity</b>	<b>Amount</b>	<b>Sub-Total in USD(\$)</b>
<b>Basic Filing:</b>				
<b>Pages:</b>				
<b>Claims:</b>				
<b>Miscellaneous-Filing:</b>				
<b>Petition:</b>				
<b>Patent-Appeals-and-Interference:</b>				
Post-Allowance-and-Post-Issuance:				
<b>Extension-of-Time:</b>				

Description	Fee Code	Quantity	Amount	Sub-Total in USD(\$)
<b>Miscellaneous:</b>				
Submission- Information Disclosure Stmt	1806	1	180	180
<b>Total in USD (\$)</b>				<b>180</b>

## Electronic Acknowledgement Receipt

<b>EFS ID:</b>	1762854
<b>Application Number:</b>	10667026
<b>International Application Number:</b>	
<b>Confirmation Number:</b>	9123
<b>Title of Invention:</b>	Methods, systems, and devices for cartographic alerts
<b>First Named Inventor/Applicant Name:</b>	Darrin W. Kabel
<b>Customer Number:</b>	38933
<b>Filer:</b>	David L. Terrell/Christine Terrell
<b>Filer Authorized By:</b>	David L. Terrell
<b>Attorney Docket Number:</b>	702.254
<b>Receipt Date:</b>	10-MAY-2007
<b>Filing Date:</b>	18-SEP-2003
<b>Time Stamp:</b>	13:47:43
<b>Application Type:</b>	Utility

### Payment information:

Submitted with Payment	yes
Payment was successfully received in RAM	\$ 180
RAM confirmation Number	1839
Deposit Account	501791

The Director of the USPTO is hereby authorized to charge indicated fees and credit any overpayment as follows:  
Charge any Additional Fees required under 37 C.F.R. Section 1.16 and 1.17

### File Listing:

Document Number	Document Description	File Name	File Size(Bytes)	Multi Part /.zip	Pages (if appl.)
1	NPL Documents	RaymarineCSeriesReferenceManual.pdf	9703595	no	244
<b>Warnings:</b>					
<b>Information:</b>					
2	NPL Documents	GPSMAP2000SeriesOwnersManual.pdf	3036286	no	104
<b>Warnings:</b>					
The page size in the PDF is too large. The pages should be 8.5 x 11 or A4. If this PDF is submitted, the pages will be resized upon entry into the Image File Wrapper and may affect subsequent processing					
<b>Information:</b>					
3	NPL Documents	GPSMAP3000SeriesOwnersManual.pdf	6780522	no	130
<b>Warnings:</b>					
The page size in the PDF is too large. The pages should be 8.5 x 11 or A4. If this PDF is submitted, the pages will be resized upon entry into the Image File Wrapper and may affect subsequent processing					
<b>Information:</b>					
4	Information Disclosure Statement (IDS) Filed	IDStoPTOSupp.pdf	12523	no	1
<b>Warnings:</b>					
<b>Information:</b>					
This is not an USPTO supplied IDS fillable form					
5	Information Disclosure Statement (IDS) Filed	IDSForm1449Supp.pdf	22151	no	2
<b>Warnings:</b>					
<b>Information:</b>					
This is not an USPTO supplied IDS fillable form					
6	Fee Worksheet (PTO-06)	fee-info.pdf	8176	no	2
<b>Warnings:</b>					
<b>Information:</b>					
<b>Total Files Size (in bytes):</b>			19563253		

This Acknowledgement Receipt evidences receipt on the noted date by the USPTO of the indicated documents, characterized by the applicant, and including page counts, where applicable. It serves as evidence of receipt similar to a Post Card, as described in MPEP 503.

**New Applications Under 35 U.S.C. 111**

If a new application is being filed and the application includes the necessary components for a filing date (see 37 CFR 1.53(b)-(d) and MPEP 506), a Filing Receipt (37 CFR 1.54) will be issued in due course and the date shown on this Acknowledgement Receipt will establish the filing date of the application.

**National Stage of an International Application under 35 U.S.C. 371**

If a timely submission to enter the national stage of an international application is compliant with the conditions of 35 U.S.C. 371 and other applicable requirements a Form PCT/DO/EO/903 indicating acceptance of the application as a national stage submission under 35 U.S.C. 371 will be issued in addition to the Filing Receipt, in due course.

**New International Application Filed with the USPTO as a Receiving Office**

If a new international application is being filed and the international application includes the necessary components for an international filing date (see PCT Article 11 and MPEP 1810), a Notification of the International Application Number and of the International Filing Date (Form PCT/RO/105) will be issued in due course, subject to prescriptions concerning national security, and the date shown on this Acknowledgement Receipt will establish the international filing date of the application.

**IN THE UNITED STATES PATENT AND TRADEMARK OFFICE**

Application of:	)	
	)	
KABEL, DARRIN W.	)	Attorney Docket No.:
	)	702.254
Serial No.: 10/667,026	)	
	)	
Filed: September 18, 2003	)	Group Art Unit No. 2636
	)	
METHODS, SYSTEMS AND DEVICES	)	
FOR CARTOGRAPHIC ALERTS	)	Examiner: MEHMOOD, J.

**APPEAL BRIEF**



**IN THE UNITED STATES PATENT AND TRADEMARK OFFICE**

Application of:	)	
	)	
KABEL, DARRIN W.	)	Attorney Docket No.:
	)	702.254
Serial No.: 10/667,026	)	
	)	
Filed: September 18, 2003	)	Group Art Unit No. 2636
	)	
METHODS, SYSTEMS AND DEVICES	)	
FOR CARTOGRAPHIC ALERTS	)	Examiner: MEHMOOD, J.

Mail Stop Appeal Brief - Patents  
Commissioner for Patents  
P.O. Box 1450  
Alexandria, VA 22313-1450

**APPELLANT'S AMENDED BRIEF ON APPEAL**

In response to the Notification of Non-Compliant Appeal Brief dated January 17, 2007, Appellant's amended brief on Appeal in accordance with 37 C.F.R. § 41.37 is hereby submitted. The Examiner's rejections of claims 1, 5-10, 19-23, 27-34, and 38-67 are herein appealed, and allowance of said claims is respectfully requested.

The filing fee for the Appeal Brief was paid on December 13, 2006. The Commissioner is hereby authorized to charge any additional fees which may be required, or credit any overpayment, to Account No. 501-791.

Respectfully submitted,

By: /David L. Terrell/  
David L. Terrell, Reg. No. 50,576  
Garmin International, Inc.  
1200 East 151<sup>st</sup> Street  
Olathe, KS 66062  
(913) 397-8200  
(913) 397-9079 (Fax)

Following are the requisite statements under 37 C.F.R. § 41.37:

**I. Real Party in Interest**

Darrin W. Kabel and Steven J. Meyers are the inventors of the claimed invention. The inventors assigned the above-referenced application to Garmin Ltd., the Real Party in Interest.

**II. Related Appeals and Interferences**

There are no related appeals or interferences, known to the Appellants, which may directly affect or be directly affected by the Board's decision in the pending appeal.

**III. Status of Claims**

Claims 1, 5-10, 19-23, 27-34, and 38-67 stand rejected and appealed. Claims 2-4, 11-18, 24-26, and 35-37 have been canceled.

**IV. Status of Amendments**

All amendments submitted by the Appellant have been entered.

**V. Summary of Claimed Subject Matter**

The claimed embodiments of the present invention are directed at an aid to marine navigation. More specifically, the present invention displays, highlights, and/or calculates a

route in order to avoid obstacles, such as underwater sand bars, reef structure, and the like.

Claim 1 recites “A method for marine navigation, comprising: receiving one or more preselected conditions from a user”, as described on page 6, lines 6-20; “identifying a potential waypoint”, as described on page 16, lines 29-31, and shown as step 600 in Figure 6; and “performing a marine route calculation algorithm to route a course between a first location and the potential waypoint avoiding the preselected conditions, including analyzing cartographic data between the first location and the potential waypoint and re-routing the course to avoid the preselected conditions by identifying one or more non-user selected waypoints”, as described on page 8, lines 4-10, and shown as steps 610 and 620 in Figure 6, which is discussed on page 16, line 27, thru page 17, line 13.

Claim 19 recites “[a] method for marine navigation, comprising: receiving one or more preselected conditions from a user”, as described on page 6, lines 6-20; “receiving a user defined graphical filter area from the user”, as described on page 14, line 24, thru page 15, line 2, and shown as item 478 in Figure 4E; “identifying the user defined graphical filter area on a display”, as shown in Figure 4E; “analyzing cartographic data only within the user defined graphical filter area for the preselected conditions”, as shown in Figure 4E (It can be seen that the land is depicted as a dangerous preselected condition, only within the graphical filter area. The land outside the graphical filter area remains unaltered); and “providing an alert signal when cartographic data within the user defined graphical filter area indicate the preselected conditions”, as described on page 15, lines 3-10.

Claim 23 recites “[a] computer readable medium having a set of computer readable instructions, the set of computer readable instructions comprising instructions for: receiving one or more preselected conditions from a user”, as described on page 6, lines 6-20; “identifying a potential waypoint upon a first event”, as described on page 16, lines 29-31, and shown as step 600 in Figure 6; and “performing a marine route calculation algorithm to analyze a course between a first location and the potential waypoint avoiding the preselected conditions, including analyzing cartographic data between the first location and the potential waypoint and re-routing the course to avoid the preselected conditions by identifying one or more non-user selected waypoints”, as described on page 8, lines 4-10, and shown as steps 610 and 620 in Figure 6, which is discussed on page 16, line 27, thru page 17, line 13.

Claim 34 recites “[a]n electronic marine navigation device, comprising: a processor”, as described on page 5, line 27, thru page 6, line 5, and shown as item 310 in Figure 3; “a user interface operatively coupled to the processor, wherein the user interface receives one or more preselected conditions from a user”, as described on page 6, lines 6-20; “a location input operatively coupled to the processor, wherein the location input receives a first location and a potential waypoint separate from the first location”, as described on page 6, lines 21-31, and shown as item 320 in Figure 3; and “a memory operatively coupled to the processor and the location input, the memory having cartographic data including data related to the preselected conditions, wherein the processor operates on a marine route calculation algorithm to analyze a course between the first location and the

potential waypoint in view of the preselected conditions of the cartographic data and re-route the course to avoid the preselected conditions by identifying one or more non-user selected waypoints”, as described on page 6, lines 6-31; described on page 8, lines 4-10; and shown as steps 610 and 620 in Figure 6, which is discussed on page 16, line 27, thru page 17, line 13.

Claim 44 recites “[a] method for marine navigation, comprising: identifying a potential waypoint”, as described on page 16, lines 29-31, and shown as step 600 in Figure 6; and “performing a marine route calculation algorithm to analyze a course between a first location and the potential waypoint in order to avoid preselected conditions received from a user and re-route the course to avoid the preselected conditions by identifying one or more non-user selected waypoints”, as described on page 8, lines 4-10, and shown as steps 610 and 620 in Figure 6, which is discussed on page 16, line 27, thru page 17, line 13.

Claim 45 recites “[a] method for marine navigation, comprising: receiving indication of a minimum water depth from a user”, as described on page 6, lines 6-20; “identifying a potential waypoint”, as described on page 16, lines 29-31, and shown as step 600 in Figure 6; and “performing a marine route calculation algorithm to route a course between a first location and the potential waypoint avoiding water depth less than the minimum water depth by identifying one or more non-user selected waypoints”, as described on page 8, lines 4-10, and shown as steps 610 and 620 in Figure 6, which is discussed on page 16, line 27, thru page 17, line 13.

Claim 47 recites “[a] method for marine navigation, comprising: receiving indication

of a minimum water depth from a user”, as described on page 6, lines 6-20; “displaying marine cartographic data”, as described on page 12, lines 7-17, and shown as item 400 in Figure 4A; “receiving indication of a potential waypoint”, as described on page 16, lines 29-31, and shown as step 600 in Figure 6; “displaying a substantially straight line between a first location and the potential waypoint”, as described on page 16, lines 18-20, and shown as the line between items 410 and 414 in Figure 4A; “wherein the line depicts both where the water depth is expected to be greater than the minimum water depth and where the water depth is expected to be less than the minimum water depth, and wherein the line highlights where the water depth is expected to be less than the minimum water depth”, as described on page 16, lines 21-24, and shown as item 418 in Figure 4A; and “performing a marine route calculation algorithm to route a course between the first location and the potential waypoint avoiding water depth less than the minimum water depth”, as described on page 8, lines 4-10, and shown as steps 610 and 620 in Figure 6, which is discussed on page 16, line 27, thru page 17, line 13.

Claim 48 recites “[a] method for marine navigation, comprising: displaying marine cartographic data”, as described on page 12, lines 7-17, and shown as item 400 in Figure 4A; “receiving indication of a potential waypoint”, as described on page 16, lines 29-31, and shown as step 600 in Figure 6; “displaying a substantially straight line between a first location and the potential waypoint”, as described on page 16, lines 18-20, and shown as the line between items 410 and 414 in Figure 4A; “wherein the line distinguishes where the water depth is expected to be greater than a preset minimum water depth from where the

water depth is expected to be less than the minimum water depth”, as described on page 16, lines 21-24, and shown as item 418 in Figure 4A; and “performing a marine route calculation algorithm to route a course between the first location and the potential waypoint avoiding water depth less than the minimum water depth”, as described on page 8, lines 4-10, and shown as steps 610 and 620 in Figure 6, which is discussed on page 16, line 27, thru page 17, line 13.

Claim 54 recites “[a] method for marine navigation, comprising: displaying marine cartographic data”, as described on page 12, lines 7-17, and shown as item 400 in Figure 4A; “receiving indication of a potential waypoint”, as described on page 16, lines 29-31, and shown as step 600 in Figure 6; and “displaying a substantially straight line on the marine cartographic data between a first location and the potential waypoint”, as described on page 16, lines 18-20, and shown as the line between items 410 and 414 in Figure 4A; and “wherein the line highlights where the water depth is expected to be less than a minimum water depth”, as described on page 16, lines 21-24, and shown as item 418 in Figure 4A.

Thus, various claimed embodiments of the present invention provides an aid to marine navigation by displaying, highlighting, and or routing around obstacles, such as underwater sand bars, reef structure, and the like.

Appellants also note that the page and line numbers cited above are for reference purposes only and should not be taken as a limitation on the support for, or scope of, the claimed subject matter. Support for the claimed subject matter may be found throughout the specification and drawings and the page and line numbers cited above merely refer to

exemplary portions of the specification.

**VI. Grounds of Rejection to be Reviewed on Appeal**

- a. Claims 19, 20, and 22 stand rejected under 35 U.S.C. 102(b) as being anticipated Bailey et al., U.S. Patent No. 4,873,676.
- b. Claims 1, 5-10, 23, 27-32, 34, 38-40, 42-44, 58-61, 66, and 67 stand rejected under 35 U.S.C. 103(a) as being unpatentable over Fujimoto et al., U.S. Patent Application No. 2004/0006423 (Fujimoto '423) in view of Michaelson et al., U.S. Patent No. 6,734,808.
- c. Claims 45, 46, and 62 stand rejected under 35 U.S.C. 103(a) as being unpatentable over Fujimoto '423 and Michaelson in view of Walsh et al., U.S. Patent No. 3,886,487.
- d. Claims 47-57 and 63-65 stand rejected under 35 U.S.C. 103(a) as being unpatentable over Fujimoto et al., U.S. Patent Application No. 2004/0003958 (Fujimoto '958), in view of Fujimoto '423 and Michaelson.
- e. Claim 21 stands rejected under 35 U.S.C. 103(a) as being unpatentable over Bailey in view of Fujimoto '423.
- f. Claim 33 stands rejected under 35 U.S.C. 103(a) as being unpatentable over Fujimoto '423 and Michaelson, in view of Tobin Jr., U.S. Patent No. 4,323,992.



- g. Claim 41 stands rejected under 35 U.S.C. 103(a) as being unpatentable over Fujimoto '423 and Michaelson in view of Bailey.

Applicant appeals from these grounds of rejection.

## VII. Argument

### Anticipation

"A claim is anticipated only if each and every element as set forth in the claim is found, either expressly or inherently described, in a single prior art reference." MPEP § 2131, citing *Verdegaal Bros. v. Union Oil Co. of California*, 814 F.2d 628, 631, 2 USPQ2d 1051, 1053 (Fed. Cir. 1987). More specifically, "Federal Circuit decisions repeatedly emphasize that anticipation (lack of novelty) is established only if (1) all the elements of an invention, as stated in a patent claim, (2) are identically set forth, (3) in a single prior art reference". Chisum on Patents § 3.02. See *also* *Gechter v. Davidson*, 43 USPQ2d 1030, 1032 (Fed. Cir. 1997) ("Under 35 U.S.C. § 102, every limitation of a claim must identically appear in a single prior art reference for it to anticipate the claim.").

- a. **Rejection of claims 19, 20, and 22 under 35 U.S.C. 102(b) as being anticipated Bailey et al., U.S. Patent No. 4,873,676.**

#### I. Summary of Arguments

Rather than analyzing cartographic data only within a user defined area, Bailey

teaches analyzing sonar returns and automatically rescaling a user defined display area. Thus, Bailey cannot be said to teach, or even suggest, “analyzing cartographic data only within the user defined graphical filter area for the preselected conditions”, as claimed.

## **II. Summary of the Reference**

Bailey teaches a sonar apparatus. Bailey’s improvement over the prior art is his ability to detect the bottom and “change display scales in response to the detected bottom going off-scale”. Abstract. In other words, Bailey teaches rescaling a sonar display. It is important to note that Bailey does not teach cartographic data. Bailey’s only use of the term “map” is in association with a memory map, with is simply non-analogous to cartographic data.

## **III. The Examiner failed to establish a *prima facie* case of anticipation as the cited reference does not teach each claim limitation.**

Claim 19 recites “analyzing *cartographic* data *only* within the user defined graphical filter area for the preselected conditions”. The Examiner mistakenly asserts that this limitation is disclosed by Bailey in column 3, lines 26-36 and 46-48. Page 3 of the August 8, 2006 Final Office Action. However, column 3, lines 26-29 state “[a]utomatic display scale changing is provided in response to the detected bottom going off-scale, or in response to the detected bottom rising to within a predetermined depth”. Therefore, Bailey actually teaches a system for automatically *rescaling* a display area based on changing

water depth. In other words, rather than analyzing data only within a user defined area, Bailey teaches automatically redefining the user defined display area. In fact, the Examiner acknowledges “Bailey discloses an automatic display scale changing”. Page 14 of the August 8, 2006 Final Office Action. Thus, Bailey overrides any user definition of an area.

Furthermore, Bailey analyzes the entirety of his automatically redefined display area for target data or sonar returns. In fact, Bailey must analyze the entirety of the sonar returns for at least two reasons. First, the very nature of sonar is that one sends out a pulse and times the echo, thereby determining a distance to a target. Bailey’s sonar signals, by their very nature, must pass completely through a predefined space under a boat. This space is predefined by the transducer itself. In other words, the user simply cannot define where the sonar signals go, and therefore cannot define any area, and Bailey’s cannot analyze only a portion of the returns. Thus, one cannot analyze only a user defined area, one must analyze everything that is received. Second, Bailey must analyze all received signals in order to detect the bottom, which is of course, the entire point of Bailey’s invention. Thus, Bailey analyzes the entirety of the area. Bailey may only display some portion of that area, but, as discussed above, Bailey redefines the display area, based on the analyzed sonar returns from the entire area.

Finally, Bailey does not teach analyzing *cartographic* data. Rather, as discussed above, Bailey teaches analyzing sonar returns. This is an important distinction. They are simply not the same nor analogous to one another, as they convey distinctly different

information. Therefore, Bailey cannot be said to suggest “analyzing **cartographic** data **only** within the user defined graphical filter area for the preselected conditions” (emphasis added), as claimed. Thus, Bailey fails to disclose, suggest or make obvious “analyzing cartographic data only within the user defined graphical filter area for the preselected conditions” as claimed in claim 19. As a result, the Examiner has failed to properly establish a *prima facie* case of anticipation, and therefore the present rejections of claims 19, 20, and 22 cannot be sustained.

### **Obviousness**

Obviousness can be a problematic basis for rejection because the Examiner, in deciding that a feature is obvious, has the benefit of the applicant’s disclosure as a blueprint and guide. In contrast, one with ordinary skill in the art would have no such guide, in which light even an exceedingly complex solution may seem easy or obvious. Furthermore, once an obviousness rejection has been made, the applicant is in the exceedingly difficult position of having to prove a negative proposition (i.e., non-obviousness) in order to overcome the rejection.

For these reasons, the law places upon the Examiner the initial burden of establishing a *prima facie* case of obviousness. If the Examiner fails to establish the requisite *prima facie* case, the rejection is improper and will be overturned. *In re Rijckaert*, 9 F.3d 1531, 1532, 28 U.S.P.Q.2d 1955 (Fed. Cir. 1993). Only if the Examiner’s burden is met does the burden shift to the Applicant to provide evidence to refute the rejection.

In meeting this initial burden, the Examiner “cannot use hindsight reconstruction to pick and choose among isolated disclosures in the prior art to deprecate the claimed invention.” *In re Fine*, 837 F.2d 1071, 1075, 5 U.S.P.Q.2d 1596 (Fed. Cir. 1988). Thus, the Examiner is required to perform the “critical step” of casting his or her mind back to the time of invention, to consider the thinking of one of ordinary skill in the art, guided only by the prior art references and the then-accepted wisdom in the field. *See, e.g., W. L. Gore & Assoc., Inc. v. Garlock, Inc.*, 721 F.2d 1540, 1553, 220 U.S.P.Q. 303 (Fed. Cir. 1983).

Rejections on obviousness grounds also cannot be sustained by mere conclusory statements; instead, there must be some articulated reasoning with some rational underpinning to support the legal conclusion of obviousness. *In re Kahn*, 441 F.3d 977, 988, 78 U.S.P.Q.2d 1329 (Fed. Cir. 2006). The factual inquiry performed by the Examiner in issuing an obviousness rejection must be thorough and searching. *McGinley v. Franklin Sports, Inc.*, 262 F.3d 1339, 1351-52, 60 U.S.P.Q.2d 1001 (Fed. Cir. 2001). The prohibition against conclusory examination is as much rooted in the Administrative Procedure Act, which ensures due process and non-arbitrary decision-making, as it is in § 103. *In re Kahn*, 441 F.3d at 988.

Three criteria must be satisfied by the Examiner in order to establish a prima facie case of obviousness: (1) there must be some suggestion or motivation, either in the references themselves or in the knowledge generally available to one of ordinary skill in the art, to modify the reference or combine their teachings; (2) there must be a reasonable expectation of success; and (3) the combination of references must teach or suggest all

the claim limitations. See MPEP § 706.02(j), citing *In re Vaeck*, 947 F.2d 488, 493, 20 U.S.P.Q.2d 1438 (Fed. Cir. 1991). This "motivation-suggestion-teaching" requirement protects against the entry of hindsight into the obviousness analysis, a problem which § 103 was meant to confront. *In re Kahn*, 441 F.3d at 988.

Consequently, an Examiner's mere identification in the prior art of each individual element claimed is insufficient to defeat the patentability of a claimed invention without a proper suggestion to combine or modify the elements. *In re Rouffet*, 149 F.3d 1350, 1357, 47 U.S.P.Q.2d 1453 (Fed. Cir. 1998). The fact that references can be combined or modified does not render the resultant combination obvious unless the prior art also suggests the desirability of the combination. *In re Gordon*, 733 F.2d 900, 902, 221 USPQ 1125 (Fed. Cir. 1984).

In presenting the suggestion or motivation to combine prior art references, the Examiner may not resort to broad and conclusory statements; as such statements are not "evidence" of anything. *In re Kotzab*, 217 F.3d 1365, 1370, 55 U.S.P.Q.2d 1313 (Fed. Cir. 2000). The suggestion to make the claimed combination must be found in the prior art, not in the applicant's disclosure. *In re Vaeck*, 947 F.2d at 490. If the Examiner's proposed combination renders the prior art invention unsatisfactory for its intended purpose, or changes its principal of operation, there can be no suggestion or motivation to form the combination—and thus no *prima facie* case of obviousness. See MPEP § 2143.01; *In re Gordon*, 733 F.2d at 902.

- b. Claims 1, 5-10, 23, 27-32, 34, 38-40, 42-44, 58-61, 66, and 67 stand rejected under 35 U.S.C. 103(a) as being unpatentable over Fujimoto et al., U.S. Patent Application No. 2004/0006423 (Fujimoto '423) in view of Michaelson et al., U.S. Patent No. 6,734,808.**

### **I. Summary of Arguments**

Rather than identifying a non-user selected waypoint to avoid a condition, Michaelson teaches only suggesting a heading and/or depth change. Thus, the cited references cannot be said to teach, or even suggest, rerouting a “course to avoid the preselected conditions by identifying one or more non-user selected waypoints”, as claimed. Furthermore, the Examiner fails to provide the requisite suggestion or motivation to combine Fujimoto '423 and Michaelson.

### **II. Summary of the References**

Fujimoto '423 teaches a maneuvering “system for automatically track-keeping a movable object so as to move along a planned route”. ¶ 0002. In other words, when a user selects a waypoint, the system draws a straight line to the waypoint and Fujimoto's system attempts to not only reach the waypoint, but to also keep the vessel on the line with as little deviation as possible.

Michaelson teaches a navigational system for providing a “warning of an impending grounding”. Abstract. However, Michaelson only suggests a heading and/or depth change

to avoid an obstacle. Michaelson is devoid of any suggestion of identifying non-user selected waypoints.

**III. The Examiner failed to establish a *prima facie* case of obviousness as the cited references do not teach each claim limitation nor does the Examiner provide the requisite suggestion or motivation for combining references.**

Claim 1 recites “performing a marine route calculation algorithm to route a course between a first location and the potential waypoint avoiding the preselected conditions, including analyzing cartographic data between the first location and the potential waypoint and re-routing the course to avoid the preselected conditions by identifying one or more non-user selected waypoints”. Similarly, claim 23 recites “performing a marine route calculation algorithm to analyze a course between a first location and the potential waypoint avoiding the preselected conditions, including analyzing cartographic data between the first location and the potential waypoint and re-routing the course to avoid the preselected conditions by identifying one or more non-user selected waypoints”. Claim 34 recites “wherein the processor operates on a marine route calculation algorithm to analyze a course between the first location and the potential waypoint in view of the preselected conditions of the cartographic data and re-route the course to avoid the preselected conditions by identifying one or more non-user selected waypoints”. Claim 44 recites “performing a marine route calculation algorithm to analyze a course between a first



location and the potential waypoint in order to avoid preselected conditions received from a user and re-route the course to avoid the preselected conditions by identifying one or more non-user selected waypoints”. Claim 66 recites “wherein the step of performing a marine route calculation algorithm includes identifying one or more non-user selected waypoints”.

In contrast, the Examiner acknowledges that “Fujimoto ... does not disclose non-user waypoints”. Page 4 of the August 8, 2006 Final Office Action. To cure this defect, the Examiner mistakenly asserts that “Michaelson, on the other hand discloses re-routing the course by identifying one or more non-user waypoints”. Page 4 of the August 8, 2006 Final Office Action. In supporting this assertion, the Examiner points to column 24 lines 41-50 and 55-64. The Examiner also points to column 13, line 56, through column 14, line 4.

However, column 24 clearly states that Michaelson’s invention merely “alerts the crew to a new heading to steer or engine setting to avoid collisions”. Column 24, lines 38-41. Specifically, column 24, lines 57-58, state an “alternate track PT’ is first generated by incrementing the ship’s heading by [a] nominal step size”. Columns 13 and 14, on the other hand, merely disclose providing warnings such as “go shallow” to avoid grounding a submarine. Thus, Michaelson only suggests a heading and/or depth change to avoid an obstacle. In fact, Michaelson is devoid of any suggestion of “**identifying one or more non-user selected waypoints**” (emphasis added), as claimed.

As a result, no combination of Fujimoto ‘423 and/or Michaelson discloses, suggests or makes obvious “performing a marine route calculation algorithm to route a course

between a first location and the potential waypoint avoiding the preselected conditions, including analyzing cartographic data between the first location and the potential waypoint and re-routing the course to avoid the preselected conditions by identifying one or more non-user selected waypoints”, as claimed in claim 1. No combination of Fujimoto ‘423 and/or Michaelson discloses, suggests or makes obvious “performing a marine route calculation algorithm to analyze a course between a first location and the potential waypoint avoiding the preselected conditions, including analyzing cartographic data between the first location and the potential waypoint and re-routing the course to avoid the preselected conditions by identifying one or more non-user selected waypoints”, as claimed in claim 23. No combination of Fujimoto ‘423 and/or Michaelson discloses, suggests or makes obvious “wherein the processor operates on a marine route calculation algorithm to analyze a course between the first location and the potential waypoint in view of the preselected conditions of the cartographic data and re-route the course to avoid the preselected conditions by identifying one or more non-user selected waypoints”, as claimed in claim 34. No combination of Fujimoto ‘423 and/or Michaelson discloses, suggests or makes obvious “performing a marine route calculation algorithm to analyze a course between a first location and the potential waypoint in order to avoid preselected conditions received from a user and re-route the course to avoid the preselected conditions by identifying one or more non-user selected waypoints”, as claimed in claim 44. No combination of Fujimoto ‘423 and/or Michaelson discloses, suggests or makes obvious “wherein the step of performing a marine route calculation algorithm includes identifying

one or more non-user selected waypoints”, as claimed in claim 66.

Claims 58-61 and 67 each recite “displaying the course from the first location to the potential waypoint via the non-user selected waypoints”.

As discussed above, neither Fujimoto ‘423 and/or Michaelson discloses or suggests **identifying** one or more **non-user selected waypoints**. Furthermore, neither Fujimoto ‘423 and/or Michaelson discloses or suggests “displaying the course from the first location to the potential waypoint via the non-user selected waypoints”, as claimed in claims 58-61 and 67, much less in combination with the other limitations of these claims.

Furthermore, the Examiner fails to provide the requisite suggestion or motivation to combine Fujimoto ‘423 and Michaelson. Rather, with respect to claims 1 and 44, the Examiner asserts “[i]t would have been obvious to disclose non-user waypoints so that an operator of a ship relies on automatic navigation between a point of origin and a destination without constantly monitoring the ship’s travel route”. Page 4 of the August 8, 2006 Final Office Action.

However, the test is not what might “have been **obvious to disclose**” (emphasis added). Rather, there must be some suggestion, found in the prior art rather than the applicant’s disclosure, to combine one prior art reference with another. Here, as discussed above, the references don’t even teach what the Examiner asserts, much less provide any suggestion or motivation to combine their teachings.

In the present case, Fujimoto identifies a problem and solves it. Similarly, Michaelson identifies a problem and solves it. The Examiner’s stated motivation might

provide Fujimoto's motivation or might provide Michaelson's motivation, but would not motivate one with ordinary skill in the art to combine their teachings. Specifically, the Examiner's assertion does not provide any motivation to actually identify "one or more non-user selected waypoints", as claimed, certainly not over Michaelson's warnings and suggestion of a heading change. Indeed, once the crew has been alerted and even given a new heading the steer, as taught by Michaelson, the motivation would be satisfied, and therefore no longer exist. Thus, not only does the Examiner fail to cite references that teach each and every claim limitation, the Examiner also fails to provide the requisite suggestion or motivation to combine references. As a result, the Examiner has failed to establish a *prima facie* case of obviousness, and therefore the present rejections cannot be sustained.

- c. Claims 45, 46, and 62 stand rejected under 35 U.S.C. 103(a) as being unpatentable over Fujimoto '423 and Michaelson in view of Walsh et al., U.S. Patent No. 3,886,487.**

**I. Summary of Arguments**

As discussed above, rather than identifying a non-user selected waypoint to avoid a condition, Michaelson teaches only suggesting a heading and/or depth change. Neither Fujimoto '423 nor Walsh even go this far. Thus, the cited references cannot be said to teach, or even suggest, rerouting a "course to avoid the preselected conditions by

identifying one or more non-user selected waypoints”, as claimed. Furthermore, the Examiner fails to provide the requisite suggestion or motivation to combine Fujimoto '423, Michaelson, and/or Walsh.

## **II. Summary of the References**

Both Fujimoto '423 and Michaelson have been summarized above.

Walsh, like Bailey, teaches a sonar system. Walsh's improvement over the prior art is that his sonar is forwardly directed, and therefore is useful in navigating shallow waters.

Abstract.

## **III. The Examiner failed to establish a *prima facie* case of obviousness as the cited references do not teach each claim limitation nor does the Examiner provide the requisite suggestion or motivation for combining references.**

Claim 45 recites “performing a marine route calculation algorithm to route a course between a first location and the potential waypoint avoiding water depth less than the minimum water depth by identifying one or more non-user selected waypoints”.

The Examiner rejected claim 45 “for the same reasons as stated in the rejection of claim 1 as stated above”. Page 9 of the August 8, 2006 Final Office Action. Specifically, the Examiner acknowledges that “Fujimoto ... does not disclose non-user waypoints”. Page 4 of the August 8, 2006 Final Office Action. To cure this defect, the Examiner

mistakenly asserts that “Michaelson, on the other hand discloses re-routing the course by identifying one or more non-user waypoints”. Page 4 of the August 8, 2006 Final Office Action. However, as discussed above, Michaelson only suggests a heading and/or depth change to avoid an obstacle and is devoid of any suggestion of “**identifying one or more non-user selected waypoints**” (emphasis added), as claimed.

The Examiner goes on to mistakenly assert that “Walsh discloses receiving indication of a minimum water depth from a user and avoiding water depth less than the minimum water depth”. Page 10 of the August 8, 2006 Final Office Action.

However, Walsh merely warns the operator to change course. Specifically, Walsh doesn’t even suggest an alternate heading/depth, much less any non-user defined waypoints. For example, as stated in column 9, lines 6-10, Walsh merely discloses transmitting “a signal to the alarm 188 which in turn then warns the operator of the ship 20 to change course or take other evasive action”, when the depth ahead is too shallow. In other words, Walsh simply provides a warning of an impending collision/grounding. Therefore, Walsh fails to even provide a suggested heading and/or depth change, much less non-user selected waypoints that may be used to avoid the hazard. Thus, at least in this regard, Walsh teaches even less than Michaelson.

Thus, neither Michaelson nor Walsh supply the element that the Examiner acknowledges is absent from Fujimoto ‘423. As a result, no combination of Fujimoto ‘423, Michaelson, and/or Walsh discloses, suggests or makes obvious “performing a marine route calculation algorithm to route a course between a first location and the potential

waypoint avoiding water depth less than the minimum water depth by identifying one or more non-user selected waypoints”, as claimed in claim 45.

Claim 62 recites “displaying the course from the first location to the potential waypoint via the non-user selected waypoints”.

It should be noted that Walsh is not specifically applied to claim 62. Rather, the Examiner’s rejection of claim 62 consists entirely of “the claim is interpreted and rejected for the same reasons as stated in the rejections of claims 1 and 58 as stated above.” Page 10 of the August 8, 2006 Final Office Action.

In contrast, as discussed above, neither Fujimoto ‘423 and/or Michaelson discloses or suggests **identifying** one or more **non-user selected waypoints**. Furthermore, no combination of Fujimoto ‘423 and/or Michaelson discloses, suggests or makes obvious “displaying the course from the first location to the potential waypoint via the non-user selected waypoints”, as claimed in claim 62.

Furthermore, the Examiner fails to provide the requisite suggestion or motivation to combine Fujimoto ‘423, Michaelson, and Walsh. The Examiner asserts “[i]t would have been obvious to avoid a water depth less than the minimum water depth so that a ship’s operator acknowledges a dangerous water depth and verifies that the ship is maneuvered around or away from an insufficient water depth to ensure the safety of the ships’ passengers”. Page 10 of the August 8, 2006 Final Office Action. However, this assertion does not provide any motivation to actually identify “one or more non-user selected waypoints”, as claimed, certainly not over Michaelson’s warnings and suggestion of a

heading change. Specifically, once the crew has been alerted and even given a new heading, there would be no need for Walsh's warning. Therefore, the stated motivation doesn't actually provide any motivation to combine Walsh with the system of Michaelson, much less any motivation that might render the present claims obvious.

Thus, not only does the Examiner fail to cite references that teach each and every claim limitation, the Examiner also fails to provide the requisite suggestion or motivation to combine references. As a result, the Examiner has failed to establish a *prima facie* case of obviousness, and therefore the present rejections cannot be sustained.

- d. Claims 47-57 and 63-65 stand rejected under 35 U.S.C. 103(a) as being unpatentable over Fujimoto et al., U.S. Patent Application No. 2004/0003958 (Fujimoto '958), in view of Fujimoto '423 and Michaelson.**

**I. Summary of Arguments**

None of the cited prior art references teach, or suggest, "highlighting where the water depth is expected to be less than the minimum water depth" on "a substantially straight line between a first location and the potential waypoint". Furthermore, the Examiner fails to provide the requisite suggestion or motivation to combine Fujimoto '958, Fujimoto '423, and/or Michaelson.



## **II. Summary of the References**

Like Bailey, Fujimoto '958 teaches a sonar apparatus. Fujimoto '958's improvements appear to be a split screen display and a shallow water alarm. See Abstract. However, like Bailey, Fujimoto '958 does not teach cartographic data. In fact, Fujimoto '958 does not even include any version of the word "cartography" or the term "map". Furthermore, Fujimoto '958 does not include the term "waypoint", as Fujimoto is simply unrelated to navigation.

Both Fujimoto '423 and Michaelson have been summarized above.

## **III. The Examiner failed to establish a *prima facie* case of obviousness as the cited references do not teach each claim limitation nor does the Examiner provide the requisite suggestion or motivation for combining references.**

Claim 47 recites "displaying a substantially straight line between a first location and the potential waypoint, wherein the line depicts both where the water depth is expected to be greater than the minimum water depth and where the water depth is expected to be less than the minimum water depth, and wherein the line highlights where the water depth is expected to be less than the minimum water depth". Similarly, claim 48 recites "displaying a substantially straight line between a first location and the potential waypoint, wherein the line distinguishes where the water depth is expected to be greater than a preset minimum water depth from where the water depth is expected to be less than the minimum water

depth”. Claim 51 recites “wherein the line is displayed on the marine cartographic data in a plan view”. Claim 54 recites “displaying a substantially straight line on the marine cartographic data between a first location and the potential waypoint, wherein the line highlights where the water depth is expected to be less than a minimum water depth”.

In contrast, the only straight line the Examiner points to, Fujimoto ‘958’s item 45, is depicted completely independently of actual water depth. In fact, Fujimoto ‘958’s item 45 “designates an alarm water depth line”. ¶ 73. This line is arbitrarily set by the user as a minimum water depth, above which Fujimoto ‘958’s apparatus provides an alarm. Therefore, as taught by Fujimoto ‘958, this line, item 45, as well as all other lines taught by Fujimoto ‘958, is necessarily displayed on a sonar display, rather than “between a first location and the potential waypoint”, much less “on the marine **cartographic** data” (emphasis added), or “wherein the line is displayed on the marine cartographic data in a plan view”, as claimed.

Fujimoto ‘958’s only line that relates to an actual water depth is item 43, which depicts a seabed and therefore simply cannot be substantially straight. Of course, displaying item 43 as substantially straight would render it unsatisfactory for its intended purpose, namely depicting the seabed. Furthermore, like item 45, item 43 is necessarily displayed on a sonar display, rather than “between a first location and the potential waypoint”, much less “on the marine **cartographic** data” (emphasis added), or “wherein the line is displayed on the marine cartographic data in a plan view”, as claimed.

Finally, neither of these lines, themselves, actually highlight or distinguish where the

water depth is above or below a minimum. In fact, the Examiner acknowledges that “Fujimoto does not disclose highlighting the water depth line”. Page 11 of the August 8, 2006 Final Office Action. In order to cure this defect, the Examiner asserts “Michaelson discloses highlighting a terrain threat indication”. Pages 11 and 12 of the August 8, 2006 Final Office Action. However, the Examiner fails to cite to any portion of Michaelson that teaches this. In fact, Michaelson does not include any variation on the word “highlight”. Michaelson simply does not teach highlighting or distinguishing any portion of any *line* “between a first location and the potential waypoint”, much less any line “on the marine *cartographic* data” (emphasis added), or “wherein the line is displayed on the marine cartographic data in a plan view”, as claimed.

As a result, no combination of either Fujimoto reference and/or Michaelson discloses, suggests or makes obvious “displaying a substantially straight line between a first location and the potential waypoint, wherein the line depicts both where the water depth is expected to be greater than the minimum water depth and where the water depth is expected to be less than the minimum water depth, and wherein the line highlights where the water depth is expected to be less than the minimum water depth”, as claimed in claim 47, “displaying a substantially straight line between a first location and the potential waypoint, wherein the line distinguishes where the water depth is expected to be greater than a preset minimum water depth from where the water depth is expected to be less than the minimum water depth”, as claimed in claim 48, “wherein the line is displayed on the marine cartographic data in a plan view”, as claimed in claim 51, or “displaying a

substantially straight line on the marine cartographic data between a first location and the potential waypoint, wherein the line highlights where the water depth is expected to be less than a minimum water depth”, as claimed in claim 54.

Claim 50 recites “wherein the line is depicted in a first manner where the water depth is expected to be greater than the minimum water depth and the line is depicted in a second manner where the water depth is expected to be less than the minimum water depth”.

The Examiner mistakenly asserts that Fujimoto '958 teaches these limitations. However, as discussed above, Fujimoto '958 merely displays a seabed line 125 above or below a depth mark 124, as the case may be, but the seabed line 125 is otherwise displayed in the exact same manner both above and below the depth mark 124. In fact, the Examiner acknowledges that “Fujimoto does not disclose highlighting the water depth line”. Page 11 of the August 8, 2006 Final Office Action. The Examiner also acknowledges that “Fujimoto ... does not disclose first and second manners of displaying a line”. Page 12 of the August 8, 2006 Final Office Action. Simply put, there is no difference in the line itself or the manner in which it is displayed, such as highlighting color, solid vs. broken or dashed, whether that portion of the line is flashing, or whether that portion of the line is bolded. In fact, Fujimoto '958 lacks any suggestion to show any portion of the seabed line 123 in a different manner. As a result, no combination of either Fujimoto reference and/or Michaelson discloses, suggests or makes obvious “wherein the line is depicted in a first manner where the water depth is expected to be greater than the

minimum water depth and the line is depicted in a second manner where the water depth is expected to be less than the minimum water depth”, as claimed in claim 50.

Claim 52 recites “wherein the first manner is different from the second manner, such that the line itself is displayed differently in the first manner compared with the second manner”. Claim 53 recites “wherein the first manner comprises displaying the line in a first color and the second manner comprises displaying the line in a second color different from the first color”. Claim 57 recites “wherein the line is displayed in a different manner where the water depth is expected to be less than a minimum water depth”. Claim 65 recites “wherein the line is displayed in a first manner where the water depth is expected to be greater than the preset minimum water depth and a second manner, different from the first manner, where the water depth is expected to be less than the minimum water depth”.

For example, this capability is shown in figures 2A, 4A, and 4C and described on pages 11-14, among other places. Of course, claim 48, from which claims 52 and 53 depend, recites “displaying a substantially straight line between a first location and the potential waypoint”. Similarly, claim 54, from which claim 57 depends, recites “displaying a substantially straight line on the marine cartographic data between a first location and the potential waypoint”. Finally, claim 47, from which claim 65 depends, recites “displaying a substantially straight line between a first location and the potential waypoint”. Thus, the line is substantially straight and depicts a path between two points. Furthermore, in the case of claim 57, the line is displayed on “marine cartographic data”.

In contrast, the Examiner acknowledges that “Fujimoto ... does not disclose first and

second manners of displaying a line”. Page 12 of the August 8, 2006 Final Office Action. In order to cure this defect, the Examiner asserts “Michaelson discloses first and second colors to display terrain indications”. Page 12 of the August 8, 2006 Final Office Action. In supporting this assertion, the Examiner points to column 27, lines 40-65. However, Michaelson’s terrain indications are simply not analogous to the presently claimed line. Specifically, Michaelson merely teaches varying the color of the displayed terrain data itself, rather than any path through the terrain. See column 27, lines 48-65. As a result, no combination of either Fujimoto reference and/or Michaelson discloses, suggests or makes obvious “wherein the first manner is different from the second manner, such that the line itself is displayed differently in the first manner compared with the second manner”, as claimed in claim 52, “wherein the first manner comprises displaying the line in a first color and the second manner comprises displaying the line in a second color different from the first color”, as claimed in claim 53, “wherein the line is displayed in a different manner where the water depth is expected to be less than a minimum water depth”, as claimed in claim 57, or “wherein the line is displayed in a first manner where the water depth is expected to be greater than the preset minimum water depth and a second manner, different from the first manner, where the water depth is expected to be less than the minimum water depth”, as claimed in claim 65.

Claim 55 recites “performing a marine route calculation algorithm to route a course from the first location to the potential waypoint avoiding areas where the water depth is expected to be less than the minimum water depth by identifying one or more non-user

selected waypoints”. Claim 63 recites “wherein the step of performing a marine route calculation algorithm includes identifying one or more non-user selected waypoints”. Similarly, claims 56 and 64 each recite “displaying the course from the first location to the potential waypoint via the non-user selected waypoints”.

In contrast, as discussed above, no combination of either Fujimoto reference and/or Michaelson discloses, suggests or makes obvious “**identifying** one or more **non-user selected waypoints**” (emphasis added), as claimed in claims 55 and 63, or “displaying the course from the first location to the potential waypoint via the non-user selected waypoints”, as claimed in claims 56 and 64, much less doing so in combination with the other limitations of these claims.

Furthermore, the Examiner fails to provide the requisite suggestion or motivation to combine Fujimoto '958, Fujimoto '423, and/or Michaelson. Rather, the Examiner asserts that “[i]t would have been obvious to emphasize a **water depth line** by highlighting” (emphasis added). Page 12 of the August 8, 2006 Final Office Action. Such broad and conclusory statements are not “evidence” of anything. *See In re Kotzab*, 217 F.3d at 1370. Furthermore, whether highlighting a **water depth line** would be obvious or not is immaterial to the question of whether it would be obvious to highlight a line between two locations, such as a route segment, according to water depth. Such teachings are found only in Applicant’s own disclosure. In order to establish a *prima facie* case of obviousness, there must be some suggestion, found in the prior art rather than the applicant’s disclosure, to combine one prior art reference with another. Here, as discussed above, the references

do not even teach what the Examiner asserts, much less provide any suggestion or motivation to combine their teachings. Thus, not only does the Examiner fail to cite references that teach each and every claim limitation, the Examiner also fails to provide the requisite suggestion or motivation to combine references. As a result, the Examiner has failed to establish a *prima facie* case of obviousness, and therefore the present rejections cannot be sustained.

**e. Claim 21 stands rejected under 35 U.S.C. 103(a) as being unpatentable over Bailey in view of Fujimoto '423.**

**I. Summary of Arguments**

Neither Bailey nor Fujimoto '423 teach, or even suggest, the claimed limitations. Furthermore, the Examiner fails to provide the requisite suggestion or motivation to combine Bailey and Fujimoto '423.

**II. Summary of the References**

Both Bailey and Fujimoto '423 have been summarized above.

**III. The Examiner failed to establish a *prima facie* case of obviousness as the cited references do not teach each claim limitation nor does the**



**Examiner provide the requisite suggestion or motivation for combining references.**

Claim 21 depends from claim 19. As discussed above, Bailey fails to teach the limitations of claim 19. Fujimoto '423 likewise fails to teach the limitations of claim 19 missing from Bailey. Thus, no combination of Bailey and Fujimoto '423 teaches each and every limitation of claim 19, much less with the added limitation of claim 21.

Furthermore, the Examiner fails to provide the requisite suggestion or motivation to combine Bailey and Fujimoto '423. Rather, the Examiner asserts "[i]t would have been obvious to acquire cartographic data from a GPS so that a ship's captain relies on accurate real-time data". Page 8 of the August 8, 2006 Final Office Action.

However, Bailey already acquires real-time sonar data and, as discussed above, does not even mention cartographic data. Therefore, Bailey's captain already relies on accurate real-time data. Furthermore, at least for Bailey's purposes, namely display of sonar data, Bailey's system has no need of GPS or cartographic data. Therefore, the Examiner's stated motivation would not in fact motivation one to combine Bailey and Fujimoto '423. Thus, not only does the Examiner fail to cite references that teach each and every claim limitation, the Examiner also fails to provide the requisite suggestion or motivation to combine references. As a result, the Examiner has failed to establish a *prima facie* case of obviousness, and therefore the present rejections cannot be sustained.

- f. **Claim 33 stands rejected under 35 U.S.C. 103(a) as being unpatentable over Fujimoto '423 and Michaelson, in view of Tobin Jr., U.S. Patent No. 4,323,992.**

### **I. Summary of Arguments**

Neither Fujimoto '423, Michaelson, nor Tobin teach, or even suggest, the claimed limitations. Furthermore, the Examiner fails to provide the requisite suggestion or motivation to combine Fujimoto '423, Michaelson, and Tobin.

### **II. Summary of the References**

Both Fujimoto '423 and Michaelson have been summarized above. Tobin teaches a sonar repeater. See Abstract.

### **III. The Examiner failed to establish a *prima facie* case of obviousness as the cited references do not teach each claim limitation nor does the Examiner provide the requisite suggestion or motivation for combining references.**

Claim 33 depends from claim 23. As discussed above, Fujimoto '423 and Michaelson fail to teach the limitations of claim 23. Tobin likewise fails to teach the limitations of claim 23 missing from Fujimoto '423 and Michaelson. In fact, the Examiner never even asserts how Tobin is applicable to claims 23 and/or 33. Thus, no combination

of Fujimoto '423, Michaelson, and Tobin teaches each and every limitation of claim 23, much less with the added limitation of claim 33.

Furthermore, the Examiner fails to provide the requisite suggestion or motivation to combine Fujimoto '423, Michaelson, and Tobin. Rather, the Examiner asserts "[i]t would have been obvious to include the preselected condition of water depth so that a ship's operator acknowledges a dangerous water depth". Page 8 of the August 8, 2006 Final Office Action.

However, as discussed above, Michaelson already warns of and suggests a heading and/or depth change to avoid an obstacle. Therefore, Michaelson would not need Tobin's teachings to satisfy the Examiner's stated motivation. Thus, not only does the Examiner fail to cite references that teach each and every claim limitation, the Examiner also fails to provide the requisite suggestion or motivation to combine references. As a result, the Examiner has failed to establish a *prima facie* case of obviousness, and therefore the present rejections cannot be sustained.

- g. Claim 41 stands rejected under 35 U.S.C. 103(a) as being unpatentable over Fujimoto '423 and Michaelson in view of Bailey.

## **I. Summary of Arguments**

Neither Fujimoto '423, Michaelson, nor Bailey teach, or even suggest, the claimed limitations. Furthermore, the Examiner fails to provide the requisite suggestion or motivation to combine Fujimoto '423, Michaelson, and Bailey.

## **II. Summary of the References**

Fujimoto '423, Michaelson, and Bailey have been summarized above.

## **III. The Examiner failed to establish a *prima facie* case of obviousness as the cited references do not teach each claim limitation nor does the Examiner provide the requisite suggestion or motivation for combining references.**

Claim 41 depends from claim 34. As discussed above, Fujimoto '423 and Michaelson fail to teach the limitations of claim 34. Bailey likewise fails to teach the limitations of claim 34 missing from Fujimoto '423 and Michaelson. Thus, no combination of Fujimoto '423, Michaelson, and Bailey teaches each and every limitation of claim 34, much less with the added limitation of claim 41.

Furthermore, the Examiner fails to provide the requisite suggestion or motivation to combine Fujimoto '423, Michaelson, and Bailey. Rather, the Examiner asserts “[i]t would have been obvious to display cartographic data as a user defined graphical filter area to so that a user has a certain degree of control over the display”. Page 9 of the August 8, 2006 Final Office Action.

However, in the present case, Fujimoto '423, Michaelson, and Bailey each identifies a different problem and solves it. Thus, the Examiner's stated motivation might provide Fujimoto '423's motivation, might provide Michaelson's motivation, or might provide Bailey's motivation, but would not motivate one with ordinary skill in the art to combine their teachings. Furthermore, as discussed above, Bailey does not even mention cartographic data. Finally, as discussed above, Bailey teaches automatically redefining his display area, thereby taking such control out of the user's hands contrary to the Examiner's asserted motivation. Thus, not only does the Examiner fail to cite references that teach each and every claim limitation, the Examiner also fails to provide the requisite suggestion or motivation to combine references. As a result, the Examiner has failed to establish a *prima facie* case of obviousness, and therefore the present rejections cannot be sustained.

#### **VIII. Conclusion**

The Examiner failed, with regard to the rejection of the pending claims under 35 U.S.C. §102(e), to establish the requisite *prima facie* case of anticipation because the cited references do not teach each and every claim limitation. Similarly, the Examiner failed, with regard to the rejection of the pending claims under 35 U.S.C. §103(a), to establish the requisite *prima facie* case of obviousness because the cited references do not teach each and every claim limitation and the Examiner has not provided the requisite suggestion or motivation to combine the cited references. In fact, the Examiner acknowledges that Fujimoto fails to expressly set forth each element of the currently pending claims.

Appeal of U.S. Application No. 10/667,026  
Amended Appeal Brief

However, the Examiner's assertions that Michealson, Welsh, Tobin, and/or Bailey set forth the missing elements are simply erroneous, as described above. Thus, the Examiner failed to establish the requisite *prima facie* case of anticipation and obviousness, and therefore the rejections under 35 U.S.C. § 102 and 35 U.S.C. § 103 cannot be sustained and must be overturned.

Accordingly, reversal of the Examiner's rejections is proper, and such favorable action is solicited.

Respectfully submitted,

By: /David L. Terrell/  
David L. Terrell, Reg. No. 50,576  
Garmin International, Inc.  
1200 East 151<sup>st</sup> Street  
Olathe, KS 66062  
(913) 397-8200  
(913) 397-9079 (Fax)

**VIII. Claims Appendix**

1. (Previously Presented) A method for marine navigation, comprising:  
receiving one or more preselected conditions from a user;  
identifying a potential waypoint; and  
performing a marine route calculation algorithm to route a course between a first location and the potential waypoint avoiding the preselected conditions, including analyzing cartographic data between the first location and the potential waypoint and re-routing the course to avoid the preselected conditions by identifying one or more non-user selected waypoints.
  
5. (Previously Presented) The method of claim 1, further including determining the first location on the course based on a signal from a global positioning system (GPS); and analyzing cartographic data for a predetermined area around the first location for preselected conditions.
  
6. (Original) The method of claim 5, further including providing an alert signal when the analyzed cartographic data for the predetermined area around the first location includes preselected conditions.

7. (Previously Presented) The method of claim 1, further including providing an alert signal when the analyzed cartographic data between the first location and the potential waypoint includes preselected conditions.

8. (Original) The method of claim 7, wherein providing the alert signal includes emitting an audio alert.

9. (Original) The method of claim 7, wherein providing the alert signal includes displaying a visual alert.

10. (Previously Presented) The method of claim 1, the preselected conditions including a weather condition.

19. (Previously Presented) A method for marine navigation, comprising:  
receiving one or more preselected conditions from a user;  
receiving a user defined graphical filter area from the user;  
identifying the user defined graphical filter area on a display;  
analyzing cartographic data only within the user defined graphical filter area for the preselected conditions; and  
providing an alert signal when cartographic data within the user defined graphical filter area indicate the preselected conditions.



20. (Original) The method of claim 19, wherein identifying the user defined graphical filter area includes repositioning the user defined graphical filter area.

21. (Original) The method of claim 19, wherein analyzing cartographic data further comprises acquiring cartographic data from a global positioning system (GPS).

22. (Original) The method of claim 19, further including receiving preselected conditions selected from the group of land, water depth, rock(s), sandbars, shelves, tide condition, tidal data, wind conditions, weather conditions, ice, above-water obstacles, underwater obstacles, type of water bottom, and prohibited areas.

23. (Previously Presented) A computer readable medium having a set of computer readable instructions, the set of computer readable instructions comprising instructions for:  
receiving one or more preselected conditions from a user;  
identifying a potential waypoint upon a first event; and  
performing a marine route calculation algorithm to analyze a course between a first location and the potential waypoint avoiding the preselected conditions, including analyzing cartographic data between the first location and the potential waypoint and re-routing the course to avoid the preselected conditions by identifying one or more non-user selected waypoints.

27. (Original) The computer readable medium of claim 23, further including determining the first location on the course based on a signal from a global positioning system (GPS); and analyzing cartographic data for a predetermined area around the first location for preselected conditions.

28. (Original) The computer readable medium of claim 27, further including providing an alert signal when the analyzed cartographic data for the predetermined area around the first location includes preselected conditions.

29. (Original) The computer readable medium of claim 23, wherein analyzing cartographic data further comprises acquiring cartographic data from a global positioning system (GPS).

30. (Original) The computer readable medium of claim 23, further including providing an alert signal when the analyzed cartographic data between the first location and the potential waypoint includes preselected conditions.

31. (Original) The computer readable medium of claim 30, wherein providing the alert signal includes emitting a signal for an audio alert.

32. (Original) The computer readable medium of claim 30, wherein providing the alert signal includes displaying a visual alert.

33. (Previously Presented) The computer readable medium of claim 23, the preselected conditions including a water depth.

34. (Previously Presented) An electronic marine navigation device, comprising:  
a processor;  
a user interface operatively coupled to the processor, wherein the user interface receives one or more preselected conditions from a user;  
a location input operatively coupled to the processor, wherein the location input receives a first location and a potential waypoint separate from the first location; and  
a memory operatively coupled to the processor and the location input, the memory having cartographic data including data related to the preselected conditions, wherein the processor operates on a marine route calculation algorithm to analyze a course between the first location and the potential waypoint in view of the preselected conditions of the cartographic data and re-route the course to avoid the preselected conditions by identifying one or more non-user selected waypoints.

38. (Previously Presented) The electronic marine navigation device of claim 34, further including a receiver for a global positioning system (GPS) operatively coupled to the processor, wherein the processor determines the first location on the course based on a signal received from the GPS, and analyzes cartographic data for a predetermined area around the first location for preselected conditions.

39. (Original) The electronic marine navigation device of claim 38, wherein the processor provides an alert signal when the analyzed cartographic data for the predetermined area around the first location includes preselected conditions.

40. (Previously Presented) The electronic marine navigation device of claim 34, wherein the processor provides an alert signal when the analyzed cartographic data between the first location and the potential waypoint includes preselected conditions.

41. (Original) The electronic marine navigation device of claim 34, wherein the location input receives a user defined graphical filter area, and wherein the processor operates on the marine route calculation algorithm to analyze cartographic data within the defined graphical filter area for preselected conditions and wherein the processor provides an alert signal when the analyzed cartographic data for the user defined graphical filter area includes preselected conditions.

42. (Previously Presented) The method of claim 1, wherein both the first location and the potential waypoint are independent of a current location of a device implementing the method.

43. (Previously Presented) The method of claim 1, wherein at least a portion of the course is unrelated to a current heading of a device implementing the method.

44. (Previously Presented) A method for marine navigation, comprising:  
identifying a potential waypoint; and  
performing a marine route calculation algorithm to analyze a course between a first location and the potential waypoint in order to avoid preselected conditions received from a user and re-route the course to avoid the preselected conditions by identifying one or more non-user selected waypoints.

45. (Previously Presented) A method for marine navigation, comprising:  
receiving indication of a minimum water depth from a user;  
identifying a potential waypoint; and  
performing a marine route calculation algorithm to route a course between a first location and the potential waypoint avoiding water depth less than the minimum water depth by identifying one or more non-user selected

waypoints.

46. (Previously Presented) The method of claim 45, displaying a visual indication of places along the calculated course where the water depth is expected to approach the minimum water depth.

47. (Previously Presented) A method for marine navigation, comprising:  
receiving indication of a minimum water depth from a user;  
displaying marine cartographic data;  
receiving indication of a potential waypoint;  
displaying a substantially straight line between a first location and the potential waypoint, wherein the line depicts both where the water depth is expected to be greater than the minimum water depth and where the water depth is expected to be less than the minimum water depth, and wherein the line highlights where the water depth is expected to be less than the minimum water depth; and  
performing a marine route calculation algorithm to route a course between the first location and the potential waypoint avoiding water depth less than the minimum water depth.

48. (Previously Presented) A method for marine navigation, comprising:  
displaying marine cartographic data;  
receiving indication of a potential waypoint;  
displaying a substantially straight line between a first location and the potential  
waypoint, wherein the line distinguishes where the water depth is expected to  
be greater than a preset minimum water depth from where the water depth is  
expected to be less than the minimum water depth; and  
performing a marine route calculation algorithm to route a course between the first  
location and the potential waypoint avoiding water depth less than the  
minimum water depth.
49. (Previously Presented) The method of claim 48, wherein the minimum water depth  
is user selectable.
50. (Previously Presented) The method of claim 48, wherein the line is depicted in a  
first manner where the water depth is expected to be greater than the minimum water  
depth and the line is depicted in a second manner where the water depth is expected to be  
less than the minimum water depth.
51. (Previously Presented) The method of claim 48, wherein the line is displayed on the

marine cartographic data in a plan view.

52. (Previously Presented) The method of claim 50, wherein the first manner is different from the second manner, such that the line itself is displayed differently in the first manner compared with the second manner.

53. (Previously Presented) The method of claim 50, wherein the first manner comprises displaying the line in a first color and the second manner comprises displaying the line in a second color different from the first color.

54. (Previously Presented) A method for marine navigation, comprising:  
displaying marine cartographic data;  
receiving indication of a potential waypoint; and  
displaying a substantially straight line on the marine cartographic data between a first location and the potential waypoint, wherein the line highlights where the water depth is expected to be less than a minimum water depth.

55. (Previously Presented) The method of claim 54, further including the step of performing a marine route calculation algorithm to route a course from the first location to the potential waypoint avoiding areas where the water depth is expected to be less than the minimum water depth by identifying one or more non-user selected waypoints.



56. (Previously Presented) The method of claim 55, further including the step of displaying the course from the first location to the potential waypoint via the non-user selected waypoints.

57. (Previously Presented) The method of claim 54, wherein the line is displayed in a different manner where the water depth is expected to be less than a minimum water depth.

58. (Previously Presented) The method of claim 1, further including the step of displaying the course from the first location to the potential waypoint via the non-user selected waypoints.

59. (Previously Presented) The computer readable medium of claim 23, further including instructions for displaying the course from the first location to the potential waypoint via the non-user selected waypoints.

60. (Previously Presented) The electronic marine navigation device of claim 34, further including a display for displaying the course from the first location to the potential waypoint via the non-user selected waypoints.

61. (Previously Presented) The method of claim 44, further including the step of displaying the course from the first location to the potential waypoint via the non-user selected waypoints.

62. (Previously Presented) The method of claim 45, further including the step of displaying the course from the first location to the potential waypoint via the non-user selected waypoints.

63. (Previously Presented) The method of claim 47, wherein the step of performing a marine route calculation algorithm includes identifying one or more non-user selected waypoints.

64. (Previously Presented) The method of claim 63, further including the step of displaying the course from the first location to the potential waypoint via the non-user selected waypoints.

65. (Previously Presented) The method of claim 47, wherein the line is displayed in a first manner where the water depth is expected to be greater than the preset minimum water depth and a second manner, different from the first manner, where the water depth is expected to be less than the minimum water depth.

66. (Previously Presented) The method of claim 48, wherein the step of performing a marine route calculation algorithm includes identifying one or more non-user selected waypoints.

67. (Previously Presented) The method of claim 66, further including the step of displaying the course from the first location to the potential waypoint via the non-user selected waypoints.

Appeal of U.S. Application No. 10/667,026  
Amended Appeal Brief

**IX. Evidence Appendix**

None.

Appeal of U.S. Application No. 10/667,026  
Amended Appeal Brief

**X. Related Proceedings Appendix**

None.

## Electronic Acknowledgement Receipt

<b>EFS ID:</b>	1499073
<b>Application Number:</b>	10667026
<b>International Application Number:</b>	
<b>Confirmation Number:</b>	9123
<b>Title of Invention:</b>	Methods, systems, and devices for cartographic alerts
<b>First Named Inventor/Applicant Name:</b>	Darrin W. Kabel
<b>Customer Number:</b>	38933
<b>Filer:</b>	David L. Terrell/Christine Terrell
<b>Filer Authorized By:</b>	David L. Terrell
<b>Attorney Docket Number:</b>	702.254
<b>Receipt Date:</b>	07-FEB-2007
<b>Filing Date:</b>	18-SEP-2003
<b>Time Stamp:</b>	17:39:02
<b>Application Type:</b>	Utility

### Payment information:

Submitted with Payment	no
------------------------	----

### File Listing:

Document Number	Document Description	File Name	File Size(Bytes)	Multi Part /.zip	Pages (if appl.)
1	Appeal Brief Filed	AmendedAppealBrief.pdf	206754	no	54

### Warnings:

<b>Information:</b>	
<b>Total Files Size (in bytes):</b>	206754
<p><b>This Acknowledgement Receipt evidences receipt on the noted date by the USPTO of the indicated documents, characterized by the applicant, and including page counts, where applicable. It serves as evidence of receipt similar to a Post Card, as described in MPEP 503.</b></p> <p><b><u>New Applications Under 35 U.S.C. 111</u></b>  <b>If a new application is being filed and the application includes the necessary components for a filing date (see 37 CFR 1.53(b)-(d) and MPEP 506), a Filing Receipt (37 CFR 1.54) will be issued in due course and the date shown on this Acknowledgement Receipt will establish the filing date of the application.</b></p> <p><b><u>National Stage of an International Application under 35 U.S.C. 371</u></b>  <b>If a timely submission to enter the national stage of an international application is compliant with the conditions of 35 U.S.C. 371 and other applicable requirements a Form PCT/DO/EO/903 indicating acceptance of the application as a national stage submission under 35 U.S.C. 371 will be issued in addition to the Filing Receipt, in due course.</b></p> <p><b><u>New International Application Filed with the USPTO as a Receiving Office</u></b>  <b>If a new international application is being filed and the international application includes the necessary components for an international filing date (see PCT Article 11 and MPEP 1810), a Notification of the International Application Number and of the International Filing Date (Form PCT/RO/105) will be issued in due course, subject to prescriptions concerning national security, and the date shown on this Acknowledgement Receipt will establish the international filing date of the application.</b></p>	



UNITED STATES PATENT AND TRADEMARK OFFICE

UNITED STATES DEPARTMENT OF COMMERCE  
United States Patent and Trademark Office  
Address: COMMISSIONER FOR PATENTS  
P.O. Box 1450  
Alexandria, Virginia 22313-1450  
www.uspto.gov

APPLICATION NO.	FILING DATE	FIRST NAMED INVENTOR	ATTORNEY DOCKET NO.	CONFIRMATION NO.
10/667,026	09/18/2003	Darrin W. Kabel	702.254	9123

38933 7590 01/17/2007

GARMIN LTD.  
C/O GARMIN INTERNATIONAL, INC.  
ATTN: Legal - IP  
1200 EAST 151ST STREET  
OLATHE, KS 66062

EXAMINER

ART UNIT PAPER NUMBER

DATE MAILED: 01/17/2007

Please find below and/or attached an Office communication concerning this application or proceeding.



<b>Notification of Non-Compliant Appeal Brief (37 CFR 41.37)</b>	<b>Application No.</b> 10/667,026	<b>Applicant(s)</b> KABEL ET AL.	
	<b>Examiner</b> Jennifer Mehmood	<b>Art Unit</b> 2612	

*--The MAILING DATE of this communication appears on the cover sheet with the correspondence address--*

The Appeal Brief filed on 13 December 2006 is defective for failure to comply with one or more provisions of 37 CFR 41.37.

To avoid dismissal of the appeal, applicant must file an amended brief or other appropriate correction (see MPEP 1205.03) within **ONE MONTH or THIRTY DAYS** from the mailing date of this Notification, whichever is longer. **EXTENSIONS OF THIS TIME PERIOD MAY BE GRANTED UNDER 37 CFR 1.136.**

1.  The brief does not contain the items required under 37 CFR 41.37(c), or the items are not under the proper heading or in the proper order.
2.  The brief does not contain a statement of the status of all claims, (e.g., rejected, allowed, withdrawn, objected to, canceled), or does not identify the appealed claims (37 CFR 41.37(c)(1)(iii)).
3.  At least one amendment has been filed subsequent to the final rejection, and the brief does not contain a statement of the status of each such amendment (37 CFR 41.37(c)(1)(iv)).
4.  (a) The brief does not contain a concise explanation of the subject matter defined in each of the independent claims involved in the appeal, referring to the specification by page and line number and to the drawings, if any, by reference characters; and/or (b) the brief fails to: (1) identify, for each independent claim involved in the appeal and for each dependent claim argued separately, every means plus function and step plus function under 35 U.S.C. 112, sixth paragraph, and/or (2) set forth the structure, material, or acts described in the specification as corresponding to each claimed function with reference to the specification by page and line number, and to the drawings, if any, by reference characters (37 CFR 41.37(c)(1)(v)).
5.  The brief does not contain a concise statement of each ground of rejection presented for review (37 CFR 41.37(c)(1)(vi)).
6.  The brief does not present an argument under a separate heading for each ground of rejection on appeal (37 CFR 41.37(c)(1)(vii)).
7.  The brief does not contain a correct copy of the appealed claims as an appendix thereto (37 CFR 41.37(c)(1)(viii)).
8.  The brief does not contain copies of the evidence submitted under 37 CFR 1.130, 1.131, or 1.132 or of any other evidence entered by the examiner **and relied upon by appellant in the appeal**, along with a statement setting forth where in the record that evidence was entered by the examiner, as an appendix thereto (37 CFR 41.37(c)(1)(ix)).
9.  The brief does not contain copies of the decisions rendered by a court or the Board in the proceeding identified in the Related Appeals and Interferences section of the brief as an appendix thereto (37 CFR 41.37(c)(1)(x)).
10.  Other (including any explanation in support of the above items):

1.) The grounds of rejections and argument section of the brief fails to mention appealed claims (21, 33 and 41).

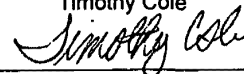
Timothy Cole  

**IN THE UNITED STATES PATENT AND TRADEMARK OFFICE**

Application of:	)	
	)	
KABEL, DARRIN W.	)	Attorney Docket No.:
	)	702.254
Serial No.: 10/667,026	)	
	)	
Filed: September 18, 2003	)	Group Art Unit No. 2636
	)	
METHODS, SYSTEMS AND DEVICES	)	
FOR CARTOGRAPHIC ALERTS	)	Examiner: MEHMOOD, J.

**APPEAL BRIEF**

**IN THE UNITED STATES PATENT AND TRADEMARK OFFICE**

<b>Application of:</b>	)	
	)	
<b>KABEL, DARRIN W.</b>	)	<b>Attorney Docket No.:</b>
	)	<b>702.254</b>
<b>Serial No.: 10/667,026</b>	)	
	)	
<b>Filed: September 18, 2003</b>	)	<b>Group Art Unit No. 2636</b>
	)	
<b>METHODS, SYSTEMS AND DEVICES</b>	)	
<b>FOR CARTOGRAPHIC ALERTS</b>	)	<b>Examiner: MEHMOOD, J.</b>

Mail Stop Appeal Brief - Patents  
Commissioner for Patents  
P.O. Box 1450  
Alexandria, VA 22313-1450

**APPELLANT'S BRIEF ON APPEAL**

In response to the Final Action dated August 8, 2006 and the Advisory Action dated November 1, 2006, Appellant's brief on Appeal in accordance with 37 C.F.R. § 41.37 is hereby submitted. The Examiner's rejections of claims 1, 5-10, 19-23, 27-34, and 38-67 are herein appealed, and allowance of said claims is respectfully requested.

The Commissioner is hereby authorized to charge \$500.00, the amount of the filing fee for this Appeal Brief, and any additional fees which may be required, or credit any overpayment, to Account No. 501-791.

Respectfully submitted,

By: /David L. Terrell/  
David L. Terrell, Reg. No. 50,576  
Garmin International, Inc.  
1200 East 151<sup>st</sup> Street  
Olathe, KS 66062  
(913) 397-8200  
(913) 397-9079 (Fax)

Appeal of U.S. Application No. 10/667,026  
Appeal Brief dated December 13, 2006

Following are the requisite statements under 37 C.F.R. § 41.37:

**I. Real Party in Interest**

Darrin W. Kabel and Steven J. Meyers are the inventors of the claimed invention. The inventors assigned the above-referenced application to Garmin Ltd., the Real Party in Interest.

**II. Related Appeals and Interferences**

There are no related appeals or interferences, known to the Appellants, which may directly affect or be directly affected by the Board's decision in the pending appeal.

**III. Status of Claims**

Claims 1, 5-10, 19-23, 27-34, and 38-67 stand rejected and appealed. Claims 2-4, 11-18, 24-26, and 35-37 have been canceled.

**IV. Status of Amendments**

All amendments submitted by the Appellant have been entered.

**V. Summary of Claimed Subject Matter**

The claimed embodiments of the present invention are directed at an aid to marine navigation. More specifically, the present invention displays, highlights, and/or calculates a

route in order to avoid obstacles, such as underwater sand bars, reef structure, and the like.

Claim 1 recites “A method for marine navigation, comprising: receiving one or more preselected conditions from a user”, as described on page 6, lines 6-20; “identifying a potential waypoint”, as described on page 16, lines 29-31, and shown as step 600 in Figure 6; and “performing a marine route calculation algorithm to route a course between a first location and the potential waypoint avoiding the preselected conditions, including analyzing cartographic data between the first location and the potential waypoint and re-routing the course to avoid the preselected conditions by identifying one or more non-user selected waypoints”, as described on page 8, lines 4-10, and shown as steps 610 and 620 in Figure 6, which is discussed on page 16, line 27, thru page 17, line 13.

Claim 19 recites “[a] method for marine navigation, comprising: receiving one or more preselected conditions from a user”, as described on page 6, lines 6-20; “receiving a user defined graphical filter area from the user”, as described on page 14, line 24, thru page 15, line 2, and shown as item 478 in Figure 4E; “identifying the user defined graphical filter area on a display”, as shown in Figure 4E; “analyzing cartographic data only within the user defined graphical filter area for the preselected conditions”, as shown in Figure 4E (It can be seen that the land is depicted as a dangerous preselected condition, only within the graphical filter area. The land outside the graphical filter area remains unaltered); and “providing an alert signal when cartographic data within the user defined graphical filter area indicate the preselected conditions”, as described on page 15, lines 3-10.

Claim 23 recites “[a] computer readable medium having a set of computer readable instructions, the set of computer readable instructions comprising instructions for: receiving one or more preselected conditions from a user”, as described on page 6, lines 6-20; “identifying a potential waypoint upon a first event”, as described on page 16, lines 29-31, and shown as step 600 in Figure 6; and “performing a marine route calculation algorithm to analyze a course between a first location and the potential waypoint avoiding the preselected conditions, including analyzing cartographic data between the first location and the potential waypoint and re-routing the course to avoid the preselected conditions by identifying one or more non-user selected waypoints”, as described on page 8, lines 4-10, and shown as steps 610 and 620 in Figure 6, which is discussed on page 16, line 27, thru page 17, line 13.

Claim 34 recites “[a]n electronic marine navigation device, comprising: a processor”, as described on page 5, line 27, thru page 6, line 5, and shown as item 310 in Figure 3; “a user interface operatively coupled to the processor, wherein the user interface receives one or more preselected conditions from a user”, as described on page 6, lines 6-20; “a location input operatively coupled to the processor, wherein the location input receives a first location and a potential waypoint separate from the first location”, as described on page 6, lines 21-31, and shown as item 320 in Figure 3; and “a memory operatively coupled to the processor and the location input, the memory having cartographic data including data related to the preselected conditions, wherein the processor operates on a marine route calculation algorithm to analyze a course between the first location and the

potential waypoint in view of the preselected conditions of the cartographic data and re-route the course to avoid the preselected conditions by identifying one or more non-user selected waypoints”, as described on page 6, lines 6-31; described on page 8, lines 4-10; and shown as steps 610 and 620 in Figure 6, which is discussed on page 16, line 27, thru page 17, line 13.

Claim 44 recites “[a] method for marine navigation, comprising: identifying a potential waypoint”, as described on page 16, lines 29-31, and shown as step 600 in Figure 6; and “performing a marine route calculation algorithm to analyze a course between a first location and the potential waypoint in order to avoid preselected conditions received from a user and re-route the course to avoid the preselected conditions by identifying one or more non-user selected waypoints”, as described on page 8, lines 4-10, and shown as steps 610 and 620 in Figure 6, which is discussed on page 16, line 27, thru page 17, line 13.

Claim 45 recites “[a] method for marine navigation, comprising: receiving indication of a minimum water depth from a user”, as described on page 6, lines 6-20; “identifying a potential waypoint”, as described on page 16, lines 29-31, and shown as step 600 in Figure 6; and “performing a marine route calculation algorithm to route a course between a first location and the potential waypoint avoiding water depth less than the minimum water depth by identifying one or more non-user selected waypoints”, as described on page 8, lines 4-10, and shown as steps 610 and 620 in Figure 6, which is discussed on page 16, line 27, thru page 17, line 13.

Claim 47 recites “[a] method for marine navigation, comprising: receiving indication

of a minimum water depth from a user”, as described on page 6, lines 6-20; “displaying marine cartographic data”, as described on page 12, lines 7-17, and shown as item 400 in Figure 4A; “receiving indication of a potential waypoint”, as described on page 16, lines 29-31, and shown as step 600 in Figure 6; “displaying a substantially straight line between a first location and the potential waypoint”, as described on page 16, lines 18-20, and shown as the line between items 410 and 414 in Figure 4A; “wherein the line depicts both where the water depth is expected to be greater than the minimum water depth and where the water depth is expected to be less than the minimum water depth, and wherein the line highlights where the water depth is expected to be less than the minimum water depth”, as described on page 16, lines 21-24, and shown as item 418 in Figure 4A; and “performing a marine route calculation algorithm to route a course between the first location and the potential waypoint avoiding water depth less than the minimum water depth”, as described on page 8, lines 4-10, and shown as steps 610 and 620 in Figure 6, which is discussed on page 16, line 27, thru page 17, line 13.

Claim 48 recites “[a] method for marine navigation, comprising: displaying marine cartographic data”, as described on page 12, lines 7-17, and shown as item 400 in Figure 4A; “receiving indication of a potential waypoint”, as described on page 16, lines 29-31, and shown as step 600 in Figure 6; “displaying a substantially straight line between a first location and the potential waypoint”, as described on page 16, lines 18-20, and shown as the line between items 410 and 414 in Figure 4A; “wherein the line distinguishes where the water depth is expected to be greater than a preset minimum water depth from where the



water depth is expected to be less than the minimum water depth”, as described on page 16, lines 21-24, and shown as item 418 in Figure 4A; and “performing a marine route calculation algorithm to route a course between the first location and the potential waypoint avoiding water depth less than the minimum water depth”, as described on page 8, lines 4-10, and shown as steps 610 and 620 in Figure 6, which is discussed on page 16, line 27, thru page 17, line 13.

Claim 54 recites “[a] method for marine navigation, comprising: displaying marine cartographic data”, as described on page 12, lines 7-17, and shown as item 400 in Figure 4A; “receiving indication of a potential waypoint”, as described on page 16, lines 29-31, and shown as step 600 in Figure 6; and “displaying a substantially straight line on the marine cartographic data between a first location and the potential waypoint”, as described on page 16, lines 18-20, and shown as the line between items 410 and 414 in Figure 4A; and “wherein the line highlights where the water depth is expected to be less than a minimum water depth”, as described on page 16, lines 21-24, and shown as item 418 in Figure 4A.

Thus, various claimed embodiments of the present invention provides an aid to marine navigation by displaying, highlighting, and or routing around obstacles, such as underwater sand bars, reef structure, and the like.

Appellants also note that the page and line numbers cited above are for reference purposes only and should not be taken as a limitation on the support for, or scope of, the claimed subject matter. Support for the claimed subject matter may be found throughout the specification and drawings and the page and line numbers cited above merely refer to

exemplary portions of the specification.

## **VI. Grounds of Rejection to be Reviewed on Appeal**

- a. Claims 19, 20, and 22 stand rejected under 35 U.S.C. 102(b) as being anticipated Bailey et al., U.S. Patent No. 4,873,676.
- b. Claims 1, 5-10, 23, 27-32, 34, 38-40, 42-44, 58-61, 66, and 67 stand rejected under 35 U.S.C. 103(a) as being unpatentable over Fujimoto et al., U.S. Patent Application No. 2004/0006423 (Fujimoto '423) in view of Michaelson et al., U.S. Patent No. 6,734,808.
- c. Claims 45, 46, and 62 stand rejected under 35 U.S.C. 103(a) as being unpatentable over Fujimoto '423 and Michaelson in view of Walsh et al., U.S. Patent No. 3,886,487.
- d. Claims 47-57 and 63-65 stand rejected under 35 U.S.C. 103(a) as being unpatentable over Fujimoto et al., U.S. Patent Application No. 2004/0003958 (Fujimoto '958), in view of Fujimoto '423 and Michaelson.

Applicant appeals from these grounds of rejection.

## **VII. Argument**

### **Legal Discussion of Anticipation**

"A claim is anticipated only if each and every element as set forth in the claim is found, either expressly or inherently described, in a single prior art reference." MPEP §

Appeal of U.S. Application No. 10/667,026  
Appeal Brief dated December 13, 2006

2131, citing *Verdegaal Bros. v. Union Oil Co. of California*, 814 F.2d 628, 631, 2 USPQ2d 1051, 1053 (Fed. Cir. 1987). More specifically, “Federal Circuit decisions repeatedly emphasize that anticipation (lack of novelty) is established only if (1) all the elements of an invention, as stated in a patent claim, (2) are identically set forth, (3) in a single prior art reference”. Chisum on Patents § 3.02. See also *Gechter v. Davidson*, 43 USPQ2d 1030, 1032 (Fed. Cir. 1997) (“Under 35 U.S.C. § 102, every limitation of a claim must identically appear in a single prior art reference for it to anticipate the claim.”).

**a. Rejection of claims 19, 20, and 22 under 35 U.S.C. 102(b) as being anticipated Bailey et al., U.S. Patent No. 4,873,676.**

**I. Summary of Arguments**

Rather than analyzing cartographic data only within a user defined area, Bailey teaches analyzing sonar returns and automatically rescaling a user defined display area. Thus, Bailey cannot be said to teach, or even suggest, “analyzing cartographic data only within the user defined graphical filter area for the preselected conditions”, as claimed.

**II. Summary of the reference**

Bailey teaches a sonar apparatus. Bailey’s improvement over the prior art is his ability to detect the bottom and “change display scales in response to the detected bottom going off-scale”. Abstract. In other words, Bailey teaches rescaling a sonar display. It is

important to note that Bailey does not teach anything related to cartography. Bailey's only use of the term "map" is in association with a memory map, with is simply non-analogous to cartography.

**III. The Examiner failed to establish a *prima facie* case of anticipation as the cited reference does not teach each claim limitation.**

Claim 19 recites "analyzing *cartographic* data *only* within the user defined graphical filter area for the preselected conditions". The Examiner mistakenly asserts that this limitation is disclosed by Bailey in column 3, lines 26-36 and 46-48. Page 3 of the August 8, 2006 Final Office Action. However, column 3, lines 26-29 state "[a]utomatic display scale changing is provided in response to the detected bottom going off-scale, or in response to the detected bottom rising to within a predetermined depth". Therefore, Bailey actually teaches a system for automatically *rescaling* a display area based on changing water depth. In other words, rather than analyzing data only within a user defined area, Bailey teaches automatically redefining the user defined display area. In fact, the Examiner acknowledges "Bailey discloses an automatic display scale changing". Page 14 of the August 8, 2006 Final Office Action. Thus, Bailey overrides any user definition of an area.

Furthermore, Bailey analyzes the entirety of his automatically redefined display area for target data or sonar returns. In fact, Bailey must analyze the entirety of the sonar returns for two reasons. First, the very nature of sonar is that one sends out a pulse and

times the echo, thereby determining a distance to a target. Bailey's sonar signals, by their very nature, must pass completely through a predefined space under a boat. This space is predefined by the transducer itself. In other words, the user simply cannot define where the sonar signals go, and therefore cannot define any area, and Bailey's device therefore cannot analyze only a portion of the returns. Thus, one cannot analyze only a user defined area, one must analyze everything that is received. Second, Bailey must analyze all received signals in order to detect the bottom, which is of course, the entire point of Bailey's invention. Thus, Bailey analyzes the entirety of the area. Bailey may only display some portion of that area, but, as discussed above, Bailey redefines the display area, based on the analyzed sonar returns from the entire area.

Finally, Bailey doesn't teach analyzing **cartographic** data at all. Rather, as discussed above, Bailey teaches analyzing sonar returns. This is an important distinction. They are simply not the same nor analogous to one another, as they convey distinctly different information. Therefore, Bailey cannot be said to suggest "analyzing **cartographic** data **only** within the user defined graphical filter area for the preselected conditions", emphasis added, as claimed. Thus, Bailey simply fails to disclose, suggest or make obvious "analyzing cartographic data only within the user defined graphical filter area for the preselected conditions" as claimed in claim 19. As a result, the Examiner has failed to properly establish a *prima facie* case of anticipation, and therefore the present rejections of claims 19, 20, and 22 cannot be sustained.

### **Legal Discussion of Obviousness**

Obviousness can be a problematic basis for rejection because the Examiner, in deciding that a feature is obvious, has the benefit of the applicant's disclosure as a blueprint and guide. In contrast, one with ordinary skill in the art would have no such guide, in which light even an exceedingly complex solution may seem easy or obvious. Furthermore, once an obviousness rejection has been made, the applicant is in the exceedingly difficult position of having to prove a negative proposition (i.e., non-obviousness) in order to overcome the rejection.

For these reasons, the law places upon the Examiner the initial burden of establishing a *prima facie* case of obviousness. If the Examiner fails to establish the requisite *prima facie* case, the rejection is improper and will be overturned. *In re Rijckaert*, 9 F.3d 1531, 1532, 28 U.S.P.Q.2d 1955 (Fed. Cir. 1993). Only if the Examiner's burden is met does the burden shift to the Applicant to provide evidence to refute the rejection.

In meeting this initial burden, the Examiner "cannot use hindsight reconstruction to pick and choose among isolated disclosures in the prior art to deprecate the claimed invention." *In re Fine*, 837 F.2d 1071, 1075, 5 U.S.P.Q.2d 1596 (Fed. Cir. 1988). Thus, the Examiner is required to perform the "critical step" of casting his or her mind back to the time of invention, to consider the thinking of one of ordinary skill in the art, guided only by the prior art references and the then-accepted wisdom in the field. *See, e.g., W. L. Gore & Assoc., Inc. v. Garlock, Inc.*, 721 F.2d 1540, 1553, 220 U.S.P.Q. 303 (Fed. Cir. 1983).

Rejections on obviousness grounds also cannot be sustained by mere conclusory

statements; instead, there must be some articulated reasoning with some rational underpinning to support the legal conclusion of obviousness. *In re Kahn*, 441 F.3d 977, 988, 78 U.S.P.Q.2d 1329 (Fed. Cir. 2006). The factual inquiry performed by the Examiner in issuing an obviousness rejection must be thorough and searching. *McGinley v. Franklin Sports, Inc.*, 262 F.3d 1339, 1351-52, 60 U.S.P.Q.2d 1001 (Fed. Cir. 2001). The prohibition against conclusory examination is as much rooted in the Administrative Procedure Act, which ensures due process and non-arbitrary decision-making, as it is in § 103. *In re Kahn*, 441 F.3d at 988.

Three criteria must be satisfied by the Examiner in order to establish a prima facie case of obviousness: (1) there must be some suggestion or motivation, either in the references themselves or in the knowledge generally available to one of ordinary skill in the art, to modify the reference or combine their teachings; (2) there must be a reasonable expectation of success; and (3) the combination of references must teach or suggest all the claim limitations. See MPEP § 706.02(j), citing *In re Vaeck*, 947 F.2d 488, 493, 20 U.S.P.Q.2d 1438 (Fed. Cir. 1991). This "motivation-suggestion-teaching" requirement protects against the entry of hindsight into the obviousness analysis, a problem which § 103 was meant to confront. *In re Kahn*, 441 F.3d at 988.

Consequently, an Examiner's mere identification in the prior art of each individual element claimed is insufficient to defeat the patentability of a claimed invention without a proper suggestion to combine or modify the elements. *In re Rouffet*, 149 F.3d 1350, 1357, 47 U.S.P.Q.2d 1453 (Fed. Cir. 1998). The fact that references can be combined or

Appeal of U.S. Application No. 10/667,026  
Appeal Brief dated December 13, 2006

modified does not render the resultant combination obvious unless the prior art also suggests the desirability of the combination. *In re Gordon*, 733 F.2d 900, 902, 221 USPQ 1125 (Fed. Cir. 1984).

In presenting the suggestion or motivation to combine prior art references, the Examiner may not resort to broad and conclusory statements; as such statements are not “evidence” of anything. *In re Kotzab*, 217 F.3d 1365, 1370, 55 U.S.P.Q.2d 1313 (Fed. Cir. 2000). The suggestion to make the claimed combination must be found in the prior art, not in the applicant's disclosure. *In re Vaeck*, 947 F.2d at 490. If the Examiner's proposed combination renders the prior art invention unsatisfactory for its intended purpose, or changes its principal of operation, there can be no suggestion or motivation to form the combination—and thus no *prima facie* case of obviousness. See MPEP § 2143.01; *In re Gordon*, 733 F.2d at 902.

- b. Claims 1, 5-10, 23, 27-32, 34, 38-40, 42-44, 58-61, 66, and 67 stand rejected under 35 U.S.C. 103(a) as being unpatentable over Fujimoto et al., U.S. Patent Application No. 2004/0006423 (Fujimoto '423) in view of Michaelson et al., U.S. Patent No. 6,734,808.**

#### **I. Summary of Arguments**

Rather than identifying a non-user selected waypoint to avoid a condition, Michaelson teaches only suggesting a heading and/or depth change. Thus, the cited



references cannot be said to teach, or even suggest, rerouting a “course to avoid the preselected conditions by identifying one or more non-user selected waypoints”, as claimed. Furthermore, the Examiner fails to provide the requisite suggestion or motivation to combine Fujimoto ‘423 and Michaelson.

## **II. Summary of the References**

Fujimoto ‘423 teaches a maneuvering “system for automatically track-keeping a movable object so as to move along a planned route”. ¶ 0002. In other words, when a user selects a waypoint, the system draws a straight line to the waypoint and Fujimoto’s system attempts to not only reach the waypoint, but to also keep the vessel on the line with as little deviation as possible.

Michaelson teaches a navigational system for providing a “warning of an impending grounding”. Abstract. However, Michaelson only suggests a heading and/or depth change to avoid an obstacle. Michaelson is simply devoid of any suggestion of identifying non-user selected waypoints.

## **III. The Examiner failed to establish a *prima facie* case of obviousness as the cited references do not teach each claim limitation nor does the Examiner provide the requisite suggestion or motivation for combining references.**

Claims 1, 23, 34, and 44, stand rejected under various combinations of Fujimoto

'423 and Michaelson. Claim 1 recites "performing a marine route calculation algorithm to route a course between a first location and the potential waypoint avoiding the preselected conditions, including analyzing cartographic data between the first location and the potential waypoint and re-routing the course to avoid the preselected conditions by identifying one or more non-user selected waypoints". Similarly, claim 23 recites "performing a marine route calculation algorithm to analyze a course between a first location and the potential waypoint avoiding the preselected conditions, including analyzing cartographic data between the first location and the potential waypoint and re-routing the course to avoid the preselected conditions by identifying one or more non-user selected waypoints". Claim 34 recites "wherein the processor operates on a marine route calculation algorithm to analyze a course between the first location and the potential waypoint in view of the preselected conditions of the cartographic data and re-route the course to avoid the preselected conditions by identifying one or more non-user selected waypoints". Claim 44 recites "performing a marine route calculation algorithm to analyze a course between a first location and the potential waypoint in order to avoid preselected conditions received from a user and re-route the course to avoid the preselected conditions by identifying one or more non-user selected waypoints".

In contrast, the Examiner acknowledges that "Fujimoto ... does not disclose non-user waypoints". Page 4 of the August 8, 2006 Final Office Action. To cure this defect, the Examiner mistakenly asserts that "Michaelson, on the other hand discloses re-routing the course by identifying one or more non-user waypoints". Page 4 of the August 8, 2006

Final Office Action. In supporting this assertion, the Examiner points to column 24 lines 41-50 and 55-64. The Examiner also points to column 13, line 56, through column 14, line 4.

However, column 24 clearly states that Michaelson's invention merely "alerts the crew to a new heading to steer or engine setting to avoid collisions". Column 24, lines 38-41. Specifically, column 24, lines 57-58, state an "alternate track PT" is first generated by incrementing the ship's heading by [a] nominal step size". Columns 13 and 14, on the other hand, merely disclose providing warnings such as "go shallow" to avoid grounding a submarine. Thus, Michaelson only suggests a heading and/or depth change to avoid an obstacle. In fact, Michaelson is devoid of any suggestion of "**identifying one or more non-user selected waypoints**", emphasis added, as claimed.

As a result, no combination of Fujimoto '423 and/or Michaelson discloses, suggests or makes obvious "performing a marine route calculation algorithm to route a course between a first location and the potential waypoint avoiding the preselected conditions, including analyzing cartographic data between the first location and the potential waypoint and re-routing the course to avoid the preselected conditions by identifying one or more non-user selected waypoints", as claimed in claim 1. No combination of Fujimoto '423 and/or Michaelson discloses, suggests or makes obvious "performing a marine route calculation algorithm to analyze a course between a first location and the potential waypoint avoiding the preselected conditions, including analyzing cartographic data between the first location and the potential waypoint and re-routing the course to avoid the

preselected conditions by identifying one or more non-user selected waypoints”, as claimed in claim 23. No combination of Fujimoto ‘423 and/or Michaelson discloses, suggests or makes obvious “wherein the processor operates on a marine route calculation algorithm to analyze a course between the first location and the potential waypoint in view of the preselected conditions of the cartographic data and re-route the course to avoid the preselected conditions by identifying one or more non-user selected waypoints”, as claimed in claim 34. No combination of Fujimoto ‘423 and/or Michaelson discloses, suggests or makes obvious “performing a marine route calculation algorithm to analyze a course between a first location and the potential waypoint in order to avoid preselected conditions received from a user and re-route the course to avoid the preselected conditions by identifying one or more non-user selected waypoints”, as claimed in claim 44.

Furthermore, the Examiner fails to provide the requisite suggestion or motivation to combine Fujimoto ‘423 and Michaelson. Rather, with respect to claims 1 and 44, the Examiner asserts “[i]t would have been obvious to disclose non-user waypoints so that an operator of a ship relies on automatic navigation between a point of origin and a destination without constantly monitoring the ship’s travel route”. Page 4 of the August 8, 2006 Final Office Action.

However, the test is not what might “have been obvious to disclose”. Rather, there must be some suggestion, found in the prior art rather than the applicant's disclosure, to combine one prior art reference with another. Here, as discussed above, the references don’t even teach what the Examiner asserts, much less provide any suggestion or

motivation to combine their teachings.

In the present case, Fujimoto identifies a problem and solves it. Similarly, Michaelson identifies a problem and solves it. The Examiner's stated motivation might provide Fujimoto's motivation or might provide Michaelson's motivation, but would not motivate one with ordinary skill in the art to combine their teachings. Specifically, the Examiner's assertion does not provide any motivation to actually identify "one or more non-user selected waypoints", as claimed, certainly not over Michaelson's warnings and suggestion of a heading change. Specifically, once the crew has been alerted and even given a new heading to steer, as taught by Michaelson, the motivation would be satisfied, and therefore no longer exist. Thus, not only does the Examiner fail to cite references that teach each and every claim limitation, the Examiner also fails to provide the requisite suggestion or motivation to combine references. As a result, the Examiner has failed to establish a *prima facie* case of obviousness, and therefore the present rejections cannot be sustained.

- c. Claims 45, 46, and 62 stand rejected under 35 U.S.C. 103(a) as being unpatentable over Fujimoto '423 and Michaelson in view of Walsh et al., U.S. Patent No. 3,886,487.**

**I. Summary of Arguments**

As discussed above, rather than identifying a non-user selected waypoint to avoid a condition, Michaelson teaches only suggesting a heading and/or depth change. Neither Fujimoto nor Walsh even go this far. Thus, the cited references cannot be said to teach, or even suggest, rerouting a “course to avoid the preselected conditions by identifying one or more non-user selected waypoints”, as claimed. Furthermore, the Examiner fails to provide the requisite suggestion or motivation to combine Fujimoto ‘423, Michaelson, and/or Walsh.

## **II. Summary of the References**

Both Fujimoto and Michaelson have been summarized above.

Walsh, like Bailey, teaches a sonar system. Walsh’s improvement over the prior art is the fact his sonar is forwardly directed, and therefore is useful in navigating shallow waters. Abstract.

## **III. The Examiner failed to establish a *prima facie* case of obviousness as the cited references do not teach each claim limitation nor does the Examiner provide the requisite suggestion or motivation for combining references.**

Claim 45 recites “performing a marine route calculation algorithm to route a course between a first location and the potential waypoint avoiding water depth less than the minimum water depth by identifying one or more non-user selected waypoints”.

The Examiner rejected claim 45 “for the same reasons as stated in the rejection of claim 1 as stated above”. Page 9 of the August 8, 2006 Final Office Action. Specifically, the Examiner acknowledges that “Fujimoto ... does not disclose non-user waypoints”. Page 4 of the August 8, 2006 Final Office Action. To cure this defect, the Examiner mistakenly asserts that “Michaelson, on the other hand discloses re-routing the course by identifying one or more non-user waypoints”. Page 4 of the August 8, 2006 Final Office Action. However, as discussed above, Michaelson only suggests a heading and/or depth change to avoid an obstacle and is devoid of any suggestion of “**identifying one or more non-user selected waypoints**”, emphasis added, as claimed.

The Examiner goes on to mistakenly assert that “Walsh discloses receiving indication of a minimum water depth from a user and avoiding water depth less than the minimum water depth”. Page 10 of the August 8, 2006 Final Office Action.

However, Walsh merely warns the operator to change course. Specifically, Walsh doesn’t even suggest an alternate heading/depth, much less any non-user defined waypoints. For example, as stated in column 9, lines 6-10, Walsh merely discloses transmitting “as signal to the alarm 188 which in turn then warns the operator of the ship 20 to change course or take other evasive action”, when the depth ahead is too shallow. In other words, Walsh simply provides a warning of an impending collision/grounding. Therefore, Walsh fails to even provide a suggested heading and/or depth change, much less non-user selected waypoints that may be used to avoid the hazard. Thus, at least in this regard, Walsh teaches even less than Michaelson.

Thus, neither Michaelson nor Walsh supply the element the Examiner acknowledge is absent from Fujimoto. As a result, no combination of Fujimoto '423, Michaelson, and/or Walsh discloses, suggests or makes obvious "performing a marine route calculation algorithm to route a course between a first location and the potential waypoint avoiding water depth less than the minimum water depth by identifying one or more non-user selected waypoints", as claimed in claim 45.

Furthermore, the Examiner asserts "[i]t would have been obvious to avoid a water depth less than the minimum water depth so that a ship's operator acknowledges a dangerous water depth and verifies that the ship is maneuvered around or away from an insufficient water depth to ensure the safety of the ships' passengers". Page 10 of the August 8, 2006 Final Office Action. However, this assertion does not provide any motivation to actually identify "one or more non-user selected waypoints", as claimed, certainly not over Michaelson's warnings and suggestion of a heading change. Specifically, once the crew has been alerted and even given a new heading, there would be no need for Walsh's warning. Therefore, the stated motivation doesn't actually provide any motivation to combine Walsh with the system of Michaelson, much less any motivation that might render the present claims obvious.

Thus, not only does the Examiner fail to cite references that teach each and every claim limitation, the Examiner also fails to provide the requisite suggestion or motivation to combine references. As a result, the Examiner has failed to establish a *prima facie* case of obviousness, and therefore the present rejections cannot be sustained.



- d. Claims 47-57 and 63-65 stand rejected under 35 U.S.C. 103(a) as being unpatentable over Fujimoto et al., U.S. Patent Application No. 2004/0003958 (Fujimoto '958), in view of Fujimoto '423 and Michaelson.**

**I. Summary of Arguments**

None of the cited prior art references teach, or suggest, “highlighting where the water depth is expected to be less than the minimum water depth” on “a substantially straight line between a first location and the potential waypoint”. Furthermore, the Examiner fails to provide the requisite suggestion or motivation to combine Fujimoto '958, Fujimoto '423, and/or Michaelson.

**II. Summary of the Reference**

Like Bailey, Fujimoto '958 teaches a sonar apparatus. Fujimoto's improvements appear to be a split screen display and a shallow water alarm. See Abstract. However, like Bailey, Fujimoto does not teach anything related to cartography. In fact, Fujimoto does not even include any version of the word “cartography” or the term “map”. Furthermore, Fujimoto does not include the term “waypoint”, as Fujimoto is simply unrelated to navigation.

Both Fujimoto '423 and Michaelson have been summarized above.

**III. The Examiner failed to establish a *prima facie* case of obviousness as the cited references do not teach each claim limitation nor does the Examiner provide the requisite suggestion or motivation for combining references.**

Claim 47 recites “displaying a substantially straight line between a first location and the potential waypoint, wherein the line depicts both where the water depth is expected to be greater than the minimum water depth and where the water depth is expected to be less than the minimum water depth, and wherein the line highlights where the water depth is expected to be less than the minimum water depth”. Similarly, claim 48 recites “displaying a substantially straight line between a first location and the potential waypoint, wherein the line distinguishes where the water depth is expected to be greater than a preset minimum water depth from where the water depth is expected to be less than the minimum water depth”. Claim 51 recites “wherein the line is displayed on the marine cartographic data in a plan view”. Claim 54 recites “displaying a substantially straight line on the marine cartographic data between a first location and the potential waypoint, wherein the line highlights where the water depth is expected to be less than a minimum water depth”.

In contrast, the only straight line the Examiner points to, Fujimoto '958's item 45, is depicted completely independently of actual water depth. In fact, Fujimoto '958's item 45 “designates an alarm water depth line”. ¶ 73. This line is arbitrarily set by the user as a minimum water depth, above which Fujimoto '958's apparatus provides an alarm.

Therefore, as taught by Fujimoto '958, this line, item 45, as well as all other lines taught by Fujimoto '958, is necessarily displayed on a sonar display, rather than "between a first location and the potential waypoint", much less "on the marine **cartographic** data", emphasis added, or "wherein the line is displayed on the marine cartographic data in a plan view", as claimed.

Fujimoto '958's only line that relates to an actual water depth is item 43, which depicts a seabed and therefore simply cannot be substantially straight. Of course, displaying item 43 as substantially straight would render it unsatisfactory for its intended purpose, namely depicting the seabed. Furthermore, as discussed above, this line, item 43, is necessarily displayed on a sonar display, rather than "between a first location and the potential waypoint", much less "on the marine **cartographic** data", emphasis added, or "wherein the line is displayed on the marine cartographic data in a plan view", as claimed.

Finally, neither of these lines, themselves, actually highlight or distinguish where the water depth is above or below a minimum. In fact, the Examiner acknowledges that "Fujimoto does not disclose highlighting the water depth line". Page 11 of the August 8, 2006 Final Office Action. In order to cure this defect, the Examiner asserts "Michaelson discloses highlighting a terrain threat indication". Pages 11 and 12 of the August 8, 2006 Final Office Action. However, the Examiner fails to cite to any portion of Michaelson that teaches this. In fact, Michaelson does not include any variation on the word "highlight". Michaelson simply does not teach highlighting or distinguishing any portion of any **line** "between a first location and the potential waypoint", much less any line "on the marine

**cartographic** data”, emphasis added, or “wherein the line is displayed on the marine cartographic data in a plan view”, as claimed.

As a result, no combination of either Fujimoto reference and/or Michaelson discloses, suggests or makes obvious “displaying a substantially straight line between a first location and the potential waypoint, wherein the line depicts both where the water depth is expected to be greater than the minimum water depth and where the water depth is expected to be less than the minimum water depth, and wherein the line highlights where the water depth is expected to be less than the minimum water depth”, as claimed in claim 47, “displaying a substantially straight line between a first location and the potential waypoint, wherein the line distinguishes where the water depth is expected to be greater than a preset minimum water depth from where the water depth is expected to be less than the minimum water depth”, as claimed in claim 48, “wherein the line is displayed on the marine cartographic data in a plan view”, as claimed in claim 51, or “displaying a substantially straight line on the marine cartographic data between a first location and the potential waypoint, wherein the line highlights where the water depth is expected to be less than a minimum water depth”, as claimed in claim 54.

Furthermore, the Examiner fails to provide the requisite suggestion or motivation to combine Fujimoto ‘958, Fujimoto ‘423, and/or Michaelson. Rather, the Examiner asserts that “[i]t would have been obvious to emphasize a **water depth line** by highlighting”, emphasis added. Page 12 of the August 8, 2006 Final Office Action. Of course, whether highlighting a **water depth line** would be obvious or not is immaterial to the question of

whether it would be obvious to highlight a line between two locations, such as a route segment, depending on water depth. Such teachings are found only in Applicant's own disclosure. In contrast, as discussed above, in order to establish a *prima facie* case of obviousness, there must be some suggestion, found in the prior art rather than the applicant's disclosure, to combine one prior art reference with another. Here, as discussed above, the references don't even teach what the Examiner asserts, much less provide any suggestion or motivation to combine their teachings.

Thus, not only does the Examiner fail to cite references that teach each and every claim limitation, the Examiner also fails to provide the requisite suggestion or motivation to combine references. As a result, the Examiner has failed to establish a *prima facie* case of obviousness, and therefore the present rejections cannot be sustained.

Claim 50 recites "wherein the line is depicted in a first manner where the water depth is expected to be greater than the minimum water depth and the line is depicted in a second manner where the water depth is expected to be less than the minimum water depth".

The Examiner mistakenly asserts that Fujimoto '958 teaches these limitations. However, as discussed above, Fujimoto '958 merely displays a seabed line 125 above or below a depth mark 124, as the case may be, but the seabed line 125 is otherwise displayed in the exact same manner both above and below the depth mark 124. In fact, the Examiner acknowledges that "Fujimoto does not disclose highlighting the water depth line". Page 11 of the August 8, 2006 Final Office Action. The Examiner also

acknowledges that “Fujimoto ... does not disclose first and second manners of displaying a line”. Page 12 of the August 8, 2006 Final Office Action. Simply put, there is no difference in the line itself or the manner in which it is displayed, such as highlighting color, solid vs. broken or dashed, whether that portion of the line is flashing, or whether that portion of the line is bolded. In fact, Fujimoto ‘958 lacks any suggestion to show any portion of the seabed line 123 in a different manner. As a result, no combination of either Fujimoto reference and/or Michaelson discloses, suggests or makes obvious “wherein the line is depicted in a first manner where the water depth is expected to be greater than the minimum water depth and the line is depicted in a second manner where the water depth is expected to be less than the minimum water depth”, as claimed in claim 50.

Claim 52 recites “wherein the first manner is different from the second manner, such that the line itself is displayed differently in the first manner compared with the second manner”. Claim 53 recites “wherein the first manner comprises displaying the line in a first color and the second manner comprises displaying the line in a second color different from the first color”. Claim 57 recites “wherein the line is displayed in a different manner where the water depth is expected to be less than a minimum water depth”. Claim 65 recites “wherein the line is displayed in a first manner where the water depth is expected to be greater than the preset minimum water depth and a second manner, different from the first manner, where the water depth is expected to be less than the minimum water depth”.

For example, this capability is shown in figures 2A, 4A, and 4C and described on pages 11-14, among other places. Of course, claim 48, from which claims 52 and 53

depend, recites “displaying a substantially straight line between a first location and the potential waypoint”. Similarly, claim 54, from which claim 57 depends, recites “displaying a substantially straight line on the marine cartographic data between a first location and the potential waypoint”. Finally, claim 47, from which claim 65 depends, recites “displaying a substantially straight line between a first location and the potential waypoint”. Thus, the line is substantially straight and depicts a path between two points. Furthermore, in the case of claim 57, the line is displayed on “marine cartographic data”.

In contrast, the Examiner acknowledges that “Fujimoto ... does not disclose first and second manners of displaying a line”. Page 12 of the August 8, 2006 Final Office Action. In order to cure this defect, the Examiner asserts “Michaelson discloses first and second colors to display terrain indications”. Page 12 of the August 8, 2006 Final Office Action. In supporting this assertion, the Examiner points to column 27, lines 40-65. However, Michaelson’s terrain indications are simply not analogous to the presently claimed line. Specifically, Michaelson merely teaches varying the color of the displayed terrain data itself, rather than any path through the terrain. See column 27, lines 48-65. As a result, no combination of either Fujimoto reference and/or Michaelson discloses, suggests or makes obvious “wherein the first manner is different from the second manner, such that the line itself is displayed differently in the first manner compared with the second manner”, as claimed in claim 52, “wherein the first manner comprises displaying the line in a first color and the second manner comprises displaying the line in a second color different from the first color”, as claimed in claim 53, “wherein the line is displayed in a different manner

where the water depth is expected to be less than a minimum water depth”, as claimed in claim 57, or “wherein the line is displayed in a first manner where the water depth is expected to be greater than the preset minimum water depth and a second manner, different from the first manner, where the water depth is expected to be less than the minimum water depth”, as claimed in claim 65.

Claim 55 recites “performing a marine route calculation algorithm to route a course from the first location to the potential waypoint avoiding areas where the water depth is expected to be less than the minimum water depth by identifying one or more non-user selected waypoints”. Claims 63 and 66 each recite “wherein the step of performing a marine route calculation algorithm includes identifying one or more non-user selected waypoints”. Similarly, claims 56, 58-62, 64, and 67 each recite “displaying the course from the first location to the potential waypoint via the non-user selected waypoints”.

In contrast, as discussed above, no combination of either Fujimoto reference and/or Michaelson discloses, suggests or makes obvious “identifying one or more non-user selected waypoints”, as claimed in claims 55, 63, and 66, or “displaying the course from the first location to the potential waypoint via the non-user selected waypoints”, as claimed in claims 56, 58-62, 64, and 67, much less in combination with the other limitations of these claims.

It should be noted that claims 58-61, 66, and 67 stand rejected in view of only Fujimoto '423 and Michaelson. However, the limitations added by claims 58-61, 66, and 67 are identical to the limitations added by claims 56 and 63. Additionally, the references



addressed in this section include the references used in the rejection of claims 58-61, 66, and 67. Therefore, the rejections of claims 58-61, 66, and 67 are properly addressed here.

Additionally, claim 62 stands rejected in view of Fujimoto '423, Michaelson, and Walsh. However, Walsh is not specifically applied to claim 62. Rather, the Examiner's rejection of claim 62 consists entirely of "the claim is interpreted and rejected for the same reasons as stated in the rejections of claims 1 and 58 as stated above." Page 10 of the August 8, 2006 Final Office Action. Therefore, the rejection of claim 62 is also properly addressed here.

#### **G. Conclusion**

The Examiner failed, with regard to the rejection of the pending claims under 35 U.S.C. §102(e), to establish the requisite *prima facie* case of anticipation because the cited references do not teach each claim limitation. Similarly, the Examiner failed, with regard to the rejection of the pending claims under 35 U.S.C. §103(a), to establish the requisite *prima facie* case of obviousness because the cited references do not teach each claim limitation and the Examiner has not provided the requisite suggestion or motivation to combine the cited references. In summation, the Examiner acknowledges that Fujimoto fails to expressly set forth each element of the currently pending claims. However, the Examiner's assertions that Michealson and/or Welsh set forth the missing elements are simply erroneous, as described above. Thus, the Examiner failed to establish the requisite

Appeal of U.S. Application No. 10/667,026  
Appeal Brief dated December 13, 2006

*prima facie* case of anticipation and obviousness, and therefore the rejections under 35 U.S.C. § 102 and 35 U.S.C. § 103 cannot be sustained and must be overturned.

Accordingly, reversal of the Examiner's rejections is proper, and such favorable action is solicited.

Respectfully submitted,

By: /David L. Terrell/  
David L. Terrell, Reg. No. 50,576  
Garmin International, Inc.  
1200 East 151<sup>st</sup> Street  
Olathe, KS 66062  
(913) 397-8200  
(913) 397-9079 (Fax)

**VIII. Claims Appendix**

1. (Previously Presented) A method for marine navigation, comprising:  
receiving one or more preselected conditions from a user;  
identifying a potential waypoint; and  
performing a marine route calculation algorithm to route a course between a first location and the potential waypoint avoiding the preselected conditions, including analyzing cartographic data between the first location and the potential waypoint and re-routing the course to avoid the preselected conditions by identifying one or more non-user selected waypoints.
  
5. (Previously Presented) The method of claim 1, further including determining the first location on the course based on a signal from a global positioning system (GPS); and analyzing cartographic data for a predetermined area around the first location for preselected conditions.
  
6. (Original) The method of claim 5, further including providing an alert signal when the analyzed cartographic data for the predetermined area around the first location includes preselected conditions.

7. (Previously Presented) The method of claim 1, further including providing an alert signal when the analyzed cartographic data between the first location and the potential waypoint includes preselected conditions.

8. (Original) The method of claim 7, wherein providing the alert signal includes emitting an audio alert.

9. (Original) The method of claim 7, wherein providing the alert signal includes displaying a visual alert.

10. (Previously Presented) The method of claim 1, the preselected conditions including a weather condition.

19. (Previously Presented) A method for marine navigation, comprising:  
receiving one or more preselected conditions from a user;  
receiving a user defined graphical filter area from the user;  
identifying the user defined graphical filter area on a display;  
analyzing cartographic data only within the user defined graphical filter area for the preselected conditions; and  
providing an alert signal when cartographic data within the user defined graphical filter area indicate the preselected conditions.

20. (Original) The method of claim 19, wherein identifying the user defined graphical filter area includes repositioning the user defined graphical filter area.

21. (Original) The method of claim 19, wherein analyzing cartographic data further comprises acquiring cartographic data from a global positioning system (GPS).

22. (Original) The method of claim 19, further including receiving preselected conditions selected from the group of land, water depth, rock(s), sandbars, shelves, tide condition, tidal data, wind conditions, weather conditions, ice, above-water obstacles, underwater obstacles, type of water bottom, and prohibited areas.

23. (Previously Presented) A computer readable medium having a set of computer readable instructions, the set of computer readable instructions comprising instructions for:

- receiving one or more preselected conditions from a user;
- identifying a potential waypoint upon a first event; and
- performing a marine route calculation algorithm to analyze a course between a first location and the potential waypoint avoiding the preselected conditions, including analyzing cartographic data between the first location and the potential waypoint and re-routing the course to avoid the preselected conditions by identifying one or more non-user selected waypoints.

27. (Original) The computer readable medium of claim 23, further including determining the first location on the course based on a signal from a global positioning system (GPS); and analyzing cartographic data for a predetermined area around the first location for preselected conditions.

28. (Original) The computer readable medium of claim 27, further including providing an alert signal when the analyzed cartographic data for the predetermined area around the first location includes preselected conditions.

29. (Original) The computer readable medium of claim 23, wherein analyzing cartographic data further comprises acquiring cartographic data from a global positioning system (GPS).

30. (Original) The computer readable medium of claim 23, further including providing an alert signal when the analyzed cartographic data between the first location and the potential waypoint includes preselected conditions.

31. (Original) The computer readable medium of claim 30, wherein providing the alert signal includes emitting a signal for an audio alert.

32. (Original) The computer readable medium of claim 30, wherein providing the alert signal includes displaying a visual alert.

33. (Previously Presented) The computer readable medium of claim 23, the preselected conditions including a water depth.

34. (Previously Presented) An electronic marine navigation device, comprising:  
a processor;  
a user interface operatively coupled to the processor, wherein the user interface receives one or more preselected conditions from a user;  
a location input operatively coupled to the processor, wherein the location input receives a first location and a potential waypoint separate from the first location; and  
a memory operatively coupled to the processor and the location input, the memory having cartographic data including data related to the preselected conditions, wherein the processor operates on a marine route calculation algorithm to analyze a course between the first location and the potential waypoint in view of the preselected conditions of the cartographic data and re-route the course to avoid the preselected conditions by identifying one or more non-user selected waypoints.

38. (Previously Presented) The electronic marine navigation device of claim 34, further including a receiver for a global positioning system (GPS) operatively coupled to the processor, wherein the processor determines the first location on the course based on a signal received from the GPS, and analyzes cartographic data for a predetermined area around the first location for preselected conditions.

39. (Original) The electronic marine navigation device of claim 38, wherein the processor provides an alert signal when the analyzed cartographic data for the predetermined area around the first location includes preselected conditions.

40. (Previously Presented) The electronic marine navigation device of claim 34, wherein the processor provides an alert signal when the analyzed cartographic data between the first location and the potential waypoint includes preselected conditions.

41. (Original) The electronic marine navigation device of claim 34, wherein the location input receives a user defined graphical filter area, and wherein the processor operates on the marine route calculation algorithm to analyze cartographic data within the defined graphical filter area for preselected conditions and wherein the processor provides an alert signal when the analyzed cartographic data for the user defined graphical filter area includes preselected conditions.



42. (Previously Presented) The method of claim 1, wherein both the first location and the potential waypoint are independent of a current location of a device implementing the method.

43. (Previously Presented) The method of claim 1, wherein at least a portion of the course is unrelated to a current heading of a device implementing the method.

44. (Previously Presented) A method for marine navigation, comprising:  
identifying a potential waypoint; and  
performing a marine route calculation algorithm to analyze a course between a first location and the potential waypoint in order to avoid preselected conditions received from a user and re-route the course to avoid the preselected conditions by identifying one or more non-user selected waypoints.

45. (Previously Presented) A method for marine navigation, comprising:  
receiving indication of a minimum water depth from a user;  
identifying a potential waypoint; and  
performing a marine route calculation algorithm to route a course between a first location and the potential waypoint avoiding water depth less than the minimum water depth by identifying one or more non-user selected waypoints.

46. (Previously Presented) The method of claim 45, displaying a visual indication of places along the calculated course where the water depth is expected to approach the minimum water depth.

47. (Previously Presented) A method for marine navigation, comprising:  
receiving indication of a minimum water depth from a user;  
displaying marine cartographic data;  
receiving indication of a potential waypoint;  
displaying a substantially straight line between a first location and the potential waypoint, wherein the line depicts both where the water depth is expected to be greater than the minimum water depth and where the water depth is expected to be less than the minimum water depth, and wherein the line highlights where the water depth is expected to be less than the minimum water depth; and  
performing a marine route calculation algorithm to route a course between the first location and the potential waypoint avoiding water depth less than the minimum water depth.

48. (Previously Presented) A method for marine navigation, comprising:
- displaying marine cartographic data;
  - receiving indication of a potential waypoint;
  - displaying a substantially straight line between a first location and the potential waypoint, wherein the line distinguishes where the water depth is expected to be greater than a preset minimum water depth from where the water depth is expected to be less than the minimum water depth; and
  - performing a marine route calculation algorithm to route a course between the first location and the potential waypoint avoiding water depth less than the minimum water depth.
49. (Previously Presented) The method of claim 48, wherein the minimum water depth is user selectable.
50. (Previously Presented) The method of claim 48, wherein the line is depicted in a first manner where the water depth is expected to be greater than the minimum water depth and the line is depicted in a second manner where the water depth is expected to be less than the minimum water depth.
51. (Previously Presented) The method of claim 48, wherein the line is displayed on the marine cartographic data in a plan view.

52. (Previously Presented) The method of claim 50, wherein the first manner is different from the second manner, such that the line itself is displayed differently in the first manner compared with the second manner.

53. (Previously Presented) The method of claim 50, wherein the first manner comprises displaying the line in a first color and the second manner comprises displaying the line in a second color different from the first color.

54. (Previously Presented) A method for marine navigation, comprising:  
displaying marine cartographic data;  
receiving indication of a potential waypoint; and  
displaying a substantially straight line on the marine cartographic data between a first location and the potential waypoint, wherein the line highlights where the water depth is expected to be less than a minimum water depth.

55. (Previously Presented) The method of claim 54, further including the step of performing a marine route calculation algorithm to route a course from the first location to the potential waypoint avoiding areas where the water depth is expected to be less than the minimum water depth by identifying one or more non-user selected waypoints.

56. (Previously Presented) The method of claim 55, further including the step of displaying the course from the first location to the potential waypoint via the non-user selected waypoints.

57. (Previously Presented) The method of claim 54, wherein the line is displayed in a different manner where the water depth is expected to be less than a minimum water depth.

58. (Previously Presented) The method of claim 1, further including the step of displaying the course from the first location to the potential waypoint via the non-user selected waypoints.

59. (Previously Presented) The computer readable medium of claim 23, further including instructions for displaying the course from the first location to the potential waypoint via the non-user selected waypoints.

60. (Previously Presented) The electronic marine navigation device of claim 34, further including a display for displaying the course from the first location to the potential waypoint via the non-user selected waypoints.

61. (Previously Presented) The method of claim 44, further including the step of displaying the course from the first location to the potential waypoint via the non-user selected waypoints.

62. (Previously Presented) The method of claim 45, further including the step of displaying the course from the first location to the potential waypoint via the non-user selected waypoints.

63. (Previously Presented) The method of claim 47, wherein the step of performing a marine route calculation algorithm includes identifying one or more non-user selected waypoints.

64. (Previously Presented) The method of claim 63, further including the step of displaying the course from the first location to the potential waypoint via the non-user selected waypoints.

65. (Previously Presented) The method of claim 47, wherein the line is displayed in a first manner where the water depth is expected to be greater than the preset minimum water depth and a second manner, different from the first manner, where the water depth is expected to be less than the minimum water depth.

Appeal of U.S. Application No. 10/667,026  
Appeal Brief dated December 13, 2006

66. (Previously Presented) The method of claim 48, wherein the step of performing a marine route calculation algorithm includes identifying one or more non-user selected waypoints.

67. (Previously Presented) The method of claim 66, further including the step of displaying the course from the first location to the potential waypoint via the non-user selected waypoints.

Appeal of U.S. Application No. 10/667,026  
Appeal Brief dated December 13, 2006

**IX. Evidence Appendix**

None.



Appeal of U.S. Application No. 10/667,026  
Appeal Brief dated December 13, 2006

**X. Related Proceedings Appendix**

None.

## Electronic Patent Application Fee Transmittal

<b>Application Number:</b>	10667026			
<b>Filing Date:</b>	18-Sep-2003			
<b>Title of Invention:</b>	Methods, systems, and devices for cartographic alerts			
First Named Inventor/Applicant Name:	Darrin W. Kabel			
<b>Filer:</b>	David L. Terrell/Christine Terrell			
<b>Attorney Docket Number:</b>	702.254			
Filed as Large Entity				
<b>Utility Filing Fees</b>				
<b>Description</b>	<b>Fee Code</b>	<b>Quantity</b>	<b>Amount</b>	<b>Sub-Total in USD(\$)</b>
<b>Basic Filing:</b>				
<b>Pages:</b>				
<b>Claims:</b>				
<b>Miscellaneous-Filing:</b>				
<b>Petition:</b>				
<b>Patent-Appeals-and-Interference:</b>				
Filing a brief in support of an appeal	1402	1	500	500
Post-Allowance-and-Post-Issuance:				
<b>Extension-of-Time:</b>				

Description	Fee Code	Quantity	Amount	Sub-Total in USD(\$)
<b>Miscellaneous:</b>				
<b>Total in USD (\$)</b>				<b>500</b>

## Electronic Acknowledgement Receipt

<b>EFS ID:</b>	1371975
<b>Application Number:</b>	10667026
<b>International Application Number:</b>	
<b>Confirmation Number:</b>	9123
<b>Title of Invention:</b>	Methods, systems, and devices for cartographic alerts
<b>First Named Inventor/Applicant Name:</b>	Darrin W. Kabel
<b>Customer Number:</b>	38933
<b>Filer:</b>	David L. Terrell/Christine Terrell
<b>Filer Authorized By:</b>	David L. Terrell
<b>Attorney Docket Number:</b>	702.254
<b>Receipt Date:</b>	13-DEC-2006
<b>Filing Date:</b>	18-SEP-2003
<b>Time Stamp:</b>	15:36:48
<b>Application Type:</b>	Utility

### Payment information:

Submitted with Payment	yes
Payment was successfully received in RAM	\$500
RAM confirmation Number	167
Deposit Account	501791

The Director of the USPTO is hereby authorized to charge indicated fees and credit any overpayment as follows:  
Charge any Additional Fees required under 37 C.F.R. Section 1.16 and 1.17

### File Listing:

Document Number	Document Description	File Name	File Size(Bytes)	Multi Part /.zip	Pages (if appl.)
1	Appeal Brief Filed	AppealBrief.pdf	185720	no	48
<b>Warnings:</b>					
<b>Information:</b>					
2	Fee Worksheet (PTO-875)	fee-info.pdf	8156	no	2
<b>Warnings:</b>					
<b>Information:</b>					
<b>Total Files Size (in bytes):</b>			193876		
<p><b>This Acknowledgement Receipt evidences receipt on the noted date by the USPTO of the indicated documents, characterized by the applicant, and including page counts, where applicable. It serves as evidence of receipt similar to a Post Card, as described in MPEP 503.</b></p> <p><b><u>New Applications Under 35 U.S.C. 111</u></b>  If a new application is being filed and the application includes the necessary components for a filing date (see 37 CFR 1.53(b)-(d) and MPEP 506), a Filing Receipt (37 CFR 1.54) will be issued in due course and the date shown on this Acknowledgement Receipt will establish the filing date of the application.</p> <p><b><u>National Stage of an International Application under 35 U.S.C. 371</u></b>  If a timely submission to enter the national stage of an international application is compliant with the conditions of 35 U.S.C. 371 and other applicable requirements a Form PCT/DO/EO/903 indicating acceptance of the application as a national stage submission under 35 U.S.C. 371 will be issued in addition to the Filing Receipt, in due course.</p>					

IN THE UNITED STATES PATENT AND TRADEMARK OFFICE

<b>Application of:</b>	)	
	)	<b>Attorney Docket No. 702.254</b>
<b>KABEL, DARRIN W., et al.</b>	)	
	)	
<b>Serial No.: 10/667,026</b>	)	<b>Group Art Unit No. 2612</b>
	)	
<b>Filed: September 18, 2003</b>	)	
	)	<b>Examiner: MEHMOOD, JENNIFER</b>
<b>METHODS, SYSTEMS, AND DEVICES</b>	)	
<b>FOR CARTOGRAPHIC ALERTS</b>	)	

NOTICE OF APPEAL

Mail Stop AF  
Commissioner for Patents  
P.O. Box 1450  
Alexandria, VA 22313-1450

Dear Sir:

Applicant hereby appeals to the Board of Appeals from the decision dated August 8, 2006 of the Primary Examiner finally rejecting claims 1, 5-10, 19-23, 27-34, and 38-67.

The Commissioner is hereby authorized to charge the amount of the filing fee for this Notice of Appeal in the amount of \$500, or any additional fees which may be required, or credit any overpayment, to Account No. 501-791.

Respectfully submitted,

/David L. Terrell/

By \_\_\_\_\_  
David L. Terrell, Reg. No. 50,576  
Garmin International, Inc.  
1200 East 151<sup>st</sup> Street  
Olathe, KS 66062  
(913) 397-8200  
(913) 397-9079 - Facsimile

## Electronic Patent Application Fee Transmittal

<b>Application Number:</b>	10667026			
<b>Filing Date:</b>	18-Sep-2003			
<b>Title of Invention:</b>	Methods, systems, and devices for cartographic alerts			
First Named Inventor/Applicant Name:	Darrin W. Kabel			
<b>Filer:</b>	David L. Terrell/Christine Terrell			
<b>Attorney Docket Number:</b>	702.254			
Filed as Large Entity				
<b>Utility Filing Fees</b>				
<b>Description</b>	<b>Fee Code</b>	<b>Quantity</b>	<b>Amount</b>	<b>Sub-Total in USD(\$)</b>
<b>Basic Filing:</b>				
<b>Pages:</b>				
<b>Claims:</b>				
<b>Miscellaneous-Filing:</b>				
<b>Petition:</b>				
<b>Patent-Appeals-and-Interference:</b>				
Notice of appeal	1401	1	500	500
Post-Allowance-and-Post-Issuance:				
<b>Extension-of-Time:</b>				

Description	Fee Code	Quantity	Amount	Sub-Total in USD(\$)
<b>Miscellaneous:</b>				
<b>Total in USD (\$)</b>				<b>500</b>



## Electronic Acknowledgement Receipt

<b>EFS ID:</b>	1299962
<b>Application Number:</b>	10667026
<b>International Application Number:</b>	
<b>Confirmation Number:</b>	9123
<b>Title of Invention:</b>	Methods, systems, and devices for cartographic alerts
<b>First Named Inventor/Applicant Name:</b>	Darrin W. Kabel
<b>Customer Number:</b>	38933
<b>Filer:</b>	David L. Terrell/Christine Terrell
<b>Filer Authorized By:</b>	David L. Terrell
<b>Attorney Docket Number:</b>	702.254
<b>Receipt Date:</b>	08-NOV-2006
<b>Filing Date:</b>	18-SEP-2003
<b>Time Stamp:</b>	12:17:37
<b>Application Type:</b>	Utility

### Payment information:

Submitted with Payment	yes
Payment was successfully received in RAM	\$500
RAM confirmation Number	1105
Deposit Account	501791

The Director of the USPTO is hereby authorized to charge indicated fees and credit any overpayment as follows:  
Charge any Additional Fees required under 37 C.F.R. Section 1.16 and 1.17

### File Listing:

Document Number	Document Description	File Name	File Size(Bytes)	Multi Part /.zip	Pages (if appl.)
1	Notice of Appeal Filed	NoticeofAppeal.pdf	17694	no	1
<b>Warnings:</b>					
<b>Information:</b>					
2	Fee Worksheet (PTO-875)	fee-info.pdf	8144	no	2
<b>Warnings:</b>					
<b>Information:</b>					
<b>Total Files Size (in bytes):</b>			25838		
<p><b>This Acknowledgement Receipt evidences receipt on the noted date by the USPTO of the indicated documents, characterized by the applicant, and including page counts, where applicable. It serves as evidence of receipt similar to a Post Card, as described in MPEP 503.</b></p> <p><b><u>New Applications Under 35 U.S.C. 111</u></b>  If a new application is being filed and the application includes the necessary components for a filing date (see 37 CFR 1.53(b)-(d) and MPEP 506), a Filing Receipt (37 CFR 1.54) will be issued in due course and the date shown on this Acknowledgement Receipt will establish the filing date of the application.</p> <p><b><u>National Stage of an International Application under 35 U.S.C. 371</u></b>  If a timely submission to enter the national stage of an international application is compliant with the conditions of 35 U.S.C. 371 and other applicable requirements a Form PCT/DO/EO/903 indicating acceptance of the application as a national stage submission under 35 U.S.C. 371 will be issued in addition to the Filing Receipt, in due course.</p>					



UNITED STATES PATENT AND TRADEMARK OFFICE

UNITED STATES DEPARTMENT OF COMMERCE  
United States Patent and Trademark Office  
Address: COMMISSIONER FOR PATENTS  
P.O. Box 1450  
Alexandria, Virginia 22313-1450  
www.uspto.gov

APPLICATION NO.	FILING DATE	FIRST NAMED INVENTOR	ATTORNEY DOCKET NO.	CONFIRMATION NO.
10/667,026	09/18/2003	Darrin W. Kabel	702.254	9123

38933 7590 11/01/2006  
GARMIN LTD.  
C/O GARMIN INTERNATIONAL, INC.  
ATTN: Legal - IP  
1200 EAST 151ST STREET  
OLATHE, KS 66062

EXAMINER

MEHMOOD, JENNIFER

ART UNIT PAPER NUMBER

2612

DATE MAILED: 11/01/2006

Please find below and/or attached an Office communication concerning this application or proceeding.

sf

<b>Advisory Action Before the Filing of an Appeal Brief</b>	<b>Application No.</b> 10/667,026	<b>Applicant(s)</b> KABEL ET AL.	
	<b>Examiner</b> Jennifer A. Mehmood	<b>Art Unit</b> 2612	

--The MAILING DATE of this communication appears on the cover sheet with the correspondence address --

THE REPLY FILED 04 October 2006 FAILS TO PLACE THIS APPLICATION IN CONDITION FOR ALLOWANCE.

1.  The reply was filed after a final rejection, but prior to or on the same day as filing a Notice of Appeal. To avoid abandonment of this application, applicant must timely file one of the following replies: (1) an amendment, affidavit, or other evidence, which places the application in condition for allowance; (2) a Notice of Appeal (with appeal fee) in compliance with 37 CFR 41.31; or (3) a Request for Continued Examination (RCE) in compliance with 37 CFR 1.114. The reply must be filed within one of the following time periods:

- a)  The period for reply expires \_\_\_\_\_ months from the mailing date of the final rejection.
- b)  The period for reply expires on: (1) the mailing date of this Advisory Action, or (2) the date set forth in the final rejection, whichever is later. In no event, however, will the statutory period for reply expire later than SIX MONTHS from the mailing date of the final rejection.

Examiner Note: If box 1 is checked, check either box (a) or (b). ONLY CHECK BOX (b) WHEN THE FIRST REPLY WAS FILED WITHIN TWO MONTHS OF THE FINAL REJECTION. See MPEP 706.07(f).

Extensions of time may be obtained under 37 CFR 1.136(a). The date on which the petition under 37 CFR 1.136(a) and the appropriate extension fee have been filed is the date for purposes of determining the period of extension and the corresponding amount of the fee. The appropriate extension fee under 37 CFR 1.17(a) is calculated from: (1) the expiration date of the shortened statutory period for reply originally set in the final Office action; or (2) as set forth in (b) above, if checked. Any reply received by the Office later than three months after the mailing date of the final rejection, even if timely filed, may reduce any earned patent term adjustment. See 37 CFR 1.704(b).

**NOTICE OF APPEAL**

2.  The Notice of Appeal was filed on \_\_\_\_\_. A brief in compliance with 37 CFR 41.37 must be filed within two months of the date of filing the Notice of Appeal (37 CFR 41.37(a)), or any extension thereof (37 CFR 41.37(e)), to avoid dismissal of the appeal. Since a Notice of Appeal has been filed, any reply must be filed within the time period set forth in 37 CFR 41.37(a).

**AMENDMENTS**

- 3.  The proposed amendment(s) filed after a final rejection, but prior to the date of filing a brief, will not be entered because
  - (a)  They raise new issues that would require further consideration and/or search (see NOTE below);
  - (b)  They raise the issue of new matter (see NOTE below);
  - (c)  They are not deemed to place the application in better form for appeal by materially reducing or simplifying the issues for appeal; and/or
  - (d)  They present additional claims without canceling a corresponding number of finally rejected claims.

NOTE: \_\_\_\_\_. (See 37 CFR 1.116 and 41.33(a)).

- 4.  The amendments are not in compliance with 37 CFR 1.121. See attached Notice of Non-Compliant Amendment (PTOL-324).
- 5.  Applicant's reply has overcome the following rejection(s): \_\_\_\_\_.
- 6.  Newly proposed or amended claim(s) \_\_\_\_\_ would be allowable if submitted in a separate, timely filed amendment canceling the non-allowable claim(s).
- 7.  For purposes of appeal, the proposed amendment(s): a)  will not be entered, or b)  will be entered and an explanation of how the new or amended claims would be rejected is provided below or appended.  
The status of the claim(s) is (or will be) as follows:  
Claim(s) allowed: \_\_\_\_\_.  
Claim(s) objected to: \_\_\_\_\_.  
Claim(s) rejected: 1, 5-10, 19-23, 27-34, 38-67.  
Claim(s) withdrawn from consideration: \_\_\_\_\_.

**AFFIDAVIT OR OTHER EVIDENCE**

- 8.  The affidavit or other evidence filed after a final action, but before or on the date of filing a Notice of Appeal will not be entered because applicant failed to provide a showing of good and sufficient reasons why the affidavit or other evidence is necessary and was not earlier presented. See 37 CFR 1.116(e).
- 9.  The affidavit or other evidence filed after the date of filing a Notice of Appeal, but prior to the date of filing a brief, will not be entered because the affidavit or other evidence failed to overcome all rejections under appeal and/or appellant fails to provide a showing a good and sufficient reasons why it is necessary and was not earlier presented. See 37 CFR 41.33(d)(1).
- 10.  The affidavit or other evidence is entered. An explanation of the status of the claims after entry is below or attached.

**REQUEST FOR RECONSIDERATION/OTHER**

- 11.  The request for reconsideration has been considered but does NOT place the application in condition for allowance because:  
See Continuation Sheet.
- 12.  Note the attached Information Disclosure Statement(s). (PTO/SB/08) Paper No(s). \_\_\_\_\_
- 13.  Other: \_\_\_\_\_.

Continuation of 11. does NOT place the application in condition for allowance because: For claims 1, 23, 34, 44, 45, 47, 48, and 54, Michaelson alerts the crew to a new heading to avoid potential collisions by re-routing a course by identifying non-user waypoints. In addition, column 13, lines 56-67 and column 14, lines 1-4 disclose a course that is re-routed by identifying non-user waypoints. See also figure 9A. In addition, see col 24, lns 41-50 and 55-64.

For claim 19, Applicant argues as follows: Bailey discloses neither analyzing cartographic data nor analyzing cartographic data only within the user defined graphical filter area for the preselected conditions. Bailey discloses analyzing cartographic data by a microprocessor that detects sonar data and then displays the data on a display screen. Furthermore, the data is stored and the screen is rescaled according to a depth scale. In addition, Bailey discloses an automatic display scale changing is provided in response to the detected bottom going off-scale or in response to the detected bottom rising to within a predetermined depth.

For claim 47, Fujimoto '958's discloses a straight line in figure 3, item 45 which relates to alarm water depth line (paragraph 0073).

For claim 50, See figure 23, the line for the water depth (124) is depicted in a first manner as a non-alarming condition where the seabed line (125) does not intersect the water depth line. Furthermore, 124 is depicted in a second manner as an alarming condition where the seabed line intersects the water depth line to produce an alarm (128).

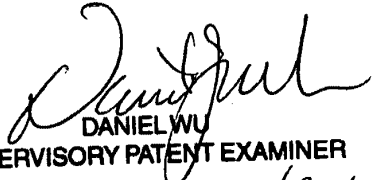
  
DANIEL WU  
SUPERVISORY PATENT EXAMINER  
10/29/06

OK to enter JM 10/17/2006  
upon filing Brief. (Darrin)

**IN THE UNITED STATES PATENT AND TRADEMARK OFFICE**

Application of:	)	
	)	
KABEL, DARRIN W.	)	Attorney Docket No.:
	)	702.254
Serial No.: 10/667,026	)	
	)	
Filed: September 18, 2003	)	Group Art Unit No. 2636
	)	
METHODS, SYSTEMS AND DEVICES	)	
FOR CARTOGRAPHIC ALERTS	)	Examiner: MEHMOOD, J.

Mail Stop AF  
Commissioner for Patents  
P.O. Box 1450  
Alexandria, VA 22313-1450

**AMENDMENT**

In response to the Office Action of August 8, 2006, applicant respectfully requests that this amendment be entered in the above-referenced application. Because this amendment puts the application in a condition for allowance, does not present new issues or require a new search, and at least places the application in a better condition for appeal, Applicant respectfully requests that this amendment be entered after Final Action.

**Listing of the Claims** begins on page 2 of this paper.

**Remarks** begin on page 16 of this paper.

**IN THE UNITED STATES PATENT AND TRADEMARK OFFICE**

Application of:	)	
	)	
KABEL, DARRIN W.	)	Attorney Docket No.:
	)	702.254
Serial No.: 10/667,026	)	
	)	
Filed: September 18, 2003	)	Group Art Unit No. 2636
	)	
METHODS, SYSTEMS AND DEVICES	)	
FOR CARTOGRAPHIC ALERTS	)	Examiner: MEHMOOD, J.

Mail Stop AF  
Commissioner for Patents  
P.O. Box 1450  
Alexandria, VA 22313-1450

**AMENDMENT**

In response to the Office Action of August 8, 2006, applicant respectfully requests that this amendment be entered in the above-referenced application. Because this amendment puts the application in a condition for allowance, does not present new issues or require a new search, and at least places the application in a better condition for appeal, Applicant respectfully requests that this amendment be entered after Final Action.

**Listing of the Claims** begins on page 2 of this paper.

**Remarks** begin on page 16 of this paper.

**Listing of the Claims:**

This listing of claims will replace all prior versions, and listings, of claims in the application:

**CLAIMS:**

Please amend claims 52 and 53, as follows:

1. (Previously Presented) A method for marine navigation, comprising:  
receiving one or more preselected conditions from a user;  
identifying a potential waypoint; and  
performing a marine route calculation algorithm to route a course between a first location and the potential waypoint avoiding the preselected conditions, including analyzing cartographic data between the first location and the potential waypoint and re-routing the course to avoid the preselected conditions by identifying one or more non-user selected waypoints.

2-4. (Canceled)



5. (Previously Presented) The method of claim 1, further including determining the first location on the course based on a signal from a global positioning system (GPS); and analyzing cartographic data for a predetermined area around the first location for preselected conditions.
  
6. (Original) The method of claim 5, further including providing an alert signal when the analyzed cartographic data for the predetermined area around the first location includes preselected conditions.
  
7. (Previously Presented) The method of claim 1, further including providing an alert signal when the analyzed cartographic data between the first location and the potential waypoint includes preselected conditions.
  
8. (Original) The method of claim 7, wherein providing the alert signal includes emitting an audio alert.
  
9. (Original) The method of claim 7, wherein providing the alert signal includes displaying a visual alert.
  
10. (Previously Presented) The method of claim 1, the preselected conditions including a weather condition.

11-18. (Canceled)

19. (Previously Presented) A method for marine navigation, comprising:  
receiving one or more preselected conditions from a user;  
receiving a user defined graphical filter area from the user;  
identifying the user defined graphical filter area on a display;  
analyzing cartographic data only within the user defined graphical filter area for the  
preselected conditions; and  
providing an alert signal when cartographic data within the user defined graphical  
filter area indicate the preselected conditions.
20. (Original) The method of claim 19, wherein identifying the user defined graphical  
filter area includes repositioning the user defined graphical filter area.
21. (Original) The method of claim 19, wherein analyzing cartographic data further  
comprises acquiring cartographic data from a global positioning system (GPS).

22. (Original) The method of claim 19, further including receiving preselected conditions selected from the group of land, water depth, rock(s), sandbars, shelves, tide condition, tidal data, wind conditions, weather conditions, ice, above-water obstacles, underwater obstacles, type of water bottom, and prohibited areas.

23. (Previously Presented) A computer readable medium having a set of computer readable instructions, the set of computer readable instructions comprising instructions for:

- receiving one or more preselected conditions from a user;
- identifying a potential waypoint upon a first event; and
- performing a marine route calculation algorithm to analyze a course between a first location and the potential waypoint avoiding the preselected conditions, including analyzing cartographic data between the first location and the potential waypoint and re-routing the course to avoid the preselected conditions by identifying one or more non-user selected waypoints.

24-26. (Canceled)

27. (Original) The computer readable medium of claim 23, further including determining the first location on the course based on a signal from a global positioning system (GPS); and analyzing cartographic data for a predetermined area around the first location for preselected conditions.

28. (Original) The computer readable medium of claim 27, further including providing an alert signal when the analyzed cartographic data for the predetermined area around the first location includes preselected conditions.

29. (Original) The computer readable medium of claim 23, wherein analyzing cartographic data further comprises acquiring cartographic data from a global positioning system (GPS).

30. (Original) The computer readable medium of claim 23, further including providing an alert signal when the analyzed cartographic data between the first location and the potential waypoint includes preselected conditions.

31. (Original) The computer readable medium of claim 30, wherein providing the alert signal includes emitting a signal for an audio alert.

32. (Original) The computer readable medium of claim 30, wherein providing the alert signal includes displaying a visual alert.

33. (Previously Presented) The computer readable medium of claim 23, the preselected conditions including a water depth.

34. (Previously Presented) An electronic marine navigation device, comprising:
- a processor;
  - a user interface operatively coupled to the processor, wherein the user interface receives one or more preselected conditions from a user;
  - a location input operatively coupled to the processor, wherein the location input receives a first location and a potential waypoint separate from the first location; and
  - a memory operatively coupled to the processor and the location input, the memory having cartographic data including data related to the preselected conditions, wherein the processor operates on a marine route calculation algorithm to analyze a course between the first location and the potential waypoint in view of the preselected conditions of the cartographic data and re-route the course to avoid the preselected conditions by identifying one or more non-user selected waypoints.

35-37. (Canceled)

38. (Previously Presented) The electronic marine navigation device of claim 34, further including a receiver for a global positioning system (GPS) operatively coupled to the processor, wherein the processor determines the first location on the course based on a signal received from the GPS, and analyzes cartographic data for a predetermined area around the first location for preselected conditions.

39. (Original) The electronic marine navigation device of claim 38, wherein the processor provides an alert signal when the analyzed cartographic data for the predetermined area around the first location includes preselected conditions.

40. (Previously Presented) The electronic marine navigation device of claim 34, wherein the processor provides an alert signal when the analyzed cartographic data between the first location and the potential waypoint includes preselected conditions.

41. (Original) The electronic marine navigation device of claim 34, wherein the location input receives a user defined graphical filter area, and wherein the processor operates on the marine route calculation algorithm to analyze cartographic data within the defined graphical filter area for preselected conditions and wherein the processor provides an alert signal when the analyzed cartographic data for the user defined graphical filter area includes preselected conditions.

42. (Previously Presented) The method of claim 1, wherein both the first location and the potential waypoint are independent of a current location of a device implementing the method.

43. (Previously Presented) The method of claim 1, wherein at least a portion of the course is unrelated to a current heading of a device implementing the method.

44. (Previously Presented) A method for marine navigation, comprising:  
identifying a potential waypoint; and  
performing a marine route calculation algorithm to analyze a course between a first location and the potential waypoint in order to avoid preselected conditions received from a user and re-route the course to avoid the preselected conditions by identifying one or more non-user selected waypoints.

45. (Previously Presented) A method for marine navigation, comprising:  
receiving indication of a minimum water depth from a user;  
identifying a potential waypoint; and  
performing a marine route calculation algorithm to route a course between a first location and the potential waypoint avoiding water depth less than the minimum water depth by identifying one or more non-user selected waypoints.

46. (Previously Presented) The method of claim 45, displaying a visual indication of places along the calculated course where the water depth is expected to approach the minimum water depth.

47. (Previously Presented) A method for marine navigation, comprising:  
receiving indication of a minimum water depth from a user;  
displaying marine cartographic data;  
receiving indication of a potential waypoint;  
displaying a substantially straight line between a first location and the potential waypoint, wherein the line depicts both where the water depth is expected to be greater than the minimum water depth and where the water depth is expected to be less than the minimum water depth, and wherein the line highlights where the water depth is expected to be less than the minimum water depth; and  
performing a marine route calculation algorithm to route a course between the first location and the potential waypoint avoiding water depth less than the minimum water depth.



48. (Previously Presented) A method for marine navigation, comprising:  
displaying marine cartographic data;  
receiving indication of a potential waypoint;  
displaying a substantially straight line between a first location and the potential  
waypoint, wherein the line distinguishes where the water depth is expected to  
be greater than a preset minimum water depth from where the water depth is  
expected to be less than the minimum water depth; and  
performing a marine route calculation algorithm to route a course between the first  
location and the potential waypoint avoiding water depth less than the  
minimum water depth.
49. (Previously Presented) The method of claim 48, wherein the minimum water depth  
is user selectable.
50. (Previously Presented) The method of claim 48, wherein the line is depicted in a  
first manner where the water depth is expected to be greater than the minimum water  
depth and the line is depicted in a second manner where the water depth is expected to be  
less than the minimum water depth.
51. (Previously Presented) The method of claim 48, wherein the line is displayed on the  
marine cartographic data in a plan view.

52. (Currently Amended) The method of claim [[48]] 50, wherein the first manner is different from the second manner, such that the line itself is displayed differently in the first manner compared with the second manner.

53. (Currently Amended) The method of claim [[48]] 50, wherein the first manner comprises displaying the line in a first color and the second manner comprises displaying the line in a second color different from the first color.

54. (Previously Presented) A method for marine navigation, comprising:  
displaying marine cartographic data;  
receiving indication of a potential waypoint; and  
displaying a substantially straight line on the marine cartographic data between a first location and the potential waypoint, wherein the line highlights where the water depth is expected to be less than a minimum water depth.

55. (Previously Presented) The method of claim 54, further including the step of performing a marine route calculation algorithm to route a course from the first location to the potential waypoint avoiding areas where the water depth is expected to be less than the minimum water depth by identifying one or more non-user selected waypoints.

56. (Previously Presented) The method of claim 55, further including the step of displaying the course from the first location to the potential waypoint via the non-user selected waypoints.

57. (Previously Presented) The method of claim 54, wherein the line is displayed in a different manner where the water depth is expected to be less than a minimum water depth.

58. (Previously Presented) The method of claim 1, further including the step of displaying the course from the first location to the potential waypoint via the non-user selected waypoints.

59. (Previously Presented) The computer readable medium of claim 23, further including instructions for displaying the course from the first location to the potential waypoint via the non-user selected waypoints.

60. (Previously Presented) The electronic marine navigation device of claim 34, further including a display for displaying the course from the first location to the potential waypoint via the non-user selected waypoints.

61. (Previously Presented) The method of claim 44, further including the step of displaying the course from the first location to the potential waypoint via the non-user selected waypoints.

62. (Previously Presented) The method of claim 45, further including the step of displaying the course from the first location to the potential waypoint via the non-user selected waypoints.

63. (Previously Presented) The method of claim 47, wherein the step of performing a marine route calculation algorithm includes identifying one or more non-user selected waypoints.

64. (Previously Presented) The method of claim 63, further including the step of displaying the course from the first location to the potential waypoint via the non-user selected waypoints.

65. (Previously Presented) The method of claim 47, wherein the line is displayed in a first manner where the water depth is expected to be greater than the preset minimum water depth and a second manner, different from the first manner, where the water depth is expected to be less than the minimum water depth.

66. (Previously Presented) The method of claim 48, wherein the step of performing a marine route calculation algorithm includes identifying one or more non-user selected waypoints.

67. (Previously Presented) The method of claim 66, further including the step of displaying the course from the first location to the potential waypoint via the non-user selected waypoints.

**REMARKS:**

**Status Of Claims**

Claims 1, 5-10, 19-23, 27-34, and 38-67 were previously pending in the application. Claims 52 and 53 have been amended. Thus, claims 1, 5-10, 19-23, 27-34, and 38-67 are currently pending in the application with claims 1, 19, 23, 34, 44, 45, 47, 48, and 54 being independent.

**Office Action**

In the Office Action, the Examiner rejected claims 52 and 53 under 35 U.S.C. § 112, second paragraph. Claims 52 and 53 have been amended to obviate this ground of rejection. Therefore, this amendment at least places the application in a better condition for appeal. Thus, Applicant respectfully requests that this amendment be entered after Final Action.

The Examiner also rejected claims 19, 20, and 22 under 35 U.S.C. 102(b) as being anticipated Bailey et al., U.S. Patent No. 4,873,676. The Examiner also rejected claims 1, 5-10, 23, 27-32, 34, 38-40, 42-44, 58-61, 66, and 67 under 35 U.S.C. 103(a) as being unpatentable over Fujimoto et al., U.S. Patent Application No. 2004/0006423 (Fujimoto '423) in view of Michaelson et al., U.S. Patent No. 6,734,808. The Examiner also rejected claim 21 under 35 U.S.C. 103(a) as being unpatentable over Bailey in view of Fujimoto '423. The Examiner also rejected claim 33 under 35 U.S.C. 103(a) as being unpatentable over Fujimoto '423 and Michaelson, in view of Tobin Jr., U.S. Patent No. 4,323,992. The

Examiner also rejected claim 41 under 35 U.S.C. 103(a) as being unpatentable over Fujimoto '423 and Michaelson in view of Bailey. The Examiner also rejected claims 45, 46, and 62 under 35 U.S.C. 103(a) as being unpatentable over Fujimoto '423 and Michaelson in view of Walsh et al., U.S. Patent No. 3,886,487. The Examiner also rejected claims 47-57 and 63-65 under 35 U.S.C. 103(a) as being unpatentable over Fujimoto et al., U.S. Patent Application No. 2004/0003958 (Fujimoto '958), in view of Fujimoto '423 and Michaelson. Applicant respectfully submits that the currently pending claims distinguish the present invention from both Fujimoto references, Tobin, Bailey, Michaelson, Walsh, and the other prior art references of record, taken alone or in combination with each other.

### **Anticipation**

"A claim is anticipated only if each and every element as set forth in the claim is found, either expressly or inherently described, in a single prior art reference." MPEP § 2131, citing *Verdegaal Bros. v. Union Oil Co. of California*, 814 F.2d 628, 631, 2 USPQ2d 1051, 1053 (Fed. Cir. 1987). More specifically, "Federal Circuit decisions repeatedly emphasize that anticipation (lack of novelty) is established only if (1) all the elements of an invention, as stated in a patent claim, (2) are identically set forth, (3) in a single prior art reference". Chisum on Patents § 3.02. *See also* *Gechter v. Davidson*, 43 USPQ2d 1030, 1032 (Fed. Cir. 1997) ("Under 35 U.S.C. § 102, every limitation of a claim must identically appear in a single prior art reference for it to anticipate the claim.").

Claim 19 recites "analyzing cartographic data only within the user defined graphical

filter area for the preselected conditions”. The Examiner mistakenly asserts that this limitation is disclosed by Bailey in column 3, lines 26-36 and 46-48. However, column 3, lines 26-29 state “[a]utomatic display scale changing is provided in response to the detected bottom going off-scale, or in response to the detected bottom rising to within a predetermined depth”. Therefore, Bailey actually rather clearly teaches a system for automatically **redefining** a display area based on changing water depth. In other words, rather than analyzing data only within a user defined area, Bailey teaches automatically redefining some user defined display area. In fact, on page 14 of the Final Office Action, the Examiner acknowledges “Bailey discloses an automatic display scale changing”. Furthermore, Bailey analyzes the entirety of this automatically redefined display area for target data or sonar returns.

In column 3, lines 46-48, Bailey goes on to suggest user “selection of an area of interest” to be displayed. The Examiner appears to be focusing on this “customizable (user-defined)” display screen. Page 14 of the Final Office Action. However, a distinction must be drawn between what is displayed and what is analyzed. Bailey teaches only customizing a display. In fact, Bailey is completely devoid of any suggestion of “**analyzing** cartographic data **only** within the user defined graphical filter area”, emphasis added. At best, lines 46-48 can only suggest displaying some limited area of interest.

In fact, Bailey doesn’t teach “analyzing **cartographic** data”, emphasis added, at all. Rather, as discussed above, Bailey teaches analyzing target data or sonar returns. Furthermore, Bailey must analyze all of the received target data or sonar returns. These



are important distinctions in that Bailey's sonar signals, by their very nature, must pass completely through a predefined space under a boat. This space is predefined by the transducer itself. The **only** limits that **can** be imposed on this space are related to the maximum depth that the sonar signals reach. This is a function of transducer design and underwater obstacles, neither of which is under the user's control. In other words, the user simply cannot define where the sonar signals go, and therefore cannot define any area, and Bailey's device therefore cannot analyze only a portion of the returns. Simply put, Bailey cannot be said to suggest analyzing data **only** within a user defined area, much less "analyzing cartographic data only within the user defined graphical filter area for the preselected conditions", as claimed. As a result, Bailey simply fails to disclose, suggest or make obvious "analyzing cartographic data only within the user defined graphical filter area for the preselected conditions" as claimed in claim 19.

### **Obviousness**

Obviousness can be a problematic basis for rejection because the Examiner, in deciding that a feature is obvious, has the benefit of the applicant's disclosure as a blueprint and guide. In contrast, one with ordinary skill in the art would have no such guide, in which light even an exceedingly complex solution may seem easy or obvious. Furthermore, once an obviousness rejection has been made, the applicant is in the exceedingly difficult position of having to prove a negative proposition (i.e., non-obviousness) in order to overcome the rejection.

For these reasons, the law places upon the Examiner the initial burden of establishing a *prima facie* case of obviousness. If the Examiner fails to establish the requisite *prima facie* case, the rejection is improper and will be overturned. *In re Rijckaert*, 9 F.3d 1531, 1532, 28 U.S.P.Q.2d 1955 (Fed. Cir. 1993). Only if the Examiner's burden is met does the burden shift to the Applicant to provide evidence to refute the rejection.

In meeting this initial burden, the Examiner "cannot use hindsight reconstruction to pick and choose among isolated disclosures in the prior art to deprecate the claimed invention." *In re Fine*, 837 F.2d 1071, 1075, 5 U.S.P.Q.2d 1596 (Fed. Cir. 1988). Thus, the Examiner is required to perform the "critical step" of casting his or her mind back to the time of invention, to consider the thinking of one of ordinary skill in the art, guided only by the prior art references and the then-accepted wisdom in the field. *See, e.g., W. L. Gore & Assoc., Inc. v. Garlock, Inc.*, 721 F.2d 1540, 1553, 220 U.S.P.Q. 303 (Fed. Cir. 1983).

Rejections on obviousness grounds also cannot be sustained by mere conclusory statements; instead, there must be some articulated reasoning with some rational underpinning to support the legal conclusion of obviousness. *In re Kahn*, 441 F.3d 977, 988, 78 U.S.P.Q.2d 1329 (Fed. Cir. 2006). The factual inquiry performed by the Examiner in issuing an obviousness rejection must be thorough and searching. *McGinley v. Franklin Sports, Inc.*, 262 F.3d 1339, 1351-52, 60 U.S.P.Q.2d 1001 (Fed. Cir. 2001). The prohibition against conclusory examination is as much rooted in the Administrative Procedure Act, which ensures due process and non-arbitrary decision-making, as it is in § 103. *In re Kahn*, 441 F.3d at 988.

Three criteria must be satisfied by the Examiner in order to establish a prima facie case of obviousness: (1) there must be some suggestion or motivation, either in the references themselves or in the knowledge generally available to one of ordinary skill in the art, to modify the reference or combine their teachings; (2) there must be a reasonable expectation of success; and (3) the combination of references must teach or suggest all the claim limitations. See MPEP § 706.02(j), citing *In re Vaeck*, 947 F.2d 488, 493, 20 U.S.P.Q.2d 1438 (Fed. Cir. 1991). This "motivation-suggestion-teaching" requirement protects against the entry of hindsight into the obviousness analysis, a problem which § 103 was meant to confront. *In re Kahn*, 441 F.3d at 988.

Consequently, an Examiner's mere identification in the prior art of each individual element claimed is insufficient to defeat the patentability of a claimed invention without a proper suggestion to combine or modify the elements. *In re Rouffet*, 149 F.3d 1350, 1357, 47 U.S.P.Q.2d 1453 (Fed. Cir. 1998). The fact that references can be combined or modified does not render the resultant combination obvious unless the prior art also suggests the desirability of the combination. *In re Gordon*, 733 F.2d 900, 902, 221 USPQ 1125 (Fed. Cir. 1984).

In presenting the suggestion or motivation to combine prior art references, the Examiner may not resort to broad and conclusory statements; as such statements are not "evidence" of anything. *In re Kotzab*, 217 F.3d 1365, 1370, 55 U.S.P.Q.2d 1313 (Fed. Cir. 2000). The suggestion to make the claimed combination must be found in the prior art, not in the applicant's disclosure. *In re Vaeck*, 947 F.2d at 490. If the Examiner's proposed

combination renders the prior art invention unsatisfactory for its intended purpose, or changes its principal of operation, there can be no suggestion or motivation to form the combination—and thus no *prima facie* case of obviousness. See MPEP § 2143.01; *In re Gordon*, 733 F.2d at 902.

Claims 1, 23, 34, 44, and 45, stand rejected under various combinations of Fujimoto '423, Michaelson, and Walsh. Claim 1 recites “performing a marine route calculation algorithm to route a course between a first location and the potential waypoint avoiding the preselected conditions, including analyzing cartographic data between the first location and the potential waypoint and re-routing the course to avoid the preselected conditions by identifying one or more non-user selected waypoints”. Similarly, claim 23 recites “performing a marine route calculation algorithm to analyze a course between a first location and the potential waypoint avoiding the preselected conditions, including analyzing cartographic data between the first location and the potential waypoint and re-routing the course to avoid the preselected conditions by identifying one or more non-user selected waypoints”. Claim 34 recites “wherein the processor operates on a marine route calculation algorithm to analyze a course between the first location and the potential waypoint in view of the preselected conditions of the cartographic data and re-route the course to avoid the preselected conditions by identifying one or more non-user selected waypoints”. Claim 44 recites “performing a marine route calculation algorithm to analyze a course between a first location and the potential waypoint in order to avoid preselected conditions received from a user and re-route the course to avoid the preselected conditions

by identifying one or more non-user selected waypoints”. Claim 45 recites “performing a marine route calculation algorithm to route a course between a first location and the potential waypoint avoiding water depth less than the minimum water depth by identifying one or more non-user selected waypoints”.

In contrast, the Examiner acknowledges that “Fujimoto discloses identifying user waypoints ... but does not disclose non-user waypoints”. Page 4 of the Final Office Action. To cure this defect, the Examiner mistakenly asserts that “Michaelson, on the other hand discloses re-routing the course by identifying one or more non-user waypoints”. Page 4 of the Final Office Action. In supporting this assertion, the Examiner points to column 24 lines 41-50 and 55-64. The Examiner also points to column 13, line 56, through column 14, line 4.

However, column 24 clearly states that Michaelson’s invention merely “alerts the crew to a new heading to steer or engine setting to avoid collisions”. Column 24, lines 38-41. Specifically, column 24, lines 57-58, state an “alternate track PT’ is first generated by incrementing the ship’s heading by [a] nominal step size”. Columns 13 and 14, on the other hand, merely disclose providing warnings such as “go shallow” to avoid grounding a submarine. Thus, Michaelson only suggests a heading and/or depth change to avoid an obstacle. In fact, Michaelson is devoid of any suggestion of “**identifying one or more non-user selected waypoints**”, emphasis added, as claimed.

Walsh doesn’t even suggest an alternate heading/depth. Specifically, as stated in column 9, lines 6-10, Walsh merely discloses transmitting “as signal to the alarm 188 which

in turn then warns the operator of the ship 20 to change course or take other evasive action”, when the depth ahead is too shallow. In other words, Walsh simply provides a warning of an impending collision/grounding. Thus, Walsh fails to even provide a suggested heading and/or depth change, much less non-user selected waypoints that may be used to avoid the hazard.

As a result, no combination of Fujimoto '423, Michaelson, and/or Walsh discloses, suggests or makes obvious “performing a marine route calculation algorithm to route a course between a first location and the potential waypoint avoiding the preselected conditions, including analyzing cartographic data between the first location and the potential waypoint and re-routing the course to avoid the preselected conditions by identifying one or more non-user selected waypoints”, as claimed in claim 1. No combination of Fujimoto '423, Michaelson, and/or Walsh discloses, suggests or makes obvious “performing a marine route calculation algorithm to analyze a course between a first location and the potential waypoint avoiding the preselected conditions, including analyzing cartographic data between the first location and the potential waypoint and re-routing the course to avoid the preselected conditions by identifying one or more non-user selected waypoints”, as claimed in claim 23. No combination of Fujimoto '423, Michaelson, and/or Walsh discloses, suggests or makes obvious “wherein the processor operates on a marine route calculation algorithm to analyze a course between the first location and the potential waypoint in view of the preselected conditions of the cartographic data and re-route the course to avoid the preselected conditions by identifying one or more non-user

selected waypoints”, as claimed in claim 34. No combination of Fujimoto ‘423, Michaelson, and/or Walsh discloses, suggests or makes obvious “performing a marine route calculation algorithm to analyze a course between a first location and the potential waypoint in order to avoid preselected conditions received from a user and re-route the course to avoid the preselected conditions by identifying one or more non-user selected waypoints”, as claimed in claim 44. No combination of Fujimoto ‘423, Michaelson, and/or Walsh discloses, suggests or makes obvious “performing a marine route calculation algorithm to route a course between a first location and the potential waypoint avoiding water depth less than the minimum water depth by identifying one or more non-user selected waypoints”, as claimed in claim 45.

Furthermore, the Examiner fails to provide the requisite suggestion or motivation to combine Fujimoto ‘423, Michaelson, and/or Walsh. Rather, with respect to claims 1 and 44, the Examiner asserts “[i]t would have been obvious to disclose non-user waypoints so that an operator of a ship relies on automatic navigation between a point of origin and a destination without constantly monitoring the ship’s travel route”. Page 4 of the Final Office Action.

However, the test is not what might “have been obvious to disclose”. Rather, there must be some suggestion, found in the prior art rather than the applicant's disclosure, to combine one prior art reference with another. Here, as discussed above, the references don’t even teach what the Examiner asserts, much less provide any suggestion or motivation to combine their teachings.

With respect to claim 45, the Examiner asserts “[i]t would have been obvious to avoid a water depth less than the minimum water depth so that a ship’s operator acknowledges a dangerous water depth and verifies that the ship is maneuvered around or away from an insufficient water depth to ensure the safety of the ships’ passengers”. However, this assertion does not provide any motivation to actually identify “one or more non-user selected waypoints”, as claimed, certainly not over Michaelson’s warnings and suggestion of a heading change. In other words, once the crew has been alerted and even given a new heading the steer, as taught by Michaelson, any such motivation would be satisfied. Specifically, once the crew has been alerted and even given a new heading, there would be no need for Walsh’s warning. Therefore, the stated motivation doesn’t actually provide any motivation to combine Walsh with the system of Michaelson, much less any motivation that might render the present claims obvious.

Thus, not only does the Examiner fail to cite references that teach each and every claim limitation, the Examiner also fails to provide the requisite suggestion or motivation to combine references. As a result, the Examiner has failed to establish a *prima facie* case of obviousness, and therefore the present rejections cannot be sustained.

Claims 47, 48, 51, and 54 stand rejected under Fujimoto ‘958, Fujimoto ‘423, and Michaelson. Claim 47 recites “displaying a substantially straight line between a first location and the potential waypoint, wherein the line depicts both where the water depth is expected to be greater than the minimum water depth and where the water depth is expected to be less than the minimum water depth, and wherein the line highlights where



the water depth is expected to be less than the minimum water depth”. Similarly, claim 48 now recites “displaying a substantially straight line between a first location and the potential waypoint, wherein the line distinguishes where the water depth is expected to be greater than a preset minimum water depth from where the water depth is expected to be less than the minimum water depth”. Claim 51 recites “wherein the line is displayed on the marine cartographic data in a plan view”. Claim 54 recites “displaying a substantially straight line on the marine cartographic data between a first location and the potential waypoint, wherein the line highlights where the water depth is expected to be less than a minimum water depth”.

In contrast, the only straight line the Examiner points to, Fujimoto '958's item 45, is depicted completely independently of water depth. In fact, Fujimoto '958's item 45 “designates an alarm water depth line”. ¶ 73. This line is arbitrarily set by the user as a minimum water depth, above which Fujimoto '958's apparatus provides an alarm. Therefore, as taught by Fujimoto '958, this line, item 45, as well as all other lines taught by Fujimoto '958, is necessarily displayed on a sonar display, rather than “between a first location and the potential waypoint”, much less “on the marine *cartographic* data”, emphasis added, or “wherein the line is displayed on the marine cartographic data in a plan view”, as claimed.

Fujimoto '958's only line that relates to an actual water depth is item 43, which depicts a seabed and therefore simply cannot be substantially straight. Of course, displaying item 43 as substantially straight would render it unsatisfactory for its intended

purpose, namely depicting the seabed. Furthermore, as discussed above, this line, item 43, is necessarily displayed on a sonar display, rather than “between a first location and the potential waypoint”, much less “on the marine **cartographic** data”, emphasis added, or “wherein the line is displayed on the marine cartographic data in a plan view”, as claimed.

Finally, neither of these lines, themselves, actually highlight or distinguish where the water depth is above or below a minimum. In fact, the Examiner acknowledges that “Fujimoto does not disclose highlighting the water depth line”. Page 11 of the Final Office Action. In order to cure this defect, the Examiner asserts “Michaelson discloses highlighting a terrain threat indication”. Pages 11 and 12 of the Final Office Action. However, the Examiner fails to cite to any portion of Michaelson that teaches this. In fact, Michaelson does not include any variation on the word “highlight”. Michaelson simply does not teach highlighting or distinguishing any portion of any **line** “between a first location and the potential waypoint”, much less any line “on the marine **cartographic** data”, emphasis added, or “wherein the line is displayed on the marine cartographic data in a plan view”, as claimed.

As a result, no combination of either Fujimoto reference and/or Michaelson discloses, suggests or makes obvious “displaying a substantially straight line between a first location and the potential waypoint, wherein the line depicts both where the water depth is expected to be greater than the minimum water depth and where the water depth is expected to be less than the minimum water depth, and wherein the line highlights where the water depth is expected to be less than the minimum water depth”, as claimed in claim

47, “displaying a substantially straight line between a first location and the potential waypoint, wherein the line distinguishes where the water depth is expected to be greater than a preset minimum water depth from where the water depth is expected to be less than the minimum water depth”, as claimed in claim 48, “wherein the line is displayed on the marine cartographic data in a plan view”, as claimed in claim 51, or “displaying a substantially straight line on the marine cartographic data between a first location and the potential waypoint, wherein the line highlights where the water depth is expected to be less than a minimum water depth”, as claimed in claim 54.

Furthermore, the Examiner fails to provide the requisite suggestion or motivation to combine Fujimoto '958, Fujimoto '423, and/or Michaelson. Rather, the Examiner's asserted motivation is found only in Applicant's own disclosure. Specifically, as discussed above, none of the prior art references actually teach emphasizing “a water depth line by highlighting”, as asserted by the Examiner. Page 12 of the Final Office Action. Such teachings are found only in Applicant's own disclosure. In contrast, as discussed above, in order to establish a *prima facie* case of obviousness, there must be some suggestion, found in the prior art rather than the applicant's disclosure, to combine one prior art reference with another. Here, as discussed above, the references don't even teach what the Examiner asserts, much less provide any suggestion or motivation to combine their teachings.

Thus, not only does the Examiner fail to cite references that teach each and every claim limitation, the Examiner also fails to provide the requisite suggestion or motivation to

combine references. As a result, the Examiner has failed to establish a *prima facie* case of obviousness, and therefore the present rejections cannot be sustained.

Claim 50 recites “wherein the line is depicted in a first manner where the water depth is expected to be greater than the minimum water depth and the line is depicted in a second manner where the water depth is expected to be less than the minimum water depth”.

The Examiner mistakenly asserts that Fujimoto '958 teaches these limitations. However, as discussed above, Fujimoto '958 merely displays a seabed line 125 above or below a depth mark 124, as the case may be, but the seabed line 125 is otherwise displayed in the exact same manner. In fact, the Examiner acknowledges that “Fujimoto does not disclose highlighting the water depth line”. Page 11 of the Final Office Action. The Examiner also acknowledges that “Fujimoto ... does not disclose first and second manners of displaying a line”. Page 12 of the Final Office Action. Simply put, there is no difference in the line itself or the manner in which it is displayed, such as highlighting color, solid vs. broken or dashed, whether that portion of the line is flashing, or whether that portion of the line is bolded. In fact, Fujimoto '958 lacks any suggestion to show any portion of the seabed line 123 in a different manner. As a result, no combination of either Fujimoto reference and/or Michaelson discloses, suggests or makes obvious “wherein the line is depicted in a first manner where the water depth is expected to be greater than the minimum water depth and the line is depicted in a second manner where the water depth is expected to be less than the minimum water depth”, as claimed in claim 50.

Claim 52 recites “wherein the first manner is different from the second manner, such that the line itself is displayed differently in the first manner compared with the second manner”. Claim 53 recites “wherein the first manner comprises displaying the line in a first color and the second manner comprises displaying the line in a second color different from the first color”. Claim 57 recites “wherein the line is displayed in a different manner where the water depth is expected to be less than a minimum water depth”. Claim 65 recites “wherein the line is displayed in a first manner where the water depth is expected to be greater than the preset minimum water depth and a second manner, different from the first manner, where the water depth is expected to be less than the minimum water depth”.

For example, this capability is shown in figures 2A, 4A, and 4C and described on pages 11-14, among other places. Of course, claim 48, from which claims 52 and 53 depend, recites “displaying a substantially straight line between a first location and the potential waypoint”. Similarly, claim 54, from which claim 57 depends, recites “displaying a substantially straight line on the marine cartographic data between a first location and the potential waypoint”. Finally, claim 47, from which claim 65 depends, recites “displaying a substantially straight line between a first location and the potential waypoint”. Thus, the line is substantially straight and depicts a path between two points. Furthermore, in the case of claim 57, the line is displayed on “marine cartographic data”.

In contrast, the Examiner acknowledges that “Fujimoto ... does not disclose first and second manners of displaying a line”. Page 12 of the Final Office Action. In order to cure this defect, the Examiner asserts “Michaelson discloses first and second colors to display

terrain indications". Page 12 of the Final Office Action. In supporting this assertion, the Examiner points to column 27, lines 40-65. However, Michaelson's terrain indications are simply not analogous to the presently claimed line. Specifically, Michaelson merely teaches varying the color of the displayed terrain data itself, rather than any path through the terrain. See column 27, lines 48-65. As a result, no combination of either Fujimoto reference and/or Michaelson discloses, suggests or makes obvious "wherein the first manner is different from the second manner, such that the line itself is displayed differently in the first manner compared with the second manner", as claimed in claim 52, "wherein the first manner comprises displaying the line in a first color and the second manner comprises displaying the line in a second color different from the first color", as claimed in claim 53, "wherein the line is displayed in a different manner where the water depth is expected to be less than a minimum water depth", as claimed in claim 57, or "wherein the line is displayed in a first manner where the water depth is expected to be greater than the preset minimum water depth and a second manner, different from the first manner, where the water depth is expected to be less than the minimum water depth", as claimed in claim 65.

Claim 55 recites "performing a marine route calculation algorithm to route a course from the first location to the potential waypoint avoiding areas where the water depth is expected to be less than the minimum water depth by identifying one or more non-user selected waypoints". Claims 63 and 66 each recite "wherein the step of performing a marine route calculation algorithm includes identifying one or more non-user selected

waypoints". Similarly, claims 56, 58-62, 64, and 67 each recite "displaying the course from the first location to the potential waypoint via the non-user selected waypoints".

In contrast, as discussed above, no combination of either Fujimoto reference and/or Michaelson discloses, suggests or makes obvious "identifying one or more non-user selected waypoints", as claimed in claims 55, 63, and 66, or "displaying the course from the first location to the potential waypoint via the non-user selected waypoints", as claimed in claims 56, 58-62, 64, and 67, much less in combination with the other limitations of these claims.

The remaining claims all depend directly or indirectly from independent claims 1, 19, 23, 34, 45, or 48, and are therefore also allowable.

Any additional fee which is due in connection with this amendment should be applied against our Deposit Account No. 501-791. In view of the foregoing, a Notice of Allowance appears to be in order and such is courteously solicited.

Respectfully submitted,

By: /David L. Terrell/  
David L. Terrell, Reg. No. 50,576  
Garmin International, Inc.  
1200 East 151<sup>st</sup> Street  
Olathe, KS 66062  
(913) 397-8200  
(913) 397-9079 (Fax)

## Electronic Acknowledgement Receipt

<b>EFS ID:</b>	1236078
<b>Application Number:</b>	10667026
<b>Confirmation Number:</b>	9123
<b>Title of Invention:</b>	Methods, systems, and devices for cartographic alerts
<b>First Named Inventor:</b>	Darrin W. Kabel
<b>Customer Number:</b>	38933
<b>Filer:</b>	David L. Terrell/Christine Terrell
<b>Filer Authorized By:</b>	David L. Terrell
<b>Attorney Docket Number:</b>	702.254
<b>Receipt Date:</b>	04-OCT-2006
<b>Filing Date:</b>	18-SEP-2003
<b>Time Stamp:</b>	17:44:30
<b>Application Type:</b>	Utility
<b>International Application Number:</b>	

### Payment information:

Submitted with Payment	no
------------------------	----

### File Listing:

Document Number	Document Description	File Name	File Size(Bytes)	Multi Part	Pages
1		Amendment7.pdf	145952	yes	33



<b>Multipart Description</b>		
<b>Doc Desc</b>	<b>Start</b>	<b>End</b>
Amendment After Final	1	1
Claims	2	15
Applicant Arguments/Remarks Made in an Amendment	16	33
<b>Warnings:</b>		
<b>Information:</b>		
<b>Total Files Size (in bytes):</b>	145952	
<p><b>This Acknowledgement Receipt evidences receipt on the noted date by the USPTO of the indicated documents, characterized by the applicant, and including page counts, where applicable. It serves as evidence of receipt similar to a Post Card, as described in MPEP 503.</b></p> <p><b><u>New Applications Under 35 U.S.C. 111</u></b>  <b>If a new application is being filed and the application includes the necessary components for a filing date (see 37 CFR 1.53(b)-(d) and MPEP 506), a Filing Receipt (37 CFR 1.54) will be issued in due course and the date shown on this Acknowledgement Receipt will establish the filing date of the application.</b></p> <p><b><u>National Stage of an International Application under 35 U.S.C. 371</u></b>  <b>If a timely submission to enter the national stage of an international application is compliant with the conditions of 35 U.S.C. 371 and other applicable requirements a Form PCT/DO/EO/903 indicating acceptance of the application as a national stage submission under 35 U.S.C. 371 will be issued in addition to the Filing Receipt, in due course.</b></p>		

Under the Paperwork Reduction Act of 1995, no persons are required to respond to a collection of information unless it displays a valid OMB control number.

**PATENT APPLICATION FEE DETERMINATION RECORD**  
 Substitute for Form PTO-875.

Application of DocId Number  
10/667026

**CLAIMS AS FILED - PART I**  
 (Column 1) (Column 2)

**SMALL ENTITY** OR

**OTHER THAN SMALL ENTITY**

FOR	NUMBER FILED	NUMBER EXTRA	RATE	FEE	OR	RATE	FEE
BASIC FEE (37 CFR 1.16(a))				\$	OR		\$
TOTAL CLAIMS (37 CFR 1.16(c))		minus 20 =	X \$	=	OR	X \$	=
INDEPENDENT CLAIMS (37 CFR 1.16(b))		minus 3 =	X \$	=	OR	X \$	=
MULTIPLE DEPENDENT CLAIM PRESENT (37 CFR 1.16(d))			+	\$	OR	+	\$
* If the difference in column 1 is less than zero, enter "0" in column 2.			TOTAL		OR	TOTAL	

**CLAIMS AS AMENDED - PART II**

7-25-06

AMENDMENT	(Column 1)	(Column 2)	(Column 3)	SMALL ENTITY		OR	OTHER THAN SMALL ENTITY	
	CLAIMS REMAINING AFTER AMENDMENT	HIGHEST NUMBER PREVIOUSLY PAID FOR	PRESENT EXTRA	RATE	ADDITIONAL FEE		RATE	ADDITIONAL FEE
Total (37 CFR 1.162(b))	<u>50</u>	Minus	<u>50</u>	X \$	=	OR	X \$	=
Independent (37 CFR 1.162(a))	<u>9</u>	Minus	<u>9</u>	X \$	=	OR	X \$	=
FIRST PRESENTATION OF MULTIPLE DEPENDENT CLAIM (37 CFR 1.162(i))				+	\$	OR	+	\$
				TOTAL ADDL FEE		OR	TOTAL ADDL FEE	

AMENDMENT	(Column 1)	(Column 2)	(Column 3)	SMALL ENTITY		OR	OTHER THAN SMALL ENTITY	
	CLAIMS REMAINING AFTER AMENDMENT	HIGHEST NUMBER PREVIOUSLY PAID FOR	PRESENT EXTRA	RATE	ADDITIONAL FEE		RATE	ADDITIONAL FEE
Total (37 CFR 1.162(b))	<u>50</u>	Minus	<u>50</u>	X \$	=	OR	X \$	=
Independent (37 CFR 1.162(a))	<u>9</u>	Minus	<u>9</u>	X \$	=	OR	X \$	=
FIRST PRESENTATION OF MULTIPLE DEPENDENT CLAIM (37 CFR 1.162(i))				+	\$	OR	+	\$
				TOTAL ADDL FEE		OR	TOTAL ADDL FEE	

AMENDMENT	(Column 1)	(Column 2)	(Column 3)	SMALL ENTITY		OR	OTHER THAN SMALL ENTITY	
	CLAIMS REMAINING AFTER AMENDMENT	HIGHEST NUMBER PREVIOUSLY PAID FOR	PRESENT EXTRA	RATE	ADDITIONAL FEE		RATE	ADDITIONAL FEE
Total (37 CFR 1.162(b))		Minus		X \$	=	OR	X \$	=
Independent (37 CFR 1.162(a))		Minus		X \$	=	OR	X \$	=
FIRST PRESENTATION OF MULTIPLE DEPENDENT CLAIM (37 CFR 1.162(i))				+	\$	OR	+	\$
				TOTAL ADDL FEE		OR	TOTAL ADDL FEE	

\* If the entry in column 1 is less than the entry in column 2, write "0" in column 3.  
 \*\* If the "Highest Number Previously Paid For" IN THIS SPACE is less than 20, enter "20".  
 \*\*\* If the "Highest Number Previously Paid For" IN THIS SPACE is less than 3, enter "3".  
 The "Highest Number Previously Paid For" (Total or Independent) is the highest number found in the appropriate box in column 1.

This collection of information is required by 37 CFR 1.16. The information is required to obtain or retain a benefit by the public which is to file (and by the USPTO to process) an application. Confidentiality is governed by 35 U.S.C. 122 and 37 CFR 1.14. This collection is estimated to take 12 minutes to complete, including gathering, preparing, and submitting the completed application form to the USPTO. Time will vary depending upon the individual case. Any comments on the amount of time you require to complete this form and/or suggestions for reducing this burden should be sent to the Chief Information Officer, U.S. Patent and Trademark Office, U.S. Department of Commerce, P.O. Box 1450, Alexandria, VA 22313-1450. DO NOT SEND FEES OR COMPLETED FORMS TO THIS ADDRESS. SEND TO: Commissioner for Patents, P.O. Box 1450, Alexandria, VA 22313-1450.

If you need assistance in completing this form, call 1-800-PTO-9199 and select option 7.



UNITED STATES PATENT AND TRADEMARK OFFICE

UNITED STATES DEPARTMENT OF COMMERCE  
United States Patent and Trademark Office  
Address: COMMISSIONER FOR PATENTS  
P.O. Box 1450  
Alexandria, Virginia 22313-1450  
www.uspto.gov

APPLICATION NO.	FILING DATE	FIRST NAMED INVENTOR	ATTORNEY DOCKET NO.	CONFIRMATION NO.
10/667,026	09/18/2003	Darrin W. Kabel	702.254	9123

38933          7590          08/08/2006

GARMIN LTD.  
C/O GARMIN INTERNATIONAL, INC.  
ATTN: Legal - IP  
1200 EAST 151ST STREET  
OLATHE, KS 66062

EXAMINER

MEHMOOD, JENNIFER

ART UNIT	PAPER NUMBER
2612	

2612

DATE MAILED: 08/08/2006

Please find below and/or attached an Office communication concerning this application or proceeding.

<b>Office Action Summary</b>	<b>Application No.</b> 10/667,026	<b>Applicant(s)</b> KABEL ET AL.	
	<b>Examiner</b> Jennifer A. Mehmood	<b>Art Unit</b> 2612	

-- The MAILING DATE of this communication appears on the cover sheet with the correspondence address --

**Period for Reply**

A SHORTENED STATUTORY PERIOD FOR REPLY IS SET TO EXPIRE 3 MONTH(S) OR THIRTY (30) DAYS, WHICHEVER IS LONGER, FROM THE MAILING DATE OF THIS COMMUNICATION.

- Extensions of time may be available under the provisions of 37 CFR 1.136(a). In no event, however, may a reply be timely filed after SIX (6) MONTHS from the mailing date of this communication.
- If NO period for reply is specified above, the maximum statutory period will apply and will expire SIX (6) MONTHS from the mailing date of this communication.
- Failure to reply within the set or extended period for reply will, by statute, cause the application to become ABANDONED (35 U.S.C. § 133). Any reply received by the Office later than three months after the mailing date of this communication, even if timely filed, may reduce any earned patent term adjustment. See 37 CFR 1.704(b).

**Status**

- 1)  Responsive to communication(s) filed on 25 July 2006.
- 2a)  This action is **FINAL**.                      2b)  This action is non-final.
- 3)  Since this application is in condition for allowance except for formal matters, prosecution as to the merits is closed in accordance with the practice under *Ex parte Quayle*, 1935 C.D. 11, 453 O.G. 213.

**Disposition of Claims**

- 4)  Claim(s) 1,5-10,19-23,27-34 and 38-67 is/are pending in the application.
- 4a) Of the above claim(s) \_\_\_\_\_ is/are withdrawn from consideration.
- 5)  Claim(s) \_\_\_\_\_ is/are allowed.
- 6)  Claim(s) 1,5-10,19-23,27-34 and 38-67 is/are rejected.
- 7)  Claim(s) \_\_\_\_\_ is/are objected to.
- 8)  Claim(s) \_\_\_\_\_ are subject to restriction and/or election requirement.

**Application Papers**

- 9)  The specification is objected to by the Examiner.
- 10)  The drawing(s) filed on \_\_\_\_\_ is/are: a)  accepted or b)  objected to by the Examiner.  
Applicant may not request that any objection to the drawing(s) be held in abeyance. See 37 CFR 1.85(a).  
Replacement drawing sheet(s) including the correction is required if the drawing(s) is objected to. See 37 CFR 1.121(d).
- 11)  The oath or declaration is objected to by the Examiner. Note the attached Office Action or form PTO-152.

**Priority under 35 U.S.C. § 119**

- 12)  Acknowledgment is made of a claim for foreign priority under 35 U.S.C. § 119(a)-(d) or (f).
- a)  All    b)  Some \*    c)  None of:
1.  Certified copies of the priority documents have been received.
2.  Certified copies of the priority documents have been received in Application No. \_\_\_\_\_.
3.  Copies of the certified copies of the priority documents have been received in this National Stage application from the International Bureau (PCT Rule 17.2(a)).
- \* See the attached detailed Office action for a list of the certified copies not received.

**Attachment(s)**

- |  |   |
|--|---|
| 1) <input type="checkbox"/> Notice of References Cited (PTO-892)   | 4) <input type="checkbox"/> Interview Summary (PTO-413)<br>Paper No(s)/Mail Date. _____ |
| 2) <input type="checkbox"/> Notice of Draftsperson's Patent Drawing Review (PTO-948)   | 5) <input type="checkbox"/> Notice of Informal Patent Application (PTO-152)             |
| 3) <input checked="" type="checkbox"/> Information Disclosure Statement(s) (PTO-1449 or PTO/SB/08)<br>Paper No(s)/Mail Date <u>July 25, 2006</u> . | 6) <input type="checkbox"/> Other: _____  |

***Claim Rejections - 35 USC § 112***

1. The following is a quotation of the second paragraph of 35 U.S.C. 112:  
  
The specification shall conclude with one or more claims particularly pointing out and distinctly claiming the subject matter which the applicant regards as his invention.
2. Claims 52 and 53 are rejected under 35 U.S.C. 112, second paragraph, as being indefinite for failing to particularly point out and distinctly claim the subject matter which applicant regards as the invention.
3. Claims 52 and 53 recites the limitations "the first manner" and "the second manner" in lines 1-3. There is insufficient antecedent basis for this limitation in the claim.

***Claim Rejections - 35 USC § 102***

4. The following is a quotation of the appropriate paragraphs of 35 U.S.C. 102 that form the basis for the rejections under this section made in this Office action:  
  
A person shall be entitled to a patent unless –  
  
(b) the invention was patented or described in a printed publication in this or a foreign country or in public use or on sale in this country, more than one year prior to the date of application for patent in the United States.
5. Claims 19, 20, and 22 are rejected under 35 U.S.C. 102(b) as being anticipated by Bailey et al. (US 4,873,676).

For claim 19, Bailey discloses a method for marine navigation, comprising: receiving one or more preselected conditions from a user (col 7, lns 62-68; col 8, lns 1-4, 19, and 20; Fig. 1, item 15a, 16a); receiving a user defined graphical filter area from the user (col 4, lns 11-14; col 8, lns 15-17); identifying the user defined graphical filter

area on a display (col 8, Ins 25-37; Fig. 1, item 15a); analyzing cartographic data only within the user defined graphical filter area for the preselected conditions (col 3, Ins 26-36 and 46-48); and providing an alert signal when cartographic data within the user defined graphical filter area indicate the preselected conditions (col 9, Ins 1-15; col 15, Ins 25-28; col 23, Ins 30-38; col 28, Ins 40-45).

For claim 20, Bailey discloses identifying the user defined graphical filter area includes repositioning the user defined graphical filter area (col 3, Ins 30-36; col 4, Ins 11-24; col 8, Ins 14-20; col 10, Ins 59-68; col 11, Ins 1-17).

For claim 22, Bailey discloses receiving preselected conditions selected from the group of land, water depth, rock(s), sandbars, shelves, tide condition, tidal data, wind conditions, ice, above-water obstacles, underwater obstacles, type of water bottom, and prohibited areas (col 10, Ins 50-55; col 28, Ins 18-32 and 40-45).

### ***Claim Rejections - 35 USC § 103***

6. The following is a quotation of 35 U.S.C. 103(a) which forms the basis for all obviousness rejections set forth in this Office action:

(a) A patent may not be obtained though the invention is not identically disclosed or described as set forth in section 102 of this title, if the differences between the subject matter sought to be patented and the prior art are such that the subject matter as a whole would have been obvious at the time the invention was made to a person having ordinary skill in the art to which said subject matter pertains. Patentability shall not be negated by the manner in which the invention was made.

7. Claims 1, 5-10, 23, 27-29, 38, 39, 42-44, 58-61, 66, and 67 are rejected under 35 U.S.C. 103(a) as being unpatentable over Fujimoto et al. (US 2004/0006423) and further in view of Michaelson et al. (US 6,734,808).

For claims 1, 44, 60, 61, 66, and 67 Fujimoto discloses a method for marine navigation, comprising: receiving one or more preselected conditions from a user (parag 0115; parag 0018; 0047; 0115; Fig. 17a-c, items 301, 302); identifying a potential waypoint (paragraph 0071, 0072; Figure 4); and performing a marine route calculation algorithm to route a course between a first location and the potential waypoint avoiding the preselected conditions (parag 0076-0078), including analyzing cartographic data between the first location and the potential waypoint (parag 0023, 0132, 0133; Fig. 22a, 22b) and re-routing the course to avoid the preselected conditions (parag 0023, 0132, 0133; Fig. 22a, 22b). Fujimoto discloses identifying user waypoints (parag 0140, Ins 1-5), but does not disclose identifying non-user waypoints. Michaelson, on the other hand discloses re-routing a course by identifying one or more non-user waypoints (determined by the system, not the user) between the first location and the potential waypoint (col 24, Ins 41-50 and 55-64). It would have been obvious to disclose non-user waypoints so that an operator of a ship relies on automatic navigation between a point of origin and a destination without constantly monitoring the ship's travel route.

For claims 5 and 27, Fujimoto determines a first location on the course based on a signal from a GPS; and analyzing cartographic data for a predetermined area around the first location for preselected conditions (parag 0067, Ins 1-10; parag 0068, last 9 lines; parag 0071, 0072).

For claims 6, 28, and 39 Fujimoto does not disclose an alert signal; however, Michaelson discloses an alert signal when analyzed cartographic data for a predetermined area around a location includes preselected conditions (col 5, Ins 35-40;

col 13, Ins 56-67). It would have been obvious to provide an alert signal so that a ship's operator acknowledges an alert and verifies that the ship is maneuvered around a preselected condition to ensure the safety of the ships passengers.

For claims 7, 30, and 40 Fujimoto discloses analyzing cartographic data between the first location and the potential waypoint includes preselected conditions, but does not disclose an alert signal between a first location and a potential waypoint; however, Michaelson discloses an alert signal is provided when the analyzed cartographic data for the predetermined data between the first location and the potential waypoint (col 5, Ins 35-40; col 13, Ins 56-67). It would have been obvious to provide an alert signal so that a ship's operator acknowledges an alert and verifies that the ship is maneuvered around a dangerous condition to ensure the safety of the ships passengers.

For claims 8 and 31, the claim is interpreted and rejected for the same reasons as stated in the rejections of claim 6 and 7 as stated above. In addition, Michaelson discloses the alert signal includes emitting an audio alert (col 6, Ins 15-18; Fig. 2, item 28). It would have been obvious to emit an audio alert so that a ship's operator acknowledges an alert and verifies that the ship is maneuvered around a preselected condition to ensure the safety of the ships passengers.

For claims 9 and 32, the claim is interpreted and rejected for the same reasons as stated in the rejections of claim 6-8 as stated above. Michaelson discloses providing the alert signal to include displaying a visual alert (Fig. 48). It would have been obvious to emit a visual alert so that a ship's operator acknowledges an alert and verifies that



the ship is maneuvered around a preselected condition to ensure the safety of the ships passengers.

For claim 10, Fujimoto discloses receiving preselected conditions, but does not include weather conditions. However, Michaelson discloses this feature (col 26, Ins 18-30). It would have been obvious to include weather conditions, so that an operator of a ship predicts changing weather patterns via a weather radar display.

For claim 23, the claim is interpreted and rejected for the same reasons as stated in the rejection of claim 1 as stated above. In addition, Fujimoto discloses a computer readable medium having a set of computer readable instructions (parag 0067, Ins 1-10; parag 0068, Ins 1-8 and last 12 lines) for receiving one or more preselected conditions as discussed in the limitations of claim 1.

For claim 29, Fujimoto discloses acquiring cartographic data from a GPS (parag 0067, Ins 1-10; parag 0068, last 9 lines; parag 0071, 0072).

For claim 34, the claim is interpreted and rejected for the same reasons as stated in the rejection of claim 1 as stated above, regarding re-routing a course and non-user selected waypoints. Furthermore, Fujimoto discloses an electronic marine navigation device, comprising: a processor; a user interface operatively coupled to the processor, wherein the user interface receives one or more preselected conditions from a user (parag 0018; 0047; 0115; Fig. 17a-c, items 301, 302); a location input operatively coupled to the processor, wherein the location input receives a first location and a potential waypoint separate from the first location (parag 0067, Ins 6-12; Fig. 1, items 2, 3); and a memory operatively coupled to the processor and the location input (parag

0116), the memory having cartographic data including data related to the preselected conditions (parag 0115), wherein the processor operates on a marine route calculation algorithm to analyze a course between the first location and the potential waypoint in view of the preselected conditions of the cartographic data.

For claim 38, Fujimoto discloses a GPS system operatively coupled to the processor (Fig. 1, items 3, 6; parag 0066, lns 1-3, 12-16), wherein the processor determines the first location on the course based on a signal received from the GPS (parag 0068, last 9 lines), and analyzes cartographic data for a predetermined area around the first location for preselected conditions (parag 0072; 0113). Even though Fujimoto does not specifically disclose a GPS receiver, it would have been obvious to one of ordinary skill in the art, at the time the invention was made to include a GPS receiver to receive signals from a satellite in order to determine the ships position.

For claim 42, Fujimoto discloses a first location and a potential waypoint independent of a current location of a device implementing the method (parag 0139; 0140).

For claim 43, Fujimoto discloses at least a portion of the course is unrelated to a current heading of a device implementing the method (parag 0140, last 10 lines).

For claims 58 and 59, Fujimoto discloses the step of displaying the course from the first location to the potential waypoint via user selected waypoints (parag 0067, lns 6-12), but not non-user selected waypoints. However, Michaelson discloses displaying the course from the first location to the potential waypoint via non-user user selected waypoints (col 25, lns 55-63; Fig. 34, item 4000; Figs. 35, 36). It would have been

obvious to display all user waypoints, so that an operator of a ship predicts the path of travel.

8. Claim 21 is rejected under 35 U.S.C. 103(a) as being unpatentable over Bailey et al. (US 4,873,676), and further in view of Fujimoto et al. (US 2004/0006423).

Bailey discloses analyzing cartographic data, but does not acquire the cartographic data from a GPS; however, Fujimoto discloses acquiring cartographic data from a GPS (parag 0067, lns 1-10; parag 0068, last 9 lines; parag 0071, 0072). It would have been obvious to acquire cartographic data from a GPS so that a ship's captain relies on accurate real-time data in order to ensure a navigational route.

9. Claim 33 is rejected under 35 U.S.C. 103(a) as being unpatentable over Fujimoto et al. (US 2004/0006423) and Michaelson et al. (US 6,734,808), and further in view of Tobin, Jr. (US 4,323,992).

Fujimoto does not disclose the preselected condition of water depth; however, Michaelson discloses a preselected condition of water depth (col 8, lns 54-62; col 9, lns 6-16 and 36-39). It would have been obvious to include the preselected condition of water depth so that a ship's operator acknowledges a dangerous water depth and verifies that the ship is maneuvered around or away from an insufficient water depth to ensure the safety of the ships' passengers.

10. Claim 41 is rejected under 35 U.S.C. 103(a) as being unpatentable over Fujimoto et al. (US 2004/0006423) and Michaelson et al. (US 6,734,808), as applied to claim 34, and further in view of Bailey et al. (US 4,873,676).

Fujimoto discloses a processor to operate on the marine route calculation algorithm to analyze cartographic data (parag 0067, Ins 6-12; parag 0068, Ins 1-10); however, Fujimoto does not disclose an alert signal. Michaelson discloses an alert as discussed in the rejection of claim 6. However, Fujimoto does not disclose a user defined graphical filter area. Bailey, on the other hand, does disclose a user defined graphical filter area (col 4, Ins 11-14; col 7, Ins 62-68; col 8, Ins 1-4, 15-17, 25-37; Fig. 1, item 15a, 16a); wherein a processor operates to analyze cartographic data within the defined graphical filter area and provides an alert signal when the analyzed cartographic data for the user defined graphical filter area includes preselected conditions. It would have been obvious to display cartographic data as a user defined graphical filter area so that a user has a certain degree of control over the display in order to customize it according to the user's preferences.

11. Claims 45, 46, and 62 are rejected under 35 U.S.C. 103(a) as being unpatentable over Fujimoto et al. (US 2004/0006423) and Michaelson et al. (US 6,734,808) further in view of Walsh et al. (US 3,886,487).

For claim 45, the claim is interpreted and rejected for the same reasons as stated in the rejection of claim 1 as stated above. In addition, Fujimoto discloses a method for marine navigation, comprising: receiving indication of a preselected condition from a user (parag 0047; parag 0115; Fig. 17a-c, items 301, 302); identifying a potential waypoint (paragraph 0066; 0072, lines 1,2); and performing a marine route calculation algorithm to route a course between a first location and the potential waypoint (parag 0068, Ins 5-8) in order to avoid the preselected condition. Fujimoto, on the other hand,

discloses neither receiving indication of a minimum water depth from a user nor avoiding water depth less than the minimum water depth. However, Walsh discloses receiving indication of a minimum water depth from a user and avoiding water depth less than the minimum water depth (col 2, Ins 13-19; col 3, Ins 21-30; col 8, Ins 24-34, 53-60; col 9, Ins 1-10; Fig. 4, items 182, 184, 186, 188, 98; Figs. 1 and 2, items 40, 42, 48). It would have been obvious to avoid a water depth less than the minimum water depth so that a ship's operator acknowledges a dangerous water depth and verifies that the ship is maneuvered around or away from an insufficient water depth to ensure the safety of the ships' passengers.

For claim 46, Fujimoto discloses displaying a visual indication of places along the calculated course to include expected preselected conditions (parag 0047; parag 0115; Fig. 17a-c, items 301, 302); however, Fujimoto does not disclose the preselected conditions to include a water depth that is expected to approach the minimum water depth. Walsh, on the other hand, discloses receiving indication of a water depth that is expected to approach the minimum water depth. (col 3, Ins 21-30; col 8, Ins 24-34, 53-60; col 9, Ins 1-10; Fig. 4, items 182, 184, 186, 188, 98; Figs. 1 and 2, items 40, 42, 48). It would have been obvious to avoid a water depth less than the minimum water depth so that a ship's operator acknowledges a dangerous water depth and verifies that the ship is maneuvered around or away from an insufficient water depth to ensure the safety of the ships' passengers.

For claim 62, the claim is interpreted and rejected for the same reasons as stated in the rejection of claims 1 and 58 as stated above.

12. Claims 47-57, and 63-65 are rejected under 35 U.S.C. 103(a) as being unpatentable over Fujimoto et al. (2004/0003958) and further in view of Fujimoto et al. (US 2004/0006423) and Michaelson et al. (US 6,734,808).

For claims 47 and 54, Fujimoto '958 discloses a method for marine navigation comprising: receiving indication of a minimum water depth from a user (Fig. 3, item 47; parag 0125, Ins 7-14; parag 0126, Ins 3, 4, 10-17); displaying marine cartographic data (Fig. 3); displaying substantially straight line between a first location and a second location, wherein the line depicts both where the water depth is expected to be greater than the minimum water depth and where the water depth is expected to be less than the minimum water depth (parag 0073; Fig. 3, items 45, 47, 43; parag 0125, Ins 6-15). Fujimoto '958, however, discloses neither receiving indications of waypoints nor performing a marine route calculation algorithm to route a course between a first location and a potential waypoint avoiding water depth less than a minimum water depth. Fujimoto '423, on the other hand, discloses receiving indications of waypoints and performing a marine route calculation algorithm to route a course between a first location and a potential waypoint avoiding a preselected condition (parag 0075-0078; parag 0115; 0047; 0115; Fig. 17a-c, items 301, 302). It would have been obvious to receive indications of waypoints and perform a marine route calculation algorithm to route a course between a first location and a potential waypoint avoiding water depth less than the minimum water depth so that accurate navigation is achieved while avoiding low water levels to ensure the safety of the ships' passengers. Furthermore, Fujimoto does not disclose highlighting the water depth line, however, Michaelson

discloses highlighting a terrain threat indication. It would have been obvious to emphasize a water depth line by highlighting so that an individual easily recognizes and avoids locations of low water levels that are threatening to the path of travel.

For claim 48, the claim is interpreted and rejected for the same reasons as stated in the rejection of claim 47 as stated above. In addition, the line distinguishes where the water depth is expected to be greater than a preset minimum water depth from where the water depth is expected to be less than the minimum water depth (parag 0073; Fig. 3, items 45, 47, 43; parag 0125, Ins 6-15).

For claim 49, Fujimoto '958 discloses the minimum water depth is user selectable (Fig. 3, item 47; parag 0125, Ins 7-14; 0126, Ins 3, 4, 10-17).

For claim 50, Fujimoto '958 discloses a line depicted in a first manner where the water depth is expected to be greater than the minimum water depth and the line is depicted in a second manner where the water depth is expected to be less than the minimum water depth (parag 0133; Fig. 23, items 128, 124, 125; parag 0129).

For claim 51, Fujimoto '958 discloses the line displayed on the marine cartographic data in a plan view (Fig. 22, 23).

For claims 52 and 53, Fujimoto discloses a water depth line but does not disclose first and second manners of displaying a line; however, Michaelson discloses first and second colors to display terrain indications (col 27, Ins 40-65; Fig. 48). It would have been obvious to emphasize a water depth line by color changes so that an individual easily recognizes and avoids low water levels that are threatening to the path of travel.

For claims 55 and 56, the claim is interpreted and rejected for the same reasons as stated in the rejection of claims 1 and 54 as stated above.

For claim 57, the claim is interpreted and rejected for the same reasons as stated in the rejection of claims 48 and 52 as stated above.

For claims 63 and 64, the claim is interpreted and rejected for the same reasons as stated in the rejection of claims 1, 58, and 59 as stated above.

For claim 65, the claim is interpreted and rejected for the same reasons as stated in the rejection of claims 48 and 53 as stated above.

### ***Response to Arguments***

13. Applicant's arguments filed July 25, 2006 have been fully considered but they are not persuasive.

For amended claim 1 (old claim 4), Applicant argues as follows: Michaelson does not re-route a course by identifying one or more non-user waypoints, but only alerts the crew to a new heading to steer or engine setting to avoid collisions. Michaelson only suggests a heading change to avoid an obstacle.

Reference rejection of claim one. By Michaelson alerting the crew to a new heading to avoid potential collisions, Michaelson is re-routing a course by identifying non-user waypoints. In addition, column 13, lines 56-67 and column 14, lines 1-4 disclose a course that is re-routed by identifying non-user waypoints. See also figure 9A.

For claim 19, Applicant argues as follows: Bailey does not disclose analyzing cartographic data only within the user defined graphical filter area for the preselected



conditions. Bailey discloses an automatic display scale changing is provided in response to the detected bottom going off-scale or in response to the detected bottom rising to within a predetermined depth.

The display screen, which includes preselected conditions (Fig. 1) is completely customizable (user defined) by the user via the control switches 16a. Therefore, cartographic data is analyzed only within the user defined graphical filter area for the preselected conditions.

For claim 47, Fujimoto '958's only line that relates to water depth is item 43, which depicts a seabed and therefore simply cannot be substantially straight.

See the straight line in figure 3, item 45 which relates to alarm water depth line paragraph 0073.

For claim 50, because Fujimoto '958 does not depict a difference in a line, Fujimoto does not disclose a line depicted in a first manner where the water depth is expected to be greater than the minimum water depth and the line is depicted in a second manner where the water depth is expected to be less than the minimum water depth.

See figure 23, the line for the water depth (124) is depicted in a first manner as a non-alarming condition where the seabed line (125) does not intersect the water depth line. Furthermore, 124 is depicted in a second manner as an alarming condition where the seabed line intersects the water depth line to produce an alarm (128).

***Conclusion***

14. Applicant's amendment necessitated the new ground(s) of rejection presented in this Office action. Accordingly, **THIS ACTION IS MADE FINAL**. See MPEP § 706.07(a). Applicant is reminded of the extension of time policy as set forth in 37 CFR 1.136(a).

A shortened statutory period for reply to this final action is set to expire **THREE MONTHS** from the mailing date of this action. In the event a first reply is filed within **TWO MONTHS** of the mailing date of this final action and the advisory action is not mailed until after the end of the **THREE-MONTH** shortened statutory period, then the shortened statutory period will expire on the date the advisory action is mailed, and any extension fee pursuant to 37 CFR 1.136(a) will be calculated from the mailing date of the advisory action. In no event, however, will the statutory period for reply expire later than **SIX MONTHS** from the date of this final action.

15. Any inquiry concerning this communication or earlier communications from the examiner should be directed to Jennifer A. Mehmood whose telephone number is (571) 272.2976. The examiner can normally be reached 8:00-4:30, M-F.

If attempts to reach the examiner by telephone are unsuccessful, the examiner's supervisor, Mr. Daniel Wu can be reached at (571) 272.2964. The fax phone number for the organization where this application or proceeding is assigned is (571) 273.8300 for regular and after final communications.

Any inquiry of a general nature of relating to the status of this application or proceeding should be directed to the receptionist whose telephone number is (571) 272.2600.

Information regarding the status of an application may be obtained from the Patent Application Information Retrieval (PAIR) system. Status information for published applications may be obtained from either Private PAIR or Public PAIR. Status information for unpublished applications is available through Private PAIR only. For more information about the PAIR system, see <http://pair-direct.uspto.gov>. Should you have questions on access to the Private PAIR system, contact the Electronic Business Center (EBC) at 866-217-9197 (toll-free).

Jennifer Mehmood  
July 28, 2006

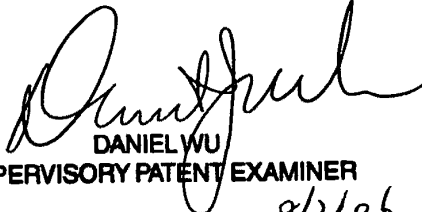
  
DANIEL WU  
SUPERVISORY PATENT EXAMINER  
8/3/06

IDS - 07/25/2006

Under the Paperwork Reduction Act of 1995, no persons are required to respond to a collection of information unless it contains a valid OMB control number.

PTO/SB/08a (08-03 )  
 Approved for use through 07/31/2006. OMB 0851-0031  
 U.S. Patent and Trademark Office; U.S. DEPARTMENT OF COMMERCE

<b>INFORMATION DISCLOSURE STATEMENT BY APPLICANT</b> ( Not for submission under 37 CFR 1.99)	Application Number	10677026
	Filing Date	2003-09-18
	First Named Inventor	KABEL, DARIN W.
	Art Unit	2612
	Examiner Name	MEHMOOD, JENNIFER
	Attorney Docket Number	702.254

U.S. PATENTS							Remove	
Examiner Initial*	Cite No	Patent Number	Kind Code <sup>1</sup>	Issue Date	Name of Patentee or Applicant of cited Document	Pages, Columns, Lines where Relevant Passages or Relevant Figures Appear		
JM	1	5398188		1995-03-14	Maruyama			
JM	2	5872526		1999-02-16	Tognazzini			
If you wish to add additional U.S. Patent citation information please click the Add button.							Add	
U.S. PATENT APPLICATION PUBLICATIONS							Remove	
Examiner Initial*	Cite No	Publication Number	Kind Code <sup>1</sup>	Publication Date	Name of Patentee or Applicant of cited Document	Pages, Columns, Lines where Relevant Passages or Relevant Figures Appear		
	1							
If you wish to add additional U.S. Published Application citation information please click the Add button.							Add	
FOREIGN PATENT DOCUMENTS							Remove	
Examiner Initial*	Cite No	Foreign Document Number <sup>3</sup>	Country Code <sup>2</sup> j	Kind Code <sup>4</sup>	Publication Date	Name of Patentee or Applicant of cited Document	Pages, Columns, Lines where Relevant Passages or Relevant Figures Appear	T <sup>5</sup>
	1							<input type="checkbox"/>
If you wish to add additional Foreign Patent Document citation information please click the Add button.							Add	
NON-PATENT LITERATURE DOCUMENTS							Remove	

<b>INFORMATION DISCLOSURE STATEMENT BY APPLICANT</b> ( Not for submission under 37 CFR 1.99)	Application Number		10677026
	Filing Date		2003-09-18
	First Named Inventor	KABEL, DARIN W.	
	Art Unit	2612	
	Examiner Name	MEHMOOD, JENNIFER	
	Attorney Docket Number	702.254	

Examiner Initials*	Cite No	Include name of the author (in CAPITAL LETTERS), title of the article (when appropriate), title of the item (book, magazine, journal, serial, symposium, catalog, etc), date, pages(s), volume-issue number(s), publisher, city and/or country where published.	T <sup>5</sup>
	1		<input type="checkbox"/>

If you wish to add additional non-patent literature document citation information please click the Add button

**EXAMINER SIGNATURE**

Examiner Signature	/Jennifer Mehmood/	Date Considered	07/27/2006
--------------------	--------------------	-----------------	------------

\*EXAMINER: Initial if reference considered, whether or not citation is in conformance with MPEP 609. Draw line through a citation if not in conformance and not considered. Include copy of this form with next communication to applicant.

<sup>1</sup> See Kind Codes of USPTO Patent Documents at [www.USPTO.GOV](http://www.USPTO.GOV) or MPEP 901.04. <sup>2</sup> Enter office that issued the document, by the two-letter code (WIPO Standard ST.3). <sup>3</sup> For Japanese patent documents, the indication of the year of the reign of the Emperor must precede the serial number of the patent document. <sup>4</sup> Kind of document by the appropriate symbols as indicated on the document under WIPO Standard ST.16 if possible. <sup>5</sup> Applicant is to place a check mark here if English language translation is attached.

**Index of Claims**



Application No.

10/667,026

Examiner

Jennifer A Mehmood

Applicant(s)

KABEL ET AL.

Art Unit

2612

√	Rejected
=	Allowed

-	(Through numeral) Cancelled
+	Restricted

N	Non-Elected
I	Interference

A	Appeal
O	Objected

Claim	Date
Final Original	7/28/06
1	√
2	<del>—</del>
3	<del>—</del>
4	<del>—</del>
5	√
6	<del>—</del>
7	<del>—</del>
8	<del>—</del>
9	<del>—</del>
10	√
11	<del>—</del>
12	<del>—</del>
13	<del>—</del>
14	<del>—</del>
15	<del>—</del>
16	<del>—</del>
17	<del>—</del>
18	<del>—</del>
19	√
20	<del>—</del>
21	<del>—</del>
22	<del>—</del>
23	√
24	<del>—</del>
25	<del>—</del>
26	<del>—</del>
27	√
28	<del>—</del>
29	<del>—</del>
30	<del>—</del>
31	<del>—</del>
32	<del>—</del>
33	<del>—</del>
34	√
35	<del>—</del>
36	<del>—</del>
37	<del>—</del>
38	√
39	<del>—</del>
40	<del>—</del>
41	<del>—</del>
42	<del>—</del>
43	<del>—</del>
44	<del>—</del>
45	<del>—</del>
46	<del>—</del>
47	<del>—</del>
48	<del>—</del>
49	<del>—</del>
50	√

Claim	Date
Final Original	7/28/06
51	√
52	<del>—</del>
53	<del>—</del>
54	<del>—</del>
55	<del>—</del>
56	<del>—</del>
57	<del>—</del>
58	<del>—</del>
59	<del>—</del>
60	<del>—</del>
61	<del>—</del>
62	<del>—</del>
63	<del>—</del>
64	<del>—</del>
65	<del>—</del>
66	<del>—</del>
67	√
68	<del>—</del>
69	<del>—</del>
70	<del>—</del>
71	<del>—</del>
72	<del>—</del>
73	<del>—</del>
74	<del>—</del>
75	<del>—</del>
76	<del>—</del>
77	<del>—</del>
78	<del>—</del>
79	<del>—</del>
80	<del>—</del>
81	<del>—</del>
82	<del>—</del>
83	<del>—</del>
84	<del>—</del>
85	<del>—</del>
86	<del>—</del>
87	<del>—</del>
88	<del>—</del>
89	<del>—</del>
90	<del>—</del>
91	<del>—</del>
92	<del>—</del>
93	<del>—</del>
94	<del>—</del>
95	<del>—</del>
96	<del>—</del>
97	<del>—</del>
98	<del>—</del>
99	<del>—</del>
100	<del>—</del>

Claim	Date
Final Original	
101	
102	
103	
104	
105	
106	
107	
108	
109	
110	
111	
112	
113	
114	
115	
116	
117	
118	
119	
120	
121	
122	
123	
124	
125	
126	
127	
128	
129	
130	
131	
132	
133	
134	
135	
136	
137	
138	
139	
140	
141	
142	
143	
144	
145	
146	
147	
148	
149	
150	

**Search Notes**



Application No.

10/667,026

Examiner

Jennifer A Mehmood

Applicant(s)

KABEL ET AL.

Art Unit

2612

**SEARCHED**

Class	Subclass	Date	Examiner
340	686.6 995.1 984 985 851 539.13	12/28/2005	JS
340	539.2 961	12/28/2005	JS
340	539.22	12/28/2005	JS
340	7.56	12/28/2005	JS
340	825.36	12/28/2005	JS
340	995.11	12/28/2005	JS
367	909	12/28/2005	JS
342	357.13 41	12/28/2005	JS
701	21 201	12/28/2005	JS
701	301	12/28/2005	JS
340	850 851	9/27/2005	JS
367	87-116	4/21/2006	JM
701	211	7/25/2006	JM

**INTERFERENCE SEARCHED**

Class	Subclass	Date	Examiner

**SEARCH NOTES  
(INCLUDING SEARCH STRATEGY)**

	DATE	EXMR
Brent Swartout	1/5/2005	JS
East Search	12/28/2004	JS
Brent Swartout	5/24/2005	JS
Updated Search	5/20/2005	JS
Updated Search	9/27/2005	JS
Updated Search	12/27/2005	JS
Updated Search	4/21/2006	JM
Updated Search	7/25/2006	JM

Y

## EAST Search History

Ref #	Hits	Search Query	DBs	Default Operator	Plurals	Time Stamp
S123	2	"6734808".pn. and (alarm\$4 alert\$4)	US-PGPUB; USPAT; EPO; JPO; DERWENT	OR	ON	2006/07/27 14:35
S124	4	("20040003958").PN.	US-PGPUB; USPAT; EPO; JPO; DERWENT; IBM_TDB	OR	OFF	2006/07/27 14:35
S125	0	("1and(highlight\$4color\$4)").PN.	US-PGPUB; USPAT; EPO; JPO; DERWENT; IBM_TDB	OR	OFF	2006/07/27 14:36
S126	1	S124 and (highlight\$4 color\$4)	US-PGPUB; USPAT; EPO; JPO; DERWENT; IBM_TDB	OR	ON	2006/07/27 14:42
S127	15	"340".cls. and ((water near5 depth) and ((line mark\$4) same (color highlight\$4)))	US-PGPUB; USPAT; EPO; JPO; DERWENT; IBM_TDB	OR	ON	2006/07/27 14:49
S128	0	701/211.ccls. and ((water near5 depth) and ((line mark\$4) same (color highlight\$4)))	US-PGPUB; USPAT; EPO; JPO; DERWENT; IBM_TDB	OR	ON	2006/07/27 14:49
S129	212	701/211.ccls. and ((change near4 color) highlight\$4)	US-PGPUB; USPAT; EPO; JPO; DERWENT; IBM_TDB	OR	ON	2006/07/27 14:51
S130	1	"6734808".pn. and (color\$4 hightlight\$4)	US-PGPUB; USPAT; EPO; JPO; DERWENT; IBM_TDB	OR	ON	2006/07/27 14:51



**IN THE UNITED STATES PATENT AND TRADEMARK OFFICE**

Application of:	)	
	)	
KABEL, DARRIN W.	)	Attorney Docket No.:
	)	702.254
Serial No.: 10/667,026	)	
	)	
Filed: September 18, 2003	)	Group Art Unit No. 2636
	)	
METHODS, SYSTEMS AND DEVICES	)	
FOR CARTOGRAPHIC ALERTS	)	Examiner: MEHMOOD, J.

Mail Stop Amendment  
Commissioner for Patents  
P.O. Box 1450  
Alexandria, VA 22313-1450

**AMENDMENT**

In response to the Office Action of May 3, 2006, applicant respectfully requests that this amendment be entered in the above-referenced application.

**Amendments to the Claims** are reflected in the listing of claims which begins on page 2 of this paper.

**Remarks** begin on page 18 of this paper.

**Amendments to the Claims:**

This listing of claims will replace all prior versions, and listings, of claims in the application:

**CLAIMS:**

Please amend claims 1, 5, 7, 23, 34, 38, 40, 44, 45, 47, and 48, cancel claims 2-4, 11-18, 24-26, and 35-37 without prejudice or disclaimer, as follows:

1. (Currently Amended) A method for marine navigation, comprising:  
receiving one or more preselected conditions from a user, ~~the preselected conditions being selected from the group of water depth, sandbars, shelves, tide condition, tidal data, wind conditions, weather conditions, ice, and type of water bottom;~~  
identifying a potential waypoint; and  
performing a marine route calculation algorithm to route a course between a first location and the potential waypoint avoiding the preselected conditions, including analyzing cartographic data between the first location and the potential waypoint and re-routing the course to avoid the preselected conditions by identifying one or more non-user selected waypoints.
  
- 2-4. (Canceled)

5. (Currently Amended) The method of claim 1, further including determining the first location on the course based on a signal from a global positioning system (GPS); and analyzing cartographic data for a predetermined area around the first location for preselected conditions.
6. (Original) The method of claim 5, further including providing an alert signal when the analyzed cartographic data for the predetermined area around the first location includes preselected conditions.
7. (Currently Amended) The method of claim 1, further including providing an alert signal when the analyzed cartographic data between the first location and the potential waypoint includes preselected conditions.
8. (Original) The method of claim 7, wherein providing the alert signal includes emitting an audio alert.
9. (Original) The method of claim 7, wherein providing the alert signal includes displaying a visual alert.

10. (Previously Presented) The method of claim 1, the preselected conditions including a weather condition.

11-18. (Canceled)

19. (Previously Presented) A method for marine navigation, comprising:  
receiving one or more preselected conditions from a user;  
receiving a user defined graphical filter area from the user;  
identifying the user defined graphical filter area on a display;  
analyzing cartographic data only within the user defined graphical filter area for the preselected conditions; and  
providing an alert signal when cartographic data within the user defined graphical filter area indicate the preselected conditions.

20. (Original) The method of claim 19, wherein identifying the user defined graphical filter area includes repositioning the user defined graphical filter area.

21. (Original) The method of claim 19, wherein analyzing cartographic data further comprises acquiring cartographic data from a global positioning system (GPS).

22. (Original) The method of claim 19, further including receiving preselected conditions selected from the group of land, water depth, rock(s), sandbars, shelves, tide condition, tidal data, wind conditions, weather conditions, ice, above-water obstacles, underwater obstacles, type of water bottom, and prohibited areas.

23. (Currently Amended) A computer readable medium having a set of computer readable instructions, the set of computer readable instructions comprising instructions for:

receiving one or more preselected conditions from a user, ~~the preselected conditions being selected from the group of water depth, sandbars, shelves, tide condition, tidal data, wind conditions, weather conditions, ice, and type of water bottom;~~

identifying a potential waypoint upon a first event; and

performing a marine route calculation algorithm to analyze a course between a first location and the potential waypoint avoiding the preselected conditions, including analyzing cartographic data between the first location and the potential waypoint and re-routing the course to avoid the preselected conditions by identifying one or more non-user selected waypoints.

24-26. (Canceled)

27. (Original) The computer readable medium of claim 23, further including determining the first location on the course based on a signal from a global positioning system (GPS); and analyzing cartographic data for a predetermined area around the first location for preselected conditions.

28. (Original) The computer readable medium of claim 27, further including providing an alert signal when the analyzed cartographic data for the predetermined area around the first location includes preselected conditions.

29. (Original) The computer readable medium of claim 23, wherein analyzing cartographic data further comprises acquiring cartographic data from a global positioning system (GPS).

30. (Original) The computer readable medium of claim 23, further including providing an alert signal when the analyzed cartographic data between the first location and the potential waypoint includes preselected conditions.

31. (Original) The computer readable medium of claim 30, wherein providing the alert signal includes emitting a signal for an audio alert.

32. (Original) The computer readable medium of claim 30, wherein providing the alert signal includes displaying a visual alert.

33. (Previously Presented) The computer readable medium of claim 23, the preselected conditions including a water depth.

34. (Currently Amended) An electronic marine navigation device, comprising:
- a processor;
  - a user interface operatively coupled to the processor, wherein the user interface receives one or more preselected conditions from a user, ~~the preselected conditions being selected from the group of water depth, sandbars, shelves, tide condition, tidal data, wind conditions, weather conditions, ice, and type of water bottom;~~
  - a location input operatively coupled to the processor, wherein the location input receives a first location and a potential waypoint separate from the first location; and
  - a memory operatively coupled to the processor and the location input, the memory having cartographic data including data related to the preselected conditions, wherein the processor operates on a marine route calculation algorithm to analyze a course between the first location and the potential waypoint in view of the preselected conditions of the cartographic data and re-route the course to avoid the preselected conditions by identifying one or more non-user selected waypoints.

35-37. (Canceled)



38. (Currently Amended) The electronic marine navigation device of claim ~~[[35]]~~ 34, further including a receiver for a global positioning system (GPS) operatively coupled to the processor, wherein the processor determines the first location on the course based on a signal received from the GPS, and analyzes cartographic data for a predetermined area around the first location for preselected conditions.

39. (Original) The electronic marine navigation device of claim 38, wherein the processor provides an alert signal when the analyzed cartographic data for the predetermined area around the first location includes preselected conditions.

40. (Currently Amended) The electronic marine navigation device of claim ~~[[35]]~~ 34, wherein the processor provides an alert signal when the analyzed cartographic data between the first location and the potential waypoint includes preselected conditions.

41. (Original) The electronic marine navigation device of claim 34, wherein the location input receives a user defined graphical filter area, and wherein the processor operates on the marine route calculation algorithm to analyze cartographic data within the defined graphical filter area for preselected conditions and wherein the processor provides an alert signal when the analyzed cartographic data for the user defined graphical filter area includes preselected conditions.

42. (Previously Presented) The method of claim 1, wherein both the first location and the potential waypoint are independent of a current location of a device implementing the method.

43. (Previously Presented) The method of claim 1, wherein at least a portion of the course is unrelated to a current heading of a device implementing the method.

44. (Currently Amended) A method for marine navigation, comprising:  
identifying a potential waypoint; and  
performing a marine route calculation algorithm to analyze a course between a first location and the potential waypoint in order to avoid preselected conditions received from a user ~~and selected from the group of naturally occurring land mass, water depth, sandbars, shelves, wind conditions, weather conditions, ice, and type of water bottom~~ and re-route the course to avoid the preselected conditions by identifying one or more non-user selected waypoints.

45. (Currently Amended) A method for marine navigation, comprising:
- receiving indication of a minimum water depth from a user;
  - identifying a potential waypoint; and
  - performing a marine route calculation algorithm to route a course between a first location and the potential waypoint avoiding water depth less than the minimum water depth by identifying one or more non-user selected waypoints.
46. (Previously Presented) The method of claim 45, displaying a visual indication of places along the calculated course where the water depth is expected to approach the minimum water depth.

47. (Currently Amended) A method for marine navigation, comprising:
- receiving indication of a minimum water depth from a user;
  - displaying marine cartographic data;
  - receiving indication of a potential waypoint;
  - displaying a substantially straight line between a first location and the potential waypoint, wherein the line depicts both where the water depth is expected to be greater than the minimum water depth and where the water depth is expected to be less than the minimum water depth, and wherein the line highlights where the water depth is expected to be less than the minimum water depth; and
  - performing a marine route calculation algorithm to route a course between the first location and the potential waypoint avoiding water depth less than the minimum water depth.

48. (Previously Presented) A method for marine navigation, comprising:
- displaying marine cartographic data;
  - receiving indication of a potential waypoint;
  - displaying a substantially straight line between a first location and the potential waypoint, wherein the line ~~depicts both~~ distinguishes where the water depth is expected to be greater than a preset minimum water depth ~~and from~~ where the water depth is expected to be less than the minimum water depth;
  - and
  - performing a marine route calculation algorithm to route a course between the first location and the potential waypoint avoiding water depth less than the minimum water depth.
49. (Previously Presented) The method of claim 48, wherein the minimum water depth is user selectable.
50. (Previously Presented) The method of claim 48, wherein the line is depicted in a first manner where the water depth is expected to be greater than the minimum water depth and the line is depicted in a second manner where the water depth is expected to be less than the minimum water depth.

Please add new claims 51-67, as follows:

51. (New) The method of claim 48, wherein the line is displayed on the marine cartographic data in a plan view.
  
52. (New) The method of claim 48, wherein the first manner is different from the second manner, such that the line itself is displayed differently in the first manner compared with the second manner.
  
53. (New) The method of claim 48, wherein the first manner comprises displaying the line in a first color and the second manner comprises displaying the line in a second color different from the first color.
  
54. (New) A method for marine navigation, comprising:
  - displaying marine cartographic data;
  - receiving indication of a potential waypoint; and
  - displaying a substantially straight line on the marine cartographic data between a first location and the potential waypoint, wherein the line highlights where the water depth is expected to be less than a minimum water depth.

55. (New) The method of claim 54, further including the step of performing a marine route calculation algorithm to route a course from the first location to the potential waypoint avoiding areas where the water depth is expected to be less than the minimum water depth by identifying one or more non-user selected waypoints.

56. (New) The method of claim 55, further including the step of displaying the course from the first location to the potential waypoint via the non-user selected waypoints.

57. (New) The method of claim 54, wherein the line is displayed in a different manner where the water depth is expected to be less than a minimum water depth.

58. (New) The method of claim 1, further including the step of displaying the course from the first location to the potential waypoint via the non-user selected waypoints.

59. (New) The computer readable medium of claim 23, further including instructions for displaying the course from the first location to the potential waypoint via the non-user selected waypoints.

60. (New) The electronic marine navigation device of claim 34, further including a display for displaying the course from the first location to the potential waypoint via the non-user selected waypoints.

61. (New) The method of claim 44, further including the step of displaying the course from the first location to the potential waypoint via the non-user selected waypoints.

62. (New) The method of claim 45, further including the step of displaying the course from the first location to the potential waypoint via the non-user selected waypoints.

63. (New) The method of claim 47, wherein the step of performing a marine route calculation algorithm includes identifying one or more non-user selected waypoints.

64. (New) The method of claim 63, further including the step of displaying the course from the first location to the potential waypoint via the non-user selected waypoints.

65. (New) The method of claim 47, wherein the line is displayed in a first manner where the water depth is expected to be greater than the preset minimum water depth and a second manner, different from the first manner, where the water depth is expected to be less than the minimum water depth.

66. (New) The method of claim 48, wherein the step of performing a marine route calculation algorithm includes identifying one or more non-user selected waypoints.



67. (New) The method of claim 66, further including the step of displaying the course from the first location to the potential waypoint via the non-user selected waypoints.

**REMARKS:**

**Status Of Claims**

Claims 1-50 were previously pending in the application. Claims 1, 5, 7, 23, 34, 38, 40, 44, 45, 47, and 48 have been amended. Claims 2-4, 11-18, 24-26, and 35-37 have been canceled without prejudice or disclaimer. Claims 51-67 have been added. Thus, claims 1, 5-10, 19-23, 27-34, and 38-67 are currently pending in the application with claims 1, 19, 23, 34, 44, 45, 47, 48, and 52 being independent.

**Office Action**

In the Office Action, the Examiner rejected claims 1-3, 5, 6, 11, 12, 15-18, 23-25, 27-29, 33, 34-36, 38, and 42-44 under 35 U.S.C. 103(a) as being unpatentable over Fujimoto et al., U.S. Patent Application No. 2004/0006423 (Fujimoto '423), in view of Tobin Jr., U.S. Patent No. 4,323,992. The Examiner also rejected claims 4, 7-10, 13, 14, 26, 30-32, 37, 39, and 40 under 35 U.S.C. 103(a) as being unpatentable over Fujimoto '423 and Tobin in view of Michaelson et al., U.S. Patent No. 6,734,808. The Examiner also rejected claims 19, 20, and 22 under 35 U.S.C. 102(b) as being anticipated Bailey et al., U.S. Patent No. 4,873,676. The Examiner also rejected claim 21 under 35 U.S.C. 103(a) as being unpatentable over Bailey in view of Fujimoto '423. The Examiner also rejected claim 41 under 35 U.S.C. 103(a) as being unpatentable over Fujimoto '423 and Tobin in view of Bailey. The Examiner also rejected claims 45 and 46 under 35 U.S.C. 103(a) as being unpatentable over Fujimoto 423 in view of Walsh et al., U.S. Patent No. 3,886,487. The

Examiner also rejected claims 47-50 under 35 U.S.C. 103(a) as being unpatentable over Fujimoto et al., U.S. Patent Application No. 2004/0003958 (Fujimoto '958), in view of Fujimoto '423. Applicant respectfully submits that the currently pending claims distinguish the present invention from both Fujimoto references, Tobin, Bailey, Michaelson, Walsh, and the other prior art references of record, taken alone or in combination with each other.

Specifically, claim 1 now recites "performing a marine route calculation algorithm to route a course between a first location and the potential waypoint avoiding the preselected conditions, including analyzing cartographic data between the first location and the potential waypoint and re-routing the course to avoid the preselected conditions by identifying one or more non-user selected waypoints". Similarly, claim 23 now recites "performing a marine route calculation algorithm to analyze a course between a first location and the potential waypoint avoiding the preselected conditions, including analyzing cartographic data between the first location and the potential waypoint and re-routing the course to avoid the preselected conditions by identifying one or more non-user selected waypoints". Claim 34 now recites "wherein the processor operates on a marine route calculation algorithm to analyze a course between the first location and the potential waypoint in view of the preselected conditions of the cartographic data and re-route the course to avoid the preselected conditions by identifying one or more non-user selected waypoints". It should be noted that claims 1, 23, and 34 now include limitations similar to those previously found in claims 4, 26, and 37, respectively.

In contrast, in rejecting claim 4, the Examiner acknowledges that "Fujimoto discloses

re-routing the course ... by identifying user waypoints”, rather than non-user waypoints. To cure this defect, the Examiner mistakenly asserts that “Michaelson, on the other hand discloses re-routing the course by identifying one or more non-user waypoints”. In supporting this assertion, the Examiner points to column 24. However, column 24 clearly states that Michaelson’s invention merely “alerts the crew to a new heading to steer or engine setting to avoid collisions”. Column 24, lines 38-41. Specifically, column 24, lines 57-58, state an “alternate track PT’ is first generated by incrementing the ship’s heading by [a] nominal step size”. Thus, Michaelson discloses only suggesting a heading change to avoid an obstacle. In fact, Michaelson is devoid of any suggestion of “re-routing the course to avoid the preselected conditions **by identifying one or more non-user selected waypoints**”, emphasis added, as claimed in claim 1.

As a result, no combination of either Fujimoto references, Tobin, Bailey, and/or Michaelson discloses, suggests or makes obvious “performing a marine route calculation algorithm to route a course between a first location and the potential waypoint avoiding the preselected conditions, including analyzing cartographic data between the first location and the potential waypoint and re-routing the course to avoid the preselected conditions by identifying one or more non-user selected waypoints”, as claimed in claim 1. Furthermore, no combination of either Fujimoto references, Tobin, Bailey, and/or Michaelson discloses, suggests or makes obvious “performing a marine route calculation algorithm to analyze a course between a first location and the potential waypoint avoiding the preselected conditions, including analyzing cartographic data between the first location and the

potential waypoint and re-routing the course to avoid the preselected conditions by identifying one or more non-user selected waypoints”, as claimed in claim 23. Finally, no combination of either Fujimoto references, Tobin, Bailey, and/or Michaelson discloses, suggests or makes obvious “wherein the processor operates on a marine route calculation algorithm to analyze a course between the first location and the potential waypoint in view of the preselected conditions of the cartographic data and re-route the course to avoid the preselected conditions by identifying one or more non-user selected waypoints”, as claimed in claim 34.

Claim 19 recites “analyzing cartographic data only within the user defined graphical filter area for the preselected conditions”. The Examiner mistakenly asserts that this limitation is disclosed by Bailey in column 3, lines 26-36 and 46-48. However, column 3, lines 26-29 state “[a]utomatic display scale changing is provided in response to the detected bottom going off-scale, or in response to the detected bottom rising to within a predetermined depth”. Thus, Bailey actually rather clearly teaches a system for automatically **redefining** a display area based on changing water depth. As a result, Bailey simply fails to disclose, suggest or make obvious “analyzing cartographic data only within the user defined graphical filter area for the preselected conditions” as claimed in claim 19.

Claim 44 now recites “performing a marine route calculation algorithm to analyze a course between a first location and the potential waypoint in order to avoid preselected conditions received from a user and re-route the course to avoid the preselected conditions

by identifying one or more non-user selected waypoints”. Claim 45 now recites “performing a marine route calculation algorithm to route a course between a first location and the potential waypoint avoiding water depth less than the minimum water depth by identifying one or more non-user selected waypoints”.

In contrast, as discussed above with regard to claims 1, 23, and 34, neither Fujimoto references, Tobin, Bailey, and/or Michaelson disclose avoiding a hazard by identifying non-user selected waypoints. For example, as discussed above, Michaelson only discloses suggesting a heading change. Walsh doesn't even go that far. Specifically, as stated in column 9, lines 6-10, Walsh simply discloses transmitting “as signal to the alarm 188 which in turn then warns the operator of the ship 20 to change course or take other evasive action”, when the depth ahead is too shallow. Thus, Walsh fails to even provide a suggested heading change, much less non-user selected waypoints that may be used to avoid the hazard. As a result, no combination of the cited prior art references discloses, suggests or makes obvious “performing a marine route calculation algorithm to analyze a course between a first location and the potential waypoint in order to avoid preselected conditions received from a user and re-route the course to avoid the preselected conditions by identifying one or more non-user selected waypoints”, as claimed in claim 44, or “performing a marine route calculation algorithm to route a course between a first location and the potential waypoint avoiding water depth less than the minimum water depth by identifying one or more non-user selected waypoints”, as claimed in claim 45.

Claim 47 now recites “displaying a substantially straight line between a first location

and the potential waypoint, wherein the line depicts both where the water depth is expected to be greater than the minimum water depth and where the water depth is expected to be less than the minimum water depth, and wherein the line highlights where the water depth is expected to be less than the minimum water depth". Similarly, claim 48 now recites "displaying a substantially straight line between a first location and the potential waypoint, wherein the line distinguishes where the water depth is expected to be greater than a preset minimum water depth from where the water depth is expected to be less than the minimum water depth".

In contrast, the only straight line the Examiner points to, Fujimoto '958's item 45, is depicted completely independently of water depth. Fujimoto '958's only line that relates to water depth is item 43, which depicts a seabed and therefore simply cannot be substantially straight. Furthermore, displayed item 43 as substantially straight would render it unsatisfactory for its intended purpose, namely depicting the seabed. As a result, neither Fujimoto reference discloses, suggests or makes obvious "displaying a substantially straight line between a first location and the potential waypoint, wherein the line depicts both where the water depth is expected to be greater than the minimum water depth and where the water depth is expected to be less than the minimum water depth, and wherein the line highlights where the water depth is expected to be less than the minimum water depth", as claimed in claim 47, or "displaying a substantially straight line between a first location and the potential waypoint, wherein the line distinguishes where the water depth is expected to be greater than a preset minimum water depth from where the water depth is

expected to be less than the minimum water depth”, as claimed in claim 48.

Claim 50 recites “wherein the line is depicted in a first manner where the water depth is expected to be greater than the minimum water depth and the line is depicted in a second manner where the water depth is expected to be less than the minimum water depth”. For example, this capability is shown in figures 2A, 4A, and 4C and described on pages 11-14, among other places.

The Examiner mistakenly asserts that Fujimoto '958 teaches this limitation. However, Fujimoto '958 merely displays a seabed line 125 above or below a depth mark 124, as the case may be, but the seabed line 125 is otherwise displayed in the exact same manner. Simply put, there is no difference in the line itself or the manner in which it is displayed, such as highlighting color, solid vs. broken or dashed, whether that portion of the line is flashing, or whether that portion of the line is bolded. In fact, Fujimoto '958 lacks any suggestion to show any portion of the seabed line 123 in a different manner. As a result, neither Fujimoto reference discloses, suggests or makes obvious “wherein the line is depicted in a first manner where the water depth is expected to be greater than the minimum water depth and the line is depicted in a second manner where the water depth is expected to be less than the minimum water depth”, as claimed in claim 50.

Claims 51-67 have been added to further distinguish the present invention over the prior art. The remaining claims all depend directly or indirectly from independent claims 1, 19, 23, 34, 45, or 48, and are therefore also allowable.



Application No. 10/667,026  
Amendment dated July 25, 2006  
Reply to Office Action of May 3, 2006

Any additional fee which is due in connection with this amendment should be applied against our Deposit Account No. 501-791. In view of the foregoing, a Notice of Allowance appears to be in order and such is courteously solicited.

Respectfully submitted,

By: /David L. Terrell/  
David L. Terrell, Reg. No. 50,576  
Garmin International, Inc.  
1200 East 151<sup>st</sup> Street  
Olathe, KS 66062  
(913) 397-8200  
(913) 397-9079 (Fax)

Under the Paperwork Reduction Act of 1995, no persons are required to respond to a collection of information unless it contains a valid OMB control number.

<b>INFORMATION DISCLOSURE STATEMENT BY APPLICANT</b> ( Not for submission under 37 CFR 1.99)	Application Number	10677026
	Filing Date	2003-09-18
	First Named Inventor	KABEL, DARIN W.
	Art Unit	2612
	Examiner Name	MEHMOOD, JENNIFER
	Attorney Docket Number	702.254

U.S. PATENTS							Remove	
Examiner Initial*	Cite No	Patent Number	Kind Code <sup>1</sup>	Issue Date	Name of Patentee or Applicant of cited Document	Pages, Columns, Lines where Relevant Passages or Relevant Figures Appear		
	1	5398188		1995-03-14	Maruyama			
	2	5872526		1999-02-16	Tognazzini			
If you wish to add additional U.S. Patent citation information please click the Add button.							Add	
U.S. PATENT APPLICATION PUBLICATIONS							Remove	
Examiner Initial*	Cite No	Publication Number	Kind Code <sup>1</sup>	Publication Date	Name of Patentee or Applicant of cited Document	Pages, Columns, Lines where Relevant Passages or Relevant Figures Appear		
	1							
If you wish to add additional U.S. Published Application citation information please click the Add button.							Add	
FOREIGN PATENT DOCUMENTS							Remove	
Examiner Initial*	Cite No	Foreign Document Number <sup>3</sup>	Country Code <sup>2</sup> j	Kind Code <sup>4</sup>	Publication Date	Name of Patentee or Applicant of cited Document	Pages, Columns, Lines where Relevant Passages or Relevant Figures Appear	T <sup>5</sup>
	1							<input type="checkbox"/>
If you wish to add additional Foreign Patent Document citation information please click the Add button.							Add	
NON-PATENT LITERATURE DOCUMENTS							Remove	

<b>INFORMATION DISCLOSURE STATEMENT BY APPLICANT ( Not for submission under 37 CFR 1.99)</b>	Application Number	10677026
	Filing Date	2003-09-18
	First Named Inventor	KABEL, DARIN W.
	Art Unit	2612
	Examiner Name	MEHMOOD, JENNIFER
	Attorney Docket Number	702.254

Examiner Initials*	Cite No	Include name of the author (in CAPITAL LETTERS), title of the article (when appropriate), title of the item (book, magazine, journal, serial, symposium, catalog, etc), date, pages(s), volume-issue number(s), publisher, city and/or country where published.	T <sup>5</sup>
	1		<input type="checkbox"/>

If you wish to add additional non-patent literature document citation information please click the Add button

**EXAMINER SIGNATURE**

Examiner Signature		Date Considered	
--------------------	--	-----------------	--

\*EXAMINER: Initial if reference considered, whether or not citation is in conformance with MPEP 609. Draw line through a citation if not in conformance and not considered. Include copy of this form with next communication to applicant.

<sup>1</sup> See Kind Codes of USPTO Patent Documents at [www.USPTO.GOV](http://www.USPTO.GOV) or MPEP 901.04. <sup>2</sup> Enter office that issued the document, by the two-letter code (WIPO Standard ST.3). <sup>3</sup> For Japanese patent documents, the indication of the year of the reign of the Emperor must precede the serial number of the patent document. <sup>4</sup> Kind of document by the appropriate symbols as indicated on the document under WIPO Standard ST.16 if possible. <sup>5</sup> Applicant is to place a check mark here if English language translation is attached.

<b>INFORMATION DISCLOSURE STATEMENT BY APPLICANT</b> ( Not for submission under 37 CFR 1.99)	Application Number	10677026
	Filing Date	2003-09-18
	First Named Inventor	KABEL, DARIN W.
	Art Unit	2612
	Examiner Name	MEHMOOD, JENNIFER
	Attorney Docket Number	702.254

**CERTIFICATION STATEMENT**

Please see 37 CFR 1.97 and 1.98 to make the appropriate selection(s):

That each item of information contained in the information disclosure statement was first cited in any communication from a foreign patent office in a counterpart foreign application not more than three months prior to the filing of the information disclosure statement. See 37 CFR 1.97(e)(1).

**OR**

That no item of information contained in the information disclosure statement was cited in a communication from a foreign patent office in a counterpart foreign application, and, to the knowledge of the person signing the certification after making reasonable inquiry, no item of information contained in the information disclosure statement was known to any individual designated in 37 CFR 1.56(c) more than three months prior to the filing of the information disclosure statement. See 37 CFR 1.97(e)(2).

- See attached certification statement.
- Fee set forth in 37 CFR 1.17 (p) has been submitted herewith.
- None

**SIGNATURE**

A signature of the applicant or representative is required in accordance with CFR 1.33, 10.18. Please see CFR 1.4(d) for the form of the signature.

Signature	/David L. Terrell/	Date (YYYY-MM-DD)	2006-07-25
Name/Print	David L. Terrell	Registration Number	50,576

This collection of information is required by 37 CFR 1.97 and 1.98. The information is required to obtain or retain a benefit by the public which is to file (and by the USPTO to process) an application. Confidentiality is governed by 35 U.S.C. 122 and 37 CFR 1.14. This collection is estimated to take 1 hour to complete, including gathering, preparing and submitting the completed application form to the USPTO. Time will vary depending upon the individual case. Any comments on the amount of time you require to complete this form and/or suggestions for reducing this burden, should be sent to the Chief Information Officer, U.S. Patent and Trademark Office, U.S. Department of Commerce, P.O. Box 1450, Alexandria, VA 22313-1450. **DO NOT SEND FEES OR COMPLETED FORMS TO THIS ADDRESS. SEND TO: Commissioner for Patents, P.O. Box 1450, Alexandria, VA 22313-1450.**

## Privacy Act Statement

The Privacy Act of 1974 (P.L. 93-579) requires that you be given certain information in connection with your submission of the attached form related to a patent application or patent. Accordingly, pursuant to the requirements of the Act, please be advised that: (1) the general authority for the collection of this information is 35 U.S.C. 2(b)(2); (2) furnishing of the information solicited is voluntary; and (3) the principal purpose for which the information is used by the U.S. Patent and Trademark Office is to process and/or examine your submission related to a patent application or patent. If you do not furnish the requested information, the U.S. Patent and Trademark Office may not be able to process and/or examine your submission, which may result in termination of proceedings or abandonment of the application or expiration of the patent.

The information provided by you in this form will be subject to the following routine uses:

1. The information on this form will be treated confidentially to the extent allowed under the Freedom of Information Act (5 U.S.C. 552) and the Privacy Act (5 U.S.C. 552a). Records from this system of records may be disclosed to the Department of Justice to determine whether the Freedom of Information Act requires disclosure of these records.
2. A record from this system of records may be disclosed, as a routine use, in the course of presenting evidence to a court, magistrate, or administrative tribunal, including disclosures to opposing counsel in the course of settlement negotiations.
3. A record in this system of records may be disclosed, as a routine use, to a Member of Congress submitting a request involving an individual, to whom the record pertains, when the individual has requested assistance from the Member with respect to the subject matter of the record.
4. A record in this system of records may be disclosed, as a routine use, to a contractor of the Agency having need for the information in order to perform a contract. Recipients of information shall be required to comply with the requirements of the Privacy Act of 1974, as amended, pursuant to 5 U.S.C. 552a(m).
5. A record related to an International Application filed under the Patent Cooperation Treaty in this system of records may be disclosed, as a routine use, to the International Bureau of the World Intellectual Property Organization, pursuant to the Patent Cooperation Treaty.
6. A record in this system of records may be disclosed, as a routine use, to another federal agency for purposes of National Security review (35 U.S.C. 181) and for review pursuant to the Atomic Energy Act (42 U.S.C. 218(c)).
7. A record from this system of records may be disclosed, as a routine use, to the Administrator, General Services, or his/her designee, during an inspection of records conducted by GSA as part of that agency's responsibility to recommend improvements in records management practices and programs, under authority of 44 U.S.C. 2904 and 2906. Such disclosure shall be made in accordance with the GSA regulations governing inspection of records for this purpose, and any other relevant (i.e., GSA or Commerce) directive. Such disclosure shall not be used to make determinations about individuals.
8. A record from this system of records may be disclosed, as a routine use, to the public after either publication of the application pursuant to 35 U.S.C. 122(b) or issuance of a patent pursuant to 35 U.S.C. 151. Further, a record may be disclosed, subject to the limitations of 37 CFR 1.14, as a routine use, to the public if the record was filed in an application which became abandoned or in which the proceedings were terminated and which application is referenced by either a published application, an application open to public inspections or an issued patent.
9. A record from this system of records may be disclosed, as a routine use, to a Federal, State, or local law enforcement agency, if the USPTO becomes aware of a violation or potential violation of law or regulation.

## Electronic Acknowledgement Receipt

<b>EFS ID:</b>	1126598
<b>Application Number:</b>	10667026
<b>Confirmation Number:</b>	9123
<b>Title of Invention:</b>	Methods, systems, and devices for cartographic alerts
<b>First Named Inventor:</b>	Darrin W. Kabel
<b>Customer Number:</b>	38933
<b>Filer:</b>	David L. Terrell
<b>Filer Authorized By:</b>	
<b>Attorney Docket Number:</b>	702.254
<b>Receipt Date:</b>	25-JUL-2006
<b>Filing Date:</b>	18-SEP-2003
<b>Time Stamp:</b>	15:50:03
<b>Application Type:</b>	Utility
<b>International Application Number:</b>	

### Payment information:

Submitted with Payment	no
------------------------	----

### File Listing:

Document Number	Document Description	File Name	File Size(Bytes)	Multi Part	Pages
1		Amendment6.pdf	99742	yes	25

Multipart Description			
Doc Desc	Start	End	
Amendment - After Non-Final Rejection	1	1	
Claims	2	17	
Applicant Arguments/Remarks Made in an Amendment	18	25	

**Warnings:**

**Information:**

2	Information Disclosure Statement (IDS) Filed	US_IDS_Form__SB_08a.pdf	705695	no	4
---	--	-------------------------	--------	----	---

**Warnings:**

**Information:**

<b>Total Files Size (in bytes):</b>			805437		
-------------------------------------	--	--	--------	--	--

This Acknowledgement Receipt evidences receipt on the noted date by the USPTO of the indicated documents, characterized by the applicant, and including page counts, where applicable. It serves as evidence of receipt similar to a Post Card, as described in MPEP 503.

**New Applications Under 35 U.S.C. 111**

If a new application is being filed and the application includes the necessary components for a filing date (see 37 CFR 1.53(b)-(d) and MPEP 506), a Filing Receipt (37 CFR 1.54) will be issued in due course and the date shown on this Acknowledgement Receipt will establish the filing date of the application.

**National Stage of an International Application under 35 U.S.C. 371**

If a timely submission to enter the national stage of an international application is compliant with the conditions of 35 U.S.C. 371 and other applicable requirements a Form PCT/DO/EO/903 indicating acceptance of the application as a national stage submission under 35 U.S.C. 371 will be issued in addition to the Filing Receipt, in due course.

Under the Paperwork Reduction Act of 1995, no persons are required to respond to a collection of information unless it displays a valid OMB control number.

PATENT APPLICATION FEE DETERMINATION RECORD					Application of Docket Number <b>10/667026</b>					
Substitute for Form PTO-875										
<b>CLAIMS AS FILED - PART I</b>										
(Column 1)		(Column 2)		SMALL ENTITY		OR	OTHER THAN SMALL ENTITY			
FOR	NUMBER FILED	NUMBER EXTRA		RATE	FEE		RATE	FEE		
BASIC FEE (37 CFR 1.16(a))					\$ _____	OR	\$ _____			
TOTAL CLAIMS (37 CFR 1.16(c))	minus 20 =			X \$ _____ =		OR	X \$ _____ =			
INDEPENDENT CLAIMS (37 CFR 1.16(b))	minus 3 =			X \$ _____ =		OR	X \$ _____ =			
MULTIPLE DEPENDENT CLAIM PRESENT (37 CFR 1.16(d))				+ \$ _____ =		OR	+ \$ _____ =			
				TOTAL		OR	TOTAL			
* If the difference in column 1 is less than zero, enter "0" in column 2										
<b>CLAIMS AS AMENDED - PART II</b>										
(Column 1)		(Column 2)		(Column 3)		SMALL ENTITY		OR	OTHER THAN SMALL ENTITY	
AMENDMENT	CLAIMS REMAINING AFTER AMENDMENT	MINUS	HIGHEST NUMBER PREVIOUSLY PAID FOR	PRESENT EXTRA	RATE	ADDITIONAL FEE		RATE	ADDITIONAL FEE	
Total (37 CFR 1.14(c))	<b>50</b>	-	<b>50</b>	=	X \$ _____ =		OR	X \$ _____ =		
Independent (37 CFR 1.16(b))	<b>9</b>	-	<b>9</b>	=	X \$ _____ =		OR	X \$ _____ =		
FIRST PRESENTATION OF MULTIPLE DEPENDENT CLAIM (37 CFR 1.16(d))				+ \$ _____ =		OR	+ \$ _____ =			
				TOTAL ADD'L FEE		OR	TOTAL ADD'L FEE			
(Column 1)		(Column 2)		(Column 3)		SMALL ENTITY		OR	OTHER THAN SMALL ENTITY	
AMENDMENT	CLAIMS REMAINING AFTER AMENDMENT	MINUS	HIGHEST NUMBER PREVIOUSLY PAID FOR	PRESENT EXTRA	RATE	ADDITIONAL FEE		RATE	ADDITIONAL FEE	
Total (37 CFR 1.14(c))		-		=	X \$ _____ =		OR	X \$ _____ =		
Independent (37 CFR 1.16(b))		-		=	X \$ _____ =		OR	X \$ _____ =		
FIRST PRESENTATION OF MULTIPLE DEPENDENT CLAIM (37 CFR 1.16(d))				+ \$ _____ =		OR	+ \$ _____ =			
				TOTAL ADD'L FEE		OR	TOTAL ADD'L FEE			
(Column 1)		(Column 2)		(Column 3)		SMALL ENTITY		OR	OTHER THAN SMALL ENTITY	
AMENDMENT	CLAIMS REMAINING AFTER AMENDMENT	MINUS	HIGHEST NUMBER PREVIOUSLY PAID FOR	PRESENT EXTRA	RATE	ADDITIONAL FEE		RATE	ADDITIONAL FEE	
Total (37 CFR 1.14(c))		-		=	X \$ _____ =		OR	X \$ _____ =		
Independent (37 CFR 1.16(b))		-		=	X \$ _____ =		OR	X \$ _____ =		
FIRST PRESENTATION OF MULTIPLE DEPENDENT CLAIM (37 CFR 1.16(d))				+ \$ _____ =		OR	+ \$ _____ =			
				TOTAL ADD'L FEE		OR	TOTAL ADD'L FEE			

\* If the entry in column 1 is less than the entry in column 2, write "0" in column 3  
 \*\* If the "Highest Number Previously Paid For" IN THIS SPACE is less than 20, enter "20"  
 \*\*\* If the "Highest Number Previously Paid For" IN THIS SPACE is less than 3, enter "3"

The "Highest Number Previously Paid For" (Total or Independent) is the highest number found in the appropriate box in column 1.

This collection of information is required by 37 CFR 1.16. The information is required to obtain or retain a benefit by the public which is to file (and by the USPTO to process) an application. Confidentiality is governed by 35 U.S.C. 172 and 37 CFR 1.14. This collection is estimated to take 12 minutes to complete, including gathering, preparing, and submitting the completed application form to the USPTO. Time will vary depending upon the individual case. Any comments on the amount of time you require to complete this form and/or suggestions for reducing this burden should be sent to the Chief Information Officer, U.S. Patent and Trademark Office, U.S. Department of Commerce, P.O. Box 1450, Alexandria, VA 22313-1450. DO NOT SEND FEES OR COMPLETED FORMS TO THIS ADDRESS. SEND TO: Commissioner for Patents, P.O. Box 1450, Alexandria, VA 22313-1450.

If you need assistance in completing the form, call 1-800-PTO-9199 and select option 2





UNITED STATES PATENT AND TRADEMARK OFFICE

UNITED STATES DEPARTMENT OF COMMERCE  
United States Patent and Trademark Office  
Address: COMMISSIONER FOR PATENTS  
P.O. Box 1450  
Alexandria, Virginia 22313-1450  
www.uspto.gov

APPLICATION NO.	FILING DATE	FIRST NAMED INVENTOR	ATTORNEY DOCKET NO.	CONFIRMATION NO.
10/667,026	09/18/2003	Darrin W. Kabel	702.254	9123

38933 7590 05/03/2006  
GARMIN LTD.  
C/O GARMIN INTERNATIONAL, INC.  
ATTN: Legal - IP  
1200 EAST 151ST STREET  
OLATHE, KS 66062

EXAMINER

MEHMOOD, JENNIFER

ART UNIT PAPER NUMBER

2612

DATE MAILED: 05/03/2006

Please find below and/or attached an Office communication concerning this application or proceeding.

SP

<b>Office Action Summary</b>	<b>Application No.</b>	<b>Applicant(s)</b>	
	10/667,026	KABEL ET AL.	
	<b>Examiner</b>	<b>Art Unit</b>	
	Jennifer A. Mehmood	2612	

-- The MAILING DATE of this communication appears on the cover sheet with the correspondence address --

**Period for Reply**

A SHORTENED STATUTORY PERIOD FOR REPLY IS SET TO EXPIRE 3 MONTH(S) OR THIRTY (30) DAYS, WHICHEVER IS LONGER, FROM THE MAILING DATE OF THIS COMMUNICATION.

- Extensions of time may be available under the provisions of 37 CFR 1.136(a). In no event, however, may a reply be timely filed after SIX (6) MONTHS from the mailing date of this communication.
- If NO period for reply is specified above, the maximum statutory period will apply and will expire SIX (6) MONTHS from the mailing date of this communication.
- Failure to reply within the set or extended period for reply will, by statute, cause the application to become ABANDONED (35 U.S.C. § 133). Any reply received by the Office later than three months after the mailing date of this communication, even if timely filed, may reduce any earned patent term adjustment. See 37 CFR 1.704(b).

**Status**

- 1)  Responsive to communication(s) filed on March 28, 2006 (RCEX filed).
- 2a)  This action is FINAL.                      2b)  This action is non-final.
- 3)  Since this application is in condition for allowance except for formal matters, prosecution as to the merits is closed in accordance with the practice under *Ex parte Quayle*, 1935 C.D. 11, 453 O.G. 213.

**Disposition of Claims**

- 4)  Claim(s) 1-50 is/are pending in the application.
  - 4a) Of the above claim(s) \_\_\_\_\_ is/are withdrawn from consideration.
- 5)  Claim(s) \_\_\_\_\_ is/are allowed.
- 6)  Claim(s) 1-50 is/are rejected.
- 7)  Claim(s) \_\_\_\_\_ is/are objected to.
- 8)  Claim(s) \_\_\_\_\_ are subject to restriction and/or election requirement.

**Application Papers**

- 9)  The specification is objected to by the Examiner.
- 10)  The drawing(s) filed on 18 September 2003 is/are: a)  accepted or b)  objected to by the Examiner. Applicant may not request that any objection to the drawing(s) be held in abeyance. See 37 CFR 1.85(a). Replacement drawing sheet(s) including the correction is required if the drawing(s) is objected to. See 37 CFR 1.121(d).
- 11)  The oath or declaration is objected to by the Examiner. Note the attached Office Action or form PTO-152.

**Priority under 35 U.S.C. § 119**

- 12)  Acknowledgment is made of a claim for foreign priority under 35 U.S.C. § 119(a)-(d) or (f).
  - a)  All    b)  Some \*    c)  None of:
  - 1.  Certified copies of the priority documents have been received.
  - 2.  Certified copies of the priority documents have been received in Application No. \_\_\_\_\_.
  - 3.  Copies of the certified copies of the priority documents have been received in this National Stage application from the International Bureau (PCT Rule 17.2(a)).

\* See the attached detailed Office action for a list of the certified copies not received.

**Attachment(s)**

- 1)  Notice of References Cited (PTO-892)
- 2)  Notice of Draftsperson's Patent Drawing Review (PTO-948)
- 3)  Information Disclosure Statement(s) (PTO-1449 or PTO/SB/08)  
Paper No(s)/Mail Date 3/28/2006
- 4)  Interview Summary (PTO-413)  
Paper No(s)/Mail Date \_\_\_\_\_
- 5)  Notice of Informal Patent Application (PTO-152)
- 6)  Other: \_\_\_\_\_

***Claim Rejections - 35 USC § 102***

1. The following is a quotation of the appropriate paragraphs of 35 U.S.C. 102 that form the basis for the rejections under this section made in this Office action:

A person shall be entitled to a patent unless –

(b) the invention was patented or described in a printed publication in this or a foreign country or in public use or on sale in this country, more than one year prior to the date of application for patent in the United States.

2. Claims 19, 20, and 22 are rejected under 35 U.S.C. 102(b) as being anticipated by Bailey et al. (US 4,873,676).

For claim 19, Bailey discloses a method for marine navigation, comprising: receiving one or more preselected conditions from a user (col 7, lns 62-68; col 8, lns 1-4, 19, and 20; Fig. 1, item 15a, 16a); receiving a user defined graphical filter area from the user (col 4, lns 11-14; col 8, lns 15-17); identifying the user defined graphical filter area on a display (col 8, lns 25-37; Fig. 1, item 15a); analyzing cartographic data only within the user defined graphical filter area for the preselected conditions (col 3, lns 26-36 and 46-48); and providing an alert signal when cartographic data within the user defined graphical filter area indicate the preselected conditions (col 9, lns 1-15; col 15, lns 25-28; col 23, lns 30-38; col 28, lns 40-45).

For claim 20, Bailey discloses identifying the user defined graphical filter area includes repositioning the user defined graphical filter area (col 3, lns 30-36; col 4, lns 11-24; col 8, lns 14-20; col 10, lns 59-68; col 11, lns 1-17).

For claim 22, Bailey discloses receiving preselected conditions selected from the group of land, water depth, rock(s), sandbars, shelves, tide condition, tidal data, wind

conditions, ice, above-water obstacles, underwater obstacles, type of water bottom, and prohibited areas (col 10, lns 50-55; col 28, lns 18-32 and 40-45).

***Claim Rejections - 35 USC § 103***

3. The following is a quotation of 35 U.S.C. 103(a) which forms the basis for all obviousness rejections set forth in this Office action:

(a) A patent may not be obtained though the invention is not identically disclosed or described as set forth in section 102 of this title, if the differences between the subject matter sought to be patented and the prior art are such that the subject matter as a whole would have been obvious at the time the invention was made to a person having ordinary skill in the art to which said subject matter pertains. Patentability shall not be negated by the manner in which the invention was made.

Claims 1-3, 5, 6, 42, and 43 are rejected under 35 U.S.C. 103(a) as being unpatentable over Fujimoto et al. (US 2004/0006423) and further in view of Tobin, Jr. (US 4,323,992). For claim 1, Fujimoto discloses a method for marine navigation, comprising: receiving one or more preselected conditions from a user (parag 0115; parag 0018; 0047; 0115; Fig. 17a-c, items 301, 302); identifying a potential waypoint (paragraph 0071, 0072; Figure 4); and performing a marine route calculation algorithm to route a course between a first location and the potential waypoint avoiding the preselected conditions (parag 0076-0078). Fujimoto does not disclose selecting a preselected condition from the group of water depth, sandbars, shelves, tidal data, wind conditions, weather conditions, ice, and type of water bottom. However, Tobin discloses a user selected (preselected) condition of water depth (col 8, lns 54-62; col 9, lns 6-16 and 36-39). It would have been obvious to include the preselected condition of water depth so that a ship's operator acknowledges a dangerous water depth and verifies that the ship is

maneuvered around or away from an insufficient water depth to ensure the safety of the ships' passengers.

For claim 2, Fujimoto discloses performing the marine route calculation algorithm to include analyzing cartographic data that include preselected conditions between the first location and the potential waypoint with a preference for avoiding preselected conditions (parag 0023, parag 0106, lines 1-7; parag 0113; parag 0115).

For claim 3, Fujimoto discloses the marine route calculation algorithm further includes re-routing the course to avoid the preselected conditions when the marine route calculation algorithm identifies one or more preselected conditions between the first location and the potential waypoint (parag 0023, 0132, 0133; Fig. 22a, 22b).

For claim 5, Fujimoto determines a first location on the course based on a signal from a GPS; and analyzing cartographic data for a predetermined area around the first location for preselected conditions (parag 0067, lns 1-10; parag 0068, last 9 lines; parag 0071, 0072).

For claim 6, Fujimoto does not disclose an alert signal; however, Tobin discloses an alert signal when analyzed cartographic data for the predetermined area around a location includes preselected conditions (col 12, lns 34-40; Fig. 8, items 252, 248). It would have been obvious to provide an alert signal so that a ship's operator acknowledges an alert and verifies that the ship is maneuvered around a preselected condition to ensure the safety of the ships passengers.

For claim 42, Fujimoto discloses a first location and a potential waypoint independent of a current location of a device implementing the method (parag 0139; 0140).

For claim 43, Fujimoto discloses at least a portion of the course is unrelated to a current heading of a device implementing the method (parag 0140, last 10 lines).

4. Claims 4 and 7-10 are rejected under 35 U.S.C. 103(a) as being unpatentable over Fujimoto et al. (US 2004/0006423) and Tobin, Jr. (US 4,323,992), and further in view of Michaelson et al. (US 6,734,808).

For claim 4, Fujimoto discloses re-routing the course calculated, but does so by identifying user waypoints (parag 0140, Ins 1-5). Michaelson, on the other hand discloses re-routing a course by identifying one or more non-user waypoints (determined by the system, not the user) between the first location and the potential waypoint (col 24, Ins 41-50 and 55-64). It would have been obvious to disclose non-user waypoints so that an operator of a ship relies on automatic navigation between a point of origin and a destination without constantly monitoring the ship's travel route.

For claim 7, Fujimoto does not disclose an alert signal between a first location and a potential waypoint; however, Michaelson discloses an alert signal is provided when the analyzed cartographic data for the predetermined data between the first location and the potential waypoint includes preselected conditions (col 6, Ins 13-26). It would have been obvious to provide an alert signal so that a ship's operator acknowledges an alert and verifies that the ship is maneuvered around a preselected condition to ensure the safety of the ships passengers.

For claim 8, the claim is interpreted and rejected for the same reasons as stated in the rejections of claim 6 and 7 as stated above. In addition, Michaelson discloses the alert signal includes emitting an audio alert (col 6, Ins 15-18; Fig. 2, item 28). It would have been obvious to emit an audio alert so that a ship's operator acknowledges an alert and verifies that the ship is maneuvered around a preselected condition to ensure the safety of the ships passengers.

For claim 9, the claim is interpreted and rejected for the same reasons as stated in the rejections of claim 6-8 as stated above. Michaelson discloses providing the alert signal to include displaying a visual alert. It would have been obvious to emit a visual alert so that a ship's operator acknowledges an alert and verifies that the ship is maneuvered around a preselected condition to ensure the safety of the ships passengers.

For claim 10, Fujimoto discloses receiving preselected conditions, but does not include weather conditions. However, Michaelson discloses this feature (col 26, Ins 18-30). It would have been obvious to include weather conditions, so that an operator of a ship predicts changing weather patterns via a weather radar display.

5. Claims 11, 12, 15-18 are rejected under 35 U.S.C. 103(a) as being unpatentable over Fujimoto et al. (US 20045/0006423), and further in view of Tobin, Jr. (US 4,323,992).

For claim 11, the claim is interpreted and rejected for the same reasons as stated in the rejection of claims 1 and 6 as stated above.

For claim 12, the claim is interpreted and rejected for the same reasons as stated in the rejection of claim 3 as stated above.

For claim 15, the claim is interpreted and rejected for the same reasons as stated in the rejection of claim 5 as stated above.

For claim 16, the claim is interpreted and rejected for the same reasons as stated in the rejection of claim 6 as stated above.

For claim 17, Fujimoto discloses analyzing cartographic data further comprises acquiring cartographic data from a GPS (parag 0067, lns 1-5).

For claim 18, the claim is interpreted and rejected for the same reasons as stated in the rejection of claims 1 and 11 as stated above.

6. Claim 21 is rejected under 35 U.S.C. 103(a) as being unpatentable over Bailey et al. (US 4,873,676), and further in view of Fujimoto et al. (US 2004/0006423).

Bailey discloses analyzing cartographic data, but does not acquire the cartographic data from a GPS; however, Fujimoto discloses acquiring cartographic data from a GPS (parag 0067, lns 1-10; parag 0068, last 9 lines; parag 0071, 0072). It would have been obvious to acquire cartographic data from a GPS so that a ship's captain relies on accurate real-time data in order to ensure a navigational route.

7. Claims 13 and 14 are rejected under 35 U.S.C. 103(a) as being unpatentable over Fujimoto et al. (US 20045/0006423) and Tobin, Jr. (US 4,323,992), and further in view of Michaelson et al. (US 6,734,808).

For claim 13, the claim is interpreted and rejected for the same reasons as stated in the rejection of claim 4 as stated above.



For claim 14, the claim is interpreted and rejected for the same reasons as stated in the rejection of claim 7 as stated above.

8. Claims 23-25, 27-29, and 33 are rejected under 35 U.S.C. 103(a) as being unpatentable over Fujimoto et al. (US 20045/0006423) and Tobin, Jr. (US 4,323,992).

For claim 23, Fujimoto discloses a computer readable medium having a set of computer readable instructions (parag 0067, Ins 1-10; parag 0068, Ins 1-8 and last 12 lines), the set of computer readable instructions comprising instructions for: receiving one or more preselected conditions from a user (parag 0115, parag 0018; 0047; 0115; Fig. 17a-c, items 301, 302); identifying a potential waypoint upon a first event (parag 0071, 0072; parag 0077, 0078); and performing a marine route calculation algorithm to analyze a course between a first location and the potential waypoint in view of preselected conditions (parag 0082). Fujimoto does not disclose selecting a preselected condition from the group of water depth, sandbars, shelves, tidal data, wind conditions, weather conditions, ice, and type of water bottom. However, Tobin discloses a user selected (preselected) condition of water depth (col 8, Ins 54-62; col 9, Ins 6-16 and 36-39). It would have been obvious to include the preselected condition of water depth so that a ship's operator acknowledges a dangerous water depth and verifies that the ship is maneuvered around or away from an insufficient water depth to ensure the safety of the ships' passengers.

For claim 24, the claim is interpreted and rejected for the same reasons as stated in the rejection of claim 2 as stated above.

For claim 25, the claim is interpreted and rejected for the same reasons as stated in the rejection of claim 3 as stated above.

For claim 27, the claim is interpreted and rejected for the same reasons as stated in the rejection of claim 5 as stated above.

For claim 28 is interpreted and rejected for the same reasons as stated in the rejection of claim 6 as stated above.

For claim 29, the claim is interpreted and rejected for the same reasons as stated in the rejection of claim 17 as stated above.

For claim 33, the claim is interpreted and rejected for the same reasons as stated in the rejection of claim 23 as stated above.

9. Claims 26, and 30-32 are rejected under 35 U.S.C. 103(a) as being unpatentable over Fujimoto et al. (US 2004/0006423) and Tobin, Jr. (US 4,323,992), and further in view of Michaelson et al. (US 6,734,808).

Claim 26 is interpreted and rejected for the same reasons as stated in the rejection of claim 4 as stated above.

Claims 30-32 are interpreted and rejected for the same reasons as stated in the rejection of claims 7-9, respectively, and as stated above.

10. Claims 34-36, and 38 are rejected under 35 U.S.C. 103(a) as being unpatentable over Fujimoto et al. (US 2004/0006423), and further in view of Tobin, Jr. (US 4,323,992).

For claim 34, Fujimoto discloses an electronic marine navigation device, comprising: a processor; a user interface operatively coupled to the processor, wherein the user interface receives one or more preselected conditions from a user (parag 0018;

0047; 0115; Fig. 17a-c, items 301, 302); a location input operatively coupled to the processor, wherein the location input receives a first location and a potential waypoint separate from the first location (parag 0067, lns 6-12; Fig. 1, items 2, 3); and a memory operatively coupled to the processor and the location input (parag 0116), the memory having cartographic data including data related to the preselected conditions (parag 0115), wherein the processor operates on a marine route calculation algorithm to analyze a course between the first location and the potential waypoint in view of the preselected conditions of the cartographic data. Fujimoto does not disclose selecting a preselected condition from the group of water depth, sandbars, shelves, tidal data, wind conditions, weather conditions, ice, and type of water bottom. However, Tobin discloses a user selected (preselected) condition of water depth (col 8, lns 54-62; col 9, lns 6-16 and 36-39). It would have been obvious to include the preselected condition of water depth so that a ship's operator acknowledges a dangerous water depth and verifies that the ship is maneuvered around or away from an insufficient water depth to ensure the safety of the ships' passengers.

For claim 35, the claim is interpreted and rejected for the same reasons as stated in the rejection of claims 2 and 34 as stated above.

For claim 36, the claim is interpreted and rejected for the same reasons as stated in the rejection of claims 3 and 34 as stated above.

For claim 38, Fujimoto discloses a GPS system operatively coupled to the processor (Fig. 1, items 3, 6; parag 0066, lns 1-3, 12-16), wherein the processor determines the first location on the course based on a signal received from the GPS

(parag 0068, last 9 lines), and analyzes cartographic data for a predetermined area around the first location for preselected conditions (parag 0072; 0113). Even though Fujimoto does not specifically disclose a GPS receiver, it would have been obvious to one of ordinary skill in the art, at the time the invention was made to include a GPS receiver to receive signals from a satellite in order to determine the ships position.

11. Claims 37, 39, and 40 are rejected under 35 U.S.C. 103(a) as being unpatentable over Fujimoto et al. (US 2004/0006423) and Tobin, Jr. (US 4,323,992), and further in view of Michaelson et al. (US 6,734,808).

For claim 37, the claim is interpreted and rejected for the same reasons as stated in the rejection of claims 4 and 34 as stated above.

For claim 39, the claim is interpreted and rejected for the same reasons as stated in the rejection of claims 6 and 34 as stated above.

For claim 40, the claim is interpreted and rejected for the same reasons as stated in the rejection of claims 7 and 34 as stated above.

12. Claim 41 is rejected under 35 U.S.C. 103(a) as being unpatentable over Fujimoto et al. (US 2004/0006423) and Tobin, Jr. (US 4,323,992), as applied to claim 34, and further in view of Bailey et al. (US 4,873,676).

Fujimoto discloses a processor to operate on the marine route calculation algorithm to analyze cartographic data (parag 0067, lns 6-12; parag 0068, lns 1-10); however, Fujimoto does not disclose an alert signal. Tobin discloses an alert signal wherein a processor provides an alert signal when analyzed cartographic data includes preselected conditions (col 12, lns 34-40; Fig. 8, items 252, 248). It would have been

obvious to provide an alert signal so that a ship's operator acknowledges an alert and verifies that the ship is maneuvered around a preselected condition to ensure the safety of the ships passengers. However, neither Fujimoto nor Tobin discloses a user defined graphical filter area. Bailey, on the other hand, does disclose a user defined graphical filter area (col 4, lns 11-14; col 7, lns 62-68; col 8, lns 1-4,15-17, 25-37; Fig. 1, item 15a, 16a); wherein a processor operates to analyze cartographic data within the defined graphical filter area and provides an alert signal when the analyzed cartographic data for the user defined graphical filter area includes preselected conditions. It would have been obvious to display cartographic data as a user defined graphical filter area to so that a user has a certain degree of control over the display in order to customize it according to the user's preferences.

13. Claim 44 is rejected under 35 U.S.C. 103(a) as being unpatentable over Fujimoto et al. (US 2004/0006423) and further in view of Tobin, Jr. (US 4,323,992).

Fujimoto discloses a method for marine navigation, comprising: identifying a potential waypoint (paragraph 0066; 0072, lines 1,2); and performing a marine route calculation algorithm to analyze a course between a first location and the potential waypoint (parag 0068, lns 5-8) in order to avoid preselected conditions received from a user. Fujimoto does not disclose selecting a preselected condition from the group of naturally occurring land mass, water depth, sandbars, shelves, wind conditions, weather conditions, ice, and type of water bottom (parag 0047; parag 0115; Fig. 17a-c, items 301, 302). However, Tobin discloses a user selected (preselected) condition of water depth (col 8, lns 54-62; col 9, lns 6-16 and 36-39). It would have been obvious to

provide an alert signal so that a ship's operator acknowledges a dangerous water depth and verifies that the ship is maneuvered around or away from an insufficient water depth to ensure the safety of the ships' passengers.

14. Claims 45 and 46 are rejected under 35 U.S.C. 103(a) as being unpatentable over Fujimoto et al. (US 2004/0006423) and further in view of Walsh et al. (US 3,886,487).

For claim 45, Fujimoto discloses a method for marine navigation, comprising: receiving indication of a preselected condition from a user (parag 0047; parag 0115; Fig. 17a-c, items 301, 302); identifying a potential waypoint (paragraph 0066; 0072, lines 1,2); and performing a marine route calculation algorithm to route a course between a first location and the potential waypoint (parag 0068, Ins 5-8) in order to avoid the preselected condition. Fujimoto, on the other hand, discloses neither receiving indication of a minimum water depth from a user nor avoiding water depth less than the minimum water depth. However, Walsh discloses receiving indication of a minimum water depth from a user and avoiding water depth less than the minimum water depth (col 2, Ins 13-19; col 3, Ins 21-30; col 8, Ins 24-34, 53-60; col 9, Ins 1-10; Fig. 4, items 182, 184, 186, 188, 98; Figs. 1 and 2, items 40, 42, 48). It would have been obvious to avoid a water depth less than the minimum water depth so that a ship's operator acknowledges a dangerous water depth and verifies that the ship is maneuvered around or away from an insufficient water depth to ensure the safety of the ships' passengers.

For claim 46, Fujimoto discloses displaying a visual indication of places along the calculated course to include expected preselected conditions (parag 0047; parag 0115; Fig. 17a-c, items 301, 302); however, Fujimoto does not disclose the preselected conditions to include a water depth that is expected to approach the minimum water depth. Walsh, on the other hand, discloses receiving indication of a water depth that is expected to approach the minimum water depth. (col 3, lns 21-30; col 8, lns 24-34, 53-60; col 9, lns 1-10; Fig. 4, items 182, 184, 186, 188, 98; Figs. 1 and 2, items 40, 42, 48). It would have been obvious to avoid a water depth less than the minimum water depth so that a ship's operator acknowledges a dangerous water depth and verifies that the ship is maneuvered around or away from an insufficient water depth to ensure the safety of the ships' passengers.

15. Claim 47 is rejected under 35 U.S.C. 103(a) as being unpatentable over Fujimoto et al. (2004/0003958) and further in view of Fujimoto et al. (US 2004/0006423).

Fujimoto '958 discloses a method for marine navigation comprising: receiving indication of a minimum water depth from a user (Fig. 3, item 47; parag 0125, lns 7-14; parag 0126, lns 3, 4, 10-17); displaying marine cartographic data (Fig. 3); displaying substantially straight line between a first location and a second location, wherein the line depicts both where the water depth is expected to be greater than the minimum water depth and where the water depth is expected to be less than the minimum water depth (parag 0073; Fig. 3, items 45, 47, 43; parag 0125, lns 6-15). Fujimoto '958, however, discloses neither receiving indications of waypoints nor performing a marine route calculation algorithm to route a course between a first location and a potential waypoint

avoiding water depth less than a minimum water depth. Fujimoto '423, on the other hand, discloses receiving indications of waypoints and performing a marine route calculation algorithm to route a course between a first location and a potential waypoint avoiding a preselected condition (parag 0075-0078; parag 0115; 0047; 0115; Fig. 17a-c, items 301, 302). It would have been obvious to receive indications of waypoints and perform a marine route calculation algorithm to route a course between a first location and a potential waypoint avoiding water depth less than the minimum water depth so that accurate navigation is achieved while avoiding low water levels to ensure the safety of the ships' passengers.

16. Claims 48-50 are rejected under 35 U.S.C. 103(a) as being unpatentable over Fujimoto et al. (2004/0003958) and further in view of Fujimoto et al. (US 2004/0006423).

For claim 48, the claim is interpreted and rejected for the same reasons as stated in the rejection of claim 47 as stated above.

For claim 49, Fujimoto '958 discloses the minimum water depth is user selectable (Fig. 3, item 47; parag 0125, lns 7-14; 0126, lns 3, 4, 10-17).

For claim 50, Fujimoto '958 discloses a line depicted in a first manner where the water depth is expected to be greater than the minimum water depth and the line is depicted in a second manner where the water depth is expected to be less than the minimum water depth (parag 0133; Fig. 23, items 128, 124, 125; parag 0129).



***Response to Arguments***

17. Applicant's arguments with respect to claims 1-50 have been considered but are moot in view of the new ground(s) of rejection.

***Conclusion***

18. Any inquiry concerning this communication or earlier communications from the examiner should be directed to Jennifer A. Mehmood whose telephone number is (571) 272.2976. The examiner can normally be reached 8:00-4:30, M-F.

If attempts to reach the examiner by telephone are unsuccessful, the examiner's supervisor, Mr. Daniel Wu can be reached at (571) 272.2964. The fax phone number for the organization where this application or proceeding is assigned is (571) 273.8300 for regular and after final communications.

Any inquiry of a general nature of relating to the status of this application or proceeding should be directed to the receptionist whose telephone number is (571) 272.2600.

Information regarding the status of an application may be obtained from the Patent Application Information Retrieval (PAIR) system. Status information for published applications may be obtained from either Private PAIR or Public PAIR. Status information for unpublished applications is available through Private PAIR only. For more information about the PAIR system, see <http://pair-direct.uspto.gov>. Should you have questions on access to the Private PAIR system, contact the Electronic Business Center (EBC) at 866-217-9197 (toll-free).

Application/Control Number: 10/667,026

Page 17

Art Unit: 2612

Jennifer Mehmood

April 25, 2006

  
**BENJAMIN C. LEE**  
**PRIMARY EXAMINER**

FORM PTO-1449 (Rev. 2-32)  U.S. DEPARTMENT OF COMMERCE PATENT AND TRADEMARK OFFICE  INFORMATION DISCLOSURE STATEMENT BY APPLICANT	ATTORNEY DOCKET NO.: 702.254	SERIAL NUMBER: 10/667,026
	APPLICANT: KABEL, Darrin W.	
	FILING DATE: September 18, 2003	GROUP: <del>2656</del> 2612

**U.S. PATENT DOCUMENTS**

EXAM. INITIAL	DOCUMENT NUMBER	INVENTOR NAME	CLASS	SUB-CLASS	ISSUE DATE (PATENT); PUBLICATION DATE (PUBLISHED APPLICATION); OR FILING DATE (NON-PUBLISHED APPLICATION)
JM	4,646,244	Bateman et al.			2/1987
JM	5,220,507	Kirson			6/1993
JM	5,470,233	Fruchterman et al.			11/1995
	5,543,789	Behr et al.			08/1996
	5,559,707	DeLorme et al.			09/1996
	5,635,924	Tran et al.			06/1997
	5,878,368	DeGraaf			03/1999
	5,893,081	Poppen			04/1999
	6,061,629	Yano et al.			05/2000
	6,104,316	Behr et al.			08/2000
	6,289,277	Feyereisen et al.			09/2001
	6,362,751	Upparapalli			03/2002
	6,381,538	Robinson et al.			04/2002
	6,577,947	Kronfeld et al.			06/2003
	6,654,669	Kelly			11/2003
	6,845,324	Smith			1/2005

BEST AVAILABLE COPY

**FOREIGN PATENT DOCUMENTS**

EXAM. INITIAL	DOCUMENT NUMBER	PUBLICATION DATE	COUNTRY OR PATENT OFFICE	CLASS	SUB-CLASS	TRANSLATION	
						YES	NO

**OTHER DOCUMENTS (Including Publisher, Author, Title, Date, Relevant Pages, and Place of Publication)**

JM	U. S. Publication No. 2002/0121989 entitled METHOD AND SYSTEM FOR PROVIDING PERSONALIZED TRAFFIC ALERTS, Pub. Date 9/8/2002, Burns.
----	---

EXAMINER /Jennifer Mehmood/	DATE CONSIDERED 05/01/2006
EXAMINER: Initial citation if reference was considered. Draw line through citation if not in conformance to MPEP 609 and not considered. Include copy of this form with next communication to applicant.	

<b>Notice of References Cited</b>	Application/Control No. 10/667,026	Applicant(s)/Patent Under Reexamination KABEL ET AL.	
	Examiner Jennifer A. Mehmood	Art Unit 2612	Page 1 of 1

**U.S. PATENT DOCUMENTS**

*	Document Number Country Code-Number-Kind Code	Date MM-YYYY	Name	Classification
*	A US-2004/0003958	01-2004	Fujimoto et al.	181/124
*	B US-4,323,992	04-1982	Tobin, Jr., Leo W.	367/108
*	C US-3,886,487	05-1975	Walsh et al.	367/92
*	D US-4,873,676	10-1989	Bailey et al.	367/98
E	US-			
F	US-			
G	US-			
H	US-			
I	US-			
J	US-			
K	US-			
L	US-			
M	US-			

**FOREIGN PATENT DOCUMENTS**

*	Document Number Country Code-Number-Kind Code	Date MM-YYYY	Country	Name	Classification
N					
O					
P					
Q					
R					
S					
T					

**NON-PATENT DOCUMENTS**

*	Include as applicable: Author, Title Date, Publisher, Edition or Volume, Pertinent Pages)
U	
V	
W	
X	

\*A copy of this reference is not being furnished with this Office action. (See MPEP § 707.05(a).)  
Dates in MM-YYYY format are publication dates. Classifications may be US or foreign.

**Index of Claims**



Application No.

10/667,026

Applicant(s)

KABEL ET AL.

Examiner

Mehmood  
Jennifer A. Stone

Art Unit

2638

✓	Rej cted
=	Allowed

-	(Through num ral) Canc lled
+	Restricted

N	Non-Elected
I	Interference

A	Appeal
O	Objected

Claim		Date	Claim		Date	Claim		Date
Final	Original		Final	Original		Final	Original	
			51			101		
			52			102		
			53			103		
			54			104		
			55			105		
			56			106		
			57			107		
			58			108		
			59			109		
			60			110		
			61			111		
			62			112		
			63			113		
			64			114		
			65			115		
			66			116		
			67			117		
			68			118		
			69			119		
			70			120		
			71			121		
			72			122		
			73			123		
			74			124		
			75			125		
			76			126		
			77			127		
			78			128		
			79			129		
			80			130		
			81			131		
			82			132		
			83			133		
			84			134		
			85			135		
			86			136		
			87			137		
			88			138		
			89			139		
			90			140		
			91			141		
			92			142		
			93			143		
			94			144		
			95			145		
			96			146		
			97			147		
			98			148		
			99			149		
			100			150		

**Search Notes**



Application No.

10/667,026

Applicant(s)

KABEL ET AL.

Examiner

Jennifer A Stone

*Mehmood*

Art Unit

2636

**SEARCHED**

Class	Subclass	Date	Examiner
340	686.6 995.1 984 985 851 539.13	12/28/2005	JS
340	539.2 961	12/28/2005	JS
340	539.22	12/28/2005	JS
340	7.56	12/28/2005	JS
340	825.36	12/28/2005	JS
340	995.11	12/28/2005	JS
367	909	12/28/2005	JS
342	357.13 41	12/28/2005	JS
701	21 201	12/28/2005	JS
701	301	12/28/2005	JS
340	850 851	9/27/2005	JS
367	87-116	4/21/2006	JM

**INTERFERENCE SEARCHED**

Class	Subclass	Date	Examiner

**SEARCH NOTES  
(INCLUDING SEARCH STRATEGY)**

	DATE	EXMR
Brent Swartout	1/5/2005	JS
East Search	12/28/2004	JS
Brent Swartout	5/24/2005	JS
Updated Search	5/20/2005	JS
Updated Search	9/27/2005	JS
Updated Search	12/27/2005	JS
Updated Search	4/21/2006	JM

RECEIVED  
CENTRAL FAX CENTER  
MAR 28 2006

006

**IN THE UNITED STATES PATENT AND TRADEMARK OFFICE**

Application of:	)	
	)	
KABEL, DARRIN W.	)	Attorney Docket No.:
	)	702.254
Serial No.: 10/667,026	)	
	)	
Filed: September 18, 2003	)	Group Art Unit No. 2636
	)	
METHODS, SYSTEMS AND DEVICES	)	
FOR CARTOGRAPHIC ALERTS	)	Examiner: STONE, Jennifer

CERTIFICATE OF MAILING 37 C.F.R. 1.8	
I hereby certify that this correspondence is being sent by facsimile to 571-273-8300 on:	
3/28/06 <small>Date</small>	 <small>Signature</small>

Mail Stop RCE  
Commissioner for Patents  
P.O. Box 1450  
Alexandria, VA 22313-1450

**PRELIMINARY AMENDMENT**

This preliminary amendment is being submitted simultaneously with the filing of a Request for Continued Examination of the above-referenced application.

Amendments to the Claims are reflected in the listing of claims which begins on page 2 of this paper.

Remarks begin on page 17 of this paper.

03/29/2006 NNGUYEN1 00000002 501791 10667026

02 FC:1201 600.00 DA  
03 FC:1202 300.00 DA

Application No. 10/667,026  
Amendment dated March 28, 2006  
Reply to Office Action of January 10, 2006

**Amendments to the Claims:**

This listing of claims will replace all prior versions, and listings, of claims in the application:

**CLAIMS:**

Please amend claims 1, 11, 23, 33, 34, and 44, as follows:

1. (Currently Amended) A method for marine navigation, comprising:  
receiving one or more preselected conditions from a user, the preselected conditions being selected from the group of ~~land~~, water depth, ~~rock(s)~~, sandbars, shelves, tide condition, tidal data, wind conditions, weather conditions, ice, ~~underwater obstacles~~, and type of water bottom;  
identifying a potential waypoint; and  
performing a marine route calculation algorithm to ~~analyze route~~ a course between a first location and the potential waypoint ~~in view of avoiding~~ the preselected conditions.



Application No. 10/667,025  
Amendment dated March 28, 2006  
Reply to Office Action of January 10, 2006

2. (Original) The method of claim 1, wherein performing the marine route calculation algorithm includes analyzing cartographic data that include preselected conditions between the first location and the potential waypoint with a preference for avoiding preselected conditions.
  
3. (Original) The method of claim 2, wherein performing the marine route calculation algorithm further includes re-routing the course to avoid the preselected conditions when the marine route calculation algorithm identifies one or more preselected conditions between the first location and the potential waypoint.
  
4. (Original) The method of claim 3, wherein re-routing the course calculated further includes identifying one or more non-user waypoints between the first location and the potential waypoint.
  
5. (Original) The method of claim 2, further including determining the first location on the course based on a signal from a global positioning system (GPS); and analyzing cartographic data for a predetermined area around the first location for preselected conditions.

Application No. 10/667,026  
Amendment dated March 28, 2006  
Reply to Office Action of January 10, 2006

6. (Original) The method of claim 5, further including providing an alert signal when the analyzed cartographic data for the predetermined area around the first location includes preselected conditions.
  
7. (Original) The method of claim 2, further including providing an alert signal when the analyzed cartographic data between the first location and the potential waypoint includes preselected conditions.
  
8. (Original) The method of claim 7, wherein providing the alert signal includes emitting an audio alert.
  
9. (Original) The method of claim 7, wherein providing the alert signal includes displaying a visual alert.
  
10. (Previously Presented) The method of claim 1, the preselected conditions including a weather condition.

Application No. 10/667,026  
Amendment dated March 28, 2006  
Reply to Office Action of January 10, 2006

11. (Currently Amended) A method for marine navigation, comprising:
- receiving one or more preselected conditions from a user, the preselected conditions being selected from the group of ~~land~~, water depth, ~~rock(s)~~, sandbars, shelves, tide condition, tidal data, wind conditions, weather conditions, ice, ~~underwater obstacles~~, and type of water bottom;
  - identifying a potential waypoint;
  - analyzing cartographic data between a first location and the potential waypoint for the preselected conditions; and
  - providing an alert signal when cartographic data between the first location and the potential waypoint indicate the preselected conditions.
12. (Original) The method of claim 11, wherein performing the marine route calculation algorithm further includes re-routing the course to avoid the preselected conditions when the marine route calculation algorithm identifies one or more preselected conditions between the first location and the potential waypoint.
13. (Original) The method of claim 12, wherein re-routing the course further includes identifying one or more non-user waypoints between the first location and the potential waypoint.

Application No. 10/667,026  
Amendment dated March 28, 2006  
Reply to Office Action of January 10, 2006

14. (Original) The method of claim 11, further including providing an alert signal when the analyzed cartographic data between the first location and the potential waypoint includes preselected conditions.

15. (Original) The method of claim 11, further including determining the first location on the course based on a signal from a global positioning system (GPS); and analyzing cartographic data for a predetermined area around the first location for preselected conditions.

16. (Original) The method of claim 15, further including providing an alert signal when the analyzed cartographic data for the predetermined area around the first location includes preselected conditions.

17. (Original) The method of claim 11, wherein analyzing cartographic data further comprises acquiring cartographic data from a global positioning system (GPS).

18. (Previously Presented) The method of claim 11, the preselected conditions including a water depth.

Application No. 10/667,026  
Amendment dated March 28, 2006  
Reply to Office Action of January 10, 2006

19. (Previously Presented) A method for marine navigation, comprising:
- receiving one or more preselected conditions from a user;
  - receiving a user defined graphical filter area from the user;
  - identifying the user defined graphical filter area on a display;
  - analyzing cartographic data only within the user defined graphical filter area for the preselected conditions; and
  - providing an alert signal when cartographic data within the user defined graphical filter area indicate the preselected conditions.
20. (Original) The method of claim 19, wherein identifying the user defined graphical filter area includes repositioning the user defined graphical filter area.
21. (Original) The method of claim 19, wherein analyzing cartographic data further comprises acquiring cartographic data from a global positioning system (GPS).
22. (Original) The method of claim 19, further including receiving preselected conditions selected from the group of land, water depth, rock(s), sandbars, shelves, tide condition, tidal data, wind conditions, weather conditions, ice, above-water obstacles, underwater obstacles, type of water bottom, and prohibited areas.

Application No. 10/667,026  
Amendment dated March 28, 2006  
Reply to Office Action of January 10, 2006

23. (Currently Amended) A computer readable medium having a set of computer readable instructions, the set of computer readable instructions comprising instructions for:
- receiving one or more preselected conditions from a user, the preselected conditions being selected from the group of ~~land,~~ water depth, ~~rock(s),~~ sandbars, shelves, tide condition, tidal data, wind conditions, weather conditions, ice, ~~underwater obstacles,~~ and type of water bottom;
  - identifying a potential waypoint upon a first event; and
  - performing a marine route calculation algorithm to analyze a course between a first location and the potential waypoint in view of the preselected conditions.
24. (Original) The computer readable medium of claim 23, wherein performing the marine route calculation algorithm includes analyzing cartographic data between the first location and the potential waypoint to avoid preselected conditions.
25. (Original) The computer readable medium of claim 24, wherein performing the marine route calculation algorithm further includes re-routing the course to avoid the preselected conditions when the marine route calculation algorithm identifies one or more preselected conditions between the first location and the potential waypoint.

Application No. 10/667,026  
Amendment dated March 28, 2006  
Reply to Office Action of January 10, 2006

26. (Original) The computer readable medium of claim 25, wherein re-routing the course further includes identifying one or more non-user waypoints between the first location and the potential waypoint.

27. (Original) The computer readable medium of claim 23, further including determining the first location on the course based on a signal from a global positioning system (GPS); and analyzing cartographic data for a predetermined area around the first location for preselected conditions.

28. (Original) The computer readable medium of claim 27, further including providing an alert signal when the analyzed cartographic data for the predetermined area around the first location includes preselected conditions.

29. (Original) The computer readable medium of claim 23, wherein analyzing cartographic data further comprises acquiring cartographic data from a global positioning system (GPS).

30. (Original) The computer readable medium of claim 23, further including providing an alert signal when the analyzed cartographic data between the first location and the potential waypoint includes preselected conditions.

Application No. 10/667,026  
Amendment dated March 28, 2006  
Reply to Office Action of January 10, 2006

31. (Original) The computer readable medium of claim 30, wherein providing the alert signal includes emitting a signal for an audio alert.
  
32. (Original) The computer readable medium of claim 30, wherein providing the alert signal includes displaying a visual alert.
  
33. (Currently Amended) The computer readable medium of claim 23, the preselected conditions including an ~~underwater obstacle~~ a water depth.



Application No. 10/667,026  
Amendment dated March 28, 2006  
Reply to Office Action of January 10, 2006

34. (Currently Amended) An electronic marine navigation device, comprising:
- a processor;
  - a user interface operatively coupled to the processor, wherein the user interface receives one or more preselected conditions from a user, the preselected conditions being selected from the group of ~~land~~, water depth, ~~rock(s)~~, sandbars, shelves, tide condition, tidal data, wind conditions, weather conditions, ice, ~~underwater obstacles~~, and type of water bottom;
  - a location input operatively coupled to the processor, wherein the location input receives a first location and a potential waypoint separate from the first location; and
  - a memory operatively coupled to the processor and the location input, the memory having cartographic data including data related to the preselected conditions, wherein the processor operates on a marine route calculation algorithm to analyze a course between the first location and the potential waypoint in view of the preselected conditions of the cartographic data.
35. (Original) The electronic marine navigation device of claim 34, wherein the processor operates on the route calculating algorithm to analyze cartographic data to identify and avoid preselected conditions in the course between the first location and the potential waypoint.

Application No. 10/667,026  
Amendment dated March 28, 2006  
Reply to Office Action of January 10, 2006

36. (Original) The electronic marine navigation device of claim 35, wherein the processor operates on the route calculating algorithm to re-route the course to avoid the preselected conditions when the processor operating on the marine route calculation algorithm identifies one or more preselected conditions between the first location and the potential waypoint.

37. (Original) The electronic marine navigation device of claim 36, wherein the processor operates on the route calculating algorithm to identify one or more non-user waypoints between the first location and the potential waypoint.

38. (Original) The electronic marine navigation device of claim 35, further including a receiver for a global positioning system (GPS) operatively coupled to the processor, wherein the processor determines the first location on the course based on a signal received from the GPS, and analyzes cartographic data for a predetermined area around the first location for preselected conditions.

39. (Original) The electronic marine navigation device of claim 38, wherein the processor provides an alert signal when the analyzed cartographic data for the predetermined area around the first location includes preselected conditions.

Application No. 10/667,026  
Amendment dated March 28, 2006  
Reply to Office Action of January 10, 2006

40. (Original) The electronic marine navigation device of claim 35, wherein the processor provides an alert signal when the analyzed cartographic data between the first location and the potential waypoint includes preselected conditions.

41. (Original) The electronic marine navigation device of claim 34, wherein the location input receives a user defined graphical filter area, and wherein the processor operates on the marine route calculation algorithm to analyze cartographic data within the defined graphical filter area for preselected conditions and wherein the processor provides an alert signal when the analyzed cartographic data for the user defined graphical filter area includes preselected conditions.

42. (Previously Presented) The method of claim 1, wherein both the first location and the potential waypoint are independent of a current location of a device implementing the method.

43. (Previously Presented) The method of claim 1, wherein at least a portion of the course is unrelated to a current heading of a device implementing the method.

Application No. 10/667,026  
Amendment dated March 28, 2006  
Reply to Office Action of January 10, 2006

44. (Currently Amended) A method for marine navigation, comprising:
- identifying a potential waypoint; and
  - performing a marine route calculation algorithm to analyze a course between a first location and the potential waypoint in ~~view of~~ order to avoid preselected conditions received from a user and selected from the group of naturally occurring land mass, water depth, ~~rock(s)~~, sandbars, shelves, wind conditions, weather conditions, ice, ~~underwater obstacles~~, and type of water bottom.

Please add claims 45-50 as follows:

45. (New) A method for marine navigation, comprising:
- receiving indication of a minimum water depth from a user;
  - identifying a potential waypoint; and
  - performing a marine route calculation algorithm to route a course between a first location and the potential waypoint avoiding water depth less than the minimum water depth.
46. (New) The method of claim 45, displaying a visual indication of places along the calculated course where the water depth is expected to approach the minimum water depth.

Application No. 10/667,026  
Amendment dated March 28, 2006  
Reply to Office Action of January 10, 2006

47. (New) A method for marine navigation, comprising:
- receiving indication of a minimum water depth from a user;
  - displaying marine cartographic data;
  - receiving indication of a potential waypoint;
  - displaying a substantially straight line between a first location and the potential waypoint, wherein the line depicts both where the water depth is expected to be greater than the minimum water depth and where the water depth is expected to be less than the minimum water depth; and
  - performing a marine route calculation algorithm to route a course between the first location and the potential waypoint avoiding water depth less than the minimum water depth.

Application No. 10/667,026  
Amendment dated March 28, 2006  
Reply to Office Action of January 10, 2006

48. (New) A method for marine navigation, comprising:
- displaying marine cartographic data;
  - receiving indication of a potential waypoint;
  - displaying a substantially straight line between a first location and the potential waypoint, wherein the line depicts both where the water depth is expected to be greater than a preset minimum water depth and where the water depth is expected to be less than the minimum water depth; and
  - performing a marine route calculation algorithm to route a course between the first location and the potential waypoint avoiding water depth less than the minimum water depth.
49. (New) The method of claim 48, wherein the minimum water depth is user selectable.
50. (New) The method of claim 48, wherein the line is depicted in a first manner where the water depth is expected to be greater than the minimum water depth and the line is depicted in a second manner where the water depth is expected to be less than the minimum water depth.

Application No. 10/667,026  
Amendment dated March 28, 2006  
Reply to Office Action of January 10, 2006

**REMARKS:****Status Of Claims**

Claims 1-44 were previously pending in the application. Claims 1, 11, 23, 33, 34, and 44 have been amended. Claims 45-50 have been added. Thus, claims 1-50 are currently pending in the application with claims 1, 11, 19, 23, 34, 44, 45, 47, and 48 being independent.

**Office Action**

Applicant would like to thank the Examiner for indicating that claims 19-22 are allowed.

In the Office Action, the Examiner rejected claims 1-3, 5, 23-25, 27, 29, 33-36, and 42-44 under 35 U.S.C. 102(e) as being anticipated by Fujimoto et al., U.S. Patent Application No. 2004/0006423. The Examiner also rejected claim 38 under 35 U.S.C. 103(a) as being unpatentable over Fujimoto. The Examiner also rejected claims 4, 6-18, 26, 28, 30-32, 37, 39, and 40 under 35 U.S.C. 103(a) as being unpatentable over Fujimoto in view of Michaelson, U.S. Patent No. 6,734,808. The Examiner also rejected claim 41 under 35 U.S.C. 103(a) as being unpatentable over Fujimoto in view of Michaelson and Horvath et al., U.S. Patent No. 6,473,003. Applicant respectfully submits that the currently pending claims distinguish the present invention from Fujimoto, Michaelson, Horvath, and the other prior art references of record, taken alone or in combination with each other.

Specifically, claims 1, 11, and 23 all recite "receiving one or more preselected

Application No. 10/667,026  
Amendment dated March 28, 2006  
Reply to Office Action of January 10, 2006

conditions from a user". Similarly, claim 34 recites "a user interface operatively coupled to the processor, wherein the user interface receives one or more preselected conditions from a user". Claim 44 recites "performing a marine route calculation algorithm to analyze a course between a first location and the potential waypoint in view of preselected conditions received from a user", emphasis added. Furthermore, claims 1, 11, 23, and 34, each now require that the preselected conditions be "selected from the group of water depth, sandbars, shelves, wind conditions, weather conditions, ice, and type of water bottom". Claim 44 now requires the preselected conditions being "selected from the group of naturally occurring land mass, water depth, sandbars, shelves, wind conditions, weather conditions, ice, and type of water bottom". Finally, claim 10 recites "the preselected conditions including a weather condition", claim 18 recites "the preselected conditions including a water depth", and claim 33 now recites "the preselected conditions including a water depth". It should be noted that the claims require actually routing and/or analyzing a course in view of the preselected conditions to provide an alert or avoid the preselected conditions.

In contrast, Fujimoto neither discloses nor suggests any of these criteria being used as preselected conditions. Rather, Fujimoto only discloses an automatic maneuvering system that can avoid docks and other man-made structures, and then only when the user specifically defines those obstacles for his system. While Michaelson does display weather conditions, Michealson fails to teach analyzing a course in view of those weather conditions, much less routing a course to avoid them. Thus, no combination of Fujimoto,



Application No. 10/667,026  
Amendment dated March 28, 2006  
Reply to Office Action of January 10, 2006

Michaelson, and/or Horvath discloses, suggests, or make obvious the limitations of the currently pending claims.

Claims 45-50 have been added to further distinguish the present invention over the prior art. The remaining claims all depend directly or indirectly from independent claims 1, 11, 23, and 34, and are therefore also allowable.

Any additional fee which is due in connection with this amendment should be applied against our Deposit Account No. 501-791. In view of the foregoing, a Notice of Allowance appears to be in order and such is courteously solicited.

Respectfully submitted,

By:

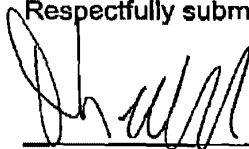

David L. Terrell, Reg. No. 50,576  
Garmin International, Inc.  
1200 East 151<sup>st</sup> Street  
Olathe, KS 66062  
(913) 397-8200  
(913) 397-9079 (Fax)

IN THE UNITED STATES PATENT AND TRADEMARK OFFICE

Application of:	)	Group Art Unit No. 2636
	)	
KABEL, Darin W.	)	Examiner: STONE, Jennifer A.
	)	
Serial No.: 10/667,026	)	Confirmation No.: 9123
	)	
Filed: 09/18/2003	)	Customer No.: 38933
	)	
	)	Docket No. 702.254

Commissioner of Patents  
P.O. Box 1450  
Alexandria, VA 22313-1450

Sir:

INFORMATION DISCLOSURE STATEMENT

Transmitted herewith is a list on Form PTO-1449 of patents, publications, or other information submitted by the applicants for consideration by the Office pursuant to the duty of disclosure under 37 CFR 1.56, together with legible copies of any non-patent or foreign patent publications to the extent clean copies are available.

It is respectfully submitted that the present invention as claimed is patentable over the listed references.

Any additional fee which might be due in connection with this Disclosure Statement should be applied against our Deposit Account No. 501-791.

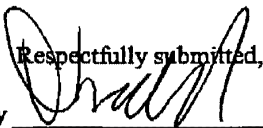
Respectfully submitted,  

By  
David L. Terrell, Reg. No. 50,576  
Garmin International, Inc.  
1200 East 151st Street  
Olathe, KS 66062  
(913) 397-8200  
(913) 397-9079 - Facsimile

BEST AVAILABLE COPY

FORM PTO-1449 (Rev. 2-32)  U.S. DEPARTMENT OF COMMERCE PATENT AND TRADEMARK OFFICE  INFORMATION DISCLOSURE STATEMENT BY APPLICANT	ATTORNEY DOCKET NO.: 702.254	SERIAL NUMBER: 10/667,026
	APPLICANT: KABEL, Darrin W.	
	FILING DATE: September 18, 2003	GROUP: 2636

**U.S. PATENT DOCUMENTS**

EXAM. INITIAL	DOCUMENT NUMBER	INVENTOR NAME	CLASS	SUB-CLASS	ISSUE DATE (PATENT); PUBLICATION DATE (PUBLISHED APPLICATION); OR FILING DATE (NON-PUBLISHED APPLICATION)
	4,646,244	Bateman et al.			2/1987
	5,220,507	Kirson			6/1993
	5,470,233	Fruchterman et al.			11/1995
	5,543,789	Behr et al.			08/1998
	5,559,707	DeLorme et al.			09/1998
	5,635,924	Tran et al.			06/1997
	5,878,368	DeGraaf			03/1999
	5,893,081	Poppen			04/1999
	6,061,629	Yano et al.			05/2000
	6,104,316	Behr et al.			08/2000
	6,289,277	Feyereisen et al.			09/2001
	6,362,751	Upparapalli			03/2002
	6,381,538	Robinson et al.			04/2002
	6,577,947	Kronfeld et al.			06/2003
	6,654,689	Kelly			11/2003
	6,845,324	Smith			1/2005

**FOREIGN PATENT DOCUMENTS**

EXAM. INITIAL	DOCUMENT NUMBER	PUBLICATION DATE	COUNTRY OR PATENT OFFICE	CLASS	SUB-CLASS	TRANSLATION	
						YES	NO

**OTHER DOCUMENTS (Including Publisher, Author, Title, Date, Relevant Pages, and Place of Publication)**

U. S. Publication No. 2002/0121989 entitled METHOD AND SYSTEM FOR PROVIDING PERSONALIZED TRAFFIC ALERTS, Pub. Date 9/5/2002, Burns.

EXAMINER	DATE CONSIDERED
EXAMINER: Initial citation if reference was considered. Draw line through citation if not in conformance to MPEP 609 and not considered. Include copy of this form with next communication to applicant.	

BEST AVAILABLE COPY

MAR 28 2006



GARMIN INTERNATIONAL, INC. • 1200 E. 151st Street • OLATHE, KS. 66082 USA • TEL. (913) 397-8200 • FAX (913) 397-9079

<b>TO:</b>	<b>USPTO</b>
<b>FAX #:</b>	<b>(571) 273-8300</b>
<b>FROM:</b>	<b>David L. Terrell</b>
	<b>Garmin International, Inc. (E-mail: david.terrell@garmin.com)</b>
<b>DATE:</b>	<b>March 28, 2006</b>

**FACSIMILE COVER SHEET (Page 1 of 26)**

Re:

Darrin W. Kabel et al.  
Serial No. 10/667,026  
Filed: 9-18-2003

Atty. Dkt. No. 702.254  
Examiner: Stone, Jennifer  
Group Art Unit 2636

**METHODS, SYSTEMS AND DEVICES FOR CARTOGRAPHIC ALERTS**

Attached is a Request for Continued Examination (in duplicate); Amendment Fee Worksheet (in duplicate); Preliminary Amendment (19 pages); Information Disclosure Statement (1 page); and Form 1449 (1 page) for filing in connection with the above-referenced application. The Commissioner is hereby authorized to charge any additional fee which is found to be due, or credit any overpayment, to Deposit Account No. 501-791.

**BEST AVAILABLE COPY**

The information contained in this facsimile transmission is confidential and intended only for the use of the named addressee. If the reader of this message is not the intended recipient, you are hereby notified that any dissemination, distribution or copying of this communication is strictly prohibited. If you have received this communication in error, please call the sender immediately at (913) 397-8200 and return the original message to us at the above address via mail. You will be reimbursed for the cost of the call and postage. Thank you.

GARMIN  
 GARMIN INTERNATIONAL, INC.  
 1200 East 151<sup>st</sup> Street  
 Olathe, Kansas 66062

RECEIVED  
 CENTRAL FAX CENTER  
 MAR 28 2006

Applicant(s): KABEL Darin W. et al.

Attorney Docket No. 702.254

Serial No.: 10/667,026

Group Art Unit: 2636

Filed: 09/18/2003

Examiner: STONE, Jennifer

For: METHODS, SYSTEMS AND DEVICES FOR  
 CARTOGRAPHIC ALERTS

Confirmation No. 9123

Mail Stop RCE  
 Commissioner for Patents  
 PO Box 1450  
 Alexandria, VA 22313-1450

Transmitted herewith is an amendment in the above-identified application. The fee has been calculated as shown below:

CLAIMS AS AMENDED						
	Currently Filed Claims	Highest Number Previously Paid For	Extra	Rate		Amount
				Large Entity	Small Entity	
Total Number of claims Remaining after Amendment	50	44	6	\$ 50	\$ 25	\$ 300
Independent Claims Remaining after Amendment	9	6	3	200	100	\$ 600
First Presentation of Multiple Dependent Claims				360	180	\$
Extension Fee:	a) One Month			120	60	\$
	b) Two Months			450	225	
	c) Three Months			1,020	510	
	d) Four Months			1,590	795	
	e) Five Months			2,160	1,080	
<b>TOTAL FEE DUE</b>						<b>\$ 900</b>

BEST AVAILABLE COPY

- No additional fee is required.
- A check in the amount of \* is attached.
- Charge \$900 to Deposit Account No. 501-791. A duplicate of this sheet is enclosed.
- Charge any additional fees or credit any overpayment to Deposit Account No. 501-791. A duplicate of this sheet is enclosed.

A verified statement under 37 C.F.R. §§ 1.9 and 1.27

- is attached.
- is of record in this application.

Respectfully submitted,  
 GARMIN INTERNATIONAL, INC.

Date: 3/28/06

By: *David L. Tewell*  
 Name: David L. Tewell



PTO/SB/30 (04-05)

Approved for use through 07/31/2008. OMB 0651-0031  
U.S. Patent and Trademark Office; U.S. DEPARTMENT OF COMMERCE

Under the Paperwork Reduction Act of 1995, no persons are required to respond to a collection of information unless it contains a valid OMB control number.

<p align="center"><b>Request for Continued Examination (RCE) Transmittal</b></p> <p>Address to: Mail Stop RCE Commissioner for Patents P.O. Box 1450 Alexandria, VA 22313-1450</p>	Application Number	10/667,026
	Filing Date	September 18, 2003
	First Named Inventor	KABEL, Darrin W.
	Art Unit	2636
	Examiner Name	STONE, Jennifer
	Attorney Docket Number	702.254

This is a Request for Continued Examination (RCE) under 37 CFR 1.114 of the above-identified application. Request for Continued Examination (RCE) practice under 37 CFR 1.114 does not apply to any utility or plant application filed prior to June 8, 1995, or to any design application. See Instruction Sheet for RCEs (not to be submitted to the USPTO) on page 2.

1. **Submission required under 37 CFR 1.114** Note: If the RCE is proper, any previously filed unentered amendments and amendments enclosed with the RCE will be entered in the order in which they were filed unless applicant instructs otherwise. If applicant does not wish to have any previously filed unentered amendment(s) entered, applicant must request non-entry of such amendment(s).

a.  Previously submitted. If a final Office action is outstanding, any amendments filed after the final Office action may be considered as a submission even if this box is not checked.

    i.  Consider the arguments in the Appeal Brief or Reply Brief previously filed on \_\_\_\_\_

    ii.  Other \_\_\_\_\_

b.  Enclosed

    i.  Amendment/Reply

    ii.  Affidavit(s)/ Declaration(s)

    iii.  Information Disclosure Statement (IDS)

    iv.  Other \_\_\_\_\_

2. **Miscellaneous**

a.  Suspension of action on the above-identified application is requested under 37 CFR 1.103(c) for a period of \_\_\_\_\_ months. (Period of suspension shall not exceed 3 months; Fee under 37 CFR 1.17(f) required)

b.  Other \_\_\_\_\_

3. **Fees** The RCE fee under 37 CFR 1.17(e) is required by 37 CFR 1.114 when the RCE is filed. The Director is hereby authorized to charge the following fees, any underpayment of fees, or credit any overpayments, to Deposit Account No. 501-791. I have enclosed a duplicate copy of this sheet.

a.  RCE fee required under 37 CFR 1.17(e)

    ii.  Extension of time fee (37 CFR 1.136 and 1.17)

    iii.  Other \_\_\_\_\_

b.  Check in the amount of \$ \_\_\_\_\_ enclosed

c.  Payment by credit card (Form PTO-2038 enclosed)

**WARNING: Information on this form may become public. Credit card information should not be included on this form. Provide credit card information and authorization on PTO-2038.**

BEST AVAILABLE COPY

SIGNATURE OF APPLICANT, ATTORNEY, OR AGENT REQUIRED			
Signature	David L. Terrell	Date	3/28/06
Name (Print/Type)		Registration No.	50,576

CERTIFICATE OF MAILING OR TRANSMISSION			
I hereby certify that this correspondence is being deposited with the United States Postal Service with sufficient postage as first class mail in an envelope addressed to: Mail Stop RCE, Commissioner for Patents, P. O. Box 1450, Alexandria, VA 22313-1450 or facsimile transmitted to the U.S. Patent and Trademark Office on the date shown below.			
Signature	<i>Christine M. Terrell</i>	Date	3/28/06
Name (Print/Type)	Christine M. Terrell		

This collection of information is required by 37 CFR 1.114. The information is required to obtain or retain a benefit by the public which is to file (and by the USPTO to process) an application. Confidentiality is governed by 35 U.S.C. 122 and 37 CFR 1.11 and 1.14. This collection is estimated to take 12 minutes to complete, including gathering, preparing, and submitting the completed application form to the USPTO. Time will vary depending upon the individual case. Any comments on the amount of time you require to complete this form and/or suggestions for reducing this burden, should be sent to the Chief Information Officer, U.S. Patent and Trademark Office, U.S. Department of Commerce, P.O. Box 1450, Alexandria, VA 22313-1450. DO NOT SEND FEES OR COMPLETED FORMS TO THIS ADDRESS. SEND TO: Mail Stop RCE, Commissioner for Patents, P.O. Box 1450, Alexandria, VA 22313-1450.  
If you need assistance in completing the form, call 1-800-PTO-9199 and select option 2.

Under the Paperwork Reduction Act of 1995, no persons are required to respond to a collection of information unless it displays a valid OMB control number.

PATENT APPLICATION FEE DETERMINATION RECORD					Application or Docket Number <b>10/661024</b>				
Substitute for Form PTO-875									
<b>APPLICATION AS FILED - PART I</b>					SMALL ENTITY OR OTHER THAN SMALL ENTITY				
(Column 1)		(Column 2)							
FOR	NUMBER FILED	NUMBER EXTRA		RATE (\$)	FEE (\$)				
BASIC FEE (37 CFR 1.16(a), (b), or (c))									
SEARCH FEE (37 CFR 1.16(b), (f), or (m))									
EXAMINATION FEE (37 CFR 1.16(a), (p), or (q))									
TOTAL CLAIMS (37 CFR 1.16(f))		minus 20 =	*	X	=	OR X =			
INDEPENDENT CLAIMS (37 CFR 1.16(h))		minus 3 =	*	X	=	OR X =			
APPLICATION SIZE FEE (37 CFR 1.16(s))	If the specification and drawings exceed 100 sheets of paper, the application size fee due is \$250 (\$125 for small entity) for each additional 50 sheets or fraction thereof. See 35 U.S.C. 41(a)(1)(G) and 37 CFR 1.16(s).								
MULTIPLE DEPENDENT CLAIM PRESENT (37 CFR 1.16(j))									
* If the difference in column 1 is less than zero, enter "0" in column 2.									
<b>APPLICATION AS AMENDED - PART II</b>					SMALL ENTITY OR OTHER THAN SMALL ENTITY				
(Column 1)		(Column 2)		(Column 3)					
AMENDMENT A	CLAIMS REMAINING AFTER AMENDMENT	HIGHEST NUMBER PREVIOUSLY PAID FOR		PRESENT EXTRA	RATE (\$)	ADDITIONAL FEE (\$)		RATE (\$)	ADDITIONAL FEE (\$)
	Total (37 CFR 1.16(g))	44	Minus	44	X	=	OR X =		
	Independent (37 CFR 1.16(g))	6	Minus	6	X	=	OR X =		
	Application Size Fee (37 CFR 1.16(s))								
FIRST PRESENTATION OF MULTIPLE DEPENDENT CLAIM (37 CFR 1.16(j))									
TOTAL ADDL FEE									
OR TOTAL ADDL FEE									
* If the entry in column 1 is less than the entry in column 2, write "0" in column 3. ** If the "Highest Number Previously Paid For" IN THIS SPACE is less than 20, enter "20". *** If the "Highest Number Previously Paid For" IN THIS SPACE is less than 3, enter "3". The "Highest Number Previously Paid For" (Total or Independent) is the highest number found in the appropriate box in column 1.									
<b>AMENDMENT B</b>					SMALL ENTITY OR OTHER THAN SMALL ENTITY				
(Column 1)		(Column 2)		(Column 3)					
AMENDMENT B	CLAIMS REMAINING AFTER AMENDMENT	HIGHEST NUMBER PREVIOUSLY PAID FOR		PRESENT EXTRA	RATE (\$)	ADDITIONAL FEE (\$)		RATE (\$)	ADDITIONAL FEE (\$)
	Total (37 CFR 1.16(g))	50	Minus	44	X	=	OR X 50 =	300	
	Independent (37 CFR 1.16(g))	9	Minus	6	X	=	OR X 200 =	600	
	Application Size Fee (37 CFR 1.16(s))								
FIRST PRESENTATION OF MULTIPLE DEPENDENT CLAIM (37 CFR 1.16(j))									
TOTAL ADDL FEE									
OR TOTAL ADDL FEE <b>900</b>									

This collection of information is required by 37 CFR 1.16. The information is required to obtain or retain a benefit by the public which is to file (and by the USPTO to process) an application. Confidentiality is governed by 35 U.S.C. 122 and 37 CFR 1.14. This collection is estimated to take 12 minutes to complete, including gathering, preparing, and submitting the completed application form to the USPTO. Time will vary depending upon the individual case. Any comments on the amount of time you require to complete this form and/or suggestions for reducing this burden, should be sent to the Chief Information Officer, U.S. Patent and Trademark Office, U.S. Department of Commerce, P.O. Box 1450, Alexandria, VA 22313-1450. DO NOT SEND FEES OR COMPLETED FORMS TO THIS ADDRESS. SEND TO: Commissioner for Patents, P.O. Box 1450, Alexandria, VA 22313-1450.

If you need assistance in completing the form, call 1-800-PTO-9199 and select option 2.





UNITED STATES PATENT AND TRADEMARK OFFICE

*col*

UNITED STATES DEPARTMENT OF COMMERCE  
United States Patent and Trademark Office  
Address: COMMISSIONER FOR PATENTS  
P.O. Box 1450  
Alexandria, Virginia 22313-1450  
www.uspto.gov

APPLICATION NO.	FILING DATE	FIRST NAMED INVENTOR	ATTORNEY DOCKET NO.	CONFIRMATION NO.
-----------------	-------------	----------------------	---------------------	------------------

10/667,026	09/18/2003	Darrin W. Kabel	702.254	9123
------------	------------	-----------------	---------	------

38933	7590	01/10/2006		
-------	------	------------	--	--

DEVON A. ROLF  
GARMIN LTD.  
1200 EAST 151ST STREET  
OLATHE, KS 66062

EXAMINER
----------

STONE, JENNIFER A

ART UNIT	PAPER NUMBER
----------	--------------

2636

DATE MAILED: 01/10/2006

Please find below and/or attached an Office communication concerning this application or proceeding.

<b>Office Action Summary</b>	Application No. 10/667,026	Applicant(s) KABEL ET AL.	
	Examiner Jennifer A. Stone	Art Unit 2636	

-- The MAILING DATE of this communication appears on the cover sheet with the correspondence address --

**Period for Reply**

A SHORTENED STATUTORY PERIOD FOR REPLY IS SET TO EXPIRE 3 MONTH(S) OR THIRTY (30) DAYS, WHICHEVER IS LONGER, FROM THE MAILING DATE OF THIS COMMUNICATION.

- Extensions of time may be available under the provisions of 37 CFR 1.136(a). In no event, however, may a reply be timely filed after SIX (6) MONTHS from the mailing date of this communication.
- If NO period for reply is specified above, the maximum statutory period will apply and will expire SIX (6) MONTHS from the mailing date of this communication.
- Failure to reply within the set or extended period for reply will, by statute, cause the application to become ABANDONED (35 U.S.C. § 133). Any reply received by the Office later than three months after the mailing date of this communication, even if timely filed, may reduce any earned patent term adjustment. See 37 CFR 1.704(b).

**Status**

- 1)  Responsive to communication(s) filed on 20 December 2005.
- 2a)  This action is **FINAL**.                      2b)  This action is non-final.
- 3)  Since this application is in condition for allowance except for formal matters, prosecution as to the merits is closed in accordance with the practice under *Ex parte Quayle*, 1935 C.D. 11, 453 O.G. 213.

**Disposition of Claims**

- 4)  Claim(s) 1-44 is/are pending in the application.
  - 4a) Of the above claim(s) \_\_\_\_\_ is/are withdrawn from consideration.
- 5)  Claim(s) 19-22 is/are allowed.
- 6)  Claim(s) 1-18 and 23-44 is/are rejected.
- 7)  Claim(s) \_\_\_\_\_ is/are objected to.
- 8)  Claim(s) \_\_\_\_\_ are subject to restriction and/or election requirement.

**Application Papers**

- 9)  The specification is objected to by the Examiner.
- 10)  The drawing(s) filed on 18 September 2003 is/are: a)  accepted or b)  objected to by the Examiner.
  - Applicant may not request that any objection to the drawing(s) be held in abeyance. See 37 CFR 1.85(a).
  - Replacement drawing sheet(s) including the correction is required if the drawing(s) is objected to. See 37 CFR 1.121(d).
- 11)  The oath or declaration is objected to by the Examiner. Note the attached Office Action or form PTO-152.

**Priority under 35 U.S.C. § 119**

- 12)  Acknowledgment is made of a claim for foreign priority under 35 U.S.C. § 119(a)-(d) or (f).
  - a)  All    b)  Some \*    c)  None of:
  - 1.  Certified copies of the priority documents have been received.
  - 2.  Certified copies of the priority documents have been received in Application No. \_\_\_\_\_.
  - 3.  Copies of the certified copies of the priority documents have been received in this National Stage application from the International Bureau (PCT Rule 17.2(a)).

\* See the attached detailed Office action for a list of the certified copies not received.

**Attachment(s)**

- 1)  Notice of References Cited (PTO-892)
- 2)  Notice of Draftsperson's Patent Drawing Review (PTO-948)
- 3)  Information Disclosure Statement(s) (PTO-1449 or PTO/SB/08)  
Paper No(s)/Mail Date \_\_\_\_\_.
- 4)  Interview Summary (PTO-413)  
Paper No(s)/Mail Date. \_\_\_\_\_.
- 5)  Notice of Informal Patent Application (PTO-152)
- 6)  Other: \_\_\_\_\_.

***Claim Rejections - 35 USC § 102***

1. The following is a quotation of the appropriate paragraphs of 35 U.S.C. 102 that form the basis for the rejections under this section made in this Office action:

A person shall be entitled to a patent unless –

(e) the invention was described in (1) an application for patent, published under section 122(b), by another filed in the United States before the invention by the applicant for patent or (2) a patent granted on an application for patent by another filed in the United States before the invention by the applicant for patent, except that an international application filed under the treaty defined in section 351(a) shall have the effects for purposes of this subsection of an application filed in the United States only if the international application designated the United States and was published under Article 21(2) of such treaty in the English language.

2. Claims 1-3, 5, 42, 43 are rejected under 35 U.S.C. 102(e) as being anticipated by Fujimoto et al. (US 20045/0006423).

For claim 1, Fujimoto discloses a method for marine navigation, comprising: receiving one or more preselected conditions from a user (parag 0115); the preselected conditions being selected from the group of land, water depth, rock(s), sandbars, shelves, tide condition, tidal data, wind conditions, weather conditions, ice, underwater obstacles, and type of water bottom, (parag 0018; 0047; 0115; Fig. 17a-c, items 301, 302); identifying a potential waypoint (paragraph 0071, 0072; Figure 4); and performing a marine route calculation algorithm to analyze a course between a first location and the potential waypoint in view of the preselected conditions (parag 0076-0078).

For claim 2, Fujimoto discloses performing the marine route calculation algorithm to include analyzing cartographic data that include preselected conditions between the first location and the potential waypoint with a preference for avoiding preselected conditions (parag 0023, parag 0106, lines 1-7; parag 0113; parag 0115).

For claim 3, the marine route calculation algorithm further includes re-routing the course to avoid the preselected conditions when the marine route calculation algorithm identifies one or more preselected conditions between the first location and the potential waypoint (parag 0023, 0132, 0133; Fig. 22a, 22b).

For claim 5, Fujimoto determines a first location on the course based on a signal from a GPS; and analyzing cartographic data for a predetermined area around the first location for preselected conditions (parag 0067, lns 1-10; parag 0068, last 9 lines; parag 0071, 0072).

For claim 42, Fujimoto discloses a first location and a potential waypoint independent of a current location of a device implementing the method (parag 0139; 0140).

For claim 43, Fujimoto discloses at least a portion of the course is unrelated to a current heading of a device implementing the method (parag 0140, last 10 lines).

3. Claims 23-25, 27, 29, 33 are rejected under 35 U.S.C. 102(e) as being anticipated by Fujimoto et al. (US 20045/0006423).

For claim 23, Fujimoto discloses a computer readable medium having a set of computer readable instructions (parag 0067, lns 1-10; parag 0068, lns 1-8 and last 12 lines), the set of computer readable instructions comprising instructions for: receiving one or more preselected conditions from a user (parag 0115), the preselected conditions being selected from the group of land, water depth, rock(s), sandbars, shelves, tide condition, tidal data, wind conditions, weather conditions, ice, underwater obstacles, and type of water bottom, (parag 0018; 0047; 0115; Fig. 17a-c, items 301,

302); identifying a potential waypoint upon a first event (parag 0071, 0072; parag 0077, 0078); and performing a marine route calculation algorithm to analyze a course between a first location and the potential waypoint in view of preselected conditions (parag 008245).

For claim 24, the claim is interpreted and rejected for the same reasons as stated in the rejection of claim 2 as stated above.

For claim 25, the claim is interpreted and rejected for the same reasons as stated in the rejection of claim 3 as stated above.

For claim 27, the claim is interpreted and rejected for the same reasons as stated in the rejection of claim 5 as stated above.

For claim 29, the claim is interpreted and rejected for the same reasons as stated in the rejection of claim 17 as stated above.

For claim 33, the computer readable medium includes underwater obstacles as preselected conditions (parag 0108). A jetty and a pier are examples of both underwater and above water obstacles.

4. Claims 34-36 are rejected under 35 U.S.C. 102(e) as being anticipated by Fujimoto et al. (US 20045/0006423).

For claim 34, Fujimoto discloses an electronic marine navigation device, comprising: a processor; a user interface operatively coupled to the processor, wherein the user interface receives one or more preselected conditions from a user the preselected conditions being selected from the group of land, water depth, rock(s), sandbars, shelves, tide condition, tidal data, wind conditions, weather conditions, ice,

underwater obstacles, and type of water bottom (parag 0018; 0047; 0115; Fig. 17a-c, items 301, 302) (parag 0067, Ins 6-12; Fig. 1, items 2, 3); a location input operatively coupled to the processor, wherein the location input receives a first location and a potential waypoint separate from the first location; and a memory operatively coupled to the processor and the location input (parag 0116), the memory having cartographic data including data related to the preselected conditions (parag 0115), wherein the processor operates on a marine route calculation algorithm to analyze a course between the first location and the potential waypoint in view of the preselected conditions of the cartographic data.

For claim 35, the claim is interpreted and rejected for the same reasons as stated in the rejection of claims 2 and 34 as stated above.

For claim 36, the claim is interpreted and rejected for the same reasons as stated in the rejection of claims 3 and 34 as stated above.

5. Claim 44 is rejected under 35 U.S.C. 102(e) as being anticipated by Fujimoto et al. (US 20045/0006423).

Fujimoto discloses a method for marine navigation, comprising: identifying a potential waypoint (paragraph 0066; 0072, lines 1,2); and performing a marine route calculation algorithm to analyze a course between a first location and the potential waypoint (parag 0068, Ins 5-8) in view of preselected conditions received from a user and selected from the group of land, water depth, rock(s), sandbars, shelves, tide condition, wind conditions, weather conditions, ice, underwater obstacles, and type of water bottom (parag 0047; parag 0115; Fig. 17a-c, items 301, 302).

***Claim Rejections - 35 USC § 103***

6. The following is a quotation of 35 U.S.C. 103(a) which forms the basis for all obviousness rejections set forth in this Office action:

(a) A patent may not be obtained though the invention is not identically disclosed or described as set forth in section 102 of this title, if the differences between the subject matter sought to be patented and the prior art are such that the subject matter as a whole would have been obvious at the time the invention was made to a person having ordinary skill in the art to which said subject matter pertains. Patentability shall not be negated by the manner in which the invention was made.

7. Claim 38 is rejected under 35 U.S.C. 103(a) as being unpatentable over Fujimoto et al. (US 20045/0006423),

Fujimoto discloses a GPS system operatively coupled to the processor (Fig. 1, items 3, 6; parag 0066, lns 1-3, 12-16), wherein the processor determines the first location on the course based on a signal received from the GPS (parag 0068, last 9 lines), and analyzes cartographic data for a predetermined area around the first location for preselected conditions (parag 0072; 0113). Even though Fujimoto does not specifically disclose a GPS receiver, it would have been obvious to one of ordinary skill in the art, at the time the invention was made to include a GPS receiver to receive signals from a satellite in order to determine the ships position.

8. Claims 4 and 6-10 are rejected under 35 U.S.C. 103(a) as being unpatentable over Fujimoto et al. (US 20045/0006423), and further in view of Michaelson et al. (US 6,734,808).

For claim 4, Fujimoto discloses re-routing the course calculated, but does so by identifying user waypoints (parag 0140, lns 1-5). Michaelson, on the other hand

discloses re-routing a course by identifying one or more non-user waypoints (determined by the system, not the user) between the first location and the potential waypoint (col 24, Ins 41-50 and 55-64). It would have been obvious to disclose non-user waypoints so that an operator of a ship relies on automatic navigation between a point of origin and a destination without constantly monitoring the ship's travel route.

For claim 6, Fujimoto does not disclose an alert signal; however, Michaelson discloses an alert signal is provided when the analyzed cartographic data for the predetermined area around the first location includes preselected conditions (col 2, Ins 11-14; col 6, Ins 13-17). It would have been obvious to provide an alert signal so that a ship's operator acknowledges an alert and verifies that the ship is maneuvered around a preselected condition to ensure the safety of the ship's passengers.

For claim 7, Fujimoto does not disclose an alert signal; however, Michaelson discloses an alert signal is provided when the analyzed cartographic data for the predetermined data between the first location and the potential waypoint includes preselected conditions (col 6, Ins 13-26). It would have been obvious to provide an alert signal so that a ship's operator acknowledges an alert and verifies that the ship is maneuvered around a preselected condition to ensure the safety of the ship's passengers.

For claim 8, the claim is interpreted and rejected for the same reasons as stated in the rejections of claim 6 and 7 as stated above. In addition, Michaelson discloses the alert signal includes emitting an audio alert (col 6, Ins 15-18; Fig. 2, item 28).



For claim 9, the claim is interpreted and rejected for the same reasons as stated in the rejections of claim 6-8 as stated above. Michaelson discloses providing the alert signal to include displaying a visual alert.

For claim 10, Fujimoto discloses receiving preselected conditions, but does not include weather conditions. However, Michaelson discloses this feature (col 26, Ins 18-30). It would have been obvious to include weather conditions, so that an operator of a ship predicts changing weather patterns via a weather radar display.

9. Claims 11-18 are rejected under 35 U.S.C. 103(a) as being unpatentable over Fujimoto et al. (US 20045/0006423), and further in view of Michaelson et al. (US 6,734,808).

For claim 11, the claim is interpreted and rejected for the same reasons as stated in the rejection of claims 1 and 6 as stated above.

For claim 12, the claim is interpreted and rejected for the same reasons as stated in the rejection of claim 3 as stated above.

For claim 13, the claim is interpreted and rejected for the same reasons as stated in the rejection of claim 4 as stated above.

For claim 14, the claim is interpreted and rejected for the same reasons as stated in the rejection of claim 7 as stated above.

For claim 15, the claim is interpreted and rejected for the same reasons as stated in the rejection of claim 5 as stated above.

For claim 16, the claim is interpreted and rejected for the same reasons as stated in the rejection of claim 6 as stated above.

For claim 17, Fujimoto discloses analyzing cartographic data further comprises acquiring cartographic data from a GPS (parag 0067, Ins 1-5).

For claim 18, the claim is interpreted and rejected for the same reasons as stated in the rejection of claim 10 as stated above. In addition, Fujimoto discloses receiving preselected conditions, but does not include water depth. However, Michaelson discloses this feature (col 2, Ins 15-19, 35-47; Fig. 9A-10B, col 13, Ins 56-67; col 14, Ins 1-10). It would have been obvious to include water depth, so that an operator of a ship maneuvers based on the depth of the water in order to avoid underwater obstacles.

10. Claims 26, 28, and 30-32 are rejected under 35 U.S.C. 103(a) as being unpatentable over Fujimoto et al. (US 20045/0006423), and further in view of Michaelson et al. (US 6,734,808).

Claim 26 is interpreted and rejected for the same reasons as stated in the rejection of claim 4 as stated above.

Claim 28 is interpreted and rejected for the same reasons as stated in the rejection of claim 6 as stated above.

Claims 30-32 are interpreted and rejected for the same reasons as stated in the rejection of claims 7-9, respectively, and as stated above.

11. Claims 37, 39 and 40 are rejected under 35 U.S.C. 103(a) as being unpatentable over Fujimoto et al. (US 20045/0006423), and further in view of Michaelson et al. (US 6,734,808).

For claim 37, the claim is interpreted and rejected for the same reasons as stated in the rejection of claims 4 and 34 as stated above.

For claim 39, the claim is interpreted and rejected for the same reasons as stated in the rejection of claims 6 and 34 as stated above.

For claim 40, the claim is interpreted and rejected for the same reasons as stated in the rejection of claims 7 and 34 as stated above.

12. Claim 41 is rejected under 35 U.S.C. 103(a) as being unpatentable over Fujimoto et al. (US 20045/0006423), as applied to claim 34, and further in view of Michaelson et al. (US 6,734,808) and Horvath et al. (US 6,473,003).

Fujimoto discloses a processor to operate on the marine route calculation algorithm to analyze cartographic data (parag 0067, Ins 6-12; parag 0068, Ins 1-10); however, Fujimoto does not disclose an alert signal. Michaelson discloses an alert signal wherein a processor provides an alert signal when analyzed cartographic data includes preselected conditions (col 2, Ins 11-14; col 6, Ins 13-17). It would have been obvious to provide an alert signal so that a ship's operator acknowledges an alert and verifies that the ship is maneuvered around a preselected condition to ensure the safety of the ships passengers. However, neither Fujimoto nor Michaelson disclose a user defined graphical filter area. Horvath, on the other hand, does disclose a user defined graphical filter area (col 1, Ins 10-14; col 2, Ins 30, 31, 44-48) wherein a processor operates to analyze cartographic data and provides an alert signal when the analyzed cartographic data for the user defined graphical filter area includes preselected conditions (col 2, Ins 60-63; Fig. 4, 30i). Even though Horvath's primary application is aircraft navigation, it would have been obvious to apply a user defined graphical filter area to a marine

navigation system so that a user has a certain degree of control over the display in order to customize it according to the user's preferences.

***Allowable Subject Matter***

13. Claims 19-22 are allowed.

***Response to Arguments***

14. Applicant's arguments filed December 20, 2005 have been fully considered but they are not persuasive.

The Applicant argues as follows:

a. Fujimoto neither discloses nor suggests any of these criteria (selected from the group of land, water depth, rock(s), sandbars, shelves, wind/weather conditions, weather conditions, ice, underwater obstacles, and type of water bottom) being used as preselected conditions.

b. Fujimoto only discloses an automatic maneuvering system that can avoid docks and the like, and then only when the user specifically defines the docks for the system. Fujimoto, Michaelson, and Horvath do not disclose receiving one or more preselected conditions from a user.

a. Fujimoto discloses that during marine navigation obstacles are avoided by either GPS data or manually set data (parag 0015). Further, Fujimoto describes the obstacles as a jetty and pier (Fig. 13-17, items 302 and 301, respectively). These obstacles are considered both underwater and above water obstacles. A jetty's support

system and a pier include support systems that are underwater. In addition, a jetty is a rock, land, or other manmade structure that extends into a body of water in order to influence the tide or current, or protect the frame of a pier. The area of a jetty that is either above or underwater changes depending on tidal changes. Therefore, Fujimoto meets the criteria being used as preselected conditions.

b. Fujimoto discloses obstacles such as piers and jetty's, not docks. In addition, a user either specifically defines the obstacle received as a preselected condition or the system automatically recognizes the preset condition based on GPS data (parag 0115). Either of the above methods of defining an obstacle constitute the system to recognize and receive one or more preselected conditions from a user. Thus, Fujimoto meets all claim limitations.

### ***Conclusion***

15. Applicant's amendment necessitated the new ground(s) of rejection presented in this Office action. Accordingly, **THIS ACTION IS MADE FINAL**. See MPEP § 706.07(a). Applicant is reminded of the extension of time policy as set forth in 37 CFR 1.136(a).

A shortened statutory period for reply to this final action is set to expire **THREE MONTHS** from the mailing date of this action. In the event a first reply is filed within **TWO MONTHS** of the mailing date of this final action and the advisory action is not mailed until after the end of the **THREE-MONTH** shortened statutory period, then the shortened statutory period will expire on the date the advisory action is mailed, and any

extension fee pursuant to 37 CFR 1.136(a) will be calculated from the mailing date of the advisory action. In no event, however, will the statutory period for reply expire later than SIX MONTHS from the date of this final action.

16. Any inquiry concerning this communication or earlier communications from the examiner should be directed to Jennifer A Stone whose telephone number is (571) 272.2976. The examiner can normally be reached on M-F from 8:00am to 4:30pm.

If attempts to reach the examiner by telephone are unsuccessful, the examiner's supervisor, Jeffrey Hofsass, can be reached at (571) 272.2981. The fax phone number for the organization where this application or proceeding is assigned is (571) 273.8300.

Information regarding the status of an application may be obtained from the Patent Application Information Retrieval (PAIR) system. Status information for published applications may be obtained from either Private PAIR or Public PAIR. Status information for unpublished applications is available through Private PAIR only. For more information about the PAIR system, see <http://pair-direct.uspto.gov>. Should you have questions on access to the Private PAIR system, contact the Electronic Business Center (EBC) at 866-217-9197 (toll-free).

Jennifer Stone  
December 27, 2005

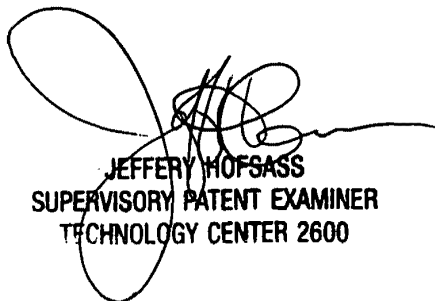

JEFFERY HOFSSASS  
SUPERVISORY PATENT EXAMINER  
TECHNOLOGY CENTER 2600

**Search Notes**



Application No.

10/667,026

Examiner

Jennifer A Stone

Applicant(s)

KABEL ET AL.

Art Unit

2636

**SEARCHED**

Class	Subclass	Date	Examiner
340	686.6 995.1 984 985 851 539.13	12/28/2005	JS
340	539.2 961	12/28/2005	JS
340	539.22	12/28/2005	JS
340	7.56	12/28/2005	JS
340	825.36	12/28/2005	JS
340	995.11	12/28/2005	JS
367	909	12/28/2005	JS
342	357.13 41	12/28/2005	JS
701	21 201	12/28/2005	JS
701	301	12/28/2005	JS
340	850 851	9/27/2005	JS

**INTERFERENCE SEARCHED**

Class	Subclass	Date	Examiner

**SEARCH NOTES  
(INCLUDING SEARCH STRATEGY)**

	DATE	EXMR
Brent Swartout	1/5/2005	JS
East Search	12/28/2004	JS
Brent Swartout	5/24/2005	JS
Updated Search	5/20/2005	JS
Updated Search	9/27/2005	JS
Updated Search	12/27/2005	JS

**Index of Claims**



Application No.

10/667,026

Examiner

Jennifer A Stone

Applicant(s)

KABEL ET AL.

Art Unit

2636

✓	Rej cted
=	Allowed

-	(Through num ral) Canc lled
+	Restricted

N	Non-Elected
I	Interference

A	Appeal
O	Objected

Claim		Date	Claim		Date	Claim		Date
Final	Original		Final	Original		Final	Original	
			51			101		
			52			102		
			53			103		
			54			104		
			55			105		
			56			106		
			57			107		
			58			108		
			59			109		
			60			110		
			61			111		
			62			112		
			63			113		
			64			114		
			65			115		
			66			116		
			67			117		
			68			118		
			69			119		
			70			120		
			71			121		
			72			122		
			73			123		
			74			124		
			75			125		
			76			126		
			77			127		
			78			128		
			79			129		
			80			130		
			81			131		
			82			132		
			83			133		
			84			134		
			85			135		
			86			136		
			87			137		
			88			138		
			89			139		
			90			140		
			91			141		
			92			142		
			93			143		
			94			144		
			95			145		
			96			146		
			97			147		
			98			148		
			99			149		
			100			150		



RECEIVED  
CENTRAL FAX CENTER  
DEC 20 2005



GARMIN INTERNATIONAL, INC. • 1200 E. 151st Street • OLATHE, KS. 66062 USA • TEL. (913) 397-8200 • FAX (913) 397-9079

**TO:** USPTO  
**FAX #:** (703) 872-9306  
**FROM:** David L. Terrell  
Garmin International, Inc. (E-mail: david.terrell@garmin.com)  
**DATE:** December 20, 2005

FACSIMILE COVER SHEET (Page 1 of 18)

Re:

Darrin W. Kabel et al.  
Serial No. 10/667,026  
Filed: 9-18-2003

Atty. Dkt. No. 702.254  
Examiner: Stone, Jennifer  
Group Art Unit 2636

METHODS, SYSTEMS AND DEVICES FOR CARTOGRAPHIC ALERTS

Attached is an Amendment for filing in connection with the above-referenced application. The Commissioner is hereby authorized to charge any additional fee which is found to be due, or credit any overpayment, to Deposit Account No. 501-791.

The information contained in this facsimile transmission is confidential and intended only for the use of the named addressee. If the reader of this message is not the intended recipient, you are hereby notified that any dissemination, distribution or copying of this communication is strictly prohibited. If you have received this communication in error, please call the sender immediately at (913) 397-8200 and return the original message to us at the above address via mail. You will be reimbursed for the cost of the call and postage. Thank you.

RECEIVED  
CENTRAL FAX CENTER  
DEC 20 2005

**IN THE UNITED STATES PATENT AND TRADEMARK OFFICE**

Application of:	)	
	)	
KABEL, DARRIN W.	)	Attorney Docket No.:
	)	702.254
Serial No.: 10/667,026	)	
	)	
Filed: September 18, 2003	)	Group Art Unit No. 2636
	)	
METHODS, SYSTEMS AND DEVICES	)	
FOR CARTOGRAPHIC ALERTS	)	Examiner: STONE, Jennifer

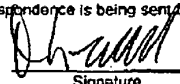
CERTIFICATE OF MAILING 37 C.F.R. 1.8	
I hereby certify that this correspondence is being sent by facsimile to 571-273-6300 on:	
12/20/05 <small>Date</small>	 <small>Signature</small>

Mail Stop Amendment  
Commissioner for Patents  
P.O. Box 1450  
Alexandria, VA 22313-1450

**AMENDMENT**

In response to the Office Action of October 4, 2005, applicant respectfully requests that this amendment be entered in the above-referenced application.

**Amendments to the Claims** are reflected in the listing of claims which begins on page 2 of this paper.

**Remarks** begin on page 15 of this paper.

Application No. 10/667,026  
Amendment dated December 20, 2005  
Reply to Office Action of October 4, 2005

**Amendments to the Claims:**

This listing of claims will replace all prior versions, and listings, of claims in the application:

**CLAIMS:**

Please amend claims 1, 10, 11, 18, 23, 33, 34, and 44, as follows:

1. (Currently Amended) A method for marine navigation, comprising:  
receiving one or more preselected conditions from a user, the preselected conditions being selected from the group of land, water depth, rock(s), sandbars, shelves, tide condition, tidal data, wind conditions, weather conditions, ice, underwater obstacles, and type of water bottom;  
identifying a potential waypoint; and  
performing a marine route calculation algorithm to analyze a course between a first location and the potential waypoint in view of the preselected conditions.
  
2. (Original) The method of claim 1, wherein performing the marine route calculation algorithm includes analyzing cartographic data that include preselected conditions between the first location and the potential waypoint with a preference for avoiding preselected conditions.

Application No. 10/667,026  
Amendment dated December 20, 2005  
Reply to Office Action of October 4, 2005

3. (Original) The method of claim 2, wherein performing the marine route calculation algorithm further includes re-routing the course to avoid the preselected conditions when the marine route calculation algorithm identifies one or more preselected conditions between the first location and the potential waypoint.
  
4. (Original) The method of claim 3, wherein re-routing the course calculated further includes identifying one or more non-user waypoints between the first location and the potential waypoint.
  
5. (Original) The method of claim 2, further including determining the first location on the course based on a signal from a global positioning system (GPS); and analyzing cartographic data for a predetermined area around the first location for preselected conditions.
  
6. (Original) The method of claim 5, further including providing an alert signal when the analyzed cartographic data for the predetermined area around the first location includes preselected conditions.

Application No. 10/667,026  
Amendment dated December 20, 2005  
Reply to Office Action of October 4, 2005

7. (Original) The method of claim 2, further including providing an alert signal when the analyzed cartographic data between the first location and the potential waypoint includes preselected conditions.
8. (Original) The method of claim 7, wherein providing the alert signal includes emitting an audio alert.
9. (Original) The method of claim 7, wherein providing the alert signal includes displaying a visual alert.
10. (Currently Amended) The method of claim 1, ~~the further including receiving~~ preselected conditions ~~selected from the group of land, water depth, rock(s), sandbars, shelves, tide condition, tidal data, wind conditions,~~ including a weather condition[[s]], ice, ~~above water obstacles, underwater obstacles, type of water bottom, and prohibited areas.~~

Application No. 10/667,026  
Amendment dated December 20, 2005  
Reply to Office Action of October 4, 2005

11. (Currently Amended) A method for marine navigation, comprising:
- receiving one or more preselected conditions from a user, the preselected conditions being selected from the group of land, water depth, rock(s), sandbars, shelves, tide condition, tidal data, wind conditions, weather conditions, ice, underwater obstacles, and type of water bottom;
- identifying a potential waypoint;
- analyzing cartographic data between a first location and the potential waypoint for the preselected conditions; and
- providing an alert signal when cartographic data between the first location and the potential waypoint indicate the preselected conditions.
12. (Original) The method of claim 11, wherein performing the marine route calculation algorithm further includes re-routing the course to avoid the preselected conditions when the marine route calculation algorithm identifies one or more preselected conditions between the first location and the potential waypoint.
13. (Original) The method of claim 12, wherein re-routing the course further includes identifying one or more non-user waypoints between the first location and the potential waypoint.

Application No. 10/667,026  
Amendment dated December 20, 2005  
Reply to Office Action of October 4, 2005

14. (Original) The method of claim 11, further including providing an alert signal when the analyzed cartographic data between the first location and the potential waypoint includes preselected conditions.
15. (Original) The method of claim 11, further including determining the first location on the course based on a signal from a global positioning system (GPS); and analyzing cartographic data for a predetermined area around the first location for preselected conditions.
16. (Original) The method of claim 15, further including providing an alert signal when the analyzed cartographic data for the predetermined area around the first location includes preselected conditions.
17. (Original) The method of claim 11, wherein analyzing cartographic data further comprises acquiring cartographic data from a global positioning system (GPS).
18. (Currently Amended) The method of claim 11, ~~the further including receiving preselected conditions selected from the group of land, including a water depth, rock(s), sandbars, shelves, tide condition, tidal data, wind conditions, weather conditions, ice, above water obstacles, underwater obstacles, type of water bottom, and prohibited areas.~~

Application No. 10/667,026  
Amendment dated December 20, 2005  
Reply to Office Action of October 4, 2005

19. (Previously Presented) A method for marine navigation, comprising:
- receiving one or more preselected conditions from a user;
  - receiving a user defined graphical filter area from the user;
  - identifying the user defined graphical filter area on a display;
  - analyzing cartographic data only within the user defined graphical filter area for the preselected conditions; and
  - providing an alert signal when cartographic data within the user defined graphical filter area indicate the preselected conditions.
20. (Original) The method of claim 19, wherein identifying the user defined graphical filter area includes repositioning the user defined graphical filter area.
21. (Original) The method of claim 19, wherein analyzing cartographic data further comprises acquiring cartographic data from a global positioning system (GPS).
22. (Original) The method of claim 19, further including receiving preselected conditions selected from the group of land, water depth, rock(s), sandbars, shelves, tide condition, tidal data, wind conditions, weather conditions, ice, above-water obstacles, underwater obstacles, type of water bottom, and prohibited areas.



Application No. 10/667,026  
Amendment dated December 20, 2005  
Reply to Office Action of October 4, 2005

23. (Currently Amended) A computer readable medium having a set of computer readable instructions, the set of computer readable instructions comprising instructions for: receiving one or more preselected conditions from a user, the preselected conditions being selected from the group of land, water depth, rock(s), sandbars, shelves, tide condition, tidal data, wind conditions, weather conditions, ice, underwater obstacles, and type of water bottom; identifying a potential waypoint upon a first event; and performing a marine route calculation algorithm to analyze a course between a first location and the potential waypoint in view of the preselected conditions.

24. (Original) The computer readable medium of claim 23, wherein performing the marine route calculation algorithm includes analyzing cartographic data between the first location and the potential waypoint to avoid preselected conditions.

25. (Original) The computer readable medium of claim 24, wherein performing the marine route calculation algorithm further includes re-routing the course to avoid the preselected conditions when the marine route calculation algorithm identifies one or more preselected conditions between the first location and the potential waypoint.

Application No. 10/667,026  
Amendment dated December 20, 2005  
Reply to Office Action of October 4, 2005

26. (Original) The computer readable medium of claim 25, wherein re-routing the course further includes identifying one or more non-user waypoints between the first location and the potential waypoint.

27. (Original) The computer readable medium of claim 23, further including determining the first location on the course based on a signal from a global positioning system (GPS); and analyzing cartographic data for a predetermined area around the first location for preselected conditions.

28. (Original) The computer readable medium of claim 27, further including providing an alert signal when the analyzed cartographic data for the predetermined area around the first location includes preselected conditions.

29. (Original) The computer readable medium of claim 23, wherein analyzing cartographic data further comprises acquiring cartographic data from a global positioning system (GPS).

30. (Original) The computer readable medium of claim 23, further including providing an alert signal when the analyzed cartographic data between the first location and the potential waypoint includes preselected conditions.

Application No. 10/667,026  
Amendment dated December 20, 2005  
Reply to Office Action of October 4, 2005

31. (Original) The computer readable medium of claim 30, wherein providing the alert signal includes emitting a signal for an audio alert.
32. (Original) The computer readable medium of claim 30, wherein providing the alert signal includes displaying a visual alert.
33. (Currently Amended) The computer readable medium of claim 23, ~~further including receiving the preselected conditions selected from the group of land, water depth, rock(s), sandbars, shelves, tide condition, tidal data, wind conditions, weather conditions, ice, above water obstacles, including an underwater obstacle[[s]], type of water bottom, and prohibited areas.~~

Application No. 10/667,026  
Amendment dated December 20, 2005  
Reply to Office Action of October 4, 2005

34. (Currently Amended) An electronic marine navigation device, comprising:
- a processor;
  - a user interface operatively coupled to the processor, wherein the user interface receives one or more preselected conditions from a user, the preselected conditions being selected from the group of land, water depth, rock(s), sandbars, shelves, tide condition, tidal data, wind conditions, weather conditions, ice, underwater obstacles, and type of water bottom;
  - a location input operatively coupled to the processor, wherein the location input receives a first location and a potential waypoint separate from the first location; and
  - a memory operatively coupled to the processor and the location input, the memory having cartographic data including data related to the preselected conditions, wherein the processor operates on a marine route calculation algorithm to analyze a course between the first location and the potential waypoint in view of the preselected conditions of the cartographic data.
35. (Original) The electronic marine navigation device of claim 34, wherein the processor operates on the route calculating algorithm to analyze cartographic data to identify and avoid preselected conditions in the course between the first location and the potential waypoint.

Application No. 10/667,026  
Amendment dated December 20, 2005  
Reply to Office Action of October 4, 2005

36. (Original) The electronic marine navigation device of claim 35, wherein the processor operates on the route calculating algorithm to re-route the course to avoid the preselected conditions when the processor operating on the marine route calculation algorithm identifies one or more preselected conditions between the first location and the potential waypoint.

37. (Original) The electronic marine navigation device of claim 36, wherein the processor operates on the route calculating algorithm to identify one or more non-user waypoints between the first location and the potential waypoint.

38. (Original) The electronic marine navigation device of claim 35, further including a receiver for a global positioning system (GPS) operatively coupled to the processor, wherein the processor determines the first location on the course based on a signal received from the GPS, and analyzes cartographic data for a predetermined area around the first location for preselected conditions.

39. (Original) The electronic marine navigation device of claim 38, wherein the processor provides an alert signal when the analyzed cartographic data for the predetermined area around the first location includes preselected conditions.

Application No. 10/667,026  
Amendment dated December 20, 2005  
Reply to Office Action of October 4, 2005

40. (Original) The electronic marine navigation device of claim 35, wherein the processor provides an alert signal when the analyzed cartographic data between the first location and the potential waypoint includes preselected conditions.

41. (Original) The electronic marine navigation device of claim 34, wherein the location input receives a user defined graphical filter area, and wherein the processor operates on the marine route calculation algorithm to analyze cartographic data within the defined graphical filter area for preselected conditions and wherein the processor provides an alert signal when the analyzed cartographic data for the user defined graphical filter area includes preselected conditions.

42. (Previously Presented) The method of claim 1, wherein both the first location and the potential waypoint are independent of a current location of a device implementing the method.

43. (Previously Presented) The method of claim 1, wherein at least a portion of the course is unrelated to a current heading of a device implementing the method.

Application No. 10/667,026  
Amendment dated December 20, 2005  
Reply to Office Action of October 4, 2005

44. (Currently Amended) A method for marine navigation, comprising:
- identifying a potential waypoint; and
  - performing a marine route calculation algorithm to analyze a course between a first location and the potential waypoint in view of preselected conditions received from a user and selected from the group of land, water depth, rock(s), sandbars, shelves, wind conditions, weather conditions, ice, ~~above water obstacles~~, underwater obstacles, and type of water bottom, ~~and prohibited areas~~.

Application No. 10/667,026  
Amendment dated December 20, 2005  
Reply to Office Action of October 4, 2005

**REMARKS:****Status Of Claims**

Claims 1-44 were previously pending in the application. Claims 1, 10, 11, 18, 23, 33, 34, and 44 have been amended. Thus, claims 1-44 are currently pending in the application with claims 1, 11, 19, 23, 34, and 44 being independent.

**Office Action**

Applicant would like to thank the Examiner for indicating that claims 19-22 are allowed.

In the Office Action, the Examiner rejected claims 1-3, 5, 10, 23-25, 27, 29, 33-36, and 42-44 under 35 U.S.C. 102(e) as being anticipated by Fujimoto et al., U.S. Patent Application No. 2004/0006423. The Examiner also rejected claim 38 under 35 U.S.C. 103(a) as being unpatentable over Fujimoto. The Examiner also rejected claims 4, 6-9, 11-18, 26, 28, 30-32, 37, 39, and 40 under 35 U.S.C. 103(a) as being unpatentable over Fujimoto in view of Michaelson, U.S. Patent No. 6,734,808. The Examiner also rejected claim 41 under 35 U.S.C. 103(a) as being unpatentable over Fujimoto in view of Michaelson and Horvath et al., U.S. Patent No. 6,473,003. Applicant respectfully submits that the currently pending claims distinguish the present invention from Fujimoto, Michaelson, Horvath, and the other prior art references of record, taken alone or in combination with each other.

Specifically, claims 1, 11, and 23 all recite "receiving one or more preselected



Application No. 10/667,026  
Amendment dated December 20, 2005  
Reply to Office Action of October 4, 2005

conditions from a user". Similarly, claim 34 recites "a user interface operatively coupled to the processor, wherein the user interface receives one or more preselected conditions from a user". Claim 44 recites "performing a marine route calculation algorithm to analyze a course between a first location and the potential waypoint in view of preselected conditions received from a user", emphasis added. Furthermore, claims 1, 11, 23, 34, and 44 each now require the preselected conditions being "selected from the group of land, water depth, rock(s), sandbars, shelves, wind conditions, weather conditions, ice, underwater obstacles, and type of water bottom". Finally, claim 10 recites "the preselected conditions including a weather condition", claim 18 recites "the preselected conditions including a water depth", and claim 33 recites "the preselected conditions including an underwater obstacle".

In contrast, Fujimoto neither discloses nor suggests any of these criteria being used as preselected conditions. Rather, Fujimoto only discloses an automatic maneuvering system that can avoid docks and the like, and then only when the user specifically defines the docks for his system. As previously argued, no combination of Michaelson and/or Horvath discloses, suggests, or makes obvious "receiving one or more preselected conditions from a user". Nor does any combination of Michaelson and/or Horvath cure the defects in Fujimoto. Therefore, no combination of Fujimoto, Michaelson, and/or Horvath discloses, suggests, or make obvious the limitations of the currently pending claims.

The remaining claims all depend directly or indirectly from independent claims 1, 11, 23, and 34, and are therefore also allowable.

Application No. 10/667,026  
Amendment dated December 20, 2005  
Reply to Office Action of October 4, 2005

Any additional fee which is due in connection with this amendment should be applied against our Deposit Account No. 501-791. In view of the foregoing, a Notice of Allowance appears to be in order and such is courteously solicited.

Respectfully submitted,

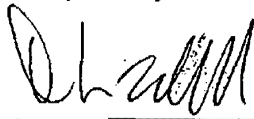

By:

---

David L. Terrell, Reg. No. 50,576  
Garmin International, Inc.  
1200 East 151<sup>st</sup> Street  
Olathe, KS 66062  
(913) 397-8200  
(913) 397-9079 (Fax)

Under the Paperwork Reduction Act of 1995, no persons are required to respond to a collection of information unless it displays a valid OMB control number.

PATENT APPLICATION FEE DETERMINATION RECORD					Application or Docket Number <i>10/667026</i>	
Substitute for Form PTO-875						
<b>APPLICATION AS FILED – PART I</b>					SMALL ENTITY OR OTHER THAN SMALL ENTITY	
(Column 1)		(Column 2)				
FOR	NUMBER FILED	NUMBER EXTRA			RATE (\$)	FEE (\$)
BASIC FEE (37 CFR 1.16(a), (b), or (c))						
SEARCH FEE (37 CFR 1.16(k), (l), or (m))						
EXAMINATION FEE (37 CFR 1.16(o), (p), or (q))						
TOTAL CLAIMS (37 CFR 1.16(i))		minus 20 =	*		X =	X =
INDEPENDENT CLAIMS (37 CFR 1.16(h))		minus 3 =	*		X =	X =
APPLICATION SIZE FEE (37 CFR 1.16(s))	If the specification and drawings exceed 100 sheets of paper, the application size fee due is \$250 (\$125 for small entity) for each additional 50 sheets or fraction thereof. See 35 U.S.C. 41(a)(1)(G) and 37 CFR 1.16(s).					
MULTIPLE DEPENDENT CLAIM PRESENT (37 CFR 1.16(j))						
* If the difference in column 1 is less than zero, enter "0" in column 2.						
<b>APPLICATION AS AMENDED – PART II</b>					SMALL ENTITY OR OTHER THAN SMALL ENTITY	
(Column 1)		(Column 2)		(Column 3)		
AMENDMENT A		CLAIMS REMAINING AFTER AMENDMENT	HIGHEST NUMBER PREVIOUSLY PAID FOR	PRESENT EXTRA	RATE (\$)	ADDITIONAL FEE (\$)
	Total (37 CFR 1.16(i))	* <i>44</i>	Minus ** <i>44</i>	=	X =	
	Independent (37 CFR 1.16(h))	* <i>6</i>	Minus *** <i>6</i>	=	X =	
	Application Size Fee (37 CFR 1.16(s))					
FIRST PRESENTATION OF MULTIPLE DEPENDENT CLAIM (37 CFR 1.16(j))						
TOTAL ADD'L FEE						
AMENDMENT B		CLAIMS REMAINING AFTER AMENDMENT	HIGHEST NUMBER PREVIOUSLY PAID FOR	PRESENT EXTRA	RATE (\$)	ADDITIONAL FEE (\$)
	Total (37 CFR 1.16(i))	*	Minus **	=	X =	
	Independent (37 CFR 1.16(h))	*	Minus ***	=	X =	
	Application Size Fee (37 CFR 1.16(s))					
FIRST PRESENTATION OF MULTIPLE DEPENDENT CLAIM (37 CFR 1.16(j))						
TOTAL ADD'L FEE						
* If the entry in column 1 is less than the entry in column 2, write "0" in column 3.						
** If the "Highest Number Previously Paid For" IN THIS SPACE is less than 20, enter "20".						
*** If the "Highest Number Previously Paid For" IN THIS SPACE is less than 3, enter "3".						
The "Highest Number Previously Paid For" (Total or Independent) is the highest number found in the appropriate box in column 1.						

This collection of information is required by 37 CFR 1.16. The information is required to obtain or retain a benefit by the public which is to file (and by the USPTO to process) an application. Confidentiality is governed by 35 U.S.C. 122 and 37 CFR 1.14. This collection is estimated to take 12 minutes to complete, including gathering, preparing, and submitting the completed application form to the USPTO. Time will vary depending upon the individual case. Any comments on the amount of time you require to complete this form and/or suggestions for reducing this burden, should be sent to the Chief Information Officer, U.S. Patent and Trademark Office, U.S. Department of Commerce, P.O. Box 1450, Alexandria, VA 22313-1450. DO NOT SEND FEES OR COMPLETED FORMS TO THIS ADDRESS. SEND TO: Commissioner for Patents, P.O. Box 1450, Alexandria, VA 22313-1450.

If you need assistance in completing the form, call 1-800-PTO-9199 and select option 2

oh



UNITED STATES PATENT AND TRADEMARK OFFICE

UNITED STATES DEPARTMENT OF COMMERCE  
United States Patent and Trademark Office  
Address: COMMISSIONER FOR PATENTS  
P.O. Box 1450  
Alexandria, Virginia 22313-1450  
www.uspto.gov

APPLICATION NO.	FILING DATE	FIRST NAMED INVENTOR	ATTORNEY DOCKET NO.	CONFIRMATION NO.
10/667,026	09/18/2003	Darrin W. Kabel	702.254	9123
38933	7590	10/04/2005	EXAMINER	
DEVON A. ROLF GARMIN LTD. 1200 EAST 151ST STREET OLATHE, KS 66062			STONE, JENNIFER A	
			ART UNIT	PAPER NUMBER
			2636	

DATE MAILED: 10/04/2005

Please find below and/or attached an Office communication concerning this application or proceeding.

<b>Office Action Summary</b>	<b>Application No.</b> 10/667,026	<b>Applicant(s)</b> KABEL ET AL.	
	<b>Examiner</b> Jennifer A. Stone	<b>Art Unit</b> 2636	

-- The MAILING DATE of this communication appears on the cover sheet with the correspondence address --

**Period for Reply**

A SHORTENED STATUTORY PERIOD FOR REPLY IS SET TO EXPIRE 3 MONTH(S) OR THIRTY (30) DAYS, WHICHEVER IS LONGER, FROM THE MAILING DATE OF THIS COMMUNICATION.

- Extensions of time may be available under the provisions of 37 CFR 1.136(a). In no event, however, may a reply be timely filed after SIX (6) MONTHS from the mailing date of this communication.
- If NO period for reply is specified above, the maximum statutory period will apply and will expire SIX (6) MONTHS from the mailing date of this communication.
- Failure to reply within the set or extended period for reply will, by statute, cause the application to become ABANDONED (35 U.S.C. § 133). Any reply received by the Office later than three months after the mailing date of this communication, even if timely filed, may reduce any earned patent term adjustment. See 37 CFR 1.704(b).

**Status**

- 1)  Responsive to communication(s) filed on 31 August 2005.
- 2a)  This action is FINAL.                      2b)  This action is non-final.
- 3)  Since this application is in condition for allowance except for formal matters, prosecution as to the merits is closed in accordance with the practice under *Ex parte Quayle*, 1935 C.D. 11, 453 O.G. 213.

**Disposition of Claims**

- 4)  Claim(s) 1-44 is/are pending in the application.  
4a) Of the above claim(s) \_\_\_\_\_ is/are withdrawn from consideration.
- 5)  Claim(s) 19-22 is/are allowed.
- 6)  Claim(s) 1-18 and 23-44 is/are rejected.
- 7)  Claim(s) \_\_\_\_\_ is/are objected to.
- 8)  Claim(s) \_\_\_\_\_ are subject to restriction and/or election requirement.

**Application Papers**

- 9)  The specification is objected to by the Examiner.
- 10)  The drawing(s) filed on 18 September 2003 is/are: a)  accepted or b)  objected to by the Examiner.  
Applicant may not request that any objection to the drawing(s) be held in abeyance. See 37 CFR 1.85(a).  
Replacement drawing sheet(s) including the correction is required if the drawing(s) is objected to. See 37 CFR 1.121(d).
- 11)  The oath or declaration is objected to by the Examiner. Note the attached Office Action or form PTO-152.

**Priority under 35 U.S.C. § 119**

- 12)  Acknowledgment is made of a claim for foreign priority under 35 U.S.C. § 119(a)-(d) or (f).  
a)  All    b)  Some \*    c)  None of:
1.  Certified copies of the priority documents have been received.
2.  Certified copies of the priority documents have been received in Application No. \_\_\_\_\_.
3.  Copies of the certified copies of the priority documents have been received in this National Stage application from the International Bureau (PCT Rule 17.2(a)).
- \* See the attached detailed Office action for a list of the certified copies not received.

**Attachment(s)**

- |  |   |
|--|---|
| 1) <input checked="" type="checkbox"/> Notice of References Cited (PTO-892)  | 4) <input type="checkbox"/> Interview Summary (PTO-413)<br>Paper No(s)/Mail Date. _____ |
| 2) <input type="checkbox"/> Notice of Draftsperson's Patent Drawing Review (PTO-948)                                   | 5) <input type="checkbox"/> Notice of Informal Patent Application (PTO-152)             |
| 3) <input type="checkbox"/> Information Disclosure Statement(s) (PTO-1449 or PTO/SB/08)<br>Paper No(s)/Mail Date _____ | 6) <input type="checkbox"/> Other: _____  |

***Claim Rejections - 35 USC § 102***

1. The following is a quotation of the appropriate paragraphs of 35 U.S.C. 102 that form the basis for the rejections under this section made in this Office action:

A person shall be entitled to a patent unless –

(e) the invention was described in (1) an application for patent, published under section 122(b), by another filed in the United States before the invention by the applicant for patent or (2) a patent granted on an application for patent by another filed in the United States before the invention by the applicant for patent, except that an international application filed under the treaty defined in section 351(a) shall have the effects for purposes of this subsection of an application filed in the United States only if the international application designated the United States and was published under Article 21(2) of such treaty in the English language.

2. Claims 1-3, 5, 10, 42, 43 are rejected under 35 U.S.C. 102(e) as being anticipated by Fujimoto et al. (US 20045/0006423).

For claim 1, Fujimoto discloses a method for marine navigation, comprising: receiving one or more preselected conditions from a user (parag 0115); identifying a potential waypoint (paragraph 0071, 0072; Figure 4); and performing a marine route calculation algorithm to analyze a course between a first location and the potential waypoint in view of the preselected conditions (parag 0076-0078).

For claim 2, Fujimoto discloses performing the marine route calculation algorithm to include analyzing cartographic data that include preselected conditions between the first location and the potential waypoint with a preference for avoiding preselected conditions (parag 0023, parag 0106, lines 1-7; parag 0113; parag 0115).

For claim 3, the marine route calculation algorithm further includes re-routing the course to avoid the preselected conditions when the marine route calculation algorithm identifies one or more preselected conditions between the first location and the potential waypoint (parag 0023, 0132, 0133; Fig. 22a, 22b).

For claim 5, Fujimoto determines a first location on the course based on a signal from a GPS; and analyzing cartographic data for a predetermined area around the first location for preselected conditions (parag 0067, Ins 1-10; parag 0068, last 9 lines; parag 0071, 0072).

For claim 10, Fujimoto discloses receiving preselected conditions selected from the group of land, water depth, rock(s), sandbars, shelves, tide condition, tidal data, wind conditions, weather conditions, ice, above-water obstacles, underwater obstacles, type of water bottom, and prohibited areas (parag 0047; parag 0115; Fig. 17a-c, items 301, 302).

For claim 42, Fujimoto discloses a first location and a potential waypoint independent of a current location of a device implementing the method (parag 0139; 0140).

For claim 43, Fujimoto discloses at least a portion of the course is unrelated to a current heading of a device implementing the method (parag 0140, last 10 lines).

3. Claims 23-25, 27, 29, 33 are rejected under 35 U.S.C. 102(e) as being anticipated by Fujimoto et al. (US 20045/0006423).

For claim 23, Fujimoto discloses a computer readable medium having a set of computer readable instructions (parag 0067, Ins 1-10; parag 0068, Ins 1-8 and last 12 lines), the set of computer readable instructions comprising instructions for: receiving one or more preselected conditions from a user (parag 0115); identifying a potential waypoint upon a first event (parag 0071, 0072; parag 0077, 0078); and performing a

marine route calculation algorithm to analyze a course between a first location and the potential waypoint in view of preselected conditions (parag 008245).

For claim 24, the claim is interpreted and rejected for the same reasons as stated in the rejection of claim 2 as stated above.

For claim 25, the claim is interpreted and rejected for the same reasons as stated in the rejection of claim 3 as stated above.

For claim 27, the claim is interpreted and rejected for the same reasons as stated in the rejection of claim 5 as stated above.

For claim 29, the claim is interpreted and rejected for the same reasons as stated in the rejection of claim 17 as stated above.

For claim 33, the claim is interpreted and rejected for the same reasons as stated in the rejection of claim 10 as stated above.

4. Claims 34-36 are rejected under 35 U.S.C. 102(e) as being anticipated by Fujimoto et al. (US 20045/0006423).

For claim 34, Fujimoto discloses an electronic marine navigation device, comprising: a processor; a user interface operatively coupled to the processor, wherein the user interface receives one or more preselected conditions from a user (parag 0067, Ins 6-12; Fig. 1, items 2, 3); a location input operatively coupled to the processor, wherein the location input receives a first location and a potential waypoint separate from the first location; and a memory operatively coupled to the processor and the location input (parag 0116), the memory having cartographic data including data related to the preselected conditions (parag 0115), wherein the processor operates on a marine



route calculation algorithm to analyze a course between the first location and the potential waypoint in view of the preselected conditions of the cartographic data.

For claim 35, the claim is interpreted and rejected for the same reasons as stated in the rejection of claims 2 and 34 as stated above.

For claim 36, the claim is interpreted and rejected for the same reasons as stated in the rejection of claims 3 and 34 as stated above.

5. Claim 44 is rejected under 35 U.S.C. 102(e) as being anticipated by Fujimoto et al. (US 20045/0006423).

Fujimoto discloses a method for marine navigation, comprising: identifying a potential waypoint (paragraph 0066; 0072, lines 1,2); and performing a marine route calculation algorithm to analyze a course between a first location and the potential waypoint (parag 0068, lns 5-8) in view of preselected conditions received from a user and selected from the group of land, water depth, rock(s), sandbars, shelves, tide condition, wind conditions, weather conditions, ice, above-water obstacles, underwater obstacles, type of water bottom, and prohibited areas (parag 0047; parag 0115; Fig. 17a-c, items 301, 302).

### ***Claim Rejections - 35 USC § 103***

6. The following is a quotation of 35 U.S.C. 103(a) which forms the basis for all obviousness rejections set forth in this Office action:

(a) A patent may not be obtained though the invention is not identically disclosed or described as set forth in section 102 of this title, if the differences between the subject matter sought to be patented and the prior art are such that the subject matter as a whole would have been obvious at the time the invention was made to a person having ordinary skill in the art to which said subject matter pertains. Patentability shall not be negated by the manner in which the invention was made.

7. Claim 38 is rejected under 35 U.S.C. 103(a) as being unpatentable over Fujimoto et al. (US 20045/0006423),

Fujimoto discloses a GPS system operatively coupled to the processor (Fig. 1, items 3, 6; parag 0066, Ins 1-3, 12-16), wherein the processor determines the first location on the course based on a signal received from the GPS (parag 0068, last 9 lines), and analyzes cartographic data for a predetermined area around the first location for preselected conditions (parag 0072; 0113). Even though Fujimoto does not specifically disclose a GPS receiver, it would have been obvious to one of ordinary skill in the art, at the time the invention was made to include a GPS receiver to receive signals from a satellite in order to determine the ships position.

8. Claims 4 and 6-9 are rejected under 35 U.S.C. 103(a) as being unpatentable over Fujimoto et al. (US 20045/0006423), and further in view of Michaelson et al. (US 6,734,808).

For claim 4, Fujimoto discloses re-routing the course calculated, but does so by identifying user waypoints (parag 0140, Ins 1-5). Michaelson, on the other hand discloses re-routing a course by identifying one or more non-user waypoints (determined by the system, not the user) between the first location and the potential waypoint (col 24, Ins 41-50 and 55-64). It would have been obvious to disclose non-user waypoints so that an operator of a ship relies on automatic navigation between a point of origin and a destination without constantly monitoring the ship's travel route.

For claim 6, Fujimoto does not disclose an alert signal; however, Michaelson discloses an alert signal is provided when the analyzed cartographic data for the predetermined area around the first location includes preselected conditions (col 2, Ins 11-14; col 6, Ins 13-17). It would have been obvious to provide an alert signal so that a ship's operator acknowledges an alert and verifies that the ship is maneuvered around a preselected condition to ensure the safety of the ship's passengers.

For claim 7, Fujimoto does not disclose an alert signal; however, Michaelson discloses an alert signal is provided when the analyzed cartographic data for the predetermined data between the first location and the potential waypoint includes preselected conditions (col 6, Ins 13-26). It would have been obvious to provide an alert signal so that a ship's operator acknowledges an alert and verifies that the ship is maneuvered around a preselected condition to ensure the safety of the ship's passengers.

For claim 8, the claim is interpreted and rejected for the same reasons as stated in the rejections of claim 6 and 7 as stated above. In addition, Michaelson discloses the alert signal includes emitting an audio alert (col 6, Ins 15-18; Fig. 2, item 28).

For claim 9, the claim is interpreted and rejected for the same reasons as stated in the rejections of claim 6-8 as stated above. Michaelson discloses providing the alert signal to include displaying a visual alert.

9. Claims 11-18 are rejected under 35 U.S.C. 103(a) as being unpatentable over Fujimoto et al. (US 20045/0006423), and further in view of Michaelson et al. (US 6,734,808).

For claim 11, the claim is interpreted and rejected for the same reasons as stated in the rejection of claims 1 and 6 as stated above.

For claim 12, the claim is interpreted and rejected for the same reasons as stated in the rejection of claim 3 as stated above.

For claim 13, the claim is interpreted and rejected for the same reasons as stated in the rejection of claim 4 as stated above.

For claim 14, the claim is interpreted and rejected for the same reasons as stated in the rejection of claim 7 as stated above.

For claim 15, the claim is interpreted and rejected for the same reasons as stated in the rejection of claim 5 as stated above.

For claim 16, the claim is interpreted and rejected for the same reasons as stated in the rejection of claim 6 as stated above.

For claim 17, Fujimoto discloses analyzing cartographic data further comprises acquiring cartographic data from a GPS (parag 0067, lns 1-5).

For claim 18, the claim is interpreted and rejected for the same reasons as stated in the rejection of claim 10 as stated above.

10. Claims 26, 28, and 30-32 are rejected under 35 U.S.C. 103(a) as being unpatentable over Fujimoto et al. (US 20045/0006423), and further in view of Michaelson et al. (US 6,734,808).

Claim 26 is interpreted and rejected for the same reasons as stated in the rejection of claim 4 as stated above.

Claim 28 is interpreted and rejected for the same reasons as stated in the rejection of claim 6 as stated above.

Claims 30-32 are interpreted and rejected for the same reasons as stated in the rejection of claims 7-9, respectively, and as stated above.

11. Claims 37, 39 and 40 are rejected under 35 U.S.C. 103(a) as being unpatentable over Fujimoto et al. (US 20045/0006423), and further in view of Michaelson et al. (US 6,734,808).

For claim 37, the claim is interpreted and rejected for the same reasons as stated in the rejection of claims 4 and 34 as stated above.

For claim 39, the claim is interpreted and rejected for the same reasons as stated in the rejection of claims 6 and 34 as stated above.

For claim 40, the claim is interpreted and rejected for the same reasons as stated in the rejection of claims 7 and 34 as stated above.

12. Claim 41 is rejected under 35 U.S.C. 103(a) as being unpatentable over Fujimoto et al. (US 20045/0006423), as applied to claim 34, and further in view of Michaelson et al. (US 6,734,808) and Horvath et al. (US 6,473,003).

Fujimoto discloses a processor to operate on the marine route calculation algorithm to analyze cartographic data (parag 0067, Ins 6-12; parag 0068, Ins 1-10); however, Fujimoto does not disclose an alert signal. Michaelson discloses an alert signal wherein a processor provides an alert signal when analyzed cartographic data includes preselected conditions (col 2, Ins 11-14; col 6, Ins 13-17). It would have been obvious to provide an alert signal so that a ship's operator acknowledges an alert and verifies

Art Unit: 2636

that the ship is maneuvered around a preselected condition to ensure the safety of the ships passengers. However, neither Fujimoto nor Michaelson disclose a user defined graphical filter area. Horvath, on the other hand, does disclose a user defined graphical filter area (col 1, Ins 10-14; col 2, Ins 30, 31, 44-48) wherein a processor operates to analyze cartographic data and provides an alert signal when the analyzed cartographic data for the user defined graphical filter area includes preselected conditions (col 2, Ins 60-63; Fig. 4, 30i). Even though Horvath's primary application is aircraft navigation, it would have been obvious to apply a user defined graphical filter area to a marine navigation system so that a user has a certain degree of control over the display in order to customize it according to the user's preferences.

***Allowable Subject Matter***

13. Claims 19-22 are allowed.

***Continued Examination Under 37 CFR 1.114***

14. A request for continued examination under 37 CFR 1.114, including the fee set forth in 37 CFR 1.17(e), was filed in this application after final rejection. Since this application is eligible for continued examination under 37 CFR 1.114, and the fee set forth in 37 CFR 1.17(e) has been timely paid, the finality of the previous Office action has been withdrawn pursuant to 37 CFR 1.114. Applicant's submission filed on August 31, 2005 has been entered.

***Response to Arguments***

15. Applicant's arguments with respect to claims 1-44 have been considered but are moot in view of the new ground(s) of rejection.

***Conclusion***

16. Any inquiry concerning this communication or earlier communications from the examiner should be directed to Jennifer A. Stone whose telephone number is (571) 272.2976. The examiner can normally be reached 8:00-4:30, M-F.

If attempts to reach the examiner by telephone are unsuccessful, the examiner's supervisor, Mr. Jeffery Hofsass can be reached at (571) 272.2981. The fax phone number for the organization where this application or proceeding is assigned is (571) 273.8300 for regular and after final communications.

Any inquiry of a general nature of relating to the status of this application or proceeding should be directed to the receptionist whose telephone number is (571) 272.2600.

Information regarding the status of an application may be obtained from the Patent Application Information Retrieval (PAIR) system. Status information for published applications may be obtained from either Private PAIR or Public PAIR. Status information for unpublished applications is available through Private PAIR only. For more information about the PAIR system, see <http://pair-direct.uspto.gov>. Should you have questions on access to the Private PAIR system, contact the Electronic Business Center (EBC) at 866-217-9197 (toll-free).

Application/Control Number: 10/667,026  
Art Unit: 2636

Page 12

Jennifer Stone  
September 30, 2005

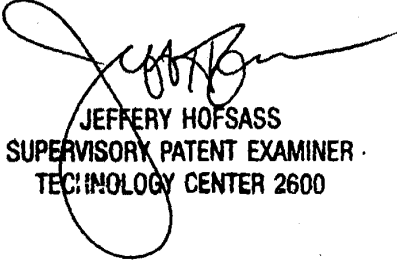

JEFFERY HOFSSASS  
SUPERVISORY PATENT EXAMINER  
TECHNOLOGY CENTER 2600



<b>Notice of References Cited</b>	Application/Control No. 10/667,026	Applicant(s)/Patent Under Reexamination KABEL ET AL.	
	Examiner Jennifer A. Stone	Art Unit 2636	Page 1 of 1

**U.S. PATENT DOCUMENTS**

*	Document Number Country Code-Number-Kind Code	Date MM-YYYY	Name	Classification
A	US-2004/0006423	01-2004	Fujimoto et al.	701/201
B	US-			
C	US-			
D	US-			
E	US-			
F	US-			
G	US-			
H	US-			
I	US-			
J	US-			
K	US-			
L	US-			
M	US-			

**FOREIGN PATENT DOCUMENTS**

*	Document Number Country Code-Number-Kind Code	Date MM-YYYY	Country	Name	Classification
N					
O					
P					
Q					
R					
S					
T					

**NON-PATENT DOCUMENTS**

*	Include as applicable: Author, Title Date, Publisher, Edition or Volume, Pertinent Pages)
U	
V	
W	
X	

\*A copy of this reference is not being furnished with this Office action. (See MPEP § 707.05(a).)  
Dates in MM-YYYY format are publication dates. Classifications may be US or foreign.

**Search Notes**



Application No.

10/667,026

Examiner

Jennifer A Stone

Applicant(s)

KABEL ET AL.

Art Unit

2636

**SEARCHED**

Class	Subclass	Date	Examiner
340	686.6 995.1 984 985 851 539.13	12/28/2005	JS
340	539.2 961	12/28/2005	JS
340	539.22	12/28/2005	JS
340	7.56	12/28/2005	JS
340	825.36	12/28/2005	JS
340	995.11	12/28/2005	JS
367	909	12/28/2005	JS
342	357.13 41	12/28/2005	JS
701	21 201	12/28/2005	JS
701	301	12/28/2005	JS
340	850 851	9/27/2005	JS

**INTERFERENCE SEARCHED**

Class	Subclass	Date	Examiner

**SEARCH NOTES  
(INCLUDING SEARCH STRATEGY)**

	DATE	EXMR
Brent Swartout	1/5/2005	JS
East Search	12/28/2004	JS
Brent Swartout	5/24/2005	JS
Updated Search	5/20/2005	JS
Updated East Search	9/27/2005	JS





UNITED STATES PATENT AND TRADEMARK OFFICE

UNITED STATES DEPARTMENT OF COMMERCE  
United States Patent and Trademark Office  
Address: COMMISSIONER FOR PATENTS  
P.O. Box 1450  
Alexandria, Virginia 22313-1450  
www.uspto.gov

APPLICATION NUMBER	PATENT NUMBER	GROUP ART UNIT	FILE WRAPPER LOCATION
10/667,026		2636	28M1

## Correspondence Address / Fee Address Change

The following fields have been set to Customer Number 38933 on 09/30/2005

- Correspondence Address
- Maintenance Fee Address

The address of record for Customer Number 38933 is:

DEVON A. ROLF  
GARMIN LTD.  
1200 EAST 151ST STREET  
OLATHE,KS 66062

RECEIVED  
CENTRAL FAX CENTER  
AUG 31 2005

**IN THE UNITED STATES PATENT AND TRADEMARK OFFICE**

Application of:	)	
KABEL, DARRIN W.	)	Attorney Docket No.:
Serial No.: 10/667,026	)	702.254
Filed: September 18, 2003	)	Group Art Unit No. 2636
METHODS, SYSTEMS AND DEVICES FOR CARTOGRAPHIC ALERTS	)	Examiner: STONE, Jennifer

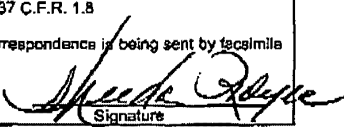
CERTIFICATE OF MAILING 37 C.F.R. 1.8	
I hereby certify that this correspondence is being sent by facsimile to 571-273-5600 on:	
8/31/05 <small>Date</small>	 <small>Signature</small>

Mail Stop RCE  
Commissioner for Patents  
P.O. Box 1450  
Alexandria, VA 22313-1450

**PRELIMINARY AMENDMENT**

This preliminary amendment is being submitted simultaneously with the filing of a Request for Continued Examination of the above-referenced application.

Amendments to the Claims are reflected in the listing of claims which begins on page 2 of this paper.

Remarks begin on page 14 of this paper.

Application No. 10/667,026  
Amendment dated September 1, 2005  
Reply to Advisory Action of August 24, 2005

**Amendments to the Claims:**

This listing of claims will replace all prior versions, and listings, of claims in the application:

**CLAIMS:**

Please amend claims 1, 11, 19, 23, and 34, as follows:

1. (Currently Amended) A method for marine navigation, comprising:  
receiving one or more preselected conditions from a user;  
identifying a potential waypoint; and  
performing a marine route calculation algorithm to analyze a course between a first location and the potential waypoint in view of the preselected conditions.
2. (Original) The method of claim 1, wherein performing the marine route calculation algorithm includes analyzing cartographic data that include preselected conditions between the first location and the potential waypoint with a preference for avoiding preselected conditions.

Application No. 10/667,026  
Amendment dated September 1, 2005  
Reply to Advisory Action of August 24, 2005

3. (Original) The method of claim 2, wherein performing the marine route calculation algorithm further includes re-routing the course to avoid the preselected conditions when the marine route calculation algorithm identifies one or more preselected conditions between the first location and the potential waypoint.
4. (Original) The method of claim 3, wherein re-routing the course calculated further includes identifying one or more non-user waypoints between the first location and the potential waypoint.
5. (Original) The method of claim 2, further including determining the first location on the course based on a signal from a global positioning system (GPS); and analyzing cartographic data for a predetermined area around the first location for preselected conditions.
6. (Original) The method of claim 5, further including providing an alert signal when the analyzed cartographic data for the predetermined area around the first location includes preselected conditions.
7. (Original) The method of claim 2, further including providing an alert signal when the analyzed cartographic data between the first location and the potential waypoint includes preselected conditions.

Application No. 10/667,026  
Amendment dated September 1, 2005  
Reply to Advisory Action of August 24, 2005

8. (Original) The method of claim 7, wherein providing the alert signal includes emitting an audio alert.
9. (Original) The method of claim 7, wherein providing the alert signal includes displaying a visual alert.
10. (Original) The method of claim 1, further including receiving preselected conditions selected from the group of land, water depth, rock(s), sandbars, shelves, tide condition, tidal data, wind conditions, weather conditions, ice, above-water obstacles, underwater obstacles, type of water bottom, and prohibited areas.
11. (Currently Amended) A method for marine navigation, comprising:  
receiving one or more preselected conditions from a user;  
identifying a potential waypoint;  
analyzing cartographic data between a first location and the potential waypoint for the preselected conditions; and  
providing an alert signal when cartographic data between the first location and the potential waypoint indicate the preselected conditions.



Application No. 10/667,026  
Amendment dated September 1, 2005  
Reply to Advisory Action of August 24, 2005

12. (Original) The method of claim 11, wherein performing the marine route calculation algorithm further includes re-routing the course to avoid the preselected conditions when the marine route calculation algorithm identifies one or more preselected conditions between the first location and the potential waypoint.
  
13. (Original) The method of claim 12, wherein re-routing the course further includes identifying one or more non-user waypoints between the first location and the potential waypoint.
  
14. (Original) The method of claim 11, further including providing an alert signal when the analyzed cartographic data between the first location and the potential waypoint includes preselected conditions.
  
15. (Original) The method of claim 11, further including determining the first location on the course based on a signal from a global positioning system (GPS); and analyzing cartographic data for a predetermined area around the first location for preselected conditions.
  
16. (Original) The method of claim 15, further including providing an alert signal when the analyzed cartographic data for the predetermined area around the first location includes preselected conditions.

Application No. 10/667,026  
Amendment dated September 1, 2005  
Reply to Advisory Action of August 24, 2005

17. (Original) The method of claim 11, wherein analyzing cartographic data further comprises acquiring cartographic data from a global positioning system (GPS).
18. (Original) The method of claim 11, further including receiving preselected conditions selected from the group of land, water depth, rock(s), sandbars, shelves, tide condition, tidal data, wind conditions, weather conditions, ice, above-water obstacles, underwater obstacles, type of water bottom, and prohibited areas.
19. (Currently Amended) A method for marine navigation, comprising:  
receiving one or more preselected conditions from a user;  
receiving a user defined graphical filter area from the user;  
identifying [[a]] the user defined graphical filter area on a display;  
analyzing cartographic data only within the user defined graphical filter area for the preselected conditions; and  
providing an alert signal when cartographic data within the user defined graphical filter area indicate the preselected conditions.
20. (Original) The method of claim 19, wherein identifying the user defined graphical filter area includes repositioning the user defined graphical filter area.

Application No. 10/667,026  
Amendment dated September 1, 2005  
Reply to Advisory Action of August 24, 2005

21. (Original) The method of claim 19, wherein analyzing cartographic data further comprises acquiring cartographic data from a global positioning system (GPS).
22. (Original) The method of claim 19, further including receiving preselected conditions selected from the group of land, water depth, rock(s), sandbars, shelves, tide condition, tidal data, wind conditions, weather conditions, ice, above-water obstacles, underwater obstacles, type of water bottom, and prohibited areas.
23. (Currently Amended) A computer readable medium having a set of computer readable instructions, the set of computer readable instructions comprising instructions for:  
receiving one or more preselected conditions from a user;  
identifying a potential waypoint upon a first event; and  
performing a marine route calculation algorithm to analyze a course between a first location and the potential waypoint in view of the preselected conditions.
24. (Original) The computer readable medium of claim 23, wherein performing the marine route calculation algorithm includes analyzing cartographic data between the first location and the potential waypoint to avoid preselected conditions.

Application No. 10/667,026  
Amendment dated September 1, 2005  
Reply to Advisory Action of August 24, 2005

25. (Original) The computer readable medium of claim 24, wherein performing the marine route calculation algorithm further includes re-routing the course to avoid the preselected conditions when the marine route calculation algorithm identifies one or more preselected conditions between the first location and the potential waypoint.

26. (Original) The computer readable medium of claim 25, wherein re-routing the course further includes identifying one or more non-user waypoints between the first location and the potential waypoint.

27. (Original) The computer readable medium of claim 23, further including determining the first location on the course based on a signal from a global positioning system (GPS); and analyzing cartographic data for a predetermined area around the first location for preselected conditions.

28. (Original) The computer readable medium of claim 27, further including providing an alert signal when the analyzed cartographic data for the predetermined area around the first location includes preselected conditions.

29. (Original) The computer readable medium of claim 23, wherein analyzing cartographic data further comprises acquiring cartographic data from a global positioning system (GPS).

Application No. 10/667,026  
Amendment dated September 1, 2005  
Reply to Advisory Action of August 24, 2005

30. (Original) The computer readable medium of claim 23, further including providing an alert signal when the analyzed cartographic data between the first location and the potential waypoint includes preselected conditions.

31. (Original) The computer readable medium of claim 30, wherein providing the alert signal includes emitting a signal for an audio alert.

32. (Original) The computer readable medium of claim 30, wherein providing the alert signal includes displaying a visual alert.

33. (Original) The computer readable medium of claim 23, further including receiving preselected conditions selected from the group of land, water depth, rock(s), sandbars, shelves, tide condition, tidal data, wind conditions, weather conditions, ice, above-water obstacles, underwater obstacles, type of water bottom, and prohibited areas.

Application No. 10/667,026  
Amendment dated September 1, 2005  
Reply to Advisory Action of August 24, 2005

34. (Currently Amended) An electronic marine navigation device, comprising:
- a processor;
  - a user interface operatively coupled to the processor, wherein the user interface receives one or more preselected conditions from a user;
  - a location input operatively coupled to the processor, wherein the location input receives a first location and a potential waypoint separate from the first location; and
  - a memory operatively coupled to the processor and the location input, the memory having cartographic data including data related to the preselected conditions, wherein the processor operates on a marine route calculation algorithm to analyze a course between the first location and the potential waypoint in view of the preselected conditions of the cartographic data.
35. (Original) The electronic marine navigation device of claim 34, wherein the processor operates on the route calculating algorithm to analyze cartographic data to identify and avoid preselected conditions in the course between the first location and the potential waypoint.

Application No. 10/667,026  
Amendment dated September 1, 2005  
Reply to Advisory Action of August 24, 2005

36. (Original) The electronic marine navigation device of claim 35, wherein the processor operates on the route calculating algorithm to re-route the course to avoid the preselected conditions when the processor operating on the marine route calculation algorithm identifies one or more preselected conditions between the first location and the potential waypoint.

37. (Original) The electronic marine navigation device of claim 36, wherein the processor operates on the route calculating algorithm to identify one or more non-user waypoints between the first location and the potential waypoint.

38. (Original) The electronic marine navigation device of claim 35, further including a receiver for a global positioning system (GPS) operatively coupled to the processor, wherein the processor determines the first location on the course based on a signal received from the GPS, and analyzes cartographic data for a predetermined area around the first location for preselected conditions.

39. (Original) The electronic marine navigation device of claim 38, wherein the processor provides an alert signal when the analyzed cartographic data for the predetermined area around the first location includes preselected conditions.

Application No. 10/667,026  
Amendment dated September 1, 2005  
Reply to Advisory Action of August 24, 2005

40. (Original) The electronic marine navigation device of claim 35, wherein the processor provides an alert signal when the analyzed cartographic data between the first location and the potential waypoint includes preselected conditions.

41. (Original) The electronic marine navigation device of claim 34, wherein the location input receives a user defined graphical filter area, and wherein the processor operates on the marine route calculation algorithm to analyze cartographic data within the defined graphical filter area for preselected conditions and wherein the processor provides an alert signal when the analyzed cartographic data for the user defined graphical filter area includes preselected conditions.

42. (Previously Presented) The method of claim 1, wherein both the first location and the potential waypoint are independent of a current location of a device implementing the method.

43. (Previously Presented) The method of claim 1, wherein at least a portion of the course is unrelated to a current heading of a device implementing the method.



Application No. 10/667,026  
Amendment dated September 1, 2005  
Reply to Advisory Action of August 24, 2005

44. (Previously Presented) A method for marine navigation, comprising:
- identifying a potential waypoint; and
  - performing a marine route calculation algorithm to analyze a course between a first location and the potential waypoint in view of preselected conditions received from a user and selected from the group of land, water depth, rock(s), sandbars, shelves, wind conditions, weather conditions, ice, above-water obstacles, underwater obstacles, type of water bottom, and prohibited areas.

Application No. 10/687,026  
Amendment dated September 1, 2005  
Reply to Advisory Action of August 24, 2005

**REMARKS:****Status Of Claims**

Claims 1-44 were previously pending in the application. Claims 1, 11, 19, 23, and 34 have been amended. Thus, claims 1-44 are currently pending in the application with claims 1, 11, 19, 23, 34, and 44 being independent.

**Office Action**

In the June 1, 2005 Office Action, the Examiner rejected claims 1-18 and 23-40 under 35 U.S.C. 102(e) as being anticipated by Michaelson et al., U.S. Patent No. 6,734,808. The Examiner also rejected claims 19-22 under 35 U.S.C. 103(a) as being unpatentable over Horvath et al., U.S. Patent No. 6,473,003. The Examiner also rejected claim 41 under 35 U.S.C. 103(a) as being unpatentable over Michaelson in view of Horvath. The Examiner also rejected claim 42 under 35 U.S.C. 103(a) as being unpatentable over Michaelson in view of Mounce, U.S. Patent No. 4,340,936. The Examiner also rejected claim 43 under 35 U.S.C. 103(a) as being unpatentable over Michaelson in view of Wyant et al., U.S. Patent No. 6,885,919. The Examiner also rejected claim 44 under 35 U.S.C. 102(b) as being anticipated by Mounce. Applicant respectfully submits that the currently pending claims distinguish the present invention from Michaelson, Horvath, Mounce, Wyant, and the other prior art references of record, taken alone or in combination with each other.

Specifically, claims 1, 11, 19, and 23 all now recite "receiving one or more

Application No. 10/667,026  
Amendment dated September 1, 2005  
Reply to Advisory Action of August 24, 2005

preselected conditions from a user". Similarly, claim 34 recites "a user interface operatively coupled to the processor, wherein the user interface receives one or more preselected conditions from a user". Finally, claim 44 previously recited and currently recites "performing a marine route calculation algorithm to analyze a course between a first location and the potential waypoint in view of *preselected conditions received from a user*", emphasis added. Support for these amendments may be found, among other places, on page 6, lines 9-20:

In addition, memory 330 can further retrievably store cartographic data, including marine craft data and a variety of preselected conditions that are also used in conjunction with the marine route calculation algorithm. Preselected conditions can include user identified parameters, and any values associated with the parameters, that are associated with geographical conditions of particular interest. For example, preselected conditions a user can select include, but are not limited to, indications of land, water depth, rock(s), sandbars, shelves, tide condition, tidal data, wind conditions, weather conditions, ice, above-water obstacles (e.g., bridges), underwater obstacles (e.g., submerged wrecks), type of water bottom, and prohibited areas, to name only a few. The preselected conditions, and their associated values, can be selected and programmed by a user through, for example, controlling one or more input menus on display screen 340 with the location input 320.

Thus, these claims require the user to select the "preselected conditions" to be avoided. Specifically, the present invention analyzes map data looking for a condition to be avoided, preselected by the user.

In contrast, as previously argued, Michaelson and Horvath both analyze map data looking for a depth, or height, that conflicts with the vessel's, or aircraft's, current depth, or altitude, as determined by the device. As pervasively argued, this current depth, or

Application No. 10/667,026  
Amendment dated September 1, 2005  
Reply to Advisory Action of August 24, 2005

altitude, is dynamic and is simply not *preselected* by the user. Thus, no combination of Michaelson and/or Horvath discloses, suggests, or makes obvious "receiving one or more preselected conditions from a user", as claimed in claims 1, 11, 19, and 23. Nor does any combination of Michaelson and/or Horvath disclose, suggest, or make obvious "a user interface operatively coupled to the processor, wherein the user interface receives one or more preselected conditions from a user", as claimed in claim 34, or "performing a marine route calculation algorithm to analyze a course between a first location and the potential waypoint in view of preselected conditions received from a user", as claimed in claim 44.

While Mounce does disclose a user 'selecting' some information, Mounce simply does not disclose a user providing the preselected conditions defined in the specification or used in the claims. Specifically, Mounce discloses only a user selecting whether or not to display individual pieces of information. For example, the Examiner points to Mounce's column 3, lines 2-6 and 10-12, column 4, lines 9-20, and Figure 1, items 1-5. However, column 3, lines 2-6, discloses "[t]he present illustrated embodiment shows more than a dozen readouts which are processed and displayed, and a display control unit is provided with a switch for each calculated readout by which the operator can selectively display or skip that value". Column 3, lines 10-12, discloses "[t]he main routine of the microprocessor calculates selected readouts sequentially and displays selected ones thereof so that each value is displayed for an interval of time long enough to make it easy to read". Column 4, lines 9-20, discloses:

It is still another important object of the invention to provide a system having an automatic routine which sequentially displays the calculated

Application No. 10/667,026  
Amendment dated September 1, 2005  
Reply to Advisory Action of August 24, 2005

information and companion alpha identification, but which can be manually controlled by the operator to omit, or include, any selection of measured or calculated data. The system provides a set of display switches so arranged that the actuation of the switches determines which data will be displayed and which will be passed over without display, whereby the operator can elect to display in more rapid succession only those quantities which particularly interest him at the moment.

Thus, the cited portions of Mounce merely disclose which of several inputs the user wishes to be displayed. Finally, as disclosed in column 5, items 1-5 of Mounce's Figure 1 are "input parameter sensors". It should also be noted that Mounce's input sensors are variable inputs, received from sensors, rather than "preselected conditions received from a user", as claimed in claim 44

Furthermore, Mounce simply does not disclose the other limitations of claim 44. For example, Mounce simply does not calculate a route, as defined in the specification and used in the claims. Rather, as disclosed in column 3, lines 38-56:

The microprocessor system calculates such values as actual wind direction and speed, actual boat direction and speed over the bottom, relative wind direction on the port side, or on the starboard side, leeway angle, course and distance to or from a destination mark, or course and distance from an origin at the beginning of the course being traversed by the boat, etc.

It is another very important object of the invention to provide a system capable of making calculations at a high rate from the raw data being collected as measured parameters from the sensors because the raw data is all interrelated and continuously varying, so that manually made calculations would provide only very incomplete and sparse data. The rapidity of the calculations and the high repetition rate permit effective integrating of the values to provide much more accurate information as to the progress and ultimate position of the boat with respect to an origin point or with respect to a destination mark.

In fact, Mounce' only use of the term route, in column 10, lines 46-50, relates to

Application No. 10/667,026  
Amendment dated September 1, 2005  
Reply to Advisory Action of August 24, 2005

'routing' information from a RAM to a display. In any case, no route or course of Mounce is ever analyzed in view of preselected conditions received from a user. Therefore, Mounce only discloses calculation of a heading based on variable inputs received from sensors.

The Examiner might be confused by Mounce's disclosure of the user selecting which of those inputs he or she wishes to be displayed. However, such disclosure is just that. The user's selections only impact which inputs will be displayed. The user's selections have no impact on the calculation of the heading, and is therefore simply not analogous to analyzing a route in view of preselected conditions received from a user, as described in the specification and claimed in the claims. Thus, Mounce does not disclose, suggest, or make obvious "performing a marine route calculation algorithm to analyze a course between a first location and the potential waypoint in view of preselected conditions received from a user", much less the other limitations of claim 44.

Claim 19 further recites "receiving a user defined graphical filter area from the user" and "analyzing cartographic data only within the user defined graphical filter area for the preselected conditions". Support for this amendment may be found, among other places, on page 8, lines 11-25:

The marine route calculation algorithm can also be used to analyze cartographic data within a user defined graphical filter area (shown as 478 in Figure 4E). In one embodiment, the user defined graphical filter area includes a geographical area defined by a user on the display screen 340. Examples of defining the user defined graphical filter area on the display screen 340 include, but are not limited to, use of the input devices 216 or the display screen 340 itself. For example, a user could draw the user defined graphical filter area using a cursor shown on the display screen 340. The

Application No. 10/667,026  
Amendment dated September 1, 2005  
Reply to Advisory Action of August 24, 2005

user defined graphical filter area can include an area smaller than the display screen 340.

The user defined graphical filter area can also include any number of shapes, including, but not limited to, square, rectangular, triangular, or circular. Other shapes for the user defined graphical filter area are also possible. The user defined graphical filter area can further be positioned and/or repositioned over any number of locations on the display screen 340.

In one embodiment, a displayed cursor under the control of one or more of the input devices 216 can be used to position and/or reposition the user defined graphical filter area over any number of locations on the display screen 340.

As stated on page 9, lines 5-13:

In one example, the dynamic analysis of cartographic data, including the marine craft data, within the defined graphical filter area for preselected conditions allows for a user to be aware of preselected conditions that may be located within the area, but not necessarily at the first location and/or along the course which the device is traveling. In an additional embodiment, analyzing the cartographic data within the defined graphical filter area can be available regardless of whether a calculated course is being used or not. In other words, a user need not have a destination point, one or more waypoints (e.g., a potential, or other waypoint) and/or a calculated a course to have the cartographic data analyzed within the defined graphical filter area.

Thus, claim 19 also requires the user to define an area to which the analysis will be limited.

In contrast, as previously argued, neither Michaelson nor Horvath disclose the user to defining an area to which analysis is limited. As previously argued, Horvath's range indicator is just that, a circle showing a fixed range from an aircraft. While the circle is useful for showing the aircraft's relation to objects, and for general situational awareness, the area within Horvath's circle is simply not analyzed for anything or even defined in any

Application No. 10/667,026  
Amendment dated September 1, 2005  
Reply to Advisory Action of August 24, 2005

useful way. For example, as stated in column 7, lines 27-29, "a range ring can be overlaid on a weather, terrain, statutory map, traffic, or other display of a condition near the aircraft". Thus, Horvath simply discloses an overlay which defines, at most, a linear relationship rather than an area. As a result, Horvath does not disclose, suggest, or make obvious "receiving a user defined graphical filter area from the user" or "analyzing cartographic data only within the user defined graphical filter area for the preselected conditions", as claimed in claim 19.

The remaining claims all depend directly or indirectly from independent claims 1, 11, 19, 23, and 34, and are therefore also allowable.

Any additional fee which is due in connection with this amendment should be applied against our Deposit Account No. 501-791. In view of the foregoing, a Notice of Allowance appears to be in order and such is courteously solicited.

Respectfully submitted,

By:

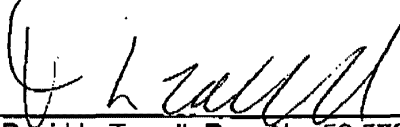
  
\_\_\_\_\_  
David L. Terrell, Reg. No. 50,576  
Garmin International, Inc.  
1200 East 151<sup>st</sup> Street  
Olathe, KS 66062  
(913) 397-8200  
(913) 397-9079 (Fax)



AUG 31 2005

**IN THE UNITED STATES PATENT AND TRADEMARK OFFICE**

Application of:	)	
KABEL, DARRIN W.	)	Attorney Docket No.:
Serial No.: 10/667,026	)	702.254
Filed: September 18, 2003	)	Group Art Unit No. 2636
METHODS, SYSTEMS AND DEVICES FOR CARTOGRAPHIC ALERTS	)	Examiner: STONE, Jennifer

CERTIFICATE OF MAILING 37 C.F.R. 1.8	
I hereby certify that this correspondence is being sent by facsimile to 571/273-8300 on:	
8/31/05	<i>Shude Rapp</i>
Date	Signature

Mail Stop RCE  
Commissioner for Patents  
P.O. Box 1450  
Alexandria, VA 22313-1450

**REQUEST FOR CONTINUED EXAMINATION TRANSMITTAL**

This is a Request for Continued Examination (RCE) under 37 C.F.R. §1.114 of the above-identified application. Applicant requests consideration of the Preliminary Amendment filed simultaneously herewith.

The Commissioner is hereby authorized to charge the filing fee in the amount of \$790, and any other required fees, or credit any overpayments, to Deposit Account No. 501-791.

Respectfully submitted,

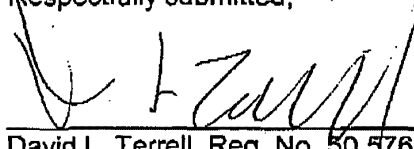

By:

09/01/2005 TL0111 00000023 501791 10667026  
01 FC:1801 790.00 DA

David L. Terrell, Reg. No. 50,576  
Garmin International, Inc.  
1200 East 151<sup>st</sup> Street  
Olathe, KS 66062  
(913) 397-8200  
(913) 397-9079 (Fax)

RECEIVED 001  
CENTRAL FAX CENTER  
AUG 31 2005



GARMIN INTERNATIONAL, INC. • 1200 E. 151st Street • OLATHE, KS. 66062 USA • TEL. (913) 397-8200 • FAX (913) 397-9079

**TO:** USPTO  
**FAX #:** (703) 872-9306  
**FROM:** Devon A. Rolf, Assistant General Counsel—Intellectual Property  
Garmin International, Inc. (E-mail: devon.rolf@garmin.com)  
**DATE:** August 31, 2005

**FACSIMILE COVER SHEET (Page 1 of 23)**

Re:

Darrin W. Kabel et al.  
Serial No. 10/667,026  
Filed: 9-18-2003

Atty. Dkt. No. 702.254  
Examiner: Stone, Jennifer  
Group Art Unit 2636

**METHODS, SYSTEMS AND DEVICES FOR CARTOGRAPHIC ALERTS**

Attached is a Request for Continued Examination and Preliminary Amendment for filing in connection with the above-referenced application. The Commissioner is hereby authorized to charge any additional fee which is found to be due, or credit any overpayment, to Deposit Account No. 501-791.

The information contained in this facsimile transmission is confidential and intended only for the use of the named addressee. If the reader of this message is not the intended recipient, you are hereby notified that any dissemination, distribution or copying of this communication is strictly prohibited. If you have received this communication in error, please call the sender immediately at (913) 397-8200 and return the original message to us at the above address via mail. You will be reimbursed for the cost of the call and postage. Thank you.

GARMIN INTERNATIONAL, INC.  
1200 East 151<sup>st</sup> Street  
Olathe, Kansas 66062

Applicant(s): Darrin W. Kabel et al.

Attorney Docket No. 702.254

Serial No.: 10/667,026

Group Art Unit: 2636

Filed: 9-18-2003

Examiner: Stone, Jennifer

For: METHODS, SYSTEMS AND DEVICES FOR  
CARTOGRAPHIC ALERTS

Confirmation No. 9123

RECEIVED  
CENTRAL FAX CENTER

AUG 31 2005

Mail Stop Amendment  
Commissioner for Patents  
PO Box 1450  
Alexandria, VA 22313-1450

Transmitted herewith is an amendment in the above-identified application. The fee has been calculated as shown below:

CLAIMS AS AMENDED						
	Currently Filed Claims	Highest Number Previously Paid For	Extra	Rate		Amount
				Large Entity	Small Entity	
Total Number of claims Remaining after Amendment	44	44	0	\$ 50	\$ 25	\$
Independent Claims Remaining after Amendment	6	6	0	200	100	\$
First Presentation of Multiple Dependent Claims				360	180	\$
Extension Fee:	a) One Month			120	60	\$
	b) Two Months			450	225	
	c) Three Months			1,020	510	
	d) Four Months			1,590	795	
	e) Five Months			2,160	1,080	
Request for Continued Examination						\$ 790
<b>TOTAL FEE DUE</b>						\$

- No additional fee is required.
- A check in the amount of \* is attached.
- Charge \$790.00 to Deposit Account No. 501-791. A duplicate of this sheet is enclosed.
- Charge any additional fees or credit any overpayment to Deposit Account No. 501-791. A duplicate of this sheet is enclosed.

A verified statement under 37 C.F.R. §§ 1.9 and 1.27

- is attached.
- is of record in this application.

Respectfully submitted,

GARMIN INTERNATIONAL, INC.

By   
Name: David L. Terrell  
Reg. No. 50.576

Date: 8/31/05

RECEIVED 001  
CENTRAL FAX CENTER  
AUG 31 2005



GARMIN INTERNATIONAL, INC. • 1200 E. 151st Street • OLATHE, KS. 66062 USA • TEL. (913) 397-8200 • FAX (913) 397-9079

**TO:** USPTO  
**FAX #:** (703) 872-9306  
**FROM:** Devon A. Rolf, Assistant General Counsel—Intellectual Property  
Garmin International, Inc. (E-mail: devon.rolf@garmin.com)  
**DATE:** August 31, 2005

**FACSIMILE COVER SHEET (Page 1 of 23)**

Re:

Darrin W. Kabel et al.  
Serial No. 10/667,026  
Filed: 9-18-2003

Atty. Dkt. No. 702.254  
Examiner: Stone, Jennifer  
Group Art Unit 2636

**METHODS, SYSTEMS AND DEVICES FOR CARTOGRAPHIC ALERTS**

Attached is a Request for Continued Examination and Preliminary Amendment for filing in connection with the above-referenced application. The Commissioner is hereby authorized to charge any additional fee which is found to be due, or credit any overpayment, to Deposit Account No. 501-791.

The information contained in this facsimile transmission is confidential and intended only for the use of the named addressee. If the reader of this message is not the intended recipient, you are hereby notified that any dissemination, distribution or copying of this communication is strictly prohibited. If you have received this communication in error, please call the sender immediately at (913) 397-8200 and return the original message to us at the above address via mail. You will be reimbursed for the cost of the call and postage. Thank you.

GARMIN INTERNATIONAL, INC.  
1200 East 151<sup>st</sup> Street  
Olathe, Kansas 66062

Applicant(s): Darrin W. Kabel et al.

Attorney Docket No. 702.254

Serial No.: 10/667,026

Group Art Unit: 2636

Filed: 9-18-2003

Examiner: Stone, Jennifer

For: METHODS, SYSTEMS AND DEVICES FOR  
CARTOGRAPHIC ALERTS

Confirmation No. 9123

RECEIVED  
CENTRAL FAX CENTER

AUG 31 2005

Mail Stop Amendment  
Commissioner for Patents  
PO Box 1450  
Alexandria, VA 22313-1450

Transmitted herewith is an amendment in the above-identified application. The fee has been calculated as shown below:

CLAIMS AS AMENDED						
	Currently Filed Claims	Highest Number Previously Paid For	Extra	Rate		Amount
				Large Entity	Small Entity	
Total Number of claims Remaining after Amendment	44	44	0	\$ 50	\$ 25	\$
Independent Claims Remaining after Amendment	6	6	0	200	100	\$
First Presentation of Multiple Dependent Claims				360	180	\$
Extension Fee:	a) One Month			120	60	\$
	b) Two Months			450	225	
	c) Three Months			1,020	510	
	d) Four Months			1,590	795	
	e) Five Months			2,160	1,080	
Request for Continued Examination						\$ 790
<b>TOTAL FEE DUE</b>						\$

- No additional fee is required.
- A check in the amount of \* is attached.
- Charge \$790.00 to Deposit Account No. 501-791. A duplicate of this sheet is enclosed.
- Charge any additional fees or credit any overpayment to Deposit Account No. 501-791. A duplicate of this sheet is enclosed.

A verified statement under 37 C.F.R. §§ 1.9 and 1.27

- is attached.
- is of record in this application.

Respectfully submitted,

GARMIN INTERNATIONAL, INC.

By   
Name: David L. Terrell  
Reg. No. 50.576

Date: 8/31/05

LEGAL

*Entered with REC of  
8-31-05*

002

*Do NOT enter*

*JAS 8/8/2005*

**IN THE UNITED STATES PATENT AND TRADEMARK OFFICE**

**RECEIVED  
CENTRAL FAX CENTER**

**JUL 12 2005**

Application of:

**KABEL, DARRIN W.**

Attorney Docket No.:  
702.254

Serial No.: 10/667,026

Filed: September 18, 2003

Group Art Unit No. 2838

**METHODS, SYSTEMS AND DEVICES  
FOR CARTOGRAPHIC ALERTS**

Examiner: STONE, Jennifer

CERTIFICATE OF MAILING 37 C.F.R. 1.8
I hereby certify that this correspondence is being sent by facsimile to 703-572-9308 of
<i>7/12/05</i> <i>[Signature]</i>
Date Signature

Mall Stop AF  
Commissioner for Patents  
P.O. Box 1450  
Alexandria, VA 22313-1450

**AMENDMENT**

In response to the Office Action of June 1, 2005, applicant respectfully requests that this amendment be entered in the above-referenced application. Because this Amendment puts the application in a condition for allowance and does not present new issues or require a new search, Applicant respectfully requests that this Amendment be entered after Final Action.

Amendments to the Claims are reflected in the listing of claims which begins on page 2 of this paper.

Remarks begin on page 14 of this paper.

10/667,026

**PATENT APPLICATION FEE DETERMINATION RECORD**  
Effective January 1, 2003

Application or Docket Number

702.254  
10/667026

**CLAIMS AS FILED - PART I**

	(Column 1)	(Column 2)
TOTAL CLAIMS	41	
FOR	NUMBER FILED	NUMBER EXTRA
TOTAL CHARGEABLE CLAIMS	41 minus 20 =	21
INDEPENDENT CLAIMS	5 minus 3 =	2
MULTIPLE DEPENDENT CLAIM PRESENT	<input type="checkbox"/>	

\* If the difference in column 1 is less than zero, enter "0" in column 2

SMALL ENTITY TYPE  OR

OTHER THAN SMALL ENTITY

RATE	FEE	OR	RATE	FEE
BASIC FEE	375.00	OR	BASIC FEE	750.00
X\$ 9=		OR	X\$18=	
X42=		OR	X84=	168
+140=		OR	+280=	
TOTAL		OR	TOTAL	

**CLAIMS AS AMENDED - PART II**

	(Column 1)	(Column 2)	(Column 3)
AMENDMENT A	CLAIMS REMAINING AFTER AMENDMENT	HIGHEST NUMBER PREVIOUSLY PAID FOR	PRESENT EXTRA
Total	44	41	3
Independent	6	5	1
FIRST PRESENTATION OF MULTIPLE DEPENDENT CLAIM	<input type="checkbox"/>		

SMALL ENTITY OR

OTHER THAN SMALL ENTITY

RATE	ADDITIONAL FEE	OR	RATE	ADDITIONAL FEE
X\$ 8=		OR	X\$16=	150
X42=		OR	X84=	200
+140=		OR	+280=	
TOTAL ADDIT. FEE		OR	TOTAL ADDIT. FEE	350

5/4/5

7-12-05

	(Column 1)	(Column 2)	(Column 3)
AMENDMENT B	CLAIMS REMAINING AFTER AMENDMENT	HIGHEST NUMBER PREVIOUSLY PAID FOR	PRESENT EXTRA
Total	44	44	
Independent	6	6	
FIRST PRESENTATION OF MULTIPLE DEPENDENT CLAIM	<input type="checkbox"/>		

SMALL ENTITY OR

OTHER THAN SMALL ENTITY

RATE	ADDITIONAL FEE	OR	RATE	ADDITIONAL FEE
X\$ 8=		OR	X\$16=	
X42=		OR	X84=	
+140=		OR	+280=	
TOTAL ADDIT. FEE		OR	TOTAL ADDIT. FEE	

8-31-05

	(Column 1)	(Column 2)	(Column 3)
AMENDMENT C	CLAIMS REMAINING AFTER AMENDMENT	HIGHEST NUMBER PREVIOUSLY PAID FOR	PRESENT EXTRA
Total	44	44	
Independent	6	6	
FIRST PRESENTATION OF MULTIPLE DEPENDENT CLAIM	<input type="checkbox"/>		

SMALL ENTITY OR

OTHER THAN SMALL ENTITY

RATE	ADDITIONAL FEE	OR	RATE	ADDITIONAL FEE
X\$ 8=		OR	X\$16=	
X42=		OR	X84=	
+140=		OR	+280=	
TOTAL ADDIT. FEE		OR	TOTAL ADDIT. FEE	

\* If the entry in column 1 is less than the entry in column 2, write "0" in column 3.

\*\* If the "Highest Number Previously Paid For" IN THIS SPACE is less than 20, enter "20."

\*\*\* If the "Highest Number Previously Paid For" IN THIS SPACE is less than 3, enter "3."

The "Highest Number Previously Paid For" (Total or Independent) is the highest number found in the appropriate box in column 1.



UNITED STATES PATENT AND TRADEMARK OFFICE

*eh*

UNITED STATES DEPARTMENT OF COMMERCE  
United States Patent and Trademark Office  
Address: COMMISSIONER FOR PATENTS  
P.O. Box 1450  
Alexandria, Virginia 22313-1450  
www.uspto.gov

APPLICATION NO.	FILING DATE	FIRST NAMED INVENTOR	ATTORNEY DOCKET NO.	CONFIRMATION NO.
-----------------	-------------	----------------------	---------------------	------------------

10/667,026	09/18/2003	Darrin W. Kabel	702.254	9123
------------	------------	-----------------	---------	------

7590 08/24/2005  
 Devon A. Rolf  
 GARMIN INTERNATIONAL, INC.  
 1200 East 151st Street  
 Olathe, KS 66062

EXAMINER

STONE, JENNIFER A

ART UNIT	PAPER NUMBER
----------	--------------

2636

DATE MAILED: 08/24/2005

Please find below and/or attached an Office communication concerning this application or proceeding.



<b>Advisory Action Before the Filing of an Appeal Brief</b>	<b>Application No.</b> 10/667,026	<b>Applicant(s)</b> KABEL ET AL.	
	<b>Examiner</b> Jennifer A. Stone	<b>Art Unit</b> 2636	

**--The MAILING DATE of this communication appears on the cover sheet with the correspondence address --**

THE REPLY FILED 12 July 2005 FAILS TO PLACE THIS APPLICATION IN CONDITION FOR ALLOWANCE.

1.  The reply was filed after a final rejection, but prior to or on the same day as filing a Notice of Appeal. To avoid abandonment of this application, applicant must timely file one of the following replies: (1) an amendment, affidavit, or other evidence, which places the application in condition for allowance; (2) a Notice of Appeal (with appeal fee) in compliance with 37 CFR 41.31; or (3) a Request for Continued Examination (RCE) in compliance with 37 CFR 1.114. The reply must be filed within one of the following time periods:

- a)  The period for reply expires \_\_\_\_\_ months from the mailing date of the final rejection.  
b)  The period for reply expires on: (1) the mailing date of this Advisory Action, or (2) the date set forth in the final rejection, whichever is later. In no event, however, will the statutory period for reply expire later than SIX MONTHS from the mailing date of the final rejection.  
Examiner Note: If box 1 is checked, check either box (a) or (b). ONLY CHECK BOX (b) WHEN THE FIRST REPLY WAS FILED WITHIN TWO MONTHS OF THE FINAL REJECTION. See MPEP 706.07(f).

Extensions of time may be obtained under 37 CFR 1.136(a). The date on which the petition under 37 CFR 1.136(a) and the appropriate extension fee have been filed is the date for purposes of determining the period of extension and the corresponding amount of the fee. The appropriate extension fee under 37 CFR 1.17(a) is calculated from: (1) the expiration date of the shortened statutory period for reply originally set in the final Office action; or (2) as set forth in (b) above, if checked. Any reply received by the Office later than three months after the mailing date of the final rejection, even if timely filed, may reduce any earned patent term adjustment. See 37 CFR 1.704(b).

**NOTICE OF APPEAL**

2.  The Notice of Appeal was filed on \_\_\_\_\_. A brief in compliance with 37 CFR 41.37 must be filed within two months of the date of filing the Notice of Appeal (37 CFR 41.37(a)), or any extension thereof (37 CFR 41.37(e)), to avoid dismissal of the appeal. Since a Notice of Appeal has been filed, any reply must be filed within the time period set forth in 37 CFR 41.37(a).

**AMENDMENTS**

3.  The proposed amendment(s) filed after a final rejection, but prior to the date of filing a brief, will not be entered because  
(a)  They raise new issues that would require further consideration and/or search (see NOTE below);  
(b)  They raise the issue of new matter (see NOTE below);  
(c)  They are not deemed to place the application in better form for appeal by materially reducing or simplifying the issues for appeal; and/or  
(d)  They present additional claims without canceling a corresponding number of finally rejected claims.

NOTE: \_\_\_\_\_. (See 37 CFR 1.116 and 41.33(a)).

4.  The amendments are not in compliance with 37 CFR 1.121. See attached Notice of Non-Compliant Amendment (PTOL-324).

5.  Applicant's reply has overcome the following rejection(s): \_\_\_\_\_.

6.  Newly proposed or amended claim(s) \_\_\_\_\_ would be allowable if submitted in a separate, timely filed amendment canceling the non-allowable claim(s).

7.  For purposes of appeal, the proposed amendment(s): a)  will not be entered, or b)  will be entered and an explanation of how the new or amended claims would be rejected is provided below or appended.

The status of the claim(s) is (or will be) as follows:

Claim(s) allowed: \_\_\_\_\_.

Claim(s) objected to: \_\_\_\_\_.

Claim(s) rejected: 1-44.

Claim(s) withdrawn from consideration: \_\_\_\_\_.

**AFFIDAVIT OR OTHER EVIDENCE**

8.  The affidavit or other evidence filed after a final action, but before or on the date of filing a Notice of Appeal will not be entered because applicant failed to provide a showing of good and sufficient reasons why the affidavit or other evidence is necessary and was not earlier presented. See 37 CFR 1.116(e).

9.  The affidavit or other evidence filed after the date of filing a Notice of Appeal, but prior to the date of filing a brief, will not be entered because the affidavit or other evidence failed to overcome all rejections under appeal and/or appellant fails to provide a showing of a good and sufficient reasons why it is necessary and was not earlier presented. See 37 CFR 41.33(d)(1).

10.  The affidavit or other evidence is entered. An explanation of the status of the claims after entry is below or attached.

**REQUEST FOR RECONSIDERATION/OTHER**

11.  The request for reconsideration has been considered but does NOT place the application in condition for allowance because: Mounce discloses receiving one or more preselected conditions from a user. See the rejection of claim 44 in the final rejection.

12.  Note the attached Information Disclosure Statement(s). (PTO/SB/08 or PTO-1449) Paper No(s). \_\_\_\_\_

13.  Other: \_\_\_\_\_.

  
**JEFFERY HOFSSASS**  
**SUPERVISORY PATENT EXAMINER**  
**TECHNOLOGY CENTER 2600**

Do NOT enter.

JAS 8/8/2005

**IN THE UNITED STATES PATENT AND TRADEMARK OFFICE**

**RECEIVED  
CENTRAL FAX CENTER**

JUL 12 2005

Application of: )  
 )  
 KABEL, DARRIN W. )  
 )  
 Serial No.: 10/667,026 )  
 )  
 Filed: September 18, 2003 )  
 )  
 METHODS, SYSTEMS AND DEVICES )  
 FOR CARTOGRAPHIC ALERTS )

Attorney Docket No.:  
702.254

Group Art Unit No. 2636

Examiner: STONE, Jennifer

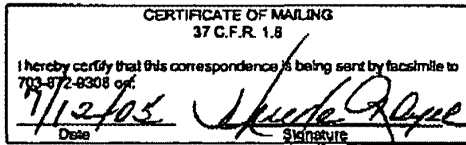

Mail Stop AF  
Commissioner for Patents  
P.O. Box 1450  
Alexandria, VA 22313-1450

**AMENDMENT**

In response to the Office Action of June 1, 2005, applicant respectfully requests that this amendment be entered in the above-referenced application. Because this Amendment puts the application in a condition for allowance and does not present new issues or require a new search, Applicant respectfully requests that this Amendment be entered after Final Action.

Amendments to the Claims are reflected in the listing of claims which begins on page 2 of this paper.

Remarks begin on page 14 of this paper.



RECEIVED  
CENTRAL FAX CENTER

JUL 12 2005

GARMIN INTERNATIONAL, INC. • 1200 E. 151st Street • OLATHE, KS. 66062 USA • TEL (913) 397-8200 • FAX (913) 397-8079

**TO:** USPTO  
**FAX #:** (703) 872-9306  
**FROM:** Devon A. Rolf, Assistant General Counsel—Intellectual Property  
Garmin International, Inc. (E-mail: devon.rolf@garmin.com)  
**DATE:** July 12, 2005

FACSIMILE COVER SHEET (Page 1 of 20)

Re:

Darrin W. Kabel et al.  
Serial No. 10/667,026  
Filed: 9-18-2003

Atty. Dkt. No. 702.254  
Examiner: Stone, Jennifer  
Group Art Unit 2636

METHODS, SYSTEMS AND DEVICES FOR CARTOGRAPHIC ALERTS

Attached is a response to the outstanding Final Office Action dated June 1, 2005 for filing in connection with the above-referenced application. It is believed that no additional fee is due; however, the Commissioner is hereby authorized to charge any additional fee which is found to be due, or credit any overpayment, to Deposit Account No. 501-791.

The information contained in this facsimile transmission is confidential and intended only for the use of the named addressee. If the reader of this message is not the intended recipient, you are hereby notified that any dissemination, distribution or copying of this communication is strictly prohibited. If you have received this communication in error, please call the sender immediately at (913) 397-8200 and return the original message to us at the above address via mail. You will be reimbursed for the cost of the call and postage. Thank you.

**IN THE UNITED STATES PATENT AND TRADEMARK OFFICE**

**RECEIVED  
CENTRAL FAX CENTER**

JUL 12 2005

Application of: )  
 )  
**KABEL, DARRIN W.** )  
 )  
 Serial No.: 10/667,026 )  
 )  
 Filed: September 18, 2003 )  
 )  
**METHODS, SYSTEMS AND DEVICES** )  
**FOR CARTOGRAPHIC ALERTS** )

**Attorney Docket No.:**  
702.254

**Group Art Unit No. 2636**

**Examiner: STONE, Jennifer**

CERTIFICATE OF MAILING 37 C.F.R. 1.8	
I hereby certify that this correspondence is being sent by facsimile to 703-872-9308 of:	
<i>7/12/05</i> Date	<i>[Signature]</i> Signature

Mail Stop AF  
 Commissioner for Patents  
 P.O. Box 1450  
 Alexandria, VA 22313-1450

**AMENDMENT**

In response to the Office Action of June 1, 2005, applicant respectfully requests that this amendment be entered in the above-referenced application. Because this Amendment puts the application in a condition for allowance and does not present new issues or require a new search, Applicant respectfully requests that this Amendment be entered after Final Action.

**Amendments to the Claims** are reflected in the listing of claims which begins on page 2 of this paper.

**Remarks** begin on page 14 of this paper.

Application No. 10/667,026  
Amendment dated July 12, 2005  
Reply to Office Action of June 1, 2005

**Amendments to the Claims:**

This listing of claims will replace all prior versions, and listings, of claims in the application:

**CLAIMS:**

Please amend claims 1, 11, 19, 23, and 34, as follows:

1. (Currently Amended) A method for marine navigation, comprising:  
receiving one or more preselected conditions from a user;  
identifying a potential waypoint; and  
performing a marine route calculation algorithm to analyze a course between a first location and the potential waypoint in view of the preselected conditions.
  
2. (Original) The method of claim 1, wherein performing the marine route calculation algorithm includes analyzing cartographic data that include preselected conditions between the first location and the potential waypoint with a preference for avoiding preselected conditions.

Application No. 10/667,026  
Amendment dated July 12, 2005  
Reply to Office Action of June 1, 2005

3. (Original) The method of claim 2, wherein performing the marine route calculation algorithm further includes re-routing the course to avoid the preselected conditions when the marine route calculation algorithm identifies one or more preselected conditions between the first location and the potential waypoint.
4. (Original) The method of claim 3, wherein re-routing the course calculated further includes identifying one or more non-user waypoints between the first location and the potential waypoint.
5. (Original) The method of claim 2, further including determining the first location on the course based on a signal from a global positioning system (GPS); and analyzing cartographic data for a predetermined area around the first location for preselected conditions.
6. (Original) The method of claim 5, further including providing an alert signal when the analyzed cartographic data for the predetermined area around the first location includes preselected conditions.
7. (Original) The method of claim 2, further including providing an alert signal when the analyzed cartographic data between the first location and the potential waypoint includes preselected conditions.

Application No. 10/667,026  
Amendment dated July 12, 2005  
Reply to Office Action of June 1, 2005

8. (Original) The method of claim 7, wherein providing the alert signal includes emitting an audio alert.
  
9. (Original) The method of claim 7, wherein providing the alert signal includes displaying a visual alert.
  
10. (Original) The method of claim 1, further including receiving preselected conditions selected from the group of land, water depth, rock(s), sandbars, shelves, tide condition, tidal data, wind conditions, weather conditions, ice, above-water obstacles, underwater obstacles, type of water bottom, and prohibited areas.
  
11. (Currently Amended) A method for marine navigation, comprising:
  - receiving one or more preselected conditions from a user;
  - identifying a potential waypoint;
  - analyzing cartographic data between a first location and the potential waypoint for the preselected conditions; and
  - providing an alert signal when cartographic data between the first location and the potential waypoint indicate the preselected conditions.

Application No. 10/667,026  
Amendment dated July 12, 2005  
Reply to Office Action of June 1, 2005

12. (Original) The method of claim 11, wherein performing the marine route calculation algorithm further includes re-routing the course to avoid the preselected conditions when the marine route calculation algorithm identifies one or more preselected conditions between the first location and the potential waypoint.

13. (Original) The method of claim 12, wherein re-routing the course further includes identifying one or more non-user waypoints between the first location and the potential waypoint.

14. (Original) The method of claim 11, further including providing an alert signal when the analyzed cartographic data between the first location and the potential waypoint includes preselected conditions.

15. (Original) The method of claim 11, further including determining the first location on the course based on a signal from a global positioning system (GPS); and analyzing cartographic data for a predetermined area around the first location for preselected conditions.

16. (Original) The method of claim 15, further including providing an alert signal when the analyzed cartographic data for the predetermined area around the first location includes preselected conditions.



Application No. 10/667,026  
Amendment dated July 12, 2005  
Reply to Office Action of June 1, 2005

17. (Original) The method of claim 11, wherein analyzing cartographic data further comprises acquiring cartographic data from a global positioning system (GPS).
18. (Original) The method of claim 11, further including receiving preselected conditions selected from the group of land, water depth, rock(s), sandbars, shelves, tide condition, tidal data, wind conditions, weather conditions, ice, above-water obstacles, underwater obstacles, type of water bottom, and prohibited areas.
19. (Currently Amended) A method for marine navigation, comprising:  
receiving one or more preselected conditions from a user;  
receiving a user defined graphical filter area from the user;  
identifying [[a]] the user defined graphical filter area on a display;  
analyzing cartographic data only within the user defined graphical filter area for the preselected conditions; and  
providing an alert signal when cartographic data within the user defined graphical filter area indicate the preselected conditions.
20. (Original) The method of claim 19, wherein identifying the user defined graphical filter area includes repositioning the user defined graphical filter area.

Application No. 10/667,026  
Amendment dated July 12, 2005  
Reply to Office Action of June 1, 2005

21. (Original) The method of claim 19, wherein analyzing cartographic data further comprises acquiring cartographic data from a global positioning system (GPS).
22. (Original) The method of claim 19, further including receiving preselected conditions selected from the group of land, water depth, rock(s), sandbars, shelves, tide condition, tidal data, wind conditions, weather conditions, ice, above-water obstacles, underwater obstacles, type of water bottom, and prohibited areas.
23. (Currently Amended) A computer readable medium having a set of computer readable instructions, the set of computer readable instructions comprising instructions for:  
receiving one or more preselected conditions from a user;  
identifying a potential waypoint upon a first event; and  
performing a marine route calculation algorithm to analyze a course between a first location and the potential waypoint in view of the preselected conditions.
24. (Original) The computer readable medium of claim 23, wherein performing the marine route calculation algorithm includes analyzing cartographic data between the first location and the potential waypoint to avoid preselected conditions.

Application No. 10/667,026  
Amendment dated July 12, 2005  
Reply to Office Action of June 1, 2005

25. (Original) The computer readable medium of claim 24, wherein performing the marine route calculation algorithm further includes re-routing the course to avoid the preselected conditions when the marine route calculation algorithm identifies one or more preselected conditions between the first location and the potential waypoint.

26. (Original) The computer readable medium of claim 25, wherein re-routing the course further includes identifying one or more non-user waypoints between the first location and the potential waypoint.

27. (Original) The computer readable medium of claim 23, further including determining the first location on the course based on a signal from a global positioning system (GPS); and analyzing cartographic data for a predetermined area around the first location for preselected conditions.

28. (Original) The computer readable medium of claim 27, further including providing an alert signal when the analyzed cartographic data for the predetermined area around the first location includes preselected conditions.

29. (Original) The computer readable medium of claim 23, wherein analyzing cartographic data further comprises acquiring cartographic data from a global positioning system (GPS).

Application No. 10/667,026  
Amendment dated July 12, 2005  
Reply to Office Action of June 1, 2005

30. (Original) The computer readable medium of claim 23, further including providing an alert signal when the analyzed cartographic data between the first location and the potential waypoint includes preselected conditions.
31. (Original) The computer readable medium of claim 30, wherein providing the alert signal includes emitting a signal for an audio alert.
32. (Original) The computer readable medium of claim 30, wherein providing the alert signal includes displaying a visual alert.
33. (Original) The computer readable medium of claim 23, further including receiving preselected conditions selected from the group of land, water depth, rock(s), sandbars, shelves, tide condition, tidal data, wind conditions, weather conditions, ice, above-water obstacles, underwater obstacles, type of water bottom, and prohibited areas.

Application No. 10/657,026  
Amendment dated July 12, 2005  
Reply to Office Action of June 1, 2005

34. (Currently Amended) An electronic marine navigation device, comprising:
- a processor;
  - a user interface operatively coupled to the processor, wherein the user interface receives one or more preselected conditions from a user;
  - a location input operatively coupled to the processor, wherein the location input receives a first location and a potential waypoint separate from the first location; and
  - a memory operatively coupled to the processor and the location input, the memory having cartographic data including data related to the preselected conditions, wherein the processor operates on a marine route calculation algorithm to analyze a course between the first location and the potential waypoint in view of the preselected conditions of the cartographic data.
35. (Original) The electronic marine navigation device of claim 34, wherein the processor operates on the route calculating algorithm to analyze cartographic data to identify and avoid preselected conditions in the course between the first location and the potential waypoint.

Application No. 10/667,028  
Amendment dated July 12, 2005  
Reply to Office Action of June 1, 2005

36. (Original) The electronic marine navigation device of claim 35, wherein the processor operates on the route calculating algorithm to re-route the course to avoid the preselected conditions when the processor operating on the marine route calculation algorithm identifies one or more preselected conditions between the first location and the potential waypoint.

37. (Original) The electronic marine navigation device of claim 36, wherein the processor operates on the route calculating algorithm to identify one or more non-user waypoints between the first location and the potential waypoint.

38. (Original) The electronic marine navigation device of claim 35, further including a receiver for a global positioning system (GPS) operatively coupled to the processor, wherein the processor determines the first location on the course based on a signal received from the GPS, and analyzes cartographic data for a predetermined area around the first location for preselected conditions.

39. (Original) The electronic marine navigation device of claim 38, wherein the processor provides an alert signal when the analyzed cartographic data for the predetermined area around the first location includes preselected conditions.

Application No. 10/667,026  
Amendment dated July 12, 2005  
Reply to Office Action of June 1, 2005

40. (Original) The electronic marine navigation device of claim 35, wherein the processor provides an alert signal when the analyzed cartographic data between the first location and the potential waypoint includes preselected conditions.

41. (Original) The electronic marine navigation device of claim 34, wherein the location input receives a user defined graphical filter area, and wherein the processor operates on the marine route calculation algorithm to analyze cartographic data within the defined graphical filter area for preselected conditions and wherein the processor provides an alert signal when the analyzed cartographic data for the user defined graphical filter area includes preselected conditions.

42. (Previously Presented) The method of claim 1, wherein both the first location and the potential waypoint are independent of a current location of a device implementing the method.

43. (Previously Presented) The method of claim 1, wherein at least a portion of the course is unrelated to a current heading of a device implementing the method.

Application No. 10/667,026  
Amendment dated July 12, 2005  
Reply to Office Action of June 1, 2005

44. (Previously Presented) A method for marine navigation, comprising:
- identifying a potential waypoint; and
  - performing a marine route calculation algorithm to analyze a course between a first location and the potential waypoint in view of preselected conditions received from a user and selected from the group of land, water depth, rock(s), sandbars, shelves, wind conditions, weather conditions, ice, above-water obstacles, underwater obstacles, type of water bottom, and prohibited areas.



Application No. 10/667,026  
Amendment dated July 12, 2005  
Reply to Office Action of June 1, 2005

**REMARKS:****Status Of Claims**

Claims 1-44 were previously pending in the application. Claims 1, 11, 19, 23, and 34 have been amended. Thus, claims 1-44 are currently pending in the application with claims 1, 11, 19, 23, 34, and 44 being independent.

**Office Action**

In the office action, the Examiner rejected claims 1-18 and 23-40 under 35 U.S.C. 102(e) as being anticipated by Michaelson et al., U.S. Patent No. 6,734,808. The Examiner also rejected claims 19-22 under 35 U.S.C. 103(a) as being unpatentable over Horvath et al., U.S. Patent No. 6,473,003. The Examiner also rejected claim 41 under 35 U.S.C. 103(a) as being unpatentable over Michaelson in view of Horvath. The Examiner also rejected claim 42 under 35 U.S.C. 103(a) as being unpatentable over Michaelson in view of Mounce, U.S. Patent No. 4,340,936. The Examiner also rejected claim 43 under 35 U.S.C. 103(a) as being unpatentable over Michaelson in view of Wyant et al., U.S. Patent No. 6,885,919. The Examiner also rejected claim 44 under 35 U.S.C. 102(b) as being anticipated by Mounce. Applicant respectfully submits that the currently pending claims distinguish the present invention from Michaelson, Horvath, Mounce, Wyant, and the other prior art references of record, taken alone or in combination with each other.

Specifically, claims 1, 11, 19, and 23 all now recite "receiving one or more preselected conditions from a user". Similarly, claim 34 recites "a user interface operatively

Application No. 10/667,026  
Amendment dated July 12, 2005  
Reply to Office Action of June 1, 2005

coupled to the processor, wherein the user interface receives one or more preselected conditions from a user". Finally, claim 44 previously recited and currently recites "performing a marine route calculation algorithm to analyze a course between a first location and the potential waypoint in view of *preselected conditions received from a user*", emphasis added. Support for these amendments may be found, among other places, on page 6, lines 9-20:

In addition, memory 330 can further retrievably store cartographic data, including marine craft data and a variety of preselected conditions that are also used in conjunction with the marine route calculation algorithm. Preselected conditions can include user identified parameters, and any values associated with the parameters, that are associated with geographical conditions of particular interest. For example, preselected conditions a user can select include, but are not limited to, indications of land, water depth, rock(s), sandbars, shelves, tide condition, tidal data, wind conditions, weather conditions, ice, above-water obstacles (e.g., bridges), underwater obstacles (e.g., submerged wrecks), type of water bottom, and prohibited areas, to name only a few. The preselected conditions, and their associated values, can be selected and programmed by a user through, for example, controlling one or more input menus on display screen 340 with the location input 320.

Thus, these claims require the user to select the "preselected conditions" to be avoided. Specifically, the present invention analyzes map data looking for a condition to be avoided, preselected by the user.

In contrast, as previously argued, Michaelson and Horvath both analyze map data looking for a depth, or height, that conflicts with the vessel's, or aircraft's, current depth, or altitude, as determined by the device. As pervasively argued, this current depth, or altitude, is dynamic and is simply not *preselected* by the user. Thus, neither Michaelson

Application No. 10/667,026  
Amendment dated July 12, 2005  
Reply to Office Action of June 1, 2005

nor Horvath disclose, suggest, or make obvious "receiving one or more preselected conditions from a user", "a user interface operatively coupled to the processor, wherein the user interface receives one or more preselected conditions from a user", or "performing a marine route calculation algorithm to analyze a course between a first location and the potential waypoint in view of preselected conditions received from a user", as claimed.

While Mounce does disclose a user providing selected information, Mounce simply does not disclose a user providing the preselected conditions, as defined in the specification or used in the claims. Furthermore, Mounce simply does not disclose the other limitations of claim 44. For example, Mounce simply does not calculate a route, as defined in the specification and used in the claims. Rather, as disclosed in column 3, lines 38-56:

The microprocessor system calculates such values as actual wind direction and speed, actual boat direction and speed over the bottom, relative wind direction on the port side, or on the starboard side, leeway angle, course and distance to or from a destination mark, or course and distance from an origin at the beginning of the course being traversed by the boat, etc.

It is another very important object of the invention to provide a system capable of making calculations at a high rate from the raw data being collected as measured parameters from the sensors because the raw data is all interrelated and continuously varying, so that manually made calculations would provide only very incomplete and sparse data. The rapidity of the calculations and the high repetition rate permit effective integrating of the values to provide much more accurate information as to the progress and ultimate position of the boat with respect to an origin point or with respect to a destination mark.

Application No. 10/667,026  
Amendment dated July 12, 2005  
Reply to Office Action of June 1, 2005

Specifically, Mounces' "course" is simply a heading or vector to the destination. Such a simple heading is hardly a route, as defined in the present specification. In fact, Mounce' only use of the term route, in column 10, lines 46-50, relates to 'routing' information from a RAM to a display. In any case, no route or course of Mounce is ever analyzed "in view of preselected conditions received from a user", as claimed in claim 19. Thus, Mounce does not disclose, suggest, or make obvious "performing a marine route calculation algorithm to analyze a course between a first location and the potential waypoint in view of preselected conditions received from a user", much less the other limitations of claim 44.

As claim 44 previously included this limitation, these amendments do not present new issues or require a new search. Thus, applicant requests that this amendment be entered after Final Action.

Claim 19 further recites "receiving a user defined graphical filter area from the user" and "analyzing cartographic data only within the user defined graphical filter area for the preselected conditions". Support for this amendment may be found, among other places, on page 8, lines 11-25:

The marine route calculation algorithm can also be used to analyze cartographic data within a user defined graphical filter area (shown as 478 in Figure 4E). In one embodiment, the user defined graphical filter area includes a geographical area defined by a user on the display screen 340. Examples of defining the user defined graphical filter area on the display screen 340 include, but are not limited to, use of the input devices 216 or the display screen 340 itself. For example, a user could draw the user defined graphical filter area using a cursor shown on the display screen 340. The user defined graphical filter area can include an area smaller than the display screen 340.

Application No. 10/667,026  
Amendment dated July 12, 2005  
Reply to Office Action of June 1, 2005

The user defined graphical filter area can also include any number of shapes, including, but not limited to, square, rectangular, triangular, or circular. Other shapes for the user defined graphical filter area are also possible. The user defined graphical filter area can further be positioned and/or repositioned over any number of locations on the display screen 340.

In one embodiment, a displayed cursor under the control of one or more of the input devices 216 can be used to position and/or reposition the user defined graphical filter area over any number of locations on the display screen 340.

As stated on page 9, lines 5-13:

In one example, the dynamic analysis of cartographic data, including the marine craft data, within the defined graphical filter area for preselected conditions allows for a user to be aware of preselected conditions that may be located within the area, but not necessarily at the first location and/or along the course which the device is traveling. In an additional embodiment, analyzing the cartographic data within the defined graphical filter area can be available regardless of whether a calculated course is being used or not.

In other words, a user need not have a destination point, one or more waypoints (e.g., a potential, or other waypoint) and/or a calculated a course to have the cartographic data analyzed within the defined graphical filter area.

Thus, claim 19 also requires the user to define an area to which the analysis will be limited.

In contrast, as previously argued, neither Michaelson nor Horvath disclose the user to defining an area to which analysis is limited. As previously argued, Horvath's range indicator is just that, a circle showing a fixed range from an aircraft. While the circle is useful for showing the aircraft's relation to objects, and for general situational awareness, the area within Horvath's circle is simply not analyzed for anything or even defined in any useful way. For example, as stated in column 7, lines 27-29, "a range ring can be overlaid

Application No. 10/667,026  
Amendment dated July 12, 2005  
Reply to Office Action of June 1, 2005

on a weather, terrain, statutory map, traffic, or other display of a condition near the aircraft".

Thus, Horvath simply discloses an overlay which defines, at most, a linear relationship rather than an area. As a result, Horvath does not disclose, suggest, or make obvious "receiving a user defined graphical filter area from the user" or "analyzing cartographic data only within the user defined graphical filter area for the preselected conditions", as claimed in claim 19.

The remaining claims all depend directly or indirectly from independent claims 1, 11, 19, 23, and 34, and are therefore also allowable.

Any additional fee which is due in connection with this amendment should be applied against our Deposit Account No. 501-791. In view of the foregoing, a Notice of Allowance appears to be in order and such is courteously solicited.

Respectfully submitted,

By: 

David L. Terrell, Reg. No. 50,576  
Garmin International, Inc.  
1200 East 151<sup>st</sup> Street  
Olathe, KS 66062  
(913) 397-8200  
(913) 397-9079 (Fax)

001  
**RECEIVED**  
CENTRAL FAX CENTER  
JUL 12 2005



GARMIN INTERNATIONAL, INC. • 1200 E. 151st Street • OLATHE, KS. 66062 USA • TEL. (913) 397-8200 • FAX (913) 397-9079

**TO:** USPTO  
**FAX #:** (703) 872-9306  
**FROM:** Devon A. Rolf, Assistant General Counsel—Intellectual Property  
Garmin International, Inc. (E-mail: devon.rolf@garmin.com)  
**DATE:** July 12, 2005

**FACSIMILE COVER SHEET (Page 1 of 20)**

Re:

Darrin W. Kabel et al.  
Serial No. 10/667,026  
Filed: 9-18-2003

Atty. Dkt. No. 702.254  
Examiner: Stone, Jennifer  
Group Art Unit 2636

**METHODS, SYSTEMS AND DEVICES FOR CARTOGRAPHIC ALERTS**

Attached is a response to the outstanding Final Office Action dated June 1, 2005 for filing in connection with the above-referenced application. It is believed that no additional fee is due; however, the Commissioner is hereby authorized to charge any additional fee which is found to be due, or credit any overpayment, to Deposit Account No. 501-791.

**BEST AVAILABLE COPY**

The information contained in this facsimile transmission is confidential and intended only for the use of the named addressee. If the reader of this message is not the intended recipient, you are hereby notified that any dissemination, distribution or copying of this communication is strictly prohibited.

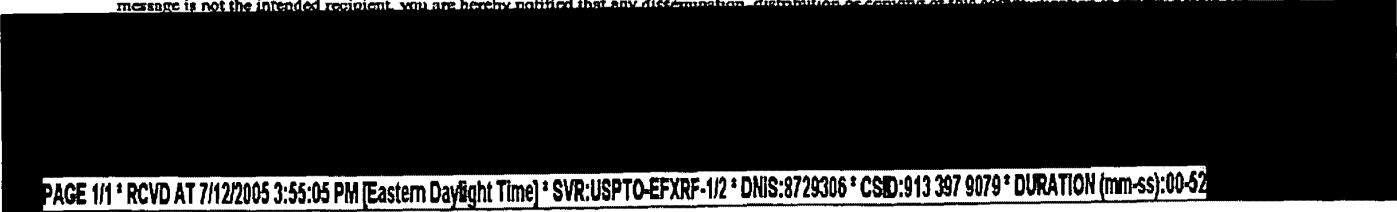

PAGE 1/1 \* RCVD AT 7/12/2005 3:55:05 PM [Eastern Daylight Time] \* SVR:USPTO-EFAX-1/2 \* DNIS:8729306 \* CSID:913 397 9079 \* DURATION (mm-ss):00-52

10/667,026

**PATENT APPLICATION FEE DETERMINATION RECORD**  
Effective January 1, 2003

Application or Docket Number

702.254  
10/667026

**CLAIMS AS FILED - PART I**

	(Column 1)	(Column 2)
TOTAL CLAIMS	41	
FOR	NUMBER FILED	NUMBER EXTRA
TOTAL CHARGEABLE CLAIMS	41 minus 20 =	21
INDEPENDENT CLAIMS	5 minus 3 =	2
MULTIPLE DEPENDENT CLAIM PRESENT	<input type="checkbox"/>	

\* If the difference in column 1 is less than zero, enter "0" in column 2

**SMALL ENTITY TYPE**  OR

**OTHER THAN SMALL ENTITY**

RATE	FEE	OR	RATE	FEE
BASIC FEE	375.00	OR	BASIC FEE	750.00
X\$ 9=		OR	X\$18=	
X42=		OR	X84=	168
+140=		OR	+280=	
TOTAL		OR	TOTAL	

**CLAIMS AS AMENDED - PART II**

5/4/5

	(Column 1)	(Column 2)	(Column 3)
AMENDMENT A	CLAIMS REMAINING AFTER AMENDMENT	HIGHEST NUMBER PREVIOUSLY PAID FOR	PRESENT EXTRA
Total	44	41	3
Independent	6	5	1
FIRST PRESENTATION OF MULTIPLE DEPENDENT CLAIM	<input type="checkbox"/>		

**SMALL ENTITY** OR

**OTHER THAN SMALL ENTITY**

RATE	ADDITIONAL FEE	OR	RATE	ADDITIONAL FEE
X\$ 9=		OR	X\$18=	150
X42=		OR	X84=	200
+140=		OR	+280=	
TOTAL ADDIT. FEE		OR	TOTAL ADDIT. FEE	350

7-12-05

	(Column 1)	(Column 2)	(Column 3)
AMENDMENT B	CLAIMS REMAINING AFTER AMENDMENT	HIGHEST NUMBER PREVIOUSLY PAID FOR	PRESENT EXTRA
Total	44	44	0
Independent	6	6	0
FIRST PRESENTATION OF MULTIPLE DEPENDENT CLAIM	<input type="checkbox"/>		

**SMALL ENTITY** OR

**OTHER THAN SMALL ENTITY**

RATE	ADDITIONAL FEE	OR	RATE	ADDITIONAL FEE
X\$ 9=		OR	X\$18=	
X42=		OR	X84=	
+140=		OR	+280=	
TOTAL ADDIT. FEE		OR	TOTAL ADDIT. FEE	

	(Column 1)	(Column 2)	(Column 3)
AMENDMENT C	CLAIMS REMAINING AFTER AMENDMENT	HIGHEST NUMBER PREVIOUSLY PAID FOR	PRESENT EXTRA
Total			
Independent			
FIRST PRESENTATION OF MULTIPLE DEPENDENT CLAIM	<input type="checkbox"/>		

**SMALL ENTITY** OR

**OTHER THAN SMALL ENTITY**

RATE	ADDITIONAL FEE	OR	RATE	ADDITIONAL FEE
X\$ 9=		OR	X\$18=	
X42=		OR	X84=	
+140=		OR	+280=	
TOTAL ADDIT. FEE		OR	TOTAL ADDIT. FEE	

• If the entry in column 1 is less than the entry in column 2, write "0" in column 3.  
 • If the "Highest Number Previously Paid For" IN THIS SPACE is less than 20, enter "20."  
 • If the "Highest Number Previously Paid For" IN THIS SPACE is less than 3, enter "3."  
 The "Highest Number Previously Paid For" (Total or Independent) is the highest number found in the appropriate box in column 1.





UNITED STATES PATENT AND TRADEMARK OFFICE

*Edn*

UNITED STATES DEPARTMENT OF COMMERCE  
United States Patent and Trademark Office  
Address: COMMISSIONER FOR PATENTS  
P.O. Box 1450  
Alexandria, Virginia 22313-1450  
www.uspto.gov

APPLICATION NO.	FILING DATE	FIRST NAMED INVENTOR	ATTORNEY DOCKET NO.	CONFIRMATION NO.
10/667,026	09/18/2003	Darrin W. Kabel	702.254	9123

7590                      06/01/2005  
 Devon A. Rolf  
 GARMIN INTERNATIONAL, INC.  
 1200 East 151st Street  
 Olathe, KS 66062

EXAMINER

STONE, JENNIFER A

ART UNIT	PAPER NUMBER
2636	

2636

DATE MAILED: 06/01/2005

Please find below and/or attached an Office communication concerning this application or proceeding.

<b>Office Action Summary</b>	<b>Application No.</b> 10/667,026	<b>Applicant(s)</b> KABEL ET AL.	
	<b>Examiner</b> Jennifer A. Stone	<b>Art Unit</b> 2636	

-- The MAILING DATE of this communication appears on the cover sheet with the correspondence address --  
**Period for Reply**

A SHORTENED STATUTORY PERIOD FOR REPLY IS SET TO EXPIRE 3 MONTH(S) FROM THE MAILING DATE OF THIS COMMUNICATION.

- Extensions of time may be available under the provisions of 37 CFR 1.136(a). In no event, however, may a reply be timely filed after SIX (6) MONTHS from the mailing date of this communication.
- If the period for reply specified above is less than thirty (30) days, a reply within the statutory minimum of thirty (30) days will be considered timely.
- If NO period for reply is specified above, the maximum statutory period will apply and will expire SIX (6) MONTHS from the mailing date of this communication.
- Failure to reply within the set or extended period for reply will, by statute, cause the application to become ABANDONED (35 U.S.C. § 133). Any reply received by the Office later than three months after the mailing date of this communication, even if timely filed, may reduce any earned patent term adjustment. See 37 CFR 1.704(b).

**Status**

- 1)  Responsive to communication(s) filed on 04 May 2005.
- 2a)  This action is FINAL.                      2b)  This action is non-final.
- 3)  Since this application is in condition for allowance except for formal matters, prosecution as to the merits is closed in accordance with the practice under *Ex parte Quayle*, 1935 C.D. 11, 453 O.G. 213.

**Disposition of Claims**

- 4)  Claim(s) \_\_\_\_\_ is/are pending in the application.  
4a) Of the above claim(s) \_\_\_\_\_ is/are withdrawn from consideration.
- 5)  Claim(s) \_\_\_\_\_ is/are allowed.
- 6)  Claim(s) 1-44 is/are rejected.
- 7)  Claim(s) \_\_\_\_\_ is/are objected to.
- 8)  Claim(s) \_\_\_\_\_ are subject to restriction and/or election requirement.

**Application Papers**

- 9)  The specification is objected to by the Examiner.
- 10)  The drawing(s) filed on 18 September 2003 is/are: a)  accepted or b)  objected to by the Examiner.  
Applicant may not request that any objection to the drawing(s) be held in abeyance. See 37 CFR 1.85(a).  
Replacement drawing sheet(s) including the correction is required if the drawing(s) is objected to. See 37 CFR 1.121(d).
- 11)  The oath or declaration is objected to by the Examiner. Note the attached Office Action or form PTO-152.

**Priority under 35 U.S.C. § 119**

- 12)  Acknowledgment is made of a claim for foreign priority under 35 U.S.C. § 119(a)-(d) or (f).  
a)  All    b)  Some \*    c)  None of:  
1.  Certified copies of the priority documents have been received.  
2.  Certified copies of the priority documents have been received in Application No. \_\_\_\_\_  
3.  Copies of the certified copies of the priority documents have been received in this National Stage application from the International Bureau (PCT Rule 17.2(a)).  
\* See the attached detailed Office action for a list of the certified copies not received.

**Attachment(s)**

- 1)  Notice of References Cited (PTO-892)
- 2)  Notice of Draftsperson's Patent Drawing Review (PTO-948)
- 3)  Information Disclosure Statement(s) (PTO-1449 or PTO/SB/08)  
Paper No(s)/Mail Date \_\_\_\_\_
- 4)  Interview Summary (PTO-413)  
Paper No(s)/Mail Date. \_\_\_\_\_
- 5)  Notice of Informal Patent Application (PTO-152)
- 6)  Other: \_\_\_\_\_

***Claim Rejections - 35 USC § 102***

1. The following is a quotation of the appropriate paragraphs of 35 U.S.C. 102 that form the basis for the rejections under this section made in this Office action:

A person shall be entitled to a patent unless –

(e) the invention was described in (1) an application for patent, published under section 122(b), by another filed in the United States before the invention by the applicant for patent or (2) a patent granted on an application for patent by another filed in the United States before the invention by the applicant for patent, except that an international application filed under the treaty defined in section 351(a) shall have the effects for purposes of this subsection of an application filed in the United States only if the international application designated the United States and was published under Article 21(2) of such treaty in the English language.

2: Claims 1-10 are rejected under 35 U.S.C. 102(e) as being anticipated by Michaelson et al. (US 6,734,808).

For claim 1, Michaelson discloses a method for marine navigation, comprising (col 2, Ins 11-14 and 35-38): identifying a potential waypoint (Fig. 28, points A-F; col 23, Ins 30-32 and 39-41); and performing a marine route calculation algorithm to analyze a course between a first location and the potential waypoint in view of preselected conditions (col 23, Ins 64-67; col 24, Ins 33-45 and 62-66).

For claim 2, Michaelson discloses performing the marine route calculation algorithm to include analyzing cartographic data that include preselected conditions between the first location and the potential waypoint with a preference for avoiding preselected conditions (col 24, Ins 37-45).

For claim 3, the marine route calculation algorithm further includes re-routing the course to avoid the preselected conditions when the marine route calculation algorithm identifies one or more preselected conditions between the first location and the potential waypoint (col 24, Ins 25-37 and 55-61).

For claim 4, re-routing the course calculated further includes identifying one or more non-user waypoints (determined by the system, not the user) between the first location and the potential waypoint (col 24, Ins 41-50 and 55-64).

For claim 5, Michaelson determines a first location on the course based on a signal from a GPS; and analyzing cartographic data for a predetermined area around the first location for preselected conditions (col 7, Ins 50-65; col 8, Ins 11-21 and 46-51).

For claim 6, an alert signal is provided when the analyzed cartographic data for the predetermined area around the first location includes preselected conditions (col 2, Ins 11-14; col 6, Ins 13-17).

For claim 7, an alert signal is provided when the analyzed cartographic data for the predetermined data between the first location and the potential waypoint includes preselected conditions (col 6, Ins 13-26).

For claim 8, the alert signal includes emitting an audio alert (col 6, Ins 15-18; Fig. 2, item 28).

For claim 9, Michaelson discloses providing the alert signal to include displaying a visual alert.

For claim 10, Michaelson discloses receiving preselected conditions selected from the group of land, water depth, rock(s), sandbars, shelves, tide condition, tidal data, wind conditions, weather conditions, ice, above-water obstacles, underwater obstacles, type of water bottom, and prohibited areas (col 2, lns 41-43; col 8, lns 28-36 and 40-52).

3. Claims 11-18 are rejected under 35 U.S.C. 102(e) as being anticipated by Michaelson et al. (US 6,734,808).

For claim 11, the claim is interpreted and rejected for the same reasons as stated in the rejection of claims 1 and 6 as stated above.

For claim 12, the claim is interpreted and rejected for the same reasons as stated in the rejection of claim 3 as stated above.

For claim 13, the claim is interpreted and rejected for the same reasons as stated in the rejection of claim 4 as stated above.

For claim 14, the claim is interpreted and rejected for the same reasons as stated in the rejection of claim 7 as stated above.

For claim 15, the claim is interpreted and rejected for the same reasons as stated in the rejection of claim 5 as stated above.

For claim 16, the claim is interpreted and rejected for the same reasons as stated in the rejection of claim 6 as stated above.

For claim 17, Michaelson discloses analyzing cartographic data further comprises acquiring cartographic data from a GPS (col 7, lns 54-56).

For claim 18, the claim is interpreted and rejected for the same reasons as stated in the rejection of claim 10 as stated above.

4. Claims 23-33 are rejected under 35 U.S.C. 102(e) as being anticipated by Michaelson et al. (US 6,734,808).

For claim 23, Michaelson discloses a computer readable medium having a set of computer readable instructions (col 11, Ins 38-41), the set of computer readable instructions comprising instructions for: identifying a potential waypoint upon a first event (col 23, Ins 30-41); and performing a marine route calculation algorithm to analyze a course between a first location and the potential waypoint in view of preselected conditions (col 27, Ins 11-20).

For claim 24, the claim is interpreted and rejected for the same reasons as stated in the rejection of claim 2 as stated above.

For claim 25, the claim is interpreted and rejected for the same reasons as stated in the rejection of claim 3 as stated above.

For claim 26, the claim is interpreted and rejected for the same reasons as stated in the rejection of claim 4 as stated above.

For claim 27, the claim is interpreted and rejected for the same reasons as stated in the rejection of claim 5 as stated above.

For claim 28, the claim is interpreted and rejected for the same reasons as stated in the rejection of claim 6 as stated above.

For claim 29, the claim is interpreted and rejected for the same reasons as stated in the rejection of claim 17 as stated above.

For claim 30, the claim is interpreted and rejected for the same reasons as stated in the rejection of claim 7 as stated above.

For claim 31, the claim is interpreted and rejected for the same reasons as stated in the rejection of claim 8 as stated above.

For claim 32, the claim is interpreted and rejected for the same reasons as stated in the rejection of claim 9 as stated above.

For claim 33, the claim is interpreted and rejected for the same reasons as stated in the rejection of claim 10 as stated above.

5. Claims 34-40 are rejected under 35 U.S.C. 102(e) as being anticipated by Michaelson et al. (US 6,734,808).

For claim 34, Michaelson discloses an electronic marine navigation device, comprising: a processor (col 2, lns 41-44; Fig. 40, item 486); a location input operatively coupled to the processor (col 5, lns 12-15; Fig. 40, item 24), wherein the location input receives a first location and a potential waypoint separate from the first location (col 23, lns 30-32 and 39-41; Fig. 28); and a memory operatively coupled to the processor and the location input (col 31, lns 18-24; Fig. 40, item 4760), the memory having cartographic data including preselected conditions (Fig. 40, 4800; col 31, lns 48-51), wherein the processor operates on a marine route calculation algorithm to analyze a course between the first location and the potential waypoint in view of preselected conditions of the cartographic data (col 23, lns 30-41).

For claim 35, the claim is interpreted and rejected for the same reasons as stated in the rejection of claims 2 and 34 as stated above.

For claim 36, the claim is interpreted and rejected for the same reasons as stated in the rejection of claims 3 and 34 as stated above.

For claim 37, the claim is interpreted and rejected for the same reasons as stated in the rejection of claims 4 and 34 as stated above.

For claim 38, Michaelson discloses a receiver for a GPS (Fig. 2, GPS, 14; Fig. 40, item 24) operatively coupled to the processor, wherein the processor determines the first location on the course based on a signal received from the GPS (col 7, Ins 50-56), and analyzes cartographic data for a predetermined area around the first location for preselected conditions (col 5, Ins 9-15).

For claim 39, the claim is interpreted and rejected for the same reasons as stated in the rejection of claims 6 and 34 as stated above.

For claim 40, the claim is interpreted and rejected for the same reasons as stated in the rejection of claims 7 and 34 as stated above.

A person shall be entitled to a patent unless –

(b) the invention was patented or described in a printed publication in this or a foreign country or in public use or on sale in this country, more than one year prior to the date of application for patent in the United States.

6. Claim 44 is rejected under 35 U.S.C. 102(b) as being anticipated by Mounce (US 4,340,936).

Mounce discloses a method for marine navigation, comprising: identifying a potential waypoint (col 3, Ins 38-43 and 51-56); and performing a marine route calculation algorithm to analyze a course between a first location and the potential waypoint in view of preselected conditions received from a user and selected from the group of land, water depth, rock(s), sandbars, shelves, tide condition, wind conditions, weather conditions, ice, above-water obstacles, underwater obstacles, type of water bottom, and prohibited areas (col 3, Ins 2-6 and 10-12; col 4, Ins 9-20; Fig. 1, items 1-5).



***Claim Rejections - 35 USC § 103***

7. The following is a quotation of 35 U.S.C. 103(a) which forms the basis for all obviousness rejections set forth in this Office action:

(a) A patent may not be obtained though the invention is not identically disclosed or described as set forth in section 102 of this title, if the differences between the subject matter sought to be patented and the prior art are such that the subject matter as a whole would have been obvious at the time the invention was made to a person having ordinary skill in the art to which said subject matter pertains. Patentability shall not be negated by the manner in which the invention was made.

8. Claims 19-22 are rejected under 35 U.S.C. 103(a) as being unpatentable over Horvath et al. (US 6,473,003).

For claim 19, Horvath discloses identifying a user defined graphical filter area on a display; analyzing cartographic data within the user defined graphical filter area for preselected conditions; and providing an alert signal when cartographic data within the user defined graphical filter area indicate preselected conditions. Even though Horvath's primary application is aircraft navigation, it would have been obvious one of ordinary skill in the art, at the time the invention was made to apply the disclosure of Horvath to a marine navigation system so that a user has a certain degree of control over the display in order to customize it according to the user's preferences. In addition, the graphical filter area is applied to one or more display maps, such as weather, terrain, and traffic. All of the aforementioned maps are also applied to marine navigation (col 7, Ins 26-31).

For claim 20, identifying the user defined graphical filter area includes repositioning the user defined graphical filter area (col 2, Ins 26-37).

For claim 21, Horvath includes analyzing cartographic data further comprises acquiring cartographic data from a GPS (col 4, Ins 54-56; Fig. 7, item 110, 123-125).

For claim 22, Horvath discloses receiving preselected conditions selected from the group of land, water depth, rock(s), sandbars, shelves, tide condition, tidal data, wind conditions, weather conditions, ice, above-water obstacles, underwater obstacles, type of water bottom, and prohibited areas (col 4, Ins 60-63; col 7, Ins 26-31; Fig. 7, items 124, 125).

9. Claim 41 is rejected under 35 U.S.C. 103(a) as being unpatentable over Michaelson et al. (US 6,734,808), as applied to claim 34, and further in view of Horvath et al. (US 6,473,003).

Michaelson discloses a processor to operate on the marine route calculation algorithm to analyze cartographic data, wherein the processor provides an alert signal when the analyzed cartographic data includes preselected conditions; however, Michaelson does not disclose a user defined graphical filter area. Horvath, on the other hand, does disclose a user defined graphical filter area (col 1, Ins 10-14; col 2, Ins 30, 31, 44-48) wherein a processor operates to analyze cartographic data and provides an alert signal when the analyzed cartographic data for the user defined graphical filter area includes preselected conditions (col 2, Ins 60-63; Fig. 4, 30i). Even though Horvath's primary application is aircraft navigation, it would have been obvious to apply a user defined graphical filter area to a marine navigation system so that a

user has a certain degree of control over the display in order to customize it according to the user's preferences.

10. Claim 42 is rejected under 35 U.S.C. 103(a) as being unpatentable over Michaelson et al. (US 6,734,808), as applied to claim 1, and further in view of Mounce (US 4,340,936).

Michaelson does not disclose a first location and a potential waypoint independent of a current location; however, Mounce discloses this feature (col 7 lns 36-42). Mounce is only concerned with parameters between a point of origin and a waypoint. It would have been obvious to disregard a current location between a first location and a potential waypoint and place a higher priority on parameters such as distance to waypoint and current drift in order to predict a course.

11. Claim 43 is rejected under 35 U.S.C. 103(a) as being unpatentable over Michaelson et al. (US 6,734,808), as applied to claim 1, and further in view of Wyant et al. (US 6,885,919).

Michaelson includes a course related to current heading; however, Wyant discloses a portion of a course for marine navigation that is unrelated to a current heading of a device implementing (col 1, lns 4-14; col 4, lns 36-50) the method. After a route is planned (Fig. 1), the system will re-route the vessel according to the following parameters depicted in Fig. 2, items 21, 22, and 24, which are unrelated to a current heading of the vessel. It would have been obvious for a portion of the course to be unrelated to a current heading, and related to other

parameters, such as fuel level, so that a sufficient amount of fuel is available to reach a destination thereby ensuring the safety of the vessel and its passengers.

***Response to Remarks***

12. Applicant's arguments filed May 4, 2005 have been fully considered but they are not persuasive.

The Applicant argues as follows:

a. Michaelson does not disclose waypoints in view of pre-selected conditions.

b. Horvath fails to disclose a user-defined graphical filter area for pre-selected conditions.

a. A waypoint is defined as a point between major points on a route, as along a track. Michaelson, therefore, discloses multiple waypoints (col 4, Ins 1 and 2; Fig. 28, items A-F). In addition, Michaelson discloses a system that analyzes a course between a first location and the potential waypoint in view of pre-selected conditions (col 23, Ins 30-44). The pre-selected conditions are hazardous terrain or obstructions (col 25, Ins 21-34). Furthermore, pre-selected conditions of independent claims 1, 11, 23, and 34 are not limited to user-defined conditions, therefore, Michaelson discloses the computer/machine defined pre-selected conditions (col 6, Ins 27-35).

b. The graphical filter area disclosed by Horvath is considered to be user-defined because the user can choose between two modes: a set scale distance mode and a fixed distance mode. In addition, the pre-selected

conditions consist of selected targets within a user-defined boundary (col 7, Ins 3-7).

### ***Conclusion***

13. **THIS ACTION IS MADE FINAL.** Applicant is reminded of the extension of time policy as set forth in 37 CFR 1.136(a).

A shortened statutory period for reply to this final action is set to expire **THREE MONTHS** from the mailing date of this action. In the event a first reply is filed within **TWO MONTHS** of the mailing date of this final action and the advisory action is not mailed until after the end of the **THREE-MONTH** shortened statutory period, then the shortened statutory period will expire on the date the advisory action is mailed, and any extension fee pursuant to 37 CFR 1.136(a) will be calculated from the mailing date of the advisory action. In no event, however, will the statutory period for reply expire later than **SIX MONTHS** from the mailing date of this final action.

14. Any inquiry concerning this communication or earlier communications from the examiner should be directed to Jennifer A Stone whose telephone number is (571) 272.2976. The examiner can normally be reached on M-F from 8:00am to 4:30pm.

If attempts to reach the examiner by telephone are unsuccessful, the examiner's supervisor, Jeffrey Hofsass, can be reached at (571) 272.2981. The fax phone number for the organization where this application or proceeding is assigned is 703-872-9306.

Information regarding the status of an application may be obtained from the Patent Application Information Retrieval (PAIR) system. Status information for published applications may be obtained from either Private PAIR or Public PAIR. Status information for unpublished applications is available through Private PAIR only. For more information about the PAIR system, see <http://pair-direct.uspto.gov>. Should you have questions on access to the Private PAIR system, contact the Electronic Business Center (EBC) at 866-217-9197 (toll-free).

Jennifer Stone  
January 5, 2004

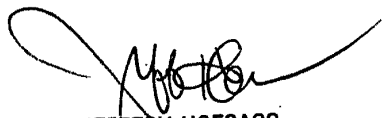

JEFFERY HOFSSASS  
SUPERVISORY PATENT EXAMINER  
TECHNOLOGY CENTER 2600

<b>Notice of References Cited</b>	Application/Control No. 10/667,026	Applicant(s)/Patent Under Reexamination KABEL ET AL.	
	Examiner Jennifer A. Stone	Art Unit 2636	Page 1 of 1

**U.S. PATENT DOCUMENTS**

*	Document Number Country Code-Number-Kind Code	Date MM-YYYY	Name	Classification
A	US-4,340,936	07-1982	Mounce, George R.	701/200
B	US-6,885,919	04-2005	Wyant et al.	701/21
C	US-			
D	US-			
E	US-			
F	US-			
G	US-			
H	US-			
I	US-			
J	US-			
K	US-			
L	US-			
M	US-			

**FOREIGN PATENT DOCUMENTS**

*	Document Number Country Code-Number-Kind Code	Date MM-YYYY	Country	Name	Classification
N					
O					
P					
Q					
R					
S					
T					

**NON-PATENT DOCUMENTS**

*	Include as applicable: Author, Title Date, Publisher, Edition or Volume, Pertinent Pages)
U	
V	
W	
X	

\*A copy of this reference is not being furnished with this Office action. (See MPEP § 707.05(a).)  
Dates in MM-YYYY format are publication dates. Classifications may be US or foreign.

**Index of Claims**



Application No.

10/667,026

Applicant(s)

KABEL ET AL.

Examiner

Jennifer A Stone

Art Unit

2636

✓	Rej cted
≡	Allowed

-	(Through num ral) Canc lled
+	Restricted

N	Non-Elected
I	Interference

A	Appeal
O	Objected

Claim	Date
Final	
Original	
1	
2	
3	
4	
5	
6	
7	
8	
9	
10	
11	
12	
13	
14	
15	
16	
17	
18	
19	
20	
21	
22	
23	
24	
25	
26	
27	
28	
29	
30	
31	
32	
33	
34	
35	
36	
37	
38	
39	
40	
41	
42	
43	
44	
45	
46	
47	
48	
49	
50	

Claim	Date
Final	
Original	
51	
52	
53	
54	
55	
56	
57	
58	
59	
60	
61	
62	
63	
64	
65	
66	
67	
68	
69	
70	
71	
72	
73	
74	
75	
76	
77	
78	
79	
80	
81	
82	
83	
84	
85	
86	
87	
88	
89	
90	
91	
92	
93	
94	
95	
96	
97	
98	
99	
100	

Claim	Date
Final	
Original	
101	
102	
103	
104	
105	
106	
107	
108	
109	
110	
111	
112	
113	
114	
115	
116	
117	
118	
119	
120	
121	
122	
123	
124	
125	
126	
127	
128	
129	
130	
131	
132	
133	
134	
135	
136	
137	
138	
139	
140	
141	
142	
143	
144	
145	
146	
147	
148	
149	
150	



**Search Notes**



Application No.

10/667,026

Examiner

Jennifer A Stone

Applicant(s)

KABEL ET AL.

Art Unit

2636

**SEARCHED**

Class	Subclass	Date	Examiner
340	686.6 995.1 984 985 851 539.13	12/28/2005	JS
340	539.2 961	12/28/2005	JS
340	539.22	12/28/2005	JS
340	7.56	12/28/2005	JS
340	825.36	12/28/2005	JS
340	995.11	12/28/2005	JS
367	909	12/28/2005	JS
342	357.13 41	12/28/2005	JS
701	21 201	12/28/2005	JS
701	301	12/28/2005	JS

**INTERFERENCE SEARCHED**

Class	Subclass	Date	Examiner

**SEARCH NOTES  
(INCLUDING SEARCH STRATEGY)**

	DATE	EXMR
Brent Swartout	1/5/2005	JS
East Search	12/28/2004	JS
Brent Swartout	5/24/2005	JS
Updated Search	5/20/2005	JS

*H*



RECEIVED  
CENTRAL FAX CENTER  
MAY 04 2005

GARMIN INTERNATIONAL, INC. • 1200 E. 151st Street • OLATHE, KS. 66062 USA • TEL. (913) 397-8200 • FAX (913) 397-9079

TO: USPTO  
FAX #: (703) 872-9306  
FROM: Devon A. Rolf, Assistant General Counsel—Intellectual Property  
Garmin International, Inc. (E-mail: devon.rolf@garmin.com)  
DATE: May 4, 2005

FACSIMILE COVER SHEET (Page 1 of 26)

Re:

Darrin W. Kabel et al.  
Serial No. 10/667,026  
Filed: 9-18-2003

Atty. Dkt. No. 702.254  
Examiner: Stone, Jennifer  
Group Art Unit 2636

METHODS, SYSTEMS AND DEVICES FOR CARTOGRAPHIC ALERTS

Attached is a response to the outstanding Office Action dated January 12, 2005 along with a request for a one month extension of time for filing in connection with the above-referenced application. The Commissioner is hereby authorized to charge any fee which may be due, or credit any overpayment, to Deposit Account No. 501-791.

RECEIVED  
MAY -5 2005  
OIRE/JCWS

The information contained in this facsimile transmission is confidential and intended only for the use of the named addressee. If the reader of this message is not the intended recipient, you are hereby notified that any dissemination, distribution or copying of this communication is strictly prohibited. If you have received this communication in error, please call the sender immediately at (913) 397-8200 and return the original message to us at the above address via mail. You will be reimbursed for the cost of the call and postage. Thank you.

GARMIN INTERNATIONAL, INC.  
 1200 East 151<sup>st</sup> Street  
 Olathe, Kansas 66062

**RECEIVED  
 CENTRAL FAX CENTER**

MAY 04 2005

Applicant(s): Darrin W. Kabel et al.

Attorney Docket No. 702.254

Serial No.: 10/667,026

Group Art Unit: 2636

Filed: September 18, 2003

Examiner: Stone, Jennifer

METHODS, SYSTEMS AND DEVICES FOR  
 CARTOGRAPHIC ALERTS

Confirmation No. 9123

Mail Stop Amendment  
 Commissioner for Patents  
 PO Box 1450  
 Alexandria, VA 22313-1450

Transmitted herewith is an amendment in the above-identified application. The fee has been calculated as shown below:

CLAIMS AS AMENDED						
	Currently Filed Claims	Highest Number Previously Paid For	Extra	Rate		Amount
				Large Entity	Small Entity	
Total Number of claims Remaining after Amendment	44	41	3	\$ 50	\$ 25	\$ 150
Independent Claims Remaining after Amendment	6	5	1	200	100	\$ 200
First Presentation of Multiple Dependent Claims				360	180	\$
Extension Fee:	a) One Month			120	60	\$ 120
	b) Two Months			450	225	
	c) Three Months			1,020	510	
	d) Four Months			1,590	795	
	e) Five Months			2,160	1,080	
<b>TOTAL FEE DUE</b>						<b>\$ 470</b>

- No additional fee is required.
- A check in the amount of \* is attached.
- Charge \$470 to Deposit Account No. 501-791.
- Charge any additional fees or credit any overpayment to Deposit Account No. 501-791.

A verified statement under 37 C.F.R. §§ 1.9 and 1.27

- is attached.
- is of record in this application.

Respectfully submitted,

GARMIN INTERNATIONAL, INC.

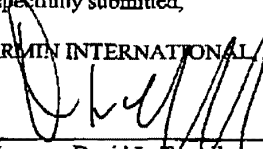

By   
 Name: David L. Carroll  
 Reg. No. 50,576

Date: 5/4/05

RECEIVED  
CENTRAL FAX CENTER  
MAY 04 2005

IN THE UNITED STATES PATENT AND TRADEMARK OFFICE

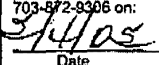
Application of:	)	
KABEL, DARRIN W.	)	Attorney Docket No.:
Serial No.: 10/667,026	)	702.254
Filed: September 18, 2003	)	Group Art Unit No. 2636
METHODS, SYSTEMS AND DEVICES FOR CARTOGRAPHIC ALERTS	)	Examiner: STONE, Jennifer

CERTIFICATE OF MAILING 37 C.F.R. 1.8	
I hereby certify that this correspondence is being sent by facsimile to 703-872-9306 on:	
 Date	 Signature

Mail Stop Amendment  
Commissioner for Patents  
P.O. Box 1450  
Alexandria, VA 22313-1450

AMENDMENT

In response to the Office Action of January 12, 2005, applicant respectfully requests that this amendment be entered in the above-referenced application. A request for a one-month extension of time accompanies this amendment.

**Amendments to the Claims** are reflected in the listing of claims which begins on page 2 of this paper.

**Remarks** begin on page 13 of this paper.

05/06/2005 EFLORES 00000070 501791 10667026

01 FC:1201	200.00 DA
02 FC:1202	150.00 DA

Application No. 10/667,026  
Amendment dated May 3, 2005  
Reply to Office Action of January 12, 2005

**Amendments to the Claims:**

This listing of claims will replace all prior versions, and listings, of claims in the application:

**CLAIMS:**

1. (Original) A method for marine navigation, comprising:  
identifying a potential waypoint; and  
performing a marine route calculation algorithm to analyze a course between a first location and the potential waypoint in view of preselected conditions.
2. (Original) The method of claim 1, wherein performing the marine route calculation algorithm includes analyzing cartographic data that include preselected conditions between the first location and the potential waypoint with a preference for avoiding preselected conditions.
3. (Original) The method of claim 2, wherein performing the marine route calculation algorithm further includes re-routing the course to avoid the preselected conditions when the marine route calculation algorithm identifies one or more preselected conditions between the first location and the potential waypoint.

2.

Application No. 10/667,026  
Amendment dated May 3, 2005  
Reply to Office Action of January 12, 2005

4. (Original) The method of claim 3, wherein re-routing the course calculated further includes identifying one or more non-user waypoints between the first location and the potential waypoint.
  
5. (Original) The method of claim 2, further including determining the first location on the course based on a signal from a global positioning system (GPS); and analyzing cartographic data for a predetermined area around the first location for preselected conditions.
  
6. (Original) The method of claim 5, further including providing an alert signal when the analyzed cartographic data for the predetermined area around the first location includes preselected conditions.
  
7. (Original) The method of claim 2, further including providing an alert signal when the analyzed cartographic data between the first location and the potential waypoint includes preselected conditions.
  
8. (Original) The method of claim 7, wherein providing the alert signal includes emitting an audio alert.

Application No. 10/657,026  
Amendment dated May 3, 2005  
Reply to Office Action of January 12, 2005

9. (Original) The method of claim 7, wherein providing the alert signal includes displaying a visual alert.

10. (Original) The method of claim 1, further including receiving preselected conditions selected from the group of land, water depth, rock(s), sandbars, shelves, tide condition, tidal data, wind conditions, weather conditions, ice, above-water obstacles, underwater obstacles, type of water bottom, and prohibited areas.

11. (Original) A method for marine navigation, comprising:  
identifying a potential waypoint;  
analyzing cartographic data between a first location and the potential waypoint for preselected conditions; and  
providing an alert signal when cartographic data between the first location and the potential waypoint indicate preselected conditions.

12. (Original) The method of claim 11, wherein performing the marine route calculation algorithm further includes re-routing the course to avoid the preselected conditions when the marine route calculation algorithm identifies one or more preselected conditions between the first location and the potential waypoint.

Application No. 10/667,026  
Amendment dated May 3, 2005  
Reply to Office Action of January 12, 2005

13. (Original) The method of claim 12, wherein re-routing the course further includes identifying one or more non-user waypoints between the first location and the potential waypoint.
14. (Original) The method of claim 11, further including providing an alert signal when the analyzed cartographic data between the first location and the potential waypoint includes preselected conditions.
15. (Original) The method of claim 11, further including determining the first location on the course based on a signal from a global positioning system (GPS); and analyzing cartographic data for a predetermined area around the first location for preselected conditions.
16. (Original) The method of claim 15, further including providing an alert signal when the analyzed cartographic data for the predetermined area around the first location includes preselected conditions.
17. (Original) The method of claim 11, wherein analyzing cartographic data further comprises acquiring cartographic data from a global positioning system (GPS).



Application No. 10/667,026  
Amendment dated May 3, 2005  
Reply to Office Action of January 12, 2005

18. (Original) The method of claim 11, further including receiving preselected conditions selected from the group of land, water depth, rock(s), sandbars, shelves, tide condition, tidal data, wind conditions, weather conditions, ice, above-water obstacles, underwater obstacles, type of water bottom, and prohibited areas.

19. (Original) A method for marine navigation, comprising:  
identifying a user defined graphical filter area on a display;  
analyzing cartographic data within the user defined graphical filter area for preselected conditions; and  
providing an alert signal when cartographic data within the user defined graphical filter area indicate preselected conditions.

20. (Original) The method of claim 19, wherein identifying the user defined graphical filter area includes repositioning the user defined graphical filter area.

21. (Original) The method of claim 19, wherein analyzing cartographic data further comprises acquiring cartographic data from a global positioning system (GPS).

Application No. 10/667,026  
Amendment dated May 3, 2005  
Reply to Office Action of January 12, 2005

22. (Original) The method of claim 19, further including receiving preselected conditions selected from the group of land, water depth, rock(s), sandbars, shelves, tide condition, tidal data, wind conditions, weather conditions, ice, above-water obstacles, underwater obstacles, type of water bottom, and prohibited areas.
23. (Original) A computer readable medium having a set of computer readable instructions, the set of computer readable instructions comprising instructions for:
- identifying a potential waypoint upon a first event; and
  - performing a marine route calculation algorithm to analyze a course between a first location and the potential waypoint in view of preselected conditions.
24. (Original) The computer readable medium of claim 23, wherein performing the marine route calculation algorithm includes analyzing cartographic data between the first location and the potential waypoint to avoid preselected conditions.
25. (Original) The computer readable medium of claim 24, wherein performing the marine route calculation algorithm further includes re-routing the course to avoid the preselected conditions when the marine route calculation algorithm identifies one or more preselected conditions between the first location and the potential waypoint.

Application No. 10/667,026  
Amendment dated May 3, 2005  
Reply to Office Action of January 12, 2005

26. (Original) The computer readable medium of claim 25, wherein re-routing the course further includes identifying one or more non-user waypoints between the first location and the potential waypoint.
27. (Original) The computer readable medium of claim 23, further including determining the first location on the course based on a signal from a global positioning system (GPS); and  
analyzing cartographic data for a predetermined area around the first location for preselected conditions.
28. (Original) The computer readable medium of claim 27, further including providing an alert signal when the analyzed cartographic data for the predetermined area around the first location includes preselected conditions.
29. (Original) The computer readable medium of claim 23, wherein analyzing cartographic data further comprises acquiring cartographic data from a global positioning system (GPS).
30. (Original) The computer readable medium of claim 23, further including providing an alert signal when the analyzed cartographic data between the first location and the potential waypoint includes preselected conditions.

Application No. 10/667,026  
Amendment dated May 3, 2005  
Reply to Office Action of January 12, 2005

31. (Original) The computer readable medium of claim 30, wherein providing the alert signal includes emitting a signal for an audio alert.
32. (Original) The computer readable medium of claim 30, wherein providing the alert signal includes displaying a visual alert.
33. (Original) The computer readable medium of claim 23, further including receiving preselected conditions selected from the group of land, water depth, rock(s), sandbars, shelves, tide condition, tidal data, wind conditions, weather conditions, ice, above-water obstacles, underwater obstacles, type of water bottom, and prohibited areas.
34. (Original) An electronic marine navigation device, comprising:  
a processor;  
a location input operatively coupled to the processor, wherein the location input receives a first location and a potential waypoint separate from the first location; and  
a memory operatively coupled to the processor and the location input, the memory having cartographic data including preselected conditions, wherein the processor operates on a marine route calculation algorithm to analyze a course between the first location and the potential waypoint in view of preselected conditions of the cartographic data.

Application No. 10/667,026  
Amendment dated May 3, 2005  
Reply to Office Action of January 12, 2005

35. (Original) The electronic marine navigation device of claim 34, wherein the processor operates on the route calculating algorithm to analyze cartographic data to identify and avoid preselected conditions in the course between the first location and the potential waypoint.

36. (Original) The electronic marine navigation device of claim 35, wherein the processor operates on the route calculating algorithm to re-route the course to avoid the preselected conditions when the processor operating on the marine route calculation algorithm identifies one or more preselected conditions between the first location and the potential waypoint.

37. (Original) The electronic marine navigation device of claim 36, wherein the processor operates on the route calculating algorithm to identify one or more non-user waypoints between the first location and the potential waypoint.

38. (Original) The electronic marine navigation device of claim 35, further including a receiver for a global positioning system (GPS) operatively coupled to the processor, wherein the processor determines the first location on the course based on a signal received from the GPS, and analyzes cartographic data for a predetermined area around the first location for preselected conditions.

Application No. 10/667,026  
Amendment dated May 3, 2005  
Reply to Office Action of January 12, 2005

39. (Original) The electronic marine navigation device of claim 38, wherein the processor provides an alert signal when the analyzed cartographic data for the predetermined area around the first location includes preselected conditions.

40. (Original) The electronic marine navigation device of claim 35, wherein the processor provides an alert signal when the analyzed cartographic data between the first location and the potential waypoint includes preselected conditions.

41. (Original) The electronic marine navigation device of claim 34, wherein the location input receives a user defined graphical filter area, and wherein the processor operates on the marine route calculation algorithm to analyze cartographic data within the defined graphical filter area for preselected conditions and wherein the processor provides an alert signal when the analyzed cartographic data for the user defined graphical filter area includes preselected conditions.

Application No. 10/667,026  
Amendment dated May 3, 2005  
Reply to Office Action of January 12, 2005

Please add claims 42-44, as follows:

42. (New) The method of claim 1, wherein both the first location and the potential waypoint are independent of a current location of a device implementing the method.
43. (New) The method of claim 1, wherein at least a portion of the course is unrelated to a current heading of a device implementing the method.
44. (New) A method for marine navigation, comprising:  
identifying a potential waypoint; and  
performing a marine route calculation algorithm to analyze a course between a first location and the potential waypoint in view of preselected conditions received from a user and selected from the group of land, water depth, rock(s), sandbars, shelves, wind conditions, weather conditions, ice, above-water obstacles, underwater obstacles, type of water bottom, and prohibited areas.

Application No. 10/667,026  
Amendment dated May 3, 2005  
Reply to Office Action of January 12, 2005

**REMARKS:**

**Status Of Claims**

Claims 1-41 were previously pending in the application. Claims 42-44 has been added. Thus, claims 1-44 are currently pending in the application with claims 1, 11, 19, 23, 34, and 44 being independent.

**Office Action**

In the office action, the Examiner rejected claims 1-18 and 23-40 under 35 U.S.C. 102(e) as being anticipated by Michaelson et al., U.S. Patent No. 6,734,808. The Examiner also rejected claims 19-22 under 35 U.S.C. 103(a) as being unpatentable over Horvath et al., U.S. Patent No. 6,473,003. The Examiner also rejected claim 41 under 35 U.S.C. 103(a) as being unpatentable over Michaelson in view of Horvath. Applicant respectfully submits that the currently pending claims distinguish the present invention from Michaelson, Horvath, and the other prior art references of record, taken alone or in combination with each other.

Specifically, claim 1 recites "analyze a course between a first location and the *potential waypoint* in view of preselected conditions", emphasis added.

As stated on page 7, lines 1-4:

Embodiments of the present invention also allow for a course to be analyzed between the first location and one or more waypoints, where cartographic data, including marine craft data, for the area between the first location and the waypoints can be analyzed to determine whether preselected conditions are present along the course.



Application No. 10/667,026  
Amendment dated May 3, 2005  
Reply to Office Action of January 12, 2005

As stated on page 7, lines 18-24:

In addition, the processor 310 further operates on the marine route calculation algorithm to analyze a course between the first location and the potential waypoint in view of preselected conditions of the cartographic data, including the marine craft data. So, for example, the processor 310 can operate on the route calculating algorithm to analyze the cartographic data, including the marine craft data, to identify and avoid preselected conditions in the course being calculated between the first location and the potential waypoint.

As stated on page 8, lines 4-10:

In a situation where the processor 310 operating on the marine route calculation algorithm identifies one or more preselected conditions in analyzing the course, the processor 310 operates on the route calculating algorithm to re-route the course to avoid the preselected conditions. In one embodiment, in routing and/or re-routing the course to avoid the preselected conditions, the processor operates on the route calculating algorithm to identify one or more non-user waypoints between the first location and the potential waypoint.

As shown in figures 4A and 4B, and stated on page 12, line 18, through page 13,  
line 4:

Figure 4A illustrates course 404 between a first location 410 and a potential waypoint 414 that passes through land 416. In the present embodiment, the first location 410 is shown as a first waypoint that has been selected by a user. As described herein, land can be classified as a preselected condition. As such, course 404 has been highlighted to indicate that at least one preselected condition has been identified in the analysis of course 404. Highlighting in the instant case is provided by a bolding of the line representative course 404 in a region 418. At this point, the device can calculate one or more possible courses around the preselected condition.

Figure 4B provides map display 400 having course 403 recalculated to avoid the one or more preselected conditions (e.g., avoid the land in region 418 of the previous course 404). Recalculating of course 403 relative to the original calculation of course 404 shown in Figure 4A provides the recalculated course 403 with one or more additional waypoints, shown as

Application No. 10/667,026  
Amendment dated May 3, 2005  
Reply to Office Action of January 12, 2005

420. The additional waypoints 420 have been included to allow the course 403 to avoid the preselected conditions. The waypoints 420, in the present situation, are non-user waypoints. In other words, waypoints 420 were determined by the system, and not the user. Embodiments however are not so limited. In an additional embodiment, the user can indicate waypoints to be used and/or alter waypoints that are provided by the system.

Therefore, the above discussed portions of the instant application make it clear that the waypoints, between which a course is analyzed, are not simply projections along a vessel's present heading. For example, as shown in figure 4A, if it is assumed that the vessel is heading toward waypoint 410, along course 404, then the portion of course 404 between waypoints 410 and 414 is clearly not a projection along the vessel's present heading. It is at least that portion of course 404, between waypoints 410 and 414, that is being analyzed for the preselected conditions. Furthermore, neither of waypoints 410 or 414 are necessarily even related to the vessel's current location. Thus, the waypoints of the present invention are simply not defined by a vessel's present heading or current location.

In contrast, Michaelson's invention is strictly limited to analyzing a "look ahead distance". Specifically, Michaelson determines a vessel's current location and present heading, or a direction the vessel is travelling. Then, Michaelson looks for bottom hazards from the vessel's current location extending for specified look ahead distances along the vessel's present heading. Therefore, Michaelson's warning system is limited to projections from the vessel's current location along the vessel's present heading. There is simply no disclosure of waypoints, as defined in the present specification and used in the currently

Application No. 10/667,026  
Amendment dated May 3, 2005  
Reply to Office Action of January 12, 2005

pending claims. As Michaelson fails to disclose waypoints, as defined in the present specification and used in the currently pending claims, Michaelson fails to disclose "analyze a course between a first location and the *potential waypoint* in view of preselected conditions", as claimed in claim 1.

Claim 10 defines the preselected conditions as being "selected from the group of land, water depth, rock(s), sandbars, shelves, tide condition, tidal data, wind conditions, weather conditions, ice, above-water obstacles, underwater obstacles, type of water bottom, and prohibited areas".

As stated on page 6 of the present specification, lines 11-20:

Preselected conditions can include user identified parameters, and any values associated with the parameters, that are associated with geographical conditions of particular interest. For example, preselected conditions a user can select include, but are not limited to, indications of land, water depth, rock(s), sandbars, shelves, tide condition, tidal data, wind conditions, weather conditions, ice, above-water obstacles (e.g., bridges), underwater obstacles (e.g., submerged wrecks), type of water bottom, and prohibited areas, to name only a few. The preselected conditions, and their associated values, can be selected and programmed by a user through, for example, controlling one or more input menus on display screen 340 with the location input 320.

Thus, the method of the present invention, as claimed in claims 1 and 10, analyzes a course for one or more preselected conditions, such as conditions to be avoided like "land, water depth, rock(s), sandbars, shelves, tide condition, tidal data, wind conditions, weather conditions, ice, above-water obstacles, underwater obstacles, type of water bottom, and prohibited areas".

Application No. 10/667,026  
Amendment dated May 3, 2005  
Reply to Office Action of January 12, 2005

By way of example, suppose a user intends to use the present invention on a small and light fiberglass canoe. In this case, the user may be primarily concerned with rocks, having the ability to portage their boat over land, but not wanting to risk impact with the rocks. The user would pre-select rocks, thereby configuring the present invention to calculate a route avoiding any rocks.

By way of another example, suppose a user intends to use the present invention on a large ocean going ship. In this case, the user may simply select a water depth greater than the ship's draft, thereby avoiding any possible grounding problems. It is important to note that, as claimed in claims 1 and 10, these conditions must be "preselected".

In contrast, Michaelson's system must dynamically determine his conditions to be avoided. Specifically, as Michaelson discloses in column 8, lines 48-49, "the present invention addresses hazards related to submerged vessels", such as submarines. Simply put, in Michaelson, the water depth that presents a hazard changes dynamically with the submarine's current depth, and therefore cannot be "preselected", as claimed in the present claims.

For example, as stated in Michaelson, column 8, lines 23-28:

Navigation system 14 also stores data or retrieves input from other shipboard systems as needed to compute the maximum bull depth. In the case of a submerged submarine, this parameter can be computed or obtained directly from on board pressure instrumentation such as a fathometer designed to measure depth below the surface.

Since submarines can be at virtually any depth, and therefore need to avoid

Application No. 10/667,026  
Amendment dated May 3, 2005  
Reply to Office Action of January 12, 2005

obstacles conflicting with a dynamic depth, Michaelson's system must avoid dynamic depths rather than "preselected" depths. In fact, throughout his disclosure, Michaelson teaches generating alerts and course deviations based on dynamic, rather than "preselected", conditions. As a result, Michaelson simply does not disclose, suggest, or make obvious "analyze a course between a first location and the potential waypoint in view of preselected conditions selected from the group of land, water depth, rock(s), sandbars, shelves, tide condition, tidal data, wind conditions, weather conditions, ice, above-water obstacles, underwater obstacles, type of water bottom, and prohibited areas", as claimed in claim 1, much less "receiving the preselected conditions from a user", as claimed in claim 10.

Similarly, claims 11, 19, 23, and 34 are all limited to "preselected conditions". As discussed above, Michaelson fails to disclose waypoints and seeks to avoid dynamic, rather than "preselected", conditions, and therefore does not disclose, suggest, or make obvious the limitations of claims 11, 19, 23, or 34.

Furthermore, Horvath fails to disclose waypoints, as defined in the present specification and used in the currently pending claims. Horvath is likewise concerned with dynamic conditions, rather than the "preselected conditions" claimed in claim 19. Rather than Michaelson's submarine, Horvath is concerned with terrain avoidance for aircraft. However, just like a submarine can be at virtually any depth, an aircraft can be at virtually any altitude. Therefore, both Michaelson and Horvath teach of warning against possible impact with obstacles based on a dynamic height above those obstacles and not on any

Application No. 10/667,026  
Amendment dated May 3, 2005  
Reply to Office Action of January 12, 2005

"preselected condition".

Finally, Horvath also fails to disclose the graphical filter area, as described in the present specification and claimed in claims 19-22 and 41. Specifically, claim 19 recites "analyzing cartographic data within the user defined graphical filter area for preselected conditions".

As stated on page 8, lines 11-25:

The marine route calculation algorithm can also be used to analyze cartographic data within a user defined graphical filter area (shown as 478 in Figure 4E). In one embodiment, the user defined graphical filter area includes a geographical area defined by a user on the display screen 340. Examples of defining the user defined graphical filter area on the display screen 340 include, but are not limited to, use of the input devices 216 or the display screen 340 itself. For example, a user could draw the user defined graphical filter area using a cursor shown on the display screen 340. The user defined graphical filter area can include an area smaller than the display screen 340.

The user defined graphical filter area can also include any number of shapes, including, but not limited to, square, rectangular, triangular, or circular. Other shapes for the user defined graphical filter area are also possible. The user defined graphical filter area can further be positioned and/or repositioned over any number of locations on the display screen 340. In one embodiment, a displayed cursor under the control of one or more of the input devices 216 can be used to position and/or reposition the user defined graphical filter area over any number of locations on the display screen 340.

As stated on page 9, lines 5-13:

In one example, the dynamic analysis of cartographic data, including the marine craft data, within the defined graphical filter area for preselected conditions allows for a user to be aware of preselected conditions that may be located within the area, but not necessarily at the first location and/or along the course which the device is traveling. In an additional embodiment, analyzing the cartographic data within the defined graphical filter area can be available regardless of whether a calculated course is being used or not.

Application No. 10/667,026  
Amendment dated May 3, 2005  
Reply to Office Action of January 12, 2005

In other words, a user need not have a destination point, one or more waypoints (e.g., a potential, or other waypoint) and/or a calculated a course to have the cartographic data analyzed within the defined graphical filter area.

Thus, the term graphical filter area, as used in the present specification and the claims, refers to a user defined *area* that is analyzed for the "preselected conditions", instead of or in addition to a potential path of the vessel.

In contrast, Horvath discloses no such functionality. As discussed above, Horvath does not disclose "preselected conditions". In addition, Horvath does not disclose functionality analogous to the graphical filter area of the present invention. The Examiner mistakenly points to Horvath's range indicator as showing this functionality. However, Horvath's range indicator is just that, a circle showing a fixed range from an aircraft. While the circle is useful for showing the aircraft's relation to objects, and for general situational awareness, the area within Horvath's circle is simply not analyzed for anything or even defined in any useful way. For example, as stated in column 7, lines 27-29, "a range ring can be overlaid on a weather, terrain, statutory map, traffic, or other display of a condition near the aircraft". Thus, Horvath simply discloses an overlay which defines, at most, a linear relationship rather than an area. Furthermore, neither that linear relationship nor any area associated with Horvath's range indicator is analyzed. As a result, Horvath does not disclose, suggest, or make obvious "analyzing cartographic data within the user defined graphical filter area for preselected conditions", as claimed in claim 19.

Application No. 10/667,026  
Amendment dated May 3, 2005  
Reply to Office Action of January 12, 2005

Obviousness, it will be appreciated, can be a problematic basis for rejection because the Examiner, in deciding that a feature is obvious, has benefit of the Applicant's disclosure as a blueprint and guide, whereas one with ordinary skill in the art would have no such guide, in which light even an exceedingly complex solution may seem easy or obvious. Furthermore, once an obviousness rejection has been made, the Applicant is in the exceedingly difficult position of having to prove a negative proposition (i.e., non-obviousness) in order to overcome the rejection. For these reasons, MPEP § 2142 places upon the Examiner the initial burden of establishing a *prima facie* case which requires, among other things, that there be identified some motivation or suggestion in the prior art or in the knowledge of one with ordinary skill to modify the reference or to combine reference teachings. If the Examiner fails to establish the requisite *prima facie* case, the rejection is improper and will be overturned. *In re Rijckaert*, 28 USPQ2d 1955, 1956 (Fed. Cir. 1993). Only if the Examiner's burden is met does the burden shift to the applicant to provide evidence to refute the rejection.

Specifically, the Examiner must satisfy three criteria in order to establish the requisite *prima facie* case of obviousness: (1) there must be some suggestion or motivation, either in the references themselves or in the knowledge generally available to one of ordinary skill in the art, to modify the reference or combine their teachings; (2) there must be a reasonable expectation of success; and (3) the prior art reference (or combination of references) must teach or suggest all the claim limitations. MPEP §706.02(j), citing *In re Vaeck*, 20 USPQ2d 1438 (Fed. Cir. 1991).



Application No. 10/667,026  
Amendment dated May 3, 2005  
Reply to Office Action of January 12, 2005

In meeting this initial burden, the Examiner "cannot use hindsight reconstruction to pick and choose among isolated disclosures in the prior art to deprecate the claimed invention". *In re Fine*, 5 USPQ 2d 1596,1600 (Fed. Cir. 1988). The teaching or suggestion to make the claimed combination and the reasonable expectation of success must both be found in the prior art and not based on the applicant's disclosure. *In re Vaeck*, 1442 (Fed. Cir. 1991). Thus, measuring a claimed invention against the standard established by section 103 requires the oft-difficult but critical step of casting the mind back to the time of invention, to consider the thinking of one of ordinary skill in the art, guided only by the prior art references and the then-accepted wisdom in the field. See e.g., *W. L. Gore & Assoc., Inc. v. Garlock, Inc.*, 220 USPQ 303, 313 (Fed. Cir. 1983).

Furthermore, "[t]he mere fact that the prior art may be modified in the manner suggested by the Examiner does not make the modification obvious unless the prior art suggested the desirability of the modification." *In re Fritch*, 23 USPQ2d 1780, 1783-84 (Fed. Cir. 1992); see also *In re Gordon*, 221 USPQ 1125, 1127 (Fed. Cir. 1984). Additionally, "the mere possibility that one [element] could be modified or replaced ... does not make the [claim] obvious 'unless the prior art suggested the desirability of [such a] modification' or replacement". *In re Brouwer*, 37 USPQ2d 1663 (Fed. Cir. 1995) (citing *In re Gordon*).

In the present case, the prior art references made of record do not teach or suggest each of the claimed limitations. For example, as discussed above, neither Michaelson nor Horvath disclose waypoints or the "preselected conditions" of the present claims.

Application No. 10/567,026  
Amendment dated May 3, 2005  
Reply to Office Action of January 12, 2005

Furthermore, Horvath fails to disclose "analyzing cartographic data within the user defined graphical filter area for preselected conditions", as claimed in claim 19. As a result, the present obviousness rejections simply cannot be sustained.

Claims 42-44 have been added to further distinguish the present invention over the prior art. The remaining claims all depend directly or indirectly from independent claims 1, 11, 19, 23, and 34, and are therefore also allowable.

Any additional fee which is due in connection with this amendment should be applied against our Deposit Account No. 501-791. In view of the foregoing, a Notice of Allowance appears to be in order and such is courteously solicited.

Respectfully submitted,

By:

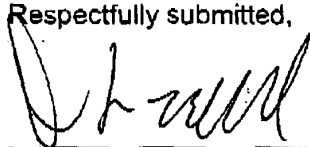

David L. Terrell, Reg. No. 50,576  
Garmin International, Inc.  
1200 East 151<sup>st</sup> Street  
Olathe, KS 66062  
(913) 397-8200  
(913) 397-9079 (Fax)

RECEIVED  
CENTRAL FAX CENTER

003

MAY 04 2005

PATENT

IN THE UNITED STATES PATENT AND TRADEMARK OFFICE

Applicant(s): Darrin W. Kabel et al.	)	Attorney Docket No. 702.254
	)	
Serial No. 10/667,026	)	Examiner: Stone, Jennifer
	)	
Filed: September 18, 2003	)	
	)	Art Unit: 2636
METHODS, SYSTEMS AND DEVICES	)	
FOR CARTOGRAPHIC ALERTS	)	

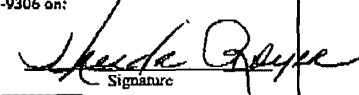
CERTIFICATE OF MAILING 37 C.F.R. 1.8	
I hereby certify that this correspondence is being sent by facsimile to 703-872-9306 on:	
<i>5/4/05</i> Date	 Signature

**PETITION FOR EXTENSION OF TIME**

Commissioner for Patents  
P.O. Box 1450  
Alexandria, VA 22313-1450

Sir:

It is hereby requested that the time period for responding to the outstanding Office Action be extended for one month or until May 12, 2005.

The Commissioner is hereby authorized to charge the Petition fee in the amount of \$120, and any additional fees that are required, or credit any overpayment, to Deposit Account No. 501-791.

Respectfully submitted,

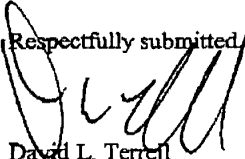
  
 David L. Terrell  
 Reg. No. 50,576

05/06/2005 EFLORES 00000069 501791 10667026  
01 FC:1251 120.00 DA

Garmin International, Inc.  
1200 East 151<sup>st</sup> Street  
Olathe, KS 66062  
(913) 397-8200  
(913) 397-9079 - Fax

**PATENT APPLICATION FEE DETERMINATION RECORD**  
Effective January 1, 2003

Application or Docket Number

10/702.254  
10/667026

**CLAIMS AS FILED - PART I**

	(Column 1)	(Column 2)
TOTAL CLAIMS	41	
FOR	NUMBER FILED	NUMBER EXTRA
TOTAL CHARGEABLE CLAIMS	41 minus 20 = *	21
INDEPENDENT CLAIMS	5 minus 3 = *	2
MULTIPLE DEPENDENT CLAIM PRESENT <input type="checkbox"/>		

\* If the difference in column 1 is less than zero, enter "0" in column 2

**SMALL ENTITY TYPE**  OR

**OTHER THAN SMALL ENTITY**

RATE	FEE	OR	RATE	FEE
BASIC FEE	375.00		BASIC FEE	750.00
X\$ 9=			X\$18=	
X42=			X84=	168
+140=			+280=	
TOTAL			TOTAL	

**CLAIMS AS AMENDED - PART II**

5/4/5

	(Column 1)	(Column 2)	(Column 3)
AMENDMENT A	CLAIMS REMAINING AFTER AMENDMENT	HIGHEST NUMBER PREVIOUSLY PAID FOR	PRESENT EXTRA
	Total	* 44 Minus ** 41	= 3
	Independent	* 6 Minus *** 5	= 1
FIRST PRESENTATION OF MULTIPLE DEPENDENT CLAIM <input type="checkbox"/>			

**SMALL ENTITY** OR

**OTHER THAN SMALL ENTITY**

RATE	ADDITIONAL FEE	OR	RATE	ADDITIONAL FEE
X\$ 9=			X\$18=	150
X42=			X84=	200
+140=			+280=	
TOTAL ADDIT. FEE			TOTAL ADDIT. FEE	350

	(Column 1)	(Column 2)	(Column 3)
AMENDMENT B	CLAIMS REMAINING AFTER AMENDMENT	HIGHEST NUMBER PREVIOUSLY PAID FOR	PRESENT EXTRA
	Total	* Minus **	=
	Independent	* Minus ***	=
FIRST PRESENTATION OF MULTIPLE DEPENDENT CLAIM <input type="checkbox"/>			

RATE	ADDITIONAL FEE	OR	RATE	ADDITIONAL FEE
X\$ 9=			X\$18=	
X42=			X84=	
+140=			+280=	
TOTAL ADDIT. FEE			TOTAL ADDIT. FEE	

	(Column 1)	(Column 2)	(Column 3)
AMENDMENT C	CLAIMS REMAINING AFTER AMENDMENT	HIGHEST NUMBER PREVIOUSLY PAID FOR	PRESENT EXTRA
	Total	* Minus **	=
	Independent	* Minus ***	=
FIRST PRESENTATION OF MULTIPLE DEPENDENT CLAIM <input type="checkbox"/>			

RATE	ADDITIONAL FEE	OR	RATE	ADDITIONAL FEE
X\$ 9=			X\$18=	
X42=			X84=	
+140=			+280=	
TOTAL ADDIT. FEE			TOTAL ADDIT. FEE	

\* If the entry in column 1 is less than the entry in column 2, write "0" in column 3.

\*\* If the "Highest Number Previously Paid For" IN THIS SPACE is less than 20, enter "20."

\*\*\* If the "Highest Number Previously Paid For" IN THIS SPACE is less than 3, enter "3."

The "Highest Number Previously Paid For" (Total or Independent) is the highest number found in the appropriate box in column 1.



UNITED STATES PATENT AND TRADEMARK OFFICE

UNITED STATES DEPARTMENT OF COMMERCE  
United States Patent and Trademark Office  
Address: COMMISSIONER FOR PATENTS  
P.O. Box 1450  
Alexandria, Virginia 22313-1450  
www.uspto.gov

APPLICATION NO.	FILING DATE	FIRST NAMED INVENTOR	ATTORNEY DOCKET NO.	CONFIRMATION NO.
10/667,026	09/18/2003	Darrin W. Kabel	702.254	9123
	7590	01/12/2005	EXAMINER	
Devon A. Rolf GARMIN INTERNATIONAL, INC. 1200 East 151st Street Olathe, KS 66062			STONE, JENNIFER A	
			ART UNIT	PAPER NUMBER
			2636	

DATE MAILED: 01/12/2005

Please find below and/or attached an Office communication concerning this application or proceeding.

<b>Office Action Summary</b>	Application No. 10/667,026	Applicant(s) KABEL ET AL. <span style="float: right;">AK</span>
	Examiner Jennifer A Stone	Art Unit 2636

**-- The MAILING DATE of this communication appears on the cover sheet with the correspondence address --**  
**Period for Reply**

A SHORTENED STATUTORY PERIOD FOR REPLY IS SET TO EXPIRE 3 MONTH(S) FROM THE MAILING DATE OF THIS COMMUNICATION.

- Extensions of time may be available under the provisions of 37 CFR 1.136(a). In no event, however, may a reply be timely filed after SIX (6) MONTHS from the mailing date of this communication.
- If the period for reply specified above is less than thirty (30) days, a reply within the statutory minimum of thirty (30) days will be considered timely.
- If NO period for reply is specified above, the maximum statutory period will apply and will expire SIX (6) MONTHS from the mailing date of this communication.
- Failure to reply within the set or extended period for reply will, by statute, cause the application to become ABANDONED (35 U.S.C. § 133). Any reply received by the Office later than three months after the mailing date of this communication, even if timely filed, may reduce any earned patent term adjustment. See 37 CFR 1.704(b).

**Status**

- 1)  Responsive to communication(s) filed on \_\_\_\_.
- 2a)  This action is **FINAL**.                      2b)  This action is non-final.
- 3)  Since this application is in condition for allowance except for formal matters, prosecution as to the merits is closed in accordance with the practice under *Ex parte Quayle*, 1935 C.D. 11, 453 O.G. 213.

**Disposition of Claims**

- 4)  Claim(s) 1-41 is/are pending in the application.  
4a) Of the above claim(s) \_\_\_\_ is/are withdrawn from consideration.
- 5)  Claim(s) \_\_\_\_ is/are allowed.
- 6)  Claim(s) 1-41 is/are rejected.
- 7)  Claim(s) \_\_\_\_ is/are objected to.
- 8)  Claim(s) \_\_\_\_ are subject to restriction and/or election requirement.

**Application Papers**

- 9)  The specification is objected to by the Examiner.
- 10)  The drawing(s) filed on 18 September 2003 is/are: a)  accepted or b)  objected to by the Examiner.  
Applicant may not request that any objection to the drawing(s) be held in abeyance. See 37 CFR 1.85(a).  
Replacement drawing sheet(s) including the correction is required if the drawing(s) is objected to. See 37 CFR 1.121(d).
- 11)  The oath or declaration is objected to by the Examiner. Note the attached Office Action or form PTO-152.

**Priority under 35 U.S.C. § 119**

- 12)  Acknowledgment is made of a claim for foreign priority under 35 U.S.C. § 119(a)-(d) or (f).  
a)  All    b)  Some \*    c)  None of:
1.  Certified copies of the priority documents have been received.
2.  Certified copies of the priority documents have been received in Application No. \_\_\_\_.
3.  Copies of the certified copies of the priority documents have been received in this National Stage application from the International Bureau (PCT Rule 17.2(a)).
- \* See the attached detailed Office action for a list of the certified copies not received.

**Attachment(s)**

- |  |   |
|--|---|
| 1) <input checked="" type="checkbox"/> Notice of References Cited (PTO-892)  | 4) <input type="checkbox"/> Interview Summary (PTO-413)<br>Paper No(s)/Mail Date. ____. |
| 2) <input type="checkbox"/> Notice of Draftsperson's Patent Drawing Review (PTO-948)                                   | 5) <input type="checkbox"/> Notice of Informal Patent Application (PTO-152)             |
| 3) <input type="checkbox"/> Information Disclosure Statement(s) (PTO-1449 or PTO/SB/08)<br>Paper No(s)/Mail Date ____. | 6) <input type="checkbox"/> Other: ____.  |

***Claim Rejections - 35 USC § 102***

1. The following is a quotation of the appropriate paragraphs of 35 U.S.C. 102 that form the basis for the rejections under this section made in this

Office action:

A person shall be entitled to a patent unless –

(e) the invention was described in (1) an application for patent, published under section 122(b), by another filed in the United States before the invention by the applicant for patent or (2) a patent granted on an application for patent by another filed in the United States before the invention by the applicant for patent, except that an international application filed under the treaty defined in section 351(a) shall have the effects for purposes of this subsection of an application filed in the United States only if the international application designated the United States and was published under Article 21(2) of such treaty in the English language.

2. Claims 1-10 are rejected under 35 U.S.C. 102(e) as being anticipated by Michaelson et al. (US 6,734,808).

For claim 1, Michaelson discloses a method for marine navigation, comprising (col 2, Ins 11-14 and 35-38): identifying a potential waypoint (Fig. 28, points A-F; col 23, Ins 30-32 and 39-41); and performing a marine route calculation algorithm to analyze a course between a first location and the potential waypoint in view of preselected conditions (col 23, Ins 64-67; col 24, Ins 33-45 and 62-66).

For claim 2, Michaelson discloses performing the marine route calculation algorithm to include analyzing cartographic data that include preselected conditions between the first location and the potential waypoint with a preference for avoiding preselected conditions (col 24, Ins 37-45).

For claim 3, the marine route calculation algorithm further includes re-routing the course to avoid the preselected conditions when the marine route calculation algorithm identifies one or more preselected conditions between the first location and the potential waypoint (col 24, lns 25-37 and 55-61).

For claim 4, re-routing the course calculated further includes identifying one or more non-user waypoints (determined by the system, not the user) between the first location and the potential waypoint (col 24, lns 41-50 and 55-64).

For claim 5, Michaelson determines a first location on the course based on a signal from a GPS; and analyzing cartographic data for a predetermined area around the first location for preselected conditions (col 7, lns 50-65; col 8, lns 11-21 and 46-51).

For claim 6, an alert signal is provided when the analyzed cartographic data for the predetermined area around the first location includes preselected conditions (col 2, lns 11-14; col 6, lns 13-17).

For claim 7, an alert signal is provided when the analyzed cartographic data for the predetermined data between the first location and the potential waypoint includes preselected conditions (col 6, lns 13-26).

For claim 8, the alert signal includes emitting an audio alert (col 6, lns 15-18; Fig. 2, item 28).

For claim 9, Michaelson discloses providing the alert signal to include displaying a visual alert.



For claim 10, Michaelson discloses receiving preselected conditions selected from the group of land, water depth, rock(s), sandbars, shelves, tide condition, tidal data, wind conditions, weather conditions, ice, above-water obstacles, underwater obstacles, type of water bottom, and prohibited areas (col 2, lns 41-43; col 8, lns 28-36 and 40-52).

3. Claims 11-18 are rejected under 35 U.S.C. 102(e) as being anticipated by Michaelson et al. (US 6,734,808).

For claim 11, the claim is interpreted and rejected for the same reasons as stated in the rejection of claims 1 and 6 as stated above.

For claim 12, the claim is interpreted and rejected for the same reasons as stated in the rejection of claim 3 as stated above.

For claim 13, the claim is interpreted and rejected for the same reasons as stated in the rejection of claim 4 as stated above.

For claim 14, the claim is interpreted and rejected for the same reasons as stated in the rejection of claim 7 as stated above.

For claim 15, the claim is interpreted and rejected for the same reasons as stated in the rejection of claim 5 as stated above.

For claim 16, the claim is interpreted and rejected for the same reasons as stated in the rejection of claim 6 as stated above.

For claim 17, Michaelson discloses analyzing cartographic data further comprises acquiring cartographic data from a GPS (col 7, lns 54-56).

For claim 18, the claim is interpreted and rejected for the same reasons as stated in the rejection of claim 10 as stated above.

4. Claims 23-33 are rejected under 35 U.S.C. 102(e) as being anticipated by Michaelson et al. (US 6,734,808).

For claim 23, Michaelson discloses a computer readable medium having a set of computer readable instructions (col 11, Ins 38-41), the set of computer readable instructions comprising instructions for: identifying a potential waypoint upon a first event (col 23, Ins 30-41); and performing a marine route calculation algorithm to analyze a course between a first location and the potential waypoint in view of preselected conditions (col 27, Ins 11-20).

For claim 24, the claim is interpreted and rejected for the same reasons as stated in the rejection of claim 2 as stated above.

For claim 25, the claim is interpreted and rejected for the same reasons as stated in the rejection of claim 3 as stated above.

For claim 26, the claim is interpreted and rejected for the same reasons as stated in the rejection of claim 4 as stated above.

For claim 27, the claim is interpreted and rejected for the same reasons as stated in the rejection of claim 5 as stated above.

For claim 28, the claim is interpreted and rejected for the same reasons as stated in the rejection of claim 6 as stated above.

For claim 29, the claim is interpreted and rejected for the same reasons as stated in the rejection of claim 17 as stated above.

For claim 30, the claim is interpreted and rejected for the same reasons as stated in the rejection of claim 7 as stated above.

For claim 31, the claim is interpreted and rejected for the same reasons as stated in the rejection of claim 8 as stated above.

For claim 32, the claim is interpreted and rejected for the same reasons as stated in the rejection of claim 9 as stated above.

For claim 33, the claim is interpreted and rejected for the same reasons as stated in the rejection of claim 10 as stated above.

5. Claims 34-40 are rejected under 35 U.S.C. 102(e) as being anticipated by Michaelson et al. (US 6,734,808).

For claim 34, Michaelson discloses an electronic marine navigation device, comprising: a processor (col 2, lns 41-44; Fig. 40, item 486); a location input operatively coupled to the processor (col 5, lns 12-15; Fig. 40, item 24), wherein the location input receives a first location and a potential waypoint separate from the first location (col 23, lns 30-32 and 39-41; Fig. 28); and a memory operatively coupled to the processor and the location input (col 31, lns 18-24; Fig. 40, item 4760), the memory having cartographic data including preselected conditions (Fig. 40, 4800; col 31, lns 48-51), wherein the processor operates on a marine route calculation algorithm to analyze a course between the first location and the potential waypoint in view of preselected conditions of the cartographic data (col 23, lns 30-41).

For claim 35, the claim is interpreted and rejected for the same reasons as stated in the rejection of claims 2 and 34 as stated above.

For claim 36, the claim is interpreted and rejected for the same reasons as stated in the rejection of claims 3 and 34 as stated above.

For claim 37, the claim is interpreted and rejected for the same reasons as stated in the rejection of claims 4 and 34 as stated above.

For claim 38, Michaelson discloses a receiver for a GPS (Fig. 2, GPS, 14; Fig. 40, item 24) operatively coupled to the processor, wherein the processor determines the first location on the course based on a signal received from the GPS (col 7, lns 50-56), and analyzes cartographic data for a predetermined area around the first location for preselected conditions (col 5, lns 9-15).

For claim 39, the claim is interpreted and rejected for the same reasons as stated in the rejection of claims 6 and 34 as stated above.

For claim 40, the claim is interpreted and rejected for the same reasons as stated in the rejection of claims 7 and 34 as stated above.

***Claim Rejections - 35 USC § 103***

6. The following is a quotation of 35 U.S.C. 103(a) which forms the basis for all obviousness rejections set forth in this Office action:

(a) A patent may not be obtained though the invention is not identically disclosed or described as set forth in section 102 of this title, if the differences between the subject matter sought to be patented and the prior art are such that the subject matter as a whole would have been obvious at the time the invention was made to a person having ordinary skill in the art to which said subject matter pertains. Patentability shall not be negated by the manner in which the invention was made.

7. Claims 19-22 are rejected under 35 U.S.C. 103(a) as being unpatentable over Horvath et al. (US 6,473,003).

For claim 19, Horvath discloses identifying a user defined graphical filter area on a display; analyzing cartographic data within the user defined graphical filter area for preselected conditions; and providing an alert signal when

cartographic data within the user defined graphical filter area indicate preselected conditions. Even though Horvath's primary application is aircraft navigation, it would have been obvious one of ordinary skill in the art, at the time the invention was made to apply the disclosure of Horvath to a marine navigation system so that a user has a certain degree of control over the display in order to customize it according to the user's preferences. In addition, the graphical filter area is applied to one or more display maps, such as weather, terrain, and traffic. All of the aforementioned maps are also applied to marine navigation (col 7, Ins 26-31).

For claim 20, identifying the user defined graphical filter area includes repositioning the user defined graphical filter area (col 2, Ins 26-37).

For claim 21, Horvath includes analyzing cartographic data further comprises acquiring cartographic data from a GPS (col 4, Ins 54-56; Fig. 7, item 110, 123-125).

For claim 22, Horvath discloses receiving preselected conditions selected from the group of land, water depth, rock(s), sandbars, shelves, tide condition, tidal data, wind conditions, weather conditions, ice, above-water obstacles, underwater obstacles, type of water bottom, and prohibited areas (col 4, Ins 60-63; col 7, Ins 26-31; Fig. 7, items 124, 125).

8. Claim 41 is rejected under 35 U.S.C. 103(a) as being unpatentable over Michaelson et al. (US 6,734,808), as applied to claim 34, and further in view of Horvath et al. (US 6,473,003).

Michaelson discloses a processor to operate on the marine route calculation algorithm to analyze cartographic data, wherein the processor

provides an alert signal when the analyzed cartographic data includes preselected conditions; however, Michaelson does not disclose a user defined graphical filter area. Horvath, on the other hand, does disclose a user defined graphical filter area (col 1, lns 10-14; col 2, lns 30, 31, 44-48) wherein a processor operates to analyze cartographic data and provides an alert signal when the analyzed cartographic data for the user defined graphical filter area includes preselected conditions (col 2, lns 60-63; Fig. 4, 30i). Even though Horvath's primary application is aircraft navigation, it would have been obvious to apply a user defined graphical filter area to a marine navigation system so that a user has a certain degree of control over the display in order to customize it according to the user's preferences.

### ***Conclusion***

9. The prior art made of record and not relied upon is considered pertinent to applicant's disclosure:

Clark et al. (US 4,893,127) discloses a marine navigation system that analyzes cartographic data based on preselected conditions.

Any inquiry concerning this communication or earlier communications from the examiner should be directed to Jennifer A. Stone whose telephone number is (571) 272.2976. The examiner can normally be reached 8:00-4:30, M-F.

If attempts to reach the examiner by telephone are unsuccessful, the examiner's supervisor, Mr. Jeffery Hofsass can be reached at (571) 272.2981.

Application/Control Number: 10/667,026  
Art Unit: 2636

Page 10

The fax phone number for the organization where this application or proceeding is assigned is (703) 872.9306 for regular and after final communications.

Any inquiry of a general nature of relating to the status of this application or proceeding should be directed to the receptionist whose telephone number is (571) 272.2600.

Jennifer Stone  
January 6, 2005

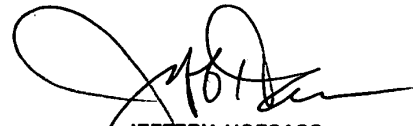

JEFFERY HOFSSASS  
SUPERVISORY PATENT EXAMINER  
TECHNOLOGY CENTER 2600

<b>Notice of References Cited</b>	Application/Control No. 10/667,026	Applicant(s)/Patent Under Reexamination KABEL ET AL.	
	Examiner Jennifer A Stone	Art Unit 2636	Page 1 of 1

**U.S. PATENT DOCUMENTS**

*	Document Number Country Code-Number-Kind Code	Date MM-YYYY	Name	Classification
A	US-6,473,003	10-2002	Horvath et al.	340/945
B	US-6,734,808	05-2004	Michaelson et al.	340/984
C	US-4,893,127	01-1990	Clark et al.	342/386
D	US-			
E	US-			
F	US-			
G	US-			
H	US-			
I	US-			
J	US-			
K	US-			
L	US-			
M	US-			

**FOREIGN PATENT DOCUMENTS**

*	Document Number Country Code-Number-Kind Code	Date MM-YYYY	Country	Name	Classification
N					
O					
P					
Q					
R					
S					
T					

**NON-PATENT DOCUMENTS**

*	Include as applicable: Author, Title Date, Publisher, Edition or Volume, Pertinent Pages)
U	
V	
W	
X	

\*A copy of this reference is not being furnished with this Office action. (See MPEP § 707.05(a).)  
Dates in MM-YYYY format are publication dates. Classifications may be US or foreign.



**Index of Claims**



Application No.

10/667,026

Examiner

Jennifer A Stone

Applicant(s)

KABEL ET AL.

Art Unit

2636

√	Rej cted
=	Allowed

-	(Through num ral) Canc lled
+	Restricted

N	Non-Elected
I	Interference

A	Appeal
O	Objected

Claim		Date		Claim		Date		Claim		Date	
Final	Original			Final	Original			Final	Original		
	1				51				101		
	2				52				102		
	3				53				103		
	4				54				104		
	5				55				105		
	6				56				106		
	7				57				107		
	8				58				108		
	9				59				109		
	10				60				110		
	11				61				111		
	12				62				112		
	13				63				113		
	14				64				114		
	15				65				115		
	16				66				116		
	17				67				117		
	18				68				118		
	19				69				119		
	20				70				120		
	21				71				121		
	22				72				122		
	23				73				123		
	24				74				124		
	25				75				125		
	26				76				126		
	27				77				127		
	28				78				128		
	29				79				129		
	30				80				130		
	31				81				131		
	32				82				132		
	33				83				133		
	34				84				134		
	35				85				135		
	36				86				136		
	37				87				137		
	38				88				138		
	39				89				139		
	40				90				140		
	41				91				141		
	42				92				142		
	43				93				143		
	44				94				144		
	45				95				145		
	46				96				146		
	47				97				147		
	48				98				148		
	49				99				149		
	50				100				150		



UNITED STATES PATENT AND TRADEMARK OFFICE

UNITED STATES DEPARTMENT OF COMMERCE  
 United States Patent and Trademark Office  
 Address: COMMISSIONER FOR PATENTS  
 P.O. Box 1450  
 Alexandria, Virginia 22313-1450  
 www.uspto.gov

**\*BIBDATASHEET\***

CONFIRMATION NO. 9123

Bib Data Sheet

SERIAL NUMBER 10/667,026	FILING DATE 09/18/2003  RULE	CLASS 340	GROUP ART UNIT 2636	ATTORNEY DOCKET NO. 702.254
-----------------------------	---------------------------------------	--------------	------------------------	--------------------------------

APPLICANTS

Darrin W. Kabel, Overland Park, KS;  
 Steven J. Myers, Edgerton, KS;

\*\* CONTINUING DATA \*\*\*\*\*

\*\* FOREIGN APPLICATIONS \*\*\*\*\*

IF REQUIRED, FOREIGN FILING LICENSE GRANTED  
 \*\* 12/11/2003

Foreign Priority claimed <input type="checkbox"/> yes <input checked="" type="checkbox"/> no	STATE OR COUNTRY KS	SHEETS DRAWING 10	TOTAL CLAIMS 41	INDEPENDENT CLAIMS 5
35 USC 119 (a-d) conditions met <input type="checkbox"/> yes <input checked="" type="checkbox"/> no <input type="checkbox"/> Met after Allowance	Verified and Acknowledged Examiner's Signature: <i>[Signature]</i> Initials: <i>JAS</i>			

ADDRESS

Devon A. Rolf  
 GARMIN INTERNATIONAL, INC.  
 1200 East 151st Street  
 Olathe , KS  
 66062

TITLE

Methods, systems, and devices for cartographic alerts

FILING FEE RECEIVED 1296	FEES: Authority has been given in Paper No. _____ to charge/credit DEPOSIT ACCOUNT No. _____ for following:	<input type="checkbox"/> All Fees <input type="checkbox"/> 1.16 Fees ( Filing ) <input type="checkbox"/> 1.17 Fees ( Processing Ext. of time ) <input type="checkbox"/> 1.18 Fees ( Issue ) <input type="checkbox"/> Other _____ <input type="checkbox"/> Credit
-----------------------------	---	---



<b>UTILITY PATENT APPLICATION TRANSMITTAL</b> (for nonprovisional applications under 37 C.F.R. § 1.53(b))	Attorney Docket No.	702.254
	CERTIFICATE OF MAILING 37 C.F.R. 110 I hereby certify that this correspondence, along with any documents referred to, is being deposited with the U.S. Postal Service, on <u>7-18-03</u> , in an envelope addressed Mail Stop Patent Application, Commissioner for Patents, PO Box 1450, Alexandria, VA 22313-1450 as Express Mail Post Office to Addressee" Mailing Label No. EL 917297110 US.	

10/667026  
 09/18/03

*Unecda Royer*  
Unecda Royer

TO: Mail Stop Patent Application  
 Commissioner for Patents  
 P.O. Box 1450  
 Alexandria, VA 22313-1450

Inventor(s): Darrin W. Kabel and Steven J. Myers

Title: METHODS, SYSTEMS, AND DEVICES FOR CARTOGRAPHIC ALERTS

Enclosed are:

- 19 pages of specification
- 7 pages of claims
- 1 pages of Abstract
- 10 sheet(s) of drawings
- an assignment of the invention, including Cover Sheet for Assignment accompanying New Patent Application **GARMIN LTD., a Cayman Islands Corporation**

<input checked="" type="checkbox"/>	Declaration/Oath of Inventor(s)	<input checked="" type="checkbox"/>	Newly executed	<input type="checkbox"/>	Copy from a prior application (for contin/div)
-------------------------------------	---------------------------------	-------------------------------------	----------------	--------------------------	--

Incorporation by Reference: the entire disclosure of the prior application, from which a copy of the oath or declaration is supplied, is considered to be part of the disclosure of the accompanying application and is hereby incorporated by reference therein.

- Applicant hereby asserts status as a small entity under 37 C.F.R. § 1.27 a small entity statement was filed in prior application; status still proper and desired.
- Information Disclosure Statement/PTO-1449/Copies of IDS citations.
- Preliminary Amendment
- Amendment to Claims
- Cancel in this application claims \_\_\_\_\_ before calculating filing fee.
- Add claims shown on attached amendment.
- Other: Request and Certification under C.F.R. 122(b)(2)(B)(i)

If a Continuing Application: Check appropriate box, and supply the requisite information below:

<input type="checkbox"/>	Continuation	<input type="checkbox"/>	Divisional	<input type="checkbox"/>	Continuation-in-Part (CIP)	of prior application No.
--------------------------	--------------	--------------------------	------------	--------------------------	----------------------------	--------------------------

Filing Date of Prior application:	Group Art Unit:
Prior application information: Examiner:	Reel/Frame of Assignment of Parent Application:

**CLAIMS AS FILED**

	NUMBER FILED	NUMBER EXTRA	RATE	FEE
BASIC FEE			\$750	\$ 750
TOTAL CLAIMS	40 - 20 =	20	X \$ 18	\$ 360
INDEPENDENT CLAIMS	5 - 3 =	2	X \$ 84	\$ 168
MULTIPLE DEPENDENT CLAIM PRESENT			\$280	\$
* Number extra must be zero or larger				
<b>TOTAL</b>				<b>\$1,446</b>
<input type="checkbox"/> If applicant has small entity status under 37 CFR 1.9 and SMALL ENTITY 1.27, then divide total fee by 2, and enter amount here.				\$

- A check in the amount of \$ \_\_\_\_\_ to cover the filing fee is enclosed. Commissioner is hereby authorized to charge/credit Deposit Acct. No. 501-791 as described below. Enclosed is a duplicate of this sheet.
- Charge the amount of \$1,486.00 as filing fee and assignment recordal fee.
- Credit any overpayment.
- Charge any additional filing fees required under 37 CFR 1.16 and 1.17.

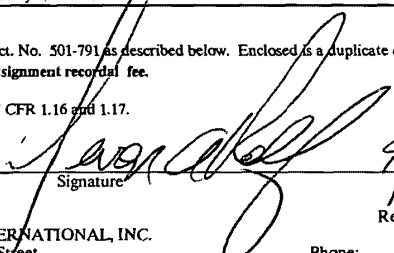
  
 Signature \_\_\_\_\_ Date 9/17/03

Correspondence Address:

Name: Devan A. Rolf  
 GARMIN INTERNATIONAL, INC.  
 1200 East 151<sup>st</sup> Street  
 Olathe, Kansas 66062

Reg. No.: 35,337

Phone: 913-397-8200  
 Fax: 913-397-9079

Under the Paperwork Reduction Act of 1995, no persons are required to respond to a collection of information unless it displays a valid OMB control number.

<b>NONPUBLICATION REQUEST UNDER 35 U.S.C. 122(b)(2)(B)(i)</b>	First Named Inventor	Darrin W. Kabel
	Title	Methods, Systems, and Devices For Cartographic Alerts
	Attorney Docket Number	702.254

I hereby certify that the invention disclosed in the attached application **has not and will not be** the subject of an application filed in another country, or under a multilateral agreement, that requires publication at eighteen months after filing.

I hereby request that the attached application not be published under 35 U.S.C. 122(b).

9/17/03  
Date

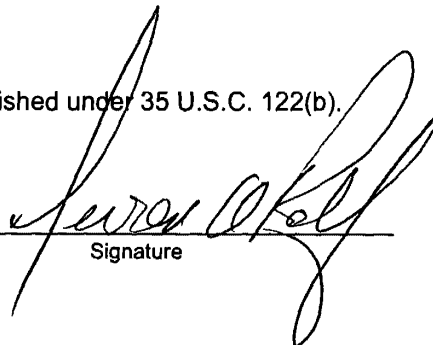
  
Signature

(913) 397-8200

Devon A. Rolf

Telephone number

Typed or printed name

This request must be signed in compliance with 37 CFR 1.33(b) and submitted with the application **upon filing**.

Applicant may rescind this nonpublication request at any time. If applicant rescinds a request that an application not be published under 35 U.S.C. 122(b), the application will be scheduled for publication at eighteen months from the earliest claimed filing date for which a benefit is claimed.

If applicant subsequently files an application directed to the invention disclosed in the attached application in another country, or under a multilateral international agreement, that requires publication of applications eighteen months after filing, the applicant **must** notify the United States Patent and Trademark Office of such filing within forty-five (45) days after the date of the filing of such foreign or international application. **Failure to do so will result in abandonment of this application (35 U.S.C. 122(b)(2)(B)(iii)).**

This collection of information is required by 37 CFR 1.213(a). The information is required to obtain or retain a benefit by the public which is to file (and by the USPTO to process) an application. Confidentiality is governed by 35 U.S.C. 122 and 37 CFR 1.14. This collection is estimated to take 6 minutes to complete, including gathering, preparing, and submitting the completed application form to the USPTO. Time will vary depending upon the individual case. Any comments on the amount of time you require to complete this form and/or suggestions for reducing this burden, should be sent to the Chief Information Officer, U.S. Patent and Trademark Office, U.S. Department of Commerce, P.O. Box 1450, Alexandria, VA 22313-1450. DO NOT SEND FEES OR COMPLETED FORMS TO THIS ADDRESS. SEND TO: Commissioner for Patents, P.O. Box 1450, Alexandria, VA 22313-1450.

If you need assistance in completing the form, call 1-800-PTO-9199 (1-800-786-9199) and select option 2.

**EXPRESS MAIL NO.**

**EL 917297110US**

**Methods, Systems, and Devices for Cartographic Alerts**

5

**Field of the Invention**

The present invention relates generally to navigational devices, and in particular to marine navigational devices with cartographic alert capabilities.

**Background of the Invention**

10

Boating is an activity enjoyed by many people. Safe boating, however, requires common sense and the ability to remain alert to the prevailing boating conditions. A variety of equipment is available to boaters to aid them in these endeavors. For example, boats can be equipped with radios, radar systems, cameras, and sensors for providing a variety of information to the boater. The boater can then use the information from these devices in planning and navigating a course for the boat.

15

Many times, however, there can be quite a lot of information for the boater to consider in planning and navigating a course for the boat. For example, which courses might be preferable, or even available, for the size and type of boat being used. In addition, a user may inadvertently overlook one or more hazards in planning their course.

20

**Brief Description of the Drawings**

Figure 1 is a representative view of a Global Positioning System (GPS);

Figures 2A and 2B illustrate views for one embodiment of an electronic marine navigational device;

25

Figure 3 is a block diagram of one embodiment for the electronic components within the hardware of Figures 2A-2B;

Figures 4A-4E illustrate a number of display screen embodiments which are operable with the electronic marine navigational device of the present invention; and

30

Figures 5-7 are flow charts illustrating various method embodiments.

### **Detailed Description of the Invention**

Embodiments of the present invention include marine navigational methods,  
5 systems, and devices having course calculation and analysis capabilities. The marine  
navigational methods, systems, and devices can use any number of devices for  
determining one or more positions. For example, the marine navigational device can  
include devices for receiving signals (e.g., radio signals) from which positional  
triangulation can be performed to determine the one or more positions. In additional  
10 embodiments, a global positioning system (GPS) enabled marine navigational device can  
be used for determining one or more positions. Such GPS systems are known and have a  
variety of uses.

Although the term marine navigation is used in the present application, one of  
ordinary skill in the art will appreciate from reading the disclosure that the techniques  
15 described herein could equally be applied for use in non-street based navigation. So, the  
use of the word "marine" in the embodiments of the present invention (including the  
claims) could be replaced with the phrase "non-street based", where non-street based can  
include a navigational method, system, and devices that do not necessarily rely on one or  
more roads, highways, streets, and/or freeways in providing navigational methods,  
20 systems and/or devices.

In general, GPS is a satellite-based radio navigation system capable of  
determining continuous position, velocity, time, and in some instances direction  
information for an unlimited number of users. GPS incorporates a plurality of satellites  
which orbit the earth in extremely precise orbits. Based on these precise orbits, GPS  
25 satellites can relay their location to any number of receiving units.

The GPS system is implemented when a device specially equipped to receive GPS  
data begins scanning radio frequencies for GPS satellite signals. Upon receiving a radio  
signal from a GPS satellite, the device can determine the precise location of that satellite  
via one of different conventional methods. The device will continue scanning for signals  
30 until it has acquired at least three different satellite signals. Implementing geometric  
triangulation, the receiver utilizes the three known positions to determine its own two-

dimensional position relative to the satellites. Additionally, acquiring a fourth satellite signal will allow the receiving device to calculate its three-dimensional position by the same geometrical calculation. The positioning and velocity data can be updated in real time on a continuous basis by an unlimited number of users.

5           Figure 1 is representative of a GPS denoted generally by reference numeral 100. A plurality of satellites 120 are in orbit about the Earth 124. The orbit of each satellite 120 is not necessarily synchronous with the orbits of other satellites 120 and, in fact, is likely asynchronous. A GPS receiver device 140 of the present embodiment is shown receiving spread spectrum GPS satellite signals 160 from the various satellites 120.

10           The spread spectrum signals 160 continuously transmitted from each satellite 120 utilize a highly accurate frequency standard accomplished with an extremely accurate atomic clock. Each satellite 120, as part of its data signal transmission 160, transmits a data stream indicative of that particular satellite 120. It will be appreciated by those skilled in the relevant art that the GPS receiver device 140 must acquire spread spectrum  
 15 GPS satellite signals 160 from at least three satellites 120 for the GPS receiver device 140 to calculate its two-dimensional position by triangulation. Acquisition of an additional signal 160, resulting in signals 160 from a total of four satellites 120, permits GPS receiver device 140 to calculate its three-dimensional position.

          Figures 2A and 2B illustrate views for one embodiment of an electronic marine  
 20 navigational device 200. Device 200 can be portable and can be utilized in any number of implementations besides marine application. For example, device 200 could possibly be used in an automobile and in avionic navigation.

          Figure 2A illustrates a front view of marine navigational device 200. Marine navigational device 200 can include a housing 202. In the various embodiments, housing  
 25 202 includes a fully gasketed, high-impact strength plastic or plastic/alloy, waterproof case and has been rounded for aesthetic and ergonomic purposes. This is but one example, and other protective housings 202 (e.g., metal or metal alloy) are possible.

          Marine navigational device 200 further includes a control panel 204 that includes a display screen 214. For example, display screen 214 can be a color LCD display which  
 30 is capable of displaying both text and graphical information. The invention, however, is not so limited. Audio information can likewise be provided. In addition, marine



navigational device 200 can further include two-way voice communication capabilities (e.g., two-way radio or cellular communication) and capabilities for receiving National Oceanic and Atmospheric Administration (NOAA) weather broadcasts.

5 Display screen 214 is operable to present a number of different screen displays, examples of which are provided herein. The number of different screen displays includes, but are not limited to, a map display, including a split-screen moving map, a radio display, including, for example, channel selection and squelch code settings; location lookup for use with downloaded cartographic data, including marine craft data, of a map; a navigation display, including, for example, graphic compass, distance to  
10 destination, speed, and time of arrival prediction; point of interest display; listing of location display; trip computer display, including, for example, trip distance, average and maximum speeds, travel time, and location; and waypoint display for setting waypoints or locations.

Display 214 illustrates an embodiment of a map display. As will be explained in  
15 more detail below, in the various embodiments of the present invention, electronic marine navigational device 200 includes a basemap operable to show lakes, rivers, channels, lock and dams, buoys (e.g., marine buoys, navigation buoys, mooring buoys), channel markers, ports, docks, land, underwater obstacles, land, water depth, rock(s), sandbars, shelves, tidal conditions, tidal data, above-water obstacles (e.g., bridges), type of water  
20 bottom, and prohibited areas, cities, highways, streets, counties boundaries, and state boundaries on display 214. In one embodiment, the basemap can be built-in. In an additional embodiment, the basemap can be transferred to and/or provided on a removable data card to the device 200.

As further shown in Figure 2A, marine navigational device 200 further includes a  
25 number of input devices 216 such as a power on/off button, display zoom control buttons, menu selection button, user confirmation key, and the like. The input devices 216 shown in Figure 2A also include a multiposition (e.g., 3-axis) data entry button 220 for use with the display screen 214. The display 214 can also receive data through a touch sensitive screen (e.g., screen can be responsive to use of a stylus and/or finger touch).

30 Figure 2B illustrates a rear view for an embodiment of the electronic marine navigational device 200. The electronic marine navigational device 200 includes a data

port 224 operable to upload and download data between the electronic marine navigational device 200 and another electronic device, such as by using a USB connector, Ethernet, or other suitable connection. In some embodiments, as will be discussed below, data can be uploaded and downloaded to the electronic marine navigational device 200 using a transceiver in the device 200 which can accommodate a wireless transmission medium such as, for example, infrared, Bluetooth, and/or Radio Frequency (RF) signals. Other transmission medium might also be used. In the various embodiments of the present invention and as will be explained further herein, the data port is operable to upload and download device 200 software, marine craft data, and/or other cartographic data. Marine navigational device 200 can also include at least one antenna, including GPS antenna 226 coupled to an integrated GPS receiver, and voice data antenna 228 coupled to an integrated communication transceiver. Device 200 can further include input ports for externally mounted antennas for GPS receiver and/or for the communication transceiver.

The marine navigational device 200 can includes an electrical power input port 230 for coupling to an external power supply. The invention, however, is not so limited. For example, a battery power supply could be operatively coupled to device 200 to power its electronic components. Likewise, the various embodiments can include an electronic device having a data card slot, or data card port 234. The marine navigational device 200 can further include a mounting bracket 236 so that device 200 can be selectably and removably mounted on a removable clip and/or surface.

The illustrations shown in Figures 2A and 2B are but one example of a hardware configuration for a marine navigational device according to the teachings of the present invention. However, the invention is not limited to the configuration shown in Figures 2A and 2B. Other suitable designs for a hardware device which can accommodate the present invention are also possible.

Figure 3 illustrates one embodiment of a block diagram for the electronic components within the hardware of Figures 2A-2B, such as within housing 202 and utilized by the electronic marine navigational device. The electronic components of the electronic device can include a processor 310 that is operatively coupled to a location input 320, such as input devices 216 (e.g., data entry button 220). Processor 310 can also

be operatively coupled with memory 330 and display screen 340. It will be understood that input 320 may additionally include a microphone for receiving voice commands and/or an input from display screen 340 (e.g., touch sensitive screen). The electronic components further include a power source input 346 for powering the electronic components of the marine navigational device.

Memory 330 can retrievably store instructions for executing one or more executable programs according to the present invention. For example, the memory 330 can retrievably store a marine route calculation algorithm, as discussed herein, of the present invention. In addition, memory 330 can further retrievably store cartographic data, including marine craft data and a variety of preselected conditions that are also used in conjunction with the marine route calculation algorithm. Preselected conditions can include user identified parameters, and any values associated with the parameters, that are associated with geographical conditions of particular interest. For example, preselected conditions a user can select include, but are not limited to, indications of land, water depth, rock(s), sandbars, shelves, tide condition, tidal data, wind conditions, weather conditions, ice, above-water obstacles (e.g., bridges), underwater obstacles (e.g., submerged wrecks), type of water bottom, and prohibited areas, to name only a few. The preselected conditions, and their associated values, can be selected and programmed by a user through, for example, controlling one or more input menus on display screen 340 with the location input 320.

The location input 320 can also receive additional cartographic data, including marine craft data, through the input devices 216 (e.g., data entry button 220) and/or the display screen 340 from a user. This additional cartographic data, including marine craft data, can include a first location, such as a present location or a waypoint location, or other waypoint locations, such as a destination location, that can be used in calculating and/or analyzing a course for a marine craft. In one embodiment, the present location can be up-dated at a preselected rate in real-time. In addition, the location input 320 can further receive coordinate positions for the waypoints (e.g., a potential waypoint). The location input 320 can also receive the coordinate positions for waypoints by inputs through the display 340. In one example, the coordinate positions can be longitude and latitude coordinate positions.

Embodiments of the present invention also allow for a course to be analyzed between the first location and one or more waypoints, where cartographic data, including marine craft data, for the area between the first location and the waypoints can be analyzed to determine whether preselected conditions are present along the course. So, for example, a user may want to have a course analyzed between a first location and a potential waypoint that is separate from the first location. In the present example, the first location can be a present location of the device in which the coordinates of the present location can be entered by the user or determined based on a signal from a global positioning system, or other signal triangulation system. In an additional embodiment, the first location can be set as a waypoint location separate from the potential waypoint, in which the waypoint location will not change during the calculation of the course between the first location and the potential waypoint. In a further embodiment, the potential waypoint can identify a waypoint location that may be changed by the user, for example, based on the outcome of the course calculated between the first location and the potential waypoint. In other words, the potential waypoint may be moved so as to have alternative courses calculated and/or analyzed between the first location and the potential waypoint.

In addition, the processor 310 further operates on the marine route calculation algorithm to analyze a course between the first location and the potential waypoint in view of preselected conditions of the cartographic data, including the marine craft data. So, for example, the processor 310 can operate on the route calculating algorithm to analyze the cartographic data, including the marine craft data, to identify and avoid preselected conditions in the course being calculated between the first location and the potential waypoint.

The course analyzed with the marine route calculation algorithm can also analyze a predetermined distance on either side of the calculated course for preselected conditions. In other words, a buffer zone around the calculated course can be analyzed for preselected conditions. In one embodiment, the predetermined distance to be analyzed can be automatically determined by the marine route calculation algorithm based on the type of marine craft that is being used. The predetermined distance can also be determined and programmed into the device by the user. The size of the

predetermined distance can be influenced by any number of factors, including, but not limited to, the size (e.g., width), the maneuverability, and/or the steering characteristics of the marine craft.

5 In a situation where the processor 310 operating on the marine route calculation algorithm identifies one or more preselected conditions in analyzing the course, the processor 310 operates on the route calculating algorithm to re-route the course to avoid the preselected conditions. In one embodiment, in routing and/or re-routing the course to avoid the preselected conditions, the processor operates on the route calculating algorithm to identify one or more non-user waypoints between the first location and the  
10 potential waypoint.

The marine route calculation algorithm can also be used to analyze cartographic data within a user defined graphical filter area (shown as 478 in Figure 4E). In one embodiment, the user defined graphical filter area includes a geographical area defined by a user on the display screen 340. Examples of defining the user defined graphical  
15 filter area on the display screen 340 include, but are not limited to, use of the input devices 216 or the display screen 340 itself. For example, a user could draw the user defined graphical filter area using a cursor shown on the display screen 340. The user defined graphical filter area can include an area smaller than the display screen 340.

The user defined graphical filter area can also include any number of shapes,  
20 including, but not limited to, square, rectangular, triangular, or circular. Other shapes for the user defined graphical filter area are also possible. The user defined graphical filter area can further be positioned and/or repositioned over any number of locations on the display screen 340. In one embodiment, a displayed cursor under the control of one or more of the input devices 216 can be used to position and/or reposition the user defined  
25 graphical filter area over any number of locations on the display screen 340.

The processor 310 can operate on the marine route calculation algorithm to analyze cartographic data within the user defined graphical filter area for preselected conditions. For example, the processor 310 can operate on the marine route calculation algorithm to analyze cartographic data within the defined graphical filter area selected  
30 and positioned, or repositioned, by the user for preselected conditions. In an additional example, the processor 310 can dynamically analyze the cartographic data within the

defined graphical filter area for preselected conditions as the area is being position and/or repositioned. So, for example, the processor 310 dynamically analyzes the cartographic data within the defined graphical filter area for preselected conditions when repositioning the graphical filter area from a first position to a second position.

5           In one example, the dynamic analysis of cartographic data, including the marine craft data, within the defined graphical filter area for preselected conditions allows for a user to be aware of preselected conditions that may be located within the area, but not necessarily at the first location and/or along the course which the device is traveling. In an additional embodiment, analyzing the cartographic data within the defined graphical  
10 filter area can be available regardless of whether a calculated course is being used or not. In other words, a user need not have a destination point, one or more waypoints (e.g., a potential, or other waypoint) and/or a calculated a course to have the cartographic data analyzed within the defined graphical filter area.

          An antenna/receiver 350, such as a GPS antenna/receiver is operatively coupled to  
15 processor 310. It will be understood that the antenna and receiver, designated by reference numeral 350, are combined schematically for illustration, but that the antenna and receiver may be separately located components, and that the antenna may be a GPS patch antenna or a helical antenna. The electronic components further include I/O ports 370 operatively connected to processor 310. In addition, the electronic components can  
20 further include a cartridge bay 376 operatively coupled to the processor 310 for receiving cartographic data, including marine craft data, from a map data cartridge.

          Using antenna/receiver 350 as a GPS, processor 310 can determine the first location, for example, as being a present location of the device on a course based on the signals received from the GPS. Processor 310 can dynamically analyze cartographic  
25 data, including the marine craft data, for a predetermined area around the first location, in this situation the present location, for preselected conditions. The area around the first location for analysis can have a preselected size and shape relative to the first location. In addition, the area to be analyzed can be refreshed at a preselected rate so as to ensure that the first location does not move out of the analyzed area prior to the analysis being  
30 refreshed.

In one example, the dynamic analysis of cartographic data, including the marine craft data, around the first location for preselected conditions allows for a user to be aware of preselected conditions that may be in the vicinity, but not necessarily at the first location and/or along the course which the device is traveling. In this way, the user will better understand the nature of the area surrounding the first location and/or the calculated course with respect to the preselected conditions. Analyzing the cartographic data around the first location can also be available regardless of whether a calculated course is being used or not. In other words, a user need not have a destination point, one or more waypoints (e.g., a potential, or other waypoint) and/or a calculated course to have the cartographic data analyzed for the predetermined area around the first location.

In a further embodiment, the analysis of the present invention also need not be used in conjunction with calculating a course, but rather can be used to analyze the cartographic data in the area between the first location and the potential waypoint. In this way a user can better understand what predetermined conditions exist between the first location and the potential waypoint without having to calculate a course. In an additional embodiment, the analysis of the present invention also can be used in conjunction with calculating a course that includes the first location and the potential waypoint.

The area to be dynamically analyzed can also have a preselected size and shape relative to the present location. Examples of the preselected shape include, but are not limited to, a triangular or a sector of a circle shape. In one embodiment, the size of the area can be defined by radii extending along the course from the first location (e.g., a present location), such as a heading determined through the use of a track log. In addition, the size of the predetermined area can be determined based on a number of factors, including, but not limited to, the speed and heading of the electronic marine navigational device. In an additional embodiment, an angle of the analyzed area emanating from the first location can be either set by the user or determined based on type and nature of the marine craft in which the device is being utilized (e.g., a large craft with a large turn radius may require a larger angle of analysis as compared to a smaller more maneuverable craft having a smaller turn radius). In an additional embodiment, the area can encircle the first location, where a radius of the area analyzed can be a function of the speed and heading of the electronic marine navigational device. Any number of

shapes could be used for the area to be analyzed, where the area could be selected based on the application of the analysis.

The device of the present invention can also include one or more ways of providing an alert signal to the user of the device when a preselected condition is encountered during the analysis. In one embodiment, processor 310 provides the alert signal when the analyzed cartographic data, including the marine craft data, for the course and/or the predetermined area around the first location includes preselected conditions. So, processor 310 would provide the alert signal when the analyzed cartographic data, including the marine craft data, for the user defined graphical filter area and/or between the first location and the potential waypoint included preselected conditions. The device can further include an audio output device 380 operatively coupled to processor 310 to audibly present the alert signal. For example, the device can include a speaker, including associated amplifiers and circuitry, for providing the audio alert signal. The alert signal can also be graphically presented on display 340 under the control of processor 310. Examples of graphically presenting the alert signal can include, but are not limited to, highlighting the analyzed course and/or the analyzed area that includes the preselected condition. This highlighting can include, but it not limited to, causing a change in the display color for the analyzed course (e.g., changing the plotted course color from black to red, changing from a solid line to a broken or dashed line, or causing a line of the plotted course to flash on and off) or the analyzed area (e.g., stippling the area, or portion of the analyzed area that contains the preselected condition). In addition, the alert signal can also include text displayed on display 340 that indicates the preselected conditions encountered in analyzing the course and, optionally, indicators of their approximate locations along the course.

Different configurations of the components shown in Figure 3 are considered within the scope of the embodiments of the present invention.

Software embodiments of the present invention provide a device which is capable of analyzing a course between a first location and a potential waypoint or dynamically analyzing an area for preselected conditions. Embodiments of the device can also re-route to avoid the preselected condition between a first location and a potential waypoint,



as discussed herein. The device can incorporate these and other functions as will be explained in more detail below in connection with Figures 4, 5, 6, and 7.

Figures 4A-4E, illustrate a number of display screen embodiments which are operable with various embodiments of the present invention. That is, software  
 5 embodiments are operable to present data and provide various user interfaces on a display, such as those described herein.

For example, Figure 4A provides a map display 400 showing cartographic data 402, including the marine craft data, which includes, but is not limited to, water depth, land, geographical boundaries, rivers, navigational aides (e.g., landmarks), lakes,  
 10 channels, lock and dams, buoys (e.g., marine buoys, navigation buoys, mooring buoys), channel markers, ports, docks, land, underwater structures (e.g., wrecks and obstructions), weather, and the like. In various embodiments, the displays of the present invention can be accessed and displayed using selectable menus shown on a display screen and/or through use of input devices on the device. As shown, map display 400 can  
 15 include a portion of a course 404 along with cartographic data 402, including the marine craft data, such as rivers, lakes, topographic data, and county and state boarders, to name only a few.

Figure 4A illustrates course 404 between a first location 410 and a potential waypoint 414 that passes through land 416. In the present embodiment, the first location  
 20 410 is shown as a first waypoint that has been selected by a user. As described herein, land can be classified as a preselected condition. As such, course 404 has been highlighted to indicate that at least one preselected condition has been identified in the analysis of course 404. Highlighting in the instant case is provided by a bolding of the line representative course 404 in a region 418. At this point, the device can calculate one  
 25 or more possible courses around the preselected condition.

Figure 4B provides map display 400 having course 403 recalculated to avoid the one or more preselected conditions (e.g., avoid the land in region 418 of the previous course 404). Recalculating of course 403 relative to the original calculation of course 404 shown in Figure 4A provides the recalculated course 403 with one or more additional  
 30 waypoints, shown as 420. The additional waypoints 420 have been included to allow the course 403 to avoid the preselected conditions. The waypoints 420, in the present

situation, are non-user waypoints. In other words, waypoints 420 were determined by the system, and not the user. Embodiments however are not so limited. In an additional embodiment, the user can indicate waypoints to be used and/or alter waypoints that are provided by the system.

5           The user can also request a subsequent recalculation of course 403 between the first location 410 and the potential waypoint 414. In one embodiment, this request could be made through a menu displayed on the display screen of the device. Other mechanisms for requesting the recalculation of course 404 are also possible. Additionally, in the situation where the user does not like the recalculated course 403, the user can reposition the potential waypoint 414 to a new location and allow a course  
10           between the new location and the first location 410 to be analyzed.

          Figure 4C provides map display 400 having recalculated course 403. In Figure 4C, the potential waypoint (414 of Figures 4A and 4B) has now been designated by the user to be a second location 430. The user can select a new potential waypoint 414 so  
15           that an additional portion of course 404 can be analyzed. In the embodiment shown in Figure 4C, another preselected condition has been identified between the second location 430 and the potential waypoint 414. As such, a new portion of the course between 430 and 414 has been highlighted to indicate that at least one preselected condition has been identified in this portion of the course 403. Highlighting in the instant case is provided  
20           by a bolding of the line representative course 403 in a region 434. At this point, the device can once again calculate one or more possible courses around the preselected condition.

          Figure 4D provides an additional embodiment of a map display 450, where cartographic data, including the marine craft data, is dynamically analyzed for  
25           preselected conditions in a predetermined area 454 around the first location 456. In the present embodiment, the first location 456 includes the present location of the device as determined using a GPS signal or other triangulation signals. In the embodiment shown in Figure 4D, the cartographic data, including the marine craft data, of the predetermined area 454 is dynamically analyzed for preselected conditions. In the present example, an  
30           alert signal 460 for at least one preselected condition within the predetermined area 454 is shown in Figure 4D.

In the present embodiment, the alert signal 460 is provided as a highlighted area that contains the one or more preselected conditions. In addition, one or more text messages may be associated with and displayed on display 470. For example, the one or more text messages may be automatically displayed on the display 470. The user may  
5 also interact with the marine device to request further information regarding the alert signal 460. When more than one alert signal is present on a display, each alert signal can be identified by a unique designator (e.g., "AX7") for which the user can request additional information.

The predetermined area 454 to be analyzed can be refreshed at a preselected rate  
10 so as to ensure that the first location 456 does not move out of the current analyzed area (e.g., area 454) prior to the analysis being refreshed. In one embodiment, the present speed, average speed, potential top speed, and heading of the marine craft can all be used in determining a refresh rate for analyzing subsequent predetermined area to ensure that the marine craft does not move out of the predetermined area 454 prior to the analysis  
15 being refreshed. Figure 4D also shows examples of previously analyzed areas 472, shown with, for example, broken lines. Other ways of representing the previously analyzed areas 472 are also possible, including not showing the previously analyzed areas.

In an additional embodiment, the device can further, optionally, provide  
20 alternative visual alerts to the encountered preselected conditions, audio to present the alert signal, and/or text messages displayed on the display that indicates the preselected conditions encountered in calculating the course and, optionally, indicators of their approximate locations along the course.

Figure 4E provides an additional embodiment of a map display 476, where  
25 cartographic data, including the marine craft data, can be dynamically analyzed for preselected conditions in a user defined graphical filter area 478. The size and shape of the user defined graphical filter area 478 can be selected by a user. In the embodiment shown in Figure 4E, the user defined graphical filter area 478 is shown positioned over both water 480 and at least one preselected condition (e.g., land 482). The user defined  
30 graphical filter area 478 provides a visually defined area that a user can, for example,

position at one or more locations, including being dragged over, the map display 476 so as to identify the location of preselected conditions.

In the present example, an alert signal 486 for at least one preselected condition within the user defined graphical filter area 478 is shown in Figure 4E, in which the land 482 within the user defined graphical filter area 478 has a first color (e.g., black) that is different than a second color (e.g., grey) of land 490 outside of the user defined graphical filter area 478. One or more text messages may be associated with and displayed on display 476. Other visual and/or audio alerts to the encountered preselected conditions may also be used in conjunction with, or for, the alert signal 486 for at least one preselected condition within the user defined graphical filter area 478 in Figure 4E.

Embodiments of the present invention include software, application modules, and computer executable instructions operable on the devices and systems described herein. The embodiments, however, are not limited to any particular operating environment. Nor is the software limited to software written in a particular programming language. Thus, the invention includes a set of instructions executable by an information handling system to produce the embodiments described herein. That is, the software can reside on a free standing device as shown in Figures 2A and 2B and/or can, in some embodiments, be loaded, stored, and reside on a data cartridge.

Figures 5-7 are flow charts illustrating various method embodiments of the invention. As one of ordinary skill in the art will understand, the methods can be performed by software, application modules, and computer executable instructions operable on the systems and devices shown herein or otherwise. The invention, however, is not limited to any particular operating environment or to software written in a particular programming language.

Figure 5 is a flow chart illustrating one method according to an embodiment of the present invention. It should be understood by those of ordinary skill in the art that one or more of the methods provided herein may be executed in a different order than that described herein. That is, elements of each method claim do not need to be executed in the order shown unless it is stated herein that such order is explicitly required.

As shown in Figure 5, a method for marine navigation is provided. The method includes identifying a potential waypoint, 500. In the various embodiments, identifying

the potential waypoint can be accomplished by identifying the potential waypoint on or through a display, as discussed herein. At 510, a marine route calculation algorithm can be performed to analyze a course between a first location and the potential waypoint in view of preselected conditions. The first location can include, but is not limited to, a first  
5 waypoint, as may be selected by a user, or a present location, as may be determined by a GPS or other triangulation signals. So, for example, a course could be analyzed between the present location (i.e., the first location in this example is the present location) and the potential waypoint. In an additional example, a course could be analyzed between a first  
10 waypoint (i.e., the first location in this example is the first waypoint as set by a user) and the potential waypoint.

Performing the marine route calculation algorithm can include analyzing cartographic data, including the marine craft data that includes preselected conditions between the first location and the potential waypoint. The course analysis is performed to avoid the preselected conditions. One approach to avoiding the preselected conditions  
15 includes routing and/or re-routing the course to avoid the preselected conditions when the marine route calculation algorithm identifies one or more preselected conditions between the first location and the potential waypoint.

In re-routing the course calculated by the marine route calculation algorithm, the algorithm can further include identifying one or more non-user waypoints between the  
20 first location and the potential waypoint. These non-user waypoints represent the waypoints identified by the device in re-routing the course. Alert signals can be provided to the user when the analyzed cartographic data, including the marine craft data, between the first location and the potential waypoint includes preselected conditions. Providing the alert signal can include displaying a visual alert and/or emitting an audio alert. Other  
25 alert signals are also possible, such as, for example, a mechanical alert (e.g., vibration of the device).

Figure 6 is a flow chart illustrating an additional method according to an embodiment of the present invention. As shown in Figure 6, a method for marine navigation is provided. The method includes identifying a potential waypoint at 600. In  
30 the various embodiments, identifying the potential waypoint can be accomplished by identifying the potential waypoint on or through a display. Cartographic data, including

the marine craft data, for the area between a first location and the potential waypoint can be analyzed for preselected conditions at 610. In one example, analyzing the area between the first location and the potential waypoint includes identifying one or more preselected conditions in the area between the first location and the potential waypoint.

5           The one or more preselected conditions identified in the analysis can be used, along with other factors, in performing the marine route calculation algorithm to calculate the course so as to best avoid preselected conditions between the first location and the potential waypoint at 620. One approach to avoiding the preselected conditions includes re-routing the course to avoid the preselected conditions when the marine route  
10 calculation algorithm identifies one or more preselected conditions between the first location and the potential waypoint. Alert signals are provided to the user when the analyzed cartographic data, including the marine craft data, between the first location and the potential waypoint includes preselected conditions.

Figure 7 is a flow chart illustrating an additional method according to an  
15 embodiment of the present invention. As shown in Figure 7, a method for marine navigation is provided. The method includes identifying a user defined graphical filter area on a display at 700. In the various embodiments, identifying the user defined graphical filter area on the display can be accomplished through the use of a displayed cursor on a display screen, or through the display screen, as described in connection with  
20 Figure 3. Cartographic data, including the marine craft data, within the user defined graphical filter area can be analyzed for preselected conditions at 710. An alert signal can be provided at 720 when cartographic data within the user defined graphical filter area indicate preselected conditions.

In an additional embodiment, the method can further provide dynamic analysis for  
25 preselected conditions within the user defined graphical filter area. So, the user defined graphical filter area can, for example, be repositioned from a first location to a second location on the display screen. The user defined graphical filter area can be dynamically analyzed for preselected conditions as a user drags the user defined graphical filter area across the display screen. Based on the analysis, alert signals can be provided to the user  
30 of the device when the analyzed cartographic data, including the marine craft data, for the user defined graphical filter area includes preselected conditions.

The method sequence shown in Figures 5-7 can be repeated as many times as necessary, without limitation, in order to achieve a desired course. In addition, the analyzed cartographic data, including the marine craft data, between the first location and the potential waypoint can also be stored in the memory of the device so as to be available for repeated attempts at calculating a course according to the present invention. Thus, the present invention provides a system, device and method by which information received for a course and a reroute calculation can be maintained.

In addition, other variations on the above scenario are included within the scope of the present invention. That is, calculating the re-route can include calculating the re-route with a preference for avoiding one or more preselected conditions in any previous course. Thus, embodiments of the present invention provide methods by which one or more course and/or re-route analysis and/or calculations provide a course that best avoids courses with preselected conditions.

Although specific embodiments have been illustrated and described herein, those of ordinary skill in the art will appreciate that an arrangement calculated to achieve the same techniques can be substituted for the specific embodiments shown. This disclosure is intended to cover adaptations or variations of various embodiments of the invention. It is to be understood that the above description has been made in an illustrative fashion, and not a restrictive one. Combination of the above embodiments, and other embodiments not specifically described herein will be apparent to those of skill in the art upon reviewing the above description. The scope of the various embodiments of the invention includes other applications in which the above structures and methods are used. Therefore, the scope of various embodiments of the invention should be determined with reference to the appended claims, along with the full range of equivalents to which such claims are entitled.

It is emphasized that the Abstract is provided to comply with 37 C.F.R. § 1.72(b) requiring an Abstract that will allow the reader to quickly ascertain the nature of the technical disclosure. It is submitted with the understanding that it will not be used to limit the scope of the claims.

In the foregoing Detailed Description, various features are grouped together in a single embodiment for the purpose of streamlining the disclosure. This method of

disclosure is not to be interpreted as reflecting an intention that the embodiments of the invention require more features than are expressly recited in each claim. Rather, as the following claims reflect, inventive subject matter lies in less than all features of a single disclosed embodiment. Thus, the following claims are hereby incorporated into the  
5 Detailed Description, with each claim standing on its own as a separate embodiment.



WHAT IS CLAIMED IS:

1. A method for marine navigation, comprising:  
identifying a potential waypoint; and  
5 performing a marine route calculation algorithm to analyze a course between a first location and the potential waypoint in view of preselected conditions.
2. The method of claim 1, wherein performing the marine route calculation algorithm includes analyzing cartographic data that include preselected conditions  
10 between the first location and the potential waypoint with a preference for avoiding preselected conditions.
3. The method of claim 2, wherein performing the marine route calculation algorithm further includes re-routing the course to avoid the preselected conditions when  
15 the marine route calculation algorithm identifies one or more preselected conditions between the first location and the potential waypoint.
4. The method of claim 3, wherein re-routing the course calculated further includes identifying one or more non-user waypoints between the first location and the potential  
20 waypoint.
5. The method of claim 2, further including determining the first location on the course based on a signal from a global positioning system (GPS); and  
analyzing cartographic data for a predetermined area around the first location for  
25 preselected conditions.
6. The method of claim 5, further including providing an alert signal when the analyzed cartographic data for the predetermined area around the first location includes preselected conditions.  
30

7. The method of claim 2, further including providing an alert signal when the analyzed cartographic data between the first location and the potential waypoint includes preselected conditions.

5 8. The method of claim 7, wherein providing the alert signal includes emitting an audio alert.

9. The method of claim 7, wherein providing the alert signal includes displaying a visual alert.

10

10. The method of claim 1, further including receiving preselected conditions selected from the group of land, water depth, rock(s), sandbars, shelves, tide condition, tidal data, wind conditions, weather conditions, ice, above-water obstacles, underwater obstacles, type of water bottom, and prohibited areas.

15

11. A method for marine navigation, comprising:  
identifying a potential waypoint;  
analyzing cartographic data between a first location and the potential waypoint for preselected conditions; and

20

providing an alert signal when cartographic data between the first location and the potential waypoint indicate preselected conditions.

25

12. The method of claim 11, wherein performing the marine route calculation algorithm further includes re-routing the course to avoid the preselected conditions when the marine route calculation algorithm identifies one or more preselected conditions between the first location and the potential waypoint.

30

13. The method of claim 12, wherein re-routing the course further includes identifying one or more non-user waypoints between the first location and the potential waypoint.

14. The method of claim 11, further including providing an alert signal when the analyzed cartographic data between the first location and the potential waypoint includes preselected conditions.
- 5 15. The method of claim 11, further including determining the first location on the course based on a signal from a global positioning system (GPS); and  
analyzing cartographic data for a predetermined area around the first location for preselected conditions.
- 10 16. The method of claim 15, further including providing an alert signal when the analyzed cartographic data for the predetermined area around the first location includes preselected conditions.
17. The method of claim 11, wherein analyzing cartographic data further comprises  
15 acquiring cartographic data from a global positioning system (GPS).
18. The method of claim 11, further including receiving preselected conditions selected from the group of land, water depth, rock(s), sandbars, shelves, tide condition, tidal data, wind conditions, weather conditions, ice, above-water obstacles, underwater  
20 obstacles, type of water bottom, and prohibited areas.
19. A method for marine navigation, comprising:  
identifying a user defined graphical filter area on a display;  
analyzing cartographic data within the user defined graphical filter area for  
25 preselected conditions; and  
providing an alert signal when cartographic data within the user defined graphical filter area indicate preselected conditions.
20. The method of claim 19, wherein identifying the user defined graphical filter area  
30 includes repositioning the user defined graphical filter area.

21. The method of claim 19, wherein analyzing cartographic data further comprises acquiring cartographic data from a global positioning system (GPS).

22. The method of claim 19, further including receiving preselected conditions  
5 selected from the group of land, water depth, rock(s), sandbars, shelves, tide condition, tidal data, wind conditions, weather conditions, ice, above-water obstacles, underwater obstacles, type of water bottom, and prohibited areas.

23. A computer readable medium having a set of computer readable instructions, the  
10 set of computer readable instructions comprising instructions for:  
identifying a potential waypoint upon a first event; and  
performing a marine route calculation algorithm to analyze a course between a  
first location and the potential waypoint in view of preselected conditions.

15 24. The computer readable medium of claim 23, wherein performing the marine route calculation algorithm includes analyzing cartographic data between the first location and the potential waypoint to avoid preselected conditions.

25. The computer readable medium of claim 24, wherein performing the marine route  
20 calculation algorithm further includes re-routing the course to avoid the preselected conditions when the marine route calculation algorithm identifies one or more preselected conditions between the first location and the potential waypoint.

26. The computer readable medium of claim 25, wherein re-routing the course further  
25 includes identifying one or more non-user waypoints between the first location and the potential waypoint.

27. The computer readable medium of claim 23, further including determining the  
first location on the course based on a signal from a global positioning system (GPS); and  
30 analyzing cartographic data for a predetermined area around the first location for preselected conditions.

28. The computer readable medium of claim 27, further including providing an alert signal when the analyzed cartographic data for the predetermined area around the first location includes preselected conditions.

5

29. The computer readable medium of claim 23, wherein analyzing cartographic data further comprises acquiring cartographic data from a global positioning system (GPS).

30. The computer readable medium of claim 23, further including providing an alert signal when the analyzed cartographic data between the first location and the potential waypoint includes preselected conditions.

10

31. The computer readable medium of claim 30, wherein providing the alert signal includes emitting a signal for an audio alert.

15

32. The computer readable medium of claim 30, wherein providing the alert signal includes displaying a visual alert.

20

33. The computer readable medium of claim 23, further including receiving preselected conditions selected from the group of land, water depth, rock(s), sandbars, shelves, tide condition, tidal data, wind conditions, weather conditions, ice, above-water obstacles, underwater obstacles, type of water bottom, and prohibited areas.

25

34. An electronic marine navigation device, comprising:  
a processor;  
a location input operatively coupled to the processor, wherein the location input receives a first location and a potential waypoint separate from the first location; and  
a memory operatively coupled to the processor and the location input, the memory having cartographic data including preselected conditions, wherein the processor operates on a marine route calculation algorithm to analyze a course between the first

30

location and the potential waypoint in view of preselected conditions of the cartographic data.

35. The electronic marine navigation device of claim 34, wherein the processor  
5 operates on the route calculating algorithm to analyze cartographic data to identify and avoid preselected conditions in the course between the first location and the potential waypoint.

36. The electronic marine navigation device of claim 35, wherein the processor  
10 operates on the route calculating algorithm to re-route the course to avoid the preselected conditions when the processor operating on the marine route calculation algorithm identifies one or more preselected conditions between the first location and the potential waypoint.

15 37. The electronic marine navigation device of claim 36, wherein the processor operates on the route calculating algorithm to identify one or more non-user waypoints between the first location and the potential waypoint.

38. The electronic marine navigation device of claim 35, further including a receiver  
20 for a global positioning system (GPS) operatively coupled to the processor, wherein the processor determines the first location on the course based on a signal received from the GPS, and analyzes cartographic data for a predetermined area around the first location for preselected conditions.

25 39. The electronic marine navigation device of claim 38, wherein the processor provides an alert signal when the analyzed cartographic data for the predetermined area around the first location includes preselected conditions.

40. The electronic marine navigation device of claim 35, wherein the processor  
30 provides an alert signal when the analyzed cartographic data between the first location and the potential waypoint includes preselected conditions.

41. The electronic marine navigation device of claim 34, wherein the location input receives a user defined graphical filter area, and wherein the processor operates on the marine route calculation algorithm to analyze cartographic data within the defined graphical filter area for preselected conditions and wherein the processor provides an alert signal when the analyzed cartographic data for the user defined graphical filter area includes preselected conditions.

## **Methods, Systems, and Devices for Cartographic Alerts**

### **Abstract of the Disclosure**

Systems, devices, and methods are provided for marine navigation and course  
5 calculation for avoiding preselected conditions. An electronic marine navigation device  
with marine course calculation capabilities includes a processor connected to a memory  
that includes cartographic data. A potential waypoint can be identified and a marine  
route calculation algorithm can be preformed to calculate a course between a first  
location and the potential waypoint in view of preselected conditions. Performing the  
10 marine route calculation algorithm includes analyzing the cartographic data for the area  
between the first location and the potential waypoint with a preference for providing a  
course that avoids preselected conditions. A display is connected to the processor and is  
capable of displaying the calculated course and cartographic data. The device is also  
adapted to dynamically analyze an area surrounding the first location for preselected  
15 conditions and display the results of the analysis.



TITLE: METHODS, SYSTEMS, AND DEVICES FOR CARTOGRAPHIC HAZARD ALERTS  
INVENTOR: Camrin W. Kabel et al.  
DUCKET NO.: 702,234

1/10

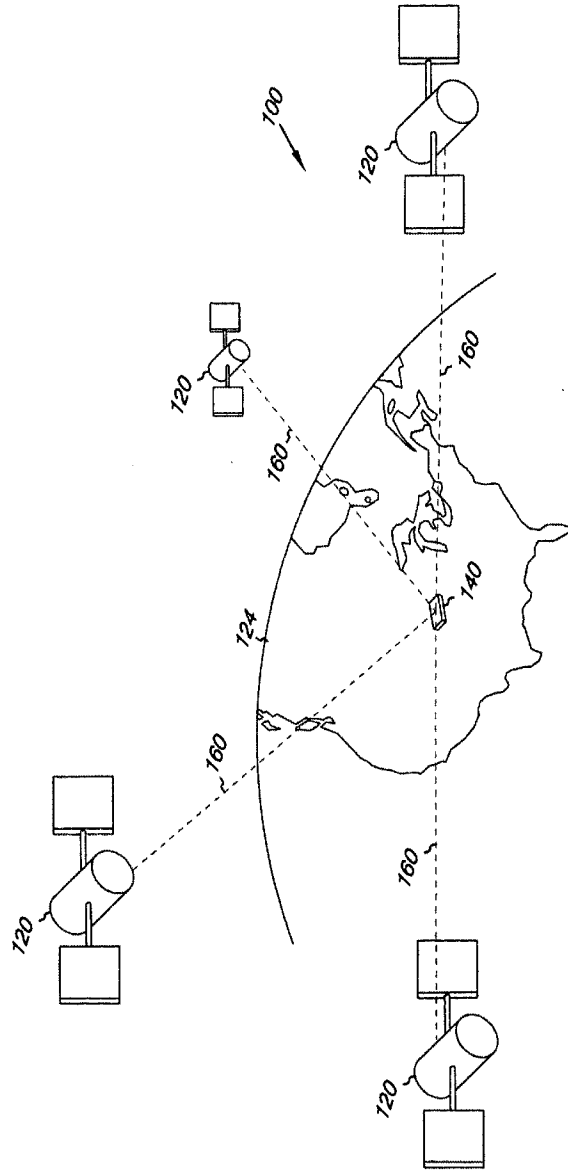
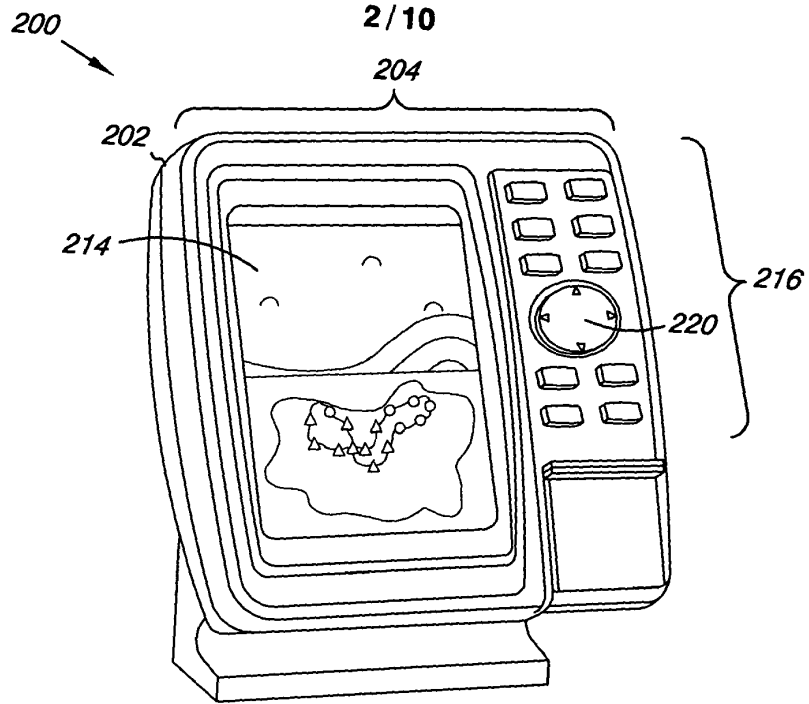
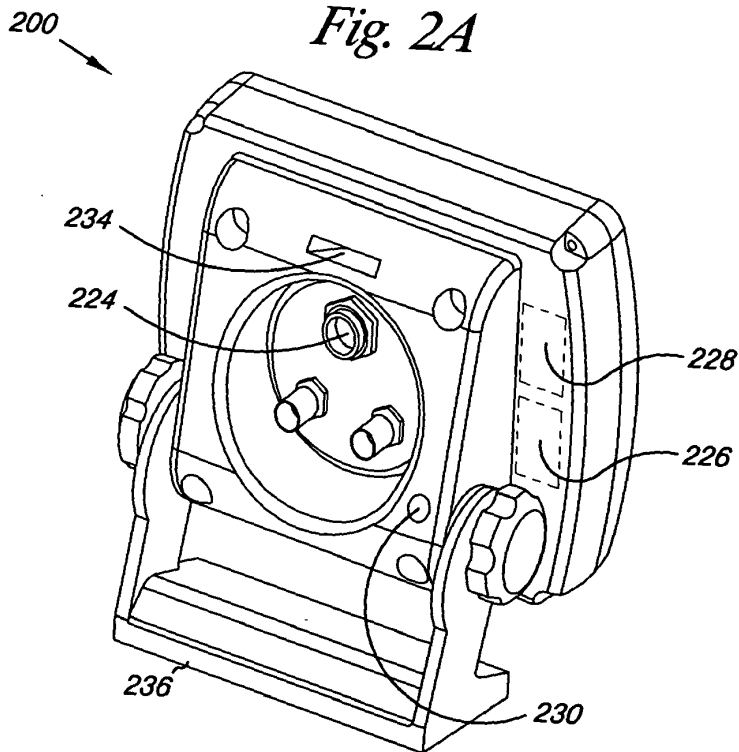

Fig. 1



*Fig. 2A*



*Fig. 2B*

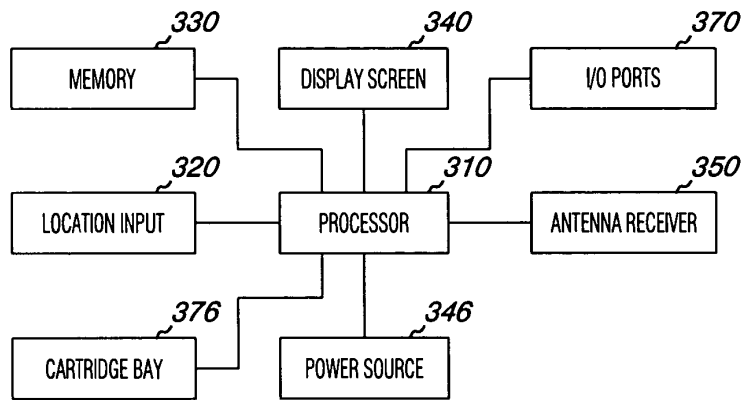

*Fig. 3*

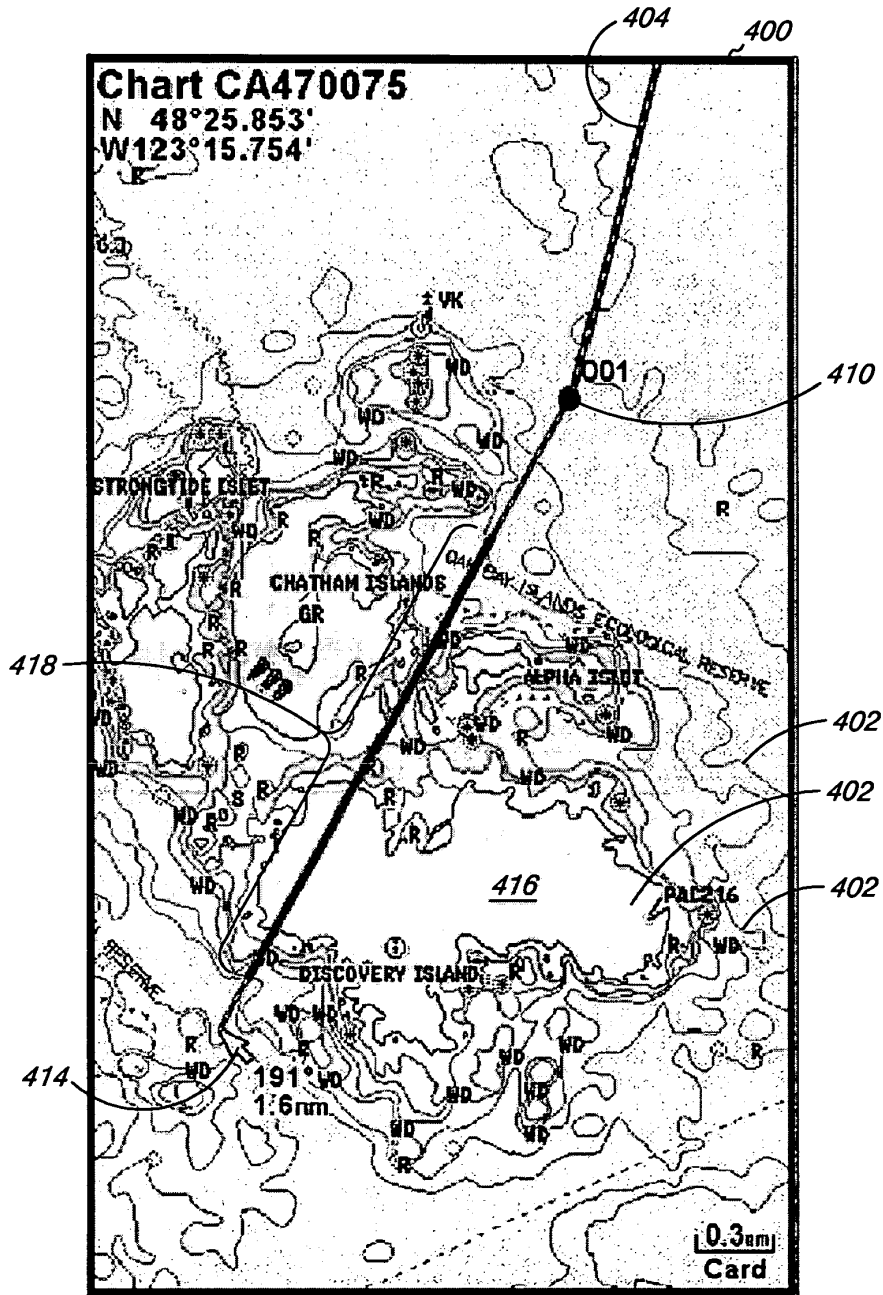

Fig. 4A

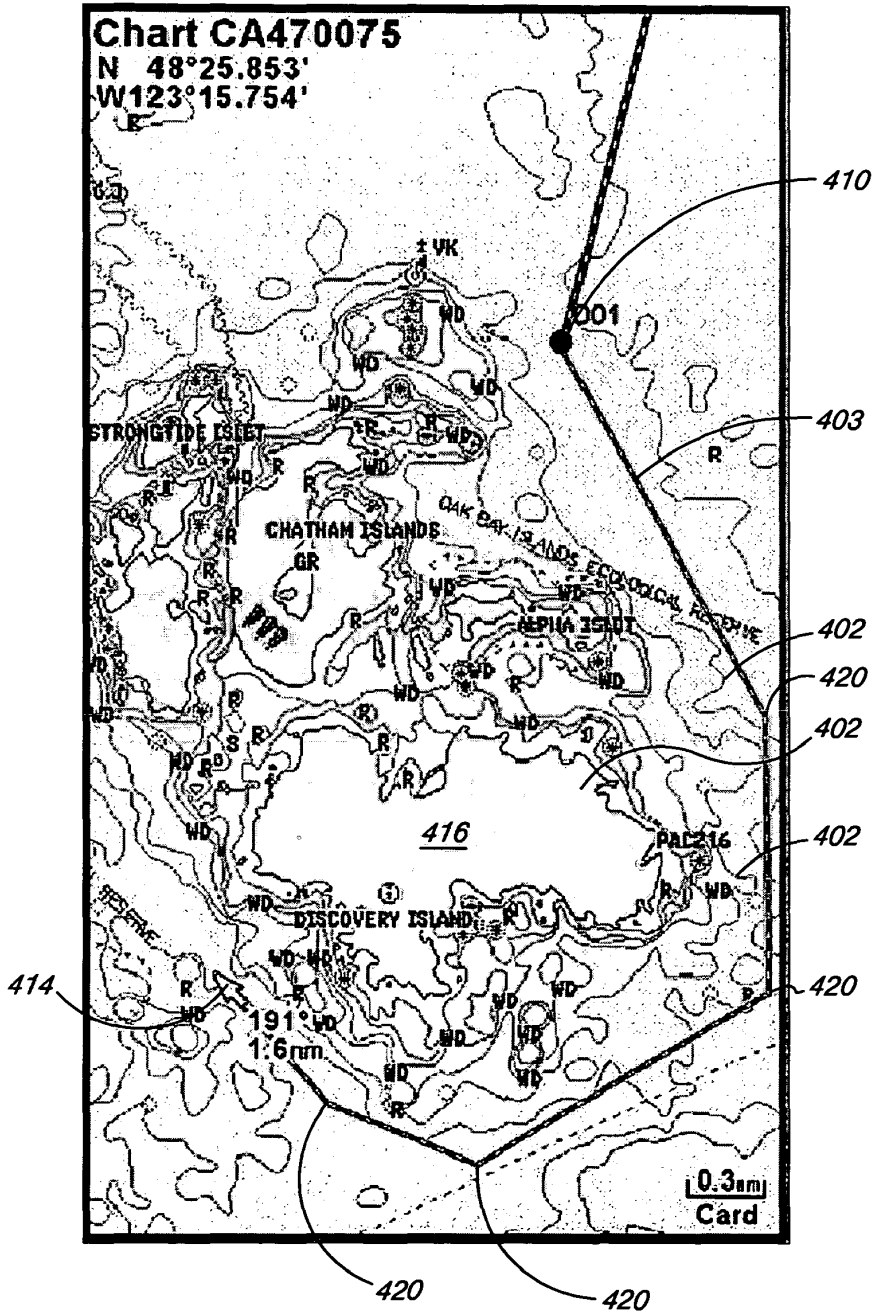

Fig. 4B

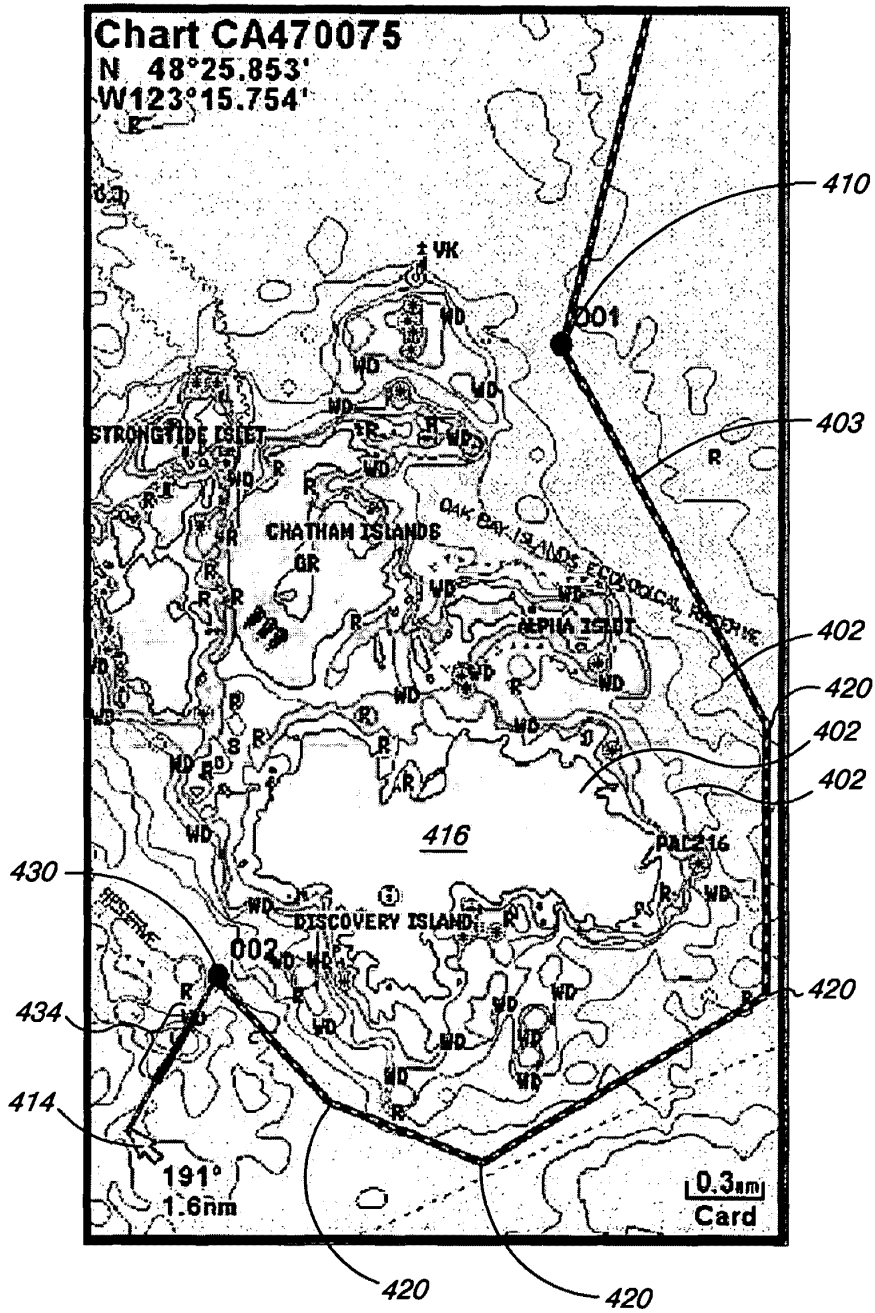

Fig. 4C

7

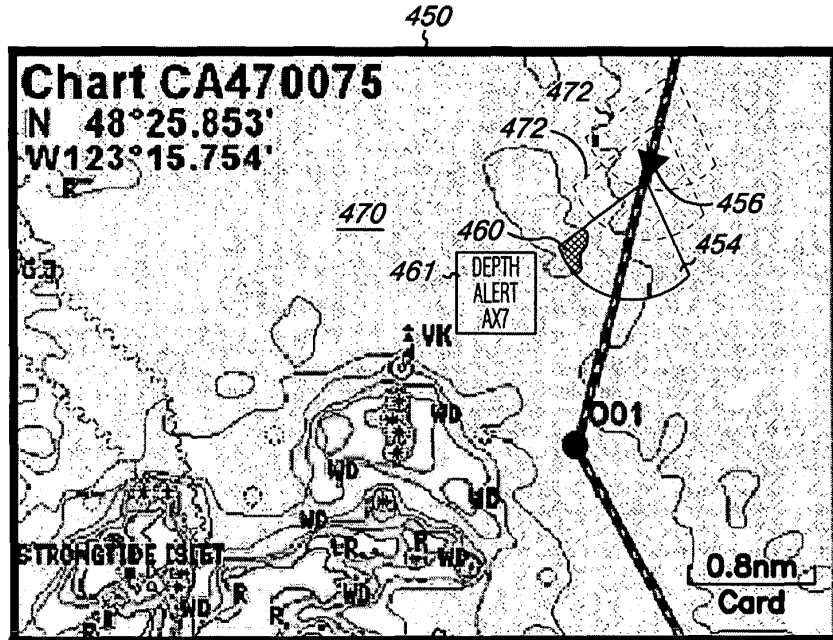

Fig. 4D

L

8/10

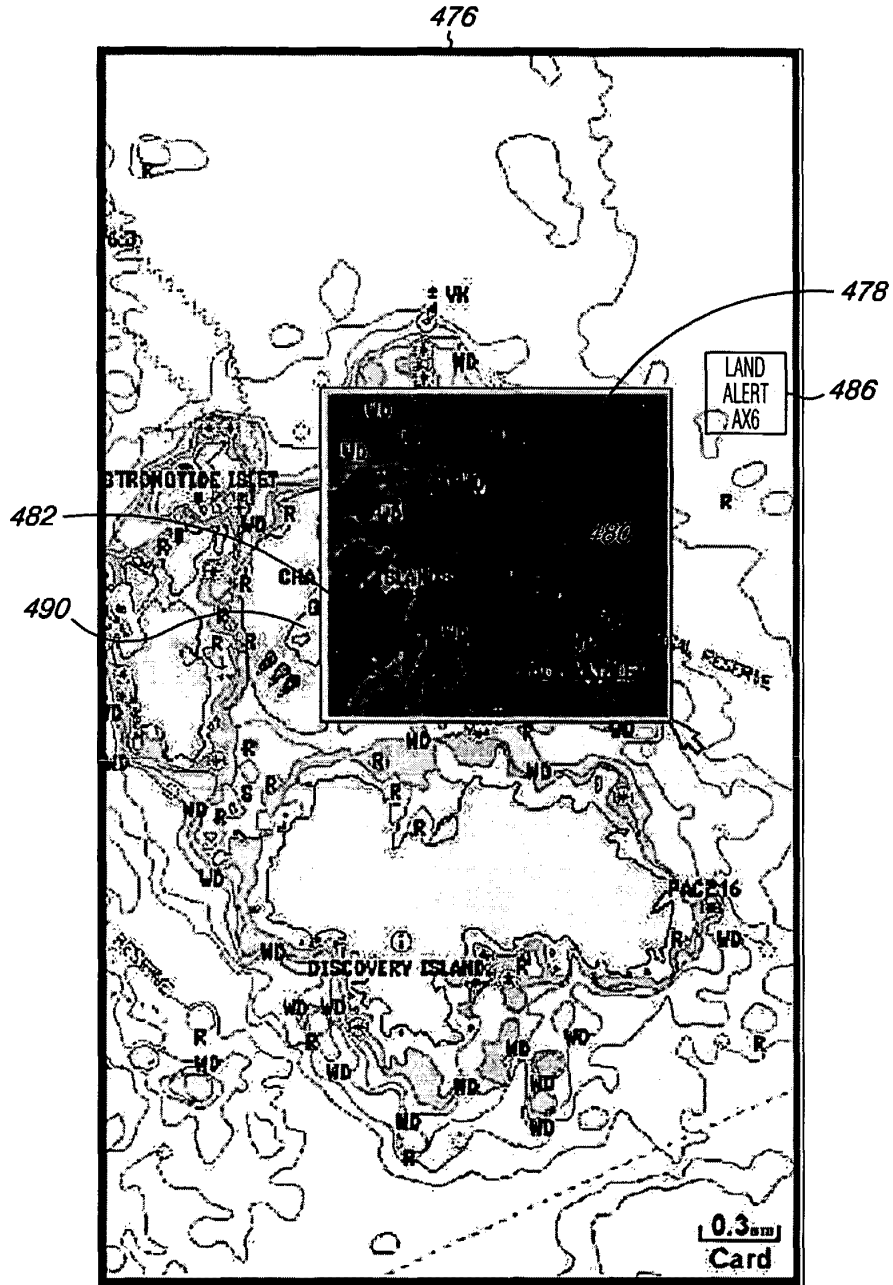
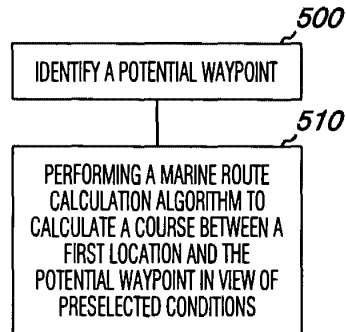
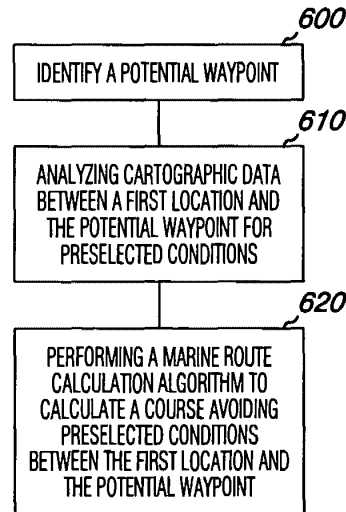

Fig. 4E

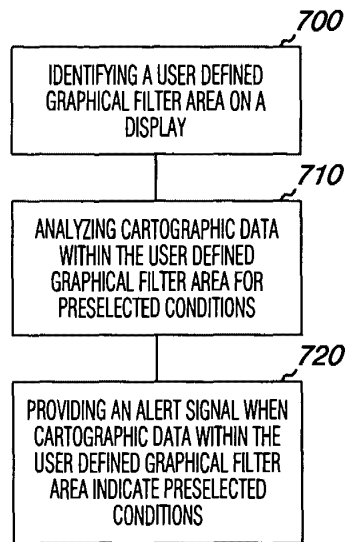



*Fig. 5*



*Fig. 6*



*Fig. 7*

## JOINT DECLARATION FOR PATENT APPLICATION

As below-named inventors, we hereby declare that:

Our residence, post office address and citizenship are as stated below next to our respective names.

We believe we are the original, first and joint inventors of the subject matter which is claimed and for which a patent is sought on the invention entitled **METHODS, SYSTEMS, AND DEVICES FOR CARTOGRAPHIC ALERTS**, the specification of which is attached hereto.

We hereby state that we have reviewed and understand the contents of the above-identified specification, including the claims, as amended by any amendment referred to above.

We acknowledge the duty to disclose information which is material to the examination of this application in accordance with Title 37, Code of Federal Regulations, 1.56(a), including for continuation-in-part applications, material information which became available between the filing date of the prior application and the national or PCT international filing date of the continuation-in-part application.

We hereby claim foreign priority benefits under Title 35, United States Code, § 119(a)-(d) or (f), or 365(b) of any foreign application(s) for patent or inventor's or plant breeder's right certificate(s), or 365(a) of any PCT international application which designated at least one country other than the United States of America, listed below and have also identified below any foreign application for patent, inventor's or plant breeder's rights certificate(s), or any PCT international application having a filing date before that of the application on which priority is claimed: None.

We hereby claim the benefit under Title 35, United States Code, § 120 of any United States application(s) listed below and, insofar as the subject matter of each of the claims of this application is not disclosed in the prior United States application in the manner provided by the first paragraph of Title 35, United States Code, § 112, we acknowledge the duty to disclose material information as defined in Title 37, Code of Federal Regulations, 1.56(a) which occurred between the filing date of the prior application and the national or PCT international filing date of this application: None.

We hereby appoint the following attorneys to prosecute this application and to transact all business in the Patent and Trademark Office connected therewith and to file and prosecute any corresponding foreign applications, including any international applications under the Patent Cooperation Treaty or the European Patent Convention: Devon A. Rolf, Reg. No. 35,337. Address all correspondence to: Devon A. Rolf, Garmin International, Inc., 1200 East 151<sup>st</sup> Street, Olathe, Kansas 66062, telephone number (913) 397-8200. Power of attorney is also given to: Edward J. Brooks, III, Reg. No. 40,925; Jeffrey L. Cameron, Reg. No. 43,527; and Joseph C. Huebsch, Reg. No. 42,673, all of the firm of E.J. Brooks & Associates, PLLC, 1221 Nicollet Avenue, Suite 500, Minneapolis, MN 55403.

We hereby declare that all statements made herein of our own knowledge are true and that all statements made on information and belief are believed to be true; and further that these statements were made with the knowledge that willful false statements and the like so made are punishable by fine or imprisonment, or both, under Section 1001 of Title 18 of the United States Code and that such willful false statements may jeopardize the validity of the application or any patent issued thereon.

Inventor's signature:  \_\_\_\_\_ 9/16/03  
Darin W. Kabel Date

Residence: Overland Park, Johnson County, Kansas  
Citizenship: United States of America  
Post Office Address: 15116 Horton  
Overland Park, KS 66223

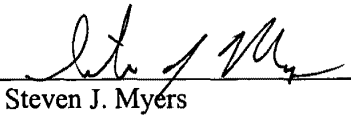
Inventor's signature:  \_\_\_\_\_ 9/16/03  
Steven J. Myers Date

Residence: Edgerton, Johnson County, Kansas  
Citizenship: United States of America  
Post Office Address: 21310 Evening Star Road  
Edgerton, KS 66021

§ 1.56 Duty to disclose information material to patentability.

(a) A patent by its very nature is affected with a public interest. The public interest is best served, and the most effective patent examination occurs when, at the time an application is being examined, the Office is aware of and evaluates the teachings of all information material to patentability. Each individual associated with the filing and prosecution of a patent application has a duty of candor and good faith in dealing with the Office, which includes a duty to disclose to the Office all information known to that individual to be material to patentability as defined in this section. The duty to disclose information exists with respect to each pending claim until the claim is canceled or withdrawn from consideration, or the application becomes abandoned. Information material to the patentability of a claim that is canceled or withdrawn from consideration need not be submitted if the information is not material to the patentability of any claim remaining under consideration in the application. There is no duty to submit information which is not material to the patentability of any existing claim. The duty to disclose all information known to be material to patentability is deemed to be satisfied if all information known to be material to patentability of any claim issued in a patent was cited by the Office or submitted to the Office in the manner prescribed by §§ 1.97(b)-(d) and 1.98. However, no patent will be granted on an application in connection with which fraud on the Office was practiced or attempted or the duty of disclosure was violated through bad faith or intentional misconduct. The Office encourages applicants to carefully examine:

- (1) prior art cited in search reports of a foreign patent office in a counterpart application, and
- (2) the closest information over which individuals associated with the filing or prosecution of a patent application believe any pending claim patentably defines, to make sure that any material information contained therein is disclosed to the Office.

(b) Under this section, information is material to patentability when it is not cumulative to information already of record or being made of record in the application, and

- (1) It establishes, by itself or in combination with other information, a prima facie case of unpatentability of a claim; or
- (2) It refutes, or is inconsistent with, a position the applicant takes in:
  - (i) Opposing an argument of unpatentability relied on by the Office, or
  - (ii) Asserting an argument of patentability.

A prima facie case of unpatentability is established when the information compels a conclusion that a claim is unpatentable under the preponderance of evidence, burden-of-proof standard, giving each term in the claim its broadest reasonable construction consistent with the specification, and before any consideration is given to evidence which may be submitted in an attempt to establish a contrary conclusion of patentability.

(c) Individuals associated with the filing or prosecution of a patent application within the meaning of this section are:

- (1) Each inventor named in the application;
- (2) Each attorney or agent who prepares or prosecutes the application; and
- (3) Every other person who is substantively involved in the preparation or prosecution of the application and who is associated with the inventor, with the assignee or with anyone to whom there is an obligation to assign the application.

(d) Individuals other than the attorney, agent or inventor may comply with this section by disclosing information to the attorney, agent, or inventor.

PATENT APPLICATION SERIAL NO. \_\_\_\_\_

U.S. DEPARTMENT OF COMMERCE  
PATENT AND TRADEMARK OFFICE  
FEE RECORD SHEET

09/25/2003 AADDF01 00000052 501791 10667026

01 FC:1001	750.00 DA
02 FC:1201	168.00 DA
03 FC:1202	378.00 DA

PTO-1556  
(5/87)

**PATENT APPLICATION FEE DETERMINATION RECORD**  
Effective January 1, 2003

Application or Docket Number

702.254

**CLAIMS AS FILED - PART I**

	(Column 1)	(Column 2)
TOTAL CLAIMS	41	
FOR	NUMBER FILED	NUMBER EXTRA
TOTAL CHARGEABLE CLAIMS	41 minus 20 = *	21
INDEPENDENT CLAIMS	5 minus 3 = *	2
MULTIPLE DEPENDENT CLAIM PRESENT		<input type="checkbox"/>

\* If the difference in column 1 is less than zero, enter "0" in column 2

**SMALL ENTITY TYPE**  OR

**OTHER THAN SMALL ENTITY**

RATE	FEE	OR	RATE	FEE
BASIC FEE	375.00	OR	BASIC FEE	750.00
X\$ 9=		OR	X\$18=	
X42=		OR	X84=	168
+140=		OR	+280=	
TOTAL		OR	TOTAL	

**CLAIMS AS AMENDED - PART II**

	(Column 1)	(Column 2)	(Column 3)
<b>AMENDMENT A</b>	CLAIMS REMAINING AFTER AMENDMENT		HIGHEST NUMBER PREVIOUSLY PAID FOR
	Total	* Minus	** =
	Independent	* Minus	*** =
FIRST PRESENTATION OF MULTIPLE DEPENDENT CLAIM <input type="checkbox"/>			

**SMALL ENTITY** OR

**OTHER THAN SMALL ENTITY**

RATE	ADDITIONAL FEE	OR	RATE	ADDITIONAL FEE
X\$ 9=		OR	X\$18=	
X42=		OR	X84=	
+140=		OR	+280=	
TOTAL ADDIT. FEE		OR	TOTAL ADDIT. FEE	

	(Column 1)	(Column 2)	(Column 3)
<b>AMENDMENT B</b>	CLAIMS REMAINING AFTER AMENDMENT		HIGHEST NUMBER PREVIOUSLY PAID FOR
	Total	* Minus	** =
	Independent	* Minus	*** =
FIRST PRESENTATION OF MULTIPLE DEPENDENT CLAIM <input type="checkbox"/>			

RATE	ADDITIONAL FEE	OR	RATE	ADDITIONAL FEE
X\$ 9=		OR	X\$18=	
X42=		OR	X84=	
+140=		OR	+280=	
TOTAL ADDIT. FEE		OR	TOTAL ADDIT. FEE	

	(Column 1)	(Column 2)	(Column 3)
<b>AMENDMENT C</b>	CLAIMS REMAINING AFTER AMENDMENT		HIGHEST NUMBER PREVIOUSLY PAID FOR
	Total	* Minus	** =
	Independent	* Minus	*** =
FIRST PRESENTATION OF MULTIPLE DEPENDENT CLAIM <input type="checkbox"/>			

RATE	ADDITIONAL FEE	OR	RATE	ADDITIONAL FEE
X\$ 9=		OR	X\$18=	
X42=		OR	X84=	
+140=		OR	+280=	
TOTAL ADDIT. FEE		OR	TOTAL ADDIT. FEE	

\* If the entry in column 1 is less than the entry in column 2, write "0" in column 3.

\*\* If the "Highest Number Previously Paid For" IN THIS SPACE is less than 20, enter "20."

\*\*\* If the "Highest Number Previously Paid For" IN THIS SPACE is less than 3, enter "3."

The "Highest Number Previously Paid For" (Total or Independent) is the highest number found in the appropriate box in column 1.