

**IN THE UNITED STATES PATENT AND TRADEMARK OFFICE  
BEFORE THE PATENT TRIAL AND APPEAL BOARD**

---

In re U.S. Patent No. 7,268,703

Filed: Sep. 18, 2003

Issued: Sep. 11, 2007

Named Inventors: Darrin W. Kabel, Steven J. Myers

Original Assignee: Garmin Ltd.

Title: Methods, systems, and devices for cartographic alerts

---

**DECLARATION OF CHRISTINE MIDDLETON**

I, Christine Middleton, make this declaration in connection with the petition for *inter partes* review submitted by Petitioner for U.S. Patent No. 7,268,703 (“the 703 Patent”). All statements herein are made of my own personal knowledge. I am over age 21 and otherwise competent to make this declaration. I have not received any compensation in return for making this declaration and have no financial or other interest in the Petitioner, the Patent Owner, or the outcome of this or any other legal proceedings relating to the 703 Patent.

1. I am the Associate Director (Content and Discovery) of Libraries, Research and Learning Resources at the University of Nottingham. I attended the University of Nottingham as an undergraduate and graduated with a degree in mechanical engineering in 1980. I have

been employed by the University of Nottingham in positions relating to library and information services continuously since 1993. Specifically, I served as (1) the Faculty Team Leader (Science and Engineering) for the Information Services department from 1993 to 2009; (2) the Head of Academic Services for the Information Services department from 2009 to 2014; and (3) the Associate Director (Content and Discovery) of Libraries, Research and Learning Resources—my current position—from 2014 to the present.

2. As a result of my employment experience, I am intimately familiar with and have personal knowledge of both the University of Nottingham's current library policies and procedures and those that were in place in 2002, including the policies and procedures regarding the receipt, indexing, and public availability of student theses and dissertations.

3. The University of Nottingham is a premier global research institution that originated with the 1881 founding of Nottingham's first civic college and was officially chartered as the University of Nottingham in 1948. The University has campuses in England, Malaysia (opened 2000), and China (opened 2004). The University of Nottingham library system has over one million printed documents and, based upon my personal experience, has been frequently utilized by researchers in a wide variety of scientific and technical fields for decades.

4. According to standard University of Nottingham library policies and procedures that were in effect in August 2002, student theses and dissertations are indexed in the library catalogue and are made freely available to both the faculty and student body of the University, and the general public. The library catalogue is electronically searchable by subject,

author, and keyword, and was searchable in this way in August 2002.

5. The University of Nottingham possesses a copy of a dissertation by Wichert J. de Jong entitled *Automated Route Planning – A Network-Based Route Planning Solution for Marine Navigation* (the “de Jong Dissertation”). According to University of Nottingham records, the de Jong Dissertation was indexed in the University library catalogue and made available to the public on August 6, 2002, and was removed from public availability on April 26, 2013. Exhibit A to this declaration is the original de Jong Dissertation that the University of Nottingham added to its library catalogue and made available to the public between 2002 and 2013.

6. Exhibit B to this declaration is a screenshot of the University of Nottingham library electronic catalogue entry for the de Jong Dissertation that I generated from University of Nottingham’s electronic recordkeeping system. In accordance with standard University of Nottingham policies and procedures, the “List of Catalogers” field contains a record of when a particular resource was added or removed from the catalogue. As is apparent from Exhibit B, the de Jong Dissertation was added to the catalogue on “06/08/02” which (under standard European date abbreviation conventions) corresponds to August 6, 2002.

7. Accordingly, University of Nottingham library records demonstrate that the de Jong Dissertation was catalogued in the University of Nottingham library and available to both the University community and the general public from August 6, 2002 to April 26, 2013.

I affirm and declare under penalty of perjury under the laws of the United States of America that all statements in this declaration made of my own knowledge are true and that all statements made on information and

belief are believed to be true. I understand that willful false statements and the like are punishable by fine, imprisonment, or both (18 U.S.C. § 1001), and may jeopardize the validity of an application or any patent issuing thereon.

Christine Middleton

\_\_\_\_\_

Date

Christine Middleton

Sworn to before me this 12<sup>th</sup> day of December, 2016.

RB Hammond

Signature, Notary Public



Richard Brian Hammond  
Notary Public  
England and Wales  
2 Kayes Walk  
Nottingham  
NG1 1PZ

# AUTOMATED ROUTE PLANNING

Heading JONG

Classmark TZM02

Book No. 1002814967

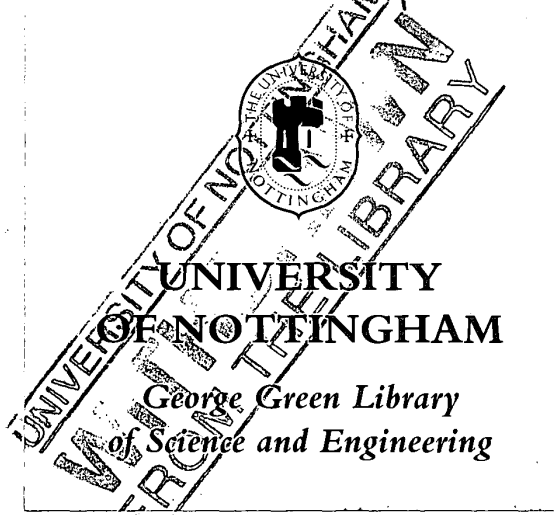

**FINAL TOUCH**  
Quality Thesis Binding  
Nottingham 9706062

This is Exhibit 'A' referred to in  
the declaration of Christine Middleton  
declared before me this 12<sup>th</sup> December  
2016  
R B Hammond  
RICHARD BRIAN HAMMOND

DATE DUE FOR RETURN

Richard Brian Hammond  
Notary Public  
England and Wales  
2 Kayes Walk  
Nottingham  
NG1 1PZ

UNIVERSITY OF NOTTINGHAM  
10.0281496  
WV  
FROM THE LIBRARY

UNIVERSITY OF NOTTINGHAM  
**WITHDRAWN**  
FROM THE LIBRARY

# **AUTOMATED ROUTE PLANNING**

## **A NETWORK-BASED ROUTE PLANNING SOLUTION FOR MARINE NAVIGATION**

Department of Nautical Sciences, Royal Netherlands Naval College

Institute of Engineering Surveying & Space Geodesy, University of Nottingham

Author:  
Wichert J. de Jong, LTZ3

Supervisor Royal Netherlands Naval College:  
H. Sabelis, KTZ ir.  
Head of the department of Nautical Sciences.

Supervisor University of Nottingham:  
N. Bonnor, Air Commodore



Bergen, December 2001

This dissertation is submitted to the Royal Netherlands Naval College in partial fulfilment of the scientific education for naval officers.

This dissertation is submitted to the University of Nottingham in partial fulfilment for the degree of Master of Science (Navigation Technology).



## Foreword.

This thesis was written as conclusion of my studies at the Royal Netherlands Naval College. In addition, this dissertation was submitted to the University of Nottingham, in partial fulfilment for the degree of Master of Science in Navigation Technology.

On the 14th of August 1996, I entered the Royal Dutch Navy, in order to fulfil my childhood dreams of sailing the seas. As my studies proceeded in the first three years of midshipman at the Royal Netherlands Naval College, my interest in especially navigation and its backgrounds grew. Therefore, I choose to attend the faculty of Nautical Sciences for the two years of specialisation. This choice also gave me the opportunity of attending the postgraduate MSc-course in Navigation Technology at the Institute of Engineering Surveying and Space Geodesy (IESSG) at the University of Nottingham.

During the lectures at the Royal Netherlands Naval College and the University of Nottingham, my interest was aroused in the modernisation of navigation, especially for the development of the Electronic Chart Display and Information System (ECDIS). Some research at the faculty of nautical sciences focussed on the automation of voyage planning. However, this research did not yet result in actual principles and algorithms. Therefore, I chose the subject of automation of route planning as the subject for this final project.

In addition to this thesis, Martijn van der Drift wrote his thesis on the same subject, but focussed on the exact form and the programming of the route planning algorithm. [Drift, 2001]

Now that my thesis is finished, I would like to thank a number of people. In the first place, I thank KTZ Ir. H. Sabelis, for the great enthusiasm he showed during his lectures and during the period of supervising my project. In the second place, I would like to thank Air Commodore Norman Bonnor for supervising my dissertation overseas. In the third place, I thank Martijn van der Drift for the close co-operation during the last months. I would like to thank Hanke for her great patience and unlimited support. Finally, I would like to thank my parents for their everlasting trust and support. Without all these people, I would never have come this far!

Den Helder, September 2001,

Wichert J. de Jong, LTZ3

## Abstract.

In this thesis, a solution is presented for automating a part of the voyage planning process in marine navigation, namely route planning. Another, better term, for route planning is route selection, since route planning is about selecting an optimal route. The presented principle is a network-based route finding solution under multiple criteria.

The voyage planning process is first analysed. A model presented by Sabelis [Sabelis, 1999(ii)], provides a good overview on the different phases of voyage planning. Also, it is made clear, that voyage planning is a time-consuming and laborious process. Automating the process can best be done by first automating the different phases. In that perspective, a principle is developed for automating the route planning phase.

Existing routes at sea are historically formed by depth and land contours, positions of harbours and international and national regulations. When analysing these, it shows that a network is already formed by the existing routes.

The components of the route-network and the structure of the network are meant to provide as many options as possible with appropriate coverage of the world. The route-network should be fitted into the ECDIS data structure, since ECDIS is the most suitable platform for the automation of route planning. Therefore, some recommendations are made to create new objects in S-57, the IHO transfer standard for digital hydrographic data. In order to test the principle, a chain-node data structure is used, mainly because of the simplicity of the structure.

The information that is required during the route planning phase is divided into the sailing order and the route characteristics. The sailing order contains the ship's characteristics and the mission characteristics. The route characteristics can be divided into dimensions, regulations and restrictions, navigational aspects and remaining aspects. The information requirements heavily depend on the classification (ocean, coastal or confined) of a passage. There are different sources of information but in order to automate the voyage planning process, all information should be available in ECDIS via ENC's or other data bases.

The route characteristics influence the decision process in terms of denial and preference. The information that denies passage through a route-segment is implemented as filter criteria in the filter algorithm; the information that influences the phase in terms of preference is implemented as criteria of preference in the decision algorithm.

The sequence of the presented algorithm is to firstly filter the unnavigable segments; then to calculate the shortest possible route; thirdly all possible routes within an interval are calculated, whereafter the route-alternatives are compared by means of the criteria of preference.

The presented principle seems to give the desired results, although more tests and new and reviewed criteria are required for optimisation of the algorithm. Also more research is needed in order to provide the perfect setting of weights.

## List of contents.

<b>Foreword.....</b>	<b>ii</b>
<b>Abstract.....</b>	<b>iii</b>
<b>List of contents.....</b>	<b>iv</b>
<b>I Preface.....</b>	<b>1</b>
I.1 Setting the scene.....	1
I.2 The project.....	2
I.3 The structure of this dissertation.....	4
<b>II Voyage planning.....</b>	<b>6</b>
II.1 The need for voyage planning.....	6
II.2 A model of the voyage planning-process.....	7
II.2.1 International regulations on voyage planning.....	7
II.2.2 The voyage planning-process according to Sabelis.....	7
II.2.3 Automating the voyage planning-process.....	9
II.3 Route planning.....	10
II.3.1 The route planning-cycle.....	10
II.3.2 Automating the route planning-process.....	11
II.4 Equivalentents in the navigation domains.....	12
II.5 Geographic Information Systems (GIS) and Electronic Chart Display and Information Systems (ECDIS).....	13
II.5.1 Geographic Information Systems.....	13
II.5.2 Electronic Chart Display and Information Systems (ECDIS).....	15
<b>III Route-network analysis.....</b>	<b>17</b>
III.1 Analysing the shipping routes at sea.....	17
III.2 Network and graphs.....	20
III.3 Route-network.....	22
III.3.1 Different components needed in the route-network.....	22
III.3.2 Positioning of the route-points and -segments.....	26
III.4 Designing the data structure.....	28
III.4.1 Some basics on data formats.....	28
III.4.2 Commonly used data structures.....	30
III.4.3 ECDIS: S-57 Transfer Standard for Digital Hydrographic Data [IHO, 1996].....	30
III.4.4 The route-network in S-57.....	34
III.4.5 Chain-node structure.....	35
<b>IV Route planning information requirements.....</b>	<b>38</b>
IV.1 Sailing order.....	38
IV.1.1 Mission characteristics needed for route selecting.....	38
IV.1.2 Ship's characteristics needed for route selection.....	40
IV.2 Some considerations on the required information for route-planning.....	42
IV.2.1 Sources & availability.....	42
IV.2.2 Ocean, coastal and confined passages.....	43
IV.3 Relevant passage information during the route-planning process.....	44
IV.3.1 Dimension characteristics.....	45
IV.3.2 Navigational aspects.....	46
IV.3.3 Regulations and restrictions.....	47
IV.3.4 Remaining aspects.....	49
IV.4 Relations between and influence of different kinds of information in the route-selection process.....	50
IV.4.1 Testing the passages in terms of suitability and feasibility.....	51
IV.4.2 Analysing the passages in terms of preferability of characteristics.....	52
IV.5 Implementation in the test-environment.....	53
IV.5.1 Implementation of Sailing Order characteristics in the test-environment.....	53
IV.5.2 Implementation of passage characteristics in the test-environment.....	54

<b>V</b>	<b>Route planning algorithm.</b>	<b>56</b>
V.1	Important considerations when automating route planning.	56
V.1.1	What is the optimal route?	56
V.1.2	The time-distance problem.	57
V.2	Structure of the route planning algorithm.	58
V.3	Preparing the data set for the algorithm.	61
V.3.1	Collecting the information.	61
V.3.2	Filtering.	61
V.3.3	Calculations.	63
V.4	Optimal route finding algorithm.	64
V.4.1	Dijkstra's algorithm for the shortest path.	64
V.4.2	Generating the $K$ – shortest paths.	66
V.4.3	Criteria of preference.	66
V.4.4	Group decision making under multiple criteria for selection of alternatives.	70
<b>VI</b>	<b>Testing the route planning algorithm.</b>	<b>75</b>
VI.1	Developing the test environment.	75
VI.1.1	The goal of testing the algorithm.	75
VI.1.2	Choice for a synthetic test environment.	75
VI.1.3	Often occurring situations.	76
VI.1.4	The final area.	77
VI.2	Test scenarios.	77
VI.2.1	The test ship.	77
VI.2.2	Scenario 1: Testing the filter algorithm and Dijkstra's algorithm.	78
VI.2.3	Scenario 2: Testing the decision algorithm in limited test areas.	79
VI.2.4	Scenario 3: Testing the whole algorithm in larger test areas.	81
<b>VII</b>	<b>Conclusions and recommendations.</b>	<b>84</b>
VII.1	Conclusions.	84
VII.1.1	The first question: the route-network.	84
VII.1.2	The second question: information requirements.	86
VII.1.3	The third question: the algorithm.	88
VII.2	Recommendations.	90
	<b>Glossary</b>	<b>92</b>
	<b>References</b>	<b>97</b>
	<b>List of figures</b>	<b>103</b>
	<b>Appendices</b>	<b>104</b>
	Appendix A: Traffic density chart: route bound traffic on the North Sea. [Traffic, 2000]	104
	Appendix B: Example of the positioning of route-segments	105
	Appendix C: Cargo classification and ice classification.	106
	Appendix D: Attributes and attribute values as used in the test-environment.	108
	Appendix E: Final chain-node structure as used in the test-environment.	112
	Appendix F: The synthetic test environment	115
	Appendix G: Test results of scenario 1.	116
	Appendix H: Test results of scenario 2.	120
	Appendix I: Test results of scenario 3.	127

# I Preface

## I.1 Setting the scene.

The present developments in navigation are especially dealing with automation. Even the conservative world of marine navigation is at the threshold of the computerised environment. A great deal of effort is being put into integrating navigation systems, developing the one-man-bridge and using computers as the new medium for publications. A large share of this effort is ascribed to the Electronic Chart Display and Information System (ECDIS), since the possibilities for development of this system are endless. In addition to the electronically displayed nautical chart, with the real-time presentation of the own ship's position and the projection of radar and ARPA (Automatic Radar Plotting Aid) information on top of the chart, having other kinds of information, such as sailing directions and lists of lights, at the users' disposal interactively should be possible in the future. The role of ECDIS should therefore be supportive in more disciplines than it is now.

A process, which is not always completed with the same *accuracy* and precision as appropriate as general navigation is the voyage planning-process. The planning of a voyage is rightly contemplated as a time-consuming and laborious activity. The great diversity of sources of information that have to be consulted during the planning-process makes the process cluttered and difficult. Among other possibilities that ECDIS offers, it should be able to support voyage planning. Research has been undertaken on the various digital storage methods and the presentation of all the required information, that is not displayed on the nautical chart [Carol, 1996]. However, the planning of a voyage in ECDIS is still only possible by clicking and dragging way-points with a mouse or track-ball; it is just a drawing tool. The only automated function with respect to route planning is checking the drawn track against a few features within a certain safety-zone around the track. No warning is giving on following the wrong traffic lane, for example. Neither can the optimal route be calculated.

This is remarkable, because in the other two navigation domains, land navigation and air navigation, these processes have been automated already. Widely available (e.g. on internet) are route planners for car navigation. By giving the start and end position (cities, streets or postal codes), the software is able to calculate the shortest route, either in length or in travelling time, using a real road network. It then presents the route on a digital map together with an information sheet. The same types of systems exist in air navigation, since aircraft use a network of airways and preferred routes. Spatial analyses are possible too (where is the

nearest gas station?), because these route planners are applications of dedicated Geographical Information Systems. Is an ECDIS not a special form of GIS? Hence, particularly an ECDIS forms an ideal environment for automated voyage planning. [Sabelis, 1999(ii)]

The voyage planning-process can be dissected into route planning, navigation planning and watch preparation. [Sabelis, 1999(ii)] Route planning deals with the selection of the route, navigation planning deals with the more detailed planning of the track and watch preparation should provide the officer of the watch with all information needed during his particular watch. All these steps are feasible for automation in one way or another. An automated tool for voyage planning should always be supportive, because safety of life and environment is involved. Decisions should thus always be the navigator's. During the preparation and execution of the watch, ECDIS should present relevant information dealing with the area the ship is, and will be, sailing. During the first two sub-processes, the software can generate route and track options without the active participation of the navigator. Given the fact that these stages of the voyage planning-process are the most laborious, route planning and navigation planning are ideal for automation.

This thesis will focus on the first process of voyage planning, route planning or route selection. Sabelis sketched the functionality of voyage planning software. [Sabelis, 1999(ii)] He supposed that a route-network should be a robust basis for route planning-algorithms. The use of such a network enables the developer of these algorithms to use the methods and knowledge on route planners from the other navigation domains. My thesis is based on the assumption that using a route-network as a basis for the selection of a route would offer a reasonable solution for the route planning-problem in marine navigation. I will not discuss what should be the best solution.

## **I.2 The project.**

The subject of this dissertation is automating the route planning-process. The main goal of my project is the development of a route planning-tool, which, based on a route-network, calculates an optimal route from the point of departure to the point of arrival. Within the route, the navigator can determine his track. In order to develop a route planning-tool as described above, an inventory of the features of such a tool is required. First, there has to be some kind of data storage and structure, which is geographically referenced and easy to access, to allow the system to analyse the information quickly and correctly. The route-network will form the basis for the data structure and information storage. Secondly, an

algorithm is needed, which both analyses and combines all information, and which calculates and optimises route-alternatives. In the third place, a presentation method is required. The method of presentation will not be an issue in this dissertation. The following two objectives are defined:

1. The development of a route-network at sea, which is suitable as basis for route planning-calculations.
2. The search for a simple shortest path algorithm, with which the route planning-problem can be solved, considering all the relevant information and in such way that the different options are feasible and navigable.

From these objectives, the following questions and sub-questions are formed and will be answered in this thesis:

- A. What should be the structure of a route-network, to provide a robust basis for a shortest route algorithm?
  - i. What data structure should be used for such a route-network, in order to provide the algorithm with the relevant information, and to provide compatibility with the Electronic Chart Display and Information System?
  - ii. What kinds of real routes can be distinguished at sea and with what kind of features can they be described adequately?
  - iii. How can such a network cover as many parts of the world as possible, without diminishing the calculation speed and extending disk storage?
- B. Which information is essential when selecting a route and should therefore be available to the shortest path algorithm?
  - i. What are the relevant characteristics of a passage that are essential for the selection of a route?
  - ii. How should the characteristics of a route-segment be implemented in the route-network?
  - iii. How should the influence of particular route characteristics be expressed in terms of preference?
  - iv. What are the ship's characteristics that are essential when selecting a route?
- C. How can the optimal route be calculated on the basis of a route-network?
  - i. What is the optimal route?
  - ii. How should the ship's characteristics 'delete' route-segments that can or may not be used?

iii. How is an 'optimal' route (and alternatives) calculated?

This project is carried out in co-operation with Martijn van der Drift. His project will focus on the development of the algorithm. He will engage himself in programming the algorithms and in discussing which algorithm is the most suitable solution for route planning at sea. The design of the test-environment as well as the testing is carried out together. If the reader is interested in his part of our project, he should read his dissertation [DRIFT, 2001].

### **I.3 The structure of this dissertation.**

This thesis consists of seven chapters, including the preface. In the first chapter an introduction in the subject is given. After the introduction, the objectives of this thesis are discussed and translated into three research questions and a number of sub questions.

Before we go into answering the questions, the reader is provided with the theory and backgrounds of the voyage planning process in chapter two. A model is used to describe the whole voyage planning process in order to clarify the role of route planning within that process. Some considerations are presented on the automation of the whole voyage planning process and the route planning process specifically. Also, the route planning equivalents in the other navigation domains are discussed, because of the fact that knowledge in the other domains could well be used for automation of voyage planning in marine navigation. Some important details on Geographical Information Systems (GIS) and the Electronic Chart Display and Information Systems (ECDIS) are discussed, since these are probably the systems a route planning tool should run on.

Chapter three then concentrates on the first research question, concerning the route-network. It starts with the analysis of the existing routes at sea, and how they were formed historically. These routes are used as a basis for positioning the required route-network components, that are discussed in the next paragraph. Also, the appropriate data structure is discussed, after some theory on networks and graphs is presented. Finally, the implementation in the S-57 data structure is described, as is the data structure that is used for testing the principle.

The next chapter all the route planning information requirements are analysed and presented in chronological order. The route planning phase starts with the definition of the sailing order, which includes ship's characteristics and mission characteristics. Then the required



route characteristics that influence the selection of the route are discussed. Finally, the kind of influence of the different types of information is described.

Chapter five considers all the aspects of the route planning algorithm. First, a definition of the best route is researched. Then, the important considerations and the logical sequence of the algorithm are discussed. The whole algorithm is presented in the following paragraphs.

In the next chapter, the test environment and the tests are described, followed by conclusions and recommendations in chapter seven.

Some words are printed in italics, which means that a definition of the term is listed in the glossary. After a term is mentioned, it will not be printed in italics again. The glossary also contains some important abbreviations.

## II Voyage planning.

In this first chapter, some important theory is presented, that is essential for the understanding the different subjects covered by this research. The chapter begins with the need for voyage planning and what it is all about. Then, a model of the voyage planning process is presented against the background of international regulations on voyage planning. The following paragraphs will discuss some issues on automation of the voyage planning and route-selection processes. In the fourth paragraph, existing equivalents to route-planning in all the navigation domains are described. Finally, some background on Geographical Information Systems (GIS) and Electronic Chart Display and Information Systems (ECDIS) complete the chapter.

### II.1 The need for voyage planning.

Before I go into the process of voyage planning more deeply, I should emphasise the need for a thorough preparation. The International Maritime Organisation (IMO) has set the present standard in the 'Guide to the planning and conduct of passages'. [IMO, 1978(i)] In paragraph three, the importance of planning and monitoring a passage is stated:

'...both planning of passages and the close and continuous monitoring of position during the execution of such plans are necessary and highly important in the interest of the safety of navigation.'

Still, many casualties occur, of which many are due to the lack of a thorough planning of the passage. Especially groundings and strandings could be avoided if the planning is carried out correctly.

In addition, it is important to state the objectives that can be achieved by planning a voyage. In the first place, the preparation provides a reference for the voyage enabling sensible monitoring of the ship's position. Monitoring the ship's state vector is only useful when all the safety limits and other important external factors in the vicinity of the ship are well defined. In the second place, dangerous situations and potential conflicts can be foreseen and hence prevented. When the mariner is aware of these situations and can identify the areas where potential conflicts can occur in advance, he can avoid these. Thirdly, planning is meant to provide a detailed scenario for the execution of a passage. The fourth objective is the possibility of optimising the route, in terms of travelling time or fuel consumption. The

utilisation of weather routing software, for example, can reduce the fuel consumption for an ocean passage.

## II.2 A model of the voyage planning-process.

### II.2.1 International regulations on voyage planning.

In order to provide a robust basis for automated route planning, I should use some sort of model of the process. A model provides a logical structure of voyage planning. In the aforementioned guide, the IMO distinguishes four stages in the planning and achievement of a safe passage, namely Appraisal, Planning, Execution and Monitoring. [IMO, 1978] Appraisal deals with the gathering of all information from charts and publications (e.g. sailing directions, Notices to Mariners, radio aids to navigation, etcetera). During the planning stage, a detailed plan of the passage is prepared, taking all gathered information into account. The execution stage should provide the navigator with all the tactics that will be used during the execution of the plan. The last stage, monitoring the ship's progress along the planned track, is then essential for the safe conduct of the passage.

In my opinion, the IMO omits to distinguish the difference between the choice of the trajectory and the detailed planning of a passage. The IMO deals directly with the (detailed) planning of a passage. This creates an illogical structure in the planning process. Sabelis [Sabelis, 1999(ii)] described the process in a more logical way and therefore I will base my research on his model of voyage planning.

### II.2.2 The voyage planning-process according to Sabelis.

Sabelis divided the voyage planning-process into three cycles, Route Planning, Navigation Planning and Watch Preparation. [Sabelis, 1999(ii)] Going through these cycles iteratively, every cycle results in a more detailed outcome (directives), starting with the sailing order and finally resulting in the navigation scenario. Furthermore, all cycles exist of four steps, namely Analysis, Synthesis, Decision and Direction (See figure II-1). All cycles and steps, including the directives are briefly explained below, in order to get a good view on the marine voyage planning-process.

The sailing order is the start of the whole voyage planning-process. All the demands are laid down in this directive, initiating the first cycle. During the first cycle, Route Planning, the best route has to be selected.<sup>1</sup> The outcome is the Route Plan, which is a description of the route

---

<sup>1</sup> Perhaps a better term is Route-selection. In the further thesis these two terms are used as synonyms.

that satisfies the conditions from the Sailing Order. The selected route is still not navigable; it is only an outline of which channel, sound, passage or traffic separation scheme will be passed.

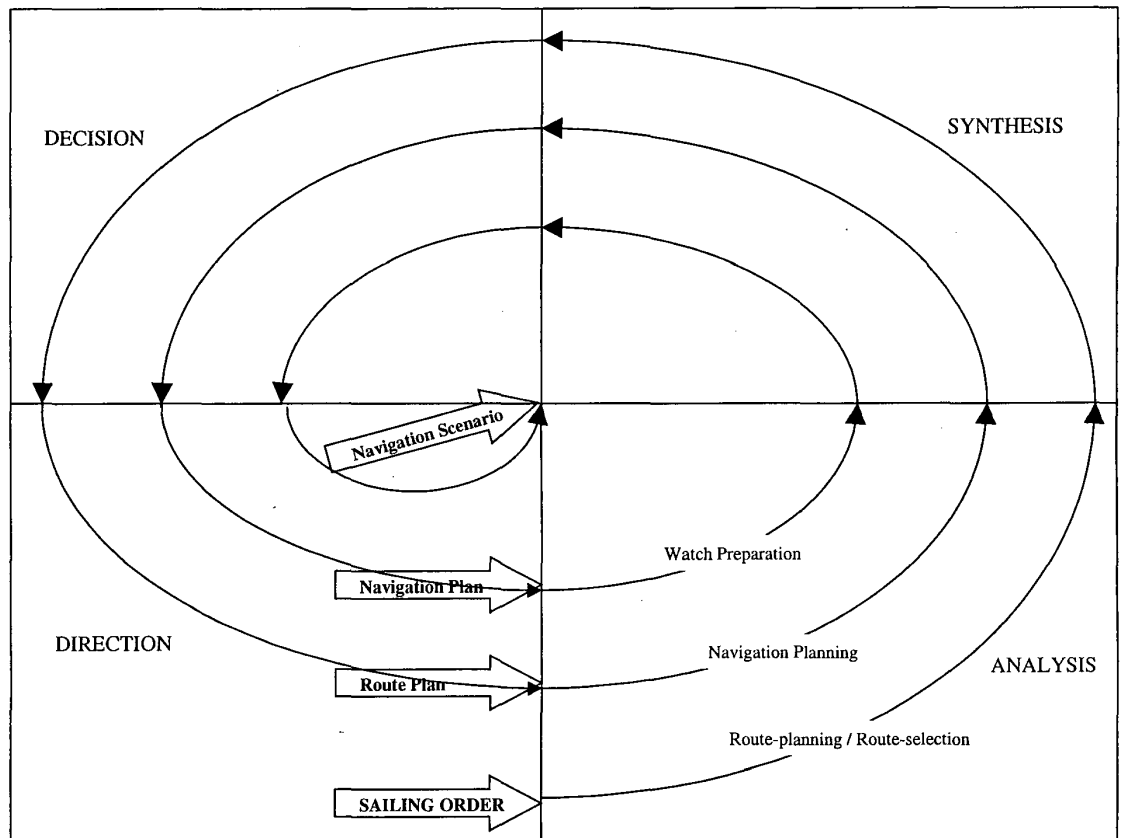

Figure II-1: Sabelis' model of the voyage planning-process. [Sabelis, 1999(ii)]

More detailed planning is done in the second cycle, Navigation Planning. The main question here is how to navigate within the selected route. The Navigation Plan, which contains track, safety margins, time schedules and procedures, is the outcome of this cycle. This plan is a guide for the officers of the watch, who will perform the third cycle, Watch Preparation. In this cycle, the officer of the watch will define all actions in detail, in order to be able to carry these out during his watch. The Navigation Scenario contains all the details, and is to be considered as the guide for that particular watch.

The four steps within every cycle are Analysis, Synthesis, Decision and Direction. In the first step the information requirement is stated, and this information is then gathered. The last directive and the gathered information have to be analysed thoroughly. On the basis of all this information and analysis, one or more alternatives are created during the Synthesis step. Which alternative is the most desirable and navigable is decided during the third step,

Decision. The fourth step is meant to provide the navigator with a directive for the next cycle.

Since all cycles are dependent on the preceding cycle(s) and directive(s), changes in directives and decisions are fatal for the process. Every change means that the whole process has to be executed again, at least from the point of change onwards. Obviously, the care taken during the planning-process finally qualifies the performance during the navigation scenario.

### II.2.3 Automating the voyage planning-process.

Now that the whole voyage planning-process is well defined, it is possible to discuss which part of the process is feasible for automation. It is important to remember, that an automated process should be focussed on supporting the navigator in the decisions he has to make. The subjectivity of a navigator is difficult to determine. Some navigators have personal thoughts on or knowledge about a particular passage, which makes them decide to take a route, that differs from a logically generated route. Another important aspect is the captain's responsibility for the safety of the ship. He must not be blinded with computer derived, 'intelligent' solutions. The captain, or in his delegated responsibility, the navigator, should thus be involved intensively during a decision process. A tool for the planning of a voyage should thus always be supportive, providing the navigator with the information he requires for making decisions.

Typically, mathematical calculations are feasible for automation, as well as the steps where something has to be 'generated' or 'produced'. Looking at the voyage planning-process, the last part of the analysis-step (analysing the information) and the synthesis-step are thus ideal for automation. During watch preparation and the execution of the navigation scenario, only detailed information on the voyage for the coming four to six hours is required. An easily accessible databank and information windows popping up at the right time (when passing the particular area) should be sufficient. The determination of the track and the safety margins could be done automatically, but it will be a rather difficult process to automate.

The selection of a route, however, is a very suitable process for automation. The route planning cycle is a very time-consuming part of the voyage planning-process, especially when it is compared with the other cycles. The result is merely an outline of the areas the ship has to pass, whilst during the other cycles the exact intended trajectory (with safety margins, wheel over points and safety bearings) and behaviour (radio procedures, speeds, etc.) are determined. It is a process which allows for little detail and accuracy. Hence, automating the

route planning-cycle can reduce the workload of the voyage planning-process without diminishing safety.

### **II.3 Route planning.**

#### **II.3.1 The route planning-cycle.**

A more detailed description of the route planning-cycle is needed, starting with the sailing order and ending with the route plan, outlining all the aspects and steps that influence the selection of the route.

In the Sailing Order, the initial conditions and constraints are defined. Two types of initial conditions can be determined: mission characteristics and ship characteristics. Mission characteristics consist of information such as Point of Departure, Point of Arrival, operation requirements (depending on the type of operation, like fishery or mine-hunting), weather demands (also depending on cargo), obliged passages and demands of the navigator. Ship's characteristics consist of ship's size, draught, optimal and maximum speed, manoeuvring capabilities, cargo, etcetera.

When studying the sailing order, the information requirements are stated. This information can be gathered from paper publications, such as charts and nautical publications (e.g. pilots, sailing directions, Admiralty lists of radio signals), and from databases that are used in electronic systems, such as ECDIS. Apart from the data in the sailing order, information on waters and passages is required, as well as meteorological and oceanographical information. Information on waters and passages consist of distances, depths, restrictions (e.g. speed limits), prohibitions (e.g. cargo classes) and geographic (e.g. territorial waters, routeing measures and piracy) characteristics. Meteorological and oceanographical features are for example storm, fog and ice probabilities. The great amount of information that is stored in a lot of different publications makes the gathering of information a time-consuming process.

After the information is collected, it has to be studied and analysed. Collecting, analysing and studying are covered by the Analysis step. It is the task of the navigator to interpret all the details in such a way that reasonable route-options or *route-alternatives* can be generated. There is seldom such a thing as a perfect or *optimal route*<sup>2</sup>; therefore, usually a few reasonable alternatives are needed. Then, simply all advantages and disadvantages of every option are

---

<sup>2</sup> More on the optimal route in paragraph V.I.I.

listed, after which some sort of order of preference can be made. All these actions are covered by the Synthesis step.

During the Decision step the most feasible route-alternative has to be selected. This selection is based on all the characteristics of a certain option, such as distance, time, economical features (e.g. fuel consumption) and the dimensions (depth and width of a passage). After this decision is made, the directive is made for the next cycle. Finally, the directive contains the *route*, an initial distance/ time-schedule, an outline of the required charts and some notices on confined waters and time-slots, for example.

It is important to state the difference between the route and the *track*. The selected route is only a delineation of those waters and passages between the point of departure and the point of arrival, that successively have to be sailed. The track is the intended trajectory of the ship and is determined along the route. Furthermore, the *boundaries* of the route do not limit the navigator to deviate from the route.

### II.3.2 Automating the route planning-process.

In order to provide the reader with a good perception of how an automated route planning-tool should work, a description of its functions is needed. Since full automation of the route planning process seems not to be attainable yet, the navigator will be obliged to make the final decisions himself. The tool will be of a supportive kind rather than of a decisive kind. As the main goal of this cycle is selecting a route, the route planning-tool should generate the alternatives and present them to the decision maker. Ideally, the navigator inputs the sailing order and the route planning-tool will output a few route-alternatives, which are more or less optimised for the given conditions.

Translating that to the route planning-process, the analysis and synthesis steps are the subjects of the automation, since then alternatives are 'generated' and 'produced', taking all available information into consideration. Obviously, the required information should already be available, either implemented in the tool, or as ECDIS/ GIS data. The tool should analyse this information and then generate and present the possible routes based on mathematical logic.

The final step would be the presentation of the route-alternatives. Ideally, the alternatives should be displayed on a map, which provides the user with a good overview. Also, some characteristics and notices in terms of distance, time, economy and environmental factors should be presented. Together, it should provide the navigator with a good idea of all the

alternatives and their drawbacks, so that he can make the final route selection easily. At the same time, the tool is supportive during the directive steps, too, since all the characteristics and details are required in the route plan, which is the directive for the next cycle. Other information that is needed in the route plan, such as a list of all the required charts, could easily be coupled with the characteristics of the selected route.

#### **II.4 Equivalentents in the navigation domains.**

During the preparation of this thesis, I began with an extensive search for equivalentents and solutions for optimal route finding within all navigation domains (land-, air- and marine navigation).

Generally speaking, three types of route planning systems are commonly used within the three branches of navigation. The first type is based on terrain models (e.g. digital terrain models, DTM) and is also referred to as path finding [charting]. The terrain model provides a surface of cost or height; the algorithm searches for a path using slopes. In land navigation those tools are used for tank routing, for example. The best path is then considered to be the path with the least 'cost' (resistance) or perhaps the route with the least change to be intercepted.<sup>3</sup> In flight planning (especially for military purposes) DTMs are used for the planning of low level flight, for example. As will be discussed in the next chapter, this type of path finding is not a good option for route planning at sea.

The second type of route planning systems is databank based. A database-based type of route planning is often used in flight planning. It uses a database containing all possible routes, or all routes that previously have been flown. [Flightplanner] After the input of departure and destination airports, the software searches the database and comes up with the correct route. It can also combine parts of routes and provide a list of alternatives. Similar systems are used in marine navigation, with the extra option of saving new routes and way-points [internetpagina, chartworx].

The third type of route planning systems is network- or *graph*-based and are probably the most commonly used. This type is also referred to as route finding. There are many (often quite simple) algorithms available for route finding. A good example of these route finding systems is frequently used in land navigation. When I have to drive my car from Den Helder to Nottingham University, the software calculates the shortest route in length or in time and presents it on a map. The roads are stored as a road-network defined by *links* (road) and *nodes*

---

<sup>3</sup> This type of planning is called Cross Country Movement Planning (CCMP).



(crossroad). The route planners use the length of a road, maximum speed, class of road and direction restrictions (one-way or two-way road) to calculate the shortest route. These road characteristics are stored as *attributes* to the link (road). Some route planners have the possibility to use real-time traffic information. [Bailey, 1997] Some In-car navigation systems can even be equipped with GPS receivers, so that they can provide the driver with real-time direction advice (a female voice urging 'turn left here').

The same sort of applications are used for flight planning, since aircraft use a sort of route-network, too. Nevertheless, especially now that people are arguing on free-flight policy, an aircraft can almost always use *great circle* navigation, since it is barely limited by natural or cultural boundaries. In inland shipping, route finding applications are available. [Stentec, 1999] The rivers and canals form the route-network. Even the extra limitations, such as depth, locks and bridges, are coped with. The only route planning-tools found in my search, that apply to marine navigation (at sea) are weather routeing-tools. [Spaans, 1994]

All types of route planning systems are available on (dedicated) Geographic Information Systems (GIS), so that some spatial analysis is also possible (where is the nearest gas station?). ECDIS is also a type of dedicated GIS, so using these systems (or a GIS) as a basis for route planning at sea is a logical step.

## II.5 Geographic Information Systems (GIS) and Electronic Chart Display and Information Systems (ECDIS).

The equivalents as discussed in the previous paragraph all show the importance of Geographic Information Systems in path and route finding. In this paragraph, I will make some comments on both these Geographic Information Systems (GIS) and Electronic Chart Display and Information Systems (ECDIS).

### II.5.1 Geographic Information Systems.

A Geographic Information System is a computer-based system, which is developed to assist the user in making decisions <sup>o</sup>in spatial problems. A GIS provides input, storage, display and analysis of spatial information. The data that is used in GIS is spatial referenced data, or 'information with whereness'. [Sabelis, 1997(i)] Besides, some sort of intelligent data processing is characteristic for GIS, which makes use of the intelligence of data (connectivity, contiguity, vicinity etcetera). The advantages of a GIS lie especially in the great amount of analysis possibilities. The components of a GIS are the spatial data, the data management system, the spatial analysis tools and algorithms and the graphical display.

Spatial data is typically of vector, matrix or raster format (see paragraph III.4.1.), whereby vector is the most intelligent. Data is captured in a number of different ways. Direct data capture consists of Aerial photography, remote sensing, satellite surveying and total station survey. Scanning a paper map is a typical example of indirect data capture. Incorporation of existing data means the use of corporate data, postcoded data and digital maps. The data management system provides storage, integration and conversion of data. Map overlay is an important feature of GIS. The data management system can overlay data sets, once they are geo-referenced. This overlay provides both visual and mathematical comparison between different data sets.

Furthermore, spatial analysis tools are developed, also called spatial queries. The most important types of spatial query are point-in-polygon queries, zone queries, vacant place queries, distance and buffer zone queries and path queries. [Laurini, 1992; p. 536] A point-in-polygon query involves the search for the objects, into which input co-ordinates 'falls'. A zone query determines which objects belong to the zone we are interested in. Vacant place queries provide vacant places within a certain area. With distance and buffer zone queries, the GIS can calculate distances and can retrieve all objects lying at a certain distance from a certain zone or object. Path queries provide path finding. There are various kinds of path finding that can be distinguished. First, there are network-based path queries, such as the search for the shortest path in a graph, the selection of a path in a hierarchized graph, and the travelling salesman problem. Secondly, it is possible to find paths within polygons. Finally, least-cost surface path finding based on matrix or raster formatted data is another type of path query, as provided in GIS.

All kinds of queries could be very useful during the route planning phase. Various kinds of data are already available in the electronic charts and databases. Point in polygon queries could provide information on the passage of a routing system; zone queries offers us the opportunity of searching for objects such as buoys and shallows within certain boundaries; distance and buffer zone queries provide distances to other objects and the vicinity of navigational dangers.

Finally, GIS provides the graphical display of information. Overlay techniques of different kinds of (selected) information, provides an optimal view on various situations. This encourages comparison between sets of data, stages of development and so on. Typical employment of GIS is in a variety of fields of study, such as town and country planning, emergency services (e.g. police), farming, forestry and environmental protection.

### II.5.2 Electronic Chart Display and Information Systems (ECDIS).

Some of the applications of GIS are specially developed for a particular utilisation. This implies detailed specification of the system, with special designs and implementation of specific subject-related tools. These systems are sometimes referred to as dedicated GISs. A good example is the Electronic Chart Display and Information System (ECDIS).<sup>4</sup> ECDIS displays only hydrographical and nautical information (real-time positioning data, ARPA data overlay) and holds some nautical analysis tools, such as calculation of bearings and search for navigational dangers depending on track and ship's characteristics. ECDIS was specially designed for navigation at sea. Stringent legislation on types, technical standards and data storage and management are enforced by international committees, such as IMO and IHO (International Hydrographic Organisation). The relevancy of ECDIS to this project speaks for itself.

The precursor of ECDIS was the Electronic Chart System (ECS). Searches for a way of electronically displaying nautical charts were initialised by users in fishery and pleasure sailing, finally leading to the development of ECS. However, the authority in international shipping (IMO) only set a standard after ten years. This standard recognises the possibilities of ECS and stated the need for a system that had more possibilities than displaying nautical charts. The ECS was renamed; it became the Electronic Chart Display and Information System (ECDIS).

ECDIS Standards are well defined in a few documents. The IMO Performance Standard was issued in December 1995 in IMO resolution A.817 (19). [IMO, 1995] The International Electrotechnical Commission set the 'ECDIS Performance Standards, Methods of Testing and Required Test Results (IEC 61174). The data requirements are set in IHO's Transfer standards for digital hydrographical data, S-57 edition 3 (1997). [IHO, 1996] Typically, ECDIS can only use the vector data format. S-57 also only describes vector data. An approved vector nautical chart is referred to as the Electronic Nautical Chart (ENC). Nevertheless, since nautical vector data is not widely available yet, a lot of systems provide raster format compatibility (dual fuel ECDIS). Raster formatted nautical charts are provided and approved by the British Hydrographic Office, for example (ARCS – Admiralty Raster Chart Service), covering almost the whole world, since they are facsimiles of the paper chart.

---

<sup>4</sup> The main difference between ECDIS and GIS is the amount of legislation. IMO prescribes strict specifications for data, display, technical details etc. Due to this great difference some people would argue if ECDIS can be referred to as dedicated GIS.

The great variety of possibilities an ECDIS offers is still to be explored. In the S-57 data transfer standard, spaces are left vacant to enable the implementation of information that is normally not displayed on the nautical chart. Think of tidal information, information of lists of lights and information from the lists of radio signals. Also, the implementation of time varying objects, such as drying heights, could be made possible in the future. IMO is expected to come up with international rules on these extensions of the ECDIS functionality.

An important issue of ECDIS is the way voyage planning is dealt with. Nowadays, voyage planning is offered as a simple drawing tool; way-points and legs are drawn on an overlaid 'drawing sheet', projected on top of the nautical information. Some producers implemented a database function. Routes that are already used can be saved and stored in the data-base, and they can be used over and over again. Although ECDIS is very much the same as a GIS, its capabilities that can be useful during the voyage planning process are limited. A track can be checked by defining a safety buffer around the legs, and then searching for navigational dangers and obstacles. The tool cannot provide information on separation schemes or typical 'rules of behaviour' that are encountered during a passage. Route selection is also not offered.

In order to implement a GIS 'path query' type of tool in ECDIS, the stringent regulations and various standards on ECDIS should be adhered to. In the first place, the data structure must be similar to, or at least compatible with, the S-57 standard. Secondly, a provision of a route-network implies the implementation of a new layer (route-network layer). As the layers are well-defined in the performance standards, this layer should be approved by an IMO resolution (or amendment) as well. In the author's opinion, this should not be a major problem. The standards should be revisited every few years, since successful research and development requires that the international organisations provide clarity in the international regulations.

In the remaining, I will constantly keep in mind the details on ECDIS and the implementation of a route-planning tool.

### III Route-network analysis.

In order to develop a route-network that provides a good basis for route planning, a clear description of the relevant aspects is needed. Firstly, the existing shipping routes at sea are analysed, since the network should be based on these. Then, some principles of networks and graphs are discussed. Thirdly, the required components of a route-network are described. In the last paragraph, considerations on data format and data structure are discussed, providing a robust data concept for the route selection tool. Finally the data structure is adapted to the demands.

#### III.1 Analysing the shipping routes at sea.

When developing a route-network at sea, it is important to discuss some existing routes and how they were formed historically, geographically and culturally. Route planners for car navigation use a route-network based on existing highways, roads and streets, hence developing that route-network was a clear task. However, laying down a route-network at sea, where no obvious roads and boundaries exist, is a much harder job. When making an inventory of existing routes at sea, it is clear that some distinct parts of the shipping routes form a system of roads and crossings already.

Commonly used shipping lanes and routes were firstly formed by the local characteristics of the sea and shore, together with the location of ports and harbours. The seabed is subject to many changes through time in some areas, causing shallows, banks and reefs. In other areas, cliffs and rocks delimit the ships' passage.

Harbours were located in favourable and sheltered areas. Obviously, the position of these harbours result in (sometimes heavily) congested routes and passages. Main ports like Rotterdam and Antwerp cause dense traffic in the southern part of the North Sea. Ships passing through that part of the North Sea are limited in the choice of routes by the characteristics in the region (sandbanks and the width of Dover Strait) and by the prevailing routeing regulations (Traffic Separation Schemes).

International regulations on the routeing of ships cause another example of (obvious) existing routes. At the end of the nineteenth century, the first systems for separating opposite traffic flows were already being developed for the Dover Strait. At the Grand Banks (north west Atlantic Ocean), routeing consisted of season-variable way-points to avoid dangerous areas

with ice and bad visibility. [Jong, 1996; p. 6-10] After a number of serious accidents in Dover Strait between 1960 and 1970, the recent routeing measures evolved.

Heavy traffic in some regions persuaded the various authorities to start regulating traffic, in order to prevent collisions and other accidents that were often caused by misunderstandings and indistinctness. Regulating traffic is now also motivated by several environmental arguments, like the threat that vessels with dangerous cargo form to the flora and fauna of the sea and shores. In the Netherlands for example, great effort was made to ensure that ships carrying dangerous goods pass well clear of the Dutch coast. 'The objectives of ship's routeing have evolved into an instrument of 'spatial planning at sea', in order to provide a smooth and efficient handling of sea traffic and to protect the maritime environment.' [Jong, 1996; p. 6-10]

A few types of traffic regulations and routeing measures can be distinguished today. In the first place, international regulations consist of Traffic Separation Schemes, Inshore Traffic Zones, Caution Areas and Deep Water Routes. In the second place, national or local routeing measures include Recommended routes, anchorage areas, prohibited areas and military exercise areas.

International routeing measures are established by IMO.<sup>5</sup> A difference is made between 'mandatory' routeing measures and 'normal' routeing measures. Mandatory measures were introduced during the nineteenth assembly of IMO, in order to create the possibility of forcing ships carrying dangerous goods, to take the longer route, which is situated well off the coast. [Jong, 1996; p. 6-9] An example of such a route is the Friesland Traffic Separation Scheme in the North Sea (see figure III-1). Local authorities can propose a new routeing system to IMO; with IMO's approval the routeing system will be officially proclaimed in Resolution A.711(17). [IMO, 1991] The ships' behaviour when passing a routeing scheme is set down in COLREG, rule 10. [COLREG, 1977]

Local authorities can also provide some route recommendations for a distinct area. Although it can be argued whether or not these are real routeing measures, recommended routes will be treated as such in this dissertation. In proper navigational practice, a navigator will generally not deviate from such a recommended route, considering the fact that local authorities will have the best knowledge and experience available when designing these recommendations. Ships' behaviour in areas with recommended routes will resemble the behaviour in areas with

---

<sup>5</sup> The routeing of ships is described in SOLAS, chapter V, regulation 8. [IMO, 1974] Furthermore, 'General provisions on ships' routeing' are described in IMO resolution A.827(19). [IMO, 1995(ii)]

other routing measures. The recommended routes and routing measures in the Danish waters are a good example. A few routes with some restrictive measures are well marked, providing passage through the different islands.

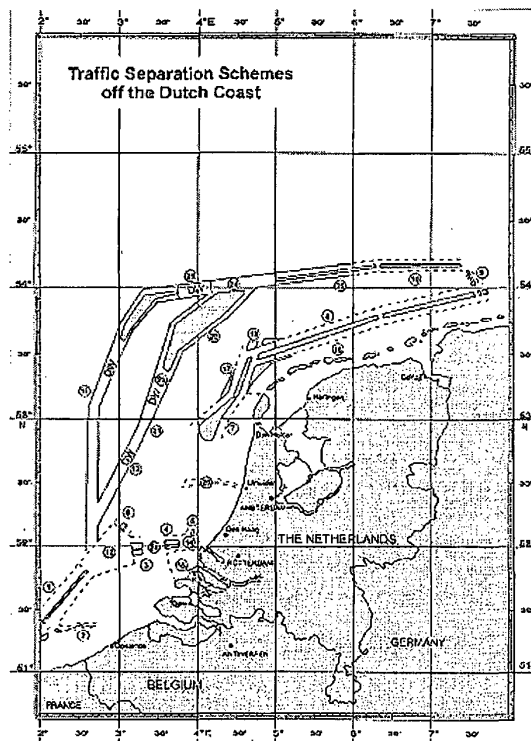

Figure III-1: Routing measures off the Dutch coast. [HP1]

Furthermore, a couple of area-type routing measures exist, which are normally laid down by local authorities. In the first place, anchorage areas are created to direct vessels to a place to anchor, without interfering with other traffic. Mostly, there are no regulations that describe the behaviour in, and in the vicinity of these areas; in accordance with proper navigational practice, ships will only enter these distinct areas to anchor. Prohibited areas are areas where temporary prohibitions are proclaimed by the local authorities. The conduct of nuclear tests can be a reason for creating a prohibited area. Military exercise areas are well defined in all publications, to provide clarity in Maritime Safety Information messages (MSI, for example provided via NAVTEX) in case of a military exercise. Temporary demands of giving a wide berth can be declared for these areas, but strict prohibitions cannot be issued.

Other examples of routes that already exist are those that are described in publications such as 'Ocean passages of the world', published by the British Admiralty. [NP 136] For almost every area, some feasible options are shown and described, considering also meteorological and oceanographical effects. Not (always) the shortest route or the optimal route are shown as such, but the practical options for various directions. These publications can provide us

with many important routes and information, obviously. It is, in the author's opinion, absolutely justified to handle these routes as recommended routes, too. An example is shown in figure III-2.

In conclusion, all the historically and geographically formed routes produce an existing web of lanes, areas and crossings, which can provide the basis of a route-network. An important tool I found when analysing these routes, is a traffic density chart of the Dutch Continental Shelf of the North Sea, that was provided by the Directorate-General for freight transport [Traffic, 2000] (see Appendix A). It shows the traffic density per km<sup>2</sup> over the past ten years. Clearly, a network of traffic flows and directions can be distinguished.

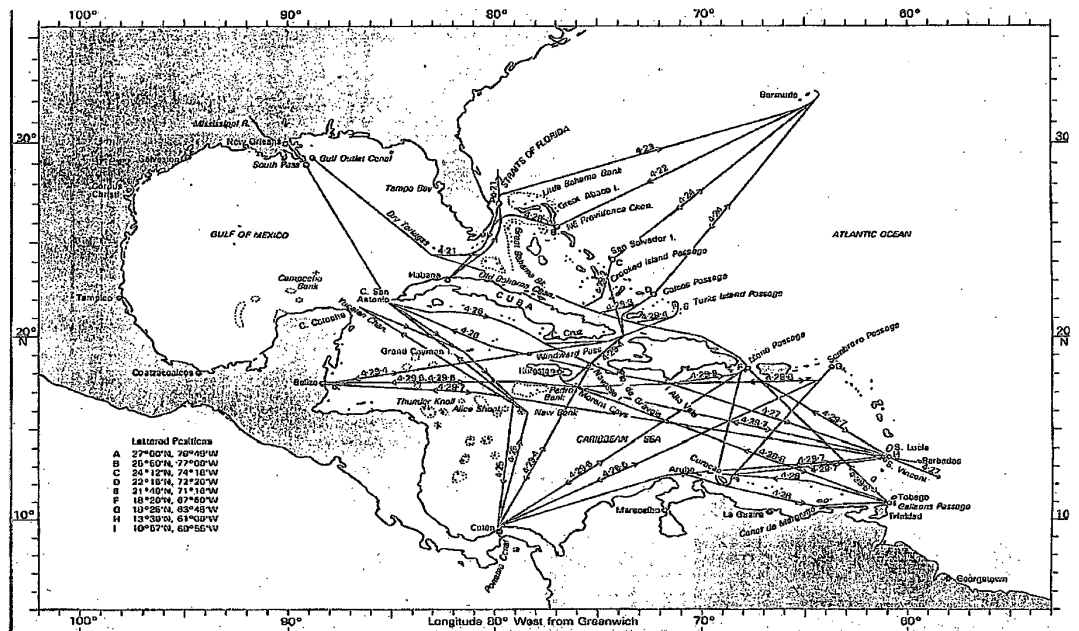

Figure III-2: Routes in the Caribbean Sea. [NP136]

### III.2 Network and graphs.

When a network is used as a basis in route planning algorithms, it is often treated as graph. Therefore, some basics and comments on graph-theory are discussed in this paragraph.

Space can be viewed as a theoretically infinite set of points with observations possible for one or more attributes or spatial properties anywhere. [Laurini, 1992; p. 175] The transportation problem, with roads and highways, deals only with a small number of positions. Obviously not all points on the earth's surface are roads. The positions of the crossings and points of contacts between two roads, the nodes, are dominant elements. [Laurini, 1992; p. 175]



A graph is the combination of links and nodes [Laurini, 1992; p. 181] and can be seen as a very simple representation of a network. The structural components of the network that are represented by a graph are the junctions and connections. Characteristics such as line shape and compass orientations are neglected. In fact, the remaining elements are relative characteristics, such as connectivity and orientation. The intersections and end points of connections are represented by nodes or vertices. The connections are referred to as edges or links.  $G=(N,E)$  [Ikeda, 2000] is the normal mathematical notation<sup>6</sup>. *Subgraphs* are separated or disconnected (sets of) links. A distinction can be made between *planar* and non-planar graphs. Planar graphs are based on connections that are all in the same plane, where non-planar graphs contain links that cross but not intersect each other (e.g. road-network with tunnels or viaducts).

An important property of graphs is the possibility of adding attributes to both links and nodes. Attributes associated with links could be maximum allowed speed or the time taken to travel the link, whereas nodes could have measures like total number of passengers in case of an airfield. The addition of attributes produces a weighted graph. This property is used in land navigation applications, as discussed in paragraph II-4. Another property that is important to solve the routeing problem is the distinction of connectivity. Connectivity is required to discern the spatial relationship or topology between two nodes. In a graph, a connection (link) between node A and node B means that we can travel from A to B in either way. In a *directed* graph a direction is added; travel is possible from A to B or from B to A, or in both directions. Connectivity can either be dealt with by a link-node list or by a connectivity matrix. [Laurini, 1992; p. 209]

Graphs are extremely useful for network based operations such as route finding, because of the simple representation and the advantages of adding attributes and connectivity. Other types of graph operations are the *spanning tree* problem and the *travelling salesman* problem. Many route finding algorithms as used in the equivalent applications, are based on graphs. Choosing the graph as starting-point is thus a sensible approach.

The graphs used in transportation problems are generally both directed and *cyclic* graphs. Directed, because of the fact that some connections cannot be travelled in both directions (e.g. one-way roads). A graph is called cyclic when a node is connected to itself, without using a link in both directions. The route-network that is developed in this project, is considered to have these same characteristics, after all, it is possible to depart from Den Helder via the

---

<sup>6</sup> Where N is the number of nodes and E is the number of links.

Schulpengat (south-westwards) and then to return via the Molengat (south-eastwards), without using the same passages twice.

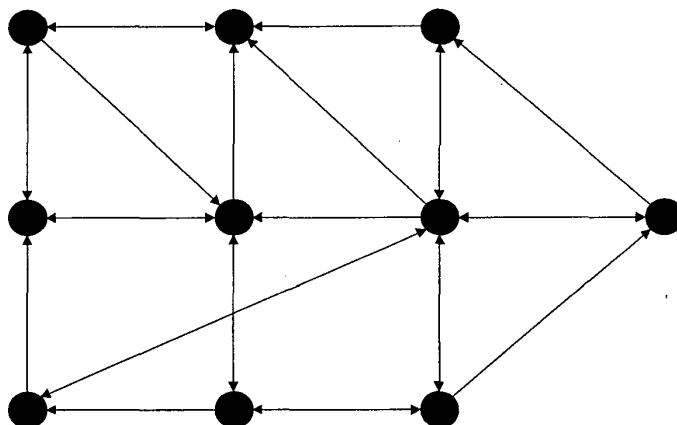

Figure III-3: An example of a graph.

### III.3 Route-network.

#### III.3.1 Different components needed in the route-network.

In the preceding paragraphs, existing routes at sea are discussed, as well as some theory on networks and graphs. Links and nodes have been distinguished as the smallest components of a network. As described in paragraph II-4, crossings form the nodes and roads form links in route finding algorithms. Obviously, it is important to translate this structure to a structure that is logical and useful in the marine navigation route finding problem. Eventually, three types of components are needed for this network, namely *route-points*, *route-lanes* and *route-areas*. Consider the network and all its components as *real world entities*.

Nodes are the most important features, as everything is hung up to these points. A node is described as a position in space, which is geographically referenced. A link connects nodes, and is thus described by node A to node B, from which the positions are known (latitude, longitude and height, or x, y, z). No further position information is needed. However, using this position alone does not fulfil the need within the network. For example, it is wise to use a node to describe a harbour or other end position, which implies the need for extra information, including more dimensions (entrance depths/ heights and width of any approach channel(s)). Since a node is only the position of the crossing, the complex object Route-point is introduced, which is described by a node, but can have more characteristics. The route-point can thus either be a 'route-point' or a 'harbour-point'. The definition of a route-point is:

**Route-point:** A route-point is a node in the route-network; it forms an access to a *route-segment*; a route-point has at least one connection with another route-point, either through a *centreline* or a route-area.

Existing routes due to the geographical and cultural characteristics (as described in paragraph III-1) can be considered as the roads of the marine network. Those are the links of the network. There are a few problems that arise when describing a trajectory or passage as a simple link. Firstly, a link only forms the connection between nodes, whereas a trajectory or passage should be described in three dimensions (length, width and depth/ height), which all influence the selection process and the further voyage planning-process, since the outcome of the route selecting stage should be a delineation of the waters and passages that will be sailed during the voyage. In land navigation, the only two stages are route selection and the execution (the driving) of the planned voyage; no more detail is required, for there is no need for planning the specific lane to drive. In the second place, when designing the network in such a way, that it can be integrated in ECDIS and that it optimally utilises the information that is already available in ECDIS, a simple link defining a connection would not provide the possibility of using all sorts of GIS queries.

Furthermore, the network should not limit the possibility of using all available waters. For example, describing an ocean with links, and providing as many options as possible, would severely limit the use of weather routing algorithms. Hence, we should rather use more complex components to get the most out of our network. These complex components are called route-segments. Important to note is that this route-segment is a three dimensional object, that delimits a navigable water. The characteristics of the area the segment covers should be considered to be the same in the whole area. In case of route selection, this is justified, because of the required level of detail during this process (as explained in paragraph II-3). The following definition can be used for a route-segment:

**Route-segment:** A route-segment is by definition a complex component of the route-network, which describes a (part of a) navigable passage or water and for which all the characteristics are valid for the area the component covers.

There are two types of route-segments. The first type of route-segment is the route-lane. A route-lane is a segment between two crossings, but with not more than two entries.<sup>7</sup> It

---

<sup>7</sup> A route-lane can have one entry, if it is a one-way lane. In that case, one crossing is an entry, and the other an exit.

resembles a road as used in car navigation, which is a link between two nodes. A route-lane is built up with a few simple features (see figure III-4). First there is the link, which is the straight line between the two route points. It is the centreline of a route-lane. Then there are the *boundaries* that delimit the area that is described by the route-lane. The area described by a route-lane is, for simplicity reasons, of a rectangular shape. The distance between the boundaries is the width of the segment. Length is of course the distance between the two route-points. *Sailing direction* is the compass bearing between the nodes. The following definition can be used for a route-lane:

Route-lane:            A route-lane is a route-segment with not more than two accesses, that takes up an area which is delimited by the centreline and boundaries.

The second route-segment is the route-area, although it is not recognised within the graph theory. However, if we want to avoid the limitations that were discussed above, the use of areas seems to be the only possible principle. Areas are perfect to cover large areas, within which (almost) the same characteristics apply, or within which other calculations of optimal routes are preferred.<sup>8</sup> Also, in regions where many lanes from various directions join, creating heavy traffic, an area provides the freedom of sailing direction needed to connect all lanes. Other types of areas, caused by routeing measures (caution areas, anchorage areas) can be coped with also, creating multiple access and exit positions. Military exercise areas are implemented especially for naval use, providing the possibility of dealing with practice schedules.<sup>9</sup>

In the GIS type of data structures, an area would be described as a set of links that include the area.<sup>10</sup> This inclusion enables the use of GIS queries on the required information. However, these links could be considered to state a connection between the nodes it is referenced by. Hence, it is very important that the algorithm uses only those connections defined by segments, not those that are link only. Another description can be used for the test data. In the route planning tool that is described in this dissertation, the route-area is a set of all the nodes that are present in the area. No links are defined between these nodes (and thus no connections and no route-lanes).

---

<sup>8</sup> eg. in case of ocean passages, weather routeing algorithms are preferred to other calculations such as route finding.

<sup>9</sup> Naval ships often execute busy exercise programme, going from exercise area to exercise area on their way to the port of destination. In such cases, optimal routes can provide more time to practice for example.

<sup>10</sup> More on data structures in paragraph III-4

By definition, all route-points within the particular area are connected with each other; only the sailing direction and the length are not set. In a route-area, width is not important, since the whole area is navigable. Defining this, great freedom is created in the way the navigator can cross the area. For every movement within the boundaries of the area, almost the same characteristics apply. Furthermore, the nodes within the area are all in at least one link connected with a route-point outside the area. The area-nodes can be considered as access and exit positions for that area. The route-area is defined as (see figure III-4):

**Route-area:** A route-area is a route-segment with more than two accesses, within which the sailing direction is not defined; a route-area is defined by at least three route-points; the characteristics apply only for connections between route-points that are within the particular route-area.

We can now define the route-network as follows:

**Route-network:** The route-network is the whole system of route-segments and route-points.

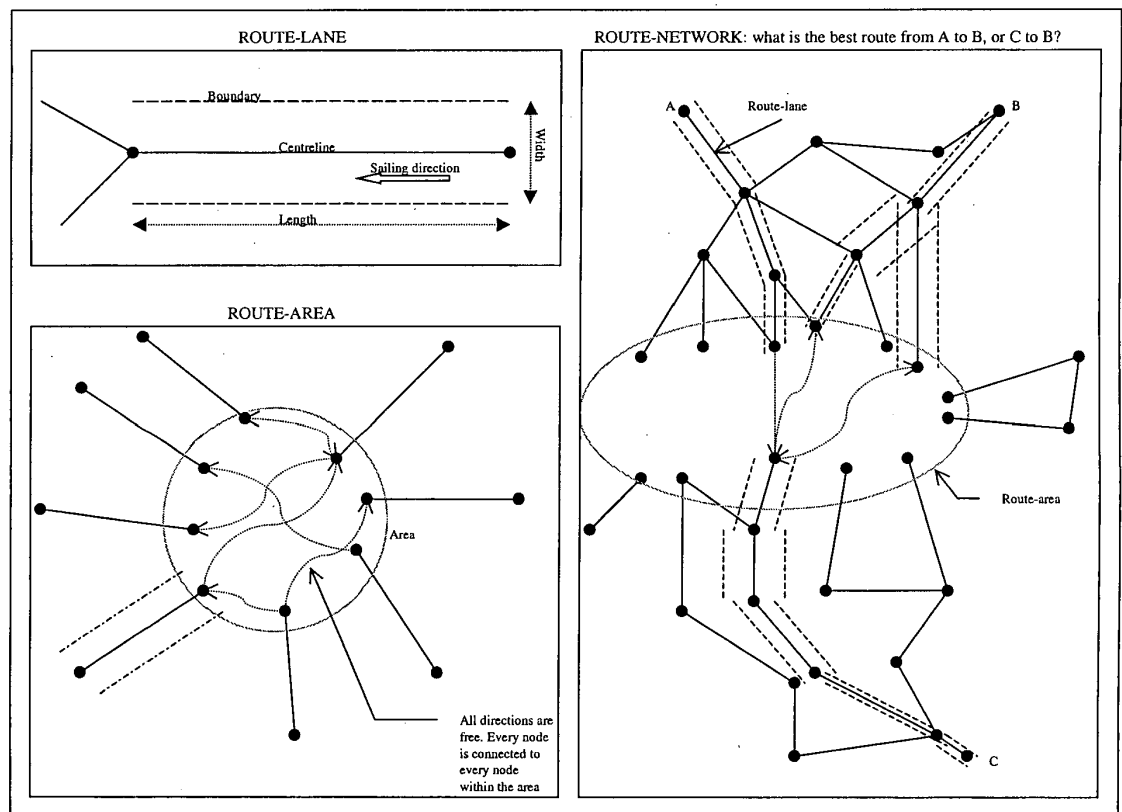

Figure III-4: Components of the route-network.

### III.3.2 Positioning of the route-points and -segments.

Now that all the required components are well defined, we should be able to develop a network, for a real world situation, using all these components. A set of rules is needed to overlay the components in a correct and efficient manner. A few problems and requirements underlie these basic rules; they will be discussed before getting to the actual rules.

The first problem is coverage. This problem arises because of the fact that ships navigate the whole earth, so that a route selection tool has to be able to cope with a world covering network. When a route planning tool is developed as such, the overlay of the components would not only be time-consuming, but it would also be very difficult to create the network in such a way that it provides efficient and reasonably correct answers. After all, an overview on the overlay process is hard to provide. Another issue concerning the coverage is the computing capability of the software. Not only is there far too much data that has to be searched (except for when indeed a journey around the world is wanted), also the chance of unreasonable answers (sailing from Rotterdam to New York via the east) is significantly present.

A solution for this problem is to divide the world's seas into reasonably small *network-regions*, connecting them via a few route-points or, perhaps more practical, a route-area. For example, when looking at the seas around Europe, a network for the North Sea region could be linked to a network in the Mediterranean region via a route-lane through Gibraltar Strait; and to a Baltic region via the Skagerak and Nord-Ostsee Kanal. These Europe regions could then easily be linked to an East Canadian region, connected by an area (Atlantic Ocean). Advantage of using this system of subdivision, is the possibility of switching off regions to limit the data that has to be searched, as well as the possibility of 'demanding' the tool to use only certain areas.

The second significant problem that occurs when placing the various components is providing as much *freedom of sailing direction* as possible. Freedom of sailing direction is the capability of the network to provide as many options as possible to the algorithm. As mentioned before, the main disadvantage of using a network at sea is the limitation of navigable waters it implies. Too many lanes limit the 'open sea'. However, a part of this problem is refuted by stating the goal of route-selection. The selection process is only to provide a delineation of the passages to sail and not to provide legs and way-points. A navigator is still free to deviate from the route plan. Nevertheless, to compute reasonable answers to our route selection problem, all navigable seas have to be considered, meaning there is still the matter of freedom of sailing direction. When as many areas as possible are

implemented in the network, this freedom is more or less guaranteed within the required detail margins.

The demand of homogeneity of prevailing characteristics is the last major issue. It is important that a route-area or route-lane is provided with the correct characteristics, which can be assumed to be valid for the whole area or lane. The positioning of a route-lane, -area or -point should provide parts of passages or seas, in which the characteristics are (almost) the same for the area it delimits, in order to provide the correct information to the algorithm, which has to filter and weigh all the options. To realise this, all segments would become too small. The segments should be created as large as possible, both in length as well as in width. Some manipulation of information is possible<sup>11</sup>, although it is important to note the possible occurrence of 'false' options. Manipulating has to be done with great care and on the safe side of the margins.

Now the basic rules can be discussed:

1. The use of all available sources is essential to create a thorough network. The sources should first be consulted to distinguish all existing routes, then to collect all other important information to attribute to the different segments.
2. The routeing measures are used as a basis for the network. The advantages of beginning with the routeing measures are the fact that these measures all form existing routes and that routeing measures are well defined in terms of positioning etcetera. For Traffic Separation Schemes, route-lanes are used, either one-way or two-way, depending on the size of the separation zone. Deep Water Routes are treated equally. Caution areas are depicted by a route-area, as well as anchorage areas, prohibited areas and military exercise areas. Recommended routes are usually not as well bounded by separation zones; it is therefore wise to provide the largest width possible (depending on the situation of course).
3. The length and width of the segments should be as large as possible, but in such a way that still a continuous and homogeneous region is taken up. There is no need to divert a segment in case of a small obstacle. When the width of the segment is well chosen, it should provide enough space to avoid the obstacle during the more detailed navigation planning phase.
4. Route-lanes cannot contain unsuitable or unnavigable waters (land, drying heights, large sandbanks etcetera) within the boundaries.

---

<sup>11</sup> Manipulation is not altering the information, but handling it practically. For example, depths in a segment would never be homogenous, but by taking the least depth within the boundaries of the segment, an homogenous depth is created.

5. Narrow sounds and straits should always be covered by route-lanes.
6. Route-areas are only suitable to depict coastal and ocean passages, since confined waters have a very small distance to the nearest navigational danger<sup>12</sup> (<2nmi). For these distances a route-lane is more appropriate.
7. Each crossing is covered by a route-point.
8. A harbour is covered by a route-point, to which extra information concerning the harbour is added.
9. Ocean tracks are covered by route-areas if possible, in order to enable the use of weather routeing algorithms.

It is important to note that the region covered by a segment is not free of *navigational dangers*. The depth of the segment is never homogeneous; it is typically an irregular surface. In order to provide homogeneity, the least depth is valid for the whole area. However, if, for example, a wreck lies in the middle of the segment, the depth above the wreck could be the least depth. But, using this depth could deny passage to many vessels, while they could well sail around the wreck within the boundaries of the segment. Thus, segment depth is defined as the least depth that is not above a wreck. Nevertheless, the wreck is still there! (wrecks are dealt with by a different field of information (see paragraph IV.3.2)).

Appendix B show some examples of the positioning of the route-network.

### III.4 Designing the data structure.

#### III.4.1 Some basics on data formats.

GIS data is spatial data, which means that it contains implicit or explicit information about location. The essential function of spatial data is to subdivide the earth's surface into meaningful entities or objects that can be characterised [Star, 1990]. The data format describes the way the data is stored and treated and how the geographical reference is provided. Generally, there are three types of commonly used data formats. These types are:

- **Raster data format.** The raster data format consists of a regular structured array of picture cells (pixels), which are assigned a typical value. Usually, raster data is collected by optical scanning; the colour of each pixel is treated as the value in that case. The pixel position correlates to its geographic position. Important drawbacks are the huge data sets

---

<sup>12</sup> A navigational danger is normally a wreck, cliff or rock which forms a significant threat to the operated vessel. Buoys or platforms are not navigational dangers!



required to obtain high accuracy (accuracy is cell size) and unsuitability for modelling linear features, nor for algorithms based on connectivity of linear features (route planning!). [charting]

- **Matrix data format.** The data is stored as a grid of evenly spaced data points; each can be assigned values of the attributes of that point. The matrix data format is often used for storing height values. Terrain slopes and surface roughness can be computed from these height-matrices. Matrix also permits the depiction of areas of terrain for display in various formats. [charting]
- **Vector data format.** The vector data format represents real world objects as points (nodes), lines (edges/links) and areas (faces/polygons). The features are represented using Cartesian geometry. Each point, link and area is described by feature codes and attributes. Features are modelled using combinations of 'primitives' (point, line, area). [charting]

The matrix format and the raster format can be used for path finding where no network exists. (See paragraph II.4) In case of an existing network, route finding is done using a vector data format.

The selection of a data format for the route planning problem is not easy to make. A lot of navigators feel hesitant about using a network, since that would deny the free use of the whole wide-open sea. However, the option of using a matrix format and path finding algorithms implies complexity in both data and algorithms. The heights or costs would then be depths (soundings), but it is very difficult to implement the very large amount of relevant information (see chapter IV).

Also, the algorithms are very complex. The option of using the route-network has more advantages; simplicity of data format, simplicity of routing algorithms and the possibility of adding attributes. Furthermore, accuracy requirements for route-planning are not very demanding, as discussed in paragraph II.3. The justification of the choice of a route-network lies in the fact that large-scale introduction of routing measures has taken place. Also, density and movement charts<sup>13</sup> show de-facto 'routes' and passages in terms of ships passing per year, and channels and straits form routes.

Hence, the choice of a route-network as the basis for the route planning problem, implies the use of the vector data format. The route-network is a graph.

---

<sup>13</sup> Traffic Density Chart [Traffic, 2000].

### III.4.2 Commonly used data structures.

Now that the vector data format has been chosen and the network theory discussed, we must look at the possible data structures. There are a few vector data structures that are commonly used:

- **Sequential or spaghetti data structure.** [charting] Each feature is stored as a discrete point or line with its co-ordinates and attributes in the same record. There are no spatial relationships established between the various features.
- **Chain-node data structure.** [charting] The different features are stored in separate records, including descriptions and spatial extent, linked by pointers. All intersections, as well as points, are stored as nodes.
- **Relational or topological data structure.** [charting] This structure is very similar to the chain-node structure but spatial relationships (connectivity, adjacency, inclusion) between features are established by separating descriptive data from spatial data in different records, again linked by pointers.
- **Feature-based/ object-oriented data structure.** This structure is partly similar to the relational data structure. However, characteristic of this structure is the building-up of complex features to get more complex features. Every set of data is dissected this way; every feature is separated into different records. This structure is used for the IHO Transfer Standard for Digital Hydrographic Data (S-57) [IHO, 1996], and thus for ENC data for ECDIS.

The use of a network determines the need for connectivity and well-defined topology. The choice of a sequential data structure would thus not fulfil the needs. The latter three structures are all suitable to use for a route-network. The simplest structure to use is chain-node. All the information is gathered together, which makes the records very surveyable. The relational structure is suitable too, since the only difference with chain-node data is the separation of topology and descriptive attributes. The feature-based structure would, in spite of its complexity, be the most logical choice, since it is the structure that is used for hydrographic data. [IHO, 1996] Compatibility with ECDIS would only be achieved by implementing the route-network data in the S-57 structure.

### III.4.3 ECDIS: S-57 Transfer Standard for Digital Hydrographic Data [IHO, 1996]

Already many arguments are presented in this thesis that favour the use of ECDIS and hence the S-57 as data standard for the route selection tool. This paragraph discusses the S-57

transfer standard briefly first, and contains some considerations and problems that are inherent in using ECDIS.

The S-57<sup>14</sup> transfer standard is typically feature based (or object oriented). The structure is designed in two stages. During the first stage, a theoretical data model is created to represent the real world, since it is obviously far too complex and large. Then this model is translated into the data structure. The theoretical data model begins with the definition of an *object* as a real world entity. An object is described with attributes with certain *attribute values*. For example, an 'object class' could be 'lateral buoy', with 'attribute' 'colour' and 'attribute value' 'green'. [Carol, 1996; p. 54] Some relations between different objects are possible. Figure III-5A shows a model that is used as a basis for the data model. The *feature objects* only contain descriptive data while they are geographically referenced by the spatial objects. A *spatial object* is always linked to a feature object. Both are defined as: [IHO, 1996; p. 1.2]

Feature object: An object which contains the non-locational information about real world entities.

Spatial object: An object which contains locational information about real world entities.

Furthermore, a feature contains several categories of descriptions. Meta data contains information about other objects. Cartographic data holds information about the cartographic representation of a real world entity. The category Geo contains descriptive characteristics about a real world entity while information about relationships between objects is kept in Collection.

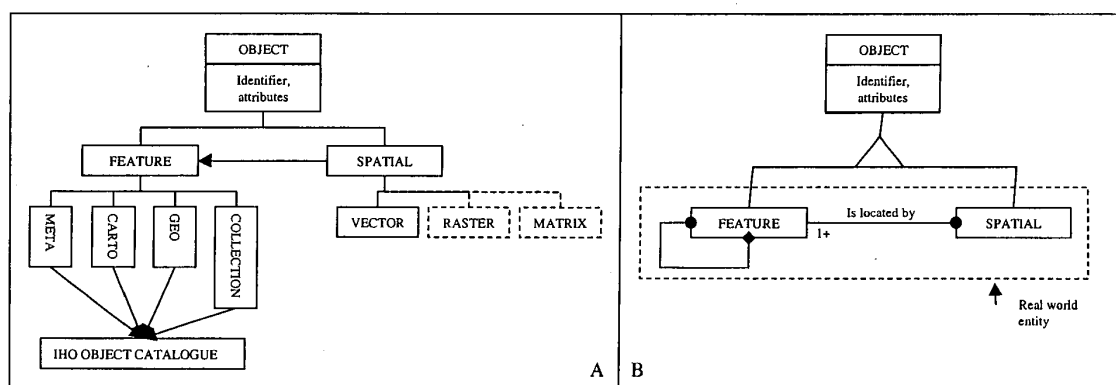

Figure III-5: Basis model for S-57. [IHO, 1996]

<sup>14</sup> S-57 is also referred to as DX-90; however S-57 is the official term.

Figure III-5B shows, that an object consists of a feature object and a spatial object; that a feature object is located by 'at least one' (1+) spatial object; and that a feature object may exist without referencing, but spatial objects always reference a feature object.

The theoretical data model used for S-57 is further simplified in the spatial object-side of the scheme. In S-57, a spatial object is considered to be 2-or less-dimensional, and the third dimension is implemented by attributes (e.g. height, depth) within the descriptive feature object. Nodes, edges and faces are defined<sup>15</sup> in four levels of topology, namely cartographic spaghetti, chain-node, planar graph and full topology. The level of planar graph is the most suitable level for the route-network, and will therefore be discussed in detail. The other levels can be found in the S-57 manual. [IHO, 1996; p. 2.5] According to the S-57 manual, a planar graph is defined as follows:

**Planar graph:** A 2-dimensional data structure in which the geometry is described in terms of nodes and edges which are topologically linked. A special case of a chain-node data structure in which edges must not cross. Connected nodes are formed at all points where edges meet. [IHO, 1996; p. 1.4]

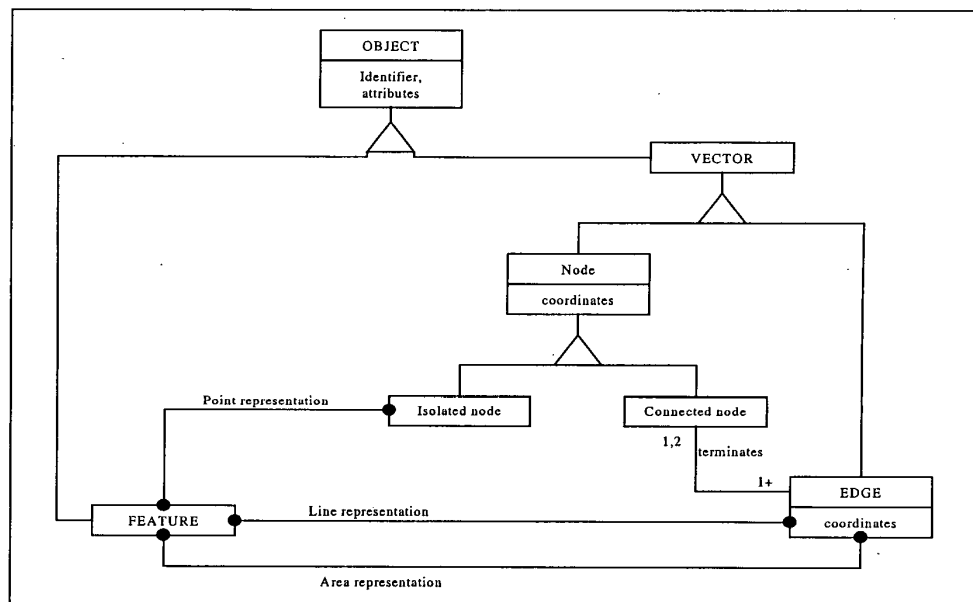

**Figure III-6: Theoretical data model for planar graph. [IHO, 1996]**

Figure III-6 shows the theoretical data model for a planar graph. A planar graph is built up in nodes and links. Areas are built up by links. Duplication of coincident geometry is prohibited.

<sup>15</sup> In most literature the terms nodes, links and areas are mentioned. However, edges is also used for links and synonyms for area are polygons or faces.

[IHO, 1996; p.2.5] A connected node terminates at least one (1+) edge and an edge is terminated by one or two connect nodes. A point is represented by isolated nodes, and areas are represented by edges.

The theoretical data model has to be translated into a data structure, in order to make the information suitable for storage. In the theoretical data model, object, attribute and attribute value were defined, representing the real world. In the data structure model, these are represented by record, field and sub-field respectively. A file is a group of records, and an exchange set is a group of files. A record consists of one or more fields and a field contains one or more sub-fields. The hierarchy is shown in figure III-7 (R stands for 'one or more').

[IHO, 1996; p. 3.2] In figure III-8, an example is worked out of a plan of an arbitrary harbour.

[Carol, 1996; p. 58]

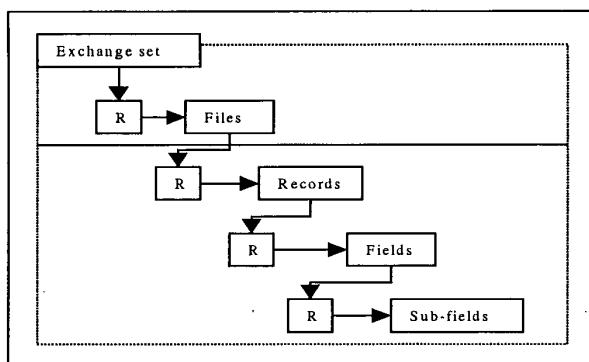

Figure III-7: Data structure model. [IHO, 1996; p. 3.2]

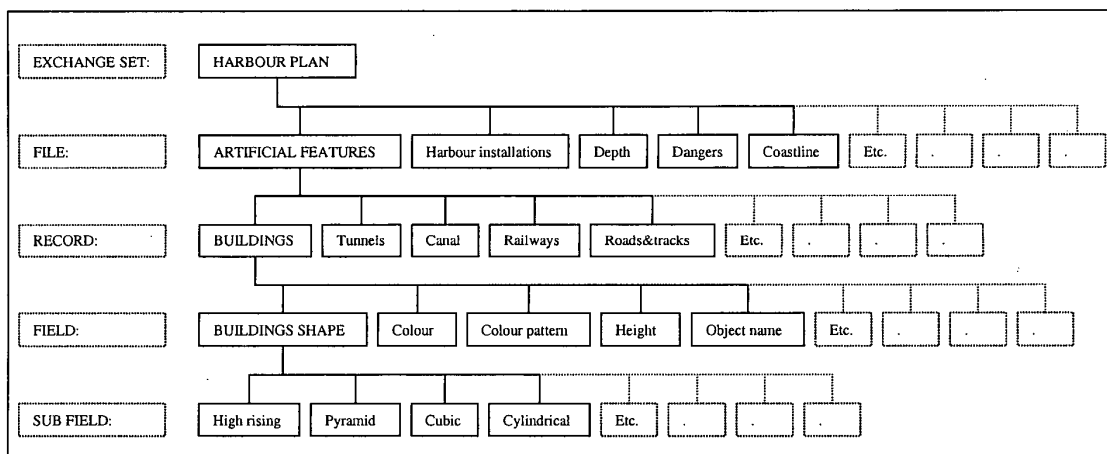

Figure III-8: S-57 data structure example. [Carol, 1996; p. 58]

Finally, it is important to note, that this data model and structure does not contain any rules on presentation. [IHO, 1996; p. 2.6] The form of presentation differs with the kind of utilisation. Presentation has to be described by a presentation model. For example, the way ECDIS

presents the nautical information can be totally different from the type of presentation used for paper charts. This concept is used to provide greater versatility and flexibility.

#### III.4.4 The route-network in S-57

Now, we have described the S-57 transfer standard. All the records are defined in the S-57 manual [IHO, 1996], as well as the fields and the sub-fields, and which record is described by which field(s) and sub-field(s). No records can be considered as left over for a route-network specifically, which means that the various components of the route-network have to be defined within S-57 in new records, fields and sub-fields.

First, consider the route-points. A route-point was defined as an access to a route-segment. It was located by a geographical position. Since route-points could well be representing a harbour (which is a descriptive characteristic), they are not treated as node but considered to be a real world entity. A route-point is thus an object in the data model and a record in the data structure. Feature is route-point represented by a node (spatial record). The new record would have a new name, within S-57 it would be something like NERTPT (network route-point).

Furthermore, a route-lane would be a new record, too. The route-lane is represented by a link (which is the centreline of the lane), and a link is built up by two nodes (but only nodes that represent route-points, too!). Within the attributes the 'other dimensions' are stored, as depth, width and height. Length of the segment is calculated with the (known) positions of the accesses (route-points).<sup>16</sup> The name of a route-lane should be like NERTLA (network route-lane).

However, the route-area as it was defined in paragraph III.3.1. is not easily inserted in the S-57 transfer standard. S-57 does not allow a feature to be represented by more than two nodes. Therefore, a link should be created between all the route-points within one area, connecting 'neighbours' and enclosing the area. Then, the route-area is represented by an area, which is terminated by edges and in turn, by nodes (which are nodes that represent route-points, too!). The route-area would then get a name like NERTAR (network route-area).

Another option is to distinguish between segments that have the characteristic 'Traffic Separation Scheme (TSRT)', Deep Water Route (DWRT), Recommended route (RCRT) or other routing measures or none. The advantage is, that amongst the records in S-57, the

---

<sup>16</sup> In chapter four all the relevant information is discussed, including a description of how they are treated as attributes to the network.

centrelines of these routing measures are defined. For example, the centreline of a deep water route is DWRTCL and the centreline of a recommended route is RCRTCL. [IHO, 1996; appendix A] Route-segments with no routing measures could then be NORTLA or NORTAR. The use of these existing records limits the 'extra' work of creating the network centrelines in places where these are implemented in the ENC already.

Anyway, the exchange set would be the Route-network and the files would be the Route-segments and Route-points. Records are Route-lanes, Route-areas, Route-points and Harbour-points. In figure III-9, an overview of how the network can be fitted to the S-57 data structure is shown (without the use of the existing centrelines!).

The implementation of the route-network data within the S-57 transfer structure is not that difficult. However, bearing in mind the complexity of the structure and the goal of this thesis, the chain-node data structure will be used in our test-environment. The first reason is the complexity of the feature-based structure that is used in S-57, in comparison with the chain-node structure; and the second reason is that the results obtained with the algorithm using the chain-node structure should not differ from results using the feature-based structure. Nevertheless, the importance of the feature-based structure means that, although the chain-node data structure is used, the aspects of S-57 should be kept in mind during further processes.

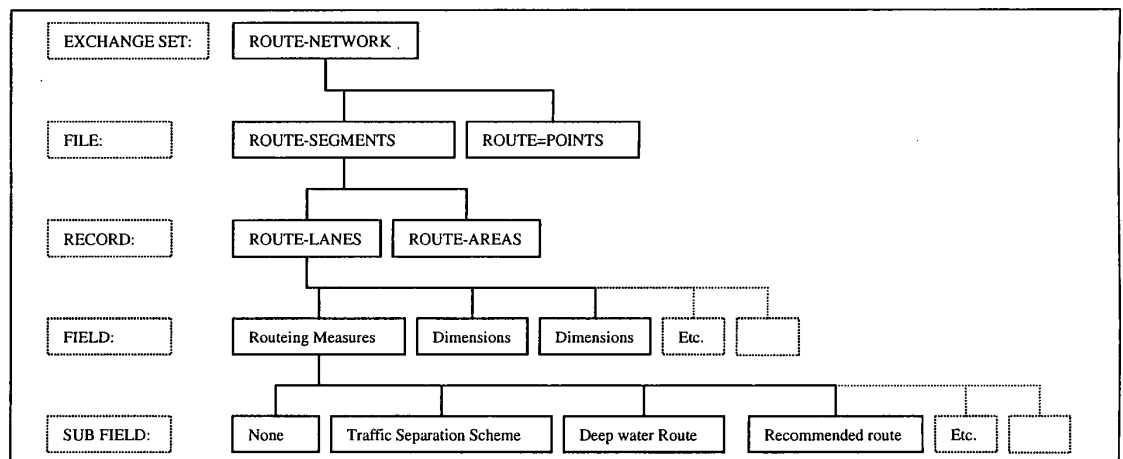

**Figure III-9: The route-network fitted to the S-57 transfer standard.**

#### III.4.5 Chain-node structure.

In the previous paragraphs, the S-57 data structure is discussed, as well as a way to implement the route-network data into this transfer standard. The reasons for developing a chain-node data structure for the test environment are also discussed. The development of this (temporary) data structure has the same two phases as the development of S-57. A theoretical

data model is created first, after which we can match the objects and attributes into the chain-node structure.

Again, we define an object as a real world entity, with attributes and attribute values. The data model still resembles the planar graph model. However, a division between connected and isolated nodes is no longer required. A link is now terminated by two nodes, and a node terminates at least one link. An area is defined by at least three nodes (otherwise it would be a link) and a node defines at least zero areas (a node is not necessarily positioned within an area). The features route-point, route-lane and route-area are represented by node, link and area respectively. Figure III-10 shows the theoretical data model that is used for developing the chain-node structure.

Now that the theoretical data model is discussed, we can translate this into the chain-node data structure. In the chain-node structure, both descriptive and spatial information is combined in one record. Topology is simply provided by linking records, thus creating a relationship. Looking at the route-network, this means that within the chain-node structure three records are created; namely the record route-points, the record route-lanes and the record route-areas. The attributes are assigned fields, whose contents contain the value of the particular attribute describing the particular component of the network. The attributes and the values they can adopt are stored in a Metadata type of table.

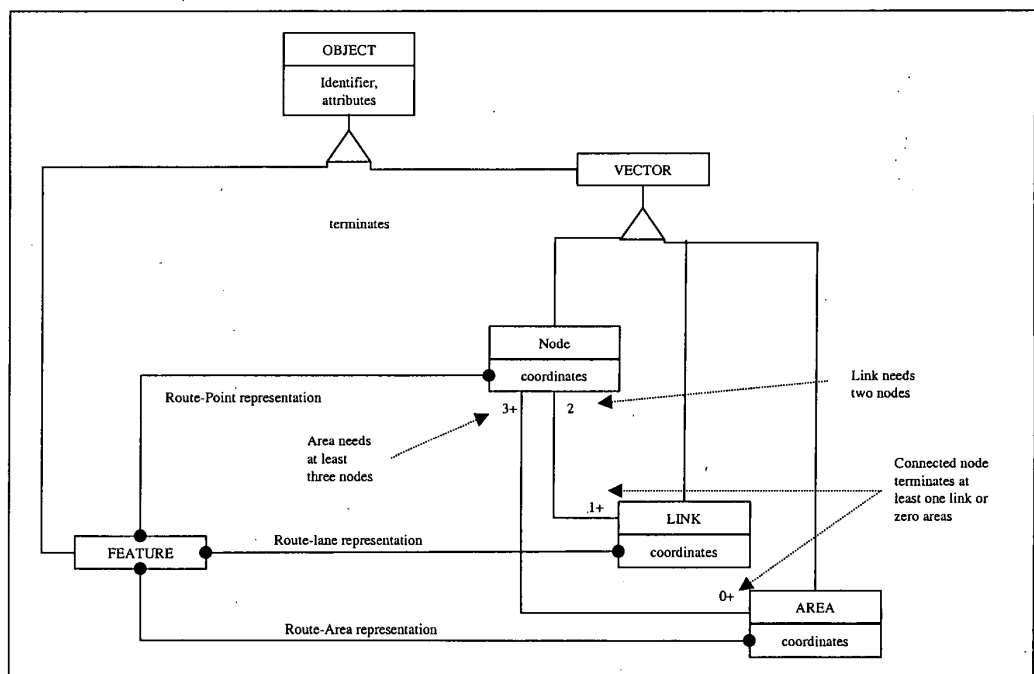

Figure III-10: Route-network theoretical data model.



The route-point record is filled with a position (most likely in latitude and longitude), a couple of fields with information about harbours (including a field stating 'is it a harbour') and a field that contains the identification of any area it belongs to.<sup>17</sup> The first field contains the name or 'identifier' of the node.

The route-lane record contains two fields to define the nodes (with the use of the unambiguous identifier) a lane is terminated by. One field is reserved for the traffic regulation (is the lane two-way or one-way). Then the rest of the fields are reserved for the attributes. The first field contains the lane-identifier again. The route-area record contains one field with its identifier and the rest of the fields are reserved for attributes. Appendix E shows the final chain-node data structure that is used for the test-environment.

---

<sup>17</sup> This is done because of the limitations of the chain-node structure. In theory, an area can be defined by an infinite number of nodes, but leaving an infinite number of fields available in the table-type record structure would be impossible. Therefore, an area is defined in a contrary way in comparison to the datamodel.

## IV Route planning information requirements

In this chapter, the required information during the route selection phase is discussed in chronological order. The voyage planning process starts with the definition of the Sailing Order, as does this chapter. Then some considerations on sources and navigation phases are discussed, followed by a listing of all the information that needs to be consulted in the route-planning process. The relationships between and the preference of the sailing order and passage characteristics are discussed in the next paragraph. Finally, from this list of different types of information, a few types are selected for the test environment.

### IV.1 Sailing order.

The definition of the sailing order starts the voyage planning process. The sailing order contains all the initial conditions, demands and constraints that apply for the oncoming journey. The sailing order has to be compiled carefully, since the rest of the voyage planning process is executed within the margins that are set by the sailing order. A deficiency in the definition of the sailing order can well cause the process to be executed again, or even cause serious accidents.

The sailing order can be divided into two types of characteristics, namely mission and ship's characteristics. These are dealt with in the next two paragraphs.

#### IV.1.1 Mission characteristics needed for route selecting.

The mission characteristics consist of all the conditions, demands and constraints that apply for a particular mission or voyage. The main source for the mission characteristics is the assignment from the shipowner(s) or the operation order from the naval command. This source contains information on port of destination, intermediate destinations, time requirements and, in case of navy vessels, exercise or mission assignments. Another source for the mission characteristics are the preferences and wishes of the captain, who normally has his own principles and guidelines on the conduct of passages (e.g. safety margins) and the fulfilment of a mission (e.g. meteorological requirements).

A few categories of mission characteristics can be distinguished:

1. **Destination characteristics.** Obviously, some information on destination is needed before planning a journey. Destination characteristics provide information on ports of call

and port of destination, or better, position of departure and position of destination. If necessary, some extra information can be added on intermediate positions/ ports, exercise areas that have to be passed and required passages and anchorage areas. The structure of the route-network implies that some extra requirements on the use of network-regions should be stated.<sup>18</sup>

2. **Time characteristics.** Time characteristics are a very important part of the sailing order. They state the conditions that influence the time-distance problem (see paragraph V.1.2.). Time characteristics consist of time of departure (ToD) and time of arrival (ToA) for the positions of departure and destination and for intermediate positions, areas and passages. Important other statements which set the time margins are for example 'on-time', 'in-time', 'not later than' and 'not sooner than'; also, 'during daytime' or 'during night-time' can be stated for some passages. Obviously, time requirements and speed requirements are very closely related to each other.
3. **Task characteristics.** Task characteristics provide extra information that is due to operational conditions and demands. For example, the type of operation of a navy vessel influences speed, time and weather requirements and manoeuvrability (e.g. mine-hunting, anti-submarine warfare and helicopter operations). Obviously, the same differences can be distinguished between merchant vessels and fishery or offshore operations. On the other hand, passenger ships and ships with embarked troops will state some weather requirements to limit ship's movement. Another type of task requirements has to do with security and risk. Security demands consists of requirements on behaviour in war zones, prohibited zones, territorial waters and danger areas. Risk demands state the limitations on acceptable damage risks, piracy risks and delay risks.
4. **Navigator's demands.** Navigator's demands consist of all sorts of demands that can also be stated in the previous types of mission characteristics. Furthermore, some typical navigation based requirements are set by the navigator. Examples are requirements on *aids to navigation*, weather and behaviour during the conduct of passages, and preference statements concerning the operational characteristics of passages.

---

<sup>18</sup> The network is divided in network-regions in order to decrease the amount of data that has to be searched during the computing process. The navigator can appoint regions that have to be used and, on the contrary, that should be avoided.

Important to note is that different requirements can strongly conflict with each other in some cases. For example, a transportation ship with embarked troops that have to land as soon as possible will have speed/time requirements (as soon as possible) and the requirements on ship's movement, which obviously conflict. The navigator must decide which is the most important requirement.

#### IV.1.2 Ship's characteristics needed for route selection.

The second part of the sailing order is the ship's characteristics definition. Most ship's characteristics prevail for every trip or voyage, and can therefore be stated once. However, information on draught, cargo, equipment and crew skills can vary with mission. These should be carefully checked every time. Important information on the vessel is [Draaisma, 1986; p 157-160] [Sabelis, 1997(ii) and 1999(ii)] [Groot, 1999; p. 30][Carol, 1996;p. 9]:

1. **Size.** The size of the ship consists of length, width, tonnage, height and observer height.
2. **Draught.** The draught of the ship is the draught at the position of propellers, rudders and domes. Draught fore and aft depends on the load of the vessel. Draught can vary during a journey, by decreasing fuel, oil, water and food supplies, or by new cargo picked up at an intermediate port. Another important aspect, dependent on ship's hull characteristics, draught and speed, is *squat*<sup>19</sup>. In combination with draught, the minimum Under Keel Clearance (UKC) should be stated. Minimum Under Keel Clearance is the safety margin on top of the ship's draught. UKC plus draught determines the minimum waterdepth needed for the conduct of a passage, setting the depth safety contours.
3. **Manoeuvrability.** Manoeuvrability limits the conduct of narrow and difficult passages, and the execution of difficult turns and manoeuvres.
4. **Propulsion.** The type of propulsion and the characteristics of the engines determine fuel consumption (also dependent on load-line condition), speed reduction, and maximum, minimum and economic speed.

---

<sup>19</sup> Squat is defined as the downward vertical displacement of ship's central gravity and trim, caused by the ship's movement at given speed. The squat effect is considered to decrease with depth. In order to prevent damage to the propellers and the keel, the speed should be decreased. [Tijben, 1998]

5. **Equipment.** The available equipment on board also limits navigation. For example, GMDSS equipment can limit the operation areas<sup>20</sup>. Also, the availability of, amongst others, different radars and positioning systems limits the conduct of certain passages with certain conditions.
6. **Crew.** The state of the crew and its skills could also limit the conduct of, especially long and difficult, passages. An inexperienced crew should only execute simple missions<sup>21</sup>.
7. **Cargo class.**<sup>22</sup> The class of cargo that is transported influences the selection of routes also. Many regulations are issued, in order to prevent ships with dangerous goods from sailing near the shores, for example. The amount of cargo also influences the load lines and the draught. Normally, the cargo classes are distinguished as defined in the IMO Marpol (73/78)<sup>23</sup> [IMO, 1978(ii)] convention.
8. **Ice class.**<sup>24</sup> The ice breaking characteristics of the vessel are important when the area of operation includes a region with chance of ice forming. There are a few class definitions issued by various local authorities, that provide ice reports and warnings. For example, the Canadian government and the Finnish and Swedish authorities use different formats, terms and procedures.<sup>25</sup> Both are used quite commonly. The classification bureau 'Det Norske Veritas' adopted classifications that are considered to meet both regulations. [DNV, 2000]

All these different characteristics will influence the decision phase in selecting routes in different ways. Not only can some information deny the conduct of certain passages, also the preference for some route characteristics will differ. This will be explained in paragraphs IV.4 and V.1.1.

In the route planning tool, sailing order information should be input at the start of the process. A window where all the data can be filled in is a good option.

---

<sup>20</sup> In the GMDSS rules, four areas are defined, for which compulsory and type-approved equipment is prescribed.

<sup>21</sup> Although in practice, captains often decide else, due to time pressure and money issues.

<sup>22</sup> More on cargo classes in appendix C.

<sup>23</sup> MARPOL 73/78 (i.e. the international convention for the prevention of pollution from ships) was first issued by IMO in 1973 and was amended by the protocol of 1978. It contains all important international regulations on dangerous cargo and pollution prevention.

<sup>24</sup> More on Ice classification in appendix C.

## **IV.2 Some considerations on the required information for route-planning.**

### **IV.2.1 Sources & availability.**

Obviously all the information that is needed within the route-planning process has to be available in some form. In order to make testing of the principles presented in this thesis possible, all the (selected) information shall be implemented as attributes in the data structure, as discussed in the previous chapter. In ECDIS applications, the information should be made available through GIS queries where possible. The gathered information is then stored as attributes to the route-segments. Other information, that normally cannot be gained from the ENC, has to be stored as attributes manually. After the collection of the information, the treatment of all the attributes is the same, no matter what source was used.

A short overview on all the sources is given in this paragraph. More detail is beyond the scope of this dissertation.<sup>26</sup> There are four possible sources to discern, which all contain information relevant for route planning:

#### **1. GIS or ECDIS data structure.**

As discussed in paragraph II.5.1, a GIS is particularly useful to manage geometrical and topological data. GIS is equipped with various tools for spatial analysis and queries. When the specific data is recorded in the data set, obtaining the data from this data set is clearly the best way to provide data availability for several applications such as route planning.

However, only some information is available in ECDIS, as seen in the current standards (S-57 for hydrographical data [IHO, 1996]). In S-57, mainly information that is on the nautical charts is allowed for. Information such as depths, buoys, wrecks and lights can be obtained from the ENC by using some sort of query. Carol [Carol, 1996] and De Groot [Groot, 1998] discussed the lack of various other kinds of information, especially the information that was available in nautical publications other than the nautical chart. De Groot even made some recommendations on extension of S-57. Availability of many kinds of information will be possible in the future; the hydrographic offices are debating the standardisation of electronic versions of nautical publications. [IHO, 1999] Hence, the ECDIS data set should be an information source for a route planning tool, but is (still) not yet sufficient.

#### **2. Conventional sources.**

---

←<sup>25</sup> The Canadian authorities issued the 'Canadian arctic regulations' and the Finnish and Swedish government co-operated when issuing the 'Finnish-Swedish ice class regulations'. [DNV, 2000]

<sup>26</sup> More reading on this subject: [Carol, 1996] en [Groot, 1998]

Most information, that is required when selecting a route, is provided by the old fashioned nautical publications, such as sailing directions and the Admiralty lists of Radio signals. As will be the method in this thesis, all this information is extracted from all kinds of sources and implemented in the data structure. Clearly, this is not the optimal way, since still the most time-consuming part has to be done manually (once, apart from updating). In the future, however, most nautical publications will be available electronically via ECDIS, as stated at 1.

### 3. Obtaining by calculation.

Some information can simply be obtained by calculations. Examples are distance, time, tidal information and astronomical calculations.<sup>27</sup> The calculations can be executed either manually or by specific software. Many of these calculations are already implemented in the ECDIS software (e.g. distance) or are easily implemented in the future (since simple calculations can easily be programmed and made compatible with the ECDIS software).

### 4. Information by consulting various types of software.

Nowadays, there is much 'nautical software' available, varying from a simple electronic nautical almanac to very complex software packages, which contain information on almost all nautical phenomena.<sup>28</sup> Obviously, some of these can provide the route planning tool with various types of information. To enable the use of nautical software, compatibility is an important requirement; different types of software must communicate properly in order to prevent errors.<sup>29</sup>

#### IV.2.2 Ocean, coastal and confined passages.

A very important criterion for information requirements, is the classification of the passage. Classification distinguishes between *ocean, coastal and confined passages*, depending on the distance to the nearest, non-floating obstacle.<sup>30</sup> The classification could also be considered as phases of marine navigation. Note the equivalence with phases in air navigation, where distinction is made between the *en route/terminal* and *approach/ landing* phase. [FRP, 1999] This location determines the importance of some kinds of information. It also influences the

---

<sup>27</sup> Provided, of course, that the fundamental data, such as tidal harmonical constants, is present in, or available to the software.

<sup>28</sup> Software such as CNAV includes for example nautical almanac, tidal predictions, (almost) all nautical calculations (transformations, distances etc) etc.

<sup>29</sup> In the further research, an error-free compatibility is assumed. Discussing these aspects of software technology is beyond the scope of this thesis.

<sup>30</sup> The US Federal Radio navigation Plan also defines a phase called inland waterway, which concerns inland shipping and very much resembles the harbour entrance and approach phase. [FRP, 1999] The latter is the same as confined waters.

operational demands, such as bridge manning, alert state, crew readiness and equipment availability. A water is said to be an ocean passage, when the nearest navigational danger is outside 50 nautical miles. When the nearest danger is within two nautical miles, the passage is confined. Coastal passage is the category in between. [Groot, 1998; p.35]<sup>31</sup>

Confined passages would normally be avoided, unless there are no other feasible options. The alert state, operational readiness and equipment availability is highest when such a passage is sailed. Normally, the best and most accurate preparation is required for a safe passage. Clearly, the most information is required during the voyage planning process and is relevant in the route planning phase, too. For the conduct of coastal passages, alert state and readiness could be less, and less accurate preparation is justified (within reasonable margins, of course!). This implies that less information is necessary during the route planning phase.

For ocean passages, the same reasoning can be applied, but there is also more attention needed on other information, especially climatic and oceanographic information. It is important to note that for the conduct of ocean passages, other methods for route planning are more feasible. It is better to use weather routeing algorithms or publications like ocean passage of the world. These applications could thus well be used in combination with the route planning algorithm presented in this thesis.

Obviously, it is justified to state the dependency of information requirements on the classification of a route-segment. This fact will be taken into account when discussing the relevant information in the next paragraphs.

### **IV.3 Relevant passage information during the route-planning process.**

In this paragraph an inventory of all the information that is of influence on the selection of a route is presented. This overview is based on three references, [Groot, 1999], [Draaisma, 1986] and [Carol, 1996], and on the author's own view. The list will include some information on the sources of the data and statements concerning the passage classification, as described in the previous paragraph.

The sequence of analysis of information during the route planning phase as proposed by Sabelis [Sabelis, 1999(ii)] is in my opinion not logical and not complete. Sabelis suggested leaving characteristics such as classification, routeing, dangers and obstacles and the *availability* of

---

<sup>31</sup> In fact, these criteria are also dependent on type of ship, weather conditions and the availability of positioning systems.



track control out of view. These characteristics would be taken into account during the navigation planning phase. However, this kind of information should be considered when selecting a route, too, although with less detail, as also suggested by De Groot [Groot, 1999; p. 42]. A good overview on all the aspects is required, as 'less important' characteristics could well be decisive in the choice between two route-options.

The following aspects and route characteristics should be taken into account during the route planning phase:

#### IV.3.1 Dimension characteristics.

1. **Depth.** Clearly, the water-depth of a passage is the most important aspect. Not enough water is simply the reason to avoid a passage. There are two quantities involved in water depth: *chart depth* and rise due to the *vertical tide movement*. Chart depth is implemented in the ECDIS structure (as soundings). Vertical tide movement can be supplied by coupling tidal prediction software or by manually looking up in tables such as Admiralty Tide Tables. Another important aspect to depth is the *reliability* of soundings. Some charts carry soundings that are more than hundred years old taken with old-fashioned low-accuracy techniques. Reliance on soundings depends also on the type of seabed. A seabed of sand varies with time for example. Structure can also be subtracted from ECDIS data. Obviously, depth is important for all classes of passages.
2. **Height.** Height is more or less related to depth. Clearance below bridges can also deny passage and is also variable with time due to tidal effects. However, reliability of height figures should not be taken into account, since they are not liable to large changes. Height is implemented in the ECDIS structure. Bridges and other obstructions that restrict passage with height are most likely to be located in confined areas.
3. **Length.** The length of a segment is of course of great influence on the selection of a route. The time-distance problem<sup>32</sup> is the key factor in route selection, since time of departure and time of arrival are often fixed. In the same breath with length, travelling time should be mentioned. Obviously, these quantities are highly related to speed. Another aspect, related to length and travelling time, is fuel consumption. Length, time and fuel consumption depend on the geometry and topology of the segment. They are

---

<sup>32</sup> More information on time-distance problem in paragraph V.1.2.

easy to calculate. In ECDIS, distance can be calculated by the software itself.<sup>33</sup> As will be discussed, both travelling time and fuel consumption are dependent on other characteristics, too.

4. **Width of the fairway.** The clearance between the safety contours of a passage is the width of a fairway. A very narrow passage limits the manoeuvring capability of the vessel and denies deviations of the track line. Width is obviously related to the classification of a passage. The width of a passage should thus be taken into account.

#### IV.3.2 Navigational aspects.

1. **Aids to navigation and means of track control.** Aids to navigation are positioning systems, such as (D)GPS, LORAN-C, visual navigation (compass bearings), radar navigation (bearing plus radar distance) and astronomical navigation. Means of track control are of various types. Good examples are leading lights and radar and visual conspicuous marks (for parallel index lines, head/stern marks and safety bearings). Important criteria are the availability of aids to navigation, their accuracy, *reliability* and *update-rate*. Depending on the vicinity of dangers, demands on availability, accuracy, reliability and update-rate vary. The smaller the distance to the nearest danger, the more aids should be available (redundancy) with higher accuracy, reliability and update-rate requirements. Together with the availability of aids to navigation, the requirements on the means of track control increase, too. Given the definitions of the different classes of passages (paragraph IV.2.2), availability of means of track control is only of vital influence in coastal and confined passages. The availability of aids to navigation is always important. They could well be obtained by spatial analysis of ECDIS data, searching for the nearest visual beacons and radar conspicuous objects. Nevertheless, information on aids to navigation is still only available in paper publications.<sup>34</sup>
2. **Obstacles.** Another characteristic of a passage is the presence of invisible wrecks, rocks and shallows, that can be hazardous to ships. These types of obstacles are called navigational dangers, when they are dangerous for the vessel that is used for the passage. Clearly, the more of these dangerous features, the less favourable the passage. However, when an obstacle is marked through buoys for example, the presence of this obstacle is of

<sup>33</sup> Important to note, is that for ocean passages sailing the great circle distance could be more favourable than using the *rumb line* distance. If wanted, other proper software should be used (e.g. weather routing algorithms).

<sup>34</sup> Information on aids to navigation is typically gathered in the Admiralty lists of Radio Signals. Although coverages of loran-c and DGPS stations are suitable to implement in the S-57 data structure, they are not implemented so far.

less influence to the choice of passage to sail, because it is made 'visible'. The combination of an obstacle with a buoy is also defined in S-57 (as collection objects). [IHO, 1996] Thus, the number of obstacles, together with the combination of buoys that mark these, is important in route-planning. Another type of obstacles is off-shore installations. However, they are normally not considered to have much influence in the route-selection process, since they are well visible and easily kept clear of. It is important to note, that the presence of navigational dangers is not of influence in ocean passages.<sup>35</sup> In coastal and confined waters, however, these obstacles cannot easily be sailed around. All obstacles are implemented in the ECDIS data set, as are the buoys and even the combinations of dangers with buoys.

3. **Fairway marking.** The state of the fairway marking in a passage is of influence to the selection process, especially in selecting confined and coastal passages. When the fairway is marked properly, the conduct of a passage could be easier, since the limits of navigable water are made visible. Although reliability on the positioning of buoys is not very good, the marks can be used to compare positioning results with the 'real world', increasing 'trust' in the obtained positions. In very narrow passages, where the accuracy of the available aids to navigation is not sufficient according to the width of the passage, navigation is often carried out by 'counting' buoys (river navigation). Although the 'state' of the fairway marking is difficult to measure, the amount of marking buoys (e.g. lateral buoys) can give sufficient information. For example, many buoys in the area means good fairway marking, few buoys means poor marking. The amount of buoys in the area can obviously be obtained from the ENC.
4. **Navigational warnings.** Navigational warnings of all kinds, issued in Notices to Mariners (NtM) and Maritime Safety Messages, could also be relevant in the choice of route, in all classes of passages.

#### IV.3.3 Regulations and restrictions.

1. **Regulatory restrictions.** In a lot of coastal and confined areas, the local authorities have enforced rules on shipping to prevent ships, for example carrying dangerous goods, from sailing close to the shore (e.g. because of the risk of pollution). The IMO often adopts these rules in their resolutions. Three types of regulatory restrictions can be distinguished:

---

<sup>35</sup> When we look at the definition of ocean passages, these obstacles shouldn't be present at all. However, the presence of one such a small obstacle in the middle of the Atlantic Ocean, would not normally change the way of looking at the trajectory, it would still be considered an ocean passage.

cargo restrictions, tonnage restrictions and draught restrictions. Cargo restrictions imply allowed classes of cargo for a certain area; tonnage restrictions prescribe the allowed tonnage for a certain area; maximal or minimal draught allowed for a certain fairway (often deep water routes). This information is sometimes available in the ENC (as notes); it can always be found in paper publications (sailing directions). It is justified to note, that these restrictions are only enforced in coastal and confined areas.

2. **Speed-limits and time-slots.** Speed-limits are laid down in order to increase safety or to protect banks and shores from damage. They are often seen in canals, as the Suez Canal, Panama Canal and the Nord-Ostsee Canal. Obviously, speed-limits increase travelling time and thus influence the time-distance problem. Details on speed-limits are normally found in publications such as Sailing Directions. They are mainly enforced in confined waters, but sometimes found in coastal passages, too. Time-slots are caused by two situations, tidal time-slots and time-slots caused by locks and opening bridges. Tidal time-slots occur when there is only a short period of time at which a passage can be conducted or a harbour can be entered, due to tidal rise and fall. Time-slots clearly influence the time-distance problem. Information on time-slots can be found in Sailing Directions (in case of locks or bridges) and in tide tables (e.g. Admiralty Tide Table) and tidal prediction software (in case of tidal time-slots).
3. **Routeing measures for routes.** There are several kinds of routeing measures, laid down by IMO (see paragraph III.1) and local authorities. The most frequently occurring type of routing measure is the Traffic Separation Scheme (TSS). There are quite strict rules of behaviour, enforced in the whole area around such a TSS, which are to be found in the IMO Collision Avoidance Regulations (COLREG). [COLREG, 1977; rule 10] Another important kind of routeing measure is the Deep Water Route (DWR). A deep water route is a route from which the depth is maintained and controlled at a certain level, in order to provide a safe passage for ships with extreme draughts. A DWR often comes with regulatory restrictions (ad 1.). Another type is the recommended route, which is mainly laid down by the local authorities. The recommended route is to be considered as the best route to take to pass the whole area. TSSs and DWR can be found in the ECDIS data set; a recommended route is sometimes found in the ECDIS structure and always stated in the Sailing Directions. All types are found in coastal and confined areas, but not in ocean passages.

4. **Routeing measures for areas.** Typical kinds of routeing measures for areas are anchorage areas, military exercise areas, caution areas and prohibited areas (see paragraph III.1). These are all found in the ECDIS structure, although information on prohibited areas and military exercise areas is often provided via Maritime Safety Information messages (e.g. via NAVTEX). Particularly, these routeing measures are found in coastal and confined areas, but a few of these types can occur in ocean passages, too (prohibited area, military exercise area).

One important note on the sources of restrictions (1 and 2) and routeing measures (3 and 4) should be made. As described above, information in these categories could well be available in the ENC. However, it would be incorrect to say that this information should be complete or sufficient. In most of the cases, information in the ENC (as it also was on paper charts) is a summary. The Sailing Directions (or an approved electronic version) should always be consulted! This again emphasises the need for a more complete set of information that can be consulted on ECDIS.

#### IV.3.4 Remaining aspects.

1. **Meteorological, climatic and oceanographic aspects.** Meteorological, climatic and oceanographic aspects are, for example, permanent currents, wind, seas and swell (sea state), storm percentages and changes on tropical cyclones, fog probabilities, ice conditions<sup>36</sup> and peculiar phenomena like freak waves. All these aspects influence speed, travelling time, fuel consumption and increase damage risks. Most of these phenomena are particularly found on ocean passages, and since great distances are travelled on the oceans, the effects are the largest on ocean passages. Information on these various conditions is found in climatic charts and atlases, Sailing Directions, weather and wave height maps and meteorological atlases. Already, some research has been done to implement information in S-57.<sup>37</sup> Weather routeing software is designed to take all these kinds of aspects into account.
2. **General information.** Some information that is not very important, but could well be consulted when selecting a route, can be gathered in this category. The availability of a port of refuge and the vicinity of a rescue or coastguard station should there be an emergency, could also be of influence in the navigator's decision. Another example is the

---

<sup>36</sup> More on ice conditions and ice classification in appendix C.

<sup>37</sup> Sevencs did some research on the overlay of ice condition data on the ECDIS screen [Scheuermann, 1999].

threat or risk of hazards (piracy risk/ passage through a (possible) war zone). For naval or military operations, information on Territorial Waters, mine danger areas, submarine threat and the coverage of land-based missile sites is important. This information is not found in the ENC, but the sources obviously vary with subject. General information is valid for all kinds of passages.

3. **Traffic density.** Traffic density should be taken into account when selecting a route. Not only can the traffic density influence the speed, but also information on crossing ferries or heavy fishery could cause the navigator to take another route. Traffic density could be found in traffic density graphs [Traffic, 2000] or in Sailing Directions. Information on ferries, fishery and so on, is found in Sailing directions and in simplified detail in the ENC. This information is valid for all passages.
4. **Communications and guidance.** This last category of information is not the least important one. The availability of communications with and guidance through, for example, a Vessel Traffic Service (VTS) can provide an increase in safety. Certainly in the choice between two possible confined passages, the presence of a VTS could be a decisive factor. Information on radio stations and their operation is found in the Admiralty list of Radio Signals.

Furthermore, there are some aspects coupled to the simple fact that we use a network with segments as a basis. These include width of a segment, the sailing direction of a segment and some traffic regulations (one-way/two way) (as discussed in paragraph III.3.1.). Also, route-points could simulate a harbour, thus there has to be an attribute 'harbour' coupled with an outline of allowable UKC. These types of attributes are discussed in more detail in appendix D.

#### **IV.4 Relations between and influence of different kinds of information in the route-selection process.**

In the previous paragraphs, all the required information of both the Sailing Order and the passage characteristics is discussed. Obviously, all these kinds of information have a particular effect on the route selection process. In most cases, a combination of different characteristics from both the Sailing Order and the passage is decisive in the process.

Some combinations will have the effect of eliminating a certain passage from the optional routes, because it simply cannot or may not be conducted. These routes are then considered to be not suitable or feasible for the available vessel. Other factors have to be considered as having a positive or negative character in combination and in comparison with the other characteristics of a waterway. The relationships between these sorts of aspects are set down in terms of preferability.

A logical decision sequence is to first eliminate non-feasible options and then use a form of weighting.

#### IV.4.1 Testing the passages in terms of suitability and feasibility.

Some combinations of Sailing Order and passage characteristics should deny the use of the particular passage. In the synthesis phase, this passage should first be eliminated, in order to prevent the navigator or the algorithm from coming up with a priori unfeasible alternatives. Elimination of passages is, in terms of algorithms, typically a filtering operation<sup>38</sup>. It is important to distinguish these combinations of characteristics which cause the waterway to be labelled 'unfeasible'.

The first combination causing an unfeasible segment is when depth of the passage is not enough. This occurs when the water depth (which is chart depth plus tidal rise) is less than the required depth, which is the ship's draught increased by the appropriate safety margin (UKC). Sometimes, depth is not sufficient during a small part of the day, due to vertical tide movements. In that case, a tidal slot occurs. Closely related to the depth-problem is the height-problem. When the ship is simply too high to pass a bridge, for example, the segment is not optional. Height depends also on tidal effects, causing a tidal slot in some cases.

Unfeasibility is also caused by regulatory restrictions such as cargo, tonnage and draught restrictions. When a passage is not allowed to be conducted by existing regulations, the passage is unfeasible. Prohibited areas are another form of regulations forbidding use of the passage.

Furthermore, some ice conditions could well deny passage in some regions. When the ice strengthening of the vessel's hull is not sufficient, considering the prevailing conditions, the region should be avoided, unless ice breakers are available.

---

<sup>38</sup> In paragraph V.3.2. the exact filtering algorithm is discussed.

Finally, in some cases the ship's equipment is not sufficient, which could deny a passage to be sailed. Examples are, when the available GMDSS equipment does not comply with the operational area, or when port authorities demand particular equipment to be fitted when entering the concerning port.

#### IV.4.2 Analysing the passages in terms of preferability of characteristics.

Now that all the unfeasible segments are filtered, the decision process is concentrated on searching for optimum solutions. As explained in paragraph II.3, the choice between a couple of options is based on balancing advantages and disadvantages. The navigator will have a personal set of demands to which the characteristics of the passage are verified. Hence, some characteristics are preferred to other characteristics, either single or in combination with other characteristics.

Nevertheless, the relationships between and the preferability of characteristics are very difficult to determine. Not only has the navigator his own preferences, preferability is also strongly dependent on type of ship and type of operation. For example, navigating a frigate or a VLCC (very large crude carrier) in confined waters makes all the difference obviously. Still a couple of relationships are valid in general.

So is the length of a passage, or the time and fuel needed for the conduct of that passage, a very important characteristic. When the route is optimised, obviously length, time and fuel are of decisive influence. As are the availability of aids to navigation and the availability of means of track control. On the contrary, characteristics such as fog percentages and piracy risks do not have great influence in the decision making process. These would be decisive in the choice between two options, whereby all characteristics are the same and only fog percentage or piracy risks are different, but will not cause the navigator to decide to make a great detour to avoid these passages.

Furthermore, the presence of routing measures is an advantage. Traffic Separation Schemes and recommended routes are clearly better options than other passages. Deep water routes are only preferable when the draught of the vessel leaves the navigator no other options than to use the DWR. Anchorage areas and military exercise areas should only be used when it is necessary to use them; thus when the mission order obliges anchorage or an exercise in these



areas passing through these is allowed. Furthermore, Inshore Traffic Zones should only be used if it is necessary to do so, according to COLREG. [COLREG, 1972; rule 10]

The presence of many (unmarked) obstacles is obviously negative, where the state of fairway marking has positive influence. Both characteristics are 'neutral' when there are no obstacles or there is no fairway marking. The presence of ice, although the passage of the ship is possible, is always a disadvantage, as it limits speed and manoeuvrability.

An important combination of information that can be distinguished is the combination of aids to navigation, fairway marking, width, obstacles and marks in case of a confined passage. If a confined passage is reasonably wide, sufficient aids to navigation are available with the right characteristics, fairway marking is good and there are no obstacles (at least no obstacles unmarked), the confined passage should not cause any problem. Conduct of that particular passage is relatively easy. However, if the passage is very narrow, if no adequate aids to navigation are available, if fairway marking is not present and if many obstacles lie within the boundaries, the case is totally different. Question is, should this option even be considered? Other combinations of these characteristics should be examined thoroughly!

For the remaining characteristics, these sort of statements can also be made. In paragraph V.1. this subject is extended, as 'the optimal route' is discussed.

#### **IV.5 Implementation in the test-environment.**

In the previous paragraphs, all the information that can influence the selection of a route is discussed. Given this large number of categories, it is rational to ignore a part of the list in the further study. Of course, when a route planning tool is finally used on board ships, it should have considered all the relevant aspects. This thesis is meant to present a working principle, rather than deliver approved software. Hence, a selection is made from the list of information to implement in a test environment.

##### **IV.5.1 Implementation of Sailing Order characteristics in the test-environment.**

In paragraph IV.1 the information in the Sailing Order is discussed. The most important block of information from the Sailing Order is the draught of the vessel and the desired minimum under keel clearance (UKC), because the draught of a vessel directly limits the route of the ship. Nevertheless, draught is ship, load and time dependent, so that draught with all the important facets is very difficult to implement. Hence, draught is implemented in

the test-environment as the largest draught, without inputting load and time. UKC can in any way simply be implemented (UKC in metres).

Furthermore, speed is implemented as the maximum possible speed. In effect, there are many factors that influence the actual speed of the ship and thus the time-distance problem (see paragraph V.1.2.). A few factors are economical speed, maximum speed, minimum speed, speed limits (see paragraph IV.1), squat, traffic density and weather circumstances. On the other hand, time requirements are important to the time-distance problem, especially when determining the Speed of Advance (SOA). As will be discussed in paragraph V.1.2., time requirements are not implemented in the test-environment.

Then, cargo class and ice class are implemented in order to provide representative filter-values (see paragraph V.3.2. and appendix C).

From the mission characteristics, only a few aspects are implemented in the test environment. Obviously, starting position and position of destination should be input; also intermediate positions can be implemented. Then, the choice between shortest route in distance and shortest route in time should be made, together with a statement on margins (see paragraph V.2.).

Details on the implementation of the Sailing Order characteristics in the test environment are presented in appendix D.

#### IV.5.2 Implementation of passage characteristics in the test-environment.

The first important condition in selecting passage characteristics to implement in the test-environment, so that still a thorough principle of a route planning tool can be developed and tested, is the obligation of taking a piece of information out of a group that should be handled in a similar way. Fitting the other information of that group in a later stage of development should then be easy. Another condition is the importance of selecting attributes that appear the most in real navigation situations. Seemingly, these attributes would be the most decisive attributes in the route selection process. A solution obtained from the algorithm would then be reasonably valid.

The following list shows the information that will be used in the next parts of the thesis:

Depth	Cargo restrictions	Fairway marking
-------	--------------------	-----------------

Classification	Speed limits	Fog probability
Length and time	Routeing measures	Ice conditions
Width	Obstacles	Piracy risk
Traffic regulations	Aids to Navigation	Minimal UKC

The most conspicuous choice is leaving out most of the meteorological, climatic and oceanographic details. Two factors are selected: fog percentages and ice conditions. Fog percentage is a good example of most of the weather related aspects, like storm percentages and swell. Ice conditions serve as an example for weather related aspects that can deny passage. Depending on type of ice and type of ship (ice breaking characteristics), a passage could be impossible to conduct. On the other hand, ice conditions are highly related to the season, as many climatic phenomena are. The implementation and correlation of weather aspects is a complex problem. Simple aspects, like percentages (changes) of occurrence of fog, could easily be input. On the implementation of ice conditions in the ENC, already some research has been completed. [Scheuermann, 1999] Moreover, some of these types are already implemented in other software (weather routing<sup>39</sup>).

Furthermore, piracy risk is selected in order to show the effects of general aspects. Cargo restrictions are chosen as example for all types of exclusive restrictions, as speed-limits do for other restrictive aspects. The navigational aspects are represented by both obstacles and aids to navigation, since both kinds of information are very important in the first place, and very different in the second place. Traffic control availability is considered to be of the same kind as aids to navigation. Routing measures are of great influence in the route planning-process, which makes the selection of that aspect logical.

Since a harbour will be represented by a route-point (see paragraph III.3.1.), an attribute is available for given maximum draught that is allowed for entering the harbour. Also, an attribute will point out if the particular route-point is representing a harbour or not. Obviously, there are a lot more details concerning harbours normally, but for simplicity purposes, they will not be discussed in this thesis.

In appendix D, the exact implementation in the test-environment is discussed.

<sup>39</sup> Since weather related aspects are mainly relevant in ocean passages, and weather routing is only valid for that class of passage, this reasoning is justified.

## V Route planning algorithm.

In the previous chapters, the route network and the relevant information were discussed. Hence, a basis for the route planning tool is provided. In this chapter, an algorithm is presented, which is able to generate a set of route alternatives tested by a set of criteria on optimality. In the first paragraph the optimal route is discussed, as well as an introduction to the time-distance problem in marine navigation. The second paragraph is meant to provide the outline of the algorithm sequence. In the third paragraph, the data set is prepared and adapted by filtering and calculations. In the last paragraph, Dijkstra's basic algorithm for calculating the shortest path and an algorithm for the  $K$  – shortest paths are discussed. Finally, a simple mathematical method is presented, that is able to compare routes by testing with a set of multiple criteria.

### V.1 Important considerations when automating route planning.

#### V.1.1 What is the optimal route?

Probably the most difficult issue when comparing and selecting routes, is the determination of what is meant by the optimal route. Although difficult, this is the most important issue. In order to know what is required for an optimal route, this route has to be defined carefully. The route planning algorithm has to compare options too, thus the best or optimal route has to be determined in advance. But, what is the optimal route?

Generally speaking, optimality is attained when an option complies with all the criteria.

Optimal route:      The optimal route is that route, that satisfies the mission requirements and complies with all the criteria, not containing unnavigable routes.

In practice, however, the chance of options satisfying all the criteria is very small. Therefore, the best option to take would be the option that complies with as many criteria as possible.

Best route:      The best route is that route, that satisfies the mission requirements and complies with as many criteria as possible, not containing unnavigable routes.

Where no restrictions apply, the optimal route would be either the shortest route in distance, in time or in fuel consumption (whatever requirements were set in the sailing order).

However, as discussed in paragraph IV.4, there are many characteristics that can restrict the choice of certain passages, or that can cause passages to be preferred to others. Besides, optimality varies with ship's characteristics, mission characteristics and navigator's demands (as explained in paragraph IV.4). Hence, before searching for the best route, unnavigable passages have to be identified and criteria for optimality have to be set carefully, considering various combinations of characteristics of both sailing order and passages.

A number of criteria for optimality can be identified for routes at sea. Two types can be distinguished, namely filter criteria and criteria of preference. Filter criteria are all those criteria that require passages to be avoided. For example, passages with insufficient water depths, iced passages or passages with cargo restrictions (considering the cargo, of course) have to be eliminated. Criteria of preference should emphasise the favourable passages and unfavourable passages. It is important to note that, although passages can be unfavourable, all the passages that passed the filter criteria are navigable.

Filter criteria are quite straightforward. 'Not enough water', 'forbidden cargo class', 'too high to pass the bridge' are all statements that can easily be implemented in an algorithm. The filter is discussed in paragraph V.3 in more detail. Criteria of preference, however, are very difficult to translate into strong requirements. 'Follow the Traffic Separation Schemes', 'avoid deep water routes', 'avoid anchorage areas', 'avoid Inshore Traffic Zones', 'choose the least unfavourable confined water' and 'try to get the shortest distance, time or fuel consumption' are vague statements. 'At what difference in distance (or time or fuel consumption) is the favourable route still preferred to the less favourable route?', or 'how much do you want to divert from the route in order to follow the TSS?' are questions that arise. A multiple criteria decision algorithm is needed to deal with these 'soft' requirements, as explained in paragraph V.2.

#### V.1.2 The time-distance problem.

One of the most essential problems in navigation is the time-distance problem. The time-distance problem is about determining speed of advance and time of departure, given the time of arrival, maximum and optimal speeds and other factors influence, or combinations of these. The time-distance is also referred to as the 2D+T problem. [Scheele, 1996][Sabelis, 1997(ii)][Manschot, 2000]

Generally, the time-distance problem is quite straightforward. However, in marine navigation time, speed and distance are influenced by a number of factors. Speed is influenced by the propulsion characteristics of the vessel (maximum, optimum, minimum speed), by the meteorological circumstances (weather, sea state, visibility, currents), by traffic situation (traffic density, caution area), by speed restrictions and by geographical circumstances (depth<sup>40</sup>, width), amongst others.

Time is influenced by time slots (locks and tidal time slots), time requirements (time of arrival, time of departure, time of passage, forced day-time passages<sup>41</sup>) and delay at intermediate passages (e.g. due to exercises). Distance is determined by the selection of a route.

The 2D+T problem is obviously important during the route selection process. With the help of a time-distance module, the different route alternatives can be examined on feasibility, according to the requirements set in the sailing order. For example, with fixed time of departure and/or the time of arrival, the route-alternatives that do not satisfy these requirements can immediately be deleted. Also, speed limits, depth, width, ice and fog influence speed, so that a shortest route in distance is not necessarily the shortest route in time.

The time-distance problem is discussed in more detail by Scheele [Scheele, 1996] and Manschot [Manschot, 2000]. In the test environment, only maximum speed and speed limitations are dealt with. The implementation of a complete 2D+T algorithm would provide the possibility of verifying routes against the speed and time requirements, taking all the factors of influence into consideration.

## **V.2 Structure of the route planning algorithm**

In the previous paragraph, the optimum route and the time-distance problem are discussed. It is now important to analyse the required capabilities and structure of a route planning algorithm.

The input of the algorithm consists of the route network data set and the sailing order. In the sailing order, requirements, mission characteristics and ship's characteristics are stated by the

---

<sup>40</sup> Depth and width can force the navigator to decrease speed. Squat effects and pressure effects (between banks and ship) can be hazardous to the ship if the speed is not adapted.

<sup>41</sup> Forced day-time passages are passages that are difficult to conduct. The navigator could require to pass these waters in day-time and good visibility only, for example.

navigator (as discussed in paragraph IV.1). The data set contains all possible routes. The information is still enclosed in the ENC and has to be gathered by GIS queries<sup>42</sup>. Therefore, the data should be prepared first, before entering the route calculation algorithm. The preparation of the data is done in the filter algorithm. The filter algorithm also contains the filter that deletes the unnavigable options, and the calculation module (in order to calculate time and distance, for example). The output of the filter algorithm is the *filtered route network*, which only contains navigable passages with all the characteristics. The filtered route network is the input for the route calculation algorithm.

The route calculation algorithm is the module that actually generates route alternatives. Route alternatives can be calculated in two ways. The first principle is to calculate the route with the least cost, with the use of an (advanced) Dijkstra algorithm (see paragraph V.4.1). The cost is then expressed in distance, time, fuel consumption or a cumulative cost. The cumulative cost is constructed by combining all the characteristics of a segment into one index number. The algorithm determines the least-cost route, only considering cost. Although the Dijkstra algorithm is efficient and robust, this is not a really good principle. After all, it is difficult and disputable to combine information with different scales, units and influence into one number, since it is comparing apples and pears! Furthermore, weighing up between distance and cost is now very hard, since the links are compared, not the whole routes. A critical distance, at which the algorithm should choose the shorter, but less favourable link, is difficult to implement. Also, the Dijkstra algorithm does not provide an option of calculating alternatives.

A better option is to first calculate the shortest possible distance (with the Dijkstra algorithm), and then determinate a margin, within which all possible routes are calculated. This implies the use of the critical distance or time, the Dijkstra algorithm lacks. Within the distance, time or fuel consumption margin the navigator is prepared to divert from the shortest route to take more favourable options. Using time margins, a time-distance algorithm can be used in order to delete route alternatives that do not satisfy the time requirements. This sequence is referred to as the interval solution in this further research.

The use of this sequence has two advantages. Firstly, all routes can now be compared with the means of the criteria of preference, which are implemented in a multiple criteria decision

---

<sup>42</sup> In the test environment, the information is enclosed in the data set as explained in paragraph IV.1. However, in order to present a realistic principle, I assume the situation as if the data is gathered from the ENC.

algorithm<sup>43</sup>. Secondly, the margins can be used to decrease the size of the data set. As it happens, the margins limit an ellipse with the position of departure and destination as foci.<sup>44</sup> All the segments outside the ellipse can be ignored, since it is mathematically not possible that segments outside the ellipse can be used to form a route which complies with the margin. This principle is used in the Dynamic Route Guidance System presented by Bailey et al. [Bailey, 1997] Figure V-1 shows the ellipse as used in a land navigation route finding system.

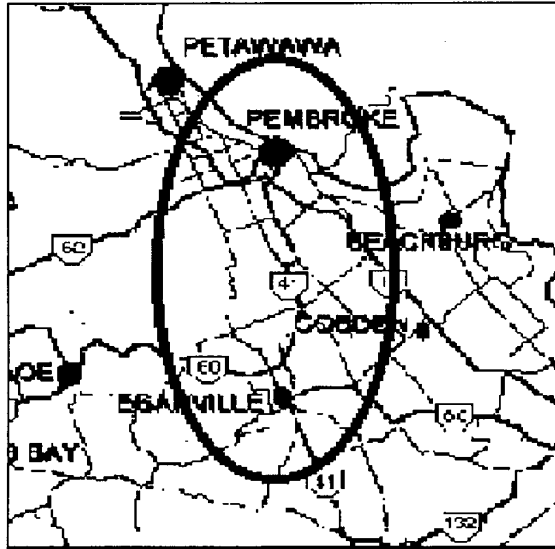

Figure V-1: The interval ellipse. [Bailey, 1997]

Perhaps a more efficient variant of the interval solution is the direct use of an algorithm that searches for the  $k$  – shortest paths. A difficulty is the determination of  $k$ ; the interval margin has to be translated into a representative number for  $k$ . The remaining sequence of comparing the routes is the same as was described above.

The sequence of the route planning algorithm is now as follows (see figure V-2). Firstly, the filter algorithm collects the information from the sailing order, route network data set and the ENC. It then filters the unnavigable segments and calculates some navigational quantities. The filtered route network is input for the route generator. The route generator calculates the shortest possible route and then generates all possible routes within the set margins for time<sup>45</sup> and/or distance (ignoring segments outside the ellipse). For every criterion of preference, the corresponding characteristic is also computed.<sup>46</sup> The set of possible routes is input for the

<sup>43</sup> This sequence of first calculating routes in terms of distance, time or fuel consumption and then comparing by using criteria of preference is proposed by Eppstein. [Eppstein, 1994 and 1997]

<sup>44</sup> Since the sum of the distances from a point on an ellipse to both foci of that ellipse is constant by definition.

<sup>45</sup> Probably the smartest way of determining the interval, is to use the time-distance algorithm and calculate the maximum allowable time for the route. This time is then expressed in percentage of the shortest possible time.

<sup>46</sup> These are further explained in paragraph V.4.3.



multiple criteria decision algorithm. Finally, the output of the algorithm is a set of the best route-alternatives, ranked in order of preference. These are presented to the navigator, who now can decide which route alternative will be used eventually (the *route*).

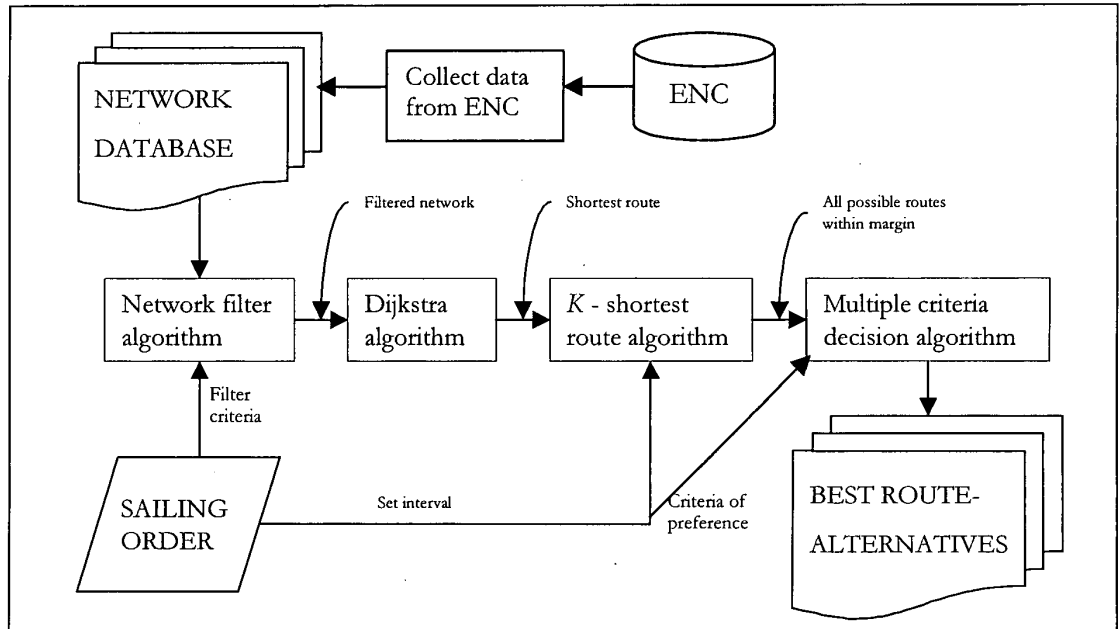

Figure V-2: Sequence of the route planning algorithm.

### V.3 Preparing the data set for the algorithm.

#### V.3.1 Collecting the information.

In chapter four, all relevant information during the route selection process is identified and discussed. Many types of information can be extracted from the ENC in the future. Therefore, the first part of the filter algorithm is to collect this information with the use of several GIS queries. How these queries can be used exactly, is beyond the scope of this thesis. This part of the algorithm will thus not be explained in detail. Here, it is only important to understand that this part should be implemented and the reasons why.

#### V.3.2 Filtering.

In the previous paragraph, the need for a filter algorithm was discussed. In this paragraph, the filter is presented, which will delete the unnavigable routes from the data set. This is done by comparing route characteristics with the characteristics as specified in the sailing order. The characteristics that prohibit passage are stated in the filter criteria.

The first and most essential filter criterion is depth. When the least depth of a passage is less than the vessel's draught, increased by a safety margin, the minimum UKC, the passage should not be used. In some cases, a tidal slot provides passage during specific time intervals. These passages are not deleted, but should be marked in order to ensure extra attention during the further voyage planning process. A time slot influences the 2D+T problem; it should thus be taken into consideration when examining the route for feasibility in accordance with the time requirements. Furthermore, it is important to note, that although a passage can be navigable, obstacles can still cause less available water depth at their position.

The second filter criterion is height. When passing bridges, the space under the span should be enough in comparison with the ship's height. Due to tidal effects, height can cause a time-slot too; it should also be marked.

Cargo, tonnage and draught restrictions obviously belong to the filter criteria. In case of a cargo restriction, the ship's cargo class is compared to the prohibited cargo class. The segment is deleted if these cargo classes correspond. The same is done with tonnage and draught restrictions, clearly.

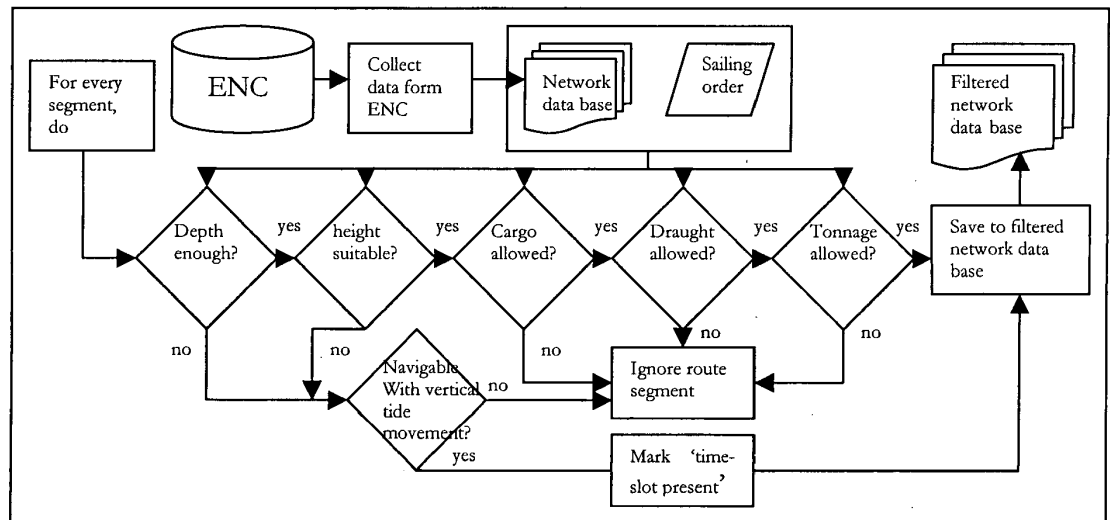

Figure V-3: The filter section of the filter algorithm.

Furthermore, a passage with reasonable chance of encountering ice is ignored if the ship's ice breaking capabilities do not allow the passage through the reported type(s) of ice.

There are probably more filter criteria than are listed above, but these are the situations that are most likely to occur. Figure V-3 shows a flow chart of this part of the filter algorithm.

### V.3.3 Calculations.

The second part of the filter algorithm contains the navigational calculations. Length and time of the segments are calculated here, because fixing them in the data structure would create dependent information, which could be a source of errors (as explained in paragraph IV-5).

The length of a segment is defined as the distance between the two route points. Generally, this distance is the length of the rhumb line which passes through both route points. Only when demanded by the navigator, the great circle distance is calculated. Sailing the great circle is considered to be favourable for ocean passages only (because of the long distances). Given the level of detail required for the route selection process, the distance could well be calculated on the standard sphere. Nevertheless, it is possible to use the ECDIS software to compute the navigational quantities, which are then computed on the geodetic datum of the ENC (normally WGS 84), providing better accuracies.<sup>47</sup>

The time needed to pass a route segment is calculated in a time-distance module, ideally. The time depends on speed restrictions, restrictions caused by depth and width (e.g. squat) and possible delays due to locks or exercises. The exact computation of the required time is not discussed in detail here.<sup>48</sup> The test algorithm calculates time using the preferred speed of the vessel and speed limitations.

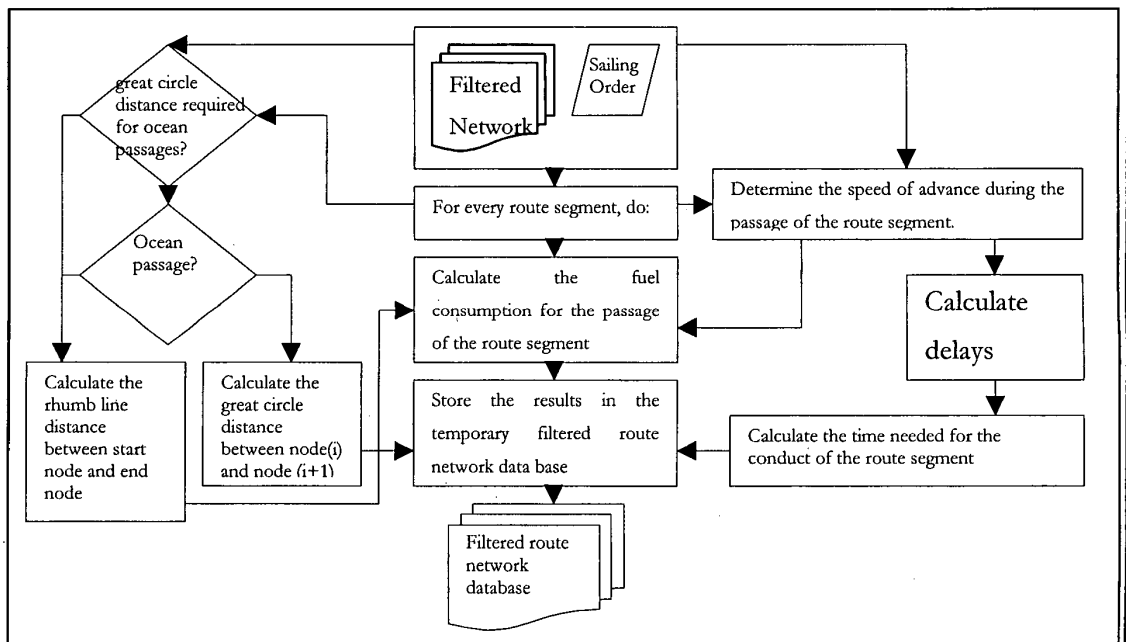

Figure V-4: The calculation module within the filter algorithm.

<sup>47</sup> The exact formulae will not be discussed. The derivatives of all the formulae can be found in [Sabelis, 1999. (i)], amongst others.

<sup>48</sup> More reading on this subject: [Manschot, 2000] and [Scheele, 1996]

Fuel consumption can also be calculated here. Fuel consumption depends on the propulsion characteristics, obviously, and weather conditions, currents and speed. In the test algorithm, fuel consumption is not implemented. The calculation part of the filter algorithm is shown in figure V-5.

#### **V.4 Optimal route finding algorithm.**

This paragraph discusses the route finding section of the algorithm as suggested in paragraph V.2. First, Dijkstra's algorithm for shortest paths is discussed; then an algorithm for computing all possible routes is described. Finally, the implemented criteria of preference are described and the decision algorithm is discussed.

##### **V.4.1 Dijkstra's algorithm for the shortest path.**

The shortest path in a graph can be calculated by using the Dijkstra's algorithm for shortest paths. Dijkstra presented this algorithm in 1959 [Dijkstra, 1959] and the algorithm has been further optimised since. [Zhan] The method is able to calculate the shortest distance (or least-cost) from one node to every node (one-to-many)<sup>49</sup>. If the shortest distance from one node to another node is required (one-to-one), the algorithm can be stopped. The principle is the same for both outcomes. The Dijkstra algorithm is based on the labelling method [Anderson, 2000], that is briefly described below.

The method starts with assigning every node a label, which consists of distance  $d(i)$ , parent node  $p(i)$  and node status  $s(i)$ . [Anderson, 2000; p. 409] The distance label contains the shortest distance from start node to node  $(i)$  that is found until that moment. The parent node is the number of the node that goes ahead in case of the shortest route that is found until that moment. The node status can be 'not reached yet', 'tentatively labelled' or 'permanently labelled'. The network consists of  $N$  nodes. The labelling procedure consists of the following steps<sup>50</sup>:

Step 1. Node 1 is the starting node; at the beginning of the process the starting node is assigned the permanent label  $P[0,S]$ . The distance from node 1 to itself is zero (0) and the  $S$  means starting node.

<sup>49</sup> One-to-many means calculating the shortest route from one node to every other node. One-to-one means that only the shortest distance to one node is required.

<sup>50</sup> The described cycle is an adaptation of the cycle as explained by Anderson et al. [Anderson, 2000; p. 416]

Step 2. Compute tentative labels for the nodes that can be reached directly from node 1. The distance label ( $d(i)$ ) adopts the value of the direct distance from node 1 to the node in question. The parent node  $p(i)$  is the previous node, thus node 1. The labels for the nodes that now are reached are  $T[d(i), 1]$ .

Step 3. Identify the tentatively labelled node with the smallest distance value, and declare that node as permanently labelled<sup>51</sup>. If all nodes are permanently labelled, go to step 5.

Step 4. Consider the remaining nodes that are not permanently labelled and that can be reached directly from the new permanently labelled node identified in step 3. Compute new tentative labels for these nodes as follows:

- a. If the node in question has a tentative label, add the distance value  $d(i)$  at the new permanently labelled node to the direct distance from the new permanently labelled node to the node in question. If this sum is less than the distance value  $d(i)$  for the node in question, set the distance for this node equal to this sum; in addition, set the parent node  $p(i)$  equal to the new permanently labelled node that provided the smaller distance. Go to step 3.
- b. If the node in question is not yet labelled, create a tentative label by adding the distance label ( $d(i)$ ) at the new permanently labelled node to the direct distance from the new permanently labelled node to the node in question. The  $p(i)$  is set equal to the new permanently labelled node. Go to step 3.

Step 5. The permanent labels identify both the shortest distance ( $d(i)$ ) from node 1 to each node and the preceding node on the shortest route ( $p(i)$ ). The shortest route to a given node can be found by starting at the given node and moving to its preceding node  $p(i)$ . Continuing this backward movement through the network will provide the shortest route from node 1 to the node in question.

If an one-to-one shortest route is required, the cycle is stopped when the nodes of interest are permanently labelled. Note that instead of using distance between nodes, optimum routes can be calculated for other quantities by assigning these to the links. In the route selection process, time needed for the conduct of a passage and fuel consumption are valid quantities, that can be optimised with the Dijkstra algorithm for the shortest route.

---

<sup>51</sup> There is no other way of reaching this tentatively labelled node travelling a shorter distance.

#### V.4.2 Generating the $K$ – shortest paths.

After the shortest route is calculated, an interval is set by the navigator. The interval, that is chosen, normally depends on the shortest distance. However, a good alternative for determining a suitable interval, within which all possible routes are calculated, is considering the time requirements. As explained in paragraph IV.1, time of departure and/or time of arrival are given in the sailing order. The difference between these times equals the maximum allowable time to execute the mission and arrive at the destination in time. The interval can then be set at the interval limited by the shortest possible and the maximum allowable time. All routes within this interval satisfy the (important) time requirements.

Calculating the  $k$  – shortest routes that comply with the set interval, is not as easy as the Dijkstra algorithm for the shortest distance. Amongst others, Eppstein presented an optimised algorithm [Eppstein, 1997] that is suitable for use in the interval solution. However, this algorithm is quite complicated; it would be going too far to discuss this algorithm in this thesis. In the test environment another algorithm is used, which is simpler but far more laborious. [Drift, 2001] When implementing this principle in a real ECDIS however, it is wiser to use Eppstein's algorithm, since it requires far less calculation time.

The method to calculate the  $k$  – shortest routes which is used to test the principle presented in this thesis, is deduced from the labelling algorithm as described in the previous paragraph. The difference is that every label is stored in a database. For every node, every tentative label that was attached to the node in question is used to compute a route to the end node. The cycle is stopped if no more routes are possible, if the distance between node(i) and end node exceeds the interval threshold, and if the end node cannot be reached through the remaining network within the interval margins (i.e. if the shortest distance from that node to the end node increased by the distance  $d(i)$  in the concerning label is more than the interval permits).

All possible routes are then stored in a temporary database.

#### V.4.3 Criteria of preference.

Now that all possible routes are calculated, the criteria of preference need to be considered. The routes all satisfy the filter criteria, as explained in paragraph V.3.2, and they have to be compared in order to get the  $m$  – most favourable route-alternatives. Therefore, the criteria of preference should be defined in such a way that they can be optimised. The decision method that will be discussed in the following paragraph optimises by maximising and minimising

criteria, depending on the effect the criterion has on the decision (i.e. either a negative – minimise! - or a positive effect – maximise!). Benefit criteria are those criteria that are favourable and cost criteria are those that are unfavourable. In the test environment, the following eleven criteria of preference are defined<sup>52</sup>:

Criterion 1. The first criterion of preference is distance. Obviously, a shorter route-alternative is better than longer alternatives. Distance is defined as the total distance of the route-alternative in nautical miles. Distance should be minimised when searching for the best route.

$$l_{dist} = \sum_{s=1}^q x_s \quad (1)$$

where  $s=1\dots q$  are the segments belonging to the route-alternative and  $x$  is distance in nautical miles.

Criterion 2. The second criterion of preference is time. Time is perhaps the most important criterion, mainly because most requirements are time requirements. Time is defined as the total time needed for covering the route, in minutes or in hours. Time is minimised also, as the less time is needed to sail the route the more freedom is provided to deviate from the route or to adapt the speed to the imminent conditions.

$$l_{time} = \sum_{s=1}^q t_s \quad (2)$$

where  $t$  is the time in minutes.

Criterion 3. The third criterion concerns the availability of aids to navigation. It is difficult to translate the availability into a suitable value for optimisation. A thought is to maximise the average number of systems that is available when sailing the route-alternative. But, the algorithm will then choose the longest route, as the average varies with distance also. The principle that is implemented in the test environment is, considering the fact that regions with no available aids to navigation should be avoided anyway, to identify the route-lanes where no aids to navigation are available. The criterion is then to minimise the distance of the part of the route-alternative, where no positioning systems are available.

$$l_{aids} = \sum_{s=1}^q x_s |navaids = 0 \quad (3)$$

Criterion 4. The next criterion of preference is link-preference for confined waters. The problem with confined waters is, that the choice between two narrow passages depends

---

<sup>52</sup> Other criteria can be added in the same way, with the same considerations.

on the combination of characteristics rather than individual characteristics. For example, a very narrow passage<sup>53</sup> with reasonable fairway marking, but no available positioning systems, is more favourable than a confined passage with no fairway marking, many unmarked obstacles and no available positioning systems. An obstacle causes more trouble without good navigation systems, than with good fairway marking. Obviously, relationships are vague; navigators can also have different preferences. However, it seems reasonable to use a ranking method. In the test environment, the number of available aids to navigation, the number of obstacles, the state of fairway marking and the width of the passage are combined in a ranking method. The most favourable passage gets number one, the least favourable passage gets number 108 (since 108 cases can be distinguished)<sup>54</sup>. In case of ocean and coastal passages, rank null is assigned. For the whole route-alternative, the link-preference rank is divided by the length of the route-segment it is attributed to, and then added up. The best route in terms of link-preference is the route with the smallest result; hence, link-preference should be minimised.

$$l_{prf} = \sum_{i=1}^q \frac{rank_{prf}}{x_i} \quad (4)$$

Criterion 5. The fifth criterion is the use of Traffic Separation Schemes (TSS). Ideally, in regions where TSSs are established, vessels should follow these as long as possible. [COLREG, 1972; rule 10] Therefore, the distances of all the segments that are marked as TSS are added and maximised in the decision algorithm.

$$l_{ts} = \sum_{i=1}^q x_i \mid routing = ts \quad (5)$$

Criterion 6. The next criterion is the requirement of avoiding Inshore Traffic Zones (ITZ). According to the collision regulations [COLREG, 1972; rule 10], ships should only use the ITZ when their destination forces them to do so. Thus, when leaving a port, vessels should exit the ITZ as soon as reasonably possible; when the vessel calls at a port, it should avoid the ITZ as long as reasonably possible. The route-alternatives that provide this behaviour should thus contain only a few miles of ITZ. The distances of route-segments marked as ITZ are added up and minimised.

$$l_{itz} = \sum_{i=1}^q x_i \mid routing = itz \quad (6)$$

<sup>53</sup> In order to enable a ranking on width, width is divided into different intervals in case of confined waters. 'Very narrow passage', 'narrow passage' and 'confined passage' are defined as passages with 'width < 0,5nm', '0,5nm < width < 1nm' and '1nm < width < 2nm' respectively.

<sup>54</sup> All the cases are described in the thesis of M.J.L. van der Drift [Drift, 2001].



Criterion 7. Deep Water Routes (DWR) are the next criterion. Since a DWR is a route of which the depth is maintained and observed continuously to provide safe passage for ships with large draughts, they should only be used by those ships that have not got an alternative route. When a vessel is passing the region and it is forced to use the DWR, all alternatives in the area should be filtered on draught and depth (according to paragraph V.3.2). In that case, all the route-alternatives will contain the particular DWR. Therefore, the length of all the segments marked as DWR is added up and minimised.

$$l_{dwr} = \sum_{s=1}^q x_s \mid \text{routing} = dwr \quad (7)$$

Criterion 8. Criterion eight is the use of recommended routes. As discussed in paragraph III.1, recommended routes should be taken, since they are considered to be preferred to other options. Hence, recommended routes are treated the same as TSSs. The distances of recommended route segments are added. This total distance of recommended routes should be maximised in the decision algorithm.

$$l_{recom} = \sum_{s=1}^q x_s \mid \text{routing} = recom \quad (8)$$

Criterion 9. Anchorage areas should be avoided if anchorage is not required in that particular area (according to the sailing order). Avoidance of anchorage areas is provided by adding and then minimising the distances of segments that are marked as anchorage areas.

$$l_{anchor} = \sum_{s=1}^q x_s \mid \text{routing} = anchor \quad (9)$$

Criterion 10. Criterion ten is meant to provide avoidance of areas with high piracy risks. For simplicity, we assigned chances of attack by pirates and other terrorists to the possible values of the attribute 'piracy probability'.<sup>55</sup> Then, the expectation (E) of the number of attacks during the voyage can be calculated by multiplying the chance with the segment distance, and then add all these values. [Buijs, 1994] Obviously, this expectation should be minimised!

$$l_{terror} = E(terror) = \sum_{s=1}^q p(terror)_s \cdot x_s \quad (10)$$

where  $p(terror)$  is the chance of an attack by terrorists.

<sup>55</sup> Attribute values for piracy chance are 'negligible', 'recognisable' and 'significant'; they are assigned chances of 0, 0.05 and 0.1 respectively.

Criterion 11. The eleventh criterion is fog. As explained in paragraph IV.3.4, there are some areas in the world where there are significantly more days with fog than elsewhere. It can be wise to try to avoid these areas. This avoidance is provided by criterion of preference eleven. Fog probability is stated in the average number of days per month that fog occurs. It is important to know how long you will be passing these fog areas, rather than what distance is covered within these areas. Although the time-distance problem is not implemented in the test-environment, the fog criterion is defined as the time needed to pass the segment, multiplied by the average number of days per month.<sup>56</sup> This expectation is minimised in the multiple criteria decision problem.

$$l_{fog} = \sum_{s=1}^q t_s \cdot d_s \quad (11)$$

where  $d$  is the average number of days with fog per month.

Criterion 12. The last criterion is that concerning ice conditions. In proper navigational practice, areas with a probability of encountering ice, should be avoided if possible, even if the ship's ice strengthening allows passage. Therefore, this criterion of preference is meant to provide avoidance of (possible) iced regions. The criterion on ice is defined as the total distance the route-alternative passes through iced areas. This distance should be minimised obviously.

$$l_{ice} = \sum_{s=1}^q x_s |_{ice = icetype} \quad (12)$$

#### V.4.4 Group decision making under multiple criteria for selection of alternatives.

The last phase of the route planning algorithm is to compare the different route-alternatives and present a number of best route-alternatives. Therefore, a ranking of route-alternatives should be created. As discussed in paragraph V.1.1, the best route is the route that complies with all the criteria. The route-alternatives that have passed the filter, satisfy the filter criteria already, so that in this stage the route-alternatives are examined for compliance with the criteria of preference discussed in the previous paragraph. The decision algorithm must be able to deal with criteria which differ in units and scales, since the criteria can be either of quantitative or of qualitative kind (see the previous paragraph). A method that is able to examine and rank the route-alternatives is described in this paragraph.

<sup>56</sup> Time is expressed in minutes and the fog probability is expressed in days per month. Although it is more correct to work with the same unit for time (either minutes or days), it does not affect the final result, because the factor that is left out, is constant.

Decision making includes four phases, namely the preparatory phase, the screening phase, the evaluation phase and the decision phase. [Hwang, 1987; p. 271] During the preparatory phase, an inventory of all the information that is relevant to compare alternatives is made. In the route selection problem, this inventory is not required.<sup>57</sup> The information is translated into criteria (see paragraph V.1.1). The screening phase is meant to eliminate the unqualified candidates; in the algorithm that is presented here, the screening phase is provided by filtering (see paragraph V.3.2). During the evaluation phase, the alternatives are examined on advantages and disadvantages, and then presented to the decision maker. In the decision phase, the decision maker chooses the best alternative(s).

The evaluation and decision phases are especially important in group decision making. Two approaches can be made, which are different in the method of evaluation. Methods of evaluation are ranking, rating, scoring and voting. The ordinal approach involves the ranking of candidates; the cardinal approach involves the scoring of alternatives. [Hwang, 1987; p. 271] The latter seems to be the most appropriate approach to use in route selection.<sup>58</sup>

An important characteristic of the group decision making algorithm is the ability of using different experts. These experts could use the same criteria (agreed criteria) or individual criteria (individual) for evaluating the alternatives. The agreed criteria option is the best for route planning, since the criteria are the same in all cases. However, it could be useful to define more than one expert, so that the user can choose between different settings of weights.

The different steps of the cardinal approach are discussed below. [Hwang, 1987; p. 273-285]

Assume  $m$  alternatives, evaluated by  $n$  experts (in route selection,  $n = 1$ ), using  $p$  criteria. The following matrix can now be formed:

$$A^k = [a_{ij}]^k = \begin{bmatrix} a_{11} & \cdots & a_{1j} & \cdots & a_{1p} \\ a_{21} & \cdots & a_{2j} & \cdots & a_{2p} \\ \vdots & & & & \vdots \\ a_{m1} & \cdots & a_{mj} & \cdots & a_{mp} \end{bmatrix}, (k = 1, \dots, n) \quad (13)$$

<sup>57</sup> This inventory is superfluous, since this set of information is the same every time the process is executed. The inventory is made and discussed in chapter four.

<sup>58</sup> The cardinal approach is the approach that is tested during this research. The ordinal approach should however not be rejected beforehand.

Matrix  $A^k$  is filled with the values of the different criteria of preference. This data is characterised by different units. Therefore, matrix  $A^k$  has to be normalised. There are a number of methods to normalise data, considering scales and evaluating method. Hwang [Hwang, 1987; p. 282] uses vector normalisation. Although this method is not entirely justified for use in the route selection problem, we choose to follow Hwang. Vector normalisation is usually only justified when all the criteria are measured in dimensionless units; this is not the case, but since all units of the criteria of preference are scaled to length (nautical miles), an error caused by choosing this method of normalisation is not expected to be significantly high. The components of the normalised matrix  $D^k$  are calculated as

$$d_{ij}^k = \frac{a_{ij}^k}{\sqrt{\sum_{i=1}^m (a_{ij}^k)^2}}, (k = 1, \dots, n), (j = 1, \dots, p) \quad (14)$$

For every expert, the matrix  $D^k$  is normalised. Since the experts have agreed on the required criteria, the different expert-matrices can be added (5.15). It is possible to assign different weights  $w_k$  to the various experts, in order to define which arguments (i.e. setting of criteria weights) the user wants to use:

$$C = [c_{ij}] = \left[ \sum_{k=1}^n w_k \cdot d_{ij}^k \right], (i = 1, \dots, m), (j = 1, \dots, p), (k = 1, \dots, n) \quad (15)$$

where:  $\sum_{k=1}^n w_k = 1$

The criteria are not considered to be of equal importance. Therefore, also the criteria are assigned certain weights  $w_l$ . The weighted normalised collective matrix is now calculated by multiplying each column of matrix  $C$  (15) with its associated weight:

$$F = [f_{ij}] = [c_{ij} \cdot w_l], (i = 1, \dots, m), (j = 1, \dots, p) \quad (16)$$

The alternatives are ordered by using the Technique for Order Preference by Similarity to Ideal Solution (TOPSIS). [Hwang, 1987; p.283] This technique is based on the distance of relative closeness to the ideal solution. This technique contains the following four steps:

Step 1. The first step determines the ideal and negative-ideal solutions  $A^*$  and  $A^-$ .<sup>59</sup> The ideal solution is defined by maximising benefit criteria and minimise the cost criteria. The negative-ideal solution is defined the other way around.

$$A^* = \left\{ \left( \max_i (f_{ij}) \mid j \in J \right), \left( \min_i (f_{ij}) \mid j \in J' \right) \right\}, (i = 1, \dots, m) \quad (17)$$

$$= \{f_1^*, \dots, f_j^*, \dots, f_p^*\}$$

$$A^- = \left\{ \left( \min_i (f_{ij}) \mid j \in J \right), \left( \max_i (f_{ij}) \mid j \in J' \right) \right\}, (i = 1, \dots, m) \quad (18)$$

$$= \{f_1^-, \dots, f_j^-, \dots, f_p^-\}$$

where  $J = \{j=1, \dots, p \mid j \text{ associated with benefit criteria}\}$  and  
 $J' = \{j=1, \dots, p \mid j \text{ associated with cost criteria}\}$ .

Step 2. During step two, the separation measures are computed.  $S_i^*$  and  $S_i^-$  are the separations between the alternative and the ideal solution and the alternative and the negative-ideal solution respectively, calculated per criterion.

$$S_i^* = \sqrt{\sum_{j=1}^p (f_{ij} - f_j^*)^2}, (i = 1, \dots, m) \quad (19)$$

$$S_i^- = \sqrt{\sum_{j=1}^p (f_{ij} - f_j^-)^2}, (i = 1, \dots, m) \quad (20)$$

Step 3. In step three, the relative closeness  $G_i$  to the ideal solution is calculated in such a way, that the most preferable alternative is closest to 1, and the least preferable route is closest to 0.

$$G_i = \frac{S_i^-}{(S_i^* + S_i^-)}, \quad 0 < G_i < 1, \quad (i = 1, \dots, m) \quad (21)$$

Step 4. In step four, the alternatives are ranked according to the ascending order of  $G_i$ . This order gives the several alternatives in order of preference. In the route selection problem, the navigator should be presented the most preferable routes (e.g. the first five or ten route-alternatives).

Now, a decision method, based on multiple criteria, is discussed. In the previous paragraph, the different criteria of preference were described and every criteria is defined as 'benefit' or

<sup>59</sup> The ideal solution is the most preferable solution; the negative-ideal solution is the least preferable solution.

'cost' criterion. The only thing left is to determine the values of weight vector  $w_l$ . In the test environment, different values are used in the weight vector. It is difficult to state exact values that provide the perfect solution. However, it is possible to state the mutual proportions, which are concluded by arguing which criteria are the most important. This mutual proportions are listed below:

$$l_{time} > l_{dist} \geq l_{iss} = l_{dvr} = l_{recon} = l_{ice} = l_{pref} \geq l_{aids} > l_{anchor} > l_{fog} \geq l_{terror} \geq l_{ice}$$

The time-distance problem is very important, therefore time is assigned a higher weight than distance. In turn, distance is at least more important than the remaining criteria. Routing measures and link-preference are also very important, since they cause the tool to choose the right route according to the proper navigational practice. The availability of aids to navigation is considered to be more important than the remaining criteria. The avoidance of anchorage areas is slightly less important; in most of the real situations, these are positioned in such a way, that ships at anchor do not hinder other traffic. Finally, the criteria of preference concerning fog, piracy and ice are least important. A route is not often moved because of these latter characteristics.

## VI Testing the route planning algorithm.

### VI.1 Developing the test environment.

#### VI.1.1 The goal of testing the algorithm.

Before a test environment and test scenarios are developed, it is important to determine what the goal of testing is. When the goal is clear, specific test areas and scenarios can be made.

The goal of testing in this research is to prove that the principle of route selection provides reasonable route-alternatives. Note that it is not the purpose of this thesis to provide a perfect setting of criteria and weight, that can be implemented directly in ECDIS. What should be demonstrated is that the filter algorithm indeed eliminates unnavigable options; that the shortest route algorithm comes up with the shortest route that can be sailed; and that the decision algorithm provides a set of route-alternatives that indeed comply with the criteria as reasonably as possible. Furthermore, it is important to show that different settings of weights result in slightly different alternatives.

#### VI.1.2 Choice for a synthetic test environment.

The test environment is an important part of the tests. It should contain as many often-occurring situations as possible. Also, it should provide a good overview of the possibilities, in order to see what the algorithm does during the various stages of calculations and to judge the final results.

The decision to use a self-created synthetic environment instead of a real existing situation was made for several reasons. Firstly, it is difficult to find an existing area, which contains as many situations as possible and, as such, forms a representative area. Probably the best option is to select the North Sea region. However, when a real situation is used, the data should be accurate and complete. On the other hand, a self-created area provides the possibility to create situations and manipulate information in such a way that many types of problems can be implemented. Also, the use of an existing sea area would rather complicate presentation of the data, where the test area should be as simple as possible to provide overview and to enable identification of the algorithm's decisions. Another reason is that developing a real sea area test environment appeared to be too time consuming, where this extra time was not available. Therefore, a synthetic test environment was self-created.

In the future, the perfect weight settings of the route selection algorithm should be calculated using all possible criteria in a self-made environment, and then verified using several existing sea regions.

The test-environment should contain as many occurring problems as possible, therefore all these important situations are defined in the next paragraph.

### VI.1.3 Often occurring situations.

In this paragraph, a couple of relevant situations are defined, that should be implemented in the test area. These situations all occur often. The selection of the route is the most significant in these situations, where proper navigational practice often forces the navigator to take a longer, indirect, route (in case of Traffic Separation Schemes, for example); or where the choice is of direct impact to the safety of the ship (in case of confined waters).

Situation 1. The first situation that should be represented in the test area is a complex combination of Traffic Separation Schemes (TSS), Deep Water Routes (DWR) and Inshore Traffic Zones (ITZ). The North Sea provides good examples of some of these complex routing systems (see figure III-1). In these situations, the shortest route would be through an ITZ, while the rules of COLREG [COLREG, 1972] force the navigator to follow the TSS. Also, the DWR can provide a shorter route, while it should also be avoided. The algorithm should decide to choose the TSS, or, in case of deep draught vessels, to choose the DWR. The ITZ should only be chosen when the destination forces the navigator to pass through an ITZ.

Situation 2. A wide variety of confined waters should be present in the test environment, since the choice of confined water is of direct impact to the safety of the ship. Decisions of the algorithm should always be on the safe side.

Situation 3. A military exercise or anchorage area should be implemented in order to test behaviour of the algorithm if an intermediate passage is required.



Situation 4. The test area should contain a situation that gives one choice of confined waters: either taking a short route passing through unfavourable confined waters, or taking a significant longer route passing through favourable confined waters.<sup>60</sup>

Situation 5. Furthermore, some areas that involve a risk of piracy and fog should be implemented, as well as an area where no aids to navigation are available. Also, areas with speed limits and recommended routes should be implemented.

#### VI.1.4 The final area.

The test area is shown in appendix F. Three harbours are implemented (harbour A, B and C). The green regions are land areas. Eight choices of confined waters can be made in the vicinity of Harbour A and Harbour B. Situation four is created in front of harbour C. The system of TSS, DWR and ITZ is created around the north-west corner of land. A normal TSS is created to the south. A military exercise area is created in the south-west.

Although the depiction of the test area is not scaled, it was scaled during the development process. The latitude varies from 40°N to 44°N and the longitude varies from 1°E to 8°E. The different characteristics of the segments will be adapted according to the different test-scenarios.

The test area is a representative area, because of a number of reasons. Firstly, significant route selection problems as described in the previous paragraphs appear. Secondly, the simplicity provides a good overview of the behaviour of the algorithm. Thirdly, data can easily be changed so that many situations can be examined. Finally, the area can be divided into a number of smaller areas, so that the criteria can be tested individually before putting everything together.

### VI.2 Test scenarios.

#### VI.2.1 The test ship.

When testing the route selection tool, a number of ships with different characteristics and settings should be used. However, the tests are all executed with a naval frigate. The main

---

<sup>60</sup> This situation resembles the situation in the estuary of the Westerschelde. Coming from the north, the choice between Scheur, which is a short route but has many disadvantages, and Wielingen, which is a much longer route but with favourable and well-marked waters, is not easy to make. Some ships pass through Scheur, but there are a lot of navigators who decide to take the longer route.

reason is, that the author has a naval background and is most familiar with selection practice and requirements as generally used in the Royal Dutch Navy. For every type of ship, slightly different criteria and weight settings apply. However, due to time problems, the author was not able to investigate and implement these. In order to test the filter for cargo class, the frigate is considered to have a certain type of cargo. The other filter criteria are tested in the same way.

### VI.2.2 Scenario 1: Testing the filter algorithm and Dijkstra's algorithm.

The first scenario was developed in order to test the filter algorithm and the Dijkstra algorithm for shortest paths. The start position of scenario 1 is route-point 1 (harbour A); end position is route-point 68 (harbour B). The results of test scenario 1 are attached in appendix G.

The first test (testcase1\_1) shows that the shortest path algorithm works well without any restrictions. The route passes through all the Inshore Traffic Zones. In the second test (testcase1\_2), the mission order contains the intermediate position route-point 40, for the conduct of an exercise in that area. It shows that the algorithm passes route-point 40, and continues with the shortest path to route-point 68. The third test of scenario 1 (testcase1\_3) contains three segments with speed limitations. It shows that the route with the shortest distance is still the route through all the ITZs (as expected), but the shortest route in time is different, avoiding the passages with speed limitations.

In the fourth test (testcase1\_4), the depth filter is tested. Eight segments are now considered to have a depth of 5 metres; the speed limitations are removed. As we can see, the segments with insufficient water depths are avoided. The fifth test is to determine if the cargo class restrictions do have the required result. In test A (testcase1\_5A), the frigate's cargo consists of oil, and various segments are assigned cargo restrictions. There are no other restrictions. The algorithm avoids the segments that restrict ships carrying oil or gas properly. Test B (testcase1\_5B) shows that if the ship is carrying dangerous goods category A, B, C and D, the algorithm ignores the segments with corresponding restrictions.

Finally, in the sixth test (testcase1\_6A and testcase1\_6B) all the restrictions are implemented. In test A, the frigate carries oil/gas; in test B the cargo is dangerous goods category A, B, C and D. The results are as expected. The shortest route in time is slightly different from the shortest route in distance. Furthermore, all the restricted segments are ignored and avoided.

We can now conclude that the filter algorithm and the Dijkstra's algorithm for shortest paths work properly; the results are all according to expectations. We can continue with test scenario 2, testing the decision algorithm.

### VI.2.3 Scenario 2: Testing the decision algorithm in limited test areas.

The second scenario is to examine the ranking algorithm. This testing is executed in several steps. In every step, another criterion is added through the assignment of weight. Due to time problems, the decision was made to test only ten criteria instead of the suggested twelve criteria. No tests were executed to examine the criteria on ice and anchorage areas. Only small parts of the test area are used, in order to be able to check and compare the different results and to keep a good overview. The test results of scenario two are added in appendix H. Only the remarkable solutions are printed, so that the differences in results are made clear.

The first test (testcase2\_1) contains the distance criterion only. It should result in a ranking of distances, obviously. Position of departure is route-point one; position of destination is route-point 72. No restrictions are added to the route-segments. The results are as expected. Note in the following test cases the rank of ITZ-based routes (inshore and outshore), DWR-based routes, TSS-based routes and the routes that pass through route-point 70.

The second test case (testcase2\_2) contains the time criterion only. As should be expected, the ranking of the routes is equal to the previous test.

The third test case (testcase2\_3) is a small case of only four possible routes. One route is passing through the ITZ (inshore=northerly), one through the TSS, one through the DWR and one through the ITZ (outshore). Ranking is now based on the distance, TSS and DWR criteria. The best route should follow the TSS, the most unfeasible passes through the DWR.<sup>61</sup> The results show that the algorithm does as expected. The fourth test case (testcase2\_4) is expanded with four extra possible routes. Still, the algorithm follows the TSS.

The next test case (testcase2\_5) involves testing with the same criteria and weights as the previous tests. Now, the best route is searched in the whole set of possible routes from route-point 1 to route-point 72. Note, that still the routes that pass through the TSS are strongly preferred to the rest. The other remarkable route-alternatives are listed in the appendix.

---

<sup>61</sup> Note that the inshore and out-shore route still are 'normal routes' since the ITZ criterion still has weight=0.

In test case number six (testcase2\_6) the criterion of link-preference is added. Note, that in the trajectory from route-point 1 to route-point 7, the route that passes through points 1, 2, 5, 6 and 7 is the preferred route considering link-preference. Furthermore, the route that passes through route-point 70 is preferred to the route that only passes through route-point 69. The expected result is, that the best route should pass through the best parts of confined waters (that were described above) and through the TSS. However, the route that is ranked as best route only passes through one part of the preferred route in terms of link-preference. Probably, this occurs because of the distance criterion.<sup>62</sup> Still, the expected best route is in the top three.

The next test case (testcase2\_7) also tests on the ITZ criterion. The inshore route (8-13) and offshore route (12-17) are marked as Inshore Traffic Zone. Still, the route that passes through the TSS should be preferred to other alternatives. However, considering the lengths of ITZ-lanes and DWR-lanes and the weights corresponding to their criteria, the offshore route will be preferred to the inshore route and DWR respectively, although this is not really a wanted effect. The results show what we expected. Perhaps a small difference in weight would prevent this effect from happening.

The criterion 'recommended routes' is added in test case eight (testcase2\_8). The route-segment (7-10) is now recommended, so that the DWR should appear higher in the ranking than in the previous test. As shown in the appendix, this is obviously the case.

In the next test cases, the area is extended by linking harbour B through the segment between route-point 63 and route-point 1.<sup>63</sup> This is done in order to examine the algorithm on choices that are less important. The routes between route-point 68 and route-point 63 are coastal waters now, and criteria on piracy, fog, aids to navigation and speed limitations can be tested because of the small differences in distance. Test case nine (testcase2\_9) tests the algorithm on speed limits. The time criterion is said to be more important than distance (see paragraph V.1.2), so that the expectation is that the segments with speed limits are avoided. Indeed, the results show that the first couple of best routes are the routes avoiding speed limits. Due to the small differences, the first route that passes through segments with speed limitations appears at rank 7.

---

<sup>62</sup> The difference in distance has become too large to select the other option.

<sup>63</sup> Note that the routes-segments to the south of the land area are not in use, so that all the routes pass through the extra route-lane between 63 and 1.

The region used in test case ten (test case 2\_10) is smaller in order to test the availability of aids to navigation. Position of departure is route-point 68; destination is route-point 1. On one segment (64-68) there are no aids to navigation available. In fact, the results show that the routes containing that particular segment are the least favoured. Obviously, this should be the answer too.

Test case eleven shows the effect of a segment lacking aids to navigation. In the first test (testcase2\_11A), the route-lane (64-68) has two aids to navigation available, while in the next test (testcase2\_11B) the same segment has no aids to navigation available. Note that the rank of the route-alternatives containing the segment without aids to navigation changes from rank 3 to rank 37!

In the last tests of this scenario, fog probabilities and piracy are implemented. In the first test (testcase2\_12A), the probabilities of fog and piracy attacks are zero everywhere. In the second test, two segments contain either fog or piracy probability. Note that the route-alternatives that were ranked 1 and 2 in the first test now contain piracy and fog probability. In the second test, the route containing fog probability appears at rank 7; the rank of the route-alternative containing piracy probability is now 367! The difference in rank in case of higher fog chances is logical. However, the great difference in rank in case of high piracy attack probability is enormous. The first route with piracy attack probability is, concerning the algorithm, less favourable than routes passing through the DWR. Why this is the case, is not clear. Perhaps, the weight settings should be altered, or perhaps the criterion is not defined well. The route should appear near the alternative passing through the fog area.

In conclusion, the tests show that the decision algorithm provides reasonable results. In every test, it is made clear that indeed some different rankings appear. The implementation of new criteria thus influences the results. Furthermore, the expected effects occur in most cases. Only in case of piracy probabilities is the ranking disputable. Nevertheless, probably most of the occurring problems are due to a sub-optimal set of weight factors.

#### VI.2.4 Scenario 3: Testing the whole algorithm in larger test areas.

Now that the filter algorithm is tested and the decision algorithm is proved to be reasonably correct, the tests can be executed in larger areas, where all the different aspects are included. The route is now calculated from route-point 27 to harbour B (route-point 27 to route-point 68) and from harbour A to harbour B (route-point 1 to route-point 68). The extra link

between route-point 63 and route-point 1 is 'switched off'. Some extra depth limitations are included in order to limit the number of different possible routes.<sup>64</sup> Test results of scenario 3 are attached in appendix I.

The first case is to calculate a route from route-point 27 to harbour B (test case 3\_1). To every route-segment some extra characteristics are added (see appendix). The results show that the best route considering all the criteria avoids perfectly all the unfavourable segments. Only in the case of confined waters is a slightly shorter route selected instead of good link-preference. This was to be expected, because in all the other tests this was the case. Wisely, the algorithm prefers the route-lane (55-58) with high fog probability to the route-lane (52-57) with both fog probability and a chance of attacks by piracy. In the result sheet, the other significant route-alternatives are listed.

In the second case (test case 3\_2), the route has to be calculated from harbour A to harbour B, thus through almost the whole area. In the results the five best route-alternatives are listed, together with some other significant results. Again, the algorithm comes up with some acceptable results. However, some unpleasant effects show. The route-alternatives, which pass through relatively unfavourable confined waters, are preferred to an alternative, which passes through a DWR or TSS, although the other way should be expected. In proper navigational practice, a navigator would always prefer favourable confined waters to unfavourable ones, and rather pass through an ITZ or DWR, since the passing of confined waters can be of direct hazard to the ship. However, a different set of weight, emphasising on the proper selection of confined waters could resolve this problem. Nevertheless, it shows immediately, that the navigator should not use the routes without checking them!

The tests all show, that the whole route planning algorithm calculates some very reasonable route-alternatives. However, the setting of weights and the criteria should be examined more deeply, in order to fine-tune the algorithm. One criterion could already be adapted. The definition of the criterion of link-preference (4) was the ranking divided by the individual segment distance. However, this definition allows the contrary effect; a lane with a large distance and low ranking, can be preferred to a link with small length and small rank. It would therefore be better to use the following definition:

$$l_{pref} = \sum_{s=1}^q \frac{1}{x_s \cdot rank_{pref}} \quad (22)$$

<sup>64</sup> The areas to the south are all excluded.

---

The criterion of link-preference should then be maximised.

The fact that the algorithm computes too many possible routes is a major problem, since it requires much calculation time. This is only partly solved by setting the interval properly. It is difficult to draw conclusions from this, because the algorithm that is used to calculate all possible routes within the interval is not an optimised version. However, it would be better to determine another division in the route-network. Apart from the division into network-regions, a division within these regions could be made, in order to limit the number of possible routes. For example, the network-region North Sea could be divided into North Sea south, North Sea East and North Sea West. Using this extra division would also prevent the algorithm considering illogical solutions.

Finally, the exact algorithm should be further optimised, in order to improve calculation time.

What is proven is that, if the algorithm is given proper information and the network is designed and constructed carefully, this principle of automated route selection could do a reasonable job in assisting the navigator.

## VII Conclusions and recommendations.

Now that all the important details are described and discussed, conclusions have to be drawn and recommendations can be made.

### VII.1 Conclusions.

In this paragraph, the findings and results are discussed, in order to provide a good overview. The question, whether or not the two objectives of this research are achieved, is an important issue. This question is considered by first answering the research questions individually.

#### VII.1.1 The first question: the route-network.

The first question and sub-question that were asked are (see paragraph I.2):

- A. What should be the structure of a route-network, to provide a robust basis for an optimal route algorithm?
  - i. What data structure should be used for such a route-network, in order to provide the algorithm with the relevant information, and to provide compatibility with the Electronic Chart Display and Information System?
  - ii. What kinds of real routes can be distinguished at sea and with what kind of features can they be described adequately?
  - iii. How can such a network cover as many parts of the world as possible, without diminishing the calculation speed and extending disk storage?

Many existing shipping routes can be discerned at sea. Geographical circumstances (depth contour, position of harbours, land), international regulations (routeing, restrictions) and local regulations (routeing, recommendations) have formed these routes historically. Important sources which show and record these existing routes are density charts [Traffic, 2000], routeing charts [BA5500], pilots and sailing directions [HP1] and 'Ocean passages of the world' [NP 136]. Both lanes and areas can be discerned at sea. Lanes are formed by sounds, narrow passages, TSSs, DWRs, recommended routes and shallows. Areas are formed by ocean areas, prohibited areas, caution areas, anchorage areas and military exercise areas. The existing routes form a route-network already, which is the main justification for using a network-based route planning tool.

The structure of a route-network strongly resembles the structure of graphs. The advantage of using graph-theory is that a variety of simple algorithms is available. The route finding



tools that were found in the other navigation domains, also use graph based computations. The graph is constructed with links and nodes which implies the use of the vector data format. An important feature of graphs is that attributes can be attached to the features. The route-network that is developed in this research, is apparently cyclic, directed and planar graph.

A number of main components of the route-network has been defined, namely route-points and route-segments; the latter is divided into route-lanes and route-areas. Route-points can be either a route-point or harbour-point; they are referenced by a node and form access to route-segments. Route-segments are complex components of the route-network. Route-lanes are referenced by two route-points and route-areas by three or more route-points. Route-lanes are used in passages of all classifications, in order to describe straits, passages, sounds, TSSs, DWRs and recommended routes, amongst others. Route-areas are positioned in coastal and ocean passages and can represent caution areas, anchorage areas and military exercise areas, amongst others. Rules for positioning are discussed in paragraph III.3.2.

Many arguments were made for using the Electronic Chart Display and Information System characteristics as guideline for developing a route planning tool. Obviously, ECDIS is the main component of modern bridge design. ECDIS will play a large role in modernising marine navigation, especially in automating the provision of information and supporting tools that underpin the traditional navigation phases that require this information. Furthermore, because of the equivalence between ECDIS and GIS (ECDIS is in fact a dedicated GIS), ECDIS enables the use of spatial queries, improving access to and availability of nautical information. It is not a coincidence, that all the route planning equivalents in other navigation domains are based on (simplified) GISs.

The amount of information that has to be analysed during the voyage planning process, makes this process laborious and time consuming. When voyage planning is automated, a system that provides availability and accessibility of all the required information is needed. Thus, ECDIS as a basis for automated voyage planning is the only logical choice. However, much nautical information is not yet available in ECDIS; the provision of information in ECDIS should thus be improved in the future. The expectation is that this improvement is forthcoming. The choice of using ECDIS as a basis of automated voyage planning implies the use of the ECDIS data structure.

The ECDIS data structure is the IHO transfer standard for digital hydrographic data, S-57. This standard is of a feature-based or object oriented data structure. In the transfer standard, many records, fields and sub-fields are well-defined. However, no records are left spare in order to allow for new, extra, data. The implementation of the route-network thus implies the creation of new exchange standards, files, records, fields and sub-fields in S-57. Another option is to use the records that are already in use (e.g. Deep water route centreline).

In fact, the implementation of the network in S-57 is not very difficult. The problem is the legislation; IMO and IHO only change or extend the existing standard once in a few years. Approved implementation in S-57 could thus take some time. Furthermore, the ECDIS system uses layered projection of data. The route-network should be created in a new layer, projected on top of the nautical chart. However, no extra layers are allowed for in resolution A.817(19). [IMO, 1995] These strict regulations on the performance of ECDIS cause the same problem as with implementation of the route-network in S-57; legal support for extra tools, such as the route planning algorithm, should be awaited.

World coverage can be provided by dividing the world seas into different network-regions, coupled by a few route-segments. Disk storage problems are dealt with in the same way. Furthermore, if the route-segments are positioned well, providing as much freedom of sailing as possible, coverage and storage problems decrease. Using route-areas in large regions, such as ocean regions, and coupling the route planning algorithm with weather routing software, improves coverage and storage also.

Calculation speed heavily depends on the kind of algorithm used. Since a non-optimised algorithm is used for calculating the  $k$  – shortest paths, it is difficult to conclude whether or not the suggested structure of the route-network diminishes calculation speed. Nevertheless, it seems to be wiser to make another region division, which contain parts of the network-regions. This further division prevents the algorithm from calculating too many possible routes. Thus, the route-network consists of network-regions, which in turn are divided into smaller network-parts. Unfortunately, this principle could not be tested. Further tests, with more optimised algorithms, are necessary.

#### VII.1.2 The second question: information requirements.

The second question that should be answered in this research is:

- B. Which information is essential when selecting a route and should therefore be available to the shortest path algorithm?
- i. What are the relevant characteristics of a passage that are essential for the selection of a route?
  - ii. How should the characteristics of a route-segment be implemented in the route-network?
  - iii. How should the influence of particular route characteristics be expressed in terms of preference?
  - iv. What are the ship's characteristics that are essential when selecting a route?

The route planning phase starts with the definition of the sailing order. The sailing order should not contain only relevant ship's characteristics. We have concluded that an important part of the sailing order is the mission characteristics. Important ship's characteristics are, amongst others, draught, various speeds, propulsion, fuel characteristics and cargo class. Few of these characteristics are fixed; those should be made available from a ship's data-bank. Important mission characteristics are, for example, destination statements, time requirements and weather requirements. The sailing order must be defined carefully, in order to prevent errors occurring. A small error during the planning of the voyage can have disastrous effects.

Many kinds of route characteristics, that are relevant in the route selection process, are distinguished in chapter four. Examples are dimensions, regulations, limitations and general aspects. The various types of information have different sources. Ideally, all information should be made available in ECDIS within a few years. The required level of detail of information during the route planning process is relatively low, depending on the classification of the route-segment. The level of detail allows simplification of the information, which enables the implementation of the information in the network as attributes.

The different kinds of information have their own effect and influence in the route planning phase. Two main types of influence can be distinguished, namely an effect of denial and an effect of preference. The first effect means, that a passage may not or cannot be passed through, according to the combination of ship's characteristics and route characteristics. The effect of preference is that the combination of characteristics can make a passage either favourable to conduct or unfavourable to conduct.

### VII.1.3 The third question: the algorithm.

The third question that should be answered, is:

- C. How can the optimal route be calculated on the basis of a route-network?
  - i. What is the optimal route?
  - ii. How should the ship's characteristics 'delete' route-segments that can or may not be used?
  - iii. How is an 'optimal' route (and alternatives) calculated?

The general definition of the optimal route, that was determined in paragraph V.1.1, was:

**Optimal route:** The optimal route is that route, that satisfies the mission requirements and complies with all the criteria, not containing unnavigable routes.

Then, considering the fact that finding the optimal route was not very realistic, the best route was defined as:

**Best route:** The best route is that route, that satisfies the mission requirements and complies with as many criteria as possible, not containing unnavigable routes.

These two definitions seem to be too vague, when searching for the best route. However, the criteria and requirement vary with ship and mission, so that more detailed definitions could only be made for specific cases.

The criteria are divided into filter criteria and criteria of preference. Filter criteria involve those characteristics that could deny passage through a route-segment. Criteria of preference determine the preferability of a route-segment. Examples of filter criteria are depth, cargo class restrictions and height; examples of criteria of preference are routeing measures, obstacles, fog probability and the availability of aids to navigation.

The presented route planning algorithm consists of a sequence of algorithms. The first step is the filter algorithm, which first collects the data from the ECDIS data by GIS queries, then filters the unnavigable route-segments, and finally calculates some navigational quantities. The second step is computing the shortest possible route, with the use of Dijkstra's algorithm for shortest paths. Thirdly, the navigator sets an interval, within which all alternatives should lie. The interval creates the shape of an ellipse, with the position of departure and the position of arrival at the foci. Ideally, this interval is determined by using a time-distance module, since time requirements are often the most important. The margin of available time should define

the interval within which all routes can fulfil the requirements. The last step of the algorithm is comparing the route-alternatives by means of relative closeness to the ideal solution, using the criteria of preference. The used technique is TOPSIS, which is part of an algorithm for group decision making with multiple criteria. The best few route-alternatives are then presented to the navigator.

The definition of the various criteria of preference is critical when searching for the best options. The criteria of preference are translated to criteria that are valid for the whole route-alternative. In this research, twelve criteria are defined of which ten are actually tested. The criteria definitions used in this thesis were not yet ideal. Furthermore, the weights used in the decision algorithm, should be re-examined and defined by optimising algorithms. Then, the real best route can be calculated, so that the algorithm can be tested in 'real-life' situations.

Now, all the questions and sub-questions are answered. I will conclude by looking at the two objectives set for this research:

1. The development of a route-network at sea, which is suitable as basis for route planning-calculations.
2. The search for a simple optimal path algorithm, with which the route planning-problem can be solved, considering all the relevant information and in such way that the different options are feasible and navigable.

The route-network that is developed in this research, should indeed be a suitable basis for automated route planning. The network can provide a proper outline of the route-alternatives that are considered to be the best options. If calculations are executed, the route-segments that are part of the chosen route(s) can be projected on top of the ENC, providing a good outline. The route plan, which contains all details of the route, can simply be put together out of the information and characteristics that are attached to the segments. Passages that require extra attention during the further process, should be marked appropriately.

The use of the network-regions in two levels of detail (regions such as the North Sea and parts of that region, such as south North Sea) should enable world coverage. Linking the algorithm with other specialised software, such as weather routeing software, can also be made possible.

The algorithm that is presented appears to work as intended. The algorithm is able to develop several alternatives and to compare them by means of a number of criteria. Unnavigable

options are properly filtered from the data set. The characteristics that were not selected for the test environment can be considered to be implemented in the same way as those that were selected. Further research should provide some more and more robust criteria and a set of corresponding weights that fulfil the needs in as many different cases as possible.

Although the route planning tool, in the form suggested in this research, provides reasonable solutions for route selection, more research is needed on criteria and weights. As I proceeded in my research, my opinion altered. Perhaps a quicker solution to automate voyage planning is the use of a data base-based tool (see paragraph II.4). Many ships operate in limited areas, so that used routes already or, better, tracks could be used over and over again (every time checking the route on new, updated, information). When a network is made from old leg and way-points, from which the details are already known, the use of the Dijkstra algorithm for shortest paths, could provide an optimised solution. The advantage of this principle is that the route selection phase is, more or less, already complete.

However, when the voyage planning process is automated entirely, the network-based solution as presented here, is the best option. The outline of navigable waters directly limits the region within which the navigation planning-process can be executed. Legs and way-points can be positioned automatically, for example using a terrain model-based path finding algorithm. Dangerous obstacles and shallows can be marked by a buffer, providing safety limits. Of course, these ideas can be researched in the future.

### **VII.2 Recommendations.**

In the previous paragraph, it is shown that all the questions are answered and the objectives are achieved. Also, some arguments for further research on automating voyage planning were mentioned. The following recommendations can be formulated:

1. A more thorough research should be executed on the formulation and definition of the criteria of preference. Obviously, not all the characteristics were part of the test environment. The implementation of the other characteristics implies the use of corresponding criteria. The presented criteria should be reviewed, in order to ensure a robust best route solution.
2. As the criteria are reviewed and new criteria are implemented, the set of weights should also be reviewed. The new criteria and weights should then be tested in a couple of areas,

with totally different situations. By formulating the best solution in advance, the optimum set of weights can be computed by proper optimisation methods.<sup>65</sup> These sets can then be examined by using a real route-network.

3. Some extra research is required in order to implement a time-distance module in the route planning algorithm and couple it with weather routing software.
4. One of the problems when implementing the route planning tool in ECDIS, and in the future a voyage planning tool, is the limitation imposed by current (international) legislation. IMO and IHO should provide space for new developments in the automation of marine navigation. Many improvements are possible, including automated voyage planning, but if legal approval remains a problem, these improvements will be difficult to realise.
5. The availability of information in ECDIS should rapidly improve. Apart from the ENC, all nautical publications should be made available on ECDIS. It not only enables automating processes, that require the availability of this information, it would also provide simple and quick updating. Without considering the environmental aspect, electronic versions of marine information will soon replace all paper publications.
6. Now that a working principle for automating route planning is developed, further research should emphasise on automating the remaining phases of voyage planning.

---

<sup>65</sup> If the best solutions are formulated, the required answers are known. Considering the set of weights as unknown variables, a mathematical method could (such as (advanced) least squares calculations) provide the best setting of weights.

## Glossary

<b>Accuracy</b>	The degree of conformance between the estimated or measured parameter of a craft at a given time and its true parameter at that time. [radar]
<b>Approach/landing</b>	The approach/ landing phase in air navigation is that portion of flight conducted immediately prior to touchdown. It is generally conducted within 20nm of the runway.
<b>ARCS</b>	Admiralty Raster Chart Service.
<b>Area</b>	An area is a two dimensional spatial object; it is a continuous area defined by a loop of one or more links which bound it. [IHO, 1996]
<b>ARPA</b>	Automatic Radar Plotting Aid.
<b>Attribute</b>	Descriptive characteristic of an object. [IHO, 1996; p. 1.3]
<b>Attribute value</b>	The applicable values of a certain attribute.
<b>Availability</b>	Availability is the percentage of time that an aid, or system of aids, is performing a required function under stated conditions. [radar]
<b>Boundary</b>	The boundary delimits the area covered by a route-lane.
<b>CCMP</b>	Cross Country Movement Planning.
<b>Centreline</b>	The centreline is a link of a route-lane; it is defined by two route-points.
<b>Chain-node structure</b>	Data structure in which the geometry is described in terms of edges, isolated nodes and connected nodes. Edges and connected nodes are topologically linked. [IHO, 1996; p. 1.3]
<b>Chart depth</b>	The depth between sea bottom and chart datum.
<b>Coastal passage</b>	A coastal passage is a passage where the distance to the nearest navigational danger is between 2nm and 50nm.
<b>COLREG</b>	Collision avoidance regulations as defined in [COLREG, 1977].
<b>Confined passage</b>	A confined passage is a passage where the distance to the nearest navigational danger is less than 2nm.
<b>Cyclic graph</b>	A graph is called cyclic when a node is connected to itself, without having to use a link in both directions.
<b>Directed graph</b>	A graph is called directed when one or more links are one-way.
<b>DTM</b>	Digital Terrain Model.
<b>Dual fuel ECDIS</b>	An ECDIS which can deal with both vector (ENC) and raster charts (e.g. ARCS).



<b>DWR</b>	Deep water route.
<b>ECDIS</b>	Electronic Chart Display and Information System.
<b>ECS</b>	Electronic Chart system. The precursor of ECDIS.
<b>Edge</b>	see 'link'.
<b>En route/ terminal</b>	The en route/ terminal phase in air navigation including all portions of flight except that within the approach/ landing phase.
<b>ENC</b>	Electronic Nautical Chart.
<b>Face</b>	see 'area'.
<b>Feature object</b>	An object which contains the non-locational information about real world entities. [IHO, 1996; p. 1.3]
<b>Filtered route-network</b>	The whole system of route-segments, which are navigable for the vessel that will be used.
<b>Freedom of sailing direction</b>	Freedom of sailing direction is the capability of the network to provide as many options as possible to the algorithm.
<b>FRP</b>	Federal Radio navigation Plan.
<b>Full topology structure</b>	A 2-dimensional data structure in which the geometry is described in terms of nodes, edges and faces which are all topologically linked. [IHO, 1996; p. 1.4]
<b>GIS</b>	Geographic Information System.
<b>GMDSS</b>	Global Maritime Distress and Safety System.
<b>GNSS</b>	Global Navigation Satellite System.
<b>GPS</b>	Global Positioning System.
<b>Great circle</b>	Line of shortest distance on a sphere.
<b>Harbour-point</b>	A route-point impersonating a harbour.
<b>IEC</b>	International Electrotechnical Commission.
<b>IHO</b>	International Hydrographic Organisation.
<b>IMO</b>	International Maritime Organisation.
<b>ITZ</b>	Inshore Traffic Zone.
<b>Leg</b>	A leg is a connecting line between two way-points and a leg represents the intended courses over ground.
<b>Link</b>	A link is a connecting line between two nodes; a link is defined by those two nodes.
<b>Loran-C</b>	A low frequency hyperbolic radionavigation system.
<b>MSI/MSM</b>	Maritime Safety Information/ Maritime Safety Message.
<b>Navigational danger</b>	A navigational danger is a non-floating object which can be

	hazardous to the particular vessel.
<b>Network-region</b>	A part of the total route-network. The network is built up of network-regions. Routes are only calculated in the regions that are 'switched on' by the navigator.
<b>Node</b>	A node is a point-object, determined in two-dimensional co-ordinates, which represents a junction of links; a node has to be connected with at least one other node, through a link.
<b>Object</b>	An identifiable set of information. [IHO, 1996]
<b>Object-class</b>	A general description of objects which have the same characteristics. [IHO, 1996]
<b>Ocean passage</b>	A ocean passage is a passage where the distance to the nearest navigational danger is more than 50nm.
<b>Optimal route</b>	The optimal route is that route, that satisfies the mission requirements and complies with all the criteria, not containing unnavigable routes.
<b>Path finding</b>	Terrain based optimal route searching.
<b>Planar graph</b>	A graph is called planar when all the nodes and links are considered to be in the same plane.
<b>Planar graph structure</b>	A 2-dimensional data structure in which the geometry is described in terms of nodes and edges which are topologically linked. [IHO, 1996; p. 1.4]
<b>Polygon</b>	see 'area'.
<b>Real world entity</b>	Something that really exists.
<b>Reliability</b>	The probability of performing a specified function without failure under given conditions for a specified period of time. [radar]
<b>Rhumb line</b>	The rhumb line is the line of constant bearing on a sphere; the angle between the rhumb line and the meridians is constant.
<b>Route</b>	A route is a delineation of those waters and passages between the point of departure and the point of arrival, that successively have to be sailed and that satisfy the demands of the navigator as satisfactorily as possible. Within this route, the track can be determined.
<b>Route-alternative</b>	A route-alternative is a delineation of those waters and passages between the point of departure and the point of arrival, that successively can be sailed, but that do not satisfy (all) the demands of the navigator as satisfactorily as possible (yet). When the route-

---

	alternative is calculated from the (filtered) route-network, it consists of a sequence of route-segments.
<b>Route-area</b>	A route-area is a route-segment with more than two accesses, within which the sailing direction is not defined; a route-area is defined by at least three route-points; the characteristics apply only for connections between route-points that are within the particular route-area.
<b>Route-lane</b>	A route-lane is a route-segment with not more than two accesses, that takes up an area which is delimited by the centreline and boundaries.
<b>Route-network</b>	The route-network is the whole system of route-segments and route-points.
<b>Route-point:</b>	A route-point is a node in the route-network; it forms an access to a <i>route-segment</i> ; a route-point has at least one connection with another route-point, either through a <i>centreline</i> or a route-area.
<b>Route-segment</b>	A route-segment is by definition a complex component of the route-network, which describes a (part of a) navigable passage or water and for which all the characteristics are valid for the area the component covers.
<b>S-57</b>	IHO transfer standard for digital hydrographic data, S-57. [IHO, 1996]
<b>Safety margin</b>	Safety margin is that margin, within which the vessel can be navigated safely.
<b>Sailing direction</b>	The sailing direction is an estimate of the direction of traffic within a route-segment; it is defined by the bearing from the second node at the first node.
<b>Spaghetti structure</b>	A data structure in which all lines and points are unrelated to each other. [IHO, 1996; p. 1.5]
<b>Spanning tree</b>	The minimum-weight tree in a weighted graph which contains all of the graph's links.
<b>Spatial object</b>	An object which contains locational information about real world entities. [IHO, 1996; p. 1.5]
<b>Squat</b>	Squat is defined as the downward vertical displacement of ship's central gravity and trim, caused by the ship's movement at given speed. The squat effect is considered to decrease with depth. In order to prevent damage to the propellers and the keel, the speed

---

	should be decreased. [Tijben, 1998]
<b>Subgraph</b>	A subgraph is a separated and disconnected (set of) link(s).
<b>Track</b>	A track is the intended navigable trajectory of the ship between the point of departure and the point of arrival; it is established within the safety margins by the whole of way-points and legs.
<b>Travelling Salesman</b>	The travelling salesman problem concerns finding a tour visiting all the nodes of a graph while minimising the total angle that the traveller must turn along that tour.
<b>TSS</b>	Traffic Separation Scheme.
<b>UKC</b>	Under keel clearance.
<b>Update/ fix rate</b>	The update rate is the number of fixes per unit time. [radar]
<b>Vertex</b>	see 'link'
<b>Vertical tide movement</b>	The with time varying height of the water surface above chart depth.
<b>Voyage planning</b>	The systematic process in which a sailing order is translated into an optimal navigation plan and detailed navigation scenario to fulfil the mission, having considered all relevant information. [Sabelis, 1999(ii)]
<b>Way-point</b>	A way-point is a connecting point of two legs; it is geographically located and has some navigational significant characteristics.

## References

- Anderson, 2000      Anderson, Sweeney en Williams – AN INTRODUCTION TO MANAGEMENT SCIENCE - QUANTATIVE APPROACHES TO DECISION MAKING – 9th edition, South-western college publishing – 2000.
- ARP, 1998            Author unknown – AUTOMATIC ROUTE PLANNER – <http://ourworld.compuserve.com/homepages/gpss/arp.htm> – November 1998.
- Bailey, 1997        Bailey, J et all. – DYNAMIC ROUTE GUIDANCE SYSTEM – <http://pmri.uwaterloo.ca/~edward/projs/sd362/> - April, 1997.
- Buijs, 1994         Buijs, drs. A. – STATISTIEK OM MEE TE WERKEN (*transl. Statistics to work with*)– fourth, revised edition, Educatieve Partners Nederland BV, Houten, the Netherlands – 1994.
- Carol, 1996         Carol, J. – DIGITAL NAVIGATIONAL INFORMATION AND AUTOMATION OF PASSAGE PLANNING – Dissertation submitted to University of Nottingham and Royal Netherlands Naval College – november, 1996.
- Charting            IESSG – ELECTRONIC CHARTING& CARTOGRAPHY – lecture notes, module Navigation Technology – February, 2001.
- Chartworx, 2000    Chartworx – QUODFISH PLANNER AND THEMAMAP PLANNER – [http://www.chartworx.com/product\\_qfplanner.htm](http://www.chartworx.com/product_qfplanner.htm) , Chartworx – 2000.
- Cockcroft, 1990    Cockcroft, A.N. and Lameijer, J.N.F. – A GUIDE TO THE COLLISION AVOIDANCE RULES – fourth edition, BH Newnes Ltd, Oxford, UK – 1990.
- COLREG, 1977      IMO – INTERNATIONAL REGULATIONS FOR PREVENTING COLLISIONS AT SEA (COLREG) – IMO, London, last amendment 1993 – 15 July 1977.
- Dawson, 1997      Dawson, J. – DIGITAL CHARTING, NOW AND IN THE FUTURE – Journal of Navigation, vol. 45, pagina 251-255 – 1997.
- De Jong, 1996      De Jong, W. – ZEESCHEEPVAART EN VEILIGHEID, CURSUSBOEK (*transl. Sea shippery and safety, course book*)– Ministerie van Verkeer en Waterstaat, Directoraat Goederenvervoer, Rijswijk – October 1996.
- Dijkstra, 1959      Dijkstra, E.W. – A NOTE ON TWO PROBLEMS IN CONNECTION WITH GRAPHS – Numerische Mathematik (1959), p. 1:269-271 – 1959.
- DNV, 2000          Det Norske Veritas – CLASSIFICATION, DESCRIPTION OF CLASS

- NOTATIONS AS OF JANUARY 2000 – DNV Register of Vessels,  
<http://www.dnv.com/registerofvessels/keyclassnotations.htm> –  
 January, 2000.
- Dood, 1996 Dood, R. and Otter, L. – BASISBOEK GIS (*transl. Basics on GIS*)–  
 Rijkswaterstaat, Meetkundige dienst – oktober 1996.
- Douglas, 1999 Douglas, D.H. – LEAST COST PATH IN GIS USING AN ACCUMULATED  
 COST SURFACE AND SLOPE LINES –  
<http://www.hig.se/~dds/research/leastcos/cumcost4.htm> – februari  
 1999.
- Draaisma, 1982 Y. Draaisma, JJ. de Meester, Ir. J.A. Spaans, Ir. H.M. v.d. Weele –  
 LEERBOEK NAVIGATIE 2 (*transl. Textbook for Navigation 2*)– De Boer  
 Maritiem, 1<sup>e</sup> druk, Houten – 1982
- Draaisma, 1986 Y. Draaisma, JJ. de Meester, J.H. Mulders, Ir. J.A. Spaans – LEERBOEK  
 NAVIGATIE 1 (*transl. Textbook for Navigation 1*)– De Boer Maritiem, 3<sup>e</sup>  
 druk, Houten – 1986
- Drift, 2001 Drift, M.J.L. van der – GEAUTOMATISEERDE ROUTEPLANNING OP ZEE,  
 AUTOMATISERING VAN DE ROUTEPLANNINGSFASE VAN HET  
 REISVOORBEREIDINGSproces OP BASIS VAN EEN ROUTENETWERK  
*(transl. Automated route planning at sea, automisation of the route planning phase  
 of voyage planning based on a network)* – dissertation submitted to the Royal  
 Netherlands Naval College – October 2001.
- Eppstein, 1994 Eppstein, D. – FINDING THE K- SHORTEST PATHS – Department of  
 Information and computer science, University of California, technical  
 report 94-26 – may 31, 1994.
- Eppstein, 1997 Eppstein, D. – FINDING THE K- SHORTEST PATHS – Revised edition,  
 Department of Information and computer science, University of  
 California, technical report 94-26 – march 31, 1997.
- Flightplanner Author unknown – 5.0 THE FLIGHTPLANNER –  
<http://www.mdstud.chalmers.se/~md6pl/mercator/manual/plan.html>
- Fohl, 1996 Fohl, P. et all. – A NON-PLANAR, LANE.BASED NAVIGABLE DATA  
 MODEL FOR ITS – <http://www.ncgia.ucsb.edu/~curtin/nonplanar.html>  
 – 1996.
- FRP, 1999 DoD, DoT – FEDERAL RADIONAVIGATION PLAN, 1999 – Department  
 of Defense (DoD), Department of transport (DoT), United States –  
 December, 1999.

- Gabriel, 2000 Gabriel, S.A. and Bernstein, D. – NONADDITIVE SHORTEST PATHS: SUBPROBLEMS IN MULTI-AGENT COMPETITIVE NETWORK MODELS – Computational & Mathematical Organization theory 6, p. 29-45, Kluwer Academic Publishers, the Netherlands – 2000.
- Groot, 1998 Groot, C.A. de – NAUTISCHE INFORMATIE IN S57 VERSIE 3.0 (*transl. Nautical information in S-57 version 3.0*)– Royal Netherlands Naval College, Den Helder – december 1998.
- Groot, 1999 Groot, C.A. de – DICTAAT REISVOORBEREIDING (*transl. lecture notes on Voyage planning*)– Royal Netherlands Naval College, Den Helder – 1999.
- HP 1 Hydrographer of the Royal Netherlands Navy – HP 1, NETHERLANDS COAST PILOT – Netherlands Hydrographic Office, 3<sup>rd</sup> edition – 1999.
- Hwang, 1987 Hwang, Ching-Lai and Lin, Ming-Jeng – LECTURE NOTES IN ECONOMICS AND MATHEMATICAL SYSTEMS 281; GROUP DECISION MAKING UNDER MULTIPLE CRITERIA, METHODS AND APPLICATIONS – Springer-Verlag, Berlin Heidelberg, Germany – 1987.
- Hydro, 1991 Hydrografische Dienst – DEEP DRAUGHT PLANNING GUIDE – Hydrografische Dienst, Den Haag, revised edition – november 1991.
- ICS161, 1996 Author unknown – ICS 161: DESIGN AND ANALYSIS OF ALGORITHMS – lecture notes for februari 8, 1996, <http://www.ics.uci.edu/~eppstein/161/960208.html> – 1996
- IHO, 1996 IHO, International Hydrographic Bureau – S-57 TRANSFER STANDARD FOR DIGITAL HYDROGRAPHIC DATA – edition 3.0 – march 1996.
- IHO, 1999 IHO, International Hydrographic Bureau – STANDARDISATION OF NAUTICAL PUBLICATIONS WORKING GROUP MEETING, SUMMARY OF DISCUSSIONS – International Hydrographic Bureau, Monaco – 13-14 September 1999.
- Ikeda, 2000 Ikeda, K. – SHORTEST PATH PROBLEM: DIJKSTRA'S ALGORITHM – <http://www-b2.is.tokushima-u.ac.jp/~ikeda/suuri/dijkstra/dijkstra.shtml> – June 2000.
- IMO, 1974 IMO, International Maritime Organisation – SOLAS CONVENTION 1974 – IMO, London – 1974.
- IMO, 1978(i) IMO, International Maritime Organisation – GUIDE TO THE PLANNING AND CONDUCT OF PASSAGES – IMO Circular SN/CIRC. 92, London – 23 October 1978.
- IMO, 1978(ii) IMO – THE INTERNATIONAL CONVENTION FOR THE PREVENTION OF

- POLLUTION FROM SHIPS (MARPOL) – IMO, london, 1978.
- IMO, 1991      IMO – Ships' routing – IMO Resolution A.711(17), London – 6 November 1991.
- IMO, 1995(i)      IMO, International Maritime Organisation – PERFORMANCE STANDARDS FOR ELECTRONIC CHART DISPLAY AND INFORMATION SYSTEMS (ECDIS) – Resolution A.817(19) adopted at the 19<sup>th</sup> session of the IMO general Assembly, London – 23 November 1995.
- IMO, 1995(ii)      IMO – General provisions on ship's routing – resolution A.827(19), IMO, London - 1995
- IMO, 2001      IMO MSC – DRAMATIC INCREASE IN PIRACY AND ARMED ROBBERY – Maritime Safety Committee (MSC), 74th session, [http://www.imo.org/Newsroom/contents.asp?topic\\_id=67&doc\\_id=1060](http://www.imo.org/Newsroom/contents.asp?topic_id=67&doc_id=1060) – June, 2001.
- Kerr, 1996      Kerr, J.B. – INTERNATIONAL PERSPECTIVES ON ECDIS – International Hydrographic Review, LXXIII(1), p. 115-125 – March 1996.
- Korte, 1997      Korte, G.B. – THE GIS BOOK – OnWord Press, Santa Fe, NM, 4<sup>th</sup> edition – 1997.
- Kottman, 1992      Kottman, C.A. – SOME QUESTIONS AND ANSWERS ABOUT DIGITAL GEOGRAPHIC INFORMATION EXCHANGE STANDARDS – Intergraph Corporation, second edition – November 1992.
- Laurini, 1992      R. Laurini and D. Thompson – FUNDAMENTALS OF SPATIAL INFORMATION SYSTEMS – the APIC series no. 37, Academic Press, San Diego – 1992.
- Mankabady, 1986      Mankabady, S. – THE INTERNATIONAL MARITIME ORGANISATION; VOL.1 INTERNATIONAL SHIPPING RULES – Croom helm Ltd., London – 1986.
- Manschot, 2000      Manschot, J.P. – HET ONTWIKKELEN VAN EEN 2D+T ALGORITME VOOR DE MARITIEME REISVOORBEREIDING (*transl. the development of a 2D+T algorithm for maritime voyage planning*)– Dissertation submitted to the Royal Netherlands Naval College – Januari 2000.
- Norris, 1998      Norris, A.P. – THE STATUS AND FUTURE OF THE ELECTRONIC CHART – Journal of navigation, vol. 51, pagina 321-326 –1998.
- NP 100      British Hydrographic Office – NP 100, THE MARINERS HANDBOOK – British Hydrographic Office, 6<sup>th</sup> edition – 1989.
- NP 136      British Hydrographic Office – NP 136, OCEAN PASSAGES OF THE



- WORLD – British Hydrographic Office, 4<sup>th</sup> edition – 1987.
- Radar IESSG – RADAR&RADIO POSITIONING – lecture notes, module  
Navigation Technology – October, 2000.
- Rijkswaterstaat, 1995 Rijkswaterstaat – INFORMATIE VOOR DE VAART MET GEULGEBONDEN  
SCHEPEN NAAR DE HAVEN VAN ROTTERDAM (*transl. Information for sailing  
channel binded ships to the port of Rotterdam*)– Rijkswaterstaat, directie  
Noordzee – edition 1995.
- Sabelis, 1997(i) Sabelis, H. Ir. – GEOGRAFISCHE INFORMATIE SYSTEMEN (GIS) EN  
NAVIGATIE (*transl. GIS and navigation*)– KIM spiegel, nr.123, 2<sup>nd</sup> quarter  
1997, volume 32, p. 11-15, Den Helder – 1997.
- Sabelis, 1997(ii) Sabelis, H. Ir. – NAVIGATIEPLANNING EN WACHTVOORBEREIDING  
(*transl. Navigation planning and watch preparation*)– KIM spiegel, nr. 125, 4<sup>th</sup>  
quarter 1997, volume 32, p. 9-19, Den Helder – 1997.
- Sabelis, 1999(i) Sabelis, H. Ir. – DICTAAT NAVIGATIE 4: NAVIGATIE EN GEODESIE  
(*transl. Lecture notes Navigation4: Navigation and Geodesy*)– Royal  
Netherlands Naval College, Den Helder – 24 maart 1999.
- Sabelis, 1999(ii) Sabelis, H. Ir. – VOYAGE PLANNING IN ECDIS – International  
Hydrographic Review, LXXV(2) – september 1999.
- Scheele, 1996 Scheele, C.A. – COMPUTER AIDED PASSAGE PLANNING AND  
NAVIGATION – dissertation submitted to the University of Nottingham  
– January, 1996.
- Scheuermann Scheuermann, W. – ROUTE PLANNING, ROUTE CHECKING AND ROUTE  
MONITORING IN ECDIS – sevencs,  
<http://www.sevencs.com/publicat/routechk/routechk.htm> – date  
unknown.
- Scheuermann, 1999 Scheuermann, W. and Pahmeyer, K. – ICE INFORMATION IN ECDIS –  
Sevencs and university of the German armed forces,  
<http://www.sevencs.com/publicat/ice/icecds.html> – January, 1999.
- Seo, 1988 Seo, F. and Sakawa, M. – MULTIPLE CRITERIA DECISION ANALYSIS IN  
REGIONAL PLANNING; CONCEPTS, METHODS AND APPLICATIONS –  
Theory and Decision library, Dordrecht, The Netherlands – 1988.
- Smeaton, 1992 Smeaton, G.P. et all. – THE ELECTRONIC CHART IN THE INTEGRATED  
BRIDGE: AN EMERGING TECHNOLOGY AT SEA – Transactions Institute  
Marine Engineers, vol. 104, pagina 171-185 – 1992.
- Spaans, 1992 Spaans, J.A. – ECDIS SEA TRIALS – Journal of Navigation, vol. 45,

- pagina 19-25 – 1992.
- Spaans, 1994 Spaans, J.A. and Stoter, P.H. – NEW DEVELOPMENTS IN SHIP WEATHER ROUTEING – Navigation, Revue Technique de Navigation Maritime, Aérienne, Spatiale et Terrestre, No 169, p. 95-106 – January 1994.
- Spoelstra, 1996 Spoelstra, G.G. – ECDIS EN STANDAARDISATIE (*transl. ECDIS and standardisation*)– lecture during workshop ECDIS, Netherlands Institute for Navigation, Rotterdam – 1996.
- Starr, 1990 Starr, J. and Estes, J. – GEOGRAPHIC INFORMATION SYSTEMS - AN INTRODUCTION – Prentice-Hall, Inc, Englewood Cliffs, New Jersey – 1990.
- Stentec, 1999 Stentec – PC NAVIGO 4.0 – Stentec, Noorderzon cruises, <http://www.stentec.com/software/pcnav.html> – 1999.
- Tijben, 1998 Tijben, A.C. – SQUAT – MEASURING THE VERTICAL DISPLACEMENT USING GPS - Dissertation submitted to University of Nottingham and Royal Netherlands Naval College – September, 1998.
- Traffic, 2000 Ministerie van Verkeer en Waterstaat – VESSEL TRAFFIC ON THE NORTH SEA – Ministerie van Verkeer en Waterstaat, directorate-general for freight transport – 2000.
- Warburton, 1987 Warburton, A. – APPROXIMATION OF PARETO OPTIMA IN MULTIPLE-OBJECTIVE, SHORTEST PATH PROBLEMS – Operations Research, vol. 35, no.1, p. 70-79 - January-Februari 1987.
- Zhan Zhan, F.B. – THREE FASTEST SHORTEST PATH ALGORITHMS ON REAL ROAD NETWORKS: DATA STRUCTURES AND PROCEDURES – Journal of Geographic Information and Decision Analysis, vol.1, No. 1, p. 69-82, [http://publish.uwo.ca/~jmalczew/gida\\_1/Zhan/Zhan.htm](http://publish.uwo.ca/~jmalczew/gida_1/Zhan/Zhan.htm)

---

## List of figures

Figure II-1: Sabelis' model of the voyage planning-process. [Sabelis, 1999(ii)] .....	8
Figure III-1: Routeing measures off the Dutch coast. [HP1] .....	19
Figure III-2: Routes in the Caribbean Sea. [NP136] .....	20
Figure III-3: An example of a graph. ....	22
Figure III-4: Components of the route-network. ....	25
Figure III-5: Basis model for S-57. [IHO, 1996] .....	31
Figure III-6: Theoretical data model for planar graph. [IHO, 1996] .....	32
Figure III-7: Data structure model. [IHO, 1996; p. 3.2] .....	33
Figure III-8: S-57 data structure example. [Carol, 1996; p. 58] .....	33
Figure III-9: The route-network fitted to the S-57 transfer standard. ....	35
Figure III-10: Route-network theoretical data model. ....	36
Figure V-1: The interval ellipse. [Bailey, 1997] .....	60
Figure V-2: Sequence of the route planning algorithm. ....	61
Figure V-3: The filter section of the filter algorithm. ....	62
Figure V-4: The calculation module within the filter algorithm. ....	63

# Appendices

**Appendix A: Traffic density chart: route bound traffic on the North Sea. [Traffic, 2000]**

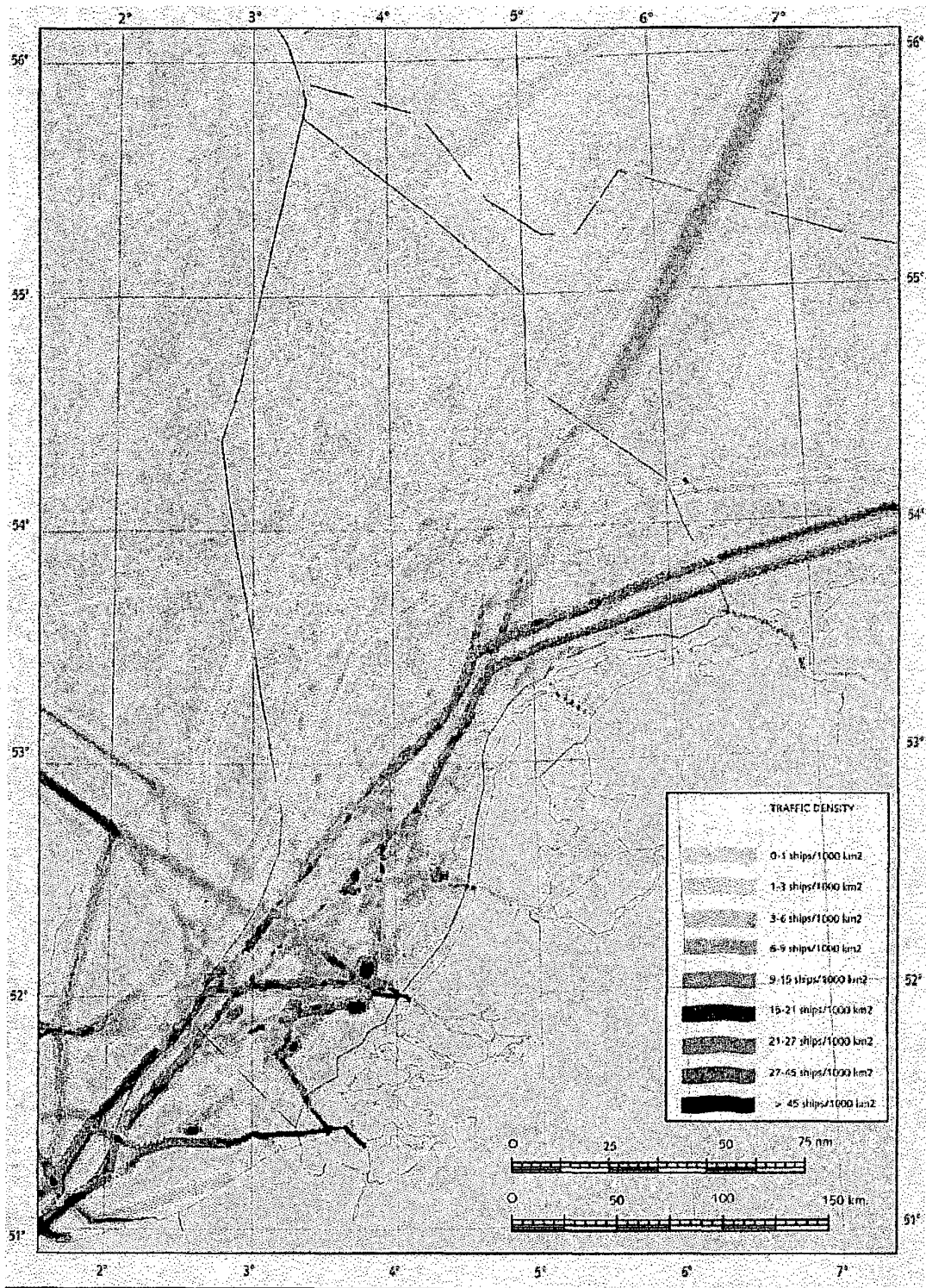

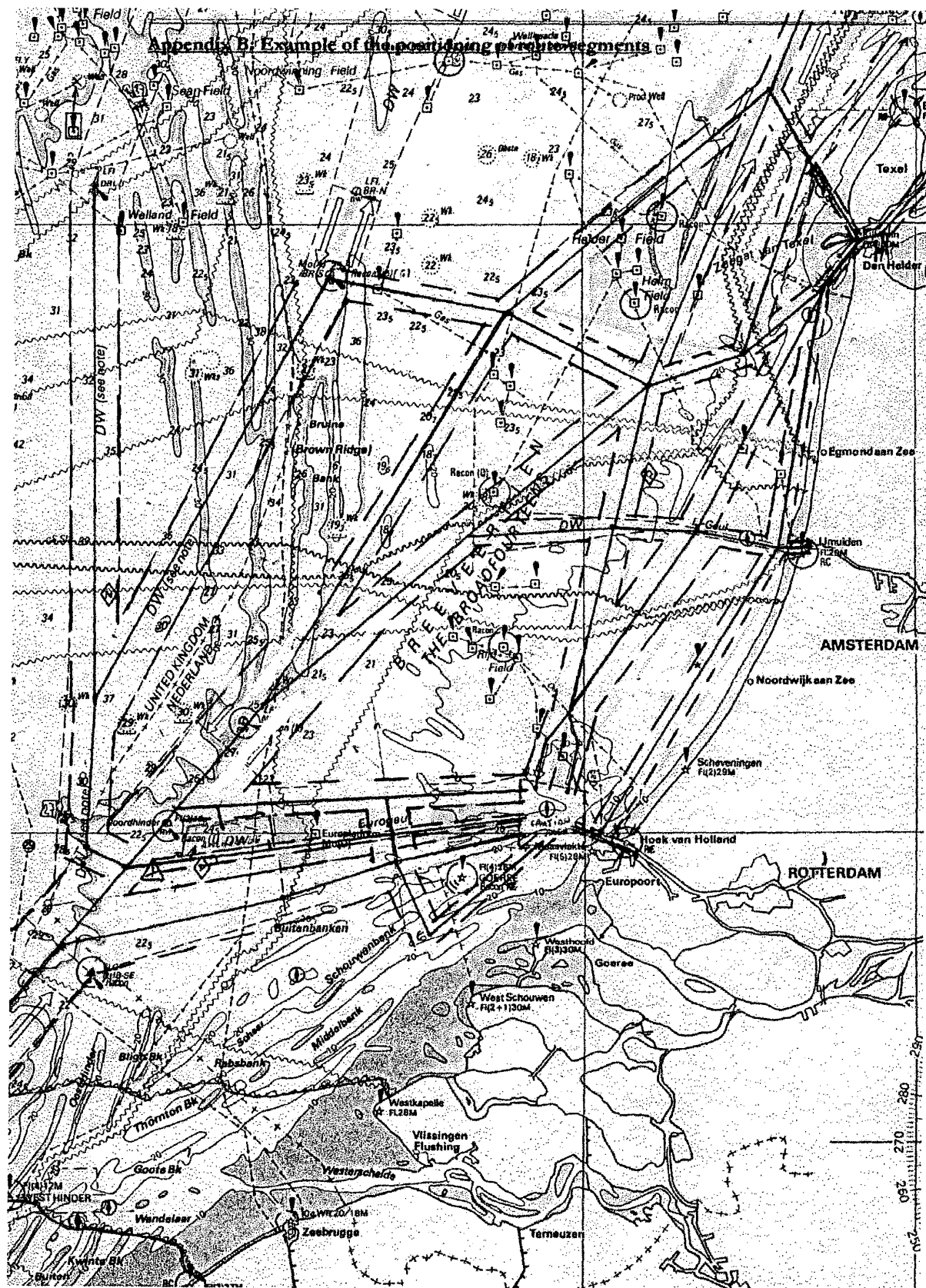

### **Appendix C: Cargo classification and ice classification.**

#### **1. Cargo classification.**

In order to determine the critical cargo classes, more detail is required on this subject. Therefore, international legislation (MARPOL 73/78) was examined, as well as some copies of Sailing Directions. The conclusion is that most cargo restrictive measures are based on the categorisation as employed in MARPOL 73/78. The most important categories are:

- Oil and gas [IMO, 1978(ii); annex I]
- Noxious liquid substances in bulk (petroleum chemicals, vegetable oils etcetera) in the categories:
  - A. major hazard if discharged in sea for human and marine environment (stringent anti-pollution measures needed).
  - B. hazard if discharged in sea for human and marine environment (special anti-pollution measures needed).
  - C. minor hazard if discharged in sea for human and marine environment (special operation conditions needed).
  - D. recognisable hazard if discharged in sea for human and marine environment (some attention in operations needed).

For other classes of cargo, no restrictions were found, therefore no further classes need to be input in the sailing order and passage characteristics.<sup>66</sup>

#### **2. Ice classification.**

As explained in paragraph IV.1.2, different formats, terms and procedures in ice condition reports and ice classification are issued by several authorities. Two examples are the Canadian Arctic regulations and the Finnish-Swedish ice class regulations. The Norwegian classification bureau Det Norske Veritas operate classification rules that meet both the ice regulation systems. The following most important classes can be distinguished [DNV, 2000]:

- Ice-1A\*. A vessel with Ice-1A\* may operate in channels prepared by icebreakers and/or in open waters with smaller ice flows. This vessel can cope with extreme ice conditions, where ice floes of thickness 1.0m are anticipated.
- Ice-1A. A vessel with Ice-1A may operate in channels prepared by icebreakers and/or in open waters with smaller ice flows. This vessel can cope with severe ice conditions, where ice floes of thickness 0.8m are anticipated.

<sup>66</sup> With reservations. It is very possible that there are restrictions made on other cargo classes, since only a couple of situations are studied.

- Ice-1B. A vessel with Ice-1B may operate in channels prepared by icebreakers and/or in open waters with smaller ice flows. This vessel can cope with medium ice conditions, where ice floes of thickness 0.6m are anticipated.
- Ice-1C. A vessel with Ice-1C may operate in channels prepared by icebreakers and/or in open waters with smaller ice flows. This vessel can cope with light ice conditions, where ice floes of thickness 0.4m are anticipated.

There are a couple of other classes, which are meant for ships that are intended for ice breaking as main purpose. The classes that are mentioned above are the most common classes for 'normal' vessels. These are thus implemented in the test-environment.

Besides, there are many types and forms of ice at sea. Several local authorities operate ice reporting systems which are based on a series of codes that indicate the type, form and thickness of ice. The German company Sevens (that produces ECDIS system, amongst others), has completed research on how to implement these ice reports in the ECDIS software, so that the different areas with ice are projected on the ENC. [Scheuermann, 1999] In this thesis, the following types of ice are implemented in the test-environment<sup>67</sup>: [NP 100]

- New ice or nilas. Ice that is relatively soft and pliable and will not normally damage the hull of modern steel vessels except small craft. The thickness is normally up to 10 cm.
- Young ice. Young ice is normally older and thicker than new ice or nilas. Thickness can be up to 30 cm.
- First year ice. First year ice is older than young ice and thicker. It will normally draw off in the summer as do the younger types of ice. Thickness of first year ice can be more than 120cm. Depending on the thickness, ice strengthened vessels can pass. Therefore, four types are used in the test-environment, namely -60cm, -80cm, -100cm and  $\geq 100$ cm.

Another important aspect on ice conditions is that the occurrence of ice depends on the season. When studying the weather chart in the Mariners Handbook [NP 100], it can be seen that in the northern hemisphere ice conditions are at their maximum extent in February and March. In the southern hemisphere the maximum extent occurs in September and October.

---

<sup>67</sup> There are many other types of ice that can be distinguished. Normally, these are older than one year and consist of hard, thick ice. Ice strengthened vessel cannot break through these ice types, usually.

**Appendix D: Attributes and attribute values as used in the test-environment.****1. Sailing Order input characteristics.**

In paragraph IV.5.1, the selection of Sailing Order characteristics was argued. The most important ship's characteristics are type of vessel, draught, Under Keel Clearance, Cargo class, Ice breaking class and maximum speed. There are a few important types of vessels, which imply different sets of preferences and relationships. Although in this thesis, tests are carried out with a navy vessel (frigate), other important types are small merchant vessel (up to 150 m), large merchant vessel (larger than 150m) and pleasure yacht, amongst others.

Draught is implemented in the test-environment as the maximum draught in metres at the position of the hull attachments (rudder, propeller, sonardome). Minimal Under Keel Clearance is the safety margin set by the navigator in metres. Maximum speed is expressed in knots (nm/h).

The cargo classes are implemented in accordance with the Marpol classification (as described in appendix C), namely 'oil/gas', 'noxious liquid in bulk category A/B', 'noxious liquid in bulk category C/D', 'noxious liquid in bulk category A/B/C/D' and 'other'. Ice classes are in accordance with the regulation that are described in more detail in appendix C, namely 'no ice strengthening', 'class 1A\*', 'class 1A', 'class 1B', 'class 1C' and 'ice breaker'.

From the mission characteristics, only start position, end position, intermediate position(s) and distance/time requirements are implemented in the test-environment. The positions are the particular route-points and the distance/time requirements are set in percentage (see also paragraph V.2).

**2. Attributes input characteristics.**

A complete description of the way that the attributes are handled is necessary to create a well-organised and complete data set and to prevent dependence in the data structure. Clarity is provided by organising the several attributes in classes, and then determining the values of these attributes. The attribute value in the first place limits the forms of the attribute and correlates the figure in the data set with a feature (e.g. attribute: buoy colour; values: red, blue, yellow, black and so on). Dependence is prevented by separating information, like length and time, from the original data-base, and calculating whilst computing the optimal route. Normally, a lot of the information would be obtained from the ENC; in that case, the spatial queries would be carried out during the computing stages, too.



For all the aspects the manner of storage of the data should be considered as well as the possible values that the attributes could adopt. Therefore, all the selected aspects will be reviewed briefly.

- **Classification.** The attribute ‘classification’ will appoint the classification of the passage, namely ocean, coastal or confined passage. These are at the same time the attribute values.
  
- **Dimensions.** There are two attributes gathered in the attribute-group dimensions. These are depth and width. Depth should normally be divided into chart depth and tidal rise. However, the implementation of tidal prediction algorithms is too complex to deal with within the scope of this dissertation. Therefore, only chart depth will be considered. Another difficult aspect is the fact that depth will never be constant over a large area, such as a passage. A sort of threshold must be derived for every route-segment. I have decided to choose the minimum chart depth in the whole segment, not being an obstacle (wreck, rock). The thought is, that the size of the obstacle is relatively small compared with the size of the segment. When the minimum depth is chosen above an obstacle, it would deny some ships the conduct of the passage, although it could well have sailed around it. Hence, the attribute value for depth is the chart depth in metres.  
*Width* determines the width of the segment, namely the shortest distance between the boundaries (i.e. perpendicular to the centreline). Normally the centreline would be in the centre, thus taking half the width is sufficient. The value of width is half the width of a segment in nautical miles. Width is only important in case of route-lanes.
  
- **Cargo class restriction.** The attribute *prohibited cargo class* is the only regulatory restriction implemented in the test-environment. The possible values of this attribute are the cargo classes as described in appendix C. Often, regulations involve both oil/gas and noxious liquid substances category A and B. Sometimes, all categories are restricted. Therefore, the attribute values for prohibited cargo class are ‘none’, ‘noxious liquid substances category A and B’, ‘noxious liquid substances category C and D’, ‘oil/gas’, ‘noxious liquid substances category A and B and oil/gas’, all categories of noxious liquid substances and oil/gas’.

- **Speed limit.** The attribute '*speed-limit*' gives the maximum allowable speed (attribute value) in knots (nm/h) for the conduct of the passage. Speed-limits would only occur in case of route-lanes.
  
- **Routeing measures.** The attribute '*routeing measures*' assigns a routing measure to the route-lane or area. The values are 'none', 'traffic separation scheme', 'deep water route', 'recommended route', 'caution area', 'anchorage area', 'military exercise area' and 'inshore traffic zone'. The first and last value can be assigned to both lanes and areas, the second, third and fourth are only valid for lanes and the fifth, sixth and seventh value can be assigned to areas.
  
- **Piracy risk.** Piracy is still a very important issue in maritime safety. IMO noted a 'dramatic increase piracy and armed robbery' during the year 2000 [IMO, 2001]. It is easy to discern that there are a lot of areas with high piracy risk around the world, since a majority of cases of armed robbery and piracy are reported to IMO. Therefore, we can assign a 'piracy risk' value to a route-segment, which is the chance of an attack by terrorists during the conduct of the segment. The attribute '*piracy*' is implemented in terms of a 'negligible chance', a 'recognisable chance' or a 'significant chance' of an attack.
  
- **Navigational aspects.** In the first place, the attribute '*obstacles*' denotes the number of significant obstacles (wrecks, rocks etc)<sup>68</sup> that are located within the boundaries of the segment. The attribute value is the number of obstacles.  
 The second attribute is the '*number of marks*'. The number of marks describes the number of buoys or other navigational signs that mark obstacles. The value is the number of these 'marking' signs within the boundaries.  
 Furthermore, the attribute '*fairway marking*' describes the state of fairway marking of the passage. Values that are implemented are 'none', 'poor' and 'good'.  
 The last attribute is '*aids to navigation*'. As described in paragraph IV.3.2 there are a number of important figures to denote, when speaking about aids to navigation. Because of the complexity of these figures, the dependence on navigational situation of the desired values of these figures, I choose to consider availability only. The value of this attribute is the statement of which positioning system or method is available during the passage of

<sup>68</sup> An obstacle is considered to be significant when the depth above the obstacle is smaller than the minimum chart depth in the area surrounding it, or when the depth above the obstacle is not obtained by dredging.

the segment. These values are 'none', 'GNSS', 'Loran-C', 'Visual/radar positioning'<sup>69</sup>, 'GNSS and Loran-C', 'GNSS and visual/radar', 'Loran-C and visual/radar' and 'all available'.

- **Ice conditions.** The attribute '*ice condition*' states the ice conditions of the segment as should have been reported by local authorities. The values are as described in appendix..., namely 'no ice', 'new ice or nilas', 'young ice', 'first year ice -60cm', 'first year ice -80cm', 'first year ice -100cm' and 'first year ice  $\geq 100$ cm'.
- **Fog probability.** The attribute '*fog probability*' describes the chance of occurrence of fog during the passage of the segment. According to the Mariners Handbook [NP 100] the fog chances are given in the number of days of fog per month. Commonly used values are '0 days/month' if not significantly more fog occurs in the particular region, (around) '5 days/month' if fog occurs quite often in that area and (around) '10 days/month' if fog occurs often in that region.
- **Connectivity.** Because of the fact that the chain-node structure is used in the test-environment, the start node and end node are implemented as well (in terms of their unique ID number). Also traffic regulation is implemented with the values 'two-way', 'one-way, start node to end node' and 'one-way, end node to start node'.
- **Harbour characteristics.** Route-points can have the attributes describing the simulated harbour. In the test-environment this is done by creating an attribute '*harbour*' with the values 'no harbour' and 'harbour', and an attribute '*maximum allowable draught*' with the maximum allowable draught in meters as value.

---

<sup>69</sup> Since the withdrawal of Decca, GNSSs, Loran-C and Visual/radar positioning are the only important positioning systems left for marine navigation. The latter system, rather a method, is dependent on the presence of visual and radar conspicuous objects, in order to take bearings and measure distances to the 'beacons'.

**Appendix E: Final chain-node structure as used in the test-environment.**

<b>Sailing order</b>			
<b>Statements</b>	<b>values</b>	<b>oblig.</b>	<b>Description</b>
Start position	ID_routepoint	yes	The position of departure
End position	ID_routepoint		The position of destination
Intermediate position	ID_routepoint	no	The position of a node that has to be passed
Distance/time interval	Search interval definition	yes	The requirements concerning distance and time
Draught	m	yes	maximum draught in meters
UKC	m	yes	minimum allowed UKC
Maximum speed	kts	yes	Maximum speed in knots
Cargo class	0=other 1=oil/gas 2=goods cat A/B 3=goods cat C/D 4=all cat (A/B/C/D)	yes	cargo class
Ice breaking class	1=no strengthening 2=class 1A* 3=class 1A 4=class 1B 5=class 1C 6=ice breaker	yes	Ice breaking class

<b>Route-points</b>			
<b>Attribute</b>	<b>values</b>	<b>oblig.</b>	<b>description</b>
Latitude	degrees	yes	the position in latitude and longitude in degrees
Longitude	degrees		
Harbour	0=no 1=yes	yes	Is the route-point a port?
Maximum draught	m	no	Maximum allowable draught in m (In case of harbour)
Area	ID_area	no	ID of the area the route-point lies in

<b>Route-lanes</b>			
<b>Attribute</b>	<b>values</b>	<b>oblig.</b>	<b>description</b>
Start node	ident of route-point 1	yes	Identification (name) of the first route-point (start of centre-line)
End node	ident of route-point 2	yes	Identification (name) of the second route-point (end of centre-line)
Traffic regulation	1=two way segment 2=one way: 1st to 2nd 3=one way: 2nd to 1st	yes	Information on traffic regulations and connectivity. First route-point is starting route-point First route-point is ending route-point
Classification	1=ocean passage 2=coastal passage 3=confined passage	yes	What is the classification of the passage
Depth	minimal chart depth (m)	yes	Minimal chart depth within boundaries (not an obstacle!)
Width	width of the segment (nm)	yes	Distance between CL and Boundary.
prohib. cargo class	0=none 1=dangerous goods cat A/B 2=dangerous goods cat C/D 3=oil/gas 4=cat A/B and oil/gas 5=all categories and oil/gas	yes	Forbidden cargo classes.

Speedlimit	max. allowed speed (kts)	no	Maximum allowed speed in knots.
routing measures	0= none 1= TSS 2= Deep water route 3= Recomm. route 7=Inshore traffic zone	yes	Type of routing measure (0=no routing measure enforced!)
piracy	0=negligible 1=recognisable 2=significant	yes	The chance of a attack of pirates or terrorists expressed in percentage.
obstacles	number of obstacles	yes	Number of obstacles within the boundaries.
no of marks	number of marks	yes	Number of marks that indicate obstacles.
fairway marking	0= none 1= poor 2= good	yes	state of fairway marking
aids to navigation	0= none 1= GNSS 2= Loran-C 3= visual/radar 4= GNSS + Loran-C 5= GNSS + visual/ radar 6= Loran-C + visual/radar 7= all available	yes	Availability. The indicated positioning system is available in the area.
fog	days of fog per month	yes	Days of fog per month, >5 days is significant, >10 days is many
ice	0=No chance of ice 1=New ice or Nilas 2=Young ice 3=First year ice -60cm 4=First year ice -80cm 5=First year ice -100cm 6=First year/old ice >100 cm	yes	Ice types. Type of ice represents thickness and determines the possibility of passage.
ice season	1=februari/march 2=september/october	no no	Month with the greatest extent of ice; in these months thickness of ice shall be the greatest. Normally: 1=Northern hemisphere; 2= southern hemisphere.

Route-areas			
attribute	values	oblig.	description
classification	1=ocean passage 2=coastal passage 3=confined passage	yes	What is the classification of the passage
depth	minimal chart depth (m)	yes	Minimal chart depth within boundaries (not an obstacle!)
prohib. cargo class	0=none 1=dangerous goods cat A/B 2=dangerous goods cat C/D 3=oil/gas 4=cat A/B and oil/gas 5=all categories and oil/gas	yes	Forbidden cargo classes.
routing measures	0= none 4= Caution area 5= Anchorage area 6= Military exercise area 7=Inshore traffic zone	yes	Type of routing measure (0=no routing measure enforced!) routing measures for areas
piracy	0=negligible 1=recognisable 2=significant	yes	The chance of a attack of pirates or terrorists expressed in percentage.
obstacles	number of obstacles	yes	Number of obstacles within the boundaries.
no of marks	number of marks	yes	Number of marks that indicate obstacles.
aids to navigation	0= none 1= GNSS 2= Loran-C 3= visual/radar 4= GNSS + Loran-C 5= GNSS + visual radar	yes	Availability. The indicated positioning system is available in the area.

	6= Loran-C + visual radar 7= all available		
fog	days of fog per month	yes	Days of fog per month, >5 days is significant, >10 days is many
ice	0=No chance of ice 1=New ice or Nilas 2=Young ice 3=First year ice -60cm 4=First year ice -80cm 5=First year ice -100cm 6=First year/old ice >100 cm	yes	Ice types. Type of ice represents thickness and determines the possibility of passage.
ice season	1=februari/march 2=september/october	no no	Month with the greatest extent of ice; in these months thickness of ice shall be the greatest. Normally: 1=Northern hemisphere; 2= southern hemisphere.

**Appendix F: Test area**

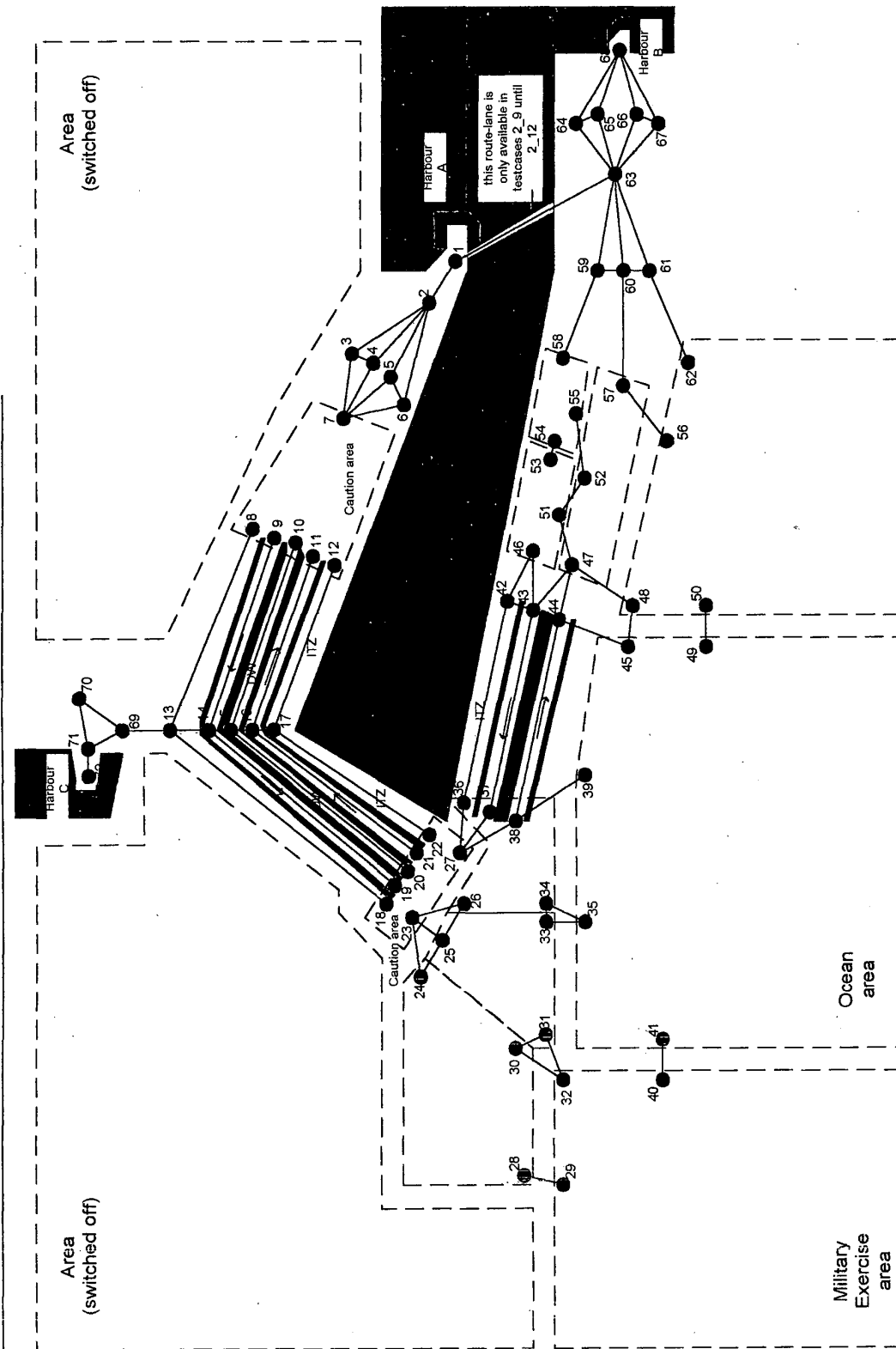

Appendices

**Appendix G: Test results of scenario 1**

**TESTCASE 1 1:** Testing the shortest path algorithm without restrictions

Sailing order:			
Ship's characteristics:		Mission characteristics	
Type of vessel	Navy vessel (frigate)	Start Route-point	1
Maximum speed	30	End Route-point	68
Draught	6	Via Route-point	-
UKC	2		
Cargo class	no		
Ice class	no		

Optimal Route: shortest distance				Optimal Route: shortest time			
Start node	End node	Distance (nm)	Time (min)	Start node	End node	Distance (nm)	Time (min)
1	2	12	24	1	2	12	24
2	4	21	42	2	4	21	42
4	7	16	32	4	7	16	32
7	12	35	70	7	12	35	70
12	17	43	86	12	17	43	86
17	22	49	98	17	22	49	98
22	27	9	18	22	27	9	18
27	36	12	24	27	36	12	24
36	42	50	100	36	42	50	100
42	46	14	28	42	46	14	28
46	53	23	46	46	53	23	46
53	54	5	10	53	54	5	10
54	58	20	40	54	58	20	40
58	59	23	46	58	59	23	46
59	63	24	48	59	63	24	48
63	65	15	30	63	65	15	30
65	68	17	34	65	68	17	34
Total		388	776	Total		388	776

**TESTCASE 1 2:** Testing the shortest path algorithm without restrictions

Sailing order:			
Ship's characteristics:		Mission characteristics	
Type of vessel	Navy vessel (frigate)	Start Route-point	1
Maximum speed	30	End Route-point	68
Draught	6	Via Route-point	40
UKC	2		
Cargo class	no		
Ice class	no		

Optimal Route: shortest distance				Optimal Route: shortest time			
Start node	End node	Distance (nm)	Time (min)	Start node	End node	Distance (nm)	Time (min)
1	2	12	24	1	2	12	24
2	4	21	42	2	4	21	42
4	7	16	32	4	7	16	32
7	12	35	70	7	12	35	70
12	17	43	86	12	17	43	86
17	22	49	98	17	22	49	98
22	23	21	42	22	23	21	42
23	25	10	20	23	25	10	20
25	31	36	72	25	31	36	72
31	32	12	24	31	32	12	24
32	40	26	52	32	40	26	52
40	41	10	20	40	41	10	20
41	49	98	196	41	49	98	196
49	50	10	20	49	50	10	20
50	62	60	120	50	62	60	120
61	62	25	50	61	62	25	50
61	63	25	50	61	63	25	50
63	65	15	30	63	65	15	30
65	68	17	34	65	68	17	34
Total		541	1082	Total		541	1082

**TESTCASE 1 3:** Testing the shortest path algorithm with speed limits

Sailing order:			
Ship's characteristics:		Mission characteristics	
Type of vessel	Navy vessel (frigate)	Start Route-point	1
Maximum speed	30	End Route-point	68
Draught	6	Via Route-point	-
UKC	2		
Cargo class	no		
Ice class	no		

Optimal Route: shortest distance				Optimal Route: shortest time			
Start node	End node	Distance	Time	Start node	End node	Distance	Time
1	2	12	24	1	2	12	24
2	4	21	42	2	4	21	42
4	7	16	32	4	7	16	32



7	12	35	70	7	12	35	70
12	17	43	86	12	17	43	86
17	22	49	98	17	22	49	98
22	27	9	18	22	27	9	18
27	36	12	24	27	36	17	34
36	42	50	100	38	44	51	102
42	46	14	120	44	47	14	28
46	53	23	46	47	57	46	92
53	54	5	10	57	60	28	56
54	58	20	40	60	63	24	48
58	59	23	197	63	65	15	30
59	63	24	206	65	68	17	34
63	65	15	30				
65	68	17	34				
Total		388	1177	Total		397	794

Route-segments with restrictions:		
Start node	End node	Speed limit
42	46	7
58	59	7
59	63	7

**TESTCASE 1 4:** Testing the shortest path algorithm with depth restrictions

Sailing order:			
Ship's characteristics:		Mission characteristics:	
Type of vessel	Navy vessel (frigate)	Start Route-point	1
Maximum speed	30	End Route-point	68
Draught	6	Via Route-point	-
UKC	2		
Cargo class	no		
Ice class	no		

Optimal Route: shortest distance				Optimal Route: shortest time			
Start node	End node	Distance	Time	Start node	End node	Distance	Time
1	2	12	24	1	2	12	24
2	4	21	42	2	4	21	42
4	7	16	32	4	7	16	32
7	10	32	64	7	10	32	64
10	15	48	96	10	15	48	96
15	20	58	116	15	20	58	116
20	27	14	28	20	27	14	28
27	36	12	24	27	36	12	24
36	42	50	100	36	42	50	100
42	46	14	28	42	46	14	28
46	53	23	46	46	53	23	46
53	54	5	10	53	54	5	10
54	58	20	40	54	58	20	40
58	59	23	46	58	59	23	46
59	63	24	48	59	63	24	48
63	65	15	30	63	65	15	30
65	68	17	34	65	68	17	34
Total		404	808	Total		404	808

Route-segments with restrictions:		
Start node	End node	depth (m)
8	13	5
9	14	5
11	16	5
12	17	5
13	18	5
14	19	5
16	21	5
17	22	5

**TESTCASE 1 5A:** Testing the shortest path algorithm with cargo class restrictions

Sailing order:			
Ship's characteristics:		Mission characteristics:	
Type of vessel	Navy vessel (frigate)	Start Route-point	1
Maximum speed	30	End Route-point	68
Draught	6	Via Route-point	-
UKC	2		
Cargo class	oil/gas		
Ice class	no		

Optimal Route: shortest distance				Optimal Route: shortest time			
Start node	End node	Distance	Time	Start node	End node	Distance	Time
1	2	12	24	1	2	12	24
2	4	21	42	2	4	21	42
4	7	16	32	4	7	16	32
7	10	32	64	7	10	32	64
10	15	48	96	10	15	48	96
15	16	6	12	15	16	6	12

16	17	6	12	16	17	6	12
17	22	49	98	17	22	49	98
22	27	9	18	22	27	9	18
27	38	17	34	27	38	17	34
38	44	51	102	38	44	51	102
44	47	14	28	44	47	14	28
47	57	46	92	47	57	46	92
57	60	28	56	57	60	28	56
60	63	24	48	60	63	24	48
63	65	15	30	63	65	15	30
65	68	17	34	65	68	17	34
Total		411	822	Total		411	822

Route-segments with restrictions:		
Start node	End node	cargo restriction
2	4	dangerous goods cat A/B
2	5	all categories and oil/gas
2	6	dangerous goods cat C/D
12	17	cat A/B and oil/gas
17	22	dangerous goods cat C/D
36	42	all categories and oil/gas
63	65	dangerous goods cat A/B
66	68	oil/gas

**TESTCASE 1 5B:** Testing the shortest path algorithm with cargo class restrictions

Sailing order:			
Ship's characteristics:		Mission characteristics	
Type of vessel	Navy vessel (frigate)	Start Route-point	1
Maximum speed	30	End Route-point	68
Draught	6	Via Route-point	-
UKC	2		
Cargo class	goods cat A-D		
Ice class	no		

Optimal Route: shortest distance				Optimal Route: shortest time			
Start node	End node	Distance	Time	Start node	End node	Distance	Time
1	2	12	24	1	2	12	24
2	3	24	48	2	3	24	48
3	7	16	32	3	7	16	32
7	10	32	64	7	10	32	64
10	15	48	96	10	15	48	96
15	20	58	116	15	20	58	116
20	27	14	28	20	27	14	28
27	38	17	34	27	38	17	34
38	44	51	102	38	44	51	102
44	47	14	28	44	47	14	28
47	57	46	92	47	57	46	92
57	60	28	56	57	60	28	56
60	63	24	48	60	63	24	48
63	66	16	32	63	66	16	32
66	68	16	32	66	68	16	32
Total		416	832	Total		416	832

Route-segments with restrictions:		
Start node	End node	cargo restriction
2	4	dangerous goods cat A/B
2	5	all categories and oil/gas
2	6	dangerous goods cat C/D
12	17	cat A/B and oil/gas
17	22	dangerous goods cat C/D
36	42	all categories and oil/gas
63	65	dangerous goods cat A/B
66	68	oil/gas

**TESTCASE 1 6A:** Testing the shortest path algorithm with all sorts of restrictions

Sailing order:			
Ship's characteristics:		Mission characteristics	
Type of vessel	Navy vessel (frigate)	Start Route-point	1
Maximum speed	30	End Route-point	68
Draught	6	Via Route-point	-
UKC	2		
Cargo class	oil/gas		
Ice class	no		

Optimal Route: shortest distance				Optimal Route: shortest time			
Start node	End node	Distance	Time	Start node	End node	Distance	Time
1	2	12	24	1	2	12	24
2	4	21	180	2	3	24	48
4	7	16	32	3	7	16	32
7	10	32	64	7	10	32	64
10	15	48	96	10	15	48	96
15	16	6	12	15	16	6	12

16	17	6	12	16	17	6	12
17	22	49	98	17	22	49	98
22	27	9	18	22	27	9	18
27	38	17	34	27	38	17	34
38	44	51	102	38	44	51	102
44	47	14	28	44	47	14	28
47	57	46	92	47	57	46	92
57	60	28	56	57	60	28	56
60	63	24	120	60	61	7	14
63	65	15	30	61	63	25	50
65	68	17	34	63	65	15	30
				65	68	17	34
Total		411	1032	Total		422	844

Route-segments with restrictions:				
Start node	End node	depth (m)	Cargo	Sp. limit
2	4	-	dangerous goods cat A/B	7
2	5	-	all categories and oil/gas	-
2	6	-	dangerous goods cat C/D	12
12	17	-	cat A/B and oil/gas	-
17	22	-	dangerous goods cat C/D	-
36	42	-	all categories and oil/gas	-
63	65	-	dangerous goods cat A/B	-
66	68	-	oil/gas	-
59	63	-	-	7
60	63	-	-	12
63	66	-	-	7
5	7	5	-	-
61	62	5	-	-
58	59	5	-	-
64	68	5	-	-

**TESTCASE 1 6B:** Testing the shortest path algorithm with all sorts of restrictions

Sailing order:			
Ship's characteristics:		Mission characteristics	
Type of vessel	Navy vessel (frigate)	Start Route-point	1
Maximum speed	30	End Route-point	68
Draught	6	Via Route-point	-
UKC	2		
Cargo class	goods cat A-D		
Ice class	no		

Optimal Route: shortest distance				Optimal Route: shortest time			
Start node	End node	Distance	Time	Start node	End node	Distance	Time
1	2	12	24	1	2	12	24
2	3	24	48	2	3	24	48
3	7	16	32	3	7	16	32
7	10	32	64	7	10	32	64
10	15	48	96	10	15	48	96
15	20	58	116	15	20	58	116
20	27	14	28	20	27	14	28
27	38	17	34	27	38	17	34
38	44	51	102	38	44	51	102
44	47	14	28	44	47	14	28
47	57	46	92	47	57	46	92
57	60	28	56	57	60	28	56
60	63	24	120	60	61	7	14
63	66	16	137	61	63	25	50
66	68	16	32	63	67	17	34
				67	68	21	42
Total		416	1009	Total		430	860

Route-segments with restrictions:				
Start node	End node	depth (m)	Cargo	Sp. limit
2	4	-	dangerous goods cat A/B	7
2	5	-	all categories and oil/gas	-
2	6	-	dangerous goods cat C/D	12
12	17	-	cat A/B and oil/gas	-
17	22	-	dangerous goods cat C/D	-
36	42	-	all categories and oil/gas	-
63	65	-	dangerous goods cat A/B	-
66	68	-	oil/gas	-
59	63	-	-	7
60	63	-	-	12
63	66	-	-	7
5	7	5	-	-
61	62	5	-	-
58	59	5	-	-
64	68	5	-	-

**Appendix H: Test results of scenario 2**

**TESTCASE 2 1:** Testing the ranking algorithm on distance ranking only.

Sailing order:			
Ship's characteristics:		Mission characteristics	
Type of vessel	Navy vessel (frigate)	Start Route-point	1
Maximum speed	30	End Route-point	72
Draught	6	Via Route-point	-
UKC	2		
Cargo class	no		
Ice class	no		

Optimal Route: shortest distance					
Rank	Route	Distance	Time	g-value	Comments
1	1-2-4-7-8-13-69-71-72	168	336	1	Via inshore route
2	1-2-5-7-8-13-69-71-72	168	336	1	
3	1-2-3-7-8-13-69-71-72	171	342	0.91892	
4	1-2-6-7-8-13-69-71-72	172	344	0.89189	
5	1-2-4-7-9-14-13-69-71-72	172	344	0.89189	first via TSS
6	1-2-5-7-9-14-13-69-71-72	172	344	0.89189	
7	1-2-4-3-7-8-13-69-71-72	174	348	0.83784	
8	1-2-4-7-10-15-14-13-69-71-72	175	350	0.81081	first via DW
9	1-2-3-7-9-14-13-69-71-72	175	350	0.81081	
10	1-2-5-6-7-8-13-69-71-72	175	350	0.81081	
23	1-2-5-7-8-13-69-70-71-72	184	368	0.56757	first via 70
26	1-2-5-7-12-17-16-15-14-13-69-71-72	185	370	0.54054	first via outshore route
30	1-2-4-7-9-14-13-69-70-71-72	188	376	0.45946	first via TSS and 70
37	1-2-4-7-10-15-14-13-69-70-71-72	191	382	0.37838	first via DWR and 70
56	1-2-5-7-12-17-16-15-14-13-69-70-71-72	201	402	0.10811	first via outshore and 70

Route-segments with changes:		
Start node	End node	Changes

Weights:	
distance	1
time	0
tss	0
dwr	0
recom	0
itz	0
linkpref	0
navaids	0
fog	0
terror	0
ice	0
anchor.	0

**TESTCASE 2 2:** Testing the ranking algorithm with time only

Sailing order:			
Ship's characteristics:		Mission characteristics	
Type of vessel	Navy vessel (frigate)	Start Route-point	1
Maximum speed	30	End Route-point	72
Draught	6	Via Route-point	-
UKC	2		
Cargo class	no		
Ice class	no		

Optimal Route: shortest distance					
Rank	Route	Distance	Time	g-value	Comments
1	1-2-4-7-8-13-69-71-72	168	336	1	Via inshore route
2	1-2-5-7-8-13-69-71-72	168	336	1	
3	1-2-3-7-8-13-69-71-72	171	342	0.91892	
4	1-2-6-7-8-13-69-71-72	172	344	0.89189	
5	1-2-4-7-9-14-13-69-71-72	172	344	0.89189	first via TSS
6	1-2-5-7-9-14-13-69-71-72	172	344	0.89189	
7	1-2-4-3-7-8-13-69-71-72	174	348	0.83784	
8	1-2-4-7-10-15-14-13-69-71-72	175	350	0.81081	first via DW
9	1-2-3-7-9-14-13-69-71-72	175	350	0.81081	
10	1-2-5-6-7-8-13-69-71-72	175	350	0.81081	
23	1-2-5-7-8-13-69-70-71-72	184	368	0.56757	first via 70
26	1-2-5-7-12-17-16-15-14-13-69-71-72	185	370	0.54054	first via outshore route
30	1-2-4-7-9-14-13-69-70-71-72	188	376	0.45946	first via TSS and 70
37	1-2-4-7-10-15-14-13-69-70-71-72	191	382	0.37838	first via DWR and 70
56	1-2-5-7-12-17-16-15-14-13-69-70-71-72	201	402	0.10811	first via outshore and 70

Route-segments with changes:		
Start node	End node	Changes

Weights:	
distance	0
time	1
tss	0

dwr	0
recom	0
itz	0
linkpref	0
navaids	0
fog	0
terror	0
ice	0
anchor.	0

**TESTCASE 2.3:** Testing the ranking algorithm with four routes and TSS and DWR

<b>Sailing order:</b>			
Ship's characteristics:		Mission characteristics	
Type of vessel	Navy vessel (frigate)	Start Route-point	1
Maximum speed	30	End Route-point	72
Draught	6	Via Route-point	-
UKC	2		
Cargo class	no		
Ice class	no		

<b>Optimal Route: shortest distance</b>					
Rank	Route	Distance	Time	g-value	Comments
1	1-2-4-7-9-14-13-69-71-72	172	344	0.99777	Via TSS
2	1-2-4-7-8-13-69-71-72	168	336	0.50518	Via inshore route
3	1-2-4-7-12-17-16-15-14-13-69-71-72	185	370	0.50513	Via outshore route
4	1-2-4-7-10-15-14-13-69-71-72	175	350	0.00556	Via DWR

<b>Route-segments with changes:</b>		
Start node	End node	Changes

<b>Weights:</b>	
distance	0.5
time	0
tss	0.25
dwr	0.25
recom	0
itz	0
linkpref	0
navaids	0
fog	0
terror	0
ice	0
anchor.	0

**TESTCASE 2.4:** Testing the ranking algorithm with eight routes and TSS and DWR

<b>Sailing order:</b>			
Ship's characteristics:		Mission characteristics	
Type of vessel	Navy vessel (frigate)	Start Route-point	1
Maximum speed	30	End Route-point	72
Draught	6	Via Route-point	-
UKC	2		
Cargo class	no		
Ice class	no		

<b>Optimal Route: shortest distance</b>					
Rank	Route	Distance	Time	g-value	Comments
1	1-2-4-7-9-14-13-69-71-72	172	344	0.99788	Via TSS
2	1-2-3-4-7-9-14-13-69-71-72	181	362	0.99314	Via TSS
3	1-2-4-7-8-13-69-71-72	168	336	0.5052	Via inshore route
4	1-2-3-4-7-8-13-69-71-72	177	354	0.50517	Via inshore route
5	1-2-4-7-12-17-16-15-14-13-69-71-72	185	370	0.50514	Via outshore route
6	1-2-3-4-7-12-17-16-15-14-13-69-71-72	194	388	0.50511	Via outshore route
7	1-2-4-7-10-15-14-13-69-71-72	175	350	0.0999	Via DWR
8	1-2-3-4-7-10-15-14-13-69-71-72	184	368	0.00528	Via DWR

<b>Route-segments with changes:</b>		
Start node	End node	Changes

<b>Weights:</b>	
distance	0.5
time	0
tss	0.25
dwr	0.25
recom	0
itz	0
linkpref	0
navaids	0
fog	0
terror	0
ice	0
anchor.	0

**TESTCASE 2.5:** Testing the ranking algorithm with all routes and TSS and DWR

Sailing order:			
Ship's characteristics:		Mission characteristics	
Type of vessel	Navy vessel (frigate)	Start Route-point	1
Maximum speed	30	End Route-point	72
Draught	6	Via Route-point	-
UKC	2		
Cargo class	no		
Ice class	no		

Optimal Route: shortest distance					
Rank	Route	Distance	Time	g-value	Comments
1	1-2-4-7-9-14-13-69-71-72	172	344	0.99791	Via TSS
2	1-2-5-7-9-14-13-69-71-72	172	344	0.99791	Via TSS
3	1-2-3-7-9-14-13-69-71-72	175	350	0.99635	Via TSS
4	1-2-6-7-9-14-13-69-71-72	176	352	0.99583	Via TSS
5	1-2-4-3-7-9-14-13-69-71-72	178	356	0.99479	Via TSS
9	1-2-5-7-9-14-13-69-70-71-72	188	376	0.98963	first via TSS and 70
17	1-2-5-7-8-13-69-71-72	168	336	0.50525	first via inshore
25	1-2-4-7-8-13-69-70-71-72	184	368	0.50517	first via inshore and 70
27	1-2-4-7-12-17-16-15-14-13-69-71-72	185	370	0.50516	first via outshore
41	1-2-5-7-12-17-16-15-14-13-69-70-71-72	201	402	0.50508	first via outshore and 70
45	1-2-4-7-10-15-14-13-69-71-72	175	350	0.01547	first via dwr
53	1-2-4-7-10-15-14-13-69-70-71-72	191	382	0.00726	first via dwr and 70

Route-segments with changes:		
Start node	End node	Changes

Weights:	
distance	0.5
time	0
tss	0.25
dwr	0.25
recom	0
itz	0
linkpref	0
navaids	0
fog	0
terror	0
ice	0
anchor.	0

**TESTCASE 2.6:** Testing the ranking algorithm with TSS, DWR and linkpreference

Sailing order:			
Ship's characteristics:		Mission characteristics	
Type of vessel	Navy vessel (frigate)	Start Route-point	1
Maximum speed	30	End Route-point	72
Draught	6	Via Route-point	-
UKC	2		
Cargo class	no		
Ice class	no		

Optimal Route: shortest distance					
Rank	Route	Distance	Time	g-value	Comments
1	1-2-6-7-9-14-13-69-70-71-72	192	384	0.99103	TSS
2	1-2-5-7-9-14-13-69-70-71-72	188	376	0.9903	TSS
3	1-2-6-5-7-9-14-13-69-70-71-72	199	398	0.96131	TSS + best LP
4	1-2-4-7-9-14-13-69-70-71-72	188	376	0.93005	TSS
5	1-2-6-7-9-14-13-69-71-72	176	352	0.92249	TSS first not via 70
6	1-2-5-7-9-14-13-69-71-72	172	344	0.91699	TSS
17	1-2-6-7-8-13-69-70-71-72	188	376	0.5376	first inshore route
18	1-2-6-7-12-17-16-15-14-13-69-70-71-72	205	410	0.53755	first outshore route
19	1-2-5-7-8-13-69-70-71-72	184	368	0.53663	inshore route
20	1-2-5-7-12-17-16-15-14-13-69-70-71-72	201	402	0.53658	outshore route
24	1-2-6-7-8-13-69-71-72	172	344	0.52375	inshore not via 70
25	1-2-6-7-12-17-16-15-14-13-69-71-72	189	378	0.5237	outshore not via 70
45	1-2-6-7-10-15-14-13-69-70-71-72	195	390	0.28029	first DWR
49	1-2-6-7-10-15-14-13-69-71-72	179	358	0.23122	DWR not via 70

Route-segments with changes:		
Start node	End node	width/obsta/aids/fairmark
1	2	0,4 / 1 / 4 / good
2	3	0,7 / 0 / 0 / good
2	5	0,7 / 1 / 4 / none
2	4	0,2 / 3 / 3 / good
2	6	0,7 / 0 / 7 / good
3	4	0,2 / 1 / 2 / poor
3	7	0,4 / 1 / 3 / poor
4	7	0,4 / 1 / 3 / good

Weights:	
distance	0.34
time	0
tss	0.22
dwr	0.22
recom	0
itz	0
linkpref	0.22
navaids	0
fog	0

5	7	0,4 / 0 / 7 / poor
5	6	0,7 / 1 / 5 / good
6	7	0,2 / 2 / 6 / poor

terror	0
ice	0
anchor.	0

**TESTCASE 2 7:** Testing the ranking algorithm with with TSS, DWR, linkpreference and ITZ

Sailing order:	
Ship's characteristics:	
Type of vessel	Navy vessel (frigate)
Maximum speed	30
Draught	6
UKC	2
Cargo class	no
Ice class	no
Mission characteristics	
Start Route-point	1
End Route-point	72
Via Route-point	-

Optimal Route: shortest distance					
Rank	Route	Distance	Time	g-value	Comments
1	1-2-6-7-9-14-13-69-70-71-72	192	384	0.98988	TSS
2	1-2-5-7-9-14-13-69-70-71-72	188	376	0.9898	TSS
3	1-2-6-5-7-9-14-13-69-70-71-72	199	398	0.96337	TSS
17	1-2-6-7-12-17-16-15-14-13-69-70-71-72	205	410	0.51078	outshore route!!
18	1-2-5-7-12-17-16-15-14-13-69-70-71-72	201	402	0.5098	outshore route
20	1-2-6-7-12-17-16-15-14-13-69-71-72	189	378	0.49738	outshore route
19	1-2-6-7-8-13-69-70-71-72	188	376	0.49714	first inshore route!!
45	1-2-6-7-10-15-14-13-69-70-71-72	195	390	0.36807	first dwr

Route-segments with changes:		
Start node	End node	Routeing
8	13	Inshore traffic zone
12	17	Inshore traffic zone

Weights:	
distance	0.34
time	0
tss	0.17
dwr	0.17
recom	0
itz	0.17
linkpref	0.17
navaids	0
fog	0
terror	0
ice	0
anchor.	0

**TESTCASE 2 8:** Testing the ranking algorithm with TSS, DWR, LP, ITZ and recommended routes

Sailing order:	
Ship's characteristics:	
Type of vessel	Navy vessel (frigate)
Maximum speed	30
Draught	6
UKC	2
Cargo class	no
Ice class	no
Mission characteristics	
Start Route-point	1
End Route-point	72
Via Route-point	-

Optimal Route: shortest distance					
Rank	Route	Distance	Time	g-value	Comments
1	1-2-6-7-14-13-69-70-71-72	192	384	0.76768	TSS
2	1-2-5-7-9-14-13-69-70-71-72	188	376	0.76736	TSS
3	1-2-6-5-7-9-14-13-69-70-71-72	199	398	0.76455	TSS
17	1-2-6-7-12-17-16-15-14-13-69-70-71-72	205	410	0.50179	first outshore route
20	1-2-6-7-8-13-69-70-71-72	188	376	0.49041	first inshore route
27	1-2-6-7-10-15-14-13-69-70-71-72	195	390	0.46695	first DWR!!!!
28	1-2-5-7-10-15-14-13-69-70-71-72	191	382	0.46612	DWR
33	1-2-3-4-7-8-13-69-70-71-72	193	386	0.45086	next other than DWR

Route-segments with changes:		
Start node	End node	Routeing
7	10	recommended route

Weights:	
distance	0.2
time	0.25
tss	0.11
dwr	0.11
recom	0.11
itz	0.11
linkpref	0.11
navaids	0
fog	0
terror	0
ice	0
anchor.	0

**TESTCASE 2 9:** Testing the ranking algorithm with speed limits and extended area

Sailing order:			
Ship's characteristics:		Mission characteristics	
Type of vessel	Navy vessel (frigate)	Start Route-point	68
Maximum speed	30	End Route-point	72
Draught	6	Via Route-point	-
UKC	2		
Cargo class	no		
Ice class	no		

Optimal Route: shortest distance					
Rank	Route	Distance	Time	g-value	Comments
1	68-65-63-1-2-6-7-9-14-13-69-70-71-72	272	544	0.77195	avoid speed limits
2	68-64-63-1-2-6-7-9-14-13-69-70-71-72	277	554	0.77194	avoid speed limits
3	68-67-63-1-2-6-7-9-14-13-69-70-71-72	278	556	0.77194	avoid speed limits
4	68-65-64-63-1-2-6-7-9-14-13-69-70-71-72	279	558	0.77193	avoid speed limits
5	68-64-65-63-1-2-6-7-9-14-13-69-70-71-72	282	564	0.77192	avoid speed limits
6	68-67-66-63-1-2-6-7-9-14-13-69-70-71-72	283	566	0.77192	avoid speed limits
7	68-66-63-1-2-6-7-9-14-13-69-70-71-72	272	704	0.77185	first with speed limit
8	68-66-67-63-1-2-6-7-9-14-13-69-70-71-72	279	718	0.77182	with speed limit

Route-segments with changes:		
Start node	End node	Class/ trafreg/ aids/ S-L
1	63	ocean/ two-way/ 1/ no
66	68	coast/ two-way/ 4/ 5
63	67	coast/ two-way/ 4/ no
63	64	coast/ two-way/ 4/ no
63	65	coast/ two-way/ 4/ no
63	66	coast/ two-way/ 4/ no
64	65	coast/ two-way/ 4/ no
66	67	coast/ two-way/ 4/ no
64	68	coast/ two-way/ 4/ no
65	68	coast/ two-way/ 4/ no
67	68	coast/ two-way/ 4/ no

Weights:	
distance	0.2
time	0.25
tss	0.11
dwr	0.11
recom	0.11
itz	0.11
linkpref	0.11
navaids	0
fog	0
terror	0
ice	0
anchor.	0

**TESTCASE 2\_10:** Testing the ranking algorithm with small area and navaids

Sailing order:			
Ship's characteristics:		Mission characteristics	
Type of vessel	Navy vessel (frigate)	Start Route-point	68
Maximum speed	30	End Route-point	1
Draught	6	Via Route-point	-
UKC	2		
Cargo class	no		
Ice class	no		

Optimal Route: shortest distance					
Rank	Route	Distance	Time	g-value	Comments
1	68-65-63-1	80	160	1	
2	68-67-63-1	86	172	0.98213	
3	68-65-64-63-1	87	174	0.97922	
4	68-67-66-63-1	91	182	0.96771	
5	68-66-63-1	80	320	0.92143	speed limit
6	68-66-67-63-1	87	334	0.91333	speed limit
7	68-64-63-1	85	170	0.0818	navaids = 0
8	68-64-65-63-1	90	180	0.07589	navaids = 0

Route-segments with changes:		
Start node	End node	navaids
64	68	0

Weights:	
distance	0.2
time	0.25
tss	0.1
dwr	0.1
recom	0.1
itz	0.1
linkpref	0.1
navaids	0.05
fog	0
terror	0
ice	0
anchor.	0

**TESTCASE 2\_11A:** Testing the ranking algorithm with whole area and navaids

Sailing order:			
Ship's characteristics:		Mission characteristics	
Type of vessel	Navy vessel (frigate)	Start Route-point	68
Maximum speed	30	End Route-point	72
Draught	6	Via Route-point	-
UKC	2		



Cargo class	no
Ice class	no

Optimal Route: shortest distance					
Rank	Route	Distance	Time	g-value	Comments
1	68-65-63-1-2-6-7-9-14-13-69-70-71-72	272	544	0.99659	
2	68-65-63-1-2-5-7-9-14-13-69-70-71-72	268	536	0.99638	
3	68-64-63-1-2-6-7-9-14-13-69-70-71-72	277	554	0.99588	navaids=4, 11B=0!!
4	68-64-63-1-2-5-7-9-14-13-69-70-71-72	273	546	0.9958	
13	68-66-63-1-2-5-7-9-14-13-69-70-71-72	268	696	0.99252	speed limit (66-68)=5

Route-segments with changes:		
Start node	End node	Navais
64	68	4

Weights:	
distance	0.2
time	0.25
tss	0.1
dwr	0.1
recom	0.1
itz	0.1
linkpref	0.1
navais	0.05
fog	0
terror	0
ice	0
anchor.	0

**TESTCASE 2\_11B:** Testing the ranking algorithm with whole area and navais

Sailing order:			
Ship's characteristics:		Mission characteristics	
Type of vessel	Navy vessel (frigate)	Start Route-point	68
Maximum speed	30	End Route-point	72
Draught	6	Via Route-point	-
UKC	2		
Cargo class	no		
Ice class	no		

Optimal Route: shortest distance					
Rank	Route	Distance	Time	g-value	Comments
1	68-65-63-1-2-6-7-9-14-13-69-70-71-72	272	544	0.99652	
2	68-65-63-1-2-5-7-9-14-13-69-70-71-72	268	536	0.9963	
9	68-66-63-1-2-5-7-9-14-13-69-70-71-72	268	696	0.99236	Speed limit
10	68-66-63-1-2-6-7-9-14-13-69-70-71-72	272	704	0.99227	Speed limit
37	68-64-63-1-2-6-7-9-14-13-69-70-71-72	277	554	0.85675	Navais=0
38	68-64-65-63-1-2-6-7-9-14-13-69-70-71-72	282	564	0.85674	Navais=0

Route-segments with changes:		
Start node	End node	Navais
64	68	0

Weights:	
distance	0.2
time	0.25
tss	0.1
dwr	0.1
recom	0.1
itz	0.1
linkpref	0.1
navais	0.05
fog	0
terror	0
ice	0
anchor.	0

**TESTCASE 2\_12A:** Testing the ranking algorithm with fog and piracy

Sailing order:			
Ship's characteristics:		Mission characteristics	
Type of vessel	Navy vessel (frigate)	Start Route-point	68
Maximum speed	30	End Route-point	72
Draught	6	Via Route-point	-
UKC	2		
Cargo class	no		
Ice class	no		

Optimal Route: shortest distance					
Rank	Route	Distance	Time	g-value	Comments
1	68-65-63-1-2-6-7-9-14-13-69-70-71-72	272	544	0.99618	piracy=0 (12B=1)
2	68-65-63-1-2-5-7-9-14-13-69-70-71-72	268	536	0.99609	fog=0 (12B=5)
13	68-65-63-1-2-6-5-7-9-14-13-69-70-71-72	279	558	0.97864	High score on Linkpref
14	68-67-63-1-2-6-5-7-9-14-13-69-70-71-72	285	570	0.97643	High score on Linkpref

Route-segments with changes:		
Start node	End node	Changes

Weights:	
distance	0.2

time	0.25
tss	0.09
dwr	0.09
recom	0.09
itz	0.09
linkpref	0.09
nav aids	0.05
fog	0.03
terror	0.02
ice	0
anchor.	0

**TESTCASE 2. 12B:** Testing the ranking algorithm with fog and piracy

<b>Sailing order:</b>			
Ship's characteristics:		Mission characteristics	
Type of vessel	Navy vessel (frigate)	Start Route-point	68
Maximum speed	30	End Route-point	72
Draught	6	Via Route-point	-
UKC	2		
Cargo class	no		
Ice class	no		

<b>Optimal Route: shortest distance</b>					
Rank	Route	Distance	Time	g-value	Comments
1	68-65-63-1-2-6-5-7-9-14-13-69-70-71-72	279	558	0.99556	linkpref high!
2	68-67-63-1-2-6-5-7-9-14-13-69-70-71-72	285	570	0.99551	linkpref high!
7	68-65-63-1-2-5-7-9-14-13-69-70-71-72	268	536	0.99437	fog!
366	68-64-65-63-1-2-3-4-7-10-15-14-13-69-71-72	274	548	0.84432	DWRI!?
367	68-65-63-1-2-6-7-9-14-13-69-70-71-72	272	544	0.15909	piracy!!!???

<b>Route-segments with changes:</b>		
Start node	End node	Fog/ Piracy
2	5	5 / 0
6	7	0 / 1

<b>Weights:</b>	
distance	0.2
time	0.25
tss	0.09
dwr	0.09
recom	0.09
itz	0.09
linkpref	0.09
nav aids	0.05
fog	0.03
terror	0.02
ice	0
anchor.	0



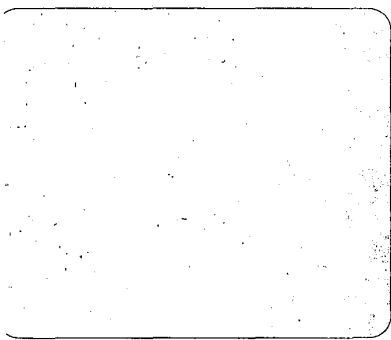

UNIVERSITY  
LIBRARY  
NOTTINGHAM

00000nem^a22^.....a^4500  
 001 000687907  
 005 20120426100937.0  
 000 991104s2002^.....enks^.....000^0^eng^d  
 040 a UKRTU  
 c UKRTU  
 049 2  
 100 1 a Jong, Wichert J. de.  
 245 10 a Automated route planning :  
 a network-based route planning solution for marine navigation /  
 c Wichert J. de Jong.  
 260 c 2002.  
 300 1 v. 115 leaves :  
 b maps :  
 c 31 cm.  
 504 c Includes bibliographical references (leaves 97-102).  
 502 a Dissertation (M.Sc. (Navigation Technology))--University of Nottingham, 2002.  
 599 a Suppressed

List of Catalogers

Catalogger	Level	Date	Hour
	01	06/08/02	08:15
	01	06/08/02	08:24
	01	26/04/13	10:00

Close Help

This is Exhibit 'B'  
 referred to in the declaration  
 of Christine Middleton  
 declared this 12<sup>th</sup> December  
 2016 before me

*Richard Brian Hammond*

Richard Brian Hammond  
 Notary Public  
 England and Wales  
 2 Kayes Walk  
 Nottingham  
 NG1 1PZ