

1c903 U.S. PTO  
09/756647  
01/04/01

377	24.2	Class	Subclass	ISSUE CLASSIFICATION
-----	------	-------	----------	----------------------

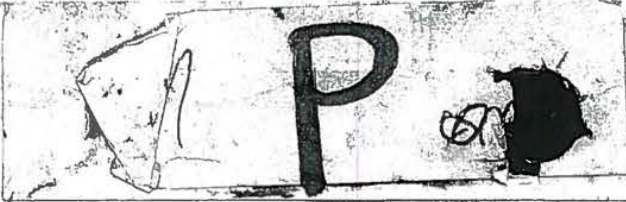

PATENT NUMBER  
**6434212**  
6434212

U.S. UTILITY Patent Application

O.I.P.E. PATENT DATE  
 M4 SCANNED 043 Q.A. AA AUG 18 2002

APPLICATION NO.	CONT/PRIOR	CLASS	SUBCLASS	ART UNIT	EXAMINER
09/756647	D	377	24.2	2816	Wambach

APPLICANTS: Nathan Pyles  
 TITLE: Pedometer  
 Mcopy of 09/181,738 (Margaret) 12/738

PTO-2040  
12/99

ISSUING CLASSIFICATION			
ORIGINAL		CROSS REFERENCE(S)	
CLASS	SUBCLASS	CLASS	SUBCLASS (ONE SUBCLASS PER BLOCK)
377	24.2		
INTERNATIONAL CLASSIFICATION			
G01C	21/00	NONE	

Continued on Issue Slip Inside File Jacket

7-12-02 Formal Drawings (1 shts) set 1-4-01

<input type="checkbox"/> <b>TERMINAL DISCLAIMER</b>	<b>DRAWINGS</b>			<b>CLAIMS ALLOWED</b>	
	Sheets Drwg. 1	Figs. Drwg. 1	Print Fig. 1	Total Claims 8	Print Claim for O.G. 1
<input type="checkbox"/> The term of this patent subsequent to _____ (date) has been disclaimed.	<del>_____ (Assistant Examiner) _____ (Date)</del>			<b>NOTICE OF ALLOWANCE MAILED</b> 3/19/02	
<input type="checkbox"/> The term of this patent shall not extend beyond the expiration date of U.S. Patent. No. _____	Margaret R. Wambach Primary Examiner  M. Wambach 3/17/02 (Primary Examiner) (Date)			<b>ISSUE FEE</b> Amount Due: 1280 Date Paid: 6.17.02	
<input type="checkbox"/> The terminal _____ months of this patent have been disclaimed.	<del>_____ (Legal Instruments Examiner) _____ (Date)</del>			<b>ISSUE BATCH NUMBER</b> 32202	

**WARNING:**  
The information disclosed herein may be restricted. Unauthorized disclosure may be prohibited by the United States Code Title 35, Sections 122, 181 and 368. Possession outside the U.S. Patent & Trademark Office is restricted to authorized employees and contractors only.

Form PTO-436A (Rev. 8/99)

FILED WITH:  DISK (CRF)  FICHE  CD-ROM  
(Attached in pocket on right inside flap)

Issue Fee

(FACE)

PATENT APPLICATION



09756647

09/03 U.S. PTO

09/756647



01/04/01

INITIALS

*vef*

CONTENTS

Date Received  
(Incl. C. of M.)  
or  
Date Mailed

Date Received  
(Incl. C. of M.)  
or  
Date Mailed

1. Application \_\_\_\_\_ papers.

2. LTR. Re. Dec. y B. Fee Mass.

02/15/01

42.

3. Dec. Fee

04/16/01

43.

4. LTR

07/1-01

44.

5. Reg. (3 months)

11-13-01

45.

6. PDS

1/15/02

46.

7. Amended

1/13/02

47.

8. PTO 37 Reason of Allow

3/19/02

48.

9. PTO 37

3/29/02

49.

10. 10-02 Small Entity

6-17-02

50.

11.

51.

12.

52.

13.

53.

14.

54.

15.

55.

16.

56.

17.

57.

18.

58.

19.

59.

20.

60.

21.

61.

22.

62.

23.

63.

24.

64.

25.

65.

26.

66.

27.

67.

28.

68.

29.

69.

30.

70.

31.

71.

32.

72.

33.

73.

34.

74.

35.

75.

36.

76.

37.

77.

38.

78.

39.

79.

40.

80.

41.

81.

82.

(LEFT OUTSIDE)



### SEARCHED

Class	Sub.	Date	Exmr.
377	24.2	11/8/01	M/W
update		3/10/02	M/W

### SEARCH NOTES (INCLUDING SEARCH STRATEGY)

	Date	Exmr.
EAST completed	3/17/02	M/W

### INTERFERENCE SEARCHED

Class	Sub.	Date	Exmr.
377	24.2	3/10/02	M/W

(RIGHT OUTSIDE)

O.C.  
2/21  
AG

ISSUE SLIP STAPLE AREA (for additional cross references)

POSITION	INITIALS	N.O.	DATE
FEE DETERMINATION			
O.I.P.E. CLASSIFIER			
FORMALITY REVIEW	A.S	943	1-31-1
RESPONSE FORMALITY REVIEW	Request	925	05-31-01

INDEX OF CLAIMS

- ✓ ..... Rejected
- = ..... Allowed
- (Through numeral)... Canceled
- ÷ ..... Restricted
- N ..... Non-elected
- I ..... Interference
- A ..... Appeal
- O ..... Objected

Claim	Date
1	1/18/01
2	3/10/02
3	
4	
5	
6	
7	
8	
9	
10	
11	
12	
13	
14	
15	
16	
17	
18	
19	
20	
21	
22	
23	
24	
25	
26	
27	
28	
29	
30	
31	
32	
33	
34	
35	
36	
37	
38	
39	
40	
41	
42	
43	
44	
45	
46	
47	
48	
49	
50	

Claim	Date
51	
52	
53	
54	
55	
56	
57	
58	
59	
60	
61	
62	
63	
64	
65	
66	
67	
68	
69	
70	
71	
72	
73	
74	
75	
76	
77	
78	
79	
80	
81	
82	
83	
84	
85	
86	
87	
88	
89	
90	
91	
92	
93	
94	
95	
96	
97	
98	
99	
100	

Claim	Date
101	
102	
103	
104	
105	
106	
107	
108	
109	
110	
111	
112	
113	
114	
115	
116	
117	
118	
119	
120	
121	
122	
123	
124	
125	
126	
127	
128	
129	
130	
131	
132	
133	
134	
135	
136	
137	
138	
139	
140	
141	
142	
143	
144	
145	
146	
147	
148	
149	
150	

If more than 150 claims or 10 actions  
staple additional sheet here

(LEFT INSIDE)

## CLASSIFICATION NOTES

Examiner/ Classifier	Class	Date	Initials



UNITED STATES PATENT AND TRADEMARK OFFICE

**FILE COPY**

COMMISSIONER FOR PATENTS  
 UNITED STATES PATENT AND TRADEMARK OFFICE  
 WASHINGTON, D.C. 20231  
 www.uspto.gov



Bib Data Sheet

CONFIRMATION NO. 7058

<b>SERIAL NUMBER</b> 09/756,647	<b>FILING DATE</b> 01/04/2001 <b>RULE</b>	<b>CLASS</b> 377	<b>GROUP ART UNIT</b> 2816	<b>ATTORNEY DOCKET NO.</b> KNOWMO-6
<b>APPLICANTS</b> Nathan Pyles, Lake Mills, WI;				
** CONTINUING DATA ***** THIS APPLICATION IS A CON OF 09/181,738 10/28/1998 PAT 6,175,608 <i>yes MRW 3/17/02</i>				
** FOREIGN APPLICATIONS ***** <i>no MRW 3/17/02</i>				
IF REQUIRED, FOREIGN FILING LICENSE GRANTED ** SMALL ENTITY ** ** 01/31/2001				
Foreign Priority claimed <input type="checkbox"/> yes <input checked="" type="checkbox"/> no	35 USC 119 (a-d) conditions met <input type="checkbox"/> yes <input checked="" type="checkbox"/> no <input type="checkbox"/> Met after Allowance	<b>STATE OR COUNTRY</b> WI	<b>SHEETS DRAWING</b> 1	<b>TOTAL CLAIMS</b> 9
Verified and Acknowledged <i>[Signature]</i> Examiner's Signature	Initials		<b>INDEPENDENT CLAIMS</b> 2	
<b>ADDRESS</b> 020455				
<b>TITLE</b> Pedometer				
<b>FILING FEE RECEIVED</b> 420	FEES: Authority has been given in Paper No. _____ to charge/credit DEPOSIT ACCOUNT No. _____ for following:		<input type="checkbox"/> All Fees <input type="checkbox"/> 1.16 Fees ( Filing ) <input type="checkbox"/> 1.17 Fees ( Processing Ext. of time ) <input type="checkbox"/> 1.18 Fees ( Issue ) <input type="checkbox"/> Other _____ <input type="checkbox"/> Credit	

Please type a plus sign (+) inside this box

+

01-05-01

PTO/SB/05 (12/97)

Patent and Trademark Office: U.S. DEPARTMENT OF COMMERCE

Under the Paperwork Reduction Act of 1995, no persons are required to respond to a collection of information unless it displays a valid OMB control number

13984 U.S. PTO  
01/04/01

<b>UTILITY PATENT APPLICATION TRANSMITTAL</b>		Attorney Docket No.	KNOWMO - 6	Total Pages	
(Only for new nonprovisional applications under 37 CFR 1.53(b))		First Named Inventor or Application Identifier			
		Nathan Pyles			
		Express Mail Label No.	EL281944856US		
APPLICATION ELEMENTS			ADDRESS TO:		
See MPEP chapter 600 concerning utility patent application contents.			Assistant Commissioner for Patents Box Patent Application Washington, DC 20231		
1.	<input type="checkbox"/> Fee Transmittal Form (submit an original, and a duplicate for fee processing)	6.	<input type="checkbox"/> Microfiche Computer Program (Appendix)		
2.	<input checked="" type="checkbox"/> Specification [Total Pages 13] (preferred arrangement set forth below)	7.	<input type="checkbox"/> Nucleotide and/or Amino Acid Sequence Submission (if applicable, all necessary)		
	- Descriptive title of the Invention	a.	<input type="checkbox"/> Computer Readable Copy		
	- Cross References to Related Applications	b.	<input type="checkbox"/> Paper Copy (identical to computer copy)		
	- Statement Regarding Fed sponsored R&D	c.	<input type="checkbox"/> Statement verifying identity of above copies		
	- Reference to Microfiche Appendix	ACCOMPANYING APPLICATION PARTS			
	- Background of the Invention	8.	<input type="checkbox"/> Assignment Papers (cover sheet & document(s))		
	- Brief Summary of the Invention	9.	<input type="checkbox"/> 37 CFR 3.73(b) Statement (when there is an assignee)	<input type="checkbox"/> Power of Attorney	
	- Brief Description of the Drawings (if filed)	10.	<input type="checkbox"/> English Translation Document (if applicable)		
	- Detailed Description	11.	<input type="checkbox"/> Information Disclosure Statement (IDS)/PTO-1449	<input type="checkbox"/> Copies of IDS Citations	
	- Claim(s)	12.	<input type="checkbox"/> Preliminary Amendment		
	- Abstract of the Disclosure	13.	<input checked="" type="checkbox"/> Return Receipt Postcard (MPEP 503) (Should be specifically itemized)		
3.	<input checked="" type="checkbox"/> Drawing(s) (356 USC 113) [Total Sheets 1]	14.	<input type="checkbox"/> Small Entity Statement(s)	<input type="checkbox"/> Statement filed in prior application, Status still proper and desired	
4.	<input type="checkbox"/> Oath or Declaration [Total Pages ]	15.	<input type="checkbox"/> Certified Copy of Priority Document(s) (if foreign priority is claimed)		
	a. <input type="checkbox"/> Newly executed (original or copy)	16.	<input type="checkbox"/> Other: _____		
	b. <input type="checkbox"/> Copy from a prior application (37 CFR 1.63(d)) (for continuation/divisional with Box 17 completed) [Note Box 5 below]				
	i. <input type="checkbox"/> <b>DELETION OF INVENTOR(S)</b> Signed statement attached deleting inventor(s) named in the prior application, see 37 CFR 1.63(d)(2) and 1.33(b).				
5.	<input type="checkbox"/> Incorporation By Reference (useable if Box 4b is checked). The entire disclosure of the prior application, from which a copy of the oath or declaration is supplied under Box 4b, is considered as being part of the disclosure of the accompanying application and is hereby incorporated by reference therein.				
17. If a CONTINUING APPLICATION, check appropriate box and supply the requisite information:					
<input checked="" type="checkbox"/> Continuation <input type="checkbox"/> Divisional <input type="checkbox"/> Continuation-in-part (CIP) of prior application No.: 09/181,738					
18. CORRESPONDENCE ADDRESS					
<input checked="" type="checkbox"/> Customer Number or Bar Code Label		020,455 (Insert Customer No. or Attach bar code label here)		or <input type="checkbox"/> Correspondence address below	
Name					
Address					
City	State	Zip Code			
Country	Telephone	Fax			

PATENT APPLICATION  
IN THE UNITED STATES PATENT AND TRADEMARK OFFICE

Applicant: Nathan Pyles

For: PEDOMETER

Docket No.: KNOWMO-6

BOX PATENT APPLICATION  
Assistant Commissioner for Patents  
Washington, D.C. 20231

"Express Mail" Mailing Label No.: EL281944856US  
Date of Deposit: January 4, 2001

I hereby certify that these attached documents

- Response postcard
- PTO/SB 05 (1p)
- Specification, Claims and Formal Drawing (14 pp)

are being deposited with the United States Postal Service "Express Mail Post Office to Addressee" service under 35 C.F.R. §1.10 on the date indicated above and is addressed to the Assistant Commissioner for Patents, Washington, D.C. 20231.

  
\_\_\_\_\_  
(Jeffrey W. Smith, Reg. No. 33455)

Enclosed for filing please find the above-referenced new patent application. Please indicate receipt of this application by returning the attached postcard with the official Patent and Trademark Office receipt and serial number stamped thereon.

Respectfully submitted,

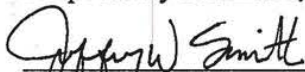
  
\_\_\_\_\_  
Jeffrey W. Smith, Reg. No. 33455  
Attorney for Applicant  
Lathrop & Clark LLP  
P.O. Box 1507  
Madison, Wisconsin 53701-1507  
(608) 257-7766

exprmail.app





09/156647

**ABSTRACT OF THE DISCLOSURE**

The pedometer having improved accuracy by calculating actual stride lengths of a user based on relative stride rates. The pedometer includes a waist or leg mounted stride counter, a transmitter for transmitting data to a wrist-mounted display unit, and a data processor for calculating necessary base units and actual stride rates and lengths. The pedometer can also interact with a heart monitoring device.

5

The undersigned hereby certifies that this document is being deposited with the United States Postal Service today Jan 4, 2001, by the "Express Mail" service, utilizing express mail number EL281944856US addressed to: Assistant Commissioner for Patents, Washington, D.C. 20231

JEFFRY W. SMITH  
Name of Person signing  
Jeffrey W. Smith  
Signature of Person mailing this document

## PEDOMETER

This application is a continuation of Application No. 09/181,738, filed October 28, 1998, the disclosure of which is incorporated by reference herein.  
*now US patent no. 6,175,608*

5

### FIELD AND BACKGROUND OF THE INVENTION

The present invention relates generally to pedometers having a waist mounted stride-counting device and transmitter, and a wrist-mounted receiver and display. The invention also relates to a distance calculation device that calculates a distance walked or run based on an algorithm that converts a base stride length and a base stride rate to an actual stride length for use in calculating the distance traveled.

10

Pedometers are known which include devices or algorithms for determining the distance a person travels on foot. For example, U.S. Patent 4,371,945 discloses an electronic pedometer that calculates distance by electronically measuring the length of each stride taken by a user. Stride length is measured by ultrasonic waves generated by an ultrasonic module strapped to one leg and an ultrasonic detector worn on the other leg. A program compensates for a variety of measurement errors and the results are displayed on

15

a wrist-mounted display after being transmitted by VHF waves from the leg to the wrist.

U.S. Patent 4,771,394 discloses a computer shoe with a heel-mounted electronic device with an inertia footstrike counter, a timer, a sound generating device, a battery, and a gate array for counting time and footstrikes to calculate distance and running time as a function of stride time. Although recognizing the important relationship of stride length and foot speed, the shoe in this patent requires data from at least 15 test runs or walks and the data must be user-entered in pairs of footstrikes and elapsed time to cover a pre-determined distance. Further, user adjustments of time must be performed to accommodate start and stop times, and the number of counted footstrikes is increased one percent to overcome inherent errors in the inertia step counter. The shoe-mounted device is subject to damage from impact, dirt, and water, and requires a stay-at-home computer with which to interface. There is no means disclosed to transmit data to a wrist-mounted display device or an "on-board" computing device that provides "real time" data to a runner.

U.S. Patent 4,855,942 discloses a pedometer and calorie measuring device that includes a wrist-mounted step counter and a fixed stride length to calculate distance traveled. Wrist-mounted step counters are known to be inaccurate because they assume a step for every arm movement. Even with error correction, such a device will provide less accurate step counts than a leg or waist-mounted counter. Further, fixed stride lengths do not take into account the fact that stride length varies with rate of movement.

U.S. Patent 5,117,444 discloses a pedometer and calibration method with two calibration modes. First, a user travels a predetermined "half-distance" for the device to count and store the number of strides in that distance. Next, the user travels a second distance with the step counter comparing actual steps to the steps in memory and a current trip memory are incremented by a tenth of a "whole unit" distance. There is no correlation between stride length and stride rate which requires the user to re-calibrate the device when walking as opposed to running.

U.S. Patent 5,475,725 discloses a pulse meter with pedometer function to determine pace and pulse rate of a user. The meter uses pulse wave base data compared to actual pulse wave data rates.

U.S. Patent 5,476,427 discloses a pace display device utilizing a base rate for traveling pre-set distances in successive trails. The device calculates step counts and rates, and compares actual step count rates to display data to a user for comparison of present running rates to previous rates.

5 Thus, there is a need for a simple, but highly accurate, pedometer that displays distance traveled, pace, speed, heart rate, and other important information on an easily read wrist-mounted device.

#### SUMMARY OF THE INVENTION

10 The present invention overcomes problems and shortcomings in the prior art by providing a device that includes a waist, chest, or leg-mounted stride counting device, a transmitter, and a wrist-mounted receiver/display device that provides highly accurate travel distances and other information. The device includes a computer that stores base stride length and rate data from traveling a pre-determined distance and compares that to actual stride rate data to calculate actual distance traveled, speed, and pace. The invention  
15 recognizes the interdependency of stride length and stride rate and uses that relationship to provide superior distance-calculating accuracy.

The invention also provides for improved display of relevant data on a wrist-mounted display that receives digital signals from devices worn on other body parts such as legs, waist, and chest. Transmitters that can send coded signals are desirable because  
20 they will not interfere with similar devices worn by other users in the vicinity.

The accuracy of the device is enhanced by the use of an algorithm that adjusts a base stride length based on actual stride rates. The algorithm is defined as: Actual Stride Length = Base Stride Length + Base Stride Length \*(((Actual Stride Rate - Base Stride Rate) N)/Base Stride Rate); where N is either an average value or a derived value from a  
25 plurality of samples.

The invention also includes a method for calculating an actual stride length including steps of: timing a first user run of a predetermined distance; counting the total number of strides in the user first run; dividing the first run distance by the stride count to obtain a base stride length; dividing the stride count by the first run time to obtain a base  
30 stride rate; counting strides during a user's second run to obtain an actual stride rate;

calculating the actual stride length using the formula: Actual Stride Length = Base Stride Length + Base Stride Length

\*(((Actual Stride Rate - Base Stride Rate )N)/Base Stride Rate); wherein N is an average value or a derived value.

5           The average value method can be refined by comparing Base Stride Rate to Actual Stride Rate to determine a percentage difference; and using  $N=1$  when the Actual Stride Rate  $\leq$  Base Stride Rate \* 1.02 and using  $N=3$  when Actual Stride Rate  $>$  Base Stride Rate \* 1.02. A preferred embodiment uses a plurality of sample runs over known distances to derive an accurate N value for each individual.

10

#### BRIEF DESCRIPTION OF THE DRAWINGS

Fig. 1 is a schematic diagram of a pedometer in accordance with the present invention.

#### DETAILED DESCRIPTION OF THE DRAWINGS

As illustrated in Fig. 1, the present invention is directed to an improved pedometer 15 20 including: a waist, chest, or leg mounted stride counter 24, and a wrist or waist mounted display unit 26. An optional chest-mounted heart monitor 28 can be included. All of the device components are mounted in suitable housings. The pedometer 20 includes a data processor 30 that is mounted in the same housing as either the step counter 24 or the display unit 26.

20           The step counter 24 is an inertia device that counts the number of steps a user takes. The number of steps is transmitted to a data archive 32 either directly or via a transmitter 34. The data archive 32 is mounted in the housing with the step counter 24 or the display 26.

25           The transmitter 34 is mounted in the step counter housing and is preferably an Rf telemetric signal transmitter with a 30 inches to 36 inches transmission range. Alternately, the transmitter is a wireless or wired digital transmitter with a coding function to limit or eliminate interference with other similar devices. The wireless transmission range is set between 30 inches and 36 inches to provide adequate range to transmit signals from a user's waist to wrist, but not so far as to cause interference with other Rf or digital devices 30 in the vicinity.

The transmitter 34 transmits either raw data or calculated distances, pace, etc. to a wrist-mounted display unit receiver 40. The receiver 40 relays a raw data signal to the data processor 30 or a calculated data signal directly to the display panel 42, such as an LCD or LED.

5 Similarly, the heart rate monitor 28 includes a transmitter 44 that transmits heart rate data to the display unit 26. The heart monitor transmitter 44 can transmit at the same or a different frequency as the stride counter 24, and to the same or a different receiver in the display unit 26. The heart rate transmitter 44 is preferably Rf, but can be digital for the reasons stated above. The range of the heart rate transmitter 44 should also be between  
10 30 inches and 36 inches to ensure effective communication with the receiver while limiting outside interference.

The data processor 30 can also include a programmable logic controller, a personal computer, a programmable read-only memory, or other suitable processor. The data processor 30 includes a data archive 32 to store historic data on stride length and  
15 pace to be used in an algorithm for calculating actual distances, speed, and rate for real-time conversion of data to useful information for a user.

The data processor 30 can also include closed loop or fuzzy logic programming to continually or periodically replace the base stride rate and length with recently calculated stride rates and lengths so that long term conditioning trends are accommodated in the  
20 base stride archive. Incorporating trend capabilities may further enhance accuracy of the distance and pace calculations.

The display unit 26 also includes an operator interface 46 such as a key pad, button, knob, etc. that enables the user to start and stop a clock 48 (or stop watch) and activate various use modes within the pedometer, such as a sampling mode and operation  
25 mode.

One option for using the pedometer 20, requires the user to operate a "sampling mode" and begin walking or running a pre-determined distance such as a mile or 1600 meters, preferably on a running track of a known size. Upon completion of the distance, a stop button on the operator interface 46 is pushed. The data processor 30 is programmed  
30 to then divide the distance by the number of strides counted to calculate an average stride

length. This value is stored in the data archive 32 as the "Base Stride Length."

Also, the data processor 30 is programmed to divide the number of strides by the time of the run or walk as measured by the clock 48 to arrive at a "Base Stride Rate."

The data processor 30 preferably includes programming that queries the user  
5 about the distance to be run during the sampling mode. By providing options or enabling  
the use of any distance during the sampling mode, the pedometer 20 provides maximum  
flexibility for use by people of various physical conditions, or having access to courses of  
different known distances. Thus, a user may be queried to input a distance to be used in  
the sampling mode and then be given a list of options such as 400 meters, 440 yards,  
10 1600 meters, or one mile, or be asked to simply input any distance known to the user that  
will be traveled during the sampling mode.

The present invention makes full use of the relationship between a faster rate of  
travel and longer stride lengths. In other words, the faster a user is moving, the longer will  
be the stride length. Over the course of the run or walk, the user's step rate and,  
15 therefore, stride length will change and the user will cover more ground when moving fast  
and less ground when moving slow.

Clearly, using a fixed average stride length in calculating distance traveled will  
result in errors using prior pedometers. This is particularly true if a user changes pace, or  
improves conditioning and speed to the point where the average stride length over a given  
20 run increases dramatically. The error compensators in prior devices do not adjust for  
changes in pace. With the old devices, a user needed to re-calibrate periodically to be  
close to getting an accurate reading, and could not change pace during a workout without  
decreasing accuracy.

To make the correction, the user activates a "Use Mode" in which the data  
25 processor 30 calculates an Actual Stride Rate based on data from the stride counter 24  
and the clock 48. For example, an Actual Stride Rate can be calculated every five  
seconds without the user doing more than activating the "Use Mode" button, while all the  
calculations are performed by the data processor automatically. The percentage change  
between the Actual Stride Rate and the Base Stride Rate is then computed by the data  
30 processor 30 to determine an Actual Stride Length. Again, if the Actual Stride Rate is

greater than the Base Stride Rate, the Actual Stride Length is longer than the Base Stride Length. If the Actual Steps Per Second is lower than the Base Steps Per Second, the Actual Stride Length is shorter than the Base Stride Length. The algorithm below provides a means for comparing the Actual and Base Stride rates to arrive at an accurate Actual Stride Length.

First, a comparison between the Actual Stride Rate and the Base Stride Rate is made to determine whether Actual Stride Rate is less than or equal to Base Stride Rate multiplied by 1.02. Stride Length is calculated by:

$$\text{Actual Stride Length} = \text{Base Stride Length} +$$

$$\text{Base Stride Length} * (((\text{Actual Stride Rate} - \text{Base Stride Rate})N) / \text{Base Stride Rate})$$

Where: N=1 when Actual Stride Rate is less than or equal to Base Stride Rate multiplied by 1.02, and N=3 when Actual Stride Rate is greater than Base Stride Rate multiplied by 1.02, although other N values in the range of one to three can be used.

The above algorithm is accurate for heel to toe activities such as walking or jogging, but is less accurate for sprinting (toe only).

A third method of calculating actual stride length uses three separate run or walk samples at three different paces. This is the most accurate option. With this method, the N values are unique for each individual. By deriving an N value for each individual, this value more accurately reflects the actual change in stride length with a change in pace. After a proper warmup, the user completes a sample run or walk on the track at a normal pace. This first sample S1, will establish the Base Stride and the Base Steps Per Second.

S1 SAMPLE:

$$S1 \text{ Stride} = \text{Base Stride} = \text{Distance} / \text{Number of Steps}$$

$$S1 \text{ Steps Per Second or } S1 \text{ Steps Per Second} = \text{Base Steps Per Second} = \text{Number of Steps Per Second}$$

Following completion of the first run or walk at normal pace, the user runs or walks the same course and the same distance at a faster run or walking pace, but not a sprinting pace. The user should not run on his toes, but maintain the normal heel to toe jogging style. This is the S2 sample. The purpose of the S2 sample is to calculate an N2



value for each individual which reflects the effect an increase in Steps Per Second has on this individual's stride length. Some individual's steps will lengthen more than others as Steps Per Second increases, and by finding the value for N2, this relative increase can be quantified for a more accurate and customized algorithm for each individual.

5 S2 SAMPLE:

To find the N2 value, which will be used by the algorithm when Actual Steps Per Second > Base Steps Per Second

$$N2 = ((S2 \text{ Stride} * S1 \text{ Steps Per Second}) - (S1 \text{ Stride} * S1 \text{ Steps Per Second})) / (S1 \text{ Stride} (S2 \text{ Steps Per Second} - S1 \text{ Steps Per Second}))$$

10 This value can be calculated since the distance is known, and both a Fast Stride Length (S2 Stride) and a Fast Steps Per Second (S2 Steps Per Second) can be calculated from the second sample.

Following completion of the fast run or walk, the user runs the same course and the same distance at a slower than normal run or walking pace. This pace cannot exceed  
15 the first sample pace. This is the S3 sample. The purpose of the S3 sample is to calculate an N3 value for each individual which reflects the effect a decrease in Steps Per Second has on this individual's stride length. Some individual's steps will shorten more than others as Steps Per Second decreases, and by finding the value for N3, this relative decrease can be quantified for a more accurate and customized algorithm for each individual.

20 S3 SAMPLE:

To find the N3 value, which will be used by the algorithm when Actual Steps Per Second < Base Steps Per Second.

$$N3 = ((S3 \text{ Stride} * S1 \text{ Steps Per Second}) - (S1 \text{ Stride} * S1 \text{ Steps Per Second})) / (S1 \text{ Stride} (S2 \text{ Steps Per Second} - S1 \text{ Steps Per Second}))$$

25 This value can be calculated since the distance is known and both a "Slow" Stride Length (S3 Stride) and a "Slow" Steps Per Second (S3 Steps Per Second) can be calculated from the third sample.

Once these three samples are completed and the information automatically calculated and stored in the data processor 30, then the following formula can be used for  
30 the most accurate measurements of speed and distance.

If: Actual Steps Per Second is less than or equal to Base Steps Per Second

Then:

Stride Length = Base Stride + Base Stride\*(((Actual Steps Per Second - Base Steps Per Second)N)/Base Steps Per Second)

And N = N3 (Stored Value)

If: Actual Steps Per Second > Base Steps Per Second

Then:

Stride Length = Base Stride + Base Stride\*(((Actual Steps Per Second - Base Steps Per Second)N)/Base Steps Per Second)

And N = N2 (Stored Value)

This third option for calculating stride length, and subsequently distance, speed, and pace, is a far more accurate method than a fixed stride length pedometer. This device and method are also practical, convenient, and has a relatively low manufacturing cost. If an individual's running or walking style is progressing with training and practice (as seen by significantly improved times), then it may be beneficial for them to recalibrate their device by repeating the three samples every 3 to 6 months. If there are no significant improvements in time, then recalibration is not necessary.

It is noted that any single stride length or pace discussed above can in fact be an average of a plurality of stride lengths or rates from test runs to further refine accuracy in the calculations of actual stride data.

Other variations on this device could also incorporate an altimeter which measures changes in elevation. The stride length could then be adjusted (shortened) when elevation is increasing, and lengthened when elevation is decreasing. This adjustment could be done with an average value, as we used in setting option 2, or with a derived value by running or walking over a known distance on a hilly course. This device can use two batteries so that the calibration data is not lost when the batteries are replaced one at a time.

Once the actual stride length is calculated for a given period of time, the value can be multiplied by the number of strides in that period to obtain a total distance for that period to be stored in a data archive file for that particular walk or run and added to other

actual stride lengths or distances for other periods in which stride length was calculated. When the run or walk is completed, the user engages the operator interface 46 to indicate that a total distance is to be displayed on the display unit. Preferably, there is continual display of the distance traveled.

5           As a result of accurately calculating distance traveled, the pedometer 20 also has the capability of calculating speed in miles per hour, for example or pace in minutes per mile, including average speed and pace over the course of that particular walk or run. Further, the pedometer 20 can include a port for coupling to a separate personal computer or computing device to create larger training histories, trends, etc.

10           Additional features can include stop watches, day, date and time displays, as well as, heart rate displays as discussed above. Also, it will be understood that all distances and time periods used above can be varied in length and units of measure (English, metric, seconds, minutes, hours, etc.).

15           The foregoing detailed description is provided for clearness of understanding only and no unnecessary limitations therefrom should be read into the following claims.

CLAIMS

1. An exercise monitoring device comprising:  
a strap for releasably securing the exercise monitoring device to a user;  
a step counter joined to the strap; and  
a heart rate monitor joined to the strap.

5

Sub  
a1

2. The exercise monitoring device of claim 1, and further comprising:  
a data processor programmed to calculate a distance traveled by multiplying a  
number of steps counted by the step counter by a stride length  
that varies according to a rate at which steps are counted.

10

3. The exercise monitoring device of claim 1, and further comprising:  
a data processor programmed to calculate a distance traveled by multiplying a  
number of steps counted by the step counter by a stride length that varies  
in accordance with a stride rate, wherein the stride length is determined  
with reference to a plurality of calibrations that each calculate a stride  
length as a function of a known stride rate.

15

4. The exercise monitoring device of claim 3, wherein the data processor is  
further programmed to recalibrate the stride length as a function of a subsequently  
calculated and known stride rate.

20

~~4~~ 5. The exercise monitoring device of claim ~~4~~ 3, wherein the data processor is  
further programmed to recalibrate the stride length by calculating an average stride length  
from the calibration stride length and the recalibration stride length.

Sub  
A2

5

6. The pedometer of claim 1, and further comprising:  
a data processor programmed to calculate a distance traveled by multiplying the number of steps counted by the step counter by a stride length that varies according to a rate at which steps are counted, and further programmed to derive the stride length from a range of stride lengths calculated from a range of corresponding stride rates calculated from a plurality of calibration samples

10

7. A pedometer comprising:  
a step counter;  
a transmitter in communication with the step counter to generate a step count signal corresponding to each step and transmit the step count signal;  
a receiver mountable on a user body portion to receive the step count signal transmitted from the transmitter; and

15

a data processor programmed to calculate a distance traveled by multiplying a number of steps counted by a stride length that varies according to a rate at which steps are taken, and further programmed to derive an actual stride length from a range of stride lengths calculated from a range of corresponding stride rates.

10  
15  
20  
25

20

7x The pedometer of claim 7, wherein the data processor is further programmed to:

use the range of stride rates to create a corresponding range of stride lengths and compare an actual stride rate to the range of stride rates to derive a corresponding actual stride length.

25

8x The pedometer of claim 7, wherein the data processor is further programmed to:

interpolate between and extrapolate from the ranges of stride rates and stride lengths to calculate a plurality of additional corresponding stride rates and stride lengths.

14

377  
PA. 2

PRINT OF DRAWINGS  
AS ORIGINALLY FILED

09/17/06 CH7

+

1/1

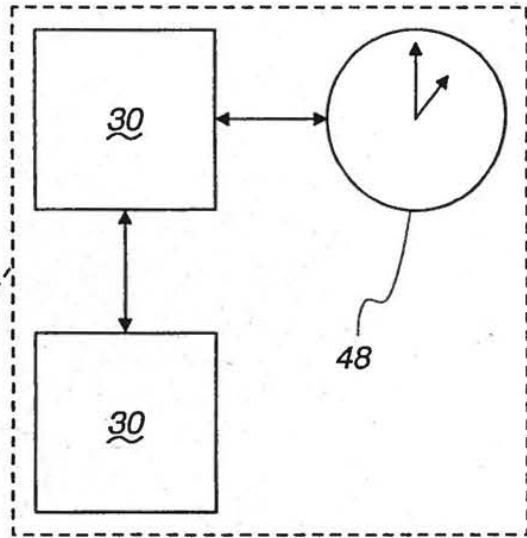
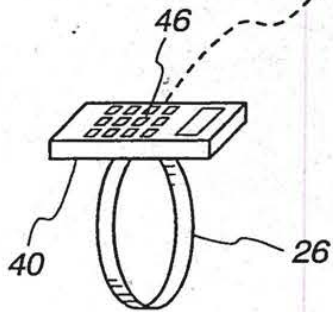
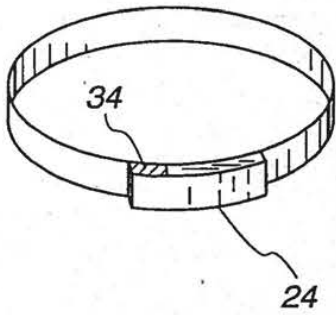
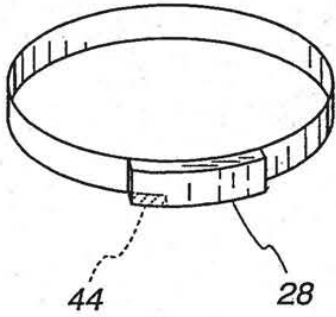



UNITED STATES PATENT AND TRADEMARK OFFICE

COMMISSIONER FOR PATENTS  
UNITED STATES PATENT AND TRADEMARK OFFICE  
WASHINGTON, D.C. 20231  
www.uspto.gov

APPLICATION NUMBER	FILING/RECEIPT DATE	FIRST NAMED APPLICANT	ATTORNEY DOCKET NUMBER
09/756,647	01/04/2001	Nathan Pyles	KNOWMO-6

020455  
LATHROP & CLARK LLP  
740 REGENT STREET SUITE 400  
P.O. BOX 1507  
MADISON, WI 537011507

CONFIRMATION NO. 7058

FORMALITIES LETTER



\*OC00000000576777\*

2#

Date Mailed: 02/15/2001

**NOTICE TO FILE MISSING PARTS OF NONPROVISIONAL APPLICATION**

FILED UNDER 37 CFR 1.53(b)

*Filing Date Granted*

An application number and filing date have been accorded to this application. The item(s) indicated below, however, are missing. Applicant is given TWO MONTHS from the date of this Notice within which to file all required items and pay any fees required below to avoid abandonment. Extensions of time may be obtained by filing a petition accompanied by the extension fee under the provisions of 37 CFR 1.136(a).

- The statutory basic filing fee is missing.  
*Applicant must submit \$ 710 to complete the basic filing fee and/or file a small entity statement claiming such status (37 CFR 1.27).*
- The oath or declaration is missing.
- To avoid abandonment, a late filing fee or oath or declaration surcharge as set forth in 37 CFR 1.16(e) of \$130 for a non-small entity, must be submitted with the missing items identified in this letter.
- **The balance due by applicant is \$ 840.**

*A copy of this notice **MUST** be returned with the reply.*

Customer Service Center  
Initial Patent Examination Division (703) 308-1202

PART 3 - OFFICE COPY



#3

PATENT APPLICATION

In the United States Patent and Trademark Office

Applicant: Nathan Pyles  
 Docket No.: KNOWMO-6  
 Date: April 16, 2001  
 Application No.: 09/756,647  
 Filed: January 4, 2001  
 Art Unit: 2816  
 Examiner:  
 For: PEDOMETER

**Certificate of Mailing**  
 I hereby certify that this correspondence is being deposited with the United States Postal Service as Express Mail in an envelope addressed to: Box Missing Parts, Assistant Commissioner for Patents, Washington, D.C. 20231  
 On April 16, 2001  
 Signature Jeffrey W. Smith  
 Jeffrey W. Smith, Reg. No. 33455  
 Name of Applicant, assignee or Registered Representative

**TRANSMITTAL OF MISSING PARTS OF APPLICATION UNDER 37 C.F.R. §1.53**

Box Missing Parts  
Assistant Commissioner for Patents  
Washington, D.C. 20231

Dear Sir:

In response to the Notice of Missing Parts mailed February 15, 2001, enclosed are the following items for filing in the above-referenced U.S. patent application:

1. A Declaration and Power of Attorney, executed by the Applicant(s) on April 13, 2001.
2. Copy of Notice to File Missing Parts of Nonprovisional Application.
3. A check in the amount of \$420.00 to cover the filing fee (37 C.F.R. §1.16(a) et seq.), and the surcharge set forth in 37 C.F.R. §1.16(e).



Applicant: Nathan Pyles  
Application No.: 09/756,647

4. Statement Claiming Small Entity Status – Small Business Concern (37 C.F.R. §§1.9(f) and 1.27(c).

The Commissioner is hereby authorized to charge payment of any additional fees associated with this communication or credit any overpayment to Deposit Account No. 15-0660.

A duplicate copy of this document is enclosed.

Having now complied with all the requirements of 37 C.F.R. §1.53, Applicant(s) respectfully requests that this application be placed upon the files for examination.

Respectfully submitted,

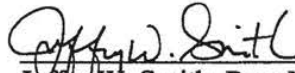

Jeffrey W. Smith, Reg. No. 33455  
Attorney for Applicant  
LATHROP & CLARK LLP  
740 Regent Street, Suite 400  
P.O. Box 1507  
Madison, Wisconsin 53701-1507  
(608) 257-7766



Docket No.: KNOWMO-6

**DECLARATION AND POWER OF ATTORNEY**

As a below named inventor, I hereby declare that:

My residence, post office address and citizenship are as stated below next to my name.

I believe I am the original, first and sole inventor of the subject matter which is claimed and for which a patent is sought on the invention entitled: PEDOMETER, the specification of which

is attached hereto.

was filed on January 4, 2001 as Application No. 09/756,647 and was amended on \_\_\_\_\_ (if applicable).

I hereby state that I have reviewed and understand the contents of the above-identified specification, including the claims, as amended by any amendment referred to above. I acknowledge the duty to disclose information which is material to patentability as defined in 37 CFR 1.56.

I hereby claim foreign priority benefits under Title 35, United States Code, §119 of any foreign application(s) for patent or inventor's certificate listed below and have also identified below any foreign application for patent or inventor's certificate having a filing date before that of the application on which priority is claimed:

Prior Foreign Application(s)			Priority Claimed	
<u>None.</u> (Number)	<u>                    </u> (Country)	<u>                    </u> (Day/Month/Year Filed)	<input type="checkbox"/> Yes	<input type="checkbox"/> No
<u>                    </u> (Number)	<u>                    </u> (Country)	<u>                    </u> (Day/Month/Year Filed)	<input type="checkbox"/> Yes	<input type="checkbox"/> No

I hereby claim the benefit under Title 35, United States Code, §120 of any United States application(s) listed below and, insofar as the subject matter of each of the claims of this



Full name of sole Inventor

Nathan Pyles

Inventor's Signature

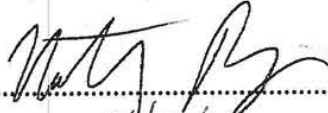

Date

4/13/01

Residence

Lake Mills, Wisconsin

Citizenship

United States of America

Post Office Address

529 College Street, Lake Mills, Wisconsin 53551



Under the Paperwork Reduction Act of 1995, no persons are required to respond to a collection of information unless it displays a valid OMB control number.

<b>STATEMENT CLAIMING SMALL ENTITY STATUS (37 CFR 1.9(f) &amp; 1.27(c))-SMALL BUSINESS CONCERN</b>	<b>Docket Number (Optional)</b> KNOWMO-6
----------------------------------------------------------------------------------------------------	---------------------------------------------

Applicant, Patentee, or Identifier: Nathan Pyles  
 Application or Patent No.: 09/756,647  
 Filed or issued: January 4, 2001  
 Title: Pedometer

I hereby state that I am

- the owner of the small business concern identified below:
- an official of the small business concern empowered to act on behalf of the concern identified below:
- one of the parties identified in §1.33(b) representing the small business concern identified below:

NAME OF SMALL BUSINESS CONCERN KnowMo, LLC d/b/a Knowledge-In-Motion

ADDRESS OF SMALL BUSINESS CONCERN 529 College Street, P.O. Box 760, Lake Mills, Wisconsin 53551

I hereby state that the above identified small business concern qualifies as a small business concern as defined in 13 CFR Part 121 for purposes of paying reduced fees to the United States Patent and Trademark Office, in that the number of employees of the concern, including those of its affiliates, does not exceed 500 persons. For purposes of this statement, (1) the number of employees of the business concern is the average over the previous fiscal year of the concern of the persons employed on a full-time, part-time, or temporary basis during each of the pay periods of the fiscal year, and (2) concerns are affiliates of each other when either, directly or indirectly, one concern controls or has the power to control the other, or a third party or parties controls or has the power to control both.

I hereby state that rights under contract or law have been conveyed to and remain with the small business concern identified above with regard to the invention described in:

- the specification filed herewith with title as listed above.
- the application identified above.
- the patent identified above.

If the rights held by the above identified small business concern are not exclusive, each individual, concern, or organization having rights in the invention must file separate statements as to their status as small entities, and no rights to the invention are held by any person, other than the inventor, who would not qualify as an independent inventor under 37 CFR 1.9(c) if that person made the invention, or by any concern which would not qualify as a small business concern under 37 CFR 1.9(d), or a nonprofit organization under 37 CFR 1.9(e).

Each person, concern, or organization having any rights in the invention is listed below:

- no such person, concern, or organization exists.
- each such person, concern, or organization is listed below.

Separate statements are required from each named person, concern or organization having rights to the invention stating their status as small entities (37 CFR 1.27).

I acknowledge the duty to file, in this application or patent, notification of any change in status resulting in loss of entitlement to small entity status prior to paying, or at the time of paying, the earliest of the issue fee or any maintenance fee due after the date on which status as a small entity is no longer appropriate (37 CFR 1.28(b)).

NAME OF PERSON SIGNING Jeffrey W. Smith, Reg. No. 33455  
 TITLE OF PERSON IF OTHER THAN OWNER Attorney for Applicant  
 ADDRESS OF PERSON SIGNING Lathrop & Clark LLP, 740 Regent St. Ste. 400, P.O. Box 1507, Madison, WI 53701-1507  
 SIGNATURE Jeffrey W. Smith DATE April 16, 2001

Burden Hour Statement: This form is estimated to take 0.2 hours to complete. Time will vary depending upon the needs of the individual case. Any comments on the amount of time you are required to complete this form should be sent to the Chief Information Officer, Patent and Trademark Office, Washington, DC 20231. DO NOT SEND FEES OR COMPLETED FORMS TO THIS ADDRESS. SEND TO: Assistant Commissioner for Patents, Washington, DC 20231.



Please type a plus sign (+) inside this box →

Approved for use through 09/30/2000. OMB 0651-0031  
 Patent and Trademark Office: U.S. DEPARTMENT OF COMMERCE

Under the Paperwork Reduction Act of 1995, no persons are required to respond to a collection of information unless it displays a valid OMB control number.

<h2>TRANSMITTAL FORM</h2> <p>(to be used for all correspondence after initial filing)</p>	Application Number	09/756,647
	Filing Date	January 4, 2001
	First Named Inventor	Nathan Pyles
	Group Art Unit	2816
	Examiner Name	
Total Number of Pages in This Submission	Attorney Docket Number <b>KNOWMO-6</b>	

ENCLOSURES (check all that apply)		
<input checked="" type="checkbox"/> Fee Transmittal Form	<input type="checkbox"/> Assignment Papers (for an Application)	<input type="checkbox"/> After Allowance Communication to Group
<input checked="" type="checkbox"/> Fee Attached	<input type="checkbox"/> Drawing(s)	<input type="checkbox"/> Appeal Communication to Board of Appeals and Interferences
<input type="checkbox"/> Amendment / Response	<input type="checkbox"/> Licensing-related Papers	<input type="checkbox"/> Appeal Communication to Group (Appeal Notice, Brief, Reply Brief)
<input type="checkbox"/> After Final	<input type="checkbox"/> Petition Routing Slip (PTO/SB/69) and Accompanying Petition	<input type="checkbox"/> Proprietary Information
<input type="checkbox"/> Affidavits/declaration(s)	<input type="checkbox"/> Petition to Convert to a Provisional Application	<input type="checkbox"/> Status Letter
<input type="checkbox"/> Extension of Time Request	<input type="checkbox"/> Power of Attorney, Revocation Change of Correspondence Address	<input checked="" type="checkbox"/> Additional Enclosure(s) (please identify below):
<input type="checkbox"/> Express Abandonment Request	<input type="checkbox"/> Terminal Disclaimer	Notice to File Missing Parts of Nonprovisional Application (1p)
<input type="checkbox"/> Information Disclosure Statement	<input checked="" type="checkbox"/> Small Entity Statement	
<input type="checkbox"/> Certified Copy of Priority Document(s)	<input type="checkbox"/> Request for Refund	
<input type="checkbox"/> Response to Missing Parts/Incomplete Application	Remarks	
<input checked="" type="checkbox"/> Response to Missing Parts under 37 CFR 1.52 or 1.53		

SIGNATURE OF APPLICANT, ATTORNEY, OR AGENT	
Firm or Individual name	Jeffrey W. Smith, Reg. No. 33455
Signature	<i>Jeffrey W. Smith</i>
Date	April 16, 2001

CERTIFICATE OF MAILING	
I hereby certify that this correspondence is being deposited with the United States Postal Service as first class mail in an envelope addressed to: Assistant Commissioner for Patents, Washington, D.C. 20231 on this date: _____	
Typed or printed name	Jeffrey W. Smith, Reg. No. 33455
Signature	<i>Jeffrey W. Smith</i>
Date	April 16, 2001

Burden Hour Statement: This form is estimated to take 0.2 hours to complete. Time will vary depending upon the needs of the individual case. Any comments on the amount of time you are required to complete this form should be sent to the Chief Information Officer Patent and Trademark Office, Washington, DC 20231. DO NOT SEND FEES OR COMPLETED FORMS TO THIS ADDRESS. SEND TO: Assistant Commissioner for Patents, Washington, DC 20231.



PTO/SB/17 (12/99)

Approved for use through 09/30/2000. OMB 0651-0032  
Patent and Trademark Office: U.S. DEPARTMENT OF COMMERCE

Under the Paperwork Reduction Act of 1995, no persons are required to respond to a collection of information unless it displays a valid OMB control number.

# FEE TRANSMITTAL for FY 2000

Patent fees are subject to annual revision.  
Small Entity payments must be supported by a small entity statement,  
otherwise large entity fees must be paid. See Forms PTO/SB/09-12.  
See 37 C.F.R. §§ 1.27 and 1.28.

TOTAL AMOUNT OF PAYMENT (\$)**420.00**

**Complete if Known**

Application Number	09/756,647
Filing Date	January 4, 2001
First Named Inventor	Nathan Pyles
Examiner Name	
Group / Art Unit	2816
Attorney Docket No.	KNOWMO-6

**METHOD OF PAYMENT (check one)**

1.  The Commissioner is hereby authorized to charge indicated fees and credit any overpayments to:

Deposit Account Number: 15-0660

Deposit Account Name: LATHROP & CLARK LLP

Charge Any Additional Fee Required Under 37 CFR §§ 1.16 and 1.17

2.  Payment Enclosed:  
 Check     Money Order     Other

**FEE CALCULATION (continued)**

3. ADDITIONAL FEES			Fee Description	Fee Paid
Large Entity Fee Code (\$)	Small Entity Fee Code (\$)	Entity		
105	130	205 65	Surcharge - late filing fee or oath	65.00
127	50	227 25	Surcharge - late provisional filing fee or cover sheet.	0.00
139	130	139 130	Non-English specification *	0.00
147	2,520	147 2,520	For filing a request for reexamination	0.00
112	920*	112 920*	Requesting publication of SIR prior to Examiner action	0.00
113	1,840*	113 1,840*	Requesting publication of SIR after Examiner action	0.00
115	110	215 55	Extension for reply within first month	0.00
116	380	216 190	Extension for reply within second month	0.00
117	870	217 435	Extension for reply within third month	0.00
118	1,380	218 680	Extension for reply within fourth month	0.00
128	1,850	228 925	Extension for reply within fifth month	0.00
119	300	219 150	Notice of Appeal	0.00
120	300	220 150	Filing a brief in support of an appeal	0.00
121	260	221 130	Request for oral hearing	0.00
138	1,510	138 1,510	Petition to institute a public use proceeding	0.00
140	110	240 55	Petition to revive - unavoidable	0.00
141	1,210	241 605	Petition to revive - unintentional	0.00
142	1,210	242 605	Utility issue fee (or reissue)	0.00
143	430	243 215	Design issue fee	0.00
144	580	244 290	Plant issue fee	0.00
122	130	122 130	Petitions to the Commissioner	0.00
123	50	123 50	Petitions related to provisional applications	0.00
126	240	126 240	Submission of Information Disclosure Stmt	0.00
581	40	581 40	Recording each patent assignment per property (times number of properties)	0.00
146	690	246 345	Filing a submission after final rejection (37 CFR § 1.129(a))	0.00
149	690	249 345	For each additional invention to be examined (37 CFR § 1.129(b))	0.00
Other fee (specify) _____				0.00
Other fee (specify) _____				0.00
*Reduced by Basic Filing Fee Paid			<b>SUBTOTAL (3)</b>	<b>(\$) 65.00</b>

**FEE CALCULATION**

**1. BASIC FILING FEE**

Large Entity Fee Code (\$)	Small Entity Fee Code (\$)	Fee Description	Fee Paid
101	690	201 345 Utility filing fee	355.00
106	310	206 155 Design filing fee	
107	480	207 240 Plant filing fee	
108	690	208 345 Reissue filing fee	
114	150	214 75 Provisional filing fee	
<b>SUBTOTAL (1)</b>			<b>(\$) 355.00</b>

**2. EXTRA CLAIM FEES**

Total Claims	Extra Claims	Fee from below	Fee Paid
9	-20** = 0	9	0
2	-3** = 0	40	0
Multiple Dependent = 0			

\*\*or number previously paid, if greater; For Reissues, see below

Large Entity Fee Code (\$)	Small Entity Fee Code (\$)	Fee Description	Fee Paid
103	18	203 9 Claims in excess of 20	
102	78	202 39 Independent claims in excess of 3	
104	260	204 130 Multiple dependent claim, if not paid	
109	78	209 39 ** Reissue independent claims over original patent	
110	18	210 9 ** Reissue claims in excess of 20 and over original patent	
<b>SUBTOTAL (2)</b>			<b>(\$) 0.00</b>

<b>SUBMITTED BY</b>		<b>Complete (if applicable)</b>	
Name (Print/Type)	Jeffrey W. Smith	Registration No. (Attorney/Agent)	33455
Signature	<i>Jeffrey W. Smith</i>	Telephone	(608) 257-7766
		Date	April 16, 2001

**WARNING:**

Information on this form may become public. Credit card information should not be included on this form. Provide credit card information and authorization on PTO-2038.

Burden Hour Statement: This form is estimated to take 0.2 hours to complete. Time will vary depending upon the needs of the individual case. Any comments on the amount of time you are required to complete this form should be sent to the Chief Information Officer, Patent and Trademark Office, Washington, DC 20231. DO NOT SEND FEES OR COMPLETED FORMS TO THIS ADDRESS. SEND TO: Assistant Commissioner for Patents, Washington, DC 20231.



PTO/ST/17 (12/99)  
 Approved for use through 09/30/2000. OMB 0651-0032  
 Patent and Trademark Office: U.S. DEPARTMENT OF COMMERCE

Under the Paperwork Reduction Act of 1995, no persons are required to respond to a collection of information unless it displays a valid OMB control number.

<b>FEE TRANSMITTAL</b> <b>for FY 2000</b> <small>Patent fees are subject to annual revision. Small Entity payments must be supported by a small entity statement, otherwise large entity fees must be paid. See Forms PTO/ST/09-12. See 37 C.F.R. §§ 1.27 and 1.28.</small>	<b>Complete if Known</b>	
	Application Number	09/756,647
	Filing Date	January 4, 2001
	First Named Inventor	Nathan Pyles
	Examiner Name	
	Group / Art Unit	2816
<b>TOTAL AMOUNT OF PAYMENT</b>	<b>(\$)</b> 420.00	
	Attorney Docket No.	KNOWMO-6

<p><b>METHOD OF PAYMENT (check one)</b></p> <p>1. <input checked="" type="checkbox"/> The Commissioner is hereby authorized to charge indicated fees and credit any overpayments to:</p> <p>Deposit Account Number: 15-0660</p> <p>Deposit Account Name: LATHROP &amp; CLARK LLP</p> <p><input type="checkbox"/> Charge Any Additional Fee Required Under 37 CFR §§ 1.16 and 1.17</p> <p>2. <input type="checkbox"/> Payment Enclosed:  <input checked="" type="checkbox"/> Check    <input type="checkbox"/> Money Order    <input type="checkbox"/> Other</p> <p style="text-align: center;"><b>FEE CALCULATION</b></p> <p><b>1. BASIC FILING FEE</b></p> <table border="1"> <thead> <tr> <th>Large Entity Code</th> <th>Large Entity Fee (\$)</th> <th>Small Entity Code</th> <th>Small Entity Fee (\$)</th> <th>Fee Description</th> <th>Fee Paid</th> </tr> </thead> <tbody> <tr> <td>101</td> <td>690</td> <td>201</td> <td>345</td> <td>Utility filing fee</td> <td>355.00</td> </tr> <tr> <td>106</td> <td>310</td> <td>206</td> <td>155</td> <td>Design filing fee</td> <td></td> </tr> <tr> <td>107</td> <td>480</td> <td>207</td> <td>240</td> <td>Plant filing fee</td> <td></td> </tr> <tr> <td>108</td> <td>690</td> <td>208</td> <td>345</td> <td>Reissue filing fee</td> <td></td> </tr> <tr> <td>114</td> <td>150</td> <td>214</td> <td>75</td> <td>Provisional filing fee</td> <td></td> </tr> <tr> <td colspan="5"><b>SUBTOTAL (1)</b></td> <td><b>(\$)</b> 355.00</td> </tr> </tbody> </table> <p><b>2. EXTRA CLAIM FEES</b></p> <table border="1"> <thead> <tr> <th>Total Claims</th> <th>Extra Claims</th> <th>Fee from below</th> <th>Fee Paid</th> </tr> </thead> <tbody> <tr> <td>9</td> <td>-20** = 0</td> <td>X 9</td> <td>= 0</td> </tr> <tr> <td>2</td> <td>-3** = 0</td> <td>X 40</td> <td>= 0</td> </tr> <tr> <td colspan="4">Multiple Dependent = 0</td> </tr> </tbody> </table> <p>**or number previously paid, if greater; For Reissues, see below</p> <table border="1"> <thead> <tr> <th>Large Entity Code</th> <th>Large Entity Fee (\$)</th> <th>Small Entity Code</th> <th>Small Entity Fee (\$)</th> <th>Fee Description</th> <th>Fee Paid</th> </tr> </thead> <tbody> <tr> <td>103</td> <td>18</td> <td>203</td> <td>9</td> <td>Claims in excess of 20</td> <td></td> </tr> <tr> <td>102</td> <td>78</td> <td>202</td> <td>39</td> <td>Independent claims in excess of 3</td> <td></td> </tr> <tr> <td>104</td> <td>260</td> <td>204</td> <td>130</td> <td>Multiple dependent claim, if not paid</td> <td></td> </tr> <tr> <td>109</td> <td>78</td> <td>209</td> <td>39</td> <td>** Reissue independent claims over original patent</td> <td></td> </tr> <tr> <td>110</td> <td>18</td> <td>210</td> <td>9</td> <td>** Reissue claims in excess of 20 and over original patent</td> <td></td> </tr> <tr> <td colspan="5"><b>SUBTOTAL (2)</b></td> <td><b>(\$)</b> 0.00</td> </tr> </tbody> </table>	Large Entity Code	Large Entity Fee (\$)	Small Entity Code	Small Entity Fee (\$)	Fee Description	Fee Paid	101	690	201	345	Utility filing fee	355.00	106	310	206	155	Design filing fee		107	480	207	240	Plant filing fee		108	690	208	345	Reissue filing fee		114	150	214	75	Provisional filing fee		<b>SUBTOTAL (1)</b>					<b>(\$)</b> 355.00	Total Claims	Extra Claims	Fee from below	Fee Paid	9	-20** = 0	X 9	= 0	2	-3** = 0	X 40	= 0	Multiple Dependent = 0				Large Entity Code	Large Entity Fee (\$)	Small Entity Code	Small Entity Fee (\$)	Fee Description	Fee Paid	103	18	203	9	Claims in excess of 20		102	78	202	39	Independent claims in excess of 3		104	260	204	130	Multiple dependent claim, if not paid		109	78	209	39	** Reissue independent claims over original patent		110	18	210	9	** Reissue claims in excess of 20 and over original patent		<b>SUBTOTAL (2)</b>					<b>(\$)</b> 0.00	<p><b>3. ADDITIONAL FEES</b></p> <table border="1"> <thead> <tr> <th>Large Entity Code</th> <th>Large Entity Fee (\$)</th> <th>Small Entity Code</th> <th>Small Entity Fee (\$)</th> <th>Fee Description</th> <th>Fee Paid</th> </tr> </thead> <tbody> <tr> <td>105</td> <td>130</td> <td>205</td> <td>65</td> <td>Surcharge - late filing fee or oath</td> <td>65.00</td> </tr> <tr> <td>127</td> <td>50</td> <td>227</td> <td>25</td> <td>Surcharge - late provisional filing fee or cover sheet</td> <td>0.00</td> </tr> <tr> <td>139</td> <td>130</td> <td>139</td> <td>130</td> <td>Non-English specification</td> <td>0.00</td> </tr> <tr> <td>147</td> <td>2,520</td> <td>147</td> <td>2,520</td> <td>For filing a request for reexamination</td> <td>0.00</td> </tr> <tr> <td>112</td> <td>920*</td> <td>112</td> <td>920*</td> <td>Requesting publication of SIR prior to Examiner action</td> <td>0.00</td> </tr> <tr> <td>113</td> <td>1,840*</td> <td>113</td> <td>1,840*</td> <td>Requesting publication of SIR after Examiner action</td> <td>0.00</td> </tr> <tr> <td>115</td> <td>110</td> <td>215</td> <td>55</td> <td>Extension for reply within first month</td> <td>0.00</td> </tr> <tr> <td>116</td> <td>380</td> <td>216</td> <td>190</td> <td>Extension for reply within second month</td> <td>0.00</td> </tr> <tr> <td>117</td> <td>670</td> <td>217</td> <td>435</td> <td>Extension for reply within third month</td> <td>0.00</td> </tr> <tr> <td>118</td> <td>1,360</td> <td>218</td> <td>680</td> <td>Extension for reply within fourth month</td> <td>0.00</td> </tr> <tr> <td>128</td> <td>1,850</td> <td>228</td> <td>925</td> <td>Extension for reply within fifth month</td> <td>0.00</td> </tr> <tr> <td>119</td> <td>300</td> <td>219</td> <td>150</td> <td>Notice of Appeal</td> <td>0.00</td> </tr> <tr> <td>120</td> <td>300</td> <td>220</td> <td>150</td> <td>Filing a brief in support of an appeal</td> <td>0.00</td> </tr> <tr> <td>121</td> <td>260</td> <td>221</td> <td>130</td> <td>Request for oral hearing</td> <td>0.00</td> </tr> <tr> <td>138</td> <td>1,510</td> <td>138</td> <td>1,510</td> <td>Petition to institute a public use proceeding</td> <td>0.00</td> </tr> <tr> <td>140</td> <td>110</td> <td>240</td> <td>55</td> <td>Petition to revive - unavoidable</td> <td>0.00</td> </tr> <tr> <td>141</td> <td>1,210</td> <td>241</td> <td>605</td> <td>Petition to revive - unintentional</td> <td>0.00</td> </tr> <tr> <td>142</td> <td>1,210</td> <td>242</td> <td>605</td> <td>Utility issue fee (or reissue)</td> <td>0.00</td> </tr> <tr> <td>143</td> <td>430</td> <td>243</td> <td>215</td> <td>Design issue fee</td> <td>0.00</td> </tr> <tr> <td>144</td> <td>580</td> <td>244</td> <td>290</td> <td>Plant issue fee</td> <td>0.00</td> </tr> <tr> <td>122</td> <td>130</td> <td>122</td> <td>130</td> <td>Petitions to the Commissioner</td> <td>0.00</td> </tr> <tr> <td>123</td> <td>50</td> <td>123</td> <td>50</td> <td>Petitions related to provisional applications</td> <td>0.00</td> </tr> <tr> <td>128</td> <td>240</td> <td>128</td> <td>240</td> <td>Submission of Information Disclosure Stmt</td> <td>0.00</td> </tr> <tr> <td>581</td> <td>40</td> <td>581</td> <td>40</td> <td>Recording each patent assignment per property (times number of properties)</td> <td>0.00</td> </tr> <tr> <td>146</td> <td>690</td> <td>246</td> <td>345</td> <td>Filing a submission after final rejection (37 CFR § 1.129(a))</td> <td>0.00</td> </tr> <tr> <td>149</td> <td>690</td> <td>249</td> <td>345</td> <td>For each additional invention to be examined (37 CFR § 1.129(b))</td> <td>0.00</td> </tr> <tr> <td colspan="5">Other fee (specify) _____</td> <td>0.00</td> </tr> <tr> <td colspan="5">Other fee (specify) _____</td> <td>0.00</td> </tr> <tr> <td colspan="5"><b>SUBTOTAL (3)</b></td> <td><b>(\$)</b> 65.00</td> </tr> </tbody> </table> <p>* Reduced by Basic Filing Fee Paid</p>	Large Entity Code	Large Entity Fee (\$)	Small Entity Code	Small Entity Fee (\$)	Fee Description	Fee Paid	105	130	205	65	Surcharge - late filing fee or oath	65.00	127	50	227	25	Surcharge - late provisional filing fee or cover sheet	0.00	139	130	139	130	Non-English specification	0.00	147	2,520	147	2,520	For filing a request for reexamination	0.00	112	920*	112	920*	Requesting publication of SIR prior to Examiner action	0.00	113	1,840*	113	1,840*	Requesting publication of SIR after Examiner action	0.00	115	110	215	55	Extension for reply within first month	0.00	116	380	216	190	Extension for reply within second month	0.00	117	670	217	435	Extension for reply within third month	0.00	118	1,360	218	680	Extension for reply within fourth month	0.00	128	1,850	228	925	Extension for reply within fifth month	0.00	119	300	219	150	Notice of Appeal	0.00	120	300	220	150	Filing a brief in support of an appeal	0.00	121	260	221	130	Request for oral hearing	0.00	138	1,510	138	1,510	Petition to institute a public use proceeding	0.00	140	110	240	55	Petition to revive - unavoidable	0.00	141	1,210	241	605	Petition to revive - unintentional	0.00	142	1,210	242	605	Utility issue fee (or reissue)	0.00	143	430	243	215	Design issue fee	0.00	144	580	244	290	Plant issue fee	0.00	122	130	122	130	Petitions to the Commissioner	0.00	123	50	123	50	Petitions related to provisional applications	0.00	128	240	128	240	Submission of Information Disclosure Stmt	0.00	581	40	581	40	Recording each patent assignment per property (times number of properties)	0.00	146	690	246	345	Filing a submission after final rejection (37 CFR § 1.129(a))	0.00	149	690	249	345	For each additional invention to be examined (37 CFR § 1.129(b))	0.00	Other fee (specify) _____					0.00	Other fee (specify) _____					0.00	<b>SUBTOTAL (3)</b>					<b>(\$)</b> 65.00
Large Entity Code	Large Entity Fee (\$)	Small Entity Code	Small Entity Fee (\$)	Fee Description	Fee Paid																																																																																																																																																																																																																																																																																				
101	690	201	345	Utility filing fee	355.00																																																																																																																																																																																																																																																																																				
106	310	206	155	Design filing fee																																																																																																																																																																																																																																																																																					
107	480	207	240	Plant filing fee																																																																																																																																																																																																																																																																																					
108	690	208	345	Reissue filing fee																																																																																																																																																																																																																																																																																					
114	150	214	75	Provisional filing fee																																																																																																																																																																																																																																																																																					
<b>SUBTOTAL (1)</b>					<b>(\$)</b> 355.00																																																																																																																																																																																																																																																																																				
Total Claims	Extra Claims	Fee from below	Fee Paid																																																																																																																																																																																																																																																																																						
9	-20** = 0	X 9	= 0																																																																																																																																																																																																																																																																																						
2	-3** = 0	X 40	= 0																																																																																																																																																																																																																																																																																						
Multiple Dependent = 0																																																																																																																																																																																																																																																																																									
Large Entity Code	Large Entity Fee (\$)	Small Entity Code	Small Entity Fee (\$)	Fee Description	Fee Paid																																																																																																																																																																																																																																																																																				
103	18	203	9	Claims in excess of 20																																																																																																																																																																																																																																																																																					
102	78	202	39	Independent claims in excess of 3																																																																																																																																																																																																																																																																																					
104	260	204	130	Multiple dependent claim, if not paid																																																																																																																																																																																																																																																																																					
109	78	209	39	** Reissue independent claims over original patent																																																																																																																																																																																																																																																																																					
110	18	210	9	** Reissue claims in excess of 20 and over original patent																																																																																																																																																																																																																																																																																					
<b>SUBTOTAL (2)</b>					<b>(\$)</b> 0.00																																																																																																																																																																																																																																																																																				
Large Entity Code	Large Entity Fee (\$)	Small Entity Code	Small Entity Fee (\$)	Fee Description	Fee Paid																																																																																																																																																																																																																																																																																				
105	130	205	65	Surcharge - late filing fee or oath	65.00																																																																																																																																																																																																																																																																																				
127	50	227	25	Surcharge - late provisional filing fee or cover sheet	0.00																																																																																																																																																																																																																																																																																				
139	130	139	130	Non-English specification	0.00																																																																																																																																																																																																																																																																																				
147	2,520	147	2,520	For filing a request for reexamination	0.00																																																																																																																																																																																																																																																																																				
112	920*	112	920*	Requesting publication of SIR prior to Examiner action	0.00																																																																																																																																																																																																																																																																																				
113	1,840*	113	1,840*	Requesting publication of SIR after Examiner action	0.00																																																																																																																																																																																																																																																																																				
115	110	215	55	Extension for reply within first month	0.00																																																																																																																																																																																																																																																																																				
116	380	216	190	Extension for reply within second month	0.00																																																																																																																																																																																																																																																																																				
117	670	217	435	Extension for reply within third month	0.00																																																																																																																																																																																																																																																																																				
118	1,360	218	680	Extension for reply within fourth month	0.00																																																																																																																																																																																																																																																																																				
128	1,850	228	925	Extension for reply within fifth month	0.00																																																																																																																																																																																																																																																																																				
119	300	219	150	Notice of Appeal	0.00																																																																																																																																																																																																																																																																																				
120	300	220	150	Filing a brief in support of an appeal	0.00																																																																																																																																																																																																																																																																																				
121	260	221	130	Request for oral hearing	0.00																																																																																																																																																																																																																																																																																				
138	1,510	138	1,510	Petition to institute a public use proceeding	0.00																																																																																																																																																																																																																																																																																				
140	110	240	55	Petition to revive - unavoidable	0.00																																																																																																																																																																																																																																																																																				
141	1,210	241	605	Petition to revive - unintentional	0.00																																																																																																																																																																																																																																																																																				
142	1,210	242	605	Utility issue fee (or reissue)	0.00																																																																																																																																																																																																																																																																																				
143	430	243	215	Design issue fee	0.00																																																																																																																																																																																																																																																																																				
144	580	244	290	Plant issue fee	0.00																																																																																																																																																																																																																																																																																				
122	130	122	130	Petitions to the Commissioner	0.00																																																																																																																																																																																																																																																																																				
123	50	123	50	Petitions related to provisional applications	0.00																																																																																																																																																																																																																																																																																				
128	240	128	240	Submission of Information Disclosure Stmt	0.00																																																																																																																																																																																																																																																																																				
581	40	581	40	Recording each patent assignment per property (times number of properties)	0.00																																																																																																																																																																																																																																																																																				
146	690	246	345	Filing a submission after final rejection (37 CFR § 1.129(a))	0.00																																																																																																																																																																																																																																																																																				
149	690	249	345	For each additional invention to be examined (37 CFR § 1.129(b))	0.00																																																																																																																																																																																																																																																																																				
Other fee (specify) _____					0.00																																																																																																																																																																																																																																																																																				
Other fee (specify) _____					0.00																																																																																																																																																																																																																																																																																				
<b>SUBTOTAL (3)</b>					<b>(\$)</b> 65.00																																																																																																																																																																																																																																																																																				

<b>SUBMITTED BY</b>		<b>Complete (if applicable)</b>	
Name (Print/Type)	Jeffrey W. Smith	Registration No. (Attorney/Agent)	33455
Signature	<i>Jeffrey W. Smith</i>	Telephone	(608) 257-7766
		Date	April 16, 2001

WARNING:

Information on this form may become public. Credit card information should not be included on this form. Provide credit card information and authorization on PTO-2038.

Burden Hour Statement: This form is estimated to take 0.2 hours to complete. Time will vary depending upon the needs of the individual case. Any comments on the amount of time you are required to complete this form should be sent to the Chief Information Officer, Patent and Trademark Office, Washington, DC 20231. DO NOT SEND FEES OR COMPLETED FORMS TO THIS ADDRESS. SEND TO: Assistant Commissioner for Patents, Washington, DC 20231.





PATENT APPLICATION

**IN THE UNITED STATES PATENT AND TRADEMARK OFFICE**

Applicant: Nathan Pyles  
Filed: January 4, 2001  
For: PEDOMETER  
Docket No.: KNOWMO-6

Box Missing Parts  
Assistant Commissioner for Patents  
Washington, D.C. 20231

"Express Mail" Mailing Label No.: EL055846909US  
Date of Deposit: April 16, 2001

I hereby certify that these attached documents

- Response postcard
- Check in the amount of \$420.00
- PTO/SB 21 (1p)
- PTO/SB 17 (1p) and 1 copy
- Notice to File Missing Parts of Nonprovisional Application (1p)
- Transmittal of Missing Parts (2pp) and 1 copy
- Small Entity Statement – Small Business Concern (1p)
- Executed Declaration and Power of Attorney (3pp)

are being deposited with the United States Postal Service "Express Mail Post Office to Addressee" service under 35 C.F.R. §1.10 on the date indicated above and is addressed to the Assistant Commissioner for Patents, Washington, D.C. 20231.

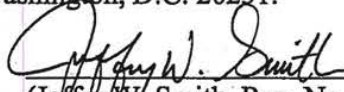
  
(Jeffrey W. Smith, Reg. No. 33455)

Enclosed for filing please find the above-referenced documents. Please indicate receipt of these documents by returning the attached postcard with the official Patent and Trademark Office receipt stamped thereon.

Respectfully submitted,

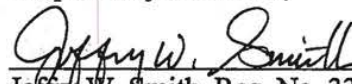
  
Jeffrey W. Smith, Reg. No. 33455  
Attorney for Applicant  
Lathrop & Clark LLP  
P.O. Box 1507  
Madison, Wisconsin 53701-1507  
(608) 257-7766



RECEIVED  
PATENT APPLICATION  
AUG 22 2001  
TECHNOLOGY CENTER 2800

#4

In the United States Patent and Trademark Office

Applicant: Nathan Pyles  
Docket No.: KNOWMO-6  
Date: June 6, 2001  
Application No.: 09/756,647  
Filed: January 4, 2001  
Art Unit: 2816  
Examiner:  
For: PEDOMETER

**Certificate of Mailing**  
I hereby certify that this correspondence is being deposited with the United States Postal Service as first class mail in an envelope addressed to: Office of Initial Patent Examination's Customer Service Center, Assistant Commissioner for Patents, Washington, D.C. 20231  
On June 6, 2001  
Signature Jeffrey W. Smith  
Jeffrey W. Smith, Reg. No. 33455  
Name of Applicant, assignee or Registered Representative

**REQUEST TO CORRECT ERRONEOUS RECORD ON FILING RECEIPT**

Office of Initial Patent Examination's  
Customer Service Center  
Assistant Commissioner for Patents  
Washington, D.C. 20231

Dear Sir:

Responsive to the Filing Receipt received on May 31, 2001, Applicant hereby respectfully requests that the following error be corrected:

The Applicant's residence should be **Lake Mills, WI.**

A copy of the Filing Receipt with the change noted in red thereon is enclosed.

Respectfully submitted,  
Jeffrey W. Smith  
Jeffrey W. Smith, Reg. No. 33455  
Attorney for Applicant  
LATHROP & CLARK LLP  
740 Regent Street, Suite 400  
P.O. Box 1507  
Madison, Wisconsin 53701-1507  
(608) 257-7766



UNITED STATES PATENT AND TRADEMARK OFFICE

RECEIVED

COMMISSIONER FOR PATENTS  
 UNITED STATES PATENT AND TRADEMARK OFFICE  
 WASHINGTON, D.C. 20231  
 www.uspto.gov

APPLICATION NUMBER	FILING DATE	GRP ART UNIT	FIL FEE REC'D	ATTY. DOCKET NO	DRAWINGS	INTL CLAIMS	IND CLAIMS
09/756,647	01/04/2001	2816	420	KNOWMO-6	1	9	2

020455  
 LATHROP & CLARK LLP  
 740 REGENT STREET SUITE 400  
 P.O. BOX 1507  
 MADISON, WI 537011507

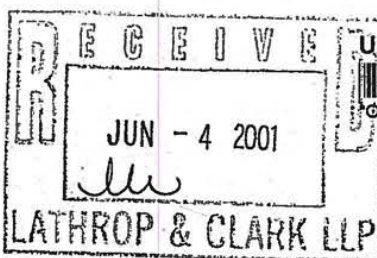

CONFIRMATION NO. 7058

UPDATED FILING RECEIPT



©C000000006133328\*

Date Mailed: 05/31/2001

Receipt is acknowledged of this nonprovisional Patent Application. It will be considered in its order and you will be notified as to the results of the examination. Be sure to provide the U.S. APPLICATION NUMBER, FILING DATE, NAME OF APPLICANT, and TITLE OF INVENTION when inquiring about this application. Fees transmitted by check or draft are subject to collection. Please verify the accuracy of the data presented on this receipt. If an error is noted on this Filing Receipt, please write to the Office of Initial Patent Examination's Customer Service Center. Please provide a copy of this Filing Receipt with the changes noted thereon. If you received a "Notice to File Missing Parts" for this application, please submit any corrections to this Filing Receipt with your reply to the Notice. When the USPTO processes the reply to the Notice, the USPTO will generate another Filing Receipt incorporating the requested corrections (if appropriate).

**Applicant(s)**

Nathan Pyles, Lake Mills, WI

**Domestic Priority data as claimed by applicant**

THIS APPLICATION IS A CON OF 09/181,738 10/28/1998 PAT 6,175,608

**Foreign Applications**

If Required, Foreign Filing License Granted 01/31/2001

Projected Publication Date: 09/06/2001

Non-Publication Request: No

Early Publication Request: No

\*\* SMALL ENTITY \*\*

**Title**

Pedometer

**Preliminary Class**



Receipt



Please type a plus sign (+) inside this box →

Approved for use through 09/30/2000. OMB 0651-0031 Patent and Trademark Office: U.S. DEPARTMENT OF COMMERCE

RECEIVED AUG 22 2001 TECHNOLOGY CENTER 2800

<b>TRANSMITTAL FORM</b> <small>(to be used for all correspondence after initial filing)</small>	Application Number	09/756,647
	Filing Date	January 4, 2001
	First Named Inventor	Nathan Pyles
	Group Art Unit	2816
	Examiner Name	
Total Number of Pages in This Submission	Attorney Docket Number <b>KNOWMO-6</b>	

ENCLOSURES (check all that apply)		
<input type="checkbox"/> Fee Transmittal Form	<input type="checkbox"/> Assignment Papers (for an Application)	<input type="checkbox"/> After Allowance Communication to Group
<input type="checkbox"/> Fee Attached	<input type="checkbox"/> Drawing(s)	<input type="checkbox"/> Appeal Communication to Board of Appeals and Interferences
<input type="checkbox"/> Amendment / Response	<input type="checkbox"/> Licensing-related Papers	<input type="checkbox"/> Appeal Communication to Group (Appeal Notice, Brief, Reply Brief)
<input type="checkbox"/> After Final	<input type="checkbox"/> Petition Routing Slip (PTO/SB/69) and Accompanying Petition	<input type="checkbox"/> Proprietary Information
<input type="checkbox"/> Affidavits/declaration(s)	<input type="checkbox"/> Petition to Convert to a Provisional Application	<input type="checkbox"/> Status Letter
<input type="checkbox"/> Extension of Time Request	<input type="checkbox"/> Power of Attorney, Revocation Change of Correspondence Address	<input checked="" type="checkbox"/> Additional Enclosure(s) (please identify below):
<input type="checkbox"/> Express Abandonment Request	<input type="checkbox"/> Terminal Disclaimer	Request to Correct Erroneous Record on Filing Receipt and copy of May 31, 2001 Filing Receipt
<input type="checkbox"/> Information Disclosure Statement	<input type="checkbox"/> Small Entity Statement	
<input type="checkbox"/> Certified Copy of Priority Document(s)	<input type="checkbox"/> Request for Refund	
<input type="checkbox"/> Response to Missing Parts/ Incomplete Application	Remarks	The Commissioner is hereby authorized to charge any additional fees that may be required with respect to this communication, or credit any overpayment, to Deposit Account No. 15-0660.
<input type="checkbox"/> Response to Missing Parts under 37 CFR 1.52 or 1.53		

SIGNATURE OF APPLICANT, ATTORNEY, OR AGENT	
Firm or Individual name	Jeffry W. Smith, Reg. No. 33455
Signature	<i>Jeffry W. Smith</i>
Date	June 6, 2001

CERTIFICATE OF MAILING			
I hereby certify that this correspondence is being deposited with the United States Postal Service as first class mail in an envelope addressed to: Assistant Commissioner for Patents, Washington, D.C. 20231 on this date: <input type="text"/>			
Typed or printed name	Jeffry W. Smith, Reg. No. 33455		
Signature	<i>Jeffry W. Smith</i>	Date	June 6, 2001

⊕ Burden Hour Statement: This form is estimated to take 0.2 hours to complete. Time will vary depending upon the needs of the individual case. Any comments on the amount of time you are required to complete this form should be sent to the Chief Information Officer Patent and Trademark Office, Washington, DC 20231. DO NOT SEND FEES OR COMPLETED FORMS TO THIS ADDRESS. SEND TO: Assistant Commissioner for Patents, Washington, DC 20231.



Please type a plus sign (+) inside this box →

Approved for use through 09/30/2000. OMB 0651-0031  
 Patent and Trademark Office: U.S. DEPARTMENT OF COMMERCE

Under the Paperwork Reduction Act of 1995, no persons are required to respond to a collection of information unless it displays a valid OMB control number.

RECEIVED  
 AUG 22 2001  
 POST CENTER 2800

<b>TRANSMITTAL FORM</b> (to be used for all correspondence after initial filing)	Application Number	09/756,647
	Filing Date	January 4, 2001
	First Named Inventor	Nathan Pyles
	Group Art Unit	2816
	Examiner Name	
Total Number of Pages in This Submission	Attorney Docket Number <b>KNOWMO-6</b>	

ENCLOSURES (check all that apply)		
<input type="checkbox"/> Fee Transmittal Form	<input type="checkbox"/> Assignment Papers (for an Application)	<input type="checkbox"/> After Allowance Communication to Group
<input type="checkbox"/> Fee Attached	<input type="checkbox"/> Drawing(s)	<input type="checkbox"/> Appeal Communication to Board of Appeals and Interferences
<input type="checkbox"/> Amendment / Response	<input type="checkbox"/> Licensing-related Papers	<input type="checkbox"/> Appeal Communication to Group (Appeal Notice, Brief, Reply Brief)
<input type="checkbox"/> After Final	<input type="checkbox"/> Petition Routing Slip (PTO/SB/69) and Accompanying Petition	<input type="checkbox"/> Proprietary Information
<input type="checkbox"/> Affidavits/declaration(s)	<input type="checkbox"/> Petition to Convert to a Provisional Application	<input type="checkbox"/> Status Letter
<input type="checkbox"/> Extension of Time Request	<input type="checkbox"/> Power of Attorney, Revocation Change of Correspondence Address	<input checked="" type="checkbox"/> Additional Enclosure(s) (please identify below):
<input type="checkbox"/> Express Abandonment Request	<input type="checkbox"/> Terminal Disclaimer	Request to Correct Erroneous Record on Filing Receipt and copy of May 31, 2001 Filing Receipt
<input type="checkbox"/> Information Disclosure Statement	<input type="checkbox"/> Small Entity Statement	
<input type="checkbox"/> Certified Copy of Priority Document(s)	<input type="checkbox"/> Request for Refund	
<input type="checkbox"/> Response to Missing Parts/ Incomplete Application	Remarks	The Commissioner is hereby authorized to charge any additional fees that may be required with respect to this communication, or credit any overpayment, to Deposit Account No. 15-0660.
<input type="checkbox"/> Response to Missing Parts under 37 CFR 1.52 or 1.53		

SIGNATURE OF APPLICANT, ATTORNEY, OR AGENT	
Firm or Individual name	Jeffry W. Smith, Reg. No. 33455
Signature	<i>Jeffry W. Smith</i>
Date	June 6, 2001

CERTIFICATE OF MAILING	
I hereby certify that this correspondence is being deposited with the United States Postal Service as first class mail in an envelope addressed to: Assistant Commissioner for Patents, Washington, D.C. 20231 on this date: _____	
Typed or printed name	Jeffry W. Smith, Reg. No. 33455
Signature	<i>Jeffry W. Smith</i>
Date	June 6, 2001

⊕ Burden Hour Statement: This form is estimated to take 0.2 hours to complete. Time will vary depending upon the needs of the individual case. Any comments on the amount of time you are required to complete this form should be sent to the Chief Information Officer Patent and Trademark Office, Washington, DC 20231. DO NOT SEND FEES OR COMPLETED FORMS TO THIS ADDRESS. SEND TO: Assistant Commissioner for Patents, Washington, DC 20231.



**UNITED STATES DEPARTMENT OF COMMERCE  
Patent and Trademark Office**

Address: COMMISSIONER OF PATENTS AND TRADEMARKS  
Washington, D.C. 20231

AKC

AKC

APPLICATION NO.	FILING DATE	FIRST NAMED INVENTOR	ATTORNEY DOCKET NO.
-----------------	-------------	----------------------	---------------------

09/756,647 01/04/01 PYLES

N KNOWMO-E  
EXAMINER

020455  
LATHROP & CLARK LLP  
740 REGENT STREET SUITE 400  
P.O. BOX 1507  
MADISON WI 53701-1507

MMC2/1113

ART UNIT PAPER NUMBER

DATE MAILED:

11/13/01

**Please find below and/or attached an Office communication concerning this application or proceeding.**

Commissioner of Patents and Trademarks

**Office Action Summary**

Application No. <b>09/756,647</b>	Applicant(s) <b>Pyles</b>
Examiner <b>Wambach</b>	Art Unit <b>2816</b>



-- The MAILING DATE of this communication appears on the cover sheet with the correspondence address --

**Period for Reply**

A SHORTENED STATUTORY PERIOD FOR REPLY IS SET TO EXPIRE 3 MONTH(S) FROM THE MAILING DATE OF THIS COMMUNICATION.

- Extensions of time may be available under the provisions of 37 CFR 1.136 (a). In no event, however, may a reply be timely filed after SIX (6) MONTHS from the mailing date of this communication.
- If the period for reply specified above is less than thirty (30) days, a reply within the statutory minimum of thirty (30) days will be considered timely.
- If NO period for reply is specified above, the maximum statutory period will apply and will expire SIX (6) MONTHS from the mailing date of this communication.
- Failure to reply within the set or extended period for reply will, by statute, cause the application to become ABANDONED (35 U.S.C. § 133).
- Any reply received by the Office later than three months after the mailing date of this communication, even if timely filed, may reduce any earned patent term adjustment. See 37 CFR 1.704(b).

**Status**

- 1)  Responsive to communication(s) filed on \_\_\_\_\_
- 2a)  This action is FINAL.
- 2b)  This action is non-final.
- 3)  Since this application is in condition for allowance except for formal matters, prosecution as to the merits is closed in accordance with the practice under *Ex parte Quayle*, 1935 C.D. 11; 453 O.G. 213.

**Disposition of Claims**

- 4)  Claim(s) 1-9 is/are pending in the application.
- 4a) Of the above, claim(s) \_\_\_\_\_ is/are withdrawn from consideration.
- 5)  Claim(s) 7-9 is/are allowed.
- 6)  Claim(s) 1 is/are rejected.
- 7)  Claim(s) 2-6 is/are objected to.
- 8)  Claims \_\_\_\_\_ are subject to restriction and/or election requirement.

**Application Papers**

- 9)  The specification is objected to by the Examiner.
- 10)  The drawing(s) filed on \_\_\_\_\_ is/are objected to by the Examiner.
- 11)  The proposed drawing correction filed on \_\_\_\_\_ is: a)  approved b)  disapproved.
- 12)  The oath or declaration is objected to by the Examiner.

**Priority under 35 U.S.C. § 119**

- 13)  Acknowledgement is made of a claim for foreign priority under 35 U.S.C. § 119(a)-(d).
  - a)  All b)  Some\* c)  None of:
    - 1.  Certified copies of the priority documents have been received.
    - 2.  Certified copies of the priority documents have been received in Application No. \_\_\_\_\_
    - 3.  Copies of the certified copies of the priority documents have been received in this National Stage application from the International Bureau (PCT Rule 17.2(a)).
- \*See the attached detailed Office action for a list of the certified copies not received.
- 14)  Acknowledgement is made of a claim for domestic priority under 35 U.S.C. § 119(e).

**Attachment(s)**

- 15)  Notice of References Cited (PTO-892)
- 16)  Notice of Draftsperson's Patent Drawing Review (PTO-948)
- 17)  Information Disclosure Statement(s) (PTO-1449) Paper No(s). \_\_\_\_\_
- 18)  Interview Summary (PTO-413) Paper No(s). \_\_\_\_\_
- 19)  Notice of Informal Patent Application (PTO-152)
- 20)  Other:



Application/Control Number: 09/756647

Page 2

Art Unit: 2816

### DETAILED ACTION

#### *Claim Objections*

1. Claims 4 and 7 are objected to because of the following informalities: "calculated" and "signal", respectively, are misspelled. Appropriate correction is required.

#### *Claim Rejections - 35 USC § 102*

2. The following is a quotation of the appropriate paragraphs of 35 U.S.C. 102 that form the basis for the rejections under this section made in this Office action:

A person shall be entitled to a patent unless --

(e) the invention was described in a patent granted on an application for patent by another filed in the United States before the invention thereof by the applicant for patent, or on an international application by another who has fulfilled the requirements of paragraphs (1), (2), and (4) of section 371(c) of this title before the invention thereof by the applicant for patent.

3. Claim 1 is rejected under 35 U.S.C. 102(e) as being clearly anticipated by Sham et al. Referring to Figure of Sham, an exercise monitoring device is taught which includes a strap for releasably securing the exercise monitoring device to a user (the strap connected to 14), a step counter (within 14) and a heart rate monitor (within 14) as recited in claim 1.

#### *Allowable Subject Matter*

4. Claims 2-6 are objected to as being dependent upon a rejected base claim, but would be allowable if rewritten in independent form including all of the limitations of the base claim and any intervening claims.
5. Claims 7-9 are allowed.

Application/Control Number: 09/756647

Page 3

Art Unit: 2816

Any inquiry concerning this communication or earlier communications from the examiner should be directed to Examiner Wambach whose telephone number is (703) 308-4875. The examiner can normally be reached on Monday-Thursday from 6:30 to 5p.m.

If attempts to reach the examiner by telephone are unsuccessful, the examiner's supervisor, Tim Callahan, can be reached on (703) 308-4876. The fax phone number for this Group is (703) 308-7722.

Any inquiry of a general nature or relating to the status of this application or proceeding should be directed to the Group receptionist whose telephone number is (703) 308-0956.

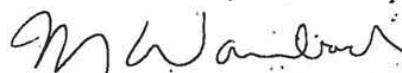

Margaret R. Wambach  
Primary Examiner

**Notice of References Cited**

Applicant/Patent Pyles	Application/Control No. 09/756,647	
Examiner Wambach	Art Unit 2816	Page 1 of 1

**U.S. PATENT DOCUMENTS**

	Document Number Country Code-Number-Kind Code	Date MM-YYYY <sup>1</sup>	Name	Classification <sup>2</sup>
A	5,891,042	4/1999	Sham et al.	600 483
B				
C				
D				
E				
F				
G				
H				
I				
J				
K				
L				
M				

**FOREIGN PATENT DOCUMENTS**

	Document Number Country Code-Number-Kind Code	Date MM-YYYY <sup>1</sup>	Country	Name	Classification <sup>2</sup>
N					
O					
P					
Q					
R					
S					
T					

**NON-PATENT DOCUMENTS**

	Include, as applicable: Author, Title, Date, Publisher, Edition or Volume, Pertinent Pages
U	
V	
W	
X	

<sup>1</sup> A copy of this reference is not being furnished with this Office action. See MPEP § 707.05(a). <sup>2</sup> Dates in MM-YYYY format are publication dates. <sup>3</sup> Classifications may be U.S. or foreign.



PATENT APPLICATION

In the United States Patent and Trademark Office

RECEIVED  
JAN 18 2002  
TC 2003 MAIL ROOM

Handwritten initials and date: 1/25/02

Applicant: Nathan Pyles  
Docket No.: KNOWMO-6  
Date: November 19, 2001  
Application No.: 09/756,647  
Filed: January 4, 2001  
Art Unit: 2816  
Examiner:  
For: PEDOMETER

**Certificate of Mailing**

I hereby certify that this correspondence is being deposited with the United States Postal Service as first class mail in an envelope addressed to:  
Assistant Commissioner for Patents  
Washington, D.C. 20231

On November 19, 2001  
Signature Jeffrey W. Smith  
Name of Applicant, assignee or Registered Representative  
Jeffrey W. Smith, Reg. No. 33455

**INFORMATION DISCLOSURE STATEMENT**

Assistant Commissioner for Patents  
Washington, D.C. 20231

Dear Sir:

In accordance with 37 C.F.R. §1.56, Applicant wishes to call the attention of the Examiner to the following documents:

United States Patents

<u>United States Patent No.</u>	<u>Issue Date</u>	<u>Patentee</u>
4,053,755	10-11-1977	Sherrill
4,144,568	03-13-1979	Hiller et al.
4,192,000	03-04-1980	Lipsey
4,220,996	09-02-1980	Searcy
4,223,211	09-16-1980	Allsen et al.
4,334,190	06-08-1982	Sochaczewski
4,337,529	06-29-1982	Morokawa
4,367,752	01-11-1983	Jiminez
4,371,945	02-01-1983	Karr et al.

Applicant: Nathan Pyles  
Application No.: 09/756,647

4,387,437	06-07-1983	Lowrey et al.
4,460,823	07-17-1984	Ruehleemann
4,466,204	08-21-1984	Wu
4,499,394	02-12-1985	Koal
4,510,704	04-16-1985	Johnson
4,560,861	12-24-1985	Kato et al.
4,566,461	01-28-1986	Lubell et al.
4,578,769	03-25-1986	Frederick
4,649,552	03-10-1987	Yukawa
4,651,446	03-24-1987	Yukawa
4,703,445	10-27-1987	Dassler
4,741,001	04-26-1988	Ma
4,763,287	08-09-1988	Gerhaeuser et al.
4,771,394	09-13-1988	Cavanagh
4,814,661	03-21-1989	Ratzlaff
4,821,218	04-11-1989	Potsch
4,830,021	05-16-1989	Thornton
4,848,009	07-18-1989	Rodgers
4,855,942	08-08-1989	Bianco
4,956,628	09-11-1990	Furlong
4,962,469	10-09-1990	Ono et al.
5,033,013	07-16-1991	Kato et al.
5,065,414	11-12-1991	Endou et al.
5,117,444	05-26-1992	Sutton et al.
5,164,967	11-17-1992	Endo et al.
5,188,447	02-23-1993	Chiang
5,285,586	02-15-1994	Goldston
5,335,664	10-09-1994	Nagashima
5,361,778	11-08-1994	Seitz
5,373,651	12-20-1994	Wood
5,456,262	10-10-1995	Birnbaum
5,457,900	10-17-1995	Roy
5,475,725	12-12-1995	Nakamura
5,476,427	12-19-1995	Fujima
5,485,402	01-16-1996	Smith et al.
5,490,816	02-13-1996	Sakumoto
5,491,474	02-13-1996	Suni
5,500,635	03-19-1996	Mott
5,516,334	05-14-1996	Easton
5,526,290	06-11-1996	Kanzaki
5,539,706	07-23-1996	Takenaka
5,583,776	12-10-1996	Levi et al.
5,611,621	03-18-1997	Chien
5,640,786	06-24-1997	Buyayez
5,689,099	11-18-1997	Domburg
5,720,200	02-24-1998	Anderson

Applicant: Nathan Pyles  
Application No.: 09/756,647

5,724,265	03-03-1998	Hutchings
5,797,201	10-25-1998	Huang
5,891,042	04-06-1999	Sham et al.
5,899,963	05-04-1999	Hutchings
5,918,502	07-06-1999	Bishop
5,945,911	10-31-1999	Healy
5,976,083	11-02-1999	Richardson et al.
6,018,705	01-25-2000	Gaudet et al.
6,175,608	01-16-2001	Pyles et al.

Foreign Patent Documents

<u>Patent No.</u>	<u>Publication Date</u>	<u>Patentee</u>
EP 0 119 009 A1	19-09-1984	Frederick

Other Documents

Form PCT/IPEA/408, Written Opinion received August 8, 2000, 5pgs.

Form PCT/ISA/210, International Search Report, 4pgs.

Sportsline Products, "Fitness Pedometer 360", web page, 1pg.

Sportsline Products, Fitness Pedometer 360 packaging label, 5 pgs.

Copies of these documents are submitted herewith along with Form PTO/SB 08a and/or PTO/SB 08b.

Applicant respectfully requests that these documents be expressly considered during the prosecution of this application and made of record herein and appear among the "documents cited" on any patent to issue herefrom.

Applicant: Nathan Pyles  
Application No.: 09/756,647

Respectfully submitted,

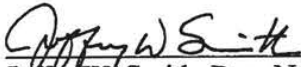
  
Jeffrey W. Smith, Reg. No. 33455  
Attorney for Applicant  
LATHROP & CLARK LLP  
740 Regent Street, Suite 400  
P.O. Box 1507  
Madison, Wisconsin 53701-1507  
(608) 257-7766



6#

PTO/SB/08A (10-01)  
 Approved for use through 10/31/2002, OMB 0851-0031  
 U.S. Patent and Trademark Office: U.S. DEPARTMENT OF COMMERCE

Under the Paperwork Reduction Act of 1995, no persons are required to respond to a collection of information unless it contains a valid OMB control number.

Substitute for form 1449A/PTO		<b>Complete if Known</b>	
<b>INFORMATION DISCLOSURE STATEMENT BY APPLICANT</b> <i>(use as many sheets as necessary)</i>		Application Number	09/756.647
		Filing Date	01/04/2001
		First Named Inventor	Nathan Pyles
		Art Unit	2816
		Examiner Name	Nambach
Sheet	1	of	1
		Attorney Docket Number	KNOWMO-6

U.S. PATENT DOCUMENTS						
Examiner Initials*	Cite No. <sup>1</sup>	Document Number		Publication Date MM-DD-YYYY	Name of Patentee or Applicant of Cited Document	Pages, Columns, Lines, Where Relevant Passages or Relevant Figures Appear
		Number	-Kind Code <sup>2</sup> (if known)			
MW		US-4,053,755		10-11-1977	Sherrill	
MW		US-4,144,568		03-13-1979	Hiller et al.	
MW		US-4,192,000		03-04-1980	Lipsey	
MW		US-4,220,996		09-02-1980	Searcy	
MW		US-4,223,211		09-16-1980	Allsen et al.	
MW		US-4,334,190		06-08-1982	Sochaczewski	
MW		US-4,337,529		06-29-1982	Morokawa	
MW		US-4,367,752		01-11-1983	Jiminez	
MW		US-4,371,945		02-01-1983	Karr et al.	
MW		US-4,387,437		06-07-1983	Lowrey et al.	
MW		US-4,460,823		07-17-1984	Ruehlmann	
MW		US-4,466,204		08-21-1984	Wu	
MW		US-4,499,394		02-12-1985	Koal	
MW		US-4,510,704		04-16-1985	Johnson	
MW		US-4,560,861		12-24-1985	Kato et al.	
MW		US-4,566,461		01-28-1986	Lubell et al.	
MW		US-4,578,769		03-25-1986	Frederick	
MW		US-4,649,552		03-10-1987	Yukawa	
MW		US-4,651,446		03-24-1987	Yukawa	
MW		US-4,703,445		10-27-1987	Dassler	

FOREIGN PATENT DOCUMENTS							
Examiner Initials*	Cite No. <sup>1</sup>	Foreign Patent Document		Publication Date MM-DD-YYYY	Name of Patentee or Applicant of Cited Document	Pages, Columns, Lines, Where Relevant Passages or Relevant Figures Appear	T <sup>6</sup>
		Country Code <sup>3</sup>	-Number <sup>4</sup> -Kind Code <sup>5</sup> (if known)				
MW		EP	0 119 009 A1	09-19-1984	Frederick		

Examiner Signature	Nambach	Date Considered	2/02
--------------------	---------	-----------------	------

\*EXAMINER: Initial if reference considered, whether or not citation is in conformance with MPEP 609. Draw line through citation if not in conformance and not considered. Include copy of this form with next communication to applicant.  
<sup>1</sup> Applicant's unique citation designation number (optional). <sup>2</sup> See Kinds Codes of USPTO Patent Documents at [www.uspto.gov](http://www.uspto.gov) or MPEP 901.04. <sup>3</sup> Enter Office that issued the document, by the two-letter code (WIPO Standard ST.3). <sup>4</sup> For Japanese patent documents, the indication of the year of the reign of the Emperor must precede the serial number of the patent document. <sup>5</sup> Kind of document by the appropriate symbols as indicated on the document under WIPO Standard ST. 16 if possible. <sup>6</sup> Applicant is to place a check mark here if English language Translation is attached.  
 Burden Hour Statement: This form is estimated to take 2.0 hours to complete. Time will vary depending upon the needs of the individual case. Any comments on the amount of time you are required to complete this form should be sent to the Chief Information Officer, U.S. Patent and Trademark Office, Washington, DC 20231. DO NOT SEND FEES OR COMPLETED FORMS TO THIS ADDRESS. SEND TO: Assistant Commissioner for Patents, Washington, DC 20231.





PTO/SB/08A (10-01)

Approved for use through 10/31/2002. OMB 0851-0031

U.S. Patent and Trademark Office: U.S. DEPARTMENT OF COMMERCE

Under the Paperwork Reduction Act of 1995, no persons are required to respond to a collection of information unless it contains a valid OMB control number.

Substitute for form 1449A/PTO		<b>Complete if Known</b>	
<b>INFORMATION DISCLOSURE STATEMENT BY APPLICANT</b> <i>(use as many sheets as necessary)</i>		Application Number	09/756,647
		Filing Date	01/04/2001
		First Named Inventor	Nathan Pyles
		Art Unit	2816
		Examiner Name	Janbach
Sheet 1 of 1	Attorney Docket Number	KNOWMO-6	

U.S. PATENT DOCUMENTS					
Examiner Initials*	Cite No. <sup>1</sup>	Document Number Number-Kind Code <sup>2</sup> (if known)	Publication Date MM-DD-YYYY	Name of Patentee or Applicant of Cited Document	Pages, Columns, Lines, Where Relevant Passages or Relevant Figures Appear
MLW		US-4,741,001	04-26-1988	Ma	
MLW		US-4,763,287	08-09-1988	Gerhaeuser et al.	
MLW		US-4,771,394	09-13-1988	Cavanaugh	
MLW		US-4,814,661	03-21-1989	Ratzlaff	
MLW		US-4,821,218	04-11-1989	Potsch	
MLW		US-4,830,021	05-16-1989	Thornton	
MLW		US-4,848,009	07-18-1989	Rodgers	
MLW		US-4,855,942	08-08-1989	Bianco	
MLW		US-4,956,628	09-11-1990	Furlong	
MLW		US-4,962,469	10-09-1990	Ono et al.	
MLW		US-5,033,013	07-16-1991	Kato et al.	
MLW		US-5,065,414	11-12-1991	Endou et al.	
MLW		US-5,117,444	05-26-1992	Sutton et al.	
MLW		US-5,164,967	11-17-1992	Endo et al.	
MLW		US-5,188,447	02-23-1993	Chiang	
MLW		US-5,285,586	02-15-1994	Goldston	
MLW		US-5,335,664	10-09-1994	Nagashima	
MLW		US-5,361,778	11-08-1994	Seitz	
MLW		US-5,373,651	12-20-1994	Wood	
MLW		US-5,456,262	10-10-1995	Birnbaum	

Per MLW

FOREIGN PATENT DOCUMENTS							
Examiner Initials*	Cite No. <sup>1</sup>	Foreign Patent Document Country Code <sup>3</sup> -Number <sup>4</sup> -Kind Code <sup>5</sup> (if known)		Publication Date MM-DD-YYYY	Name of Patentee or Applicant of Cited Document	Pages, Columns, Lines, Where Relevant Passages or Relevant Figures Appear	T <sup>6</sup>

Examiner Signature	Janbach	Date Considered	3/02
--------------------	---------	-----------------	------

\*EXAMINER: Initial if reference considered, whether or not citation is in conformance with MPEP 609. Draw line through citation if not in conformance and not considered. Include copy of this form with next communication to applicant.  
<sup>1</sup> Applicant's unique citation designation number (optional). <sup>2</sup> See Kinds Codes of USPTO Patent Documents at [www.uspto.gov](http://www.uspto.gov) or MPEP 901.04. <sup>3</sup> Enter Office that issued the document, by the two-letter code (WIPO Standard ST.3). <sup>4</sup> For Japanese patent documents, the indication of the year of the reign of the Emperor must precede the serial number of the patent document. <sup>5</sup> Kind of document by the appropriate symbols as indicated on the document under WIPO Standard ST. 16 if possible. <sup>6</sup> Applicant is to place a check mark here if English language Translation is attached.

Burden Hour Statement: This form is estimated to take 2.0 hours to complete. Time will vary depending upon the needs of the individual case. Any comments on the amount of time you are required to complete this form should be sent to the Chief Information Officer, U.S. Patent and Trademark Office, Washington, DC 20231. DO NOT SEND FEES OR COMPLETED FORMS TO THIS ADDRESS. SEND TO: Assistant Commissioner for Patents, Washington, DC 20231.





PTO/SB/08A (10-01)

Approved for use through 10/31/2002. OMB 0651-0031  
U.S. Patent and Trademark Office: U.S. DEPARTMENT OF COMMERCE

Under the Paperwork Reduction Act of 1995, no persons are required to respond to a collection of information unless it contains a valid OMB control number.

Substitute for form 1449A/PTO		<b>Complete if Known</b>	
<b>INFORMATION DISCLOSURE STATEMENT BY APPLICANT</b> <i>(use as many sheets as necessary)</i>		Application Number	09/756,647
		Filing Date	01/04/2001
		First Named Inventor	Nathan Pyles
		Art Unit	2816
		Examiner Name	Wambach
Sheet 1 of 1	Attorney Docket Number	KNOWMO-6	

U.S. PATENT DOCUMENTS						
Examiner Initials*	Cite No. <sup>1</sup>	Document Number		Publication Date MM-DD-YYYY	Name of Patentee or Applicant of Cited Document	Pages, Columns, Lines, Where Relevant Passages or Relevant Figures Appear
		Number-Kind Code <sup>2</sup> (if known)				
MW		US-5,945,911	8	10-31-1999	Healy	
MW		US-5,976,083		11-02-1999	Richardson et al.	
MW		US-6,018,705		01-25-2000	Gaudet et al.	
MW		US-6,175,608		01-16-2001	Pyles et al.	
		US-				
		US-				
		US-				
		US-				
		US-				
		US-				
		US-				
		US-				
		US-				
		US-				
		US-				
		US-				
		US-				
		US-				
		US-				
		US-				
		US-				
		US-				
		US-				

FOREIGN PATENT DOCUMENTS								
Examiner Initials*	Cite No. <sup>1</sup>	Foreign Patent Document			Publication Date MM-DD-YYYY	Name of Patentee or Applicant of Cited Document	Pages, Columns, Lines, Where Relevant Passages or Relevant Figures Appear	T <sup>6</sup>
		Country Code <sup>3</sup>	Number <sup>4</sup>	Kind Code <sup>5</sup> (if known)				

Examiner Signature	Wambach	Date Considered	3/10/02
--------------------	---------	-----------------	---------

\*EXAMINER: Initial if reference considered, whether or not citation is in conformance with MPEP 809. Draw line through citation if not in conformance and not considered. Include copy of this form with next communication to applicant.  
<sup>1</sup> Applicant's unique citation designation number (optional). <sup>2</sup> See Kinds Codes of USPTO Patent Documents at [www.uspto.gov](http://www.uspto.gov) or MPEP 901.04. <sup>3</sup> Enter Office that issued the document, by the two-letter code (WIPO Standard ST.3). <sup>4</sup> For Japanese patent documents, the indication of the year of the reign of the Emperor must precede the serial number of the patent document. <sup>5</sup> Kind of document by the appropriate symbols as indicated on the document under WIPO Standard ST. 16 if possible. <sup>6</sup> Applicant is to place a check mark here if English language translation is attached.

Burden Hour Statement: This form is estimated to take 2.0 hours to complete. Time will vary depending upon the needs of the individual case. Any comments on the amount of time you are required to complete this form should be sent to the Chief Information Officer, U.S. Patent and Trademark Office, Washington, DC 20231. DO NOT SEND FEES OR COMPLETED FORMS TO THIS ADDRESS. SEND TO: Assistant Commissioner for Patents, Washington, DC 20231.



PTO/SB/08B (10-01)  
 Approved for use through 10/31/2002. OMB 0851-0031  
 U.S. Patent and Trademark Office: U.S. DEPARTMENT OF COMMERCE

Under the Paperwork Reduction Act of 1995, no persons are required to respond to a collection of information unless it contains a valid OMB control number.

Substitute for form 1449B/PTO		<b>Complete if Known</b>	
<b>INFORMATION DISCLOSURE STATEMENT BY APPLICANT</b>  <i>(use as many sheets as necessary)</i>		Application Number	09/756.647
		Filing Date	01/04/2001
		First Named Inventor	Nathan Pyles
		Group Art Unit	2816
		Examiner Name	
		Attorney Docket Number	KNOWMO-6
Sheet	1	of	1

OTHER PRIOR ART -- NON PATENT LITERATURE DOCUMENTS			
Examiner Initials*	Cite No. <sup>1</sup>	Include name of the author (in CAPITAL LETTERS), title of the article (when appropriate), title of the item (book, magazine, journal, serial, symposium, catalog, etc.), date, page(s), volume-issue number(s), publisher, city and/or country where published.	T <sup>2</sup>
MW		Form PCT/IPEA/408, Written Opinion received August 8, 2000, 5pgs.	
MW		Form PCT/ISA/210, International Search Report, 4pgs.	
MW		Sportline Products, "Fitness Pedometer 360", web page, 1pg.	
MW		Sportline Products, Fitness Pedometer 360 packaging label, 5pgs.	

Examiner Signature	<i>Narbaul</i>	Date Considered	3/02
--------------------	----------------	-----------------	------

\*EXAMINER: Initial if reference considered, whether or not citation is in conformance with MPEP 609. Draw line through citation if not in conformance and not considered. Include copy of this form with next communication to applicant.  
<sup>1</sup> Applicant's unique citation designation number (optional). <sup>2</sup> Applicant is to place a check mark here if English language Translation is attached.  
 Burden Hour Statement: This form is estimated to take 2.0 hours to complete. Time will vary depending upon the needs of the individual case. Any comments on the amount of time you are required to complete this form should be sent to the Chief Information Officer, U.S. Patent and Trademark Office, Washington, DC 20231. DO NOT SEND FEES OR COMPLETED FORMS TO THIS ADDRESS. SEND TO: Assistant Commissioner for Patents, Washington, DC 20231.

PATENT COOPERATION TREATY

**RECEIVED**  
AUG - 7 2000  
LATHROP & CLARK LLP

From the INTERNATIONAL PRELIMINARY EXAMINING AUTHORITY

RESPONSE DUE 10/1/00

To: JEFFRY W. SMITH  
LATHROP & CLARK LLP  
740 REGENT STREET, SUITE 400  
P.O. BOX 1507  
MADISON WI 53701-1507

ACTION *Resp. to Written Opinion Due*

WRITTEN BY LATHROP & CLARK LLP

DOCKETED

BY: *llh*

DATE: 8/8/00 (PCT Rule 66)

BY: TICKLER

DATE:

BY:

DATE:

Date of Mailing (day/month/year) **AUG 2000**

Applicant's or agent's file reference  
EPIXINC-9

REPLY DUE within TWO months from the above date of mailing

International application No.  
PCT/US99/25314

International filing date (day/month/year)  
28 OCTOBER 1999

Priority date (day/month/year)  
28 OCTOBER 1998

International Patent Classification (IPC) or both national classification and IPC  
IPC(7): GOIC 21/00 and US Cl.: 377/24.2

Applicant  
Epix, Inc.

1. This written opinion is the first (first, etc.) drawn by this International Preliminary Examining Authority.

2. This opinion contains indications relating to the following items:

- I  Basis of the opinion
- II  Priority
- III  Non-establishment of opinion with regard to novelty, inventive step or industrial applicability
- IV  Lack of unity of invention
- V  Reasoned statement under Rule 66.2(a)(ii) with regard to novelty, inventive step or industrial applicability; citations and explanations supporting such statement
- VI  Certain documents cited
- VII  Certain defects in the international application
- VIII  Certain observations on the international application

3. The applicant is hereby invited to reply to this opinion.

**When?** See the time limit indicated above. The applicant may, before the expiration of that time limit, request this Authority to grant an extension, see Rule 66.2(d).

**How?** By submitting a written reply, accompanied, where appropriate, by amendments, according to Rule 66.3. For the form and the language of the amendments, see Rules 66.8 and 66.9.

**Also** For an additional opportunity to submit amendments, see Rule 66.4. For the examiner's obligation to consider amendments and/or arguments, see Rule 66.4 bis. For an informal communication with the examiner, see Rule 66.6.

If no reply is filed, the international preliminary examination report will be established on the basis of this opinion.

4. The final date by which the international preliminary examination report must be established according to Rule 69.2 is: 28 FEBRUARY 2001

Name and mailing address of the IPEA/US  
Commissioner of Patents and Trademarks  
Box PCT  
Washington, D.C. 20231  
Facsimile No. (703) 305-3230

Authorized officer  
MARGARET ROSE WAMBACH  
Telephone No. (703) 308-4875

PATENT COOPERATION TREATY

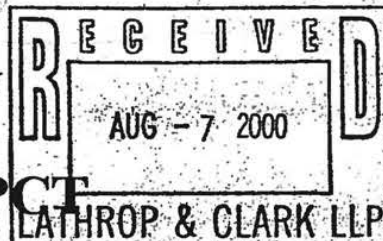

From the INTERNATIONAL PRELIMINARY EXAMINING AUTHORITY

To: JEFFRY W. SMITH  
LATHROP & CLARK LLP  
740 REGENT STREET, SUITE 400  
P.O. BOX 1507  
MADISON WI 53701-1507

WRITTEN OPINION  
(PCT Rule 66)

Date of Mailing (day/month/year)		01 AUG 2000
Applicant's or agent's file reference		REPLY DUE within TWO months from the above date of mailing
EPIXINC-9		
International application No.	International filing date (day/month/year)	Priority date (day/month/year)
PCT/US99/25314	28 OCTOBER 1999	28 OCTOBER 1998
International Patent Classification (IPC) or both national classification and IPC IPC(7): GO1C 21/00 and US Cl.: 377/24.2		
Applicant Epix, Inc.		

1. This written opinion is the first (first, etc.) drawn by this International Preliminary Examining Authority.

2. This opinion contains indications relating to the following items:

- I  Basis of the opinion
- II  Priority
- III  Non-establishment of opinion with regard to novelty, inventive step or industrial applicability
- IV  Lack of unity of invention
- V  Reasoned statement under Rule 66.2(a)(ii) with regard to novelty, inventive step or industrial applicability; citations and explanations supporting such statement
- VI  Certain documents cited
- VII  Certain defects in the international application
- VIII  Certain observations on the international application

3. The applicant is hereby invited to reply to this opinion.

When? See the time limit indicated above. ~~The applicant may, before the expiration of that time limit, request this Authority to grant an extension, see Rule 66.2(d).~~

How? By submitting a written reply, accompanied, where appropriate, by amendments, according to Rule 66.3. For the form and the language of the amendments, see Rules 66.8 and 66.9.

Also For an additional opportunity to submit amendments, see Rule 66.4. For the examiner's obligation to consider amendments and/or arguments, see Rule 66.4 bis. For an informal communication with the examiner, see Rule 66.6.

If no reply is filed, the international preliminary examination report will be established on the basis of this opinion.

4. The final date by which the international preliminary examination report must be established according to Rule 69.2 is: 28 FEBRUARY 2001

Name and mailing address of the IPEA/US Commissioner of Patents and Trademarks Box PCT Washington, D.C. 20231	Authorized officer MARGARET ROSE WAMBACH
Facsimile No. (703) 305-3230	Telephone No. (703) 308-4875

Form PCT/IPEA/408 (cover sheet) (July 1998)\*

WRITTEN OPINION

International application No.

PCT/US99/25314

I. Basis of the opinion

1. With regard to the elements of the international application:\*

the international application as originally filed

the description:

pages 1-23, as originally filed  
 pages NONE, filed with the demand  
 pages NONE, filed with the letter of \_\_\_\_\_

the claims:

pages 24-34, as originally filed  
 pages NONE, as amended (together with any statement) under Article 19  
 pages NONE, filed with the demand  
 pages NONE, filed with the letter of \_\_\_\_\_

the drawings:

pages 1, as originally filed  
 pages NONE, filed with the demand  
 pages NONE, filed with the letter of \_\_\_\_\_

the sequence listing part of the description:

pages NONE, as originally filed  
 pages NONE, filed with the demand  
 pages NONE, filed with the letter of \_\_\_\_\_

2. With regard to the language, all the elements marked above were available or furnished to this Authority in the language in which the international application was filed, unless otherwise indicated under this item.

These elements were available or furnished to this Authority in the following language \_\_\_\_\_ which is:

- the language of a translation furnished for the purposes of international search (under Rule 23.1(b)).
- the language of publication of the international application (under Rule 48.3(b)).
- the language of the translation furnished for the purposes of international preliminary examination (under Rules 55.2 and/or 55.3).

3. With regard to any nucleotide and/or amino acid sequence disclosed in the international application, the written opinion was drawn on the basis of the sequence listing:

- contained in the international application in printed form.
- filed together with the international application in computer readable form.
- furnished subsequently to this Authority in written form.
- furnished subsequently to this Authority in computer readable form.
- The statement that the subsequently furnished written sequence listing does not go beyond the disclosure in the international application as filed has been furnished.
- The statement that the information recorded in computer readable form is identical to the written sequence listing has been furnished.

4.  The amendments have resulted in the cancellation of:

- the description, pages NONE
- the claims, Nos. NONE
- the drawings, sheets/fig NONE

5.  This opinion has been drawn as if (some of) the amendments had not been made, since they have been considered to go beyond the disclosure as filed, as indicated in the Supplemental Box (Rule 70.2(c)).

\* Replacement sheets which have been furnished to the receiving Office in response to an invitation under Article 14 are referred to in this opinion as "originally filed".-

WRITTEN OPINION

International application No.

PCT/US99/25314

**V. Reasoned statement under Rule 66.2(a)(ii) with regard to novelty, inventive step or industrial applicability; citations and explanations supporting such statement**

**1. statement**

Novelty (N)	Claims <u>14-16, 28-54</u>	YES
	Claims <u>1-13 and 17-27</u>	NO
Inventive Step (IS)	Claims <u>14, 16, 28-54</u>	YES
	Claims <u>1-13 and 17-27</u>	NO
Industrial Applicability (IA)	Claims <u>1-54</u>	YES
	Claims <u>NONE</u>	NO

**2. citations and explanations**

Claims 1-13, 17-28 lack novelty under PCT Article 33(2) as being anticipated by Hutchins.

Hutchins discloses a device which wirelessly transmits data from a wrist sensor to another location, includes a display and a data processor which calculates a distance traveled by multiplying the number of strides taken by a stride length that varies according to a rate at which strides are taken.

Claims 14-16 and 29-54 meet the criteria set out in PCT Article 33(2)-(4), because the prior art does not teach or fairly suggest use of data input from runs or walks over known distances to establish a range of stride rate versus stride length data.

NEW CITATIONS

US 5724265 (Hutchings) 03 MAR 1998, see entire document.  
 US 5033013 (Kato et al) 16 JUL 1991, see entire document.



WRITTEN OPINION

International application No.

PCT/US99/25314

**Supplemental Box**  
(To be used when the space in any of the preceding boxes is not sufficient)

Continuation of: Boxes I - VIII

Sheet 10

**TIME LIMIT:**

The time limit set for response to a Written Opinion may not be extended. 37 CFR 1.484(d). Any response received after the expiration of the time limit set in the Written Opinion will not be considered in preparing the International Preliminary Examination Report.

PATENT COOPERATION TREATY

PCT

INTERNATIONAL SEARCH REPORT

(PCT Article 18 and Rules 43 and 44)

Applicant's or agent's file reference <b>EPIXINC-9</b>	<b>FOR FURTHER ACTION</b> see Notification of Transmittal of International Search Report (Form PCT/ISA/220) as well as, where applicable, Item 5 below.	
International application No. <b>PCT/US 99/ 25314</b>	International filing date (day/month/year) <b>28/10/1999</b>	(Earliest) Priority Date (day/month/year) <b>28/10/1998</b>
Applicant <b>EPIX, INC. et al.</b>		

This international Search Report has been prepared by this International Searching Authority and is transmitted to the applicant according to Article 18. A copy is being transmitted to the International Bureau.

This international Search Report consists of a total of 3 sheets.  
 It is also accompanied by a copy of each prior art document cited in this report.

1. Basis of the report

a. With regard to the language, the international search was carried out on the basis of the international application in the language in which it was filed, unless otherwise indicated under this item.

the international search was carried out on the basis of a translation of the international application furnished to this Authority (Rule 23.1(b)).

b. With regard to any nucleotide and/or amino acid sequence disclosed in the international application, the international search was carried out on the basis of the sequence listing:

contained in the international application in written form.

filed together with the international application in computer readable form.

furnished subsequently to this Authority in written form.

furnished subsequently to this Authority in computer readable form.

the statement that the subsequently furnished written sequence listing does not go beyond the disclosure in the international application as filed has been furnished.

the statement that the information recorded in computer readable form is identical to the written sequence listing has been furnished.

2.  Certain claims were found unsearchable (See Box I).

3.  Unity of invention is lacking (see Box II).

4. With regard to the title,

the text is approved as submitted by the applicant.

the text has been established by this Authority to read as follows:

5. With regard to the abstract,

the text is approved as submitted by the applicant.

the text has been established, according to Rule 38.2(b), by this Authority as it appears in Box III. The applicant may, within one month from the date of mailing of this international search report, submit comments to this Authority.

6. The figure of the drawings to be published with the abstract is Figure No.

as suggested by the applicant.

1

None of the figures.

because the applicant failed to suggest a figure.

because this figure better characterizes the invention.



INTERNATIONAL SEARCH REPORT

International Application No  
PCT/US 99/25314

C.(Continuation) DOCUMENTS CONSIDERED TO BE RELEVANT		
Category *	Citation of document, with indication, where appropriate, of the relevant passages	Relevant to claim No.
X A	EP 0 119 009 A (NIKE INTERNATIONAL LTD) 19 September 1984 (1984-09-19) page 6  page 10 page 11	1,2,5-7, 13 14,17, 18, 21-23, 27,49
X	US 4 371 945 A (KARR LAWRENCE J ET AL) 1 February 1983 (1983-02-01) cited in the application column 4, line 33 -column 5, line 26	1,2,6-8, 17
X A	US 5 583 776 A (LEVI ROBERT W ET AL) 10 December 1996 (1996-12-10) column 6, line 6 - line 42; claim 14; figures 5,7 abstract	49,53,54  32,35, 44,50

**INTERNATIONAL SEARCH REPORT**

Information on patent family members

International Application No

PCT/US 99/25314

Patent document cited in search report	Publication date	Patent family member(s)	Publication date
US 5033013 A	16-07-1991	JP 62032936 A	12-02-1987
EP 0119009 A	19-09-1984	US 4578769 A CA 1218455 A JP 59171564 A	25-03-1986 24-02-1987 28-09-1984
US 4371945 A	01-02-1983	NONE	
US 5583776 A	10-12-1996	NONE	

Form PCT/ISA/210 (patent family annex) (July 1992)

web page

### FITNESS PEDOMETER 360

The best double line display pedometer for walking, hiking and/or jogging. Accurately measures your distance, steps (including steps per minute and miles per hour), calories, speed, and time actually spent exercising. Seven (7) day memory keeps your activity for the past 7 days -- all instantly recallable. Time of day clock keeps you on time. Scan feature shows you all your information without having to push a button. Automatically shuts "off" when there's no activity, "on" when there is.



#### Features:

- New European design, easy-to-read flipcase design
- Displays distance traveled, steps, mph, steps per minute, and calories burned
- Distance measured to 1/100 of a mile (.01), steps to 10,000
- Distance and stride sets in mile (ML) and kilometers (KM)
- "Scan" feature automatically cycles through all functions and displays distance, steps, timer, calories, mph, steps per min., and time-of-day
- Individual stride adjustment for walking and running
- Automatic built-in sensitivity adjustment
- Large double display
- Push-button mode and selection buttons
- KM or MILE selectable

Price: \$39.95



2 Year Warranty



Cover

Packaging

## FITNESS PEDOMETER 360

**WHAT ABOUT WALKING?** *Walking is one of the best forms of exercise. It burns calories, and it is easy on your joints. You can walk anywhere - inside a mall, around your neighborhood, or up the side of a mountain. Walking can help you reduce your stress, make your muscles stronger, lower your blood pressure and cholesterol levels, prevent Type 2 diabetes, reduce your risk of heart disease, control your appetite and lose weight, feel and look better. Walking is a great way to get fit, especially if you're just starting to exercise. If you buy...*

# FITNESS PEDOMETER 360

**WHAT ABOUT WALKING?** Walking is one of the best forms of exercise. It burns calories, and it is easy on your joints. You can walk anywhere - inside a mall, around your neighborhood, or up the side of a mountain. Walking can help you reduce your stress, make your muscles stronger, lower your blood pressure and cholesterol levels, prevent Type 2 diabetes, reduce your risk of heart disease, control your appetite and lose weight, feel and look better. Walking is a great way to get fit, especially if you're just starting to exercise. If you haven't exercised in a while, start out by walking briskly for 20 minutes, three times a week. Increase your time by a few minutes each walk until you can walk for 30 minutes. Aim to walk two miles or more in a half hour, three times a week and gradually increase your walking time and distance.

Inside  
Cover

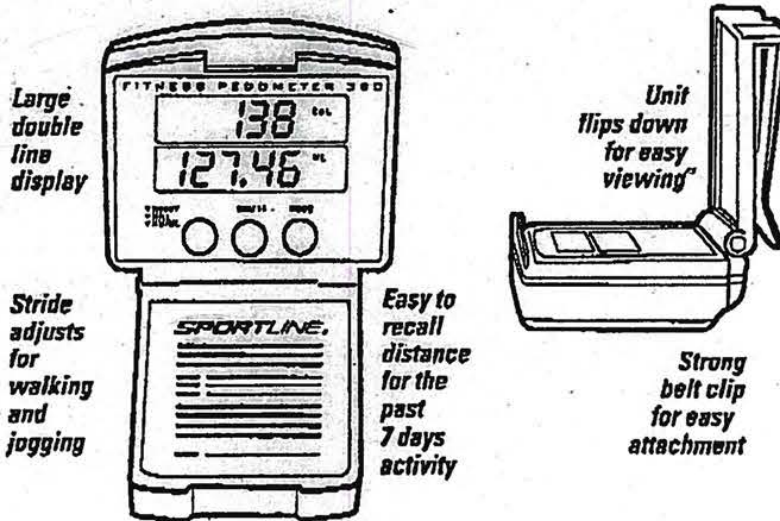

-  DETAILED INSTRUCTIONS ENCLOSED
-  2 YEAR WARRANTY
-  QUARTZ
-  LASER TUNED



**SPORTLINE**  
THE PROFESSIONAL'S CHOICE

SPORTLINE INC., 847 MCGLINCEY LANE, CAMPBELL, CA 95008

**AFTER WARRANTY**  
If the warranty period has expired and the unit is returned to Sportline for servicing, enclose \$7.50 for postage and handling. Send your unit insured to our Service Department listed below. If you are located outside the United States either return the unit by insured mail or to the dealer/distributor where purchased.

7



## SPORTLINE 360 FITNESS PEDOMETER INSTRUCTIONS

Your new pedometer has been designed for your easy use and the accurate measurement of the distance you travel (travel distance records up to 7 days in memory), the steps you take, the calories "burned" while you walk or run, how long you exercise, what speed you walk or run, conversion of distance measurement from mile (MIL) to kilometer (KM) or kilometer to mile, and auto power on/off. Also included is a convenient Time-of-Day clock with 12 hour or 24 hour format to tell you what time it is. The unit will also measure your distance in miles/kilometers and fractions of miles/kilometers.

### EXPLANATION OF SYMBOLS

#### Buttons

- Button A - RESET, H(HR), ▲ (UP), KM/MIL
- Button B - MIN (MINUTES) ▼ (DOWN)
- Button C - MODE

#### Display (upper window)

- STEP - You are in Step mode
- TIMER - You are in Count Up Timer mode
- CAL - You are in Calorie mode
- KM/H, MIL/H - You are in Speed per hour mode
- STEP/M - You are in Step per Minute mode
- ODD - You are in total Mileage/Kilometer mode
- Nothing or P - You are in Time of Day with 12 hour or 24 hour format Clock mode

#### Display (lower window)

- WALK - You are in Walk & Run mode
- RUN - You are in Run/Stride measurement mode
- WALK & RUN - You are in Walk & Run stride setting mode
- ▲ - Pedometer is counting successfully
- ⊖ - You are in auto power OFF mode
- Numbers of distance traveled in MIL or KM (7 days records).

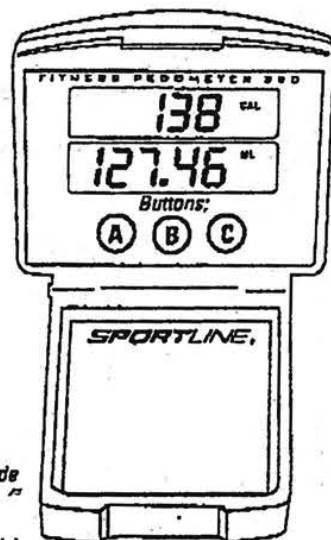

Note: Remove battery isolation strip from battery compartment to "power up" your unit.

### UNIQUE SCAN FEATURE

Your pedometer has a very unique scanning feature. After you turn on the pedometer the display will be in STEP mode. Press "C" button once or repeatedly to show TIMER, CAL, KM/H or MIL/H, STEP/M and Time of Day modes. When you return back to the STEP mode, it will be "blinking". You are now in the Auto-Scan mode. Now the display will automatically show the blinking words "STEP, TIMER, CAL, KM/H or MIL/H, STEP/M and Clock". The pedometer will now rotate through each one of these displays for 3 seconds sequentially as long as the auto-scan function is activated... or until you press the "C" button once more for new data setting or viewing.

### HOW TO OPERATE YOUR NEW PEDOMETER

You will need to give your pedometer some information for it to operate properly. In the sections below you will see how to enter your personal STRIDE LENGTH (for walking, hiking), your WEIGHT (for calories), and TIME OF DAY. Once this information has been entered into the unit, you're ready to go!

#### YOUR STRIDE LENGTH (Your stride length and how to measure it)

This pedometer automatically records your exercise distance based upon your walking or running or hiking movements. The maximum distance reading is 999.99 miles/kilometers. The numbers to the right of the decimal point are fractions of a mile (just like your car's odometer) right down to 1/100 of a mile or kilometer. It is important to walk or run or hike consistently. If you vary your walking pace, your stride length will vary and your distance traveled will be different.

#### HOW TO MEASURE YOUR STRIDE

In order to measure your exercise distance accurately, you must enter your stride length into the Pedometer's "memory" so it knows how much distance you cover with each step you take. (Stride length is the length of each one of your steps, measured either from heel to heel or toe to toe). It's easy to find your stride length!

#### FOR WALKERS

1. Walk 10 steps. 2. Measure the distance. 3. Divide by 10 the distance covered to arrive at your stride length. 4. Example: Distance covered in 10 steps = 30 feet. Steps taken to cover the distance (10 steps), 30 feet divided by 10 steps = 3 feet, stride length = 3 feet.

#### FOR JOGGERS OR HIKERS

Follow the directions above, except jog or hike for 10 steps.

#### HOW TO ENTER YOUR "WALK" STRIDE LENGTH INTO THE PEDOMETER

1. Press the MODE button "C" on the display panel to STEP mode, and hold for 2 seconds to get to the WALK stride length setting mode. 2. Press button "A" + "B" for setting your WALK stride length information, every press of button "A" will increase 1 inch or 1 cm. Every press of button "B" will decrease 1 inch or 1 cm in the reverse order. 3. After you set your WALK stride length

3

information, the numbers of the stride length on the display will automatically return back to STEP mode automatically after 5 seconds.

#### HOW TO ENTER YOUR "RUN" STRIDE LENGTH INTO THE ODOMETER

1. Press the MODE button "C" on the display panel to STEP mode, and hold for 2 seconds to WALK stride length setting mode. Press MODE button "C" once again to get RUN stride length setting mode. 2. Press button "A" + "B" for setting your RUN stride length information (the same as above).

#### HOW TO SET CALORIE COUNTER

1. Press the MODE button "C" on the display panel until you see CALORIE mode.  
2. Press MODE button "C" and hold for 2 seconds to get WEIGHT setting mode.  
3. Press button "A" + "B" to set your weight information. Every press on button "A" increases the weight by 10 LB (pounds) or 4.5 KG (kilograms). Every press of button "B" decreases the weight by 10 LB (pounds) or 4.5 KG (kilograms). 4. Once you set the proper weight, the display will blink for 5 seconds and then the display will skip back to CALORIE mode.

#### HOW TO SET TIME OF DAY

1. Press the MODE button "C" on the display panel repeatedly to reach CLOCK mode.  
2. Press button "C" once and hold for 2 seconds to get 12 or 24 hour time setting mode. Press either button "A" or "B" once to set 12 hour time format or 24 hour time format. 3. Press MODE button "C" once to get into CLOCK setting. Press button "A" for hour setting and "B" button for minute setting. After completing the setting, display will automatically go back to CLOCK mode after 5 seconds.

#### TO START YOUR EXERCISE

1. Press "C" until the upper display will show STEP mode. 2. The display will show 00000 in the STEP mode in the upper display window (if numbers appear in either display, RESET the display by pressing "A" for 2 seconds), and 0.00 MIL or KM for distance on lower display window.  
3. Select WALK, RUN or WALK/RUN mode by pressing "C" button and holding it for 2 seconds for WALK, then pressing again quickly for RUN, pressing again for WALK/RUN. (Note: The WALK/RUN mode senses when you walk and uses the WALK stride, and uses the RUN stride when you run.) When you get the mode you want, simply wait for display to stop blinking. Begin your exercise

#### TO RESET YOUR Pedometer

Press the RESET button "A" and hold for 2 seconds. The upper display and lower display will be reset to zero except the CLOCK mode and the previous 7 days distance travel records. TO RESET THE 7 DAY MEMORY, press and hold "A" for 5 seconds. All the digits will show. Release "A". The memory will clear. However, this will also change MIL to KM, or KM to MIL. Simply press and hold "A" for 5 seconds again to change back to your preferred (KM or MIL) distance measurement.

#### MILE/KILOMETER CONVERSION

To change from MILE to KILOMETER, press and hold RESET button "A" for 5 seconds. This will change STRIDE setting measurement from feet to cm (centimeters) as well.

#### HOW TO USE THE TIMER COUNTER

This pedometer accurately measures the time you spend exercising. When you stop, the timer stops. When you exercise, the timer runs. Press MODE button "C" on the display panel until you get to the TIMER mode for viewing the record of your exercise time.

#### DISTANCE COUNTER FUNCTION

This feature allows you to count the distance you travel during an exercise period, or all day if you wish. Your target should be to walk or jog 4 miles each day. Try it.

1. Press the MODE button "C" to get to STEP mode. 2. Press RESET button "A" and hold for 2 seconds and begin walking, running or hiking. The display will show 00000 and will begin to record your steps and distance.

#### DISTANCE WITH 7 DAY MEMORY & ODOMETER FUNCTION

This feature allows you to view the record of any day in miles or kilometers for 7 days. Starting from the 8th day, new data will automatically replace the memory of the 1st day recorded, and the 9th day will replace the 2nd day recorded... and so forth. Press and release button "A" to view each consecutive day's memory, and press button "B" to view each previous day's memory and total distance traveled "ODO" (like your car's odometer). Please note: You can complete your viewing of the 7 days activities and total distance before you return to the main pedometer functions OR press "C" once to return to the main pedometer functions.

#### SPEED FUNCTION

This feature allows you to know what speed you travel per hour and how many steps per minute.

1. SPEED/HOUR: Press MODE button "C" repeatedly to locate SPEED mode to view speed function. The display will show MIL/H (mile per hour) or KM/H (kilometer per hour).  
2. STEP/MINUTE: Press MODE button "C" once to advance to the next display STEP/M (step/minute) mode to view step per minute function.

#### AUTO POWER ON/OFF

To save battery power this unit will automatically "go to sleep" when no activity has been detected.

4

#### **DISTANCE COUNTER FUNCTION**

This feature allows you to count the distance you travel during an exercise period, or all day if you wish. Your target should be to walk or jog 4 miles each day. Try it.

1. Press the MODE button "C" to get to STEP mode. 2. Press RESET button "A" and hold for 2 seconds and begin walking, running or hiking. The display will show 00000 and will begin to record your steps and distance.

#### **DISTANCE WITH 7 DAY MEMORY & ODOMETER FUNCTION**

This feature allows you to view the record of any day in miles or kilometers for 7 days. Starting from the 8th day, new data will automatically replace the memory of the 1st day recorded, and the 9th day will replace the 2nd day recorded... and so forth. Press and release button "A" to view each consecutive day's memory, and press button "B" to view each previous day's memory and total distance traveled "ODO" (like your car's odometer). Please note: You can complete your viewing of the 7 days activities and total distance before you return to the main pedometer functions OR press "C" once to return to the main pedometer functions.

#### **SPEED FUNCTION**

This feature allows you to know what speed you travel per hour and how many steps per minute.

1. SPEED/HOUR: Press MODE button "C" repeatedly to locate SPEED mode to view speed function. The display will show MIL/H (mile per hour) or KM/H (kilometer per hour).  
2. STEP/MINUTE: Press MODE button "C" once to advance to the next display STEP/M (step/minute) mode to view step per minute function.

#### **AUTO POWER ON/OFF**

To save battery power, this unit will automatically "go to sleep" when no activity has been detected, for four (4) minutes. The lower display will show  whenever unit is not in use.

#### **HOW TO WEAR YOUR PEDOMETER**

Your pedometer clips easily to your trousers or shorts. For best results keep the unit in line with the "crease line" of your trousers.

#### **SENSITIVITY ADJUSTMENT**

Everyone's walking style is different. This pedometer has an automatic sensitivity adjuster that compensates for the different walking, running or jogging styles.

#### **BATTERY REPLACEMENT**

1. The battery hatch is on the side of your pedometer. Slide open the battery door with your finger to access the battery. 2. Replace battery with LR-44 type when display dims. 3. Reset the pedometer and reenter the WEIGHT / STRIDE length and CLOCK information.

#### **OTHER INFORMATION**

1. Treat your pedometer with care and it will work most efficiently. 2. Pedometer is NOT waterproof, so keep it dry.

5



Please type a plus sign (+) inside this box →

RECEIVED

PTO/SB/21 (08-00)  
 Approved for use through 10/31/2002. OMB 0651-0031  
 U.S. Patent and Trademark Office: U.S. DEPARTMENT OF COMMERCE

Under the Paperwork Reduction Act of 1995, no persons are required to respond to a collection of information unless it displays a valid OMB control number.

<h1>TRANSMITTAL FORM</h1> <p>(to be used for all correspondence after initial filing)</p>	Application Number	09/756,647
	Filing Date	January 4, 2001
	First Named Inventor	Nathan Pyles
	Group Art Unit	2816
	Examiner Name	
Total Number of Pages in This Submission	Attorney Docket Number <b>KNOWMO-6</b>	

ENCLOSURES (check all that apply)		
<input type="checkbox"/> Fee Transmittal Form	<input type="checkbox"/> Assignment Papers (for an Application)	<input type="checkbox"/> After Allowance Communication to Group
<input type="checkbox"/> Fee Attached	<input type="checkbox"/> Drawing(s)	<input type="checkbox"/> Appeal Communication to Board of Appeals and Interferences
<input type="checkbox"/> Amendment / Reply	<input type="checkbox"/> Licensing-related Papers	<input type="checkbox"/> Appeal Communication to Group (Appeal Notice, Brief, Reply Brief)
<input type="checkbox"/> After Final	<input type="checkbox"/> Petition	<input type="checkbox"/> Proprietary Information
<input type="checkbox"/> Affidavits/declaration(s)	<input type="checkbox"/> Petition to Convert to a Provisional Application	<input type="checkbox"/> Status Letter
<input type="checkbox"/> Extension of Time Request	<input type="checkbox"/> Power of Attorney, Revocation Change of Correspondence Address	<input checked="" type="checkbox"/> Other Enclosure(s) (please identify below): PTO/SB 08a, PTO/SB 08b and 69 documents
<input type="checkbox"/> Express Abandonment Request	<input type="checkbox"/> Terminal Disclaimer	
<input checked="" type="checkbox"/> Information Disclosure Statement	<input type="checkbox"/> Request for Refund	
<input type="checkbox"/> Certified Copy of Priority Document(s)	<input type="checkbox"/> CD, Number of CD(s) _____	
<input type="checkbox"/> Response to Missing Parts/ Incomplete Application	Remarks: The Commissioner is hereby authorized to charge any additional fees that may be required with respect to this communication, or credit any overpayment, to Deposit Account No. 15-0660.	
<input type="checkbox"/> Response to Missing Parts under 37 CFR 1.52 or 1.53		

SIGNATURE OF APPLICANT, ATTORNEY, OR AGENT	
Firm or Individual name	Jeffrey W. Smith, Reg. No. 33455
Signature	<i>Jeffrey W. Smith</i>
Date	November 19, 2001

CERTIFICATE OF MAILING	
I hereby certify that this correspondence is being deposited with the United States Postal Service with sufficient postage as first class mail in an envelope addressed to: Commissioner for Patents, Washington, DC 20231 on this date: <input type="text"/>	
Typed or printed name	Jeffrey W. Smith, Reg. No. 33455
Signature	<i>Jeffrey W. Smith</i>
Date	November 19, 2001

Burden Hour Statement: This form is estimated to take 0.2 hours to complete. Time will vary depending upon the needs of the individual case. Any comments on the amount of time you are required to complete this form should be sent to the Chief Information Officer, U.S. Patent and Trademark Office, Washington, DC 20231. DO NOT SEND FEES OR COMPLETED FORMS TO THIS ADDRESS. SEND TO: Assistant Commissioner for Patents, Washington, DC 20231.

2816



Please type a plus sign (+) inside this box →

PTO/SB/21 (08-0)

Approved for use through 10/31/2002. OMB 0651-003

U.S. Patent and Trademark Office: U.S. DEPARTMENT OF COMMERCE

Under the Paperwork Reduction Act of 1995, no persons are required to respond to a collection of information unless it displays a valid OMB control number.

<b>TRANSMITTAL FORM</b> <i>(to be used for all correspondence after initial filing)</i>	<b>Application Number</b>	09/756,647
	<b>Filing Date</b>	January 4, 2001
	<b>First Named Inventor</b>	Nathan Pyles
	<b>Group Art Unit</b>	2816
	<b>Examiner Name</b>	
<b>Total Number of Pages in This Submission</b>		<b>Attorney Docket Number</b> KNOWMO-6

<b>ENCLOSURES (check all that apply)</b>		
<input type="checkbox"/> Fee Transmittal Form	<input type="checkbox"/> Assignment Papers (for an Application)	<input type="checkbox"/> After Allowance Communication to Group
<input type="checkbox"/> Fee Attached	<input type="checkbox"/> Drawing(s)	<input type="checkbox"/> Appeal Communication to Board of Appeals and Interferences
<input type="checkbox"/> Amendment / Reply	<input type="checkbox"/> Licensing-related Papers	<input type="checkbox"/> Appeal Communication to Group (Appeal Notice, Brief, Reply Brief)
<input type="checkbox"/> After Final	<input type="checkbox"/> Petition	<input type="checkbox"/> Proprietary Information
<input type="checkbox"/> Affidavits/declaration(s)	<input type="checkbox"/> Petition to Convert to a Provisional Application	<input type="checkbox"/> Status Letter
<input type="checkbox"/> Extension of Time Request	<input type="checkbox"/> Power of Attorney, Revocation Change of Correspondence Address	<input checked="" type="checkbox"/> Other Enclosure(s) (please identify below): PTO/SB 08a, PTO/SB 08b and 69 documents
<input type="checkbox"/> Express Abandonment Request	<input type="checkbox"/> Terminal Disclaimer	
<input checked="" type="checkbox"/> Information Disclosure Statement	<input type="checkbox"/> Request for Refund	
<input type="checkbox"/> Certified Copy of Priority Document(s)	<input type="checkbox"/> CD, Number of CD(s) _____	
<input type="checkbox"/> Response to Missing Parts/ Incomplete Application	<b>Remarks</b> The Commissioner is hereby authorized to charge any additional fees that may be required with respect to this communication, or credit any overpayment, to Deposit Account No. 15-0660.	
<input type="checkbox"/> Response to Missing Parts under 37 CFR 1.52 or 1.53		

RECEIVED  
JAN 18 2002  
T 2800 MAIL ROOM

<b>SIGNATURE OF APPLICANT, ATTORNEY, OR AGENT</b>	
Firm or Individual name	Jeffry W. Smith, Reg. No. 33455
Signature	<i>Jeffry W. Smith</i>
Date	November 19, 2001

<b>CERTIFICATE OF MAILING</b>			
I hereby certify that this correspondence is being deposited with the United States Postal Service with sufficient postage as first class mail in an envelope addressed to: Commissioner for Patents, Washington, DC 20231 on this date: _____			
Typed or printed name	Jeffry W. Smith, Reg. No. 33455		
Signature	<i>Jeffry W. Smith</i>	Date	November 19, 2001

Burden Hour Statement: This form is estimated to take 0.2 hours to complete. Time will vary depending upon the needs of the individual case. Any comments on the amount of time you are required to complete this form should be sent to the Chief Information Officer, U.S. Patent and Trademark Office, Washington, DC 20231. DO NOT SEND FEES OR COMPLETED FORMS TO THIS ADDRESS. SEND TO: Assistant Commissioner for Patents, Washington, DC 20231.



PATENT APPLICATION

In the United States Patent and Trademark Office

RECEIVED  
FEB 22 2002  
TECHNOLOGY CENTER 2200  
#710

Applicant: Nathan Pyles  
Docket No.: KNOWMO-6  
Date: February 13, 2002  
Application No.: 09/756,647  
Filed: January 4, 2001  
Art Unit: 2816  
Examiner: M. Wambach  
For: PEDOMETER

**Certificate of Mailing**  
I hereby certify that this correspondence is being deposited with the United States Postal Service as Express Mail in an envelope addressed to: Box Responses-No Fee, Assistant Commissioner for Patents, Washington, D.C. 20231  
On February 13, 2002  
Signature Jeffrey W. Smith  
Jeffrey W. Smith, Reg. No. 33455  
Name of Applicant, assignee or Registered Representative

**AMENDMENT**

Box Responses-No Fee  
Assistant Commissioner for Patents  
Washington, D.C. 20231

2/26/02  
Smith

Dear Sir:

In response to a November 13, 2001 official action, Applicant makes the following amendments and remarks. Reconsideration and allowance are respectfully requested. A marked-up version of the amended claims is attached herewith as Exhibit A.

Please amend the application as follows:

**In The Claims**

Please cancel claim 1 without prejudice.

1/2 (Amended.) An exercise monitoring device comprising:

a strap for releasably securing the exercise monitoring device to a user;

a

15

a

Applicant: Nathan Pyles  
Application No.: 09/756,647

a step counter joined to the strap;  
a heart rate monitor joined to the strap; and  
a data processor programmed to calculate a distance traveled by multiplying a  
number of steps counted by the step counter by a stride length  
that varies according to a rate at which steps are counted.

cont  
A1

~~2/~~ 3. (Amended.) An exercise monitoring device comprising:

a strap for releasably securing the exercise monitoring device to a user;  
a step counter joined to the strap;  
a heart rate monitor joined to the strap; and  
a data processor programmed to calculate a distance traveled by multiplying a  
number of steps counted by the step counter by a stride length that varies  
in accordance with a stride rate, wherein the stride length is determined  
with reference to a plurality of calibrations that each calculate a stride  
length as a function of a known stride rate.

~~3/~~ 4. (Amended.) The exercise monitoring device of claim ~~2/~~ 3, wherein the data processor is  
further programmed to recalibrate the stride length as a function of a subsequently calculated  
and known stride rate.

~~5/~~ 5. (Amended.) An exercise monitoring device comprising:

a strap for releasably securing the exercise monitoring device to a user;  
a step counter joined to the strap;  
a heart rate monitor joined to the strap; and

A2

Applicant: Nathan Pyles  
Application No.: 09/756,647

cont  
A2

a data processor programmed to calculate a distance traveled by multiplying the number of steps counted by the step counter by a stride length that varies according to the rate at which steps are counted, and further programmed to derive the stride length from a range of stride lengths calculated from a range of corresponding stride rates calculated from a plurality of calibration samples.

6 7. (Amended.) A pedometer comprising:

a step counter;

a transmitter in communication with the step counter to generate a step count signal corresponding to each step and transmit the step count signal;

a receiver mountable on a user body portion to receive the step count signal transmitted from the transmitter; and

a data processor programmed to calculate a distance traveled by multiplying a number of steps counted by a stride length that varies according to a rate at which steps are taken, and further programmed to derive an actual stride length from a range of stride lengths calculated from a range of corresponding stride rates.

**Remarks**

In the November 13, 2001 official action, claim 1 was rejected under 35 U.S.C. §102(b), claims 2 to 6 were allowable if amended to overcome an objection as being dependent from a rejected base claim, and claims 7 to 9 were allowed. Claims 4 and 7 were objected to as including misspelled words that are corrected by the above amendment.



Applicant: Nathan Pyles  
Application No.: 09/756,647

Claim 1 has been canceled without prejudice because although Applicant disagrees with the basis for rejection, it wishes to expedite prosecution and allowance of this application.

Claims 2, 3, and 6, which all depended from rejected claim 1, have been amended into an independent claim format to include all of the limitations of claim 1. These claims are now believed to be allowable.

Claims 4 and 5 depended from claim 3, and require no amendment to overcome the objection because claim 3 is now in independent format. Claims 4 and 5 are, therefore, believed to be allowable.

Claims 7 to 9 were allowable and require no amendment or comment.

**Conclusion**

For the foregoing reasons, claims 2 to 9 are in allowable form. Applicant requests that this case be passed to issue.

Respectfully submitted,

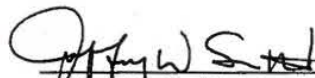

Jeffrey W. Smith, Reg. No. 33455  
Attorney for Applicant  
LATHROP & CLARK LLP  
740 Regent Street, Suite 400  
P.O. Box 1507  
Madison, Wisconsin 53701-1507  
(608) 257-7766

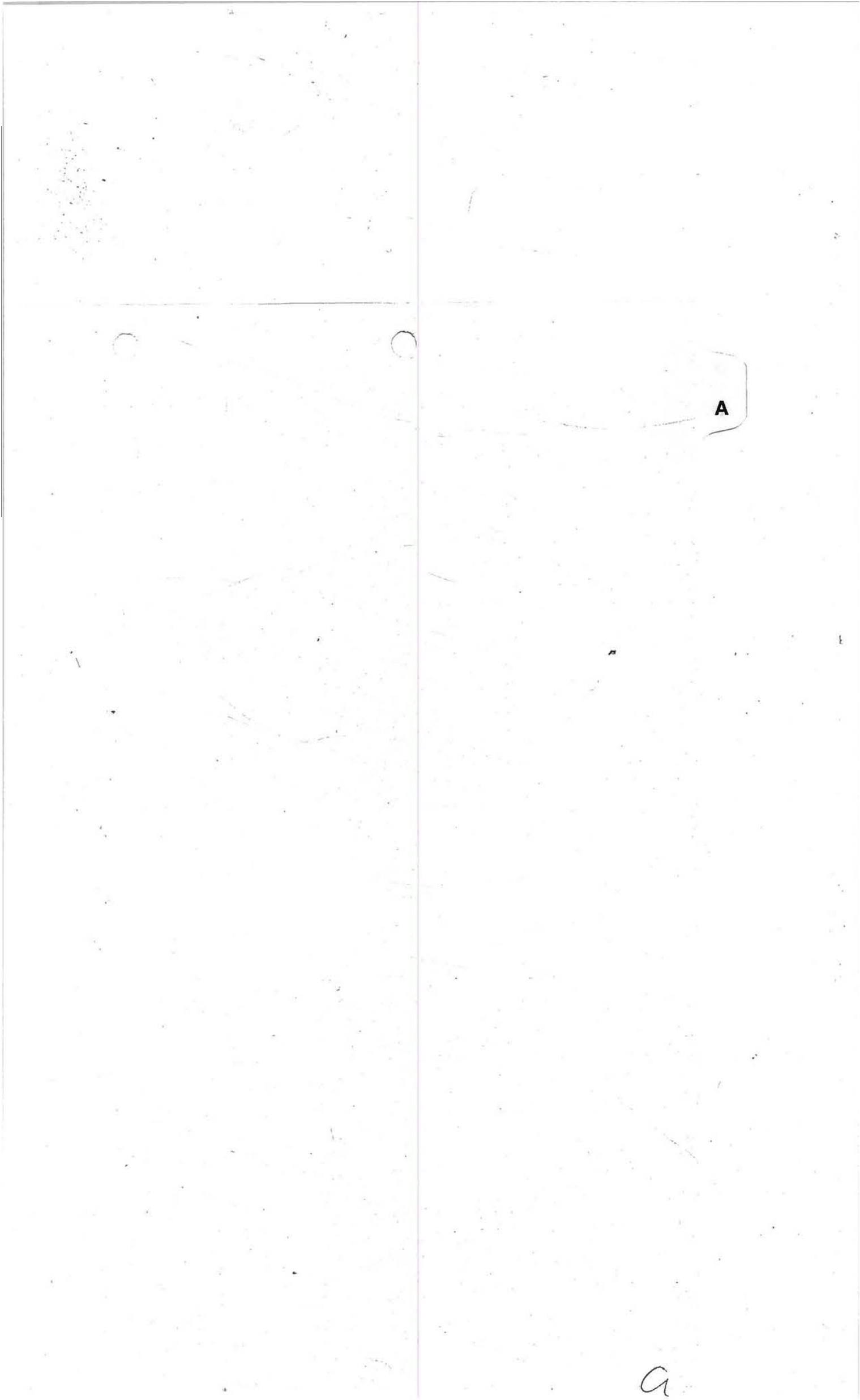

A

a

Applicant: Nathan Pyles  
Application No.: 09/756,647

2. (Amended.) An exercise monitoring device comprising:  
a strap for releasably securing the exercise monitoring device to a user;  
a step counter joined to the strap;  
a heart rate monitor joined to the strap; and

[The exercise monitoring device of claim 1, and further comprising:]

a data processor programmed to calculate a distance traveled by multiplying a  
number of steps counted by the step counter by a stride length  
that varies according to a rate at which steps are counted.

3. (Amended.) An exercise monitoring device comprising:  
a strap for releasably securing the exercise monitoring device to a user;  
a step counter joined to the strap;  
a heart rate monitor joined to the strap; and

[The exercise monitoring device of claim 1, and further comprising:]

a data processor programmed to calculate a distance traveled by multiplying a  
number of steps counted by the step counter by a stride length that varies  
in accordance with a stride rate, wherein the stride length is determined  
with reference to a plurality of calibrations that each calculate a stride  
length as a function of a known stride rate.

4. (Amended.) The exercise monitoring device of claim 3, wherein the data processor is  
further programmed to recalibrate the stride length as a function of a subsequently calculated  
[calculated] and known stride rate.

a

6. (Amended.) An exercise monitoring device comprising:

a strap for releasably securing the exercise monitoring device to a user;

a step counter joined to the strap;

a heart rate monitor joined to the strap; and

[The pedometer of claim 1, and further comprising:]

a data processor programmed to calculate a distance traveled by multiplying the number of steps counted by the step counter by a stride length that varies according to the rate at which steps are counted, and further programmed to derive the stride length from a range of stride lengths calculated from a range of corresponding stride rates calculated from a plurality of calibration samples.

7. (Amended.) A pedometer comprising:

a step counter;

a transmitter in communication with the step counter to generate a step count signal corresponding to each step and transmit the step count signal [singal];

a receiver mountable on a user body portion to receive the step count signal transmitted from the transmitter; and

a data processor programmed to calculate a distance traveled by multiplying a number of steps counted by a stride length that varies according to a rate at which steps are taken, and further programmed to derive an actual stride length from a range of stride lengths calculated from a range of corresponding stride rates.

9



02-14-02

9p 2816

Please type a plus sign (+) inside this box →

Approved for use through 10/31/2002. OMB 0851-0031  
 U.S. Patent and Trademark Office: U.S. DEPARTMENT OF COMMERCE

Under the Paperwork Reduction Act of 1995, no persons are required to respond to a collection of information unless it displays a valid OMB control number.

<h2>TRANSMITTAL FORM</h2> <p><i>(to be used for all correspondence after initial filing)</i></p>	Application Number	09/756,647
	Filing Date	January 4, 2001
	First Named Inventor	Nathan Pyles
	Group Art Unit	2816
	Examiner Name	M. Wambach
Total Number of Pages In This Submission	Attorney Docket Number KNOWMO-6	

RECEIVED  
 TECHNOLOGY CENTER 2001  
 JAN 22 2001

ENCLOSURES (check all that apply)		
<input type="checkbox"/> Fee Transmittal Form	<input type="checkbox"/> Assignment Papers (for an Application)	<input type="checkbox"/> After Allowance Communication to Group
<input type="checkbox"/> Fee Attached	<input type="checkbox"/> Drawing(s)	<input type="checkbox"/> Appeal Communication to Board of Appeals and Interferences
<input checked="" type="checkbox"/> Amendment / Reply	<input type="checkbox"/> Licensing-related Papers	<input type="checkbox"/> Appeal Communication to Group (Appeal Notice, Brief, Reply Brief)
<input type="checkbox"/> After Final	<input type="checkbox"/> Petition	<input type="checkbox"/> Proprietary Information
<input type="checkbox"/> Affidavits/declaration(s)	<input type="checkbox"/> Petition to Convert to a Provisional Application	<input type="checkbox"/> Status Letter
<input type="checkbox"/> Extension of Time Request	<input type="checkbox"/> Power of Attorney, Revocation Change of Correspondence Address	<input type="checkbox"/> Other Enclosure(s) (please identify below):
<input type="checkbox"/> Express Abandonment Request	<input type="checkbox"/> Terminal Disclaimer	
<input type="checkbox"/> Information Disclosure Statement	<input type="checkbox"/> Request for Refund	
<input type="checkbox"/> Certified Copy of Priority Document(s)	<input type="checkbox"/> CD, Number of CD(s) _____	
<input type="checkbox"/> Response to Missing Parts/ Incomplete Application	Remarks: The Commissioner is hereby authorized to charge any additional fees that may be required with respect to this communication, or credit any overpayment, to Deposit Account No. 15-0660.	
<input type="checkbox"/> Response to Missing Parts under 37 CFR 1.52 or 1.53		

SIGNATURE OF APPLICANT, ATTORNEY, OR AGENT	
Firm or Individual name	Jeffrey W. Smith, Reg. No. 33455
Signature	<i>Jeffrey W. Smith</i>
Date	February 13, 2002

CERTIFICATE OF MAILING	
I hereby certify that this correspondence is being deposited with the United States Postal Service with sufficient postage as first class mail in an envelope addressed to: Commissioner for Patents, Washington, DC 20231 on this date: <input type="text"/>	
Typed or printed name	Jeffrey W. Smith, Reg. No. 33455
Signature	<i>Jeffrey W. Smith</i>
Date	February 13, 2002

Burden Hour Statement: This form is estimated to take 0.2 hours to complete. Time will vary depending upon the needs of the individual case. Any comments on the amount of time you are required to complete this form should be sent to the Chief Information Officer, U.S. Patent and Trademark Office, Washington, DC 20231. DO NOT SEND FEES OR COMPLETED FORMS TO THIS ADDRESS. SEND TO: Assistant Commissioner for Patents, Washington, DC 20231.

ca



Please type a plus sign (+) inside this box →

PTO/SB/21 (08-00)  
 Approved for use through 10/31/2002. OMB 0651-0031  
 U.S. Patent and Trademark Office: U.S. DEPARTMENT OF COMMERCE  
 Under the Paperwork Reduction Act of 1995, no persons are required to respond to a collection of information unless it displays a valid OMB control number.

<h1>TRANSMITTAL FORM</h1> <p>(to be used for all correspondence after initial filing)</p>	Application Number	09/756,647
	Filing Date	January 4, 2001
	First Named Inventor	Nathan Pyles
	Group Art Unit	2816
	Examiner Name	M. Wambach
Total Number of Pages in This Submission	Attorney Docket Number	KNOWMO-6

RECEIVED  
 FEB 22 2002  
 TECHNOLOGY CENTER 2800

ENCLOSURES (check all that apply)		
<input type="checkbox"/> Fee Transmittal Form	<input type="checkbox"/> Assignment Papers (for an Application)	<input type="checkbox"/> After Allowance Communication to Group
<input type="checkbox"/> Fee Attached	<input type="checkbox"/> Drawing(s)	<input type="checkbox"/> Appeal Communication to Board of Appeals and Interferences
<input checked="" type="checkbox"/> Amendment / Reply	<input type="checkbox"/> Licensing-related Papers	<input type="checkbox"/> Appeal Communication to Group (Appeal Notice, Brief, Reply Brief)
<input type="checkbox"/> After Final	<input type="checkbox"/> Petition	<input type="checkbox"/> Proprietary Information
<input type="checkbox"/> Affidavits/declaration(s)	<input type="checkbox"/> Petition to Convert to a Provisional Application	<input type="checkbox"/> Status Letter
<input type="checkbox"/> Extension of Time Request	<input type="checkbox"/> Power of Attorney, Revocation Change of Correspondence Address	<input type="checkbox"/> Other Enclosure(s) (please identify below):
<input type="checkbox"/> Express Abandonment Request	<input type="checkbox"/> Terminal Disclaimer	
<input type="checkbox"/> Information Disclosure Statement	<input type="checkbox"/> Request for Refund	
<input type="checkbox"/> Certified Copy of Priority Document(s)	<input type="checkbox"/> CD, Number of CD(s) _____	
<input type="checkbox"/> Response to Missing Parts/ Incomplete Application	Remarks	The Commissioner is hereby authorized to charge any additional fees that may be required with respect to this communication, or credit any overpayment, to Deposit Account No. 15-0660.
<input type="checkbox"/> Response to Missing Parts under 37 CFR 1.52 or 1.53		

SIGNATURE OF APPLICANT, ATTORNEY, OR AGENT	
Firm or Individual name	Jeffry W. Smith, Reg. No. 33455
Signature	<i>Jeffry W. Smith</i>
Date	February 13, 2002

CERTIFICATE OF MAILING	
I hereby certify that this correspondence is being deposited with the United States Postal Service with sufficient postage as first class mail in an envelope addressed to: Commissioner for Patents, Washington, DC 20231 on this date: _____	
Typed or printed name	Jeffry W. Smith, Reg. No. 33455
Signature	<i>Jeffry W. Smith</i>
Date	February 13, 2002

Burden Hour Statement: This form is estimated to take 0.2 hours to complete. Time will vary depending upon the needs of the individual case. Any comments on the amount of time you are required to complete this form should be sent to the Chief Information Officer, U.S. Patent and Trademark Office, Washington, DC 20231. DO NOT SEND FEES OR COMPLETED FORMS TO THIS ADDRESS. SEND TO: Assistant Commissioner for Patents, Washington, DC 20231.

9



UNITED STATES PATENT AND TRADEMARK OFFICE

UNITED STATES DEPARTMENT OF COMMERCE
United States Patent and Trademark Office
Address: COMMISSIONER OF PATENTS AND TRADEMARKS
Washington, D.C. 20231
www.uspto.gov

NOTICE OF ALLOWANCE AND FEE(S) DUE

020455 7590 03/19/2002

LATHROP & CLARK LLP
740 REGENT STREET SUITE 400
P.O. BOX 1507
MADISON, WI 537011507

EXAMINER

WAMBACH, MARGARET R

Table with 2 columns: ART UNIT, CLASS-SUBCLASS. Row 1: 2816, 377-024200

DATE MAILED: 03/19/2002

Table with 5 columns: APPLICATION NO., FILING DATE, FIRST NAMED INVENTOR, ATTORNEY DOCKET NO., CONFIRMATION NO. Row 1: 09/756,647, 01/04/2001, Nathan Pyles, KNOWMO-6, 7058

TITLE OF INVENTION: PEDOMETER

Table with 7 columns: TOTAL CLAIMS, APPLN. TYPE, SMALL ENTITY, ISSUE FEE, PUBLICATION FEE, TOTAL FEE(S) DUE, DATE DUE. Row 1: 8, nonprovisional, NO, \$1280, \$300, \$1580, 06/19/2002

THE APPLICATION IDENTIFIED ABOVE HAS BEEN EXAMINED AND IS ALLOWED FOR ISSUANCE AS A PATENT. PROSECUTION ON THE MERITS IS CLOSED. THIS NOTICE OF ALLOWANCE IS NOT A GRANT OF PATENT RIGHTS. THIS APPLICATION IS SUBJECT TO WITHDRAWAL FROM ISSUE AT THE INITIATIVE OF THE OFFICE OR UPON PETITION BY THE APPLICANT. SEE 37 CFR 1.313 AND MPEP 1308.

THE ISSUE FEE AND PUBLICATION FEE (IF REQUIRED) MUST BE PAID WITHIN THREE MONTHS FROM THE MAILING DATE OF THIS NOTICE OR THIS APPLICATION SHALL BE REGARDED AS ABANDONED. THIS STATUTORY PERIOD CANNOT BE EXTENDED. SEE 35 U.S.C. 151. THE ISSUE FEE DUE INDICATED ABOVE REFLECTS A CREDIT FOR ANY PREVIOUSLY PAID ISSUE FEE APPLIED IN THIS APPLICATION. THE PTOL-85B (OR AN EQUIVALENT) MUST BE RETURNED WITHIN THIS PERIOD EVEN IF NO FEE IS DUE OR THE APPLICATION WILL BE REGARDED AS ABANDONED.

HOW TO REPLY TO THIS NOTICE:

- I. Review the SMALL ENTITY status shown above. If the SMALL ENTITY is shown as YES, verify your current SMALL ENTITY status:
A. If the status is changed, pay the PUBLICATION FEE (if required) and twice the amount of the ISSUE FEE shown above and notify the United States Patent and Trademark Office of the change in status, or
B. If the status is the same, pay the TOTAL FEE(S) DUE shown above.

If the SMALL ENTITY is shown as NO:

- A. Pay TOTAL FEE(S) DUE shown above, or
B. If applicant claimed SMALL ENTITY status before, or is now claiming SMALL ENTITY status, check the box below and enclose the PUBLICATION FEE and 1/2 the ISSUE FEE shown above.
[ ] Applicant claims SMALL ENTITY status. See 37 CFR 1.27.

II. PART B - FEE(S) TRANSMITTAL should be completed and returned to the United States Patent and Trademark Office (USPTO) with your ISSUE FEE and PUBLICATION FEE (if required). Even if the fee(s) have already been paid, Part B - Fee(s) Transmittal should be completed and returned. If you are charging the fee(s) to your deposit account, section "4b" of Part B - Fee(s) Transmittal should be completed and an extra copy of the form should be submitted.

III. All communications regarding this application must give the application number. Please direct all communications prior to issuance to Box ISSUE FEE unless advised to the contrary.

IMPORTANT REMINDER: Utility patents issuing on applications filed on or after Dec. 12, 1980 may require payment of maintenance fees. It is patentee's responsibility to ensure timely payment of maintenance fees when due.

**PART B - FEE(S) TRANSMITTAL**

**Complete and mail this form, together with applicable fee(s), to:**

**Box ISSUE FEE  
Assistant Commissioner for Patents  
Washington, D.C. 20231**

**MAILING INSTRUCTIONS:** This form should be used for transmitting the ISSUE FEE and PUBLICATION FEE (if required). Blocks 1 through 4 should be completed where appropriate. All further correspondence including the Patent, advance orders and notification of maintenance fees will be mailed to the current correspondence address as indicated unless corrected below or directed otherwise in Block 1, by (a) specifying a new correspondence address; and/or (b) indicating a separate "FEE ADDRESS" for maintenance fee notifications.

CURRENT CORRESPONDENCE ADDRESS (Note: Legibly mark-up with any corrections or use Block 1)

020455                      7590                      03/19/2002

**LATHROP & CLARK LLP  
740 REGENT STREET SUITE 400  
P.O. BOX 1507  
MADISON, WI 537011507**

Note: The certificate of mailing below can only be used for domestic mailings of the Fee(s) Transmittal. This certificate cannot be used for any other accompanying papers. Each additional paper, such as an assignment or formal drawing, must have its own certificate of mailing.

**Certificate of Mailing**

I hereby certify that this Fee(s) Transmittal is being deposited with the United States Postal Service with sufficient postage for first class mail in an envelope addressed to the Box Issue Fee address above on the date indicated below.

(Depositor's name)
(Signature)
(Date)

APPLICATION NO.	FILING DATE	FIRST NAMED INVENTOR	ATTORNEY DOCKET NO.	CONFIRMATION NO.
09/756,647	01/04/2001	Nathan Pyles	KNOWMO-6	7058

TITLE OF INVENTION: PEDOMETER

TOTAL CLAIMS	APPLN. TYPE	SMALL ENTITY	ISSUE FEE	PUBLICATION FEE	TOTAL FEE(S) DUE	DATE DUE
8	nonprovisional	NO	\$1280	\$300	\$1580	06/19/2002

EXAMINER	ART UNIT	CLASS-SUBCLASS
WAMBACH, MARGARET R	2816	377-024200

1. Change of correspondence address or indication of "Fee Address" (37 CFR 1.363). Use of PTO form(s) and Customer Number are recommended, but not required.

- Change of correspondence address (or Change of Correspondence Address form PTO/SB/122) attached.  
 "Fee Address" indication (or "Fee Address" Indication form PTO/SB/47) attached.

2. For printing on the patent front page, list (1) the names of up to 3 registered patent attorneys or agents OR, alternatively, (2) the name of a single firm (having as a member a registered attorney or agent) and the names of up to 2 registered patent attorneys or agents. If no name is listed, no name will be printed.

1 \_\_\_\_\_  
 2 \_\_\_\_\_  
 3 \_\_\_\_\_

**3. ASSIGNEE NAME AND RESIDENCE DATA TO BE PRINTED ON THE PATENT (print or type)**

PLEASE NOTE: Unless an assignee is identified below, no assignee data will appear on the patent. Inclusion of assignee data is only appropriate when an assignment has been previously submitted to the USPTO or is being submitted under separate cover. Completion of this form is NOT a substitute for filing an assignment.

(A) NAME OF ASSIGNEE \_\_\_\_\_ (B) RESIDENCE: (CITY and STATE OR COUNTRY) \_\_\_\_\_

Please check the appropriate assignee category or categories (will not be printed on the patent)     individual     corporation or other private group entity     government

**4a. The following fee(s) are enclosed:**

- Issue Fee  
 Publication Fee  
 Advance Order - # of Copies \_\_\_\_\_

**4b. Payment of Fee(s):**

- A check in the amount of the fee(s) is enclosed.  
 Payment by credit card. Form PTO-2038 is attached.  
 The Commissioner is hereby authorized by charge the required fee(s), or credit any overpayment, to Deposit Account Number \_\_\_\_\_ (enclose an extra copy of this form).

The COMMISSIONER OF PATENTS AND TRADEMARKS is requested to apply the Issue Fee and Publication Fee (if any) or to re-apply any previously paid issue fee to the application identified above.

(Authorized Signature)	(Date)
<p><small>NOTE: The Issue Fee and Publication Fee (if required) will not be accepted from anyone other than the applicant; a registered attorney or agent; or the assignee or other party in interest as shown by the records of the United States Patent and Trademark Office.</small></p> <p><small>Burden Hour Statement: This form is estimated to take 0.2 hours to complete. Time will vary depending on the needs of the individual case. Any comments on the amount of time required to complete this form should be sent to the Chief Information Officer, United States Patent and Trademark Office, Washington, D.C. 20231. DO NOT SEND FEES OR COMPLETED FORMS TO THIS ADDRESS. SEND FEES AND THIS FORM TO: Box Issue Fee, Assistant Commissioner for Patents, Washington, D.C. 20231</small></p> <p><small>Under the Paperwork Reduction Act of 1995, no persons are required to respond to a collection of information unless it displays a valid OMB control number.</small></p>	

TRANSMIT THIS FORM WITH FEE(S)





UNITED STATES PATENT AND TRADEMARK OFFICE

UNITED STATES DEPARTMENT OF COMMERCE  
United States Patent and Trademark Office  
Address: COMMISSIONER OF PATENTS AND TRADEMARKS  
Washington, D.C. 20231  
www.uspto.gov

APPLICATION NO.	FILING DATE	FIRST NAMED INVENTOR	ATTORNEY DOCKET NO.	CONFIRMATION NO.
09/756,647	01/04/2001	Nathan Pyles	KNOWMO-6	7058
020455	7590	03/19/2002	EXAMINER	
LATHROP & CLARK LLP 740 REGENT STREET SUITE 400 P.O. BOX 1507 MADISON, WI 537011507			WAMBACH, MARGARET R	
			ART UNIT	PAPER NUMBER
			2816	
DATE MAILED: 03/19/2002				

**Determination of Patent Term Adjustment under 35 U.S.C. 154 (b)**  
(application filed on or after May 29, 2000)

The patent term adjustment to date is 0 days. If the issue fee is paid on the date that is three months after the mailing date of this notice and the patent issues on the Tuesday before the date that is 28 weeks (six and a half months) after the mailing date of this notice, the term adjustment will be 0 days.

If a continued prosecution application (CPA) was filed in the above-identified application, the filing date that determines patent term adjustment is the filing date of the most recent CPA.

Applicant will be able to obtain more detailed information by accessing the Patent Application Information Retrieval (PAIR) system. (<http://pair.uspto.gov>)

<b>Notice of Allowability</b>	<b>Application No.</b>	<b>Applicant(s)</b>	
	09/756,647	PYLES, NATHAN	
	<b>Examiner</b>	<b>Art Unit</b>	
	Margaret R Wambach	2816	

**-- The MAILING DATE of this communication appears on the cover sheet with the correspondence address--**

All claims being allowable, PROSECUTION ON THE MERITS IS (OR REMAINS) CLOSED in this application. If not included herewith (or previously mailed), a Notice of Allowance (PTOL-85) or other appropriate communication will be mailed in due course. **THIS NOTICE OF ALLOWABILITY IS NOT A GRANT OF PATENT RIGHTS.** This application is subject to withdrawal from issue at the Initiative of the Office or upon petition by the applicant. See 37 CFR 1.313 and MPEP 1308.

1.  This communication is responsive to Amdt A (1/13/02).
2.  The allowed claim(s) is/are 2-9.
3.  The drawings filed on 04 January 2001 are accepted by the Examiner.
4.  Acknowledgment is made of a claim for foreign priority under 35 U.S.C. § 119(a)-(d) or (f).
  - a)  All    b)  Some\*    c)  None    of the:
    1.  Certified copies of the priority documents have been received.
    2.  Certified copies of the priority documents have been received in Application No. \_\_\_\_\_.
    3.  Copies of the certified copies of the priority documents have been received in this national stage application from the International Bureau (PCT Rule 17.2(a)).

\* Certified copies not received: \_\_\_\_\_.
5.  Acknowledgment is made of a claim for domestic priority under 35 U.S.C. § 119(e) (to a provisional application).
  - (a)  The translation of the foreign language provisional application has been received.
6.  Acknowledgment is made of a claim for domestic priority under 35 U.S.C. §§ 120 and/or 121.

Applicant has THREE MONTHS FROM THE "MAILING DATE" of this communication to file a reply complying with the requirements noted below. Failure to timely comply will result in ABANDONMENT of this application. **THIS THREE-MONTH PERIOD IS NOT EXTENDABLE.**

7.  A SUBSTITUTE OATH OR DECLARATION must be submitted. Note the attached EXAMINER'S AMENDMENT or NOTICE OF INFORMAL PATENT APPLICATION (PTO-152) which gives reason(s) why the oath or declaration is deficient.
8.  CORRECTED DRAWINGS must be submitted.
  - (a)  including changes required by the Notice of Draftsperson's Patent Drawing Review ( PTO-948) attached
    - 1)  hereto or 2)  to Paper No. \_\_\_\_\_.
  - (b)  including changes required by the proposed drawing correction filed \_\_\_\_\_, which has been approved by the Examiner.
  - (c)  including changes required by the attached Examiner's Amendment / Comment or in the Office action of Paper No. \_\_\_\_\_.

identifying indicia such as the application number (see 37 CFR 1.84(c)) should be written on the drawings in the top margin (not the back) of each sheet. The drawings should be filed as a separate paper with a transmittal letter addressed to the Official Draftsperson.

9.  DEPOSIT OF and/or INFORMATION about the deposit of BIOLOGICAL MATERIAL must be submitted. Note the attached Examiner's comment regarding REQUIREMENT FOR THE DEPOSIT OF BIOLOGICAL MATERIAL.

**Attachment(s)**

- |                                                                                                        |                                                                                     |
|--------------------------------------------------------------------------------------------------------|-------------------------------------------------------------------------------------|
| 1 <input type="checkbox"/> Notice of References Cited (PTO-892)                                        | 2 <input type="checkbox"/> Notice of Informal Patent Application (PTO-152)          |
| 3 <input type="checkbox"/> Notice of Draftsperson's Patent Drawing Review (PTO-948)                    | 4 <input type="checkbox"/> Interview Summary (PTO-413), Paper No. _____             |
| 5 <input type="checkbox"/> Information Disclosure Statements (PTO-1449), Paper No. _____               | 6 <input type="checkbox"/> Examiner's Amendment/Comment                             |
| 7 <input type="checkbox"/> Examiner's Comment Regarding Requirement for Deposit of Biological Material | 8 <input checked="" type="checkbox"/> Examiner's Statement of Reasons for Allowance |
|                                                                                                        | 9 <input type="checkbox"/> Other                                                    |

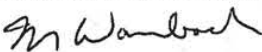
  
 Margaret R Wambach  
 Primary Examiner  
 Art Unit: 2816

Application/Control Number: 09/756,647  
Art Unit: 2816

Page 2

### REASONS FOR ALLOWANCE

The following is an examiner's statement of reasons for allowance: None of the references of record teach an exercise monitoring device comprising the data processing limitations included in the dependent claims.

Any comments considered necessary by applicant must be submitted no later than the payment of the issue fee and, to avoid processing delays, should preferably accompany the issue fee. Such submissions should be clearly labeled "Comments on Statement of Reasons for Allowance."

Any inquiry concerning this communication or earlier communications from the examiner should be directed to Margaret R Wambach whose telephone number is (703) 308-4875. The examiner can normally be reached on Tues-Thurs 3-6pm.

If attempts to reach the examiner by telephone are unsuccessful, the examiner's supervisor, Timothy Callahan can be reached on (703) 308-4876. The fax phone numbers for the organization where this application or proceeding is assigned are (703) 872-9318 for regular communications and (703) 872-93 for After Final communications.

Any inquiry of a general nature or relating to the status of this application or proceeding should be directed to the receptionist whose telephone number is (703) 308-0956.

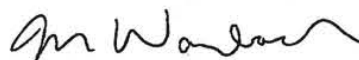

Margaret R Wambach  
Primary Examiner  
Art Unit 2816

\*\*\*

March 16, 2002



UNITED STATES PATENT AND TRADEMARK OFFICE

UNITED STATES DEPARTMENT OF COMMERCE  
United States Patent and Trademark Office  
Address: COMMISSIONER OF PATENTS AND TRADEMARKS  
Washington, D.C. 20231  
www.uspto.gov

KL

APPLICATION NO.	FILING DATE	FIRST NAMED INVENTOR	ATTORNEY DOCKET NO.	CONFIRMATION NO.
09/756,647	01/04/2001	Nathan Pyles	KNOWMO-6	7058

20455      7590      03/29/2002  
**LATHROP & CLARK LLP**  
 740 REGENT STREET SUITE 400  
 P.O. BOX 1507  
 MADISON, WI 537011507

EXAMINER

WAMBACH, MARGARET R

ART UNIT	PAPER NUMBER
----------	--------------

2816

DATE MAILED: 03/29/2002

9

Please find below and/or attached an Office communication concerning this application or proceeding.

*Supplemental*  
**Notice of Allowability**

Application No.	Applicant(s)	
09/756,647	PYLES, NATHAN	
Examiner	Art Unit	
Margaret R Wambach	2816	

-- The MAILING DATE of this communication appears on the cover sheet with the correspondence address--  
All claims being allowable, PROSECUTION ON THE MERITS IS (OR REMAINS) CLOSED in this application. If not included herewith (or previously mailed), a Notice of Allowance (PTOL-85) or other appropriate communication will be mailed in due course. THIS NOTICE OF ALLOWABILITY IS NOT A GRANT OF PATENT RIGHTS. This application is subject to withdrawal from issue at the initiative of the Office or upon petition by the applicant. See 37 CFR 1.313 and MPEP 1308.

1.  This communication is responsive to Amdt A (1/13/02).
2.  The allowed claim(s) is/are 2-9.
3.  The drawings filed on 04 January 2001 are accepted by the Examiner.
4.  Acknowledgment is made of a claim for foreign priority under 35 U.S.C. § 119(a)-(d) or (f).
  - a)  All    b)  Some\*    c)  None    of the:
    1.  Certified copies of the priority documents have been received.
    2.  Certified copies of the priority documents have been received in Application No. \_\_\_\_\_.
    3.  Copies of the certified copies of the priority documents have been received in this national stage application from the International Bureau (PCT Rule 17.2(a)).
- \* Certified copies not received: \_\_\_\_\_.
5.  Acknowledgment is made of a claim for domestic priority under 35 U.S.C. § 119(e) (to a provisional application).
  - (a)  The translation of the foreign language provisional application has been received.
6.  Acknowledgment is made of a claim for domestic priority under 35 U.S.C. §§ 120 and/or 121.

Applicant has THREE MONTHS FROM THE "MAILING DATE" of this communication to file a reply complying with the requirements noted below. Failure to timely comply will result in ABANDONMENT of this application. THIS THREE-MONTH PERIOD IS NOT EXTENDABLE.

7.  A SUBSTITUTE OATH OR DECLARATION must be submitted. Note the attached EXAMINER'S AMENDMENT or NOTICE OF INFORMAL PATENT APPLICATION (PTO-152) which gives reason(s) why the oath or declaration is deficient.
8.  CORRECTED DRAWINGS must be submitted.
  - (a)  including changes required by the Notice of Draftsperson's Patent Drawing Review ( PTO-948) attached
    - 1)  hereto or 2)  to Paper No. \_\_\_\_\_.
  - (b)  including changes required by the proposed drawing correction filed \_\_\_\_\_, which has been approved by the Examiner.
  - (c)  including changes required by the attached Examiner's Amendment / Comment or in the Office action of Paper No. \_\_\_\_\_.

Identifying indicia such as the application number (see 37 CFR 1.84(c)) should be written on the drawings in the top margin (not the back) of each sheet. The drawings should be filed as a separate paper with a transmittal letter addressed to the Official Draftsperson.

9.  DEPOSIT OF and/or INFORMATION about the deposit of BIOLOGICAL MATERIAL must be submitted. Note the attached Examiner's comment regarding REQUIREMENT FOR THE DEPOSIT OF BIOLOGICAL MATERIAL.

**Attachment(s)**

- |                                                                                                        |                                                                            |
|--------------------------------------------------------------------------------------------------------|----------------------------------------------------------------------------|
| 1 <input type="checkbox"/> Notice of References Cited (PTO-892)                                        | 2 <input type="checkbox"/> Notice of Informal Patent Application (PTO-152) |
| 3 <input type="checkbox"/> Notice of Draftsperson's Patent Drawing Review (PTO-948)                    | 4 <input type="checkbox"/> Interview Summary (PTO-413), Paper No. _____    |
| 5 <input checked="" type="checkbox"/> Information Disclosure Statements (PTO-1449), Paper No. <u>5</u> | 6 <input type="checkbox"/> Examiner's Amendment/Comment                    |
| 7 <input type="checkbox"/> Examiner's Comment Regarding Requirement for Deposit of Biological Material | 8 <input type="checkbox"/> Examiner's Statement of Reasons for Allowance   |
|                                                                                                        | 9 <input type="checkbox"/> Other <i>M. Wambach</i>                         |

Margaret R Wambach  
Primary Examiner  
Art Unit: 2816



UNITED STATES PATENT AND TRADEMARK OFFICE

UNITED STATES DEPARTMENT OF COMMERCE  
United States Patent and Trademark Office  
Address: COMMISSIONER OF PATENTS AND TRADEMARKS  
Washington, D.C. 20531  
www.uspto.gov

#10  
7-1002  
JA

NOTICE OF ALLOWANCE AND FEE(S) DUE

020455 7590 03/19/2002  
LATHROP & CLARK LLP  
740 REGENT STREET SUITE 400  
P.O. BOX 1507  
MADISON, WI 537011507

RESPONSE DUE 6/19/02

ACTION Issue fee due  
DOCKETED  
BY: lu DATE: 3/25/02  
TICKLER  
BY: \_\_\_\_\_ DATE: \_\_\_\_\_

EXAMINER

WAMBACH, MARGARET R

ART UNIT CLASS-SUBCLASS  
2816 377-024200

DATE MAILED: 03/19/2002

APPLICATION NO. 09/756,647	FILING DATE 01/04/2001	FIRST NAMED INVENTOR Nathan Pyles	ATTORNEY DOCKET NO. KNOWMO-6	CONFIRMATION NO. 7058
-------------------------------	---------------------------	--------------------------------------	---------------------------------	--------------------------

TITLE OF INVENTION: PEDOMETER



TOTAL CLAIMS 8	APPLN. TYPE nonprovisional	SMALL ENTITY NO	ISSUE FEE \$1280	PUBLICATION FEE \$300	TOTAL FEE(S) DUE \$1580	DATE DUE 06/19/2002
-------------------	-------------------------------	--------------------	---------------------	--------------------------	----------------------------	------------------------

THE APPLICATION IDENTIFIED ABOVE HAS BEEN EXAMINED AND IS ALLOWED FOR ISSUANCE AS A PATENT. PROSECUTION ON THE MERITS IS CLOSED. THIS NOTICE OF ALLOWANCE IS NOT A GRANT OF PATENT RIGHTS. THIS APPLICATION IS SUBJECT TO WITHDRAWAL FROM ISSUE AT THE INITIATIVE OF THE OFFICE OR UPON PETITION BY THE APPLICANT. SEE 37 CFR 1.313 AND MPEP 1308.

THE ISSUE FEE AND PUBLICATION FEE (IF REQUIRED) MUST BE PAID WITHIN THREE MONTHS FROM THE MAILING DATE OF THIS NOTICE OR THIS APPLICATION SHALL BE REGARDED AS ABANDONED. THIS STATUTORY PERIOD CANNOT BE EXTENDED. SEE 35 U.S.C. 151. THE ISSUE FEE DUE INDICATED ABOVE REFLECTS A CREDIT FOR ANY PREVIOUSLY PAID ISSUE FEE APPLIED IN THIS APPLICATION. THE PTOL-85B (OR AN EQUIVALENT) MUST BE RETURNED WITHIN THIS PERIOD EVEN IF NO FEE IS DUE OR THE APPLICATION WILL BE REGARDED AS ABANDONED.

HOW TO REPLY TO THIS NOTICE:

Review the SMALL ENTITY status shown above. If the SMALL ENTITY is shown as YES, verify your current SMALL ENTITY status:

- A. If the status is changed, pay the PUBLICATION FEE (if required) and twice the amount of the ISSUE FEE shown above and notify the United States Patent and Trademark Office of the change in status, or
- B. If the status is the same, pay the TOTAL FEE(S) DUE shown above.

If the SMALL ENTITY is shown as NO:

A. Pay TOTAL FEE(S) DUE shown above, or

B. If applicant claimed SMALL ENTITY status before, or is now claiming SMALL ENTITY status, check the box below and enclose the PUBLICATION FEE and 1/2 the ISSUE FEE shown above.

Applicant claims SMALL ENTITY status. See 37 CFR 1.27.

II. PART B - FEE(S) TRANSMITTAL should be completed and returned to the United States Patent and Trademark Office (USPTO) with your ISSUE FEE and PUBLICATION FEE (if required). Even if the fee(s) have already been paid, Part B - Fee(s) Transmittal should be completed and returned. If you are charging the fee(s) to your deposit account, section "4b" of Part B - Fee(s) Transmittal should be completed and an extra copy of the form should be submitted.

III. All communications regarding this application must give the application number. Please direct all communications prior to issuance to Box ISSUE FEE unless advised to the contrary.

IMPORTANT REMINDER: Utility patents issuing on applications filed on or after Dec. 12, 1980 may require payment of maintenance fees. It is patentee's responsibility to ensure timely payment of maintenance fees when due.

**PART B - FEE(S) TRANSMITTAL**

Complete and mail this form, together with applicable fee(s), to:

**Box ISSUE FEE**  
**Assistant Commissioner for Patents**  
**Washington, D.C. 20231**

**MAILING INSTRUCTIONS:** This form should be used for transmitting the ISSUE FEE and PUBLICATION FEE (if required). Blocks 1 through 4 should be completed where appropriate. All further correspondence including the Patent, advance orders and notification of maintenance fees will be mailed to the current correspondence address as indicated unless corrected below or directed otherwise in Block 1, by (a) specifying a new correspondence address; and/or (b) indicating a separate "FEE ADDRESS" for maintenance fee notifications.

CURRENT CORRESPONDENCE ADDRESS (Note: Legibly mark-up with any corrections or see Block 1)

020455 7590 03/19/2002  
**LATHROP & CLARK LLP**  
**740 REGENT STREET SUITE 400**  
**P.O. BOX 1507**  
**MADISON, WI 537011507**



Note: The certificate of mailing below can only be used for domestic mailings of the Fee(s) Transmittal. This certificate cannot be used for any other accompanying papers. Each additional paper, such as an assignment or formal drawing, must have its own certificate of mailing.

**Certificate of Mailing**

I hereby certify that this Fee(s) Transmittal is being deposited with the United States Postal Service with sufficient postage for first class mail in an envelope addressed to the Box Issue Fee address above on the date indicated below.

<b>Jeffry W. Smith</b>	(Depositor's name)
<i>Jeffry W. Smith</i>	(Signature)
<b>June 10, 2002</b>	(Date)

09/756,647

APPLICATION NO.	FILING DATE	FIRST NAMED INVENTOR	ATTORNEY DOCKET NO.	CONFIRMATION NO.
09/756,647	01/04/2001	Nathan Pyles	KNOWMO-6	7058

TITLE OF INVENTION: PEDOMETER

TOTAL CLAIMS	APPLN. TYPE	SMALL ENTITY	ISSUE FEE	PUBLICATION FEE	TOTAL FEE(S) DUE	DATE DUE
8	nonprovisional	NO	\$1280	\$300	\$1580	06/19/2002

EXAMINER	ART UNIT	CLASS-SUBCLASS
WAMBACH, MARGARET R	2816	377-024200

1/Change of correspondence address or indication of "Fee Address" (37 CFR 1.363). Use of PTO form(s) and Customer Number are recommended, but not required.

- Change of correspondence address (or Change of Correspondence Address form PTO/SB/122) attached.
- "Fee Address" indication (or "Fee Address" Indication form PTO/SB/47) attached.

2. For printing on the patent front page, list (1) the names of up to 3 registered patent attorneys or agents OR, alternatively, (2) the name of a single firm (having as a member a registered attorney or agent) and the names of up to 2 registered patent attorneys or agents. If no name is listed, no name will be printed.

- 1 Lathrop & Clark LLP
- 2 \_\_\_\_\_
- 3 \_\_\_\_\_

**3. ASSIGNEE NAME AND RESIDENCE DATA TO BE PRINTED ON THE PATENT (print or type)**

PLEASE NOTE: Unless an assignee is identified below, no assignee data will appear on the patent. Inclusion of assignee data is only appropriate when an assignment has been previously submitted to the USPTO or is being submitted under separate cover. Completion of this form is NOT a substitute for filing an assignment.

(A) NAME OF ASSIGNEE

(B) RESIDENCE: (CITY and STATE OR COUNTRY)

Please check the appropriate assignee category or categories (will not be printed on the patent)  individual  corporation or other private group entity  government

4a. The following fee(s) are enclosed:

- Issue Fee
- Publication Fee
- Advance Order - # of Copies 10

4b. Payment of Fee(s):

- A check in the amount of the fee(s) is enclosed.
- Payment by credit card. Form PTO-2038 is attached.
- The Commissioner is hereby authorized by charge the required fee(s), or credit any overpayment, to Deposit Account Number 15-0660 (enclose an extra copy of this form).

The COMMISSIONER OF PATENTS AND TRADEMARKS is requested to apply the Issue Fee and Publication Fee (if any) or to re-apply any previously paid issue fee to the application identified above.

(Authorized Signature) *Jeffry W. Smith* (Date) June 10, 2002

NOTE: The Issue Fee and Publication Fee (if required) will not be accepted from anyone other than the applicant, a registered attorney or agent, or the assignee or other party in interest as shown by the records of the United States Patent and Trademark Office.

Burden Hour Statement: This form is estimated to take 0.2 hours to complete. Time will vary depending on the needs of the individual case. Any comments on the amount of time required to complete this form should be sent to the Chief Information Officer, United States Patent and Trademark Office, Washington, D.C. 20231. DO NOT SEND FEES OR COMPLETED FORMS TO THIS ADDRESS. SEND FEES AND THIS FORM TO: Box Issue Fee, Assistant Commissioner for Patents, Washington, D.C. 20231

Under the Paperwork Reduction Act of 1995, no persons are required to respond to a collection of information unless it displays a valid OMB control number.

06/21/2002 ZJUWAR2 00000015 09756647  
 01 FC:242 640.00 OP  
 02 FC:561 30.00 OP  
 03 FC:195 300.00 OP

TRANSMIT THIS FORM WITH FEE(S)



2816  
DSD

PTO/SB/21 (08-03)  
Approved for use through 08/30/2003. OMB 0651-0031  
U.S. Patent and Trademark Office; U.S. DEPARTMENT OF COMMERCE

Under the Paperwork Reduction Act of 1995, no persons are required to respond to a collection of information unless it displays a valid OMB control number.

<b>TRANSMITTAL FORM</b>  <i>(to be used for all correspondence after initial filing)</i>	Application Number	09/756,647
	Filing Date	January 4, 2001
	First Named Inventor	Nathan Pyles
	Art Unit	2816
	Examiner Name	M. Wambach
Total Number of Pages In This Submission	Attorney Docket Number	10013.006

ENCLOSURES (Check all that apply)		
<input type="checkbox"/> Fee Transmittal Form	<input type="checkbox"/> Drawing(s)	<input type="checkbox"/> After Allowance communication to Technology Center (TC)
<input type="checkbox"/> Fee Attached	<input type="checkbox"/> Licensing-related Papers	<input type="checkbox"/> Appeal Communication to Board of Appeals and Interferences
<input type="checkbox"/> Amendment/Reply	<input type="checkbox"/> Petition	<input type="checkbox"/> Appeal Communication to TC (Appeal Notice, Brief, Reply Brief)
<input type="checkbox"/> After Final	<input type="checkbox"/> Petition to Convert to a Provisional Application	<input type="checkbox"/> Proprietary Information
<input type="checkbox"/> Affidavits/declaration(s)	<input checked="" type="checkbox"/> Power of Attorney, Revocation	<input type="checkbox"/> Status Letter
<input type="checkbox"/> Extension of Time Request	<input type="checkbox"/> Change of Correspondence Address	<input type="checkbox"/> Other Enclosure(s) (please identify below):
<input type="checkbox"/> Express Abandonment Request	<input type="checkbox"/> Terminal Disclaimer	
<input type="checkbox"/> Information Disclosure Statement	<input type="checkbox"/> Request for Refund	
<input type="checkbox"/> Certified Copy of Priority Document(s)	<input type="checkbox"/> CD, Number of CD(s)	
<input type="checkbox"/> Response to Missing Parts/Incomplete Application	Remarks  The Commissioner is hereby authorized to charge any additional fees that may be required with respect to this communication, or credit any overpayment, to Deposit Account No. 50-2911.	
<input type="checkbox"/> Response to Missing Parts under 37 CFR 1.52 or 1.53		

RECEIVED OFFICE  
 2004 MAR 18 PM 4:00  
 PENDING HANDLING

SIGNATURE OF APPLICANT, ATTORNEY, OR AGENT	
Firm or Individual name	Jeffrey W. Smith, Reg. No. 33455
Signature	<i>Jeffrey W. Smith</i> 39231
Date	March 9, 2004

CERTIFICATE OF TRANSMISSION/MAILING	
I hereby certify that this correspondence is being facsimile transmitted to the USPTO or deposited with the United States Postal Service with sufficient postage as first class mail in an envelope addressed to: Commissioner for Patents, P.O. Box 1450, Alexandria, VA 22313-1450 on the date shown below.	
Typed or printed name	Jeffrey W. Smith, Reg. No. 33455
Signature	<i>Jeffrey W. Smith</i>
Date	March 9, 2004

This collection of information is required by 37 CFR 1.5. The information is required to obtain or retain a benefit by the public which is to file (and by the USPTO to process) an application. Confidentiality is governed by 35 U.S.C. 122 and 37 CFR 1.14. This collection is estimated to 12 minutes to complete, including gathering, preparing, and submitting the completed application form to the USPTO. Time will vary depending upon the individual case. Any comments on the amount of time you require to complete this form and/or suggestions for reducing this burden, should be sent to the Chief Information Officer, U.S. Patent and Trademark Office, U.S. Department of Commerce, P.O. Box 1450, Alexandria, VA 22313-1450. DO NOT SEND FEES OR COMPLETED FORMS TO THIS ADDRESS. SEND TO: Commissioner for Patents, P.O. Box 1450, Alexandria, VA 22313-1450.

If you need assistance in completing the form, call 1-800-PTO-9199 and select option 2.



6434212

1/1

TomTom

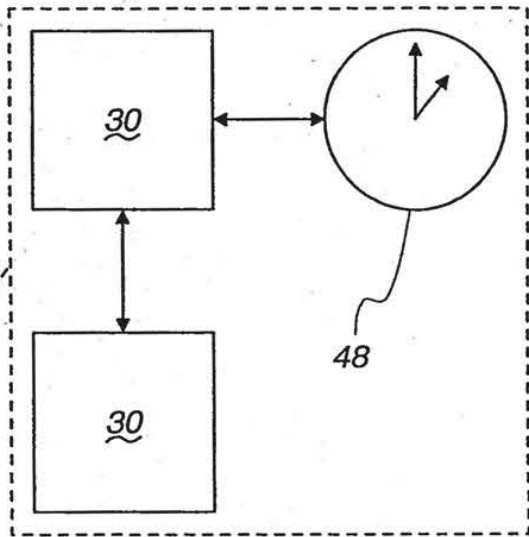
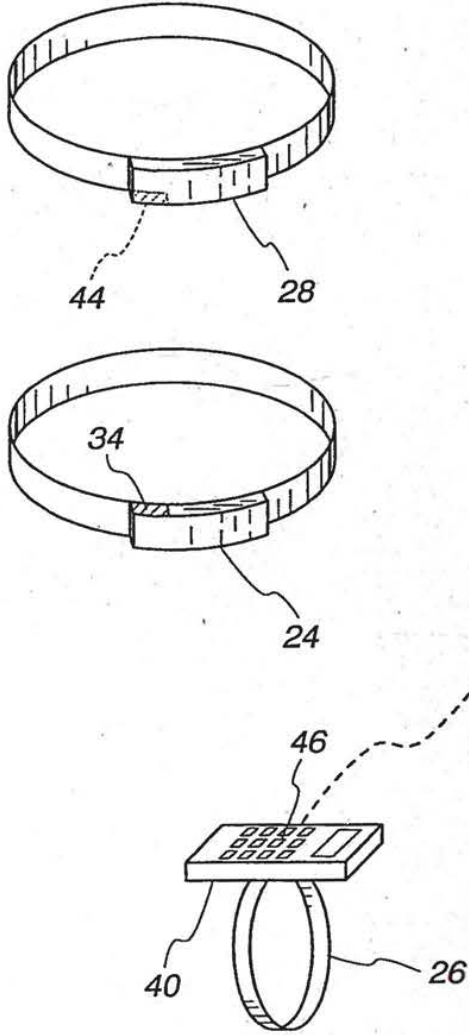

The figure

0434212



UNITED STATES PATENT AND TRADEMARK OFFICE

UNITED STATES DEPARTMENT OF COMMERCE  
United States Patent and Trademark Office  
Address: COMMISSIONER FOR PATENTS  
P.O. Box 1450  
Alexandria, Virginia 22313-1450  
www.uspto.gov

APPLICATION NUMBER	FILING OR 371 (c) DATE	FIRST NAMED APPLICANT	ATTY. DOCKET NO./TITLE
09/756,647	01/04/2001	Nathan Pyles	KNOWMO-6

39231  
SMITH & AMUNDSEN  
440 SCIENCE DR.  
SUITE 320  
MADISON, WI 53711

CONFIRMATION NO. 7058



\*OC000000012150605\*

Date Mailed: 03/22/2004

**NOTICE OF ACCEPTANCE OF POWER OF ATTORNEY**

This is in response to the Power of Attorney filed 03/19/2004.

The Power of Attorney in this application is accepted. Correspondence in this application will be mailed to the above address as provided by 37 CFR 1.33.

DAVID O LIPSCOMB  
OPR (703) 308-7127

OFFICE COPY

	Type	L #	Hits	Search Text	DBs	Time Stamp
1	BRS	L1	50	exercise adj monitor	USPAT	2002/03/17 14:04

03/17/2002, EAST Version: 1.03.0002

**PATENT APPLICATION FEE DETERMINATION RECORD**  
Effective October 1, 2000

Application or Docket Number

09756647

**CLAIMS AS FILED - PART I**

	(Column 1)	(Column 2)
TOTAL CLAIMS	9	
FOR	NUMBER FILED	NUMBER EXTRA
TOTAL CHARGEABLE CLAIMS	9 minus 20= *	0
INDEPENDENT CLAIMS	2 minus 3 = *	0
MULTIPLE DEPENDENT CLAIM PRESENT <input type="checkbox"/>		

\* If the difference in column 1 is less than zero, enter "0" in column 2

SMALL ENTITY TYPE  OR

OTHER THAN SMALL ENTITY

RATE	FEE		RATE	FEE
BASIC FEE	355.00	OR	BASIC FEE	710.00
X\$ 9=		OR	X\$18=	
X40=		OR	X80=	
+135=		OR	+270=	
TOTAL		OR	TOTAL	710

**CLAIMS AS AMENDED - PART II**

	(Column 1)	(Column 2)	(Column 3)
AMENDMENT A	CLAIMS REMAINING AFTER AMENDMENT	HIGHEST NUMBER PREVIOUSLY PAID FOR	PRESENT EXTRA
	Total *	8 Minus **	20 =
	Independent *	3 Minus ***	3 =
FIRST PRESENTATION OF MULTIPLE DEPENDENT CLAIM <input type="checkbox"/>			

SMALL ENTITY OR

OTHER THAN SMALL ENTITY

RATE	ADDITIONAL FEE		RATE	ADDITIONAL FEE
X\$ 9=		OR	X\$18=	
X40=		OR	X80=	
+135=		OR	+270=	
TOTAL ADDIT. FEE		OR	TOTAL ADDIT. FEE	

	(Column 1)	(Column 2)	(Column 3)
AMENDMENT B	CLAIMS REMAINING AFTER AMENDMENT	HIGHEST NUMBER PREVIOUSLY PAID FOR	PRESENT EXTRA
	Total *	Minus **	=
	Independent *	Minus ***	=
FIRST PRESENTATION OF MULTIPLE DEPENDENT CLAIM <input type="checkbox"/>			

RATE	ADDITIONAL FEE		RATE	ADDITIONAL FEE
X\$ 9=		OR	X\$18=	
X40=		OR	X80=	
+135=		OR	+270=	
TOTAL ADDIT. FEE		OR	TOTAL ADDIT. FEE	

	(Column 1)	(Column 2)	(Column 3)
AMENDMENT C	CLAIMS REMAINING AFTER AMENDMENT	HIGHEST NUMBER PREVIOUSLY PAID FOR	PRESENT EXTRA
	Total *	Minus **	=
	Independent *	Minus ***	=
FIRST PRESENTATION OF MULTIPLE DEPENDENT CLAIM <input type="checkbox"/>			

RATE	ADDITIONAL FEE		RATE	ADDITIONAL FEE
X\$ 9=		OR	X\$18=	
X40=		OR	X80=	
+135=		OR	+270=	
TOTAL ADDIT. FEE		OR	TOTAL ADDIT. FEE	

\* If the entry in column 1 is less than the entry in column 2, write "0" in column 3.

\*\* If the "Highest Number Previously Paid For" IN THIS SPACE is less than 20, enter "20."

\*\*\*If the "Highest Number Previously Paid For" IN THIS SPACE is less than 3, enter "3."

The "Highest Number Previously Paid For" (Total or Independent) is the highest number found in the appropriate box in column 1.