



United States Patent [19]

Aoshima et al.

[11] Patent Number: **6,099,478**

[45] Date of Patent: **Aug. 8, 2000**

[54] **PULSE COUNTER AND PULSE DISPLAY METHOD**

5,795,300 8/1998 Bryars et al. 600/500
5,807,267 9/1998 Bryars et al. 600/500

[75] Inventors: **Ichiro Aoshima; Tsukasa Kosuda,**
both of Suwa, Japan

FOREIGN PATENT DOCUMENTS

60-259239 12/1985 Japan .
4-75503 7/1992 Japan .
6-245912 9/1994 Japan .
7-148127 6/1995 Japan .
7-227383 8/1995 Japan .
8-289876 11/1996 Japan .

[73] Assignees: **Seiko Epson Corporation,** Tokyo;
Seiko Instruments, Inc., Chiba, both of
Japan

[21] Appl. No.: **09/180,727**

[22] PCT Filed: **Mar. 18, 1998**

[86] PCT No.: **PCT/JP98/01142**

§ 371 Date: **Nov. 12, 1998**

§ 102(e) Date: **Nov. 12, 1998**

[87] PCT Pub. No.: **WO98/41142**

PCT Pub. Date: **Sep. 24, 1998**

[30] Foreign Application Priority Data

Mar. 18, 1997 [JP] Japan 9-064991

[51] Int. Cl.⁷ **A61B 5/02**

[52] U.S. Cl. **600/500; 600/502**

[58] Field of Search 600/500, 502,
600/503, 501, 481

[56] References Cited

U.S. PATENT DOCUMENTS

5,697,374 12/1997 Odagiri et al. 600/500

Primary Examiner—Cary O'Connor
Assistant Examiner—Navin Natnithadhha
Attorney, Agent, or Firm—Mark P. Watson

[57] ABSTRACT

A pulse counter is provided in which the value displayed for the detected value is highly reliable. An SN condition detecting means detects the SN condition of a pulse wave signal (step S201). The SN condition detecting means then determines whether or not the detected SN condition is good based on a specific threshold value (step S202). When a determination is made that the SN condition is good, a display control signal to display the pulse rate on a display means is output to a display method switching means (step S203). Conversely, when a determination is made in step S202 that the SN condition is not good, the pulse rate is not displayed on the display means, but rather a display control signal indicating that no information at all be displayed is output to the display method switching means (step S204).

16 Claims, 10 Drawing Sheets

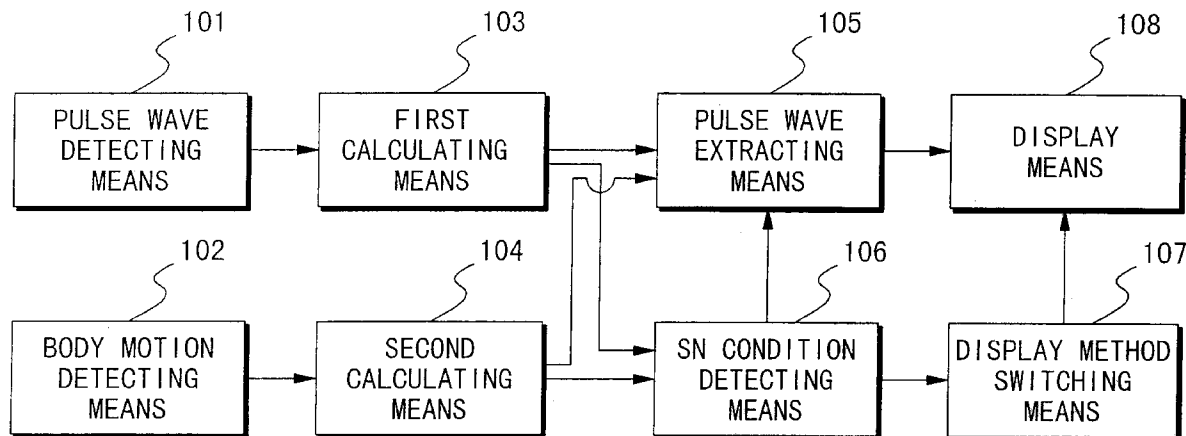

FIG. 1

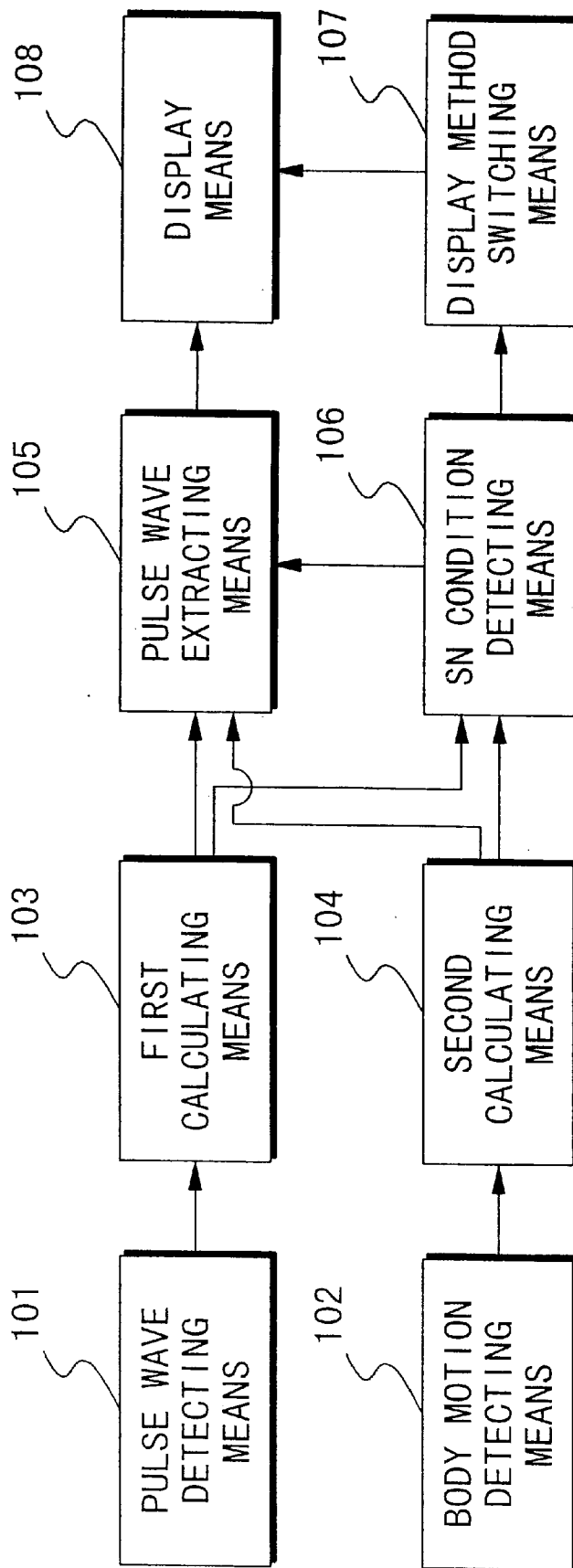

FIG. 2

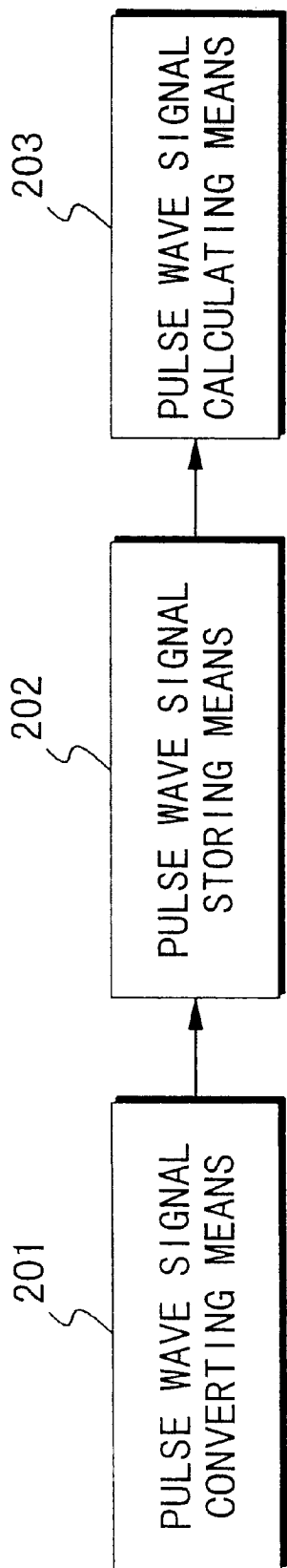

FIG. 3

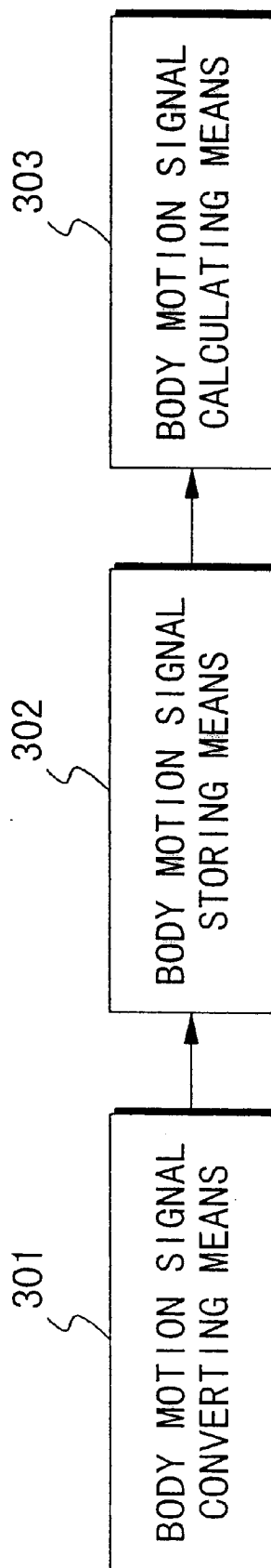

FIG. 4

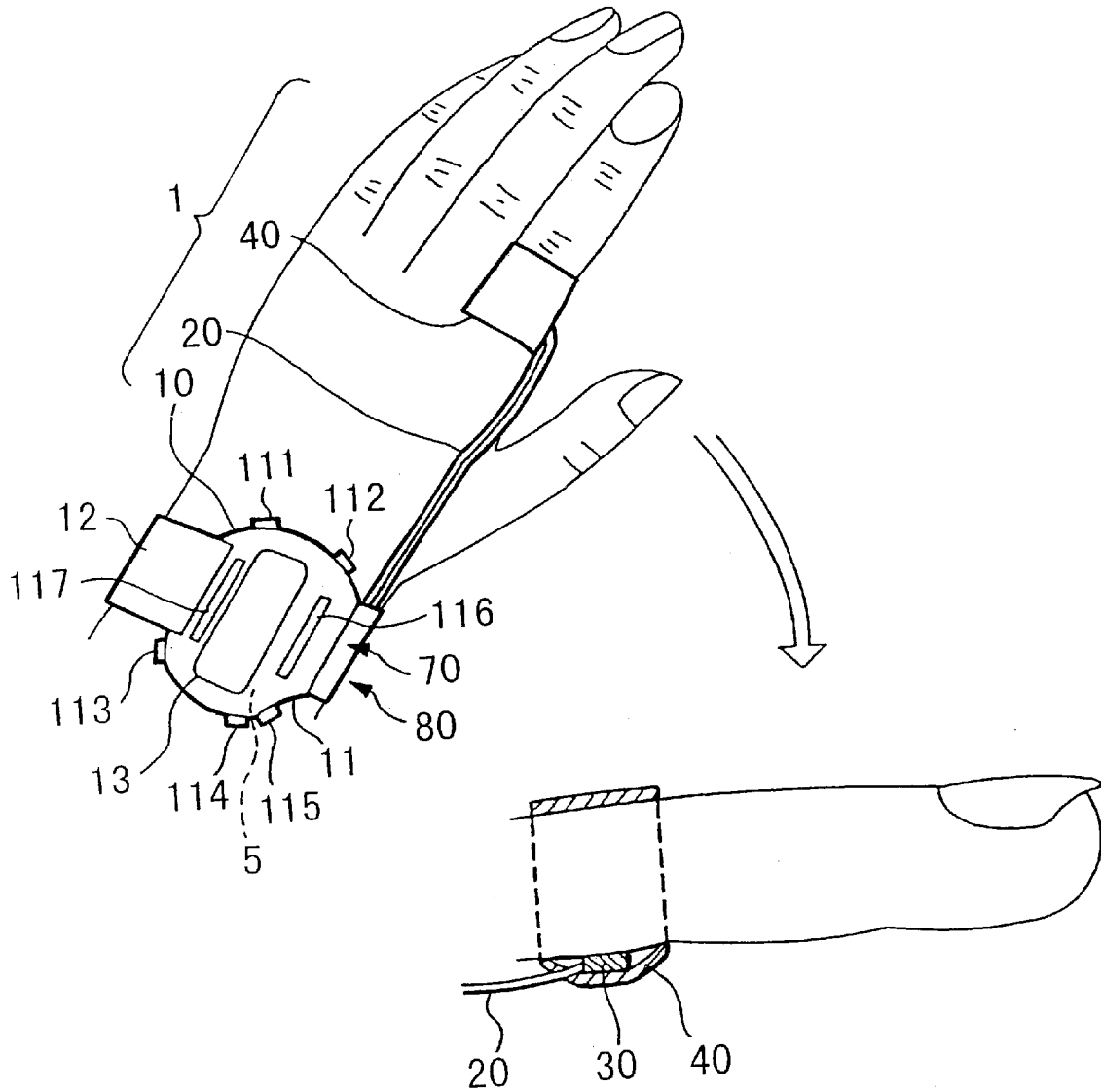

FIG. 5

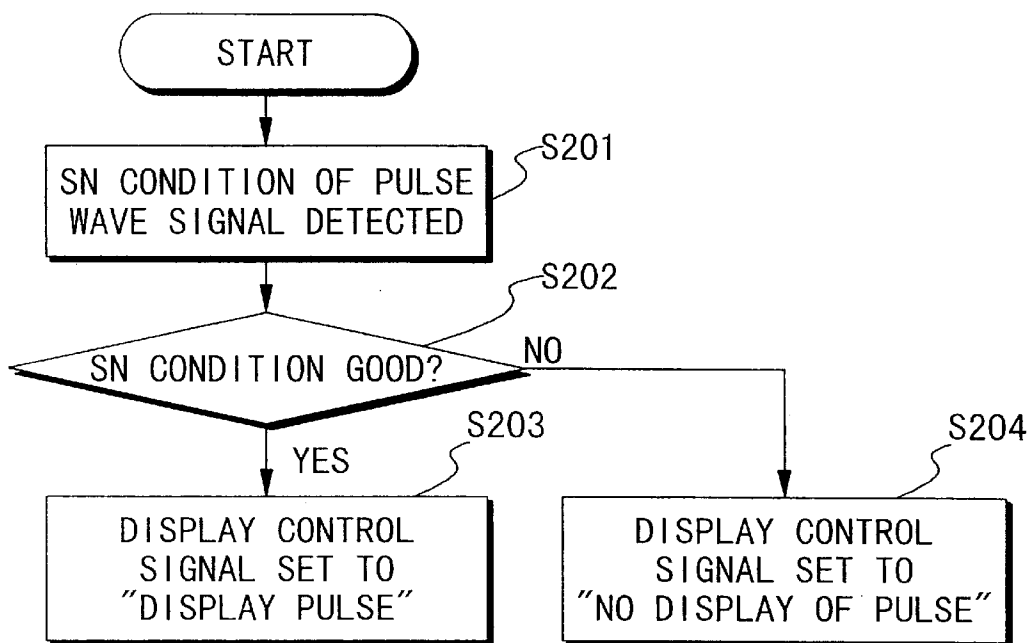
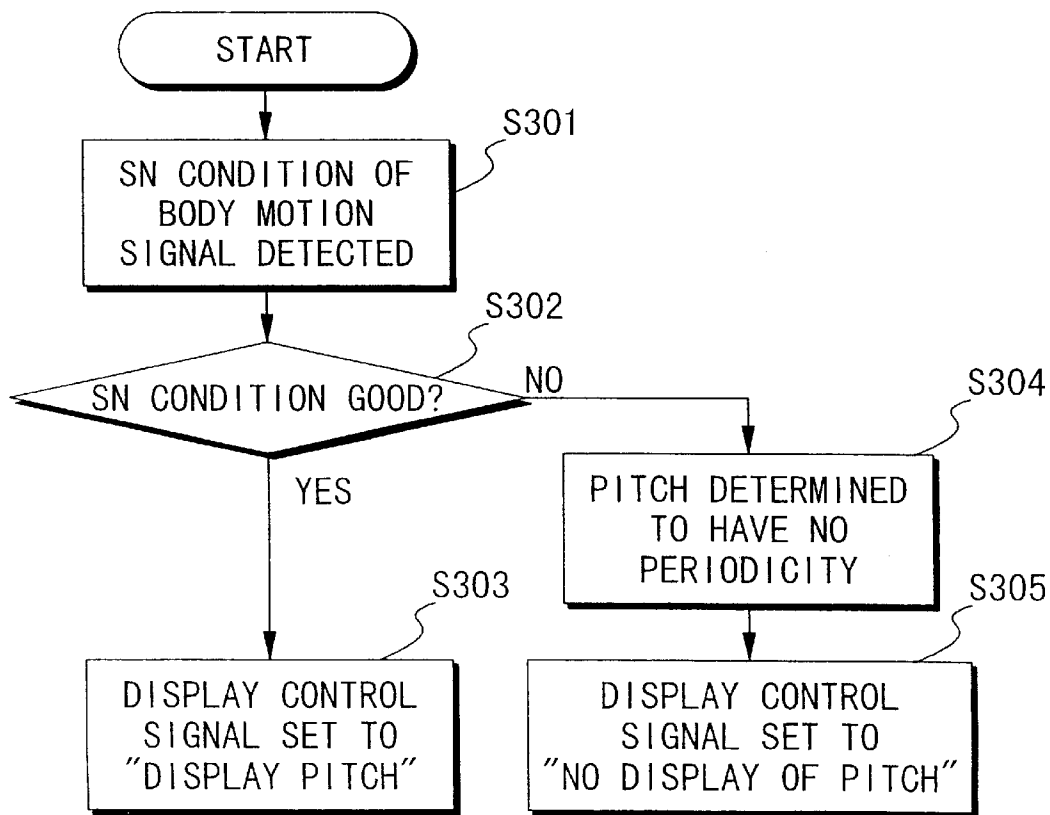

FIG. 6



Explore Litigation Insights

Docket Alarm provides insights to develop a more informed litigation strategy and the peace of mind of knowing you're on top of things.

Real-Time Litigation Alerts



Keep your litigation team up-to-date with **real-time alerts** and advanced team management tools built for the enterprise, all while greatly reducing PACER spend.

Our comprehensive service means we can handle Federal, State, and Administrative courts across the country.

Advanced Docket Research



With over 230 million records, Docket Alarm's cloud-native docket research platform finds what other services can't. Coverage includes Federal, State, plus PTAB, TTAB, ITC and NLRB decisions, all in one place.

Identify arguments that have been successful in the past with full text, pinpoint searching. Link to case law cited within any court document via Fastcase.

Analytics At Your Fingertips



Learn what happened the last time a particular judge, opposing counsel or company faced cases similar to yours.

Advanced out-of-the-box PTAB and TTAB analytics are always at your fingertips.

API

Docket Alarm offers a powerful API (application programming interface) to developers that want to integrate case filings into their apps.

LAW FIRMS

Build custom dashboards for your attorneys and clients with live data direct from the court.

Automate many repetitive legal tasks like conflict checks, document management, and marketing.

FINANCIAL INSTITUTIONS

Litigation and bankruptcy checks for companies and debtors.

E-DISCOVERY AND LEGAL VENDORS

Sync your system to PACER to automate legal marketing.