

1c518 U.S. PTO
09/181738

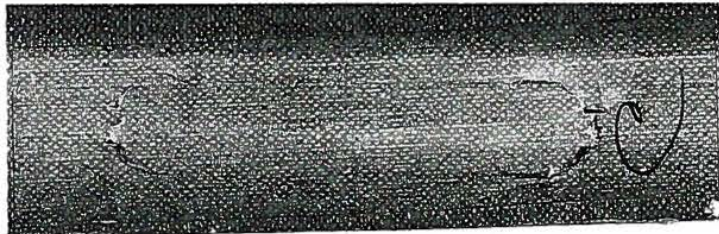

377	24.2	ISSUE CLASSIFICATION
Class	Subclass	



PATENT NUMBER
6175608

U.S. UTILITY PATENT APPLICATION

O.I.P.E. SCANNED <i>SJP</i> Q.A. <i>AM</i>	PATENT DATE JAN 16 2001
---	----------------------------

SECTOR	CLASS 377	SUBCLASS 24.2	ART UNIT 2816	EXAMINER <i>Wambach</i>
--------	---------------------	-------------------------	-------------------------	----------------------------

FILED WITH: DISK (CRF) FICHE
(Attached in pocket on right inside flap)

PREPARED AND APPROVED FOR ISSUE

ISSUING CLASSIFICATION							
ORIGINAL				CROSS REFERENCE(S)			
CLASS	SUBCLASS	CLASS	SUBCLASS (ONE SUBCLASS PER BLOCK)				
377	24.2						
INTERNATIONAL CLASSIFICATION							
G01C	21 / 00	NONE					

<input type="checkbox"/> TERMINAL DISCLAIMER	DRAWINGS			CLAIMS ALLOWED	
	Sheets Drwg.	Figs. Drwg.	Print Fig.	Total Claims	Print Claim for O.G.
	<i>1</i>	<i>1</i>	<i>1</i>	<i>33</i>	<i>1</i>
<input type="checkbox"/> a) The term of this patent subsequent to _____ (date) has been disclaimed.	NOTICE OF ALLOWANCE MAILED				
	<i>6/21/00</i>				
<input type="checkbox"/> b) The term of this patent shall not extend beyond the expiration date of U.S Patent. No. _____	Margaret R. Wambach Primary Examiner			ISSUE FEE <i>BID</i>	
	<i>Margaret R. Wambach</i> (Date) <i>6/20/00</i>			Amount Due	Date Paid
<input type="checkbox"/> c) The terminal _____ months of this patent have been disclaimed.	ISSUE BATCH NUMBER			<i>039</i>	
	<i>Ernest Clauer</i> (Date) <i>6/22/00</i>			<i>605.00</i>	<i>9/25/00</i>
WARNING: The information disclosed herein may be restricted. Unauthorized disclosure may be prohibited by the United States Code Title 35, Sections 122, 181 and 368. Possession outside the U.S. Patent & Trademark Office is restricted to authorized employees and contractors only.					

Form PTO-436A (Rev. 6/98)

Formal drawings (_____ sheets) Issue Fee

(LABEL AREA)

PATENT APPLICATION



09181738

U.S. PTO

09/181738



10/28/98

INITIALS

NOV 00 9 8 4 5

CONTENTS

Date received (Incl. C. of M.) or Date Mailed

Date received (Incl. C. of M.) or Date Mailed

1. Application 1 papers.

2. In R Deck

11/17/98

42.

3. Deck Fee

5-10-99

43.

4. IDS

2-18-99

44.

5. Suppl. IDS

12-22-99

45.

6. Dep 13 months

1-28-00

46.

7. Suppl. IDS

2/21/00

47.

8. Amdt. A

03/21/00

48.

9. Suppl. IDS

3/21/00

49.

10. Suppl. IDS PTO 913 Amdt B

4/19/00

50.

11. PTO 37=

6/21/00

51.

12. F.I.D.S

8/14/00

52.

13. Suppl PTO 37=

10-17-00

53.

14. 12/1/00 ~~initial~~ LI ~~state~~ sell 9/25/00 LH

9/25/00 LH

54.

15.

55.

16.

56.

17.

57.

18.

58.

19.

59.

20.

60.

21.

61.

22.

62.

23.

63.

24.

64.

25.

65.

26.

66.

27.

67.

28.

68.

29.

69.

30.

70.

31.

71.

32.

72.

33.

73.

34.

74.

35.

75.

36.

76.

37.

77.

38.

78.

39.

79.

40.

80.

41.

81.

82.

(LEFT OUTSIDE)



SEARCHED			
Class	Sub.	Date	Exmr.
377	24.2	1/24/00	MRW
updated		6/20/00	MRW

SEARCH NOTES (INCLUDING SEARCH STRATEGY)		
WEST performed	Date	Exmr.
	1/24/00	MRW

INTERFERENCE SEARCHED			
Class	Sub.	Date	Exmr.
377	24.2	6/20/00	MRW

(RIGHT OUTSIDE)

ISSUE SLIP STAPLE AREA (for additional cross references)

POSITION	INITIALS	ID NO.	DATE
FEE DETERMINATION	<i>JW</i>	<i>249</i>	
O.I.P.E. CLASSIFIER		<i>1.2</i>	<i>11/6</i>
FORMALITY REVIEW	<i>E F</i>	<i>59984</i>	<i>11-13-58</i>

INDEX OF CLAIMS

- ✓ Rejected
- || Allowed
- (Through numeral)... Canceled
- + Restricted
- N Non-elected
- I Interference
- A Appeal
- O Objected

Claim	Date
Final	
Original	
1	1/24/60
2	
3	
4	
5	
6	
7	
8	
9	
10	
11	
12	
13	
14	
15	
16	
17	
18	
19	
20	
21	
22	
23	
24	
25	
26	
27	
28	
29	
30	
31	
32	
33	
34	
35	
36	
37	
38	
39	
40	
41	
42	
43	
44	
45	
46	
47	
48	
49	
50	

Claim	Date
Final	
Original	
51	
52	
53	
54	
55	
56	
57	
58	
59	
60	
61	
62	
63	
64	
65	
66	
67	
68	
69	
70	
71	
72	
73	
74	
75	
76	
77	
78	
79	
80	
81	
82	
83	
84	
85	
86	
87	
88	
89	
90	
91	
92	
93	
94	
95	
96	
97	
98	
99	
100	

Claim	Date
Final	
Original	
101	
102	
103	
104	
105	
106	
107	
108	
109	
110	
111	
112	
113	
114	
115	
116	
117	
118	
119	
120	
121	
122	
123	
124	
125	
126	
127	
128	
129	
130	
131	
132	
133	
134	
135	
136	
137	
138	
139	
140	
141	
142	
143	
144	
145	
146	
147	
148	
149	
150	

If more than 150 claims or 10 actions
staple additional sheet here

(LEFT INSIDE)

PATENT APPLICATION SERIAL NO. _____

U.S. DEPARTMENT OF COMMERCE
PATENT AND TRADEMARK OFFICE
FEE RECORD SHEET

11/03/1998 CHINA 00000027 150660 09181738

01 FC:101	30.00 CH	752/00/00
02 FC:102	164.00 CH	
03 FC:103	550.00 CH	

PTO-1556
(5/87)

Printed 10/28/2000

SERIAL NUMBER 09/181,738	FILING DATE 10/28/1998	CLASS 377	GROUP ART UNIT 2816	ATTORNEY DOCKET NO EPIXINC-4	
APPLICANT NATHAN PYLES, LAKE MILLS, WISCONSIN; JOEL M MACHT, REECEVILLE, WISCONSIN; CHEN-SHUI JUNG, TAIPEI, TAIWAN. **CONTINUING DOMESTIC DATA***** VERIFIED _____ **371 (NAT'L STAGE) DATA***** VERIFIED _____ **FOREIGN APPLICATIONS***** VERIFIED _____ FOREIGN FILING LICENSE GRANTED 11/13/1998 SMALL ENTITY					
Foreign priority claimed <input type="checkbox"/> yes <input type="checkbox"/> no 35 USC 119 (a-d) conditions met <input type="checkbox"/> yes <input type="checkbox"/> no <input type="checkbox"/> Met after Allowance Verified and acknowledged _____ Examiner's Name Initials		STATE OR COUNTRY 	SHEETS DRAWINGS 1	TOTAL CLAIMS 45	INDEPENDENT CLAIMS 5
ADDRESS LATHROP & CLARK LLP 740 REGENT STREET SUITE 400 P.O. BOX 1507 MADISON , WI 53701-1507					
TITLE PEDOMETER					
FILING FEE RECEIVED \$*1569	FEES: Authority has been given in Paper No. _____ to charge/credit DEPOSIT ACCOUNT NO. _____ for the following:		<input type="checkbox"/> All Fees <input type="checkbox"/> 1.16 Fees (Filing) <input type="checkbox"/> 1.17 Fees (Processing Ext. of Time) <input type="checkbox"/> 1.18 Fees (Issue) <input type="checkbox"/> Other _____ <input type="checkbox"/> Credit		

10/28/98
 1595 U.S. PTO

Please type a plus sign (+) inside this

Patent and Trademark Office: U.S. DEPARTMENT OF COMMERCE
 Approved for use through 09/30/00. OMB 0651-0032

Under the Paperwork Reduction Act of 1995, no persons are required to respond to a collection of information unless it displays a valid OMB control number

UTILITY PATENT APPLICATION TRANSMITTAL		Attorney Docket No. EPIXINC- 4	Total Pages 4
First Named Inventor or Application Identifier			
Nathan Pyles			
(Only for new nonprovisional applications under 37 CFR 1.53(b))		Express Mail Label No.	EM164411845US
APPLICATION ELEMENTS		ADDRESS TO: Assistant Commissioner for Patents Box Patent Application Washington, DC 20231	
See MPEP chapter 600 concerning utility patent application contents.			
1.	<input checked="" type="checkbox"/> Fee Transmittal Form (submit an original, and a duplicate for fee processing)	6.	<input type="checkbox"/> Microfiche Computer Program (Appendix)
2.	<input checked="" type="checkbox"/> Specification [Total Pages 19] (preferred arrangement set forth below) - Descriptive title of the Invention - Cross References to Related Applications - Statement Regarding Fed sponsored R&D - Reference to Microfiche Appendix - Background of the Invention - Brief Summary of the Invention - Brief Description of the Drawings (if filed) - Detailed Description - Claim(s) - Abstract of the Disclosure	7.	<input type="checkbox"/> Nucleotide and/or Amino Acid Sequence Submission (if applicable, all necessary) a. <input type="checkbox"/> Computer Readable Copy b. <input type="checkbox"/> Paper Copy (identical to computer copy) c. <input type="checkbox"/> Statement verifying identity of above copies
3.	<input checked="" type="checkbox"/> Drawing(s) (356 USC 113) [Total Sheets 1]	ACCOMPANYING APPLICATION PARTS	
4.	<input type="checkbox"/> Oath or Declaration [Total Pages 4] a. <input type="checkbox"/> Newly executed (original or copy) b. <input type="checkbox"/> Copy from a prior application (37 CFR 1.63(d)) (for continuation/divisional with Box 17 completed) [Note Box 5 below] i. <input type="checkbox"/> <u>DELETION OF INVENTOR(S)</u> Signed statement attached deleting inventor(s) named in the prior application, see 37 CFR 1.63(d)(2) and 1.33(b).	8.	<input type="checkbox"/> Assignment Papers (cover sheet & document(s))
5.	<input type="checkbox"/> Incorporation By Reference (useable if Box 4b is checked). The entire disclosure of the prior application, from which a copy of the oath or declaration is supplied under Box 4b, is considered as being part of the disclosure of the accompanying application and is hereby incorporated by reference therein.	9.	<input type="checkbox"/> 37 CFR 3.73(b) Statement of Power of Attorney (when there is an assignee)
		10.	<input type="checkbox"/> English Translation Document (if applicable)
		11.	<input type="checkbox"/> Information Disclosure Statement (IDS)/PTO-1449 Copies of IDS Citations
		12.	<input type="checkbox"/> Preliminary Amendment
		13.	<input checked="" type="checkbox"/> Return Receipt Postcard (MPEP 503) (Should be specifically itemized)
		14.	<input type="checkbox"/> Small Entity Statement(s) <input type="checkbox"/> Statement filed in prior application, Status still proper and desired
		15.	<input type="checkbox"/> Certified Copy of Priority Document(s) (if foreign priority is claimed)
		16.	<input type="checkbox"/> Other: _____
17. If a CONTINUING APPLICATION, check appropriate box and supply the requisite information: <input type="checkbox"/> Continuation <input type="checkbox"/> Divisional <input type="checkbox"/> Continuation-in-part (CIP) of prior application No.: /			
18. CORRESPONDENCE ADDRESS			
<input checked="" type="checkbox"/> Customer Number or Bar Code Label		020,455 (Insert Customer No. or Attach bar code label here)	or <input type="checkbox"/> Correspondence address below
Name			
Address			
City	State	Zip Code	
Country	Telephone	Fax	

09181738-102898

09 18 17 38

ABSTRACT OF THE DISCLOSURE

The pedometer having improved accuracy by calculating actual stride lengths of a user based on relative stride rates. The pedometer includes a waist or leg mounted stride counter, a transmitter for transmitting data to a wrist-mounted display unit, and a data processor for calculating necessary base units and actual stride rates and lengths. The pedometer can also interact with a heart monitoring device.

09181738-102898

09/18/738

The undersigned hereby certifies that this document is being deposited with the United States Postal Service today October 29 1976 by the "Express Mail" service, utilizing express mail label number EM164411845US addressed to: Assistant Commissioner for Patents, Washington, D.C. 20231.

JERRY W. SMITH

Name of Person signing

Jerry W. Smith

Signature of person mailing this document

09 OCT 1976

PEDOMETER

Nathan Pyles Joel M. Macht Chen Shui-Jung

FIELD AND BACKGROUND OF THE INVENTION

5 The present invention relates generally to pedometers having a waist mounted stride-counting device and transmitter, and a wrist-mounted receiver and display. The invention also relates to a distance calculation device that calculates a distance walked or run based on an algorithm that converts a base stride length and a base stride rate to an actual stride length for use in calculating the distance traveled.

10 Pedometers are known which include devices or algorithms for determining the distance a person travels on foot. For example, U.S. Patent 4,371,945 discloses an electronic pedometer that calculates distance by electronically measuring the length of each stride taken by a user. Stride length is measured by ultrasonic waves generated by an ultrasonic module strapped to one leg and an ultrasonic detector worn on the other leg. A program compensates for a variety of measurement errors and the results are displayed on a wrist-mounted display after being transmitted by
15 VHF waves from the leg to the wrist.

2

868207" BEEZFB60

U.S. Patent 4,771,394 discloses a computer shoe with a heel-mounted electronic device with an inertia footstrike counter, a timer, a sound generating device, a battery, and a gate array for counting time and footstrikes to calculate distance and running time as a function of stride time. Although recognizing the important relationship of stride length and foot speed, the shoe in this patent requires data from at least 15 test runs or walks and the data must be user-entered in pairs of footstrikes and elapsed time to cover a pre-determined distance. Further, user adjustments of time must be performed to accommodate start and stop times, and the number of counted footstrikes is increased one percent to overcome inherent errors in the inertia step counter. The shoe-mounted device is subject to damage from impact, dirt, and water, and requires a stay-at-home computer with which to interface. There is no means disclosed to transmit data to a wrist-mounted display device or an "on-board" computing device that provides "real time" data to a runner.

U.S. Patent 4,855,942 discloses a pedometer and calorie measuring device that includes a wrist-mounted step counter and a fixed stride length to calculate distance traveled. Wrist-mounted step counters are known to be inaccurate because they assume a step for every arm movement. Even with error correction, such a device will provide less accurate step counts than a leg or waist-mounted counter. Further, fixed stride lengths do not take into account the fact that stride length varies with rate of movement.

U.S. Patent 5,117,444 discloses a pedometer and calibration method with two calibration modes. First, a user travels a predetermined "half-distance" for the device to count and store the number of strides in that distance. Next, the user travels a second distance with the step counter comparing actual steps to the steps in memory and a current trip memory are incremented by a tenth of a "whole unit" distance. There is no correlation between stride length and stride rate which requires the user to re-calibrate the device when walking as opposed to running.

U.S. Patent 5,475,725 discloses a pulse meter with pedometer function to determine pace and pulse rate of a user. The meter uses pulse wave base data compared to actual pulse wave data rates.

U.S. Patent 5,476,427 discloses a pace display device utilizing a base rate for

3

SECRET

traveling pre-set distances in successive trails. The device calculates step counts and rates, and compares actual step count rates to display data to a user for comparison of present running rates to previous rates.

Thus, there is a need for a simple, but highly accurate, pedometer that
5 displays distance traveled, pace, speed, heart rate, and other important information on an easily read wrist-mounted device.

SUMMARY OF THE INVENTION

The present invention overcomes problems and shortcomings in the prior art by providing a device that includes a waist, chest, or leg-mounted stride counting
10 device, a transmitter, and a wrist-mounted receiver/display device that provides highly accurate travel distances and other information. The device includes a computer that stores base stride length and rate data from traveling a pre-determined distance and compares that to actual stride rate data to calculate actual distance
15 traveled, speed, and pace. The invention recognizes the interdependency of stride length and stride rate and uses that relationship to provide superior distance-calculating accuracy.

The invention also provides for improved display of relevant data on a wrist-mounted display that receives digital signals from devices worn on other body parts such as legs, waist, and chest. Transmitters that can send coded signals are desirable
20 because they will not interfere with similar devices worn by other users in the vicinity.

The accuracy of the device is enhanced by the use of an algorithm that adjusts a base stride length based on actual stride rates. The algorithm is defined as: Actual Stride Length = Base Stride Length + Base Stride Length *(((Actual Stride Rate - Base Stride Rate) N)/Base Stride Rate); where N is either an average value or a
25 derived value from a plurality of samples.

The invention also includes a method for calculating an actual stride length including steps of: timing a first user run of a predetermined distance; counting the total number of strides in the user first run; dividing the first run distance by the stride count to obtain a base stride length; dividing the stride count by the first run time to
30 obtain a base stride rate; counting strides during a user's second run to obtain an actual stride rate; calculating the actual stride length using the formula: Actual Stride

H

Length = Base Stride Length + Base Stride Length

*(((Actual Stride Rate - Base Stride Rate)N)/Base Stride Rate); wherein N is an average value or a derived value.

5 The average value method can be refined by comparing Base Stride Rate to Actual Stride Rate to determine a percentage difference; and using N=1 when the Actual Stride Rate \leq Base Stride Rate * 1.02 and using N=3 when Actual Stride Rate $>$ Base Stride Rate * 1.02. A preferred embodiment uses a plurality of sample runs over known distances to derive an accurate N value for each individual.

BRIEF DESCRIPTION OF THE DRAWINGS

10 Fig. 1 is a schematic diagram of a pedometer in accordance with the present invention.

DETAILED DESCRIPTION OF THE DRAWINGS

As illustrated in Fig. 1, the present invention is directed to an improved pedometer 20 including: a waist, chest, or leg mounted stride counter 24, and a wrist or waist mounted display unit 26. An optional chest-mounted heart monitor 28 can be included. All of the device components are mounted in suitable housings. The pedometer 20 includes a data processor 30 that is mounted in the same housing as either the step counter 24 or the display unit 26.

20 The step counter 24 is an inertia device that counts the number of steps a user takes. The number of steps is transmitted to a data archive 32 either directly or via a transmitter 34. The data archive 32 is mounted in the housing with the step counter 24 or the display 26.

25 The transmitter 34 is mounted in the step counter housing and is preferably an Rf telemetric signal transmitter with a 30 inches to 36 inches transmission range. Alternately, the transmitter is a wireless or wired digital transmitter with a coding function to limit or eliminate interference with other similar devices. The wireless transmission range is set between 30 inches and 36 inches to provide adequate range to transmit signals from a user's waist to wrist, but not so far as to cause interference with other Rf or digital devices in the vicinity.

30 The transmitter 34 transmits either raw data or calculated distances, pace, etc. to a wrist-mounted display unit receiver 40. The receiver 40 relays a raw data signal

853201" BE4TBE0

001133 10260
00000 "BECT60

to the data processor 30 or a calculated data signal directly to the display panel 42, such as an LCD or LED.

Similarly, the heart rate monitor 28 includes a transmitter 44 that transmits heart rate data to the display unit 26. The heart monitor transmitter 44 can transmit at the same or a different frequency as the stride counter 24, and to the same or a different receiver in the display unit 26. The heart rate transmitter 44 is preferably Rf, but can be digital for the reasons stated above. The range of the heart rate transmitter 44 should also be between 30 inches and 36 inches to ensure effective communication with the receiver while limiting outside interference.

The data processor 30 can also include a programmable logic controller, a personal computer, a programmable read-only memory, or other suitable processor. The data processor 30 includes a data archive 32 to store historic data on stride length and pace to be used in an algorithm for calculating actual distances, speed, and rate for real-time conversion of data to useful information for a user.

The data processor 30 can also include closed loop or fuzzy logic programming to continually or periodically replace the base stride rate and length with recently calculated stride rates and lengths so that long term conditioning trends are accommodated in the base stride archive. Incorporating trend capabilities may further enhance accuracy of the distance and pace calculations.

The display unit 26 also includes an operator interface 46 such as a key pad, button, knob, etc. that enables the user to start and stop a clock 48 (or stop watch) and activate various use modes within the pedometer, such as a sampling mode and operation mode.

One option for using the pedometer 20, requires the user to operate a "sampling mode" and begin walking or running a pre-determined distance such as a mile or 1600 meters, preferably on a running track of a known size. Upon completion of the distance, a stop button on the operator interface 46 is pushed. The data processor 30 is programmed to then divide the distance by the number of strides counted to calculate an average stride length. This value is stored in the data archive 32 as the "Base Stride Length."

Also, the data processor 30 is programmed to divide the number of strides by

00117-1011760

the time of the run or walk as measured by the clock 48 to arrive at a "Base Stride Rate."

5 The data processor 30 preferably includes programming that queries the user about the distance to be run during the sampling mode. By providing options or enabling the use of any distance during the sampling mode, the pedometer 20 provides maximum flexibility for use by people of various physical conditions, or having access to courses of different known distances. Thus, a user may be queried to input a distance to be used in the sampling mode and then be given a list of options such as 400 meters, 440 yards, 1600 meters, or one mile, or be asked to simply input any distance known to the user that will be traveled during the sampling mode.

10 The present invention makes full use of the relationship between a faster rate of travel and longer stride lengths. In other words, the faster a user is moving, the longer will be the stride length. Over the course of the run or walk, the user's step rate and, therefore, stride length will change and the user will cover more ground when moving fast and less ground when moving slow.

15 Clearly, using a fixed average stride length in calculating distance traveled will result in errors using prior pedometers. This is particularly true if a user changes pace, or improves conditioning and speed to the point where the average stride length over a given run increases dramatically. The error compensators in prior devices do not adjust for changes in pace. With the old devices, a user needed to re-calibrate periodically to be close to getting an accurate reading, and could not change pace during a workout without decreasing accuracy.

20 To make the correction, the user activates a "Use Mode" in which the data processor 30 calculates an Actual Stride Rate based on data from the stride counter 24 and the clock 48. For example, an Actual Stride Rate can be calculated every five seconds without the user doing more than activating the "Use Mode" button, while all the calculations are performed by the data processor automatically. The percentage change between the Actual Stride Rate and the Base Stride Rate is then computed by the data processor 30 to determine an Actual Stride Length. Again, if the Actual Stride Rate is greater than the Base Stride Rate, the Actual Stride Length is longer than the Base Stride Length. If the Actual Steps Per Second is lower than

BBB01" BEE/TBIBD

the Base Steps Per Second, the Actual Stride Length is shorter than the Base Stride Length. The algorithm below provides a means for comparing the Actual and Base Stride rates to arrive at an accurate Actual Stride Length.

5 First, a comparison between the Actual Stride Rate and the Base Stride Rate is made to determine whether Actual Stride Rate is less than or equal to Base Stride Rate multiplied by 1.02. Stride Length is calculated by:

$$\text{Actual Stride Length} = \text{Base Stride Length} + \text{Base Stride Length} * (((\text{Actual Stride Rate} - \text{Base Stride Rate})N) / \text{Base Stride Rate})$$

10 Where: N=1 when Actual Stride Rate is less than or equal to Base Stride Rate multiplied by 1.02, and N=3 when Actual Stride Rate is greater than Base Stride Rate multiplied by 1.02, although other N values in the range of one to three can be used.

The above algorithm is accurate for heel to toe activities such as walking or jogging, but is less accurate for sprinting (toe only).

15 A third method of calculating actual stride length uses three separate run or walk samples at three different paces. This is the most accurate option. With this method, the N values are unique for each individual. By deriving an N value for each individual, this value more accurately reflects the actual change in stride length with a change in pace. After a proper warmup, the user completes a sample run or walk on the track at a normal pace. This first sample S1, will establish the Base Stride and the Base Steps Per Second.

S1 SAMPLE:

$$\text{S1 Stride} = \text{Base Stride} = \text{Distance} / \text{Number of Steps}$$

$$\text{S1 Steps Per Second or S1 Steps Per Second} = \text{Base Steps Per Second} = \text{Number of Steps Per Second}$$

25 Following completion of the first run or walk at normal pace, the user runs or walks the same course and the same distance at a faster run or walking pace, but not a sprinting pace. The user should not run on his toes, but maintain the normal heel to toe jogging style. This is the S2 sample. The purpose of the S2 sample is to calculate an N2 value for each individual which reflects the effect an increase in Steps Per Second has on this individual's stride length. Some individual's steps will lengthen

SECTION 92760

Second

Then:

Stride Length = Base Stride + Base Stride*(((Actual Steps Per Second - Base Steps Per Second)N)/Base Steps Per Second)

5 And N = N3 (Stored Value)

If: Actual Steps Per Second > Base Steps Per Second

Then:

Stride Length = Base Stride + Base Stride*(((Actual Steps Per Second - Base Steps Per Second)N)/Base Steps Per Second)

10 And N = N2 (Stored Value)

This third option for calculating stride length, and subsequently distance, speed, and pace, is a far more accurate method than a fixed stride length pedometer. This device and method are also practical, convenient, and has a relatively low manufacturing cost. If an individual's running or walking style is progressing with training and practice (as seen by significantly improved times), then it may be beneficial for them to recalibrate their device by repeating the three samples every 3 to 6 months. If there are no significant improvements in time, then recalibration is not necessary.

It is noted that any single stride length or pace discussed above can in fact be an average of a plurality of stride lengths or rates from test runs to further refine accuracy in the calculations of actual stride data.

Other variations on this device could also incorporate an altimeter which measures changes in elevation. The stride length could then be adjusted (shortened) when elevation is increasing, and lengthened when elevation is decreasing. This adjustment could be done with an average value, as we used in setting option 2, or with a derived value by running or walking over a known distance on a hilly course. This device can use two batteries so that the calibration data is not lost when the batteries are replaced one at a time.

Once the actual stride length is calculated for a given period of time, the value can be multiplied by the number of strides in that period to obtain a total distance for that period to be stored in a data archive file for that particular walk or run and added

10

to other actual stride lengths or distances for other periods in which stride length was calculated. When the run or walk is completed, the user engages the operator interface 46 to indicate that a total distance is to be displayed on the display unit. Preferably, there is continual display of the distance traveled.

5 As a result of accurately calculating distance traveled, the pedometer 20 also has the capability of calculating speed in miles per hour, for example or pace in minutes per mile, including average speed and pace over the course of that particular walk or run. Further, the pedometer 20 can include a port for coupling to a separate personal computer or computing device to create larger training histories, trends, etc.

10 Additional features can include stop watches, day, date and time displays, as well as, heart rate displays as discussed above. Also, it will be understood that all distances and time periods used above can be varied in length and units of measure (English, metric, seconds, minutes, hours, etc.).

15 The foregoing detailed description is provided for clearness of understanding only and no unnecessary limitations therefrom should be read into the following claims.

//

868207-8E2TBT50

CLAIMS

- 1. A pedometer comprising:
a step counter mountable on a user first body portion;
a transmitter in communication with the step counter to generate a signal
5 corresponding to each step and transmit the signal; and
a receiver mountable on a user second body portion to receive the signal
transmitted from the transmitter and calculate a distance measured by
the step counter.
- 2. The pedometer of claim 1, wherein the transmitter and the receiver
10 communicate via wireless transmission.
- 3. The pedometer of claim 1, wherein the transmitter and the receiver
communicate via a wire.
- 4. The pedometer of claim 1, wherein the transmission signal is digitally
coded.
- 5. The pedometer of claim 1, where in the transmitter transmits the
15 signal a wireless distance in the range of thirty to thirty-six inches.
- 6. The pedometer of claim 1, wherein the receiver is mountable on a
user's wrist.
- 7. The pedometer of claim 1, wherein the receiver processes the step
20 count signal and displays the distance traveled on a viewing screen.
- 8. The pedometer of claim 1, wherein the step counter is mountable on a
user's leg.
- 9. The pedometer of claim 1, and further comprising:
a heart rate monitor; and
25 a second transmitter in communication with the heart rate monitor to transmit
a signal corresponding to a heart rate calculated by the heart rate
monitor to the receiver and display the calculated heart rate.
- 10. The pedometer of claim 9, wherein the heart rate signal is at a
different frequency than the pedometer signal.
- 30 11. The pedometer of claim 9, wherein the heart rate monitor is
mountable to a user's third body portion.

853207 SE 2006
Sub
a1

Sub
a2

Sub
a2

Sub
B1

in order

12. The pedometer of claim 9, wherein the heart rate and the step counter transmitter are mounted in a single chest-mount housing.

13. The pedometer of claim 1, wherein the pedometer includes a data processor programmed to calculate a distance traveled by multiplying the number of strides taken by a stride length that varies according to the rate at which strides are taken.

14. The pedometer of claim 13, wherein the data processor is programmed to calculate an actual stride length of a user by performing the steps of:
timing a user first run of a predetermined distance;
counting the total number of strides in the user first run;
dividing the first run distance by the stride count to obtain a base stride length;
dividing the stride count by the first run time to obtain a base stride rate;
counting strides in a period of time during a user second run to obtain an actual stride rate;
calculating the actual stride length using the formula:
Actual Stride Length = Base Stride Length + Base Stride Length *(((Actual Stride Rate - Base Stride Rate)N)/Base Stride Rate);
where N is in the range of between 1 and 3.

15. The pedometer of claim 13, wherein the pedometer is further programmed to perform the steps of:
comparing the actual stride rate to the base stride rate; and
calculating the actual stride length using N=1 when the actual stride rate is less than or equal to the base stride rate multiplied by 1.02.

16. The pedometer of claim 13, wherein the pedometer is further programmed to perform the steps of:
comparing the actual stride rate to the base stride rate; and
calculating the actual stride length using N=3 when the actual stride rate is greater than the base stride rate multiplied by 1.02.

000001" 8E2T8760

13

Sub
A3
A2

5

17. A pedometer comprising:
a step counter;
a transmitter in communication with the step counter to generate a signal corresponding to each step and transmit the signal; and
a receiver mountable on a user body portion to receive the signal transmitted from the transmitter and calculate a distance measured by the step counter, and
a data processor programmed to calculate a distance traveled by multiplying the number of strides taken by a stride length that varies according to the rate at which strides are taken.

10

18. The pedometer of claim 17, wherein the transmitter and the receiver communicate via wireless transmission.

19. The pedometer of claim 17, wherein the transmitter and the receiver communicate via a wire.

SECTION 101

Sub
A4

15

20. The pedometer of claim 17, wherein the transmission signal is digitally coded.

21. The pedometer of claim 17, where in the transmitter transmits the signal a wireless distance in the range of thirty to thirty-six inches.

20

22. The pedometer of claim 17, wherein the receiver is mountable on a user's wrist.

23. The pedometer of claim 17, wherein the receiver processes the step count signal and displays the distance traveled on a viewing screen.

24. The pedometer of claim 17, wherein the step counter is mountable on a user's leg.

Sub
A5

25

25. The pedometer of claim 17, and further comprising:
a heart rate monitor; and
a second transmitter in communication with the heart rate monitor to transmit a signal corresponding to a heart rate calculated by the heart rate monitor to the receiver and display the calculated heart rate.

30

26. The pedometer of claim 25, wherein the heart rate signal is at a different frequency than the pedometer signal.

14

SECRET BECTF60

15

13

Sub 26

27.

The pedometer of claim 25, wherein the heart rate monitor is mountable to a user's third body portion.

28.

The pedometer of claim 25, wherein the heart rate and the step counter are mounted in a single chest-mount housing.

5

17
29.

The pedometer of claim 27, wherein the data processor is programmed to calculate an the distance traveled actual stride length of a user by performing the steps of:

- timing a user first run of a predetermined distance;
- counting the total number of strides in the user first run;
- 10 dividing the first run distance by the stride count to obtain a base stride length;
- dividing the stride count by the first run time to obtain a base stride rate;
- counting strides in a period of time during a user second run to obtain an actual stride rate;
- 15 calculating the actual stride length using the formula:

$$\text{Actual Stride Length} = \text{Base Stride Length} + \text{Base Stride Length} * (((\text{Actual Stride Rate} - \text{Base Stride Rate})N) / \text{Base Stride Rate});$$

18

where N is in the range of between 1 and 3.

20
30.

The pedometer of claim 27, wherein the pedometer is further programmed to perform the steps of:

- comparing the actual stride rate to the base stride rate; and
- calculating the actual stride length using N=1 when the actual stride rate is
- 19 less than or equal to the base stride rate multiplied by 1.02.

21.

25

The pedometer of claim 27, wherein the pedometer is further programmed to perform the steps of:

- comparing the actual stride rate to the base stride rate; and
- calculating the actual stride length using N=3 when the actual stride rate is greater than the base stride rate multiplied by 1.02.

15

Sub
Q7

5

10

32. A pedometer programmed to calculate an actual stride length of a user by performing the steps of:

- timing a user first run of a predetermined distance;
- counting the total number of strides in the user first run;
- dividing the first run distance by the stride count to obtain a base stride length;
- dividing the stride count by the first run time to obtain a base stride rate;
- counting strides in a period of time during a user second run to obtain an actual stride rate;
- calculating the actual stride length using the formula:

$$\text{Actual Stride Length} = \text{Base Stride Length} + \text{Base Stride Length} * (((\text{Actual Stride Rate} - \text{Base Stride Rate})N) / \text{Base Stride Rate});$$
 where N is in the range of between 1 and 3.

21

33. The pedometer of claim 32, wherein the pedometer is further programmed to perform the steps of:

- comparing the actual stride rate to the base stride rate; and
- calculating the actual stride length using $N=1$ when the actual stride rate is less than or equal to the base stride rate multiplied by 1.02.

22

34. The pedometer of claim 32, wherein the pedometer is further programmed to perform the steps of:

- comparing the actual stride rate to the base stride rate; and
- calculating the actual stride length using $N=3$ when the actual stride rate is greater than the base stride rate multiplied by 1.02.

Sub
Q8

25

35. The pedometer of claim 32, wherein the receiver processes the step count signal and displays the distance traveled on a viewing screen.

24

36. The pedometer of claim 32, and further comprising a heart rate monitor mounted in a chest-mount housing.

09181733-10299

Sub
QA

37. A pedometer programmed to calculate an actual stride length of a user by performing the steps of:

timing a user first run of a predetermined distance;
counting the total number of strides in the user first run;
dividing the first run distance by the stride count to obtain a first run base stride length;
dividing the first run stride count by the first run time to obtain a first run base stride rate;

10

timing a user second run of a predetermined distance;
counting the total number of strides in the user second run;
dividing the second run distance by the second run stride count to obtain a second base stride length;
dividing the second run stride count by the second run time to obtain a second base stride rate;

15

timing a user third run of a predetermined distance;
counting the total number of strides in the user third run;
dividing the third run distance by the third run stride count to obtain a third base stride length;

20

dividing the third run stride count by the third run time to obtain a third run base stride rate;
counting strides in a period of time during a user fourth run to obtain an actual stride rate;

25

calculating the actual stride length using the formula:

Actual Stride Length = Base Stride Length + Base Stride Length *(((Actual Stride Rate - Base Stride Rate)N)/Base Stride Rate);
where N is calculated by the formula ((Second Run Stride Length multiplied by First Run Stride Rate) - (First Run Stride Length multiplied by First Run Stride Rate)) / (First Run Stride Length multiplied by (Second Run Stride Rate - First Run Stride Rate)) when the Actual Stride Rate is greater than the First Run Stride Rate, and where N is calculated by the formula ((Third Run Stride Length

30

09181788-10918160

09101738-10298

multiplied by First Run Stride Rate) - (First Run Stride Length multiplied by First Run Stride Rate)) / (First Run Stride Length multiplied by (Third Run Stride Rate - First Run Stride Rate)) when the Actual Stride Rate is less than or equal to the First Run Stride

5

26
38.

Rate.
The pedometer of claim 37, wherein:

25

the first run base stride length is an average stride length calculated from a plurality of test runs; and
the first run base stride rate is an average base stride rate calculated from the

10

27
39.

plurality of test runs.
The pedometer of claim 37, wherein:

25

the second run base stride length is an average stride length calculated from a plurality of test runs; and
the second run base stride rate is an average base stride rate calculated from the plurality of test runs.

15

28
40.

The pedometer of claim 37, wherein:

25

the third run base stride-length is an average stride length calculated from a plurality of test runs; and
the third run base stride rate is an average base stride rate calculated from the plurality of test runs.

20

29
41.

The pedometer of claim 37, wherein the second run is at a faster pace than the first walk or run and the third run is at a slower pace than the first walk or run.

25

30
42.

The pedometer of claim 37, and further comprising:

25

a data processor mountable on a user body portion to calculate the actual stride length; and
a run data display device in communication with the data processor and mountable on a user body portion.

25

31
43.

The pedometer of claim 37, and further comprising a heart rate

25

30

monitor mounted in a chest-mount housing.

17

09181733-10888

Sub
P10

of:

44. A method for calculating an actual stride length comprising the steps

timing a first user run of a predetermined distance;

counting a total number of strides in the user first run;

dividing the first run time by the stride count to obtain a Base Stride Length;

dividing the stride count by the first run time to obtain a Base Stride Rate;

counting strides in a pre-determined period during a user second run to obtain an Actual Stride Rate;

calculating the actual stride length using the formula:

10

$$\text{Actual Stride Length} = \text{Base Stride Length} + \text{Base Stride Length} * (((\text{Actual Stride Rate} - \text{Base Stride Rate})N) / \text{Base Stride Rate});$$

wherein N is between one and three.

33

32

45. The method of claim 44 and further comprising the steps of comparing Base Stride Rate to Actual Stride Rate to determine a percentage difference; and using N=1 when the difference is less than two percent and using N=3 when the difference is greater than or equal to two percent.

15

18

Docket No.: EPIXINC-4

DECLARATION AND POWER OF ATTORNEY

As a below named inventor, I hereby declare that:

My residence, post office address and citizenship are as stated below next to my name.

I believe I am the original, first and sole inventor of the subject matter which is claimed and for which a patent is sought on the invention entitled: PEDOMETER, the specification of which

is attached hereto.

was filed on _____ as Application No. _____ and was amended on _____ (if applicable).

I hereby state that I have reviewed and understand the contents of the above-identified specification, including the claims, as amended by any amendment referred to above.

I do not know and do not believe that the same was ever known or used in the United States of America before my invention thereof, or patented or described in any printed publication in any country before my invention thereof or more than one year prior to this application, that the same was not in public use or on sale in the United States of America more than one year prior to this application, that the invention has not been patented or made the subject of an inventor's certificate issued before the date of this application in any country foreign to the United States of America on an application filed by me or my legal representatives or assigns more than twelve months prior to this application, that I acknowledge my duty to disclose information of which I am aware which is material to the examination of this application in accordance with Title 37, Code of Federal Regulations, §1.56(a), and that no application for patent or inventor's certificate on this invention has been filed in any country foreign to the United States of America prior to this application by me or my legal representatives or assigns, except as follows: None.

I hereby claim foreign priority benefits under Title 35, United States Code, §119 of any foreign application(s) for patent or inventor's certificate listed below and have also

09181738.10288

punishable by fine or imprisonment, or both, under Section 1001 of Title 18 of the United States Code and that such willful false statements may jeopardize the validity of the application or any patent issued thereon.

Full name of sole Inventor Nathan Pyles

Inventor's Signature

Date

Residence Lake Mills, Wisconsin

Citizenship United States of America

Post Office Address 529 College Street, Lake Mills,
Wisconsin 53551

Full name of sole Inventor Joel M. Macht

Inventor's Signature

Date

Residence Reeceville, Wisconsin

Citizenship United States of America

Post Office Address 106 North Avenue, Reeceville, Wisconsin
53579

8620F BLET60

Full name of sole Inventor

Chen Shui-Jung

Inventor's Signature

.....

Date

.....

Residence

Taipei, Taiwan

Citizenship

Republic of China

Post Office Address

2 F No. 349, Wu Shin Street, Taipei,
Taiwan

SECRET

Under the Paperwork Reduction Act of 1995, no persons are required to respond to a collection of information unless it displays a valid OMB control number.

FEE TRANSMITTAL				Complete If Known																																																																																																																																																																																													
Note: Effective October 1, 1997, Patent fees are subject to annual revision				Application Number																																																																																																																																																																																													
				Filing Date																																																																																																																																																																																													
				First Named Inventor		Pyles, et al.																																																																																																																																																																																											
				Group Art Unit																																																																																																																																																																																													
				Examiner Name																																																																																																																																																																																													
TOTAL AMOUNT OF PAYMENT		\$752.00		Attorney Docket Number		BPIXINC-4																																																																																																																																																																																											
METHOD OF PAYMENT (check one)				FEE CALCULATION (Continued)																																																																																																																																																																																													
1. <input checked="" type="checkbox"/> The Commissioner is hereby authorized to charge indicated fees and credit any over payments to:				3. ADDITIONAL FEES																																																																																																																																																																																													
Deposit Account Number: 15-0660 Deposit Account Name: Lathrop & Clark																																																																																																																																																																																																	
<input checked="" type="checkbox"/> Charge Any Additional Fee Required Under 37 CFR 1.16 and 1.17				<table border="1" style="width:100%; border-collapse: collapse;"> <thead> <tr> <th>Large Entity Fee Code</th> <th>Large Entity Fee (\$)</th> <th>Small Entity Fee Code</th> <th>Small Entity Fee (\$)</th> <th>Fee Description</th> <th>Fee Paid</th> </tr> </thead> <tbody> <tr><td>105</td><td>130</td><td>205</td><td>65</td><td>Surcharge - late filing fee or oath</td><td></td></tr> <tr><td>127</td><td>50</td><td>227</td><td>25</td><td>Surcharge - late provisional filing fee or cover sheet</td><td></td></tr> <tr><td>139</td><td>130</td><td>139</td><td>130</td><td>Non-English specification</td><td></td></tr> <tr><td>147</td><td>2,520</td><td>147</td><td>2,520</td><td>For filing a request for reexamination</td><td></td></tr> <tr><td>112</td><td>920*</td><td>112</td><td>920*</td><td>Requesting publication of SIR prior to Examiner action</td><td></td></tr> <tr><td>113</td><td>1,840*</td><td>113</td><td>1,840*</td><td>Requesting publication of SIR after Examiner action</td><td></td></tr> <tr><td>115</td><td>110</td><td>215</td><td>55</td><td>Extension for reply within first month</td><td></td></tr> <tr><td>116</td><td>400</td><td>216</td><td>200</td><td>Extension for reply within second month</td><td></td></tr> <tr><td>117</td><td>950</td><td>217</td><td>475</td><td>Extension for reply within third month</td><td></td></tr> <tr><td>118</td><td>1,510</td><td>218</td><td>755</td><td>Extension for reply within fourth month</td><td></td></tr> <tr><td>128</td><td>2,060</td><td>228</td><td>1,030</td><td>Extension for reply within fifth month</td><td></td></tr> <tr><td>119</td><td>310</td><td>219</td><td>155</td><td>Notice of Appeal</td><td></td></tr> <tr><td>120</td><td>310</td><td>220</td><td>155</td><td>Filing a brief in support of an appeal</td><td></td></tr> <tr><td>121</td><td>270</td><td>221</td><td>135</td><td>Request for oral hearing</td><td></td></tr> <tr><td>138</td><td>1,510</td><td>138</td><td>1,510</td><td>Petition to institute a public use proceeding</td><td></td></tr> <tr><td>140</td><td>110</td><td>240</td><td>55</td><td>Petition to revive - unavandable</td><td></td></tr> <tr><td>141</td><td>1,320</td><td>241</td><td>660</td><td>Petition to revive - unintentional</td><td></td></tr> <tr><td>142</td><td>1,320</td><td>242</td><td>660</td><td>Utility issue fee (or reissue)</td><td></td></tr> <tr><td>143</td><td>450</td><td>243</td><td>225</td><td>Design issue fee</td><td></td></tr> <tr><td>144</td><td>670</td><td>244</td><td>335</td><td>Plant issue fee</td><td></td></tr> <tr><td>122</td><td>130</td><td>122</td><td>130</td><td>Petitions to the Commissioner</td><td></td></tr> <tr><td>123</td><td>50</td><td>123</td><td>50</td><td>Petitions related to provisional applications</td><td></td></tr> <tr><td>126</td><td>240</td><td>126</td><td>240</td><td>Submission of information Disclosure Statement</td><td></td></tr> <tr><td>581</td><td>40</td><td>581</td><td>40</td><td>Recording each patent assignment per property (times number of properties)</td><td></td></tr> <tr><td>146</td><td>790</td><td>246</td><td>395</td><td>Filing a submission after final rejection (37 CFR 1.129(a))</td><td></td></tr> <tr><td>149</td><td>790</td><td>249</td><td>395</td><td>For each additional invention to be examined (37 CFR 1.129(b))</td><td></td></tr> <tr><td colspan="6">Other fee (specify) _____</td></tr> <tr><td colspan="6">Other fee (specify) _____</td></tr> <tr><td colspan="6">*Reduced by Basic Filing Fee Paid</td></tr> <tr><td colspan="5">SUBTOTAL (3)</td><td>\$0.00</td></tr> </tbody> </table>				Large Entity Fee Code	Large Entity Fee (\$)	Small Entity Fee Code	Small Entity Fee (\$)	Fee Description	Fee Paid	105	130	205	65	Surcharge - late filing fee or oath		127	50	227	25	Surcharge - late provisional filing fee or cover sheet		139	130	139	130	Non-English specification		147	2,520	147	2,520	For filing a request for reexamination		112	920*	112	920*	Requesting publication of SIR prior to Examiner action		113	1,840*	113	1,840*	Requesting publication of SIR after Examiner action		115	110	215	55	Extension for reply within first month		116	400	216	200	Extension for reply within second month		117	950	217	475	Extension for reply within third month		118	1,510	218	755	Extension for reply within fourth month		128	2,060	228	1,030	Extension for reply within fifth month		119	310	219	155	Notice of Appeal		120	310	220	155	Filing a brief in support of an appeal		121	270	221	135	Request for oral hearing		138	1,510	138	1,510	Petition to institute a public use proceeding		140	110	240	55	Petition to revive - unavandable		141	1,320	241	660	Petition to revive - unintentional		142	1,320	242	660	Utility issue fee (or reissue)		143	450	243	225	Design issue fee		144	670	244	335	Plant issue fee		122	130	122	130	Petitions to the Commissioner		123	50	123	50	Petitions related to provisional applications		126	240	126	240	Submission of information Disclosure Statement		581	40	581	40	Recording each patent assignment per property (times number of properties)		146	790	246	395	Filing a submission after final rejection (37 CFR 1.129(a))		149	790	249	395	For each additional invention to be examined (37 CFR 1.129(b))		Other fee (specify) _____						Other fee (specify) _____						*Reduced by Basic Filing Fee Paid						SUBTOTAL (3)					\$0.00
Large Entity Fee Code	Large Entity Fee (\$)	Small Entity Fee Code	Small Entity Fee (\$)					Fee Description	Fee Paid																																																																																																																																																																																								
105	130	205	65	Surcharge - late filing fee or oath																																																																																																																																																																																													
127	50	227	25	Surcharge - late provisional filing fee or cover sheet																																																																																																																																																																																													
139	130	139	130	Non-English specification																																																																																																																																																																																													
147	2,520	147	2,520	For filing a request for reexamination																																																																																																																																																																																													
112	920*	112	920*	Requesting publication of SIR prior to Examiner action																																																																																																																																																																																													
113	1,840*	113	1,840*	Requesting publication of SIR after Examiner action																																																																																																																																																																																													
115	110	215	55	Extension for reply within first month																																																																																																																																																																																													
116	400	216	200	Extension for reply within second month																																																																																																																																																																																													
117	950	217	475	Extension for reply within third month																																																																																																																																																																																													
118	1,510	218	755	Extension for reply within fourth month																																																																																																																																																																																													
128	2,060	228	1,030	Extension for reply within fifth month																																																																																																																																																																																													
119	310	219	155	Notice of Appeal																																																																																																																																																																																													
120	310	220	155	Filing a brief in support of an appeal																																																																																																																																																																																													
121	270	221	135	Request for oral hearing																																																																																																																																																																																													
138	1,510	138	1,510	Petition to institute a public use proceeding																																																																																																																																																																																													
140	110	240	55	Petition to revive - unavandable																																																																																																																																																																																													
141	1,320	241	660	Petition to revive - unintentional																																																																																																																																																																																													
142	1,320	242	660	Utility issue fee (or reissue)																																																																																																																																																																																													
143	450	243	225	Design issue fee																																																																																																																																																																																													
144	670	244	335	Plant issue fee																																																																																																																																																																																													
122	130	122	130	Petitions to the Commissioner																																																																																																																																																																																													
123	50	123	50	Petitions related to provisional applications																																																																																																																																																																																													
126	240	126	240	Submission of information Disclosure Statement																																																																																																																																																																																													
581	40	581	40	Recording each patent assignment per property (times number of properties)																																																																																																																																																																																													
146	790	246	395	Filing a submission after final rejection (37 CFR 1.129(a))																																																																																																																																																																																													
149	790	249	395	For each additional invention to be examined (37 CFR 1.129(b))																																																																																																																																																																																													
Other fee (specify) _____																																																																																																																																																																																																	
Other fee (specify) _____																																																																																																																																																																																																	
*Reduced by Basic Filing Fee Paid																																																																																																																																																																																																	
SUBTOTAL (3)					\$0.00																																																																																																																																																																																												
<input checked="" type="checkbox"/> Payment Enclosed: <input checked="" type="checkbox"/> Check <input type="checkbox"/> Money Order <input type="checkbox"/> Other																																																																																																																																																																																																	
FEE CALCULATION																																																																																																																																																																																																	
1. FILING FEE																																																																																																																																																																																																	
Large Entity		Small Entity																																																																																																																																																																																															
Fee Code	Fee (\$)	Fee Code	Fee (\$)	Fee Description	Fee Paid																																																																																																																																																																																												
101	790	201	395	Utility filing fee	\$395.00																																																																																																																																																																																												
106	330	206	165	Design filing fee																																																																																																																																																																																													
107	540	207	270	Plant filing fee																																																																																																																																																																																													
108	790	208	395	Reissue filing fee																																																																																																																																																																																													
114	150	214	75	Provisional filing fee																																																																																																																																																																																													
SUBTOTAL (1)					\$395.00																																																																																																																																																																																												
2. CLAIMS																																																																																																																																																																																																	
		Extra	Fee from below			Fee Paid																																																																																																																																																																																											
Total Claims	45	-20=	25	X	11	=	\$275.00																																																																																																																																																																																										
Independent Claims	5	-3=	2	X	41	=	\$82.00																																																																																																																																																																																										
Multiple Dependent Claims				X	135	=	\$0.00																																																																																																																																																																																										
Large Entity		Small Entity																																																																																																																																																																																															
Fee Code	Fee (\$)	Fee Code	Fee	Fee Description																																																																																																																																																																																													
103	22	203	11	Claims in excess of 20																																																																																																																																																																																													
102	82	202	41	Independent Claims in excess of 3																																																																																																																																																																																													
104	270	204	135	Multiple dependent claims																																																																																																																																																																																													
109	82	209	41	Reissue independent claims over original patent																																																																																																																																																																																													
110	22	210	11	Reissue claims in excess of 20 and over original patent																																																																																																																																																																																													
SUBTOTAL (2)					\$357.00																																																																																																																																																																																												
SUBMITTED BY				Complete (if applicable)																																																																																																																																																																																													
Typed or Printed Name		Jeffrey W. Smith		Reg. Number		33455																																																																																																																																																																																											
Signature		<i>Jeffrey W. Smith</i>		Date		Oct. 19, 1998																																																																																																																																																																																											
				Deposit Account User ID																																																																																																																																																																																													

PATENT APPLICATION
IN THE UNITED STATES PATENT AND TRADEMARK OFFICE

Applicant: Pyles, et al.
Filed: Simultaneously herewith
For: Pedometer
Docket No.: EPIXINC-4

jc518 U.S. PTO
09/18/1738
10/28/98

BOX PATENT APPLICATION
Assistant Commissioner for Patents
Washington, D.C. 20231

"Express Mail" Mailing Label No.: EM164411845US
Date of Deposit: October 28, 1998

I hereby certify that these attached documents

- * Response postcard
- * Check in the amount of \$752.00
- * PTO/SB/17 (1p) and 1 copy
- * Specification and Claims (19 pages) and informal drawing (1 sheet) and unexecuted Declaration and Power of Attorney (4 pp)
- * PTO/SB/05 (1p)

are being deposited with the United States Postal Service "Express Mail Post Office to Addressee" service under 35 C.F.R. §1.10 on the date indicated above and is addressed to the Assistant Commissioner for Patents, Washington, D.C. 20231.

(Jeffrey W. Smith, Reg. No. 33455)

Enclosed for filing please find the above-referenced new patent application. Please indicate receipt of this application by returning the attached postcard with the official Patent and Trademark Office receipt and serial number stamped thereon.

Respectfully submitted,

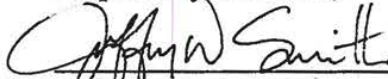
Jeffrey W. Smith, Reg. No. 33455
Attorney for Applicant
Lathrop & Clark
P.O. Box 1507
Madison, Wisconsin 53701-1507
(608) 257-7766

exprmail.app

001317E1010

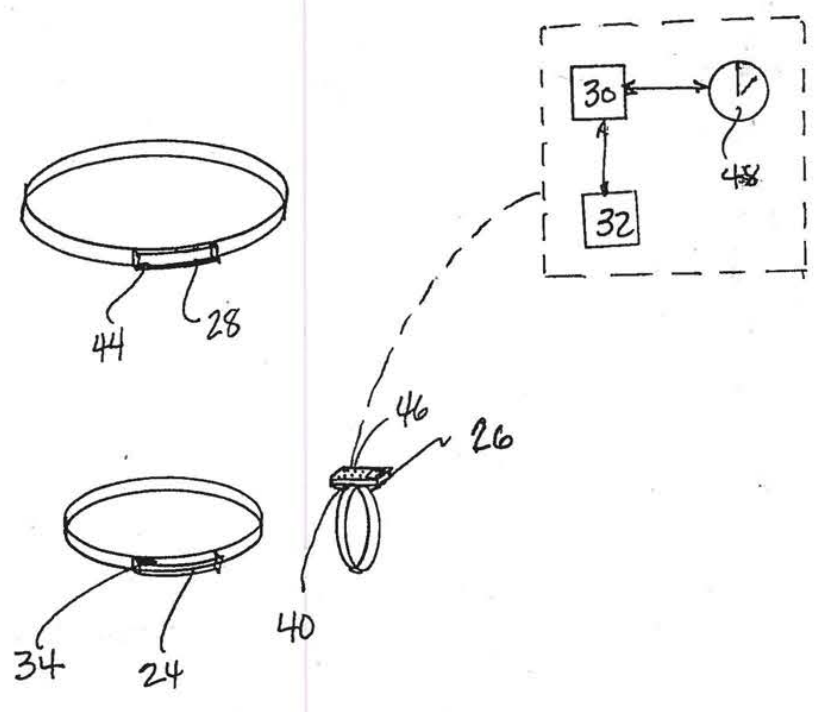

FIG. 1

1/sep

PRINT OF DRAWINGS
AS ORIGINALLY FILED

09/18/738

377/24.2
Wambach

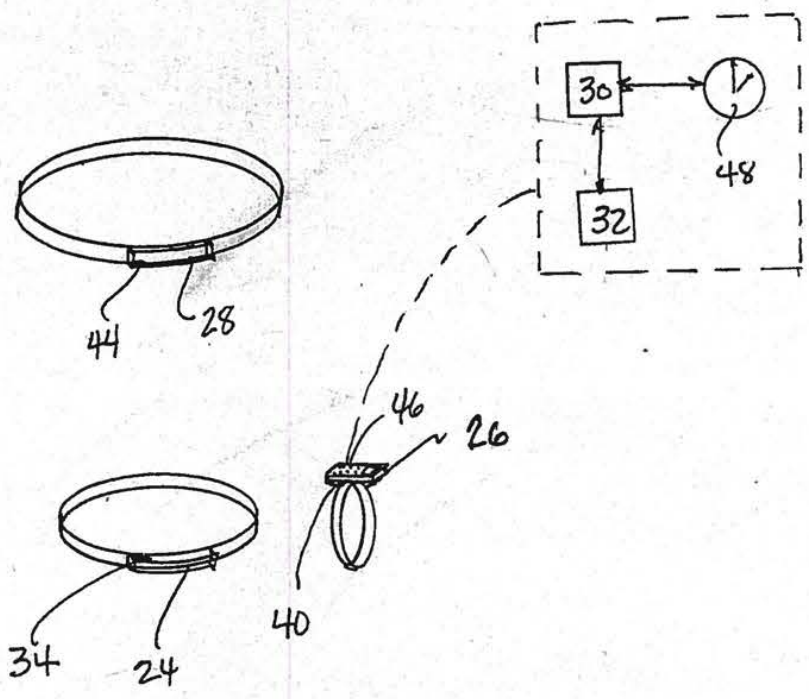

FIG. 1

REPRODUCED FROM

11/16

UNITED STATES DEPARTMENT OF COMMERCE
 Patent and Trademark Office
 Address: COMMISSIONER OF PATENTS AND TRADEMARKS
 Washington, D.C. 20231

APPLICATION NUMBER	FILING/RECEIPT DATE	FIRST NAMED APPLICANT	ATTORNEY DOCKET NO./TITLE
09/181,738	10/28/98	PYLE	N EPIKINC-4

020455
 LATHROP CLARK
 122 W WASHINGTON AVENUE
 P O BOX 1507
 MADISON WI 53701-1507

0242/1117

NOT ASSIGNED

2816

DATE MAILED: 11/17/98

NOTICE TO FILE MISSING PARTS OF APPLICATION
Filing Date Granted

An Application Number and Filing Date have been assigned to this application. The items indicated below, however, are missing. Applicant is given TWO MONTHS FROM THE DATE OF THIS NOTICE within which to file all required items and pay fees required below to avoid abandonment. Extensions of time may be obtained by filing a petition accompanied by the extension fee under the provisions of 37 CFR 1.136(a). If any of items 1 or 3 through 5 are indicated as missing, the SURCHARGE set forth in 37 CFR 1.16(e) of \$65.00 for a small entity in compliance with 37 CFR 1.27, or \$130.00 for a non-small entity, must also be timely submitted in reply to this NOTICE to avoid abandonment.

If all required items on this form are filed within the period set above, the total amount owed by applicant as a small entity (statement filed) non-small entity is \$ 130.

- 1. The statutory basic filing fee is:
 - missing.
 - insufficient.
 Applicant must submit \$ _____ to complete the basic filing fee and/or file a small entity statement claiming such status (37 CFR 1.27).
- 2. Additional claim fees of \$ _____, including any multiple dependent claim fees, are required.
 - \$ _____ for _____ independent claims over 3.
 - \$ _____ for _____ dependent claims over 20.
 - \$ _____ for multiple dependent claim surcharge.
 Applicant must either submit the additional claim fees or cancel additional claims for which fees are due.
- 3. The oath or declaration:
 - is missing or unexecuted.
 - does not cover the newly submitted items.
 - does not identify the application to which it applies.
 - does not include the city and state or foreign country of applicant's residence.
 An oath or declaration in compliance with 37 CFR 1.63, including residence information and identifying the application by the above Application Number and Filing Date is required.
- 4. The signature(s) to the oath or declaration is/are by a person other than inventor or person qualified under 37 CFR 1.42, 1.43 or 1.47.

A properly signed oath or declaration in compliance with 37 CFR 1.63, identifying the application by the above Application Number and Filing Date, is required.
- 5. The signature of the following joint inventor(s) is missing from the oath or declaration:

An oath or declaration in compliance with 37 CFR 1.63 listing the names of all inventors and signed by the omitted inventor(s), identifying this application by the above Application Number and Filing Date, is required.
- 6. A \$50.00 processing fee is required since your check was returned without payment (37 CFR 1.21(m)).
- 7. Your filing receipt was mailed in error because your check was returned without payment.
- 8. The application does not comply with the Sequence Rules.

See attached "Notice to Comply with Sequence Rules, 37 CFR 1.821-1.825."
- 9. OTHER: _____

Direct the reply and any questions about this notice to "Attention: Box Missing Parts."

A copy of this notice MUST be returned with the reply.

Customer Service Center
 Initial Patent Examination Division (703) 308-1202

PART 3 - OFFICE COPY

FORM PTO-1533 (REV. 9-97)

#3



Patent Application
IN THE UNITED STATES PATENT AND TRADEMARK OFFICE

Applicant:	Pyles et al.	Date:	May 4, 1999
Date Filed:	October 28, 1998	Docket No.:	EPIXINC-4
Application Number:	09/181,738	Art Unit:	2816
For:	PEDOMETER		

Certificate of Mailing

I hereby certify that this correspondence is being deposited with the United States Postal Service as first class mail in an envelope addressed to: Attention: Box Missing Parts Assistant Commissioner for Patents, Washington, D.C. 20231

on May 4, 1999
Date

Jeffry W. Smith
Signature
Jeffry W. Smith, Reg. No. 33455
Name of applicant, assignee or Registered Representative

TRANSMITTAL OF MISSING PARTS OF APPLICATION UNDER 37 C.F.R. §1.53

Attention: Box Missing Parts
Assistant Commissioner for Patents
Washington, D.C. 20231

Dear Sir:

In response to the Notice of Missing Parts mailed November 17, 1998, enclosed are the following items for filing in the above-referenced U.S. Patent application:

1. A Declaration and Power of Attorney, executed by the applicant on March 21,

Applicant: Nathan Pyles
Application No.: 09/181,738
Art Unit: 2816

1999; May 3, 1999; and May 3, 1999.

2. Form PTO-1533 Notice to File Missing Parts.
3. A check in the amount of \$500.00 to cover the filing fee (37 C.F.R. §1.16(a) et seq.), the surcharge set forth in 37 C.F.R. §1.16(e), and extension of time under 37 CFR 1.136(a).
4. Verified Statement Claiming Small Entity Status--Small Business Concern, executed on March 21, 1999.
5. Petition for Extension of Time Under 37 CFR 1.136(a).

The Commissioner is hereby authorized to charge payment of any additional fees associated with this communication or credit any overpayment to Deposit Account No. 15-0660. A duplicate copy of this document is enclosed.

Having now complied with all of the requirements of 37 C.F.R. §1.53, applicant respectfully requests that this application be placed upon the files for examination.

Respectfully submitted,

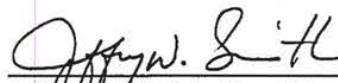

Jeffrey W. Smith, Reg. No. 33455
Attorney for Applicant
Lathrop & Clark LLP
740 Regent Street, Suite 400
P.O. Box 1507
Madison, Wisconsin 53701-1507
(608) 257-7766

files.htm



Docket No.: EPIXINC-4

DECLARATION AND POWER OF ATTORNEY

As a below named inventor, I hereby declare that:

My residence, post office address and citizenship are as stated below next to my name.

I believe I am the original, first and sole inventor of the subject matter which is claimed and for which a patent is sought on the invention entitled: **PEDOMETER**, the specification of which

#3

is attached hereto.

was filed on October 28, 1998 as Application No. 09/181,738 and was amended on _____ (if applicable).

I hereby state that I have reviewed and understand the contents of the above-identified specification, including the claims, as amended by any amendment referred to above.

I do not know and do not believe that the same was ever known or used in the United States of America before my invention thereof, or patented or described in any printed publication in any country before my invention thereof or more than one year prior to this application, that the same was not in public use or on sale in the United States of America more than one year prior to this application, that the invention has not been patented or made the subject of an inventor's certificate issued before the date of this application in any country foreign to the United States of America on an application filed by me or my legal representatives or assigns more than twelve months prior to this application, that I acknowledge my duty to disclose information of which I am aware which is material to the examination of this application in accordance with Title 37, Code of Federal Regulations, §1.56(a), and that no application for patent or inventor's certificate on this invention has been filed in any country foreign to the United States of America prior to this application by me or my legal representatives or assigns, except as follows: None.

I hereby claim foreign priority benefits under Title 35, United States Code, §119 of any foreign application(s) for patent or inventor's certificate listed below and have also

identified below any foreign application for patent or inventor's certificate having a filing date before that of the application on which priority is claimed:

Prior Foreign Application(s)			Priority Claimed	
<u>None.</u>			<input type="checkbox"/>	<input type="checkbox"/>
(Number)	(Country)	(Day/Month/Year Filed)	Yes	No
<u> </u>	<u> </u>	<u> </u>	<input type="checkbox"/>	<input type="checkbox"/>
(Number)	(Country)	(Day/Month/Year Filed)	Yes	No

I hereby claim the benefit under Title 35, United States Code, §120 of any United States application(s) listed below and, insofar as the subject matter of each of the claims of this application is not disclosed in the prior United States application in the manner provided by the first paragraph of Title 35, United States Code, §112, I acknowledge the duty to disclose material information as defined in Title 37, Code of Federal Regulations, §1.56(a) which occurred between the filing date of the prior application and the national or PCT international filing date of this application:

<u>None.</u>		
(Application Serial Number)	(filing date)	(Status--patented, pending, abandoned)
<u> </u>	<u> </u>	<u> </u>
(Application Serial Number)	(filing date)	(Status--patented, pending, abandoned)

And I hereby appoint the practitioners associated with the Customer Number provided below to prosecute this application and to transact all business in the Patent and Trademark Office connected therewith, and direct that all correspondence be addressed to that Customer Number:

Customer Number: 020,455

I hereby declare that all statements made herein of my own knowledge are true and that all statements made on information and belief are believed to be true; and further that these statements were made with the knowledge that willful false statements and the like so made are

punishable by fine or imprisonment, or both, under Section 1001 of Title 18 of the United States Code and that such willful false statements may jeopardize the validity of the application or any patent issued thereon.

Full name of sole Inventor Nathan Pyles

Inventor's Signature

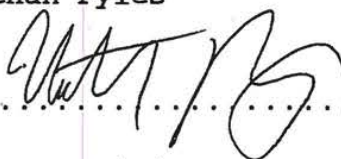

Date

5/3/99

Residence

Lake Mills, Wisconsin

Citizenship

United States of America

Post Office Address

529 College Street, Lake Mills,
Wisconsin 53551

Full name of sole Inventor Joel M. Macht

Inventor's Signature

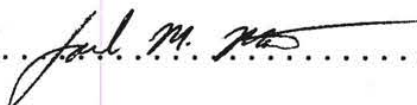

Date

5-3-99

Residence

Reeseville, Wisconsin

Citizenship

United States of America

Post Office Address

106 North Avenue, Reeseville, Wisconsin
53579

Full name of sole Inventor

Chen Shui-Jung

Inventor's Signature

... *Chen Shui-Jung*

Date

... *3/21/99*

Residence

Taipei, Taiwan



Citizenship

Republic of China

Post Office Address

2 F No. 349, Wu Shin Street, Taipei,
Taiwan

Under the Paperwork Reduction Act of 1995, no persons are required to respond to a collection of information unless it displays a valid OMB control number.

STATEMENT CLAIMING SMALL ENTITY STATUS (37 CFR 1.9(f) & 1.27(c))—SMALL BUSINESS CONCERN		Docket Number (Optional) EPIXINC-4
Applicant, Patentee, or Identifier: <u>Nathan Pyles</u>		
Application or Patent No.: <u>09/181,738</u>		
Filed or Issued: <u>October 28, 1998</u>		
Title: <u>Pedometer</u>		
		
I hereby state that I am		
<input type="checkbox"/> the owner of the small business concern identified below:		
<input checked="" type="checkbox"/> an official of the small business concern empowered to act on behalf of the concern identified below:		
NAME OF SMALL BUSINESS CONCERN <u>Epix, Inc.</u>		
ADDRESS OF SMALL BUSINESS CONCERN <u>621 D East Lake Street, Lake Mills, Wisconsin 53551</u>		
<p>I hereby state that the above identified small business concern qualifies as a small business concern as defined in 13 CFR Part 121 for purposes of paying reduced fees to the United States Patent and Trademark Office, in that the number of employees of the concern, including those of its affiliates, does not exceed 500 persons. For purposes of this statement, (1) the number of employees of the business concern is the average over the previous fiscal year of the concern of the persons employed on a full-time, part-time, or temporary basis during each of the pay periods of the fiscal year, and (2) concerns are affiliates of each other when either, directly or indirectly, one concern controls or has the power to control the other, or a third party or parties controls or has the power to control both.</p>		
<p>I hereby state that rights under contract or law have been conveyed to and remain with the small business concern identified above with regard to the invention described in:</p>		
<input checked="" type="checkbox"/> the specification filed herewith with title as listed above.		
<input type="checkbox"/> the application identified above.		
<input type="checkbox"/> the patent identified above.		
<p>If the rights held by the above identified small business concern are not exclusive, each individual, concern, or organization having rights in the invention must file separate statements as to their status as small entities, and no rights to the invention are held by any person, other than the inventor, who would not qualify as an independent inventor under 37 CFR 1.9(c) if that person made the invention, or by any concern which would not qualify as a small business concern under 37 CFR 1.9(d), or a nonprofit organization under 37 CFR 1.9(e).</p>		
<p>Each person, concern, or organization having any rights in the invention is listed below:</p>		
<input type="checkbox"/> no such person, concern, or organization exists.		
<input type="checkbox"/> each such person, concern, or organization is listed below.		
<p>Separate statements are required from each named person, concern or organization having rights to the invention stating their status as small entities (37 CFR 1.27).</p>		
<p>I acknowledge the duty to file, in this application or patent, notification of any change in status resulting in loss of entitlement to small entity status prior to paying, or at the time of paying, the earliest of the issue fee or any maintenance fee due after the date on which status as a small entity is no longer appropriate (37 CFR 1.28(b)).</p>		
NAME OF PERSON SIGNING <u>Nathan Pyles</u>		
TITLE OF PERSON IF OTHER THAN OWNER <u>President</u>		
ADDRESS OF PERSON SIGNING <u>529 College Street, Lake Mills, Wisconsin 53551-1412</u>		
SIGNATURE <u></u>		DATE <u>3/21/99</u>

Burden Hour Statement: This form is estimated to take 0.2 hours to complete. Time will vary depending upon the needs of the individual case. Any comments on the amount of time you are required to complete this form should be sent to the Chief Information Officer, Patent and Trademark Office, Washington, DC 20231. DO NOT SEND FEES OR COMPLETED FORMS TO THIS ADDRESS. SEND TO: Assistant Commissioner for Patents, Washington, DC 20231.

217

PTO/SB/22 (12-97)

Approved for use through 9/30/00. OMB 0651-0031

Patent and Trademark Office; U.S. DEPARTMENT OF COMMERCE

Under the Paperwork Reduction Act of 1995, no persons are required to respond to a collection of information unless it displays a valid OMB control number.

PETITION FOR EXTENSION OF TIME UNDER 37 CFR 1.136(a)		Docket Number (Optional) EPIXINC-4															
	In re Application of Nathan Pyles																
	Application Number 09/181,738	Filed October 28, 1998															
	For PEDOMETER																
	Group Art Unit 2816	Examiner															
<p>This is a request under the provisions of 37 CFR 1.136(a) to extend the period of filing a response in the above identified application.</p> <p>The requested extension and appropriate non-small-entity fee are as follows (check time period desired):</p> <table border="0"> <tr> <td><input type="checkbox"/></td> <td>One month (37 CFR 1.17(a)(1))</td> <td>\$ _____</td> </tr> <tr> <td><input type="checkbox"/></td> <td>Two months (37 CFR 1.17 (a)(2))</td> <td>\$ _____</td> </tr> <tr> <td><input checked="" type="checkbox"/></td> <td>Three months (37 CFR 1.17(a)(3))</td> <td>\$870.00</td> </tr> <tr> <td><input type="checkbox"/></td> <td>Four months (37 CFR 1.17(a)(4))</td> <td>\$ _____</td> </tr> <tr> <td><input type="checkbox"/></td> <td>Five months (37 CFR 1.17(a)(5))</td> <td>\$ _____</td> </tr> </table> <p><input checked="" type="checkbox"/> Applicant is a small entity under 37 CFR 1.9 and 1.27, therefore the fee amount shown above is reduced by one-half, and the resulting fee is: <u>\$435.00</u>. A small entity statement under 37 CFR 1.27:</p> <p><input checked="" type="checkbox"/> is enclosed.</p> <p><input type="checkbox"/> has already been filed in this application.</p> <p><input checked="" type="checkbox"/> A check in the amount of the fee is enclosed.</p> <p><input type="checkbox"/> The Commissioner has already been authorized to charge fees in this application to a Deposit Account.</p> <p><input checked="" type="checkbox"/> The Commissioner is hereby authorized to charge any fees which may be required, or credit any overpayment, to Deposit Account Number <u>15-0660</u>. I have enclosed a duplicate copy of this sheet.</p> <p>I am the <input type="checkbox"/> assignee of record of the entire interest. <input type="checkbox"/> applicant. <input checked="" type="checkbox"/> attorney or agent of record. <input type="checkbox"/> attorney or agent under 37 CFR 1.34(a).</p> <p>Registration number if acting under 37 CFR 1.34(a) _____</p> <p><u>May 4, 1999</u> Date <u>Jeffry W. Smith</u> Signature</p> <p><u>Jeffry W. Smith, Reg. No. 33455</u> Typed or printed name</p>			<input type="checkbox"/>	One month (37 CFR 1.17(a)(1))	\$ _____	<input type="checkbox"/>	Two months (37 CFR 1.17 (a)(2))	\$ _____	<input checked="" type="checkbox"/>	Three months (37 CFR 1.17(a)(3))	\$870.00	<input type="checkbox"/>	Four months (37 CFR 1.17(a)(4))	\$ _____	<input type="checkbox"/>	Five months (37 CFR 1.17(a)(5))	\$ _____
<input type="checkbox"/>	One month (37 CFR 1.17(a)(1))	\$ _____															
<input type="checkbox"/>	Two months (37 CFR 1.17 (a)(2))	\$ _____															
<input checked="" type="checkbox"/>	Three months (37 CFR 1.17(a)(3))	\$870.00															
<input type="checkbox"/>	Four months (37 CFR 1.17(a)(4))	\$ _____															
<input type="checkbox"/>	Five months (37 CFR 1.17(a)(5))	\$ _____															

~~#03~~

#03

Under the Paperwork Reduction Act of 1995, no persons are required to respond to a collection of information unless it displays a valid OMB control number.

PETITION FOR EXTENSION OF TIME UNDER 37 CFR 1.136(a)		Docket Number (Optional) EPIXINC-4															
	In re Application of Nathan Pyles																
	Application Number 09/181,738	Filed October 28, 1998															
	For PEDOMETER																
	Group Art Unit 2816	Examiner															
<p>This is a request under the provisions of 37 CFR 1.136(a) to extend the period of filing a response in the above identified application.</p> <p>The requested extension and appropriate non-small-entity fee are as follows (check time period desired):</p> <table style="width: 100%; border: none;"> <tr> <td style="width: 10%;"><input type="checkbox"/></td> <td style="width: 70%;">One month (37 CFR 1.17(a)(1))</td> <td style="width: 20%; text-align: right;">\$ _____</td> </tr> <tr> <td><input type="checkbox"/></td> <td>Two months (37 CFR 1.17 (a)(2))</td> <td style="text-align: right;">\$ _____</td> </tr> <tr> <td><input checked="" type="checkbox"/></td> <td>Three months (37 CFR 1.17(a)(3))</td> <td style="text-align: right;">\$870.00</td> </tr> <tr> <td><input type="checkbox"/></td> <td>Four months (37 CFR 1.17(a)(4))</td> <td style="text-align: right;">\$ _____</td> </tr> <tr> <td><input type="checkbox"/></td> <td>Five months (37 CFR 1.17(a)(5))</td> <td style="text-align: right;">\$ _____</td> </tr> </table> <p><input checked="" type="checkbox"/> Applicant is a small entity under 37 CFR 1.9 and 1.27, therefore the fee amount shown above is reduced by one-half, and the resulting fee is: <u>\$435.00</u>. A small entity statement under 37 CFR 1.27:</p> <p style="margin-left: 20px;"><input checked="" type="checkbox"/> is enclosed. <input type="checkbox"/> has already been filed in this application.</p> <p><input checked="" type="checkbox"/> A check in the amount of the fee is enclosed.</p> <p><input type="checkbox"/> The Commissioner has already been authorized to charge fees in this application to a Deposit Account.</p> <p><input checked="" type="checkbox"/> The Commissioner is hereby authorized to charge any fees which may be required, or credit any overpayment, to Deposit Account Number <u>15-0660</u>. I have enclosed a duplicate copy of this sheet.</p> <p>I am the <input type="checkbox"/> assignee of record of the entire interest. <input type="checkbox"/> applicant. <input checked="" type="checkbox"/> attorney or agent of record. <input type="checkbox"/> attorney or agent under 37 CFR 1.34(a).</p> <p style="text-align: right;">Registration number if acting under 37 CFR 1.34(a) _____</p> <p style="margin-left: 100px;"><u>May 4, 1999</u> <u>Jeffry W. Smith</u> Date Signature</p> <p style="text-align: center;"><u>Jeffry W. Smith, Reg. No. 33455</u> Typed or printed name</p>			<input type="checkbox"/>	One month (37 CFR 1.17(a)(1))	\$ _____	<input type="checkbox"/>	Two months (37 CFR 1.17 (a)(2))	\$ _____	<input checked="" type="checkbox"/>	Three months (37 CFR 1.17(a)(3))	\$870.00	<input type="checkbox"/>	Four months (37 CFR 1.17(a)(4))	\$ _____	<input type="checkbox"/>	Five months (37 CFR 1.17(a)(5))	\$ _____
<input type="checkbox"/>	One month (37 CFR 1.17(a)(1))	\$ _____															
<input type="checkbox"/>	Two months (37 CFR 1.17 (a)(2))	\$ _____															
<input checked="" type="checkbox"/>	Three months (37 CFR 1.17(a)(3))	\$870.00															
<input type="checkbox"/>	Four months (37 CFR 1.17(a)(4))	\$ _____															
<input type="checkbox"/>	Five months (37 CFR 1.17(a)(5))	\$ _____															

SECRET

Please type a plus sign (+) inside this box. Under the Paperwork Reduction Act of 1995, no persons are required to respond to a collection of information unless it displays a valid OMB control number.

Patent and Trademark Office: U.S. DEPARTMENT OF COMMERCE



TRANSMITTAL FORM

(To be used for all correspondence after initial filing)

Application Number	09/181,738
Filing Date	October 28, 1998
First Named Inventor	Nathan Pyles
Group Art Unit	2816
Examiner Name	
Attorney Docket Number	EPIXINC-4
Total Number of Pages in This Submission	

<input checked="" type="checkbox"/> Fee Transmittal Form <input checked="" type="checkbox"/> Fee Attached <input type="checkbox"/> Amendment / Response <input type="checkbox"/> After Final <input type="checkbox"/> Affidavits/declaration(s) <input checked="" type="checkbox"/> Extension of Time Request <input type="checkbox"/> Express Abandonment Request <input type="checkbox"/> Information Disclosure Statement <input type="checkbox"/> Certified Copy of Priority Document(s) <input type="checkbox"/> Response to Missing Parts/ Incomplete Application <input checked="" type="checkbox"/> Response to Missing Parts Under 37 CFR 1.52 or 1.53	<input type="checkbox"/> Assignment Papers (For an Application) <input type="checkbox"/> Drawing(s) <input type="checkbox"/> Licensing-related Papers <input type="checkbox"/> Petition Routing Slip (PTO/SB/69) And Accompanying Petition <input type="checkbox"/> To Convert a Provisional Application <input type="checkbox"/> Power of Attorney, Revocation Change of Correspondence Address <input type="checkbox"/> Terminal Disclaimer <input checked="" type="checkbox"/> Small Entity Statement <input type="checkbox"/> Request for Refund	<input type="checkbox"/> After Allowance Communication To Group <input type="checkbox"/> Appeal Communication to Board Of Appeals and Interferences <input type="checkbox"/> Appeal Communication to Group (Appeal Notice, Brief, Reply Brief) <input type="checkbox"/> Proprietary Information <input type="checkbox"/> Status Letter <input type="checkbox"/> Additional Enclosure(s) (Please identify below):
Remarks		

SIGNATURE OF APPLICANT, ATTORNEY, OR AGENT

Firm or Individual name	Jeffry W. Smith, Reg. No. 33455
Signature	<i>Jeffry W. Smith</i>
Date	May 4, 1999

CERTIFICATE OF MAILING

I hereby certify that this correspondence is being deposited with the United States Postal Service as first class mail in an envelope addressed to: Assistant Commissioner for Patents, Washington, D.C. 20231 on this date:

Typed or printed name	Jeffry W. Smith, Reg. No. 33455
Signature	<i>Jeffry W. Smith</i>
Date	May 4, 1999

Under the Paperwork Reduction Act of 1995, no persons are required to respond to a collection of information unless it displays a valid OMB control number.

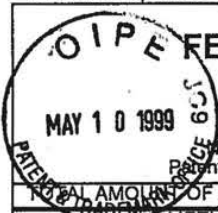
 <p style="text-align: center;">OIPE FEE TRANSMITTAL</p> <p style="text-align: center;">Note: Effective October 1, 1997, Patent fees are subject to annual revision</p>		Complete if Known																																																																																																																																																																																					
		Application Number	09/181,738																																																																																																																																																																																				
		Filing Date	October 28, 1998																																																																																																																																																																																				
		First Named Inventor	Nathan Pyles																																																																																																																																																																																				
		Group Art Unit	2816																																																																																																																																																																																				
Examiner Name																																																																																																																																																																																							
TOTAL AMOUNT OF PAYMENT \$500.00		Attorney Docket Number	EPIXINC-4																																																																																																																																																																																				
METHOD OF PAYMENT (check one) 1. <input checked="" type="checkbox"/> The Commissioner is hereby authorized to charge indicated fees and credit any over payments to: Deposit Account Number: 15-0660 Deposit Account Name: Lathrop & Clark <input checked="" type="checkbox"/> Charge Any Additional Fee Required Under 37 CFR 1.16 and 1.17 <input type="checkbox"/> Charge the Issue Fee Set in 37 CFR 1.18 at the Mailing of the Notice of Allowance		FEE CALCULATION (Continued) 3. ADDITIONAL FEES																																																																																																																																																																																					
2. <input checked="" type="checkbox"/> Payment Enclosed: <input checked="" type="checkbox"/> Check <input type="checkbox"/> Money Order <input type="checkbox"/> Other		<table border="1" style="width:100%; border-collapse: collapse;"> <thead> <tr> <th>Large Entity Fee Code</th> <th>Large Entity Fee (\$)</th> <th>Small Entity Fee Code</th> <th>Small Entity Fee (\$)</th> <th>Fee Description</th> <th>Fee Paid</th> </tr> </thead> <tbody> <tr><td>105</td><td>130</td><td>205</td><td>65</td><td>Surcharge - late filing fee or oath</td><td>\$65.00</td></tr> <tr><td>127</td><td>50</td><td>227</td><td>25</td><td>Surcharge - late provisional filing fee or cover sheet</td><td></td></tr> <tr><td>139</td><td>130</td><td>139</td><td>130</td><td>Non-English specification</td><td></td></tr> <tr><td>147</td><td>2,520</td><td>147</td><td>2,520</td><td>For filing a request for reexamination</td><td></td></tr> <tr><td>112</td><td>920*</td><td>112</td><td>920*</td><td>Requesting publication of SIR prior to Examiner action</td><td></td></tr> <tr><td>113</td><td>1,840*</td><td>113</td><td>1,840*</td><td>Requesting publication of SIR after Examiner action</td><td></td></tr> <tr><td>115</td><td>110</td><td>215</td><td>55</td><td>Extension for reply within first month</td><td></td></tr> <tr><td>116</td><td>380</td><td>216</td><td>190</td><td>Extension for reply within second month</td><td></td></tr> <tr><td>117</td><td>870</td><td>217</td><td>435</td><td>Extension for reply within third month</td><td>\$435.00</td></tr> <tr><td>118</td><td>1,360</td><td>218</td><td>680</td><td>Extension for reply within fourth month</td><td></td></tr> <tr><td>128</td><td>1850</td><td>228</td><td>925</td><td>Extension for reply within fifth month</td><td></td></tr> <tr><td>119</td><td>300</td><td>219</td><td>150</td><td>Notice of Appeal</td><td></td></tr> <tr><td>120</td><td>300</td><td>220</td><td>150</td><td>Filing a brief in support of an appeal</td><td></td></tr> <tr><td>121</td><td>260</td><td>221</td><td>130</td><td>Request for oral hearing</td><td></td></tr> <tr><td>138</td><td>1,510</td><td>138</td><td>1,510</td><td>Petition to institute a public use proceeding</td><td></td></tr> <tr><td>140</td><td>110</td><td>240</td><td>55</td><td>Petition to revive - unavoidable</td><td></td></tr> <tr><td>141</td><td>1,210</td><td>241</td><td>605</td><td>Petition to revive - unintentional</td><td></td></tr> <tr><td>142</td><td>1,210</td><td>242</td><td>605</td><td>Utility Issue fee (or reissue)</td><td></td></tr> <tr><td>143</td><td>430</td><td>243</td><td>215</td><td>Design Issue fee</td><td></td></tr> <tr><td>144</td><td>580</td><td>244</td><td>290</td><td>Plant Issue fee</td><td></td></tr> <tr><td>122</td><td>130</td><td>122</td><td>130</td><td>Petitions to the Commissioner</td><td></td></tr> <tr><td>123</td><td>50</td><td>123</td><td>50</td><td>Petitions related to provisional applications</td><td></td></tr> <tr><td>126</td><td>240</td><td>126</td><td>240</td><td>Submission of Information Disclosure Statement</td><td></td></tr> <tr><td>581</td><td>40</td><td>581</td><td>40</td><td>Recording each patent assignment per property (times number of properties)</td><td></td></tr> <tr><td>146</td><td>760</td><td>246</td><td>380</td><td>Filing a submission after final rejection (37 CFR 1.129(a))</td><td></td></tr> <tr><td>149</td><td>760</td><td>249</td><td>380</td><td>For each additional invention to be examined (37 CFR 1.129(b))</td><td></td></tr> <tr><td colspan="6">Other fee (specify) _____</td></tr> <tr><td colspan="6">Other fee (specify) _____</td></tr> <tr><td colspan="5">*Reduced by Basic Filing Fee Paid</td><td>SUBTOTAL (3) \$500.00</td></tr> </tbody> </table>		Large Entity Fee Code	Large Entity Fee (\$)	Small Entity Fee Code	Small Entity Fee (\$)	Fee Description	Fee Paid	105	130	205	65	Surcharge - late filing fee or oath	\$65.00	127	50	227	25	Surcharge - late provisional filing fee or cover sheet		139	130	139	130	Non-English specification		147	2,520	147	2,520	For filing a request for reexamination		112	920*	112	920*	Requesting publication of SIR prior to Examiner action		113	1,840*	113	1,840*	Requesting publication of SIR after Examiner action		115	110	215	55	Extension for reply within first month		116	380	216	190	Extension for reply within second month		117	870	217	435	Extension for reply within third month	\$435.00	118	1,360	218	680	Extension for reply within fourth month		128	1850	228	925	Extension for reply within fifth month		119	300	219	150	Notice of Appeal		120	300	220	150	Filing a brief in support of an appeal		121	260	221	130	Request for oral hearing		138	1,510	138	1,510	Petition to institute a public use proceeding		140	110	240	55	Petition to revive - unavoidable		141	1,210	241	605	Petition to revive - unintentional		142	1,210	242	605	Utility Issue fee (or reissue)		143	430	243	215	Design Issue fee		144	580	244	290	Plant Issue fee		122	130	122	130	Petitions to the Commissioner		123	50	123	50	Petitions related to provisional applications		126	240	126	240	Submission of Information Disclosure Statement		581	40	581	40	Recording each patent assignment per property (times number of properties)		146	760	246	380	Filing a submission after final rejection (37 CFR 1.129(a))		149	760	249	380	For each additional invention to be examined (37 CFR 1.129(b))		Other fee (specify) _____						Other fee (specify) _____						*Reduced by Basic Filing Fee Paid					SUBTOTAL (3) \$500.00
Large Entity Fee Code	Large Entity Fee (\$)	Small Entity Fee Code	Small Entity Fee (\$)	Fee Description	Fee Paid																																																																																																																																																																																		
105	130	205	65	Surcharge - late filing fee or oath	\$65.00																																																																																																																																																																																		
127	50	227	25	Surcharge - late provisional filing fee or cover sheet																																																																																																																																																																																			
139	130	139	130	Non-English specification																																																																																																																																																																																			
147	2,520	147	2,520	For filing a request for reexamination																																																																																																																																																																																			
112	920*	112	920*	Requesting publication of SIR prior to Examiner action																																																																																																																																																																																			
113	1,840*	113	1,840*	Requesting publication of SIR after Examiner action																																																																																																																																																																																			
115	110	215	55	Extension for reply within first month																																																																																																																																																																																			
116	380	216	190	Extension for reply within second month																																																																																																																																																																																			
117	870	217	435	Extension for reply within third month	\$435.00																																																																																																																																																																																		
118	1,360	218	680	Extension for reply within fourth month																																																																																																																																																																																			
128	1850	228	925	Extension for reply within fifth month																																																																																																																																																																																			
119	300	219	150	Notice of Appeal																																																																																																																																																																																			
120	300	220	150	Filing a brief in support of an appeal																																																																																																																																																																																			
121	260	221	130	Request for oral hearing																																																																																																																																																																																			
138	1,510	138	1,510	Petition to institute a public use proceeding																																																																																																																																																																																			
140	110	240	55	Petition to revive - unavoidable																																																																																																																																																																																			
141	1,210	241	605	Petition to revive - unintentional																																																																																																																																																																																			
142	1,210	242	605	Utility Issue fee (or reissue)																																																																																																																																																																																			
143	430	243	215	Design Issue fee																																																																																																																																																																																			
144	580	244	290	Plant Issue fee																																																																																																																																																																																			
122	130	122	130	Petitions to the Commissioner																																																																																																																																																																																			
123	50	123	50	Petitions related to provisional applications																																																																																																																																																																																			
126	240	126	240	Submission of Information Disclosure Statement																																																																																																																																																																																			
581	40	581	40	Recording each patent assignment per property (times number of properties)																																																																																																																																																																																			
146	760	246	380	Filing a submission after final rejection (37 CFR 1.129(a))																																																																																																																																																																																			
149	760	249	380	For each additional invention to be examined (37 CFR 1.129(b))																																																																																																																																																																																			
Other fee (specify) _____																																																																																																																																																																																							
Other fee (specify) _____																																																																																																																																																																																							
*Reduced by Basic Filing Fee Paid					SUBTOTAL (3) \$500.00																																																																																																																																																																																		
1. FILING FEE <table border="1" style="width:100%; border-collapse: collapse;"> <thead> <tr> <th>Large Entity Fee Code</th> <th>Large Entity Fee (\$)</th> <th>Small Entity Fee Code</th> <th>Small Entity Fee (\$)</th> <th>Fee Description</th> <th>Fee Paid</th> </tr> </thead> <tbody> <tr><td>101</td><td>760</td><td>201</td><td>380</td><td>Utility filing fee</td><td></td></tr> <tr><td>106</td><td>310</td><td>206</td><td>155</td><td>Design filing fee</td><td></td></tr> <tr><td>107</td><td>480</td><td>207</td><td>240</td><td>Plant filing fee</td><td></td></tr> <tr><td>108</td><td>760</td><td>208</td><td>380</td><td>Reissue filing fee</td><td></td></tr> <tr><td>114</td><td>150</td><td>214</td><td>75</td><td>Provisional filing fee</td><td></td></tr> <tr><td colspan="5">SUBTOTAL (1)</td><td>\$0.00</td></tr> </tbody> </table>		Large Entity Fee Code	Large Entity Fee (\$)	Small Entity Fee Code	Small Entity Fee (\$)	Fee Description	Fee Paid	101	760	201	380	Utility filing fee		106	310	206	155	Design filing fee		107	480	207	240	Plant filing fee		108	760	208	380	Reissue filing fee		114	150	214	75	Provisional filing fee		SUBTOTAL (1)					\$0.00	2. CLAIMS <table border="1" style="width:100%; border-collapse: collapse;"> <thead> <tr> <th>Total Claims</th> <th>Extra</th> <th>Fee from below</th> <th>Fee Paid</th> </tr> </thead> <tbody> <tr><td>0</td><td>X</td><td>11</td><td>\$0.00</td></tr> <tr><td>0</td><td>X</td><td>41</td><td>\$0.00</td></tr> <tr><td></td><td>X</td><td>135</td><td>\$0.00</td></tr> </tbody> </table>		Total Claims	Extra	Fee from below	Fee Paid	0	X	11	\$0.00	0	X	41	\$0.00		X	135	\$0.00																																																																																																																										
Large Entity Fee Code	Large Entity Fee (\$)	Small Entity Fee Code	Small Entity Fee (\$)	Fee Description	Fee Paid																																																																																																																																																																																		
101	760	201	380	Utility filing fee																																																																																																																																																																																			
106	310	206	155	Design filing fee																																																																																																																																																																																			
107	480	207	240	Plant filing fee																																																																																																																																																																																			
108	760	208	380	Reissue filing fee																																																																																																																																																																																			
114	150	214	75	Provisional filing fee																																																																																																																																																																																			
SUBTOTAL (1)					\$0.00																																																																																																																																																																																		
Total Claims	Extra	Fee from below	Fee Paid																																																																																																																																																																																				
0	X	11	\$0.00																																																																																																																																																																																				
0	X	41	\$0.00																																																																																																																																																																																				
	X	135	\$0.00																																																																																																																																																																																				
SUBMITTED BY Typed or Printed Name: Jeffry W. Smith Signature: <i>Jeffry W. Smith</i> Date: <i>May 4, 1999</i>		Complete (if applicable) Reg. Number: 33455 Deposit Account User ID:																																																																																																																																																																																					



205
 UNITED STATES DEPARTMENT OF COMMERCE
 Patent and Trademark Office
 Address: COMMISSIONER OF PATENTS AND TRADEMARKS
 Washington, D.C. 20231
 #3

APPLICATION NUMBER	FILING/RECEIPT DATE	FIRST NAMED APPLICANT	ATTORNEY DOCKET NO./TITLE
09/181,738	10/28/98	PYLES	1111/99 N EPIXINC-4

020455
 LATHROP CLARK
 122 W WASHINGTON AVENUE
 P O BOX 1507
 MADISON WI 53701-1507

0242/1117

Missing Parts Due

NOT ASSIGNED

DATE MAILED: 11/17/98

NOTICE TO FILE MISSING PARTS OF APPLICATION
Filing Date Granted

An Application Number and Filing Date have been assigned to this application. The items indicated below, however, are missing. Applicant is given TWO MONTHS FROM THE DATE OF THIS NOTICE within which to file all required items and pay fees required below to avoid abandonment. Extensions of time may be obtained by filing a petition accompanied by the extension fee under the provisions of 37 CFR 1.136(a). If any of items 1 or 3 through 5 are indicated as missing, the SURCHARGE set forth in 37 CFR 1.16(e) of \$65.00 for a small entity in compliance with 37 CFR 1.27, or \$130.00 for a non-small entity, must also be timely submitted in reply to this NOTICE to avoid abandonment.

If all required items on this form are filed within the period set above, the total amount owed by applicant as a small entity (statement filed) non-small entity is \$ 130.

- 1. The statutory basic filing fee is:
 - missing.
 - insufficient.
 Applicant must submit \$ _____ to complete the basic filing fee and/or file a small entity statement claiming such status (37 CFR 1.27).
- 2. Additional claim fees of \$ _____, including any multiple dependent claim fees, are required.
 - \$ _____ for _____ independent claims over 3.
 - \$ _____ for _____ dependent claims over 20.
 - \$ _____ for multiple dependent claim surcharge.
 Applicant must either submit the additional claim fees or cancel additional claims for which fees are due.
- 3. The oath or declaration:
 - is missing or unexecuted.
 - does not cover the newly submitted items.
 - does not identify the application to which it applies.
 - does not include the city and state or foreign country of applicant's residence.
 An oath or declaration in compliance with 37 CFR 1.63, including residence information and identifying the application by the above Application Number and Filing Date is required.
- 4. The signature(s) to the oath or declaration is/are by a person other than inventor or person qualified under 37 CFR 1.42, 1.43 or 1.47.
 A properly signed oath or declaration in compliance with 37 CFR 1.63, identifying the application by the above Application Number and Filing Date, is required.
- 5. The signature of the following joint inventor(s) is missing from the oath or declaration:

 An oath or declaration in compliance with 37 CFR 1.63 listing the names of all inventors and signed by the omitted inventor(s), identifying this application by the above Application Number and Filing Date, is required.
- 6. A \$50.00 processing fee is required since your check was returned without payment (37 CFR 1.21(m)).
- 7. Your filing receipt was mailed in error because your check was returned without payment.
- 8. The application does not comply with the Sequence Rules.
 See attached "Notice to Comply with Sequence Rules 37 CFR 1.821-1.825."
- 9. OTHER: _____

Direct the reply and any questions about this notice to "Attention: Box Missing Parts."

A copy of this notice MUST be returned with the reply.

Customer Service Center
 Initial Patent Examination Division (703) 308-1202

PART 2 - COPY TO BE RETURNED WITH RESPONSE

FORM PTO-1533 (REV. 9-97)

05/12/1999 TTRAMI 00000053 09181738
 65.00 0000
 435.00 0000

EP 2816

#4
D. Scott
6-21-99

PATENT APPLICATION

IN THE UNITED STATES PATENT AND TRADEMARK OFFICE

Applicant:	Pyles, et al.	Date:	February 16, 1999
Filed:	October 28, 1998	Docket No.:	EPIXINC-4
Application No.:	09/181,738	Art Unit:	2816
For:	PEDOMETER		

Certificate of Mailing

I hereby certify that this correspondence is being deposited with the United States Postal Service as first class mail in an envelope addressed to: Assistant Commissioner for Patents, Washington, D.C. 20231

on February 16, 1999
Date

Jeffrey W. Smith
Signature

Jeffrey W. Smith, Reg. No. 33455
Name of applicant, assignee or Registered Representative

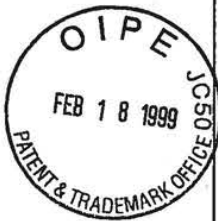

INFORMATION DISCLOSURE STATEMENT

Assistant Commissioner for Patents
Washington, D.C. 20231

Dear Sir:

In accordance with 37 C.F.R. §1.56, applicant wishes to call the attention of the Examiner to the following documents:

RECEIVED
FEB 22 1999
GROUP 2100

United States Patents

<u>U.S. Patent No.</u>	<u>Issue Date</u>	<u>Patentee</u>
4,053,755	10-11-1977	Sherrill
4,223,211	09-16-1980	Allsen et al.
4,334,190	06-08-1982	Sochaczewski
4,337,529	06-29-1982	Morokawa
4,371,945	02-01-1983	Karr et al.
4,510,704	04-16-1985	Johnson
4,651,446	03-24-1987	Yukawa et al.
4,741,001	04-26-1988	Ma
4,771,394	09-13-1988	Cavanagh
4,855,942	08-08-1989	Bianco
5,117,444	05-26-1992	Sutton et al.
5,475,725	12-12-1995	Nakamura
5,476,427	12-19-1995	Fujima
5,490,816	02-13-1996	Sakumoto
5,516,334	05-14-1996	Easton
5,526,290	06-11-1996	Kanzaki

Copies of these documents are submitted herewith along with Form PTO-SB/08A.

Applicant respectfully requests that these documents be expressly considered during the prosecution of this application and made of record herein and appear among the "documents cited" on any patent to issue herefrom.

Respectfully submitted,

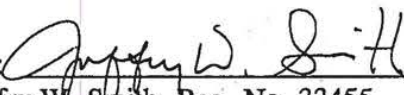
By: 
Jeffrey W. Smith, Reg. No. 33455
Attorney for Applicant
Lathrop & Clark LLP
740 Regent Street, Suite 400
P. O. Box 1507
Madison, Wisconsin 53701
(608) 257-7766

RECEIVED
FEB 22 1999
GROUP 2100

ids.app

Please type a plus sign (+) inside this box → Patent and Trademark Office: U.S. DEPARTMENT OF COMMERCE
 Under the Paperwork Reduction Act of 1995, no persons are required to respond to a collection of information unless it displays a valid OMB control number.

Substitute for form 1449A/PTO	Application Number 09/18/2008 09/181,738
INFORMATION DISCLOSURE STATEMENT BY APPLICANT <i>(Use as many sheets as necessary)</i>	Filing Date: October 28, 1998
	First Named inventor: Nathan Pyles
	Group Art Unit: 2816
	Examiner Name: Wambach
Sheet 1 of 1	Attorney Docket Number: EPIXINC-4

U.S. PATENT DOCUMENTS

Examiner Initials*	Cite No. ¹	U.S. Patent Document		Name of Patentee or Applicant of Cited Document	Date of Publication of Cited Document MM-DD-YYYY	Pages, Columns, Lines, Where Relevant Passages or Relevant Figures Appear
		Number	Kind Code ² (if known)			
TRW	X	4,053,755		Sherrill	10-11-1977	
MRW	X	4,223,211		Alisen et al.	09-16-1980	
MRW	X	4,334,190		Sochaczewski	06-08-1982	
TRW	X	4,337,529		Morokawa	06-29-1982	
MRW	X	4,371,945		Karr et al.	02-01-1983	
MRW	X	4,510,704		Johnson	04-16-1985	
MRW	X	4,651,446		Yukawa et al.	03-24-1987	
MRW	X	4,741,001		Ma	04-26-1988	
MRW	X	4,771,394		Cavanagh	09-13-1988	
MRW	X	4,855,942		Bianco	08-08-1989	
MRW	X	5,117,444		Sutton et al.	05-26-1992	
MRW	X	5,475,725		Nakamura	12-12-1995	
MRW	X	5,476,427		Fujima	12-19-1995	
MRW	X	5,490,816		Sakumoto	02-13-1996	
MRW	X	5,516,334		Easton	05-14-1996	
MRW	X	5,526,290		Kanzaki	06-11-1996	

FOREIGN PATENT DOCUMENTS

Examiner Initials*	Cite No. ¹	Foreign Patent Document			Name of Patentee or Applicant of Cited Document	Date of Publication of Cited Document MM-DD-YYYY	Pages, Columns, Lines, Where Relevant Passages or Relevant Figures Appear	T ⁶
		Office ³	Number ⁴	Kind Code ⁵ (if known)				

RECEIVED
FEB 22 1999

Examiner Signature: Margaret Wambach	Date Considered: 1/24/99	PROIP 2100
--------------------------------------	--------------------------	------------

*EXAMINER: Initial if reference considered, whether or not citation is in conformance with MPEP 609. Draw line through citation if not in conformance and not considered. Include copy of this form with next communication to applicant.

¹Unique citation designation number. ²See attached Kinds of U.S. Patent Documents. ³Enter Office that issued the document, by the two-letter code (WIPO Standard St.3). ⁴For Japanese patent documents, the indication of the year of the reign of the Emperor must precede the serial number of the patent document. ⁵Kind of document by the appropriate symbols as indicated on the document under WIPO Standard ST. 16 if possible. ⁶Applicant is to place a check mark here if English language Translation is attached.

Burden Hour Statement: This form is estimated to take 0.2 hours to complete. Time will vary depending upon the needs of the individual case. Any comments on the amount of time you are required to complete this form should be sent to the Chief Information Officer, Patent and Trademark Office, Washington, DC 20231. DO NOT SEND FEES OR COMPLETED FORMS TO THIS ADDRESS. SEND TO: Assistant Commissioner for Patents, Washington, DC 20231.

Please type a plus sign (+) inside →
 Under the Paperwork Reduction Act of 1995, no persons are required to respond to a collection of information unless it displays a valid OMB control number.

Patent and Trademark Office: U.S. DEPARTMENT OF COMMERCE
 Approved for use through 9/30/00. OMB 0651-0031



TRANSMITTAL FORM

(To be used for all correspondence after initial filing)

Application Number	09/181,738
Filing Date	October 28, 1998
First Named Inventor	Nathan Pyles
Group Art Unit	2816
Examiner Name	
Attorney Docket Number	EPIXINC-4

<input type="checkbox"/> Fee Transmittal Form <input type="checkbox"/> Fee Attached <input type="checkbox"/> Amendment / Response <input type="checkbox"/> After Final <input type="checkbox"/> Affidavits/declaration(s) <input type="checkbox"/> Extension of Time Request <input type="checkbox"/> Express Abandonment Request <input checked="" type="checkbox"/> Information Disclosure Statement <input type="checkbox"/> Certified Copy of Priority Document(s) <input type="checkbox"/> Response to Missing Parts/ incomplete Application <input type="checkbox"/> Response to Missing Parts Under 37 CFR 1.52 or 1.53	<input type="checkbox"/> Assignment Papers (For an Application) <input type="checkbox"/> Drawing(s) <input type="checkbox"/> Licensing-related Papers <input type="checkbox"/> Petition Routing Slip (PTO/SB/69) And Accompanying Petition <input type="checkbox"/> To Convert a Provisional Application <input type="checkbox"/> Power of Attorney, Revocation Change of Correspondence Address <input type="checkbox"/> Terminal Disclaimer <input type="checkbox"/> Small Entity Statement <input type="checkbox"/> Request for Refund	<input type="checkbox"/> After Allowance Communication To Group <input type="checkbox"/> Appeal Communication to Board Of Appeals and Interferences <input type="checkbox"/> Appeal Communication to Group (Appeal Notice, Brief, Reply Brief) <input type="checkbox"/> Proprietary Information <input type="checkbox"/> Status Letter <input checked="" type="checkbox"/> Additional Enclosure(s) (Please identify below): <div style="border: 1px solid black; padding: 5px; width: fit-content;">PTO-SB08A with 16 references</div>
Remarks: The Commissioner is hereby authorized to charge any additional fees that may be required with respect to this communication, or credit any overpayment, to Deposit Account No. 15-0660.		RECEIVED FEB 22 1999

SIGNATURE OF APPLICANT, ATTORNEY, OR AGENT

Firm or individual name	Jeffrey W. Smith, Reg. No. 33455 GROUP 2100
Signature	<i>Jeffrey W. Smith</i>
Date	February 16, 1999

CERTIFICATE OF MAILING

I hereby certify that this correspondence is being deposited with the United States Postal Service as first class mail in an envelope addressed to: Assistant Commissioner for Patents, Washington, D.C. 20231 on this date:

Typed or printed name	Jeffrey W. Smith, Reg. No. 33455
Signature	<i>Jeffrey W. Smith</i>
Date	Feb. 16, 1999

Please type a plus sign (+) inside → Patent and Trademark Office: U.S. DEPARTMENT OF COMMERCE
 Under the Paperwork Reduction Act of 1995, no persons are required to respond to a collection of information unless it displays a valid OMB control number.



TRANSMITTAL FORM

(To be used for all correspondence after initial filing)

Application Number	09/181,738
Filing Date	October 28, 1998
First Named Inventor	Nathan Pyles
Group Art Unit	2816
Examiner Name	
Attorney Docket Number	EPIXINC-4

<input type="checkbox"/> Fee Transmittal Form <input type="checkbox"/> Fee Attached <input type="checkbox"/> Amendment / Response <input type="checkbox"/> After Final <input type="checkbox"/> Affidavits/declaration(s) <input type="checkbox"/> Extension of Time Request <input type="checkbox"/> Express Abandonment Request <input checked="" type="checkbox"/> Information Disclosure Statement <input type="checkbox"/> Certified Copy of Priority Document(s) <input type="checkbox"/> Response to Missing Parts/ Incomplete Application <input type="checkbox"/> Response to Missing Parts Under 37 CFR 1.52 or 1.53		<input type="checkbox"/> Assignment Papers (For an Application) <input type="checkbox"/> Drawing(s) <input type="checkbox"/> Licensing-related Papers <input type="checkbox"/> Petition Routing Slip (PTO/SB/69) And Accompanying Petition <input type="checkbox"/> To Convert a Provisional Application <input type="checkbox"/> Power of Attorney, Revocation Change of Correspondence Address <input type="checkbox"/> Terminal Disclaimer <input type="checkbox"/> Small Entity Statement <input type="checkbox"/> Request for Refund		<input type="checkbox"/> After Allowance Communication To Group <input type="checkbox"/> Appeal Communication to Board Of Appeals and Interferences <input type="checkbox"/> Appeal Communication to Group (Appeal Notice, Brief, Reply Brief) <input type="checkbox"/> Proprietary Information <input type="checkbox"/> Status Letter <input checked="" type="checkbox"/> Additional Enclosure(s) (Please identify below): <div style="border: 1px solid black; padding: 5px; width: fit-content;">PTO-SB08A with 16 references</div>	
Remarks		The Commissioner is hereby authorized to charge any additional fees that may be required with respect to this communication, or credit any overpayment, to Deposit Account No. 15-0660.			

SIGNATURE OF APPLICANT, ATTORNEY, OR AGENT

Firm or individual name	Jeffry W. Smith, Reg. No. 33455	RECEIVED FEB 22 1999 GROUP 2100
Signature	<i>Jeffry W. Smith</i>	
Date	February 16, 1999	

CERTIFICATE OF MAILING

I hereby certify that this correspondence is being deposited with the United States Postal Service as first class mail in an envelope addressed to: Assistant Commissioner for Patents, Washington, D.C. 20231 on this date:

Typed or printed name	Jeffry W. Smith, Reg. No. 33455
Signature	<i>Jeffry W. Smith</i>
Date	Feb. 16, 1999



#5
Dr. Scott
1-9-00

PATENT APPLICATION

IN THE UNITED STATES PATENT AND TRADEMARK OFFICE

Applicant:	Pyles, et al.	Date:	December 17, 1999
Filed:	October 28, 1998	Docket No.:	EPIXINC-4
Application No.:	09/181,738	Art Unit:	2816
For:	PEDOMETER	Examiner:	

Certificate of Mailing

I hereby certify that this correspondence is being deposited with the United States Postal Service as first class mail in an envelope addressed to: Assistant Commissioner for Patents, Washington, D.C. 20231

on December 17, 1999
Date

Jeffrey W. Smith
Signature

Jeffrey W. Smith, Reg. No. 33455
Name of applicant, assignee or Registered Representative

RECEIVED

DEC 23 1999

TECHNOLOGY CENTER 2800

SUPPLEMENTAL INFORMATION DISCLOSURE STATEMENT

Assistant Commissioner for Patents
Washington, D.C. 20231

Dear Sir:

In accordance with 37 C.F.R. §1.56, Applicants wish to call the attention of the Examiner to the following document:



United States Patents

<u>U.S. Patent No.</u>	<u>Issue Date</u>	<u>Patentee</u>
5,583,776	12-10-1996	Levi et al.

A copy of this document is submitted herewith along with Form PTO/SB08A.

It is believed that no fee is owed for this disclosure under 37 C.F.R. 1.97(b)(3), because Applicants have not received and are not aware of a mailed office action on the merits.

If an action was mailed prior to the filing date hereof, the information disclosed herein is submitted after the mailing of a first office action and before the mailing of a final action. Thus, Applicants note, under 37 C.F.R. §1.97(e)(2), that no item of information disclosed herein was cited by a foreign patent office in a counterpart application, and to the knowledge of the undersigned after making a reasonable inquiry, no item of information contained herein was known to any individual designated in §1.56(c) more than three months prior to the filing of this information disclosure statement. Thus, it is believed no fee is owed for this filing. Nonetheless, if a fee is owed, the Office is hereby authorized to charge Account No. 15-0660. A duplicate copy of this document is enclosed.

Applicants respectfully request that this document be expressly considered during the prosecution of this application and made of record herein and appear among the "documents cited" on any patent to issue herefrom.

Respectfully submitted,

RECEIVED

DEC 23 1999

TECHNOLOGY CENTER 2800

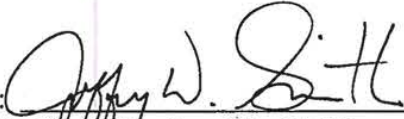
By: 
Jeffrey W. Smith, Reg. No. 33455
Attorney for Applicant
Lathrop & Clark LLP
740 Regent Street, Suite 400
P. O. Box 1507
Madison, Wisconsin 53701
(608) 257-7766



PATENT APPLICATION

IN THE UNITED STATES PATENT AND TRADEMARK OFFICE

Applicant:	Pyles, et al.	Date:	December 17, 1999
Filed:	October 28, 1998	Docket No.:	EPIXINC-4
Application No.:	09/181,738	Art Unit:	2816
For:	PEDOMETER	Examiner:	

Certificate of Mailing

I hereby certify that this correspondence is being deposited with the United States Postal Service as first class mail in an envelope addressed to: Assistant Commissioner for Patents, Washington, D.C. 20231

on December 17, 1999
Date

Jeffrey W. Smith
Signature

Jeffrey W. Smith, Reg. No. 33455
Name of applicant, assignee or Registered Representative

SUPPLEMENTAL INFORMATION DISCLOSURE STATEMENT

RECEIVED

DEC 23 1999

TECHNOLOGY CENTER 2800

Assistant Commissioner for Patents
Washington, D.C. 20231

Dear Sir:

In accordance with 37 C.F.R. §1.56, Applicants wish to call the attention of the Examiner to the following document:

United States Patents

U.S. Patent No. Issue Date
5,583,776 12-10-1996



Patentee
Levi et al.

A copy of this document is submitted herewith along with Form PTO/SB08A.

It is believed that no fee is owed for this disclosure under 37 C.F.R. 1.97(b)(3), because Applicants have not received and are not aware of a mailed office action on the merits.

If an action was mailed prior to the filing date hereof, the information disclosed herein is submitted after the mailing of a first office action and before the mailing of a final action. Thus, Applicants note, under 37 C.F.R. §1.97(e)(2), that no item of information disclosed herein was cited by a foreign patent office in a counterpart application, and to the knowledge of the undersigned after making a reasonable inquiry, no item of information contained herein was known to any individual designated in §1.56(c) more than three months prior to the filing of this information disclosure statement. Thus, it is believed no fee is owed for this filing. Nonetheless, if a fee is owed, the Office is hereby authorized to charge Account No. 15-0660. A duplicate copy of this document is enclosed.

Applicants respectfully request that this document be expressly considered during the prosecution of this application and made of record herein and appear among the "documents cited" on any patent to issue herefrom.

Respectfully submitted,

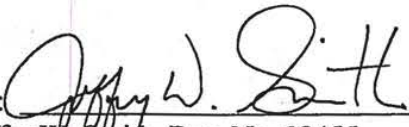
By: 
Jeffrey W. Smith, Reg. No. 33455
Attorney for Applicant
Lathrop & Clark LLP
740 Regent Street, Suite 400
P. O. Box 1507
Madison, Wisconsin 53701
(608) 257-7766

RECEIVED

DEC 23 1999

TECHNOLOGY CENTER 2800

ids2.app

GRAU 2816

PTO/SB/21 (12-97)

App. for use through 9/30/00. OMB 0651-0031

Patent and Trademark Office: U.S. DEPARTMENT OF COMMERCE

Please type a plus sign (+) inside this box. Under the Paperwork Reduction Act of 1995, no persons are required to respond to a collection of information unless it displays a valid OMB control number.



TRANSMITTAL FORM

(To be used for all correspondence after initial filing)

Application Number	09/181,738
Filing Date	October 28, 1998
First Named Inventor	Nathan Pyles
Group Art Unit	2816
Examiner Name	
Attorney Docket Number	EPIXINC-4

<input type="checkbox"/> Fee Transmittal Form	<input type="checkbox"/> Assignment Papers (For an Application)	<input type="checkbox"/> After Allowance Communication To Group
<input type="checkbox"/> Fee Attached	<input type="checkbox"/> Drawing(s)	<input type="checkbox"/> Appeal Communication to Board Of Appeals and Interferences
<input type="checkbox"/> Amendment / Response	<input type="checkbox"/> Licensing-related Papers	<input type="checkbox"/> Appeal Communication to Group (Appeal Notice, Brief, Reply Brief)
<input type="checkbox"/> After Final	<input type="checkbox"/> Petition Routing Slip (PTO/SB/69) And Accompanying Petition	<input type="checkbox"/> Proprietary Information
<input type="checkbox"/> Affidavits/declaration(s)	<input type="checkbox"/> To Convert a Provisional Application	<input type="checkbox"/> Status Letter
<input type="checkbox"/> Extension of Time Request	<input type="checkbox"/> Power of Attorney, Revocation Change of Correspondence Address	<input checked="" type="checkbox"/> Additional Enclosure(s) (Please identify below):
<input type="checkbox"/> Express Abandonment Request	<input type="checkbox"/> Terminal Disclaimer	
<input checked="" type="checkbox"/> Information Disclosure Statement	<input type="checkbox"/> Small Entity Statement	
<input type="checkbox"/> Certified Copy of Priority Document(s)	<input type="checkbox"/> Request for Refund	
<input type="checkbox"/> Response to Missing Parts/ Incomplete Application	Remarks	
<input type="checkbox"/> Response to Missing Parts Under 37 CFR 1.52 or 1.53	The Commissioner is hereby authorized to charge any additional fees that may be required with respect to this communication, or credit any overpayment, to Deposit Account No. 15-0660.	

PTO/SB08A with 1 document
RECEIVED
DEC 23 1999
 TECHNOLOGY CENTER 2800

SIGNATURE OF APPLICANT, ATTORNEY, OR AGENT

Firm or Individual name	Jeffry W. Smith, Reg. No. 33455
Signature	<i>Jeffry W. Smith</i>
Date	December 17, 1999

CERTIFICATE OF MAILING

I hereby certify that this correspondence is being deposited with the United States Postal Service as first class mail in an envelope addressed to: Assistant Commissioner for Patents, Washington, D.C. 20231 on this date:

Typed or printed name	Jeffry W. Smith, Reg. No. 33455		
Signature	<i>Jeffry W. Smith</i>	Date	December 17, 1999



**UNITED STATES DEPARTMENT OF COMMERCE
Patent and Trademark Office**

Address: COMMISSIONER OF PATENTS AND TRADEMARKS
Washington, D.C. 20231

APPLICATION NO.	FILING DATE	FIRST NAMED INVENTOR	ATTORNEY DOCKET NO.
09/181,738	10/28/98	PYLES	N EPIXINC-4

020455
 LATHROP & CLARK LLP
 740 REGENT STREET SUITE 400
 P.O. BOX 1507
 MADISON WI 53701-1507

MM42/0128

EXAMINER

WAMBACH, M

ART UNIT	PAPER NUMBER
2816	

DATE MAILED: 01/28/00

Please find below and/or attached an Office communication concerning this application or proceeding.

Commissioner of Patents and Trademarks

Office Action Summary

Application No. 09/181,738	Applicant(s) Pyles
Examiner Margaret Wambach	Group Art Unit 2816



- Responsive to communication(s) filed on _____.
- This action is **FINAL**.
- Since this application is in condition for allowance except for formal matters, prosecution as to the merits is closed in accordance with the practice under *Ex parte Quayle*, 1935 C.D. 11; 453 O.G. 213.

A shortened statutory period for response to this action is set to expire 3 month(s), or thirty days, whichever is longer, from the mailing date of this communication. Failure to respond within the period for response will cause the application to become abandoned. (35 U.S.C. § 133). Extensions of time may be obtained under the provisions of 37 CFR 1.136(a).

Disposition of Claims

- Claim(s) 1-45 is/are pending in the application.
- Of the above, claim(s) _____ is/are withdrawn from consideration.
- Claim(s) _____ is/are allowed.
- Claim(s) 1-45 is/are rejected.
- Claim(s) _____ is/are objected to.
- Claims _____ are subject to restriction or election requirement.

Application Papers

- See the attached Notice of Draftsperson's Patent Drawing Review, PTO-948.
- The drawing(s) filed on _____ is/are objected to by the Examiner.
- The proposed drawing correction, filed on _____ is approved disapproved.
- The specification is objected to by the Examiner.
- The oath or declaration is objected to by the Examiner.

Priority under 35 U.S.C. § 119

- Acknowledgement is made of a claim for foreign priority under 35 U.S.C. § 119(a)-(d).
 - All Some* None of the CERTIFIED copies of the priority documents have been
 - received.
 - received in Application No. (Series Code/Serial Number) _____.
 - received in this national stage application from the International Bureau (PCT Rule 17.2(a)).
- *Certified copies not received: _____
- Acknowledgement is made of a claim for domestic priority under 35 U.S.C. § 119(e).

Attachment(s)

- Notice of References Cited, PTO-892
- Information Disclosure Statement(s), PTO-1449, Paper No(s). 2
- Interview Summary, PTO-413
- Notice of Draftsperson's Patent Drawing Review, PTO-948
- Notice of Informal Patent Application, PTO-152

--- SEE OFFICE ACTION ON THE FOLLOWING PAGES ---

Application/Control Number: 09/181738

Page 2

Art Unit: 2816

DETAILED ACTION

Claim Rejections - 35 USC § 112

1. The following is a quotation of the second paragraph of 35 U.S.C. 112:

The specification shall conclude with one or more claims particularly pointing out and distinctly claiming the subject matter which the applicant regards as his invention.

2. Claims 1-45 are rejected under 35 U.S.C. 112, second paragraph, as being indefinite for failing to particularly point out and distinctly claim the subject matter which applicant regards as the invention.

The claims are replete with terms which lack a clear antecedent basis. Numerous instances of this problem will be specifically pointed out; however, applicant is required to proofread and correct all instances.

In claims 4, 20 "the transmission signal", in claim 7, 23 "the step count signal", in claims 10, 26, "the heart rate signal" and "the pedometer signal", in claims 12, 28, "the heart rate" and "the step counter", in claim 17, "the number of strides" and "the rate", claim 32, "the total number of strides", "the stride count" and "the first run time", claim 35, "the receiver", "the step count signal" and "the distance", claim 37, "the total number of strides", "the first run distance", "the stride count" "the first run stride count", "the first run time" and "the First Run Stride Rate" (all of the problems of claim 37 are repeated with regard to the second - fourth run), and claim 44, "the user first run", "the first run time" and "the stride count" lack a clear antecedent basis.

Application/Control Number: 09/181738

Page 3

Art Unit: 2816

Also in claim 12, applicant's intended meaning cannot be discerned from the references of "the heart rate" which is located in a housing.

Claim Rejections - 35 USC § 102

3. The following is a quotation of the appropriate paragraphs of 35 U.S.C. 102 that form the basis for the rejections under this section made in this Office action:

A person shall be entitled to a patent unless --

(a) the invention was known or used by others in this country, or patented or described in a printed publication in this or a foreign country, before the invention thereof by the applicant for a patent.

4. Claims 1, 3, 4, 6, 7, 9, 10 and 11 are rejected under 35 U.S.C. 102(a) as being anticipated by Sham et al..

Sham teaches a pedometer including a step counter (32), a transmitter (the wiring between 32 and 34) which transmits a digitally coded step signal, and a receiver (30), referring to Figure 3. It is inherent that the receiver is "mountable" to a second body portion insofar as the term itself only means that it is possible to mount the receiver elsewhere. Secondly, the term "body portion" is so broad that the limitation is met merely by having the receiver and transmitter at different locations within the same housing (therefor affixed to different body portions.)

Moreover, Sham discloses a wrist watch arrangement on column 3, lines 43-45 as recited in claim 6. Sham discloses a processor and viewing screen (34 and 18) as recited in claim 7. As recited in claim 9, a heart rate monitor and a second transmitter (10 and 31) are also taught. Insofar as the heart rate signal is a wireless signal and the pedometer signal, assuming applicant

Application/Control Number: 09/181738

Page 4

Art Unit: 2816

means the signal from the step counter, is from a wire, these signals would inherently be of different frequencies, as recited in claim 10. The heart rate monitor is mounted to the user's chest and thus, claim 11 is also met.

Claim Rejections - 35 USC § 103

5. The following is a quotation of 35 U.S.C. 103(a) which forms the basis for all obviousness rejections set forth in this Office action:

(a) A patent may not be obtained though the invention is not identically disclosed or described as set forth in section 102 of this title, if the differences between the subject matter sought to be patented and the prior art are such that the subject matter as a whole would have been obvious at the time the invention was made to a person having ordinary skill in the art to which said subject matter pertains. Patentability shall not be negated by the manner in which the invention was made.

6. Claims 2 and 8 are rejected under 35 U.S.C. 103(a) as being unpatentable over Sham et al..

The difference between Sham and claims 2 and 8 lies in the substitution of a wireless transmitter for a wire and a leg band for an arm or waist band. The first difference is not of patentable merit because the use of wireless transmitters is widespread in the art. Insofar as Sham does in fact employ a wireless transmitter for the heart monitor, and Sham would have the motivation of reducing the weight of box 14 by locating the step counter at a remote location, the motivation exists to employ that a wireless transmitter for the step counter. In terms of the leg band, it is merely commonsensical that anything which could be strapped to an arm or waist could also be strapped to a leg. In fact, Sham clearly wishes to leave the designer the latitude to make

Application/Control Number: 09/181738

Page 5

Art Unit: 2816

such decisions because of the statement on column 3, line 44 that the device could be secured "in other ways."

Allowable Subject Matter

7. Claims 5, 12-16, 18-31, 33-36, 38-43 and 45 would be allowable if rewritten to overcome the rejection(s) under 35 U.S.C. 112, 2nd paragraph, set forth in this Office action and to include all of the limitations of the base claim and any intervening claims.

8. Claims 17, 32, 37 and 44 would be allowable if rewritten or amended to overcome the rejection(s) under 35 U.S.C. 112, 2nd paragraph, set forth in this Office action.

Any inquiry concerning this communication or earlier communications from the examiner should be directed to Examiner Wambach whose telephone number is (703) 308-4875. The examiner can normally be reached on Monday-Thursday from 6:30 to 5p.m.

If attempts to reach the examiner by telephone are unsuccessful, the examiner's supervisor, Tim Callahan, can be reached on (703) 308-4876. The fax phone number for this Group is (703) 308-7722.

Any inquiry of a general nature or relating to the status of this application or proceeding should be directed to the Group receptionist whose telephone number is (703) 308-0956.



Margaret R. Wambach
Primary Examiner

Notice of References Cited

Application No.
09/181,738

Applica

Pyles

Examiner
Margaret Wambach

Group Art Unit
2816

Page 1 of 1

U.S. PATENT DOCUMENTS

	DOCUMENT NO.	DATE	NAME	CLASS	SUBCLASS
A	5,891,042	4/6/99	Sham et al.	600	48B
B					
C					
D					
E					
F					
G					
H					
I					
J					
K					
L					
M					

FOREIGN PATENT DOCUMENTS

	DOCUMENT NO.	DATE	COUNTRY	NAME	CLASS	SUBCLASS
N						
O						
P						
Q						
R						
S						
T						

NON-PATENT DOCUMENTS

	DOCUMENT (Including Author, Title, Source, and Pertinent Pages)	DATE
U		
V		
W		
X		

9/481738

NOTICE OF DRAFTSPERSON'S PATENT DRAWING REVIEW

The drawing(s) filed (insert date) 10/29/98 are:

- A. [] approved by the Draftsperson under 37 CFR 1.84 or 1.152.
B. [X] objected to by the Draftsperson under 37 CFR 1.84 or 1.152 for the reasons indicated below. The Examiner will require submission of new, corrected drawings when necessary. Corrected drawing must be submitted according to the instructions on the back of this notice.

1. DRAWINGS. 37 CFR 1.84(a): Acceptable categories of drawings: Black ink. Color.
2. PHOTOGRAPHS. 37 CFR 1.84 (b)
3. TYPE OF PAPER. 37 CFR 1.84(e)
4. SIZE OF PAPER. 37 CFR 1.84(f): Acceptable sizes:
5. MARGINS. 37 CFR 1.84(g): Acceptable margins:
6. VIEWS. 37 CFR 1.84(h)
7. SECTIONAL VIEWS. 37 CFR 1.84 (h)(3)
8. ARRANGEMENT OF VIEWS. 37 CFR 1.84(i)
9. SCALE. 37 CFR 1.84(k)
10. CHARACTER OF LINES, NUMBERS, & LETTERS. 37 CFR 1.84(i)
11. SHADING. 37 CFR 1.84(m)
12. NUMBERS, LETTERS, & REFERENCE CHARACTERS. 37 CFR 1.84(p)
13. LEAD LINES. 37 CFR 1.84(q)
14. NUMBERING OF SHEETS OF DRAWINGS. 37 CFR 1.84(t)
15. NUMBERING OF VIEWS. 37 CFR 1.84(u)
16. CORRECTIONS. 37 CFR 1.84(w)
17. DESIGN DRAWINGS. 37 CFR 1.152

COMMENTS

REVIEWER

WIS

DATE

5/25/99

TELEPHONE NO.

11033058404

ATTACHMENT TO PAPER NO.

6

PATENT APPLICATION

#7/Supp
108
J. OKON
3/28/00

IN THE UNITED STATES PATENT AND TRADEMARK OFFICE

Applicant:	Pyles et al.	Date:	March 15, 2000
Filed:	October 28, 1998	Docket No.:	EPIXINC-4
Application No.:	09/181,738	Art Unit:	2816
For:	PEDOMETER	Examiner:	M. Wambach

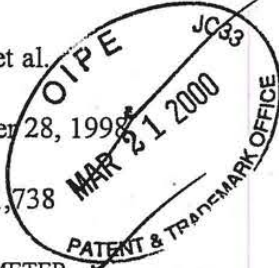

Certificate of Mailing

I hereby certify that this correspondence is being deposited with the United States Postal Service as first class mail in an envelope addressed to: Assistant Commissioner for Patents, Washington, D.C. 20231

on March 15, 2000
Date

Jeffrey W. Smith
Signature

Jeffrey W. Smith, Reg. No. 33455

Name of applicant, assignee or Registered Representative

SUPPLEMENTAL INFORMATION DISCLOSURE STATEMENT

Assistant Commissioner for Patents
Washington, D.C. 20231

Dear Sir:

In accordance with 37 C.F.R. §1.56, applicant wishes to call the attention of the Examiner to the following documents:

Other Documents

SPORTSLINE PRODUCTS, "Fitness Pedometer 360", web page, 1pg.

SPORTSLINE PRODUCTS, Fitness Pedometer 360 packaging labels, 5 pgs.

Copies of these documents are submitted herewith along with Form PTO/SB08B.

Applicant respectfully requests that these documents be expressly considered during the prosecution of this application and made of record herein and appear among the "documents cited" on any patent to issue herefrom.

This disclosure is being made pursuant to 37 C.F.R. §1.97(c)(2) and is accompanied by the fee set forth in 37 C.F.R. §1.17(p). If this fee is deficient in any manner, please charge Account No. 15-0660. A duplicate of this paper is filed herewith.

Respectfully submitted,

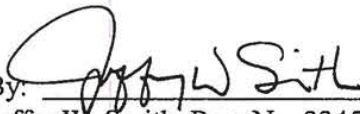
By: 
Jeffrey W. Smith, Reg. No. 33455
Attorney for Applicant
Lathrop & Clark LLP
740 Regent Street, Suite 400
P. O. Box 1507
Madison, Wisconsin 53701
(608) 257-7766

ids3.app

PATENT APPLICATION

IN THE UNITED STATES PATENT AND TRADEMARK OFFICE

Applicant: Pyles et al. Date: March 15, 2000
Filed: October 28, 1998 Docket No.: EPIXINC-4
Application No.: 09/181,738 Art Unit: 2816
For: PEDOMETER Examiner: M. Wambach

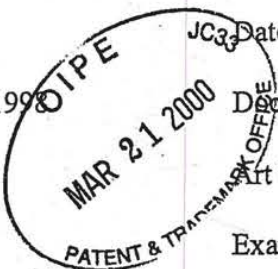

Certificate of Mailing

I hereby certify that this correspondence is being deposited with the United States Postal Service as first class mail in an envelope addressed to: Assistant Commissioner for Patents, Washington, D.C. 20231

on March 15, 2000
Date

Jeffrey W. Smith
Signature

Jeffrey W. Smith, Reg. No. 33455

Name of applicant, assignee or Registered Representative

SUPPLEMENTAL INFORMATION DISCLOSURE STATEMENT

Assistant Commissioner for Patents
Washington, D.C. 20231

Dear Sir:

In accordance with 37 C.F.R. §1.56, applicant wishes to call the attention of the Examiner to the following documents:

Other Documents

SPORTSLINE PRODUCTS, "Fitness Pedometer 360", web page, 1pg.

SPORTSLINE PRODUCTS, Fitness Pedometer 360 packaging labels, 5 pgs.

Copies of these documents are submitted herewith along with Form PTO/SB08B.

Applicant respectfully requests that these documents be expressly considered during the prosecution of this application and made of record herein and appear among the "documents cited" on any patent to issue herefrom.

This disclosure is being made pursuant to 37 C.F.R. §1.97(c)(2) and is accompanied by the fee set forth in 37 C.F.R. §1.17(p). If this fee is deficient in any manner, please charge Account No. 15-0660. A duplicate of this paper is filed herewith.

Respectfully submitted,

By: 

Jeffrey W. Smith, Reg. No. 33455

Attorney for Applicant

Lathrop & Clark LLP

740 Regent Street, Suite 400

P. O. Box 1507

Madison, Wisconsin 53701

(608) 257-7766

ids3.app

Please type a plus sign (+) inside this box →

Patent and Trademark Office: U.S. DEPARTMENT OF COMMERCE

Under the Paperwork Reduction Act of 1995, no persons are required to respond to a collection of information unless it displays a valid OMB control number.

Substitute for form 1449B/PTO		Application Number	09/181,738
INFORMATION DISCLOSURE STATEMENT BY APPLICANT <i>(Use as many sheets as necessary)</i>		Filing Date	October 28, 1998
		First Named Inventor	Nathan Pyles
		Group Art Unit	2816
		Examiner Name	M. Wambach
		Attorney Docket Number	EPIXINC-4
Sheet	1	Of	1

#7

OTHER PRIOR ART - NON PATENT LITERATURE DOCUMENTS			
Examiner Initials*	Cite No. ¹	Include name of the author (in CAPITAL LETTERS), title of the article (when appropriate), title of the item (book, magazine, journal, serial, symposium, catalog, etc.), date, page(s), volume-issue number(s), publisher, city and/or country where published.	T ²
<i>Wambach</i>		SPORTSLINE PRODUCTS, "Fitness Pedometer 360", web page, 1 pg.	
<i>Wambach</i>		SPORTSLINE PRODUCTS, Fitness Pedometer 360 packaging labels, 5 pgs.	

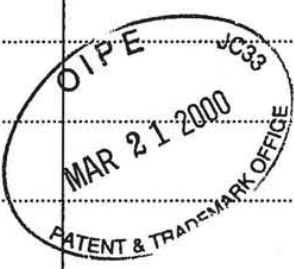

Examiner Signature	<i>Wambach</i>	Date Considered	<i>6/20/00</i>
--------------------	----------------	-----------------	----------------

*EXAMINER: Initial if reference considered, whether or not citation is in conformance with MPEP 609. Draw line through citation if not in conformance and not considered. Include copy of this form with next communication to applicant.

¹Unique citation designation number. ²Applicant is to place a check mark here if English language translation is attached

Burden Hour Statement: This form is estimated to take 0.2 hours to complete. Time will vary depending upon the needs of the individual case. Any comments on the amount of time you are required to complete this form should be sent to the Chief Information Officer, Patent and Trademark Office, Washington, DC 20231. DO NOT SEND FEES OR COMPLETED FORMS TO THIS ADDRESS. SEND TO: Assistant Commissioner for Patents, Washington, DC 20231.

Please type a plus sign (+) inside this box →

Under the Paperwork Reduction Act of 1995, no persons are required to respond to a collection of information unless it displays a valid OMB control number.

09/2816/08

TRANSMITTAL FORM

(To be used for all correspondence after initial filing)

Application Number	09/181,738
Filing Date	October 28, 1998
First Named Inventor	Nathan Pyles
Group Art Unit	2816
Examiner Name	M. Wambach
Attorney/Agent Number	33455

Total Number of Pages in This Submission

- Fee Transmittal Form
- Fee Attached
- Amendment / Response
- After Final
- Affidavits/declaration(s)
- Extension of Time Request
- Express Abandonment Request
- Information Disclosure Statement
- Certified Copy of Priority Document(s)
- Response to Missing Parts/ Incomplete Application
- Response to Missing Parts Under 37 CFR 1.52 or 1.53

- Assignment Papers (For an Application)
- Drawing(s)
- Licensing-related Papers
- Petition Routing Slip (PTO/SB/69) And Accompanying Petition
- To Convert a Provisional Application
- Power of Attorney, Revocation Change of Correspondence Address
- Terminal Disclaimer
- Small Entity Statement
- Request for Refund

- After Allowance Communication To Group
- Appeal Communication to Board Of Appeals and Interferences
- Appeal Communication to Group (Appeal Notice, Brief, Reply Brief)
- Proprietary Information
- Status Letter
- Additional Enclosure(s) (Please identify below):

PTO/SB 08b with 2 documents

STAMP: MAR 21 2000 PATENT & TRADEMARK OFFICE

Remarks

SIGNATURE OF APPLICANT, ATTORNEY, OR AGENT

Firm or Individual name: Jeffrey W. Smith, Reg. No. 33455
 Signature: [Handwritten Signature]
 Date: March 15, 2000

CERTIFICATE OF MAILING

I hereby certify that this correspondence is being deposited with the United States Postal Service as first class mail in an envelope addressed to: Assistant Commissioner for Patents, Washington, D.C. 20231 on this date:

Typed or printed name: Jeffrey W. Smith, Reg. No. 33455
 Signature: [Handwritten Signature] Date: March 15, 2000

Approved for use through 09/30/00. OMB 0651-0032
 Patent and Trademark Office: U.S. DEPARTMENT OF COMMERCE

Under the Paperwork Reduction Act of 1995, no persons are required to respond to a collection of information unless it displays a valid OMB control number.

FEE TRANSMITTAL				Complete If Known			
Note: Effective October 1, 1997, Patent fees are subject to annual revision.				Application Number	09/181,738		
				Filing Date	October 28, 1998		
				First Named Inventor	Nathan Pyles		
				Group Art Unit	2816		
				Examiner Name	M. Wambach		
TOTAL AMOUNT OF PAYMENT \$240.00				Attorney Docket Number	EPIXINC-4		
METHOD OF PAYMENT (check one)				FEE CALCULATION (Continued)			
1. <input checked="" type="checkbox"/> The Commissioner is hereby authorized to charge indicated fees and credit any over payments to: Deposit Account Number: 15-0660 Deposit Account Name: Lathrop & Clark <input checked="" type="checkbox"/> Charge Any Additional Fee Required Under 37 CFR 1.16 and 1.17 <input type="checkbox"/> Charge the Issue Fee Set in 37 CFR 1.18 at the Mailing of the Notice of Allowance				3. ADDITIONAL FEES Large Entity Small Entity Fee Code Fee (\$) Fee Code Fee (\$) Fee Description Fee Paid			
2. <input checked="" type="checkbox"/> Payment Enclosed: <input checked="" type="checkbox"/> Check <input type="checkbox"/> Money Order <input type="checkbox"/> Other				105 130 205 65 Surcharge - late filing fee or oath 127 50 227 25 Surcharge - late provisional filing fee or cover sheet 139 130 139 130 Non-English specification 147 2,520 147 2,520 For filing a request for reexamination 112 920* 112 920* Requesting publication of SIR prior to Examiner action 113 1,840* 113 1,840* Requesting publication of SIR after Examiner action 115 110 215 55 Extension for reply within first month 116 380 216 190 Extension for reply within second month 117 870 217 435 Extension for reply within third month 118 1,360 218 680 Extension for reply within fourth month 128 1850 228 925 Extension for reply within fifth month 119 300 219 150 Notice of Appeal 120 300 220 150 Filing a brief in support of an appeal 121 260 221 130 Request for oral hearing 138 1,510 138 1,510 Petition to institute a public use proceeding 140 110 240 55 Petition to revive - unavoidable 141 1,210 241 605 Petition to revive - unintentional 142 1,210 242 605 Utility issue fee (or reissue) 143 430 243 215 Design issue fee 144 580 244 290 Plant issue fee 122 130 122 130 Petitions to the Commissioner 123 50 123 50 Petitions related to provisional applications 126 240 126 240 Submission of Information Disclosure Statement \$240.00 581 40 581 40 Recording each patent assignment per property (times number of properties) 146 760 246 380 Filing a submission after final rejection (37 CFR 1.129(a)) 149 760 249 380 For each additional invention to be examined (37 CFR 1.129(b)) Other fee (specify) _____ Other fee (specify) _____			
1. FILING FEE Large Entity Small Entity Fee Code Fee (\$) Fee Code Fee (\$) Fee Description Fee Paid				119 300 219 150 Notice of Appeal 120 300 220 150 Filing a brief in support of an appeal 121 260 221 130 Request for oral hearing 138 1,510 138 1,510 Petition to institute a public use proceeding 140 110 240 55 Petition to revive - unavoidable 141 1,210 241 605 Petition to revive - unintentional 142 1,210 242 605 Utility issue fee (or reissue) 143 430 243 215 Design issue fee 144 580 244 290 Plant issue fee 122 130 122 130 Petitions to the Commissioner 123 50 123 50 Petitions related to provisional applications 126 240 126 240 Submission of Information Disclosure Statement \$240.00 581 40 581 40 Recording each patent assignment per property (times number of properties) 146 760 246 380 Filing a submission after final rejection (37 CFR 1.129(a)) 149 760 249 380 For each additional invention to be examined (37 CFR 1.129(b)) Other fee (specify) _____ Other fee (specify) _____			
SUBTOTAL (1) \$0.00				*Reduced by Basic Filing Fee Paid SUBTOTAL (3) \$240.00			
2. CLAIMS Extra Fee from below Fee Paid							
Total Claims -20= 0 X 11 = \$0.00							
Independent Claims -3= 0 X 41 = \$0.00							
Multiple Dependent Claims X 135 = \$0.00							
Large Entity Small Entity Fee Code Fee (\$) Fee Code Fee Fee Description							
103 18 203 9 Claims in excess of 20							
102 78 202 39 Independent Claims in excess of 3							
104 260 204 130 Multiple dependent claims							
109 78 209 39 Reissue independent claims over original patent							
110 18 210 9 Reissue claims in excess of 20 and over original patent							
SUBTOTAL (2) \$0.00							
SUBMITTED BY				Complete (if applicable)			
Typed or Printed Name: Jeffry W. Smith				Reg. Number: 33455			
Signature: <i>Jeffry W. Smith</i>				Date: March 15, 2000			
				Deposit Account User ID			

In The United States Patent And Trademark Office

Applicant: Pyles et al. Date: March 15, 2000
Date Filed: October 28, 1998 Docket No.: EPIXINC-4
App. No.: 09/181,738 Art Unit: 2816
For: PEDOMETER Examiner: M. Wambach

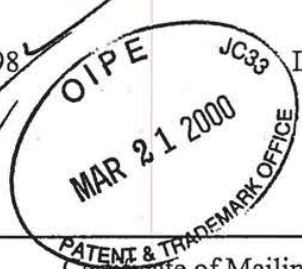

#8/Amdt. A
J. OKON
3/28/00

Certificate of Mailing
I hereby certify that this correspondence is being deposited with the United States Postal Service as first class mail in an envelope addressed to: Box Non-Fee Amendment, Assistant Commissioner for Patents, Washington, D.C. 20231
on March 15, 2000
Date
Jeffrey W. Smith
Signature
Jeffrey W. Smith, Reg. No. 33455
Name of applicant, assignee or Registered Representative

04/17/2000 VBROWN2 00000002 150660 09181738
01 FC:102 234.00 CH

Amendment

BOX NON-FEE AMENDMENT
Assistant Commissioner for Patents
Washington, D.C. 20231

Dear Sir:

This is in response to a January 28, 2000 Official Action. In view of the following amendments and remarks reconsideration and allowance of the application are requested.

In the Claims

Please cancel claims 1, 2, 3, 4, 7, 8, 9, 10, and 11 without prejudice.
Please amend the following claims as indicated.

5. (Amended.) A pedometer comprising
a step counter mountable on a user first body portion;

21

AP

03/23/2000 MSHIFERA 00000032 09181738
01 FC:126 240.00 OP

1

A

Applicant: Pyles et al.
Application No.: 09/181,738
Art Unit: 2816

Q1
end.

a transmitter in communication with the step counter to generate a signal
corresponding to each step and transmit the signal; and
a receiver mountable on a user second body portion to receive the signal transmitted
from the transmitter and use the signal to calculate a distance traveled
[The pedometer of claim 1], wherein the transmitter transmits the signal a wireless
distance in the range of [thirty] zero to thirty-six inches.

6. (Amended.) A pedometer comprising:
a step counter mountable on a user first body portion;
a transmitter in communication with the step counter to generate a signal
corresponding to each step and transmit the signal; and
a receiver mountable on a user second body portion to receive the signal transmitted
from the transmitter and use the signal to calculate a distance traveled
[The pedometer of claim 1], wherein the receiver is mountable on a user's wrist.

Q2

~~12.~~ (Amended.) A pedometer comprising:
a step counter mountable on a user first body portion;
a transmitter in communication with the step counter to generate a signal
corresponding to each step and transmit the signal;
a receiver mountable on a user second body portion to receive the signal transmitted
from the transmitter and use the signal to calculate a distance traveled;
a heart rate monitor; and
a second transmitter in communication with the heart rate monitor to transmit a signal
corresponding to a heart rate monitored by the heart rate monitor to the receiver
and display the calculated heart rate
[The pedometer of claim 9], wherein the heart rate monitor and the [step counter]

Applicant: Pyles et al.
Application No.: 09/181,738
Art Unit: 2816

transmitter are mounted in a ~~single~~ chest-mount housing.

Q2
end

Sub
B1

13. (Amended.) A pedometer comprising:
a step counter mountable on a user first body portion;
a transmitter in communication with the step counter to generate a signal
corresponding to each step and transmit the signal; and
a receiver mountable on a user second body portion to receive the signal transmitted
from the transmitter and use the signal to calculate a distance traveled
[The pedometer of claim 1], wherein the pedometer includes a data processor
programmed to calculate [a] the distance traveled by multiplying the number of strides taken by a
stride length that varies according to [the] a rate at which strides are taken.

Q3

Sub
B2

17. (Amended.) A pedometer comprising:
a step counter;
a transmitter in communication with the step counter to generate a step count signal
corresponding to each step and transmit the step count signal; and
a receiver mountable on a user body portion to receive the step count signal
transmitted from the transmitter and calculate a distance from a number of strides
measured by the step counter; and
a data processor programmed to calculate a distance traveled by multiplying the number
of strides taken by a stride length that varies according to [the] a rate at which
strides are taken.

Q4

20. (Amended.) The pedometer of claim 17, wherein the [transmission] step count signal
is digitally coded.

Applicant: Pyles et al.
Application No.: 09/181,738
Art Unit: 2816

Q4
19
5
24. (Amended.) The pedometer of claim 17, [where in] wherein the transmitter transmits the signal a wireless distance in the range of [thirty] zero to thirty-six inches.

Q5
13
5
25. (Amended.) The pedometer of claim 17, and further comprising:
a heart rate monitor; and
a second transmitter in communication with the heart rate monitor to transmit a heart rate signal corresponding to a heart rate [calculated] monitored by the heart rate monitor to the receiver and display the calculated heart rate.

14
13
26. (Amended.) The pedometer of claim 25, wherein the heart rate signal is at a different frequency than the [pedometer] step count signal.

Q6
16
13
28. (Amended.) The pedometer of claim 25, wherein the heart rate monitor and the step counter are mounted in a single chest-mount housing.

Q7
20
32. (Amended.) A pedometer programmed to calculate an actual stride length of a user by performing the steps of:
timing a user first run of a predetermined distance to obtain a user first run time;
counting [the] a total number of strides in the user first run;
dividing the first run distance by the [stride count] total number of strides to obtain a base stride length;
dividing the stride count by the first run time to obtain a base stride rate;
counting strides in a period of time during a user second run to obtain an actual stride rate;
calculating the actual stride length using the formula:
Actual Stride Length = Base Stride Length + Base Stride Length *(((Actual Stride

4

21

Applicant: Pyles et al.
Application No.: 09/181,738
Art Unit: 2816

Q7
conclude

Rate - Base Stride Rate)N)/Base Stride Rate);

where N is in the range of between 1 and 3;

calculates the actual stride length [distance] using a formula that correlates a specific stride length to a specific stride rate.

Q8

23

20

35. (Amended.) The pedometer of claim 32, wherein the [receiver processes the step count signal and displays] pedometer is further programmed to calculate and display [the] a distance traveled on a viewing screen.

Q9

25

37. (Amended.) A pedometer programmed to calculate an actual stride length of a user by performing the steps of:

timing a user first run of a predetermined first run distance to obtain a first run time;

counting [the] a total number of strides in the user first run;

dividing the first run distance by the [stride count] total number of strides in the user first run to obtain a first run [base] stride length and a base stride length;

dividing the first run stride count by the first run time to obtain a first run [base] stride rate and a base stride rate;

timing a user second run of a predetermined second run distance to obtain a second run time;

counting [the] a total number of strides in the user second run;

dividing the second run distance by the total number of strides in the user second run [stride count] to obtain a second [base] run stride length;

dividing the total number of strides in the second run [stride count] by the second run time to obtain a second [base] run stride rate;

timing a user third run of a predetermined third run distance to obtain a third run time;

counting [the] a total number of strides in the user third run;

22

Applicant: Pyles et al.
Application No.: 09/181,738
Art Unit: 2816

PP
Winkler

dividing the third run distance by the total number of strides in the user third run [stride count] to obtain a third [base] run stride length;
dividing the total number of strides in the third run [stride count] by the third run time to obtain a third run [base] stride rate;
counting strides in a period of time during a user fourth run to obtain an actual stride rate;
calculating the actual stride length using the formula:

Actual Stride Length = Base Stride Length + Base Stride Length *(((Actual Stride Rate - Base Stride Rate)N)/Base Stride Rate);

where N is calculated by the formula ((Second Run Stride Length multiplied by First Run Stride Rate) - (First Run Stride Length multiplied by First Run Stride Rate)) / (First Run Stride Length multiplied by (Second Run Stride Rate - First Run Stride Rate)) when the Actual Stride Rate is greater than the First Run Stride Rate, and where N is calculated by the formula ((Third Run Stride Length multiplied by First Run Stride Rate) - (First Run Stride Length multiplied by First Run Stride Rate)) / (First Run Stride Length multiplied by (Third Run Stride Rate - First Run Stride Rate)) when the Actual Stride Rate is less than or equal to the First Run Stride Rate.

PP

324. (Amended.) A method for calculating an actual stride length comprising the steps of:

timing a first user run of a predetermined distance to obtain a first run time;
counting a total number of strides in the [user] first user run to obtain a stride count;
dividing the first run time by the stride count to obtain a Base Stride Length;
dividing the stride count by the first run time to obtain a Base Stride Rate;
counting strides in a pre-determined period during a user second run to obtain an Actual Stride Rate;

23

Applicant: Pyles et al.
Application No.: 09/181,738
Art Unit: 2816

10
9
include

calculating the actual stride length using the formula:

Actual Stride Length = Base Stride Length + Base Stride Length *(((Actual Stride Rate - Base Stride Rate)N)/Base Stride Rate); wherein N is between one and three.

Remarks

Claims 1, 2, 3, 4, 7, 8, 9, 10, and 11 were all rejected under 35 U.S.C. §102 or §103. Applicants believe these claims are allowable over the cited art, but have canceled these claims to expedite prosecution of the application. The remaining claims were rejected under 35 U.S.C. §112, for the specific reasons cited on page 2 of the action.

Applicants have amended either the specific claims listed in the §112 rejection or the independent claims from which the rejected claims depend. It is believed that all of the §112 issues were addressed, but if the examiner disagrees, the undersigned counsel for Applicants is available for a telephone interview to expedite prosecution of this application.

Claims 5, 6, 9, and 13 all depended directly or indirectly from independent claim 1, now canceled. In claim 1 as originally filed, the last line included the phrase "calculate a distance measured by the step counter" to describe the function of the receiver after receiving a signal from the transmitter. In fact, the step counter does not "measure" anything. Step counters only count steps. In the invention as claimed herein, the receiver does the calculating based on the signal received from the step counter. Thus, in claims 5, 6, 9, and 13, the language of base claim 1 has been amended to make clear that the receiver calculates a distance traveled based, at least in part, on the signal received from the step counter.

Similarly, claim 12 depended from intervening base claim 9, which included the phrase "a heart rate calculated by the heart rate monitor." The heart rate monitor does not "calculate" a heart rate. Rather, the heart rate monitor recited in claim 9 simply "monitors" or counts heart beats. The receiver then calculates and displays the heart rate. Thus, the claim 9 language added to claim 12 has been amended to clarify this point. Claim 25 includes a similar amendment.

24

Applicant: Pyles et al.
Application No.: 09/181,738
Art Unit: 2816

In addition, claims 5 and 21 were amended to make the transmission range from zero to thirty-six inches. This reflects the broadest range supported by the specification at page 4, lines 23-29. So long as the signal is transmitted no more than the thirty to thirty-six inch range, it avoids interference with other Rf or digital devices. Given this, the two portions of the device can be mounted on different body parts without interference from external signals. Thus, zero inches is the smallest distance and thirty-six inches is the largest distance of transmission for this preferred embodiment as recited in claims 5 and 21.

Next, claim 37 was amended to accommodate the examiner's proposed changes to this claim. In addition, the "first run stride length" was given the dual name of "base stride length", and "first stride rate" was given the dual name "base stride rate". These terms are necessary to provide the necessary antecedent basis for the formula recited at the end of the claim.

The claims that were allowable if rewritten to overcome the §112 rejection and put into independent claim format have been amended to include all of the limitations of their respective base claims. Thus, all remaining claims are in condition for allowance. No new matter is believed to be added by this amendment.

Further, submitted herewith is a Supplemental Information Disclosure Statement citing a web page and instructions for a pedometer that is now commercially available. Applicants have no information indicating that this is prior art to the present application, but in the interest of full disclosure bring it to the examiner's attention. It is noteworthy that the instructions describe the pedometer as able to distinguish a walking stride length from a running stride length, and to calculate a "steps per minute". (Page 4, "Speed Function".) Significantly, however, this pedometer can only measure distance based on a uniform stride length. These instructions specifically state, "It is important to walk or run or hike consistently. If you vary your walking pace, your stride length will vary and your distance traveled will be [different]." (Page 3, "Your Stride Length".) Further, the user's stride length must be measured and then input into this pedometer's "memory". It does not measure stride length automatically. (Page 3, "How to

Applicant: Pyles et al.
Application No.: 09/181,738
Art Unit: 2816

Measure Your Stride".) Thus, even if this pedometer were prior art, it has no bearing on the allowability of the claims, particularly those relating to variable stride lengths.

Conclusion

For the foregoing reasons, Applicants submit that this case is in condition for allowance and respectfully request that the application be passed to issue.

Respectfully submitted,

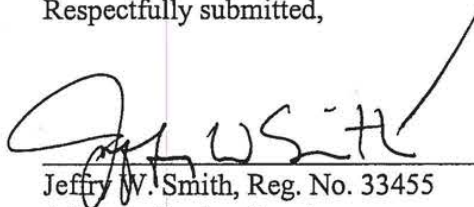

Jeffrey W. Smith, Reg. No. 33455
Attorney for Applicant
Lathrop & Clark LLP
740 Regent Street, Suite 400
P.O. Box 1507
Madison, Wisconsin 53701-1507
(608) 257-7766

Amdtl.res/amdt



PATENT APPLICATION

#9/Supp IDs
J. W. Smith
4/17/00

In the United States Patent and Trademark Office

Applicant: Pyles et al.
Docket No.: EPIXINC-4
Date: March 21, 2000
Application No.: 09/181,738 ✓
Filed: October 28, 1998 ✓
Art Unit: 2816 ✓
Examiner: M. Wambach ✓
For: PEDOMETER

RECEIVED
MAR 29 2000
TECHNOLOGY CENTER 2800

Certificate of Mailing	
I hereby certify that this correspondence is being deposited with the United States Postal Service as first class mail in an envelope addressed to: Assistant Commissioner for Patents Washington, D.C. 20231	
On	March 21, 2000
Signature	Jeffrey W. Smith
Jeffrey W. Smith, Reg. No. 33455 Name of Applicant, assignee or Registered Representative	

SUPPLEMENTAL INFORMATION DISCLOSURE STATEMENT

Assistant Commissioner for Patents
Washington, D.C. 20231

Dear Sirs:

In accordance with 37 C.F.R. §1.56, Applicants wish to call the attention of the Examiner to the following documents:

United States Patents

<u>U.S. Patent No.</u>	<u>Issue Date</u>	<u>Patentee</u>
5,033,013	07-16-1991	Kato et al.

Foreign Patent Documents

<u>Patent No.</u>	<u>Issue Date</u>	<u>Patentee</u>
EP 0 119 009 A1	09-02-1983	Frederick

Other Documents

PCT/ISA/210 – International Search Report received March 20, 2000, 4 pgs.

Copies of these documents are submitted herewith along with Form PTO/SB 08A and PTO/SB 08B.

Applicants respectfully request that these documents be expressly considered during the prosecution of this application and made of record herein and appear among the “documents cited” on any patent to issue herefrom.

Respectfully submitted,

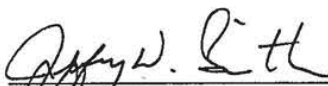

Jeffrey W. Smith, Reg. No. 33455
Attorney for Applicant
LATHROP & CLARK LLP
740 Regent Street, Suite 400
P.O. Box 1507
Madison, Wisconsin 53701-1507
(608) 257-7766

Please type a plus sign (+) inside this box →

Patent and Trademark Office: U.S. DEPARTMENT OF COMMERCE

Under the Paperwork Reduction Act of 1995, no persons are required to respond to a collection of information unless it displays a valid OMB control number.

Substitute for form 1449A/PTO		Application Number	09/181,738
INFORMATION DISCLOSURE STATEMENT BY APPLICANT <i>(Use as many sheets as necessary)</i>		Filing Date	October 28, 1998
		First Named Inventor	Nathan Pyles
		Group Art Unit	2816
		Examiner Name	M. Wambach
Sheet	1	Of	2
		Attorney Docket Number	EPIXINC-4

U.S. PATENT DOCUMENTS						
Examiner Initials*	Cite No. ¹	U.S. Patent Document		Name of Patentee or Applicant of Cited Document	Date of Publication of Cited Document MM-DD-YYYY	Pages, Columns, Lines, Where Relevant Passages or Relevant Figures Appear
		Number	Kind Code ² (if known)			
MW		5,033,013		Kato et al.	07-16-1991	

FOREIGN PATENT DOCUMENTS								
Examiner Initials*	Cite No. ¹	Foreign Patent Document			Name of Patentee or Applicant of Cited Document	Date of Publication of Cited Document MM-DD-YYYY	Pages, Columns, Lines, Where Relevant Passages or Relevant Figures Appear	T ⁶
		Office ³	Number ⁴	Kind Code ⁵ (if known)				
MW		EP	0 119 009 A1		Frederick	09-02-1983		

Examiner Signature	<i>Wambach</i>	Date Considered	6/13/00
--------------------	----------------	-----------------	---------

*EXAMINER: Initial if reference considered, whether or not citation is in conformance with MPEP 609. Draw line through citation if not in conformance and not considered. Include copy of this form with next communication to applicant.

¹Unique citation designation number. ²See attached Kinds of U.S. Patent Documents. ³Enter Office that issued the document, by the two-letter code (WIPO Standard St.3). ⁴For Japanese patent documents, the indication of the year of the reign of the Emperor must precede the serial number of the patent document. ⁵Kind of document by the appropriate symbols as indicated on the document under WIPO Standard ST. 16 if possible. ⁶Applicant is to place a check mark here if English language Translation is attached.

Burden Hour Statement: This form is estimated to take 0.2 hours to complete. Time will vary depending upon the needs of the individual case. Any comments on the amount of time you are required to complete this form should be sent to the Chief Information Officer, Patent and Trademark Office, Washington, DC 20231. DO NOT SEND FEES OR COMPLETED FORMS TO THIS ADDRESS. SEND TO: Assistant Commissioner for Patents, Washington, DC 20231.

Please type a plus sign (+) inside this box →

Patent and Trademark Office: U.S. DEPARTMENT OF COMMERCE

Under the Paperwork Reduction Act of 1995, no persons are required to respond to a collection of information unless it displays a valid OMB control number.

Substitute for form 1449B/PTO		Application Number	09/181,738		
INFORMATION DISCLOSURE STATEMENT BY APPLICANT (Use as many sheets as necessary)		Filing Date	October 28, 1998		
		First Named Inventor	Nathan Pyles		
		Group Art Unit	2816		
		Examiner Name	M. Wambach		
Sheet	2	Of	2	Attorney Docket Number	EPIXINC-4

OTHER PRIOR ART - NON PATENT LITERATURE DOCUMENTS			
Examiner Initials*	Cite No. ¹	Include name of the author (in CAPITAL LETTERS), title of the article (when appropriate), title of the item (book, magazine, journal, serial, symposium, catalog, etc.), date, page(s), volume-issue number(s), publisher, city and/or country where published.	T ²
MRW		PCT/ISA/210 - International Search Report received March 20, 2000, 4 pgs.	



Examiner Signature	Wambach	Date Considered	6/13/00
--------------------	---------	-----------------	---------

*EXAMINER: Initial if reference considered, whether or not citation is in conformance with MPEP 609. Draw line through citation if not in conformance and not considered. Include copy of this form with next communication to applicant.

¹Unique citation designation number. ²Applicant is to place a check mark here if English language translation is attached

Burden Hour Statement: This form is estimated to take 0.2 hours to complete. Time will vary depending upon the needs of the individual case. Any comments on the amount of time you are required to complete this form should be sent to the Chief Information Officer, Patent and Trademark Office, Washington, DC 20231. DO NOT SEND FEES OR COMPLETED FORMS TO THIS ADDRESS. SEND TO: Assistant Commissioner for Patents, Washington, DC 20231.

PATENT COOPERATION TREATY

PCT

INTERNATIONAL SEARCH REPORT

(PCT Article 18 and Rules 43 and 44)

Applicant's or agent's file reference EPIXINC-9	FOR FURTHER ACTION see Notification of Transmittal of International Search Report (Form PCT/ISA/220) as well as, where applicable, item 5 below.	
International application No. PCT/US 99/ 25314	International filing date (day/month/year) 28/10/1999	(Earliest) Priority Date (day/month/year) 28/10/1998
Applicant EPIX, INC. et al.		

This International Search Report has been prepared by this International Searching Authority and is transmitted to the applicant according to Article 18. A copy is being transmitted to the International Bureau.

This International Search Report consists of a total of 3 sheets.
 It is also accompanied by a copy of each prior art document cited in this report.

1. Basis of the report

a. With regard to the language, the international search was carried out on the basis of the international application in the language in which it was filed, unless otherwise indicated under this item.

the international search was carried out on the basis of a translation of the international application furnished to this Authority (Rule 23.1(b)).

b. With regard to any nucleotide and/or amino acid sequence disclosed in the international application, the international search was carried out on the basis of the sequence listing:

contained in the international application in written form.

filed together with the international application in computer readable form.

furnished subsequently to this Authority in written form.

furnished subsequently to this Authority in computer readable form.

the statement that the subsequently furnished written sequence listing does not go beyond the disclosure in the international application as filed has been furnished.

the statement that the information recorded in computer readable form is identical to the written sequence listing has been furnished.

2. Certain claims were found unsearchable (See Box I).

3. Unity of invention is lacking (see Box II).

4. With regard to the title,

the text is approved as submitted by the applicant.

the text has been established by this Authority to read as follows:

5. With regard to the abstract,

the text is approved as submitted by the applicant.

the text has been established, according to Rule 38.2(b), by this Authority as it appears in Box III. The applicant may, within one month from the date of mailing of this international search report, submit comments to this Authority.

6. The figure of the drawings to be published with the abstract is Figure No. 1

as suggested by the applicant.

because the applicant failed to suggest a figure.

because this figure better characterizes the invention.

None of the figures.

INTERNATIONAL SEARCH REPORT

International Application No

PCT/US 99/25314

A. CLASSIFICATION OF SUBJECT MATTER IPC 7 G01C22/00		
According to International Patent Classification (IPC) or to both national classification and IPC		
B. FIELDS SEARCHED Minimum documentation searched (classification system followed by classification symbols) IPC 7 G01C		
Documentation searched other than minimum documentation to the extent that such documents are included in the fields searched		
Electronic data base consulted during the international search (name of data base and, where practical, search terms used)		
C. DOCUMENTS CONSIDERED TO BE RELEVANT		
Category *	Citation of document, with indication, where appropriate, of the relevant passages	Relevant to claim No.
X	US 5 033 013 A (KATO YASUJI ET AL) 16 July 1991 (1991-07-16)	1-3, 5-7, 13, 17-19, 21-23, 49
A	column 7, line 25 - line 30 column 8, line 21 - line 28 abstract	14, 29, 32, 35, 37, 44
	—	-/-
<input checked="" type="checkbox"/> Further documents are listed in the continuation of box C.		
<input checked="" type="checkbox"/> Patent family members are listed in annex.		
* Special categories of cited documents :		
"A" document defining the general state of the art which is not considered to be of particular relevance "E" earlier document but published on or after the international filing date "L" document which may throw doubts on priority claim(s) or which is cited to establish the publication date of another citation or other special reason (as specified) "O" document referring to an oral disclosure, use, exhibition or other means "P" document published prior to the international filing date but later than the priority date claimed		
"T" later document published after the international filing date or priority date and not in conflict with the application but cited to understand the principle or theory underlying the invention "X" document of particular relevance; the claimed invention cannot be considered novel or cannot be considered to involve an inventive step when the document is taken alone "Y" document of particular relevance; the claimed invention cannot be considered to involve an inventive step when the document is combined with one or more other such documents, such combination being obvious to a person skilled in the art. "&" document member of the same patent family		
Date of the actual completion of the international search 6 March 2000		Date of mailing of the international search report 13/03/2000
Name and mailing address of the ISA European Patent Office, P.B. 5818 Patentlaan 2 NL - 2280 HV Rijswijk Tel. (+31-70) 340-2040, Tx. 31 851 epo nl, Fax (+31-70) 340-3018		Authorized officer Hunt, J

Form PCT/ISA/210 (second sheet) (July 1992)

INTERNATIONAL SEARCH REPORT

International Application No

PCT/US 99/25314

C. (Continuation) DOCUMENTS CONSIDERED TO BE RELEVANT

Category *	Citation of document, with indication, where appropriate, of the relevant passages	Relevant to claim No.
X A	EP 0 119 009 A (NIKE INTERNATIONAL LTD) 19 September 1984 (1984-09-19) page 6 page 10 page 11	1,2,5-7, 13 14,17, 18, 21-23, 27,49
X	US 4 371 945 A (KARR LAWRENCE J ET AL) 1 February 1983 (1983-02-01) cited in the application column 4, line 33 -column 5, line 26	1,2,6-8, 17
X A	US 5 583 776 A (LEVI ROBERT W ET AL) 10 December 1996 (1996-12-10) column 6, line 6 - line 42; claim 14; figures 5,7 abstract	49,53,54 32,35, 44,50

INTERNATIONAL SEARCH REPORT

Information on patent family members

International Application No

PCT/US 99/25314

Patent document cited in search report	Publication date	Patent family member(s)	Publication date
US 5033013 A	16-07-1991	JP 62032936 A	12-02-1987
EP 0119009 A	19-09-1984	US 4578769 A CA 1218455 A JP 59171564 A	25-03-1986 24-02-1987 28-09-1984
US 4371945 A	01-02-1983	NONE	
US 5583776 A	10-12-1996	NONE	

GP 2816

PTO/SB/21 (12-97)

Approved for use through 9/30/00. OMB 0651-0031
Patent and Trademark Office: U.S. DEPARTMENT OF COMMERCE

Please type a plus sign (+) inside this number.

Under the Paperwork Reduction Act of 1995, no persons are required to respond to a collection of information unless it displays a valid OMB control number.



TRANSMITTAL FORM

(To be used for all correspondence after initial filing)

Application Number	09/181,738
Filing Date	October 28, 1998
First Named Inventor	Nathan Pyles
Group Art Unit	2816
Examiner Name	M. Wambach
Attorney Docket Number	EPIXINC-4

<input type="checkbox"/> Fee Transmittal Form <input type="checkbox"/> Fee Attached <input type="checkbox"/> Amendment / Response <input type="checkbox"/> After Final <input type="checkbox"/> Affidavits/declaration(s) <input type="checkbox"/> Extension of Time Request <input type="checkbox"/> Express Abandonment Request <input checked="" type="checkbox"/> Information Disclosure Statement <input type="checkbox"/> Certified Copy of Priority Document(s) <input type="checkbox"/> Response to Missing Parts/ Incomplete Application <input type="checkbox"/> Response to Missing Parts Under 37 CFR 1.52 or 1.53	<input type="checkbox"/> Assignment Papers (For an Application) <input type="checkbox"/> Drawing(s) <input type="checkbox"/> Licensing-related Papers <input type="checkbox"/> Petition Routing Slip (PTO/SB/69) And Accompanying Petition <input type="checkbox"/> To Convert a Provisional Application <input type="checkbox"/> Power of Attorney, Revocation Change of Correspondence Address <input type="checkbox"/> Terminal Disclaimer <input type="checkbox"/> Small Entity Statement <input type="checkbox"/> Request for Refund	<input type="checkbox"/> After Allowance Communication To Group <input type="checkbox"/> Appeal Communication to Board Of Appeals and Interferences <input type="checkbox"/> Appeal Communication to Group (Appeal Notice, Brief, Reply Brief) <input type="checkbox"/> Proprietary Information <input type="checkbox"/> Status Letter <input checked="" type="checkbox"/> Additional Enclosure(s) (Please identify below): <div style="border: 1px solid black; padding: 5px; width: fit-content;"> •PTO/SB 08A and PTO/SB 08B with 3 documents </div>
--	---	---

RECEIVE
MAR 29 2000
TECHNOLOGY CENTER 2800

Remarks

The Commissioner is hereby authorized to charge any additional fees that may be required with respect to this communication, or credit any overpayment, to Deposit Account No. 15-0660.

SIGNATURE OF APPLICANT, ATTORNEY, OR AGENT

Firm or Individual name	Jeffrey W. Smith, Reg. No. 33455
Signature	<i>Jeffrey W. Smith</i>
Date	March 21, 2000

CERTIFICATE OF MAILING

I hereby certify that this correspondence is being deposited with the United States Postal Service as first class mail in an envelope addressed to: Assistant Commissioner for Patents, Washington, D.C. 20231 on this date:

Typed or printed name	Jeffrey W. Smith, Reg. No. 33455
Signature	<i>Jeffrey W. Smith</i>
Date	March 21, 2000

Please type a plus sign (+) inside this

Under the Paperwork Reduction Act of 1995, no persons are required to respond to a collection of information unless it displays a valid OMB control number.



TRANSMITTAL FORM

(To be used for all correspondence after initial filing)

Application Number	09/181,738
Filing Date	October 28, 1998
First Named Inventor	Nathan Pyles
Group Art Unit	2816
Examiner Name	M. Wambach
Attorney Docket Number	EPIXINC-4

<input type="checkbox"/> Fee Transmittal Form <input type="checkbox"/> Fee Attached <input type="checkbox"/> Amendment / Response <input type="checkbox"/> After Final <input type="checkbox"/> Affidavits/declaration(s) <input type="checkbox"/> Extension of Time Request <input type="checkbox"/> Express Abandonment Request <input checked="" type="checkbox"/> Information Disclosure Statement <input type="checkbox"/> Certified Copy of Priority Document(s) <input type="checkbox"/> Response to Missing Parts/ Incomplete Application <input type="checkbox"/> Response to Missing Parts Under 37 CFR 1.52 or 1.53	<input type="checkbox"/> Assignment Papers (For an Application) <input type="checkbox"/> Drawing(s) <input type="checkbox"/> Licensing-related Papers <input type="checkbox"/> Petition Routing Slip (PTO/SB/69) And Accompanying Petition <input type="checkbox"/> To Convert a Provisional Application <input type="checkbox"/> Power of Attorney, Revocation Change of Correspondence Address <input type="checkbox"/> Terminal Disclaimer <input type="checkbox"/> Small Entity Statement <input type="checkbox"/> Request for Refund	<input type="checkbox"/> After Allowance Communication To Group <input type="checkbox"/> Appeal Communication to Board Of Appeals and Interferences <input type="checkbox"/> Appeal Communication to Group (Appeal Notice, Brief, Reply Brief) <input type="checkbox"/> Proprietary Information <input type="checkbox"/> Status Letter <input checked="" type="checkbox"/> Additional Enclosure(s) (Please identify below): <div style="border: 1px solid black; padding: 5px; width: fit-content;"> •PTO/SB 08A and PTO/SB 08B with 3 documents </div>
--	---	---

Remarks: The Commissioner is hereby authorized to charge any additional fees that may be required with respect to this communication, or credit any overpayment, to Deposit Account No. 15-0660.

SIGNATURE OF APPLICANT, ATTORNEY, OR AGENT	
Firm or Individual name	Jeffry W. Smith, Reg. No. 33455
Signature	<i>Jeffry W. Smith</i>
Date	March 21, 2000
CERTIFICATE OF MAILING	
I hereby certify that this correspondence is being deposited with the United States Postal Service as first class mail in an envelope addressed to: Assistant Commissioner for Patents, Washington, D.C. 20231 on this date:	
Typed or printed name	Jeffry W. Smith, Reg. No. 33455
Signature	<i>Jeffry W. Smith</i>
Date	March 21, 2000

PATENT APPLICATION

In the United States Patent and Trademark Office

*10/Supple
I DS
Mack 4-19-00*

Applicant: Pyles et al.
Docket No.: EPIXINC-4
Date: April 4, 2000
Application No.: 09/181,738
Filed: October 28, 1998
Art Unit: 2816
Examiner: M. Wambach
For: PEDOMETER



Certificate of Mailing

I hereby certify that this correspondence is being deposited with the United States Postal Service as first class mail in an envelope addressed to:
Assistant Commissioner for Patents
Washington, D.C. 20231

On April 4, 2000
Signature Jeffrey W. Smith

Jeffrey W. Smith, Reg. No. 33455
Name of Applicant, assignee or Registered Representative

SUPPLEMENTAL INFORMATION DISCLOSURE STATEMENT

Assistant Commissioner for Patents
Washington, D.C. 20231

Dear Sirs:

In accordance with 37 C.F.R. §1.56, Applicants wish to call the attention of the Examiner to the following documents:

United States Patents

<u>U.S. Patent No.</u>	<u>Issue Date</u>	<u>Patentee</u>
4,144,568	03-13-1979	Hiller et al.
4,220,996	09-02-1980	Searcy
4,387,437	06-07-1983	Lowrey et al.
4,460,823	07-17-1984	Ruehlemann
4,466,204	08-21-1984	Wu
4,560,861	12-24-1985	Kato et al.
4,566,461	01-28-1986	Lubell et al.
4,578,769	03-25-1986	Frederick
4,703,445	10-27-1987	Dassler
4,763,287	08-09-1988	Gerhaeuser et al.

RECEIVED

APR 11 2000
TECHNOLOGY CENTER 2800

4,830,021	05-16-1989
4,962,469	10-09-1990
5,065,414	11-12-1991
5,164,967	11-17-1992
5,485,402	01-16-1996
5,720,200	02-24-1998
5,724,265	03-03-1998
5,899,963	05-04-1999
5,976,083	11-02-1999
6,018,705	01-25-2000

Thornton
Ono et al.
Endou et al.
Endo et al.
Smith et al.
Anderson et al.
Hutchings
Hutchings
Richardson et al.
Gaudet et al.

Copies of these documents are submitted herewith along with Form PTO/SB 08A.

This supplemental information disclosure statement shall be considered under 37 C.F.R. §1.97(c)(1) because no final action is believed to have been mailed before the mailing of this statement. Further, to the knowledge of the undersigned after making reasonable inquiry, no fee is believed to be owed because no item contained herein was known to any individual designated in §1.56(c) more than three months prior to the filing of this supplemental information disclosure statement.

Applicants respectfully request that these documents be expressly considered during the prosecution of this application and made of record herein and appear among the "documents cited" on any patent to issue herefrom.

RECEIVED

APR 11 2000

TECHNOLOGY CENTER 2800

Respectfully submitted,

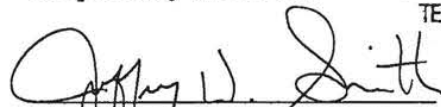

Jeffrey W. Smith, Reg. No. 33455
Attorney for Applicant
LATHROP & CLARK LLP
740 Regent Street, Suite 400
P.O. Box 1507
Madison, Wisconsin 53701-1507
(608) 257-7766

Please type a plus sign (+) inside this box →

Approved for use through 10/31/99. OMB 0651-0031
 Patent and Trademark Office: U.S. DEPARTMENT OF COMMERCE
 Under the Paperwork Reduction Act of 1995, no persons are required to respond to a collection of information unless it displays a valid OMB control number.

Substitute for form 1449A/PTO INFORMATION DISCLOSURE STATEMENT BY APPLICANT (Use as many sheets as necessary)				Application Number	09/181,738
				Filing Date	October 28, 1998
				First Named Inventor	Nathan Pyles
				Group Art Unit	2816
				Examiner Name	M. Wambach
Sheet	1	Of	1	Attorney Docket Number	EPIXINC-4

U.S. PATENT DOCUMENTS						
Examiner Initials*	Cite No. ¹	U.S. Patent Document		Name of Patentee or Applicant of Cited Document	Date of Publication of Cited Document MM-DD-YYYY	Pages, Columns, Lines, Where Relevant Passages or Relevant Figures Appear
		Number	Kind Code ² (If known)			
MRW		4,144,568		Hiller et al.	03-13-1979	
MRW		4,220,996		Searcy	09-02-1980	
MRW		4,387,437		Lowrey et al.	06-07-1983	
MRW		4,460,823		Ruehlemann	07-17-1984	
MRW		4,466,204		Wu	08-21-1984	
MRW		4,560,861		Kato et al.	12-24-1985	
MRW		4,566,461		Lubell et al.	01-28-1986	
MRW		4,578,769		Federick	03-25-1986	
MRW		4,703,445		Datsler	10-27-1987	
MRW		4,763,287		Geisaeuser et al.	08-09-1988	
MRW		4,830,021		Tsinton	05-16-1989	
MRW		4,962,469		Ono et al.	10-09-1990	
MRW		5,065,414		Endou et al.	11-12-1991	
MRW		5,164,967		Endo et al.	11-17-1992	
MRW		5,485,402		Smith et al.	01-16-1996	
MRW		5,720,200		Anderson et al.	02-24-1998	
MRW		5,724,265		Hutchings	03-03-1998	
MRW		5,899,963		Hutchings	05-04-1999	
MRW		5,976,083		Richardson et al.	11-02-1999	
MRW		6,018,705		Gaudet et al.	01-25-2000	



FOREIGN PATENT DOCUMENTS								
Examiner Initials*	Cite No. ¹	Foreign Patent Document			Name of Patentee or Applicant of Cited Document	Date of Publication of Cited Document MM-DD-YYYY	Pages, Columns, Lines, Where Relevant Passages or Relevant Figures Appear	T ⁶
		Office ³	Number ⁴	Kind Code ⁵ (If known)				

Examiner Signature	Wambach	Date Considered	6/13/05
--------------------	---------	-----------------	---------

*EXAMINER: Initial if reference considered, whether or not citation is in conformance with MPEP 609. Draw line through citation if not in conformance and not considered. Include copy of this form with next communication to applicant.

¹Unique citation designation number. ²See attached Kinds of U.S. Patent Documents. ³Enter Office that issued the document, by the two-letter code (WIPO Standard St.3). ⁴For Japanese patent documents, the Indication of the year of the reign of the Emperor must precede the serial number of the patent document. ⁵Kind of document by the appropriate symbols as indicated on the document under WIPO Standard ST. 16 if possible. ⁶Applicant is to place a check mark here if English language Translation is attached.

Burden Hour Statement: This form is estimated to take 0.2 hours to complete. Time will vary depending upon the needs of the individual case. Any comments on the amount of time you are required to complete this form should be sent to the Chief Information Officer, Patent and Trademark Office, Washington, DC 20231. DO NOT SEND FEES OR COMPLETED FORMS TO THIS ADDRESS. SEND TO: Assistant Commissioner for Patents, Washington, DC 20231.

80 2816

PTO/SB 01 (12-97)

Patent and Trademark Office: U.S. DEPARTMENT OF COMMERCE

Please type a plus sign (+) inside this box. Under the Paperwork Reduction Act of 1995, no persons are required to respond to a collection of information unless it displays a valid OMB control number.

TRANSMITTAL FORM (To be used for all correspondence after initial filing)	Application Number	09/181,738
	Filing Date	October 28, 1998
	First Named Inventor	Nathan Pyles
	Group Art Unit	2816
	Examiner Name	M. Wambach
Total Number of Pages in This Submission	Attorney Docket Number	EPIXINC-4



<input type="checkbox"/> Fee Transmittal Form <input type="checkbox"/> Fee Attached <input type="checkbox"/> Amendment / Response <input type="checkbox"/> After Final <input type="checkbox"/> Affidavits/declaration(s) <input type="checkbox"/> Extension of Time Request <input type="checkbox"/> Express Abandonment Request <input checked="" type="checkbox"/> Information Disclosure Statement <input type="checkbox"/> Certified Copy of Priority Document(s) <input type="checkbox"/> Response to Missing Parts/ Incomplete Application <input type="checkbox"/> Response to Missing Parts Under 37 CFR 1.52 or 1.53	<input type="checkbox"/> Assignment Papers (For an Application) <input type="checkbox"/> Drawing(s) <input type="checkbox"/> Licensing-related Papers <input type="checkbox"/> Petition Routing Slip (PTO/SB/69) And Accompanying Petition <input type="checkbox"/> To Convert a Provisional Application <input type="checkbox"/> Power of Attorney, Revocation Change of Correspondence Address <input type="checkbox"/> Terminal Disclaimer <input type="checkbox"/> Small Entity Statement <input type="checkbox"/> Request for Refund	<input type="checkbox"/> After Allowance Communication To Group <input type="checkbox"/> Appeal Communication to Board Of Appeals and Interferences <input type="checkbox"/> Appeal Communication to Group (Appeal Notice, Brief, Reply Brief) <input type="checkbox"/> Proprietary Information <input type="checkbox"/> Status Letter <input checked="" type="checkbox"/> Additional Enclosure(s) (Please identify below):
Remarks: The Commissioner is hereby authorized to charge any additional fees that may be required with respect to this communication, or credit any overpayment, to Deposit Account No. 15-0660.		<div style="border: 1px solid black; padding: 5px; text-align: center;"> PTO/SB 08A with 20 documents RECEIVED APR 11 2000 TECHNOLOGY CENTER 2800 </div>

SIGNATURE OF APPLICANT, ATTORNEY, OR AGENT			
Firm or Individual name	Jeffrey W. Smith, Reg. No. 33455		
Signature	<i>Jeffrey W. Smith</i>		
Date	April 4, 2000		
CERTIFICATE OF MAILING			
I hereby certify that this correspondence is being deposited with the United States Postal Service as first class mail in an envelope addressed to: Assistant Commissioner for Patents, Washington, D.C. 20231 on this date:			
Typed or printed name	Jeffrey W. Smith, Reg. No. 33455		
Signature	<i>Jeffrey W. Smith</i>	Date	April 4, 2000

Please type a plus sign (+) inside this box

Under the Paperwork Reduction Act of 1995, no persons are required to respond to a collection of information unless it displays a valid OMB control number.

<h2 style="margin: 0;">TRANSMITTAL FORM</h2> <p style="margin: 5px 0 0 0;"><i>(To be used for all correspondence after initial filing)</i></p>		Application Number	09/181,738
		Filing Date	October 28, 1998
		First Named Inventor	Nathan Pyles
		Group Art Unit	2816
		Examiner Name	M. Wambach
Total Number of Pages in This Submission		Attorney Docket Number	EPIXINC-4
<input type="checkbox"/> Fee Transmittal Form <input type="checkbox"/> Fee Attached <input type="checkbox"/> Amendment / Response <input type="checkbox"/> After Final <input type="checkbox"/> Affidavits/declaration(s) <input type="checkbox"/> Extension of Time Request <input type="checkbox"/> Express Abandonment Request <input checked="" type="checkbox"/> Information Disclosure Statement <input type="checkbox"/> Certified Copy of Priority Document(s) <input type="checkbox"/> Response to Missing Parts/ Incomplete Application <input type="checkbox"/> Response to Missing Parts Under 37 CFR 1.52 or 1.53	<input type="checkbox"/> Assignment Papers <i>(For an Application)</i> <input type="checkbox"/> Drawing(s) <input type="checkbox"/> Licensing-related Papers <input type="checkbox"/> Petition Routing Slip (PTO/SB/69) And Accompanying Petition <input type="checkbox"/> To Convert a Provisional Application <input type="checkbox"/> Power of Attorney, Revocation Change of Correspondence Address <input type="checkbox"/> Terminal Disclaimer <input type="checkbox"/> Small Entity Statement <input type="checkbox"/> Request for Refund	<input type="checkbox"/> After Allowance Communication To Group <input type="checkbox"/> Appeal Communication to Board Of Appeals and Interferences <input type="checkbox"/> Appeal Communication to Group <i>(Appeal Notice, Brief, Reply Brief)</i> <input type="checkbox"/> Proprietary Information <input type="checkbox"/> Status Letter <input checked="" type="checkbox"/> Additional Enclosure(s) <i>(Please identify below):</i>	
		PTO/SB 08A with 20 documents <div style="border: 1px solid black; padding: 5px; width: fit-content; margin: 0 auto;"> <h3 style="margin: 0;">RECEIVED</h3> <p style="margin: 0;">APR 11 2000</p> <p style="margin: 0;">TECHNOLOGY CENTER 2800</p> </div>	
Remarks		The Commissioner is hereby authorized to charge any additional fees that may be required with respect to this communication, or credit any overpayment, to Deposit Account No. 15-0660.	
SIGNATURE OF APPLICANT, ATTORNEY, OR AGENT			
Firm or Individual name	Jeffrey W. Smith, Reg. No. 33455		
Signature	<i>Jeffrey W. Smith</i>		
Date	<i>April 4, 2000</i>		
CERTIFICATE OF MAILING			
I hereby certify that this correspondence is being deposited with the United States Postal Service as first class mail in an envelope addressed to: Assistant Commissioner for Patents, Washington, D.C. 20231 on this date:			
Typed or printed name	Jeffrey W. Smith, Reg. No. 33455		
Signature	<i>Jeffrey W. Smith</i>	Date	<i>April 4, 2000</i>

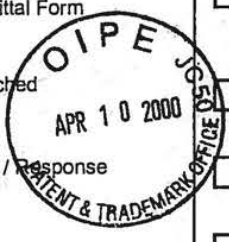

*FF 10% / Supp B
6/21/00*

PATENT APPLICATION

In the United States Patent and Trademark Office

Applicant: Pyles et al.
Docket No.: EPIXINC-4
Date: June 19, 2000
Application No.: 09/181,738
Filed: October 28, 1998
Art Unit: 2816
Examiner: M. Wambach
For: PEDOMETER

FAX COPY RECEIVED
JUN 19 2000
GROUP 2500

<p>Certificate of Mailing I hereby certify that this correspondence is being transmitted herewith via facsimile to: Examiner M. Wambach, United States Patent and Trademark Office, at (703) 308-7722</p> <p>On <u>June 19, 2000</u> Signature <u>Jeffrey W. Smith</u></p> <p><u>Jeffrey W. Smith, Reg. No. 33455</u> Name of Applicant, assignee or Registered Representative</p>

Jeffrey W. Smith

AMENDMENT

Attn: Examiner M. Wambach
Assistant Commissioner for Patents
Washington, D.C. 20231

Dear Sir:

In response to the telephone interviews on June 12 and 15, 2000 with Examiner Wambach, Applicant submits the following amendments and remarks.

In the Claims

AJ
Please cancel claims 5, 6, and 14.

Please amend claims 15 and 17 as follows:

B

2/3. (Twice Amended.) A pedometer comprising:

- a step counter mountable on a user first body portion;
- a transmitter in communication with the step counter to generate a signal corresponding to each step and transmit the signal; and
- a receiver mountable on a user second body portion to receive the signal transmitted from the transmitter and use the signal to calculate a distance traveled, wherein the pedometer includes a data processor programmed to calculate the distance traveled by multiplying the number of strides taken by a stride length that varies according to a rate at which strides are taken by:

timing a user first run of a predetermined distance;

counting the total number of strides in the user first run;

dividing the first run distance by the stride count to obtain a base stride length;

dividing the stride count by the first run time to obtain a base stride rate;

counting strides in a period of time during a user second run to obtain an actual stride rate;

calculating the actual stride length using the formula:

$$\text{Actual Stride Length} = \text{Base Stride Length} + \frac{\text{Base Stride Length} * ((\text{Actual Stride Rate} - \text{Base Stride Rate})N)}{\text{Base Stride Rate}};$$

where N is in the range of between 1 and 3.

5/1. (Twice Amended.) A pedometer comprising:

a step counter;

a transmitter in communication with the step counter to generate a step count signal corresponding to each step and transmit the step count signal; and

a receiver mountable on a user body portion to receive the step count signal transmitted from the transmitter [and calculate a distance from a number of strides measured by the step counter]; and

a data processor programmed to [calculate a distance traveled by multiplying the number of strides taken by a stride length that varies according to a rate at which strides are taken] use the step count signal to: calculate a stride rate and a stride length from a plurality of walks or runs each over a known distance to generate a range of corresponding stride rates and stride lengths, and in subsequent walks or runs, calculate an actual stride rate from the number of strides counted by the step counter over a unit of time, compare the actual stride rate with the range of corresponding generated stride rates and stride lengths, and therefrom, calculate an actual stride length to be used in calculating an actual distance traveled.

Remarks

The undersigned counsel for Applicant wishes to thank Examiner Wambach for the courteous and productive telephone interviews of June 12 and 15, 2000. In the June 12, 2000 interview, Examiner Wambach indicated that *Kato*, U.S. Patent No. 5,033,013 and *Hutchings*, U.S. Patent Nos. 5,724,265 and 5,899,963 disclosed a correspondence between stride rate and stride length. Consequently, any claims based on this broad concept were not allowable, but

claim reciting a specific algorithm for deriving a range of stride lengths or a pedometer in combination with a heart rate monitor are allowable.

On June 15, 2000, the undersigned counsel for Applicant telephone Examiner Wambach indicating that a distinction between the art of record and the present pedometer invention is the use of data input from runs or walks over known distances to establish a range of stride rate versus stride length data that can be used in subsequent runs or walks to derive actual stride lengths from actual stride rates. Therefore, claim 17 has been amended to include language addressing this novel and non-obvious concept. This is not new matter, rather it simply describes the broad concept discussed throughout the application of using trial runs/walks to obtain a range of data to be used for use in subsequent runs or walks.

Claims 5, 6, and 14 have been canceled.

Claim 13 was combined with what is believed to be its allowable dependent claim 14. Thus, amended claim 13, and its respective dependent claims are allowable.

Conclusion

Applicant submits that the present application with its remaining claims is in allowable form and in condition for allowance. Applicant respectfully requests that this application be passed to issue.

Respectfully submitted,

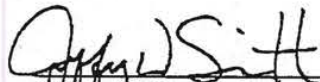
Jeffrey W. Smith, Reg. No. 33455
Attorney for Applicant
LATHROP & CLARK LLP
740 Regent Street, Suite 400
P.O. Box 1507
Madison, Wisconsin 53701-1507
(608) 257-7766

Please type a plus sign (+) inside this box.

Approved for use through 9/30/00 OMB 0651-0031
Patent and Trademark Office: U.S. DEPARTMENT OF COMMERCE

Under the Paperwork Reduction Act of 1995, no persons are required to respond to a collection of information unless it displays a valid OMB control number.

<h2 style="margin: 0;">TRANSMITTAL FORM</h2> <p style="margin: 0; font-size: small;">(To be used for all correspondence after initial filing)</p>		Application Number	09/181,738
		Filing Date	October 28, 1998
		First Named Inventor	Nathan Pyles
		Group Art Unit	2816
		Examiner Name	M. Wambach
Total Number of Pages in This Submission	Attorney Docket Number	EPIXINC-4	
<input type="checkbox"/> Fee Transmittal Form <input type="checkbox"/> Fee Attached <input checked="" type="checkbox"/> Amendment / Response <input type="checkbox"/> After Final <input type="checkbox"/> Affidavits/declaration(s) <input type="checkbox"/> Extension of Time Request <input type="checkbox"/> Express Abandonment Request <input type="checkbox"/> Information Disclosure Statement <input type="checkbox"/> Certified Copy of Priority Document(s) <input type="checkbox"/> Response to Missing Parts/ Incomplete Application <input type="checkbox"/> Response to Missing Parts Under 37 CFR 1.52 or 1.53	<input type="checkbox"/> Assignment Papers (For an Application) <input type="checkbox"/> Drawing(s) <input type="checkbox"/> Licensing-related Papers <input type="checkbox"/> Petition Routing Slip (PTO/SB/69) And Accompanying Petition <input type="checkbox"/> To Convert a Provisional Application <input type="checkbox"/> Power of Attorney, Revocation Change of Correspondence Address <input type="checkbox"/> Terminal Disclaimer <input type="checkbox"/> Small Entity Statement <input type="checkbox"/> Request for Refund	<input type="checkbox"/> After Allowance Communication To Group <input type="checkbox"/> Appeal Communication to Board Of Appeals and Interferences <input type="checkbox"/> Appeal Communication to Group (Appeal Notice, Brief, Reply Brief) <input type="checkbox"/> Proprietary Information <input type="checkbox"/> Status Letter <input type="checkbox"/> Additional Enclosure(s) (Please identify below):	<div style="border: 2px solid black; padding: 5px; transform: rotate(-15deg); font-weight: bold; font-size: 1.2em;"> FAX COPY RECEIVED JUN 19 2000 GROUP 2500 </div>
SIGNATURE OF APPLICANT, ATTORNEY, OR AGENT			
Firm or Individual name	Jeffry W. Smith, Reg. No. 33455		
Signature	<i>Jeffry W. Smith</i>		
Date	June 19, 2000		
CERTIFICATE OF FACSIMILE			
I hereby certify that this correspondence is being transmitted herewith via facsimile to Examiner M. Wambach, United States Patent and Trademark Office, at (703) 308-7722 on this date:			
Typed or printed name	Jeffry W. Smith, Reg. No. 33455		
Signature	<i>Jeffry W. Smith</i>		Date June 19, 2000

B

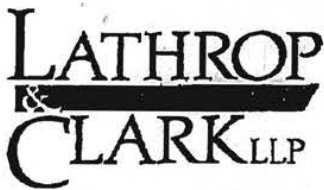

This transmission is intended for the exclusive use of the named recipient. If you are not the named recipient, you are hereby notified that any use, copying, disclosure or distribution of the information transmitted herewith may be subject to legal restriction or sanction, and you are requested to notify us by telephone (collect) (608) 257-7766 to arrange for return or destruction of the information and all copies. Thank you!

Our Fax Number: (608) 257-1507
Our Phone Number: (608) 257-7766
Our Address: P.O. Box 1507; Madison, WI 53701-1507

Fax to: Examiner M. Wambach
UNITED STATES PATENT AND TRADEMARK
OFFICE

At Fax Number: (703) 308-7722

From: Jeffry W. Smith
Date: June 19, 2000
Time:
Our Reference: EPIXINC-4

This transmission has 6 pages (including this sheet)

FAX COPY RECEIVED
JUN 19 2000
GROUP 2500

Transmission Completed

If there is a problem regarding this transmission, please call receptionist at (608) 257-7766

B

Interview Summary

Application No. 09/181,738	Applicant(s) Pyles
Examiner Margaret Wambach	Group Art Unit 2816



All participants (applicant, applicant's representative, PTO personnel):

- (1) Margaret Wambach (3) _____
(2) Jeffry Smith (4) _____ *#11*
- Date of Interview Jun 12 and 15, 2000

Type: Telephonic Personal (copy is given to applicant applicant's representative).

Exhibit shown or demonstration conducted: Yes No. If yes, brief description:

Agreement was reached. was not reached.

Claim(s) discussed: 5, 6, 13, and 17

Identification of prior art discussed:
Kato and Hutchings

Description of the general nature of what was agreed to if an agreement was reached, or any other comments:
Inventive subject matter from the disclosure was discussed in order to amend the claims such that they defined over the prior art. Mr Smith was also notified that the web pages cited on the IDS would not be considered because dates were not included.

(A fuller description, if necessary, and a copy of the amendments, if available, which the examiner agreed would render the claims allowable must be attached. Also, where no copy of the amendments which would render the claims allowable is available, a summary thereof must be attached.)

1. It is not necessary for applicant to provide a separate record of the substance of the interview.

Unless the paragraph above has been checked to indicate to the contrary, A FORMAL WRITTEN RESPONSE TO THE LAST OFFICE ACTION IS NOT WAIVED AND MUST INCLUDE THE SUBSTANCE OF THE INTERVIEW. (See MPEP Section 713.04). If a response to the last Office action has already been filed, APPLICANT IS GIVEN ONE MONTH FROM THIS INTERVIEW DATE TO FILE A STATEMENT OF THE SUBSTANCE OF THE INTERVIEW.

2. Since the Examiner's interview summary above (including any attachments) reflects a complete response to each of the objections, rejections and requirements that may be present in the last Office action, and since the claims are now allowable, this completed form is considered to fulfill the response requirements of the last Office action. Applicant is not relieved from providing a separate record of the interview unless box 1 above is also checked.

Examiner Note: You must sign and stamp this form unless it is an attachment to a signed Office action.



**UNITED STATES DEPARTMENT OF COMMERCE
Patent and Trademark Office**

Address: COMMISSIONER OF PATENTS AND TRADEMARKS
Washington, D.C. 20231

APPLICATION NO.	FILING DATE	FIRST NAMED INVENTOR	ATTORNEY DOCKET NO.
-----------------	-------------	----------------------	---------------------

09/181.738 10/28/98 PYLES

N EPIXINC-4

EXAMINER

020455
LATHROP & CLARK LLP
740 REGENT STREET SUITE 400
P.O. BOX 1507
MADISON WI 53701-1507

MMC1/0621

WAMBACH, JM PAPER NUMBER

2816
DATE MAILED:

12
06/21/00

Please find below and/or attached an Office communication concerning this application or proceeding.

Commissioner of Patents and Trademarks



UNITED STATES DEPARTMENT OF COMMERCE
Patent and Trademark Office

NOTICE OF ALLOWANCE AND ISSUE FEE DUE

020455
LATHROP & CLARK LLP
740 REGENT STREET SUITE 400
P.O. BOX 1507
MADISON WI 53701-1507

MMC1/0621

APPLICATION NO.	FILING DATE	TOTAL CLAIMS	EXAMINER AND GROUP ART UNIT	DATE MAILED
09/181.738	10/28/98	033	WAMBACH. M	2816 06/21/00
First Named Applicant	PYLES.		35 USC 154(b) term ext. =	0 Days.

TITLE OF INVENTION
PEDOMETER

ATTY'S DOCKET NO.	CLASS-SUBCLASS	BATCH NO.	APPLN. TYPE	SMALL ENTITY	FEE DUE	DATE DUE
2	EPIXINC-4	377-024.200	039 UTILITY	YES	\$605.00	09/21/00

THE APPLICATION IDENTIFIED ABOVE HAS BEEN EXAMINED AND IS ALLOWED FOR ISSUANCE AS A PATENT. PROSECUTION ON THE MERITS IS CLOSED.

THE ISSUE FEE MUST BE PAID WITHIN THREE MONTHS FROM THE MAILING DATE OF THIS NOTICE OR THIS APPLICATION SHALL BE REGARDED AS ABANDONED. THIS STATUTORY PERIOD CANNOT BE EXTENDED.

HOW TO RESPOND TO THIS NOTICE:

- I. Review the SMALL ENTITY status shown above. If the SMALL ENTITY is shown as YES, verify your current SMALL ENTITY status:
 - A. If the status is changed, pay twice the amount of the FEE DUE shown above and notify the Patent and Trademark Office of the change in status, or
 - B. If the status is the same, pay the FEE DUE shown above.

If the SMALL ENTITY is shown as NO:

- A. Pay FEE DUE shown above, or
- B. File verified statement of Small Entity Status before, or with, payment of 1/2 the FEE DUE shown above.

- II. Part B-Issue Fee Transmittal should be completed and returned to the Patent and Trademark Office (PTO) with your ISSUE FEE. Even if the ISSUE FEE has already been paid by charge to deposit account, Part B Issue Fee Transmittal should be completed and returned. If you are charging the ISSUE FEE to your deposit account, section "4b" of Part B-Issue Fee Transmittal should be completed and an extra copy of the form should be submitted.
- III. All communications regarding this application must give application number and batch number. Please direct all communications prior to issuance to Box ISSUE FEE unless advised to the contrary.

IMPORTANT REMINDER: Utility patents issuing on applications filed on or after Dec. 12, 1980 may require payment of maintenance fees. It is patentee's responsibility to ensure timely payment of maintenance fees when due.

PATENT AND TRADEMARK OFFICE COPY

Notice of Allowability

Application No. 09/181,738	Applicant(s) Pyles
Examiner Margaret Wambach	Group Art Unit 2816



All claims being allowable, PROSECUTION ON THE MERITS IS (OR REMAINS) CLOSED in this application. If not included herewith (or previously mailed), a Notice of Allowance and Issue Fee Due or other appropriate communication will be mailed in due course.

- This communication is responsive to Amdt B (6/19/00) and tele. interviews (6/12 & 6/15/00)
- The allowed claim(s) is/are 12, 13, and 15-45
- The drawings filed on _____ are acceptable.
- Acknowledgement is made of a claim for foreign priority under 35 U.S.C. § 119(a)-(d).
 - All Some* None of the CERTIFIED copies of the priority documents have been
 - received.
 - received in Application No. (Series Code/Serial Number) _____
 - received in this national stage application from the International Bureau (PCT Rule 17.2(a)).
- *Certified copies not received: _____
- Acknowledgement is made of a claim for domestic priority under 35 U.S.C. § 119(e).

A SHORTENED STATUTORY PERIOD FOR RESPONSE to comply with the requirements noted below is set to EXPIRE **THREE MONTHS** FROM THE "DATE MAILED" of this Office action. Failure to timely comply will result in ABANDONMENT of this application. Extensions of time may be obtained under the provisions of 37 CFR 1.136(a).

- Note the attached EXAMINER'S AMENDMENT or NOTICE OF INFORMAL APPLICATION, PTO-152, which discloses that the oath or declaration is deficient. A SUBSTITUTE OATH OR DECLARATION IS REQUIRED.
- Applicant MUST submit NEW FORMAL DRAWINGS
 - because the originally filed drawings were declared by applicant to be informal.
 - including changes required by the Notice of Draftsperson's Patent Drawing Review, PTO-948, attached hereto or to Paper No. 6.
 - including changes required by the proposed drawing correction filed on _____, which has been approved by the examiner.
 - including changes required by the attached Examiner's Amendment/Comment.

Identifying indicia such as the application number (see 37 CFR 1.84(c)) should be written on the reverse side of the drawings. The drawings should be filed as a separate paper with a transmittal letter addressed to the Official Draftsperson.

- Note the attached Examiner's comment regarding REQUIREMENT FOR THE DEPOSIT OF BIOLOGICAL MATERIAL.

Any response to this letter should include, in the upper right hand corner, the APPLICATION NUMBER (SERIES CODE/SERIAL NUMBER). If applicant has received a Notice of Allowance and Issue Fee Due, the ISSUE BATCH NUMBER and DATE of the NOTICE OF ALLOWANCE should also be included.

Attachment(s)

- Notice of References Cited, PTO-892
- Information Disclosure Statement(s), PTO-1449, Paper No(s). 4
- Notice of Draftsperson's Patent Drawing Review, PTO-948
- Notice of Informal Patent Application, PTO-152
- Interview Summary, PTO-413
- Examiner's Amendment/Comment
- Examiner's Comment Regarding Requirement for Deposit of Biological Material
- Examiner's Statement of Reasons for Allowance

Margaret Rose Wambach

**Margaret R. Wambach
Primary Examiner**

A13

PATENT APPLICATION

In the United States Patent and Trademark Office

Applicant: Pyles et al.
Docket No.: KNOWMO-2
Date: August 11, 2000
Application No.: 09/181,738
Filed: October 28, 1998
Art Unit: 2816
Examiner: M. Wambach
For: PEDOMETER



Certificate of Mailing
I hereby certify that this correspondence is being deposited with the United States Postal Service as first class mail in an envelope addressed to:
Assistant Commissioner for Patents
Washington, D.C. 20231
On Aug. 11, 2000
Signature Jeffrey W. Smith
Jeffrey W. Smith, Reg. No. 33455
Name of Applicant, assignee or Registered Representative

INFORMATION DISCLOSURE STATEMENT

Assistant Commissioner for Patents
Washington, D.C. 20231

RECEIVED
AUG 23 2000
TECHNOLOGY CENTER 2800

Dear Sir:

In accordance with 37 C.F.R. §1.56, Applicants wish to call the attention of the Examiner to the following document:

PCT/IPEA/408, Written Opinion received August 7, 2000, 5 pgs. The references cited in the PCT's Written Opinion are already of record.

A copy of this document is being submitted herewith along with Form PTO/SB 08b.

This Information Disclosure Statement is accompanied by a Transmittal of Information Disclosure Statement under 37 C.F.R. §1.97(d); a Statement under 37 C.F.R. §1.97(e); and the appropriate \$130.00 Petition fee.

Applicants respectfully request that these documents be expressly considered during the prosecution of this application and made of record herein and appear among the "documents cited" on any patent to issue herefrom.

Respectfully submitted,

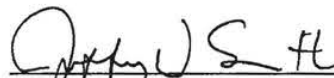
Jeffrey W. Smith, Reg. No. 33455
Attorney for Applicant
LATHROP & CLARK LLP
740 Regent Street, Suite 400
P.O. Box 1507
Madison, Wisconsin 53701-1507
(608) 257-7766

PATENT APPLICATION

In the United States Patent and Trademark Office

Applicant: Pyles et al.
Docket No.: KNOWMO-2
Date: August 11, 2000
Application No.: 09/181,738
Filed: October 28, 1998
Art Unit: 2816
Examiner: M. Wambach
For: PEDOMETER



Certificate of Mailing
I hereby certify that this correspondence is being deposited with the United States Postal Service as first class mail in an envelope addressed to: Assistant Commissioner for Patents, Washington, D.C. 20231
On Aug. 11, 2000
Signature Jeffrey W. Smith
Jeffrey W. Smith, Reg. No. 33455
Name of Applicant, assignee or Registered Representative

TRANSMITTAL OF INFORMATION DISCLOSURE STATEMENT AFTER MAILING DATE OF FINAL ACTION OR NOTICE OF ALLOWANCE BUT BEFORE PAYMENT OF ISSUE FEE (37 C.F.R. §1.97(d))

Attn: Group Director
Assistant Commissioner for Patents
Washington, D.C. 20231

RECEIVED
AUG 23 2000
TECHNOLOGY CENTER 2800

Dear Sir:

The Information Disclosure Statement submitted herewith is being filed *after* a Notice of Allowance under §1.311, but before the payment of the issue fee.

In accordance with the requirements of 37 C.F.R. §1.97(d):

- A. Accompanying this transmittal is a Statement, as specified in 37 C.F.R. §1.97(e).
- B. Applicants hereby petition for the consideration of the accompanying Information Disclosure Statement. 37 C.F.R. §1.97(d)(2).

08/16/2000 JADD01 00000035 09181738
01 FC:122 130.00 DP

C. Applicants submit the Petition fee set forth in §1.17(i) in the amount of \$130.00.

If any additional fees are due, please charge Account No. 15-0660. A duplicate copy of this document is enclosed.

Respectfully submitted,

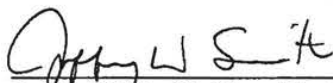

Jeffrey W. Smith, Reg. No. 33455
Attorney for Applicant
LATHROP & CLARK LLP
740 Regent Street, Suite 400
P.O. Box 1507
Madison, Wisconsin 53701-1507
(608) 257-7766

Please type a plus sign (+) inside this box →

Patent and Trademark Office: U.S. DEPARTMENT OF COMMERCE

Under the Paperwork Reduction Act of 1995, no persons are required to respond to a collection of information unless it displays a valid OMB control number.

Substitute for form 1449B/PTO		Application Number	09/181,738
INFORMATION DISCLOSURE STATEMENT BY APPLICANT (Use as many sheets as necessary)		Filing Date	October 28, 1998
		First Named inventor	Nathan Pyles
		Group Art Unit	2816
		Examiner Name	M. Wambach
		Attorney Docket Number	KNOWMO-2
Sheet	1	Of	1

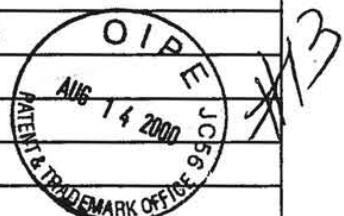

OTHER PRIOR ART - NON PATENT LITERATURE DOCUMENTS			
Examiner Initials*	Cite No. ¹	include name of the author (in CAPITAL LETTERS), title of the article (when appropriate), title of the item (book, magazine, journal, serial, symposium, catalog, etc.), date, page(s), volume-issue number(s), publisher, city and/or country where published.	T ²
MRW		PCT/IPEA/408, Written Opinion received August 7, 2000, 5 pgs.	

dup

Examiner Signature	Wambach	Date Considered	10/2/00
--------------------	---------	-----------------	---------

*EXAMINER: Initial if reference considered, whether or not citation is in conformance with MPEP 609. Draw line through citation if not in conformance and not considered. include copy of this form with next communication to applicant.

¹Unique citation designation number. ²Applicant is to place a check mark here if English language translation is attached

Burden Hour Statement: This form is estimated to take 0.2 hours to complete. Time will vary depending upon the needs of the individual case. Any comments on the amount of time you are required to complete this form should be sent to the Chief Information Officer, Patent and Trademark Office, Washington, DC 20231. DO NOT SEND FEES OR COMPLETED FORMS TO THIS ADDRESS. SEND TO: Assistant Commissioner for Patents, Washington, DC 20231.

2

PATENT COOPERATION TREATY

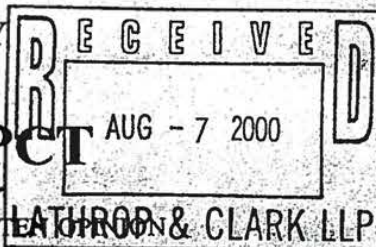

From the INTERNATIONAL PRELIMINARY EXAMINING AUTHORITY

RESPONSE DUE 10/1/00

To: JEFFRY W. SMITH LATHROP & CLARK LLP 740 REGENT STREET, SUITE 400 P.O. BOX 1507 MADISON WI 53701-1507

ACTION Resp. to written Opinion due

WRITTEN BY LATHROP & CLARK LLP

DOCKETED

BY: [Signature] DATE: 8/8/00 (PCT Rule 66)

BY: TICKLER DATE:

BY: DATE:

Date of Mailing (day/month/year) AUG 2000

Applicant's or agent's file reference EPIXINC-9

REPLY DUE within TWO months from the above date of mailing

International application No. PCT/US99/25314

International filing date (day/month/year) 28 OCTOBER 1999

Priority date (day/month/year) 28 OCTOBER 1998

International Patent Classification (IPC) or both national classification and IPC IPC(7): GO1C 21/00 and US Cl.: 377/24.2

Applicant Epix, Inc.

1. This written opinion is the first (first, etc.) drawn by this International Preliminary Examining Authority.

2. This opinion contains indications relating to the following items:

- I [X] Basis of the opinion
II [] Priority
III [] Non-establishment of opinion with regard to novelty, inventive step or industrial applicability
IV [] Lack of unity of invention
V [X] Reasoned statement under Rule 66.2(a)(ii) with regard to novelty, inventive step or industrial applicability; citations and explanations supporting such statement
VI [] Certain documents cited
VII [] Certain defects in the international application
VIII [] Certain observations on the international application

3. The applicant is hereby invited to reply to this opinion.

When? See the time limit indicated above. The applicant may, before the expiration of that time limit, request this Authority to grant an extension, see Rule 66.2(d).

How? By submitting a written reply, accompanied, where appropriate, by amendments, according to Rule 66.3. For the form and the language of the amendments, see Rules 66.8 and 66.9.

Also For an additional opportunity to submit amendments, see Rule 66.4. For the examiner's obligation to consider amendments and/or arguments, see Rule 66.4 bis. For an informal communication with the examiner, see Rule 66.6.

If no reply is filed, the international preliminary examination report will be established on the basis of this opinion.

4. The final date by which the international preliminary examination report must be established according to Rule 69.2 is: 28 FEBRUARY 2001

Name and mailing address of the IPEA/US Commissioner of Patents and Trademarks Box PCT Washington, D.C. 20231

Facsimile No. (703) 305-3230

Authorized officer

MARGARET ROSE WAMBACH

Telephone No. (703) 308-4875

PATENT COOPERATION TREATY

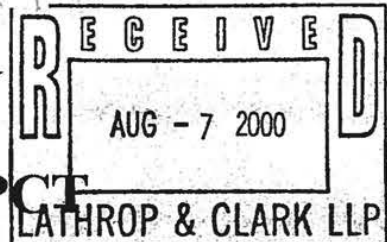

From the INTERNATIONAL PRELIMINARY EXAMINING AUTHORITY

To: JEFFRY W. SMITH
LATHROP & CLARK LLP
740 REGENT STREET, SUITE 400
P.O. BOX 1507
MADISON WI 53701-1507

WRITTEN OPINION

(PCT Rule 66)

Date of Mailing (day/month/year)		01 AUG 2000
Applicant's or agent's file reference		REPLY DUE within TWO months from the above date of mailing
EPIXINC-9		
International application No.	International filing date (day/month/year)	Priority date (day/month/year)
PCT/US99/25314	28 OCTOBER 1999	28 OCTOBER 1998
International Patent Classification (IPC) or both national classification and IPC IPC(7): GO1C 21/00 and US Cl.: 377/24.2		
Applicant Epix, Inc.		

1. This written opinion is the first (first, etc.) drawn by this International Preliminary Examining Authority.

2. This opinion contains indications relating to the following items:

- I Basis of the opinion
- II Priority
- III Non-establishment of opinion with regard to novelty, inventive step or industrial applicability
- IV Lack of unity of invention
- V Reasoned statement under Rule 66.2(a)(ii) with regard to novelty, inventive step or industrial applicability; citations and explanations supporting such statement
- VI Certain documents cited
- VII Certain defects in the international application
- VIII Certain observations on the international application

3. The applicant is hereby invited to reply to this opinion.

When? See the time limit indicated above. ~~The applicant may, before the expiration of that time limit, request this Authority to grant an extension, see Rule 66.2(d).~~

How? By submitting a written reply, accompanied, where appropriate, by amendments, according to Rule 66.3. For the form and the language of the amendments, see Rules 66.8 and 66.9.

Also For an additional opportunity to submit amendments, see Rule 66.4. For the examiner's obligation to consider amendments and/or arguments, see Rule 66.4 bis. For an informal communication with the examiner, see Rule 66.6.

If no reply is filed, the international preliminary examination report will be established on the basis of this opinion.

4. The final date by which the international preliminary examination report must be established according to Rule 69.2 is: 28 FEBRUARY 2001

Name and mailing address of the IPEA/US Commissioner of Patents and Trademarks Box PCT Washington, D.C. 20231 Facsimile No. (703) 305-3230	Authorized officer MARGARET ROSE WAMBACH Telephone No. (703) 308-4875
--	---

Form PCT/IPEA/408 (cover sheet) (July 1998)*

WRITTEN OPINION

International application No.

PCT/US99/25314

I. Basis of the opinion

1. With regard to the elements of the international application:*

- the international application as originally filed
- the description:
 - pages 1-23 , as originally filed
 - pages NONE , filed with the demand
 - pages NONE , filed with the letter of _____
- the claims:
 - pages 24-34 , as originally filed
 - pages NONE , as amended (together with any statement) under Article 19
 - pages NONE , filed with the demand
 - pages NONE , filed with the letter of _____
- the drawings:
 - pages 1 , as originally filed
 - pages NONE , filed with the demand
 - pages NONE , filed with the letter of _____
- the sequence listing part of the description:
 - pages NONE , as originally filed
 - pages NONE , filed with the demand
 - pages NONE , filed with the letter of _____

2. With regard to the language, all the elements marked above were available or furnished to this Authority in the language in which the international application was filed, unless otherwise indicated under this item.

These elements were available or furnished to this Authority in the following language _____ which is:

- the language of a translation furnished for the purposes of international search (under Rule 23.1(b)).
- the language of publication of the international application (under Rule 48.3(b)).
- the language of the translation furnished for the purposes of international preliminary examination (under Rules 55.2 and/or 55.3).

3. With regard to any nucleotide and/or amino acid sequence disclosed in the international application, the written opinion was drawn on the basis of the sequence listing:

- contained in the international application in printed form.
- filed together with the international application in computer readable form.
- furnished subsequently to this Authority in written form.
- furnished subsequently to this Authority in computer readable form.
- The statement that the subsequently furnished written sequence listing does not go beyond the disclosure in the international application as filed has been furnished.
- The statement that the information recorded in computer readable form is identical to the written sequence listing has been furnished.

4. The amendments have resulted in the cancellation of:

- the description, pages NONE
- the claims, Nos. NONE
- the drawings, sheets/fig NONE

5. This opinion has been drawn as if (some of) the amendments had not been made, since they have been considered to go beyond the disclosure as filed, as indicated in the Supplemental Box (Rule 70.2(c)).

* Replacement sheets which have been furnished to the receiving Office in response to an invitation under Article 14 are referred to in this opinion as "originally filed".

WRITTEN OPINION

International application No.
PCT/US99/25314

V. Reasoned statement under Rule 66.2(a)(ii) with regard to novelty, inventive step or industrial applicability; citations and explanations supporting such statement

1. statement

Novelty (N)	Claims <u>14-16, 28-54</u>	YES
	Claims <u>1-13 and 17-27</u>	NO
Inventive Step (IS)	Claims <u>14, 16, 28-54</u>	YES
	Claims <u>1-13 and 17-27</u>	NO
Industrial Applicability (IA)	Claims <u>1-54</u>	YES
	Claims <u>NONE</u>	NO

2. citations and explanations

Claims 1-13, 17-28 lack novelty under PCT Article 33(2) as being anticipated by Hutchins.

Hutchins discloses a device which wirelessly transmits data from a wrist sensor to another location, includes a display and a data processor which calculates a distance traveled by multiplying the number of strides taken by a stride length that varies according to a rate at which strides are taken.

Claims 14-16 and 29-54 meet the criteria set out in PCT Article 33(2)-(4), because the prior art does not teach or fairly suggest use of data input from runs or walks over known distances to establish a range of stride rate versus stride length data.

NEW CITATIONS

US 5724265 (Hutchings) 03 MAR 1998, see entire document.
US 5033013 (Kato et al) 16 JUL 1991, see entire document.

WRITTEN OPINION

International application No.
PCT/US99/25314

Supplemental Box
(To be used when the space in any of the preceding boxes is not sufficient)

Continuation of: Boxes I - VIII

Sheet 10

TIME LIMIT:

The time limit set for response to a Written Opinion may not be extended. 37 CFR 1.484(d). Any response received after the expiration of the time limit set in the Written Opinion will not be considered in preparing the International Preliminary Examination Report.

2818
#

Please type a plus sign (+) inside this box →

Approved for use through 9/30/00. OMB 0851-0031
Patent and Trademark Office: U.S. DEPARTMENT OF COMMERCE

Under the Paperwork Reduction Act of 1995, no persons are required to respond to a collection of information unless it displays a valid OMB control number.

<h1>TRANSMITTAL FORM</h1> <p>(To be used for all correspondence after initial filing)</p>		Application Number	09/181,738
		Filing Date	October 28, 1998
		First Named Inventor	Nathan Pyles
		Group Art Unit	2816
		Examiner Name	M. Wambach
Total Number of Pages in This Submission		Attorney Docket Number	KNOWMO-2
<input checked="" type="checkbox"/> Fee Transmittal Form <input checked="" type="checkbox"/> Fee Attached <input type="checkbox"/> Amendment / Response <input type="checkbox"/> After Final <input type="checkbox"/> Affidavits/declaration(s) <input type="checkbox"/> Extension of Time Request <input type="checkbox"/> Express Abandonment Request <input checked="" type="checkbox"/> Information Disclosure Statement <input type="checkbox"/> Certified Copy of Priority Document(s) <input type="checkbox"/> Response to Missing Parts/ Incomplete Application <input type="checkbox"/> Response to Missing Parts Under 37 CFR 1.52 or 1.53		<input type="checkbox"/> Assignment Papers (For an Application) <input type="checkbox"/> Drawing(s) <input type="checkbox"/> Licensing-related Papers <input type="checkbox"/> Petition Routing Slip (PTO/SB/69) And Accompanying Petition <input type="checkbox"/> To Convert a Provisional Application <input type="checkbox"/> Power of Attorney, Revocation Change of Correspondence Address <input type="checkbox"/> Terminal Disclaimer <input type="checkbox"/> Small Entity Statement <input type="checkbox"/> Request for Refund	
		<input type="checkbox"/> After Allowance Communication To Group <input type="checkbox"/> Appeal Communication to Board Of Appeals and interferences <input type="checkbox"/> Appeal Communication to Group (Appeal Notice, Brief, Reply Brief) <input type="checkbox"/> Proprietary Information <input type="checkbox"/> Status Letter <input checked="" type="checkbox"/> Additional Enclosure(s) (Please identify below):	
		* Transmittal of Information Disclosure Statement (2pp) * Statement for Information Disclosure (2pp) * PTO/SB 08b and 1 document	
		<h2>RECEIVED</h2> <p>AUG 23 2000</p> <p>TECHNOLOGY CENTER 2800</p>	
SIGNATURE OF APPLICANT, ATTORNEY, OR AGENT			
Firm or Individual name	Jeffrey W. Smith, Reg. No. 33455		
Signature	<i>Jeffrey W. Smith</i>		
Date	Aug 11, 2000		
CERTIFICATE OF MAILING			
I hereby certify that this correspondence is being deposited with the United States Postal Service as first class mail in an envelope addressed to: Assistant Commissioner for Patents, Washington, D.C. 20231 on this date:			
Typed or printed name	Jeffrey W. Smith, Reg. No. 33455		
Signature	<i>Jeffrey W. Smith</i>	Date	Aug 11, 2000

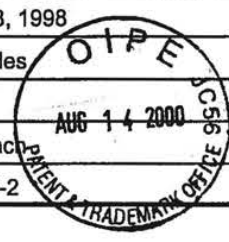

Under the Paperwork Reduction Act of 1995, no persons are required to respond to a collection of information unless it displays a valid OMB control number.

FEE TRANSMITTAL		Complete if Known																																																																																																																																																																																																	
<p style="text-align: center;">Note: Effective October 1, 1997, Patent fees are subject to annual revision</p> <p>TOTAL AMOUNT OF PAYMENT \$130.00</p>		Application Number		09/181,738																																																																																																																																																																																															
		Filing Date		October 28, 1998																																																																																																																																																																																															
		First Named Inventor		Nathan Pyles																																																																																																																																																																																															
		Group Art Unit		2816																																																																																																																																																																																															
		Examiner Name		M. Wambach																																																																																																																																																																																															
		Attorney Docket Number		KNOWMOR																																																																																																																																																																																															
METHOD OF PAYMENT (check one)		FEE CALCULATION (Continued)																																																																																																																																																																																																	
<p>1. <input checked="" type="checkbox"/> The Commissioner is hereby authorized to charge indicated fees and credit any over payments to:</p> <p>Deposit Account Number: 15-0660</p> <p>Deposit Account Name: Lathrop & Clark</p> <p><input checked="" type="checkbox"/> Charge Any Additional Fee Required Under 37 CFR 1.16 and 1.17 <input type="checkbox"/> Charge the Issue Fee Set in 37 CFR 1.18 at the Mailing of the Notice of Allowance</p>		<p>3. ADDITIONAL FEES</p> <table border="1" style="width:100%; border-collapse: collapse;"> <thead> <tr> <th colspan="2">Large Entity</th> <th colspan="2">Small Entity</th> <th rowspan="2">Fee Description</th> <th rowspan="2">Fee Paid</th> </tr> <tr> <th>Fee Code</th> <th>Fee (\$)</th> <th>Fee Code</th> <th>Fee (\$)</th> </tr> </thead> <tbody> <tr><td>105</td><td>130</td><td>205</td><td>65</td><td>Surcharge - late filing fee or oath</td><td></td></tr> <tr><td>127</td><td>50</td><td>227</td><td>25</td><td>Surcharge - late provisional filing fee or cover sheet</td><td></td></tr> <tr><td>139</td><td>130</td><td>139</td><td>130</td><td>Non-English specification</td><td></td></tr> <tr><td>147</td><td>2,520</td><td>147</td><td>2,520</td><td>For filing a request for reexamination</td><td></td></tr> <tr><td>112</td><td>920*</td><td>112</td><td>920*</td><td>Requesting publication of SIR prior to Examiner action</td><td></td></tr> <tr><td>113</td><td>1,840*</td><td>113</td><td>1,840*</td><td>Requesting publication of SIR after Examiner action</td><td></td></tr> <tr><td>115</td><td>110</td><td>215</td><td>55</td><td>Extension for reply within first month</td><td></td></tr> <tr><td>116</td><td>380</td><td>216</td><td>190</td><td>Extension for reply within second month</td><td></td></tr> <tr><td>117</td><td>870</td><td>217</td><td>435</td><td>Extension for reply within third month</td><td></td></tr> <tr><td>118</td><td>1,360</td><td>218</td><td>680</td><td>Extension for reply within fourth month</td><td></td></tr> <tr><td>128</td><td>1850</td><td>228</td><td>925</td><td>Extension for reply within fifth month</td><td></td></tr> <tr><td>119</td><td>300</td><td>219</td><td>150</td><td>Notice of Appeal</td><td></td></tr> <tr><td>120</td><td>300</td><td>220</td><td>150</td><td>Filing a brief in support of an appeal</td><td></td></tr> <tr><td>121</td><td>260</td><td>221</td><td>130</td><td>Request for oral hearing</td><td></td></tr> <tr><td>138</td><td>1,510</td><td>138</td><td>1,510</td><td>Petition to institute a public use proceeding</td><td></td></tr> <tr><td>140</td><td>110</td><td>240</td><td>55</td><td>Petition to revive - unavoidable</td><td></td></tr> <tr><td>141</td><td>1,210</td><td>241</td><td>605</td><td>Petition to revive - unintentional</td><td></td></tr> <tr><td>142</td><td>1,210</td><td>242</td><td>605</td><td>Utility Issue fee (or reissue)</td><td></td></tr> <tr><td>143</td><td>430</td><td>243</td><td>215</td><td>Design Issue fee</td><td></td></tr> <tr><td>144</td><td>580</td><td>244</td><td>290</td><td>Plant Issue fee</td><td></td></tr> <tr><td>122</td><td>130</td><td>122</td><td>130</td><td>Petitions to the Commissioner</td><td></td></tr> <tr><td>123</td><td>50</td><td>123</td><td>50</td><td>Petitions related to provisional applications</td><td></td></tr> <tr><td>128</td><td>240</td><td>126</td><td>240</td><td>Submission of Information Disclosure Statement</td><td></td></tr> <tr><td>581</td><td>40</td><td>581</td><td>40</td><td>Recording each patent assignment per property (times number of properties)</td><td></td></tr> <tr><td>146</td><td>760</td><td>246</td><td>380</td><td>Filing a submission after final rejection (37 CFR 1.129(a))</td><td></td></tr> <tr><td>149</td><td>760</td><td>249</td><td>380</td><td>For each additional invention to be examined (37 CFR 1.129(b))</td><td></td></tr> <tr><td colspan="5">Other fee (specify) <u>Petition fee under §1.17(l) for IDS</u></td><td>\$130.00</td></tr> <tr><td colspan="5">Other fee (specify) _____</td><td></td></tr> <tr><td colspan="5" style="text-align: right;">*Reduced by Basic Filing Fee Paid</td><td></td></tr> <tr><td colspan="5" style="text-align: right;">SUBTOTAL (3)</td><td>\$130.00</td></tr> </tbody> </table>				Large Entity		Small Entity		Fee Description	Fee Paid	Fee Code	Fee (\$)	Fee Code	Fee (\$)	105	130	205	65	Surcharge - late filing fee or oath		127	50	227	25	Surcharge - late provisional filing fee or cover sheet		139	130	139	130	Non-English specification		147	2,520	147	2,520	For filing a request for reexamination		112	920*	112	920*	Requesting publication of SIR prior to Examiner action		113	1,840*	113	1,840*	Requesting publication of SIR after Examiner action		115	110	215	55	Extension for reply within first month		116	380	216	190	Extension for reply within second month		117	870	217	435	Extension for reply within third month		118	1,360	218	680	Extension for reply within fourth month		128	1850	228	925	Extension for reply within fifth month		119	300	219	150	Notice of Appeal		120	300	220	150	Filing a brief in support of an appeal		121	260	221	130	Request for oral hearing		138	1,510	138	1,510	Petition to institute a public use proceeding		140	110	240	55	Petition to revive - unavoidable		141	1,210	241	605	Petition to revive - unintentional		142	1,210	242	605	Utility Issue fee (or reissue)		143	430	243	215	Design Issue fee		144	580	244	290	Plant Issue fee		122	130	122	130	Petitions to the Commissioner		123	50	123	50	Petitions related to provisional applications		128	240	126	240	Submission of Information Disclosure Statement		581	40	581	40	Recording each patent assignment per property (times number of properties)		146	760	246	380	Filing a submission after final rejection (37 CFR 1.129(a))		149	760	249	380	For each additional invention to be examined (37 CFR 1.129(b))		Other fee (specify) <u>Petition fee under §1.17(l) for IDS</u>					\$130.00	Other fee (specify) _____						*Reduced by Basic Filing Fee Paid						SUBTOTAL (3)					\$130.00
Large Entity		Small Entity		Fee Description	Fee Paid																																																																																																																																																																																														
Fee Code	Fee (\$)	Fee Code	Fee (\$)																																																																																																																																																																																																
105	130	205	65	Surcharge - late filing fee or oath																																																																																																																																																																																															
127	50	227	25	Surcharge - late provisional filing fee or cover sheet																																																																																																																																																																																															
139	130	139	130	Non-English specification																																																																																																																																																																																															
147	2,520	147	2,520	For filing a request for reexamination																																																																																																																																																																																															
112	920*	112	920*	Requesting publication of SIR prior to Examiner action																																																																																																																																																																																															
113	1,840*	113	1,840*	Requesting publication of SIR after Examiner action																																																																																																																																																																																															
115	110	215	55	Extension for reply within first month																																																																																																																																																																																															
116	380	216	190	Extension for reply within second month																																																																																																																																																																																															
117	870	217	435	Extension for reply within third month																																																																																																																																																																																															
118	1,360	218	680	Extension for reply within fourth month																																																																																																																																																																																															
128	1850	228	925	Extension for reply within fifth month																																																																																																																																																																																															
119	300	219	150	Notice of Appeal																																																																																																																																																																																															
120	300	220	150	Filing a brief in support of an appeal																																																																																																																																																																																															
121	260	221	130	Request for oral hearing																																																																																																																																																																																															
138	1,510	138	1,510	Petition to institute a public use proceeding																																																																																																																																																																																															
140	110	240	55	Petition to revive - unavoidable																																																																																																																																																																																															
141	1,210	241	605	Petition to revive - unintentional																																																																																																																																																																																															
142	1,210	242	605	Utility Issue fee (or reissue)																																																																																																																																																																																															
143	430	243	215	Design Issue fee																																																																																																																																																																																															
144	580	244	290	Plant Issue fee																																																																																																																																																																																															
122	130	122	130	Petitions to the Commissioner																																																																																																																																																																																															
123	50	123	50	Petitions related to provisional applications																																																																																																																																																																																															
128	240	126	240	Submission of Information Disclosure Statement																																																																																																																																																																																															
581	40	581	40	Recording each patent assignment per property (times number of properties)																																																																																																																																																																																															
146	760	246	380	Filing a submission after final rejection (37 CFR 1.129(a))																																																																																																																																																																																															
149	760	249	380	For each additional invention to be examined (37 CFR 1.129(b))																																																																																																																																																																																															
Other fee (specify) <u>Petition fee under §1.17(l) for IDS</u>					\$130.00																																																																																																																																																																																														
Other fee (specify) _____																																																																																																																																																																																																			
*Reduced by Basic Filing Fee Paid																																																																																																																																																																																																			
SUBTOTAL (3)					\$130.00																																																																																																																																																																																														
<p>2. <input checked="" type="checkbox"/> Payment Enclosed:</p> <p><input checked="" type="checkbox"/> Check <input type="checkbox"/> Money Order <input type="checkbox"/> Other</p>																																																																																																																																																																																																			
FEE CALCULATION																																																																																																																																																																																																			
1. FILING FEE																																																																																																																																																																																																			
Large Entity	Small Entity																																																																																																																																																																																																		
Fee Code	Fee (\$)	Fee Code	Fee (\$)	Fee Description	Fee Paid																																																																																																																																																																																														
101	690	201	345	Utility filing fee																																																																																																																																																																																															
106	310	206	155	Design filing fee																																																																																																																																																																																															
107	480	207	240	Plant filing fee																																																																																																																																																																																															
108	760	208	380	Reissue filing fee																																																																																																																																																																																															
114	150	214	75	Provisional filing fee																																																																																																																																																																																															
SUBTOTAL (1)					\$0.00																																																																																																																																																																																														
2. CLAIMS																																																																																																																																																																																																			
		Extra	Fee from below	Fee Paid																																																																																																																																																																																															
Total Claims	-20=	0	X 11	=	\$0.00																																																																																																																																																																																														
Independent Claims	-3=	0	X 41	=	\$0.00																																																																																																																																																																																														
Multiple Dependent Claims			X 135	=	\$0.00																																																																																																																																																																																														
Large Entity	Small Entity																																																																																																																																																																																																		
Fee Code	Fee (\$)	Fee Code	Fee	Fee Description																																																																																																																																																																																															
103	18	203	9	Claims in excess of 20																																																																																																																																																																																															
102	78	202	39	Independent Claims in excess of 3																																																																																																																																																																																															
104	260	204	130	Multiple dependent claims																																																																																																																																																																																															
109	78	209	39	Reissue independent claims over original patent																																																																																																																																																																																															
110	18	210	9	Reissue claims in excess of 20 and over original patent																																																																																																																																																																																															
SUBTOTAL (2)					\$0.00																																																																																																																																																																																														
SUBMITTED BY		Complete (if applicable)																																																																																																																																																																																																	
Typed or Printed Name	Jeffry W. Smith			Reg. Number	33455																																																																																																																																																																																														
Signature		Date	Aug 11, 2000	Deposit Account User ID																																																																																																																																																																																															

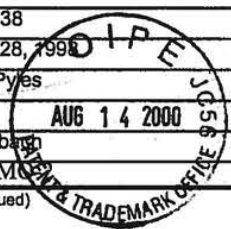



**UNITED STATES DEPARTMENT OF COMMERCE
Patent and Trademark Office**

Address: COMMISSIONER OF PATENTS AND TRADEMARKS
Washington, D.C. 20231

APPLICATION NO.	FILING DATE	FIRST NAMED INVENTOR	ATTORNEY DOCKET NO.
09/181,738	10/28/98	PYLES	N EPIXINC-4

020455
LATHROP & CLARK LLP
740 REGENT STREET SUITE 400
P.O. BOX 1507
MADISON WI 53701-1507

MM41/1017

EXAMINER
WAMBACH, M

ART UNIT	PAPER NUMBER
2816	

DATE MAILED:

10/17/00

Please find below and/or attached an Office communication concerning this application or proceeding.

Commissioner of Patents and Trademarks

Notice of Allowability

Application No. 09/181,738	Applicant(s) Pyles
Examiner Margaret Wambach	Group Art Unit 2816



All claims being allowable, PROSECUTION ON THE MERITS IS (OR REMAINS) CLOSED in this application. If not included herewith (or previously mailed), a Notice of Allowance and Issue Fee Due or other appropriate communication will be mailed in due course.

- This communication is responsive to I.D.S. (8/14/00)
- The allowed claim(s) is/are 12, 13, and 15-45
- The drawings filed on _____ are acceptable.
- Acknowledgement is made of a claim for foreign priority under 35 U.S.C. § 119(a)-(d).
 - All Some* None of the CERTIFIED copies of the priority documents have been received.
 - received in Application No. (Series Code/Serial Number) _____
 - received in this national stage application from the International Bureau (PCT Rule 17.2(a)).
- *Certified copies not received: _____
- Acknowledgement is made of a claim for domestic priority under 35 U.S.C. § 119(e).

A SHORTENED STATUTORY PERIOD FOR RESPONSE to comply with the requirements noted below is set to EXPIRE THREE MONTHS FROM THE "DATE MAILED" of this Office action. Failure to timely comply will result in ABANDONMENT of this application. Extensions of time may be obtained under the provisions of 37 CFR 1.136(a).

- Note the attached EXAMINER'S AMENDMENT or NOTICE OF INFORMAL APPLICATION, PTO-152, which discloses that the oath or declaration is deficient. A SUBSTITUTE OATH OR DECLARATION IS REQUIRED.
- Applicant MUST submit NEW FORMAL DRAWINGS
 - because the originally filed drawings were declared by applicant to be informal.
 - including changes required by the Notice of Draftsperson's Patent Drawing Review, PTO-948, attached hereto or to Paper No. 6.
 - including changes required by the proposed drawing correction filed on _____, which has been approved by the examiner.
 - including changes required by the attached Examiner's Amendment/Comment.

Identifying indicia such as the application number (see 37 CFR 1.84(c)) should be written on the reverse side of the drawings. The drawings should be filed as a separate paper with a transmittal letter addressed to the Official Draftsperson.

- Note the attached Examiner's comment regarding REQUIREMENT FOR THE DEPOSIT OF BIOLOGICAL MATERIAL.

Any response to this letter should include, in the upper right hand corner, the APPLICATION NUMBER (SERIES CODE/SERIAL NUMBER). If applicant has received a Notice of Allowance and Issue Fee Due, the ISSUE BATCH NUMBER and DATE of the NOTICE OF ALLOWANCE should also be included.

Attachment(s)

- Notice of References Cited, PTO-892
- Information Disclosure Statement(s), PTO-1449, Paper No(s). 1
- Notice of Draftsperson's Patent Drawing Review, PTO-948
- Notice of Informal Patent Application, PTO-152
- Interview Summary, PTO-413
- Examiner's Amendment/Comment
- Examiner's Comment Regarding Requirement for Deposit of Biological Material
- Examiner's Statement of Reasons for Allowance



Margaret R. Wambach
Primary Examiner



#1544

Patent Application

IN THE UNITED STATES PATENT AND TRADEMARK OFFICE

Applicant:	Nathan Pyles	Date:	September 19, 2000
Date Filed:	October 28, 1998	Docket No.:	KNOWMO-2
Serial Number:	09/181,738	Art Unit:	2816
For:	PEDOMETER	Examiner:	M. WAMBACH

Certificate of Mailing

I hereby certify that this correspondence is being deposited with the United States Postal Service as first class mail in an envelope addressed to: Assistant Commissioner for Patents, Washington, D.C. 20231

on September 19, 2000
Date

Jeffrey W. Smith
Signature

Jeffrey W. Smith, Reg. No. 33455
Name of applicant, assignee or Registered Representative

TRANSMITTAL OF FORMAL DRAWINGS

Attention: Official Draftsman
Assistant Commissioner for Patents
Washington, D.C. 20231

Dear Sir:

Enclosed for filing with respect to the above-referenced application, please find 1 sheet of new formal drawings having (1) figure to be substituted for the drawings presently on file in this application. It is believed that the drawings submitted are in conformance with the requirements set forth in 37 C.F.R. §1.84. These new formal drawings are transmitted in conformance with the requirement for new drawings set out in the Notice of Allowability on this application that

was mailed on June 21, 2000. Applicant believes no new matter has been added by these formal drawings.

It is requested that applicant's undersigned attorney be notified of any further or additional requirements with respect to the enclosed formal drawings.

Respectfully submitted,

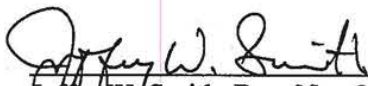

Jeffrey W. Smith, Reg. No. 33455
Attorney for Applicant
Lathrop & Clark LLP
740 Regent Street, Suite 400
P.O. Box 1507
Madison, Wisconsin 53701-1507
(608) 257-7766

PayIssueFee.app/draftsman



Lathrop & Clark
Attorney Docket EPIXINC-4
Jeffrey W. Smith, Esq.
(608) 257-7766

6175608

1/1

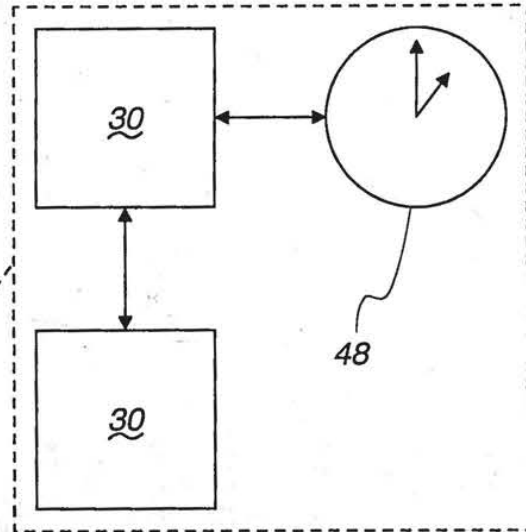
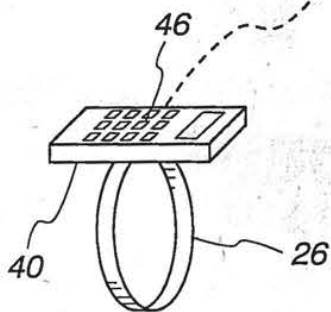
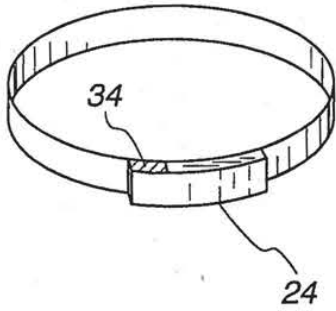
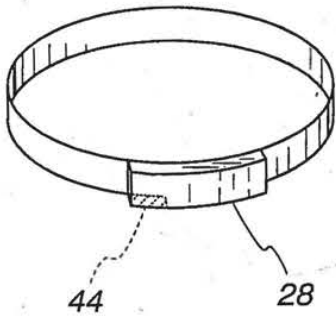

B \$

PTO/SB/21 (12-97)

Please type a plus sign (+) inside the box →
Under the Paperwork Reduction Act of 1995, no persons are required to respond to a collection of information unless it displays a valid OMB control number.

Patent and Trademark Office: U.S. DEPARTMENT OF COMMERCE



TRANSMITTAL FORM

(To be used for all correspondence after initial filing)

Application Number	09/181,738
Filing Date	October 28, 1998
First Named Inventor	Nathan Pyles
Group Art Unit	
Examiner Name	
Total Number of Pages in This Submission	
Attorney Docket Number	KNOWMO-2

<input type="checkbox"/> Fee Transmittal Form <input checked="" type="checkbox"/> Fee Attached <input type="checkbox"/> Amendment / Response <input type="checkbox"/> After Final <input type="checkbox"/> Affidavits/declaration(s) <input type="checkbox"/> Extension of Time Request <input type="checkbox"/> Express Abandonment Request <input type="checkbox"/> Information Disclosure Statement <input type="checkbox"/> Certified Copy of Priority Document(s) <input type="checkbox"/> Response to Missing Parts/ Incomplete Application <input type="checkbox"/> Response to Missing Parts Under 37 CFR 1.52 or 1.53	<input type="checkbox"/> Assignment Papers (For an Application) <input checked="" type="checkbox"/> Drawing(s) <input type="checkbox"/> Licensing-related Papers <input type="checkbox"/> Petition Routing Slip (PTO/SB/69) And Accompanying Petition <input type="checkbox"/> To Convert a Provisional Application <input type="checkbox"/> Power of Attorney, Revocation Change of Correspondence Address <input type="checkbox"/> Terminal Disclaimer <input type="checkbox"/> Small Entity Statement <input type="checkbox"/> Request for Refund	<input type="checkbox"/> After Allowance Communication To Group <input type="checkbox"/> Appeal Communication to Board Of Appeals and Interferences <input type="checkbox"/> Appeal Communication to Group (Appeal Notice, Brief, Reply Brief) <input type="checkbox"/> Proprietary Information <input type="checkbox"/> Status Letter <input checked="" type="checkbox"/> Additional Enclosure(s) (Please identify below): <div style="border: 1px solid black; padding: 5px; margin-top: 10px;"> <ul style="list-style-type: none"> • PTOL-85B • Transmittal to Official Draftsman </div>
Remarks		

SIGNATURE OF APPLICANT, ATTORNEY, OR AGENT		
Firm or Individual name	Jeffry W. Smith, Reg. No. 33455	
Signature		
Date	September 19, 2000	
CERTIFICATE OF MAILING		
I hereby certify that this correspondence is being deposited with the United States Postal Service as first class mail in an envelope addressed to: Assistant Commissioner for Patents, Washington, D.C. 20231 on this date:		
Typed or printed name	Jeffry W. Smith, Reg. No. 33455	
Signature		Date: September 19, 2000

PART B—ISSUE FEE TRANSMITTAL



Complete and mail this form, together with applicable fees, to: **Box ISSUE-FEE
Assistant Commissioner for Patents
Washington, D.C. 20231**

MAILING INSTRUCTIONS: This form should be used for transmitting the ISSUE FEE. Blocks 1 through 4 should be completed where appropriate. All further correspondence including the Issue Fee Receipt, the Patent, advance orders and notification of maintenance fees will be mailed to the current correspondence address as indicated unless corrected below or directed otherwise in Block 1, by (a) specifying a new correspondence address; and/or (b) indicating a separate "FEE ADDRESS" for maintenance fee notifications.

Note: The certificate of mailing below can only be used for domestic mailings of the Issue Fee Transmittal. This certificate cannot be used for any other accompanying papers. Each additional paper, such as an assignment or formal drawing, must have its own certificate of mailing.

Certificate of Mailing

I hereby certify that this Issue Fee Transmittal is being deposited with the United States Postal Service with sufficient postage for first class mail in an envelope addressed to the Box Issue Fee address above on the date indicated below.

Tami A. Jansen (Depositor's name)

Tami A. Jansen (Signature)

September 19, 2000 (Date)

CURRENT CORRESPONDENCE ADDRESS (Note: Legibly mark-up with any corrections or use Block 1)
**020455 MMC1/0621
LATHROP & CLARK LLP
740 REGENT STREET SUITE 400
P.O. BOX 1507
MADISON WI 53701-1507**

APPLICATION NO.	FILING DATE	TOTAL CLAIMS	EXAMINER AND GROUP ART UNIT	DATE MAILED
09/181.738	10/28/98	033	WAMBACH, M 2816	06/21/00

First Named Applicant: **PYLES.** 35 USC 154(b) term ext. = 0 Days.

TITLE OF INVENTION: **PEDOMETER**

ATTY'S DOCKET NO.	CLASS-SUBCLASS	BATCH NO.	APPLN. TYPE	SMALL ENTITY	FEE DUE	DATE DUE
2	EPIXINC-4	377-024.200	039 UTILITY	YES	\$605.00	09/21/00

1. Change of correspondence address or indication of "Fee Address" (37 CFR 1.363). Use of PTO form(s) and Customer Number are recommended, but not required.
- Change of correspondence address (or Change of Correspondence Address form PTO/SB/122) attached.
- "Fee Address" indication (or "Fee Address" indication form PTO/SB/47) attached.

2. For printing on the patent front page, list (1) the names of up to 3 registered patent attorneys or agents OR, alternatively, (2) the name of a single firm (having as a member a registered attorney or agent) and the names of up to 2 registered patent attorneys or agents. If no name is listed, no name will be printed.
- 1 Lathrop & Clark LLP
- 2 _____
- 3 _____

ASSIGNEE NAME AND RESIDENCE DATA TO BE PRINTED ON THE PATENT (print or type)
PLEASE NOTE: Unless an assignee is identified below, no assignee data will appear on the patent. Inclusion of assignee data is only appropriate when an assignment has been previously submitted to the PTO or is being submitted under separate cover. Completion of this form is NOT a substitute for filing an assignment.

(A) NAME OF ASSIGNEE: **KnowMo, LLC d/b/a**

(B) RESIDENCE: (CITY & STATE OR COUNTRY) **Knowledge-in-Motion
Lake Mills, Wisconsin**

Please check the appropriate assignee category indicated below (will not be printed on the patent)

Individual corporation or other private group entity government

4a. The following fees are enclosed (make check payable to Commissioner of Patents and Trademarks):

- Issue Fee
- Advance Order - # of Copies 10

4b. The following fees or deficiency in these fees should be charged to:

- DEPOSIT ACCOUNT NUMBER 15-0660
(ENCLOSE AN EXTRA COPY OF THIS FORM)
- Issue Fee
- Advance Order - # of Copies 10

The COMMISSIONER OF PATENTS AND TRADEMARKS IS requested to apply the Issue Fee to the application identified above.

(Authorized Signature) *[Signature]* (Date) 9/19/00

NOTE: The Issue Fee will not be accepted from anyone other than the applicant; a registered attorney or agent; or the assignee or other party in interest as shown by the records of the Patent and Trademark Office.

Burden Hour Statement: This form is estimated to take 0.2 hours to complete. Time will vary depending on the needs of the individual case. Any comments on the amount of time required to complete this form should be sent to the Chief Information Officer, Patent and Trademark Office, Washington, D.C. 20231. **DO NOT SEND FEES OR COMPLETED FORMS TO THIS ADDRESS. SEND FEES AND THIS FORM TO: Box Issue Fee, Assistant Commissioner for Patents, Washington D.C. 20231**

Under the Paperwork Reduction Act of 1995, no persons are required to respond to a collection of information unless it displays a valid OMB control number.

09/26/2000 MWOLDER2 00000102 09181738
01 FC:242 605.00 OP
02 FC:561 30.00 OP

TRANSMIT THIS FORM WITH FEE

WEST

[Help](#) [Logout](#)

[Main Menu](#) [Search Form](#) [Posting Counts](#) [Show S Numbers](#) [Edit S Numbers](#)

Search Results -

Terms	Documents
14 and transmitter	28

Database:

Refine Search:

Search History

<u>DB Name</u>	<u>Query</u>	<u>Hit Count</u>	<u>Set Name</u>
USPT	14 and transmitter	28	<u>L6</u>
USPT	13 and heart	0	<u>L5</u>
USPT	12 and heart	64	<u>L4</u>
USPT	12 and 377/24.2.ccls.	7	<u>L3</u>
USPT	step adj counter	1963	<u>L2</u>
USPT	step counter	1197322	<u>L1</u>

PATENT APPLICATION FEE DETERMINATION RECORD

Effective October 1, 1997

Application or Docket Number

09/18/738

CLAIMS AS FILED - PART I

FOR	(Column 1) NUMBER FILED	(Column 2) NUMBER EXTRA
BASIC FEE		
TOTAL CLAIMS	45 minus 20 =	* 25
INDEPENDENT CLAIMS	5 minus 3 =	* 2
MULTIPLE DEPENDENT CLAIM PRESENT		

* If the difference in column 1 is less than zero, enter "0" in column 2

SMALL ENTITY TYPE <input type="checkbox"/>		OR	OTHER THAN SMALL ENTITY	
RATE	FEE		RATE	FEE
	395.00	OR		790.00
x\$11=		OR	x\$22=	550
x41=		OR	x82=	164
+135=		OR	+270=	
TOTAL		OR	TOTAL	1504

CLAIMS AS AMENDED - PART II

AMENDMENT A	(Column 1)	(Column 2)	(Column 3)	(Column 4)	(Column 5)
	CLAIMS REMAINING AFTER AMENDMENT	HIGHEST NUMBER PREVIOUSLY PAID FOR	PRESENT EXTRA		
Total	* 36	Minus	** 45	=	
Independent	* 8	Minus	*** 5	=	3
FIRST PRESENTATION OF MULTIPLE DEPENDENT CLAIM					

SMALL ENTITY		OR	OTHER THAN SMALL ENTITY	
RATE	ADDITIONAL FEE		RATE	ADDITIONAL FEE
x\$11=		OR	x\$22=	-
x41=		OR	x82=	234
+135=		OR	+270=	-
TOTAL ADDIT. FEE		OR	TOTAL ADDIT. FEE	234

AMENDMENT B	(Column 1)	(Column 2)	(Column 3)	(Column 4)	(Column 5)
	CLAIMS REMAINING AFTER AMENDMENT	HIGHEST NUMBER PREVIOUSLY PAID FOR	PRESENT EXTRA		
Total	*	Minus	**	=	
Independent	*	Minus	***	=	
FIRST PRESENTATION OF MULTIPLE DEPENDENT CLAIM					

SMALL ENTITY		OR	OTHER THAN SMALL ENTITY	
RATE	ADDITIONAL FEE		RATE	ADDITIONAL FEE
x\$11=		OR	x\$22=	
x41=		OR	x82=	
+135=		OR	+270=	
TOTAL ADDIT. FEE		OR	TOTAL ADDIT. FEE	

AMENDMENT C	(Column 1)	(Column 2)	(Column 3)	(Column 4)	(Column 5)
	CLAIMS REMAINING AFTER AMENDMENT	HIGHEST NUMBER PREVIOUSLY PAID FOR	PRESENT EXTRA		
Total	*	Minus	**	=	
Independent	*	Minus	***	=	
FIRST PRESENTATION OF MULTIPLE DEPENDENT CLAIM					

SMALL ENTITY		OR	OTHER THAN SMALL ENTITY	
RATE	ADDITIONAL FEE		RATE	ADDITIONAL FEE
x\$11=		OR	x\$22=	
x41=		OR	x82=	
+135=		OR	+270=	
TOTAL ADDIT. FEE		OR	TOTAL ADDIT. FEE	

* If the entry in column 1 is less than the entry in column 2, write "0" in column 3.
 ** If the "Highest Number Previously Paid For" IN THIS SPACE is less than 20, enter "20."
 *** If the "Highest Number Previously Paid For" IN THIS SPACE is less than 3, enter "3."
 The "Highest Number Previously Paid For" (Total or Independent) is the highest number found in the appropriate box in column 1.