

AO 120 (Rev. 08/10)

| | |
|---|---|
| TO: Mail Stop 8 Director of the U.S. Patent and Trademark Office P.O. Box 1450 Alexandria, VA 22313-1450 | REPORT ON THE FILING OR DETERMINATION OF AN ACTION REGARDING A PATENT OR TRADEMARK |
|---|---|

In Compliance with 35 U.S.C. § 290 and/or 15 U.S.C. § 1116 you are hereby advised that a court action has been filed in the U.S. District Court Eastern District of Texas, Marshall Division on the following
 Trademarks or Patents. (the patent action involves 35 U.S.C. § 292.);

| | | |
|---|--------------------------------|---|
| DOCKET NO. 2:16-cv-640 | DATE FILED 6/14/2016 | U.S. DISTRICT COURT Eastern District of Texas, Marshall Division |
| PLAINTIFF UNILOC USA, INC., and UNILOC LUXEMBOURG, S.A. | | DEFENDANT KAKAO CORPORATION |
| PATENT OR TRADEMARK NO. | DATE OF PATENT OR TRADEMARK | HOLDER OF PATENT OR TRADEMARK |
| 1 7,535,890 | 5/19/2009 | UNILOC LUXEMBOURG, S.A. |
| 2 8,199,747 | 6/12/2012 | UNILOC LUXEMBOURG, S.A. |
| 3 8,724,622 | 5/13/2014 | UNILOC LUXEMBOURG, S.A. |
| 4 8,995,433 | 3/31/2015 | UNILOC LUXEMBOURG, S.A. |
| 5 8,243,723 | 8/14/2012 | UNILOC LUXEMBOURG, S.A. |

In the above—entitled case, the following patent(s)/ trademark(s) have been included:

| | | |
|----------------------------|---|-------------------------------|
| DATE INCLUDED | INCLUDED BY <input type="checkbox"/> Amendment <input type="checkbox"/> Answer <input type="checkbox"/> Cross Bill <input type="checkbox"/> Other Pleading | |
| PATENT OR TRADEMARK NO. | DATE OF PATENT OR TRADEMARK | HOLDER OF PATENT OR TRADEMARK |
| 1 | | |
| 2 | | |
| 3 | | |
| 4 | | |
| 5 | | |

In the above—entitled case, the following decision has been rendered or judgement issued:

| |
|---|
| DECISION/JUDGEMENT Kakao Corp. ("Kakao") should be DISMISSED WITH PREJUDICE |
|---|

| | | |
|-----------|-------------------------|-----------------|
| CLERK | (BY) DEPUTY CLERK ch | DATE 3/17/17 |
|-----------|-------------------------|-----------------|

Copy 1—Upon initiation of action, mail this copy to Director Copy 3—Upon termination of action, mail this copy to Director
 Copy 2—Upon filing document adding patent(s), mail this copy to Director Copy 4—Case file copy

AO 120 (Rev. 08/10)

| | |
|---|---|
| TO: Mail Stop 8 Director of the U.S. Patent and Trademark Office P.O. Box 1450 Alexandria, VA 22313-1450 | REPORT ON THE FILING OR DETERMINATION OF AN ACTION REGARDING A PATENT OR TRADEMARK |
|---|---|

In Compliance with 35 U.S.C. § 290 and/or 15 U.S.C. § 1116 you are hereby advised that a court action has been filed in the U.S. District Court Eastern District of Texas, Marshall Division on the following
 Trademarks or Patents. (the patent action involves 35 U.S.C. § 292.);

| | | |
|---|--------------------------------|---|
| DOCKET NO. 2:16-cv-643 | DATE FILED 6/14/2016 | U.S. DISTRICT COURT Eastern District of Texas, Marshall Division |
| PLAINTIFF UNILOC USA, INC., and UNILOC LUXEMBOURG, S.A. | | DEFENDANT VIBER MEDIA S.A.R.L., |
| PATENT OR TRADEMARK NO. | DATE OF PATENT OR TRADEMARK | HOLDER OF PATENT OR TRADEMARK |
| 1 8,724,622 | 5/13/2014 | UNILOC LUXEMBOURG, S.A. |
| 2 8,995,433 | 3/31/2015 | UNILOC LUXEMBOURG, S.A. |
| 3 7,535,890 | 5/19/2009 | UNILOC LUXEMBOURG, S.A. |
| 4 8,199,747 | 6/12/2012 | UNILOC LUXEMBOURG, S.A. |
| 5 8,243,723 | 8/14/2012 | UNILOC LUXEMBOURG, S.A. |

In the above—entitled case, the following patent(s)/ trademark(s) have been included:

| | | |
|----------------------------|---|-------------------------------|
| DATE INCLUDED | INCLUDED BY <input type="checkbox"/> Amendment <input type="checkbox"/> Answer <input type="checkbox"/> Cross Bill <input type="checkbox"/> Other Pleading | |
| PATENT OR TRADEMARK NO. | DATE OF PATENT OR TRADEMARK | HOLDER OF PATENT OR TRADEMARK |
| 1 | | |
| 2 | | |
| 3 | | |
| 4 | | |
| 5 | | |

In the above—entitled case, the following decision has been rendered or judgement issued:

| |
|--|
| DECISION/JUDGEMENT Having considered the Stipulation, the Court finds that the case should be DISMISSED under Federal Rule of Civil Procedure 41. |
|--|

| | | |
|-----------|--------------------------------|-----------------|
| CLERK | (BY) DEPUTY CLERK M. Martin | DATE 1/19/17 |
|-----------|--------------------------------|-----------------|

Copy 1—Upon initiation of action, mail this copy to Director Copy 3—Upon termination of action, mail this copy to Director
 Copy 2—Upon filing document adding patent(s), mail this copy to Director Copy 4—Case file copy

AO 120 (Rev. 08/10)

| | |
|---|---|
| TO: Mail Stop 8 Director of the U.S. Patent and Trademark Office P.O. Box 1450 Alexandria, VA 22313-1450 | REPORT ON THE FILING OR DETERMINATION OF AN ACTION REGARDING A PATENT OR TRADEMARK |
|---|---|

In Compliance with 35 U.S.C. § 290 and/or 15 U.S.C. § 1116 you are hereby advised that a court action has been filed in the U.S. District Court Eastern District of Texas, Marshall Division on the following
 Trademarks or Patents. (the patent action involves 35 U.S.C. § 292.):

| | | |
|---|--------------------------------|---|
| DOCKET NO. 2:16-cv-733 | DATE FILED 7/5/2016 | U.S. DISTRICT COURT Eastern District of Texas, Marshall Division |
| PLAINTIFF UNILOC USA, INC., and UNILOC LUXEMBOURG, S.A. | | DEFENDANT TANGOME, INC. d/b/a TANGO |
| PATENT OR TRADEMARK NO. | DATE OF PATENT OR TRADEMARK | HOLDER OF PATENT OR TRADEMARK |
| 1 7,535,890 | 5/19/2009 | UNILOC LUXEMBOURG, S.A. |
| 2 8,199,747 | 6/12/2012 | UNILOC LUXEMBOURG, S.A. |
| 3 8,243,723 | 8/14/2012 | UNILOC LUXEMBOURG, S.A. |
| 4 8,724,622 | 5/13/2014 | UNILOC LUXEMBOURG, S.A. |
| 5 8,995,433 | 3/31/2015 | UNILOC LUXEMBOURG, S.A. |

In the above—entitled case, the following patent(s)/ trademark(s) have been included:

| | | |
|----------------------------|---|-------------------------------|
| DATE INCLUDED | INCLUDED BY <input type="checkbox"/> Amendment <input type="checkbox"/> Answer <input type="checkbox"/> Cross Bill <input type="checkbox"/> Other Pleading | |
| PATENT OR TRADEMARK NO. | DATE OF PATENT OR TRADEMARK | HOLDER OF PATENT OR TRADEMARK |
| 1 | | |
| 2 | | |
| 3 | | |
| 4 | | |
| 5 | | |

In the above—entitled case, the following decision has been rendered or judgement issued:

| |
|--|
| DECISION/JUDGEMENT ORDER OF DISMISSAL WITH PREJUDICE OF ALL CLAIMS BY UNILOC AGAINST TANGOME, INC. d/b/a TANGO |
|--|

| | | |
|----------------------------------|-----------------------------------|------------------------|
| CLERK <i>David A. O'Poole</i> | (BY) DEPUTY CLERK Nakisha Love | DATE 1/11/17 |
|----------------------------------|-----------------------------------|------------------------|

Copy 1—Upon initiation of action, mail this copy to Director Copy 3—Upon termination of action, mail this copy to Director
 Copy 2—Upon filing document adding patent(s), mail this copy to Director Copy 4—Case file copy

AO 120 (Rev. 08/10)

| | |
|---|---|
| TO: Mail Stop 8 Director of the U.S. Patent and Trademark Office P.O. Box 1450 Alexandria, VA 22313-1450 | REPORT ON THE FILING OR DETERMINATION OF AN ACTION REGARDING A PATENT OR TRADEMARK |
|---|---|

In Compliance with 35 U.S.C. § 290 and/or 15 U.S.C. § 1116 you are hereby advised that a court action has been filed in the U.S. District Court Eastern District of Texas, Marshall Division on the following
 Trademarks or Patents. (the patent action involves 35 U.S.C. § 292.);

| | | |
|---|--------------------------------|---|
| DOCKET NO. 2:16-cv-893 | DATE FILED 8/11/2016 | U.S. DISTRICT COURT Eastern District of Texas, Marshall Division |
| PLAINTIFF UNILOC USA, INC., and UNILOC LUXEMBOURG, S.A. | | DEFENDANT VONAGE HOLDINGS CORP. & VONAGE AMERICAS, INC. |
| PATENT OR TRADEMARK NO. | DATE OF PATENT OR TRADEMARK | HOLDER OF PATENT OR TRADEMARK |
| 1 8,724,622 | 5/31/2014 | UNILOC LUXEMBOURG, S.A. |
| 2 8,995,433 | 3/31/2015 | UNILOC LUXEMBOURG, S.A. |
| 3 8,243,723 | 8/14/2012 | UNILOC LUXEMBOURG, S.A. |
| 4 7,535,890 | 5/19/2009 | UNILOC LUXEMBOURG, S.A. |
| 5 | | |

In the above—entitled case, the following patent(s)/ trademark(s) have been included:

| | |
|----------------------------|---|
| DATE INCLUDED | INCLUDED BY <input type="checkbox"/> Amendment <input type="checkbox"/> Answer <input type="checkbox"/> Cross Bill <input type="checkbox"/> Other Pleading |
| PATENT OR TRADEMARK NO. | DATE OF PATENT OR TRADEMARK |
| 1 | |
| 2 | |
| 3 | |
| 4 | |
| 5 | |

In the above—entitled case, the following decision has been rendered or judgement issued:

| |
|---|
| DECISION/JUDGEMENT Defendants Vonage Holdings Corp. and Vonage Americas, Inc. are dismissed with prejudice |
|---|

| | | |
|---------------|-----------------------------|----------------------|
| CLERK | (BY) DEPUTY CLERK ch | DATE 11/17/16 |
|---------------|-----------------------------|----------------------|

Copy 1—Upon initiation of action, mail this copy to Director Copy 3—Upon termination of action, mail this copy to Director
 Copy 2—Upon filing document adding patent(s), mail this copy to Director Copy 4—Case file copy



UNITED STATES PATENT AND TRADEMARK OFFICE

UNITED STATES DEPARTMENT OF COMMERCE
United States Patent and Trademark Office
Address: COMMISSIONER FOR PATENTS
P.O. Box 1450
Alexandria, Virginia 22313-1450
www.uspto.gov

| APPLICATION NUMBER | FILING OR 371(C) DATE | FIRST NAMED APPLICANT | ATTY. DOCKET NO./TITLE |
|--------------------|-----------------------|-----------------------|------------------------|
| 12/398,063 | 03/04/2009 | Michael J. Rojas | EMP0023-US |

CONFIRMATION NO. 9351

POA ACCEPTANCE LETTER

96051
Uniloc USA Inc.
Legacy Town Center
7160 Dallas Parkway
Suite 380
Plano, TX 75024



Date Mailed: 09/23/2016

NOTICE OF ACCEPTANCE OF POWER OF ATTORNEY

This is in response to the Power of Attorney filed 09/15/2016.

The Power of Attorney in this application is accepted. Correspondence in this application will be mailed to the above address as provided by 37 CFR 1.33.

Questions about the contents of this notice and the requirements it sets forth should be directed to the Office of Data Management, Application Assistance Unit, at (571) 272-4000 or (571) 272-4200 or 1-888-786-0101.

/sleutchit/



UNITED STATES PATENT AND TRADEMARK OFFICE

UNITED STATES DEPARTMENT OF COMMERCE
United States Patent and Trademark Office
Address: COMMISSIONER FOR PATENTS
P.O. Box 1450
Alexandria, Virginia 22313-1450
www.uspto.gov

| APPLICATION NUMBER | FILING OR 371(C) DATE | FIRST NAMED APPLICANT | ATTY. DOCKET NO./TITLE |
|--------------------|-----------------------|-----------------------|------------------------|
| 12/398,063 | 03/04/2009 | Michael J. Rojas | EMP0023-US |

CONFIRMATION NO. 9351

POWER OF ATTORNEY NOTICE

67050
KASHA LAW LLC
14532 Dufief Mill Road
North Potomac, MD 20878



Date Mailed: 09/23/2016

NOTICE REGARDING CHANGE OF POWER OF ATTORNEY

This is in response to the Power of Attorney filed 09/15/2016.

- The Power of Attorney to you in this application has been revoked by the assignee who has intervened as provided by 37 CFR 3.71. Future correspondence will be mailed to the new address of record(37 CFR 1.33).

Questions about the contents of this notice and the requirements it sets forth should be directed to the Office of Data Management, Application Assistance Unit, at (571) 272-4000 or (571) 272-4200 or 1-888-786-0101.

/sleutchit/

Under the Paperwork Reduction Act of 1995 no persons are required to respond to a collection of information unless it displays a valid OMB control number

| | | |
|---|----------------------|--|
| PATENT - POWER OF ATTORNEY OR REVOCATION OF POWER OF ATTORNEY WITH A NEW POWER OF ATTORNEY AND CHANGE OF CORRESPONDENCE ADDRESS | Patent Number | 8,243,723 |
| | Issue Date | August 14, 2012 |
| | First Named Inventor | Michael J. ROJAS |
| | Title | SYSTEM AND METHOD FOR INSTANT VOIP MESSAGING |
| | Attorney Docket No. | UN-NP-IT-194 |

I hereby revoke all previous powers of attorney given in the above-identified patent.

A Power of Attorney is submitted herewith.

OR

I hereby appoint Practitioner(s) associated with the Customer Number identified in the box at right as my/our attorney(s) or agent(s) with respect to the patent identified above, and to transact all business in the United States Patent and Trademark Office connected therewith: 96051

OR

I hereby appoint Practitioner(s) named below as my/our attorney(s) or agent(s) with respect to the patent identified above, and to transact all business in the United States Patent and Trademark Office connected therewith:

| Practitioner(s) Name | Registration Number |
|----------------------|---------------------|
| | |
| | |
| | |

Please recognize or change the correspondence address for the above-identified patent to:

The address associated with the above-identified Customer Number.

OR

The address associated with the Customer Number identified in the box at right:

OR

Firm or Individual Name

Address

City State Zip

Country

Telephone Email

I am the:

Applicant.

OR

Patent owner.
 Statement under 37 CFR 3.73(c) (Form PTO/AIA/96) submitted herewith or filed on _____

SIGNATURE of Applicant or Patent Owner

| | | | |
|-------------------|---|-----------|--|
| Signature |  | Date | |
| Name | Craig S. Etteregoyen | Telephone | |
| Title and Company | CEO of Uniloc Luxembourg S.A. | | |

NOTE: Signatures of all the applicants or patent owners of the entire interest or their representative(s) are required. If more than one signature is required, submit multiple forms, check the box below, and identify the total number of forms submitted in the blank below.

A total of 1 forms are submitted.

This collection of information is required by 37 CFR 1.31, 1.32, and 1.33. The information is required to obtain or retain a benefit by the public, which is to update (and by the USPTO to process) the file of a patent or reexamination proceeding. Confidentiality is governed by 35 U.S.C. 122 and 37 CFR 1.14. This collection is estimated to take 3 minutes to complete, including gathering, preparing, and submitting the completed application form to the USPTO. Time will vary depending upon the individual case. Any comments on the amount of time you require to complete this form and/or suggestions for reducing this burden, should be sent to the Chief Information Officer, U.S. Patent and Trademark Office, U.S. Department of Commerce, P.O. Box 1450, Alexandria, VA 22313-1450. DO NOT SEND FEES OR COMPLETED FORMS TO THIS ADDRESS. SEND TO: Commissioner for Patents, P.O. Box 1450, Alexandria, VA 22313-1450.
 If you need assistance in completing the form, call 1-800-PTO-9199 and select option 2.

Under the Paperwork Reduction Act of 1995, no persons are required to respond to a collection of information unless it displays a valid OMB control number.

"FEE ADDRESS" INDICATION FORM

Address to:
Mail Stop M Correspondence
Commissioner for Patents
P.O. Box 1450
Alexandria, VA 22313-1450

Fax to:
571-273-6500

- OR -

INSTRUCTIONS: The issue fee must have been paid for application(s) listed on this form. In addition, only an address represented by a Customer Number can be established as the fee address for maintenance fee purposes (hereafter, fee address). A fee address should be established when correspondence related to maintenance fees should be mailed to a different address than the correspondence address for the application. **When to check the first box below:** If you have a Customer Number to represent the fee address. **When to check the second box below:** If you have no Customer Number representing the desired fee address, in which case a completed Request for Customer Number (PTO/SB/125) must be attached to this form. For more information on Customer Numbers, see the Manual of Patent Examining Procedure (MPEP) § 403.

For the following listed application(s), please recognize as the "Fee Address" under the provisions of 37 CFR 1.363 the address associated with:



Customer Number:

96051

OR



The attached Request for Customer Number (PTO/SB/125) form.

| PATENT NUMBER (if known) | APPLICATION NUMBER |
|-----------------------------|--------------------|
| 8,243,723 | 12/398,063 |

Completed by (check one):



Applicant/Inventor

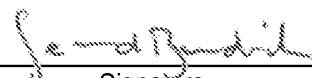

Signature



Attorney or Agent of record 51,513
 (Reg. No.)

Sean D. Burdick

Typed or printed name



Assignee of record of the entire interest. See 37 CFR 3.71.
 Statement under 37 CFR 3.73(b) is enclosed.
 (Form PTO/SB/96)

972-905-9580 x227

Requester's telephone number



Assignee recorded at Reel _____ Frame _____

September 15, 2016

Date

NOTE: Signatures of all the inventors or assignees of record of the entire interest or their representative(s) are required. Submit multiple forms if more than one signature is required, see below*.



* Total of _____ forms are submitted.

This collection of information is required by 37 CFR 1.363. The information is required to obtain or retain a benefit by the public which is to file (and by the USPTO to process) an application. Confidentiality is governed by 35 U.S.C. 122 and 37 CFR 1.11 and 1.14. This collection is estimated to take 5 minutes to complete, including gathering, preparing, and submitting the completed application form to the USPTO. Time will vary depending upon the individual case. Any comments on the amount of time you require to complete this form and/or suggestions for reducing this burden, should be sent to the Chief Information Officer, U.S. Patent and Trademark Office, U.S. Department of Commerce, P.O. Box 1450, Alexandria, VA 22313-1450. DO NOT SEND COMPLETE D FORMS TO THIS ADDRESS. SEND TO: Mail Stop M Correspondence, Commissioner for Patents, P.O. Box 1450, Alexandria, VA 22313-1450.

If you need assistance in completing the form, call 1-800-PTO-9199 and select option 2.

STATEMENT UNDER 37 CFR 3.73(b)

Applicant/Patent Owner: Uniloc Luxembourg S.A.

Application No./Patent No.: 8,243,723

Filed/Issue Date: August 14, 2012

Titled: SYSTEM AND METHOD FOR INSTANT VOIP MESSAGING

Uniloc Luxembourg S.A., a corporation

(Name of Assignee)

(Type of Assignee, e.g., corporation, partnership, university, government agency, etc.)

states that it is:

- 1. the assignee of the entire right, title, and interest in;
- 2. an assignee of less than the entire right, title, and interest in (The extent (by percentage) of its ownership interest is _____ %); or
- 3. the assignee of an undivided interest in the entirety of (a complete assignment from one of the joint inventors was made)

the patent application/patent identified above, by virtue of either:

A. An assignment from the inventor(s) of the patent application/patent identified above. The assignment was recorded in the United States Patent and Trademark Office at Reel _____, Frame _____, or for which a copy therefore is attached.

OR

B. A chain of title from the inventor(s), of the patent application/patent identified above, to the current assignee as follows:

1. From: Michael J. ROJAS To: Ayalogic, Inc.

The document was recorded in the United States Patent and Trademark Office at Reel 014827, Frame 0059, or for which a copy thereof is attached.

2. From: Ayalogic, Inc. To: Empire IP LLC

The document was recorded in the United States Patent and Trademark Office at Reel 030922, Frame 0335, or for which a copy thereof is attached.

3. From: Empire IP LLC To: Uniloc Luxembourg S.A.

The document was recorded in the United States Patent and Trademark Office at Reel 038963, Frame 0343, or for which a copy thereof is attached.

Additional documents in the chain of title are listed on a supplemental sheet(s).

As required by 37 CFR 3.73(b)(1)(i), the documentary evidence of the chain of title from the original owner to the assignee was, or concurrently is being, submitted for recordation pursuant to 37 CFR 3.11.

[NOTE: A separate copy (i.e., a true copy of the original assignment document(s)) must be submitted to Assignment Division in accordance with 37 CFR Part 3, to record the assignment in the records of the USPTO. See MPEP 302.08]

The undersigned (whose title is supplied below) is authorized to act on behalf of the assignee.

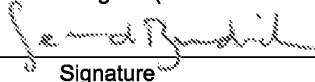

Signature

September 15, 2016

Date

Sean D. Burdick

Printed or Typed Name

IP Counsel

Title

This collection of information is required by 37 CFR 3.73(b). The information is required to obtain or retain a benefit by the public which is to file (and by the USPTO to process) an application. Confidentiality is governed by 35 U.S.C. 122 and 37 CFR 1.11 and 1.14. This collection is estimated to take 12 minutes to complete, including gathering, preparing, and submitting the completed application form to the USPTO. Time will vary depending upon the individual case. Any comments on the amount of time you require to complete this form and/or suggestions for reducing this burden, should be sent to the Chief Information Officer, U.S. Patent and Trademark Office, U.S. Department of Commerce, P.O. Box 1450, Alexandria, VA 22313-1450. DO NOT SEND FEES OR COMPLETED FORMS TO THIS ADDRESS. SEND TO: Commissioner for Patents, P.O. Box 1450, Alexandria, VA 22313-1450.

If you need assistance in completing the form, call 1-800-PTO-9199 and select option 2.

Electronic Acknowledgement Receipt

| | |
|---|--|
| EFS ID: | 26942673 |
| Application Number: | 12398063 |
| International Application Number: | |
| Confirmation Number: | 9351 |
| Title of Invention: | SYSTEM AND METHOD FOR INSTANT VOIP MESSAGING |
| First Named Inventor/Applicant Name: | Michael J. Rojas |
| Customer Number: | 67050 |
| Filer: | Sean Dylan Burdick/Kris Pangan |
| Filer Authorized By: | Sean Dylan Burdick |
| Attorney Docket Number: | EMP0023-US |
| Receipt Date: | 15-SEP-2016 |
| Filing Date: | 04-MAR-2009 |
| Time Stamp: | 19:05:32 |
| Application Type: | Utility under 35 USC 111(a) |

Payment information:

| | |
|------------------------|----|
| Submitted with Payment | no |
|------------------------|----|

File Listing:

| Document Number | Document Description | File Name | File Size(Bytes)/ Message Digest | Multi Part /.zip | Pages (if appl.) |
|-----------------|----------------------|-------------------------|--|------------------|------------------|
| 1 | Power of Attorney | IT-194_Executed_POA.pdf | 37602 29ddf0d0bc28316a15cb9e123c64dcb756e1c06 | no | 1 |

Warnings:

| Information: | | | | | |
|---|---|--|---|--------|---|
| 2 | Change of Address | IT-194_Fee_Address_Indication_Form.pdf | 268645 | no | 1 |
| | | | 081a4b7b885bc83ef198f4e9c9ae4520d85069 | | |
| Warnings: | | | | | |
| Information: | | | | | |
| 3 | Assignee showing of ownership per 37 CFR 3.73 | IT-194_Statement_Under_37_CFR.pdf | 526085 | no | 1 |
| | | | 795556b76d0a8666ae0e9d65c7240c1d962937b | | |
| Warnings: | | | | | |
| Information: | | | | | |
| | | | Total Files Size (in bytes): | 832332 | |
| <p>This Acknowledgement Receipt evidences receipt on the noted date by the USPTO of the indicated documents, characterized by the applicant, and including page counts, where applicable. It serves as evidence of receipt similar to a Post Card, as described in MPEP 503.</p> <p><u>New Applications Under 35 U.S.C. 111</u> If a new application is being filed and the application includes the necessary components for a filing date (see 37 CFR 1.53(b)-(d) and MPEP 506), a Filing Receipt (37 CFR 1.54) will be issued in due course and the date shown on this Acknowledgement Receipt will establish the filing date of the application.</p> <p><u>National Stage of an International Application under 35 U.S.C. 371</u> If a timely submission to enter the national stage of an international application is compliant with the conditions of 35 U.S.C. 371 and other applicable requirements a Form PCT/DO/EO/903 indicating acceptance of the application as a national stage submission under 35 U.S.C. 371 will be issued in addition to the Filing Receipt, in due course.</p> <p><u>New International Application Filed with the USPTO as a Receiving Office</u> If a new international application is being filed and the international application includes the necessary components for an international filing date (see PCT Article 11 and MPEP 1810), a Notification of the International Application Number and of the International Filing Date (Form PCT/RO/105) will be issued in due course, subject to prescriptions concerning national security, and the date shown on this Acknowledgement Receipt will establish the international filing date of the application.</p> | | | | | |

AO 120 (Rev. 08/10)

| | |
|---|---|
| TO: Mail Stop 8 Director of the U.S. Patent and Trademark Office P.O. Box 1450 Alexandria, VA 22313-1450 | REPORT ON THE FILING OR DETERMINATION OF AN ACTION REGARDING A PATENT OR TRADEMARK |
|---|---|

In Compliance with 35 U.S.C. § 290 and/or 15 U.S.C. § 1116 you are hereby advised that a court action has been filed in the U.S. District Court Eastern District of Texas, Marshall Division on the following
 Trademarks or Patents. (the patent action involves 35 U.S.C. § 292.);

| | | |
|---|--------------------------------|---|
| DOCKET NO. 2:16-cv-638 | DATE FILED 6/14/2016 | U.S. DISTRICT COURT Eastern District of Texas, Marshall Division |
| PLAINTIFF UNILOC USA, INC., and UNILOC LUXEMBOURG, S.A. | | DEFENDANT APPLE INC. |
| PATENT OR TRADEMARK NO. | DATE OF PATENT OR TRADEMARK | HOLDER OF PATENT OR TRADEMARK |
| 1 7,535,890 | 5/19/2009 | UNILOC LUXEMBOURG, S.A. |
| 2 8,995,433 | 3/31/2015 | UNILOC LUXEMBOURG, S.A. |
| 3 8,724,622 | 5/31/2014 | UNILOC LUXEMBOURG, S.A. |
| 4 8,243,723 | 8/14/2012 | UNILOC LUXEMBOURG, S.A. |
| 5 | | |

In the above—entitled case, the following patent(s)/ trademark(s) have been included:

| | | |
|----------------------------|---|-------------------------------|
| DATE INCLUDED | INCLUDED BY <input type="checkbox"/> Amendment <input type="checkbox"/> Answer <input type="checkbox"/> Cross Bill <input type="checkbox"/> Other Pleading | |
| PATENT OR TRADEMARK NO. | DATE OF PATENT OR TRADEMARK | HOLDER OF PATENT OR TRADEMARK |
| 1 | | |
| 2 | | |
| 3 | | |
| 4 | | |
| 5 | | |

In the above—entitled case, the following decision has been rendered or judgement issued:

| |
|--------------------|
| DECISION/JUDGEMENT |
|--------------------|

| | | |
|-------|-------------------|------|
| CLERK | (BY) DEPUTY CLERK | DATE |
|-------|-------------------|------|

Copy 1—Upon initiation of action, mail this copy to Director Copy 3—Upon termination of action, mail this copy to Director
 Copy 2—Upon filing document adding patent(s), mail this copy to Director Copy 4—Case file copy

AO 120 (Rev. 08/10)

| | |
|---|---|
| TO: Mail Stop 8 Director of the U.S. Patent and Trademark Office P.O. Box 1450 Alexandria, VA 22313-1450 | REPORT ON THE FILING OR DETERMINATION OF AN ACTION REGARDING A PATENT OR TRADEMARK |
|---|---|

In Compliance with 35 U.S.C. § 290 and/or 15 U.S.C. § 1116 you are hereby advised that a court action has been filed in the U.S. District Court Eastern District of Texas, Marshall Division on the following
 Trademarks or Patents. (the patent action involves 35 U.S.C. § 292.):

| | | |
|---|--------------------------------|---|
| DOCKET NO. 2:16-cv-722 | DATE FILED 7/5/2016 | U.S. DISTRICT COURT Eastern District of Texas, Marshall Division |
| PLAINTIFF UNILOC USA, INC., and UNILOC LUXEMBOURG, S.A. | | DEFENDANT AOL INC. |
| PATENT OR TRADEMARK NO. | DATE OF PATENT OR TRADEMARK | HOLDER OF PATENT OR TRADEMARK |
| 1 7,535,890 | 5/19/2009 | UNILOC LUXEMBOURG, S.A. |
| 2 8,199,747 | 6/12/2012 | UNILOC LUXEMBOURG, S.A. |
| 3 8,243,723 | 8/14/2012 | UNILOC LUXEMBOURG, S.A. |
| 4 8,724,622 | 5/13/2014 | UNILOC LUXEMBOURG, S.A. |
| 5 8,995,433 | 3/31/2015 | UNILOC LUXEMBOURG, S.A. |

In the above—entitled case, the following patent(s)/ trademark(s) have been included:

| | |
|----------------------------|---|
| DATE INCLUDED | INCLUDED BY <input type="checkbox"/> Amendment <input type="checkbox"/> Answer <input type="checkbox"/> Cross Bill <input type="checkbox"/> Other Pleading |
| PATENT OR TRADEMARK NO. | DATE OF PATENT OR TRADEMARK |
| 1 | HOLDER OF PATENT OR TRADEMARK |
| 2 | |
| 3 | |
| 4 | |
| 5 | |

In the above—entitled case, the following decision has been rendered or judgement issued:

| |
|--------------------|
| DECISION/JUDGEMENT |
|--------------------|

| | | |
|-------|-------------------|------|
| CLERK | (BY) DEPUTY CLERK | DATE |
|-------|-------------------|------|

Copy 1—Upon initiation of action, mail this copy to Director Copy 3—Upon termination of action, mail this copy to Director
 Copy 2—Upon filing document adding patent(s), mail this copy to Director Copy 4—Case file copy

AO 120 (Rev. 08/10)

| | |
|---|---|
| TO: Mail Stop 8 Director of the U.S. Patent and Trademark Office P.O. Box 1450 Alexandria, VA 22313-1450 | REPORT ON THE FILING OR DETERMINATION OF AN ACTION REGARDING A PATENT OR TRADEMARK |
|---|---|

In Compliance with 35 U.S.C. § 290 and/or 15 U.S.C. § 1116 you are hereby advised that a court action has been filed in the U.S. District Court Eastern District of Texas, Marshall Division on the following
 Trademarks or Patents. (the patent action involves 35 U.S.C. § 292.);

| DOCKET NO. 2:16-cv-725 | DATE FILED 7/5/2016 | U.S. DISTRICT COURT Eastern District of Texas, Marshall Division |
|---|-----------------------------|---|
| PLAINTIFF UNILOC USA, INC., and UNILOC LUXEMBOURG, S.A. | | DEFENDANT BEETALK PRIVATE LTD. |
| PATENT OR TRADEMARK NO. | DATE OF PATENT OR TRADEMARK | HOLDER OF PATENT OR TRADEMARK |
| 1 7,535,890 | 5/19/2009 | UNILOC LUXEMBOURG, S.A. |
| 2 8,199,747 | 6/12/2012 | UNILOC LUXEMBOURG, S.A. |
| 3 8,243,723 | 8/14/2012 | UNILOC LUXEMBOURG, S.A. |
| 4 8,724,622 | 5/13/2014 | UNILOC LUXEMBOURG, S.A. |
| 5 8,995,433 | 3/31/2015 | UNILOC LUXEMBOURG, S.A. |

In the above—entitled case, the following patent(s)/ trademark(s) have been included:

| DATE INCLUDED | INCLUDED BY |
|-------------------------|--|
| | <input type="checkbox"/> Amendment <input type="checkbox"/> Answer <input type="checkbox"/> Cross Bill <input type="checkbox"/> Other Pleading |
| PATENT OR TRADEMARK NO. | DATE OF PATENT OR TRADEMARK |
| 1 | |
| 2 | |
| 3 | |
| 4 | |
| 5 | |

In the above—entitled case, the following decision has been rendered or judgement issued:

| |
|--------------------|
| DECISION/JUDGEMENT |
|--------------------|

| | | |
|-------|-------------------|------|
| CLERK | (BY) DEPUTY CLERK | DATE |
|-------|-------------------|------|

Copy 1—Upon initiation of action, mail this copy to Director Copy 3—Upon termination of action, mail this copy to Director
 Copy 2—Upon filing document adding patent(s), mail this copy to Director Copy 4—Case file copy

AO 120 (Rev. 08/10)

| | |
|---|---|
| TO: Mail Stop 8 Director of the U.S. Patent and Trademark Office P.O. Box 1450 Alexandria, VA 22313-1450 | REPORT ON THE FILING OR DETERMINATION OF AN ACTION REGARDING A PATENT OR TRADEMARK |
|---|---|

In Compliance with 35 U.S.C. § 290 and/or 15 U.S.C. § 1116 you are hereby advised that a court action has been filed in the U.S. District Court Eastern District of Texas, Marshall Division on the following
 Trademarks or Patents. (the patent action involves 35 U.S.C. § 292.):

| | | |
|---|-----------------------------|---|
| DOCKET NO. 2:16-cv-893 | DATE FILED 8/11/2016 | U.S. DISTRICT COURT Eastern District of Texas, Marshall Division |
| PLAINTIFF UNILOC USA, INC., and UNILOC LUXEMBOURG, S.A. | | DEFENDANT VONAGE HOLDINGS CORP. & VONAGE AMERICAS, INC. |
| PATENT OR TRADEMARK NO. | DATE OF PATENT OR TRADEMARK | HOLDER OF PATENT OR TRADEMARK |
| 1 8,724,622 | 5/31/2014 | UNILOC LUXEMBOURG, S.A. |
| 2 8,995,433 | 3/31/2015 | UNILOC LUXEMBOURG, S.A. |
| 3 8,243,723 | 8/14/2012 | UNILOC LUXEMBOURG, S.A. |
| 4 7,535,890 | 5/19/2009 | UNILOC LUXEMBOURG, S.A. |
| 5 | | |

In the above—entitled case, the following patent(s)/ trademark(s) have been included:

| | | |
|-------------------------|---|-------------------------------|
| DATE INCLUDED | INCLUDED BY <input type="checkbox"/> Amendment <input type="checkbox"/> Answer <input type="checkbox"/> Cross Bill <input type="checkbox"/> Other Pleading | |
| PATENT OR TRADEMARK NO. | DATE OF PATENT OR TRADEMARK | HOLDER OF PATENT OR TRADEMARK |
| 1 | | |
| 2 | | |
| 3 | | |
| 4 | | |
| 5 | | |

In the above—entitled case, the following decision has been rendered or judgement issued:

| |
|--------------------|
| DECISION/JUDGEMENT |
|--------------------|

| | | |
|-------|-------------------|------|
| CLERK | (BY) DEPUTY CLERK | DATE |
|-------|-------------------|------|

Copy 1—Upon initiation of action, mail this copy to Director Copy 3—Upon termination of action, mail this copy to Director
 Copy 2—Upon filing document adding patent(s), mail this copy to Director Copy 4—Case file copy

AO 120 (Rev. 08/10)

| | |
|---|---|
| TO: Mail Stop 8 Director of the U.S. Patent and Trademark Office P.O. Box 1450 Alexandria, VA 22313-1450 | REPORT ON THE FILING OR DETERMINATION OF AN ACTION REGARDING A PATENT OR TRADEMARK |
|---|---|

In Compliance with 35 U.S.C. § 290 and/or 15 U.S.C. § 1116 you are hereby advised that a court action has been filed in the U.S. District Court Eastern District of Texas, Marshall Division on the following
 Trademarks or Patents. (the patent action involves 35 U.S.C. § 292.):

| | | |
|---|--------------------------------|---|
| DOCKET NO. 2:16-cv-892 | DATE FILED 8/11/2016 | U.S. DISTRICT COURT Eastern District of Texas, Marshall Division |
| PLAINTIFF UNILOC USA, INC., and UNILOC LUXEMBOURG, S.A. | | DEFENDANT TELEGRAM MESSENGER, LLP |
| PATENT OR TRADEMARK NO. | DATE OF PATENT OR TRADEMARK | HOLDER OF PATENT OR TRADEMARK |
| 1 8,724,622 | 5/13/2014 | UNILOC LUXEMBOURG, S.A. |
| 2 8,995,433 | 3/31/2015 | UNILOC LUXEMBOURG, S.A. |
| 3 7,535,890 | 5/19/2009 | UNILOC LUXEMBOURG, S.A. |
| 4 8,199,747 | 6/12/2012 | UNILOC LUXEMBOURG, S.A. |
| 5 8,243,723 | 8/14/2012 | UNILOC LUXEMBOURG, S.A. |

In the above—entitled case, the following patent(s)/ trademark(s) have been included:

| | |
|----------------------------|---|
| DATE INCLUDED | INCLUDED BY <input type="checkbox"/> Amendment <input type="checkbox"/> Answer <input type="checkbox"/> Cross Bill <input type="checkbox"/> Other Pleading |
| PATENT OR TRADEMARK NO. | DATE OF PATENT OR TRADEMARK |
| 1 | |
| 2 | |
| 3 | |
| 4 | |
| 5 | |

In the above—entitled case, the following decision has been rendered or judgement issued:

| |
|--------------------|
| DECISION/JUDGEMENT |
|--------------------|

| | | |
|-------|-------------------|------|
| CLERK | (BY) DEPUTY CLERK | DATE |
|-------|-------------------|------|

Copy 1—Upon initiation of action, mail this copy to Director Copy 3—Upon termination of action, mail this copy to Director
 Copy 2—Upon filing document adding patent(s), mail this copy to Director Copy 4—Case file copy

AO 120 (Rev. 08/10)

| | |
|---|---|
| TO: Mail Stop 8 Director of the U.S. Patent and Trademark Office P.O. Box 1450 Alexandria, VA 22313-1450 | REPORT ON THE FILING OR DETERMINATION OF AN ACTION REGARDING A PATENT OR TRADEMARK |
|---|---|

In Compliance with 35 U.S.C. § 290 and/or 15 U.S.C. § 1116 you are hereby advised that a court action has been filed in the U.S. District Court Eastern District of Texas, Marshall Division on the following
 Trademarks or Patents. (the patent action involves 35 U.S.C. § 292.);

| | | |
|---|--------------------------------|---|
| DOCKET NO. 2:16-cv-645 | DATE FILED 6/14/2016 | U.S. DISTRICT COURT Eastern District of Texas, Marshall Division |
| PLAINTIFF UNILOC USA, INC., and UNILOC LUXEMBOURG, S.A. | | DEFENDANT WHATSAPP, INC. |
| PATENT OR TRADEMARK NO. | DATE OF PATENT OR TRADEMARK | HOLDER OF PATENT OR TRADEMARK |
| 1 7,535,890 | 5/19/2009 | UNILOC LUXEMBOURG, S.A. |
| 2 8,199,747 | 6/12/2012 | UNILOC LUXEMBOURG, S.A. |
| 3 8,243,723 | 8/14/2012 | UNILOC LUXEMBOURG, S.A. |
| 4 8,724,622 | 5/13/2014 | UNILOC LUXEMBOURG, S.A. |
| 5 8,995,433 | 3/31/2015 | UNILOC LUXEMBOURG, S.A. |

In the above—entitled case, the following patent(s)/ trademark(s) have been included:

| | | |
|----------------------------|---|-------------------------------|
| DATE INCLUDED | INCLUDED BY <input type="checkbox"/> Amendment <input type="checkbox"/> Answer <input type="checkbox"/> Cross Bill <input type="checkbox"/> Other Pleading | |
| PATENT OR TRADEMARK NO. | DATE OF PATENT OR TRADEMARK | HOLDER OF PATENT OR TRADEMARK |
| 1 | | |
| 2 | | |
| 3 | | |
| 4 | | |
| 5 | | |

In the above—entitled case, the following decision has been rendered or judgement issued:

| |
|--------------------|
| DECISION/JUDGEMENT |
|--------------------|

| | | |
|-------|-------------------|------|
| CLERK | (BY) DEPUTY CLERK | DATE |
|-------|-------------------|------|

Copy 1—Upon initiation of action, mail this copy to Director Copy 3—Upon termination of action, mail this copy to Director
 Copy 2—Upon filing document adding patent(s), mail this copy to Director Copy 4—Case file copy

AO 120 (Rev. 08/10)

| | |
|---|---|
| TO: Mail Stop 8 Director of the U.S. Patent and Trademark Office P.O. Box 1450 Alexandria, VA 22313-1450 | REPORT ON THE FILING OR DETERMINATION OF AN ACTION REGARDING A PATENT OR TRADEMARK |
|---|---|

In Compliance with 35 U.S.C. § 290 and/or 15 U.S.C. § 1116 you are hereby advised that a court action has been filed in the U.S. District Court Eastern District of Texas, Marshall Division on the following
 Trademarks or Patents. (the patent action involves 35 U.S.C. § 292.);

| | | |
|---|--------------------------------|---|
| DOCKET NO. 2:16-cv-641 | DATE FILED 6/14/2016 | U.S. DISTRICT COURT Eastern District of Texas, Marshall Division |
| PLAINTIFF UNILOC USA, INC., and UNILOC LUXEMBOURG, S.A. | | DEFENDANT LINE EURO-AMERICAS CORP. & LINE CORPORATION |
| PATENT OR TRADEMARK NO. | DATE OF PATENT OR TRADEMARK | HOLDER OF PATENT OR TRADEMARK |
| 1 8,724,622 | 5/13/2014 | UNILOC LUXEMBOURG, S.A. |
| 2 8,995,433 | 3/31/2015 | UNILOC LUXEMBOURG, S.A. |
| 3 7,535,890 | 5/19/2009 | UNILOC LUXEMBOURG, S.A. |
| 4 8,199,747 | 6/12/2012 | UNILOC LUXEMBOURG, S.A. |
| 5 8,243,723 | 8/14/2012 | UNILOC LUXEMBOURG, S.A. |

In the above—entitled case, the following patent(s)/ trademark(s) have been included:

| | | |
|----------------------------|---|-------------------------------|
| DATE INCLUDED | INCLUDED BY <input type="checkbox"/> Amendment <input type="checkbox"/> Answer <input type="checkbox"/> Cross Bill <input type="checkbox"/> Other Pleading | |
| PATENT OR TRADEMARK NO. | DATE OF PATENT OR TRADEMARK | HOLDER OF PATENT OR TRADEMARK |
| 1 | | |
| 2 | | |
| 3 | | |
| 4 | | |
| 5 | | |

In the above—entitled case, the following decision has been rendered or judgement issued:

| |
|--------------------|
| DECISION/JUDGEMENT |
|--------------------|

| | | |
|-------|-------------------|------|
| CLERK | (BY) DEPUTY CLERK | DATE |
|-------|-------------------|------|

Copy 1—Upon initiation of action, mail this copy to Director Copy 3—Upon termination of action, mail this copy to Director
 Copy 2—Upon filing document adding patent(s), mail this copy to Director Copy 4—Case file copy

AO 120 (Rev. 08/10)

| | |
|---|---|
| TO: Mail Stop 8 Director of the U.S. Patent and Trademark Office P.O. Box 1450 Alexandria, VA 22313-1450 | REPORT ON THE FILING OR DETERMINATION OF AN ACTION REGARDING A PATENT OR TRADEMARK |
|---|---|

In Compliance with 35 U.S.C. § 290 and/or 15 U.S.C. § 1116 you are hereby advised that a court action has been filed in the U.S. District Court Eastern District of Texas, Marshall Division on the following
 Trademarks or Patents. (the patent action involves 35 U.S.C. § 292.);

| | | |
|---|--------------------------------|---|
| DOCKET NO. 2:16-cv-639 | DATE FILED 6/14/2016 | U.S. DISTRICT COURT Eastern District of Texas, Marshall Division |
| PLAINTIFF UNILOC USA, INC., and UNILOC LUXEMBOURG, S.A. | | DEFENDANT BLACKBERRY CORPORATION & BLACKBERRY LIMITED |
| PATENT OR TRADEMARK NO. | DATE OF PATENT OR TRADEMARK | HOLDER OF PATENT OR TRADEMARK |
| 1 8,724,622 | 5/13/2014 | UNILOC LUXEMBOURG, S.A. |
| 2 8,995,433 | 3/31/2015 | UNILOC LUXEMBOURG, S.A. |
| 3 7,535,890 | 5/19/2009 | UNILOC LUXEMBOURG, S.A. |
| 4 8,199,747 | 6/12/2012 | UNILOC LUXEMBOURG, S.A. |
| 5 8,243,723 | 8/14/2012 | UNILOC LUXEMBOURG, S.A. |

In the above—entitled case, the following patent(s)/ trademark(s) have been included:

| | | |
|----------------------------|---|-------------------------------|
| DATE INCLUDED | INCLUDED BY <input type="checkbox"/> Amendment <input type="checkbox"/> Answer <input type="checkbox"/> Cross Bill <input type="checkbox"/> Other Pleading | |
| PATENT OR TRADEMARK NO. | DATE OF PATENT OR TRADEMARK | HOLDER OF PATENT OR TRADEMARK |
| 1 | | |
| 2 | | |
| 3 | | |
| 4 | | |
| 5 | | |

In the above—entitled case, the following decision has been rendered or judgement issued:

| |
|--------------------|
| DECISION/JUDGEMENT |
|--------------------|

| | | |
|-------|-------------------|------|
| CLERK | (BY) DEPUTY CLERK | DATE |
|-------|-------------------|------|

Copy 1—Upon initiation of action, mail this copy to Director Copy 3—Upon termination of action, mail this copy to Director
 Copy 2—Upon filing document adding patent(s), mail this copy to Director Copy 4—Case file copy

AO 120 (Rev. 08/10)

| | |
|---|--|
| TO: Mail Stop 8 Director of the U.S. Patent and Trademark Office P.O. Box 1450 Alexandria, VA 22313-1450 | REPORT ON THE FILING OR DETERMINATION OF AN ACTION REGARDING A PATENT OR TRADEMARK |
|---|--|

In Compliance with 35 U.S.C. § 290 and/or 15 U.S.C. § 1116 you are hereby advised that a court action has been filed in the U.S. District Court Eastern District of Texas, Marshall Division on the following
 Trademarks or Patents. (the patent action involves 35 U.S.C. § 292.):

| | | |
|---|--------------------------------|---|
| DOCKET NO. 2:16-cv-728 | DATE FILED 7/5/2016 | U.S. DISTRICT COURT Eastern District of Texas, Marshall Division |
| PLAINTIFF UNILOC USA, INC., and UNILOC LUXEMBOURG, S.A. | | DEFENDANT FACEBOOK, INC. |
| PATENT OR TRADEMARK NO. | DATE OF PATENT OR TRADEMARK | HOLDER OF PATENT OR TRADEMARK |
| 1 7,535,890 | 5/19/2009 | UNILOC LUXEMBOURG, S.A. |
| 2 8,199,747 | 6/12/2012 | UNILOC LUXEMBOURG, S.A. |
| 3 8,243,723 | 8/14/2012 | UNILOC LUXEMBOURG, S.A. |
| 4 8,724,622 | 5/13/2014 | UNILOC LUXEMBOURG, S.A. |
| 5 8,995,433 | 3/31/2015 | UNILOC LUXEMBOURG, S.A. |

In the above—entitled case, the following patent(s)/ trademark(s) have been included:

| | | |
|----------------------------|---|-------------------------------|
| DATE INCLUDED | INCLUDED BY <input type="checkbox"/> Amendment <input type="checkbox"/> Answer <input type="checkbox"/> Cross Bill <input type="checkbox"/> Other Pleading | |
| PATENT OR TRADEMARK NO. | DATE OF PATENT OR TRADEMARK | HOLDER OF PATENT OR TRADEMARK |
| 1 | | |
| 2 | | |
| 3 | | |
| 4 | | |
| 5 | | |

In the above—entitled case, the following decision has been rendered or judgement issued:

| |
|--------------------|
| DECISION/JUDGEMENT |
|--------------------|

| | | |
|-------|-------------------|------|
| CLERK | (BY) DEPUTY CLERK | DATE |
|-------|-------------------|------|

Copy 1—Upon initiation of action, mail this copy to Director Copy 3—Upon termination of action, mail this copy to Director
 Copy 2—Upon filing document adding patent(s), mail this copy to Director Copy 4—Case file copy

AO 120 (Rev. 08/10)

| | |
|---|---|
| TO: Mail Stop 8 Director of the U.S. Patent and Trademark Office P.O. Box 1450 Alexandria, VA 22313-1450 | REPORT ON THE FILING OR DETERMINATION OF AN ACTION REGARDING A PATENT OR TRADEMARK |
|---|---|

In Compliance with 35 U.S.C. § 290 and/or 15 U.S.C. § 1116 you are hereby advised that a court action has been filed in the U.S. District Court Eastern District of Texas, Marshall Division on the following
 Trademarks or Patents. (the patent action involves 35 U.S.C. § 292.);

| | | |
|---|--------------------------------|---|
| DOCKET NO. 2:16-cv-644 | DATE FILED 6/14/2016 | U.S. DISTRICT COURT Eastern District of Texas, Marshall Division |
| PLAINTIFF UNILOC USA, INC., and UNILOC LUXEMBOURG, S.A. | | DEFENDANT VOXERNET LLC |
| PATENT OR TRADEMARK NO. | DATE OF PATENT OR TRADEMARK | HOLDER OF PATENT OR TRADEMARK |
| 1 8,724,622 | 5/13/2014 | UNILOC LUXEMBOURG, S.A. |
| 2 8,995,433 | 3/31/2015 | UNILOC LUXEMBOURG, S.A. |
| 3 7,535,890 | 5/19/2009 | UNILOC LUXEMBOURG, S.A. |
| 4 8,199,747 | 6/12/2012 | UNILOC LUXEMBOURG, S.A. |
| 5 8,243,723 | 8/14/2012 | UNILOC LUXEMBOURG, S.A. |

In the above—entitled case, the following patent(s)/ trademark(s) have been included:

| | | |
|----------------------------|---|-------------------------------|
| DATE INCLUDED | INCLUDED BY <input type="checkbox"/> Amendment <input type="checkbox"/> Answer <input type="checkbox"/> Cross Bill <input type="checkbox"/> Other Pleading | |
| PATENT OR TRADEMARK NO. | DATE OF PATENT OR TRADEMARK | HOLDER OF PATENT OR TRADEMARK |
| 1 | | |
| 2 | | |
| 3 | | |
| 4 | | |
| 5 | | |

In the above—entitled case, the following decision has been rendered or judgement issued:

| |
|--------------------|
| DECISION/JUDGEMENT |
|--------------------|

| | | |
|-------|-------------------|------|
| CLERK | (BY) DEPUTY CLERK | DATE |
|-------|-------------------|------|

Copy 1—Upon initiation of action, mail this copy to Director Copy 3—Upon termination of action, mail this copy to Director
 Copy 2—Upon filing document adding patent(s), mail this copy to Director Copy 4—Case file copy

AO 120 (Rev. 08/10)

| | |
|---|---|
| TO: Mail Stop 8 Director of the U.S. Patent and Trademark Office P.O. Box 1450 Alexandria, VA 22313-1450 | REPORT ON THE FILING OR DETERMINATION OF AN ACTION REGARDING A PATENT OR TRADEMARK |
|---|---|

In Compliance with 35 U.S.C. § 290 and/or 15 U.S.C. § 1116 you are hereby advised that a court action has been filed in the U.S. District Court Eastern District of Texas, Marshall Division on the following
 Trademarks or Patents. (the patent action involves 35 U.S.C. § 292.);

| | | |
|---|--------------------------------|---|
| DOCKET NO. 2:16-cv-643 | DATE FILED 6/14/2016 | U.S. DISTRICT COURT Eastern District of Texas, Marshall Division |
| PLAINTIFF UNILOC USA, INC., and UNILOC LUXEMBOURG, S.A. | | DEFENDANT VIBER MEDIA S.A.R.L., |
| PATENT OR TRADEMARK NO. | DATE OF PATENT OR TRADEMARK | HOLDER OF PATENT OR TRADEMARK |
| 1 8,724,622 | 5/13/2014 | UNILOC LUXEMBOURG, S.A. |
| 2 8,995,433 | 3/31/2015 | UNILOC LUXEMBOURG, S.A. |
| 3 7,535,890 | 5/19/2009 | UNILOC LUXEMBOURG, S.A. |
| 4 8,199,747 | 6/12/2012 | UNILOC LUXEMBOURG, S.A. |
| 5 8,243,723 | 8/14/2012 | UNILOC LUXEMBOURG, S.A. |

In the above—entitled case, the following patent(s)/ trademark(s) have been included:

| | | |
|----------------------------|---|-------------------------------|
| DATE INCLUDED | INCLUDED BY <input type="checkbox"/> Amendment <input type="checkbox"/> Answer <input type="checkbox"/> Cross Bill <input type="checkbox"/> Other Pleading | |
| PATENT OR TRADEMARK NO. | DATE OF PATENT OR TRADEMARK | HOLDER OF PATENT OR TRADEMARK |
| 1 | | |
| 2 | | |
| 3 | | |
| 4 | | |
| 5 | | |

In the above—entitled case, the following decision has been rendered or judgement issued:

| |
|--------------------|
| DECISION/JUDGEMENT |
|--------------------|

| | | |
|-------|-------------------|------|
| CLERK | (BY) DEPUTY CLERK | DATE |
|-------|-------------------|------|

Copy 1—Upon initiation of action, mail this copy to Director Copy 3—Upon termination of action, mail this copy to Director
 Copy 2—Upon filing document adding patent(s), mail this copy to Director Copy 4—Case file copy

AO 120 (Rev. 08/10)

| | |
|---|---|
| TO: Mail Stop 8 Director of the U.S. Patent and Trademark Office P.O. Box 1450 Alexandria, VA 22313-1450 | REPORT ON THE FILING OR DETERMINATION OF AN ACTION REGARDING A PATENT OR TRADEMARK |
|---|---|

In Compliance with 35 U.S.C. § 290 and/or 15 U.S.C. § 1116 you are hereby advised that a court action has been filed in the U.S. District Court Eastern District of Texas, Marshall Division on the following
 Trademarks or Patents. (the patent action involves 35 U.S.C. § 292.);

| | | |
|---|--------------------------------|---|
| DOCKET NO. 2:16-cv-642 | DATE FILED 6/14/2016 | U.S. DISTRICT COURT Eastern District of Texas, Marshall Division |
| PLAINTIFF UNILOC USA, INC., and UNILOC LUXEMBOURG, S.A. | | DEFENDANT SAMSUNG ELECTRONICS AMERICA, INC. |
| PATENT OR TRADEMARK NO. | DATE OF PATENT OR TRADEMARK | HOLDER OF PATENT OR TRADEMARK |
| 1 8,724,622 | 5/31/2014 | UNILOC LUXEMBOURG, S.A. |
| 2 8,995,433 | 3/31/2015 | UNILOC LUXEMBOURG, S.A. |
| 3 8,243,723 | 8/14/2012 | UNILOC LUXEMBOURG, S.A. |
| 4 7,535,890 | 5/19/2009 | UNILOC LUXEMBOURG, S.A. |
| 5 | | |

In the above—entitled case, the following patent(s)/ trademark(s) have been included:

| | | |
|----------------------------|---|-------------------------------|
| DATE INCLUDED | INCLUDED BY <input type="checkbox"/> Amendment <input type="checkbox"/> Answer <input type="checkbox"/> Cross Bill <input type="checkbox"/> Other Pleading | |
| PATENT OR TRADEMARK NO. | DATE OF PATENT OR TRADEMARK | HOLDER OF PATENT OR TRADEMARK |
| 1 | | |
| 2 | | |
| 3 | | |
| 4 | | |
| 5 | | |

In the above—entitled case, the following decision has been rendered or judgement issued:

| |
|--------------------|
| DECISION/JUDGEMENT |
|--------------------|

| | | |
|-------|-------------------|------|
| CLERK | (BY) DEPUTY CLERK | DATE |
|-------|-------------------|------|

Copy 1—Upon initiation of action, mail this copy to Director Copy 3—Upon termination of action, mail this copy to Director
 Copy 2—Upon filing document adding patent(s), mail this copy to Director Copy 4—Case file copy

AO 120 (Rev. 08/10)

| | |
|--|---|
| TO: <p style="text-align: center;">Mail Stop 8 Director of the U.S. Patent and Trademark Office P.O. Box 1450 Alexandria, VA 22313-1450</p> | REPORT ON THE FILING OR DETERMINATION OF AN ACTION REGARDING A PATENT OR TRADEMARK |
|--|---|

In Compliance with 35 U.S.C. § 290 and/or 15 U.S.C. § 1116 you are hereby advised that a court action has been filed in the U.S. District Court Eastern District of Texas, Marshall Division on the following
 Trademarks or Patents. (the patent action involves 35 U.S.C. § 292.):

| | | |
|---|--------------------------------|---|
| DOCKET NO. 2:16-cv-640 | DATE FILED 6/14/2016 | U.S. DISTRICT COURT Eastern District of Texas, Marshall Division |
| PLAINTIFF UNILOC USA, INC., and UNILOC LUXEMBOURG, S.A. | | DEFENDANT KAKAO CORPORATION |
| PATENT OR TRADEMARK NO. | DATE OF PATENT OR TRADEMARK | HOLDER OF PATENT OR TRADEMARK |
| 1 7,535,890 | 5/19/2009 | UNILOC LUXEMBOURG, S.A. |
| 2 8,199,747 | 6/12/2012 | UNILOC LUXEMBOURG, S.A. |
| 3 8,724,622 | 5/13/2014 | UNILOC LUXEMBOURG, S.A. |
| 4 8,995,433 | 3/31/2015 | UNILOC LUXEMBOURG, S.A. |
| 5 8,243,723 | 8/14/2012 | UNILOC LUXEMBOURG, S.A. |

In the above—entitled case, the following patent(s)/ trademark(s) have been included:

| | | |
|----------------------------|---|-------------------------------|
| DATE INCLUDED | INCLUDED BY <input type="checkbox"/> Amendment <input type="checkbox"/> Answer <input type="checkbox"/> Cross Bill <input type="checkbox"/> Other Pleading | |
| PATENT OR TRADEMARK NO. | DATE OF PATENT OR TRADEMARK | HOLDER OF PATENT OR TRADEMARK |
| 1 | | |
| 2 | | |
| 3 | | |
| 4 | | |
| 5 | | |

In the above—entitled case, the following decision has been rendered or judgement issued:

| |
|--------------------|
| DECISION/JUDGEMENT |
|--------------------|

| | | |
|-------|-------------------|------|
| CLERK | (BY) DEPUTY CLERK | DATE |
|-------|-------------------|------|

Copy 1—Upon initiation of action, mail this copy to Director Copy 3—Upon termination of action, mail this copy to Director
 Copy 2—Upon filing document adding patent(s), mail this copy to Director Copy 4—Case file copy

AO 120 (Rev. 08/10)

| | |
|--|---|
| TO: Mail Stop 8 Director of the U.S. Patent and Trademark Office P.O. Box 1450 Alexandria, VA 22313-1450 | REPORT ON THE FILING OR DETERMINATION OF AN ACTION REGARDING A PATENT OR TRADEMARK |
|--|---|

In Compliance with 35 U.S.C. § 290 and/or 15 U.S.C. § 1116 you are hereby advised that a court action has been filed in the U.S. District Court Eastern District of Texas, Marshall Division on the following

Trademarks or Patents. (the patent action involves 35 U.S.C. § 292.):

| | | |
|---|--------------------------------|---|
| DOCKET NO. 2:16-cv-732 | DATE FILED 7/5/2016 | U.S. DISTRICT COURT Eastern District of Texas, Marshall Division |
| PLAINTIFF UNILOC USA, INC., and UNILOC LUXEMBOURG, S.A. | | DEFENDANT SONY INTERACTIVE ENTERTAINMENT LLC |
| PATENT OR TRADEMARK NO. | DATE OF PATENT OR TRADEMARK | HOLDER OF PATENT OR TRADEMARK |
| 1 7,535,890 | 5/19/2009 | UNILOC LUXEMBOURG, S.A. |
| 2 8,243,723 | 8/14/2012 | UNILOC LUXEMBOURG, S.A. |
| 3 8,995,433 | 3/31/2015 | UNILOC LUXEMBOURG, S.A. |
| 4 8,724,622 | 5/13/2014 | UNILOC LUXEMBOURG, S.A. |
| 5 | | |

In the above—entitled case, the following patent(s)/ trademark(s) have been included:

| | | | |
|----------------------------|---|-------------------------------|--|
| DATE INCLUDED | INCLUDED BY <input type="checkbox"/> Amendment <input type="checkbox"/> Answer <input type="checkbox"/> Cross Bill <input type="checkbox"/> Other Pleading | | |
| PATENT OR TRADEMARK NO. | DATE OF PATENT OR TRADEMARK | HOLDER OF PATENT OR TRADEMARK | |
| 1 | | | |
| 2 | | | |
| 3 | | | |
| 4 | | | |
| 5 | | | |

In the above—entitled case, the following decision has been rendered or judgement issued:

| |
|--------------------|
| DECISION/JUDGEMENT |
|--------------------|

| | | |
|-------|-------------------|------|
| CLERK | (BY) DEPUTY CLERK | DATE |
|-------|-------------------|------|

Copy 1—Upon initiation of action, mail this copy to Director Copy 3—Upon termination of action, mail this copy to Director
 Copy 2—Upon filing document adding patent(s), mail this copy to Director Copy 4—Case file copy

AO 120 (Rev. 08/10)

| | |
|---|---|
| TO: Mail Stop 8 Director of the U.S. Patent and Trademark Office P.O. Box 1450 Alexandria, VA 22313-1450 | REPORT ON THE FILING OR DETERMINATION OF AN ACTION REGARDING A PATENT OR TRADEMARK |
|---|---|

In Compliance with 35 U.S.C. § 290 and/or 15 U.S.C. § 1116 you are hereby advised that a court action has been filed in the U.S. District Court Eastern District of Texas, Marshall Division on the following
 Trademarks or Patents. (the patent action involves 35 U.S.C. § 292.):

| | | |
|---|--------------------------------|---|
| DOCKET NO. 2:16-cv-779 | DATE FILED 7/15/2016 | U.S. DISTRICT COURT Eastern District of Texas, Marshall Division |
| PLAINTIFF UNILOC USA, INC., and UNILOC LUXEMBOURG, S.A. | | DEFENDANT SHORETEL, INC. |
| PATENT OR TRADEMARK NO. | DATE OF PATENT OR TRADEMARK | HOLDER OF PATENT OR TRADEMARK |
| 1 7,535,890 | 5/19/2009 | UNILOC LUXEMBOURG, S.A. |
| 2 8,995,433 | 3/31/2015 | UNILOC LUXEMBOURG, S.A. |
| 3 8,724,622 | 5/13/2014 | UNILOC LUXEMBOURG, S.A. |
| 4 8,243,723 | 8/14/2012 | UNILOC LUXEMBOURG, S.A. |
| 5 | | |

In the above—entitled case, the following patent(s)/ trademark(s) have been included:

| | | |
|----------------------------|---|-------------------------------|
| DATE INCLUDED | INCLUDED BY <input type="checkbox"/> Amendment <input type="checkbox"/> Answer <input type="checkbox"/> Cross Bill <input type="checkbox"/> Other Pleading | |
| PATENT OR TRADEMARK NO. | DATE OF PATENT OR TRADEMARK | HOLDER OF PATENT OR TRADEMARK |
| 1 | | |
| 2 | | |
| 3 | | |
| 4 | | |
| 5 | | |

In the above—entitled case, the following decision has been rendered or judgement issued:

| |
|--------------------|
| DECISION/JUDGEMENT |
|--------------------|

| | | |
|-------|-------------------|------|
| CLERK | (BY) DEPUTY CLERK | DATE |
|-------|-------------------|------|

Copy 1—Upon initiation of action, mail this copy to Director Copy 3—Upon termination of action, mail this copy to Director
 Copy 2—Upon filing document adding patent(s), mail this copy to Director Copy 4—Case file copy

AO 120 (Rev. 08/10)

| | |
|---|--|
| TO: Mail Stop 8 Director of the U.S. Patent and Trademark Office P.O. Box 1450 Alexandria, VA 22313-1450 | REPORT ON THE FILING OR DETERMINATION OF AN ACTION REGARDING A PATENT OR TRADEMARK |
|---|--|

In Compliance with 35 U.S.C. § 290 and/or 15 U.S.C. § 1116 you are hereby advised that a court action has been filed in the U.S. District Court Eastern District of Texas, Marshall Division on the following
 Trademarks or Patents. (the patent action involves 35 U.S.C. § 292.):

| | | |
|---|--------------------------------|---|
| DOCKET NO. 2:16-cv-777 | DATE FILED 7/15/2016 | U.S. DISTRICT COURT Eastern District of Texas, Marshall Division |
| PLAINTIFF UNILOC USA, INC., and UNILOC LUXEMBOURG, S.A. | | DEFENDANT AVAYA INC., |
| PATENT OR TRADEMARK NO. | DATE OF PATENT OR TRADEMARK | HOLDER OF PATENT OR TRADEMARK |
| 1 7,535,890 | 5/19/2009 | UNILOC LUXEMBOURG, S.A. |
| 2 8,995,433 | 3/31/2015 | UNILOC LUXEMBOURG, S.A. |
| 3 8,724,622 | 5/13/2014 | UNILOC LUXEMBOURG, S.A. |
| 4 8,243,723 | 8/14/2012 | UNILOC LUXEMBOURG, S.A. |
| 5 8,199,747 | 6/12/2012 | UNILOC LUXEMBOURG, S.A. |

In the above—entitled case, the following patent(s)/ trademark(s) have been included:

| DATE INCLUDED | INCLUDED BY | |
|----------------------------|--|-------------------------------|
| | <input type="checkbox"/> Amendment <input type="checkbox"/> Answer <input type="checkbox"/> Cross Bill <input type="checkbox"/> Other Pleading | |
| PATENT OR TRADEMARK NO. | DATE OF PATENT OR TRADEMARK | HOLDER OF PATENT OR TRADEMARK |
| 1 | | |
| 2 | | |
| 3 | | |
| 4 | | |
| 5 | | |

In the above—entitled case, the following decision has been rendered or judgement issued:

| |
|--------------------|
| DECISION/JUDGEMENT |
|--------------------|

| | | |
|-------|-------------------|------|
| CLERK | (BY) DEPUTY CLERK | DATE |
|-------|-------------------|------|

Copy 1—Upon initiation of action, mail this copy to Director Copy 3—Upon termination of action, mail this copy to Director
 Copy 2—Upon filing document adding patent(s), mail this copy to Director Copy 4—Case file copy

AO 120 (Rev. 08/10)

| | |
|---|---|
| TO: Mail Stop 8 Director of the U.S. Patent and Trademark Office P.O. Box 1450 Alexandria, VA 22313-1450 | REPORT ON THE FILING OR DETERMINATION OF AN ACTION REGARDING A PATENT OR TRADEMARK |
|---|---|

In Compliance with 35 U.S.C. § 290 and/or 15 U.S.C. § 1116 you are hereby advised that a court action has been filed in the U.S. District Court Eastern District of Texas, Marshall Division on the following

Trademarks or Patents. (the patent action involves 35 U.S.C. § 292.):

| | | |
|---|--------------------------------|---|
| DOCKET NO. 2:16-cv-733 | DATE FILED 7/5/2016 | U.S. DISTRICT COURT Eastern District of Texas, Marshall Division |
| PLAINTIFF UNILOC USA, INC., and UNILOC LUXEMBOURG, S.A. | | DEFENDANT TANGOME, INC. d/b/a TANGO |
| PATENT OR TRADEMARK NO. | DATE OF PATENT OR TRADEMARK | HOLDER OF PATENT OR TRADEMARK |
| 1 7,535,890 | 5/19/2009 | UNILOC LUXEMBOURG, S.A. |
| 2 8,199,747 | 6/12/2012 | UNILOC LUXEMBOURG, S.A. |
| 3 8,243,723 | 8/14/2012 | UNILOC LUXEMBOURG, S.A. |
| 4 8,724,622 | 5/13/2014 | UNILOC LUXEMBOURG, S.A. |
| 5 8,995,433 | 3/31/2015 | UNILOC LUXEMBOURG, S.A. |

In the above—entitled case, the following patent(s)/ trademark(s) have been included:

| | |
|----------------------------|---|
| DATE INCLUDED | INCLUDED BY <input type="checkbox"/> Amendment <input type="checkbox"/> Answer <input type="checkbox"/> Cross Bill <input type="checkbox"/> Other Pleading |
| PATENT OR TRADEMARK NO. | DATE OF PATENT OR TRADEMARK |
| 1 | HOLDER OF PATENT OR TRADEMARK |
| 2 | |
| 3 | |
| 4 | |
| 5 | |

In the above—entitled case, the following decision has been rendered or judgement issued:

| |
|--------------------|
| DECISION/JUDGEMENT |
|--------------------|

| | | |
|-------|-------------------|------|
| CLERK | (BY) DEPUTY CLERK | DATE |
|-------|-------------------|------|

Copy 1—Upon initiation of action, mail this copy to Director Copy 3—Upon termination of action, mail this copy to Director
 Copy 2—Upon filing document adding patent(s), mail this copy to Director Copy 4—Case file copy

AO 120 (Rev. 08/10)

| | |
|--|---|
| TO: Mail Stop 8 Director of the U.S. Patent and Trademark Office P.O. Box 1450 Alexandria, VA 22313-1450 | REPORT ON THE FILING OR DETERMINATION OF AN ACTION REGARDING A PATENT OR TRADEMARK |
|--|---|

In Compliance with 35 U.S.C. § 290 and/or 15 U.S.C. § 1116 you are hereby advised that a court action has been filed in the U.S. District Court Eastern District of Texas, Marshall Division on the following

Trademarks or Patents. (the patent action involves 35 U.S.C. § 292.);

| | | |
|---|--------------------------------|---|
| DOCKET NO. 2:16-cv-731 | DATE FILED 7/5/2016 | U.S. DISTRICT COURT Eastern District of Texas, Marshall Division |
| PLAINTIFF UNILOC USA, INC., and UNILOC LUXEMBOURG, S.A. | | DEFENDANT GREEN TOMATO LIMITED |
| PATENT OR TRADEMARK NO. | DATE OF PATENT OR TRADEMARK | HOLDER OF PATENT OR TRADEMARK |
| 1 7,535,890 | 5/19/2009 | UNILOC LUXEMBOURG, S.A. |
| 2 8,199,747 | 6/12/2012 | UNILOC LUXEMBOURG, S.A. |
| 3 8,243,723 | 8/14/2012 | UNILOC LUXEMBOURG, S.A. |
| 4 8,724,622 | 5/13/2014 | UNILOC LUXEMBOURG, S.A. |
| 5 8,995,433 | 3/31/2015 | UNILOC LUXEMBOURG, S.A. |

In the above—entitled case, the following patent(s)/ trademark(s) have been included:

| | | | |
|----------------------------|---|-------------------------------|--|
| DATE INCLUDED | INCLUDED BY <input type="checkbox"/> Amendment <input type="checkbox"/> Answer <input type="checkbox"/> Cross Bill <input type="checkbox"/> Other Pleading | | |
| PATENT OR TRADEMARK NO. | DATE OF PATENT OR TRADEMARK | HOLDER OF PATENT OR TRADEMARK | |
| 1 | | | |
| 2 | | | |
| 3 | | | |
| 4 | | | |
| 5 | | | |

In the above—entitled case, the following decision has been rendered or judgement issued:

| |
|--------------------|
| DECISION/JUDGEMENT |
|--------------------|

| | | |
|-------|-------------------|------|
| CLERK | (BY) DEPUTY CLERK | DATE |
|-------|-------------------|------|

Copy 1—Upon initiation of action, mail this copy to Director Copy 3—Upon termination of action, mail this copy to Director
 Copy 2—Upon filing document adding patent(s), mail this copy to Director Copy 4—Case file copy

AO 120 (Rev. 08/10)

| | |
|---|---|
| TO: Mail Stop 8 Director of the U.S. Patent and Trademark Office P.O. Box 1450 Alexandria, VA 22313-1450 | REPORT ON THE FILING OR DETERMINATION OF AN ACTION REGARDING A PATENT OR TRADEMARK |
|---|---|

In Compliance with 35 U.S.C. § 290 and/or 15 U.S.C. § 1116 you are hereby advised that a court action has been filed in the U.S. District Court Eastern District of Texas, Marshall Division on the following
 Trademarks or Patents. (the patent action involves 35 U.S.C. § 292.);

| | | |
|---|--------------------------------|---|
| DOCKET NO. 2:16-cv-777 | DATE FILED 7/15/2016 | U.S. DISTRICT COURT Eastern District of Texas, Marshall Division |
| PLAINTIFF UNILOC USA, INC., and UNILOC LUXEMBOURG, S.A. | | DEFENDANT AVAYA INC., |
| PATENT OR TRADEMARK NO. | DATE OF PATENT OR TRADEMARK | HOLDER OF PATENT OR TRADEMARK |
| 1 7,535,890 | 5/19/2009 | UNILOC LUXEMBOURG, S.A. |
| 2 8,995,433 | 3/31/2015 | UNILOC LUXEMBOURG, S.A. |
| 3 8,724,622 | 5/13/2014 | UNILOC LUXEMBOURG, S.A. |
| 4 8,243,723 | 8/14/2012 | UNILOC LUXEMBOURG, S.A. |
| 5 8,199,747 | 6/12/2012 | UNILOC LUXEMBOURG, S.A. |

In the above—entitled case, the following patent(s)/ trademark(s) have been included:

| | | |
|----------------------------|---|-------------------------------|
| DATE INCLUDED | INCLUDED BY <input type="checkbox"/> Amendment <input type="checkbox"/> Answer <input type="checkbox"/> Cross Bill <input type="checkbox"/> Other Pleading | |
| PATENT OR TRADEMARK NO. | DATE OF PATENT OR TRADEMARK | HOLDER OF PATENT OR TRADEMARK |
| 1 | | |
| 2 | | |
| 3 | | |
| 4 | | |
| 5 | | |

In the above—entitled case, the following decision has been rendered or judgement issued:

| |
|--------------------|
| DECISION/JUDGEMENT |
|--------------------|

| | | |
|-------|-------------------|------|
| CLERK | (BY) DEPUTY CLERK | DATE |
|-------|-------------------|------|

Copy 1—Upon initiation of action, mail this copy to Director Copy 3—Upon termination of action, mail this copy to Director
 Copy 2—Upon filing document adding patent(s), mail this copy to Director Copy 4—Case file copy

AO 120 (Rev. 08/10)

| | |
|---|---|
| TO: Mail Stop 8 Director of the U.S. Patent and Trademark Office P.O. Box 1450 Alexandria, VA 22313-1450 | REPORT ON THE FILING OR DETERMINATION OF AN ACTION REGARDING A PATENT OR TRADEMARK |
|---|---|

In Compliance with 35 U.S.C. § 290 and/or 15 U.S.C. § 1116 you are hereby advised that a court action has been filed in the U.S. District Court Eastern District of Texas, Marshall Division on the following
 Trademarks or Patents. (the patent action involves 35 U.S.C. § 292.):

| | | |
|---|--------------------------------|---|
| DOCKET NO. 2:16-cv-779 | DATE FILED 7/15/2016 | U.S. DISTRICT COURT Eastern District of Texas, Marshall Division |
| PLAINTIFF UNILOC USA, INC., and UNILOC LUXEMBOURG, S.A. | | DEFENDANT SHORETEL, INC. |
| PATENT OR TRADEMARK NO. | DATE OF PATENT OR TRADEMARK | HOLDER OF PATENT OR TRADEMARK |
| 1 7,535,890 | 5/19/2009 | UNILOC LUXEMBOURG, S.A. |
| 2 8,995,433 | 3/31/2015 | UNILOC LUXEMBOURG, S.A. |
| 3 8,724,622 | 5/13/2014 | UNILOC LUXEMBOURG, S.A. |
| 4 8,243,723 | 8/14/2012 | UNILOC LUXEMBOURG, S.A. |
| 5 | | |

In the above—entitled case, the following patent(s)/ trademark(s) have been included:

| | | |
|----------------------------|---|-------------------------------|
| DATE INCLUDED | INCLUDED BY <input type="checkbox"/> Amendment <input type="checkbox"/> Answer <input type="checkbox"/> Cross Bill <input type="checkbox"/> Other Pleading | |
| PATENT OR TRADEMARK NO. | DATE OF PATENT OR TRADEMARK | HOLDER OF PATENT OR TRADEMARK |
| 1 | | |
| 2 | | |
| 3 | | |
| 4 | | |
| 5 | | |

In the above—entitled case, the following decision has been rendered or judgement issued:

| |
|--------------------|
| DECISION/JUDGEMENT |
|--------------------|

| | | |
|-------|-------------------|------|
| CLERK | (BY) DEPUTY CLERK | DATE |
|-------|-------------------|------|

Copy 1—Upon initiation of action, mail this copy to Director Copy 3—Upon termination of action, mail this copy to Director
 Copy 2—Upon filing document adding patent(s), mail this copy to Director Copy 4—Case file copy



UNITED STATES PATENT AND TRADEMARK OFFICE

UNITED STATES DEPARTMENT OF COMMERCE
United States Patent and Trademark Office
Address: COMMISSIONER FOR PATENTS
P.O. Box 1450
Alexandria, Virginia 22313-1450
www.uspto.gov

| APPLICATION NUMBER | FILING OR 371(C) DATE | FIRST NAMED APPLICANT | ATTY. DOCKET NO./TITLE |
|--------------------|-----------------------|-----------------------|------------------------|
| 12/398,063 | 03/04/2009 | Michael J. Rojas | 17188Y |

CONFIRMATION NO. 9351

POWER OF ATTORNEY NOTICE

23389
SCULLY SCOTT MURPHY & PRESSER, PC
400 GARDEN CITY PLAZA
SUITE 300
GARDEN CITY, NY 11530



Date Mailed: 09/10/2013

NOTICE REGARDING CHANGE OF POWER OF ATTORNEY

This is in response to the Power of Attorney filed 08/27/2013.

- The Power of Attorney to you in this application has been revoked by the assignee who has intervened as provided by 37 CFR 3.71. Future correspondence will be mailed to the new address of record(37 CFR 1.33).

/gbien-aime/

Office of Data Management, Application Assistance Unit (571) 272-4000, or (571) 272-4200, or 1-888-786-0101



UNITED STATES PATENT AND TRADEMARK OFFICE

UNITED STATES DEPARTMENT OF COMMERCE
United States Patent and Trademark Office
Address: COMMISSIONER FOR PATENTS
P.O. Box 1450
Alexandria, Virginia 22313-1450
www.uspto.gov

| APPLICATION NUMBER | FILING OR 371(C) DATE | FIRST NAMED APPLICANT | ATTY. DOCKET NO./TITLE |
|--------------------|-----------------------|-----------------------|------------------------|
|--------------------|-----------------------|-----------------------|------------------------|

12/398,063

03/04/2009

Michael J. Rojas

EMP0023-US

CONFIRMATION NO. 9351

POA ACCEPTANCE LETTER

67050
KASHA LAW LLC
14532 Dufief Mill Road
North Potomac, MD 20878



OC00000063601727

Date Mailed: 09/10/2013

NOTICE OF ACCEPTANCE OF POWER OF ATTORNEY

This is in response to the Power of Attorney filed 08/27/2013.

The Power of Attorney in this application is accepted. Correspondence in this application will be mailed to the above address as provided by 37 CFR 1.33.

/gbien-aime/

Office of Data Management, Application Assistance Unit (571) 272-4000, or (571) 272-4200, or 1-888-786-0101

Under the Paperwork Reduction Act of 1995, no persons are required to respond to a collection of information unless it displays a valid OMB control number.

| | | |
|---|------------------------|--|
| <p align="center">POWER OF ATTORNEY OR REVOCATION OF POWER OF ATTORNEY WITH A NEW POWER OF ATTORNEY AND CHANGE OF CORRESPONDENCE ADDRESS</p> | Application Number | 12386083 |
| | Filing Date | 2008-03-04 |
| | First Named Inventor | Michael J. Rojas |
| | Title | System and Method for Instant VoIP Message |
| | Art Unit | 2614 |
| | Examiner Name | Craigton H. Smith |
| | Attorney Docket Number | EMP0023-US |

I hereby revoke all previous powers of attorney given in the above-identified application.

A Power of Attorney is submitted herewith.

OR

I hereby appoint Practitioner(s) associated with the following Customer Number as my/our attorney(s) or agent(s) to prosecute the application identified above, and to transact all business in the United States Patent and Trademark Office connected therewith:

67050

OR

I hereby appoint Practitioner(s) named below as my/our attorney(s) or agent(s) to prosecute the application identified above, and to transact all business in the United States Patent and Trademark Office connected therewith:

| Practitioner(s) Name | Registration Number |
|----------------------|---------------------|
| | |
| | |
| | |

Please recognize or change the correspondence address for the above-identified application to:

The address associated with the above-mentioned Customer Number.

OR

The address associated with Customer Number:

Firm or Individual Name

Address

City State Zip

Country

Telephone Email

I am the:

Applicant/Inventor.

OR

Assignee of record of the entire interest. See 37 CFR 3.71. Statement under 37 CFR 3.73(b) (Form PTO/SB/96) submitted herewith or filed on _____.

SIGNATURE of Applicant or Assignee of Record

| | | | |
|-------------------|--------------------------|-----------|-----------|
| Signature | | Date | 8-23-2013 |
| Name | Daniel Mitry | Telephone | |
| Title and Company | Principal, Empire IP LLC | | |

NOTE: Signatures of all the inventors or assignees of record of the entire interest or their representative(s) are required. Submit multiple forms if more than one signature is required, see below.

Total of 1 forms are submitted.

This collection of information is required by 37 CFR 1.31, 1.32 and 1.33. The information is required to obtain or retain a benefit by the public which is to file (and by the USPTO to process) an application. Confidentiality is governed by 35 U.S.C. 122 and 37 CFR 1.11 and 1.14. This collection is estimated to take 3 minutes to complete, including gathering, preparing, and submitting the completed application form to the USPTO. Time will vary depending upon the individual case. Any comments on the amount of time you require to complete this form and/or suggestions for reducing this burden, should be sent to the Chief Information Officer, U.S. Patent and Trademark Office, U.S. Department of Commerce, P.O. Box 1480, Alexandria, VA 22313-1480. **DO NOT SEND FEES OR COMPLETED FORMS TO THIS ADDRESS. SEND TO: Commissioner for Patents, P.O. Box 1480, Alexandria, VA 22313-1480.**

If you need assistance in completing the form, call 1-800-PTO-9198 and select option 2.

Under the Paperwork Reduction Act of 1995, no persons are required to respond to a collection of information unless it displays a valid OMB control number.

STATEMENT UNDER 37 CFR 3.73(b)

Applicant/Patent Owner: Empire IP LLC
Application No./Patent No.: 8,243,723 Filed/Issue Date: 2012-08-14

Title: System and Method for Instant VoIP Messaging

Empire IP LLC, a Corporation
(Name of Assignee) (Type of Assignee, e.g., corporation, partnership, university, government agency, etc.)

states that it is:

- 1. the assignee of the entire right, title, and interest in;
- 2. an assignee of less than the entire right, title, and interest in
(The extent (by percentage) of its ownership interest is _____ %); or
- 3. the assignee of an undivided interest in the entirety of (a complete assignment from one of the joint inventors was made)

the patent application/patent identified above, by virtue of either:

A. An assignment from the inventor(s) of the patent application/patent identified above. The assignment was recorded in the United States Patent and Trademark Office at Reel _____, Frame _____, or for which a copy therefore is attached.

OR

B. A chain of title from the inventor(s), of the patent application/patent identified above, to the current assignee as follows:

1. From: Rojas, Michael J. To: Ayalogic, Inc.

The document was recorded in the United States Patent and Trademark Office at
Reel 014827, Frame 0059, or for which a copy thereof is attached.

2. From: Ayalogic, Inc. To: Empire IP LLC

The document was recorded in the United States Patent and Trademark Office at
Reel 030822, Frame 0335, or for which a copy thereof is attached.

3. From: _____ To: _____

The document was recorded in the United States Patent and Trademark Office at
Reel _____, Frame _____, or for which a copy thereof is attached.

Additional documents in the chain of title are listed on a supplemental sheet(s).

As required by 37 CFR 3.73(b)(1)(ii), the documentary evidence of the chain of title from the original owner to the assignee was, or concurrently is being, submitted for recordation pursuant to 37 CFR 3.11.

[NOTE: A separate copy (i.e., a true copy of the original assignment document(s)) must be submitted to Assignment Division in accordance with 37 CFR Part 3, to record the assignment in the records of the USPTO. See MPEP 302.09]

The undersigned (whose title is supplied below) is authorized to act on behalf of the assignee.

Signature

8-23-2013
Date

Daniel Mitry
Printed or Typed Name

Principal
Title

This collection of information is required by 37 CFR 3.73(b). The information is required to obtain or retain a benefit by the public which is to be (and by the USPTO to process) an application. Confidentiality is governed by 35 U.S.C. 122 and 37 CFR 1.11 and 1.14. This collection is estimated to take 12 minutes to complete, including gathering, preparing, and submitting the completed application form to the USPTO. Time will vary depending upon the individual case. Any comments on the amount of time you require to complete this form and/or suggestions for reducing this burden, should be sent to the Chief Information Officer, U.S. Patent and Trademark Office, U.S. Department of Commerce, P.O. Box 1480, Alexandria, VA 22313-1480. DO NOT SEND FEES OR COMPLETED FORMS TO THIS ADDRESS. SEND TO: Commissioner for Patents, P.O. Box 1480, Alexandria, VA 22313-1480.

Electronic Acknowledgement Receipt

| | |
|---|--|
| EFS ID: | 16696084 |
| Application Number: | 12398063 |
| International Application Number: | |
| Confirmation Number: | 9351 |
| Title of Invention: | SYSTEM AND METHOD FOR INSTANT VOIP MESSAGING |
| First Named Inventor/Applicant Name: | Michael J. Rojas |
| Customer Number: | 23389 |
| Filer: | John Kasha |
| Filer Authorized By: | |
| Attorney Docket Number: | 17188Y |
| Receipt Date: | 27-AUG-2013 |
| Filing Date: | 04-MAR-2009 |
| Time Stamp: | 13:41:12 |
| Application Type: | Utility under 35 USC 111(a) |

Payment information:

| | |
|------------------------|----|
| Submitted with Payment | no |
|------------------------|----|

File Listing:

| Document Number | Document Description | File Name | File Size(Bytes)/ Message Digest | Multi Part /.zip | Pages (if appl.) |
|-----------------|----------------------|----------------------------|--|------------------|------------------|
| 1 | Power of Attorney | EMP0023-US_poa_signed1.pdf | 383662 1440bd3dfc1739faa61f02cae998e4ff13758303 | no | 2 |

Warnings:

Information:

This Acknowledgement Receipt evidences receipt on the noted date by the USPTO of the indicated documents, characterized by the applicant, and including page counts, where applicable. It serves as evidence of receipt similar to a Post Card, as described in MPEP 503.

New Applications Under 35 U.S.C. 111

If a new application is being filed and the application includes the necessary components for a filing date (see 37 CFR 1.53(b)-(d) and MPEP 506), a Filing Receipt (37 CFR 1.54) will be issued in due course and the date shown on this Acknowledgement Receipt will establish the filing date of the application.

National Stage of an International Application under 35 U.S.C. 371

If a timely submission to enter the national stage of an international application is compliant with the conditions of 35 U.S.C. 371 and other applicable requirements a Form PCT/DO/EO/903 indicating acceptance of the application as a national stage submission under 35 U.S.C. 371 will be issued in addition to the Filing Receipt, in due course.

New International Application Filed with the USPTO as a Receiving Office

If a new international application is being filed and the international application includes the necessary components for an international filing date (see PCT Article 11 and MPEP 1810), a Notification of the International Application Number and of the International Filing Date (Form PCT/RO/105) will be issued in due course, subject to prescriptions concerning national security, and the date shown on this Acknowledgement Receipt will establish the international filing date of the application.



UNITED STATES PATENT AND TRADEMARK OFFICE

UNITED STATES DEPARTMENT OF COMMERCE
United States Patent and Trademark Office
Address: COMMISSIONER FOR PATENTS
P.O. Box 1450
Alexandria, Virginia 22313-1450
www.uspto.gov

Table with 5 columns: APPLICATION NO., ISSUE DATE, PATENT NO., ATTORNEY DOCKET NO., CONFIRMATION NO.
Row 1: 12/398,063, 08/14/2012, 8243723, 17188Y, 9351

23389 7590 07/25/2012
SCULLY SCOTT MURPHY & PRESSER, PC
400 GARDEN CITY PLAZA
SUITE 300
GARDEN CITY, NY 11530

ISSUE NOTIFICATION

The projected patent number and issue date are specified above.

Determination of Patent Term Adjustment under 35 U.S.C. 154 (b)
(application filed on or after May 29, 2000)

The Patent Term Adjustment is 693 day(s). Any patent to issue from the above-identified application will include an indication of the adjustment on the front page.

If a Continued Prosecution Application (CPA) was filed in the above-identified application, the filing date that determines Patent Term Adjustment is the filing date of the most recent CPA.

Applicant will be able to obtain more detailed information by accessing the Patent Application Information Retrieval (PAIR) WEB site (http://pair.uspto.gov).

Any questions regarding the Patent Term Extension or Adjustment determination should be directed to the Office of Patent Legal Administration at (571)-272-7702. Questions relating to issue and publication fee payments should be directed to the Application Assistance Unit (AAU) of the Office of Data Management (ODM) at (571)-272-4200.

APPLICANT(s) (Please see PAIR WEB site http://pair.uspto.gov for additional applicants):

Michael J. Rojas, North Canton, OH;

The United States represents the largest, most dynamic marketplace in the world and is an unparalleled location for business investment, innovation, and commercialization of new technologies. The USA offers tremendous resources and advantages for those who invest and manufacture goods here. Through SelectUSA, our nation works to encourage and facilitate business investment. To learn more about why the USA is the best country in the world to develop technology, manufacture products, and grow your business, visit SelectUSA.gov.



07/02/2012 14:47 From: S S M P.

5167424366

To: USPTO

P.2/3 Fu/#

PART B - FEE(S) TRANSMITTAL

Complete and send this form, together with applicable fee(s), to: Mail Stop ISSUE FEE, Commissioner for Patents, P.O. Box 1450, Alexandria, Virginia 22313-1450 or Fax (571)-273-2885

INSTRUCTIONS: This form should be used for transmitting the ISSUE FEE and PUBLICATION FEE (if required). Blocks 1 through 3 should be completed where appropriate. All further correspondence including the Patent, advance orders and notification of maintenance fees will be mailed to the current correspondence address as indicated unless corrected below or directed otherwise in Block 1, by (a) specifying a new correspondence address; and/or (b) indicating a separate "FEE ADDRESS" for maintenance fee notifications.

CURRENT CORRESPONDENCE ADDRESS (Note: Use Block 1 for any change of address)

23389 7590 00/00/2012
SCULLY SCOTT MURPHY & PRESSER, PC
400 GARDEN CITY PLAZA
SUITE 300
GARDEN CITY, NY 11530

Note: A certificate of mailing can only be used for domestic mailings of the Fee(s) Transmittal. This certificate cannot be used for any other accompanying papers. Each additional paper, such as an assignment or formal drawing, must have its own certificate of mailing or transmission.

Certificate of Mailing or Transmission
I hereby certify that this Fee(s) Transmittal is being deposited with the United States Postal Service with sufficient postage for first class mail in an envelope addressed to the Mail Stop ISSUE FEE address above, or being electronic transmitted to the USPTO (571) 273-2885, on the date indicated below.

Table with 2 columns: (Depositor's Name), (Signature), (Date)

Table with 5 columns: APPLICATION NO., FILING DATE, FIRST NAMED INVENTOR, ATTORNEY DOCKET NO., CONFIRMATION NO.

TITLE OF INVENTION: SYSTEM AND METHOD FOR INSTANT VOIP MESSAGING

Table with 7 columns: APPLN. TYPR, SMALL ENTITY, ISSUE FEE DUE, PUBLICATION FEE DUE, PREV. PAID ISSUE FEE, TOTAL FEE(S) DUE, DATE DUE

Table with 3 columns: EXAMINER, ART UNIT, CLASS-SUBCLASS

07/03/2012
01 FC:2501
02 FC:1504
870.00 OP
300.00 OP

1. Change of correspondence address or indication of "Fee Address" (37 CFR 1.363).
2. For printing on the patent front page, list (1) the names of up to 3 registered patent attorneys or agents OR, alternatively, (2) the name of a single firm (having as a member a registered attorney or agent) and the names of up to 2 registered patent attorneys or agents.

3. ASSIGNEE NAME AND RESIDENCE DATA TO BE PRINTED ON THE PATENT (print or type)
PLEASE NOTE: Unless an assignee is identified below, no assignee data will appear on the patent. If an assignee is identified below, the document has been filed for recordation as set forth in 37 CFR 3.11. Completion of this form is NOT a substitute for filing an assignment.

(A) NAME OF ASSIGNEE: Ayalogic Inc
(B) RESIDENCE: (CITY and STATE OR COUNTRY): USA

Please check the appropriate assignee category or categories (will not be printed on the patent): Individual [X] Corporation or other private group entity [] Government []

4a. The following fee(s) are submitted: Issue Fee [X], Publication Fee [X], Advance Order - # of Copies []
4b. Payment of Fee(s): (Please first reapply any previously paid issue fee shown above) A check is enclosed [], Payment by credit card [X], The Director is hereby authorized to charge the required fee(s), any deficiency, or credit any overpayment, to Deposit Account Number []

5. Change in Entity Status (from status indicated above)
a. Applicant claims SMALL ENTITY status. Sec 37 CFR 1.27. []
b. Applicant is no longer claiming SMALL ENTITY status. Sec 37 CFR 1.27(d)(2). []

NOTE: The Issue Fee and Publication Fee (if required) will not be accepted from anyone other than the applicant, a registered attorney or agent, or the assignee or other party in interest as shown by the records of the United States Patent and Trademark Office.

Authorized Signature: [Signature] Date: 5/15/2012
Typed or printed name: Michael J. Rojas Registration No. []

This collection of information is required by 37 CFR 1.311. The information is required to obtain or retain a benefit by the public which is to file (and by the USPTO to process) an application. Confidentiality is governed by 35 U.S.C. 122 and 37 CFR 1.14. This collection is estimated to take 12 minutes to complete, including gathering, preparing, and submitting the completed application form to the USPTO. Time will vary depending upon the individual case. Any comments on the amount of time you require to complete this form and/or suggestions for reducing this burden, should be sent to the Chief Information Officer, U.S. Patent and Trademark Office, U.S. Department of Commerce, P.O. Box 1450, Alexandria, Virginia 22313-1450. DO NOT SEND FEES OR COMPLETED FORMS TO THIS ADDRESS. SEND TO: Commissioner for Patents, P.O. Box 1450, Alexandria, Virginia 22313-1450.

Under the Paperwork Reduction Act of 1995, no persons are required to respond to a collection of information unless it displays a valid OMB control number.



400 Garden City Plaza, Suite 300
Garden City, New York 11530
(516) 742-4343 - Telephone
(516) 742-4366 - Facsimile
e-mail: intprop@ssmp.com

**SCULLY, SCOTT, MURPHY
& PRESSER, P.C.**

Fax

To: Mail Stop: ISSUE FEE
Commissioner for Patents

From: Scully, Scott, Murphy & Presser, P.C.

Fax: 571-273-2885

Pages: 3

Phone: 516-742-4343

Date: July 2, 2012

Re: Michael J. Rojas
U.S. Patent Application No.: 12/398,063 filed March 4, 2009
"SYSTEM AND METHOD FOR INSTANT VOIP MESSAGE"
Our Docket: 17188Y

Urgent For Review Please Comment Please Reply Please Acknowledge

Dear Sirs:

Enclosed please find our Part B Fee(s) Transmittal for payment of the Issue/Publication Fees for the above identified docket along with PTO-2038, credit card payment form.
Thank you.

CONFIDENTIALITY: The documents accompanying this facsimile transmission may contain information which is either confidential or legally privileged and is intended only for the authorized use of the individual or entity named above without right or publication or republication, dissemination or disclosure except as expressly set forth or established by course of dealing. All rights are reserved. If you are not the intended recipient, you are hereby notified that any disclosure, copying, distribution or use of the contents of this facsimile is prohibited. If you received this transmission in error, please notify us immediately by telephone to arrange for return of the documents.

If you have any problems concerning this facsimile, please call (516) 742-4343 and ask for Roseann Gallo.



UNITED STATES PATENT AND TRADEMARK OFFICE

UNITED STATES DEPARTMENT OF COMMERCE
United States Patent and Trademark Office
Address: COMMISSIONER FOR PATENTS
P.O. Box 1450
Alexandria, Virginia 22313-1450
www.uspto.gov

NOTICE OF ALLOWANCE AND FEE(S) DUE

23389 7590 03/30/2012
SCULLY SCOTT MURPHY & PRESSER, PC
400 GARDEN CITY PLAZA
SUITE 300
GARDEN CITY, NY 11530

EXAMINER

SMITH, CREIGHTON H

ART UNIT PAPER NUMBER

2614

DATE MAILED: 03/30/2012

Table with 5 columns: APPLICATION NO., FILING DATE, FIRST NAMED INVENTOR, ATTORNEY DOCKET NO., CONFIRMATION NO.
12/398,063 03/04/2009 Michael J. Rojas 17188Y 9351

TITLE OF INVENTION: SYSTEM AND METHOD FOR INSTANT VOIP MESSAGING

Table with 7 columns: APPLN. TYPE, SMALL ENTITY, ISSUE FEE DUE, PUBLICATION FEE DUE, PREV. PAID ISSUE FEE, TOTAL FEE(S) DUE, DATE DUE
nonprovisional YES \$870 \$300 \$0 \$1170 07/02/2012

THE APPLICATION IDENTIFIED ABOVE HAS BEEN EXAMINED AND IS ALLOWED FOR ISSUANCE AS A PATENT. PROSECUTION ON THE MERITS IS CLOSED. THIS NOTICE OF ALLOWANCE IS NOT A GRANT OF PATENT RIGHTS. THIS APPLICATION IS SUBJECT TO WITHDRAWAL FROM ISSUE AT THE INITIATIVE OF THE OFFICE OR UPON PETITION BY THE APPLICANT. SEE 37 CFR 1.313 AND MPEP 1308.

THE ISSUE FEE AND PUBLICATION FEE (IF REQUIRED) MUST BE PAID WITHIN THREE MONTHS FROM THE MAILING DATE OF THIS NOTICE OR THIS APPLICATION SHALL BE REGARDED AS ABANDONED. THIS STATUTORY PERIOD CANNOT BE EXTENDED. SEE 35 U.S.C. 151. THE ISSUE FEE DUE INDICATED ABOVE DOES NOT REFLECT A CREDIT FOR ANY PREVIOUSLY PAID ISSUE FEE IN THIS APPLICATION. IF AN ISSUE FEE HAS PREVIOUSLY BEEN PAID IN THIS APPLICATION (AS SHOWN ABOVE), THE RETURN OF PART B OF THIS FORM WILL BE CONSIDERED A REQUEST TO REAPPLY THE PREVIOUSLY PAID ISSUE FEE TOWARD THE ISSUE FEE NOW DUE.

HOW TO REPLY TO THIS NOTICE:

I. Review the SMALL ENTITY status shown above.

If the SMALL ENTITY is shown as YES, verify your current SMALL ENTITY status:

- A. If the status is the same, pay the TOTAL FEE(S) DUE shown above.
B. If the status above is to be removed, check box 5b on Part B - Fee(s) Transmittal and pay the PUBLICATION FEE (if required) and twice the amount of the ISSUE FEE shown above, or

If the SMALL ENTITY is shown as NO:

- A. Pay TOTAL FEE(S) DUE shown above, or
B. If applicant claimed SMALL ENTITY status before, or is now claiming SMALL ENTITY status, check box 5a on Part B - Fee(s) Transmittal and pay the PUBLICATION FEE (if required) and 1/2 the ISSUE FEE shown above.

II. PART B - FEE(S) TRANSMITTAL, or its equivalent, must be completed and returned to the United States Patent and Trademark Office (USPTO) with your ISSUE FEE and PUBLICATION FEE (if required). If you are charging the fee(s) to your deposit account, section "4b" of Part B - Fee(s) Transmittal should be completed and an extra copy of the form should be submitted. If an equivalent of Part B is filed, a request to reapply a previously paid issue fee must be clearly made, and delays in processing may occur due to the difficulty in recognizing the paper as an equivalent of Part B.

III. All communications regarding this application must give the application number. Please direct all communications prior to issuance to Mail Stop ISSUE FEE unless advised to the contrary.

IMPORTANT REMINDER: Utility patents issuing on applications filed on or after Dec. 12, 1980 may require payment of maintenance fees. It is patentee's responsibility to ensure timely payment of maintenance fees when due.

PART B - FEE(S) TRANSMITTAL

**Complete and send this form, together with applicable fee(s), to: Mail Mail Stop ISSUE FEE
 Commissioner for Patents
 P.O. Box 1450
 Alexandria, Virginia 22313-1450
 or Fax (571)-273-2885**

INSTRUCTIONS: This form should be used for transmitting the ISSUE FEE and PUBLICATION FEE (if required). Blocks 1 through 5 should be completed where appropriate. All further correspondence including the Patent, advance orders and notification of maintenance fees will be mailed to the current correspondence address as indicated unless corrected below or directed otherwise in Block 1, by (a) specifying a new correspondence address; and/or (b) indicating a separate "FEE ADDRESS" for maintenance fee notifications.

CURRENT CORRESPONDENCE ADDRESS (Note: Use Block 1 for any change of address)

Note: A certificate of mailing can only be used for domestic mailings of the Fee(s) Transmittal. This certificate cannot be used for any other accompanying papers. Each additional paper, such as an assignment or formal drawing, must have its own certificate of mailing or transmission.

23389 7590 03/30/2012
SCULLY SCOTT MURPHY & PRESSER, PC
 400 GARDEN CITY PLAZA
 SUITE 300
 GARDEN CITY, NY 11530

Certificate of Mailing or Transmission

I hereby certify that this Fee(s) Transmittal is being deposited with the United States Postal Service with sufficient postage for first class mail in an envelope addressed to the Mail Stop ISSUE FEE address above, or being facsimile transmitted to the USPTO (571) 273-2885, on the date indicated below.

| |
|--------------------|
| (Depositor's name) |
| (Signature) |
| (Date) |

| APPLICATION NO. | FILING DATE | FIRST NAMED INVENTOR | ATTORNEY DOCKET NO. | CONFIRMATION NO. |
|-----------------|-------------|----------------------|---------------------|------------------|
| 12/398,063 | 03/04/2009 | Michael J. Rojas | 17188Y | 9351 |

TITLE OF INVENTION: SYSTEM AND METHOD FOR INSTANT VOIP MESSAGING

| APPLN. TYPE | SMALL ENTITY | ISSUE FEE DUE | PUBLICATION FEE DUE | PREV. PAID ISSUE FEE | TOTAL FEE(S) DUE | DATE DUE |
|----------------|--------------|---------------|---------------------|----------------------|------------------|------------|
| nonprovisional | YES | \$870 | \$300 | \$0 | \$1170 | 07/02/2012 |

| EXAMINER | ART UNIT | CLASS-SUBCLASS |
|--------------------|----------|----------------|
| SMITH, CREIGHTON H | 2614 | 370-352000 |

| | |
|---|---|
| <p>1. Change of correspondence address or indication of "Fee Address" (37 CFR 1.363).</p> <p><input type="checkbox"/> Change of correspondence address (or Change of Correspondence Address form PTO/SB/122) attached.</p> <p><input type="checkbox"/> "Fee Address" indication (or "Fee Address" Indication form PTO/SB/47; Rev 03-02 or more recent) attached. Use of a Customer Number is required.</p> | <p>2. For printing on the patent front page, list</p> <p>(1) the names of up to 3 registered patent attorneys or agents OR, alternatively, _____ 1</p> <p>(2) the name of a single firm (having as a member a registered attorney or agent) and the names of up to 2 registered patent attorneys or agents. If no name is listed, no name will be printed. _____ 2</p> <p>_____ 3</p> |
|---|---|

3. ASSIGNEE NAME AND RESIDENCE DATA TO BE PRINTED ON THE PATENT (print or type)

PLEASE NOTE: Unless an assignee is identified below, no assignee data will appear on the patent. If an assignee is identified below, the document has been filed for recordation as set forth in 37 CFR 3.11. Completion of this form is NOT a substitute for filing an assignment.

(A) NAME OF ASSIGNEE _____ (B) RESIDENCE: (CITY and STATE OR COUNTRY) _____

Please check the appropriate assignee category or categories (will not be printed on the patent) : Individual Corporation or other private group entity Government

| | |
|---|---|
| <p>4a. The following fee(s) are submitted:</p> <p><input type="checkbox"/> Issue Fee</p> <p><input type="checkbox"/> Publication Fee (No small entity discount permitted)</p> <p><input type="checkbox"/> Advance Order - # of Copies _____</p> | <p>4b. Payment of Fee(s): (Please first reapply any previously paid issue fee shown above)</p> <p><input type="checkbox"/> A check is enclosed.</p> <p><input type="checkbox"/> Payment by credit card. Form PTO-2038 is attached.</p> <p><input type="checkbox"/> The Director is hereby authorized to charge the required fee(s), any deficiency, or credit any overpayment, to Deposit Account Number _____ (enclose an extra copy of this form).</p> |
|---|---|

5. **Change in Entity Status** (from status indicated above)

a. Applicant claims SMALL ENTITY status. See 37 CFR 1.27. b. Applicant is no longer claiming SMALL ENTITY status. See 37 CFR 1.27(g)(2).

NOTE: The Issue Fee and Publication Fee (if required) will not be accepted from anyone other than the applicant; a registered attorney or agent; or the assignee or other party in interest as shown by the records of the United States Patent and Trademark Office.

Authorized Signature _____ Date _____

Typed or printed name _____ Registration No. _____

This collection of information is required by 37 CFR 1.311. The information is required to obtain or retain a benefit by the public which is to file (and by the USPTO to process) an application. Confidentiality is governed by 35 U.S.C. 122 and 37 CFR 1.14. This collection is estimated to take 12 minutes to complete, including gathering, preparing, and submitting the completed application form to the USPTO. Time will vary depending upon the individual case. Any comments on the amount of time you require to complete this form and/or suggestions for reducing this burden, should be sent to the Chief Information Officer, U.S. Patent and Trademark Office, U.S. Department of Commerce, P.O. Box 1450, Alexandria, Virginia 22313-1450. DO NOT SEND FEES OR COMPLETED FORMS TO THIS ADDRESS. SEND TO: Commissioner for Patents, P.O. Box 1450, Alexandria, Virginia 22313-1450.

Under the Paperwork Reduction Act of 1995, no persons are required to respond to a collection of information unless it displays a valid OMB control number.



UNITED STATES PATENT AND TRADEMARK OFFICE

UNITED STATES DEPARTMENT OF COMMERCE
United States Patent and Trademark Office
Address: COMMISSIONER FOR PATENTS
P.O. Box 1450
Alexandria, Virginia 22313-1450
www.uspto.gov

Table with 5 columns: APPLICATION NO., FILING DATE, FIRST NAMED INVENTOR, ATTORNEY DOCKET NO., CONFIRMATION NO.
12/398,063 03/04/2009 Michael J. Rojas 17188Y 9351

23389 7590 03/30/2012
SCULLY SCOTT MURPHY & PRESSER, PC
400 GARDEN CITY PLAZA
SUITE 300
GARDEN CITY, NY 11530

EXAMINER

SMITH, CREIGHTON H

ART UNIT PAPER NUMBER

2614

DATE MAILED: 03/30/2012

Determination of Patent Term Adjustment under 35 U.S.C. 154 (b)
(application filed on or after May 29, 2000)

The Patent Term Adjustment to date is 532 day(s). If the issue fee is paid on the date that is three months after the mailing date of this notice and the patent issues on the Tuesday before the date that is 28 weeks (six and a half months) after the mailing date of this notice, the Patent Term Adjustment will be 532 day(s).

If a Continued Prosecution Application (CPA) was filed in the above-identified application, the filing date that determines Patent Term Adjustment is the filing date of the most recent CPA.

Applicant will be able to obtain more detailed information by accessing the Patent Application Information Retrieval (PAIR) WEB site (http://pair.uspto.gov).

Any questions regarding the Patent Term Extension or Adjustment determination should be directed to the Office of Patent Legal Administration at (571)-272-7702. Questions relating to issue and publication fee payments should be directed to the Customer Service Center of the Office of Patent Publication at 1-(888)-786-0101 or (571)-272-4200.

Privacy Act Statement

The Privacy Act of 1974 (P.L. 93-579) requires that you be given certain information in connection with your submission of the attached form related to a patent application or patent. Accordingly, pursuant to the requirements of the Act, please be advised that: (1) the general authority for the collection of this information is 35 U.S.C. 2(b)(2); (2) furnishing of the information solicited is voluntary; and (3) the principal purpose for which the information is used by the U.S. Patent and Trademark Office is to process and/or examine your submission related to a patent application or patent. If you do not furnish the requested information, the U.S. Patent and Trademark Office may not be able to process and/or examine your submission, which may result in termination of proceedings or abandonment of the application or expiration of the patent.

The information provided by you in this form will be subject to the following routine uses:

1. The information on this form will be treated confidentially to the extent allowed under the Freedom of Information Act (5 U.S.C. 552) and the Privacy Act (5 U.S.C. 552a). Records from this system of records may be disclosed to the Department of Justice to determine whether disclosure of these records is required by the Freedom of Information Act.
2. A record from this system of records may be disclosed, as a routine use, in the course of presenting evidence to a court, magistrate, or administrative tribunal, including disclosures to opposing counsel in the course of settlement negotiations.
3. A record in this system of records may be disclosed, as a routine use, to a Member of Congress submitting a request involving an individual, to whom the record pertains, when the individual has requested assistance from the Member with respect to the subject matter of the record.
4. A record in this system of records may be disclosed, as a routine use, to a contractor of the Agency having need for the information in order to perform a contract. Recipients of information shall be required to comply with the requirements of the Privacy Act of 1974, as amended, pursuant to 5 U.S.C. 552a(m).
5. A record related to an International Application filed under the Patent Cooperation Treaty in this system of records may be disclosed, as a routine use, to the International Bureau of the World Intellectual Property Organization, pursuant to the Patent Cooperation Treaty.
6. A record in this system of records may be disclosed, as a routine use, to another federal agency for purposes of National Security review (35 U.S.C. 181) and for review pursuant to the Atomic Energy Act (42 U.S.C. 218(c)).
7. A record from this system of records may be disclosed, as a routine use, to the Administrator, General Services, or his/her designee, during an inspection of records conducted by GSA as part of that agency's responsibility to recommend improvements in records management practices and programs, under authority of 44 U.S.C. 2904 and 2906. Such disclosure shall be made in accordance with the GSA regulations governing inspection of records for this purpose, and any other relevant (i.e., GSA or Commerce) directive. Such disclosure shall not be used to make determinations about individuals.
8. A record from this system of records may be disclosed, as a routine use, to the public after either publication of the application pursuant to 35 U.S.C. 122(b) or issuance of a patent pursuant to 35 U.S.C. 151. Further, a record may be disclosed, subject to the limitations of 37 CFR 1.14, as a routine use, to the public if the record was filed in an application which became abandoned or in which the proceedings were terminated and which application is referenced by either a published application, an application open to public inspection or an issued patent.
9. A record from this system of records may be disclosed, as a routine use, to a Federal, State, or local law enforcement agency, if the USPTO becomes aware of a violation or potential violation of law or regulation.

| | | | |
|-------------------------------|------------------------|---------------------|--|
| Notice of Allowability | Application No. | Applicant(s) | |
| | 12/398,063 | ROJAS, MICHAEL J. | |
| | Examiner | Art Unit | |
| | CREIGHTON SMITH | 2614 | |

-- The MAILING DATE of this communication appears on the cover sheet with the correspondence address--

All claims being allowable, PROSECUTION ON THE MERITS IS (OR REMAINS) CLOSED in this application. If not included herewith (or previously mailed), a Notice of Allowance (PTOL-85) or other appropriate communication will be mailed in due course. **THIS NOTICE OF ALLOWABILITY IS NOT A GRANT OF PATENT RIGHTS.** This application is subject to withdrawal from issue at the initiative of the Office or upon petition by the applicant. See 37 CFR 1.313 and MPEP 1308.

1. This communication is responsive to AF amendment filed on 26 MAR '12.
2. An election was made by the applicant in response to a restriction requirement set forth during the interview on ____; the restriction requirement and election have been incorporated into this action.
3. The allowed claim(s) is/are 1 and 4-10.
4. Acknowledgment is made of a claim for foreign priority under 35 U.S.C. § 119(a)-(d) or (f).
 - a) All b) Some* c) None of the:
 1. Certified copies of the priority documents have been received.
 2. Certified copies of the priority documents have been received in Application No. ____.
 3. Copies of the certified copies of the priority documents have been received in this national stage application from the International Bureau (PCT Rule 17.2(a)).

* Certified copies not received: ____.

Applicant has THREE MONTHS FROM THE "MAILING DATE" of this communication to file a reply complying with the requirements noted below. Failure to timely comply will result in ABANDONMENT of this application.

THIS THREE-MONTH PERIOD IS NOT EXTENDABLE.

5. A SUBSTITUTE OATH OR DECLARATION must be submitted. Note the attached EXAMINER'S AMENDMENT or NOTICE OF INFORMAL PATENT APPLICATION (PTO-152) which gives reason(s) why the oath or declaration is deficient.
 6. CORRECTED DRAWINGS (as "replacement sheets") must be submitted.
 - (a) including changes required by the Notice of Draftsperson's Patent Drawing Review (PTO-948) attached
 - 1) hereto or 2) to Paper No./Mail Date ____.
 - (b) including changes required by the attached Examiner's Amendment / Comment or in the Office action of Paper No./Mail Date ____.
- Identifying indicia such as the application number (see 37 CFR 1.84(c)) should be written on the drawings in the front (not the back) of each sheet. Replacement sheet(s) should be labeled as such in the header according to 37 CFR 1.121(d).**
7. DEPOSIT OF and/or INFORMATION about the deposit of BIOLOGICAL MATERIAL must be submitted. Note the attached Examiner's comment regarding REQUIREMENT FOR THE DEPOSIT OF BIOLOGICAL MATERIAL.

Attachment(s)

- | | |
|---|--|
| <ol style="list-style-type: none"> 1. <input type="checkbox"/> Notice of References Cited (PTO-892) 2. <input type="checkbox"/> Notice of Draftsperson's Patent Drawing Review (PTO-948) 3. <input checked="" type="checkbox"/> Information Disclosure Statements (PTO/SB/08), Paper No./Mail Date ____ 4. <input type="checkbox"/> Examiner's Comment Regarding Requirement for Deposit of Biological Material | <ol style="list-style-type: none"> 5. <input type="checkbox"/> Notice of Informal Patent Application 6. <input type="checkbox"/> Interview Summary (PTO-413), Paper No./Mail Date ____. 7. <input type="checkbox"/> Examiner's Amendment/Comment 8. <input checked="" type="checkbox"/> Examiner's Statement of Reasons for Allowance 9. <input type="checkbox"/> Other ____. |
|---|--|

| | |
|--|--|
| | |
|--|--|

REASONS FOR ALLOWANCE

The following is an examiner's statement of reasons for allowance: The prior art fails to disclose applicant's method of instant voice messaging that associates a subset of nodes with a client and transmits a signal to a client that includes a list of the recorded connectivity status for each of the nodes in the sub-set corresponding to the client. No obvious combination of references found would have taught one of ordinary skill in the art to make and use applicant's method as claimed.

Any comments considered necessary by applicant must be submitted no later than the payment of the issue fee and, to avoid processing delays, should preferably accompany the issue fee. Such submissions should be clearly labeled "Comments on Statement of Reasons for Allowance."

Any inquiry concerning this communication or earlier communications from the examiner should be directed to CREIGHTON SMITH whose telephone number is (571)272-7546. The examiner can normally be reached on 5-4-9.

If attempts to reach the examiner by telephone are unsuccessful, the examiner's supervisor, Curt Kuntz can be reached on 27499. The fax phone number for the organization where this application or proceeding is assigned is 571-273-8300.

Information regarding the status of an application may be obtained from the Patent Application Information Retrieval (PAIR) system. Status information for published applications may be obtained from either Private PAIR or Public PAIR. Status information for unpublished applications is available through Private PAIR only. For more information about the PAIR system, see <http://pair-direct.uspto.gov>. Should you have questions on access to the Private PAIR system, contact the Electronic Business Center (EBC) at 866-217-9197 (toll-free). If you would like assistance from a USPTO Customer Service Representative or access to the automated information system, call 800-786-9199 (IN USA OR CANADA) or 571-272-1000.

/CREIGHTON SMITH/
Primary Examiner, Art Unit 2614

28 MAR '12

| | | | | | | |
|--|--|-------------------------------|------------------|-----------------|----------|---------------------------------|
| Form PTO-1449 U.S. DEPARTMENT OF COMMERCE (REV. 7-80) PATENT AND TRADEMARK OFFICE | | Atty. Docket No. 17188Y | | Application No. | | |
| INFORMATION DISCLOSURE CITATION (Use several sheets if necessary) | | Applicant Michael J. Rojas | | | | |
| | | Filing Date Herewith | | Group Art Unit | | |
| U.S. PATENT DOCUMENTS | | | | | | |
| EXAMINER INITIAL* | DOCUMENT NUMBER | DATE | NAME | CLASS | SUBCLASS | FILING DATE (if appropriate) |
| | 6,763,226 | 07-13-2004 | McZeal, Jr. | | | |
| U.S. PATENT PUBLICATION DOCUMENTS | | | | | | |
| | 2004/0252679 | 12-16-2004 | Williams et al. | | | |
| | 2004/0122906 | 06-24-2004 | Goodman et al. | | | |
| | 2005/0053230 | 03-10-2005 | Gierachf, K. | | | |
| | 2005/0105697 | 05-19-2005 | Hollowell et al. | | | |
| | 2003/0087632 | 05-08-2003 | Sagi et al. | | | |
| | 2006/0268750 | 11-30-2006 | Weiner, M. | | | |
| | 2004/0030046 | 02-12-2004 | Schultes et al. | | | |
| | 2007/0112925 | 05-17-2007 | Malik, D. | | | |
| | 2007/0174403 | 07-26-2007 | Barry, M. | | | |
| | 2006/0167883 | 07-27-2006 | Boukobza, E. | | | |
| | 2004/0128356 | 07-01-2004 | Bernstein et al. | | | |
| | 2003/0126207 | 07-03-2003 | Creamer et al. | | | |
| FOREIGN PATENT DOCUMENTS | | | | | | |
| | DOCUMENT NUMBER | DATE | COUNTRY | CLASS | SUBCLASS | TRANSLATION YES NO |
| | | | | | | |
| OTHER PRIOR ART (Including Author, Title, Date, Pertinent Pages, Etc.) | | | | | | |
| | http://www.cisco.com/warp/public/cc/pd/nemnsw/callmn/prodlit/cm33_ds.htm ; "Data Sheet Cisco CallManager Version 3.3", November 22, 2002; | | | | | |
| | http://www.cisco.com/en/US/products/hw/switches/ps1925/products_data_sheet_09186_a00800a3c3d.html ; "Data Sheet Cisco MGX 8000 Series" (Date unknown); | | | | | |
| EXAMINER | /Creighton Smith/ | | DATE CONSIDERED | 03/28/2012 | | |

ALL REFERENCES CONSIDERED EXCEPT WHERE LINED THROUGH. /C.S./

| | | | | | | | |
|--|------------|--|-----------------------------------|----------------|---------------------------|-----------------------|-------------------------------------|
| Form PTO-1449 U.S. DEPARTMENT OF COMMERCE (REV. 7-80) PATENT AND TRADEMARK OFFICE | | Att. Docket No. (Optional) 17188Y | | | Application Number | | |
| INFORMATION DISCLOSURE CITATION <i>(Use several sheets if necessary)</i> | | | | | | | |
| Applicant(s) Michael Rojas | | | | | | | |
| Filing Date | | | | | | Group Art Unit | |
| U.S. PATENT DOCUMENTS | | | | | | | |
| EXAMINER INITIAL* | | DOCUMENT NUMBER | DATE | NAME | CLASS | SUBCLASS | FILING DATE (if appropriate) |
| | AA | | | | | | |
| | AB | | | | | | |
| | AC | | | | | | |
| FOREIGN PATENT DOCUMENTS | | | | | | | |
| | REF | DOCUMENT NUMBER | DATE | COUNTRY | CLASS | SUBCLASS | TRANSLATION |
| | | | | | | | YES NO |
| | | | | | | | |
| | | | | | | | |
| OTHER DOCUMENTS <i>(Including Author, Title, Date, Pertinent Pages, Etc.)</i> | | | | | | | |
| | | http://www.hsteliann.com/english/?zone=3100-V21P ; "Telephone 3100-V21P", 2003; | | | | | |
| | | http://www.linuxdevices.com/articles/AT5199947519.html ; "Device Profile: snom 100 VoIP phone", May 15, 2002; | | | | | |
| | | http://www.pingtel.com/pr_xpressa.jsp ; "No limits with the advanced industry standard SIP phone, December 8, 2003; and | | | | | |
| | | AudioCoded Enabling Technology Products, TPM-1100 VoP Media Gateway Modules; 2003. | | | | | |
| EXAMINER /Creighton Smith/ | | | DATE CONSIDERED 03/28/2012 | | | | |
| * EXAMINER: Initial if reference considered, whether or not citation is in conformance with MPEP 609; draw line through citation if not in conformance and not considered. Include copy of this form with next communication to applicant. | | | | | | | |

J:\Work\1732\17188Z\MISC\1449.doc

ALL REFERENCES CONSIDERED EXCEPT WHERE LINED THROUGH. /C.S./

IN THE UNITED STATES PATENT AND TRADEMARK OFFICE

Applicant(s): Michael J. Rojas Examiner: Creighton H. Smith
Serial No: 12/398,063 Art Unit: 2614
Filed: March 4, 2009 Docket: 17188Y
For: SYSTEM AND METHOD FOR INSTANT VoIP MESSAGING
Conf. No.: 9351 Dated: March 26, 2012

Commissioner for Patents
P. O. Box 1450
Alexandria, VA 22313-1450

RESPONSE UNDER 37 C.F.R. § 1.116

Sir:

Applicant respectfully requests reconsideration of the application in view of the following remarks.

Please enter thios After Final terminal disclaimer. CHS 28 MAR '12

| | | |
|--|--|---|
| Issue Classification  | Application/Control No. 12398063 | Applicant(s)/Patent Under Reexamination ROJAS, MICHAEL J. |
| | Examiner CREIGHTON SMITH | Art Unit 2614 |

| ORIGINAL | | | | | | INTERNATIONAL CLASSIFICATION | | | | | | | | |
|---------------------------|-----------------------------------|--|----------|--|--|------------------------------|---|---|---|----------------------|--|--|--|--|
| CLASS | | | SUBCLASS | | | CLAIMED | | | | NON-CLAIMED | | | | |
| 370 | | | 352 | | | H | 0 | 4 | L | 12 / 66 (2006.01.01) | | | | |
| CROSS REFERENCE(S) | | | | | | | | | | | | | | |
| CLASS | SUBCLASS (ONE SUBCLASS PER BLOCK) | | | | | | | | | | | | | |
| 709 | 206 | | | | | | | | | | | | | |
| | | | | | | | | | | | | | | |
| | | | | | | | | | | | | | | |
| | | | | | | | | | | | | | | |
| | | | | | | | | | | | | | | |
| | | | | | | | | | | | | | | |
| | | | | | | | | | | | | | | |
| | | | | | | | | | | | | | | |
| | | | | | | | | | | | | | | |
| | | | | | | | | | | | | | | |
| | | | | | | | | | | | | | | |
| | | | | | | | | | | | | | | |
| | | | | | | | | | | | | | | |
| | | | | | | | | | | | | | | |

Claims renumbered in the same order as presented by applicant
 CPA
 T.D.
 R.1.47

| Final | Original | Final | Original | Final | Original | Final | Original | Final | Original | Final | Original | Final | Original | Final | Original |
|-------|----------|-------|----------|-------|----------|-------|----------|-------|----------|-------|----------|-------|----------|-------|----------|
| 1 | 1 | | | | | | | | | | | | | | |
| | 2 | | | | | | | | | | | | | | |
| | 3 | | | | | | | | | | | | | | |
| 2 | 4 | | | | | | | | | | | | | | |
| 3 | 5 | | | | | | | | | | | | | | |
| 4 | 6 | | | | | | | | | | | | | | |
| 5 | 7 | | | | | | | | | | | | | | |
| 6 | 8 | | | | | | | | | | | | | | |
| 7 | 9 | | | | | | | | | | | | | | |
| 8 | 10 | | | | | | | | | | | | | | |
| | | | | | | | | | | | | | | | |
| | | | | | | | | | | | | | | | |
| | | | | | | | | | | | | | | | |
| | | | | | | | | | | | | | | | |
| | | | | | | | | | | | | | | | |
| | | | | | | | | | | | | | | | |
| | | | | | | | | | | | | | | | |
| | | | | | | | | | | | | | | | |
| | | | | | | | | | | | | | | | |
| | | | | | | | | | | | | | | | |

| | | | |
|--|------------|------------------------------|-------------------|
| NONE | | Total Claims Allowed: | |
| | | 8 | |
| (Assistant Examiner) | (Date) | O.G. Print Claim(s) | O.G. Print Figure |
| /CREIGHTON SMITH/ Primary Examiner. Art Unit 2614 | 28 MAR '12 | 1 | 1 |
| (Primary Examiner) | (Date) | | |

| | | |
|--|--|---|
| <i>Index of Claims</i>  | Application/Control No. 12398063 | Applicant(s)/Patent Under Reexamination ROJAS, MICHAEL J. |
| | Examiner CREIGHTON SMITH | Art Unit 2614 |

| | | | | | | | |
|---|-----------------|---|-------------------|---|---------------------|---|-----------------|
| ✓ | Rejected | - | Cancelled | N | Non-Elected | A | Appeal |
| = | Allowed | ÷ | Restricted | I | Interference | O | Objected |

Claims renumbered in the same order as presented by applicant
 CPA
 T.D.
 R.1.47

| CLAIM | | DATE | | | | | | | |
|-------|----------|------------|------------|------------|--|--|--|--|--|
| Final | Original | 10/14/2011 | 01/22/2012 | 03/28/2012 | | | | | |
| 1 | 1 | ✓ | ✓ | = | | | | | |
| | 2 | ✓ | - | - | | | | | |
| | 3 | ✓ | - | - | | | | | |
| 2 | 4 | ✓ | ✓ | = | | | | | |
| 3 | 5 | ✓ | ✓ | = | | | | | |
| 4 | 6 | ✓ | ✓ | = | | | | | |
| 5 | 7 | ✓ | ✓ | = | | | | | |
| 6 | 8 | ✓ | ✓ | = | | | | | |
| 7 | 9 | ✓ | ✓ | = | | | | | |
| 8 | 10 | ✓ | ✓ | = | | | | | |

| | | |
|--|--|---|
| Search Notes  | Application/Control No. 12398063 | Applicant(s)/Patent Under Reexamination ROJAS, MICHAEL J. |
| | Examiner CREIGHTON SMITH | Art Unit 2614 |

| SEARCHED | | | |
|----------|----------|------------|----------|
| Class | Subclass | Date | Examiner |
| 370 | 352 | 14 OCT '11 | chs |
| 709 | 206 | " | " |

| SEARCH NOTES | | |
|--------------|------------|----------|
| Search Notes | Date | Examiner |
| EAST | 14 OCT '11 | chs |

| INTERFERENCE SEARCH | | | |
|---------------------|----------|------------|----------|
| Class | Subclass | Date | Examiner |
| EAST | | 28 MAR '12 | chs |

| | |
|--|--|
| | |
|--|--|

| | | |
|--|---|---|
| Doc Code: DIST.E.FILE Document Description: Electronic Terminal Disclaimer - Filed | | PTO/SB/26 U.S. Patent and Trademark Office Department of Commerce |
| Electronic Petition Request | TERMINAL DISCLAIMER TO OBTAIN A DOUBLE PATENTING REJECTION OVER A "PRIOR" PATENT | |
| Application Number | 12398063 | |
| Filing Date | 04-Mar-2009 | |
| First Named Inventor | Michael Rojas | |
| Attorney Docket Number | 17188Y | |
| Title of Invention | SYSTEM AND METHOD FOR INSTANT VoIP MESSAGING | |
| <input checked="" type="checkbox"/> Filing of terminal disclaimer does not obviate requirement for response under 37 CFR 1.111 to outstanding Office Action <input checked="" type="checkbox"/> This electronic Terminal Disclaimer is not being used for a Joint Research Agreement. | | |
| Owner | Percent Interest | |
| Ayalogic, Inc. | 100% | |
| <p>The owner(s) with percent interest listed above in the instant application hereby disclaims, except as provided below, the terminal part of the statutory term of any patent granted on the instant application which would extend beyond the expiration date of the full statutory term of prior patent number(s)</p> <p>7535890</p> <p>as the term of said prior patent is presently shortened by any terminal disclaimer. The owner hereby agrees that any patent so granted on the instant application shall be enforceable only for and during such period that it and the prior patent are commonly owned. This agreement runs with any patent granted on the instant application and is binding upon the grantee, its successors or assigns.</p> <p>In making the above disclaimer, the owner does not disclaim the terminal part of the term of any patent granted on the instant application that would extend to the expiration date of the full statutory term of the prior patent, "as the term of said prior patent is presently shortened by any terminal disclaimer," in the event that said prior patent later:</p> <ul style="list-style-type: none"> - expires for failure to pay a maintenance fee; - is held unenforceable; - is found invalid by a court of competent jurisdiction; - is statutorily disclaimed in whole or terminally disclaimed under 37 CFR 1.321; - has all claims canceled by a reexamination certificate; - is reissued; or - is in any manner terminated prior to the expiration of its full statutory term as presently shortened by any terminal disclaimer. <p><input checked="" type="radio"/> Terminal disclaimer fee under 37 CFR 1.20(d) is included with Electronic Terminal Disclaimer request.</p> | | |

I certify, in accordance with 37 CFR 1.4(d)(4), that the terminal disclaimer fee under 37 CFR 1.20(d) required for this terminal disclaimer has already been paid in the above-identified application.

- Applicant claims SMALL ENTITY status. See 37 CFR 1.27.
- Applicant is no longer claiming SMALL ENTITY status. See 37 CFR 1.27(g)(2).
- Applicant(s) status remains as SMALL ENTITY.
- Applicant(s) status remains as other than SMALL ENTITY.

I hereby declare that all statements made herein of my own knowledge are true and that all statements made on information and belief are believed to be true; and further that these statements were made with the knowledge that willful false statements and the like so made are punishable by fine or imprisonment, or both, under Section 1001 of Title 18 of the United States Code and that such willful false statements may jeopardize the validity of the application or any patent issued thereon.

THIS PORTION MUST BE COMPLETED BY THE SIGNATORY OR SIGNATORIES

- I certify, in accordance with 37 CFR 1.4(d)(4) that I am:
- An attorney or agent registered to practice before the Patent and Trademark Office who is of record in this application
Registration Number 30749
 - A sole inventor
 - A joint inventor; I certify that I am authorized to sign this submission on behalf of all of the inventors
 - A joint inventor; all of whom are signing this request
 - The assignee of record of the entire interest that has properly made itself of record pursuant to 37 CFR 3.71

| | |
|-----------|-----------------------|
| Signature | /Paul J. Esatto, Jr./ |
| Name | Paul J. Esatto, Jr. |

*Statement under 37 CFR 3.73(b) is required if terminal disclaimer is signed by the assignee (owner). Form PTO/SB/96 may be used for making this certification. See MPEP § 324.

Electronic Patent Application Fee Transmittal

| | | | | |
|--|--|-----------------|---------------|-----------------------------|
| Application Number: | 12398063 | | | |
| Filing Date: | 04-Mar-2009 | | | |
| Title of Invention: | SYSTEM AND METHOD FOR INSTANT VoIP MESSAGING | | | |
| First Named Inventor/Applicant Name: | Michael J. Rojas | | | |
| Filer: | Paul J. Esatto/Roseann Gallo | | | |
| Attorney Docket Number: | 17188Y | | | |
| Filed as Small Entity | | | | |
| Utility under 35 USC 111(a) Filing Fees | | | | |
| Description | Fee Code | Quantity | Amount | Sub-Total in USD(\$) |
| Basic Filing: | | | | |
| Statutory or terminal disclaimer | 2814 | 1 | 80 | 80 |
| Pages: | | | | |
| Claims: | | | | |
| Miscellaneous-Filing: | | | | |
| Petition: | | | | |
| Patent-Appeals-and-Interference: | | | | |
| Post-Allowance-and-Post-Issuance: | | | | |
| Extension-of-Time: | | | | |

| Description | Fee Code | Quantity | Amount | Sub-Total in USD(\$) |
|--------------------------|----------|----------|--------|----------------------|
| Miscellaneous: | | | | |
| Total in USD (\$) | | | | 80 |

Doc Code: DISQ.E.FILE

Document Description: Electronic Terminal Disclaimer – Approved

Application No.: 12398063

Filing Date: 04-Mar-2009

Applicant/Patent under Reexamination: Rojas et al.

Electronic Terminal Disclaimer filed on March 26, 2012

APPROVED

This patent is subject to a terminal disclaimer

DISAPPROVED

Approved/Disapproved by: Electronic Terminal Disclaimer automatically approved by EFS-Web

U.S. Patent and Trademark Office

Electronic Acknowledgement Receipt

| | |
|---|--|
| EFS ID: | 12394469 |
| Application Number: | 12398063 |
| International Application Number: | |
| Confirmation Number: | 9351 |
| Title of Invention: | SYSTEM AND METHOD FOR INSTANT VoIP MESSAGING |
| First Named Inventor/Applicant Name: | Michael J. Rojas |
| Customer Number: | 23389 |
| Filer: | Paul J. Esatto/Roseann Gallo |
| Filer Authorized By: | Paul J. Esatto |
| Attorney Docket Number: | 17188Y |
| Receipt Date: | 26-MAR-2012 |
| Filing Date: | 04-MAR-2009 |
| Time Stamp: | 17:09:49 |
| Application Type: | Utility under 35 USC 111(a) |

Payment information:

| | |
|--|-----------------|
| Submitted with Payment | yes |
| Payment Type | Deposit Account |
| Payment was successfully received in RAM | \$80 |
| RAM confirmation Number | 6138 |
| Deposit Account | 191013 |
| Authorized User | |

The Director of the USPTO is hereby authorized to charge indicated fees and credit any overpayment as follows:

Charge any Additional Fees required under 37 C.F.R. Section 1.16 (National application filing, search, and examination fees)

Charge any Additional Fees required under 37 C.F.R. Section 1.17 (Patent application and reexamination processing fees)

Charge any Additional Fees required under 37 C.F.R. Section 1.21 (Miscellaneous fees and charges)

File Listing:

| Document Number | Document Description | File Name | File Size(Bytes)/ Message Digest | Multi Part /.zip | Pages (if appl.) |
|-----------------|--------------------------------------|--------------------------|--|------------------|------------------|
| 1 | Electronic Terminal Disclaimer-Filed | eTerminal-Disclaimer.pdf | 33646 e1855aeae67f8406faedc825a548a872ebc57df | no | 2 |

Warnings:

Information:

| | | | | | |
|---|----------------------|--------------|---|----|---|
| 2 | Fee Worksheet (SB06) | fee-info.pdf | 29947 212772160e68d364cfacdca387d80540116a46 | no | 2 |
|---|----------------------|--------------|---|----|---|

Warnings:

Information:

| | |
|-------------------------------------|-------|
| Total Files Size (in bytes): | 63593 |
|-------------------------------------|-------|

This Acknowledgement Receipt evidences receipt on the noted date by the USPTO of the indicated documents, characterized by the applicant, and including page counts, where applicable. It serves as evidence of receipt similar to a Post Card, as described in MPEP 503.

New Applications Under 35 U.S.C. 111

If a new application is being filed and the application includes the necessary components for a filing date (see 37 CFR 1.53(b)-(d) and MPEP 506), a Filing Receipt (37 CFR 1.54) will be issued in due course and the date shown on this Acknowledgement Receipt will establish the filing date of the application.

National Stage of an International Application under 35 U.S.C. 371

If a timely submission to enter the national stage of an international application is compliant with the conditions of 35 U.S.C. 371 and other applicable requirements a Form PCT/DO/EO/903 indicating acceptance of the application as a national stage submission under 35 U.S.C. 371 will be issued in addition to the Filing Receipt, in due course.

New International Application Filed with the USPTO as a Receiving Office

If a new international application is being filed and the international application includes the necessary components for an international filing date (see PCT Article 11 and MPEP 1810), a Notification of the International Application Number and of the International Filing Date (Form PCT/RO/105) will be issued in due course, subject to prescriptions concerning national security, and the date shown on this Acknowledgement Receipt will establish the international filing date of the application.

IN THE UNITED STATES PATENT AND TRADEMARK OFFICE

Applicant(s): Michael J. Rojas Examiner: Creighton H. Smith
Serial No: 12/398,063 Art Unit: 2614
Filed: March 4, 2009 Docket: 17188Y
For: SYSTEM AND METHOD FOR INSTANT VoIP MESSAGING
Conf. No.: 9351 Dated: March 26, 2012

Commissioner for Patents
P. O. Box 1450
Alexandria, VA 22313-1450

RESPONSE UNDER 37 C.F.R. § 1.116

Sir:

Applicant respectfully requests reconsideration of the application in view of the following remarks.

REMARKS

Applicant respectfully submits this Response in reply to the Final Official Action dated January 25, 2011. Applicant submits that the Response is fully responsive to the Final Official Action for at least the reasons set forth herein.

Claims 1 and 4-10 have allowable subject matter.

Claims 1 and 4-10 were rejected based upon a non-statutory obviousness-type double patenting rejection. The Examiner cites U.S. Patent No. 7,535,890 (the '890 Patent) in the rejection.

Without acquiescing to the rejection, and to expedite the allowance of the application, Applicant respectfully submits a terminal disclaimer herewith. Withdrawal of the rejection is respectfully requested.

However, Applicant notes that this application is a continuation application of U.S. Application Serial No. 10/740,030, which became the '890 Patent and the patent term of the instant application is defined by 35 U.S.C. § 154. Additionally, the '890 Patent is entitled to 799 days of Patent term Adjustment under 35 U.S.C. § 154(b). Therefore, Applicant respectfully disagrees with the statements on page 3 of the Official Action.

Applicant also respectfully requests that the Examiner initial the IDS submission for the entry of the "Data Sheet Cisco MGX 8000 Series" as being considered. The reference was considered by the Examiner in the parent case. Since the Examiner did in fact consider the reference, the reference should be listed on the face of the patent.

Based upon the foregoing, Applicant respectfully submits that the application is in condition for allowance and henceforth solicits a Notice of Allowability.

Respectfully submitted,

/Seth Weinfeld/

Seth Weinfeld
Registration No. 50,929

Scully, Scott, Murphy & Presser
400 Garden City Plaza
Garden City, New York 11530
(516) 742-4343
SW:reg

AMENDMENT TRANSMITTAL LETTER (Large Entity)

Commissioner for Patents
P.O. Box 1450
Alexandria, Virginia 22313-1450

| | | | |
|---------------------|--------------------|-------------------------|------------|
| Applicant(s) | Michael J. Rojas | Application No. | 12/398,063 |
| Filing Date | March 4, 2009 | Confirmation No. | 9351 |
| Examiner | Creighton H. Smith | Art Unit | 2614 |

Title of Invention SYSTEM AND METHOD FOR INSTANT VoIP MESSAGING

| | | | |
|-------------------|--------|------------------------|-------|
| Docket No. | 17188Y | Customer Number | 23389 |
|-------------------|--------|------------------------|-------|

*Transmitted herewith is an amendment in the above-identified application.
The fee has been calculated and is transmitted as shown below*

| | Claims Remaining After Amendment | | Highest # Previously Paid For | | # Extra Claims | Rate | Additional Fee |
|--|----------------------------------|---|-------------------------------|---|----------------|----------|----------------|
| TOTAL CLAIMS | 8 | - | 20 | = | 0 | \$60.00 | \$0.00 |
| TOTAL INDEP. CLAIMS | 1 | - | 3 | = | 0 | \$250.00 | \$0.00 |
| <input type="checkbox"/> Multiple Dependent Claims (if applicable) (\$450.00) | | | | | | | \$0.00 |
| TOTAL ADDITIONAL FEE FOR THIS AMENDMENT | | | | | | | \$0.00 |

Method of Payment

- Check Other
- Credit Card (*Form PTO-2038 attached*)
- Deposit Account # 19-1013

For the above-identified deposit account the Director is hereby authorized to: (check all that apply)

- Charge the fee(s) set forth
- Charge any additional filing fees required under 37 C.F.R. §1.16
- Charge any patent application processing fees under 37 C.F.R. §1.17
- Credit any overpayments

CERTIFICATION OF ELECTRONIC FILING

I hereby certify that this correspondence is being deposited with the United States Patent and Trademark Office via Electronic Filing through the United States Patent and Trademark Office e-business website on the date shown below.

/Seth Weinfeld/ _____

Dated: March 26, 2012

Seth Weinfeld
Registration No. 50,929
SCULLY, SCOTT, MURPHY & PRESSER, P.C.
400 Garden City Plaza, Suite 300
Garden City, New York 11530
516-742-4343 Telephone
516-742-4366 Fax

Electronic Acknowledgement Receipt

| | |
|---|--|
| EFS ID: | 12394905 |
| Application Number: | 12398063 |
| International Application Number: | |
| Confirmation Number: | 9351 |
| Title of Invention: | SYSTEM AND METHOD FOR INSTANT VoIP MESSAGING |
| First Named Inventor/Applicant Name: | Michael J. Rojas |
| Customer Number: | 23389 |
| Filer: | Paul J. Esatto/Roseann Gallo |
| Filer Authorized By: | Paul J. Esatto |
| Attorney Docket Number: | 17188Y |
| Receipt Date: | 26-MAR-2012 |
| Filing Date: | 04-MAR-2009 |
| Time Stamp: | 17:18:34 |
| Application Type: | Utility under 35 USC 111(a) |

Payment information:

| | |
|------------------------|----|
| Submitted with Payment | no |
|------------------------|----|

File Listing:

| Document Number | Document Description | File Name | File Size(Bytes)/ Message Digest | Multi Part /.zip | Pages (if appl.) |
|-----------------|----------------------|----------------|--|------------------|------------------|
| 1 | | 17188Y_AM2.pdf | 258896 <small>ce8a9de05ab01e7a2033c9d3c288c0457cd467f</small> | yes | 4 |

| Multipart Description/PDF files in .zip description | | | |
|---|--|--------------|------------|
| Document Description | | Start | End |
| Amendment After Final | | 1 | 1 |
| Applicant Arguments/Remarks Made in an Amendment | | 2 | 3 |
| Miscellaneous Incoming Letter | | 4 | 4 |
| Warnings: | | | |
| Information: | | | |
| Total Files Size (in bytes): | | 258896 | |
| <p>This Acknowledgement Receipt evidences receipt on the noted date by the USPTO of the indicated documents, characterized by the applicant, and including page counts, where applicable. It serves as evidence of receipt similar to a Post Card, as described in MPEP 503.</p> <p><u>New Applications Under 35 U.S.C. 111</u> If a new application is being filed and the application includes the necessary components for a filing date (see 37 CFR 1.53(b)-(d) and MPEP 506), a Filing Receipt (37 CFR 1.54) will be issued in due course and the date shown on this Acknowledgement Receipt will establish the filing date of the application.</p> <p><u>National Stage of an International Application under 35 U.S.C. 371</u> If a timely submission to enter the national stage of an international application is compliant with the conditions of 35 U.S.C. 371 and other applicable requirements a Form PCT/DO/EO/903 indicating acceptance of the application as a national stage submission under 35 U.S.C. 371 will be issued in addition to the Filing Receipt, in due course.</p> <p><u>New International Application Filed with the USPTO as a Receiving Office</u> If a new international application is being filed and the international application includes the necessary components for an international filing date (see PCT Article 11 and MPEP 1810), a Notification of the International Application Number and of the International Filing Date (Form PCT/RO/105) will be issued in due course, subject to prescriptions concerning national security, and the date shown on this Acknowledgement Receipt will establish the international filing date of the application.</p> | | | |



UNITED STATES PATENT AND TRADEMARK OFFICE

UNITED STATES DEPARTMENT OF COMMERCE
United States Patent and Trademark Office
Address: COMMISSIONER FOR PATENTS
P.O. Box 1450
Alexandria, Virginia 22313-1450
www.uspto.gov

Table with 5 columns: APPLICATION NO., FILING DATE, FIRST NAMED INVENTOR, ATTORNEY DOCKET NO., CONFIRMATION NO.
12/398,063 03/04/2009 Michael J. Rojas 17188Y 9351

23389 7590 01/25/2012
SCULLY SCOTT MURPHY & PRESSER, PC
400 GARDEN CITY PLAZA
SUITE 300
GARDEN CITY, NY 11530

EXAMINER

SMITH, CREIGHTON H

ART UNIT PAPER NUMBER

2614

MAIL DATE DELIVERY MODE

01/25/2012

PAPER

Please find below and/or attached an Office communication concerning this application or proceeding.

The time period for reply, if any, is set in the attached communication.

Office Action Summary

| | | |
|--------------------------------------|--|--|
| Application No. 12/398,063 | Applicant(s) ROJAS, MICHAEL J. | |
| Examiner CREIGHTON SMITH | Art Unit 2614 | |

-- The MAILING DATE of this communication appears on the cover sheet with the correspondence address --

Period for Reply

A SHORTENED STATUTORY PERIOD FOR REPLY IS SET TO EXPIRE 3 MONTH(S) OR THIRTY (30) DAYS, WHICHEVER IS LONGER, FROM THE MAILING DATE OF THIS COMMUNICATION.

- Extensions of time may be available under the provisions of 37 CFR 1.136(a). In no event, however, may a reply be timely filed after SIX (6) MONTHS from the mailing date of this communication.
- If NO period for reply is specified above, the maximum statutory period will apply and will expire SIX (6) MONTHS from the mailing date of this communication.
- Failure to reply within the set or extended period for reply will, by statute, cause the application to become ABANDONED (35 U.S.C. § 133). Any reply received by the Office later than three months after the mailing date of this communication, even if timely filed, may reduce any earned patent term adjustment. See 37 CFR 1.704(b).

Status

- 1) Responsive to communication(s) filed on 18 JAN '12.
- 2a) This action is **FINAL**. 2b) This action is non-final.
- 3) An election was made by the applicant in response to a restriction requirement set forth during the interview on _____; the restriction requirement and election have been incorporated into this action.
- 4) Since this application is in condition for allowance except for formal matters, prosecution as to the merits is closed in accordance with the practice under *Ex parte Quayle*, 1935 C.D. 11, 453 O.G. 213.

Disposition of Claims

- 5) Claim(s) 1 and 4-10 is/are pending in the application.
5a) Of the above claim(s) 2 and 3 is/are withdrawn from consideration.
- 6) Claim(s) _____ is/are allowed.
- 7) Claim(s) 1 and 4-10 is/are rejected.
- 8) Claim(s) _____ is/are objected to.
- 9) Claim(s) _____ are subject to restriction and/or election requirement.

Application Papers

- 10) The specification is objected to by the Examiner.
- 11) The drawing(s) filed on _____ is/are: a) accepted or b) objected to by the Examiner.
Applicant may not request that any objection to the drawing(s) be held in abeyance. See 37 CFR 1.85(a).
Replacement drawing sheet(s) including the correction is required if the drawing(s) is objected to. See 37 CFR 1.121(d).
- 12) The oath or declaration is objected to by the Examiner. Note the attached Office Action or form PTO-152.

Priority under 35 U.S.C. § 119

- 13) Acknowledgment is made of a claim for foreign priority under 35 U.S.C. § 119(a)-(d) or (f).
a) All b) Some * c) None of:
1. Certified copies of the priority documents have been received.
2. Certified copies of the priority documents have been received in Application No. _____.
3. Copies of the certified copies of the priority documents have been received in this National Stage application from the International Bureau (PCT Rule 17.2(a)).
* See the attached detailed Office action for a list of the certified copies not received.

Attachment(s)

- | | |
|--|---|
| 1) <input type="checkbox"/> Notice of References Cited (PTO-892) | 4) <input type="checkbox"/> Interview Summary (PTO-413) Paper No(s)/Mail Date. _____ |
| 2) <input type="checkbox"/> Notice of Draftsperson's Patent Drawing Review (PTO-948) | 5) <input type="checkbox"/> Notice of Informal Patent Application |
| 3) <input type="checkbox"/> Information Disclosure Statement(s) (PTO/SB/08) Paper No(s)/Mail Date _____ | 6) <input type="checkbox"/> Other: _____ |

DETAILED ACTION

The nonstatutory double patenting rejection is based on a judicially created doctrine grounded in public policy (a policy reflected in the statute) so as to prevent the unjustified or improper timewise extension of the “right to exclude” granted by a patent and to prevent possible harassment by multiple assignees. A nonstatutory obviousness-type double patenting rejection is appropriate where the conflicting claims are not identical, but at least one examined application claim is not patentably distinct from the reference claim(s) because the examined application claim is either anticipated by, or would have been obvious over, the reference claim(s). See, e.g., *In re Berg*, 140 F.3d 1428, 46 USPQ2d 1226 (Fed. Cir. 1998); *In re Goodman*, 11 F.3d 1046, 29 USPQ2d 2010 (Fed. Cir. 1993); *In re Longi*, 759 F.2d 887, 225 USPQ 645 (Fed. Cir. 1985); *In re Van Ornum*, 686 F.2d 937, 214 USPQ 761 (CCPA 1982); *In re Vogel*, 422 F.2d 438, 164 USPQ 619 (CCPA 1970); and *In re Thorington*, 418 F.2d 528, 163 USPQ 644 (CCPA 1969).

A timely filed terminal disclaimer in compliance with 37 CFR 1.321(c) or 1.321(d) may be used to overcome an actual or provisional rejection based on a nonstatutory double patenting ground provided the conflicting application or patent either is shown to be commonly owned with this application, or claims an invention made as a result of activities undertaken within the scope of a joint research agreement.

Effective January 1, 1994, a registered attorney or agent of record may sign a terminal disclaimer. A terminal disclaimer signed by the assignee must fully comply with 37 CFR 3.73(b).

Claims 1, 4-10 are rejected on the ground of nonstatutory obviousness-type double patenting as being unpatentable over claim 1-70 of U.S. Patent No. 7535890. Although the conflicting claims are not identical, they are not patentably distinct from each other because the elements and steps of the application's claims are all contained the patent's claims and could have originally been presented along with the '890 patent's claims.

To waive the requirement for a terminal disclaimer would give applicant an extra 5 years, 2 months and approximately 14 days of extra protection beyond the expiration of the original patent on 18 Dec. '23. Therefore a terminal disclaimer is required to disclaim the term of the application's claims from the period of December 18, 2023 (the end of the '890 patent's term) until 04 Mar. 2029 (the 20 year term of the application).

Concerning applicant's request that the NPL be considered that was "lined through" by examiner in the Office action dated 18 OCT '10, applicant's attention is directed to MPEP §609; 37 CFR 1.98 (b)(5) where it states that each publication listed on an IDS must be identified by . . . date. Once a date is supplied to the NPL then examiner can consider it. As it is now, it is not known whether it is prior art or not.

THIS ACTION IS MADE FINAL. Applicant is reminded of the extension of time policy as set forth in 37 CFR 1.136(a).

A shortened statutory period for reply to this final action is set to expire THREE MONTHS from the mailing date of this action. In the event a first reply is filed within TWO MONTHS of the mailing date of this final action and the advisory action is not mailed until after the end of the THREE-MONTH shortened statutory period, then the shortened statutory period will expire on the date the advisory action is mailed, and any extension fee pursuant to 37 CFR 1.136(a) will be calculated from the mailing date of the advisory action. In no event, however, will the statutory period for reply expire later than SIX MONTHS from the mailing date of this final action.

Any inquiry concerning this communication should be directed to CREIGHTON SMITH at telephone number (571)272-7546.

/CREIGHTON SMITH/

Primary Examiner, Art Unit 2614

22 JAN '12

| | | |
|--|--|---|
| <i>Index of Claims</i>  | Application/Control No. 12398063 | Applicant(s)/Patent Under Reexamination ROJAS, MICHAEL J. |
| | Examiner CREIGHTON SMITH | Art Unit 2614 |

| | | | | | | | |
|---|-----------------|---|-------------------|---|---------------------|---|-----------------|
| ✓ | Rejected | - | Cancelled | N | Non-Elected | A | Appeal |
| = | Allowed | ÷ | Restricted | I | Interference | O | Objected |

Claims renumbered in the same order as presented by applicant
 CPA
 T.D.
 R.1.47

| CLAIM | | DATE | | | | | | | |
|-------|----------|------------|------------|--|--|--|--|--|--|
| Final | Original | 10/14/2011 | 01/22/2012 | | | | | | |
| | 1 | ✓ | ✓ | | | | | | |
| | 2 | ✓ | - | | | | | | |
| | 3 | ✓ | - | | | | | | |
| | 4 | ✓ | ✓ | | | | | | |
| | 5 | ✓ | ✓ | | | | | | |
| | 6 | ✓ | ✓ | | | | | | |
| | 7 | ✓ | ✓ | | | | | | |
| | 8 | ✓ | ✓ | | | | | | |
| | 9 | ✓ | ✓ | | | | | | |
| | 10 | ✓ | ✓ | | | | | | |

IN THE UNITED STATES PATENT AND TRADEMARK OFFICE

Applicant(s): Michael J. Rojas Examiner: Creighton H. Smith
Serial No: 12/398,063 Art Unit: 2614
Filed: March 4, 2009 Docket: 17188Y
For: SYSTEM AND METHOD FOR INSTANT VoIP MESSAGING
Conf. No.: 9351 Dated: January 18, 2012

Commissioner for Patents
P. O. Box 1450
Alexandria, VA 22313-1450

RESPONSE UNDER 37 C.F.R. § 1.111

Sir:

In response to the Official Action dated October 18, 2011, please amend the above-identified application as follows:

Amendments to the Claims are reflected in the listing of claims which begins on page 2 of this paper.

Remarks/Arguments begin on page 5 of this paper.

IN THE CLAIMS

This version and listing of the claims, replaces and supercedes, all prior versions and listing of the claims.

1. (Currently Amended) A method for instant voice messaging over a packet-switched network, the method comprising:
 - monitoring a connectivity status of nodes within the packet-switched network, said connectivity status being available and unavailable;
 - recording the connectivity status for each of the nodes;
 - associating a sub-set of the nodes with a client;
 - transmitting a signal to a client including a list of the recorded connectivity status for each of the nodes in the sub-set corresponding to the client;
 - receiving an instant voice message having one or more recipients;
 - delivering the instant voice message to the one or more recipients over a packet-switched network;
 - temporarily storing the instant voice message if a recipient is unavailable; and
 - delivering the stored instant voice message to the recipient once the recipient becomes available.
- 2-3. Cancelled.
4. (Currently Amended) The method for instant voice messaging over a packet-switch network according to claim [[2]]1, wherein the instant voice message includes one or more files attached to an audio file.

5. (Currently Amended) The method for instant voice messaging over a packet-switch network according to claim [[2]]1, further comprising the step of:

controlling a method of generating the instant voice message based upon the connectivity status of said one or more recipient.

6. (Original) The method for instant voice messaging over a packet-switch network according to claim 5, wherein said method of generating said instant voice message is selected from a group comprising a record mode and an intercom mode.

7. (Original) The method for instant voice messaging over a packet-switch network according to claim 6, wherein said record mode is selected as a default when at least one recipients are unavailable.

8. (Original) The method for instant voice messaging over a packet-switch network according to claim 6, wherein said intercom mode is selected as a default when at least one recipients are available.

9. (Original) The method for instant voice messaging over a packet-switch network according to claim 7, wherein said record mode comprises the steps of:

recording the instant voice message;

receiving a stop indicator; and

transmitting the recorded instant voice message after the receipt of said stop indicator.

10. (Original) The method for instant voice messaging over a packet-switch network according to claim 8, wherein said intercom mode comprises the steps of:

buffering each of a plurality of successive portions of the instant voice as the instant message is recorded;

transmitting from each successive buffered portion; and

delivering each successive portion to the recipients wherein the recipients audibly playing each successive portion as it is delivered.

REMARKS

Applicant respectfully submits this Amendment in reply to the Official Action dated October 18, 2011. Applicant submits that the Amendment is fully responsive to the Official Action for at least the reasons set forth herein.

At the onset, Applicant would like to thank the Examiner for indicating that claims 3, 7, 8 and 10 have allowable subject matter and would be allowed if rewritten in independent form.

Accordingly, claim 1 has been amended to incorporate the subject matter of claims 2 and 3; the subject matter that the Examiner indicated was allowable. Claims 2 and 3 have been cancelled herewith without prejudice.

Claims 1, 2, and 5 were rejected under 35 U.S.C. § 103(a) as allegedly unpatentable over Vaananen, U.S. Patent No. 7,113,767 (the Examiner refers to the Patent Application Publication for the paragraph numbers) in view of Cast, U.S. Patent No. 7,515,903 (the Examiner refers to the Patent Application Publication for the paragraph numbers). Claim 4 was rejected under 35 U.S.C. § 103(a) as allegedly unpatentable over Vaananen, Cast in view of LaPoint, U.S. Pat. Pub. 2004/0179092. Claims 6 and 9 were rejected under 35 U.S.C. § 103(a) as allegedly unpatentable over Vaananen, Cast and in view of Kwag et al., U.S. Pat. Pub. 2004/0085456.

Without acquiescing to the propriety of the rejections or the Examiner's interpretation of the cited references, and to expedite prosecution, claim 1 was amended to incorporate the allowable subject matter. Thus, Applicant submits that the rejections are moot in view of the above-identified amendment to claim 1. Withdrawal of the rejections is respectfully requested.

Claims 1-10 were rejected based upon a non-statutory obviousness-type double patenting rejection. The Examiner cites U.S. Patent No. 7,535,890 (the '890 Patent) in the rejection. Applicant notes that this application is a continuation application of U.S. Application Serial No. 10/740,030, which became the '890 Patent and the patent term of the instant application is

defined by 35 U.S.C. § 154. Additionally, the '890 Patent is entitled to 799 days of Patent term Adjustment under 35 U.S.C. § 154(b).

Further, Applicant respectfully requests that the Examiner reconsider the rejection in view of the amendments to claim 1. Withdrawal of the rejection is respectfully requested.

Lastly, Applicant notes that the Examiner failed to consider one of the references cited in the Information Disclosure Statement. However, the Examiner failed to provide a reason. Applicant respectfully requests that the Examiner consider the reference.

Based upon the foregoing, Applicant respectfully submits that the application is in condition for allowance and henceforth solicits a Notice of Allowability. Should the Examiner feel that a telephone interview would expedite the allowance of the application; the Examiner is kindly requested to contact the undersigned.

Respectfully submitted,

/Seth Weinfeld/

Seth Weinfeld
Registration No. 50,929

Scully, Scott, Murphy & Presser
400 Garden City Plaza
Garden City, New York 11530
(516) 742-4343

SW:reg

AMENDMENT TRANSMITTAL LETTER (Large Entity)

Commissioner for Patents
P.O. Box 1450
Alexandria, Virginia 22313-1450

| | | | |
|---------------------------|--|-------------------------|------------|
| Applicant(s) | Michael J. Rojas | Application No. | 12/398,063 |
| Filing Date | March 4, 2009 | Confirmation No. | 9351 |
| Examiner | Creighton H. Smith | Art Unit | 2614 |
| Title of Invention | SYSTEM AND METHOD FOR INSTANT VoIP MESSAGING | | |
| Docket No. | 17188Y | Customer Number | 23389 |

*Transmitted herewith is an amendment in the above-identified application.
The fee has been calculated and is transmitted as shown below*

| | Claims Remaining After Amendment | | Highest # Previously Paid For | | # Extra Claims | Rate | Additional Fee |
|--|----------------------------------|---|-------------------------------|---|----------------|----------|----------------|
| TOTAL CLAIMS | 8 | - | 20 | = | 0 | \$60.00 | \$0.00 |
| TOTAL INDEP. CLAIMS | 1 | - | 3 | = | 0 | \$250.00 | \$0.00 |
| <input type="checkbox"/> Multiple Dependent Claims (if applicable) (\$450.00) | | | | | | | \$0.00 |
| TOTAL ADDITIONAL FEE FOR THIS AMENDMENT | | | | | | | \$0.00 |

Method of Payment

- Check Other
 Credit Card (*Form PTO-2038 attached*)
 Deposit Account # 19-1013

For the above-identified deposit account the Director is hereby authorized to: (check all that apply)

- Charge the fee(s) set forth
 Charge any additional filing fees required under 37 C.F.R. §1.16
 Charge any patent application processing fees under 37 C.F.R. §1.17
 Credit any overpayments

CERTIFICATION OF ELECTRONIC FILING

I hereby certify that this correspondence is being deposited with the United States Patent and Trademark Office via Electronic Filing through the United States Patent and Trademark Office e-business website on the date shown below.

/Seth Weinfeld/

Dated: January 18, 2012

Seth Weinfeld
Registration No. 50,929
SCULLY, SCOTT, MURPHY & PRESSER, P.C.
400 Garden City Plaza, Suite 300
Garden City, New York 11530
516-742-4343 Telephone
516-742-4366 Fax

Electronic Acknowledgement Receipt

| | |
|---|--|
| EFS ID: | 11868138 |
| Application Number: | 12398063 |
| International Application Number: | |
| Confirmation Number: | 9351 |
| Title of Invention: | SYSTEM AND METHOD FOR INSTANT VoIP MESSAGING |
| First Named Inventor/Applicant Name: | Michael J. Rojas |
| Customer Number: | 23389 |
| Filer: | Seth Weinfeld |
| Filer Authorized By: | |
| Attorney Docket Number: | 17188Y |
| Receipt Date: | 18-JAN-2012 |
| Filing Date: | 04-MAR-2009 |
| Time Stamp: | 19:26:05 |
| Application Type: | Utility under 35 USC 111(a) |

Payment information:

| | |
|------------------------|----|
| Submitted with Payment | no |
|------------------------|----|

File Listing:

| Document Number | Document Description | File Name | File Size(Bytes)/ Message Digest | Multi Part /.zip | Pages (if appl.) |
|-----------------|----------------------|----------------|---|------------------|------------------|
| 1 | | 17188Y_AM1.pdf | 492932 <small>f1e827f278ac8cce62a5b7cc2282c8b60b659346</small> | yes | 7 |

| Multipart Description/PDF files in .zip description | | |
|--|--------------|------------|
| Document Description | Start | End |
| Amendment/Req. Reconsideration-After Non-Final Reject | 1 | 1 |
| Claims | 2 | 4 |
| Applicant Arguments/Remarks Made in an Amendment | 5 | 6 |
| Miscellaneous Incoming Letter | 7 | 7 |

Warnings:

Information:

| | |
|-------------------------------------|--------|
| Total Files Size (in bytes): | 492932 |
|-------------------------------------|--------|

This Acknowledgement Receipt evidences receipt on the noted date by the USPTO of the indicated documents, characterized by the applicant, and including page counts, where applicable. It serves as evidence of receipt similar to a Post Card, as described in MPEP 503.

New Applications Under 35 U.S.C. 111

If a new application is being filed and the application includes the necessary components for a filing date (see 37 CFR 1.53(b)-(d) and MPEP 506), a Filing Receipt (37 CFR 1.54) will be issued in due course and the date shown on this Acknowledgement Receipt will establish the filing date of the application.

National Stage of an International Application under 35 U.S.C. 371

If a timely submission to enter the national stage of an international application is compliant with the conditions of 35 U.S.C. 371 and other applicable requirements a Form PCT/DO/EO/903 indicating acceptance of the application as a national stage submission under 35 U.S.C. 371 will be issued in addition to the Filing Receipt, in due course.

New International Application Filed with the USPTO as a Receiving Office

If a new international application is being filed and the international application includes the necessary components for an international filing date (see PCT Article 11 and MPEP 1810), a Notification of the International Application Number and of the International Filing Date (Form PCT/RO/105) will be issued in due course, subject to prescriptions concerning national security, and the date shown on this Acknowledgement Receipt will establish the international filing date of the application.

Under the Paperwork Reduction Act of 1995, no persons are required to respond to a collection of information unless it displays a valid OMB control number.

| | | | | | | | | | | | |
|---|---|----------------------------------|-----------|---|---------------|---|---------------------|---------------------------------------|-----------------|---------------------|--|
| PATENT APPLICATION FEE DETERMINATION RECORD Substitute for Form PTO-875 | | | | Application or Docket Number 12/398,063 | | Filing Date 03/04/2009 | | <input type="checkbox"/> To be Mailed | | | |
| APPLICATION AS FILED – PART I | | | | | | | | OTHER THAN | | | |
| (Column 1) | | (Column 2) | | SMALL ENTITY <input checked="" type="checkbox"/> | | OR | | SMALL ENTITY | | | |
| FOR | NUMBER FILED | NUMBER EXTRA | RATE (\$) | FEE (\$) | | RATE (\$) | FEE (\$) | | | | |
| <input type="checkbox"/> BASIC FEE <small>(37 CFR 1.16(a), (b), or (c))</small> | N/A | N/A | N/A | | | N/A | | | | | |
| <input type="checkbox"/> SEARCH FEE <small>(37 CFR 1.16(k), (j), or (m))</small> | N/A | N/A | N/A | | | N/A | | | | | |
| <input type="checkbox"/> EXAMINATION FEE <small>(37 CFR 1.16(o), (p), or (q))</small> | N/A | N/A | N/A | | | N/A | | | | | |
| TOTAL CLAIMS <small>(37 CFR 1.16(i))</small> | minus 20 = | * | X \$ = | | OR | X \$ = | | | | | |
| INDEPENDENT CLAIMS <small>(37 CFR 1.16(h))</small> | minus 3 = | * | X \$ = | | | X \$ = | | | | | |
| <input type="checkbox"/> APPLICATION SIZE FEE <small>(37 CFR 1.16(s))</small> | If the specification and drawings exceed 100 sheets of paper, the application size fee due is \$250 (\$125 for small entity) for each additional 50 sheets or fraction thereof. See 35 U.S.C. 41(a)(1)(G) and 37 CFR 1.16(s). | | | | | | | | | | |
| <input type="checkbox"/> MULTIPLE DEPENDENT CLAIM PRESENT <small>(37 CFR 1.16(j))</small> | | | | | | | | | | | |
| * If the difference in column 1 is less than zero, enter "0" in column 2. | | | TOTAL | | | TOTAL | | | | | |
| APPLICATION AS AMENDED – PART II | | | | | | | | OTHER THAN | | | |
| (Column 1) | | (Column 2) | | (Column 3) | | SMALL ENTITY | | OR | | SMALL ENTITY | |
| AMENDMENT | 01/18/2012 | CLAIMS REMAINING AFTER AMENDMENT | | HIGHEST NUMBER PREVIOUSLY PAID FOR | PRESENT EXTRA | RATE (\$) | ADDITIONAL FEE (\$) | | RATE (\$) | ADDITIONAL FEE (\$) | |
| | Total <small>(37 CFR 1.16(i))</small> | * 8 | Minus | ** 20 | = 0 | X \$30 = | 0 | OR | X \$ = | | |
| | Independent <small>(37 CFR 1.16(h))</small> | * 1 | Minus | *** 3 | = 0 | X \$125 = | 0 | OR | X \$ = | | |
| | <input type="checkbox"/> Application Size Fee <small>(37 CFR 1.16(s))</small> | | | | | | | | | | |
| | <input type="checkbox"/> FIRST PRESENTATION OF MULTIPLE DEPENDENT CLAIM <small>(37 CFR 1.16(j))</small> | | | | | | | | | | |
| | | | | | | TOTAL ADD'L FEE | 0 | OR | TOTAL ADD'L FEE | | |
| AMENDMENT | | CLAIMS REMAINING AFTER AMENDMENT | | HIGHEST NUMBER PREVIOUSLY PAID FOR | PRESENT EXTRA | RATE (\$) | ADDITIONAL FEE (\$) | | RATE (\$) | ADDITIONAL FEE (\$) | |
| | Total <small>(37 CFR 1.16(i))</small> | * | Minus | ** | = | X \$ = | | OR | X \$ = | | |
| | Independent <small>(37 CFR 1.16(h))</small> | * | Minus | *** | = | X \$ = | | OR | X \$ = | | |
| | <input type="checkbox"/> Application Size Fee <small>(37 CFR 1.16(s))</small> | | | | | | | | | | |
| | <input type="checkbox"/> FIRST PRESENTATION OF MULTIPLE DEPENDENT CLAIM <small>(37 CFR 1.16(j))</small> | | | | | | | | | | |
| | | | | | | TOTAL ADD'L FEE | | OR | TOTAL ADD'L FEE | | |
| * If the entry in column 1 is less than the entry in column 2, write "0" in column 3. | | | | | | Legal Instrument Examiner: /BRENDA MURPHY/ | | | | | |
| ** If the "Highest Number Previously Paid For" IN THIS SPACE is less than 20, enter "20". | | | | | | | | | | | |
| *** If the "Highest Number Previously Paid For" IN THIS SPACE is less than 3, enter "3". | | | | | | | | | | | |
| The "Highest Number Previously Paid For" (Total or Independent) is the highest number found in the appropriate box in column 1. | | | | | | | | | | | |

This collection of information is required by 37 CFR 1.16. The information is required to obtain or retain a benefit by the public which is to file (and by the USPTO to process) an application. Confidentiality is governed by 35 U.S.C. 122 and 37 CFR 1.14. This collection is estimated to take 12 minutes to complete, including gathering, preparing, and submitting the completed application form to the USPTO. Time will vary depending upon the individual case. Any comments on the amount of time you require to complete this form and/or suggestions for reducing this burden, should be sent to the Chief Information Officer, U.S. Patent and Trademark Office, U.S. Department of Commerce, P.O. Box 1450, Alexandria, VA 22313-1450. DO NOT SEND FEES OR COMPLETED FORMS TO THIS ADDRESS. **SEND TO: Commissioner for Patents, P.O. Box 1450, Alexandria, VA 22313-1450.**

If you need assistance in completing the form, call 1-800-PTO-9199 and select option 2.



UNITED STATES PATENT AND TRADEMARK OFFICE

UNITED STATES DEPARTMENT OF COMMERCE
United States Patent and Trademark Office
Address: COMMISSIONER FOR PATENTS
P.O. Box 1450
Alexandria, Virginia 22313-1450
www.uspto.gov

Table with 5 columns: APPLICATION NO., FILING DATE, FIRST NAMED INVENTOR, ATTORNEY DOCKET NO., CONFIRMATION NO.
12/398,063 03/04/2009 Michael J. Rojas 17188Y 9351

23389 7590 10/18/2011
SCULLY SCOTT MURPHY & PRESSER, PC
400 GARDEN CITY PLAZA
SUITE 300
GARDEN CITY, NY 11530

EXAMINER

SMITH, CREIGHTON H

ART UNIT PAPER NUMBER

2614

MAIL DATE DELIVERY MODE

10/18/2011

PAPER

Please find below and/or attached an Office communication concerning this application or proceeding.

The time period for reply, if any, is set in the attached communication.

| | | | |
|------------------------------|--------------------------------------|--|--|
| Office Action Summary | Application No. 12/398,063 | Applicant(s) ROJAS, MICHAEL J. | |
| | Examiner CREIGHTON SMITH | Art Unit 2614 | |

-- The MAILING DATE of this communication appears on the cover sheet with the correspondence address --

Period for Reply

A SHORTENED STATUTORY PERIOD FOR REPLY IS SET TO EXPIRE 3 MONTH(S) OR THIRTY (30) DAYS, WHICHEVER IS LONGER, FROM THE MAILING DATE OF THIS COMMUNICATION.

- Extensions of time may be available under the provisions of 37 CFR 1.136(a). In no event, however, may a reply be timely filed after SIX (6) MONTHS from the mailing date of this communication.
- If NO period for reply is specified above, the maximum statutory period will apply and will expire SIX (6) MONTHS from the mailing date of this communication.
- Failure to reply within the set or extended period for reply will, by statute, cause the application to become ABANDONED (35 U.S.C. § 133). Any reply received by the Office later than three months after the mailing date of this communication, even if timely filed, may reduce any earned patent term adjustment. See 37 CFR 1.704(b).

Status

- 1) Responsive to communication(s) filed on _____.
- 2a) This action is **FINAL**. 2b) This action is non-final.
- 3) An election was made by the applicant in response to a restriction requirement set forth during the interview on _____; the restriction requirement and election have been incorporated into this action.
- 4) Since this application is in condition for allowance except for formal matters, prosecution as to the merits is closed in accordance with the practice under *Ex parte Quayle*, 1935 C.D. 11, 453 O.G. 213.

Disposition of Claims

- 5) Claim(s) 1-10 is/are pending in the application.
 - 5a) Of the above claim(s) _____ is/are withdrawn from consideration.
- 6) Claim(s) _____ is/are allowed.
- 7) Claim(s) 1-10 is/are rejected.
- 8) Claim(s) _____ is/are objected to.
- 9) Claim(s) _____ are subject to restriction and/or election requirement.

Application Papers

- 10) The specification is objected to by the Examiner.
- 11) The drawing(s) filed on _____ is/are: a) accepted or b) objected to by the Examiner.
 Applicant may not request that any objection to the drawing(s) be held in abeyance. See 37 CFR 1.85(a).
 Replacement drawing sheet(s) including the correction is required if the drawing(s) is objected to. See 37 CFR 1.121(d).
- 12) The oath or declaration is objected to by the Examiner. Note the attached Office Action or form PTO-152.

Priority under 35 U.S.C. § 119

- 13) Acknowledgment is made of a claim for foreign priority under 35 U.S.C. § 119(a)-(d) or (f).
 - a) All b) Some * c) None of:
 - 1. Certified copies of the priority documents have been received.
 - 2. Certified copies of the priority documents have been received in Application No. _____.
 - 3. Copies of the certified copies of the priority documents have been received in this National Stage application from the International Bureau (PCT Rule 17.2(a)).
- * See the attached detailed Office action for a list of the certified copies not received.

Attachment(s)

- 1) Notice of References Cited (PTO-892)
- 2) Notice of Draftsperson's Patent Drawing Review (PTO-948)
- 3) Information Disclosure Statement(s) (PTO/SB/08)
 Paper No(s)/Mail Date 03.04.2009.
- 4) Interview Summary (PTO-413)
 Paper No(s)/Mail Date. _____.
- 5) Notice of Informal Patent Application
- 6) Other: _____.

DETAILED ACTION

The nonstatutory double patenting rejection is based on a judicially created doctrine grounded in public policy (a policy reflected in the statute) so as to prevent the unjustified or improper timewise extension of the “right to exclude” granted by a patent and to prevent possible harassment by multiple assignees. A nonstatutory obviousness-type double patenting rejection is appropriate where the conflicting claims are not identical, but at least one examined application claim is not patentably distinct from the reference claim(s) because the examined application claim is either anticipated by, or would have been obvious over, the reference claim(s). See, e.g., *In re Berg*, 140 F.3d 1428, 46 USPQ2d 1226 (Fed. Cir. 1998); *In re Goodman*, 11 F.3d 1046, 29 USPQ2d 2010 (Fed. Cir. 1993); *In re Longi*, 759 F.2d 887, 225 USPQ 645 (Fed. Cir. 1985); *In re Van Ornum*, 686 F.2d 937, 214 USPQ 761 (CCPA 1982); *In re Vogel*, 422 F.2d 438, 164 USPQ 619 (CCPA 1970); and *In re Thorington*, 418 F.2d 528, 163 USPQ 644 (CCPA 1969).

A timely filed terminal disclaimer in compliance with 37 CFR 1.321(c) or 1.321(d) may be used to overcome an actual or provisional rejection based on a nonstatutory double patenting ground provided the conflicting application or patent either is shown to be commonly owned with this application, or claims an invention made as a result of activities undertaken within the scope of a joint research agreement.

Effective January 1, 1994, a registered attorney or agent of record may sign a terminal disclaimer. A terminal disclaimer signed by the assignee must fully comply with 37 CFR 3.73(b).

Claims 1-10 are rejected on the ground of nonstatutory obviousness-type double patenting as being unpatentable over claims 1-70 of U.S. Patent No. 7,535,890.

Although the conflicting claims are not identical, they are not patentably distinct from each other because the elements and steps of the application's claims are contained in the patent's claims, and therefore could have easily been incorporated with the patent's claims.

The following is a quotation of 35 U.S.C. 103(a) which forms the basis for all obviousness rejections set forth in this Office action:

(a) A patent may not be obtained though the invention is not identically disclosed or described as set forth in section 102 of this title, if the differences between the subject matter sought to be patented and the prior art are such that the subject matter as a whole would have been obvious at the time the invention was made to a person having ordinary skill in the art to which said subject matter pertains. Patentability shall not be negated by the manner in which the invention was made.

Claims 1, 2, 5 are rejected under 35 U.S.C. 103(a) as being unpatentable over Vaananen, U.S. Pat. App. Pub. #2004/0014456, now U.S. Pat. #7,113,767 in view of Cast, U.S. Pat. App. Pub. #2010/0070275, now U.S. Pat. #7,515,903.

Vaananen discloses in the Abstract that relates to a server method of instant voice messaging. In P.0003 Vaananen discloses that messages are left for subscribers by establishing a phone call to a phone number of a remote access point of presence. The remote access point of presence digitizes the voice message and transmits the message over a packet network. In P.0006 Vaananen discloses that the sending of the voicemail message is instantaneous if the recipient is available, and if the recipient is not available the message delivery is delayed. In P.0049 Vaananen discloses that if the recipient is not available to receive the message, then the message is stored on the server, and attempts to deliver the message are taken at timed intervals. Vaanane

does not disclose delivering the instant voice message when the recipient becomes available.

However, Cast does disclose in P.0043 verifying voice availability of the intended recipient. Cast states, 2nd sentence, P.0043, “[i]f a message recipient is available for delivery of voice messages, the voice message is delivered. If the recipient is unavailable for voice message delivery, the voice message is stored.” To have provided Cast’s disclosure of delivering a voice message when the recipient becomes available in Vaananen’s invention would have been obvious to a person having ordinary skill in the art because both references are teaching the delivery of voice messages to an intended recipient, one on timely intervals and the other when the recipient becomes available. The skilled artisan in this art would have found the teachings of Cast readily combinable in Vaananen through no more than common sense.

For claim 2, Cast teaches in the last sentence of P.0043, recipient availability using recipient information at a network node. For claim 5, see Vaananen’s P.0049, 2nd sentence.

Claim 4 is rejected under 35 U.S.C. 103(a) as being unpatentable over Vaananen in view of Cast as applied to claim 1 above, and further in view of LaPoint, U.S. Pat. App. Pub. #2004/0179092.

LaPoint discloses in P.0059 that compound messaging capability gives the option to create different media (for example, attach a Word to a voice message). To

have provided LaPoint's teaching of attaching a file to a voice message in Vaananen would have been obvious to a person having ordinary skill in the messaging arts.

Claims 6, 9 are rejected under 35 U.S.C. 103(a) as being unpatentable over Vaananen in view of Cast as applied to claim 5 above, and further in view of Kwag et al, U.S. Pat. App. Pub. #2004/0085456.

Kwag et al disclose in P.0046 that voice recording mode is activated to record voice mail messages through a microphone. To have provided Kwag et al disclosure of creating a voice message in the record mode in Vaananen would have been obvious to a person having ordinary skill in the art.

Claims 3, 7, 8, 10 are objected to as being dependent upon a rejected base claim, but would be allowable if rewritten in independent form including all of the limitations of the base claim and any intervening claims.

Any inquiry concerning this communication should be directed to CREIGHTON SMITH at telephone number (571)272-7546.

/CREIGHTON SMITH/

Primary Examiner, Art Unit 2614

14 OCT '11

| | | | |
|-----------------------------------|---------------------------------------|--|-------------|
| Notice of References Cited | Application/Control No. 12/398,063 | Applicant(s)/Patent Under Reexamination ROJAS, MICHAEL J. | |
| | Examiner CREIGHTON SMITH | Art Unit 2614 | Page 1 of 1 |

U.S. PATENT DOCUMENTS

| * | | Document Number Country Code-Number-Kind Code | Date MM-YYYY | Name | Classification |
|---|---|--|-----------------|----------------------|----------------|
| * | A | US-2004/0014456 | 01-2004 | Vnnen, Mikko Kalervo | 455/413 |
| * | B | US-2010/0070275 | 03-2010 | Cast, Thomas | 704/235 |
| * | C | US-2004/0179092 | 09-2004 | LaPoint, Donald A. | 348/014.08 |
| * | D | US-2004/0085456 | 05-2004 | Kwag et al. | 348/211.11 |
| | E | US- | | | |
| | F | US- | | | |
| | G | US- | | | |
| | H | US- | | | |
| | I | US- | | | |
| | J | US- | | | |
| | K | US- | | | |
| | L | US- | | | |
| | M | US- | | | |

FOREIGN PATENT DOCUMENTS

| * | | Document Number Country Code-Number-Kind Code | Date MM-YYYY | Country | Name | Classification |
|---|---|--|-----------------|---------|------|----------------|
| | N | | | | | |
| | O | | | | | |
| | P | | | | | |
| | Q | | | | | |
| | R | | | | | |
| | S | | | | | |
| | T | | | | | |

NON-PATENT DOCUMENTS

| * | | Include as applicable: Author, Title Date, Publisher, Edition or Volume, Pertinent Pages) |
|---|---|---|
| | U | |
| | V | |
| | W | |
| | X | |

*A copy of this reference is not being furnished with this Office action. (See MPEP § 707.05(a).)
Dates in MM-YYYY format are publication dates. Classifications may be US or foreign.

| | | | | | | |
|--|---|-------------------------------|------------------|-----------------|----------|---------------------------------|
| Form PTO-1449 U.S. DEPARTMENT OF COMMERCE (REV. 7-80) PATENT AND TRADEMARK OFFICE | | Atty. Docket No. 17188Y | | Application No. | | |
| INFORMATION DISCLOSURE CITATION (Use several sheets if necessary) | | Applicant Michael J. Rojas | | | | |
| | | Filing Date Herewith | | Group Art Unit | | |
| U.S. PATENT DOCUMENTS | | | | | | |
| EXAMINER INITIAL* | DOCUMENT NUMBER | DATE | NAME | CLASS | SUBCLASS | FILING DATE (if appropriate) |
| | 6,763,226 | 07-13-2004 | McZeal, Jr. | | | |
| U.S. PATENT PUBLICATION DOCUMENTS | | | | | | |
| | 2004/0252679 | 12-16-2004 | Williams et al. | | | |
| | 2004/0122906 | 06-24-2004 | Goodman et al. | | | |
| | 2005/0053230 | 03-10-2005 | Gierachf, K. | | | |
| | 2005/0105697 | 05-19-2005 | Hollowell et al. | | | |
| | 2003/0087632 | 05-08-2003 | Sagi et al. | | | |
| | 2006/0268750 | 11-30-2006 | Weiner, M. | | | |
| | 2004/0030046 | 02-12-2004 | Schultes et al. | | | |
| | 2007/0112925 | 05-17-2007 | Malik, D. | | | |
| | 2007/0174403 | 07-26-2007 | Barry, M. | | | |
| | 2006/0167883 | 07-27-2006 | Boukobza, E. | | | |
| | 2004/0128356 | 07-01-2004 | Bernstein et al. | | | |
| | 2003/0126207 | 07-03-2003 | Creamer et al. | | | |
| FOREIGN PATENT DOCUMENTS | | | | | | |
| | DOCUMENT NUMBER | DATE | COUNTRY | CLASS | SUBCLASS | TRANSLATION YES NO |
| | | | | | | |
| OTHER PRIOR ART (Including Author, Title, Date, Pertinent Pages, Etc.) | | | | | | |
| | http://www.cisco.com/warp/public/cc/pd/nemnsw/callmn/prodlit/cm33_ds.htm; "Data Sheet Cisco CallManager Version 3.3", November 22, 2002; | | | | | |
| | http://www.cisco.com/en/US/products/hw/switches/ps1925/products_data_sheet_09186_a00800a3c3d.html; "Data Sheet Cisco MGX 8000 Series" (Date unknown); | | | | | |
| EXAMINER | /Creighton Smith/ | | DATE CONSIDERED | 10/13/2011 | | |

ALL REFERENCES CONSIDERED EXCEPT WHERE LINED THROUGH. /C.S./

| | | | | | | | |
|--|------------|--|-----------------------------------|----------------|---------------------------|-----------------------|-------------------------------------|
| Form PTO-1449 U.S. DEPARTMENT OF COMMERCE (REV. 7-80) PATENT AND TRADEMARK OFFICE | | Att. Docket No. (Optional) 17188Y | | | Application Number | | |
| INFORMATION DISCLOSURE CITATION (Use several sheets if necessary) | | | | | | | |
| Applicant(s) Michael Rojas | | | | | | | |
| Filing Date | | | | | | Group Art Unit | |
| U.S. PATENT DOCUMENTS | | | | | | | |
| EXAMINER INITIAL* | | DOCUMENT NUMBER | DATE | NAME | CLASS | SUBCLASS | FILING DATE (if appropriate) |
| | AA | | | | | | |
| | AB | | | | | | |
| | AC | | | | | | |
| FOREIGN PATENT DOCUMENTS | | | | | | | |
| | REF | DOCUMENT NUMBER | DATE | COUNTRY | CLASS | SUBCLASS | TRANSLATION |
| | | | | | | | YES NO |
| | | | | | | | |
| | | | | | | | |
| OTHER DOCUMENTS (Including Author, Title, Date, Pertinent Pages, Etc.) | | | | | | | |
| | | http://www.hsteliann.com/english/?zone=3100-V21P ; "Telephone 3100-V21P", 2003; | | | | | |
| | | http://www.linuxdevices.com/articles/AT5199947519.html ; "Device Profile: snom 100 VoIP phone", May 15, 2002; | | | | | |
| | | http://www.pingtel.com/pr_xpressa.jsp ; "No limits with the advanced industry standard SIP phone, December 8, 2003; and | | | | | |
| | | AudioCoded Enabling Technology Products, TPM-1100 VoP Media Gateway Modules; 2003. | | | | | |
| EXAMINER /Creighton Smith/ | | | DATE CONSIDERED 10/13/2011 | | | | |
| * EXAMINER: Initial if reference considered, whether or not citation is in conformance with MPEP 609; draw line through citation if not in conformance and not considered. Include copy of this form with next communication to applicant. | | | | | | | |

ALL REFERENCES CONSIDERED EXCEPT WHERE LINED THROUGH. /C.S./

| | | |
|--|--|---|
| <i>Index of Claims</i>  | Application/Control No. 12398063 | Applicant(s)/Patent Under Reexamination ROJAS, MICHAEL J. |
| | Examiner CREIGHTON SMITH | Art Unit 2614 |

| | | | | | | | |
|---|-----------------|---|-------------------|---|---------------------|---|-----------------|
| ✓ | Rejected | - | Cancelled | N | Non-Elected | A | Appeal |
| = | Allowed | ÷ | Restricted | I | Interference | O | Objected |

| <input type="checkbox"/> Claims renumbered in the same order as presented by applicant | | <input type="checkbox"/> CPA | | <input checked="" type="checkbox"/> T.D. | | <input type="checkbox"/> R.1.47 | | | |
|--|----------|------------------------------|--|--|--|---------------------------------|--|--|--|
| CLAIM | | DATE | | | | | | | |
| Final | Original | 10/14/2011 | | | | | | | |
| | 1 | ✓ | | | | | | | |
| | 2 | ✓ | | | | | | | |
| | 3 | ✓ | | | | | | | |
| | 4 | ✓ | | | | | | | |
| | 5 | ✓ | | | | | | | |
| | 6 | ✓ | | | | | | | |
| | 7 | ✓ | | | | | | | |
| | 8 | ✓ | | | | | | | |
| | 9 | ✓ | | | | | | | |
| | 10 | ✓ | | | | | | | |



UNITED STATES PATENT AND TRADEMARK OFFICE

UNITED STATES DEPARTMENT OF COMMERCE
 United States Patent and Trademark Office
 Address: COMMISSIONER FOR PATENTS
 P.O. Box 1450
 Alexandria, Virginia 22313-1450
 www.uspto.gov

BIB DATA SHEET

CONFIRMATION NO. 9351

| | | | | | | |
|---|---|--|---|--------------------------------------|---------------------------|--------------------------------|
| SERIAL NUMBER 12/398,063 | FILING or 371(c) DATE 03/04/2009 RULE | CLASS 379 | GROUP ART UNIT 2614 | ATTORNEY DOCKET NO. 17188Y | | |
| APPLICANTS Michael J. Rojas, North Canton, OH; | | | | | | |
| ** CONTINUING DATA ***** This application is a CON of 10/740,030 12/18/2003 PAT 7,535,890 | | | | | | |
| ** FOREIGN APPLICATIONS ***** | | | | | | |
| ** IF REQUIRED, FOREIGN FILING LICENSE GRANTED *** SMALL ENTITY ** 03/16/2009 | | | | | | |
| Foreign Priority claimed <input type="checkbox"/> Yes <input checked="" type="checkbox"/> No | 35 USC 119(a-d) conditions met <input type="checkbox"/> Yes <input checked="" type="checkbox"/> No | <input type="checkbox"/> Met after Allowance | STATE OR COUNTRY OH | SHEETS DRAWINGS 9 | TOTAL CLAIMS 10 | INDEPENDENT CLAIMS 1 |
| Verified and Acknowledged | /GREIGHTON H SMITH/ Examiner's Signature | Initials | | | | |
| ADDRESS SCULLY SCOTT MURPHY & PRESSER, PC 400 GARDEN CITY PLAZA SUITE 300 GARDEN CITY, NY 11530 UNITED STATES | | | | | | |
| TITLE SYSTEM AND METHOD FOR INSTANT VoIP MESSAGING | | | | | | |
| FILING FEE RECEIVED 462 | FEES: Authority has been given in Paper No. _____ to charge/credit DEPOSIT ACCOUNT No. _____ for following: | | <input type="checkbox"/> All Fees <input type="checkbox"/> 1.16 Fees (Filing) <input type="checkbox"/> 1.17 Fees (Processing Ext. of time) <input type="checkbox"/> 1.18 Fees (Issue) <input type="checkbox"/> Other _____ <input type="checkbox"/> Credit | | | |

| | | |
|--|--|---|
| Search Notes  | Application/Control No. 12398063 | Applicant(s)/Patent Under Reexamination ROJAS, MICHAEL J. |
| | Examiner CREIGHTON SMITH | Art Unit 2614 |

| SEARCHED | | | |
|----------|----------|------------|----------|
| Class | Subclass | Date | Examiner |
| 370 | 352 | 14 OCT '11 | chs |
| 709 | 206 | " | " |

| SEARCH NOTES | | |
|--------------|------------|----------|
| Search Notes | Date | Examiner |
| EAST | 14 OCT '11 | chs |

| INTERFERENCE SEARCH | | | |
|---------------------|----------|------|----------|
| Class | Subclass | Date | Examiner |
| | | | |

| | |
|--|--|
| | |
|--|--|

EAST Search History

EAST Search History (Prior Art)

| Ref # | Hits | Search Query | DBs | Default Operator | Plurals | Time Stamp |
|-------|------|--|------------------------------------|------------------|---------|------------------|
| L1 | 210 | ((@ad<="20031218") or (@rlad<="20031218")) and (instant adj voice adj messag\$4 or voice adj messag\$4) with file\$1 with audio near3 file | US-PGPUB; USPAT; EPO; JPO; DERWENT | OR | OFF | 2011/10/14 10:54 |
| L2 | 28 | ((@ad<="20031218") or (@rlad<="20031218")) and (instant adj voice adj messag\$4 or voice adj messag\$4) with file\$1 with attach\$4 with audio adj file | US-PGPUB; USPAT; EPO; JPO; DERWENT | OR | OFF | 2011/10/14 10:54 |
| L3 | 2 | ((@ad<="20031218") or (@rlad<="20031218")) and (instant adj voice adj messag\$4) with file\$1 with attach\$4 with audio adj file | US-PGPUB; USPAT; EPO; JPO; DERWENT | OR | OFF | 2011/10/14 10:55 |
| L4 | 111 | ((@ad<="20031218") or (@rlad<="20031218")) and (instant adj voice adj messag\$4 or voice adj messag\$4) near5 file\$1 near5 attach\$4 | US-PGPUB; USPAT; EPO; JPO; DERWENT | OR | OFF | 2011/10/14 11:27 |
| L5 | 68 | ((@ad<="20031218") or (@rlad<="20031218")) and (instant adj voice adj messag\$4 or voice adj messag\$4) with (record or intercom) near5 mode | US-PGPUB; USPAT; EPO; JPO; DERWENT | OR | OFF | 2011/10/14 11:43 |
| L6 | 4 | ((@ad<="20031218") or (@rlad<="20031218")) and (instant adj voice adj messag\$4) with (record or intercom) near5 mode | US-PGPUB; USPAT; EPO; JPO; DERWENT | OR | OFF | 2011/10/14 11:43 |
| S2 | 97 | (("6226322") or ("6226322") or ("5991311") or ("5889856") or ("5901205") or ("6052380") or ("6111936") or ("6154524") or ("6176710") or ("6219378") or ("6219378") or ("5243593") or ("5479447") or ("5883941") or ("5909445") or ("5930340") or ("5987069") or ("6021158") or ("6028486") or ("6075784") or ("6084885") or ("6101216") or ("6104749") or ("6118766") or ("6141330") or ("6144733") or ("6167095") or ("6236714") or ("20060159129") or ("4577255") or ("4799217") or ("4985891") or ("4999836") or ("5181198") or ("5305312") or ("5341418") or ("5347516") or ("5404388") or ("5410264") or ("5535198") or ("5682385") or ("5719870") or ("5771236") or ("5793751") or ("5805669") or ("5815505") or ("5831979") or ("5842111") or ("5848150") or ("5852630")).PN. | US-PGPUB; USPAT; EPO; JPO; DERWENT | OR | OFF | 2011/10/12 12:03 |

EAST Search History

| | | | | | | |
|----|----|--|------------------------------------|----|-----|------------------|
| S3 | 14 | ((@ad<="20031218") or (@rlad<="20031218")) and (stor\$3 or receiv\$3 or deposit\$3) same (instant adj voice adj messag\$3 or digitiz\$4 near4 audio adj file or record\$4 near3 audio adj file) and (packet or voip or ip or internet adj protocol) same (unavailable or ("not" near3 (connect\$2 or log\$4))) | US-PGPUB; USPAT; EPO; JPO; DERWENT | OR | OFF | 2011/10/13 15:51 |
| S4 | 89 | ((@ad<="20031218") or (@rlad<="20031218")) and (deliver\$3 or transmi\$5 or send\$3 or receiv\$3) with (instant adj voice adj messag\$4 or voice adj messag\$4) with (recipient or called or callee) with availab\$5 | US-PGPUB; USPAT; EPO; JPO; DERWENT | OR | OFF | 2011/10/14 08:48 |

EAST Search History (Interference)

< This search history is empty >

10/ 14/ 2011 11:51:33 AM

C:\ Users\ csmith1\ Documents\ EAST\ Workspaces\ 12- 154888.wsp



UNITED STATES PATENT AND TRADEMARK OFFICE

UNITED STATES DEPARTMENT OF COMMERCE
United States Patent and Trademark Office
Address: COMMISSIONER FOR PATENTS
P.O. Box 1450
Alexandria, Virginia 22313-1450
www.uspto.gov

Table with 4 columns: APPLICATION NUMBER (12/398,063), FILING OR 371(C) DATE (03/04/2009), FIRST NAMED APPLICANT (Michael J. Rojas), ATTY. DOCKET NO./TITLE (17188Y)

CONFIRMATION NO. 9351

PUBLICATION NOTICE

23389
SCULLY SCOTT MURPHY & PRESSER, PC
400 GARDEN CITY PLAZA
SUITE 300
GARDEN CITY, NY 11530



Title:SYSTEM AND METHOD FOR INSTANT VoIP MESSAGING

Publication No.US-2009-0161664-A1

Publication Date:06/25/2009

NOTICE OF PUBLICATION OF APPLICATION

The above-identified application will be electronically published as a patent application publication pursuant to 37 CFR 1.211, et seq. The patent application publication number and publication date are set forth above.

The publication may be accessed through the USPTO's publically available Searchable Databases via the Internet at www.uspto.gov. The direct link to access the publication is currently http://www.uspto.gov/patft/.

The publication process established by the Office does not provide for mailing a copy of the publication to applicant. A copy of the publication may be obtained from the Office upon payment of the appropriate fee set forth in 37 CFR 1.19(a)(1). Orders for copies of patent application publications are handled by the USPTO's Office of Public Records. The Office of Public Records can be reached by telephone at (703) 308-9726 or (800) 972-6382, by facsimile at (703) 305-8759, by mail addressed to the United States Patent and Trademark Office, Office of Public Records, Alexandria, VA 22313-1450 or via the Internet.

In addition, information on the status of the application, including the mailing date of Office actions and the dates of receipt of correspondence filed in the Office, may also be accessed via the Internet through the Patent Electronic Business Center at www.uspto.gov using the public side of the Patent Application Information and Retrieval (PAIR) system. The direct link to access this status information is currently http://pair.uspto.gov/. Prior to publication, such status information is confidential and may only be obtained by applicant using the private side of PAIR.

Further assistance in electronically accessing the publication, or about PAIR, is available by calling the Patent Electronic Business Center at 1-866-217-9197.

Office of Data Management, Application Assistance Unit (571) 272-4000, or (571) 272-4200, or 1-888-786-0101



UNITED STATES PATENT AND TRADEMARK OFFICE

UNITED STATES DEPARTMENT OF COMMERCE
United States Patent and Trademark Office
Address: COMMISSIONER FOR PATENTS
P.O. Box 1450
Alexandria, Virginia 22313-1450
www.uspto.gov

Table with 7 columns: APPLICATION NUMBER, FILING or 371(c) DATE, GRP ART UNIT, FIL FEE REC'D, ATTY.DOCKET.NO, TOT CLAIMS, IND CLAIMS. Row 1: 12/398,063, 03/04/2009, 2614, 462, 17188Y, 10, 1

CONFIRMATION NO. 9351

23389
SCULLY SCOTT MURPHY & PRESSER, PC
400 GARDEN CITY PLAZA
SUITE 300
GARDEN CITY, NY 11530

FILING RECEIPT



Date Mailed: 03/19/2009

Receipt is acknowledged of this non-provisional patent application. The application will be taken up for examination in due course. Applicant will be notified as to the results of the examination. Any correspondence concerning the application must include the following identification information: the U.S. APPLICATION NUMBER, FILING DATE, NAME OF APPLICANT, and TITLE OF INVENTION. Fees transmitted by check or draft are subject to collection. Please verify the accuracy of the data presented on this receipt. If an error is noted on this Filing Receipt, please submit a written request for a Filing Receipt Correction. Please provide a copy of this Filing Receipt with the changes noted thereon. If you received a "Notice to File Missing Parts" for this application, please submit any corrections to this Filing Receipt with your reply to the Notice. When the USPTO processes the reply to the Notice, the USPTO will generate another Filing Receipt incorporating the requested corrections

Applicant(s)

Michael J. Rojas, North Canton, OH;

Assignment For Published Patent Application

AYALOGIC, INC., Akron, OH

Power of Attorney:

Leopold Presser--19827 Mark Cohen--32211
William Roch--24972 Edward Grolz--33705
John Sensny--28757 Steven Fischman--34594
Paul Esatto--30749 Thomas Spinelli--39533
Frank DiGiglio--31346 Peter Bernstein--43497

Domestic Priority data as claimed by applicant

This application is a CON of 10/740,030 12/18/2003

Foreign Applications

If Required, Foreign Filing License Granted: 03/16/2009

The country code and number of your priority application, to be used for filing abroad under the Paris Convention, is US 12/398,063

Projected Publication Date: 06/25/2009

Non-Publication Request: No

Early Publication Request: No

** SMALL ENTITY **

Title

SYSTEM AND METHOD FOR INSTANT VoIP MESSAGING

Preliminary Class

370

PROTECTING YOUR INVENTION OUTSIDE THE UNITED STATES

Since the rights granted by a U.S. patent extend only throughout the territory of the United States and have no effect in a foreign country, an inventor who wishes patent protection in another country must apply for a patent in a specific country or in regional patent offices. Applicants may wish to consider the filing of an international application under the Patent Cooperation Treaty (PCT). An international (PCT) application generally has the same effect as a regular national patent application in each PCT-member country. The PCT process **simplifies** the filing of patent applications on the same invention in member countries, but **does not result** in a grant of "an international patent" and does not eliminate the need of applicants to file additional documents and fees in countries where patent protection is desired.

Almost every country has its own patent law, and a person desiring a patent in a particular country must make an application for patent in that country in accordance with its particular laws. Since the laws of many countries differ in various respects from the patent law of the United States, applicants are advised to seek guidance from specific foreign countries to ensure that patent rights are not lost prematurely.

Applicants also are advised that in the case of inventions made in the United States, the Director of the USPTO must issue a license before applicants can apply for a patent in a foreign country. The filing of a U.S. patent application serves as a request for a foreign filing license. The application's filing receipt contains further information and guidance as to the status of applicant's license for foreign filing.

Applicants may wish to consult the USPTO booklet, "General Information Concerning Patents" (specifically, the section entitled "Treaties and Foreign Patents") for more information on timeframes and deadlines for filing foreign patent applications. The guide is available either by contacting the USPTO Contact Center at 800-786-9199, or it can be viewed on the USPTO website at <http://www.uspto.gov/web/offices/pac/doc/general/index.html>.

For information on preventing theft of your intellectual property (patents, trademarks and copyrights), you may wish to consult the U.S. Government website, <http://www.stopfakes.gov>. Part of a Department of Commerce initiative, this website includes self-help "toolkits" giving innovators guidance on how to protect intellectual property in specific countries such as China, Korea and Mexico. For questions regarding patent enforcement issues, applicants may call the U.S. Government hotline at 1-866-999-HALT (1-866-999-4158).

LICENSE FOR FOREIGN FILING UNDER**Title 35, United States Code, Section 184****Title 37, Code of Federal Regulations, 5.11 & 5.15****GRANTED**

The applicant has been granted a license under 35 U.S.C. 184, if the phrase "IF REQUIRED, FOREIGN FILING LICENSE GRANTED" followed by a date appears on this form. Such licenses are issued in all applications where the conditions for issuance of a license have been met, regardless of whether or not a license may be required as

set forth in 37 CFR 5.15. The scope and limitations of this license are set forth in 37 CFR 5.15(a) unless an earlier license has been issued under 37 CFR 5.15(b). The license is subject to revocation upon written notification. The date indicated is the effective date of the license, unless an earlier license of similar scope has been granted under 37 CFR 5.13 or 5.14.

This license is to be retained by the licensee and may be used at any time on or after the effective date thereof unless it is revoked. This license is automatically transferred to any related applications(s) filed under 37 CFR 1.53(d). This license is not retroactive.

The grant of a license does not in any way lessen the responsibility of a licensee for the security of the subject matter as imposed by any Government contract or the provisions of existing laws relating to espionage and the national security or the export of technical data. Licensees should apprise themselves of current regulations especially with respect to certain countries, of other agencies, particularly the Office of Defense Trade Controls, Department of State (with respect to Arms, Munitions and Implements of War (22 CFR 121-128)); the Bureau of Industry and Security, Department of Commerce (15 CFR parts 730-774); the Office of Foreign Assets Control, Department of Treasury (31 CFR Parts 500+) and the Department of Energy.

NOT GRANTED

No license under 35 U.S.C. 184 has been granted at this time, if the phrase "IF REQUIRED, FOREIGN FILING LICENSE GRANTED" DOES NOT appear on this form. Applicant may still petition for a license under 37 CFR 5.12, if a license is desired before the expiration of 6 months from the filing date of the application. If 6 months has lapsed from the filing date of this application and the licensee has not received any indication of a secrecy order under 35 U.S.C. 181, the licensee may foreign file the application pursuant to 37 CFR 5.15(b).

2009 MAR -9 PM 1:39

IN THE UNITED STATES PATENT AND TRADEMARK OFFICE

Applicant: Michael J. Rojas **Examiner:** unassigned
Serial No: 12/398,063 **Art Unit:** unassigned
Filed: March 4, 2009 **Docket:** 17188Y
FOR: SYSTEM AND METHOD FOR INSTANT **Dated:** March 4, 2009
VoIP MESSAGING

Confirmation No. 9351

Commissioner for Patents
Mailstop 1450
Alexandria, VA 22313

REQUEST FOR REFUND AND VERIFICATION OF SMALL ENTITY

Sir:

In connection with the e-filing of the above-identified case, please note that an inadvertent error has occurred in the payment of the filing fees as a large entity.

The assignee is entitled to SMALL ENTITY status. Therefore, kindly refund \$545.00 to Deposit Account No. 19-1013.

Respectfully submitted,

/Seth Weinfeld/
Seth Weinfeld
Registration No.: 50,929

Scully, Scott, Murphy & Presser, P.C.
400 Garden City Plaza, Suit 300
Garden City, New York 11530
(516) 742-4343
SW:ae

CERTIFICATE OF ELECTRONIC FILING

I hereby certify that this correspondence is being deposited with the United States Patent & Trademark Office via Electronic Filing through the United States Patent and Trademark Office e-business website, on March 5, 2009.

Dated: March 5, 2009

/Seth Weinfeld/
Seth Weinfeld

J:\Work\1732\17188Y\MISC\DEP. ACCOUNT REQ. REFUND.doc

Electronic Patent Application Fee Transmittal

Application Number:

Filing Date:

Adjustment date: 03/16/2009 SDIRETA1
 03/05/2009 INTEFSW 00005047 191013 12398063
 01 FC:1011 330.00 CR
 02 FC:1111 540.00 CR
 03 FC:1311 220.00 CR

Title of Invention:

SYSTEM AND METHOD FOR INSTANT VOIP MESSAGING

03/16/2009 SDIRETA1 00000004 191013 12398063

01 FC:4011 82.00 DA
 02 FC:2111 270.00 DA
 03 FC:2311 110.00 DA

First Named Inventor/Applicant Name:

Michael J. Rojas

Filer:

Paul J. Esatto/Anneliese Eberle

Attorney Docket Number:

17188Y

Filed as Large Entity

Utility under 35 USC 111(a) Filing Fees

| Description | Fee Code | Quantity | Amount | Sub-Total in USD(\$) |
|----------------------------|----------|----------|--------|----------------------|
| Basic Filing: | | | | |
| Utility application filing | 1011 | 1 | 330 | 330 |
| Utility Search Fee | 1111 | 1 | 540 | 540 |
| Utility Examination Fee | 1311 | 1 | 220 | 220 |

Pages:

Claims:

Miscellaneous-Filing:

Petition:

Patent-Appeals-and-Interference:

| Description | Fee Code | Quantity | Amount | Sub-Total in USD(\$) |
|--|----------|----------|--------|----------------------|
| Post-Allowance-and-Post-Issuance: | | | | |
| Extension-of-Time: | | | | |
| Miscellaneous: | | | | |
| Total in USD (\$) | | | | 1090 |

IN THE UNITED STATES PATENT AND TRADEMARK OFFICE

| | | | |
|-------------------|---|------------------|----------------------|
| Applicant: | Michael J. Rojas | Examiner: | unassigned |
| Serial No: | 12/398,063 | Art Unit: | unassigned |
| Filed: | March 4, 2009 | Docket: | 17188Y |
| FOR: | SYSTEM AND METHOD FOR INSTANT VoIP MESSAGING | Dated: | March 4, 2009 |

Confirmation No. 9351

Commissioner for Patents
Mailstop 1450
Alexandria, VA 22313

REQUEST FOR REFUND AND VERIFICATION OF SMALL ENTITY

Sir:

In connection with the e-filing of the above-identified case, please note that an inadvertent error has occurred in the payment of the filing fees as a large entity.

The assignee is entitled to SMALL ENTITY status. Therefore, kindly refund \$545.00 to Deposit Account No. 19-1013.

Respectfully submitted,

/Seth Weinfeld/
Seth Weinfeld
Registration No.: 50,929

Scully, Scott, Murphy & Presser, P.C.
400 Garden City Plaza, Suit 300
Garden City, New York 11530
(516) 742-4343
SW:ae

CERTIFICATE OF ELECTRONIC FILING

I hereby certify that this correspondence is being deposited with the United States Patent & Trademark Office via Electronic Filing through the United States Patent and Trademark Office e-business website, on March 5, 2009.

Dated: March 5, 2009

/Seth Weinfeld/
Seth Weinfeld

J:\Work\1732\17188Y\MISC\DEP. ACCOUNT REQ. REFUND.doc

Electronic Acknowledgement Receipt

| | |
|---|--|
| EFS ID: | 4908741 |
| Application Number: | 12398063 |
| International Application Number: | |
| Confirmation Number: | 9351 |
| Title of Invention: | SYSTEM AND METHOD FOR INSTANT VoIP MESSAGING |
| First Named Inventor/Applicant Name: | Michael J. Rojas |
| Customer Number: | 23389 |
| Filer: | Seth Weinfeld/Anneliese Eberle |
| Filer Authorized By: | Seth Weinfeld |
| Attorney Docket Number: | 17188Y |
| Receipt Date: | 05-MAR-2009 |
| Filing Date: | |
| Time Stamp: | 12:20:52 |
| Application Type: | Utility under 35 USC 111(a) |

Payment information:

| | |
|------------------------|----|
| Submitted with Payment | no |
|------------------------|----|

File Listing:

| Document Number | Document Description | File Name | File Size(Bytes)/ Message Digest | Multi Part /.zip | Pages (if appl.) |
|-----------------|----------------------|------------------|--|------------------|------------------|
| 1 | Refund Request | 17188YREFUND.pdf | 46095 <small>8e52e79f6e64b1d12ad3ae1d38122ebe5f3b62a0</small> | no | 1 |

Warnings:

Information:

This Acknowledgement Receipt evidences receipt on the noted date by the USPTO of the indicated documents, characterized by the applicant, and including page counts, where applicable. It serves as evidence of receipt similar to a Post Card, as described in MPEP 503.

New Applications Under 35 U.S.C. 111

If a new application is being filed and the application includes the necessary components for a filing date (see 37 CFR 1.53(b)-(d) and MPEP 506), a Filing Receipt (37 CFR 1.54) will be issued in due course and the date shown on this Acknowledgement Receipt will establish the filing date of the application.

National Stage of an International Application under 35 U.S.C. 371

If a timely submission to enter the national stage of an international application is compliant with the conditions of 35 U.S.C. 371 and other applicable requirements a Form PCT/DO/EO/903 indicating acceptance of the application as a national stage submission under 35 U.S.C. 371 will be issued in addition to the Filing Receipt, in due course.

New International Application Filed with the USPTO as a Receiving Office

If a new international application is being filed and the international application includes the necessary components for an international filing date (see PCT Article 11 and MPEP 1810), a Notification of the International Application Number and of the International Filing Date (Form PCT/RO/105) will be issued in due course, subject to prescriptions concerning national security, and the date shown on this Acknowledgement Receipt will establish the international filing date of the application.

IN THE UNITED STATES PATENT AND TRADEMARK OFFICE

| | | | |
|----------------------|---|------------------|----------------------|
| Applicant(s): | Michael J. Rojas | Examiner: | Unassigned |
| Serial No: | Unassigned | Art Unit: | Unassigned |
| Filed: | Herewith | Docket: | 17188Y |
| For: | SYSTEM AND METHOD FOR INSTANT VoIP MESSAGING | Dated: | March 4, 2009 |

Commissioner for Patents
P. O. Box 1450
Alexandria, VA 22313-1450

INFORMATION DISCLOSURE STATEMENT

Sir:

In accordance with 37 C.F.R. §§ 1.97 and 1.98, it is requested that the following references, which are also listed on the attached Form PTO-1449, be made of record in the above-identified case.

1. U.S. 6,763,226 dated July 13, 2004 to McZeal, Jr.;
2. U.S. Patent Application Publication 2004/0252679 dated December 16, 2004 to Williams et al;

CERTIFICATE OF ELECTRONIC TRANSMISSION

I hereby certify that this document is being electronically filed in the United States Patent and Trademark Office on the date shown below.

Dated: March 4, 2009

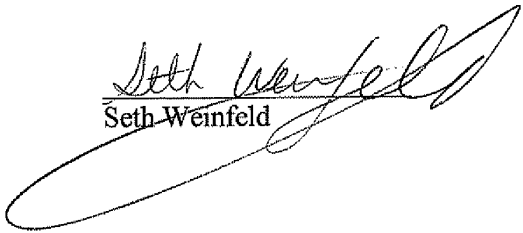
Seth Weinfeld

3. U.S. Patent Application Publication 2004/0122906 dated June 24, 2004 to Goodman et al.;
4. U.S. Patent Application Publication 2005/0053230 dated March 10, 2005 to Gierachf, K.;
5. U.S. Patent Application Publication 2005/0105697 dated May 19, 2005 to Hollowell et al.;
6. U.S. Patent Application Publication 2003/0087632 dated May 8, 2003 to Sagi et al.;
7. U.S. Patent Application Publication 2006/0268750 dated November 30, 2006 to Weiner, M.;
8. U.S. Patent Application Publication 2004/0030046 dated February 12, 2004 to Schultes et al.;
9. U.S. Patent Application Publication 2007/0112925 dated May 17, 2007 to Makik, D.;
10. U.S. Patent Application Publication 2007/0174403 dated July 26, 2007 to Barry, M.;
11. U.S. Patent Application Publication 2006/0167883 dated July 27, 2006 to Boukobza, E.;
12. U.S. Patent Application Publication 2004/0128356 dated July 1, 2004 to Bernstein et al.;
13. U.S. Patent Application Publication 2003/0126207 dated July 3, 2003 to Creamer et al.;
14. http://www.cisco.com/warp/public/cc/pd/nemnsw/callmn/prodlit/cm33_ds.htm; "Data Sheet Cisco CallManager Version 3.3", November 22, 2002;
15. http://www.cisco.com/en/US/products/hw/switches/ps1925/products_data_sheet_09186_a00800a3c3d.html; "Data Sheet Cisco MGX 8000 Series" (Date unknown);
16. <http://www.hsteliann.com/english/?zone=3100-V21P>; "Telephone 3100-V21P", 2003;
17. <http://www.linuxdevices.com/articles/AT5199947519.html>; "Device Profile: snom 100 VoIP phone", (May 15, 2002);

18. http://www.pingtel.com/pr_xpressa.jsp; "No limits with the advanced industry standard SIP phone, December 8, 2003; and
19. AudioCoded Enabling Technology Products, TPM-1100 VoP Media Gateway Modules; 2003.

Pursuant to 37 C.F.R. §1.98(d), copies of the above listed references are not provided, as references # 1 through 13 were previously cited by the Examiner in connection with the parent case, U.S. Serial No. 10/740,030 filed on December 18, 2003; and references 14 through 19 were submitted to the Examiner by the Applicant in an Information Disclosure Statement dated August 19, 2004.

Inasmuch as this Information Disclosure Statement is being submitted in accordance with the schedule set out in 37 C.F.R. §1.97(b), no statement or fee is required.

Respectfully submitted,



Seth Weinfeld
Registration No. 50,929

Scully, Scott, Murphy & Presser
400 Garden City Plaza
Garden City, New York 11530
(516) 742-4343

SW:reg

| | | | | | | |
|--|--|-------------------------------|------------------|-----------------|----------|---------------------------------|
| Form PTO-1449 U.S. DEPARTMENT OF COMMERCE (REV. 7-80) PATENT AND TRADEMARK OFFICE | | Atty. Docket No. 17188Y | | Application No. | | |
| INFORMATION DISCLOSURE CITATION (Use several sheets if necessary) | | Applicant Michael J. Rojas | | | | |
| | | Filing Date Herewith | | Group Art Unit | | |
| U.S. PATENT DOCUMENTS | | | | | | |
| EXAMINER INITIAL* | DOCUMENT NUMBER | DATE | NAME | CLASS | SUBCLASS | FILING DATE (if appropriate) |
| | 6,763,226 | 07-13-2004 | McZeal, Jr. | | | |
| U.S. PATENT PUBLICATION DOCUMENTS | | | | | | |
| | 2004/0252679 | 12-16-2004 | Williams et al. | | | |
| | 2004/0122906 | 06-24-2004 | Goodman et al. | | | |
| | 2005/0053230 | 03-10-2005 | Gierachf, K. | | | |
| | 2005/0105697 | 05-19-2005 | Hollowell et al. | | | |
| | 2003/0087632 | 05-08-2003 | Sagi et al. | | | |
| | 2006/0268750 | 11-30-2006 | Weiner, M. | | | |
| | 2004/0030046 | 02-12-2004 | Schultes et al. | | | |
| | 2007/0112925 | 05-17-2007 | Malik, D. | | | |
| | 2007/0174403 | 07-26-2007 | Barry, M. | | | |
| | 2006/0167883 | 07-27-2006 | Boukobza, E. | | | |
| | 2004/0128356 | 07-01-2004 | Bernstein et al. | | | |
| | 2003/0126207 | 07-03-2003 | Creamer et al. | | | |
| FOREIGN PATENT DOCUMENTS | | | | | | |
| | DOCUMENT NUMBER | DATE | COUNTRY | CLASS | SUBCLASS | TRANSLATION YES NO |
| | | | | | | |
| OTHER PRIOR ART (Including Author, Title, Date, Pertinent Pages, Etc.) | | | | | | |
| | http://www.cisco.com/warp/public/cc/pd/nemnsw/callmn/prodlit/cm33_ds.htm ; "Data Sheet Cisco CallManager Version 3.3", November 22, 2002; | | | | | |
| | http://www.cisco.com/en/US/products/hw/switches/ps1925/products_data_sheet_09186_a00800a3c3d.html ; "Data Sheet Cisco MGX 8000 Series" (Date unknown); | | | | | |
| EXAMINER | | | DATE CONSIDERED | | | |
| | | | | | | |

| | | | | | | | |
|--|------------|--|-------------|------------------------|---------------------------|-----------------|-------------------------------------|
| Form PTO-1449 U.S. DEPARTMENT OF COMMERCE (REV. 7-80) PATENT AND TRADEMARK OFFICE | | Att. Docket No. (Optional) 17188Y | | | Application Number | | |
| INFORMATION DISCLOSURE CITATION (Use several sheets if necessary) | | | | | | | |
| Applicant(s) Michael Rojas | | | | | | | |
| Filing Date | | | | | Group Art Unit | | |
| U.S. PATENT DOCUMENTS | | | | | | | |
| EXAMINER INITIAL* | | DOCUMENT NUMBER | DATE | NAME | CLASS | SUBCLASS | FILING DATE (if appropriate) |
| | AA | | | | | | |
| | AB | | | | | | |
| | AC | | | | | | |
| FOREIGN PATENT DOCUMENTS | | | | | | | |
| | REF | DOCUMENT NUMBER | DATE | COUNTRY | CLASS | SUBCLASS | TRANSLATION |
| | | | | | | | YES NO |
| | | | | | | | |
| | | | | | | | |
| OTHER DOCUMENTS (Including Author, Title, Date, Pertinent Pages, Etc.) | | | | | | | |
| | | http://www.hsteliann.com/english/?zone=3100-V21P ; "Telephone 3100-V21P", 2003; | | | | | |
| | | http://www.linuxdevices.com/articles/AT5199947519.html ; "Device Profile: snom 100 VoIP phone", May 15, 2002; | | | | | |
| | | http://www.pingtel.com/pr_xpressa.jsp ; "No limits with the advanced industry standard SIP phone, December 8, 2003; and | | | | | |
| | | AudioCoded Enabling Technology Products, TPM-1100 VoP Media Gateway Modules; 2003. | | | | | |
| EXAMINER | | | | DATE CONSIDERED | | | |
| * EXAMINER: Initial if reference considered, whether or not citation is in conformance with MPEP 609; draw line through citation if not in conformance and not considered. Include copy of this form with next communication to applicant. | | | | | | | |

Electronic Patent Application Fee Transmittal

| | | | | |
|--|--|-----------------|---------------|-----------------------------|
| Application Number: | | | | |
| Filing Date: | | | | |
| Title of Invention: | SYSTEM AND METHOD FOR INSTANT VoIP MESSAGING | | | |
| First Named Inventor/Applicant Name: | Michael J. Rojas | | | |
| Filer: | Paul J. Esatto/Anneliese Eberle | | | |
| Attorney Docket Number: | 17188Y | | | |
| Filed as Large Entity | | | | |
| Utility under 35 USC 111(a) Filing Fees | | | | |
| Description | Fee Code | Quantity | Amount | Sub-Total in USD(\$) |
| Basic Filing: | | | | |
| Utility application filing | 1011 | 1 | 330 | 330 |
| Utility Search Fee | 1111 | 1 | 540 | 540 |
| Utility Examination Fee | 1311 | 1 | 220 | 220 |
| Pages: | | | | |
| Claims: | | | | |
| Miscellaneous-Filing: | | | | |
| Petition: | | | | |
| Patent-Appeals-and-Interference: | | | | |

| Description | Fee Code | Quantity | Amount | Sub-Total in USD(\$) |
|--|----------|----------|--------|----------------------|
| Post-Allowance-and-Post-Issuance: | | | | |
| Extension-of-Time: | | | | |
| Miscellaneous: | | | | |
| Total in USD (\$) | | | | 1090 |

Electronic Acknowledgement Receipt

| | |
|---|--|
| EFS ID: | 4905971 |
| Application Number: | 12398063 |
| International Application Number: | |
| Confirmation Number: | 9351 |
| Title of Invention: | SYSTEM AND METHOD FOR INSTANT VoIP MESSAGING |
| First Named Inventor/Applicant Name: | Michael J. Rojas |
| Customer Number: | 23389 |
| Filer: | Paul J. Esatto/Anneliese Eberle |
| Filer Authorized By: | Paul J. Esatto |
| Attorney Docket Number: | 17188Y |
| Receipt Date: | 04-MAR-2009 |
| Filing Date: | |
| Time Stamp: | 18:44:28 |
| Application Type: | Utility under 35 USC 111(a) |

Payment information:

| | |
|--|-----------------|
| Submitted with Payment | yes |
| Payment Type | Deposit Account |
| Payment was successfully received in RAM | \$ 1090 |
| RAM confirmation Number | 5047 |
| Deposit Account | 191013 |
| Authorized User | |

The Director of the USPTO is hereby authorized to charge indicated fees and credit any overpayment as follows:

Charge any Additional Fees required under 37 C.F.R. Section 1.16 (National application filing, search, and examination fees)

Charge any Additional Fees required under 37 C.F.R. Section 1.17 (Patent application and reexamination processing fees)

Charge any Additional Fees required under 37 C.F.R. Section 1.21 (Miscellaneous fees and charges)

File Listing:

| Document Number | Document Description | File Name | File Size(Bytes)/ Message Digest | Multi Part /.zip | Pages (if appl.) |
|--|---|--------------------------|---|------------------|------------------|
| 1 | Application Data Sheet | 17188YADSpdf.pdf | 1265985 c0d0e5abea21a5e6783848be0ea32e68cb48365f | no | 4 |
| Warnings: | | | | | |
| Information: | | | | | |
| 2 | | 17188YSPEC.pdf | 2829555 ee75e1e3528385dbc7042866e32b1d03930b060 | yes | 52 |
| Multipart Description/PDF files in .zip description | | | | | |
| Document Description | | Start | End | | |
| Specification | | 1 | 48 | | |
| Claims | | 49 | 51 | | |
| Abstract | | 52 | 52 | | |
| Warnings: | | | | | |
| Information: | | | | | |
| 3 | Drawings-only black and white line drawings | 17188Yformaldrawings.pdf | 529577 399e28bd49f93953166a6235d0608d432a64b0a9 | no | 9 |
| Warnings: | | | | | |
| Information: | | | | | |
| 4 | Oath or Declaration filed | 17188YDEC.pdf | 206116 1a536ad5a8423ad44004ee6a18209589a71e74c7 | no | 3 |
| Warnings: | | | | | |
| Information: | | | | | |
| 5 | Information Disclosure Statement Letter | 17188YIDS1.pdf | 276977 371dadf4261599b31fc17b6578c11f1e9b963ef0 | no | 5 |
| Warnings: | | | | | |
| Information: | | | | | |
| 6 | Fee Worksheet (PTO-06) | fee-info.pdf | 33043 6bf6e94ac8e27390f8e3439a9752e30cefa3508a | no | 2 |
| Warnings: | | | | | |
| Information: | | | | | |
| Total Files Size (in bytes): | | | 5141253 | | |

This Acknowledgement Receipt evidences receipt on the noted date by the USPTO of the indicated documents, characterized by the applicant, and including page counts, where applicable. It serves as evidence of receipt similar to a Post Card, as described in MPEP 503.

New Applications Under 35 U.S.C. 111

If a new application is being filed and the application includes the necessary components for a filing date (see 37 CFR 1.53(b)-(d) and MPEP 506), a Filing Receipt (37 CFR 1.54) will be issued in due course and the date shown on this Acknowledgement Receipt will establish the filing date of the application.

National Stage of an International Application under 35 U.S.C. 371

If a timely submission to enter the national stage of an international application is compliant with the conditions of 35 U.S.C. 371 and other applicable requirements a Form PCT/DO/EO/903 indicating acceptance of the application as a national stage submission under 35 U.S.C. 371 will be issued in addition to the Filing Receipt, in due course.

New International Application Filed with the USPTO as a Receiving Office

If a new international application is being filed and the international application includes the necessary components for an international filing date (see PCT Article 11 and MPEP 1810), a Notification of the International Application Number and of the International Filing Date (Form PCT/RO/105) will be issued in due course, subject to prescriptions concerning national security, and the date shown on this Acknowledgement Receipt will establish the international filing date of the application.

Under the Paperwork Reduction Act of 1995, no persons are required to respond to a collection of information unless it contains a valid OMB control number.

| | | | |
|--|--|------------------------|--------|
| Application Data Sheet 37 CFR 1.76 | | Attorney Docket Number | 17188Y |
| | | Application Number | |
| Title of Invention | SYSTEM AND METHOD FOR INSTANT VoIP MESSAGING | | |
| <p>The application data sheet is part of the provisional or nonprovisional application for which it is being submitted. The following form contains the bibliographic data arranged in a format specified by the United States Patent and Trademark Office as outlined in 37 CFR 1.76. This document may be completed electronically and submitted to the Office in electronic format using the Electronic Filing System (EFS) or the document may be printed and included in a paper filed application.</p> | | | |

Secrecy Order 37 CFR 5.2

Portions or all of the application associated with this Application Data Sheet may fall under a Secrecy Order pursuant to 37 CFR 5.2 (Paper filers only. Applications that fall under Secrecy Order may not be filed electronically.)

Applicant Information:

| | | | | | |
|---|----------------------------|---|--------------------|--|---------------------------------------|
| Applicant 1 | | | | | <input type="button" value="Remove"/> |
| Applicant Authority | | <input checked="" type="radio"/> Inventor | | <input type="radio"/> Legal Representative under 35 U.S.C. 117 | |
| | | | | <input type="radio"/> Party of Interest under 35 U.S.C. 118 | |
| Prefix | Given Name | Middle Name | Family Name | Suffix | |
| | Michael | J. | Rojas | | |
| Residence Information (Select One) <input checked="" type="radio"/> US Residency <input type="radio"/> Non US Residency <input type="radio"/> Active US Military Service | | | | | |
| City | North Canton, Stark County | State/Province | OH | Country of Residence i | US |
| Citizenship under 37 CFR 1.41(b) i | | US | | | |
| Mailing Address of Applicant: | | | | | |
| Address 1 | 2828 Barclay Circle | | | | |
| Address 2 | | | | | |
| City | North Canton, Stark County | State/Province | OH | | |
| Postal Code | 44720 | Country i | US | | |
| All Inventors Must Be Listed - Additional Inventor Information blocks may be generated within this form by selecting the Add button. | | | | | <input type="button" value="Add"/> |

Correspondence Information:

| | | | |
|--|-------|--|---|
| Enter either Customer Number or complete the Correspondence Information section below. For further information see 37 CFR 1.33(a). | | | |
| <input type="checkbox"/> An Address is being provided for the correspondence Information of this application. | | | |
| Customer Number | 23389 | | |
| Email Address | | <input type="button" value="Add Email"/> | <input type="button" value="Remove Email"/> |

Application Information:

| | | | |
|--|--|--|--------------------------|
| Title of the Invention | SYSTEM AND METHOD FOR INSTANT VoIP MESSAGING | | |
| Attorney Docket Number | 17188Y | Small Entity Status Claimed | <input type="checkbox"/> |
| Application Type | Nonprovisional | | |
| Subject Matter | Utility | | |
| Suggested Class (if any) | | Sub Class (if any) | |
| Suggested Technology Center (if any) | | | |
| Total Number of Drawing Sheets (if any) | 9 | Suggested Figure for Publication (if any) | |

Under the Paperwork Reduction Act of 1995, no persons are required to respond to a collection of information unless it contains a valid OMB control number.

| | | | |
|---|--|------------------------|--------|
| Application Data Sheet 37 CFR 1.76 | | Attorney Docket Number | 17188Y |
| | | Application Number | |
| Title of Invention | SYSTEM AND METHOD FOR INSTANT VoIP MESSAGING | | |

Publication Information:

| |
|---|
| <input type="checkbox"/> Request Early Publication (Fee required at time of Request 37 CFR 1.219) |
| <input type="checkbox"/> Request Not to Publish. I hereby request that the attached application not be published under 35 U.S. C. 122(b) and certify that the invention disclosed in the attached application has not and will not be the subject of an application filed in another country, or under a multilateral international agreement, that requires publication at eighteen months after filing. |

Representative Information:

Representative information should be provided for all practitioners having a power of attorney in the application. Providing this information in the Application Data Sheet does not constitute a power of attorney in the application (see 37 CFR 1.32). Enter either Customer Number or complete the Representative Name section below. If both sections are completed the Customer Number will be used for the Representative Information during processing.

Please Select One: Customer Number US Patent Practitioner Limited Recognition (37 CFR 11.9)

| | | | | | |
|--|------------|-------------|-------------|--------|---------------------------------------|
| Prefix | Given Name | Middle Name | Family Name | Suffix | <input type="button" value="Remove"/> |
| | Paul | J. | Esatto, Jr. | | |
| Registration Number | 30749 | | | | |
| Prefix | Given Name | Middle Name | Family Name | Suffix | <input type="button" value="Remove"/> |
| | Frank | S. | DiGiglio | | |
| Registration Number | 31346 | | | | |
| Prefix | Given Name | Middle Name | Family Name | Suffix | <input type="button" value="Remove"/> |
| | Peter | I. | Bernstein | | |
| Registration Number | 43497 | | | | |
| Prefix | Given Name | Middle Name | Family Name | Suffix | <input type="button" value="Remove"/> |
| | Mark | J. | Cohen | | |
| Registration Number | 32211 | | | | |
| Additional Representative Information blocks may be generated within this form by selecting the Add button. | | | | | <input type="button" value="Add"/> |

Domestic Benefit/National Stage Information:

This section allows for the applicant to either claim benefit under 35 U.S.C. 119(e), 120, 121, or 365(c) or indicate National Stage entry from a PCT application. Providing this information in the application data sheet constitutes the specific reference required by 35 U.S.C. 119(e) or 120, and 37 CFR 1.78(a)(2) or CFR 1.78(a)(4), and need not otherwise be made part of the specification.

| | | | |
|---|-----------------|---------------------------------------|------------------------------------|
| Prior Application Status | Pending | <input type="button" value="Remove"/> | |
| Application Number | Continuity Type | Prior Application Number | Filing Date (YYYY-MM-DD) |
| | Continuation of | 10740030 | 2003-12-18 |
| Additional Domestic Benefit/National Stage Data may be generated within this form by selecting the Add button. | | | <input type="button" value="Add"/> |

Under the Paperwork Reduction Act of 1995, no persons are required to respond to a collection of information unless it contains a valid OMB control number.

| | | | |
|---|--|------------------------|--------|
| Application Data Sheet 37 CFR 1.76 | | Attorney Docket Number | 17188Y |
| | | Application Number | |
| Title of Invention | SYSTEM AND METHOD FOR INSTANT VoIP MESSAGING | | |

Foreign Priority Information:

This section allows for the applicant to claim benefit of foreign priority and to identify any prior foreign application for which priority is not claimed. Providing this information in the application data sheet constitutes the claim for priority as required by 35 U.S.C. 119(b) and 37 CFR 1.55(a).

| | | | |
|--|----------------------|---------------------------------|---|
| <input type="button" value="Remove"/> | | | |
| Application Number | Country ⁱ | Parent Filing Date (YYYY-MM-DD) | Priority Claimed |
| | | | <input type="radio"/> Yes <input checked="" type="radio"/> No |
| Additional Foreign Priority Data may be generated within this form by selecting the Add button. | | | <input type="button" value="Add"/> |

Assignee Information:

Providing this information in the application data sheet does not substitute for compliance with any requirement of part 3 of Title 37 of the CFR to have an assignment recorded in the Office.

| | | | |
|--|-----------------------|----------------|------------------------------------|
| <input type="button" value="Remove"/> | | | |
| Assignee 1 | | | |
| If the Assignee is an Organization check here. <input checked="" type="checkbox"/> | | | |
| Organization Name | Ayalogic, Inc. | | |
| Mailing Address Information: | | | |
| Address 1 | 530 South Main Street | | |
| Address 2 | | | |
| City | Akron | State/Province | OH |
| Country ⁱ | US | Postal Code | 44311-1010 |
| Phone Number | | Fax Number | |
| Email Address | | | |
| Additional Assignee Data may be generated within this form by selecting the Add button. | | | <input type="button" value="Add"/> |

Signature:

A signature of the applicant or representative is required in accordance with 37 CFR 1.33 and 10.18. Please see 37 CFR 1.4(d) for the form of the signature.

| | | | | |
|------------|------------------------|-----------|---------------------|------------|
| Signature | /Paul J. Esatto, Jr. / | | Date (YYYY-MM-DD) | 2009-03-04 |
| First Name | Paul J. Esatto, Jr. | Last Name | Registration Number | 30749 |

This collection of information is required by 37 CFR 1.76. The information is required to obtain or retain a benefit by the public which is to file (and by the USPTO to process) an application. Confidentiality is governed by 35 U.S.C. 122 and 37 CFR 1.14. This collection is estimated to take 23 minutes to complete, including gathering, preparing, and submitting the completed application data sheet form to the USPTO. Time will vary depending upon the individual case. Any comments on the amount of time you require to complete this form and/or suggestions for reducing this burden, should be sent to the Chief Information Officer, U.S. Patent and Trademark Office, U.S. Department of Commerce, P.O. Box 1450, Alexandria, VA 22313-1450. DO NOT SEND FEES OR COMPLETED FORMS TO THIS ADDRESS. **SEND TO: Commissioner for Patents, P.O. Box 1450, Alexandria, VA 22313-1450.**

Privacy Act Statement

The Privacy Act of 1974 (P.L. 93-579) requires that you be given certain information in connection with your submission of the attached form related to a patent application or patent. Accordingly, pursuant to the requirements of the Act, please be advised that: (1) the general authority for the collection of this information is 35 U.S.C. 2(b)(2); (2) furnishing of the information solicited is voluntary; and (3) the principal purpose for which the information is used by the U.S. Patent and Trademark Office is to process and/or examine your submission related to a patent application or patent. If you do not furnish the requested information, the U.S. Patent and Trademark Office may not be able to process and/or examine your submission, which may result in termination of proceedings or abandonment of the application or expiration of the patent.

The information provided by you in this form will be subject to the following routine uses:

1. The information on this form will be treated confidentially to the extent allowed under the Freedom of Information Act (5 U.S.C. 552) and the Privacy Act (5 U.S.C. 552a). Records from this system of records may be disclosed to the Department of Justice to determine whether the Freedom of Information Act requires disclosure of these records.
2. A record from this system of records may be disclosed, as a routine use, in the course of presenting evidence to a court, magistrate, or administrative tribunal, including disclosures to opposing counsel in the course of settlement negotiations.
3. A record in this system of records may be disclosed, as a routine use, to a Member of Congress submitting a request involving an individual, to whom the record pertains, when the individual has requested assistance from the Member with respect to the subject matter of the record.
4. A record in this system of records may be disclosed, as a routine use, to a contractor of the Agency having need for the information in order to perform a contract. Recipients of information shall be required to comply with the requirements of the Privacy Act of 1974, as amended, pursuant to 5 U.S.C. 552a(m).
5. A record related to an International Application filed under the Patent Cooperation Treaty in this system of records may be disclosed, as a routine use, to the International Bureau of the World Intellectual Property Organization, pursuant to the Patent Cooperation Treaty.
6. A record in this system of records may be disclosed, as a routine use, to another federal agency for purposes of National Security review (35 U.S.C. 181) and for review pursuant to the Atomic Energy Act (42 U.S.C. 218(c)).
7. A record from this system of records may be disclosed, as a routine use, to the Administrator, General Services, or his/her designee, during an inspection of records conducted by GSA as part of that agency's responsibility to recommend improvements in records management practices and programs, under authority of 44 U.S.C. 2904 and 2906. Such disclosure shall be made in accordance with the GSA regulations governing inspection of records for this purpose, and any other relevant (i.e., GSA or Commerce) directive. Such disclosure shall not be used to make determinations about individuals.
8. A record from this system of records may be disclosed, as a routine use, to the public after either publication of the application pursuant to 35 U.S.C. 122(b) or issuance of a patent pursuant to 35 U.S.C. 151. Further, a record may be disclosed, subject to the limitations of 37 CFR 1.14, as a routine use, to the public if the record was filed in an application which became abandoned or in which the proceedings were terminated and which application is referenced by either a published application, an application open to public inspections or an issued patent.
9. A record from this system of records may be disclosed, as a routine use, to a Federal, State, or local law enforcement agency, if the USPTO becomes aware of a violation or potential violation of law or regulation.

**SYSTEM AND METHOD
FOR INSTANT VoIP MESSAGING**

CROSS REFERENCE TO RELATED APPLICATION

5

This application is a continuation of U.S. Application serial number 10/740,030 filed on December 18, 2003, the entire contents of which are incorporated herein by this reference.

10

BACKGROUND OF THE INVENTION

Technical Field of the Invention

15

The present invention generally relates to Internet telephony (IP telephony). More particularly, the present invention is directed to a system and method for enabling local and global instant VoIP messaging over an IP network, such as the Internet, with PSTN support.

20

Description of the Prior Art

Traditional telephony is based on a public switched telephone network (i.e., "PSTN"). In the PSTN, a telephone terminal is electrically connected to a conventional or legacy switch. The telephone terminal and the legacy switch communicate via a proprietary
25 protocol, which may be different depending on the vendor of the legacy switch. Circuit switching provides a communication path (i.e., dedicated circuit) for a telephone call from the telephone terminal to another device over the PSTN, including another telephone

terminal. During the telephone call, voice communication takes place over that communication path.

An alternative to the PSTN is Voice over Internet Protocol (i.e., “VoIP”),
5 also known as IP telephony or Internet telephony. In the IP telephony, a VoIP terminal device is connected to a packet-switched network (e.g., Internet) and voice communication from the VoIP terminal device is digitized, packetized and transmitted over the packet-switched network to a destination VoIP terminal device, which reconstructs the packets and audibly plays, stores or otherwise processes the transmission. The VoIP terminal device
10 may be a VoIP telephone or a general-purpose personal computer (PC) enabled for IP telephony. More specifically, the PC is programmed with the software and equipped with audio input/output devices (e.g., a combination of microphone and speaker or a headset) to serve as a VoIP terminal device. The PC so enabled and equipped will herein be referred to as a VoIP terminal device or a VoIP softphone.

15

Figure 1 is an illustrative example of a prior art IP telephony system 100. The IP telephony system 100 comprises a packet-switched IP network 102, such as the Internet, which transmits VoIP traffic from and to a plurality of terminal devices 104, 106 and 110. Terminal device 104 is a VoIP softphone that is enabled for IP telephony over the
20 network 102. Terminal device 106 is a VoIP telephone, which is connected to the network 102 via a softswitch 108. The VoIP softswitch 108 is disposed on the packet-switched network (e.g., Internet) 102 between an origination terminal device (such as VoIP softphone 104) and a destination terminal device (such as VoIP telephone 106), and routes packets

over the packet-switched IP network 102. The softswitch 108 may also manage and perform administrative functions for the terminal device or devices (e.g., VoIP telephone 106) to which it is connected. Whether the terminal device is a VoIP softphone 104 or a VoIP telephone 106, the terminal device is connected to the IP network 102 via a networking
5 standard such as Ethernet, Bluetooth, IEEE 1394 (also known as “Firewire”), IEEE 802.11 (also known as “WiFi”), or networking over serial communication channels such as the Universal Serial Bus (i.e., “USB”). Data communication over the network then takes place using a connection protocol, e.g., transfer control protocol/Internet protocol (i.e., “TCP/IP”).

10 Further regarding Fig. 1, terminal device 110 is a legacy telephone that is connected to a legacy switch 112 for (circuit-switched) voice communications over the PSTN 116 with other terminal devices. A media gateway 114 may be provided between the legacy switch 112 and the packet-switched network 102 to enable IP telephony between the legacy telephone 110 and a VoIP terminal device, such as a VoIP softphone 104 or VoIP
15 telephone 106. More specifically, the media gateway 114 converts the audio signal carried over PSTN to packets carried over the packet-switched IP network 102. In addition, a media gateway 118 may be disposed over the PSTN 116 and connected to a softswitch 120 to convert the audio signal from the legacy telephone 110 to packets routed over the IP network 102 via the softswitch 120.

20

Voice messaging in both the VoIP and PSTN is known. More specifically, the foregoing systems may be provided with a facility to allow users to leave voice messages for recipients, which is a feature that is familiar to anyone who uses a telephone.

Conventionally, leaving a voice message involves dialing the recipient's telephone number (often without knowing whether the recipient will answer), waiting for the connection to be established, speaking to an operator or navigating through a menu of options, listening to a greeting message, and recording the message for later pickup by the recipient. In that
5 message, the user must typically identify himself or herself in order for the recipient to return the call.

Instant text messaging is likewise known. More specifically, a user is provided with a client terminal, which is typically a general-purpose PC programmed with
10 instant text messaging software and in data communication over an IP network with an instant text-messaging server. The instant text-messaging server presents the user, via the client terminal, with a list of persons who are currently "online" and ready to receive text messages on their own client terminals. The user then uses the client terminal to select one or more persons to whom the message will be sent and types in a text message. The text
15 message is sent immediately via the text-messaging server to the selected one or more persons and is displayed on their respective client terminals.

However, notwithstanding the foregoing advances in the VoIP/PSTN voice communication and voice/text messaging, there is still a need in the art for providing a
20 system and method for providing instant VoIP messaging over an IP network. More particularly, there is a need in the art for providing local and global instant voice messaging over VoIP with PSTN support.

SUMMARY OF THE INVENTION

The present invention is directed to a system and method for enabling local and global instant VoIP messaging over an IP network, such as the Internet.

5

According to an embodiment of the present invention, there is provided an instant voice messaging system for delivering instant messages over a packet-switched network, the system comprising: a client connected to the network, the client selecting one or more recipients, generating an instant voice message therefor, and transmitting the selected recipients and the instant voice message therefor over the network; and a server 10 connected to the network, the server receiving the selected recipients and the instant voice message therefor, and delivering the instant voice message to the selected recipients over the network, the selected recipients being enabled to audibly play the instant voice message.

15

According to another embodiment of the present invention, there is provided an instant voice messaging system for delivering instant messages over a packet-switched network enabling public switched telephone network (PSTN) support, the system comprising: a PSTN telephone connected to the network for providing input audio; a client connected to the network, the client selecting one or more recipients, generating an instant 20 voice message therefor using the input audio provided by the PSTN telephone, and transmitting the selected recipients and the instant voice message therefor over the network; a server connected to the network, the server receiving the selected recipients and the instant voice message therefor, and delivering the instant voice message to the selected recipients

over the network, the selected recipients being enabled to audibly play the instant voice message.

According to a further embodiment of the present invention, there is provided
5 an instant voice messaging system for delivering instant messages over a packet-switched network, the system comprising: a voice-over-internet-protocol (VoIP) telephone connected to the network for providing input audio; a client connected to the network, the client selecting one or more recipients, generating an instant voice message therefor using the input audio provided by the VoIP telephone, and transmitting the selected recipients and the
10 instant voice message therefor over the network; a server connected to the network, the server receiving the selected recipients and the instant voice message therefor, and delivering the instant voice message to the selected recipients over the network, the selected recipients being enabled to audibly play the instant voice message.

15 According to still another embodiment of the present invention, there is provided an instant voice messaging system for delivering instant messages over a plurality of packet-switched networks, the system comprising: a client connected to a local network, the client selecting one or more external recipients connected to an external network outside the local network, generating an instant voice message therefor, and transmitting the
20 selected recipients and the instant voice message therefor over the local network and the external network; and a server connected to the external network, the server receiving the selected recipients and the instant voice message therefor, and delivering the instant voice message to the selected recipients over the external network, the selected recipients being

enabled to audibly play the instant voice message.

According to yet another embodiment of the present invention, there is provided an instant voice messaging system for delivering instant messages over a plurality of packet-switched networks enabling public switched telephone network (PSTN) support, the system comprising: a PSTN telephone connected to a local network for providing input audio; a client connected to the local network, the client selecting one or more external recipients connected to an external network outside the local network, generating an instant voice message therefor using the input audio provided by the PSTN telephone, and transmitting the selected recipients and the instant voice message therefor over the local network and the external network; a server connected to the external network, the server receiving the selected recipients and the instant voice message therefor, and delivering the instant voice message to the selected recipients over the external network, the selected recipients being enabled to audibly play the instant voice message.

15

According to yet a further embodiment of the present invention, there is provided an instant voice messaging system for delivering instant messages over a plurality of packet-switched networks, the system comprising: a voice-over-internet-protocol (VoIP) telephone connected to a local network for providing input audio; a client connected to the local network, the client selecting one or more external recipients connected to an external network outside the local network, generating an instant voice message therefor using the input audio provided by the VoIP telephone, and transmitting the selected recipients and the instant voice message therefor over the local network and the external network; an server

connected to the external network, the external server receiving the selected recipients and the instant voice message therefor, and delivering the instant voice message to the selected recipients over the external network, the selected recipients being enabled to audibly play the instant voice message.

5

According to still a further embodiment of the present invention, there is provided an instant voice messaging system for delivering instant messages over a plurality of packet-switched networks, the system comprising: a client connected to an external network, the client selecting one or more recipients connected to a local network, generating
10 an instant voice message therefor, and transmitting the selected recipients and the instant voice message therefor over the external network; an external server system connected to the external network, the external server system receiving the selected recipients and the instant voice message, and routing the selected recipients and the instant voice message over the external network and the local network; a local server connected to the local network, the
15 local server receiving the selected recipients and the instant voice message therefor, and delivering the instant voice message to the selected recipients over the local network, the selected recipients being enabled to audibly play the instant voice message.

According to an embodiment of the present invention, there is provided a
20 method for instant voice messaging over a packet-switched network, the method comprising: selecting one or more recipients for instant voice messaging at a client; generating an instant voice message for the selected recipients at the client; transmitting the selected recipients and the instant voice message therefor over the network from the client to

a server; receiving the selected recipients and the instant voice message therefor at the server; delivering the instant voice message from the server to the selected recipients over the network; and audibly playing the instant voice message at the selected recipients.

5 According to another embodiment of the present invention, there is provided a method for instant voice messaging over a packet-switched network enabling public switched telephone network (PSTN) support, the method comprising: providing input audio via a PSTN telephone connected over the network; selecting one or more recipients for instant voice messaging at a client; generating an instant voice message using the input
10 audio from the PSTN telephone for the selected recipients at the client; transmitting the selected recipients and the instant voice message therefor over the network from the client to a server; receiving the selected recipients and the instant voice message therefor at the server; delivering the instant voice message from the server to the selected recipients over the network; and audibly playing the instant voice message at the selected recipients.

15 According to a further embodiment of the present invention, there is provided a method for instant voice messaging over a packet-switched network, the method comprising: providing input audio via a voice-over-internet-protocol (VoIP) telephone connected over the network; selecting one or more recipients for instant voice messaging at
20 a client; generating an instant voice message using the input audio from the VoIP telephone for the selected recipients at the client; transmitting the selected recipients and the instant voice message therefor over the network from the client to a server; receiving the selected recipients and the instant voice message therefor at the server; delivering the instant voice

message from the server to the selected recipients over the network; and audibly playing the instant voice message at the selected recipients.

According to still another embodiment of the present invention, there is
5 provided a method for instant voice messaging over a plurality of packet-switched networks, the method comprising: selecting one or more external recipients for instant voice messaging at a client connected to a local network, the one or more external recipients connected to an external network outside the local network; generating an instant voice message for the selected external recipients at the client; transmitting the selected external
10 recipients and the instant voice message therefor over the local network and the external network; receiving the selected external recipients and the instant voice message therefor at an external server connected to the external network; delivering the instant voice message to the selected external recipients over the external network; and audibly playing the instant voice message at the selected external recipients.

15

According to yet another embodiment of the present invention, there is
provided a method for instant voice messaging system over a plurality of packet-switched networks enabling public switched telephone network (PSTN) support, the method comprising: providing input audio via a PSTN telephone connected to a local network;
20 selecting one or more external recipients for instant voice messaging at a client, the one or more external recipients connected to an external network outside the local network; generating an instant voice message for the one or more external recipients using the input audio provided by the PSTN telephone; transmitting the selected recipients and the instant

voice message therefor over the local network and the external network; receiving the selected recipients and the instant voice message therefor at a server connected to the external network; delivering the instant voice message to the selected recipients from the server over the external network; and audibly playing the instant voice message at the
5 selected recipients.

According to still a further embodiment of the present invention, there is provided a method for instant voice messaging system over a plurality of packet-switched networks, the method comprising: providing input audio via a voice-over-internet-protocol
10 (VoIP) telephone connected to a local network; selecting one or more external recipients for instant voice messaging at a client, the one or more external recipients connected to an external network outside the local network; generating an instant voice message for the one or more external recipients using the input audio provided by the VoIP telephone; transmitting the selected recipients and the instant voice message therefor over the local
15 network and the external network; receiving the selected recipients and the instant voice message therefor at a server connected to the external network; delivering the instant voice message to the selected recipients from the server over the external network; and audibly playing the instant voice message at the selected recipients.

20 According to yet a further embodiment of the present invention, there is provided a method for instant voice messaging over a plurality of a plurality of packet-switched networks, the method comprising: selecting one or more recipients connected to a local network at a client connected to an external network; generating an instant voice

message for the selected recipients at the client; transmitting the selected recipients and the instant voice message therefor over the external network from the client to an external server system; receiving the selected recipients and the instant voice message at the external server system; routing the selected recipients and the instant voice message over the external network and the local network; receiving the selected recipients and the instant voice message therefor at a local server connected to the local network; delivering the instant voice message to the selected recipients over the local network; audibly playing the instant voice message at the selected recipients.

10

BRIEF DESCRIPTION OF THE DRAWINGS

The objects, features and advantages of the present invention will become apparent to one skilled in the art, in view of the following detailed description taken in combination with the attached drawings, in which:

15

Figure 1 illustrates an example of a prior art IP telephony system;

Figure 2 illustrates an exemplary local IVM system for enabling instant voice messaging according to the present invention;

Figure 3 illustrates an exemplary IVM client of Figure 2 for enabling instant voice messaging according to the present invention;

20

Figure 4 illustrates an exemplary IVM server of Figure 2 for enabling instant voice messaging according to the present invention;

Figure 5 illustrates an exemplary global IVM system comprising a local IVM system and global IVM clients, according to the present invention;

Fig. 6 illustrates an exemplary global IVM server system depicted in Fig. 5,

according to the present invention;

Fig. 7 illustrates an exemplary transport server depicted in Fig. 6, according to the present invention;

Fig. 8 illustrates an exemplary directory server depicted in Fig. 6, according to the present invention; and

Fig. 9 illustrates an exemplary global IVM system comprising a plurality of local IVM systems and global IVM clients, according to the present invention.

10 **DETAILED DESCRIPTION OF THE
PREFERRED EMBODIMENT OF THE INVENTION**

The present invention is directed to a system and method for enabling local and global instant VoIP messaging over an IP network with PSTN support.

15 Figure 2 is an exemplary illustration of a local instant voice messaging (IVM) system 200 according to the present invention. The instant voice messaging system 200 comprises a local IVM server 202 that provides the core functionality for enabling instant voice messaging with PSTN support according to the present invention. The architecture of the local IVM server 202 will be described in detail hereinbelow with reference to Fig. 4.

20 According to the exemplary IVM system 200, the local IVM server 202 is enabled to provide instant voice messaging to one or more IVM clients 206 and 208, as well support instant voice messaging for PSTN legacy telephones 110. It is noted that although Fig. 2 depicts one of each IVM client 206, 208 and legacy telephone 110 for clarity and brevity, the local IVM server 202 is enabled to support a plurality of each of the foregoing IVM

clients 206, 208 and legacy telephone 110. The local packet-switched IP network 204 interconnects the IVM clients 206, 208 and the legacy telephone 110 to the local IVM server 202 as well as interconnecting the local IVM server 202 to the local IP network 204. The network 204 may be a local area network (LAN), a wide area network (WAN), or the like, which supports both wired and wireless devices. The exemplary IVM client 208 is a VoIP softphone, the architecture of which will be described in detail hereinbelow with reference to Fig. 3. A microphone 212 is connected to the IVM client 208 and enables the recording of an instant voice message according to the present invention into an audio file 210 for transmission to the local IVM server 202 over the network 204. An input device 218 (e.g., a keyboard) is connected to the IVM client 208 to select one or more recipients that are to receive the recorded instant voice message. Although not depicted in Fig. 2, the input device 218 may include a trackball, digitizing pad or mouse, or the like. A display device 216 is connected to the IVM client 208 to display instant voice messages recorded and/or received by a user of the IVM client 208. An audio device 214, such as external speaker, is connected to the IVM client 208 to play received instant voice messages. It is noted that the microphone 212, audio device 214, display device 216 and input device 218 may form integral parts of the IVM client 208.

Further with reference to Fig. 2, IVM client 206 is interconnected via the network 204 to the local IVM server 202. An exemplary IVM client 206 is a VoIP telephone, which comprises a screen display (not shown) capable of displaying instant voice messages recorded and/or received by a user of the IVM client 206 according to the present invention. The VoIP telephone 206 further comprises a handset and/or speakerphone for

recording instant voice messages and listening to instant voice messages received at the VoIP telephone 206 according to the present invention. The VoIP telephones which may be implemented to provide instant voice messaging functionality according to the present invention are commercially available from many vendors, including Alcatel™, Lucent™, 5 NEC™ and Cisco™, to name just a few. In addition to the foregoing IVM clients 206, 208, the IVM system 200 supports a legacy telephone 110 for instant voice messaging according to the present invention. The legacy telephone 110 is connected to a legacy switch 112. The legacy switch 112 is further connected to a media gateway 114. Both the legacy switch 112 and the media gateway 114 interconnect the legacy telephone 110 via the network 204 to the 10 local IVM server 202, thereby facilitating instant voice messaging according to the present invention. The media gateway 114 may be a gateway that supports trunk pack network control (i.e., “TPNCP”) protocol, media gateway control protocol (i.e., “MGCP”), or a media gateway control H.428 protocol (i.e., “MEGACO”). As previously mentioned, the media gateway 114 converts the audio signal carried over PSTN to packets to be transmitted 15 over a packet-switched IP network, such as the local network 204.

The implementation of the instant voice messaging for IVM client 208 will be described first and will be followed by the implementations for IVM client 206 and legacy telephone 110, with reference to the local IVM system 200 depicted in Fig. 2. These 20 implementations implement a “record mode” of the instant voice messaging according to the present invention. There will further be described an “intercom mode” of the instant voice messaging according to the present invention. Therefore, in operation of the IVM client 208 according to Fig. 2, the IVM client (IVM softphone) 208 is connected over the network 204

to the IVM server 202, which as aforementioned enables instant voice messaging functionality over the network 204. The IVM client 208 displays a list of one or more IVM recipients on its display 216, provided and stored by the local IVM server 202, as will be particularly described hereinbelow with reference to Fig. 4. The user operates the IVM client 208 by using the input device 218 to indicate a selection of one or more IVM recipients from the list. The user selection is transmitted to the IVM server 202. The user selection also generates a start signal to the IVM client 208 that the user is ready to begin instant voice messaging according to the present invention. In response to the start signal, the IVM client (softphone) 208 listens to the input audio device 212 and records the user's speech into a digitized audio file 210 (i.e., instant voice message) stored on the IVM client 208. The audio file 210 at the IVM client 208 is finalized via a stop signal, which is generated by the user via the input device 218 or a preset time period without speech input via the input audio device 212 on the IVM client 208. Once the recording of the user's speech is finalized, IVM client 208 generates a send signal indicating that the digitized audio file 210 (instant voice message) is ready to be sent to the selected recipients. The user generates the send signal when the user operates the IVM client 208 via the input device 218, e.g., pressing a key on a keyboard or clicking a button on a mouse. The IVM client 208 transmits the digitized audio file 210 and the send signal to the local IVM server 202. In response to the send signal indicating that the instant voice message is ready to be sent, the IVM client 208 sends the recorded audio file 210 destined for the selected one or more recipients via local IVM server 202. After receiving the audio file 210, the IVM server 202 thereafter delivers the transmitted instant voice message to the selected one or more recipients via the local IP network 204. The one or more recipients are enabled to display an

indication that the instant voice message has been received and audibly play the instant voice message to an associated user. It should be understood that only the available IVM recipients, currently connected to the IVM server 202, will receive the instant voice message. It is noted that if a recipient IVM client is not currently connected to the local IVM server 202 (i.e., is unavailable), the IVM server temporarily saves the instant voice message and delivers it to the IVM client when the IVM client connects to the local IVM server 202 (i.e., is available).

There are several embodiments for the operation of the IVM client (VoIP telephone) 206 within the IVM system 200, according to the present invention. In the first embodiment, the VoIP telephone 206 is a standalone IVM client 206 enabled for instant voice messaging according to the present invention. In the second embodiment, the VoIP telephone 206 operates synchronously either with the IVM client 208 or IVM server 202 to enable instant voice messaging according to the present invention. Thus, in operation according to the first embodiment in Fig. 2, the IVM client (VoIP telephone) 206 is connected over the network 204 to the IVM server 202, which as aforementioned enables instant voice messaging functionality over the local network 204. The IVM client 206 displays a list of one or more IVM recipients on its associated display provided and stored by the local IVM server 202, as will be particularly described hereinbelow with reference to Fig. 4. The user operates the IVM client 206 by using a keypad on the VoIP telephone 206 to indicate a selection of one or more IVM recipients from the list. The VoIP telephone 206 transmits the selection to the IVM server 202. The user selection also generates a start signal to the IVM client 206 indicating the user is ready to begin instant voice messaging

according to the present invention. The user speaks into the handset of the IVM client 206 or a speakerphone on the IVM client 206. Although not shown in Fig. 2, the VoIP telephone 206 may provide a dedicated storage device, which in response to the start signal records an audio file, similar to the audio file 210 in the IVM client 208. The audio file is finalized via a stop signal. The stop signal is generated when the user presses a button on the keypad, a preset time period without speech input to the VoIP telephone 206, or when the user returns the handset to the cradle of the VoIP telephone 206. Once the recording of the user's speech is complete, a send signal is generated indicating that the instant voice message is ready to be sent to the selected recipients. The user generates the send signal when the user presses a button on the keypad or returns the handset of the VoIP telephone 206 to its cradle (on-hook). In response to the send signal, the IVM client 206 sends the recorded audio to the local IVM server 202 via the network 204. The IVM server 202 thereafter delivers the instant voice message to the selected one or more recipients via the IP network 204. As before, the one or more recipients are enabled to display an indication that the instant voice message has been received and audibly play the instant voice message. As aforementioned, if a recipient IVM client is not currently connected to the local IVM server 202, the IVM server 202 temporarily saves the instant voice message and delivers it to the IVM client when the IVM client connects to the local IVM server 202.

20 In the second embodiment of the IVM client 206 according to Fig. 2, the VoIP telephone 206 operates synchronously either with the IVM client 208 or the IVM server 202 to enable instant voice messaging according to the present invention. Thus, in operation according to the second embodiment, the IVM client (VoIP telephone) 206 is still

connected over the network 204 to the IVM server 202, which as aforementioned enables instant voice messaging functionality over the local network 204. However, VoIP telephone 206 cooperates with the IVM client 208 or IVM server 202 to record and send an instant voice message. More specifically, the VoIP telephone 206 is only used as a

5 recording/listening device for recording or listing to instant voice messages, while the IVM client 208 is used for displaying and selecting instant voice message recipients as described hereinabove. In operation, the IVM client 208 displays a list of IVM recipients on the display device 216 provided and stored by the local IVM server 202. The user operates the IVM client 208 by using the input device 218 on the IVM client 208 to indicate a selection

10 of one or more IVM recipients from the list. The user selection is transmitted to the IVM server 202. The user selection generates a start signal to the IVM server 202 indicating that the user is ready to begin instant voice messaging according to the present invention. In response to receiving the start signal, the IVM server 202 transmits a ring signal to the VoIP telephone 206, thereby indicating to the user the IVM system 200 is ready to record an

15 instant voice message. The IVM server 202 also signals the IVM client 208 to generate audio file 210 to record the instant voice message. As the user picks up the handset of the VoIP telephone 206 (off-hook), a connection is established via the network 204 between the local IVM server 202 and the VoIP telephone 206. Thereafter, the IVM server 202 forwards the user's speech transmitted from VoIP telephone 206 to the IVM client 208 for storage

20 into digitized audio file 210 on the IVM client 208. The audio file 210 is finalized by returning the handset its cradle (on-hook) or by pressing a designated button on the keypad VoIP telephone 206, which transmits the stop signal to the IVM server 202 and further from the IVM server 202 to the IVM client 208. Returning the handset to its cradle preferably

generates a send signal to the IVM server 202, which transmits the signal to the IVM client 208. The IVM client thereafter transmits the recorded audio file 210 (instant voice message) to IVM server 202 for delivery to the selected one or more IVM recipients. Alternatively, the user may press a key on the keyboard 218 to initiate the send signal. In response to the send signal, the IVM client 206 sends the recorded audio to the local IVM server 202 via the network 204. The IVM server 202 thereafter delivers the instant voice message to the selected one or more recipients via the IP network 204. The one or more recipients are enabled to display an indication that the instant voice message has been received and audibly play the instant voice message. If a recipient IVM client is not currently connected to the local IVM server 202, the IVM server 202 temporarily saves the instant voice message and delivers it to the IVM client when the IVM client connects to the local IVM server 202.

In operation of the legacy telephone 110 according to Fig. 2, the legacy telephone 110 is connected to the local IVM server 202 via media gateway 114 and legacy switch 112. The legacy telephone 110 cooperates with the IVM client 208 to record and send an instant voice message. More specifically, the legacy telephone 110 is used as a recording/listening device for recording or listing to instant voice messages, while the IVM client 208 is used for displaying and selecting instant voice message recipients as described hereinabove. Thus, in operation the IVM client 208 displays a list of IVM recipients on the display device 216 provided and stored by the local IVM server 202. The user operates the IVM client 208 by using the input device 218 on the IVM client 208 to indicate a selection of one or more IVM recipients from the list. The user selection is transmitted to the IVM

server 202. The user selection generates a start signal to the IVM server 202 indicating that the user is ready to begin instant voice messaging according to the present invention. In response to receiving the start signal, the IVM server 202 transmits an emulation code to the legacy telephone 110 to ring, thereby indicating to the user the IVM system 200 is ready to record an instant voice message. As the user picks up the handset of the legacy telephone 110 (off-hook), a connection is established via the network 204 between the legacy telephone 110 and the IVM server 202. Thereafter, the IVM server forwards the user's speech transmitted from the legacy telephone 110 to the IVM client 208 for storage into the digitized audio file 210 (i.e., instant voice message). The audio file on the IVM client 208 is finalized by returning the handset of the legacy telephone 110 to its cradle (on-hook) or by pressing a designated button on the keypad of the legacy telephone 110, which transmits a stop signal to the IVM server 202 and further to the IVM client 208. Returning the handset to its cradle also generates a send signal to the IVM server to transmit the recorded audio file (instant voice message) to the selected one or more IVM recipients. The IVM server 202 thereafter delivers the instant voice message to the selected one or more recipients via the IP network 204. The one or more recipients are enabled to display an indication that the received instant voice message has been received and audibly play the instant voice message. If a recipient IVM client is not currently connected to the local IVM server 202, the IVM server 202 temporarily saves the instant voice message and delivers it to the IVM client when the IVM client connects to the local IVM server 202.

Regarding the operational embodiments described with reference to Fig. 2 for recoding and transmitting an instant voice message according to the present invention, the

digitized audio file is preferably compressed by applying a compression algorithm before sending the audio file to the one or more selected recipients. The audio file is preferably compressed within the IVM clients 206, 208 before forwarding the audio file to the IVM server 202 for subsequent delivery to the one or more selected recipients. Alternatively, the
5 compression may be implemented within the IVM server 202 before the audio file is transmitted to the one or more selected recipients. A Lempel-Ziv compression algorithm is preferably used to compress the audio file according to the present invention. It is noted that many suitable compression algorithms are known to persons of skill in the art, including Huffman encoding, audio compression standards promulgated by the Moving Pictures
10 Experts Group (“MPEG”), G.722 wideband speech encoding standard, fractal compression, and wavelet compression. Any of the foregoing compression algorithms may be implemented within the scope of the present invention.

Further regarding the operational embodiments described with reference to
15 Fig. 2 for recoding and transmitting an instant voice message according to the present invention, the digitized audio file (which may or may not be compressed as described above) is further preferably encrypted via an encryption algorithm before transmitting the audio file to the one or more selected recipients. The encryption is preferably implemented within the IVM clients 206, 208 before forwarding the audio file to the IVM server 202 for subsequent
20 delivery to the one or more selected recipients. Alternatively, the encryption may be implemented within the IVM server 202 before the audio file is transmitted to the one or more selected recipients. An AES (Rijndael) encryption algorithm is preferably used to encrypt the audio file according to the present invention. It is noted that many suitable

encryption algorithms are known to persons skilled in the art, including DES, Triple DES, Blowfish, Twofish, Serpent, and the like. Any of the foregoing encryption algorithms may be implemented within the scope of the present invention.

5 Lastly with reference to Fig. 2, in addition to the “record mode” of instant voice messaging, the instant voice messaging system 200 also supports an “intercom mode” of voice messaging. The “intercom mode” represents real-time instant voice messaging. In the “intercom mode,” instead of creating an audio file 210, one or more buffers (not shown) of a predetermined size are generated in the IVM client 206, 208 or local IVM server 202.

10 The one or more buffers are used to automatically write successive portions of the instant voice message. Once a first buffer is full, i.e., input audio of the predetermined size is written to the buffer, the content of the first buffer is automatically transmitted to the IVM server 202 for transmission to the one or more IVM recipients. A second buffer is

15 meanwhile written with the next successive portion of input audio. Once, the second buffer is full, i.e., input audio of the predetermined size is written to the buffer, the content of the second buffer is transmitted to the IVM server 202 for transmission to the one or more IVM recipients. If the entire instant voice message or a successive portion thereof (such as a last successive portion in the instant voice message) written to either buffer is smaller the

20 predetermined size, then the buffered content of less than the predetermined size is automatically transmitted to the IVM server 202. The foregoing buffering using the first and second buffers is repeated until the entire instant voice message has been transmitted to the IVM server 202 for transmission to the one or more IVM recipients. It is noted that the invention is not limited to a particular number of buffers. The foregoing buffering and

transmission allows a “real-time” instant voice message to be transmitted to the one or more IVM recipients. The “intercom mode” may be designated as a default mode when an IVM recipient is on-line, while the “record mode” may be designated as a default if the IVM recipient is unavailable, i.e., not on-line. The user may easily change the “intercom mode”
5 to the “record mode” on the respective IVM client 206, 208. Finally, the audio contents of the buffers may be signal processed (for clarity), encrypted and compressed before transmission, as will be described in more detail hereinbelow with reference to Fig. 3.

Fig 3. an exemplary illustration of the architecture in the IVM client 208 for
10 enabling instant voice messaging according to the present invention. More specifically, the IVM client 208 comprises a client platform 302 for generating an instant voice message and a messaging system 320 for messaging between the IVM client 208 and the IVM server 202 for enabling instant voice messaging according to the present invention. The IVM client 208 is a general-purpose programmable computer equipped with a network interface (not
15 shown), such as an Ethernet card, to provide connectivity to the network 204. It is noted that any suitable networking protocol, not only Ethernet, could be used to connect the IVM client to a network 204 and thus is considered within the scope of the present invention. The client platform 302 comprises a client engine 304, which controls other components, namely the document handler 306, file manager 308, audio file creation 312, signal processing 314,
20 encryption/decryption 316, and compression/decompression 318. The messaging system 320 and the client engine 304 communicate via standard inter-process communication. The messaging system 320 and client engine 304 also communicate with the IVM server 202 over the network interface via the network 204. The document handler 306 oversees the

retrieving, sending, receiving and storing of one or more documents (or files) attached to instant voice messages from/to the one or more selected IVM recipients that may be communicating with the IVM client 208. More specifically, when an instant voice message is to be transmitted to the one or more IVM recipients, one or more documents may be attached to the instant voice message to be, stored or displayed by the one or more selected IVM recipients. The file manager accesses a message database 310, in which both the received and recorded instant voice messages are represented as database records, each record comprising a message identifier and the instant voice message. The file manager 308 services requests from the user to record, delete or retrieve messages to/from the message database 310. Audio file creation 312 creates an instant voice message as audio file 210, and is responsible for receiving input speech for the instant voice message from audio input device 212 or via network 204 and storing the input speech into audio file 210. Signal processing 314 performs noise removal and signal optimization in the audio file 210. Encryption/decryption 316 provides for respectively encrypting/decrypting of outgoing/incoming audio files (i.e., instant voice messages), and compression/decompression 318 respectively compresses/decompresses the outgoing/incoming audio files.

Further with reference to Fig. 3, the reception of an instant voice message is described as follows. It is assumed that the local IVM server 202 has determined that the IVM client 208 is available to receive an instant voice message by checking the IVM client's 208 current status, i.e., whether the IVM client 208 is "on-line." The local IVM server 202 maintains the current status of the IVM clients connected to the local IVM server

202, i.e., IVM clients 206, 208. It is further assumed that an IVM client has transmitted an instant voice message to the IVM client 208. The local IVM server 202 receives the instant voice message over the local IP network 204 and forwards the instant voice message to the IVM client 208. Upon receipt at the IVM client 208, the instant voice message is decrypted
5 at 316, decompressed at 318, and stored in the message database 310 using the file manager 308. Any files attached to the instant voice message are also stored in the message database 310 using the file manager 308. A visual and/or sound effect is initiated to notify a user of the IVM client 208 that a new instant voice message has been received at the IVM client 208. At this point in time, the instant voice message and any file attachments are available
10 to the user. The user can select the instant voice message from a listing of available instant voice messages displayed on the IVM client 208 and play the newly received instant voice message. The user may also open any file attachments and move or save the files to a separate location on the client using a drag-and-drop process.

15 Still further with reference to Fig. 3, the generation and transmission of an instant voice message is described as follows. The user selects the available one or more IVM recipients and initiates the creation of an instant voice message as described above with reference to Fig. 2. The client engine 304 detects the start signal and invokes audio file creation 312 of the audio file 210. The audio file 210 is initialized and captures the audio
20 voice message input by the user. Once the client engine 304 detects a stop signal, the instant voice message is finalized in the audio file 210 via audio file creation 312. The audio file 210 is adjusted for gain, and noise is removed via signal processing 314. The audio file 210 is further compressed at 318 and encrypted at 316. The completion of these processes

causes the client engine 304 to inform the user via display 216 that the instant voice message is available to be sent. After the client engine 304 detects the send signal from the user, the instant voice message (audio file 210) is transferred to the local IVM server 202. Before the transmission of the instant voice message (i.e., before the send signal), the user has the option to review the instant voice message, re-record the instant voice message, delete the instant voice, as well as attach one or more files (i.e., documents). The attachment of one or more files is enabled conventionally via a methodology such as “drag-and-drop” and the like, which invokes the document handler 306 to make the appropriate linkages to the one or more files and flags the messaging system 320 that the instant voice message also has the attached one or more files.

Fig 4. an exemplary illustration of the local IVM server 202 for enabling instant voice messaging according to the present invention. The IVM server 202 is a general-purpose programmable computer equipped with a network interface, such as an Ethernet card, to provide connectivity to a network 204. It is noted that any suitable networking protocol may be implemented to connect the IVM server 202 to a network 204. The IVM server 202 comprises a server communication platform 402, a messaging system 436 and a database 414, thereby enabling instant voice messaging according to the present invention. The server communication platform 402 comprises a server engine 404, client manager 406, station manager 408, gateway manager 410, database manager 412 that accesses database 414, supplemental servers 416 (including particular server subsystems 418-424), as well as a control layer 426 (including non-proprietary server subsystems 428, 430 and proprietary server subsystems 432, 434). The messaging system 436 and the server

engine 304 communicate via standard inter-process communication. The messaging system 436 and the server engine are also able to communicate with the IVM clients 206, 208 over the network interface via the network 204. The database 414 stores users (e.g., IVM clients as well as legacy telephone clients) that are known to the IVM server 202 via the database manager 412. The users are represented in the database as records, each record comprising a user name, a password, and a contact list (a list of other users with whom the user wishes to exchange instant voice messages), and other data relating to the user. The database manager 412 services requests to add, update, delete, or retrieve database records to/from the database 414. The password may be stored in the database 414 as plaintext, in encrypted form, or as a hash (e.g., MD5 hash). The messaging system 436 communicates to the server engine 404 via message objects.

A message object comprises an action field, an ID field, a source field, a destination field, and an object field. The content of the action field is selected from a list of permitted actions, which among other actions includes: connect, disconnect, subscribe, unsubscribe, and post message. In addition, the actions include: determining if an IVM client is awake (i.e., pinging), disconnecting from the IVM client, processing an IVM client message, and notifying IVM clients if the IVM server 202 goes down. The client messages include sending an instant voice message portions, checkin message, send message, set status message, send a phone command message, and send control parameters message. The content of the ID field represents a unique identifier for the message object. The content of the source field is a globally unique identifier (“GUID”) that uniquely identifies the sender of the message. This unique identifier can be generated by any known way, including the

Globally Unique ID function call available in the Microsoft Windows and Microsoft .NET environments. In some circumstances, the source field is set to a special value to indicate that the sender of the message object is entitled to special privileges. The senders with special privileges are in fact IVM servers. This allows the IVM servers to broadcast

5 messages to one another, subscribe to special events, and directly send messages to specific IVM servers. These privileges can depend upon whether the IVM servers are local servers or global servers. As an example, there can exist more than one local IVM server, each of these local IVM servers automatically has privileges to communicate to other local IVM server. On a global server system, a directory server can communicate with one or more

10 transport servers. The content of the destination field is a GUID of an intended IVM recipient of the instant voice message. The content of the object field is a block of data being carried by the message object, which may be, for example, a digitized instant voice message. Depending on the circumstances in which the message object is sent, some of the message object fields may be left blank or ignored. For example, the message object may

15 merely require an action to be performed based upon the GUID supplied. In this case, the action does not necessarily require any data to be sent or received and some of the message object's fields may be left blank or ignored.

Connection objects maintain the logical connections between the IVM server 202 and IVM clients 206, 208 connected to the IVM server 202. More specifically, a

20 connection object comprises data representing the state of the connection and code (one or more methods) for establishing and maintaining the logical connections between the IVM server 202 and the IVM clients 206, 208 within the IVM system 200 of Fig. 2. The

connection object can contain both data and/or commands, including information that describes the socket, the size of the data to be transferred, and the priority of the transfer (e.g., high, normal, low, unknown). On start up the local IVM server 202 generates and maintains a list for each IVM client 206, 208. The local IVM server 202 then waits to
5 receive connection objects from the IVM clients 206, 208 that are stored in the respective lists, decodes the received connection objects to obtain specific requests, and then services the specific requests from the IVM clients 206, 208.

Further with reference to Fig. 4, the server engine 404 controls all other subsystems in the server communication platform 402, and it is responsible for startup and
10 shutdown of the IVM server 202 and the IVM system 200. The client manager 406 controls the IVM clients 206, 208, providing contact presence (connection) information and message scheduling and delivery. The station manager 408 controls the individual legacy telephone 110 and coordinates its activity to work synchronously with the IVM client 208 and server 202. The gateway manager 410 enables the IVM server 202 to communicate with the
15 legacy telephones, such as legacy telephone 110. The control layer 426 comprises a plurality of server subsystems 428-434, each of which provides translation services to different proprietary and non-proprietary gateways 114, such as TPNCP, MGCP, and MEGACO gateways. The proprietary server subsystems 428, 430 and non-proprietary server subsystems 432, 434 are connected to respective gateways 114 via the local IP
20 network 204. The supplemental server subsystems 416 provide a number of required services such as display manager subsystem 418, dynamic host configuration protocol (i.e., "DHCP") subsystem 420, trivial file transfer protocol (i.e., "TFTP") server subsystem 422,

and hypertext transfer protocol (i.e., "HTTP"). Each of the supplemental servers 418-424 in the subsystem 416 is used during the initial set-up of the IVM system 200. The boot-up process and allocation of IP addresses to IVM clients 206, 208 are performed through an LCD panel (not shown) associated with the local IVM server 202. The LCD manager 418 supports this boot-up process. The DHCP server 420 is used to allocate IP addresses as required and allows the advanced configuration of network settings in the instant voice messaging system. The TFTP server 422 provides a TCP/IP file transfer capability. Lastly, the HTTP server 424 provides services for a web server.

Figure 5 is an exemplary illustration of a global instant voice messaging (IVM) system 500, according to the present invention. In the global IVM system 500, the local IVM system 200 is depicted as a local IVM system 510, which is connected to a packet-switched network 102 (i.e., Internet). The global IVM system 500 comprises the local IVM system 510, global IVM server system 502, and global IVM clients 506 and 508 that are optionally connected via local IP network 504. The global IVM server system 502 is connected to the IP network (i.e., Internet) 102 for enabling the local IVM clients 206, 208 and legacy telephone 110 in the local IVM system 510 to generate and send instant voice messages to the global IVM clients 506, 508, as well as the local IVM clients 206, 208 to receive instant voice messages from the global IVM clients 506, 508. The implementation of the global instant voice messaging for the IVM client 208 will be described first and will be followed by the implementations for IVM client 206 and legacy telephone 110, with reference to the global IVM system 500 depicted in Fig. 5. Thereafter, instant voice messaging for global clients 506 and 508 will be described according to the

present invention. These implementations implement a “record mode” of the instant voice messaging according to the present invention. Thereafter, there will lastly be described an “intercom mode” of the instant voice messaging according to the present invention.

5 Therefore, in operation of the IVM client 208 according to Fig. 5, the IVM client 208 is connected via the networks 204, 102 to the global IVM server system 502, which enables the global instant voice messaging functionality outside the local IVM system 510 over the network (i.e., Internet) 102. More specifically, the IVM client 208 requests from the global IVM server system 502 a global contact list (not shown) of global one or
10 more IVM recipients with which the IVM client 208 may exchange instant voice messages. For the purposes of illustration, it is assumed that global IVM clients 506, 508 are in the contact list. The global IVM server system 502 stores and maintains this contact list. Thus, the global IVM server system 502 responds by transmitting the contact list to the IVM client 208. The IVM client 208 displays the contact list on its display 216. Alternatively, the
15 global contact list may be replicated to the local IVM server 202 within the local IVM system 510, in which case the local IVM client 208 obtains the global contact list from the local IVM server 202. The user operates the IVM client 208 by using the input device 218 to indicate a selection of one or more IVM recipients from the global contact list. Here, for the purposes of illustration it is again assumed that IVM client 208 selected global IVM
20 clients 506, 508. The user selection is transmitted to the IVM server 202. The user selection also generates a start signal to the IVM client 208 that the user is ready to begin instant voice messaging. In response to the start signal, the IVM client 208 listens to the input audio device 212 and records the user’s speech into a digitized audio file 210 (i.e.,

instant voice message) stored on the IVM client 208. The audio file 210 is finalized via a stop signal, which is generated by the user via the input device 218 or a preset time period without speech input via the input audio device 212. Once the recording is finalized, the IVM client 208 generates a send signal indicating that the digitized audio file 210 (instant voice message) is ready to be sent to the selected one or more IVM recipients. The user generates the send signal when the user operates the IVM client 208 via the input device 218. The IVM client 208 transmits the digitized audio file 210 and the send signal to the global IVM server system 502 via the local IP network 204 and the global IP network 102. After receiving the audio file 210, the global IVM server system 502 delivers the transmitted instant voice message to the selected one or more recipients (e.g., IVM clients 506 and 508) via the IP network 102. The one or more recipients are enabled to display an indication that the instant voice message has been received and audibly play the instant voice message to an associated user. It is noted that if a recipient IVM client 506, 508 is not currently connected to the global IVM server system 502, the global IVM server system 502 temporarily saves the instant voice message and delivers it to the global IVM client 506, 508 when the IVM client connects to the global IVM server system 502.

There are several embodiments for the operation of the IVM client (VoIP telephone) 206 within the global IVM system 500 of Fig. 5, according to the present invention. In the first embodiment, the VoIP telephone 206 is a standalone IVM client 206 enabled for instant voice messaging according to the present invention. In the second embodiment, the VoIP telephone 206 operates synchronously with the IVM client 208 to enable instant voice messaging according to the present invention. Thus, in operation

according to the first embodiment in Fig. 5, the IVM client 206 is connected via the networks 204, 102 to the global IVM server system 502, which enables instant voice messaging functionality over the IP network (Internet) 102. As mentioned previously, the IVM client 206 is also connected to the local IVM server 202. The IVM client 208 requests from the global IVM server system 502 a global contact list (not shown) of the global one or more IVM recipients with which the IVM client 206 may exchange instant voice messages. For the purposes of illustration, it is assumed that the global IVM clients 506, 508 are in the contact list. The global IVM server system 502 stores and maintains this contact list. Thus, the global IVM server system 502 responds by transmitting the global contact list to the IVM client 206. Alternatively, the global contact list may be replicated to the local IVM server 202 within the local IVM system 510, in which case the local IVM client 206 obtains the global contact list from the local IVM server 202. The IVM client 206 displays a list of the one or more IVM recipients on its associated display. The user operates the IVM client 206 by using a keypad on the VoIP telephone 206 to indicate a selection of one or more IVM recipients from the list. The VoIP telephone 206 transmits the selection to the global IVM server system 502. The user selection also generates a start signal to the IVM client 206 indicating the user is ready to begin instant voice messaging according to the present invention. The user speaks into the handset of the IVM client 206 or a speakerphone on the IVM client 206. Although not shown in Fig. 5, the VoIP telephone 206 may provide a dedicated storage device, which in response to the start signal records an audio file, similar to the audio file 210 in the IVM client 208. The audio file is finalized via a stop signal. The stop signal is generated when the user presses a button on the keypad, a preset time period without speech input to the VoIP telephone 206, or when the user returns the handset to the

cradle of the VoIP telephone 206. Once the recording of the user's speech is complete, a send signal is generated indicating that the instant voice message is ready to be sent to the selected recipients. The user generates the send signal when the user presses a button on the keypad or returns the handset of the VoIP telephone 206 to its cradle. In response to the send
5 signal, the IVM client 206 sends the recorded audio file (instant voice message) to the global IVM server system 502 via the networks 204, 102 for delivery to the selected one or more IVM recipients. The global IVM server 502 thereafter delivers the instant voice message to the selected one or more recipients (e.g., IVM clients 506 and 508) via the IP network 102. As before, the one or more recipients are enabled to display an indication that the instant
10 voice message has been received and audibly play the instant voice message. If a recipient IVM client is not currently connected to the global IVM server system 502, the global IVM server system 502 temporarily saves the instant voice message and delivers it to the IVM client when the IVM client connects to the global IVM server system 502.

15 In the second embodiment of the IVM client 206 according to Fig. 5, the VoIP telephone 206 operates synchronously with the IVM client 208 to enable global instant voice messaging according to the present invention. Thus, in operation according to the second embodiment in Fig. 5, the VoIP telephone 206 is connected over the network 204 to the IVM client 208 and the IVM client 208 is connected via the networks 204, 102 to the
20 global IVM server system 502, which enables instant voice messaging functionality over the IP network (Internet) 102. The VoIP telephone 206 cooperates with the IVM client 208 to record and send a global instant voice message outside the local IVM system 510. The IVM client 208 displays a global contact list of IVM recipients (not shown) on the display device

216 provided by the global IVM server system 502, as described hereinabove.

Alternatively, the global contact list may be replicated to the local IVM server 202 within the local IVM system 510, in which case the IVM client 208 obtains the global contact list from the local IVM server 202. The user operates the IVM client 208 by using the input

5 device 218 to indicate a selection of one or more IVM recipients from the contact list. The user selection generates a start signal in the IVM client 208 indicating that the user is ready to begin instant voice messaging according to the present invention. In response to the start signal, the IVM client 208 generates audio file 210 to record an instant voice message and transmits a ring signal to the VoIP telephone 206. As the user picks up the handset of the

10 VoIP telephone 206 (off-hook), a connection is established via the network 204 between the local IVM client 208 and the VoIP telephone 206. Thereafter, the VoIP telephone 206 forwards the user's speech to the IVM client 208 for storage into the audio file 210. The audio file 210 is finalized by returning the handset its cradle (on-hook) or by pressing a designated button on the keypad VoIP telephone 206, which transmits the stop signal to the

15 IVM client 208. Returning the handset to its cradle preferably generates a send signal to the IVM client 208. The IVM client thereafter transmits the recorded audio file 210 (instant voice message) to the global IVM server system 502 via networks 204, 102 for delivery to the selected one or more IVM recipients. Alternatively, the user may press a key on the keyboard 218 to initiate the send signal. In response to the send signal, the IVM client 208

20 sends the recorded audio file to the global IVM server system 502 for delivery to the selected one or more IVM recipients. The global IVM server system 502 thereafter delivers the instant voice message to the selected one or more recipients (e.g., IVM clients 506 and 508) via the IP network 102. As before, the one or more IVM recipients are enabled to

display an indication that the instant voice message has been received and audibly play the instant voice message. If a recipient IVM client is not currently connected to the global IVM server system 502, the global IVM server system 502 temporarily saves the instant voice message and delivers it to the IVM client when the IVM client connects to the global
5 IVM server system 502.

In operation of the legacy telephone 110 according to Fig. 5, the legacy telephone 110 is connected to the local IVM client 208 via media gateway 114, legacy switch 112 and network 204. The legacy telephone 110 cooperates with the IVM client 208
10 to record and send an instant voice message outside the local IVM system 510. More specifically, the legacy telephone 110 is used as a recording/listening device for recording or listing to instant voice messages, while the IVM client 208 is used for displaying and selecting instant voice message recipients as described hereinabove. Thus, in operation the IVM client 208 requests from the global IVM server system 502 a global contact list of
15 global one or more IVM recipients with which the IVM client 208 may exchange instant voice messages. Alternatively, the global contact list may be replicated to the local IVM server 202 within the local IVM system 510, in which case the IVM client 208 obtains the global contact list from the local IVM server 202. The IVM client 208 displays the global list of IVM recipients, as described hereinabove. The user operates the IVM client 208 to
20 indicate a selection of one or more IVM recipients from the global contact list. The IVM client 208 transmits the user selection to the global IVM server system 502. The user selection generates a start signal in the IVM client 208 indicating that the user is ready to begin instant voice messaging according to the present invention. In response to the start

signal, the IVM client 208 transmits an emulation code to the legacy telephone 110 to ring, thereby indicating to the user the global IVM system 500 is ready to record an instant voice message. As the user picks up the handset of the legacy telephone 110 (off-hook), a connection is established via the network 204 between the legacy telephone 110 and the IVM client 208. Thereafter, the user's speech is transmitted from the legacy telephone 110 to the IVM client 208 for storage into the digitized audio file 210 (i.e., instant voice message). The audio file 210 is finalized by returning the handset of the legacy telephone 110 to its cradle (on-hook) or by pressing a designated button on the keypad of the legacy telephone 110, which transmits a stop signal to the IVM client 208. Returning the handset to its cradle may also generate a send signal to the IVM client 208 to transmit the recorded audio file (instant voice message) to the global IVM server system 502 for delivery to the selected one or more IVM recipients. Alternatively, the send signal is preferably generated from the IVM client 208 as described hereinabove. The global IVM server system 502 thereafter delivers the instant voice message to the selected one or more IVM recipients via the IP network (Internet) 102. The one or more recipients are enabled to display an indication that the instant voice message has been received and audibly play the instant voice message. If a recipient IVM client is not currently connected to the global IVM server system 502, the global IVM server system 502 temporarily saves the instant voice message and delivers it to the IVM client when the IVM client connects to the global IVM server 502.

Further with reference to Fig. 5, the instant voice messaging for global clients 506 and 508 will be described according to the present invention. In a first embodiment,

each of the global IVM clients 506, 508 is enabled to independently send an instant voice message. The IVM clients 506, 508 have like peripheral devices and functionality described respectively with reference to local IVM clients 206, 208 in Fig. 2. In second embodiment described below, the VoIP telephone 506 operates in conjunction with the IVM client 508 to
5 send an instant voice message. Therefore, in operation of the global IVM clients 506 and 508 according the first embodiment in Fig. 5, the IVM clients 506, 508 are connected via the networks 204, 102 to the global IVM server system 502, which enables the global instant voice messaging functionality outside the local IVM system 510 over the network (i.e., Internet) 102. Each of the global IVM clients 506, 508 is enabled to request from the global
10 IVM server system 502 a contact list (not shown) of global one or more IVM recipients with which each of the global IVM client 506, 508 may exchange instant voice messages. For the purposes of this illustration, it is assumed that the IVM clients 206 and 208 within the local IVM system 510 are in the contact list for each global IVM client 506, 508. The global IVM server system 502 stores and maintains the foregoing contact list for each global
15 IVM client 506, 508. Upon request, the global IVM server system 502 responds by transmitting the contact list to each of the IVM clients 506, 508. Each of the IVM clients 506, 508 displays the contact list on its display. The user operates the IVM client 506, 508 to indicate a selection of one or more IVM recipients from the contact list. Each of the global IVM clients 506, 508 transmits the user selection to the global IVM server system
20 502. The user selection also generates a start signal to the IVM clients 506, 508 that the user is ready to begin instant voice messaging. In response to the start signal, the IVM clients 506, 508 record the user's speech into a digitized audio file (i.e., instant voice message) stored on the global IVM clients 506, 508. The audio file is finalized via a stop signal,

which is generated by the user by operating the global IVM client 506, 508. Once the recording is finalized, the IVM client 506, 508 generates a send signal indicating that the digitized audio file (instant voice message) is ready to be sent to the selected one or more recipients. The user generates the send signal when the user operates the global IVM client 506, 508. The IVM client 208 transmits the digitized audio file and the send signal to the global IVM server system 502. After receiving the audio file, the global IVM server system 502 delivers the transmitted instant voice message to the local IVM server 202 in the local IVM system 510 for delivery to the selected one or more recipients (e.g., local IVM clients 206 and 208) via the local IP network 204. The one or more recipients IVM 206, 208 are enabled to display an indication that the instant voice message has been received and audibly play the instant voice message to an associated user. It is noted that if a recipient IVM client 206, 208 is not currently connected to the local IVM server 202, the IVM server 202 temporarily saves the instant voice message and delivers it to the local IVM client 206, 208 when the IVM client connects to the local IVM server 202.

15

In the second embodiment of the IVM client 506 according to Fig. 5, the VoIP telephone 506 operates synchronously with the IVM client 508 to enable global instant voice messaging according to the present invention. In this embodiment, the VoIP telephone 506 and the IVM client 508 may be located in a user's residence and be connected to a local IP network 504. This local IP network 504 can be a WiFi network or a local area network (i.e., LAN), which is also within the user's residence. The local IP network 504 may be connected to the IP network (Internet) 102 via a digital subscriber line (i.e., DSL) connection, cable connection, dialup connection, or the like. As noted above, the IVM

20

clients 506, 508 have like peripheral devices and functionality described respectively with reference to local IVM clients 206, 208 in Fig. 2. Thus, in operation according to this embodiment in Fig. 5, the global IVM client 508 requests from the global IVM server system 502 a contact list of global one or more IVM recipients with which each of the global IVM client 508 may exchange instant voice messages. For the purposes of this illustration, it is assumed that the IVM clients 206 and 208 within the local IVM system 510 are in the contact list for the global IVM client 508. The global IVM server system 502 stores and maintains the foregoing contact list for the global IVM client 508. The IVM client 508 displays a contact list of IVM recipients on the associated display device provided by the global IVM server system 502, as described hereinabove. The user operates the IVM client 508 by using the associated input device to indicate a selection of one or more IVM recipients from the contact list. The user selection generates a start signal in the IVM client 508 indicating that the user is ready to begin instant voice messaging according to the present invention. In response to the start signal, the IVM client 508 generates audio file to record an instant voice message and transmits a ring signal to the VoIP telephone 506 via local IP network 504. As the user picks up the handset of the VoIP telephone 206 (off-hook), a connection is established via the local network 504 between the local IVM client 508 and the VoIP telephone 506. Thereafter, the VoIP telephone 506 forwards the user's speech to the IVM client 508 for storage into the audio file at the IVM client 508. The audio file is finalized by returning the handset its cradle (on-hook) or by pressing a designated button on the keypad associated with the VoIP telephone 506, which transmits the stop signal to the IVM client 508. Returning the handset to its cradle preferably generates a send signal to the IVM client 508. The IVM client thereafter transmits the recorded audio file

(instant voice message) to the global IVM server system 502 for delivery to the selected one or more IVM recipients. Alternatively, the user may press a key on the input device associated with the IVM client 508 to initiate the send signal. In response to the send signal, the IVM client 508 sends the recorded audio file to the global IVM server system 502 for
5 delivery to the selected one or more IVM recipients. The global IVM server system 502 thereafter transmits the instant voice message to the local IVM server 202 for delivery selected one or more recipients (e.g., local IVM clients 206 and 208) via the local IP network 204. As before, the one or more recipients are enabled to display an indication that the instant voice message has been received and audibly play the instant voice message. If a
10 recipient IVM client is not currently connected to the local IVM server 202, the local IVM server 202 temporarily saves the instant voice message and delivers it to the IVM client when the IVM client connects to the local IVM server 202.

Lastly with reference to Fig. 5, in addition to the “record mode” of instant
15 voice messaging as described above, the instant voice messaging system 500 also supports an “intercom mode” of the instant voice messaging. The “intercom mode” represents real-time instant voice messaging. In the “intercom mode,” instead of creating an audio file as described hereinabove, one or more buffers (not shown) of a predetermined size are generated. The buffers may be generated in any one of the IVM clients 206, 208, 506 and
20 508, depending on how the global IVM system 500 is defined. The one or more buffers are used to automatically write successive portions of the instant voice message. Once a first buffer is full, i.e., input audio of the predetermined size is written to the buffer, the content of the first buffer is automatically transmitted. If the transmission is generated at a local

IVM client 206, 208 and destined for one or more local IVM recipients, the content of the first buffer is transmitted to the local IVM server 202 for delivery to the local one or more recipients. If the transmission is generated at a local IVM client 206, 208 and destined for one or more global IVM recipients 506, 508, the content of the first buffer is transmitted to the global IVM server system 502 for delivery to the one or more global recipients. In addition, if the transmission is generated at a global IVM client 506, 508 and destined for the other global IVM clients, the content of the first buffer is transmitted to the global IVM server system 502, such as for example clients 506, 508. Lastly, if the transmission is generated at a global IVM client 506, 508 and destined for the local IVM clients 206, 208, the content of the first buffer is transmitted to the global IVM server system 502 and further transmitted by the global IVM server 502 to the local IVM server 202 for delivery to clients 206, 208 within the local IVM system 510. A second buffer is meanwhile written with the next successive portion of input audio. Once, the second buffer is full, i.e., input audio of the predetermined size is written to the buffer, the content of the second buffer is transmitted in similar fashion to the first buffer. If the entire instant voice message or a successive portion thereof (such as a last successive portion in the instant voice message) written to either buffer is smaller the predetermined size, then the buffered content of less than the predetermined size is automatically transmitted to the IVM server 202. The foregoing buffering using the first and second buffers is repeated until the entire instant voice message has been transmitted as described above. It is noted that the invention is not limited to a particular number of buffers. The foregoing buffering and transmission allows a “real-time” instant voice message to be transmitted to the one or more local, as well as global, IVM recipients. The “intercom mode” may be designated as a default mode when an IVM

recipient is on-line, while the “record mode” may be designated as a default if the IVM recipient is unavailable, i.e., not on-line. The user may easily change the “intercom mode” to the “record mode” on the respective IVM client 206, 208, 506, 508. Finally, the audio contents of the buffers may be signal processed (for clarity), encrypted and compressed
5 before transmission, as was described previously.

Fig. 6 is an exemplary detailed illustration 600 of the global IVM server system 502 depicted in Fig. 5, according to the present invention. More specifically, the local IVM system 510 described in Fig. 5 is connected via the IP network (Internet) 102 to
10 the global IVM server system 502. The global IVM server system 502 comprises an IVM transport server mesh 602 and an IVM directory server 608. The IVM transport server mesh 602 comprises a plurality of interconnected IVM transport servers 604, 606. Although the mesh 602 is depicted as having two IVM transport servers 604, 606, it is to be understood that as many IVM transport servers as are desired or required for redundancy and load
15 balancing may be interconnected in a mesh. The IVM transport servers 604, 606 may be centrally located and configured to communicate (i.e., forward and receive messages) with local IVM clients 206, 208, local IVM server 202 and global IVM client 506, 508 (not depicted in Fig. 6). The plurality of IVM transport servers 604, 606 in the IVM transport server mesh 602 permits load balancing and redundancy in the global IVM system 500. The
20 directory server 608 maintains a transport server list of all the IVM transport servers 604, 606 currently connecting to the mesh 602. Each of the IVM transport servers 604, 606 first connects to the directory server 608. The directory server 608 informs each of the connecting IVM transport servers 604, 606 of all the other IVM transport servers currently

in the mesh 602 based on an active list (not shown) of transport servers 604, 606 in the mesh 602. The connecting IVM transport server then connects to each of the IVM transport servers in the transport server list, resulting in an interconnected mesh 602 of IVM transport servers 604, 606. The IVM transport servers 604, 606 and the IVM directory server 608
5 communicate via messages.

Further with reference to Fig. 6, the IVM transport servers 604, 606 connected in the mesh 602 share a database (not shown) of IVM clients, so that each IVM transport server 604, 606 refers to the same client database. It is preferable that each IVM
10 transport server 604, 606 maintains its own copy of the client database, which is mirrored and replicated conventionally amongst the IVM transport servers 604, 606 in the mesh 602. The client database may further be replicated to the local IVM server 202. Alternatively, the client database is stored on a separate file server (not shown) in data communication with the IVM transport servers 604, 606 over a network (not shown).

15

Fig. 7 is an exemplary detailed illustration of a transport server 604, 606 depicted in Fig. 6, according to the present invention. The IVM transport server 604, 606 is a general-purpose programmable computer comprising a network interface (not shown) connected to IP network (Internet) 102, a communication platform 702, a message database
20 712, and a messaging system 714. The communication platform 702 comprises a server engine 704, which controls a user manager 706, a local server manager 708, and a storage manager 710. The messaging system 714 and the server engine 704 communicate via standard inter-process communication. The storage manager 710 handles retrieving,

sending, and storing of messages, including instant voice messages and attachments thereto, to/from the message database 712. The user manager 706 is responsible for creating/maintaining IVM clients 206, 208, 506, 508, identifying them and relaying their status to the server engine 704. When an IVM client communicates an instant voice message within the global IVM system 500, the user manager 706 notifies the server engine 704 whether the one or more recipients are unavailable, and thereby the instant voice message is saved in the message database 712. When the one or more IVM recipients become available, the user manager 706 notifies the server engine 704, which instructs the storage manager 710 to retrieve any undelivered instant voice messages for the one or more recipients and delivers the instant voice messages to the designated one or more IVM recipients. The local server manager 708 is responsible for creating/maintaining and providing the status of available local IVM servers, such as IVM server 202 in Fig. 2. The availability status of the local IVM servers is checked periodically and updated.

Fig. 8 is an exemplary detailed illustration of a directory server 608 depicted in Fig. 6, according to the present invention. The directory server 608 is a general-purpose programmable computer equipped with a network interface (not shown) connected to IP network (Internet) 102, a messaging system 812, and a communication platform 802. The communication platform 802 comprises a server engine 804, which controls a local server manager 806, a user manager 808, and a transport manager 810. The messaging system 812 and the server engine 804 communicate via standard inter-process communication. The transport manager 810 maintains the status of the IVM transport servers 604, 606 in the IVM transport server mesh 602 within the global IVM system 500 and using a load-

balancing mechanism distributes instant voice messages to available transport server 604, 606 for routing to the one or more IVM recipients. The user manager 808 is responsible for creating/maintaining IVM clients 206, 208, 506, 508, identifying and relaying their status via the server engine 804 to the IVM transport server 604, 606 to be used. The local server manager 806 is responsible for creating/maintaining and providing the status of available local IVM servers, such as IVM server 202 in Fig. 2. The availability status of the local IVM servers is checked periodically and updated.

Fig. 9 illustrates an exemplary a global instant voice messaging (IVM) system 900, which comprises a plurality of local IVM systems and a plurality of global IVM clients, according to the present invention. In the global IVM system 900, there are depicted a plurality of local IVM systems 902, 910 connected to the global IP network 102. The internal representation and functionality of each local IVM system 902, 904 is identical to the local IVM system 510 described with reference to Fig. 5. In global IVM system 900 of Fig. 9, there are also depicted a plurality of global IVM clients 918-928 and a global IVM server system 502 connected to the global IP network (i.e., Internet) 102. The internal representations of the global IVM client 918-928 and the global IVM server system 502 are identical to the respective IVM client 508 (and/or IVM client or 506) and the global IVM server system 502 described with reference to Fig. 5. In the local IVM system 902, each local IVM client 206, 208 is enabled to request local IVM recipients from the local IVM server 202 and global IVM recipients from either the global IVM server system 502 or the local IVM server 202. For example, the local IVM client 1A 208 displays a list 904 to a user, comprising both local and global IVM recipients. More specifically, the list 904

enables IVM client 1A to send instant voice messages according to the present invention to local IVM clients 1B 208 and 1C 206, global IVM client C 922 and global IVM client 2A 208 in the local IVM system 910. Similar lists 906-916 are displayed to the users of the respective IVM clients 1B-1C in local IVM system 902, and 2A-2C in local IVM system
5 910. In addition, the global clients A-F 918-928 are enabled to request IVM recipients from the global IVM server system 502 and display the respective lists of IVM recipients 930-940 on the respective IVM clients 918-928.

While the invention has been particularly shown and described with regard to
10 preferred embodiments thereof, it will be understood by those skilled in the art that the foregoing and other changes in form and details may be made therein without departing from the spirit and scope of the invention.

CLAIMS:

What is claimed is:

1. A method for instant voice messaging over a packet-switched network, the method comprising:
 - receiving an instant voice message having one or more recipients;
 - delivering the instant voice message to the one or more recipients over a packet-switched network;
 - temporarily storing the instant voice message if a recipient is unavailable; and
 - delivering the stored instant voice message to the recipient once the recipient becomes available.

2. The method for instant voice messaging over a packet-switch network according to claim 1, further comprising the steps of:
 - monitoring a connectivity status of nodes within the packet-switched network, said connectivity status being available and unavailable; and
 - recording the connectivity status for each of the nodes.

3. The method for instant voice messaging over a packet-switch network according to claim 2, further comprising the steps of:
 - associating a sub-set of the nodes with a client; and
 - transmitting a signal to a client including a list of the recorded connectivity status for each of the nodes in the sub-set corresponding to the client.

4. The method for instant voice messaging over a packet-switch network according to claim 2, wherein the instant voice message includes one or more files attached to an audio file.

5. The method for instant voice messaging over a packet-switch network according to claim 2, further comprising the step of:

controlling a method of generating the instant voice message based upon the connectivity status of said one or more recipient.

6. The method for instant voice messaging over a packet-switch network according to claim 5, wherein said method of generating said instant voice message is selected from a group comprising a record mode and an intercom mode.

7. The method for instant voice messaging over a packet-switch network according to claim 6, wherein said record mode is selected as a default when at least one recipients are unavailable.

8. The method for instant voice messaging over a packet-switch network according to claim 6, wherein said intercom mode is selected as a default when at least one recipients are available.

9. The method for instant voice messaging over a packet-switch network according to claim 7, wherein said record mode comprises the steps of:

recording the instant voice message;
receiving a stop indicator; and
transmitting the recorded instant voice message after the receipt of said stop
indicator.

10. The method for instant voice messaging over a packet-switch network according to claim
8, wherein said intercom mode comprises the steps of:

buffering each of a plurality of successive portions of the instant voice as the
instant message is recorded;

transmitting from each successive buffered portion; and

delivering each successive portion to the recipients wherein the recipients audibly
playing each successive portion as it is delivered.

SYSTEM AND METHOD
FOR INSTANT VoIP MESSAGING

ABSTRACT OF THE DISCLOSURE

There is provided an instant voice messaging system (and method) for delivering instant messages over a packet-switched network, the system comprising: a client connected to the network, the client selecting one or more recipients, generating an instant voice message therefor, and transmitting the selected recipients and the instant voice message therefor over the network; and a server connected to the network, the server receiving the selected recipients and the instant voice message therefor, and delivering the instant voice message to the selected recipients over the network, the selected recipients being enabled to audibly play the instant voice message.

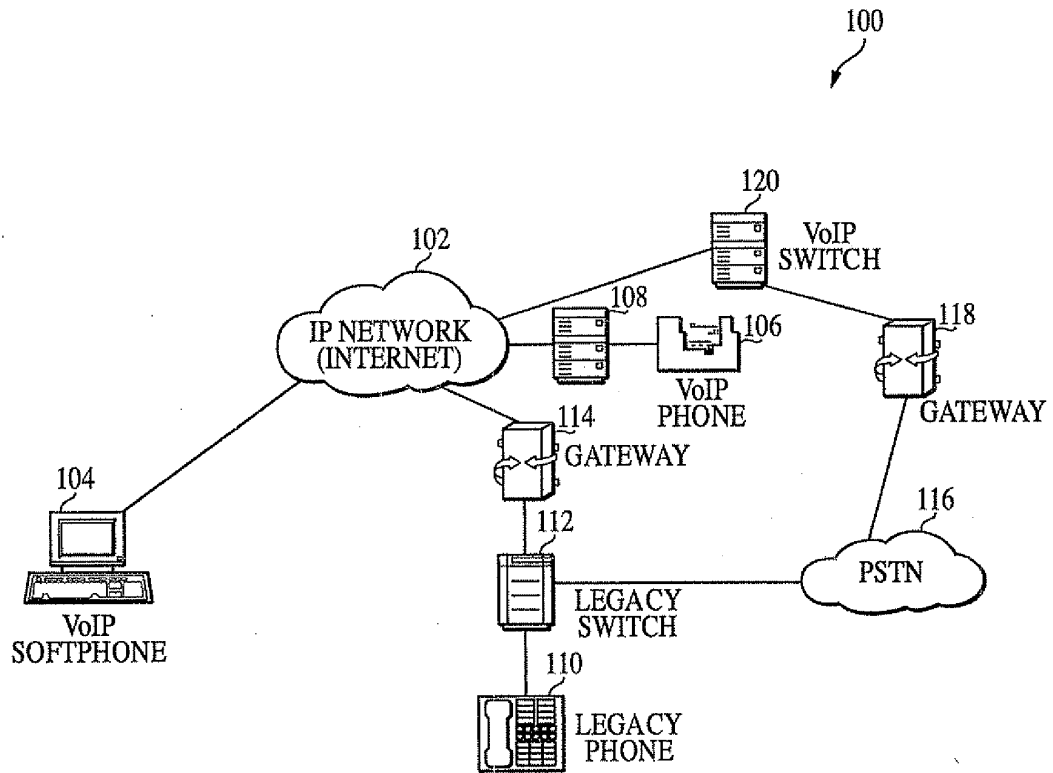

FIG. 1
(PRIOR ART)

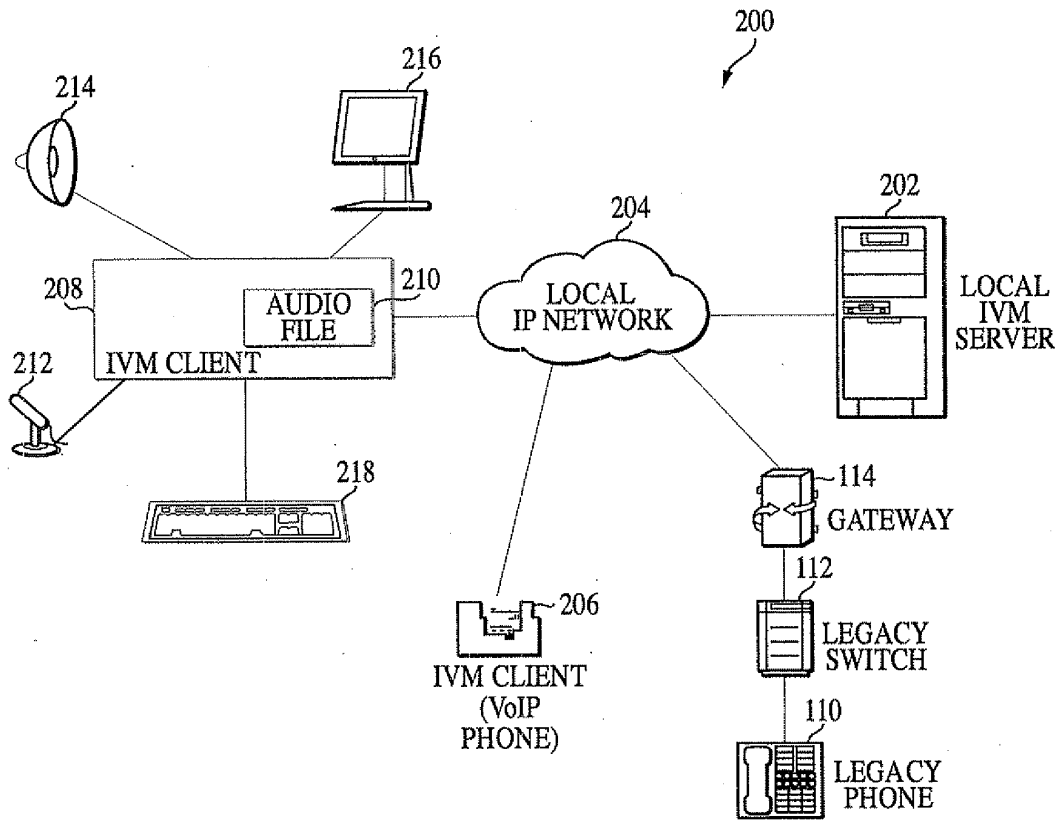

FIG. 2

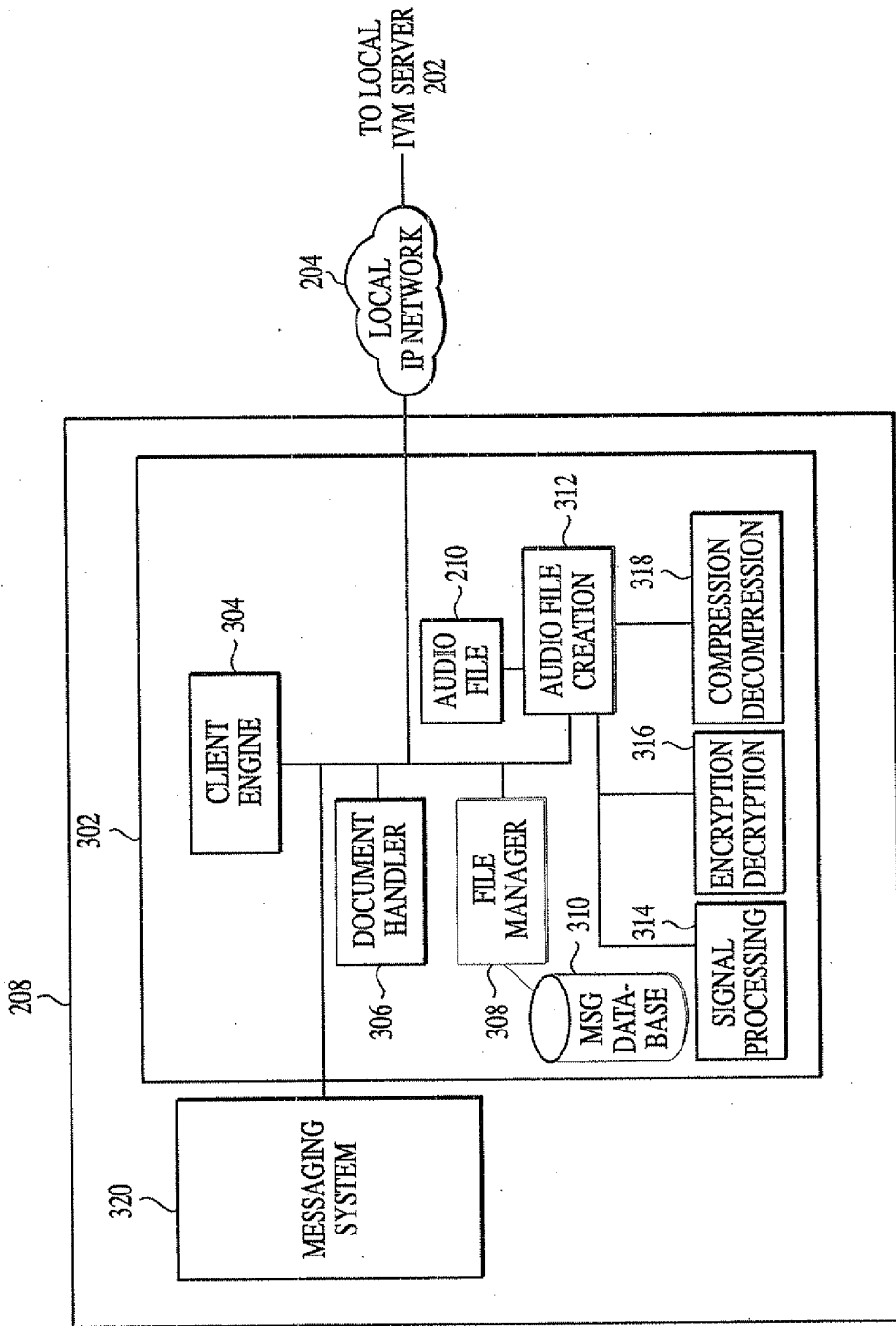

FIG. 3

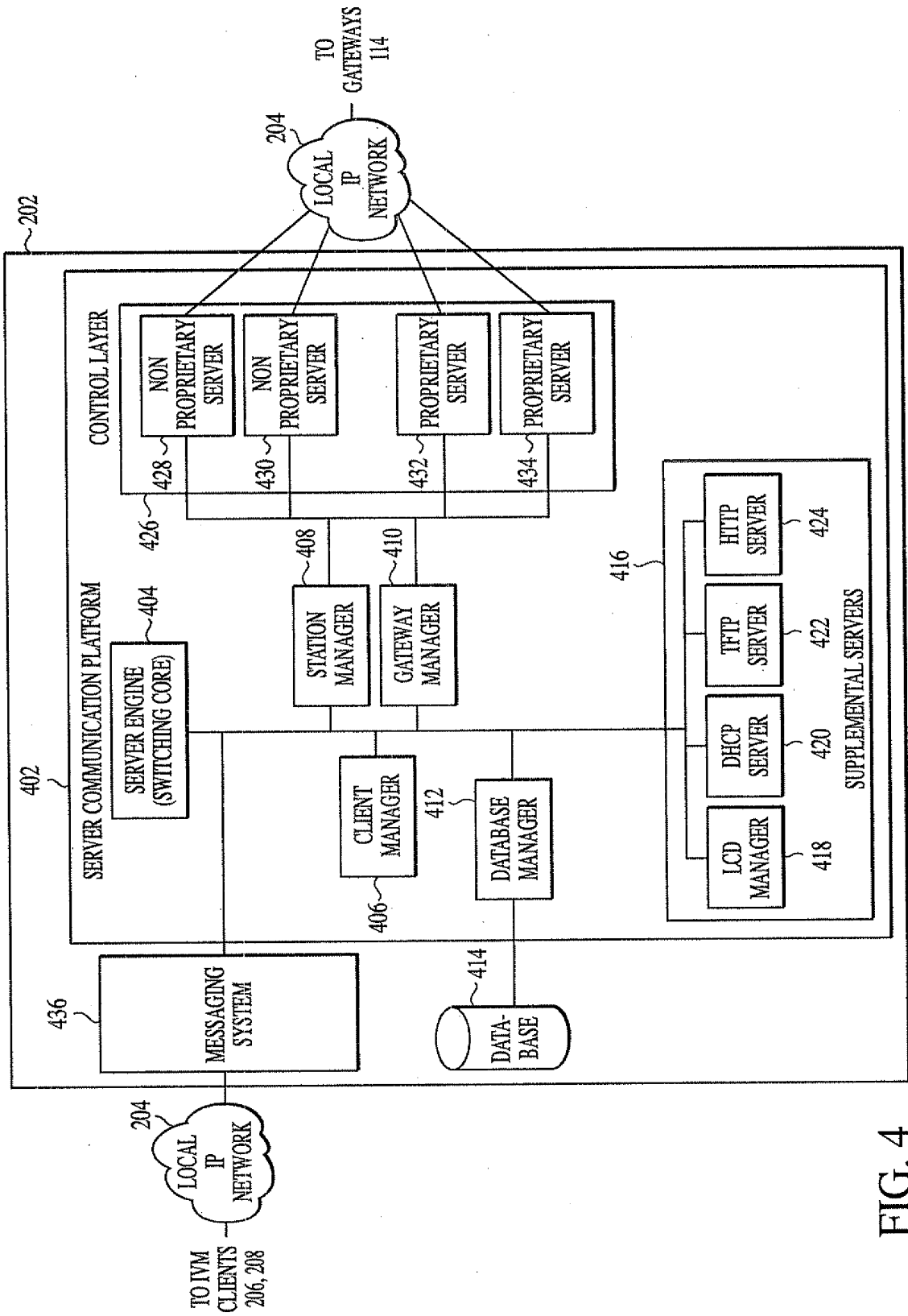

FIG. 4

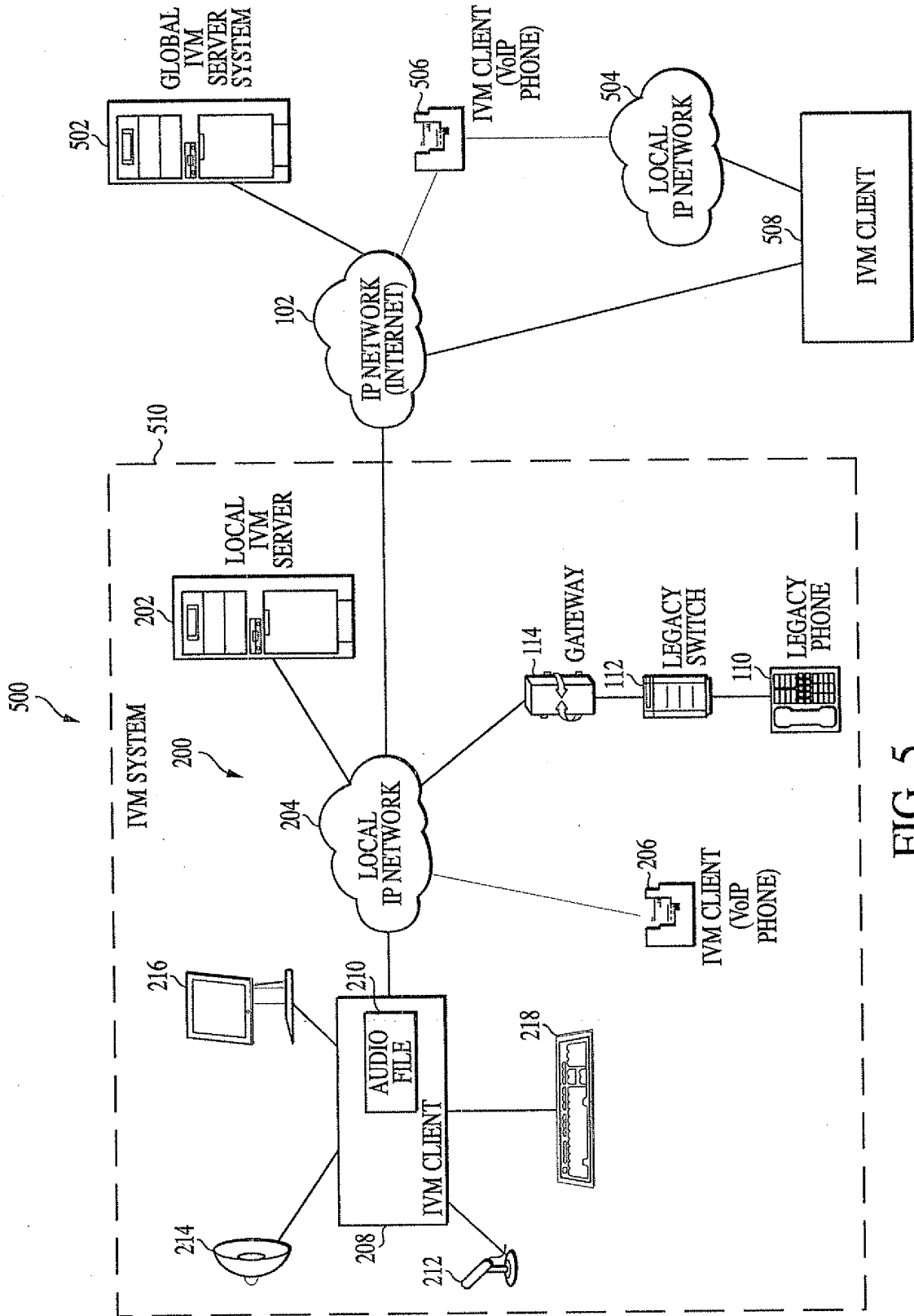

FIG. 5

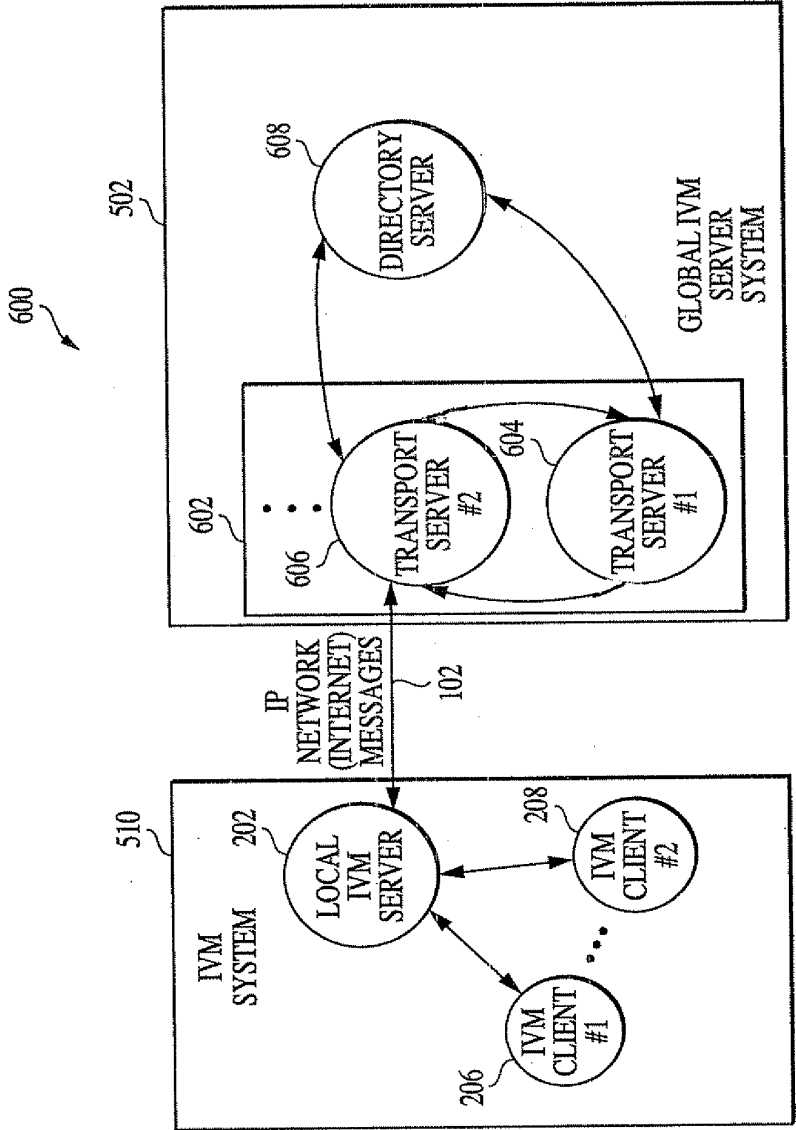

FIG. 6

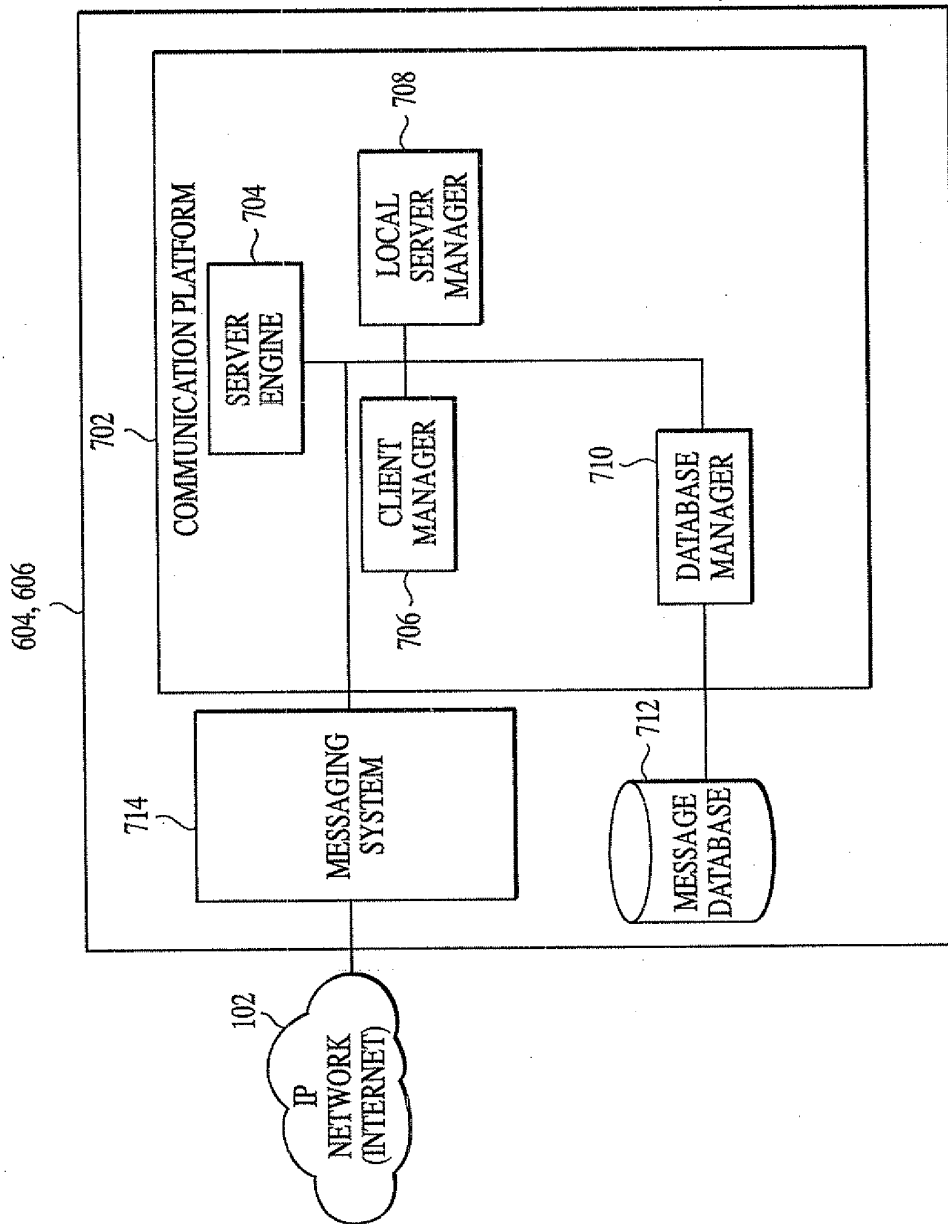

FIG. 7

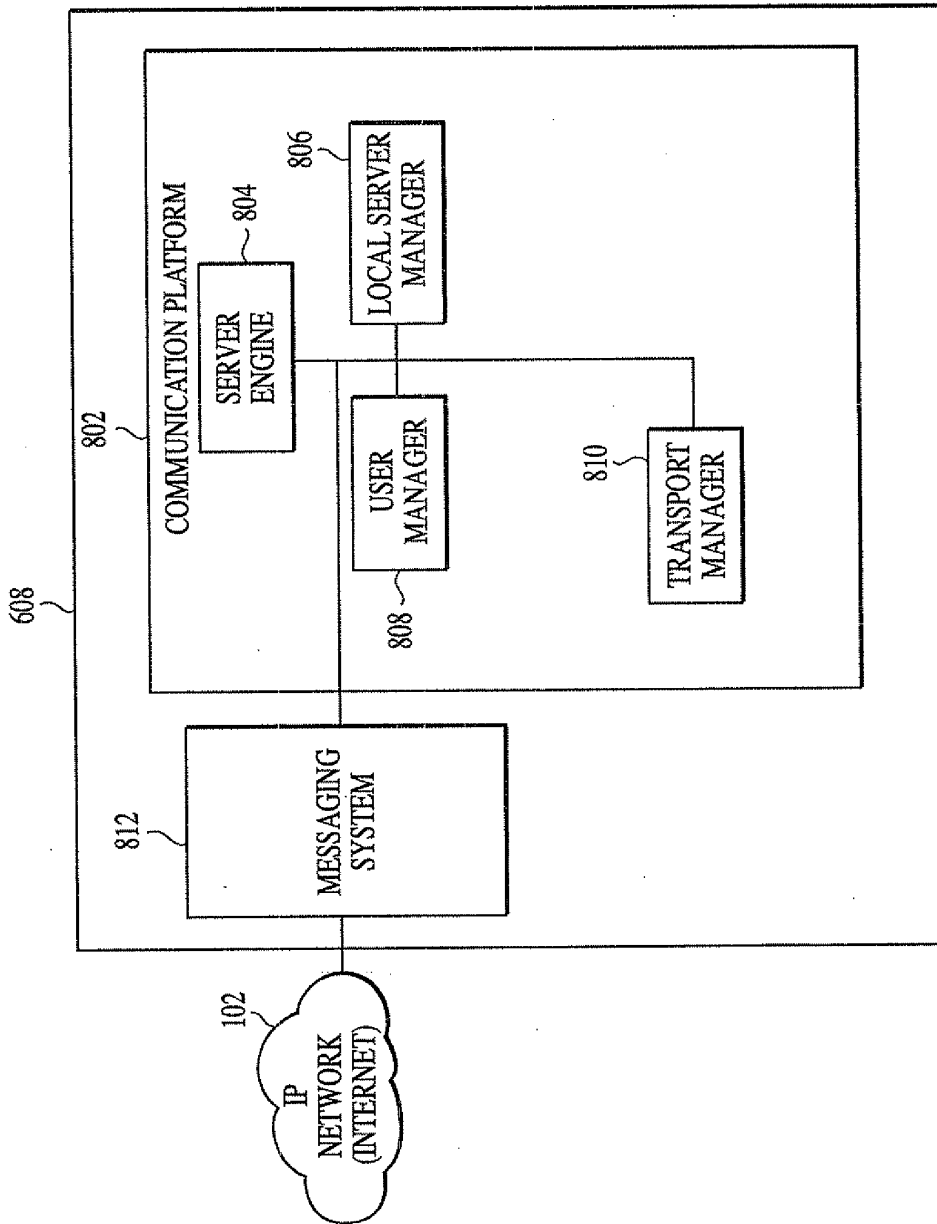

FIG. 8

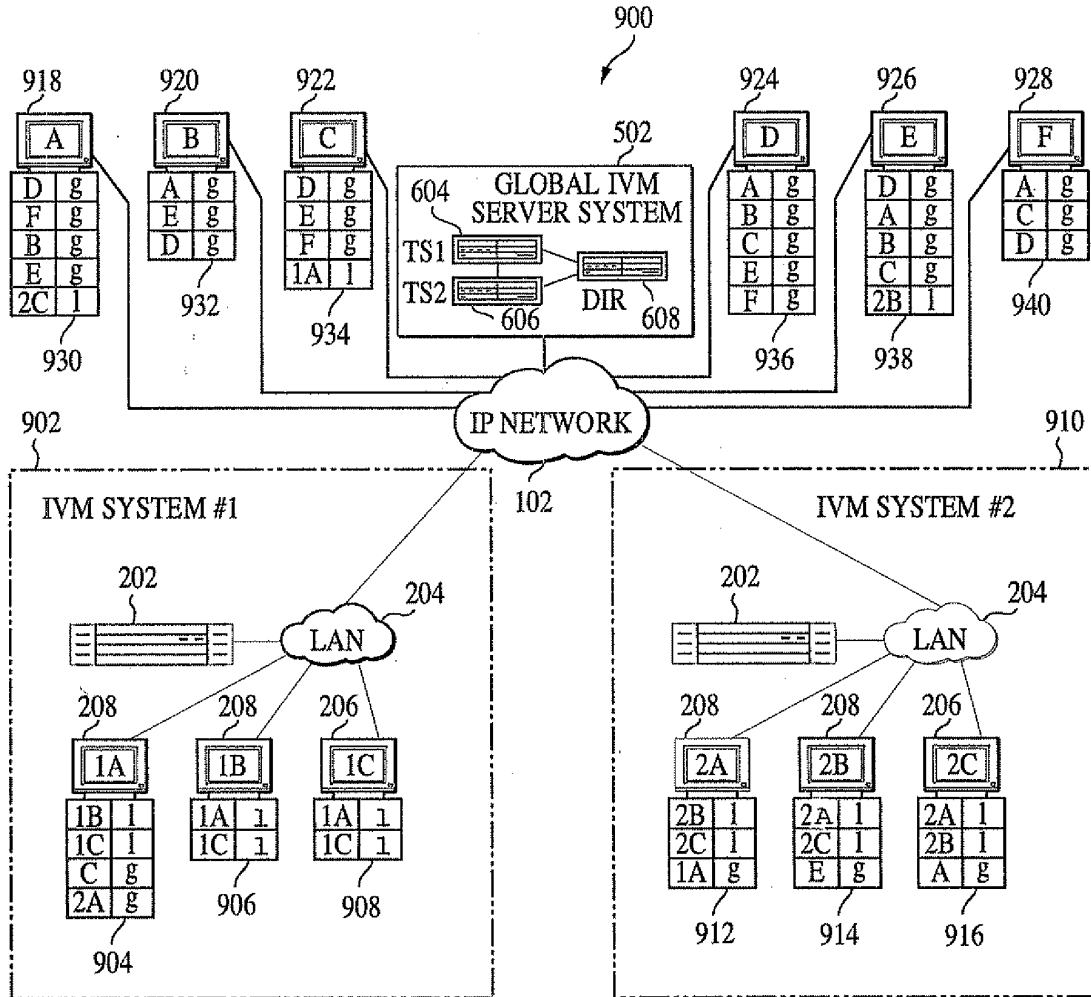

FIG. 9

Docket No.
17188

Declaration and Power of Attorney For Patent Application

English Language Declaration

As a below named inventor, I hereby declare that:

My residence, post office address and citizenship are as stated below next to my name,

I believe I am the original, first and sole inventor (if only one name is listed below) or an original, first and joint inventor (if plural names are listed below) of the subject matter which is claimed and for which a patent is sought on the invention entitled

SYSTEM AND METHOD FOR INSTANT VOIP MESSAGING

the specification of which

(check one)

is attached hereto.

was filed on _____ as United States Application No. or PCT International Application Number _____ and was amended on _____

(if applicable)

I hereby state that I have reviewed and understand the contents of the above identified specification, including the claims, as amended by any amendment referred to above.

I acknowledge the duty to disclose information which is material to patentability as defined in 37 CFR 1.56, including for continuation-in-part applications, material information which became available between the filing date of the prior application and the national or PCT international filing date of the continuation-in-part application.

I hereby claim foreign priority benefits under 35 U.S.C. 119(a)-(d) or (f), or 365(b) of any foreign application(s) for patent, or plant breeder's rights certificate(s), or 365(a) of any PCT international application which designated at least one country other than the United States of America, listed below and have also identified below, by checking the box, any foreign application for patent, inventor's or plant breeder's rights certificate(s), or any PCT international application having a filing date before that of the application on which priority is claimed.

| Prior Foreign Application(s) | | | Priority Not Claimed |
|------------------------------|--------------------|---------------------------------|--------------------------|
| _____ (Number) | _____ (Country) | _____ (Day/Month/Year Filed) | <input type="checkbox"/> |
| _____ (Number) | _____ (Country) | _____ (Day/Month/Year Filed) | <input type="checkbox"/> |
| _____ (Number) | _____ (Country) | _____ (Day/Month/Year Filed) | <input type="checkbox"/> |

I hereby claim the benefit under 35 U.S.C. Section 119(e) of any United States provisional application(s) listed below:

| | |
|--------------------------|---------------|
| _____ | _____ |
| (Application Serial No.) | (Filing Date) |
| _____ | _____ |
| (Application Serial No.) | (Filing Date) |
| _____ | _____ |
| (Application Serial No.) | (Filing Date) |

I hereby claim the benefit under 35 U. S. C. Section 120 of any United States application(s), or Section 365(c) of any PCT International application designating the United States, listed below and, insofar as the subject matter of each of the claims of this application is not disclosed in the prior United States or PCT International application in the manner provided by the first paragraph of 35 U.S.C. Section 112, I acknowledge the duty to disclose to the United States Patent and Trademark Office all information known to me to be material to patentability as defined in Title 37, C. F. R., Section 1.56 which became available between the filing date of the prior application and the national or PCT International filing date of this application:

| | | |
|--------------------------|---------------|--------------------------------|
| _____ | _____ | _____ |
| (Application Serial No.) | (Filing Date) | (Status) |
| | | (patented, pending, abandoned) |
| _____ | _____ | _____ |
| (Application Serial No.) | (Filing Date) | (Status) |
| | | (patented, pending, abandoned) |
| _____ | _____ | _____ |
| (Application Serial No.) | (Filing Date) | (Status) |
| | | (patented, pending, abandoned) |

I hereby declare that all statements made herein of my own knowledge are true and that all statements made on information and belief are believed to be true; and further that these statements were made with the knowledge that willful false statements and the like so made are punishable by fine or imprisonment, or both, under Section 1001 of Title 18 of the United States Code and that such willful false statements may jeopardize the validity of the application or any patent issued thereon.

POWER OF ATTORNEY: As a named inventor, I hereby appoint the following attorney(s) and/or agent(s) to prosecute this application and transact all business in the Patent and Trademark Office connected therewith. *(list name and registration number)*

- Frank S. DiGiglio; Reg. No. 31,346
- Leopold Presser; Reg. No. 19,827
- William C. Roch; Reg. No. 24,972
- Edward W. Grolz; Reg. No. 33,705
- Paul J. Esatto, Jr.; Reg. No. 30,749
- John S. Seneny; Reg. No. 28,757
- Mark J. Cohen; Reg. No. 32,211
- Steven Fischman; Reg. No. 34,594
- Peter I. Bernstein; Reg. No. 43,497
- Thomas Spinelli; Reg. No. 39,533

Send Correspondence to: Paul J. Esatto, Jr.
SCULLY, SCOTT, MURPHY & PRESSER
 400 Garden City Plaza
 Garden City, New York 11530

Direct Telephone Calls to: *(name and telephone number)*
 Paul J. Esatto, Jr. (516) 742-4343

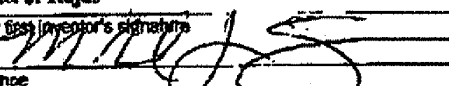
| | |
|---|------------|
| Full name of sole or first inventor | |
| Michael J. Rojas | |
| Sole or first inventor's signature | Date |
|  | 12-18-2003 |
| Residence | |
| 2825 Barclay Circle, North Canton, Stark County, Ohio 44720 | |
| Citizenship | |
| U.S.A. | |
| Post Office Address | |
| Same as above | |

| | |
|--------------------------------------|------|
| Full name of second inventor, if any | |
| | |
| Second inventor's signature | Date |
| | |
| Residence | |
| | |
| Citizenship | |
| | |
| Post Office Address | |
| | |

Filing Date: 03/04/09

Approved for use through 7/31/2006. OMB 0651-0032

U.S. Patent and Trademark Office; U.S. DEPARTMENT OF COMMERCE

Under the Paperwork Reduction Act of 1995, no persons are required to respond to a collection of information unless it displays a valid OMB control number.

| PATENT APPLICATION FEE DETERMINATION RECORD | | | | | Application or Docket Number | | | |
|---|--|------------------------------------|---------------|-----------------|------------------------------|-----------------|-------------------------|-------------------------|
| Substitute for Form PTO-875 | | | | | 12/398,063 | | | |
| APPLICATION AS FILED – PART I | | | | | | | | |
| (Column 1) | | | (Column 2) | | (Column 3) | | | |
| FOR | NUMBER FILED | NUMBER EXTRA | | | SMALL ENTITY | OR | OTHER THAN SMALL ENTITY | |
| BASIC FEE (37 CFR 1.16(a), (b), or (c)) | N/A | N/A | | | RATE (\$) | FEE (\$) | RATE (\$) | FEE (\$) |
| SEARCH FEE (37 CFR 1.16(k), (i), or (m)) | N/A | N/A | | | N/A | 82 | N/A | |
| EXAMINATION FEE (37 CFR 1.16(o), (p), or (q)) | N/A | N/A | | | N/A | 270 | N/A | |
| TOTAL CLAIMS (37 CFR 1.16(i)) | 10 | minus 20 = | | | N/A | 110 | N/A | |
| INDEPENDENT CLAIMS (37 CFR 1.16(h)) | 1 | minus 3 = | | | x\$26 | | x\$52 | |
| APPLICATION SIZE FEE (37 CFR 1.16(s)) | If the specification and drawings exceed 100 sheets of paper, the application size fee due is \$270 (\$135 for small entity) for each additional 50 sheets or fraction thereof. See 35 U.S.C. 41(a)(1)(G) and 37 CFR | | | | x\$110 | | x\$220 | |
| MULTIPLE DEPENDENT CLAIM PRESENT (37 CFR 1.16(j)) | | | | | 195 | | 390 | |
| | | | | | TOTAL | 462 | TOTAL | |
| * If the difference in column 1 is less than zero, enter "0" in column 2. | | | | | | | | |
| APPLICATION AS AMENDED – PART II | | | | | | | | |
| (Column 1) | | (Column 2) | | (Column 3) | | | | |
| AMENDMENT A | CLAIMS REMAINING AFTER AMENDMENT | HIGHEST NUMBER PREVIOUSLY PAID FOR | PRESENT EXTRA | | | SMALL ENTITY | OR | OTHER THAN SMALL ENTITY |
| | Total (37 CFR 1.16(i)) | Minus ** | = | RATE (\$) | ADDITIONAL FEE (\$) | RATE (\$) | ADDITIONAL FEE (\$) | |
| | Independent (37 CFR 1.16(h)) | Minus *** | = | X = | | X = | | |
| | Application Size Fee (37 CFR 1.16(s)) | | | N/A | | N/A | | |
| | FIRST PRESENTATION OF MULTIPLE DEPENDENT CLAIM (37 CFR 1.16(j)) | | | TOTAL ADD'T FEE | | TOTAL ADD'T FEE | | |
| (Column 1) | | (Column 2) | | (Column 3) | | | | |
| AMENDMENT B | CLAIMS REMAINING AFTER AMENDMENT | HIGHEST NUMBER PREVIOUSLY PAID FOR | PRESENT EXTRA | | | SMALL ENTITY | OR | OTHER THAN SMALL ENTITY |
| | Total (37 CFR 1.16(i)) | Minus ** | = | RATE (\$) | ADDITIONAL FEE (\$) | RATE (\$) | ADDITIONAL FEE (\$) | |
| | Independent (37 CFR 1.16(h)) | Minus *** | = | X = | | X = | | |
| | Application Size Fee (37 CFR 1.16(s)) | | | N/A | | N/A | | |
| | FIRST PRESENTATION OF MULTIPLE DEPENDENT CLAIM (37 CFR 1.16(j)) | | | TOTAL ADD'T FEE | | TOTAL ADD'T FEE | | |
| * If the entry in column 1 is less than the entry in column 2, write "0" in column 3. | | | | | | | | |
| ** If the "Highest Number Previously Paid For" IN THIS SPACE is less than 20, enter "20". | | | | | | | | |
| *** If the "Highest Number Previously Paid For" IN THIS SPACE is less than 3, enter "3". | | | | | | | | |
| The "Highest Number Previously Paid For" (Total or Independent) is the highest number found in the appropriate box in column 1. | | | | | | | | |

This collection of information is required by 37 CFR 1.16. The information is required to obtain or retain a benefit by the public which is to file (and by the USPTO to process) an application. Confidentiality is governed by 35 U.S.C. 122 and 37 CFR 1.14. This collection is estimated to take 12 minutes to complete, including gathering, preparing, and submitting the completed application form to the USPTO. Time will vary depending upon the individual case. Any comments on the amount of time you require to complete this form and/or suggestions for reducing this burden, should be sent to the Chief Information Officer, U.S. Patent and Trademark Office, U.S. Department of Commerce, P.O. Box 1450, Alexandria, VA 22313-1450. DO NOT SEND FEES OR COMPLETED FORMS TO THIS ADDRESS. SEND TO: Commissioner for Patents, P.O. Box 1450, Alexandria, VA 22313-1450.

If you need assistance in completing the form, call 1-800-PTO-9199 and select option 2.