

AO 120 (Rev. 08/10)

TO: <b>Mail Stop 8 Director of the U.S. Patent and Trademark Office P.O. Box 1450 Alexandria, VA 22313-1450</b>	<b>REPORT ON THE FILING OR DETERMINATION OF AN ACTION REGARDING A PATENT OR TRADEMARK</b>
---	---

In Compliance with 35 U.S.C. § 290 and/or 15 U.S.C. § 1116 you are hereby advised that a court action has been filed in the U.S. District Court Eastern District of Texas on the following  
 Trademarks or  Patents. (  the patent action involves 35 U.S.C. § 292.);

DOCKET NO. 2:17-cv-0214-JRG	DATE FILED 3/20/2017	U.S. DISTRICT COURT Eastern District of Texas
PLAINTIFF Uniloc USA, Inc. and Uniloc Luxembourg S.A.		DEFENDANT Google, Inc.
PATENT OR TRADEMARK NO.	DATE OF PATENT OR TRADEMARK	HOLDER OF PATENT OR TRADEMARK
1 8,724,622	5/13/2014	Uniloc Luxembourg S.A.
2 8,995,433	5/31/2015	Uniloc Luxembourg S.A.
3 7,535,890	5/19/2009	Uniloc Luxembourg S.A.
4 8,199,747	6/12/2012	Uniloc Luxembourg S.A.
5		

In the above—entitled case, the following patent(s)/ trademark(s) have been included:

DATE INCLUDED	INCLUDED BY <input type="checkbox"/> Amendment <input type="checkbox"/> Answer <input type="checkbox"/> Cross Bill <input type="checkbox"/> Other Pleading	
PATENT OR TRADEMARK NO.	DATE OF PATENT OR TRADEMARK	HOLDER OF PATENT OR TRADEMARK
1		
2		
3		
4		
5		

In the above—entitled case, the following decision has been rendered or judgement issued:

DECISION/JUDGEMENT
--------------------

CLERK	(BY) DEPUTY CLERK	DATE
-------	-------------------	------

Copy 1—Upon initiation of action, mail this copy to Director    Copy 3—Upon termination of action, mail this copy to Director  
 Copy 2—Upon filing document adding patent(s), mail this copy to Director    Copy 4—Case file copy

AO 120 (Rev. 08/10)

TO: <b>Mail Stop 8 Director of the U.S. Patent and Trademark Office P.O. Box 1450 Alexandria, VA 22313-1450</b>	<b>REPORT ON THE FILING OR DETERMINATION OF AN ACTION REGARDING A PATENT OR TRADEMARK</b>
---	---

In Compliance with 35 U.S.C. § 290 and/or 15 U.S.C. § 1116 you are hereby advised that a court action has been filed in the U.S. District Court Eastern District of Texas on the following  
 Trademarks or  Patents. (  the patent action involves 35 U.S.C. § 292.);

DOCKET NO. 2:17-cv-0224-JRG	DATE FILED 3/22/2017	U.S. DISTRICT COURT Eastern District of Texas
PLAINTIFF Uniloc USA, Inc. and Uniloc Luxembourg S.A.		DEFENDANT Google, Inc.
PATENT OR TRADEMARK NO.	DATE OF PATENT OR TRADEMARK	HOLDER OF PATENT OR TRADEMARK
1 8,724,622	5/13/2014	Uniloc Luxembourg S.A.
2 8,995,433	5/31/2015	Uniloc Luxembourg S.A.
3 7,535,890	5/19/2009	Uniloc Luxembourg S.A.
4		
5		

In the above—entitled case, the following patent(s)/ trademark(s) have been included:

DATE INCLUDED	INCLUDED BY <input type="checkbox"/> Amendment <input type="checkbox"/> Answer <input type="checkbox"/> Cross Bill <input type="checkbox"/> Other Pleading	
PATENT OR TRADEMARK NO.	DATE OF PATENT OR TRADEMARK	HOLDER OF PATENT OR TRADEMARK
1		
2		
3		
4		
5		

In the above—entitled case, the following decision has been rendered or judgement issued:

DECISION/JUDGEMENT
--------------------

CLERK	(BY) DEPUTY CLERK	DATE
-------	-------------------	------

Copy 1—Upon initiation of action, mail this copy to Director    Copy 3—Upon termination of action, mail this copy to Director  
 Copy 2—Upon filing document adding patent(s), mail this copy to Director    Copy 4—Case file copy

AO 120 (Rev. 08/10)

TO: <b>Mail Stop 8 Director of the U.S. Patent and Trademark Office P.O. Box 1450 Alexandria, VA 22313-1450</b>	<b>REPORT ON THE FILING OR DETERMINATION OF AN ACTION REGARDING A PATENT OR TRADEMARK</b>
---	---

In Compliance with 35 U.S.C. § 290 and/or 15 U.S.C. § 1116 you are hereby advised that a court action has been filed in the U.S. District Court Eastern District of Texas, Marshall Division on the following  
 Trademarks or  Patents. (  the patent action involves 35 U.S.C. § 292.);

DOCKET NO. 2:16-cv-640	DATE FILED 6/14/2016	U.S. DISTRICT COURT Eastern District of Texas, Marshall Division
PLAINTIFF UNILOC USA, INC., and UNILOC LUXEMBOURG, S.A.		DEFENDANT KAKAO CORPORATION
PATENT OR TRADEMARK NO.	DATE OF PATENT OR TRADEMARK	HOLDER OF PATENT OR TRADEMARK
1 7,535,890	5/19/2009	UNILOC LUXEMBOURG, S.A.
2 8,199,747	6/12/2012	UNILOC LUXEMBOURG, S.A.
3 8,724,622	5/13/2014	UNILOC LUXEMBOURG, S.A.
4 8,995,433	3/31/2015	UNILOC LUXEMBOURG, S.A.
5 8,243,723	8/14/2012	UNILOC LUXEMBOURG, S.A.

In the above—entitled case, the following patent(s)/ trademark(s) have been included:

DATE INCLUDED	INCLUDED BY <input type="checkbox"/> Amendment <input type="checkbox"/> Answer <input type="checkbox"/> Cross Bill <input type="checkbox"/> Other Pleading	
PATENT OR TRADEMARK NO.	DATE OF PATENT OR TRADEMARK	HOLDER OF PATENT OR TRADEMARK
1		
2		
3		
4		
5		

In the above—entitled case, the following decision has been rendered or judgement issued:

DECISION/JUDGEMENT  Kakao Corp. ("Kakao") should be DISMISSED WITH PREJUDICE
---

CLERK <i>David A. O'Poole</i>	(BY) DEPUTY CLERK ch	DATE 3/17/17
----------------------------------	-------------------------	-----------------

Copy 1—Upon initiation of action, mail this copy to Director    Copy 3—Upon termination of action, mail this copy to Director  
 Copy 2—Upon filing document adding patent(s), mail this copy to Director    Copy 4—Case file copy

AO 120 (Rev. 08/10)

TO: <b>Mail Stop 8 Director of the U.S. Patent and Trademark Office P.O. Box 1450 Alexandria, VA 22313-1450</b>	<b>REPORT ON THE FILING OR DETERMINATION OF AN ACTION REGARDING A PATENT OR TRADEMARK</b>
---	---

In Compliance with 35 U.S.C. § 290 and/or 15 U.S.C. § 1116 you are hereby advised that a court action has been filed in the U.S. District Court Eastern District of Texas, Marshall Division on the following  
 Trademarks or  Patents. (  the patent action involves 35 U.S.C. § 292.);

DOCKET NO. 2:16-cv-643	DATE FILED 6/14/2016	U.S. DISTRICT COURT Eastern District of Texas, Marshall Division
PLAINTIFF UNILOC USA, INC., and UNILOC LUXEMBOURG, S.A.		DEFENDANT VIBER MEDIA S.A.R.L.,
PATENT OR TRADEMARK NO.	DATE OF PATENT OR TRADEMARK	HOLDER OF PATENT OR TRADEMARK
1 8,724,622	5/13/2014	UNILOC LUXEMBOURG, S.A.
2 8,995,433	3/31/2015	UNILOC LUXEMBOURG, S.A.
3 7,535,890	5/19/2009	UNILOC LUXEMBOURG, S.A.
4 8,199,747	6/12/2012	UNILOC LUXEMBOURG, S.A.
5 8,243,723	8/14/2012	UNILOC LUXEMBOURG, S.A.

In the above—entitled case, the following patent(s)/ trademark(s) have been included:

DATE INCLUDED	INCLUDED BY <input type="checkbox"/> Amendment <input type="checkbox"/> Answer <input type="checkbox"/> Cross Bill <input type="checkbox"/> Other Pleading	
PATENT OR TRADEMARK NO.	DATE OF PATENT OR TRADEMARK	HOLDER OF PATENT OR TRADEMARK
1		
2		
3		
4		
5		

In the above—entitled case, the following decision has been rendered or judgement issued:

DECISION/JUDGEMENT  Having considered the Stipulation, the Court finds that the case should be DISMISSED under Federal Rule of Civil Procedure 41.
--

CLERK 	(BY) DEPUTY CLERK M. Martin	DATE 1/19/17
-----------	--------------------------------	-----------------

Copy 1—Upon initiation of action, mail this copy to Director    Copy 3—Upon termination of action, mail this copy to Director  
 Copy 2—Upon filing document adding patent(s), mail this copy to Director    Copy 4—Case file copy

AO 120 (Rev. 08/10)

TO: <b>Mail Stop 8 Director of the U.S. Patent and Trademark Office P.O. Box 1450 Alexandria, VA 22313-1450</b>	<b>REPORT ON THE FILING OR DETERMINATION OF AN ACTION REGARDING A PATENT OR TRADEMARK</b>
---	---

In Compliance with 35 U.S.C. § 290 and/or 15 U.S.C. § 1116 you are hereby advised that a court action has been filed in the U.S. District Court Eastern District of Texas, Marshall Division on the following  
 Trademarks or  Patents. (  the patent action involves 35 U.S.C. § 292.);

DOCKET NO. 2:16-cv-733	DATE FILED 7/5/2016	U.S. DISTRICT COURT Eastern District of Texas, Marshall Division
PLAINTIFF UNILOC USA, INC., and UNILOC LUXEMBOURG, S.A.		DEFENDANT TANGOME, INC. d/b/a TANGO
PATENT OR TRADEMARK NO.	DATE OF PATENT OR TRADEMARK	HOLDER OF PATENT OR TRADEMARK
1 7,535,890	5/19/2009	UNILOC LUXEMBOURG, S.A.
2 8,199,747	6/12/2012	UNILOC LUXEMBOURG, S.A.
3 8,243,723	8/14/2012	UNILOC LUXEMBOURG, S.A.
4 8,724,622	5/13/2014	UNILOC LUXEMBOURG, S.A.
5 8,995,433	3/31/2015	UNILOC LUXEMBOURG, S.A.

In the above—entitled case, the following patent(s)/ trademark(s) have been included:

DATE INCLUDED	INCLUDED BY <input type="checkbox"/> Amendment <input type="checkbox"/> Answer <input type="checkbox"/> Cross Bill <input type="checkbox"/> Other Pleading	
PATENT OR TRADEMARK NO.	DATE OF PATENT OR TRADEMARK	HOLDER OF PATENT OR TRADEMARK
1		
2		
3		
4		
5		

In the above—entitled case, the following decision has been rendered or judgement issued:

DECISION/JUDGEMENT  <b>ORDER OF DISMISSAL WITH PREJUDICE OF ALL CLAIMS BY UNILOC AGAINST TANGOME, INC. d/b/a TANGO</b>
--

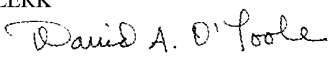
CLERK 	(BY) DEPUTY CLERK Nakisha Love	DATE <b>1/11/17</b>
--	-----------------------------------	------------------------

Copy 1—Upon initiation of action, mail this copy to Director    Copy 3—Upon termination of action, mail this copy to Director  
 Copy 2—Upon filing document adding patent(s), mail this copy to Director    Copy 4—Case file copy

AO 120 (Rev. 08/10)

<b>TO:</b> <b>Mail Stop 8</b> <b>Director of the U.S. Patent and Trademark Office</b> <b>P.O. Box 1450</b> <b>Alexandria, VA 22313-1450</b>	<b>REPORT ON THE</b> <b>FILING OR DETERMINATION OF AN</b> <b>ACTION REGARDING A PATENT OR</b> <b>TRADEMARK</b>
--	---

In Compliance with 35 U.S.C. § 290 and/or 15 U.S.C. § 1116 you are hereby advised that a court action has been filed in the U.S. District Court Eastern District of Texas, Marshall Division on the following  
 Trademarks or    Patents.   (  the patent action involves 35 U.S.C. § 292.):

DOCKET NO. 2:16-cv-994	DATE FILED 9/6/2016	U.S. DISTRICT COURT Eastern District of Texas, Marshall Division
PLAINTIFF UNILOC USA, INC., and UNILOC LUXEMBOURG, S.A.		DEFENDANT HUAWEI DEVICE USA, INC. and HUAWEI TECHNOLOGIES USA, INC.,
PATENT OR TRADEMARK NO.	DATE OF PATENT OR TRADEMARK	HOLDER OF PATENT OR TRADEMARK
1 7,535,890	5/19/2009	UNILOC LUXEMBOURG, S.A.
2 8,995,433	3/31/2015	UNILOC LUXEMBOURG, S.A.
3 8,724,622	5/13/2014	UNILOC LUXEMBOURG, S.A.
4 8,199,747	6/12/2012	UNILOC LUXEMBOURG, S.A.
5		

In the above—entitled case, the following patent(s)/ trademark(s) have been included:

DATE INCLUDED	INCLUDED BY <input type="checkbox"/> Amendment <input type="checkbox"/> Answer <input type="checkbox"/> Cross Bill <input type="checkbox"/> Other Pleading		
PATENT OR TRADEMARK NO.	DATE OF PATENT OR TRADEMARK	HOLDER OF PATENT OR TRADEMARK	
1			
2			
3			
4			
5			

In the above—entitled case, the following decision has been rendered or judgement issued:

DECISION/JUDGEMENT
--------------------

CLERK	(BY) DEPUTY CLERK	DATE
-------	-------------------	------

Copy 1—Upon initiation of action, mail this copy to Director   Copy 3—Upon termination of action, mail this copy to Director  
 Copy 2—Upon filing document adding patent(s), mail this copy to Director   Copy 4—Case file copy

AO 120 (Rev. 08/10)

<b>TO:</b> <b>Mail Stop 8</b> <b>Director of the U.S. Patent and Trademark Office</b> <b>P.O. Box 1450</b> <b>Alexandria, VA 22313-1450</b>	<b>REPORT ON THE</b> <b>FILING OR DETERMINATION OF AN</b> <b>ACTION REGARDING A PATENT OR</b> <b>TRADEMARK</b>
--	---

In Compliance with 35 U.S.C. § 290 and/or 15 U.S.C. § 1116 you are hereby advised that a court action has been filed in the U.S. District Court Eastern District of Texas, Marshall Division on the following  
 Trademarks or    Patents.   (  the patent action involves 35 U.S.C. § 292.):

DOCKET NO. 2:16-cv-994	DATE FILED 9/6/2016	U.S. DISTRICT COURT Eastern District of Texas, Marshall Division
PLAINTIFF UNILOC USA, INC., and UNILOC LUXEMBOURG, S.A.		DEFENDANT HUAWEI DEVICE USA, INC. and HUAWEI TECHNOLOGIES USA, INC.,
PATENT OR TRADEMARK NO.	DATE OF PATENT OR TRADEMARK	HOLDER OF PATENT OR TRADEMARK
1 7,535,890	5/19/2009	UNILOC LUXEMBOURG, S.A.
2 8,995,433	3/31/2015	UNILOC LUXEMBOURG, S.A.
3 8,724,622	5/13/2014	UNILOC LUXEMBOURG, S.A.
4 8,199,747	6/12/2012	UNILOC LUXEMBOURG, S.A.
5		

In the above—entitled case, the following patent(s)/ trademark(s) have been included:

DATE INCLUDED	INCLUDED BY <input type="checkbox"/> Amendment <input type="checkbox"/> Answer <input type="checkbox"/> Cross Bill <input type="checkbox"/> Other Pleading		
PATENT OR TRADEMARK NO.	DATE OF PATENT OR TRADEMARK	HOLDER OF PATENT OR TRADEMARK	
1			
2			
3			
4			
5			

In the above—entitled case, the following decision has been rendered or judgement issued:

DECISION/JUDGEMENT
--------------------

CLERK	(BY) DEPUTY CLERK	DATE
-------	-------------------	------

Copy 1—Upon initiation of action, mail this copy to Director   Copy 3—Upon termination of action, mail this copy to Director  
 Copy 2—Upon filing document adding patent(s), mail this copy to Director   Copy 4—Case file copy

AO 120 (Rev. 08/10)

<b>TO:</b> <b>Mail Stop 8</b> <b>Director of the U.S. Patent and Trademark Office</b> <b>P.O. Box 1450</b> <b>Alexandria, VA 22313-1450</b>	<b>REPORT ON THE</b> <b>FILING OR DETERMINATION OF AN</b> <b>ACTION REGARDING A PATENT OR</b> <b>TRADEMARK</b>
--	---

In Compliance with 35 U.S.C. § 290 and/or 15 U.S.C. § 1116 you are hereby advised that a court action has been filed in the U.S. District Court Eastern District of Texas, Marshall Division on the following

Trademarks or  Patents. (  the patent action involves 35 U.S.C. § 292.):

DOCKET NO. 2:16-cv-993	DATE FILED 9/6/2016	U.S. DISTRICT COURT Eastern District of Texas, Marshall Division
PLAINTIFF UNILOC USA, INC., and UNILOC LUXEMBOURG, S.A.		DEFENDANT ZTE (USA), INC. and ZTE (TX), INC.,
PATENT OR TRADEMARK NO.	DATE OF PATENT OR TRADEMARK	HOLDER OF PATENT OR TRADEMARK
1 7,535,890	5/19/2009	UNILOC LUXEMBOURG, S.A.
2 8,199,747	6/12/2012	UNILOC LUXEMBOURG, S.A.
3 8,724,622	5/13/2014	UNILOC LUXEMBOURG, S.A.
4 8,995,433	3/31/2015	UNILOC LUXEMBOURG, S.A.
5		

In the above—entitled case, the following patent(s)/ trademark(s) have been included:

DATE INCLUDED	INCLUDED BY <input type="checkbox"/> Amendment <input type="checkbox"/> Answer <input type="checkbox"/> Cross Bill <input type="checkbox"/> Other Pleading		
PATENT OR TRADEMARK NO.	DATE OF PATENT OR TRADEMARK	HOLDER OF PATENT OR TRADEMARK	
1			
2			
3			
4			
5			

In the above—entitled case, the following decision has been rendered or judgement issued:

DECISION/JUDGEMENT
--------------------

CLERK	(BY) DEPUTY CLERK	DATE
-------	-------------------	------

Copy 1—Upon initiation of action, mail this copy to Director    Copy 3—Upon termination of action, mail this copy to Director  
 Copy 2—Upon filing document adding patent(s), mail this copy to Director    Copy 4—Case file copy



AO 120 (Rev. 08/10)

<b>TO:</b> <b>Mail Stop 8</b> <b>Director of the U.S. Patent and Trademark Office</b> <b>P.O. Box 1450</b> <b>Alexandria, VA 22313-1450</b>	<b>REPORT ON THE</b> <b>FILING OR DETERMINATION OF AN</b> <b>ACTION REGARDING A PATENT OR</b> <b>TRADEMARK</b>
--	---

In Compliance with 35 U.S.C. § 290 and/or 15 U.S.C. § 1116 you are hereby advised that a court action has been filed in the U.S. District Court Eastern District of Texas, Marshall Division on the following  
 Trademarks or  Patents. (  the patent action involves 35 U.S.C. § 292.):

DOCKET NO. 2:16-cv-992	DATE FILED 9/6/2016	U.S. DISTRICT COURT Eastern District of Texas, Marshall Division
PLAINTIFF UNILOC USA, INC., and UNILOC LUXEMBOURG, S.A.		DEFENDANT MOTOROLA MOBILITY LLC
PATENT OR TRADEMARK NO.	DATE OF PATENT OR TRADEMARK	HOLDER OF PATENT OR TRADEMARK
1 7,535,890	5/19/2009	UNILOC LUXEMBOURG, S.A.
2 8,199,747	6/12/2012	UNILOC LUXEMBOURG, S.A.
3 8,724,622	5/13/2014	UNILOC LUXEMBOURG, S.A.
4 8,995,433	3/31/2015	UNILOC LUXEMBOURG, S.A.
5		

In the above—entitled case, the following patent(s)/ trademark(s) have been included:

DATE INCLUDED	INCLUDED BY <input type="checkbox"/> Amendment <input type="checkbox"/> Answer <input type="checkbox"/> Cross Bill <input type="checkbox"/> Other Pleading	
PATENT OR TRADEMARK NO.	DATE OF PATENT OR TRADEMARK	HOLDER OF PATENT OR TRADEMARK
1		
2		
3		
4		
5		

In the above—entitled case, the following decision has been rendered or judgement issued:

DECISION/JUDGEMENT
--------------------

CLERK	(BY) DEPUTY CLERK	DATE
-------	-------------------	------

Copy 1—Upon initiation of action, mail this copy to Director    Copy 3—Upon termination of action, mail this copy to Director  
 Copy 2—Upon filing document adding patent(s), mail this copy to Director    Copy 4—Case file copy

AO 120 (Rev. 08/10)

TO: <b>Mail Stop 8</b> <b>Director of the U.S. Patent and Trademark Office</b> <b>P.O. Box 1450</b> <b>Alexandria, VA 22313-1450</b>	<b>REPORT ON THE</b> <b>FILING OR DETERMINATION OF AN</b> <b>ACTION REGARDING A PATENT OR</b> <b>TRADEMARK</b>
---	---

In Compliance with 35 U.S.C. § 290 and/or 15 U.S.C. § 1116 you are hereby advised that a court action has been filed in the U.S. District Court Eastern District of Texas, Marshall Division on the following

Trademarks or  Patents. (  the patent action involves 35 U.S.C. § 292.):

DOCKET NO. 2:16-cv-991	DATE FILED 9/6/2016	U.S. DISTRICT COURT Eastern District of Texas, Marshall Division
PLAINTIFF UNILOC USA, INC., and UNILOC LUXEMBOURG, S.A.		DEFENDANT LG ELECTRONICS U.S.A., INC.,
PATENT OR TRADEMARK NO.	DATE OF PATENT OR TRADEMARK	HOLDER OF PATENT OR TRADEMARK
1 7,535,890	5/19/2009	UNILOC LUXEMBOURG, S.A.
2 8,199,747	6/12/2012	UNILOC LUXEMBOURG, S.A.
3 8,724,622	5/13/2014	UNILOC LUXEMBOURG, S.A.
4 8,995,433	3/31/2015	UNILOC LUXEMBOURG, S.A.
5		

In the above—entitled case, the following patent(s)/ trademark(s) have been included:

DATE INCLUDED	INCLUDED BY <input type="checkbox"/> Amendment <input type="checkbox"/> Answer <input type="checkbox"/> Cross Bill <input type="checkbox"/> Other Pleading		
PATENT OR TRADEMARK NO.	DATE OF PATENT OR TRADEMARK	HOLDER OF PATENT OR TRADEMARK	
1			
2			
3			
4			
5			

In the above—entitled case, the following decision has been rendered or judgement issued:

DECISION/JUDGEMENT
--------------------

CLERK	(BY) DEPUTY CLERK	DATE
-------	-------------------	------

Copy 1—Upon initiation of action, mail this copy to Director    Copy 3—Upon termination of action, mail this copy to Director  
 Copy 2—Upon filing document adding patent(s), mail this copy to Director    Copy 4—Case file copy

AO 120 (Rev. 08/10)

TO: <b>Mail Stop 8 Director of the U.S. Patent and Trademark Office P.O. Box 1450 Alexandria, VA 22313-1450</b>	<b>REPORT ON THE FILING OR DETERMINATION OF AN ACTION REGARDING A PATENT OR TRADEMARK</b>
---	---

In Compliance with 35 U.S.C. § 290 and/or 15 U.S.C. § 1116 you are hereby advised that a court action has been filed in the U.S. District Court Eastern District of Texas, Marshall Division on the following  
 Trademarks or  Patents. (  the patent action involves 35 U.S.C. § 292.);

DOCKET NO. 2:16-cv-893	DATE FILED 8/11/2016	U.S. DISTRICT COURT Eastern District of Texas, Marshall Division
PLAINTIFF UNILOC USA, INC., and UNILOC LUXEMBOURG, S.A.		DEFENDANT VONAGE HOLDINGS CORP. & VONAGE AMERICAS, INC.
PATENT OR TRADEMARK NO.	DATE OF PATENT OR TRADEMARK	HOLDER OF PATENT OR TRADEMARK
1 8,724,622	5/31/2014	UNILOC LUXEMBOURG, S.A.
2 8,995,433	3/31/2015	UNILOC LUXEMBOURG, S.A.
3 8,243,723	8/14/2012	UNILOC LUXEMBOURG, S.A.
4 7,535,890	5/19/2009	UNILOC LUXEMBOURG, S.A.
5		

In the above—entitled case, the following patent(s)/ trademark(s) have been included:

DATE INCLUDED	INCLUDED BY <input type="checkbox"/> Amendment <input type="checkbox"/> Answer <input type="checkbox"/> Cross Bill <input type="checkbox"/> Other Pleading
PATENT OR TRADEMARK NO.	DATE OF PATENT OR TRADEMARK
1	
2	
3	
4	
5	

In the above—entitled case, the following decision has been rendered or judgement issued:

DECISION/JUDGEMENT  Defendants Vonage Holdings Corp. and Vonage Americas, Inc. are dismissed with prejudice
---

CLERK  	(BY) DEPUTY CLERK  ch	DATE  11/17/16
---------------	-----------------------------	----------------------

Copy 1—Upon initiation of action, mail this copy to Director Copy 3—Upon termination of action, mail this copy to Director  
 Copy 2—Upon filing document adding patent(s), mail this copy to Director Copy 4—Case file copy



UNITED STATES PATENT AND TRADEMARK OFFICE

UNITED STATES DEPARTMENT OF COMMERCE  
United States Patent and Trademark Office  
Address: COMMISSIONER FOR PATENTS  
P.O. Box 1450  
Alexandria, Virginia 22313-1450  
www.uspto.gov

APPLICATION NUMBER	FILING OR 371(C) DATE	FIRST NAMED APPLICANT	ATTY. DOCKET NO./TITLE
--------------------	-----------------------	-----------------------	------------------------

13/546,673

07/11/2012

Michael J. Rojas

UN-NP-IT-195

**CONFIRMATION NO. 9648**

**POA ACCEPTANCE LETTER**

96051  
Uniloc USA Inc.  
Legacy Town Center  
7160 Dallas Parkway  
Suite 380  
Plano, TX 75024



\*OC00000085985214\*

Date Mailed: 09/23/2016

**NOTICE OF ACCEPTANCE OF POWER OF ATTORNEY**

This is in response to the Power of Attorney filed 09/15/2016.

The Power of Attorney in this application is accepted. Correspondence in this application will be mailed to the above address as provided by 37 CFR 1.33.

Questions about the contents of this notice and the requirements it sets forth should be directed to the Office of Data Management, Application Assistance Unit, at (571) 272-4000 or (571) 272-4200 or 1-888-786-0101.

/mnguyen/



UNITED STATES PATENT AND TRADEMARK OFFICE

UNITED STATES DEPARTMENT OF COMMERCE  
United States Patent and Trademark Office  
Address: COMMISSIONER FOR PATENTS  
P.O. Box 1450  
Alexandria, Virginia 22313-1450  
www.uspto.gov

APPLICATION NUMBER	FILING OR 371(C) DATE	FIRST NAMED APPLICANT	ATTY. DOCKET NO./TITLE
13/546,673	07/11/2012	Michael J. Rojas	EMP0024-US

**CONFIRMATION NO. 9648**

**POWER OF ATTORNEY NOTICE**

67050  
KASHA LAW LLC  
14532 Dufief Mill Road  
North Potomac, MD 20878



Date Mailed: 09/23/2016

**NOTICE REGARDING CHANGE OF POWER OF ATTORNEY**

This is in response to the Power of Attorney filed 09/15/2016.

- The Power of Attorney to you in this application has been revoked by the assignee who has intervened as provided by 37 CFR 3.71. Future correspondence will be mailed to the new address of record(37 CFR 1.33).

Questions about the contents of this notice and the requirements it sets forth should be directed to the Office of Data Management, Application Assistance Unit, at (571) 272-4000 or (571) 272-4200 or 1-888-786-0101.

/mnguyen/

AO 120 (Rev. 08/10)

<b>TO:</b> <b>Mail Stop 8</b> <b>Director of the U.S. Patent and Trademark Office</b> <b>P.O. Box 1450</b> <b>Alexandria, VA 22313-1450</b>	<b>REPORT ON THE</b> <b>FILING OR DETERMINATION OF AN</b> <b>ACTION REGARDING A PATENT OR</b> <b>TRADEMARK</b>
---	---

In Compliance with 35 U.S.C. § 290 and/or 15 U.S.C. § 1116 you are hereby advised that a court action has been filed in the U.S. District Court Eastern District of Texas, Marshall Division on the following  
 Trademarks or  Patents. (  the patent action involves 35 U.S.C. § 292.);

DOCKET NO. 2:16-cv-989	DATE FILED 9/6/2016	U.S. DISTRICT COURT Eastern District of Texas, Marshall Division
PLAINTIFF UNILOC USA, INC., and UNILOC LUXEMBOURG, S.A.		DEFENDANT HTC AMERICA, INC.
PATENT OR TRADEMARK NO.	DATE OF PATENT OR TRADEMARK	HOLDER OF PATENT OR TRADEMARK
1 7,535,890	5/19/2009	UNILOC LUXEMBOURG, S.A.
2 8,199,747	6/12/2012	UNILOC LUXEMBOURG, S.A.
3 8,724,622	5/13/2014	UNILOC LUXEMBOURG, S.A.
4 8,995,433	3/31/2015	UNILOC LUXEMBOURG, S.A.
5		

In the above—entitled case, the following patent(s)/ trademark(s) have been included:

DATE INCLUDED	INCLUDED BY <input type="checkbox"/> Amendment <input type="checkbox"/> Answer <input type="checkbox"/> Cross Bill <input type="checkbox"/> Other Pleading	
PATENT OR TRADEMARK NO.	DATE OF PATENT OR TRADEMARK	HOLDER OF PATENT OR TRADEMARK
1		
2		
3		
4		
5		

In the above—entitled case, the following decision has been rendered or judgement issued:

DECISION/JUDGEMENT
--------------------

CLERK	(BY) DEPUTY CLERK	DATE
-------	-------------------	------

Copy 1—Upon initiation of action, mail this copy to Director    Copy 3—Upon termination of action, mail this copy to Director  
 Copy 2—Upon filing document adding patent(s), mail this copy to Director    Copy 4—Case file copy

AO 120 (Rev. 08/10)

<b>TO:</b> <b>Mail Stop 8</b> <b>Director of the U.S. Patent and Trademark Office</b> <b>P.O. Box 1450</b> <b>Alexandria, VA 22313-1450</b>	<b>REPORT ON THE</b> <b>FILING OR DETERMINATION OF AN</b> <b>ACTION REGARDING A PATENT OR</b> <b>TRADEMARK</b>
---	---

In Compliance with 35 U.S.C. § 290 and/or 15 U.S.C. § 1116 you are hereby advised that a court action has been filed in the U.S. District Court Eastern District of Texas, Marshall Division on the following  
 Trademarks or  Patents. (  the patent action involves 35 U.S.C. § 292.):

DOCKET NO. 2:16-cv-990	DATE FILED 9/6/2016	U.S. DISTRICT COURT Eastern District of Texas, Marshall Division
PLAINTIFF UNILOC USA, INC., and UNILOC LUXEMBOURG, S.A.		DEFENDANT KYOCERA AMERICA, INC. and § KYOCERA COMMUNICATIONS, INC.,
PATENT OR TRADEMARK NO.	DATE OF PATENT OR TRADEMARK	HOLDER OF PATENT OR TRADEMARK
1 7,535,890	5/19/2009	UNILOC LUXEMBOURG, S.A.
2 8,199,747	6/12/2012	UNILOC LUXEMBOURG, S.A.
3 8,724,622	5/13/2014	UNILOC LUXEMBOURG, S.A.
4 8,995,433	3/31/2015	UNILOC LUXEMBOURG, S.A.
5		

In the above—entitled case, the following patent(s)/ trademark(s) have been included:

DATE INCLUDED	INCLUDED BY <input type="checkbox"/> Amendment <input type="checkbox"/> Answer <input type="checkbox"/> Cross Bill <input type="checkbox"/> Other Pleading	
PATENT OR TRADEMARK NO.	DATE OF PATENT OR TRADEMARK	HOLDER OF PATENT OR TRADEMARK
1		
2		
3		
4		
5		

In the above—entitled case, the following decision has been rendered or judgement issued:

DECISION/JUDGEMENT
--------------------

CLERK	(BY) DEPUTY CLERK	DATE
-------	-------------------	------

Copy 1—Upon initiation of action, mail this copy to Director    Copy 3—Upon termination of action, mail this copy to Director  
 Copy 2—Upon filing document adding patent(s), mail this copy to Director    Copy 4—Case file copy

AO 120 (Rev. 08/10)

<b>TO:</b> <b>Mail Stop 8</b> <b>Director of the U.S. Patent and Trademark Office</b> <b>P.O. Box 1450</b> <b>Alexandria, VA 22313-1450</b>	<b>REPORT ON THE</b> <b>FILING OR DETERMINATION OF AN</b> <b>ACTION REGARDING A PATENT OR</b> <b>TRADEMARK</b>
---	---

In Compliance with 35 U.S.C. § 290 and/or 15 U.S.C. § 1116 you are hereby advised that a court action has been filed in the U.S. District Court Eastern District of Texas, Marshall Division on the following  
 Trademarks or  Patents. (  the patent action involves 35 U.S.C. § 292.);

DOCKET NO. 2:16-cv-991	DATE FILED 9/6/2016	U.S. DISTRICT COURT Eastern District of Texas, Marshall Division
PLAINTIFF UNILOC USA, INC., and UNILOC LUXEMBOURG, S.A.		DEFENDANT LG ELECTRONICS U.S.A., INC.,
PATENT OR TRADEMARK NO.	DATE OF PATENT OR TRADEMARK	HOLDER OF PATENT OR TRADEMARK
1 7,535,890	5/19/2009	UNILOC LUXEMBOURG, S.A.
2 8,199,747	6/12/2012	UNILOC LUXEMBOURG, S.A.
3 8,724,622	5/13/2014	UNILOC LUXEMBOURG, S.A.
4 8,995,433	3/31/2015	UNILOC LUXEMBOURG, S.A.
5		

In the above—entitled case, the following patent(s)/ trademark(s) have been included:

DATE INCLUDED	INCLUDED BY <input type="checkbox"/> Amendment <input type="checkbox"/> Answer <input type="checkbox"/> Cross Bill <input type="checkbox"/> Other Pleading	
PATENT OR TRADEMARK NO.	DATE OF PATENT OR TRADEMARK	HOLDER OF PATENT OR TRADEMARK
1		
2		
3		
4		
5		

In the above—entitled case, the following decision has been rendered or judgement issued:

DECISION/JUDGEMENT
--------------------

CLERK	(BY) DEPUTY CLERK	DATE
-------	-------------------	------

Copy 1—Upon initiation of action, mail this copy to Director    Copy 3—Upon termination of action, mail this copy to Director  
 Copy 2—Upon filing document adding patent(s), mail this copy to Director    Copy 4—Case file copy



Under the Paperwork Reduction Act of 1995 no persons are required to respond to a collection of information unless it displays a valid OMB control number

<b>PATENT - POWER OF ATTORNEY                  OR                  REVOCATION OF POWER OF ATTORNEY                  WITH A NEW POWER OF ATTORNEY                  AND                  CHANGE OF CORRESPONDENCE ADDRESS</b>	Patent Number	8,724,622
	Issue Date	May 13, 2014
	First Named Inventor	Michael J. ROJAS
	Title	SYSTEM AND METHOD FOR INSTANT VOIP MESSAGING
	Attorney Docket No.	UN-NP-IT-195

I hereby revoke all previous powers of attorney given in the above-identified patent.

A Power of Attorney is submitted herewith.

**OR**

I hereby appoint Practitioner(s) associated with the Customer Number identified in the box at right as my/our attorney(s) or agent(s) with respect to the patent identified above, and to transact all business in the United States Patent and Trademark Office connected therewith:

96051

**OR**

I hereby appoint Practitioner(s) named below as my/our attorney(s) or agent(s) with respect to the patent identified above, and to transact all business in the United States Patent and Trademark Office connected therewith:

Practitioner(s) Name	Registration Number

Please recognize or change the correspondence address for the above-identified patent to:

The address associated with the above-identified Customer Number.

**OR**

The address associated with the Customer Number identified in the box at right:

Firm or Individual Name

Address

City  State  Zip

Country

Telephone  Email

I am the:

Applicant.

**OR**

Patent owner.

*Statement under 37 CFR 3.73(c) (Form PTO/AIA/96) submitted herewith or filed on \_\_\_\_\_*

**SIGNATURE of Applicant or Patent Owner**

Signature		Date	
Name	Craig S. Etchegoyen	Telephone	
Title and Company	CEO of Uniloc Luxembourg S.A.		

**NOTE:** Signatures of all the applicants or patent owners of the entire interest or their representative(s) are required. If more than one signature is required, submit multiple forms, check the box below, and identify the total number of forms submitted in the blank below.

A total of 1 forms are submitted.

This collection of information is required by 37 CFR 1.31, 1.32, and 1.33. The information is required to obtain or retain a benefit by the public, which is to update (and by the USPTO to process) the file of a patent or reexamination proceeding. Confidentiality is governed by 35 U.S.C. 122 and 37 CFR 1.14. This collection is estimated to take 3 minutes to complete, including gathering, preparing, and submitting the completed application form to the USPTO. Time will vary depending upon the individual case. Any comments on the amount of time you require to complete this form and/or suggestions for reducing this burden, should be sent to the Chief Information Officer, U.S. Patent and Trademark Office, U.S. Department of Commerce, P.O. Box 1450, Alexandria, VA 22313-1450. DO NOT SEND FEES OR COMPLETED FORMS TO THIS ADDRESS. SEND TO: Commissioner for Patents, P.O. Box 1450, Alexandria, VA 22313-1450.

*If you need assistance in completing the form, call 1-800-PTO-9199 and select option 2.*

Under the Paperwork Reduction Act of 1995, no persons are required to respond to a collection of information unless it displays a valid OMB control number.

**"FEE ADDRESS" INDICATION FORM**

**Address to:**  
**Mail Stop M Correspondence**  
**Commissioner for Patents**  
**P.O. Box 1450**  
**Alexandria, VA 22313-1450**

**Fax to:**  
**571-273-6500**

- OR -

**INSTRUCTIONS:** The issue fee must have been paid for application(s) listed on this form. In addition, only an address represented by a Customer Number can be established as the fee address for maintenance fee purposes (hereafter, fee address). A fee address should be established when correspondence related to maintenance fees should be mailed to a different address than the correspondence address for the application. **When to check the first box below:** If you have a Customer Number to represent the fee address. **When to check the second box below:** If you have no Customer Number representing the desired fee address, in which case a completed Request for Customer Number (PTO/SB/125) must be attached to this form. For more information on Customer Numbers, see the Manual of Patent Examining Procedure (MPEP) § 403.

For the following listed application(s), please recognize as the "Fee Address" under the provisions of 37 CFR 1.363 the address associated with:



Customer Number:

96051

OR



The attached Request for Customer Number (PTO/SB/125) form.

PATENT NUMBER (if known)	APPLICATION NUMBER
8,724,622	13/546,673

Completed by (check one):



Applicant/Inventor



Signature



Attorney or Agent of record 51,513

(Reg. No.)

Sean D. Burdick

Typed or printed name



Assignee of record of the entire interest. See 37 CFR 3.71.

Statement under 37 CFR 3.73(b) is enclosed.

(Form PTO/SB/96)

972-905-9580 x227

Requester's telephone number



Assignee recorded at Reel \_\_\_\_\_ Frame \_\_\_\_\_

September 15, 2016

Date

NOTE: Signatures of all the inventors or assignees of record of the entire interest or their representative(s) are required. Submit multiple forms if more than one signature is required, see below\*.



\* Total of \_\_\_\_\_ forms are submitted.

This collection of information is required by 37 CFR 1.363. The information is required to obtain or retain a benefit by the public which is to file (and by the USPTO to process) an application. Confidentiality is governed by 35 U.S.C. 122 and 37 CFR 1.11 and 1.14. This collection is estimated to take 5 minutes to complete, including gathering, preparing, and submitting the completed application form to the USPTO. Time will vary depending upon the individual case. Any comments on the amount of time you require to complete this form and/or suggestions for reducing this burden, should be sent to the Chief Information Officer, U.S. Patent and Trademark Office, U.S. Department of Commerce, P.O. Box 1450, Alexandria, VA 22313-1450. DO NOT SEND COMPLETE D FORMS TO THIS ADDRESS. SEND TO: Mail Stop M Correspondence, Commissioner for Patents, P.O. Box 1450, Alexandria, VA 22313-1450.

If you need assistance in completing the form, call 1-800-PTO-9199 and select option 2.

**STATEMENT UNDER 37 CFR 3.73(b)**Applicant/Patent Owner: Uniloc Luxembourg S.A.Application No./Patent No.: 8,724,622Filed/Issue Date: May 13, 2014Titled: SYSTEM AND METHOD FOR INSTANT VOIP MESSAGINGUniloc Luxembourg S.A., a corporation

(Name of Assignee)

(Type of Assignee, e.g., corporation, partnership, university, government agency, etc.)

states that it is:

1.  the assignee of the entire right, title, and interest in;
2.  an assignee of less than the entire right, title, and interest in  
(The extent (by percentage) of its ownership interest is \_\_\_\_\_ %); or
3.  the assignee of an undivided interest in the entirety of (a complete assignment from one of the joint inventors was made)

the patent application/patent identified above, by virtue of either:

- A.  An assignment from the inventor(s) of the patent application/patent identified above. The assignment was recorded in the United States Patent and Trademark Office at Reel \_\_\_\_\_, Frame \_\_\_\_\_, or for which a copy therefore is attached.

OR

- B.  A chain of title from the inventor(s), of the patent application/patent identified above, to the current assignee as follows:

1. From: Michael J. ROJAS To: Ayalogic, Inc.The document was recorded in the United States Patent and Trademark Office at  
Reel 014827, Frame 0059, or for which a copy thereof is attached.2. From: Ayalogic, Inc. To: Empire IP LLCThe document was recorded in the United States Patent and Trademark Office at  
Reel 030922, Frame 0335, or for which a copy thereof is attached.3. From: Empire IP LLC To: Uniloc Luxembourg S.A.The document was recorded in the United States Patent and Trademark Office at  
Reel 038963, Frame 0343, or for which a copy thereof is attached. Additional documents in the chain of title are listed on a supplemental sheet(s).

- As required by 37 CFR 3.73(b)(1)(i), the documentary evidence of the chain of title from the original owner to the assignee was, or concurrently is being, submitted for recordation pursuant to 37 CFR 3.11.

[NOTE: A separate copy (i.e., a true copy of the original assignment document(s)) must be submitted to Assignment Division in accordance with 37 CFR Part 3, to record the assignment in the records of the USPTO. See MPEP 302.08]

The undersigned (whose title is supplied below) is authorized to act on behalf of the assignee.

Signature

Sean D. Burdick

Printed or Typed Name

September 15, 2016

Date

IP Counsel for Uniloc Luxembourg S.A.

Title

This collection of information is required by 37 CFR 3.73(b). The information is required to obtain or retain a benefit by the public which is to file (and by the USPTO to process) an application. Confidentiality is governed by 35 U.S.C. 122 and 37 CFR 1.11 and 1.14. This collection is estimated to take 12 minutes to complete, including gathering, preparing, and submitting the completed application form to the USPTO. Time will vary depending upon the individual case. Any comments on the amount of time you require to complete this form and/or suggestions for reducing this burden, should be sent to the Chief Information Officer, U.S. Patent and Trademark Office, U.S. Department of Commerce, P.O. Box 1450, Alexandria, VA 22313-1450. DO NOT SEND FEES OR COMPLETED FORMS TO THIS ADDRESS. SEND TO: Commissioner for Patents, P.O. Box 1450, Alexandria, VA 22313-1450.

If you need assistance in completing the form, call 1-800-PTO-9199 and select option 2.

## Electronic Acknowledgement Receipt

<b>EFS ID:</b>	26942730
<b>Application Number:</b>	13546673
<b>International Application Number:</b>	
<b>Confirmation Number:</b>	9648
<b>Title of Invention:</b>	SYSTEM AND METHOD FOR INSTANT VoIP MESSAGING
<b>First Named Inventor/Applicant Name:</b>	Michael J. Rojas
<b>Customer Number:</b>	67050
<b>Filer:</b>	Sean Dylan Burdick/Kris Pangan
<b>Filer Authorized By:</b>	Sean Dylan Burdick
<b>Attorney Docket Number:</b>	EMP0024-US
<b>Receipt Date:</b>	15-SEP-2016
<b>Filing Date:</b>	11-JUL-2012
<b>Time Stamp:</b>	19:11:39
<b>Application Type:</b>	Utility under 35 USC 111(a)

### Payment information:

Submitted with Payment	no
------------------------	----

### File Listing:

Document Number	Document Description	File Name	File Size(Bytes)/ Message Digest	Multi Part /.zip	Pages (if appl.)
1	Power of Attorney	IT-195_Executed_POA.pdf	37603 <small>96664533004c3bd29fc80a478b337015f2d27020</small>	no	1

### Warnings:

Information:					
2	Change of Address	IT-195_Fee_Address_Indication_Form.pdf	268644	no	1
			b00880619c66c728a974f43d70fb3e7b345c2d66		
Warnings:					
Information:					
3	Assignee showing of ownership per 37 CFR 3.73	IT-195_Statement_Under_37_CFR.pdf	527623	no	1
			087ec51cace562a9d981a1580ed2f2568947016e		
Warnings:					
Information:					
<b>Total Files Size (in bytes):</b>				833870	
<p><b>This Acknowledgement Receipt evidences receipt on the noted date by the USPTO of the indicated documents, characterized by the applicant, and including page counts, where applicable. It serves as evidence of receipt similar to a Post Card, as described in MPEP 503.</b></p> <p><b><u>New Applications Under 35 U.S.C. 111</u></b>  <b>If a new application is being filed and the application includes the necessary components for a filing date (see 37 CFR 1.53(b)-(d) and MPEP 506), a Filing Receipt (37 CFR 1.54) will be issued in due course and the date shown on this Acknowledgement Receipt will establish the filing date of the application.</b></p> <p><b><u>National Stage of an International Application under 35 U.S.C. 371</u></b>  <b>If a timely submission to enter the national stage of an international application is compliant with the conditions of 35 U.S.C. 371 and other applicable requirements a Form PCT/DO/EO/903 indicating acceptance of the application as a national stage submission under 35 U.S.C. 371 will be issued in addition to the Filing Receipt, in due course.</b></p> <p><b><u>New International Application Filed with the USPTO as a Receiving Office</u></b>  <b>If a new international application is being filed and the international application includes the necessary components for an international filing date (see PCT Article 11 and MPEP 1810), a Notification of the International Application Number and of the International Filing Date (Form PCT/RO/105) will be issued in due course, subject to prescriptions concerning national security, and the date shown on this Acknowledgement Receipt will establish the international filing date of the application.</b></p>					

AO 120 (Rev. 08/10)

TO: <b>Mail Stop 8 Director of the U.S. Patent and Trademark Office P.O. Box 1450 Alexandria, VA 22313-1450</b>	<b>REPORT ON THE FILING OR DETERMINATION OF AN ACTION REGARDING A PATENT OR TRADEMARK</b>
---	---

In Compliance with 35 U.S.C. § 290 and/or 15 U.S.C. § 1116 you are hereby advised that a court action has been filed in the U.S. District Court Eastern District of Texas, Marshall Division on the following  
 Trademarks or  Patents. (  the patent action involves 35 U.S.C. § 292.);

DOCKET NO. 2:16-cv-638	DATE FILED 6/14/2016	U.S. DISTRICT COURT Eastern District of Texas, Marshall Division
PLAINTIFF UNILOC USA, INC., and UNILOC LUXEMBOURG, S.A.		DEFENDANT APPLE INC.
PATENT OR TRADEMARK NO.	DATE OF PATENT OR TRADEMARK	HOLDER OF PATENT OR TRADEMARK
1 7,535,890	5/19/2009	UNILOC LUXEMBOURG, S.A.
2 8,995,433	3/31/2015	UNILOC LUXEMBOURG, S.A.
3 8,724,622	5/31/2014	UNILOC LUXEMBOURG, S.A.
4 8,243,723	8/14/2012	UNILOC LUXEMBOURG, S.A.
5		

In the above—entitled case, the following patent(s)/ trademark(s) have been included:

DATE INCLUDED	INCLUDED BY <input type="checkbox"/> Amendment <input type="checkbox"/> Answer <input type="checkbox"/> Cross Bill <input type="checkbox"/> Other Pleading	
PATENT OR TRADEMARK NO.	DATE OF PATENT OR TRADEMARK	HOLDER OF PATENT OR TRADEMARK
1		
2		
3		
4		
5		

In the above—entitled case, the following decision has been rendered or judgement issued:

DECISION/JUDGEMENT
--------------------

CLERK	(BY) DEPUTY CLERK	DATE
-------	-------------------	------

Copy 1—Upon initiation of action, mail this copy to Director    Copy 3—Upon termination of action, mail this copy to Director  
 Copy 2—Upon filing document adding patent(s), mail this copy to Director    Copy 4—Case file copy

AO 120 (Rev. 08/10)

<b>TO:</b> <b>Mail Stop 8</b> <b>Director of the U.S. Patent and Trademark Office</b> <b>P.O. Box 1450</b> <b>Alexandria, VA 22313-1450</b>	<b>REPORT ON THE</b> <b>FILING OR DETERMINATION OF AN</b> <b>ACTION REGARDING A PATENT OR</b> <b>TRADEMARK</b>
---	---

In Compliance with 35 U.S.C. § 290 and/or 15 U.S.C. § 1116 you are hereby advised that a court action has been filed in the U.S. District Court Eastern District of Texas, Marshall Division on the following  
 Trademarks or  Patents. (  the patent action involves 35 U.S.C. § 292.):

DOCKET NO. 2:16-cv-722	DATE FILED 7/5/2016	U.S. DISTRICT COURT Eastern District of Texas, Marshall Division
PLAINTIFF UNILOC USA, INC., and UNILOC LUXEMBOURG, S.A.		DEFENDANT AOL INC.
PATENT OR TRADEMARK NO.	DATE OF PATENT OR TRADEMARK	HOLDER OF PATENT OR TRADEMARK
1 7,535,890	5/19/2009	UNILOC LUXEMBOURG, S.A.
2 8,199,747	6/12/2012	UNILOC LUXEMBOURG, S.A.
3 8,243,723	8/14/2012	UNILOC LUXEMBOURG, S.A.
4 8,724,622	5/13/2014	UNILOC LUXEMBOURG, S.A.
5 8,995,433	3/31/2015	UNILOC LUXEMBOURG, S.A.

In the above—entitled case, the following patent(s)/ trademark(s) have been included:

DATE INCLUDED	INCLUDED BY <input type="checkbox"/> Amendment <input type="checkbox"/> Answer <input type="checkbox"/> Cross Bill <input type="checkbox"/> Other Pleading		
PATENT OR TRADEMARK NO.	DATE OF PATENT OR TRADEMARK	HOLDER OF PATENT OR TRADEMARK	
1			
2			
3			
4			
5			

In the above—entitled case, the following decision has been rendered or judgement issued:

DECISION/JUDGEMENT
--------------------

CLERK	(BY) DEPUTY CLERK	DATE
-------	-------------------	------

Copy 1—Upon initiation of action, mail this copy to Director    Copy 3—Upon termination of action, mail this copy to Director  
 Copy 2—Upon filing document adding patent(s), mail this copy to Director    Copy 4—Case file copy

AO 120 (Rev. 08/10)

TO: <b>Mail Stop 8</b> <b>Director of the U.S. Patent and Trademark Office</b> P.O. Box 1450 Alexandria, VA 22313-1450	<b>REPORT ON THE                  FILING OR DETERMINATION OF AN                  ACTION REGARDING A PATENT OR                  TRADEMARK</b>
---	--

In Compliance with 35 U.S.C. § 290 and/or 15 U.S.C. § 1116 you are hereby advised that a court action has been filed in the U.S. District Court Eastern District of Texas, Marshall Division on the following  
 Trademarks or  Patents. (  the patent action involves 35 U.S.C. § 292.):

DOCKET NO. 2:16-cv-725	DATE FILED 7/5/2016	U.S. DISTRICT COURT Eastern District of Texas, Marshall Division
PLAINTIFF UNILOC USA, INC., and UNILOC LUXEMBOURG, S.A.		DEFENDANT BEETALK PRIVATE LTD.
PATENT OR TRADEMARK NO.	DATE OF PATENT OR TRADEMARK	HOLDER OF PATENT OR TRADEMARK
1 7,535,890	5/19/2009	UNILOC LUXEMBOURG, S.A.
2 8,199,747	6/12/2012	UNILOC LUXEMBOURG, S.A.
3 8,243,723	8/14/2012	UNILOC LUXEMBOURG, S.A.
4 8,724,622	5/13/2014	UNILOC LUXEMBOURG, S.A.
5 8,995,433	3/31/2015	UNILOC LUXEMBOURG, S.A.

In the above—entitled case, the following patent(s)/ trademark(s) have been included:

DATE INCLUDED	INCLUDED BY	<input type="checkbox"/> Amendment <input type="checkbox"/> Answer <input type="checkbox"/> Cross Bill <input type="checkbox"/> Other Pleading		
PATENT OR TRADEMARK NO.	DATE OF PATENT OR TRADEMARK	HOLDER OF PATENT OR TRADEMARK		
1				
2				
3				
4				
5				

In the above—entitled case, the following decision has been rendered or judgement issued:

DECISION/JUDGEMENT
--------------------

CLERK	(BY) DEPUTY CLERK	DATE
-------	-------------------	------

Copy 1—Upon initiation of action, mail this copy to Director    Copy 3—Upon termination of action, mail this copy to Director  
 Copy 2—Upon filing document adding patent(s), mail this copy to Director    Copy 4—Case file copy



AO 120 (Rev. 08/10)

TO: <b>Mail Stop 8</b> <b>Director of the U.S. Patent and Trademark Office</b> <b>P.O. Box 1450</b> <b>Alexandria, VA 22313-1450</b>	<b>REPORT ON THE</b> <b>FILING OR DETERMINATION OF AN</b> <b>ACTION REGARDING A PATENT OR</b> <b>TRADEMARK</b>
---	---

In Compliance with 35 U.S.C. § 290 and/or 15 U.S.C. § 1116 you are hereby advised that a court action has been filed in the U.S. District Court Eastern District of Texas, Marshall Division on the following  
 Trademarks or  Patents. (  the patent action involves 35 U.S.C. § 292.):

DOCKET NO. 2:16-cv-893	DATE FILED 8/11/2016	U.S. DISTRICT COURT Eastern District of Texas, Marshall Division
PLAINTIFF UNILOC USA, INC., and UNILOC LUXEMBOURG, S.A.		DEFENDANT VONAGE HOLDINGS CORP. & VONAGE AMERICAS, INC.
PATENT OR TRADEMARK NO.	DATE OF PATENT OR TRADEMARK	HOLDER OF PATENT OR TRADEMARK
1 8,724,622	5/31/2014	UNILOC LUXEMBOURG, S.A.
2 8,995,433	3/31/2015	UNILOC LUXEMBOURG, S.A.
3 8,243,723	8/14/2012	UNILOC LUXEMBOURG, S.A.
4 7,535,890	5/19/2009	UNILOC LUXEMBOURG, S.A.
5		

In the above—entitled case, the following patent(s)/ trademark(s) have been included:

DATE INCLUDED	INCLUDED BY <input type="checkbox"/> Amendment <input type="checkbox"/> Answer <input type="checkbox"/> Cross Bill <input type="checkbox"/> Other Pleading	
PATENT OR TRADEMARK NO.	DATE OF PATENT OR TRADEMARK	HOLDER OF PATENT OR TRADEMARK
1		
2		
3		
4		
5		

In the above—entitled case, the following decision has been rendered or judgement issued:

DECISION/JUDGEMENT
--------------------

CLERK	(BY) DEPUTY CLERK	DATE
-------	-------------------	------

Copy 1—Upon initiation of action, mail this copy to Director    Copy 3—Upon termination of action, mail this copy to Director  
 Copy 2—Upon filing document adding patent(s), mail this copy to Director    Copy 4—Case file copy

AO 120 (Rev. 08/10)

TO: <b>Mail Stop 8</b> <b>Director of the U.S. Patent and Trademark Office</b> P.O. Box 1450 Alexandria, VA 22313-1450	<b>REPORT ON THE                  FILING OR DETERMINATION OF AN                  ACTION REGARDING A PATENT OR                  TRADEMARK</b>
---	--

In Compliance with 35 U.S.C. § 290 and/or 15 U.S.C. § 1116 you are hereby advised that a court action has been filed in the U.S. District Court Eastern District of Texas, Marshall Division on the following  
 Trademarks or  Patents. (  the patent action involves 35 U.S.C. § 292.):

DOCKET NO. 2:16-cv-892	DATE FILED 8/11/2016	U.S. DISTRICT COURT Eastern District of Texas, Marshall Division
PLAINTIFF UNILOC USA, INC., and UNILOC LUXEMBOURG, S.A.		DEFENDANT TELEGRAM MESSENGER, LLP
PATENT OR TRADEMARK NO.	DATE OF PATENT OR TRADEMARK	HOLDER OF PATENT OR TRADEMARK
1 8,724,622	5/13/2014	UNILOC LUXEMBOURG, S.A.
2 8,995,433	3/31/2015	UNILOC LUXEMBOURG, S.A.
3 7,535,890	5/19/2009	UNILOC LUXEMBOURG, S.A.
4 8,199,747	6/12/2012	UNILOC LUXEMBOURG, S.A.
5 8,243,723	8/14/2012	UNILOC LUXEMBOURG, S.A.

In the above—entitled case, the following patent(s)/ trademark(s) have been included:

DATE INCLUDED	INCLUDED BY <input type="checkbox"/> Amendment <input type="checkbox"/> Answer <input type="checkbox"/> Cross Bill <input type="checkbox"/> Other Pleading	
PATENT OR TRADEMARK NO.	DATE OF PATENT OR TRADEMARK	HOLDER OF PATENT OR TRADEMARK
1		
2		
3		
4		
5		

In the above—entitled case, the following decision has been rendered or judgement issued:

DECISION/JUDGEMENT
--------------------

CLERK	(BY) DEPUTY CLERK	DATE
-------	-------------------	------

Copy 1—Upon initiation of action, mail this copy to Director    Copy 3—Upon termination of action, mail this copy to Director  
 Copy 2—Upon filing document adding patent(s), mail this copy to Director    Copy 4—Case file copy

AO 120 (Rev. 08/10)

<b>TO:</b> <b>Mail Stop 8</b> <b>Director of the U.S. Patent and Trademark Office</b> <b>P.O. Box 1450</b> <b>Alexandria, VA 22313-1450</b>	<b>REPORT ON THE</b> <b>FILING OR DETERMINATION OF AN</b> <b>ACTION REGARDING A PATENT OR</b> <b>TRADEMARK</b>
---	---

In Compliance with 35 U.S.C. § 290 and/or 15 U.S.C. § 1116 you are hereby advised that a court action has been filed in the U.S. District Court Eastern District of Texas, Marshall Division on the following  
 Trademarks or  Patents. (  the patent action involves 35 U.S.C. § 292.);

DOCKET NO. 2:16-cv-645	DATE FILED 6/14/2016	U.S. DISTRICT COURT Eastern District of Texas, Marshall Division
PLAINTIFF UNILOC USA, INC., and UNILOC LUXEMBOURG, S.A.		DEFENDANT WHATSAPP, INC.
PATENT OR TRADEMARK NO.	DATE OF PATENT OR TRADEMARK	HOLDER OF PATENT OR TRADEMARK
1 7,535,890	5/19/2009	UNILOC LUXEMBOURG, S.A.
2 8,199,747	6/12/2012	UNILOC LUXEMBOURG, S.A.
3 8,243,723	8/14/2012	UNILOC LUXEMBOURG, S.A.
4 8,724,622	5/13/2014	UNILOC LUXEMBOURG, S.A.
5 8,995,433	3/31/2015	UNILOC LUXEMBOURG, S.A.

In the above—entitled case, the following patent(s)/ trademark(s) have been included:

DATE INCLUDED	INCLUDED BY <input type="checkbox"/> Amendment <input type="checkbox"/> Answer <input type="checkbox"/> Cross Bill <input type="checkbox"/> Other Pleading	
PATENT OR TRADEMARK NO.	DATE OF PATENT OR TRADEMARK	HOLDER OF PATENT OR TRADEMARK
1		
2		
3		
4		
5		

In the above—entitled case, the following decision has been rendered or judgement issued:

DECISION/JUDGEMENT
--------------------

CLERK	(BY) DEPUTY CLERK	DATE
-------	-------------------	------

Copy 1—Upon initiation of action, mail this copy to Director    Copy 3—Upon termination of action, mail this copy to Director  
 Copy 2—Upon filing document adding patent(s), mail this copy to Director    Copy 4—Case file copy

AO 120 (Rev. 08/10)

TO: <b>Mail Stop 8</b> <b>Director of the U.S. Patent and Trademark Office</b> <b>P.O. Box 1450</b> <b>Alexandria, VA 22313-1450</b>	<b>REPORT ON THE</b> <b>FILING OR DETERMINATION OF AN</b> <b>ACTION REGARDING A PATENT OR</b> <b>TRADEMARK</b>
---	---

In Compliance with 35 U.S.C. § 290 and/or 15 U.S.C. § 1116 you are hereby advised that a court action has been filed in the U.S. District Court Eastern District of Texas, Marshall Division on the following  
 Trademarks or  Patents. (  the patent action involves 35 U.S.C. § 292.);

DOCKET NO. 2:16-cv-641	DATE FILED 6/14/2016	U.S. DISTRICT COURT Eastern District of Texas, Marshall Division
PLAINTIFF UNILOC USA, INC., and UNILOC LUXEMBOURG, S.A.		DEFENDANT LINE EURO-AMERICAS CORP. & LINE CORPORATION
PATENT OR TRADEMARK NO.	DATE OF PATENT OR TRADEMARK	HOLDER OF PATENT OR TRADEMARK
1 8,724,622	5/13/2014	UNILOC LUXEMBOURG, S.A.
2 8,995,433	3/31/2015	UNILOC LUXEMBOURG, S.A.
3 7,535,890	5/19/2009	UNILOC LUXEMBOURG, S.A.
4 8,199,747	6/12/2012	UNILOC LUXEMBOURG, S.A.
5 8,243,723	8/14/2012	UNILOC LUXEMBOURG, S.A.

In the above—entitled case, the following patent(s)/ trademark(s) have been included:

DATE INCLUDED	INCLUDED BY <input type="checkbox"/> Amendment <input type="checkbox"/> Answer <input type="checkbox"/> Cross Bill <input type="checkbox"/> Other Pleading	
PATENT OR TRADEMARK NO.	DATE OF PATENT OR TRADEMARK	HOLDER OF PATENT OR TRADEMARK
1		
2		
3		
4		
5		

In the above—entitled case, the following decision has been rendered or judgement issued:

DECISION/JUDGEMENT
--------------------

CLERK	(BY) DEPUTY CLERK	DATE
-------	-------------------	------

Copy 1—Upon initiation of action, mail this copy to Director    Copy 3—Upon termination of action, mail this copy to Director  
 Copy 2—Upon filing document adding patent(s), mail this copy to Director    Copy 4—Case file copy

AO 120 (Rev. 08/10)

TO: <b>Mail Stop 8 Director of the U.S. Patent and Trademark Office P.O. Box 1450 Alexandria, VA 22313-1450</b>	<b>REPORT ON THE FILING OR DETERMINATION OF AN ACTION REGARDING A PATENT OR TRADEMARK</b>
---	---

In Compliance with 35 U.S.C. § 290 and/or 15 U.S.C. § 1116 you are hereby advised that a court action has been filed in the U.S. District Court Eastern District of Texas, Marshall Division on the following  
 Trademarks or  Patents. (  the patent action involves 35 U.S.C. § 292.);

DOCKET NO. 2:16-cv-639	DATE FILED 6/14/2016	U.S. DISTRICT COURT Eastern District of Texas, Marshall Division
PLAINTIFF UNILOC USA, INC., and UNILOC LUXEMBOURG, S.A.		DEFENDANT BLACKBERRY CORPORATION & BLACKBERRY LIMITED
PATENT OR TRADEMARK NO.	DATE OF PATENT OR TRADEMARK	HOLDER OF PATENT OR TRADEMARK
1 8,724,622	5/13/2014	UNILOC LUXEMBOURG, S.A.
2 8,995,433	3/31/2015	UNILOC LUXEMBOURG, S.A.
3 7,535,890	5/19/2009	UNILOC LUXEMBOURG, S.A.
4 8,199,747	6/12/2012	UNILOC LUXEMBOURG, S.A.
5 8,243,723	8/14/2012	UNILOC LUXEMBOURG, S.A.

In the above—entitled case, the following patent(s)/ trademark(s) have been included:

DATE INCLUDED	INCLUDED BY <input type="checkbox"/> Amendment <input type="checkbox"/> Answer <input type="checkbox"/> Cross Bill <input type="checkbox"/> Other Pleading	
PATENT OR TRADEMARK NO.	DATE OF PATENT OR TRADEMARK	HOLDER OF PATENT OR TRADEMARK
1		
2		
3		
4		
5		

In the above—entitled case, the following decision has been rendered or judgement issued:

DECISION/JUDGEMENT
--------------------

CLERK	(BY) DEPUTY CLERK	DATE
-------	-------------------	------

Copy 1—Upon initiation of action, mail this copy to Director    Copy 3—Upon termination of action, mail this copy to Director  
 Copy 2—Upon filing document adding patent(s), mail this copy to Director    Copy 4—Case file copy

AO 120 (Rev. 08/10)

TO: <b>Mail Stop 8</b> <b>Director of the U.S. Patent and Trademark Office</b> <b>P.O. Box 1450</b> <b>Alexandria, VA 22313-1450</b>	<b>REPORT ON THE</b> <b>FILING OR DETERMINATION OF AN</b> <b>ACTION REGARDING A PATENT OR</b> <b>TRADEMARK</b>
---	---

In Compliance with 35 U.S.C. § 290 and/or 15 U.S.C. § 1116 you are hereby advised that a court action has been filed in the U.S. District Court Eastern District of Texas, Marshall Division on the following  
 Trademarks or  Patents. (  the patent action involves 35 U.S.C. § 292.);

DOCKET NO. 2:16-cv-728	DATE FILED 7/5/2016	U.S. DISTRICT COURT Eastern District of Texas, Marshall Division
PLAINTIFF UNILOC USA, INC., and UNILOC LUXEMBOURG, S.A.		DEFENDANT FACEBOOK, INC.
PATENT OR TRADEMARK NO.	DATE OF PATENT OR TRADEMARK	HOLDER OF PATENT OR TRADEMARK
1 7,535,890	5/19/2009	UNILOC LUXEMBOURG, S.A.
2 8,199,747	6/12/2012	UNILOC LUXEMBOURG, S.A.
3 8,243,723	8/14/2012	UNILOC LUXEMBOURG, S.A.
4 8,724,622	5/13/2014	UNILOC LUXEMBOURG, S.A.
5 8,995,433	3/31/2015	UNILOC LUXEMBOURG, S.A.

In the above—entitled case, the following patent(s)/ trademark(s) have been included:

DATE INCLUDED	INCLUDED BY <input type="checkbox"/> Amendment <input type="checkbox"/> Answer <input type="checkbox"/> Cross Bill <input type="checkbox"/> Other Pleading	
PATENT OR TRADEMARK NO.	DATE OF PATENT OR TRADEMARK	HOLDER OF PATENT OR TRADEMARK
1		
2		
3		
4		
5		

In the above—entitled case, the following decision has been rendered or judgement issued:

DECISION/JUDGEMENT
--------------------

CLERK	(BY) DEPUTY CLERK	DATE
-------	-------------------	------

Copy 1—Upon initiation of action, mail this copy to Director    Copy 3—Upon termination of action, mail this copy to Director  
 Copy 2—Upon filing document adding patent(s), mail this copy to Director    Copy 4—Case file copy

AO 120 (Rev. 08/10)

<b>TO:</b> <b>Mail Stop 8</b> <b>Director of the U.S. Patent and Trademark Office</b> <b>P.O. Box 1450</b> <b>Alexandria, VA 22313-1450</b>	<b>REPORT ON THE</b> <b>FILING OR DETERMINATION OF AN</b> <b>ACTION REGARDING A PATENT OR</b> <b>TRADEMARK</b>
---	---

In Compliance with 35 U.S.C. § 290 and/or 15 U.S.C. § 1116 you are hereby advised that a court action has been filed in the U.S. District Court Eastern District of Texas, Marshall Division on the following  
 Trademarks or  Patents. (  the patent action involves 35 U.S.C. § 292.);

DOCKET NO. 2:16-cv-644	DATE FILED 6/14/2016	U.S. DISTRICT COURT Eastern District of Texas, Marshall Division
PLAINTIFF UNILOC USA, INC., and UNILOC LUXEMBOURG, S.A.		DEFENDANT VOXERNET LLC
PATENT OR TRADEMARK NO.	DATE OF PATENT OR TRADEMARK	HOLDER OF PATENT OR TRADEMARK
1 8,724,622	5/13/2014	UNILOC LUXEMBOURG, S.A.
2 8,995,433	3/31/2015	UNILOC LUXEMBOURG, S.A.
3 7,535,890	5/19/2009	UNILOC LUXEMBOURG, S.A.
4 8,199,747	6/12/2012	UNILOC LUXEMBOURG, S.A.
5 8,243,723	8/14/2012	UNILOC LUXEMBOURG, S.A.

In the above—entitled case, the following patent(s)/ trademark(s) have been included:

DATE INCLUDED	INCLUDED BY <input type="checkbox"/> Amendment <input type="checkbox"/> Answer <input type="checkbox"/> Cross Bill <input type="checkbox"/> Other Pleading	
PATENT OR TRADEMARK NO.	DATE OF PATENT OR TRADEMARK	HOLDER OF PATENT OR TRADEMARK
1		
2		
3		
4		
5		

In the above—entitled case, the following decision has been rendered or judgement issued:

DECISION/JUDGEMENT
--------------------

CLERK	(BY) DEPUTY CLERK	DATE
-------	-------------------	------

Copy 1—Upon initiation of action, mail this copy to Director    Copy 3—Upon termination of action, mail this copy to Director  
 Copy 2—Upon filing document adding patent(s), mail this copy to Director    Copy 4—Case file copy

AO 120 (Rev. 08/10)

TO: <b>Mail Stop 8</b> <b>Director of the U.S. Patent and Trademark Office</b> <b>P.O. Box 1450</b> <b>Alexandria, VA 22313-1450</b>	<b>REPORT ON THE</b> <b>FILING OR DETERMINATION OF AN</b> <b>ACTION REGARDING A PATENT OR</b> <b>TRADEMARK</b>
---	---

In Compliance with 35 U.S.C. § 290 and/or 15 U.S.C. § 1116 you are hereby advised that a court action has been filed in the U.S. District Court Eastern District of Texas, Marshall Division on the following  
 Trademarks or  Patents. (  the patent action involves 35 U.S.C. § 292.);

DOCKET NO. 2:16-cv-643	DATE FILED 6/14/2016	U.S. DISTRICT COURT Eastern District of Texas, Marshall Division
PLAINTIFF UNILOC USA, INC., and UNILOC LUXEMBOURG, S.A.		DEFENDANT VIBER MEDIA S.A.R.L.,
PATENT OR TRADEMARK NO.	DATE OF PATENT OR TRADEMARK	HOLDER OF PATENT OR TRADEMARK
1 8,724,622	5/13/2014	UNILOC LUXEMBOURG, S.A.
2 8,995,433	3/31/2015	UNILOC LUXEMBOURG, S.A.
3 7,535,890	5/19/2009	UNILOC LUXEMBOURG, S.A.
4 8,199,747	6/12/2012	UNILOC LUXEMBOURG, S.A.
5 8,243,723	8/14/2012	UNILOC LUXEMBOURG, S.A.

In the above—entitled case, the following patent(s)/ trademark(s) have been included:

DATE INCLUDED	INCLUDED BY <input type="checkbox"/> Amendment <input type="checkbox"/> Answer <input type="checkbox"/> Cross Bill <input type="checkbox"/> Other Pleading	
PATENT OR TRADEMARK NO.	DATE OF PATENT OR TRADEMARK	HOLDER OF PATENT OR TRADEMARK
1		
2		
3		
4		
5		

In the above—entitled case, the following decision has been rendered or judgement issued:

DECISION/JUDGEMENT
--------------------

CLERK	(BY) DEPUTY CLERK	DATE
-------	-------------------	------

Copy 1—Upon initiation of action, mail this copy to Director    Copy 3—Upon termination of action, mail this copy to Director  
 Copy 2—Upon filing document adding patent(s), mail this copy to Director    Copy 4—Case file copy



AO 120 (Rev. 08/10)

<b>TO:</b> <b>Mail Stop 8</b> <b>Director of the U.S. Patent and Trademark Office</b> <b>P.O. Box 1450</b> <b>Alexandria, VA 22313-1450</b>	<b>REPORT ON THE</b> <b>FILING OR DETERMINATION OF AN</b> <b>ACTION REGARDING A PATENT OR</b> <b>TRADEMARK</b>
---	---

In Compliance with 35 U.S.C. § 290 and/or 15 U.S.C. § 1116 you are hereby advised that a court action has been filed in the U.S. District Court Eastern District of Texas, Marshall Division on the following  
 Trademarks or  Patents. (  the patent action involves 35 U.S.C. § 292.);

DOCKET NO. 2:16-cv-642	DATE FILED 6/14/2016	U.S. DISTRICT COURT Eastern District of Texas, Marshall Division
PLAINTIFF UNILOC USA, INC., and UNILOC LUXEMBOURG, S.A.		DEFENDANT SAMSUNG ELECTRONICS AMERICA, INC.
PATENT OR TRADEMARK NO.	DATE OF PATENT OR TRADEMARK	HOLDER OF PATENT OR TRADEMARK
1 8,724,622	5/31/2014	UNILOC LUXEMBOURG, S.A.
2 8,995,433	3/31/2015	UNILOC LUXEMBOURG, S.A.
3 8,243,723	8/14/2012	UNILOC LUXEMBOURG, S.A.
4 7,535,890	5/19/2009	UNILOC LUXEMBOURG, S.A.
5		

In the above—entitled case, the following patent(s)/ trademark(s) have been included:

DATE INCLUDED	INCLUDED BY <input type="checkbox"/> Amendment <input type="checkbox"/> Answer <input type="checkbox"/> Cross Bill <input type="checkbox"/> Other Pleading	
PATENT OR TRADEMARK NO.	DATE OF PATENT OR TRADEMARK	HOLDER OF PATENT OR TRADEMARK
1		
2		
3		
4		
5		

In the above—entitled case, the following decision has been rendered or judgement issued:

DECISION/JUDGEMENT
--------------------

CLERK	(BY) DEPUTY CLERK	DATE
-------	-------------------	------

Copy 1—Upon initiation of action, mail this copy to Director    Copy 3—Upon termination of action, mail this copy to Director  
 Copy 2—Upon filing document adding patent(s), mail this copy to Director    Copy 4—Case file copy

AO 120 (Rev. 08/10)

<b>TO:</b> <b>Mail Stop 8</b> <b>Director of the U.S. Patent and Trademark Office</b> <b>P.O. Box 1450</b> <b>Alexandria, VA 22313-1450</b>	<b>REPORT ON THE</b> <b>FILING OR DETERMINATION OF AN</b> <b>ACTION REGARDING A PATENT OR</b> <b>TRADEMARK</b>
---	---

In Compliance with 35 U.S.C. § 290 and/or 15 U.S.C. § 1116 you are hereby advised that a court action has been filed in the U.S. District Court Eastern District of Texas, Marshall Division on the following

Trademarks or  Patents. (  the patent action involves 35 U.S.C. § 292.):

DOCKET NO. 2:16-cv-732	DATE FILED 7/5/2016	U.S. DISTRICT COURT Eastern District of Texas, Marshall Division
PLAINTIFF UNILOC USA, INC., and UNILOC LUXEMBOURG, S.A.		DEFENDANT SONY INTERACTIVE ENTERTAINMENT LLC
PATENT OR TRADEMARK NO.	DATE OF PATENT OR TRADEMARK	HOLDER OF PATENT OR TRADEMARK
1 7,535,890	5/19/2009	UNILOC LUXEMBOURG, S.A.
2 8,243,723	8/14/2012	UNILOC LUXEMBOURG, S.A.
3 8,995,433	3/31/2015	UNILOC LUXEMBOURG, S.A.
4 8,724,622	5/13/2014	UNILOC LUXEMBOURG, S.A.
5		

In the above—entitled case, the following patent(s)/ trademark(s) have been included:

DATE INCLUDED	INCLUDED BY <input type="checkbox"/> Amendment <input type="checkbox"/> Answer <input type="checkbox"/> Cross Bill <input type="checkbox"/> Other Pleading		
PATENT OR TRADEMARK NO.	DATE OF PATENT OR TRADEMARK	HOLDER OF PATENT OR TRADEMARK	
1			
2			
3			
4			
5			

In the above—entitled case, the following decision has been rendered or judgement issued:

DECISION/JUDGEMENT
--------------------

CLERK	(BY) DEPUTY CLERK	DATE
-------	-------------------	------

Copy 1—Upon initiation of action, mail this copy to Director    Copy 3—Upon termination of action, mail this copy to Director  
 Copy 2—Upon filing document adding patent(s), mail this copy to Director    Copy 4—Case file copy

AO 120 (Rev. 08/10)

TO: <b>Mail Stop 8</b> <b>Director of the U.S. Patent and Trademark Office</b> <b>P.O. Box 1450</b> <b>Alexandria, VA 22313-1450</b>	<b>REPORT ON THE</b> <b>FILING OR DETERMINATION OF AN</b> <b>ACTION REGARDING A PATENT OR</b> <b>TRADEMARK</b>
---	---

In Compliance with 35 U.S.C. § 290 and/or 15 U.S.C. § 1116 you are hereby advised that a court action has been filed in the U.S. District Court Eastern District of Texas, Marshall Division on the following  
 Trademarks or  Patents. (  the patent action involves 35 U.S.C. § 292.):

DOCKET NO. 2:16-cv-779	DATE FILED 7/15/2016	U.S. DISTRICT COURT Eastern District of Texas, Marshall Division
PLAINTIFF UNILOC USA, INC., and UNILOC LUXEMBOURG, S.A.		DEFENDANT SHORETEL, INC.
PATENT OR TRADEMARK NO.	DATE OF PATENT OR TRADEMARK	HOLDER OF PATENT OR TRADEMARK
1 7,535,890	5/19/2009	UNILOC LUXEMBOURG, S.A.
2 8,995,433	3/31/2015	UNILOC LUXEMBOURG, S.A.
3 8,724,622	5/13/2014	UNILOC LUXEMBOURG, S.A.
4 8,243,723	8/14/2012	UNILOC LUXEMBOURG, S.A.
5		

In the above—entitled case, the following patent(s)/ trademark(s) have been included:

DATE INCLUDED	INCLUDED BY <input type="checkbox"/> Amendment <input type="checkbox"/> Answer <input type="checkbox"/> Cross Bill <input type="checkbox"/> Other Pleading	
PATENT OR TRADEMARK NO.	DATE OF PATENT OR TRADEMARK	HOLDER OF PATENT OR TRADEMARK
1		
2		
3		
4		
5		

In the above—entitled case, the following decision has been rendered or judgement issued:

DECISION/JUDGEMENT
--------------------

CLERK	(BY) DEPUTY CLERK	DATE
-------	-------------------	------

Copy 1—Upon initiation of action, mail this copy to Director    Copy 3—Upon termination of action, mail this copy to Director  
 Copy 2—Upon filing document adding patent(s), mail this copy to Director    Copy 4—Case file copy

AO 120 (Rev. 08/10)

TO: <b>Mail Stop 8 Director of the U.S. Patent and Trademark Office P.O. Box 1450 Alexandria, VA 22313-1450</b>	<b>REPORT ON THE FILING OR DETERMINATION OF AN ACTION REGARDING A PATENT OR TRADEMARK</b>
---	---

In Compliance with 35 U.S.C. § 290 and/or 15 U.S.C. § 1116 you are hereby advised that a court action has been filed in the U.S. District Court Eastern District of Texas, Marshall Division on the following  
 Trademarks or  Patents. (  the patent action involves 35 U.S.C. § 292.):

DOCKET NO. 2:16-cv-777	DATE FILED 7/15/2016	U.S. DISTRICT COURT Eastern District of Texas, Marshall Division
PLAINTIFF UNILOC USA, INC., and UNILOC LUXEMBOURG, S.A.		DEFENDANT AVAYA INC.,
PATENT OR TRADEMARK NO.	DATE OF PATENT OR TRADEMARK	HOLDER OF PATENT OR TRADEMARK
1 7,535,890	5/19/2009	UNILOC LUXEMBOURG, S.A.
2 8,995,433	3/31/2015	UNILOC LUXEMBOURG, S.A.
3 8,724,622	5/13/2014	UNILOC LUXEMBOURG, S.A.
4 8,243,723	8/14/2012	UNILOC LUXEMBOURG, S.A.
5 8,199,747	6/12/2012	UNILOC LUXEMBOURG, S.A.

In the above—entitled case, the following patent(s)/ trademark(s) have been included:

DATE INCLUDED	INCLUDED BY	
	<input type="checkbox"/> Amendment <input type="checkbox"/> Answer <input type="checkbox"/> Cross Bill <input type="checkbox"/> Other Pleading	
PATENT OR TRADEMARK NO.	DATE OF PATENT OR TRADEMARK	HOLDER OF PATENT OR TRADEMARK
1		
2		
3		
4		
5		

In the above—entitled case, the following decision has been rendered or judgement issued:

DECISION/JUDGEMENT
--------------------

CLERK	(BY) DEPUTY CLERK	DATE
-------	-------------------	------

Copy 1—Upon initiation of action, mail this copy to Director    Copy 3—Upon termination of action, mail this copy to Director  
 Copy 2—Upon filing document adding patent(s), mail this copy to Director    Copy 4—Case file copy

AO 120 (Rev. 08/10)

<b>TO:</b> <b>Mail Stop 8</b> <b>Director of the U.S. Patent and Trademark Office</b> <b>P.O. Box 1450</b> <b>Alexandria, VA 22313-1450</b>	<b>REPORT ON THE</b> <b>FILING OR DETERMINATION OF AN</b> <b>ACTION REGARDING A PATENT OR</b> <b>TRADEMARK</b>
---	---

In Compliance with 35 U.S.C. § 290 and/or 15 U.S.C. § 1116 you are hereby advised that a court action has been filed in the U.S. District Court Eastern District of Texas, Marshall Division on the following  
 Trademarks or  Patents. (  the patent action involves 35 U.S.C. § 292.):

DOCKET NO. 2:16-cv-733	DATE FILED 7/5/2016	U.S. DISTRICT COURT Eastern District of Texas, Marshall Division
PLAINTIFF UNILOC USA, INC., and UNILOC LUXEMBOURG, S.A.		DEFENDANT TANGOME, INC. d/b/a TANGO
PATENT OR TRADEMARK NO.	DATE OF PATENT OR TRADEMARK	HOLDER OF PATENT OR TRADEMARK
1 7,535,890	5/19/2009	UNILOC LUXEMBOURG, S.A.
2 8,199,747	6/12/2012	UNILOC LUXEMBOURG, S.A.
3 8,243,723	8/14/2012	UNILOC LUXEMBOURG, S.A.
4 8,724,622	5/13/2014	UNILOC LUXEMBOURG, S.A.
5 8,995,433	3/31/2015	UNILOC LUXEMBOURG, S.A.

In the above—entitled case, the following patent(s)/ trademark(s) have been included:

DATE INCLUDED	INCLUDED BY <input type="checkbox"/> Amendment <input type="checkbox"/> Answer <input type="checkbox"/> Cross Bill <input type="checkbox"/> Other Pleading
PATENT OR TRADEMARK NO.	DATE OF PATENT OR TRADEMARK
1	HOLDER OF PATENT OR TRADEMARK
2	
3	
4	
5	

In the above—entitled case, the following decision has been rendered or judgement issued:

DECISION/JUDGEMENT
--------------------

CLERK	(BY) DEPUTY CLERK	DATE
-------	-------------------	------

Copy 1—Upon initiation of action, mail this copy to Director Copy 3—Upon termination of action, mail this copy to Director  
 Copy 2—Upon filing document adding patent(s), mail this copy to Director Copy 4—Case file copy

AO 120 (Rev. 08/10)

<b>TO:</b> <b>Mail Stop 8</b> <b>Director of the U.S. Patent and Trademark Office</b> <b>P.O. Box 1450</b> <b>Alexandria, VA 22313-1450</b>	<b>REPORT ON THE</b> <b>FILING OR DETERMINATION OF AN</b> <b>ACTION REGARDING A PATENT OR</b> <b>TRADEMARK</b>
---	---

In Compliance with 35 U.S.C. § 290 and/or 15 U.S.C. § 1116 you are hereby advised that a court action has been filed in the U.S. District Court Eastern District of Texas, Marshall Division on the following

Trademarks or  Patents. (  the patent action involves 35 U.S.C. § 292.);

DOCKET NO. 2:16-cv-731	DATE FILED 7/5/2016	U.S. DISTRICT COURT Eastern District of Texas, Marshall Division
PLAINTIFF UNILOC USA, INC., and UNILOC LUXEMBOURG, S.A.		DEFENDANT GREEN TOMATO LIMITED
PATENT OR TRADEMARK NO.	DATE OF PATENT OR TRADEMARK	HOLDER OF PATENT OR TRADEMARK
1 7,535,890	5/19/2009	UNILOC LUXEMBOURG, S.A.
2 8,199,747	6/12/2012	UNILOC LUXEMBOURG, S.A.
3 8,243,723	8/14/2012	UNILOC LUXEMBOURG, S.A.
4 8,724,622	5/13/2014	UNILOC LUXEMBOURG, S.A.
5 8,995,433	3/31/2015	UNILOC LUXEMBOURG, S.A.

In the above—entitled case, the following patent(s)/ trademark(s) have been included:

DATE INCLUDED	INCLUDED BY <input type="checkbox"/> Amendment <input type="checkbox"/> Answer <input type="checkbox"/> Cross Bill <input type="checkbox"/> Other Pleading		
PATENT OR TRADEMARK NO.	DATE OF PATENT OR TRADEMARK	HOLDER OF PATENT OR TRADEMARK	
1			
2			
3			
4			
5			

In the above—entitled case, the following decision has been rendered or judgement issued:

DECISION/JUDGEMENT
--------------------

CLERK	(BY) DEPUTY CLERK	DATE
-------	-------------------	------

Copy 1—Upon initiation of action, mail this copy to Director    Copy 3—Upon termination of action, mail this copy to Director  
 Copy 2—Upon filing document adding patent(s), mail this copy to Director    Copy 4—Case file copy

AO 120 (Rev. 08/10)

<b>TO:</b> <b>Mail Stop 8</b> <b>Director of the U.S. Patent and Trademark Office</b> <b>P.O. Box 1450</b> <b>Alexandria, VA 22313-1450</b>	<b>REPORT ON THE</b> <b>FILING OR DETERMINATION OF AN</b> <b>ACTION REGARDING A PATENT OR</b> <b>TRADEMARK</b>
---	---

In Compliance with 35 U.S.C. § 290 and/or 15 U.S.C. § 1116 you are hereby advised that a court action has been filed in the U.S. District Court Eastern District of Texas, Marshall Division on the following  
 Trademarks or  Patents. (  the patent action involves 35 U.S.C. § 292.);

DOCKET NO. 2:16-cv-777	DATE FILED 7/15/2016	U.S. DISTRICT COURT Eastern District of Texas, Marshall Division
PLAINTIFF UNILOC USA, INC., and UNILOC LUXEMBOURG, S.A.		DEFENDANT AVAYA INC.,
PATENT OR TRADEMARK NO.	DATE OF PATENT OR TRADEMARK	HOLDER OF PATENT OR TRADEMARK
1 7,535,890	5/19/2009	UNILOC LUXEMBOURG, S.A.
2 8,995,433	3/31/2015	UNILOC LUXEMBOURG, S.A.
3 8,724,622	5/13/2014	UNILOC LUXEMBOURG, S.A.
4 8,243,723	8/14/2012	UNILOC LUXEMBOURG, S.A.
5 8,199,747	6/12/2012	UNILOC LUXEMBOURG, S.A.

In the above—entitled case, the following patent(s)/ trademark(s) have been included:

DATE INCLUDED	INCLUDED BY <input type="checkbox"/> Amendment <input type="checkbox"/> Answer <input type="checkbox"/> Cross Bill <input type="checkbox"/> Other Pleading	
PATENT OR TRADEMARK NO.	DATE OF PATENT OR TRADEMARK	HOLDER OF PATENT OR TRADEMARK
1		
2		
3		
4		
5		

In the above—entitled case, the following decision has been rendered or judgement issued:

DECISION/JUDGEMENT
--------------------

CLERK	(BY) DEPUTY CLERK	DATE
-------	-------------------	------

Copy 1—Upon initiation of action, mail this copy to Director    Copy 3—Upon termination of action, mail this copy to Director  
 Copy 2—Upon filing document adding patent(s), mail this copy to Director    Copy 4—Case file copy

AO 120 (Rev. 08/10)

<b>TO:</b> <b>Mail Stop 8</b> <b>Director of the U.S. Patent and Trademark Office</b> <b>P.O. Box 1450</b> <b>Alexandria, VA 22313-1450</b>	<b>REPORT ON THE</b> <b>FILING OR DETERMINATION OF AN</b> <b>ACTION REGARDING A PATENT OR</b> <b>TRADEMARK</b>
---	---

In Compliance with 35 U.S.C. § 290 and/or 15 U.S.C. § 1116 you are hereby advised that a court action has been filed in the U.S. District Court Eastern District of Texas, Marshall Division on the following  
 Trademarks or  Patents. (  the patent action involves 35 U.S.C. § 292.);

DOCKET NO. 2:16-cv-779	DATE FILED 7/15/2016	U.S. DISTRICT COURT Eastern District of Texas, Marshall Division
PLAINTIFF UNILOC USA, INC., and UNILOC LUXEMBOURG, S.A.		DEFENDANT SHORETEL, INC.
PATENT OR TRADEMARK NO.	DATE OF PATENT OR TRADEMARK	HOLDER OF PATENT OR TRADEMARK
1 7,535,890	5/19/2009	UNILOC LUXEMBOURG, S.A.
2 8,995,433	3/31/2015	UNILOC LUXEMBOURG, S.A.
3 8,724,622	5/13/2014	UNILOC LUXEMBOURG, S.A.
4 8,243,723	8/14/2012	UNILOC LUXEMBOURG, S.A.
5		

In the above—entitled case, the following patent(s)/ trademark(s) have been included:

DATE INCLUDED	INCLUDED BY <input type="checkbox"/> Amendment <input type="checkbox"/> Answer <input type="checkbox"/> Cross Bill <input type="checkbox"/> Other Pleading	
PATENT OR TRADEMARK NO.	DATE OF PATENT OR TRADEMARK	HOLDER OF PATENT OR TRADEMARK
1		
2		
3		
4		
5		

In the above—entitled case, the following decision has been rendered or judgement issued:

DECISION/JUDGEMENT
--------------------

CLERK	(BY) DEPUTY CLERK	DATE

Copy 1—Upon initiation of action, mail this copy to Director    Copy 3—Upon termination of action, mail this copy to Director  
 Copy 2—Upon filing document adding patent(s), mail this copy to Director    Copy 4—Case file copy





UNITED STATES PATENT AND TRADEMARK OFFICE

UNITED STATES DEPARTMENT OF COMMERCE
United States Patent and Trademark Office
Address: COMMISSIONER FOR PATENTS
P.O. Box 1450
Alexandria, Virginia 22313-1450
www.uspto.gov

Table with 5 columns: APPLICATION NO., ISSUE DATE, PATENT NO., ATTORNEY DOCKET NO., CONFIRMATION NO.
Row 1: 13/546,673, 05/13/2014, 8724622, EMP0024-US, 9648

67050 7590 04/23/2014
KASHA LAW LLC
14532 Dufief Mill Road
North Potomac, MD 20878

ISSUE NOTIFICATION

The projected patent number and issue date are specified above.

Determination of Patent Term Adjustment under 35 U.S.C. 154 (b)
(application filed on or after May 29, 2000)

The Patent Term Adjustment is 0 day(s). Any patent to issue from the above-identified application will include an indication of the adjustment on the front page.

If a Continued Prosecution Application (CPA) was filed in the above-identified application, the filing date that determines Patent Term Adjustment is the filing date of the most recent CPA.

Applicant will be able to obtain more detailed information by accessing the Patent Application Information Retrieval (PAIR) WEB site (http://pair.uspto.gov).

Any questions regarding the Patent Term Extension or Adjustment determination should be directed to the Office of Patent Legal Administration at (571)-272-7702. Questions relating to issue and publication fee payments should be directed to the Application Assistance Unit (AAU) of the Office of Data Management (ODM) at (571)-272-4200.

APPLICANT(s) (Please see PAIR WEB site http://pair.uspto.gov for additional applicants):

Michael J. Rojas, North Canton, OH;

The United States represents the largest, most dynamic marketplace in the world and is an unparalleled location for business investment, innovation, and commercialization of new technologies. The USA offers tremendous resources and advantages for those who invest and manufacture goods here. Through SelectUSA, our nation works to encourage and facilitate business investment. To learn more about why the USA is the best country in the world to develop technology, manufacture products, and grow your business, visit SelectUSA.gov.

**PART B - FEE(S) TRANSMITTAL**

**Complete and send this form, together with applicable fee(s), to: Mail Mail Stop ISSUE FEE  
 Commissioner for Patents  
 P.O. Box 1450  
 Alexandria, Virginia 22313-1450  
 or Fax (571)-273-2885**

**INSTRUCTIONS:** This form should be used for transmitting the ISSUE FEE and PUBLICATION FEE (if required). Blocks 1 through 5 should be completed where appropriate. All further correspondence including the Patent, advance orders and notification of maintenance fees will be mailed to the current correspondence address as indicated unless corrected below or directed otherwise in Block 1, by (a) specifying a new correspondence address; and/or (b) indicating a separate "FEE ADDRESS" for maintenance fee notifications.

CURRENT CORRESPONDENCE ADDRESS (Note: Use Block 1 for any change of address)

67050 7590 03/06/2014  
**KASHA LAW LLC**  
 14532 Dufief Mill Road  
 North Potomac, MD 20878

Note: A certificate of mailing can only be used for domestic mailings of the Fee(s) Transmittal. This certificate cannot be used for any other accompanying papers. Each additional paper, such as an assignment or formal drawing, must have its own certificate of mailing or transmission.

**Certificate of Mailing or Transmission**

I hereby certify that this Fee(s) Transmittal is being deposited with the United States Postal Service with sufficient postage for first class mail in an envelope addressed to the Mail Stop ISSUE FEE address above, or being facsimile transmitted to the USPTO (571) 273-2885, on the date indicated below.

(Depositor's name)
(Signature)
(Date)

APPLICATION NO.	FILING DATE	FIRST NAMED INVENTOR	ATTORNEY DOCKET NO.	CONFIRMATION NO.
13/546,673	07/11/2012	Michael J. Rojas	EMP0024-US	9648

TITLE OF INVENTION: SYSTEM AND METHOD FOR INSTANT VoIP MESSAGING

APPLN. TYPE	ENTITY STATUS	ISSUE FEE DUE	PUBLICATION FEE DUE	PREV. PAID ISSUE FEE	TOTAL FEE(S) DUE	DATE DUE
nonprovisional	SMALL	\$480	\$0	\$0	\$480	06/06/2014

EXAMINER	ART UNIT	CLASS-SUBCLASS
SMITH, CREIGHTON H	2656	370-352000

<p>1. Change of correspondence address or indication of "Fee Address" (37 CFR 1.363).</p> <p><input type="checkbox"/> Change of correspondence address (or Change of Correspondence Address form PTO/SB/122) attached.</p> <p><input type="checkbox"/> "Fee Address" indication (or "Fee Address" Indication form PTO/SB/47; Rev 03-02 or more recent) attached. <b>Use of a Customer Number is required.</b></p>	<p>2. For printing on the patent front page, list</p> <p>(1) The names of up to 3 registered patent attorneys or agents OR, alternatively,</p> <p>(2) The name of a single firm (having as a member a registered attorney or agent) and the names of up to 2 registered patent attorneys or agents. If no name is listed, no name will be printed.</p> <p>1 <u>John R. Kasha</u></p> <p>2 <u>Kelly L. Kasha</u></p> <p>3 <u>Kasha Law LLC</u></p>
---	---

**3. ASSIGNEE NAME AND RESIDENCE DATA TO BE PRINTED ON THE PATENT** (print or type)

PLEASE NOTE: Unless an assignee is identified below, no assignee data will appear on the patent. If an assignee is identified below, the document has been filed for recordation as set forth in 37 CFR 3.11. Completion of this form is NOT a substitute for filing an assignment.

(A) NAME OF ASSIGNEE: Empire IP LLC  
 (B) RESIDENCE: (CITY and STATE OR COUNTRY) Austin, TX

Please check the appropriate assignee category or categories (will not be printed on the patent):  Individual  Corporation or other private group entity  Government

<p>4a. The following fee(s) are submitted:</p> <p><input checked="" type="checkbox"/> Issue Fee</p> <p><input type="checkbox"/> Publication Fee (No small entity discount permitted)</p> <p><input type="checkbox"/> Advance Order - # of Copies _____</p>	<p>4b. Payment of Fee(s): (Please first reapply any previously paid issue fee shown above)</p> <p><input type="checkbox"/> A check is enclosed.</p> <p><input type="checkbox"/> Payment by credit card. Form PTO-2038 is attached.</p> <p><input checked="" type="checkbox"/> The Director is hereby authorized to charge the required fee(s), any deficiency, or credits any overpayment, to Deposit Account Number <u>504075</u> (enclose an extra copy of this form).</p>
--	--

**5. Change in Entity Status** (from status indicated above)

Applicant certifying micro entity status. See 37 CFR 1.29

Applicant asserting small entity status. See 37 CFR 1.27

Applicant changing to regular undiscounted fee status.

**NOTE:** Absent a valid certification of Micro Entity Status (see forms PTO/SB/15A and 15B), issue fee payment in the micro entity amount will not be accepted at the risk of application abandonment.

**NOTE:** If the application was previously under micro entity status, checking this box will be taken to be a notification of loss of entitlement to micro entity status.

**NOTE:** Checking this box will be taken to be a notification of loss of entitlement to small or micro entity status, as applicable.

NOTE: This form must be signed in accordance with 37 CFR 1.31 and 1.33. See 37 CFR 1.4 for signature requirements and certifications.

Authorized Signature /Kelly L. Kasha/ Date 03/25/2014  
 Typed or printed name Kelly L. Kasha Registration No. 47,743

## Electronic Patent Application Fee Transmittal

<b>Application Number:</b>	13546673			
<b>Filing Date:</b>	11-Jul-2012			
<b>Title of Invention:</b>	SYSTEM AND METHOD FOR INSTANT VoIP MESSAGING			
<b>First Named Inventor/Applicant Name:</b>	Michael J. Rojas			
<b>Filer:</b>	John Kasha			
<b>Attorney Docket Number:</b>	EMP0024-US			
Filed as Small Entity				
<b>Utility under 35 USC 111(a) Filing Fees</b>				
<b>Description</b>	<b>Fee Code</b>	<b>Quantity</b>	<b>Amount</b>	<b>Sub-Total in USD(\$)</b>
<b>Basic Filing:</b>				
<b>Pages:</b>				
<b>Claims:</b>				
<b>Miscellaneous-Filing:</b>				
<b>Petition:</b>				
<b>Patent-Appeals-and-Interference:</b>				
<b>Post-Allowance-and-Post-Issuance:</b>				
Utility Appl Issue Fee	2501	1	480	480
<b>Extension-of-Time:</b>				

Description	Fee Code	Quantity	Amount	Sub-Total in USD(\$)
<b>Miscellaneous:</b>				
<b>Total in USD (\$)</b>				<b>480</b>

## Electronic Acknowledgement Receipt

<b>EFS ID:</b>	18571970
<b>Application Number:</b>	13546673
<b>International Application Number:</b>	
<b>Confirmation Number:</b>	9648
<b>Title of Invention:</b>	SYSTEM AND METHOD FOR INSTANT VoIP MESSAGING
<b>First Named Inventor/Applicant Name:</b>	Michael J. Rojas
<b>Customer Number:</b>	67050
<b>Filer:</b>	John Kasha
<b>Filer Authorized By:</b>	
<b>Attorney Docket Number:</b>	EMP0024-US
<b>Receipt Date:</b>	25-MAR-2014
<b>Filing Date:</b>	11-JUL-2012
<b>Time Stamp:</b>	12:33:36
<b>Application Type:</b>	Utility under 35 USC 111(a)

### Payment information:

Submitted with Payment	yes
Payment Type	Deposit Account
Payment was successfully received in RAM	\$480
RAM confirmation Number	10737
Deposit Account	504075
Authorized User	

The Director of the USPTO is hereby authorized to charge indicated fees and credit any overpayment as follows:

Charge any Additional Fees required under 37 C.F.R. Section 1.16 (National application filing, search, and examination fees)

Charge any Additional Fees required under 37 C.F.R. Section 1.17 (Patent application and reexamination processing fees)

Charge any Additional Fees required under 37 C.F.R. Section 1.19 (Document supply fees)

Charge any Additional Fees required under 37 C.F.R. Section 1.20 (Post Issuance fees)

Charge any Additional Fees required under 37 C.F.R. Section 1.21 (Miscellaneous fees and charges)

**File Listing:**

Document Number	Document Description	File Name	File Size(Bytes)/ Message Digest	Multi Part /.zip	Pages (if appl.)
1	Issue Fee Payment (PTO-85B)	EMP0024-US_iss_fee_trans.pdf	87500 aa8859ea0cfe6d59a2cce38be3c99141157434	no	1

**Warnings:**

**Information:**

2	Fee Worksheet (SB06)	fee-info.pdf	30082 2859d0b57ae84d071f0dced2f923252db80f21b0	no	2
---	----------------------	--------------	---	----	---

**Warnings:**

**Information:**

**Total Files Size (in bytes):** 117582

This Acknowledgement Receipt evidences receipt on the noted date by the USPTO of the indicated documents, characterized by the applicant, and including page counts, where applicable. It serves as evidence of receipt similar to a Post Card, as described in MPEP 503.

**New Applications Under 35 U.S.C. 111**

If a new application is being filed and the application includes the necessary components for a filing date (see 37 CFR 1.53(b)-(d) and MPEP 506), a Filing Receipt (37 CFR 1.54) will be issued in due course and the date shown on this Acknowledgement Receipt will establish the filing date of the application.

**National Stage of an International Application under 35 U.S.C. 371**

If a timely submission to enter the national stage of an international application is compliant with the conditions of 35 U.S.C. 371 and other applicable requirements a Form PCT/DO/EO/903 indicating acceptance of the application as a national stage submission under 35 U.S.C. 371 will be issued in addition to the Filing Receipt, in due course.

**New International Application Filed with the USPTO as a Receiving Office**

If a new international application is being filed and the international application includes the necessary components for an international filing date (see PCT Article 11 and MPEP 1810), a Notification of the International Application Number and of the International Filing Date (Form PCT/RO/105) will be issued in due course, subject to prescriptions concerning national security, and the date shown on this Acknowledgement Receipt will establish the international filing date of the application.



UNITED STATES PATENT AND TRADEMARK OFFICE

UNITED STATES DEPARTMENT OF COMMERCE
United States Patent and Trademark Office
Address: COMMISSIONER FOR PATENTS
P.O. Box 1450
Alexandria, Virginia 22313-1450
www.uspto.gov

NOTICE OF ALLOWANCE AND FEE(S) DUE

67050 7590 03/06/2014
KASHA LAW LLC
14532 Dufief Mill Road
North Potomac, MD 20878

EXAMINER

SMITH, CREIGHTON H

ART UNIT PAPER NUMBER

2656

DATE MAILED: 03/06/2014

Table with 5 columns: APPLICATION NO., FILING DATE, FIRST NAMED INVENTOR, ATTORNEY DOCKET NO., CONFIRMATION NO.
13/546,673 07/11/2012 Michael J. Rojas EMP0024-US 9648

TITLE OF INVENTION: SYSTEM AND METHOD FOR INSTANT VoIP MESSAGING

Table with 7 columns: APPLN. TYPE, ENTITY STATUS, ISSUE FEE DUE, PUBLICATION FEE DUE, PREV. PAID ISSUE FEE, TOTAL FEE(S) DUE, DATE DUE
nonprovisional SMALL \$480 \$0 \$0 \$480 06/06/2014

THE APPLICATION IDENTIFIED ABOVE HAS BEEN EXAMINED AND IS ALLOWED FOR ISSUANCE AS A PATENT. PROSECUTION ON THE MERITS IS CLOSED. THIS NOTICE OF ALLOWANCE IS NOT A GRANT OF PATENT RIGHTS. THIS APPLICATION IS SUBJECT TO WITHDRAWAL FROM ISSUE AT THE INITIATIVE OF THE OFFICE OR UPON PETITION BY THE APPLICANT. SEE 37 CFR 1.313 AND MPEP 1308.

THE ISSUE FEE AND PUBLICATION FEE (IF REQUIRED) MUST BE PAID WITHIN THREE MONTHS FROM THE MAILING DATE OF THIS NOTICE OR THIS APPLICATION SHALL BE REGARDED AS ABANDONED. THIS STATUTORY PERIOD CANNOT BE EXTENDED. SEE 35 U.S.C. 151. THE ISSUE FEE DUE INDICATED ABOVE DOES NOT REFLECT A CREDIT FOR ANY PREVIOUSLY PAID ISSUE FEE IN THIS APPLICATION. IF AN ISSUE FEE HAS PREVIOUSLY BEEN PAID IN THIS APPLICATION (AS SHOWN ABOVE), THE RETURN OF PART B OF THIS FORM WILL BE CONSIDERED A REQUEST TO REAPPLY THE PREVIOUSLY PAID ISSUE FEE TOWARD THE ISSUE FEE NOW DUE.

HOW TO REPLY TO THIS NOTICE:

I. Review the ENTITY STATUS shown above. If the ENTITY STATUS is shown as SMALL or MICRO, verify whether entitlement to that entity status still applies.

If the ENTITY STATUS is the same as shown above, pay the TOTAL FEE(S) DUE shown above.

If the ENTITY STATUS is changed from that shown above, on PART B - FEE(S) TRANSMITTAL, complete section number 5 titled "Change in Entity Status (from status indicated above)".

For purposes of this notice, small entity fees are 1/2 the amount of undiscounted fees, and micro entity fees are 1/2 the amount of small entity fees.

II. PART B - FEE(S) TRANSMITTAL, or its equivalent, must be completed and returned to the United States Patent and Trademark Office (USPTO) with your ISSUE FEE and PUBLICATION FEE (if required). If you are charging the fee(s) to your deposit account, section "4b" of Part B - Fee(s) Transmittal should be completed and an extra copy of the form should be submitted. If an equivalent of Part B is filed, a request to reapply a previously paid issue fee must be clearly made, and delays in processing may occur due to the difficulty in recognizing the paper as an equivalent of Part B.

III. All communications regarding this application must give the application number. Please direct all communications prior to issuance to Mail Stop ISSUE FEE unless advised to the contrary.

IMPORTANT REMINDER: Utility patents issuing on applications filed on or after Dec. 12, 1980 may require payment of maintenance fees. It is patentee's responsibility to ensure timely payment of maintenance fees when due.

**PART B - FEE(S) TRANSMITTAL**

**Complete and send this form, together with applicable fee(s), to: Mail Mail Stop ISSUE FEE  
 Commissioner for Patents  
 P.O. Box 1450  
 Alexandria, Virginia 22313-1450  
 or Fax (571)-273-2885**

**INSTRUCTIONS:** This form should be used for transmitting the ISSUE FEE and PUBLICATION FEE (if required). Blocks 1 through 5 should be completed where appropriate. All further correspondence including the Patent, advance orders and notification of maintenance fees will be mailed to the current correspondence address as indicated unless corrected below or directed otherwise in Block 1, by (a) specifying a new correspondence address; and/or (b) indicating a separate "FEE ADDRESS" for maintenance fee notifications.

CURRENT CORRESPONDENCE ADDRESS (Note: Use Block 1 for any change of address)

67050                      7590                      03/06/2014  
**KASHA LAW LLC**  
 14532 Dufief Mill Road  
 North Potomac, MD 20878

Note: A certificate of mailing can only be used for domestic mailings of the Fee(s) Transmittal. This certificate cannot be used for any other accompanying papers. Each additional paper, such as an assignment or formal drawing, must have its own certificate of mailing or transmission.

**Certificate of Mailing or Transmission**

I hereby certify that this Fee(s) Transmittal is being deposited with the United States Postal Service with sufficient postage for first class mail in an envelope addressed to the Mail Stop ISSUE FEE address above, or being facsimile transmitted to the USPTO (571) 273-2885, on the date indicated below.

_____ (Depositor's name)
_____ (Signature)
_____ (Date)

APPLICATION NO.	FILING DATE	FIRST NAMED INVENTOR	ATTORNEY DOCKET NO.	CONFIRMATION NO.
13/546,673	07/11/2012	Michael J. Rojas	EMP0024-US	9648

TITLE OF INVENTION: SYSTEM AND METHOD FOR INSTANT VoIP MESSAGING

APPLN. TYPE	ENTITY STATUS	ISSUE FEE DUE	PUBLICATION FEE DUE	PREV. PAID ISSUE FEE	TOTAL FEE(S) DUE	DATE DUE
nonprovisional	SMALL	\$480	\$0	\$0	\$480	06/06/2014

EXAMINER	ART UNIT	CLASS-SUBCLASS
SMITH, CREIGHTON H	2656	370-352000

<p>1. Change of correspondence address or indication of "Fee Address" (37 CFR 1.363).</p> <p><input type="checkbox"/> Change of correspondence address (or Change of Correspondence Address form PTO/SB/122) attached.</p> <p><input type="checkbox"/> "Fee Address" indication (or "Fee Address" Indication form PTO/SB/47; Rev 03-02 or more recent) attached. <b>Use of a Customer Number is required.</b></p>	<p>2. For printing on the patent front page, list</p> <p>(1) The names of up to 3 registered patent attorneys or agents OR, alternatively, 1 _____</p> <p>(2) The name of a single firm (having as a member a registered attorney or agent) and the names of up to 2 registered patent attorneys or agents. If no name is listed, no name will be printed. 2 _____</p> <p>3 _____</p>
---	---

**3. ASSIGNEE NAME AND RESIDENCE DATA TO BE PRINTED ON THE PATENT** (print or type)

PLEASE NOTE: Unless an assignee is identified below, no assignee data will appear on the patent. If an assignee is identified below, the document has been filed for recordation as set forth in 37 CFR 3.11. Completion of this form is NOT a substitute for filing an assignment.

(A) NAME OF ASSIGNEE \_\_\_\_\_ (B) RESIDENCE: (CITY and STATE OR COUNTRY) \_\_\_\_\_

Please check the appropriate assignee category or categories (will not be printed on the patent) :  Individual  Corporation or other private group entity  Government

<p>4a. The following fee(s) are submitted:</p> <p><input type="checkbox"/> Issue Fee</p> <p><input type="checkbox"/> Publication Fee (No small entity discount permitted)</p> <p><input type="checkbox"/> Advance Order - # of Copies _____</p>	<p>4b. Payment of Fee(s): (Please first reapply any previously paid issue fee shown above)</p> <p><input type="checkbox"/> A check is enclosed.</p> <p><input type="checkbox"/> Payment by credit card. Form PTO-2038 is attached.</p> <p><input type="checkbox"/> The Director is hereby authorized to charge the required fee(s), any deficiency, or credits any overpayment, to Deposit Account Number _____ (enclose an extra copy of this form).</p>
---	---

5. **Change in Entity Status** (from status indicated above)

Applicant certifying micro entity status. See 37 CFR 1.29

Applicant asserting small entity status. See 37 CFR 1.27

Applicant changing to regular undiscounted fee status.

**NOTE:** Absent a valid certification of Micro Entity Status (see forms PTO/SB/15A and 15B), issue fee payment in the micro entity amount will not be accepted at the risk of application abandonment.

**NOTE:** If the application was previously under micro entity status, checking this box will be taken to be a notification of loss of entitlement to micro entity status.

**NOTE:** Checking this box will be taken to be a notification of loss of entitlement to small or micro entity status, as applicable.

**NOTE:** This form must be signed in accordance with 37 CFR 1.31 and 1.33. See 37 CFR 1.4 for signature requirements and certifications.

Authorized Signature \_\_\_\_\_ Date \_\_\_\_\_

Typed or printed name \_\_\_\_\_ Registration No. \_\_\_\_\_





UNITED STATES PATENT AND TRADEMARK OFFICE

UNITED STATES DEPARTMENT OF COMMERCE
United States Patent and Trademark Office
Address: COMMISSIONER FOR PATENTS
P.O. Box 1450
Alexandria, Virginia 22313-1450
www.uspto.gov

Table with 5 columns: APPLICATION NO., FILING DATE, FIRST NAMED INVENTOR, ATTORNEY DOCKET NO., CONFIRMATION NO.
13/546,673 07/11/2012 Michael J. Rojas EMP0024-US 9648

67050 7590 03/06/2014
KASHA LAW LLC
14532 Dufief Mill Road
North Potomac, MD 20878

EXAMINER

SMITH, CREIGHTON H

ART UNIT PAPER NUMBER

2656

DATE MAILED: 03/06/2014

Determination of Patent Term Adjustment under 35 U.S.C. 154 (b)
(application filed on or after May 29, 2000)

The Patent Term Adjustment to date is 0 day(s). If the issue fee is paid on the date that is three months after the mailing date of this notice and the patent issues on the Tuesday before the date that is 28 weeks (six and a half months) after the mailing date of this notice, the Patent Term Adjustment will be 0 day(s).

If a Continued Prosecution Application (CPA) was filed in the above-identified application, the filing date that determines Patent Term Adjustment is the filing date of the most recent CPA.

Applicant will be able to obtain more detailed information by accessing the Patent Application Information Retrieval (PAIR) WEB site (http://pair.uspto.gov).

Any questions regarding the Patent Term Extension or Adjustment determination should be directed to the Office of Patent Legal Administration at (571)-272-7702. Questions relating to issue and publication fee payments should be directed to the Customer Service Center of the Office of Patent Publication at 1-(888)-786-0101 or (571)-272-4200.

## OMB Clearance and PRA Burden Statement for PTOL-85 Part B

The Paperwork Reduction Act (PRA) of 1995 requires Federal agencies to obtain Office of Management and Budget approval before requesting most types of information from the public. When OMB approves an agency request to collect information from the public, OMB (i) provides a valid OMB Control Number and expiration date for the agency to display on the instrument that will be used to collect the information and (ii) requires the agency to inform the public about the OMB Control Number's legal significance in accordance with 5 CFR 1320.5(b).

The information collected by PTOL-85 Part B is required by 37 CFR 1.311. The information is required to obtain or retain a benefit by the public which is to file (and by the USPTO to process) an application. Confidentiality is governed by 35 U.S.C. 122 and 37 CFR 1.14. This collection is estimated to take 12 minutes to complete, including gathering, preparing, and submitting the completed application form to the USPTO. Time will vary depending upon the individual case. Any comments on the amount of time you require to complete this form and/or suggestions for reducing this burden, should be sent to the Chief Information Officer, U.S. Patent and Trademark Office, U.S. Department of Commerce, P.O. Box 1450, Alexandria, Virginia 22313-1450. DO NOT SEND FEES OR COMPLETED FORMS TO THIS ADDRESS. SEND TO: Commissioner for Patents, P.O. Box 1450, Alexandria, Virginia 22313-1450. Under the Paperwork Reduction Act of 1995, no persons are required to respond to a collection of information unless it displays a valid OMB control number.

### Privacy Act Statement

**The Privacy Act of 1974 (P.L. 93-579)** requires that you be given certain information in connection with your submission of the attached form related to a patent application or patent. Accordingly, pursuant to the requirements of the Act, please be advised that: (1) the general authority for the collection of this information is 35 U.S.C. 2(b)(2); (2) furnishing of the information solicited is voluntary; and (3) the principal purpose for which the information is used by the U.S. Patent and Trademark Office is to process and/or examine your submission related to a patent application or patent. If you do not furnish the requested information, the U.S. Patent and Trademark Office may not be able to process and/or examine your submission, which may result in termination of proceedings or abandonment of the application or expiration of the patent.

The information provided by you in this form will be subject to the following routine uses:

1. The information on this form will be treated confidentially to the extent allowed under the Freedom of Information Act (5 U.S.C. 552) and the Privacy Act (5 U.S.C. 552a). Records from this system of records may be disclosed to the Department of Justice to determine whether disclosure of these records is required by the Freedom of Information Act.
2. A record from this system of records may be disclosed, as a routine use, in the course of presenting evidence to a court, magistrate, or administrative tribunal, including disclosures to opposing counsel in the course of settlement negotiations.
3. A record in this system of records may be disclosed, as a routine use, to a Member of Congress submitting a request involving an individual, to whom the record pertains, when the individual has requested assistance from the Member with respect to the subject matter of the record.
4. A record in this system of records may be disclosed, as a routine use, to a contractor of the Agency having need for the information in order to perform a contract. Recipients of information shall be required to comply with the requirements of the Privacy Act of 1974, as amended, pursuant to 5 U.S.C. 552a(m).
5. A record related to an International Application filed under the Patent Cooperation Treaty in this system of records may be disclosed, as a routine use, to the International Bureau of the World Intellectual Property Organization, pursuant to the Patent Cooperation Treaty.
6. A record in this system of records may be disclosed, as a routine use, to another federal agency for purposes of National Security review (35 U.S.C. 181) and for review pursuant to the Atomic Energy Act (42 U.S.C. 218(c)).
7. A record from this system of records may be disclosed, as a routine use, to the Administrator, General Services, or his/her designee, during an inspection of records conducted by GSA as part of that agency's responsibility to recommend improvements in records management practices and programs, under authority of 44 U.S.C. 2904 and 2906. Such disclosure shall be made in accordance with the GSA regulations governing inspection of records for this purpose, and any other relevant (i.e., GSA or Commerce) directive. Such disclosure shall not be used to make determinations about individuals.
8. A record from this system of records may be disclosed, as a routine use, to the public after either publication of the application pursuant to 35 U.S.C. 122(b) or issuance of a patent pursuant to 35 U.S.C. 151. Further, a record may be disclosed, subject to the limitations of 37 CFR 1.14, as a routine use, to the public if the record was filed in an application which became abandoned or in which the proceedings were terminated and which application is referenced by either a published application, an application open to public inspection or an issued patent.
9. A record from this system of records may be disclosed, as a routine use, to a Federal, State, or local law enforcement agency, if the USPTO becomes aware of a violation or potential violation of law or regulation.

<b>Notice of Allowability</b>	<b>Application No.</b> 13/546,673	<b>Applicant(s)</b> ROJAS, MICHAEL J.	
	<b>Examiner</b> CREIGHTON SMITH	<b>Art Unit</b> 2656	<b>AIA (First Inventor to File) Status</b> No

**-- The MAILING DATE of this communication appears on the cover sheet with the correspondence address--**

All claims being allowable, PROSECUTION ON THE MERITS IS (OR REMAINS) CLOSED in this application. If not included herewith (or previously mailed), a Notice of Allowance (PTOL-85) or other appropriate communication will be mailed in due course. **THIS NOTICE OF ALLOWABILITY IS NOT A GRANT OF PATENT RIGHTS.** This application is subject to withdrawal from issue at the initiative of the Office or upon petition by the applicant. See 37 CFR 1.313 and MPEP 1308.

1.  This communication is responsive to AF amendment & Terminal Disclaimer filed on 28 FEB '14.  
 A declaration(s)/affidavit(s) under **37 CFR 1.130(b)** was/were filed on \_\_\_\_\_.
2.  An election was made by the applicant in response to a restriction requirement set forth during the interview on \_\_\_\_\_; the restriction requirement and election have been incorporated into this action.
3.  The allowed claim(s) is/are 2,5-11,13-20 and 22-44. As a result of the allowed claim(s), you may be eligible to benefit from the **Patent Prosecution Highway** program at a participating intellectual property office for the corresponding application. For more information, please see [http://www.uspto.gov/patents/init\\_events/pph/index.jsp](http://www.uspto.gov/patents/init_events/pph/index.jsp) or send an inquiry to [PPHfeedback@uspto.gov](mailto:PPHfeedback@uspto.gov).
4.  Acknowledgment is made of a claim for foreign priority under 35 U.S.C. § 119(a)-(d) or (f).

**Certified copies:**

- a)  All    b)  Some    \*c)  None of the:
1.  Certified copies of the priority documents have been received.
  2.  Certified copies of the priority documents have been received in Application No. \_\_\_\_\_.
  3.  Copies of the certified copies of the priority documents have been received in this national stage application from the International Bureau (PCT Rule 17.2(a)).
- \* Certified copies not received: \_\_\_\_\_.

Applicant has THREE MONTHS FROM THE "MAILING DATE" of this communication to file a reply complying with the requirements noted below. Failure to timely comply will result in ABANDONMENT of this application. **THIS THREE-MONTH PERIOD IS NOT EXTENDABLE.**

5.  CORRECTED DRAWINGS ( as "replacement sheets") must be submitted.  
 including changes required by the attached Examiner's Amendment / Comment or in the Office action of Paper No./Mail Date \_\_\_\_\_.  
**Identifying indicia such as the application number (see 37 CFR 1.84(c)) should be written on the drawings in the front (not the back) of each sheet. Replacement sheet(s) should be labeled as such in the header according to 37 CFR 1.121(d).**
6.  DEPOSIT OF and/or INFORMATION about the deposit of BIOLOGICAL MATERIAL must be submitted. Note the attached Examiner's comment regarding REQUIREMENT FOR THE DEPOSIT OF BIOLOGICAL MATERIAL.

**Attachment(s)**

- |  |  |
|--|--|
| 1. <input type="checkbox"/> Notice of References Cited (PTO-892)   | 5. <input type="checkbox"/> Examiner's Amendment/Comment                             |
| 2. <input type="checkbox"/> Information Disclosure Statements (PTO/SB/08),<br>Paper No./Mail Date _____    | 6. <input checked="" type="checkbox"/> Examiner's Statement of Reasons for Allowance |
| 3. <input type="checkbox"/> Examiner's Comment Regarding Requirement for Deposit<br>of Biological Material | 7. <input type="checkbox"/> Other _____.   |
| 4. <input type="checkbox"/> Interview Summary (PTO-413),<br>Paper No./Mail Date _____.                     |  |

--	--

The present application is being examined under the pre-AIA first to invent provisions.

### **REASONS FOR ALLOWANCE**

The following is an examiner's statement of reasons for allowance: The prior art fails to disclose applicant's instant voice messaging system that has a database of user records where each record includes a user's name, password, and a list of other users selected by a user. Neither does the prior art teach applicant's instant voice messaging system that has an object field including a digitized audio file, nor does the instant voice messaging system include displaying a list of recipients for an instant voice message. No obvious combination of references found would have taught one of ordinary skill in the art to make applicant's system as claimed.

Any comments considered necessary by applicant must be submitted no later than the payment of the issue fee and, to avoid processing delays, should preferably accompany the issue fee. Such submissions should be clearly labeled "Comments on Statement of Reasons for Allowance."

Any inquiry concerning this communication or earlier communications from the examiner should be directed to CREIGHTON SMITH whose telephone number is (571)272-7546. The examiner can normally be reached on 5-4-9.

If attempts to reach the examiner by telephone are unsuccessful, the examiner's supervisor, Curt Kuntz can be reached on 27499. The fax phone number for the organization where this application or proceeding is assigned is 571-273-8300.

Information regarding the status of an application may be obtained from the Patent Application Information Retrieval (PAIR) system. Status information for published applications may be obtained from either Private PAIR or Public PAIR. Status information for unpublished applications is available through Private PAIR only. For more information about the PAIR system, see <http://pair-direct.uspto.gov>. Should you have questions on access to the Private PAIR system, contact the Electronic Business Center (EBC) at 866-217-9197 (toll-free). If you would like assistance from a USPTO Customer Service Representative or access to the automated information system, call 800-786-9199 (IN USA OR CANADA) or 571-272-1000.

/CREIGHTON SMITH/  
Primary Examiner, Art Unit 2656

03 MAR '14

<b>Issue Classification</b> 	<b>Application/Control No.</b> 13546673	<b>Applicant(s)/Patent Under Reexamination</b> ROJAS, MICHAEL J.	
	<b>Examiner</b> CREIGHTON SMITH	<b>Art Unit</b> 2656	

CPC				
Symbol			Type	Version

CPC Combination Sets					
Symbol		Type	Set	Ranking	Version

NONE		<b>Total Claims Allowed:</b>	
(Assistant Examiner)	(Date)	39	
/CREIGHTON SMITH/ Primary Examiner.Art Unit 2656	03 MAR '14	O.G. Print Claim(s)	O.G. Print Figure
(Primary Examiner)	(Date)	1	1

<b>Issue Classification</b> 	<b>Application/Control No.</b> 13546673	<b>Applicant(s)/Patent Under Reexamination</b> ROJAS, MICHAEL J.
	<b>Examiner</b> CREIGHTON SMITH	<b>Art Unit</b> 2656

US ORIGINAL CLASSIFICATION						INTERNATIONAL CLASSIFICATION														
CLASS		SUBCLASS				CLAIMED					NON-CLAIMED									
370		352				H	O	4	L	12 / 66 (2006.01.01)										
<b>CROSS REFERENCE(S)</b>																				
CLASS	SUBCLASS (ONE SUBCLASS PER BLOCK)																			
709	206																			
379	88.17																			

NONE		<b>Total Claims Allowed:</b>	
		39	
(Assistant Examiner)	(Date)		
/CREIGHTON SMITH/ Primary Examiner. Art Unit 2656	03 MAR '14	O.G. Print Claim(s)	O.G. Print Figure
(Primary Examiner)	(Date)	1	1

<b>Issue Classification</b> 	<b>Application/Control No.</b> 13546673	<b>Applicant(s)/Patent Under Reexamination</b> ROJAS, MICHAEL J.
	<b>Examiner</b> CREIGHTON SMITH	<b>Art Unit</b> 2656

<input type="checkbox"/> <b>Claims renumbered in the same order as presented by applicant</b>																<input type="checkbox"/> <b>CPA</b>		<input type="checkbox"/> <b>T.D.</b>		<input type="checkbox"/> <b>R.1.47</b>	
Final	Original	Final	Original	Final	Original	Final	Original	Final	Original	Final	Original	Final	Original	Final	Original						
1	2	11	18	13	34																
	3	12	19	14	35																
	4	27	20	15	36																
2	5		21	16	37																
3	6	28	22	17	38																
4	7	29	23	18	39																
5	8	30	24	19	40																
6	9	31	25	20	41																
7	10	32	26	21	42																
8	11	33	27	22	43																
	12	37	28	23	44																
24	13	38	29																		
25	14	39	30																		
26	15	35	31																		
9	16	36	32																		
10	17	37	33																		

NONE		<b>Total Claims Allowed:</b>	
		39	
(Assistant Examiner)	(Date)	O.G. Print Claim(s)	O.G. Print Figure
/CREIGHTON SMITH/ Primary Examiner.Art Unit 2656	03 MAR '14	1	1
(Primary Examiner)	(Date)		



<b>Search Notes</b>  	<b>Application/Control No.</b>  13546673	<b>Applicant(s)/Patent Under Reexamination</b>  ROJAS, MICHAEL J.
	<b>Examiner</b>  CREIGHTON SMITH	<b>Art Unit</b>  2656

CPC- SEARCHED		
Symbol	Date	Examiner

CPC COMBINATION SETS - SEARCHED		
Symbol	Date	Examiner

US CLASSIFICATION SEARCHED			
Class	Subclass	Date	Examiner
379	88.17	03.03.14	chs
709	206	"	"
370	352	"	"

SEARCH NOTES		
Search Notes	Date	Examiner
EAST	06.03.13	chs
"	18.11.13	"
"	03.03.14	"

INTERFERENCE SEARCH			
US Class/ CPC Symbol	US Subclass / CPC Group	Date	Examiner
EAST		03.03.14	chs

--	--

<b><i>Index of Claims</i></b>  	<b>Application/Control No.</b>  13546673	<b>Applicant(s)/Patent Under Reexamination</b>  ROJAS, MICHAEL J.
	<b>Examiner</b>  CREIGHTON SMITH	<b>Art Unit</b>  2656

✓	<b>Rejected</b>	-	<b>Cancelled</b>	N	<b>Non-Elected</b>	A	<b>Appeal</b>
=	<b>Allowed</b>	÷	<b>Restricted</b>	I	<b>Interference</b>	O	<b>Objected</b>

Claims renumbered in the same order as presented by applicant
  CPA
  T.D.
  R.1.47

CLAIM		DATE							
Final	Original	06/03/2013	11/18/2013	03/03/2014					
13	34			=					
14	35			=					
15	36			=					
16	37			=					
17	38			=					
18	39			=					
19	40			=					
20	41			=					
21	42			=					
22	43			=					
23	44			=					
1	2		✓	=					
	3		✓	-					
	4		✓	-					
2	5		✓	=					
3	6		✓	=					
4	7		✓	=					
5	8		✓	=					
6	9		✓	=					
7	10		✓	=					
8	11		✓	=					
	12		✓	-					
24	13		✓	=					
25	14		✓	=					
26	15		✓	=					
9	16		✓	=					
10	17		✓	=					
11	18		✓	=					
12	19		✓	=					
27	20		✓	=					
	21		✓	-					
28	22		✓	=					
29	23		✓	=					
30	24		✓	=					
31	25		✓	=					
32	26		✓	=					

<b>Index of Claims</b>  	<b>Application/Control No.</b>  13546673	<b>Applicant(s)/Patent Under Reexamination</b>  ROJAS, MICHAEL J.
	<b>Examiner</b>  CREIGHTON SMITH	<b>Art Unit</b>  2656

✓	<b>Rejected</b>	-	<b>Cancelled</b>	N	<b>Non-Elected</b>	A	<b>Appeal</b>
=	<b>Allowed</b>	÷	<b>Restricted</b>	I	<b>Interference</b>	O	<b>Objected</b>

<input type="checkbox"/> Claims renumbered in the same order as presented by applicant		<input type="checkbox"/> CPA		<input checked="" type="checkbox"/> T.D.		<input type="checkbox"/> R.1.47			
CLAIM		DATE							
Final	Original	06/03/2013	11/18/2013	03/03/2014					
33	27		✓	=					
34	28		✓	=					
38	29		✓	=					
39	30		✓	=					
35	31		✓	=					
36	32		✓	=					
37	33		✓	=					
	1	✓	-	-					

**EAST Search History****EAST Search History (Prior Art)**

Ref #	Hits	Search Query	DBs	Default Operator	Plurals	Time Stamp
L1	0	((@ad<="20031218") or (@rlad<="20031218")) and display\$3 with list with instant adj voice adj message	US-PGPUB; USPAT; EPO; JPO; DERWENT	OR	OFF	2014/03/03 11:46

**EAST Search History (Interference)**

Ref #	Hits	Search Query	DBs	Default Operator	Plurals	Time Stamp
L2	0	((@ad<="20031218") or (@rlad<="20031218")) and display\$3 with list with instant adj voice adj message.clm.	US-PGPUB; USPAT; UPAD	OR	OFF	2014/03/03 11:47

3/ 3/ 2014 11:48:43 AM

C:\Users\csmith1\Documents\EAST\Workspaces\12974648.wsp

IN THE UNITED STATES PATENT AND TRADEMARK OFFICE

<p>In re the Application of:</p> <p>MICHAEL J. ROJAS</p> <p>Serial No.: 13/546,673</p> <p>Filed: July 11, 2012</p> <p>For: SYSTEM AND METHOD FOR INSTANT VOIP MESSAGING</p>	<p>Confirmation No.: 9648</p> <p>Art Unit: 2656</p> <p>Examiner: Creighton H. Smith</p>
---	---

**AMENDMENT AFTER FINAL REJECTION UNDER 37 C.F.R. § 1.116**

**MAIL STOP: AF**  
Commissioner for Patents  
P.O. Box 1450  
Alexandria, VA 22313-1450

Sir:

In response to the Final Office Action of November 29, 2013, please amend the above-identified application as follows:

Any fee necessary for consideration of this response is hereby authorized to be charged to Deposit Account Number 50-4075.

**Amendments to the Claims** are reflected in the listing of claims that begins on page 2 of this paper.

**Remarks** begin on page 9 of this paper.

Please enter this AF amendment. CHS 03 MAR '14

**Amendments to the Claims:**

This listing of claims replaces all prior versions and listings of claims in this application.

Listing of the Claims:

1. (Cancelled).
2. (Currently amended): A system comprising:
  - a network interface connected to a packet-switched network;
  - a messaging system communicating with a plurality of instant voice message client systems via the network interface; ~~and~~
    - a communication platform system maintaining connection information for each of the plurality of instant voice message client systems indicating whether there is a current connection to each of the plurality of instant voice message client systems; and
      - a user database storing user records identifying users of the plurality of instant voice message client systems, wherein each of the user records includes a user name, a password and a list of other users selected by a user.
3. (Cancelled).
4. (Cancelled).
5. (Currently amended): The system according to claim [[4]] 2, wherein at least part of each of the user records is encrypted.
6. (Currently amended): A system comprising:
  - a network interface connected to a packet-switched network;

a messaging system communicating with a plurality of instant voice message client systems via the network interface; and

a communication platform system maintaining connection information for each of the plurality of instant voice message client systems indicating whether there is a current connection to each of the plurality of instant voice message client systems.

~~The system according to claim 2,~~ wherein the messaging system receives an instant voice message from one of the plurality of instant voice message client systems, and

wherein the instant voice message includes an object field including a digitized audio file.

7. (Previously presented): The system according to claim 6, wherein the instant voice message includes an action field identifying one of a predetermined set of permitted actions requested by the user.

8. (Currently amended): The system according to claim 7, wherein the predetermined set of permitted actions includes at least one of a connection request, a disconnection request, a subscription request, an unsubscription request, a message transmission request, and a set status request.

9. (Previously presented): The system according to claim 6, wherein the instant voice message includes an identifier field including a unique identifier associated with the instant voice message.

10. (Previously presented): The system according to claim 6, wherein the instant voice message includes a source field including a unique identifier associated with at least one of a given one of the plurality of instant voice message client systems that created the instant voice

message and a given one of the plurality of users using the given one of the plurality of instant voice message client systems.

11. (Previously presented): The system according to claim 6, wherein the instant voice message includes a destination field including a unique identifier associated with at least one of a given one of the plurality of instant voice message client systems identified as a recipient of the instant voice message and a given one of the plurality of users using the given one of the plurality of instant voice message client systems.

12. (Cancelled).

13. (Currently amended): A system comprising:

a network interface connected to a packet-switched network;

a messaging system communicating with a plurality of instant voice message client systems via the network interface; and

a communication platform system maintaining connection information for each of the plurality of instant voice message client systems indicating whether there is a current connection to each of the plurality of instant voice message client systems,

~~The system according to claim 2,~~ wherein the messaging system receives connection object messages from the plurality of instant voice message client systems, wherein each of the connection object messages includes data representing a state of a logical connection with a given one of the plurality of instant voice message client systems.



14. (Previously presented): The system according to claim 13, wherein the connection object messages identifies at least one of a socket, a size of data to be transferred and a priority of the data.

15. (Previously presented): The system according to claim 13, wherein the communication platform system populates a connection list for the plurality of instant voice message client systems with the data in the connection object messages received from each of the plurality of instant voice message client systems.

16. (Currently amended): The system according to claim 6, wherein the communication platform system assigns an IP address to each of the instant voice message client systems when the communication platform receives a connection request from each of the instant voice message client systems.

17. (Currently amended): The system according to claim 6, further comprising: a message database storing the instant voice messages received from the instant voice message client systems.

18. (Currently amended): The system according to claim 6, wherein, upon receipt of an instant voice message, the communication platform system determines if there is the current connection to one of the plurality of instant voice message client systems identified as a recipient of the instant voice message, and if there is no connection with the one of the plurality of instant voice message client system identified as the recipient, the instant voice message is stored and delivered when the one of the plurality of instant voice message client systems identified as the recipient re-established a connection.

19. (Currently amended): The system according to claim [[2]] 6, wherein the communication platform system updates the connection information for each of the instant voice message client systems by periodically transmitting a connection status request to the given one of the plurality of instant voice message client systems.

20. (Currently amended): A system comprising:

a client device;

a network interface coupled to the client device and connecting the client device to a packet-switched network; and

an instant voice messaging application installed on the client device, wherein the instant voice messaging application includes a client platform system for generating an instant voice message and a messaging system for transmitting the instant voice message over the packet-switched network via the network interface,

wherein the instant voice messaging application includes a document handler system for attaching one or more files to the instant voice message.

21. (Cancelled).

22. (Previously presented): The system according to claim 20, wherein the instant voice messaging application includes a message database storing the instant voice message, wherein the instant voice messages is represented by a database record including a unique identifier.

23. (Previously presented): The system according to claim 22, wherein the instant voice message stored in the message database include a plurality of instant voice messages recorded by a user of the client device and instant voice messages received over the packet-switched network.

24. (Previously presented): The system according to claim 23, further comprising: a display displaying at least one of the plurality of instant voice messages stored in the message database.

25. (Previously presented): The system according to claim 22, wherein the instant voice messaging application includes a file manager system storing, deleting and retrieving the instant voice messages from the message database in response to a user request.

26. (Previously presented): The system according to claim 20, wherein the instant voice messaging application includes an audio file creation system creating an audio file for the instant voice message based on input received via an audio input device coupled to the client device.

27. (Previously presented): The system according to claim 20, wherein the instant voice messaging application includes an encryption/decryption system for encrypting the instant voice messages to be transmitted over the packet-switched network and decrypting the instant voices messages received over the packet-switched network.

28. (Previously presented): The system according to claim 20, wherein the instant voice messaging application includes a compression/decompression system for compressing the instant voice messages to be transmitted over the packet-switched network and decompressing the instant voice messages received over the packet-switched network.

29. (Currently amended): A system comprising:

a client device;

a network interface coupled to the client device and connecting the client device to a packet-switched network; and

an instant voice messaging application installed on the client device, wherein the instant voice messaging application includes a client platform system for generating an instant voice message and a messaging system for transmitting the instant voice message over the packet-switched network via the network interface,

~~The system according to claim 20, further comprising:~~ a display displaying a list of one or more potential recipients for an instant voice message.

30. (Previously presented): The system according to claim 29, wherein the display includes an indicia for each of the one or more potential recipients indicating whether the potential recipient is currently available to receive an instant voice message.

31. (Previously presented): The system according to claim 20, wherein the instant voice message application generates an audible or visual effect indicating receipt of an instant voice message.

32. (Previously presented): The system according to claim 20, wherein the instant voice message application communicates in an intercom mode when a recipient of the instant voice message is currently available to receive the instant voice message and communicates in a record mode when the recipient of the instant voice message is currently unavailable to receive the instant voice message.

33. (Previously presented): The system according to claim 32, wherein the instant voice message application utilizes the intercom mode as a default communication mode.

34. (New) The system according to claim 6, wherein each of the instant voice message client systems comprises an instant voice messaging application generating an instant voice message

and transmitting the instant voice message over the packet-switched network to the messaging system.

35. (New): The system according to claim 34, wherein the instant voice messaging application includes a message database storing the instant voice message, wherein the instant voice message is represented by a database record including a unique identifier.

36. (New): The system according to claim 35, wherein the message database includes a plurality of instant voice messages recorded by a user of the client device and instant voice messages received over the packet-switched network.

37. (New): The system according to claim 36, wherein the instant voice messaging application displays at least one of the plurality of instant voice messages stored in the message database.

38. (New): The system according to claim 35, wherein the instant voice messaging application includes a file manager system performing at least one of storing, deleting and retrieving the instant voice messages from the message database.

39. (New): The system according to claim 34, wherein the instant voice messaging application includes an audio file creation system creating an audio file for the instant voice message based on input received via an audio input device coupled to the client device.

40. (New): The system according to claim 34, wherein the instant voice messaging application includes an encryption/decryption system for encrypting the instant voice messages to be transmitted over the packet-switched network and decrypting the instant voices messages received over the packet-switched network.

41. (New): The system according to claim 34, wherein the instant voice messaging application includes a compression/decompression system for compressing the instant voice messages to be transmitted over the packet-switched network and decompressing the instant voice messages received over the packet-switched network.
42. (New): The system according to claim 34, wherein the instant voice messaging application displays a list of one or more potential recipients for the instant voice message.
43. (New): The system according to claim 42, wherein the instant voice messaging application displays an indicia for each of the one or more potential recipients indicating whether the potential recipient is currently available to receive an instant voice message.
44. (New): The system according to claim 34, wherein the instant voice message application generates an audible or visual effect indicating receipt of an instant voice message.

### REMARKS

By this amendment, claims 3, 4, 12, and 21 have been cancelled, claims 2, 5, 6, 13, 16-20, and 29 have been amended, and new claims 34-44 have been added. No new matter is introduced. Claims 2, 5-11, 13-20 and 22-44 will remain pending herein upon entry of this Response. For the reasons stated below, the Applicant respectfully submits that all claims pending in this application are in condition for allowance. Reconsideration of this application is respectfully requested in view of the following remarks.

The subject matter of new claim 34 is described in the specification at, for example, page 13, line 15 – page 14, line 17.

The subject matter of new claim 35 is described in the specification at, for example, page 25, lines 6-8.

The subject matter of new claim 36 is described in the specification at, for example, page 35, lines 6-8.

The subject matter of new claim 37 is described in the specification at, for example, page 14, lines 12-14.

The subject matter of new claim 38 is described in the specification at, for example, page 25, lines 8-10.

The subject matter of new claim 39 is described in the specification at, for example, page 25, lines 10-12.

The subject matter of new claim 40 is described in the specification at, for example, page 25, lines 14-15.

The subject matter of new claim 41 is described in the specification at, for example, page 25, lines 15-17.

The subject matter of new claim 42 is described in the specification at, for example, page 13, line 15 – page 14, line 17.

The subject matter of new claim 43 is described in the specification at, for example, page 29, line 18 – page 30, line 7.

The subject matter of new claim 44 is described in the specification at, for example, page 16, line 23 – page 17, line 2.

Entry of the above amendments is proper under 37 C.F.R. § 1.116 because the amendments (1) place the claims in better form for appeal if needed; and (2) do not introduce any elements requiring further search by the Examiner.

#### **Double Patenting Rejections**

Claims 2-33 are rejected on the ground of non-statutory obviousness-type double patenting as being unpatentable over claims 1-70 of U.S. Patent No. 7,535,890 (hereinafter the “‘890 patent”).

Claims 3, 4, 12, and 21 have been cancelled, rendering the rejection of these claims moot.

The Applicants file herewith a Terminal Disclaimer over the ‘890 patent. As set forth in the MPEP, a Terminal Disclaimer may be used to overcome a rejection based on obviousness-type double patenting (MPEP § 804.02(II)). Further, in legal principle, the filing of a Terminal Disclaimer simply serves the statutory function of removing the rejection of obviousness-type double patenting, and does not raise a presumption on the merits of the rejection. It is improper



to view the simple expedient of “obviation” as an admission or acquiescence on the merits.

*Ortho Pharmaceutical Corp. v. Smith*, 22 USPQ2d 1119, 1124 (Fed. Cir. 1992) citing *Quad Envtl. Technologies Corp. v. Union Sanitary Dist.*, 946 F.2d 870, 874, 20 USPQ2d 1392, 1394-95 (Fed. Cir. 1991).

Withdrawal of the rejection of claims 2, 5-11, 13-20, and 22-33 based on the judicially created doctrine of double patenting is respectfully requested.

### **35 U.S. C. § 102(e) Rejections**

Claims 2-3, 6, 11, 17-18, 20, 22-23, 26, and 32-33 stand rejected under 35 U.S.C. § 102(e) as unpatentable over U.S. Patent No. 7,372,826 to Dahod et al. (“Dahod”). This rejection is respectfully traversed. However, to move prosecution forward, the Applicant incorporates the allowable subject matter of claims 4, 12, 13, 21, and 29 into independent claims, as described below. The Applicant reserves the right to pursue previously filed claims in a continuation application, and this amendment does not indicate express or implicit agreement with the Examiner’s rejections of previously presented claims.

Claim 3 has been cancelled, rendering the rejection of this claim moot.

Independent claim 2 has been amended to incorporate the subject matter of claims 3 and 4. Since the Examiner indicated that claim 4, which depended from claims 2 and 3, would be allowable if rewritten in independent form, it is respectfully submitted that amended independent claim 2 and claim 5 (which depends from claim 2) are allowable.

Claim 6 has been rewritten in independent form incorporating the subject matter of claims 2 and 12. Since the Examiner indicated that claim 12, which depended from claims 2 and

6, would be allowable if rewritten in independent form, it is respectfully submitted that amended independent claim 6 and claims 7-11 and 16-19 (which depend from claim 6) are allowable.

Claim 13 has been rewritten in independent form incorporating the subject matter of claim 2. Since the Examiner indicated that claim 13, which depended from claim 2, would be allowable if rewritten in independent form, it is respectfully submitted that amended independent claim 13 and claims 14-15 (which depend from claim 13) are allowable.

Independent claim 20 has been amended to incorporate the subject matter of claim 21. Since the Examiner indicated that claim 21, which depended from claim 20, would be allowable if rewritten in independent form, it is respectfully submitted that amended independent claim 20 and claims 22-28 and 31-33 (which depend from claim 20) are allowable.

Claim 29 has been rewritten in independent form incorporating the subject matter of claim 20. Since the Examiner indicated that claim 29, which depended from claim 20, would be allowable if rewritten in independent form, it is respectfully submitted that amended independent claim 29 and claim 30 (which depends from claim 29) are allowable.

Withdrawing of the rejection of claims 2, 6, 11, 17-18, 20, 22-23, 26, and 32-33 under 35 U.S.C. § 102(e) is respectfully requested.

New claims 34-44 depend directly or indirectly from allowable amended claim 6. Thus, it is respectfully submitted that new claims 34-44 are allowable at least for the reasons that amended claim 6 is allowable.

Serial No.: 13/546,673  
Art Unit: 2656

Attorney's Docket No.: EMP0024-US  
Page 15

### **Conclusion**

Should the Examiner have any questions or determine that any further action is desirable to place this application in even better condition for issue, the Examiner is encouraged to telephone the Applicant's undersigned representative at the number listed below.

KASHA LAW LLC  
14532 Dufief Mill Rd.  
North Potomac, MD 20878  
Tel. 240-423-8431  
Date: February 28, 2014

Respectfully submitted,

By: /Kelly L. Kasha/  
Kelly L. Kasha  
Registration No. 47,743

Customer No. 67050

## IN THE UNITED STATES PATENT AND TRADEMARK OFFICE

In re the Application of: MICHAEL J. ROJAS Serial No.: 13/546,673 Filed: July 11, 2012 For: SYSTEM AND METHOD FOR INSTANT VOIP MESSAGING	Confirmation No.: 9648 Art Unit: 2656 Examiner: Creighton H. Smith
---	--

**AMENDMENT AFTER FINAL REJECTION UNDER 37 C.F.R. § 1.116****MAIL STOP: AF**

Commissioner for Patents  
P.O. Box 1450  
Alexandria, VA 22313-1450

Sir:

In response to the Final Office Action of November 29, 2013, please amend the above-identified application as follows:

Any fee necessary for consideration of this response is hereby authorized to be charged to Deposit Account Number 50-4075.

**Amendments to the Claims** are reflected in the listing of claims that begins on page 2 of this paper.

**Remarks** begin on page 9 of this paper.

**Amendments to the Claims:**

This listing of claims replaces all prior versions and listings of claims in this application.

Listing of the Claims:

1. (Cancelled).
2. (Currently amended): A system comprising:
  - a network interface connected to a packet-switched network;
  - a messaging system communicating with a plurality of instant voice message client systems via the network interface; ~~and~~
    - a communication platform system maintaining connection information for each of the plurality of instant voice message client systems indicating whether there is a current connection to each of the plurality of instant voice message client systems; and
      - a user database storing user records identifying users of the plurality of instant voice message client systems, wherein each of the user records includes a user name, a password and a list of other users selected by a user.
3. (Cancelled).
4. (Cancelled).
5. (Currently amended): The system according to claim [[4]] 2, wherein at least part of each of the user records is encrypted.
6. (Currently amended): A system comprising:
  - a network interface connected to a packet-switched network;

a messaging system communicating with a plurality of instant voice message client systems via the network interface; and

a communication platform system maintaining connection information for each of the plurality of instant voice message client systems indicating whether there is a current connection to each of the plurality of instant voice message client systems.

~~The system according to claim 2,~~ wherein the messaging system receives an instant voice message from one of the plurality of instant voice message client systems, and

wherein the instant voice message includes an object field including a digitized audio file.

7. (Previously presented): The system according to claim 6, wherein the instant voice message includes an action field identifying one of a predetermined set of permitted actions requested by the user.

8. (Currently amended): The system according to claim 7, wherein the predetermined set of permitted actions includes at least one of a connection request, a disconnection request, a subscription request, an unsubscription request, a message transmission request, and a set status request.

9. (Previously presented): The system according to claim 6, wherein the instant voice message includes an identifier field including a unique identifier associated with the instant voice message.

10. (Previously presented): The system according to claim 6, wherein the instant voice message includes a source field including a unique identifier associated with at least one of a given one of the plurality of instant voice message client systems that created the instant voice

message and a given one of the plurality of users using the given one of the plurality of instant voice message client systems.

11. (Previously presented): The system according to claim 6, wherein the instant voice message includes a destination field including a unique identifier associated with at least one of a given one of the plurality of instant voice message client systems identified as a recipient of the instant voice message and a given one of the plurality of users using the given one of the plurality of instant voice message client systems.

12. (Cancelled).

13. (Currently amended): A system comprising:

a network interface connected to a packet-switched network;

a messaging system communicating with a plurality of instant voice message client systems via the network interface; and

a communication platform system maintaining connection information for each of the plurality of instant voice message client systems indicating whether there is a current connection to each of the plurality of instant voice message client systems,

~~The system according to claim 2,~~ wherein the messaging system receives connection object messages from the plurality of instant voice message client systems, wherein each of the connection object messages includes data representing a state of a logical connection with a given one of the plurality of instant voice message client systems.

14. (Previously presented): The system according to claim 13, wherein the connection object messages identifies at least one of a socket, a size of data to be transferred and a priority of the data.

15. (Previously presented): The system according to claim 13, wherein the communication platform system populates a connection list for the plurality of instant voice message client systems with the data in the connection object messages received from each of the plurality of instant voice message client systems.

16. (Currently amended): The system according to claim [[2]] 6, wherein the communication platform system assigns an IP address to each of the instant voice message client systems when the communication platform receives a connection request from each of the instant voice message client systems.

17. (Currently amended): The system according to claim [[2]] 6, further comprising: a message database storing the instant voice messages received from the instant voice message client systems.

18. (Currently amended): The system according to claim [[2]] 6, wherein, upon receipt of an instant voice message, the communication platform system determines if there is the current connection to one of the plurality of instant voice message client systems identified as a recipient of the instant voice message, and if there is no connection with the one of the plurality of instant voice message client system identified as the recipient, the instant voice message is stored and delivered when the one of the plurality of instant voice message client systems identified as the recipient re-established a connection.



19. (Currently amended): The system according to claim [[2]] 6, wherein the communication platform system updates the connection information for each of the instant voice message client systems by periodically transmitting a connection status request to the given one of the plurality of instant voice message client systems.

20. (Currently amended): A system comprising:

a client device;

a network interface coupled to the client device and connecting the client device to a packet-switched network; and

an instant voice messaging application installed on the client device, wherein the instant voice messaging application includes a client platform system for generating an instant voice message and a messaging system for transmitting the instant voice message over the packet-switched network via the network interface,

wherein the instant voice messaging application includes a document handler system for attaching one or more files to the instant voice message.

21. (Cancelled).

22. (Previously presented): The system according to claim 20, wherein the instant voice messaging application includes a message database storing the instant voice message, wherein the instant voice messages is represented by a database record including a unique identifier.

23. (Previously presented): The system according to claim 22, wherein the instant voice message stored in the message database include a plurality of instant voice messages recorded by a user of the client device and instant voice messages received over the packet-switched network.

24. (Previously presented): The system according to claim 23, further comprising: a display displaying at least one of the plurality of instant voice messages stored in the message database.

25. (Previously presented): The system according to claim 22, wherein the instant voice messaging application includes a file manager system storing, deleting and retrieving the instant voice messages from the message database in response to a user request.

26. (Previously presented): The system according to claim 20, wherein the instant voice messaging application includes an audio file creation system creating an audio file for the instant voice message based on input received via an audio input device coupled to the client device.

27. (Previously presented): The system according to claim 20, wherein the instant voice messaging application includes an encryption/decryption system for encrypting the instant voice messages to be transmitted over the packet-switched network and decrypting the instant voices messages received over the packet-switched network.

28. (Previously presented): The system according to claim 20, wherein the instant voice messaging application includes a compression/decompression system for compressing the instant voice messages to be transmitted over the packet-switched network and decompressing the instant voice messages received over the packet-switched network.

29. (Currently amended): A system comprising:

a client device;

a network interface coupled to the client device and connecting the client device to a packet-switched network; and

an instant voice messaging application installed on the client device, wherein the instant voice messaging application includes a client platform system for generating an instant voice message and a messaging system for transmitting the instant voice message over the packet-switched network via the network interface,

~~The system according to claim 20, further comprising:~~ a display displaying a list of one or more potential recipients for an instant voice message.

30. (Previously presented): The system according to claim 29, wherein the display includes an indicia for each of the one or more potential recipients indicating whether the potential recipient is currently available to receive an instant voice message.

31. (Previously presented): The system according to claim 20, wherein the instant voice message application generates an audible or visual effect indicating receipt of an instant voice message.

32. (Previously presented): The system according to claim 20, wherein the instant voice message application communicates in an intercom mode when a recipient of the instant voice message is currently available to receive the instant voice message and communicates in a record mode when the recipient of the instant voice message is currently unavailable to receive the instant voice message.

33. (Previously presented): The system according to claim 32, wherein the instant voice message application utilizes the intercom mode as a default communication mode.

34. (New) The system according to claim 6, wherein each of the instant voice message client systems comprises an instant voice messaging application generating an instant voice message

and transmitting the instant voice message over the packet-switched network to the messaging system.

35. (New): The system according to claim 34, wherein the instant voice messaging application includes a message database storing the instant voice message, wherein the instant voice message is represented by a database record including a unique identifier.

36. (New): The system according to claim 35, wherein the message database includes a plurality of instant voice messages recorded by a user of the client device and instant voice messages received over the packet-switched network.

37. (New): The system according to claim 36, wherein the instant voice messaging application displays at least one of the plurality of instant voice messages stored in the message database.

38. (New): The system according to claim 35, wherein the instant voice messaging application includes a file manager system performing at least one of storing, deleting and retrieving the instant voice messages from the message database.

39. (New): The system according to claim 34, wherein the instant voice messaging application includes an audio file creation system creating an audio file for the instant voice message based on input received via an audio input device coupled to the client device.

40. (New): The system according to claim 34, wherein the instant voice messaging application includes an encryption/decryption system for encrypting the instant voice messages to be transmitted over the packet-switched network and decrypting the instant voices messages received over the packet-switched network.

41. (New): The system according to claim 34, wherein the instant voice messaging application includes a compression/decompression system for compressing the instant voice messages to be transmitted over the packet-switched network and decompressing the instant voice messages received over the packet-switched network.
42. (New): The system according to claim 34, wherein the instant voice messaging application displays a list of one or more potential recipients for the instant voice message.
43. (New): The system according to claim 42, wherein the instant voice messaging application displays an indicia for each of the one or more potential recipients indicating whether the potential recipient is currently available to receive an instant voice message.
44. (New): The system according to claim 34, wherein the instant voice message application generates an audible or visual effect indicating receipt of an instant voice message.

### REMARKS

By this amendment, claims 3, 4, 12, and 21 have been cancelled, claims 2, 5, 6, 13, 16-20, and 29 have been amended, and new claims 34-44 have been added. No new matter is introduced. Claims 2, 5-11, 13-20 and 22-44 will remain pending herein upon entry of this Response. For the reasons stated below, the Applicant respectfully submits that all claims pending in this application are in condition for allowance. Reconsideration of this application is respectfully requested in view of the following remarks.

The subject matter of new claim 34 is described in the specification at, for example, page 13, line 15 – page 14, line 17.

The subject matter of new claim 35 is described in the specification at, for example, page 25, lines 6-8.

The subject matter of new claim 36 is described in the specification at, for example, page 35, lines 6-8.

The subject matter of new claim 37 is described in the specification at, for example, page 14, lines 12-14.

The subject matter of new claim 38 is described in the specification at, for example, page 25, lines 8-10.

The subject matter of new claim 39 is described in the specification at, for example, page 25, lines 10-12.

The subject matter of new claim 40 is described in the specification at, for example, page 25, lines 14-15.

The subject matter of new claim 41 is described in the specification at, for example, page 25, lines 15-17.

The subject matter of new claim 42 is described in the specification at, for example, page 13, line 15 – page 14, line 17.

The subject matter of new claim 43 is described in the specification at, for example, page 29, line 18 – page 30, line 7.

The subject matter of new claim 44 is described in the specification at, for example, page 16, line 23 – page 17, line 2.

Entry of the above amendments is proper under 37 C.F.R. § 1.116 because the amendments (1) place the claims in better form for appeal if needed; and (2) do not introduce any elements requiring further search by the Examiner.

#### **Double Patenting Rejections**

Claims 2-33 are rejected on the ground of non-statutory obviousness-type double patenting as being unpatentable over claims 1-70 of U.S. Patent No. 7,535,890 (hereinafter the “‘890 patent”).

Claims 3, 4, 12, and 21 have been cancelled, rendering the rejection of these claims moot.

The Applicants file herewith a Terminal Disclaimer over the ‘890 patent. As set forth in the MPEP, a Terminal Disclaimer may be used to overcome a rejection based on obviousness-type double patenting (MPEP § 804.02(II)). Further, in legal principle, the filing of a Terminal Disclaimer simply serves the statutory function of removing the rejection of obviousness-type double patenting, and does not raise a presumption on the merits of the rejection. It is improper

to view the simple expedient of “obviation” as an admission or acquiescence on the merits.

*Ortho Pharmaceutical Corp. v. Smith*, 22 USPQ2d 1119, 1124 (Fed. Cir. 1992) citing *Quad Envtl. Technologies Corp. v. Union Sanitary Dist.*, 946 F.2d 870, 874, 20 USPQ2d 1392, 1394-95 (Fed. Cir. 1991).

Withdrawal of the rejection of claims 2, 5-11, 13-20, and 22-33 based on the judicially created doctrine of double patenting is respectfully requested.

### **35 U.S. C. § 102(e) Rejections**

Claims 2-3, 6, 11, 17-18, 20, 22-23, 26, and 32-33 stand rejected under 35 U.S.C. § 102(e) as unpatentable over U.S. Patent No. 7,372,826 to Dahod et al. (“Dahod”). This rejection is respectfully traversed. However, to move prosecution forward, the Applicant incorporates the allowable subject matter of claims 4, 12, 13, 21, and 29 into independent claims, as described below. The Applicant reserves the right to pursue previously filed claims in a continuation application, and this amendment does not indicate express or implicit agreement with the Examiner’s rejections of previously presented claims.

Claim 3 has been cancelled, rendering the rejection of this claim moot.

Independent claim 2 has been amended to incorporate the subject matter of claims 3 and 4. Since the Examiner indicated that claim 4, which depended from claims 2 and 3, would be allowable if rewritten in independent form, it is respectfully submitted that amended independent claim 2 and claim 5 (which depends from claim 2) are allowable.

Claim 6 has been rewritten in independent form incorporating the subject matter of claims 2 and 12. Since the Examiner indicated that claim 12, which depended from claims 2 and



6, would be allowable if rewritten in independent form, it is respectfully submitted that amended independent claim 6 and claims 7-11 and 16-19 (which depend from claim 6) are allowable.

Claim 13 has been rewritten in independent form incorporating the subject matter of claim 2. Since the Examiner indicated that claim 13, which depended from claim 2, would be allowable if rewritten in independent form, it is respectfully submitted that amended independent claim 13 and claims 14-15 (which depend from claim 13) are allowable.

Independent claim 20 has been amended to incorporate the subject matter of claim 21. Since the Examiner indicated that claim 21, which depended from claim 20, would be allowable if rewritten in independent form, it is respectfully submitted that amended independent claim 20 and claims 22-28 and 31-33 (which depend from claim 20) are allowable.

Claim 29 has been rewritten in independent form incorporating the subject matter of claim 20. Since the Examiner indicated that claim 29, which depended from claim 20, would be allowable if rewritten in independent form, it is respectfully submitted that amended independent claim 29 and claim 30 (which depends from claim 29) are allowable.

Withdrawing of the rejection of claims 2, 6, 11, 17-18, 20, 22-23, 26, and 32-33 under 35 U.S.C. § 102(e) is respectfully requested.

New claims 34-44 depend directly or indirectly from allowable amended claim 6. Thus, it is respectfully submitted that new claims 34-44 are allowable at least for the reasons that amended claim 6 is allowable.

Serial No.: 13/546,673  
Art Unit: 2656

Attorney's Docket No.: EMP0024-US  
Page 15

### **Conclusion**

Should the Examiner have any questions or determine that any further action is desirable to place this application in even better condition for issue, the Examiner is encouraged to telephone the Applicant's undersigned representative at the number listed below.

KASHA LAW LLC  
14532 Dufief Mill Rd.  
North Potomac, MD 20878  
Tel. 240-423-8431  
Date: February 28, 2014

Respectfully submitted,

By: /Kelly L. Kasha/  
Kelly L. Kasha  
Registration No. 47,743

Customer No. 67050

## Electronic Acknowledgement Receipt

<b>EFS ID:</b>	18332655
<b>Application Number:</b>	13546673
<b>International Application Number:</b>	
<b>Confirmation Number:</b>	9648
<b>Title of Invention:</b>	SYSTEM AND METHOD FOR INSTANT VoIP MESSAGING
<b>First Named Inventor/Applicant Name:</b>	Michael J. Rojas
<b>Customer Number:</b>	67050
<b>Filer:</b>	John Kasha
<b>Filer Authorized By:</b>	
<b>Attorney Docket Number:</b>	EMP0024-US
<b>Receipt Date:</b>	28-FEB-2014
<b>Filing Date:</b>	11-JUL-2012
<b>Time Stamp:</b>	12:14:06
<b>Application Type:</b>	Utility under 35 USC 111(a)

### Payment information:

Submitted with Payment	no
------------------------	----

### File Listing:

Document Number	Document Description	File Name	File Size(Bytes)/ Message Digest	Multi Part /.zip	Pages (if appl.)
1	Response After Final Action	EMP0024- US_af_resp_02_28_2014.pdf	130813  1b2c718c8fff1198d626b5030ad57e78dc7e0057	no	15

### Warnings:

### Information:

This Acknowledgement Receipt evidences receipt on the noted date by the USPTO of the indicated documents, characterized by the applicant, and including page counts, where applicable. It serves as evidence of receipt similar to a Post Card, as described in MPEP 503.

**New Applications Under 35 U.S.C. 111**

If a new application is being filed and the application includes the necessary components for a filing date (see 37 CFR 1.53(b)-(d) and MPEP 506), a Filing Receipt (37 CFR 1.54) will be issued in due course and the date shown on this Acknowledgement Receipt will establish the filing date of the application.

**National Stage of an International Application under 35 U.S.C. 371**

If a timely submission to enter the national stage of an international application is compliant with the conditions of 35 U.S.C. 371 and other applicable requirements a Form PCT/DO/EO/903 indicating acceptance of the application as a national stage submission under 35 U.S.C. 371 will be issued in addition to the Filing Receipt, in due course.

**New International Application Filed with the USPTO as a Receiving Office**

If a new international application is being filed and the international application includes the necessary components for an international filing date (see PCT Article 11 and MPEP 1810), a Notification of the International Application Number and of the International Filing Date (Form PCT/RO/105) will be issued in due course, subject to prescriptions concerning national security, and the date shown on this Acknowledgement Receipt will establish the international filing date of the application.

<b>Doc Code: DIST.E.FILE</b> <b>Document Description: Electronic Terminal Disclaimer - Filed</b>		PTO/SB/26 U.S. Patent and Trademark Office Department of Commerce
Electronic Petition Request	<b>TERMINAL DISCLAIMER TO OBVIATE A DOUBLE PATENTING REJECTION OVER A "PRIOR" PATENT</b>	
Application Number	13546673	
Filing Date	11-Jul-2012	
First Named Inventor	Michael Rojas	
Attorney Docket Number	EMP0024-US	
Title of Invention	SYSTEM AND METHOD FOR INSTANT VoIP MESSAGING	
<input checked="" type="checkbox"/> Filing of terminal disclaimer does not obviate requirement for response under 37 CFR 1.111 to outstanding Office Action  <input checked="" type="checkbox"/> This electronic Terminal Disclaimer is not being used for a Joint Research Agreement.		
Owner	Percent Interest	
EMPIRE IP LLC	100%	
<p>The owner(s) with percent interest listed above in the instant application hereby disclaims, except as provided below, the terminal part of the statutory term of any patent granted on the instant application which would extend beyond the expiration date of the full statutory term of prior patent number(s)</p> <p>7535890</p> <p>as the term of said prior patent is presently shortened by any terminal disclaimer. The owner hereby agrees that any patent so granted on the instant application shall be enforceable only for and during such period that it and the prior patent are commonly owned. This agreement runs with any patent granted on the instant application and is binding upon the grantee, its successors or assigns.</p> <p>In making the above disclaimer, the owner does not disclaim the terminal part of the term of any patent granted on the instant application that would extend to the expiration date of the full statutory term of the prior patent, "as the term of said prior patent is presently shortened by any terminal disclaimer," in the event that said prior patent later:</p> <ul style="list-style-type: none"> <li>- expires for failure to pay a maintenance fee;</li> <li>- is held unenforceable;</li> <li>- is found invalid by a court of competent jurisdiction;</li> <li>- is statutorily disclaimed in whole or terminally disclaimed under 37 CFR 1.321;</li> <li>- has all claims canceled by a reexamination certificate;</li> <li>- is reissued; or</li> <li>- is in any manner terminated prior to the expiration of its full statutory term as presently shortened by any terminal disclaimer.</li> </ul> <p><input checked="" type="radio"/> Terminal disclaimer fee under 37 CFR 1.20(d) is included with Electronic Terminal Disclaimer request.</p>		

I certify, in accordance with 37 CFR 1.4(d)(4), that the terminal disclaimer fee under 37 CFR 1.20(d) required for this terminal disclaimer has already been paid in the above-identified application.

Applicant claims the following fee status:

- Small Entity
- Micro Entity
- Regular Undiscounted

I hereby declare that all statements made herein of my own knowledge are true and that all statements made on information and belief are believed to be true; and further that these statements were made with the knowledge that willful false statements and the like so made are punishable by fine or imprisonment, or both, under Section 1001 of Title 18 of the United States Code and that such willful false statements may jeopardize the validity of the application or any patent issued thereon.

THIS PORTION MUST BE COMPLETED BY THE SIGNATORY OR SIGNATORIES

I certify, in accordance with 37 CFR 1.4(d)(4) that I am:

- An attorney or agent registered to practice before the Patent and Trademark Office who is of record in this application  
  
Registration Number 47743
- A sole inventor
- A joint inventor; I certify that I am authorized to sign this submission on behalf of all of the inventors as evidenced by the power of attorney in the application
- A joint inventor; all of whom are signing this request

Signature	/Kelly L. Kasha/
Name	Kelly L. Kasha

\*Statement under 37 CFR 3.73(b) is required if terminal disclaimer is signed by the assignee (owner).  
Form PTO/SB/96 may be used for making this certification. See MPEP § 324.

## Electronic Patent Application Fee Transmittal

<b>Application Number:</b>	13546673			
<b>Filing Date:</b>	11-Jul-2012			
<b>Title of Invention:</b>	SYSTEM AND METHOD FOR INSTANT VoIP MESSAGING			
<b>First Named Inventor/Applicant Name:</b>	Michael J. Rojas			
<b>Filer:</b>	John Kasha			
<b>Attorney Docket Number:</b>	EMP0024-US			
Filed as Small Entity				
<b>Utility under 35 USC 111(a) Filing Fees</b>				
<b>Description</b>	<b>Fee Code</b>	<b>Quantity</b>	<b>Amount</b>	<b>Sub-Total in USD(\$)</b>
<b>Basic Filing:</b>				
Statutory or Terminal Disclaimer	1814	1	160	160
<b>Pages:</b>				
<b>Claims:</b>				
<b>Miscellaneous-Filing:</b>				
<b>Petition:</b>				
<b>Patent-Appeals-and-Interference:</b>				
<b>Post-Allowance-and-Post-Issuance:</b>				
<b>Extension-of-Time:</b>				

Description	Fee Code	Quantity	Amount	Sub-Total in USD(\$)
<b>Miscellaneous:</b>				
<b>Total in USD (\$)</b>				<b>160</b>



Doc Code: DISQ.E.FILE

Document Description: Electronic Terminal Disclaimer – Approved

Application No.: 13546673

Filing Date: 11-Jul-2012

Applicant/Patent under Reexamination: Rojas et al.

Electronic Terminal Disclaimer filed on February 28, 2014

APPROVED

**This patent is subject to a terminal disclaimer**

DISAPPROVED

Approved/Disapproved by: Electronic Terminal Disclaimer automatically approved by EFS-Web

U.S. Patent and Trademark Office

## Electronic Acknowledgement Receipt

<b>EFS ID:</b>	18333431
<b>Application Number:</b>	13546673
<b>International Application Number:</b>	
<b>Confirmation Number:</b>	9648
<b>Title of Invention:</b>	SYSTEM AND METHOD FOR INSTANT VoIP MESSAGING
<b>First Named Inventor/Applicant Name:</b>	Michael J. Rojas
<b>Customer Number:</b>	67050
<b>Filer:</b>	John Kasha
<b>Filer Authorized By:</b>	
<b>Attorney Docket Number:</b>	EMP0024-US
<b>Receipt Date:</b>	28-FEB-2014
<b>Filing Date:</b>	11-JUL-2012
<b>Time Stamp:</b>	12:32:12
<b>Application Type:</b>	Utility under 35 USC 111(a)

### Payment information:

Submitted with Payment	yes
Payment Type	Deposit Account
Payment was successfully received in RAM	\$ 160
RAM confirmation Number	11204
Deposit Account	504075
Authorized User	

The Director of the USPTO is hereby authorized to charge indicated fees and credit any overpayment as follows:

Charge any Additional Fees required under 37 C.F.R. Section 1.16 (National application filing, search, and examination fees)

Charge any Additional Fees required under 37 C.F.R. Section 1.17 (Patent application and reexamination processing fees)

Charge any Additional Fees required under 37 C.F.R. Section 1.19 (Document supply fees)

Charge any Additional Fees required under 37 C.F.R. Section 1.20 (Post Issuance fees)

Charge any Additional Fees required under 37 C.F.R. Section 1.21 (Miscellaneous fees and charges)

**File Listing:**

Document Number	Document Description	File Name	File Size(Bytes)/ Message Digest	Multi Part /.zip	Pages (if appl.)
1	Electronic Terminal Disclaimer-Filed	eTerminal-Disclaimer.pdf	33450 90910199d4fcd611e5731daf819f390c18f0b6	no	2

**Warnings:**

**Information:**

2	Fee Worksheet (SB06)	fee-info.pdf	29956 5e64c347567afe3d1a53044fc97cfaed55a3ac9	no	2
---	----------------------	--------------	--	----	---

**Warnings:**

**Information:**

**Total Files Size (in bytes):** 63406

This Acknowledgement Receipt evidences receipt on the noted date by the USPTO of the indicated documents, characterized by the applicant, and including page counts, where applicable. It serves as evidence of receipt similar to a Post Card, as described in MPEP 503.

**New Applications Under 35 U.S.C. 111**

If a new application is being filed and the application includes the necessary components for a filing date (see 37 CFR 1.53(b)-(d) and MPEP 506), a Filing Receipt (37 CFR 1.54) will be issued in due course and the date shown on this Acknowledgement Receipt will establish the filing date of the application.

**National Stage of an International Application under 35 U.S.C. 371**

If a timely submission to enter the national stage of an international application is compliant with the conditions of 35 U.S.C. 371 and other applicable requirements a Form PCT/DO/EO/903 indicating acceptance of the application as a national stage submission under 35 U.S.C. 371 will be issued in addition to the Filing Receipt, in due course.

**New International Application Filed with the USPTO as a Receiving Office**

If a new international application is being filed and the international application includes the necessary components for an international filing date (see PCT Article 11 and MPEP 1810), a Notification of the International Application Number and of the International Filing Date (Form PCT/RO/105) will be issued in due course, subject to prescriptions concerning national security, and the date shown on this Acknowledgement Receipt will establish the international filing date of the application.

Under the Paperwork Reduction Act of 1995, no persons are required to respond to a collection of information unless it displays a valid OMB control number.

<b>PATENT APPLICATION FEE DETERMINATION RECORD</b> Substitute for Form PTO-875	Application or Docket Number <b>13/546,673</b>	Filing Date <b>07/11/2012</b>	<input type="checkbox"/> To be Mailed
---	---	----------------------------------	---------------------------------------

ENTITY:  LARGE  SMALL  MICRO

**APPLICATION AS FILED – PART I**

FOR	NUMBER FILED (Column 1)	NUMBER EXTRA (Column 2)	RATE (\$)	FEE (\$)
<input type="checkbox"/> BASIC FEE (37 CFR 1.16(a), (b), or (c))	N/A	N/A	N/A	
<input type="checkbox"/> SEARCH FEE (37 CFR 1.16(k), (j), or (m))	N/A	N/A	N/A	
<input type="checkbox"/> EXAMINATION FEE (37 CFR 1.16(c), (p), or (q))	N/A	N/A	N/A	
TOTAL CLAIMS (37 CFR 1.16(i))	minus 20 =	*	X \$ =	
INDEPENDENT CLAIMS (37 CFR 1.16(h))	minus 3 =	*	X \$ =	
<input type="checkbox"/> APPLICATION SIZE FEE (37 CFR 1.16(s))	If the specification and drawings exceed 100 sheets of paper, the application size fee due is \$310 (\$155 for small entity) for each additional 50 sheets or fraction thereof. See 35 U.S.C. 41(a)(1)(G) and 37 CFR 1.16(s).			
<input type="checkbox"/> MULTIPLE DEPENDENT CLAIM PRESENT (37 CFR 1.16(j))				
			TOTAL	

\* If the difference in column 1 is less than zero, enter "0" in column 2.

**APPLICATION AS AMENDED – PART II**

	(Column 1)	(Column 2)	(Column 3)	RATE (\$)	ADDITIONAL FEE (\$)
<b>AMENDMENT</b>	<b>02/28/2014</b>	CLAIMS REMAINING AFTER AMENDMENT	HIGHEST NUMBER PREVIOUSLY PAID FOR	PRESENT EXTRA	
	Total (37 CFR 1.16(i))	+ 39	Minus ** 32	= 7	x \$40 = 280
	Independent (37 CFR 1.16(h))	+ 5	Minus *** 3	= 2	x \$210 = 420
	<input type="checkbox"/> Application Size Fee (37 CFR 1.16(s))				
<input type="checkbox"/> FIRST PRESENTATION OF MULTIPLE DEPENDENT CLAIM (37 CFR 1.16(j))					
				TOTAL ADD'L FEE	<b>700</b>

	(Column 1)	(Column 2)	(Column 3)	RATE (\$)	ADDITIONAL FEE (\$)
<b>AMENDMENT</b>		CLAIMS REMAINING AFTER AMENDMENT	HIGHEST NUMBER PREVIOUSLY PAID FOR	PRESENT EXTRA	
	Total (37 CFR 1.16(i))	+	Minus **	=	X \$ =
	Independent (37 CFR 1.16(h))	+	Minus ***	=	X \$ =
	<input type="checkbox"/> Application Size Fee (37 CFR 1.16(s))				
<input type="checkbox"/> FIRST PRESENTATION OF MULTIPLE DEPENDENT CLAIM (37 CFR 1.16(j))					
				TOTAL ADD'L FEE	

\* If the entry in column 1 is less than the entry in column 2, write "0" in column 3.  
 \*\* If the "Highest Number Previously Paid For" IN THIS SPACE is less than 20, enter "20".  
 \*\*\* If the "Highest Number Previously Paid For" IN THIS SPACE is less than 3, enter "3".

LIE  
/KIMBERLY PANNELL/

The "Highest Number Previously Paid For" (Total or Independent) is the highest number found in the appropriate box in column 1.

This collection of information is required by 37 CFR 1.16. The information is required to obtain or retain a benefit by the public which is to file (and by the USPTO to process) an application. Confidentiality is governed by 35 U.S.C. 122 and 37 CFR 1.14. This collection is estimated to take 12 minutes to complete, including gathering, preparing, and submitting the completed application form to the USPTO. Time will vary depending upon the individual case. Any comments on the amount of time you require to complete this form and/or suggestions for reducing this burden, should be sent to the Chief Information Officer, U.S. Patent and Trademark Office, U.S. Department of Commerce, P.O. Box 1450, Alexandria, VA 22313-1450. DO NOT SEND FEES OR COMPLETED FORMS TO THIS ADDRESS. **SEND TO: Commissioner for Patents, P.O. Box 1450, Alexandria, VA 22313-1450.**

If you need assistance in completing the form, call 1-800-PTO-9199 and select option 2.

Document code: WFEE

United States Patent and Trademark Office  
Sales Receipt for Accounting Date: 03/03/2014

KPANNELL SALE #00000001 Mailroom Dt: 02/28/2014 504075 13546673  
01 FC : 1201 420.00 DA

Document code: WFEE

United States Patent and Trademark Office  
Sales Receipt for Accounting Date: 03/03/2014

KPANNELL SALE #00000002 Mailroom Dt: 02/28/2014 504075 13546673  
01 FC : 2202 280.00 DA

UNITED STATES PATENT AND TRADEMARK OFFICE  
COMMISSIONER FOR PATENTS  
P.O.BOX 1450  
ALEXANDRIA VA 22313-1451

PRESORTED  
FIRST-CLASS MAIL  
U.S. POSTAGE PAID  
POSTDIGITAL  
NNNNN

KASHA LAW LLC  
14532 Dufief Mill Road  
North Potomac, MD 20878



**Courtesy Reminder for  
Application Serial No: 13/546,673**

Attorney Docket No: EMP0024-US

Customer Number: 67050

Date of Electronic Notification: 11/29/2013

This is a courtesy reminder that new correspondence is available for this application. If you have not done so already, please review the correspondence. The official date of notification of the outgoing correspondence will be indicated on the form PTOL-90 accompanying the correspondence.

An email notification regarding the correspondence was sent to the following email address(es) associated with your customer number:

JOHN.KASHA@KASHALAW.COM

To view your correspondence online or update your email addresses, please visit us anytime at <https://sportal.uspto.gov/secure/myportal/privatepair>. If you have any questions, please email the Electronic Business Center (EBC) at [EBC@uspto.gov](mailto:EBC@uspto.gov) or call 1-866-217-9197.



UNITED STATES PATENT AND TRADEMARK OFFICE

UNITED STATES DEPARTMENT OF COMMERCE
United States Patent and Trademark Office
Address: COMMISSIONER FOR PATENTS
P.O. Box 1450
Alexandria, Virginia 22313-1450
www.uspto.gov

Table with 5 columns: APPLICATION NO., FILING DATE, FIRST NAMED INVENTOR, ATTORNEY DOCKET NO., CONFIRMATION NO.
13/546,673 07/11/2012 Michael J. Rojas EMP0024-US 9648

67050 7590 11/29/2013
KASHA LAW LLC
14532 Dufief Mill Road
North Potomac, MD 20878

Table with 1 column: EXAMINER

SMITH, CREIGHTON H

Table with 2 columns: ART UNIT, PAPER NUMBER

2656

Table with 2 columns: NOTIFICATION DATE, DELIVERY MODE

11/29/2013

ELECTRONIC

Please find below and/or attached an Office communication concerning this application or proceeding.

The time period for reply, if any, is set in the attached communication.

Notice of the Office communication was sent electronically on above-indicated "Notification Date" to the following e-mail address(es):

JOHN.KASHA@KASHALAW.COM



<b>Office Action Summary</b>	<b>Application No.</b> 13/546,673	<b>Applicant(s)</b> ROJAS, MICHAEL J.	
	<b>Examiner</b> CREIGHTON SMITH	<b>Art Unit</b> 2656	<b>AIA (First Inventor to File) Status</b> No

-- The MAILING DATE of this communication appears on the cover sheet with the correspondence address --

**Period for Reply**

A SHORTENED STATUTORY PERIOD FOR REPLY IS SET TO EXPIRE 3 MONTH(S) OR THIRTY (30) DAYS, WHICHEVER IS LONGER, FROM THE MAILING DATE OF THIS COMMUNICATION.

- Extensions of time may be available under the provisions of 37 CFR 1.136(a). In no event, however, may a reply be timely filed after SIX (6) MONTHS from the mailing date of this communication.
- If NO period for reply is specified above, the maximum statutory period will apply and will expire SIX (6) MONTHS from the mailing date of this communication.
- Failure to reply within the set or extended period for reply will, by statute, cause the application to become ABANDONED (35 U.S.C. § 133). Any reply received by the Office later than three months after the mailing date of this communication, even if timely filed, may reduce any earned patent term adjustment. See 37 CFR 1.704(b).

**Status**

- 1)  Responsive to communication(s) filed on 05 NOV '13.  
 A declaration(s)/affidavit(s) under **37 CFR 1.130(b)** was/were filed on \_\_\_\_\_.
- 2a)  This action is **FINAL**.                      2b)  This action is non-final.
- 3)  An election was made by the applicant in response to a restriction requirement set forth during the interview on \_\_\_\_\_; the restriction requirement and election have been incorporated into this action.
- 4)  Since this application is in condition for allowance except for formal matters, prosecution as to the merits is closed in accordance with the practice under *Ex parte Quayle*, 1935 C.D. 11, 453 O.G. 213.

**Disposition of Claims**

- 5)  Claim(s) 2-33 is/are pending in the application.  
5a) Of the above claim(s) \_\_\_\_\_ is/are withdrawn from consideration.
- 6)  Claim(s) \_\_\_\_\_ is/are allowed.
- 7)  Claim(s) 2-33 is/are rejected.
- 8)  Claim(s) \_\_\_\_\_ is/are objected to.
- 9)  Claim(s) \_\_\_\_\_ are subject to restriction and/or election requirement.

\* If any claims have been determined allowable, you may be eligible to benefit from the **Patent Prosecution Highway** program at a participating intellectual property office for the corresponding application. For more information, please see [http://www.uspto.gov/patents/init\\_events/pph/index.jsp](http://www.uspto.gov/patents/init_events/pph/index.jsp) or send an inquiry to [PPHfeedback@uspto.gov](mailto:PPHfeedback@uspto.gov).

**Application Papers**

- 10)  The specification is objected to by the Examiner.
- 11)  The drawing(s) filed on \_\_\_\_\_ is/are: a)  accepted or b)  objected to by the Examiner.  
Applicant may not request that any objection to the drawing(s) be held in abeyance. See 37 CFR 1.85(a).  
Replacement drawing sheet(s) including the correction is required if the drawing(s) is objected to. See 37 CFR 1.121(d).

**Priority under 35 U.S.C. § 119**

- 12)  Acknowledgment is made of a claim for foreign priority under 35 U.S.C. § 119(a)-(d) or (f).

**Certified copies:**

- a)  All    b)  Some \*    c)  None of the:
  - 1.  Certified copies of the priority documents have been received.
  - 2.  Certified copies of the priority documents have been received in Application No. \_\_\_\_\_.
  - 3.  Copies of the certified copies of the priority documents have been received in this National Stage application from the International Bureau (PCT Rule 17.2(a)).

\* See the attached detailed Office action for a list of the certified copies not received.

**Attachment(s)**

- 1)  Notice of References Cited (PTO-892)
- 2)  Information Disclosure Statement(s) (PTO/SB/08)  
Paper No(s)/Mail Date \_\_\_\_\_.
- 3)  Interview Summary (PTO-413)  
Paper No(s)/Mail Date. \_\_\_\_\_.
- 4)  Other: \_\_\_\_\_.

### DETAILED ACTION

The nonstatutory double patenting rejection is based on a judicially created doctrine grounded in public policy (a policy reflected in the statute) so as to prevent the unjustified or improper timewise extension of the “right to exclude” granted by a patent and to prevent possible harassment by multiple assignees. A nonstatutory double patenting rejection is appropriate where the claims at issue are not identical, but at least one examined application claim is not patentably distinct from the reference claim(s) because the examined application claim is either anticipated by, or would have been obvious over, the reference claim(s). See, e.g., *In re Berg*, 140 F.3d 1428, 46 USPQ2d 1226 (Fed. Cir. 1998); *In re Goodman*, 11 F.3d 1046, 29 USPQ2d 2010 (Fed. Cir. 1993); *In re Longi*, 759 F.2d 887, 225 USPQ 645 (Fed. Cir. 1985); *In re Van Ornum*, 686 F.2d 937, 214 USPQ 761 (CCPA 1982); *In re Vogel*, 422 F.2d 438, 164 USPQ 619 (CCPA 1970); and *In re Thorington*, 418 F.2d 528, 163 USPQ 644 (CCPA 1969).

A timely filed terminal disclaimer in compliance with 37 CFR 1.321(c) or 1.321(d) may be used to overcome an actual or provisional rejection based on a nonstatutory double patenting ground provided the reference application or patent either is shown to be commonly owned with this application, or claims an invention made as a result of activities undertaken within the scope of a joint research agreement. A terminal disclaimer must be signed in compliance with 37 CFR 1.321(b).

The USPTO internet Web site contains terminal disclaimer forms which may be used. Please visit <http://www.uspto.gov/forms/>. The filing date of the

application will determine what form should be used. A web-based eTerminal Disclaimer may be filled out completely online using web-screens. An eTerminal Disclaimer that meets all requirements is auto-processed and approved immediately upon submission. For more information about eTerminal Disclaimers, refer to <http://www.uspto.gov/patents/process/file/efs/guidance/eTD-info-l.jsp>.

Claims 2-33 are rejected on the ground of nonstatutory double patenting as being unpatentable over claims 1-70 of U.S. Patent No. 7,535,890. Although the claims at issue are not identical, they are not patentably distinct from each other because applicant's patent claim 1 claims the instant voice messaging system that delivers IM over the Internet (Abstract). The body of the '723 patent's claim 1 claims a server that is connected to the Internet. Applicant's recital of a network interface in the instant application reads upon the patent's server. Applicant's recital of maintaining connection information for each of the client systems reads upon the server storing the instant voice message if one of the selected recipients/clients is unavailable and delivering the instant voice message if the recipient/client is available. Therefore, maintaining connection information is another way of saying whether the recipient/client is available or unavailable.

The following is a quotation of the appropriate paragraphs of pre-AIA 35 U.S.C. 102 that form the basis for the rejections under this section made in this Office action:

A person shall be entitled to a patent unless –

(e) the invention was described in (1) an application for patent, published under section 122(b), by another filed in the United States before the invention by the applicant for patent or (2) a patent granted on an application for patent by another filed in the United States before the invention by the applicant for patent, except that an international application filed under the treaty defined in section 351(a) shall have the effects for purposes of this subsection of an application filed in the United States only if the international application designated the United States and was published under Article 21(2) of such treaty in the English language.

Claims 2, 3, 6, 11, 17, 18, 20, 22, 23, 26, 32, 33 are rejected under pre-AIA 35 U.S.C. 102E as being anticipated by Dahod et al ("Dahod"), U.S. Pat. #7,372,826.

Dahod teaches in col. 8, lines 15 et seq. teaches a media gateway 410A and a softswitch 425A and server 440, any of which are network interfaces. In col. 9, lines 31 et seq. Dahod discloses that media gateway ("IMG") provides for instant voice messaging ("VIM"). VIM is defined by Dahod where a subscriber defines a group of VIM, calls a phone number and records a voice message that is associated with the group VIM ("VG"). Dahod's system will then dial the group's members (the plurality of client systems) and play the recorded message to the client systems/VG. In col. 12, lines 19 et seq. Dahod discloses his system can handle cases like applicant's, if an intended recipient is unavailable to receive an instant voice message, the message is stored in a system mailbox on a system server for future delivery. Therefore, Dahod's system's gateway knows whether an intended recipient of the VIM is available or unavailable by whether or not the recipient phone is on, or if the recipient is busy on another call.

Pertaining to claim 3, Dahod discloses in col. 9, lines 35 et seq. that a subscriber will define a VIM GROUP (VG). The subscriber will then dial a phone number and record a message associated with the pre-defined VG. Dahod's system will dial out to the members of the VG and play the pre-recorded

message. In order to dial out to the group members, the group members' phone number, i.e. user records, will have been previously stored in Dahod's system by the subscriber who makes up the VIM GROUP/VG.

Regarding claim 11, in col. 10, lines 22 et seq. Dahod discloses the user identifies a destination user by keypad entry and the gateway causes the message to be delivered to a gateway corresponding to the other MS.

The following is a quotation of pre-AIA 35 U.S.C. 103(a) which forms the basis for all obviousness rejections set forth in this Office action:

(a) A patent may not be obtained though the invention is not identically disclosed or described as set forth in section 102 of this title, if the differences between the subject matter sought to be patented and the prior art are such that the subject matter as a whole would have been obvious at the time the invention was made to a person having ordinary skill in the art to which said subject matter pertains. Patentability shall not be negated by the manner in which the invention was made.

Claims 9, 10 are rejected under pre-AIA 35 U.S.C. 103(a) as being unpatentable over Dahod et al in view of Bear et al ("Bear"), USPAP #2004/0223599.

Bear discloses in P.0070 that an incoming data call such as IM or email will also include the source of the communication, i.e. an identifier of who called or sent the message. To have provided Bear's teaching of including an identifier of the source of a call in Dahod's system would have been obvious to a person having ordinary skill in the art because both references are teaching calls.

Claim 16 is rejected under pre-AIA 35 U.S.C. 103(a) as being unpatentable over Dahod et al in view of Hurtta et al ("Hurtta"), USPAP #2005/0117591.

Hurtta discloses in P.0054 Ip addresses that are assigned to users. To have provided Hurtta's teaching of assigning IP addresses in Dahod's messaging system would have been obvious to a person having ordinary skill in the art because both references are teaching messaging in the packet switched network .

Claim 24 is rejected under pre-AIA 35 U.S.C. 103(a) as being unpatentable over Dahod et al in view of Weiner, USPAP #2013/0279681.

Weiner discloses in P.0103 that an instant voice message (IVM) may be displayed on a handset. To have provided Weiner's teaching of displaying an IVM in Dahod's system would have been obvious to a person having ordinary skill in the art.

Claims 4, 5, 7, 8, 12-15, 19, 21, 25, 27-31 are objected to as being dependent upon a rejected base claim, but would be allowable if rewritten in independent form including all of the limitations of the base claim and any intervening claims.

Applicant's amendment necessitated the new ground(s) of rejection presented in this Office action. Accordingly, **THIS ACTION IS MADE FINAL**. See MPEP § 706.07(a). Applicant is reminded of the extension of time policy as set forth in 37 CFR 1.136(a).

A shortened statutory period for reply to this final action is set to expire THREE MONTHS from the mailing date of this action. In the event a first reply is filed within TWO MONTHS of the mailing date of this final action and the advisory action is not mailed until after the end of the THREE-MONTH shortened statutory

period, then the shortened statutory period will expire on the date the advisory action is mailed, and any extension fee pursuant to 37 CFR 1.136(a) will be calculated from the mailing date of the advisory action. In no event, however, will the statutory period for reply expire later than SIX MONTHS from the date of this final action.

Any inquiry concerning this communication should be directed to  
CREIGHTON SMITH at telephone number (571)272-7546.

/CREIGHTON SMITH/

Primary Examiner, Art Unit 2656

18 NOV '13

<b>Notice of References Cited</b>	Application/Control No. 13/546,673	Applicant(s)/Patent Under Reexamination ROJAS, MICHAEL J.	
	Examiner CREIGHTON SMITH	Art Unit 2656	Page 1 of 1

**U.S. PATENT DOCUMENTS**

*	Document Number Country Code-Number-Kind Code	Date MM-YYYY	Name	Classification
*	A US-2004/0223599	11-2004	Bear et al.	379/207.02
*	B US-2008/0298309	12-2008	DePietro et al.	370/328
*	C US-2005/0117591	06-2005	Hurtta et al.	370/401
*	D US-2013/0279681	10-2013	Weiner, Moshe	379/207.02
	E US-			
	F US-			
	G US-			
	H US-			
	I US-			
	J US-			
	K US-			
	L US-			
	M US-			

**FOREIGN PATENT DOCUMENTS**

*	Document Number Country Code-Number-Kind Code	Date MM-YYYY	Country	Name	Classification
	N				
	O				
	P				
	Q				
	R				
	S				
	T				

**NON-PATENT DOCUMENTS**

*	Include as applicable: Author, Title Date, Publisher, Edition or Volume, Pertinent Pages)
U	
V	
W	
X	

\*A copy of this reference is not being furnished with this Office action. (See MPEP § 707.05(a).)  
Dates in MM-YYYY format are publication dates. Classifications may be US or foreign.



## EAST Search History

## EAST Search History (Prior Art)

Ref #	Hits	Search Query	DBs	Default Operator	Plurals	Time Stamp
L1	0	((@ad<="20031218") or (@rlad<="20031218")) and records with name with password with list near6 other	US-PGPUB; USPAT; EPO; JPO; DERWENT	OR	OFF	2013/11/18 14:16
L2	17	((@ad<="20031218") or (@rlad<="20031218")) and records with name with password with list	US-PGPUB; USPAT; EPO; JPO; DERWENT	OR	OFF	2013/11/18 14:16
L3	28415741	((@ad<="20031218") or (@rlad<="20031218")) andmessag\$3 same records with name with password with list	US-PGPUB; USPAT; EPO; JPO; DERWENT	OR	OFF	2013/11/18 14:17
L4	7	((@ad<="20031218") or (@rlad<="20031218")) and messag\$3 same records with name with password with list	US-PGPUB; USPAT; EPO; JPO; DERWENT	OR	OFF	2013/11/18 14:17
L5	0	((@ad<="20031218") or (@rlad<="20031218")) and instant near5 voice near5 message\$3 with action near3 field	US-PGPUB; USPAT; EPO; JPO; DERWENT	OR	OFF	2013/11/18 14:23
L6	7	((@ad<="20031218") or (@rlad<="20031218")) and instant near5 voice near5 message\$3 same action near3 field	US-PGPUB; USPAT; EPO; JPO; DERWENT	OR	OFF	2013/11/18 14:23
L7	0	((@ad<="20031218") or (@rlad<="20031218")) and instant near5 voice near5 message\$3 same identifi\$7	US-PGPUB; USPAT; EPO; JPO; DERWENT	OR	OFF	2013/11/18 14:24
L8	9	((@ad<="20031218") or (@rlad<="20031218")) and instant near5 voice near5 message\$3 same source with IDentifi\$7	US-PGPUB; USPAT; EPO; JPO; DERWENT	OR	OFF	2013/11/18 14:44
L9	18	((@ad<="20031218") or (@rlad<="20031218")) and instant near5 voice near5 message\$3 same (destination or recipinet or called) with IDentifi\$7	US-PGPUB; USPAT; EPO; JPO; DERWENT	OR	OFF	2013/11/18 14:53
L10	7	((@ad<="20031218") or (@rlad<="20031218")) and instant near5 voice near5 message\$3 same digitized near4 audio near4 file	US-PGPUB; USPAT; EPO; JPO; DERWENT	OR	OFF	2013/11/18 15:14

L11	7	((@ad<="20031218") or (@rlad<="20031218")) and instant near5 voice near5 message\$3 same digitized near4 audio	US-PGPUB; USPAT; EPO; JPO; DERWENT	OR	OFF	2013/11/18 15:14
L12	29	((@ad<="20031218") or (@rlad<="20031218")) and messag\$3 same connect\$3 near5 messages with (plural\$3 or multipl\$5) with (clients or recipients)	US-PGPUB; USPAT; EPO; JPO; DERWENT	OR	OFF	2013/11/18 15:16
L13	53	((@ad<="20031218") or (@rlad<="20031218")) and (ip or internet adj protocol or packet near2 switch\$3) same assign\$3 with (ip or (internet adj protocol)) adj address same (instant adj voice adj messag\$3 or im or instant adj messag\$3)	US-PGPUB; USPAT; EPO; JPO; DERWENT	OR	OFF	2013/11/18 15:33
L14	34	((@ad<="20031218") or (@rlad<="20031218")) and (ip or internet adj protocol or packet near2 switch\$3) same assign\$3 with (ip or (internet adj protocol)) adj address with (instant adj voice adj messag\$3 or im or instant adj messag\$3)	US-PGPUB; USPAT; EPO; JPO; DERWENT	OR	OFF	2013/11/18 15:34
L15	12	((@ad<="20031218") or (@rlad<="20031218")) and instant near5 voice near5 message\$3 same attach\$3 with file	US-PGPUB; USPAT; EPO; JPO; DERWENT	OR	OFF	2013/11/18 15:43
L16	129	((@ad<="20031218") or (@rlad<="20031218")) and instant near5 voice near5 message\$3 same display\$3	US-PGPUB; USPAT; EPO; JPO; DERWENT	OR	OFF	2013/11/18 15:48
L17	14	((@ad<="20031218") or (@rlad<="20031218")) and instant adj voice adj message\$3 with display\$3	US-PGPUB; USPAT; EPO; JPO; DERWENT	OR	OFF	2013/11/18 15:49
L18	7	((@ad<="20031218") or (@rlad<="20031218")) and instant adj voice adj message\$3 same delet\$3 with retriev\$3	US-PGPUB; USPAT; EPO; JPO; DERWENT	OR	OFF	2013/11/18 15:58
L19	7	((@ad<="20031218") or (@rlad<="20031218")) and instant adj voice adj message\$3 same encrypt\$3 with decrypt\$3	US-PGPUB; USPAT; EPO; JPO; DERWENT	OR	OFF	2013/11/18 15:59
L20	8	((@ad<="20031218") or (@rlad<="20031218")) and instant adj voice adj message\$3 same compress\$3 with decompress\$3	US-PGPUB; USPAT; EPO; JPO; DERWENT	OR	OFF	2013/11/18 16:00
L21	7	((@ad<="20031218") or (@rlad<="20031218")) and instant adj voice adj message\$3 same display\$3 with list with recipients	US-PGPUB; USPAT; EPO; JPO; DERWENT	OR	OFF	2013/11/18 16:03
L22	7	((@ad<="20031218") or	US-	OR	OFF	2013/11/18

		((@rlad<="20031218")) and instant near5 voice near5 message\$3 same display\$3 with list with recipients	PGPUB; USPAT; EPO; JPO; DERWENT			16:03
L23	0	((@ad<="20031218") or (@rlad<="20031218")) and instant near5 voice near5 message\$3 same (audio or visual) with receipt	US- PGPUB; USPAT; EPO; JPO; DERWENT	OR	OFF	2013/11/18 16:05

**EAST Search History (Interference)**

< This search history is empty >

**11/ 18/ 2013 4:09:21 PM**

**C:\ Users\ csmith1\ Documents\ EAST\ Workspaces\ 12974648.wsp**

<b>Search Notes</b>  	<b>Application/Control No.</b>  13546673	<b>Applicant(s)/Patent Under Reexamination</b>  ROJAS, MICHAEL J.
	<b>Examiner</b>  CREIGHTON SMITH	<b>Art Unit</b>  2656

CPC- SEARCHED		
Symbol	Date	Examiner

CPC COMBINATION SETS - SEARCHED		
Symbol	Date	Examiner

US CLASSIFICATION SEARCHED			
Class	Subclass	Date	Examiner

SEARCH NOTES		
Search Notes	Date	Examiner
EAST	06.03.13	chs
"	18.11.13	"

INTERFERENCE SEARCH			
US Class/ CPC Symbol	US Subclass / CPC Group	Date	Examiner

--	--

**EAST Search History****EAST Search History (Prior Art)**

Ref #	Hits	Search Query	DBs	Default Operator	Plurals	Time Stamp
S1	4	((("8243723") or ("7535890")).PN.	US-PGPUB; USPAT; EPO; JPO; DERWENT	OR	OFF	2013/06/03 08:05
S2	13	((@ad<="20031218") or (@rlad<="20031218")) and (stor\$3 or retain\$3) same instant near3 (voice or voip) near3 messag\$3 same (unavailable or "not" adj available)	US-PGPUB; USPAT; EPO; JPO; DERWENT	OR	OFF	2013/06/03 09:40

**EAST Search History (Interference)**

< This search history is empty >

**6/ 3/ 2013 10:32:22 AM**

**C:\ Users\ csmith1\ Documents\ EAST\ Workspaces\ 12974648.wsp**

<b>Index of Claims</b>  	<b>Application/Control No.</b>  13546673	<b>Applicant(s)/Patent Under Reexamination</b>  ROJAS, MICHAEL J.
	<b>Examiner</b>  CREIGHTON SMITH	<b>Art Unit</b>  2656

✓	<b>Rejected</b>	-	<b>Cancelled</b>	N	<b>Non-Elected</b>	A	<b>Appeal</b>
=	<b>Allowed</b>	÷	<b>Restricted</b>	I	<b>Interference</b>	O	<b>Objected</b>

Claims renumbered in the same order as presented by applicant
  CPA
  T.D.
  R.1.47

CLAIM		DATE							
Final	Original	06/03/2013	11/18/2013						
	2		✓						
	3		✓						
	4		✓						
	5		✓						
	6		✓						
	7		✓						
	8		✓						
	9		✓						
	10		✓						
	11		✓						
	12		✓						
	13		✓						
	14		✓						
	15		✓						
	16		✓						
	17		✓						
	18		✓						
	19		✓						
	20		✓						
	21		✓						
	22		✓						
	23		✓						
	24		✓						
	25		✓						
	26		✓						
	27		✓						
	28		✓						
	29		✓						
	30		✓						
	31		✓						
	32		✓						
	33		✓						
	1	✓	-						

## IN THE UNITED STATES PATENT AND TRADEMARK OFFICE

In re the Application of: MICHAEL J. ROJAS Serial No.: 13/546,673 Filed: July 11, 2012 For: SYSTEM AND METHOD FOR INSTANT VOIP MESSAGING	Confirmation No.: 9648 Art Unit: 2656 Examiner: Creighton H. Smith
---	--

**AMENDMENT****MAIL STOP: AMENDMENTS**

Commissioner for Patents  
P.O. Box 1450  
Alexandria, VA 22313-1450

Sir:

In response to the Office Action of June 5, 2013, please amend the above-identified application as follows:

**Amendments to the Claims** are reflected in the listing of claims that begins on page 2 of this paper.

**Remarks** begin on page 8 of this paper.

**Amendments to the Claims:**

This listing of claims replaces all prior versions and listings of claims in this application.

**Listing of the Claims:**

1. (Cancelled).
2. (New) A system comprising:
  - a network interface connected to a packet-switched network;
  - a messaging system communicating with a plurality of instant voice message client systems via the network interface; and
  - a communication platform system maintaining connection information for each of the plurality of instant voice message client systems indicating whether there is a current connection to each of the plurality of instant voice message client systems.
3. (New) The system according to claim 2, further comprising: a user database storing user records identifying users of the plurality of instant voice message client systems.
4. (New) The system according to claim 3, wherein each of the user records includes a user name, a password and a list of other users selected by a user.
5. (New) The system according to claim 4, wherein at least part of each of the user records is encrypted.
6. (New) The system according to claim 2, wherein the messaging system receives an instant voice message from one of the plurality of instant voice message client systems.
7. (New) The system according to claim 6, wherein the instant voice message includes an action field identifying one of a predetermined set of permitted actions requested by the user.



8. (New) The system according to claim 7, wherein the predetermined set of permitted actions includes a connection request, a disconnection request, a subscription request, an unsubscription request, a message transmission request, and a set status request.
9. (New) The system according to claim 6, wherein the instant voice message includes an identifier field including a unique identifier associated with the instant voice message.
10. (New) The system according to claim 6, wherein the instant voice message includes a source field including a unique identifier associated with at least one of a given one of the plurality of instant voice message client systems that created the instant voice message and a given one of the plurality of users using the given one of the plurality of instant voice message client systems.
11. (New) The system according to claim 6, wherein the instant voice message includes a destination field including a unique identifier associated with at least one of a given one of the plurality of instant voice message client systems identified as a recipient of the instant voice message and a given one of the plurality of users using the given one of the plurality of instant voice message client systems.
12. (New) The system according to claim 6, wherein the instant voice message includes an object field including a digitized audio file.
13. (New) The system according to claim 2, wherein the messaging system receives connection object messages from the plurality of instant voice message client systems, wherein each of the connection object messages includes data representing a state of a logical connection with a given one of the plurality of instant voice message client systems.

14. (New) The system according to claim 13, wherein the connection object messages identifies at least one of a socket, a size of data to be transferred and a priority of the data.
15. (New) The system according to claim 13, wherein the communication platform system populates a connection list for the plurality of instant voice message client systems with the data in the connection object messages received from each of the plurality of instant voice message client systems.
16. (New) The system according to claim 2, wherein the communication platform system assigns an IP address to each of the instant voice message client systems when the communication platform receives a connection request from each of the instant voice message client systems.
17. (New) The system according to claim 2, further comprising: a message database storing the instant voice messages received from the instant voice message client systems.
18. (New) The system according to claim 2, wherein, upon receipt of an instant voice message, the communication platform system determines if there is the current connection to one of the plurality of instant voice message client systems identified as a recipient of the instant voice message, and if there is no connection with the one of the plurality of instant voice message client system identified as the recipient, the instant voice message is stored and delivered when the one of the plurality of instant voice message client systems identified as the recipient re-established a connection.
19. (New) The system according to claim 2, wherein the communication platform system updates the connection information for each of the instant voice message client systems by

periodically transmitting a connection status request to the given one of the plurality of instant voice message client systems.

20. (New) A system comprising:

a client device;

a network interface coupled to the client device and connecting the client device to a packet-switched network; and

an instant voice messaging application installed on the client device, wherein the instant voice messaging application includes a client platform system for generating an instant voice message and a messaging system for transmitting the instant voice message over the packet-switched network via the network interface.

21. (New) The system according to claim 20, wherein the instant voice messaging application includes a document handler system for attaching one or more files to the instant voice message.

22. (New) The system according to claim 20, wherein the instant voice messaging application includes a message database storing the instant voice message, wherein the instant voice messages is represented by a database record including a unique identifier.

23. (New) The system according to claim 22, wherein the instant voice message stored in the message database include a plurality of instant voice messages recorded by a user of the client device and instant voice messages received over the packet-switched network.

24. (New) The system according to claim 23, further comprising: a display displaying at least one of the plurality of instant voice messages stored in the message database.

25. (New) The system according to claim 22, wherein the instant voice messaging application includes a file manager system storing, deleting and retrieving the instant voice messages from the message database in response to a user request.
26. (New) The system according to claim 20, wherein the instant voice messaging application includes an audio file creation system creating an audio file for the instant voice message based on input received via an audio input device coupled to the client device.
27. (New) The system according to claim 20, wherein the instant voice messaging application includes an encryption/decryption system for encrypting the instant voice messages to be transmitted over the packet-switched network and decrypting the instant voices messages received over the packet-switched network.
28. (New) The system according to claim 20, wherein the instant voice messaging application includes a compression/decompression system for compressing the instant voice messages to be transmitted over the packet-switched network and decompressing the instant voice messages received over the packet-switched network.
29. (New) The system according to claim 20, further comprising: a display displaying a list of one or more potential recipients for an instant voice message.
30. (New) The system according to claim 29, wherein the display includes an indicia for each of the one or more potential recipients indicating whether the potential recipient is currently available to receive an instant voice message.
31. (New) The system according to claim 20, wherein the instant voice message application generates an audible or visual effect indicating receipt of an instant voice message.

32. (New) The system according to claim 20, wherein the instant voice message application communicates in an intercom mode when a recipient of the instant voice message is currently available to receive the instant voice message and communicates in a record mode when the recipient of the instant voice message is currently unavailable to receive the instant voice message.

33. (New) The system according to claim 32, wherein the instant voice message application utilizes the intercom mode as a default communication mode.

### REMARKS

Claim 1 is pending in this application. By this amendment, claim 1 is cancelled, and new claims 2-33 are added. Accordingly, claims 2-33 will remain pending herein upon entry of this Response. No new matter is introduced.

The subject matter of new claim 2 is described in the specification at, for example, page 27, line 12 – page 28, line 11.

The subject matter of new claim 3 is described in the specification at, for example, page 28, lines 3-8.

The subject matter of new claim 4 is described in the specification at, for example, page 28, lines 3-8.

The subject matter of new claim 5 is described in the specification at, for example, page 28, lines 9-10.

The subject matter of new claim 6 is described in the specification at, for example, page 28, lines 12-14.

The subject matter of new claim 7 is described in the specification at, for example, page 28, lines 12-17.

The subject matter of new claim 8 is described in the specification at, for example, page 28, lines 13-19.

The subject matter of new claim 9 is described in the specification at, for example, page 28, lines 12-13; 19-20.

The subject matter of new claim 10 is described in the specification at, for example, page 28, lines 12-13 and 20-22.

The subject matter of new claim 11 is described in the specification at, for example, page 29, lines 10-11.

The subject matter of new claim 12 is described in the specification at, for example, page 29, lines 11-13.

The subject matter of new claim 13 is described in the specification at, for example, page 29, lines 18-22.

The subject matter of new claim 14 is described in the specification at, for example, page 30, lines 1-3.

The subject matter of new claim 15 is described in the specification at, for example, page 30, lines 3-7.

The subject matter of new claim 16 is described in the specification at, for example, page 31, lines 2-7.

The subject matter of new claim 17 is described in the specification at, for example, page 45, line 17 – page 46, line 7.

The subject matter of new claim 18 is described in the specification at, for example, page 16, line 21 – page 17, line 7.

The subject matter of new claim 19 is described in the specification at, for example, page 28, lines 15-16.

The subject matter of new claim 20 is described in the specification at, for example, page 13, line 15 – page 14, line 17.

The subject matter of new claim 21 is described in the specification at, for example, page 24, line 23 – page 25, line 6.

The subject matter of new claim 22 is described in the specification at, for example, page 25, lines 6-8.

The subject matter of new claim 23 is described in the specification at, for example, page 25, lines 6-8.

The subject matter of new claim 24 is described in the specification at, for example, page 14, lines 12-14.

The subject matter of new claim 25 is described in the specification at, for example, page 25, lines 8-10.

The subject matter of new claim 26 is described in the specification at, for example, page 25, lines 10-12.

The subject matter of new claim 27 is described in the specification at, for example, page 25, lines 14-15.

The subject matter of new claim 28 is described in the specification at, for example, page 25, lines 15-17.

The subject matter of new claim 29 is described in the specification at, for example, page 16, lines 2-6.



The subject matter of new claim 30 is described in the specification at, for example, page 29, line 18 – page 30, line 7.

The subject matter of new claim 31 is described in the specification at, for example, page 16, line 23 – page 17, line 2.

The subject matter of new claim 32 is described in the specification at, for example, page 23, line 5 – page 24, line 2.

The subject matter of new claim 33 is described in the specification at, for example, page 24, lines 2-4.

#### **Double Patenting Rejection of Claim 1**

Claim 1 stands rejected on the ground of nonstatutory obviousness-type double patenting as being unpatentable over claims 1-70 of U.S. Patent No. 7,535,890. The Applicant respectfully submits that this rejection of claim 1 is moot in view of the cancellation of claim 1.

#### **35 U.S. C. § 102(e) Rejection of Claim 1**

Claim 1 stands rejected under 35 U.S.C. § 102(e) as unpatentable over U.S. Patent No. 7,372,826 to Dahod et al. (“Dahod”). This rejection is respectfully traversed.

First, the Examiner has not indicated how Dahod allegedly anticipates cancelled claim 1, but simply cites to col. 12, lines 19-26.

Second, the Applicant respectfully submits that this rejection of claim 1 is moot in view of the cancellation of claim 1.

Finally, Dahod does not disclose or suggest the limitations of new independent claims 2 and 20, or any of the claims depending therefrom. For example, the cited portion of Dahod does

Serial No.: 13/546,673  
Art Unit: 2656

Attorney's Docket No.: EMP0024-US  
Page 12

not disclose or suggest, "a network interface connected to a packet-switched network," as recited in claim 2, or "a network interface coupled to the client device and connecting the client device to a packet-switched network," as recited in claim 20. Therefore, the Applicant respectfully submits that all new claims 2-33 are allowable.

### **Conclusion**

Should the Examiner have any questions or determine that any further action is desirable to place this application in even better condition for issue, the Examiner is encouraged to telephone the Applicant's undersigned representative at the number listed below.

KASHA LAW LLC  
14532 Dufief Mill Rd.  
North Potomac, MD 20878  
Tel. 703-867-1886  
Date: November 5, 2013

Respectfully submitted,

By: /John R. Kasha/  
John R. Kasha  
Registration No. 53,100

JRK  
Customer No. 67050

## Electronic Patent Application Fee Transmittal

<b>Application Number:</b>	13546673			
<b>Filing Date:</b>	11-Jul-2012			
<b>Title of Invention:</b>	SYSTEM AND METHOD FOR INSTANT VoIP MESSAGING			
<b>First Named Inventor/Applicant Name:</b>	Michael J. Rojas			
<b>Filer:</b>	John Kasha			
<b>Attorney Docket Number:</b>	EMP0024-US			
Filed as Small Entity				
<b>Utility under 35 USC 111(a) Filing Fees</b>				
<b>Description</b>	<b>Fee Code</b>	<b>Quantity</b>	<b>Amount</b>	<b>Sub-Total in USD(\$)</b>
<b>Basic Filing:</b>				
<b>Pages:</b>				
<b>Claims:</b>				
Claims in excess of 20	2202	12	40	480
<b>Miscellaneous-Filing:</b>				
<b>Petition:</b>				
<b>Patent-Appeals-and-Interference:</b>				
<b>Post-Allowance-and-Post-Issuance:</b>				
<b>Extension-of-Time:</b>				

Description	Fee Code	Quantity	Amount	Sub-Total in USD(\$)
Extension - 2 months with \$0 paid	2252	1	300	300
<b>Miscellaneous:</b>				
<b>Total in USD (\$)</b>				<b>780</b>

## Electronic Acknowledgement Receipt

<b>EFS ID:</b>	17324113
<b>Application Number:</b>	13546673
<b>International Application Number:</b>	
<b>Confirmation Number:</b>	9648
<b>Title of Invention:</b>	SYSTEM AND METHOD FOR INSTANT VoIP MESSAGING
<b>First Named Inventor/Applicant Name:</b>	Michael J. Rojas
<b>Customer Number:</b>	67050
<b>Filer:</b>	John Kasha
<b>Filer Authorized By:</b>	
<b>Attorney Docket Number:</b>	EMP0024-US
<b>Receipt Date:</b>	05-NOV-2013
<b>Filing Date:</b>	11-JUL-2012
<b>Time Stamp:</b>	20:30:09
<b>Application Type:</b>	Utility under 35 USC 111(a)

### Payment information:

Submitted with Payment	yes
Payment Type	Deposit Account
Payment was successfully received in RAM	\$780
RAM confirmation Number	6893
Deposit Account	504075
Authorized User	

The Director of the USPTO is hereby authorized to charge indicated fees and credit any overpayment as follows:

Charge any Additional Fees required under 37 C.F.R. Section 1.16 (National application filing, search, and examination fees)

Charge any Additional Fees required under 37 C.F.R. Section 1.17 (Patent application and reexamination processing fees)

Charge any Additional Fees required under 37 C.F.R. Section 1.19 (Document supply fees)

Charge any Additional Fees required under 37 C.F.R. Section 1.20 (Post Issuance fees)

Charge any Additional Fees required under 37 C.F.R. Section 1.21 (Miscellaneous fees and charges)

**File Listing:**

Document Number	Document Description	File Name	File Size(Bytes)/ Message Digest	Multi Part /.zip	Pages (if appl.)
1	Amendment/Req. Reconsideration-After Non-Final Reject	EMP0024-US_resp_11_05_2013.pdf	100813 12f0efc142db47963f33a6aba2b76f0aec14f79c	no	12

**Warnings:**

**Information:**

2	Fee Worksheet (SB06)	fee-info.pdf	32172 c34516167eb5e5d002ecc9f993161107cddf318	no	2
---	----------------------	--------------	--	----	---

**Warnings:**

**Information:**

**Total Files Size (in bytes):** 132985

This Acknowledgement Receipt evidences receipt on the noted date by the USPTO of the indicated documents, characterized by the applicant, and including page counts, where applicable. It serves as evidence of receipt similar to a Post Card, as described in MPEP 503.

**New Applications Under 35 U.S.C. 111**

If a new application is being filed and the application includes the necessary components for a filing date (see 37 CFR 1.53(b)-(d) and MPEP 506), a Filing Receipt (37 CFR 1.54) will be issued in due course and the date shown on this Acknowledgement Receipt will establish the filing date of the application.

**National Stage of an International Application under 35 U.S.C. 371**

If a timely submission to enter the national stage of an international application is compliant with the conditions of 35 U.S.C. 371 and other applicable requirements a Form PCT/DO/EO/903 indicating acceptance of the application as a national stage submission under 35 U.S.C. 371 will be issued in addition to the Filing Receipt, in due course.

**New International Application Filed with the USPTO as a Receiving Office**

If a new international application is being filed and the international application includes the necessary components for an international filing date (see PCT Article 11 and MPEP 1810), a Notification of the International Application Number and of the International Filing Date (Form PCT/RO/105) will be issued in due course, subject to prescriptions concerning national security, and the date shown on this Acknowledgement Receipt will establish the international filing date of the application.

Under the Paperwork Reduction Act of 1995, no persons are required to respond to a collection of information unless it displays a valid OMB control number.

<b>PATENT APPLICATION FEE DETERMINATION RECORD</b> Substitute for Form PTO-875	Application or Docket Number <b>13/546,673</b>	Filing Date <b>07/11/2012</b>	<input type="checkbox"/> To be Mailed
---	---	----------------------------------	---------------------------------------

ENTITY:  LARGE  SMALL  MICRO

**APPLICATION AS FILED – PART I**

FOR	NUMBER FILED	NUMBER EXTRA	RATE (\$)	FEE (\$)
<input type="checkbox"/> BASIC FEE (37 CFR 1.16(a), (b), or (c))	N/A	N/A	N/A	
<input type="checkbox"/> SEARCH FEE (37 CFR 1.16(k), (j), or (m))	N/A	N/A	N/A	
<input type="checkbox"/> EXAMINATION FEE (37 CFR 1.16(c), (p), or (q))	N/A	N/A	N/A	
TOTAL CLAIMS (37 CFR 1.16(i))	minus 20 =	*	X \$ =	
INDEPENDENT CLAIMS (37 CFR 1.16(h))	minus 3 =	*	X \$ =	
<input type="checkbox"/> APPLICATION SIZE FEE (37 CFR 1.16(s))	If the specification and drawings exceed 100 sheets of paper, the application size fee due is \$310 (\$155 for small entity) for each additional 50 sheets or fraction thereof. See 35 U.S.C. 41(a)(1)(G) and 37 CFR 1.16(s).			
<input type="checkbox"/> MULTIPLE DEPENDENT CLAIM PRESENT (37 CFR 1.16(j))				
* If the difference in column 1 is less than zero, enter "0" in column 2.			TOTAL	

**APPLICATION AS AMENDED – PART II**

	(Column 1)	(Column 2)	(Column 3)	RATE (\$)	ADDITIONAL FEE (\$)
<b>AMENDMENT</b>	<b>11/05/2013</b>	CLAIMS REMAINING AFTER AMENDMENT	HIGHEST NUMBER PREVIOUSLY PAID FOR	PRESENT EXTRA	
	Total (37 CFR 1.16(i))	* 32	Minus ** 20	= 12	X \$40 = 480
	Independent (37 CFR 1.16(h))	* 2	Minus *** 3	= 0	X \$210 = 0
	<input type="checkbox"/> Application Size Fee (37 CFR 1.16(s))				
<input type="checkbox"/> FIRST PRESENTATION OF MULTIPLE DEPENDENT CLAIM (37 CFR 1.16(j))					
				TOTAL ADD'L FEE	<b>480</b>

	(Column 1)	(Column 2)	(Column 3)	RATE (\$)	ADDITIONAL FEE (\$)
<b>AMENDMENT</b>		CLAIMS REMAINING AFTER AMENDMENT	HIGHEST NUMBER PREVIOUSLY PAID FOR	PRESENT EXTRA	
	Total (37 CFR 1.16(i))	*	Minus **	=	X \$ =
	Independent (37 CFR 1.16(h))	*	Minus ***	=	X \$ =
	<input type="checkbox"/> Application Size Fee (37 CFR 1.16(s))				
<input type="checkbox"/> FIRST PRESENTATION OF MULTIPLE DEPENDENT CLAIM (37 CFR 1.16(j))					
				TOTAL ADD'L FEE	

\* If the entry in column 1 is less than the entry in column 2, write "0" in column 3.  
 \*\* If the "Highest Number Previously Paid For" IN THIS SPACE is less than 20, enter "20".  
 \*\*\* If the "Highest Number Previously Paid For" IN THIS SPACE is less than 3, enter "3".  
 The "Highest Number Previously Paid For" (Total or Independent) is the highest number found in the appropriate box in column 1.

LIE  
 /VERONICA DAY EVERETT/

This collection of information is required by 37 CFR 1.16. The information is required to obtain or retain a benefit by the public which is to file (and by the USPTO to process) an application. Confidentiality is governed by 35 U.S.C. 122 and 37 CFR 1.14. This collection is estimated to take 12 minutes to complete, including gathering, preparing, and submitting the completed application form to the USPTO. Time will vary depending upon the individual case. Any comments on the amount of time you require to complete this form and/or suggestions for reducing this burden, should be sent to the Chief Information Officer, U.S. Patent and Trademark Office, U.S. Department of Commerce, P.O. Box 1450, Alexandria, VA 22313-1450. DO NOT SEND FEES OR COMPLETED FORMS TO THIS ADDRESS. **SEND TO: Commissioner for Patents, P.O. Box 1450, Alexandria, VA 22313-1450.**  
 If you need assistance in completing the form, call 1-800-PTO-9199 and select option 2.



UNITED STATES PATENT AND TRADEMARK OFFICE

UNITED STATES DEPARTMENT OF COMMERCE  
United States Patent and Trademark Office  
Address: COMMISSIONER FOR PATENTS  
P.O. Box 1450  
Alexandria, Virginia 22313-1450  
www.uspto.gov

APPLICATION NUMBER	FILING OR 371(C) DATE	FIRST NAMED APPLICANT	ATTY. DOCKET NO./TITLE
13/546,673	07/11/2012	Michael J. Rojas	17188YX

**CONFIRMATION NO. 9648**

**POA ACCEPTANCE LETTER**

67050  
KASHA LAW LLC  
14532 Dufief Mill Road  
North Potomac, MD 20878



Date Mailed: 09/25/2013

**NOTICE OF ACCEPTANCE OF POWER OF ATTORNEY**

This is in response to the Power of Attorney filed 09/12/2013.

The Power of Attorney in this application is accepted. Correspondence in this application will be mailed to the above address as provided by 37 CFR 1.33.

/kgebremichael/

Office of Data Management, Application Assistance Unit (571) 272-4000, or (571) 272-4200, or 1-888-786-0101





UNITED STATES PATENT AND TRADEMARK OFFICE

UNITED STATES DEPARTMENT OF COMMERCE  
United States Patent and Trademark Office  
Address: COMMISSIONER FOR PATENTS  
P.O. Box 1450  
Alexandria, Virginia 22313-1450  
www.uspto.gov

APPLICATION NUMBER	FILING OR 371(C) DATE	FIRST NAMED APPLICANT	ATTY. DOCKET NO./TITLE
13/546,673	07/11/2012	Michael J. Rojas	17188YX

**CONFIRMATION NO. 9648**

**POWER OF ATTORNEY NOTICE**

23389  
SCULLY SCOTT MURPHY & PRESSER, PC  
400 GARDEN CITY PLAZA  
SUITE 300  
GARDEN CITY, NY 11530



Date Mailed: 09/25/2013

**NOTICE REGARDING CHANGE OF POWER OF ATTORNEY**

This is in response to the Power of Attorney filed 09/12/2013.

- The Power of Attorney to you in this application has been revoked by the assignee who has intervened as provided by 37 CFR 3.71. Future correspondence will be mailed to the new address of record(37 CFR 1.33).

/kgebremichael/

Office of Data Management, Application Assistance Unit (571) 272-4000, or (571) 272-4200, or 1-888-786-0101

Under the Paperwork Reduction Act of 1995, no persons are required to respond to a collection of information unless it displays a valid OMB control number.

<b>POWER OF ATTORNEY OR REVOCAION OF POWER OF ATTORNEY WITH A NEW POWER OF ATTORNEY AND CHANGE OF CORRESPONDENCE ADDRESS</b>	Application Number	13546873
	Filing Date	2012-07-11
	First Named Inventor	Michan J. Rojas
	Title	System and Method for Instant VoIP Message
	Art Unit	2698
	Examiner Name	Craigton H. Smith
	Attorney Docket Number	EMP0024-US

I hereby revoke all previous powers of attorney given in the above-identified application.

A Power of Attorney is submitted herewith.

OR

I hereby appoint Practitioner(s) associated with the following Customer Number as my/our attorney(s) or agent(s) to prosecute the application identified above, and to transact all business in the United States Patent and Trademark Office connected therewith:

67050

OR

I hereby appoint Practitioner(s) named below as my/our attorney(s) or agent(s) to prosecute the application identified above, and to transact all business in the United States Patent and Trademark Office connected therewith:

Practitioner(s) Name	Registration Number

Please recognize or change the correspondence address for the above-identified application to:

The address associated with the above-mentioned Customer Number.

OR

The address associated with Customer Number:

Firm or Individual Name

Address

City

Country

Telephone

State

Zip

Email

I am the:

Applicant/Inventor.

OR

Assignee of record of the entire interest. See 37 CFR 3.71. Statement under 37 CFR 3.73(b) (Form PTO/SB/06) submitted herewith or filed on \_\_\_\_\_

**SIGNATURE of Applicant or Assignee of Record**

Signature		Date	8-27-2013
Name	Daniel Mity	Telephone	
Title and Company	Principal, Empire IP LLC		

NOTE: Signatures of all the inventors or assignees of record of the entire interest or their representative(s) are required. Submit multiple forms if more than one signature is required, see below.

Total of 1 forms are submitted.

This collection of information is required by 37 CFR 1.31, 1.32 and 1.33. The information is required to obtain or retain a benefit by the public which is to file (and by the USPTO to process) an application. Confidentiality is governed by 35 U.S.C. 122 and 37 CFR 1.11 and 1.14. This collection is estimated to take 3 minutes to complete, including gathering, preparing, and submitting the completed application form to the USPTO. Time will vary depending upon the individual case. Any comments on the amount of time you require to complete this form and/or suggestions for reducing this burden, should be sent to the Chief Information Officer, U.S. Patent and Trademark Office, U.S. Department of Commerce, P.O. Box 1480, Alexandria, VA 22313-1480. DO NOT SEND FEES OR COMPLETED FORMS TO THIS ADDRESS. SEND TO: Commissioner for Patents, P.O. Box 1480, Alexandria, VA 22313-1480.

If you need assistance in completing the form, call 1-800-PTO-2199 and select option 2.

Under the Paperwork Reduction Act of 1995, no persons are required to respond to a collection of information unless it displays a valid OMB control number.

**STATEMENT UNDER 37 CFR 3.73(b)**

Applicant/Patent Owner: Empire IP LLC

Application No./Patent No.: 13/546,673

Filed/Issue Date: 2012-07-11

Titled: System and Method for Instant VoIP Messaging

Empire IP LLC, a Corporation

(Name of Assignee)

(Type of Assignee, e.g., corporation, partnership, university, government agency, etc.)

states that it is:

- 1.  the assignee of the entire right, title, and interest in;
- 2.  an assignee of less than the entire right, title, and interest in  
(The extent (by percentage) of its ownership interest is \_\_\_\_\_ %); or
- 3.  the assignee of an undivided interest in the entirety of (a complete assignment from one of the joint inventors was made)

the patent application/patent identified above, by virtue of either:

A.  An assignment from the inventor(s) of the patent application/patent identified above. The assignment was recorded in the United States Patent and Trademark Office at Reel \_\_\_\_\_, Frame \_\_\_\_\_, or for which a copy therefore is attached.

OR

B.  A chain of title from the inventor(s), of the patent application/patent identified above, to the current assignee as follows:

1. From: Rojas, Michael J. To: Ayalogic, Inc.

The document was recorded in the United States Patent and Trademark Office at  
Reel 014827, Frame 0059, or for which a copy thereof is attached.

2. From: Ayalogic, Inc. To: Empire IP LLC

The document was recorded in the United States Patent and Trademark Office at  
Reel 030822, Frame 0335, or for which a copy thereof is attached.

3. From: \_\_\_\_\_ To: \_\_\_\_\_

The document was recorded in the United States Patent and Trademark Office at  
Reel \_\_\_\_\_, Frame \_\_\_\_\_, or for which a copy thereof is attached.

Additional documents in the chain of title are listed on a supplemental sheet(s).

As required by 37 CFR 3.73(b)(1)(i), the documentary evidence of the chain of title from the original owner to the assignee was, or concurrently is being, submitted for recordation pursuant to 37 CFR 3.11.

[NOTE: A separate copy (i.e., a true copy of the original assignment document(s)) must be submitted to Assignment Division in accordance with 37 CFR Part 3, to record the assignment in the records of the USPTO. See MPEP 302.08]

The undersigned (whose title is supplied below) is authorized to act on behalf of the assignee.

Signature

Date

Darisl Mitry

Principal

Printed or Typed Name

Title

This collection of information is required by 37 CFR 3.73(b). The information is required to obtain or retain a benefit by the public which is in the (and by the USPTO to process) an application. Confidentiality is governed by 35 U.S.C. 122 and 37 CFR 1.11 and 1.14. This collection is estimated to take 12 minutes to complete, including gathering, preparing, and submitting the completed application form to the USPTO. Time will vary depending upon the individual case. Any comments on the amount of time you require to complete this form and/or suggestions for reducing this burden, should be sent to the Chief Information Officer, U.S. Patent and Trademark Office, U.S. Department of Commerce, P.O. Box 1480, Alexandria, VA, 22313-1480. DO NOT SEND FEES OR COMPLETED FORMS TO THIS ADDRESS. SEND TO: Commissioner for Patents, P.O. Box 1480, Alexandria, VA 22313-1480.

If you need assistance in completing the form, call 1-800-PTO-0190 and select option 2.

## Electronic Acknowledgement Receipt

<b>EFS ID:</b>	16835408
<b>Application Number:</b>	13546673
<b>International Application Number:</b>	
<b>Confirmation Number:</b>	9648
<b>Title of Invention:</b>	SYSTEM AND METHOD FOR INSTANT VoIP MESSAGING
<b>First Named Inventor/Applicant Name:</b>	Michael J. Rojas
<b>Customer Number:</b>	23389
<b>Filer:</b>	John Kasha
<b>Filer Authorized By:</b>	
<b>Attorney Docket Number:</b>	17188YX
<b>Receipt Date:</b>	12-SEP-2013
<b>Filing Date:</b>	11-JUL-2012
<b>Time Stamp:</b>	13:58:53
<b>Application Type:</b>	Utility under 35 USC 111(a)

### Payment information:

Submitted with Payment	no
------------------------	----

### File Listing:

Document Number	Document Description	File Name	File Size(Bytes)/ Message Digest	Multi Part /.zip	Pages (if appl.)
1	Power of Attorney	EMP0024-US_poa_signed1.pdf	385702 <small>5067c23652b4b9bae306dda7325299b9d12c638</small>	no	2

### Warnings:

### Information:

This Acknowledgement Receipt evidences receipt on the noted date by the USPTO of the indicated documents, characterized by the applicant, and including page counts, where applicable. It serves as evidence of receipt similar to a Post Card, as described in MPEP 503.

**New Applications Under 35 U.S.C. 111**

If a new application is being filed and the application includes the necessary components for a filing date (see 37 CFR 1.53(b)-(d) and MPEP 506), a Filing Receipt (37 CFR 1.54) will be issued in due course and the date shown on this Acknowledgement Receipt will establish the filing date of the application.

**National Stage of an International Application under 35 U.S.C. 371**

If a timely submission to enter the national stage of an international application is compliant with the conditions of 35 U.S.C. 371 and other applicable requirements a Form PCT/DO/EO/903 indicating acceptance of the application as a national stage submission under 35 U.S.C. 371 will be issued in addition to the Filing Receipt, in due course.

**New International Application Filed with the USPTO as a Receiving Office**

If a new international application is being filed and the international application includes the necessary components for an international filing date (see PCT Article 11 and MPEP 1810), a Notification of the International Application Number and of the International Filing Date (Form PCT/RO/105) will be issued in due course, subject to prescriptions concerning national security, and the date shown on this Acknowledgement Receipt will establish the international filing date of the application.



UNITED STATES PATENT AND TRADEMARK OFFICE

UNITED STATES DEPARTMENT OF COMMERCE  
United States Patent and Trademark Office  
Address: COMMISSIONER FOR PATENTS  
P.O. Box 1450  
Alexandria, Virginia 22313-1450  
www.uspto.gov

APPLICATION NUMBER	FILING OR 371(C) DATE	FIRST NAMED APPLICANT	ATTY. DOCKET NO./TITLE
13/546,673	07/11/2012	Michael J. Rojas	17188YX

**CONFIRMATION NO. 9648**

**POA ACCEPTANCE LETTER**

23389  
SCULLY SCOTT MURPHY & PRESSER, PC  
400 GARDEN CITY PLAZA  
SUITE 300  
GARDEN CITY, NY 11530



Date Mailed: 09/06/2013

**NOTICE OF ACCEPTANCE OF POWER OF ATTORNEY**

This is in response to the Power of Attorney filed 08/27/2013.

The Power of Attorney in this application is accepted. Correspondence in this application will be mailed to the above address as provided by 37 CFR 1.33.

*/gbien-aime/*

Office of Data Management, Application Assistance Unit (571) 272-4000, or (571) 272-4200, or 1-888-786-0101

Under the Paperwork Reduction Act of 1995, no persons are required to respond to a collection of information unless it displays a valid OMB control number.

<b>POWER OF ATTORNEY OR REVOCAION OF POWER OF ATTORNEY WITH A NEW POWER OF ATTORNEY AND CHANGE OF CORRESPONDENCE ADDRESS</b>	Application Number	13546873
	Filing Date	2012-07-11
	First Named Inventor	Michan J. Rojas
	Title	System and Method for Instant VoIP Message
	Art Unit	2698
	Examiner Name	Craigton H. Smith
	Attorney Docket Number	EMP0024-US

I hereby revoke all previous powers of attorney given in the above-identified application.

A Power of Attorney is submitted herewith.

OR

I hereby appoint Practitioner(s) associated with the following Customer Number as my/our attorney(s) or agent(s) to prosecute the application identified above, and to transact all business in the United States Patent and Trademark Office connected therewith:

67050

OR

I hereby appoint Practitioner(s) named below as my/our attorney(s) or agent(s) to prosecute the application identified above, and to transact all business in the United States Patent and Trademark Office connected therewith:

Practitioner(s) Name	Registration Number

Please recognize or change the correspondence address for the above-identified application to:

The address associated with the above-mentioned Customer Number.

OR

The address associated with Customer Number:

OR

Firm or Individual Name

Address

City

Country

State

Zip

Telephone

Email

I am the:

Applicant/Inventor.

OR

Assignee of record of the entire interest. See 37 CFR 3.71. Statement under 37 CFR 3.73(b) (Form PTO/SB/06) submitted herewith or filed on \_\_\_\_\_

**SIGNATURE of Applicant or Assignee of Record**

Signature		Date	8-27-2013
Name	Daniel Mitry	Telephone	
Title and Company	Principal, Empire IP LLC		

NOTE: Signatures of all the inventors or assignees of record of the entire interest or their representative(s) are required. Submit multiple forms if more than one signature is required, see below.

Total of 1 forms are submitted.

This collection of information is required by 37 CFR 1.31, 1.32 and 1.33. The information is required to obtain or retain a benefit by the public which is to file (and by the USPTO to process) an application. Confidentiality is governed by 35 U.S.C. 122 and 37 CFR 1.11 and 1.14. This collection is estimated to take 3 minutes to complete, including gathering, preparing, and submitting the completed application form to the USPTO. Time will vary depending upon the individual case. Any comments on the amount of time you require to complete this form and/or suggestions for reducing this burden, should be sent to the Chief Information Officer, U.S. Patent and Trademark Office, U.S. Department of Commerce, P.O. Box 1480, Alexandria, VA 22313-1480. DO NOT SEND FEES OR COMPLETED FORMS TO THIS ADDRESS. SEND TO: Commissioner for Patents, P.O. Box 1480, Alexandria, VA 22313-1480.

If you need assistance in completing the form, call 1-800-PTO-2199 and select option 2.

Under the Paperwork Reduction Act of 1995, no persons are required to respond to a collection of information unless it displays a valid OMB control number.

**STATEMENT UNDER 37 CFR 3.73(b)**

Applicant/Patent Owner: Empire IP LLC

Application No./Patent No.: 13/546,673

Filed/Issue Date: 2012-07-11

Titled: System and Method for Instant VoIP Messaging

Empire IP LLC, a Corporation

(Name of Assignee)

(Type of Assignee, e.g., corporation, partnership, university, government agency, etc.)

states that it is:

- 1.  the assignee of the entire right, title, and interest in;
- 2.  an assignee of less than the entire right, title, and interest in  
(The extent (by percentage) of its ownership interest is \_\_\_\_\_ %); or
- 3.  the assignee of an undivided interest in the entirety of (a complete assignment from one of the joint inventors was made)

the patent application/patent identified above, by virtue of either:

A.  An assignment from the inventor(s) of the patent application/patent identified above. The assignment was recorded in the United States Patent and Trademark Office at Reel \_\_\_\_\_, Frame \_\_\_\_\_, or for which a copy therefore is attached.

OR

B.  A chain of title from the inventor(s), of the patent application/patent identified above, to the current assignee as follows:

1. From: Rojas, Michael J. To: Ayalogic, Inc.

The document was recorded in the United States Patent and Trademark Office at  
Reel 014827, Frame 0059, or for which a copy thereof is attached.

2. From: Ayalogic, Inc. To: Empire IP LLC

The document was recorded in the United States Patent and Trademark Office at  
Reel 030822, Frame 0335, or for which a copy thereof is attached.

3. From: \_\_\_\_\_ To: \_\_\_\_\_

The document was recorded in the United States Patent and Trademark Office at  
Reel \_\_\_\_\_, Frame \_\_\_\_\_, or for which a copy thereof is attached.

Additional documents in the chain of title are listed on a supplemental sheet(s).

As required by 37 CFR 3.73(b)(1)(i), the documentary evidence of the chain of title from the original owner to the assignee was, or concurrently is being, submitted for recordation pursuant to 37 CFR 3.11.

[NOTE: A separate copy (i.e., a true copy of the original assignment document(s)) must be submitted to Assignment Division in accordance with 37 CFR Part 3, to record the assignment in the records of the USPTO. See MPEP 302.08]

The undersigned (whose title is supplied below) is authorized to act on behalf of the assignee.

Signature

Date

Darisl Mitry

Principal

Printed or Typed Name

Title

This collection of information is required by 37 CFR 3.73(b). The information is required to obtain or retain a benefit by the public which is in the (and by the USPTO to process) an application. Confidentiality is governed by 35 U.S.C. 122 and 37 CFR 1.11 and 1.14. This collection is estimated to take 12 minutes to complete, including gathering, preparing, and submitting the completed application form to the USPTO. Time will vary depending upon the individual case. Any comments on the amount of time you require to complete this form and/or suggestions for reducing this burden, should be sent to the Chief Information Officer, U.S. Patent and Trademark Office, U.S. Department of Commerce, P.O. Box 1480, Alexandria, VA, 22313-1480. DO NOT SEND FEES OR COMPLETED FORMS TO THIS ADDRESS. SEND TO: Commissioner for Patents, P.O. Box 1480, Alexandria, VA 22313-1480.

If you need assistance in completing the form, call 1-800-PTO-0190 and select option 2.



## Electronic Acknowledgement Receipt

<b>EFS ID:</b>	16696141
<b>Application Number:</b>	13546673
<b>International Application Number:</b>	
<b>Confirmation Number:</b>	9648
<b>Title of Invention:</b>	SYSTEM AND METHOD FOR INSTANT VoIP MESSAGING
<b>First Named Inventor/Applicant Name:</b>	Michael J. Rojas
<b>Customer Number:</b>	23389
<b>Filer:</b>	John Kasha
<b>Filer Authorized By:</b>	
<b>Attorney Docket Number:</b>	17188YX
<b>Receipt Date:</b>	27-AUG-2013
<b>Filing Date:</b>	11-JUL-2012
<b>Time Stamp:</b>	13:44:31
<b>Application Type:</b>	Utility under 35 USC 111(a)

### Payment information:

Submitted with Payment	no
------------------------	----

### File Listing:

Document Number	Document Description	File Name	File Size(Bytes)/ Message Digest	Multi Part /.zip	Pages (if appl.)
1	Power of Attorney	EMP0024-US_poa_signed1.pdf	385702 <small>5067c23652b4b9bae306dda7325299b9d12c638</small>	no	2

### Warnings:

### Information:

This Acknowledgement Receipt evidences receipt on the noted date by the USPTO of the indicated documents, characterized by the applicant, and including page counts, where applicable. It serves as evidence of receipt similar to a Post Card, as described in MPEP 503.

**New Applications Under 35 U.S.C. 111**

If a new application is being filed and the application includes the necessary components for a filing date (see 37 CFR 1.53(b)-(d) and MPEP 506), a Filing Receipt (37 CFR 1.54) will be issued in due course and the date shown on this Acknowledgement Receipt will establish the filing date of the application.

**National Stage of an International Application under 35 U.S.C. 371**

If a timely submission to enter the national stage of an international application is compliant with the conditions of 35 U.S.C. 371 and other applicable requirements a Form PCT/DO/EO/903 indicating acceptance of the application as a national stage submission under 35 U.S.C. 371 will be issued in addition to the Filing Receipt, in due course.

**New International Application Filed with the USPTO as a Receiving Office**

If a new international application is being filed and the international application includes the necessary components for an international filing date (see PCT Article 11 and MPEP 1810), a Notification of the International Application Number and of the International Filing Date (Form PCT/RO/105) will be issued in due course, subject to prescriptions concerning national security, and the date shown on this Acknowledgement Receipt will establish the international filing date of the application.



UNITED STATES PATENT AND TRADEMARK OFFICE

UNITED STATES DEPARTMENT OF COMMERCE
United States Patent and Trademark Office
Address: COMMISSIONER FOR PATENTS
P.O. Box 1450
Alexandria, Virginia 22313-1450
www.uspto.gov

Table with 5 columns: APPLICATION NO., FILING DATE, FIRST NAMED INVENTOR, ATTORNEY DOCKET NO., CONFIRMATION NO.
13/546,673 07/11/2012 Michael J. Rojas 17188YX 9648

23389 7590 06/05/2013
SCULLY SCOTT MURPHY & PRESSER, PC
400 GARDEN CITY PLAZA
SUITE 300
GARDEN CITY, NY 11530

EXAMINER

SMITH, CREIGHTON H

ART UNIT PAPER NUMBER

2656

MAIL DATE DELIVERY MODE

06/05/2013

PAPER

Please find below and/or attached an Office communication concerning this application or proceeding.

The time period for reply, if any, is set in the attached communication.

<b>Office Action Summary</b>	<b>Application No.</b> 13/546,673	<b>Applicant(s)</b> ROJAS, MICHAEL J.	
	<b>Examiner</b> CREIGHTON SMITH	<b>Art Unit</b> 2656	

**-- The MAILING DATE of this communication appears on the cover sheet with the correspondence address --**

**Period for Reply**

A SHORTENED STATUTORY PERIOD FOR REPLY IS SET TO EXPIRE 3 MONTH(S) OR THIRTY (30) DAYS, WHICHEVER IS LONGER, FROM THE MAILING DATE OF THIS COMMUNICATION.

- Extensions of time may be available under the provisions of 37 CFR 1.136(a). In no event, however, may a reply be timely filed after SIX (6) MONTHS from the mailing date of this communication.
- If NO period for reply is specified above, the maximum statutory period will apply and will expire SIX (6) MONTHS from the mailing date of this communication.
- Failure to reply within the set or extended period for reply will, by statute, cause the application to become ABANDONED (35 U.S.C. § 133). Any reply received by the Office later than three months after the mailing date of this communication, even if timely filed, may reduce any earned patent term adjustment. See 37 CFR 1.704(b).

**Status**

- 1)  Responsive to communication(s) filed on \_\_\_\_\_.
- 2a)  This action is **FINAL**.                      2b)  This action is non-final.
- 3)  An election was made by the applicant in response to a restriction requirement set forth during the interview on \_\_\_\_\_; the restriction requirement and election have been incorporated into this action.
- 4)  Since this application is in condition for allowance except for formal matters, prosecution as to the merits is closed in accordance with the practice under *Ex parte Quayle*, 1935 C.D. 11, 453 O.G. 213.

**Disposition of Claims**

- 5)  Claim(s) 1 is/are pending in the application.  
5a) Of the above claim(s) \_\_\_\_\_ is/are withdrawn from consideration.
- 6)  Claim(s) \_\_\_\_\_ is/are allowed.
- 7)  Claim(s) 1 is/are rejected.
- 8)  Claim(s) \_\_\_\_\_ is/are objected to.
- 9)  Claim(s) \_\_\_\_\_ are subject to restriction and/or election requirement.

\* If any claims have been determined allowable, you may be eligible to benefit from the **Patent Prosecution Highway** program at a participating intellectual property office for the corresponding application. For more information, please see [http://www.uspto.gov/patents/init\\_events/pph/index.jsp](http://www.uspto.gov/patents/init_events/pph/index.jsp) or send an inquiry to [PPHfeedback@uspto.gov](mailto:PPHfeedback@uspto.gov).

**Application Papers**

- 10)  The specification is objected to by the Examiner.
- 11)  The drawing(s) filed on \_\_\_\_\_ is/are: a)  accepted or b)  objected to by the Examiner.  
Applicant may not request that any objection to the drawing(s) be held in abeyance. See 37 CFR 1.85(a).  
Replacement drawing sheet(s) including the correction is required if the drawing(s) is objected to. See 37 CFR 1.121(d).

**Priority under 35 U.S.C. § 119**

- 12)  Acknowledgment is made of a claim for foreign priority under 35 U.S.C. § 119(a)-(d) or (f).  
a)  All    b)  Some \*    c)  None of:  
1.  Certified copies of the priority documents have been received.  
2.  Certified copies of the priority documents have been received in Application No. \_\_\_\_\_.  
3.  Copies of the certified copies of the priority documents have been received in this National Stage application from the International Bureau (PCT Rule 17.2(a)).

\* See the attached detailed Office action for a list of the certified copies not received.

**Attachment(s)**

- 1)  Notice of References Cited (PTO-892)
- 2)  Information Disclosure Statement(s) (PTO/SB/08)  
Paper No(s)/Mail Date \_\_\_\_\_.
- 3)  Interview Summary (PTO-413)  
Paper No(s)/Mail Date. \_\_\_\_\_.
- 4)  Other: \_\_\_\_\_.

### DETAILED ACTION

The nonstatutory double patenting rejection is based on a judicially created doctrine grounded in public policy (a policy reflected in the statute) so as to prevent the unjustified or improper timewise extension of the “right to exclude” granted by a patent and to prevent possible harassment by multiple assignees. A nonstatutory obviousness-type double patenting rejection is appropriate where the conflicting claims are not identical, but at least one examined application claim is not patentably distinct from the reference claim(s) because the examined application claim is either anticipated by, or would have been obvious over, the reference claim(s). See, e.g., *In re Berg*, 140 F.3d 1428, 46 USPQ2d 1226 (Fed. Cir. 1998); *In re Goodman*, 11 F.3d 1046, 29 USPQ2d 2010 (Fed. Cir. 1993); *In re Longi*, 759 F.2d 887, 225 USPQ 645 (Fed. Cir. 1985); *In re Van Ornum*, 686 F.2d 937, 214 USPQ 761 (CCPA 1982); *In re Vogel*, 422 F.2d 438, 164 USPQ 619 (CCPA 1970); and *In re Thorington*, 418 F.2d 528, 163 USPQ 644 (CCPA 1969).

A timely filed terminal disclaimer in compliance with 37 CFR 1.321(c) or 1.321(d) may be used to overcome an actual or provisional rejection based on a nonstatutory double patenting ground provided the conflicting application or patent either is shown to be commonly owned with this application, or claims an invention made as a result of activities undertaken within the scope of a joint research agreement.

Effective January 1, 1994, a registered attorney or agent of record may sign a terminal disclaimer. A terminal disclaimer signed by the assignee must fully comply with 37 CFR 3.73(b).

Claim 1 is rejected on the ground of nonstatutory obviousness-type double patenting as being unpatentable over claims 1-70 of U.S. Patent No. 7,535,890. Although the conflicting claims are not identical, they are not patentably distinct from each other because all the elements of claim 1 are found in the patent's claim 1 and could have been presented along with the '723 claims at the time of filing.

The following is a quotation of the appropriate paragraphs of 35 U.S.C. 102 that form the basis for the rejections under this section made in this Office action:

A person shall be entitled to a patent unless –

(e) the invention was described in (1) an application for patent, published under section 122(b), by another filed in the United States before the invention by the applicant for patent or (2) a patent granted on an application for patent by another filed in the United States before the invention by the applicant for patent, except that an international application filed under the treaty defined in section 351(a) shall have the effects for purposes of this subsection of an application filed in the United States only if the international application designated the United States and was published under Article 21(2) of such treaty in the English language.

Claim 1 is rejected under 35 U.S.C. 102(E) as being anticipated by Dahod et al (“Dahod”), U.S. Pat. #7,372,826.

See col. 12, lines 19-26.

Any inquiry concerning this communication should be directed to CREIGHTON SMITH at telephone number (571)272-7546.

/CREIGHTON SMITH/

Primary Examiner, Art Unit 2656

03 JUN '13

<b>Notice of References Cited</b>	Application/Control No. 13/546,673	Applicant(s)/Patent Under Reexamination ROJAS, MICHAEL J.	
	Examiner CREIGHTON SMITH	Art Unit 2656	Page 1 of 1

**U.S. PATENT DOCUMENTS**

*	Document Number Country Code-Number-Kind Code	Date MM-YYYY	Name	Classification
*	A US-7,372,826	05-2008	Dahod et al.	370/328
*	B US-2006/0268750	11-2006	Weiner, Moshe	370/260
*	C US-2008/0298309	12-2008	DePietro et al.	370/328
	D US-			
	E US-			
	F US-			
	G US-			
	H US-			
	I US-			
	J US-			
	K US-			
	L US-			
	M US-			

**FOREIGN PATENT DOCUMENTS**

*	Document Number Country Code-Number-Kind Code	Date MM-YYYY	Country	Name	Classification
	N				
	O				
	P				
	Q				
	R				
	S				
	T				

**NON-PATENT DOCUMENTS**

*	Document Number Country Code-Number-Kind Code	Date MM-YYYY	Country	Name	Classification
	U	Include as applicable: Author, Title Date, Publisher, Edition or Volume, Pertinent Pages)			
	V				
	W				
	X				

\*A copy of this reference is not being furnished with this Office action. (See MPEP § 707.05(a).)  
Dates in MM-YYYY format are publication dates. Classifications may be US or foreign.

<b>Search Notes</b>  	<b>Application/Control No.</b>  13546673	<b>Applicant(s)/Patent Under Reexamination</b>  ROJAS, MICHAEL J.
	<b>Examiner</b>  CREIGHTON SMITH	<b>Art Unit</b>  2656

<b>SEARCHED</b>			
<b>Class</b>	<b>Subclass</b>	<b>Date</b>	<b>Examiner</b>

<b>SEARCH NOTES</b>		
<b>Search Notes</b>	<b>Date</b>	<b>Examiner</b>
EAST	06.03.13	chs

<b>INTERFERENCE SEARCH</b>			
<b>Class</b>	<b>Subclass</b>	<b>Date</b>	<b>Examiner</b>

--	--



**IN THE UNITED STATES PATENT AND TRADEMARK OFFICE**

<b>Applicant(s):</b>	<b>Michael J. Rojas</b>	<b>Examiner:</b>	<b>Unassigned</b>
<b>Serial No:</b>	<b>Unassigned</b>	<b>Art Unit:</b>	<b>Unassigned</b>
<b>Filed:</b>	<b>Herewith</b>	<b>Docket:</b>	<b>17188YX</b>
<b>For:</b>	<b>SYSTEM AND METHOD FOR INSTANT VoIP MESSAGING</b>	<b>Dated:</b>	<b>July 10, 2012</b>

Commissioner for Patents  
P. O. Box 1450  
Alexandria, VA 22313-1450

**INFORMATION DISCLOSURE STATEMENT**

Sir:

In accordance with 37 C.F.R. §§ 1.97 and 1.98, it is requested that the following references, which are also listed on the attached Form PTO-1449, be made of record in the above-identified case.

1. U.S. 6,763,226 dated July 13, 2004 to McZeal, Jr.;
2. U.S. Patent Application Publication 2004/0252679 dated December 16, 2004 to Williams et al.;
3. U.S. Patent Application Publication 2004/0122906 dated June 24, 2004 to Goodman et al.;

---

**CERTIFICATE OF ELECTRONIC TRANSMISSION**

I hereby certify that this document is being electronically filed in the United States Patent and Trademark Office on the date shown below.

Dated: July 10, 2012

/Seth Weinfeld/  
Seth Weinfeld

ALL REFERENCES CONSIDERED EXCEPT WHERE LINED THROUGH. /C.S./

4. U.S. Patent Application Publication 2005/0053230 dated March 10, 2005 to Gierachf, K.;
5. U.S. Patent Application Publication 2005/0105697 dated May 19, 2005 to Hollowell et al.;
6. U.S. Patent Application Publication 2003/0087632 dated May 8, 2003 to Sagi et al.;
7. U.S. Patent Application Publication 2006/0268750 dated November 30, 2006 to Weiner, M.;
8. U.S. Patent Application Publication 2004/0030046 dated February 12, 2004 to Schultes et al.;
9. U.S. Patent Application Publication 2007/0112925 dated May 17, 2007 to Makik, D.;
10. U.S. Patent Application Publication 2007/0174403 dated July 26, 2007 to Barry, M.;
11. U.S. Patent Application Publication 2006/0167883 dated July 27, 2006 to Boukobza, E.;
12. U.S. Patent Application Publication 2004/0128356 dated July 1, 2004 to Bernstein et al.;
13. U.S. Patent Application Publication 2003/0126207 dated July 3, 2003 to Creamer et al.;
14. [http://www.cisco.com/warp/public/cc/pd/nemnsw/callmn/prodlit/cm33\\_ds.htm](http://www.cisco.com/warp/public/cc/pd/nemnsw/callmn/prodlit/cm33_ds.htm); "Data Sheet Cisco CallManager Version 3.3", November 22, 2002;
15. ~~[http://www.cisco.com/en/US/products/hw/switches/ps1925/products\\_data\\_sheet\\_09186\\_a00800a3c3d.html](http://www.cisco.com/en/US/products/hw/switches/ps1925/products_data_sheet_09186_a00800a3c3d.html)~~; "Data Sheet Cisco MGX 8000 Series" (Date unknown);
16. <http://www.hsteliann.com/english/?zone=3100-V21P>; "Telephone 3100-V21P", 2003;
17. <http://www.linuxdevices.com/articles/AT5199947519.html>; "Device Profile: snom 100 VoIP phone", (May 15, 2002);
18. [http://www.pingtel.com/pr\\_xpressa.jsp](http://www.pingtel.com/pr_xpressa.jsp); "No limits with the advanced industry standard SIP phone, December 8, 2003; and

ALL REFERENCES CONSIDERED EXCEPT WHERE LINED THROUGH. /C.S./

19. AudioCoded Enabling Technology Products, TPM-1100 VoP Media Gateway Modules; 2003.
20. U.S. Patent Application Publication No. 2004/0014456 A1 published January 22, 2004 to Väänänen;
21. U.S. Patent Application Publication No. 2010/0070275 A1 published March 18, 2012 to Cast;
22. U.S. Patent Application Publication No. 2004/0179092 A1 published September 16, 2004 to LaPoint;
23. U.S. Patent Application Publication No. 2004/0085456 A1 published May 6, 2004 to Kwag et al.
24. U.S. Patent Application Publication No. 2009/0161664 A1 published June 25, 2009 to Michael J. Rojas;
25. U.S. Patent No. 7,535,890 issued May 19, 2009 to Michael J. Rojas;
26. U.S. Patent No. 8,199,747 issued June 12, 2012 to Michael J. Rojas;
27. U.S. Office Action dated October 18, 2011 received in related case, namely, U.S. Serial No. 12/398,063 filed March 4, 2009;
28. U.S. Final Office Action dated January 25, 2012 received in related case, namely, U.S. Serial No. 12/398,063 filed March 4, 2009; and
29. Notice of Allowance dated March 30, 2012 received in related case, namely, U.S. Serial No. 12/398,063 filed March 4, 2009.

Pursuant to 37 C.F.R. §1.98(d), copies of the above listed references are not provided, as references 1-23 were previously submitted in Information Disclosure Statements filed in connection with parent case, U.S. Serial Number: 12/398,063 filed on March 4, 2009. References 24-29 are related to the present application.

Inasmuch as this Information Disclosure Statement is being submitted in accordance with the schedule set out in 37 C.F.R §1.97(b), no statement or fee is required.

Respectfully submitted,

/Seth Weinfeld/

Seth Weinfeld  
Registration No. 50,929

Scully, Scott, Murphy & Presser, P.C.  
400 Garden City Plaza, Suite 300  
Garden City, New York 11530  
(516) 742-4343  
SMW:reg

ALL REFERENCES CONSIDERED EXCEPT WHERE LINED THROUGH. /C.S./

Form PTO-1449 U.S. DEPARTMENT OF COMMERCE (REV. 7-80) PATENT AND TRADEMARK OFFICE		Atty. Docket No. 17188Y		Application No. 13-546673			
<b>INFORMATION DISCLOSURE CITATION</b>  (Use several sheets if necessary)		Applicant Michael J. Rojas					
		Filing Date Herewith		Group Art Unit			
<b>U.S. PATENT DOCUMENTS</b>							
EXAMINER INITIAL*	DOCUMENT NUMBER	DATE	NAME	CLASS	SUBCLASS	FILING DATE (if appropriate)	
	6,763,226	07-13-2004	McZeal, Jr.				
	7,535,890	05-19-2009	Michael J. Rojas				
	8,199,747	06-12-2012	Michael J. Rojas				
<b>U.S. PATENT PUBLICATION DOCUMENTS</b>							
	2004/0252679	12-16-2004	Williams et al.				
	2004/0122906	06-24-2004	Goodman et al.				
	2005/0053230	03-10-2005	Gierachf, K.				
	2005/0105697	05-19-2005	Hollowell et al.				
	2003/0087632	05-08-2003	Sagi et al.				
	2006/0268750	11-30-2006	Weiner, M.				
	2004/0030046	02-12-2004	Schultes et al.				
	2007/0112925	05-17-2007	Malik, D.				
	2007/0174403	07-26-2007	Barry, M.				
	2006/0167883	07-27-2006	Boukobza, E.				
	2004/0128356	07-01-2004	Bernstein et al.				
	2003/0126207	07-03-2003	Creamer et al.				
<b>FOREIGN PATENT DOCUMENTS</b>							
	DOCUMENT NUMBER	DATE	COUNTRY	CLASS	SUBCLASS	TRANSLATION	
						YES	NO
<b>OTHER PRIOR ART (Including Author, Title, Date, Pertinent Pages, Etc.)</b>							
	<a href="http://www.cisco.com/warp/public/cc/pd/nemnsw/callmn/prodlit/cm33_ds.htm">http://www.cisco.com/warp/public/cc/pd/nemnsw/callmn/prodlit/cm33_ds.htm</a> ; "Data Sheet Cisco CallManager Version 3.3", November 22, 2002;						
	<a href="http://www.cisco.com/en/US/products/hw/switches/ps1925/products_data_sheet_09186_a00800a3c3d.html">http://www.cisco.com/en/US/products/hw/switches/ps1925/products_data_sheet_09186_a00800a3c3d.html</a> ; "Data Sheet Cisco MGX 8000 Series" (Date unknown);						
	U.S. Office Action dated October 18, 2011 received in related case, namely, U.S. Serial No. 12/398,063 filed March 4, 2009						
EXAMINER	/Creighton Smith/		DATE CONSIDERED			06/02/2013	

ALL REFERENCES CONSIDERED EXCEPT WHERE LINED THROUGH. /C.S./

Form PTO-1449 U.S. DEPARTMENT OF COMMERCE (REV. 7-80) PATENT AND TRADEMARK OFFICE		<b>Atty. Docket No. (Optional)</b> 17188YX		<b>Application Number</b> 13-546673				
<b>INFORMATION DISCLOSURE CITATION</b> (Use several sheets if necessary)								
<b>Applicant(s)</b> Michael Rojas								
<b>Filing Date</b>				<b>Group Art Unit</b>				
<b>U.S. PATENT PUBLICATION DOCUMENTS</b>								
		2004/0014456 A1	2004-01-22	Väänänen				
		2010/0070275 A1	2010-03-18	Cast				
		2004/0179092 A1	2004-09-16	La Point				
		2004/0085456 A1	2004-05-06	Kwag et al.				
		2009/0161664 A1	2009-06-25	Michael J. Rojas				
<b>FOREIGN PATENT DOCUMENTS</b>								
	REF	DOCUMENT NUMBER	DATE	COUNTRY	CLASS	SUBCLASS	TRANSLATION	
							YES	NO
<b>OTHER DOCUMENTS</b> (Including Author, Title, Date, Pertinent Pages, Etc.)								
		<a href="http://www.hsteliann.com/english/?zone=3100-V21P">http://www.hsteliann.com/english/?zone=3100-V21P</a> ; "Telephone 3100-V21P", 2003;						
		<a href="http://www.linuxdevices.com/articles/AT5199947519.html">http://www.linuxdevices.com/articles/AT5199947519.html</a> ; "Device Profile: snom 100 VoIP phone", May 15, 2002;						
		<a href="http://www.pingtel.com/pr_xpressa.jsp">http://www.pingtel.com/pr_xpressa.jsp</a> ; "No limits with the advanced industry standard SIP phone, December 8, 2003; and						
		AudioCoded Enabling Technology Products, TPM-1100 VoP Media Gateway Modules; 2003.						
		U.S. Final Office Action dated January 25, 2012 received in related case, namely, U.S. Serial No 12/398,063 filed March 4, 2009						
		Notice of Allowance dated March 30, 2012 received in related case, namely, U.S. Serial No. 12/398,063 filed March 4, 2009						
<b>EXAMINER</b> /Creighton Smith/			<b>DATE CONSIDERED</b> 06/02/2013					
* EXAMINER: Initial if reference considered, whether or not citation is in conformance with MPEP 609; draw line through citation if not in conformance and not considered. Include copy of this form with next communication to applicant.								

J:\Work\1732\17188Z\MISC\1449.doc

ALL REFERENCES CONSIDERED EXCEPT WHERE LINED THROUGH. /C.S./



UNITED STATES PATENT AND TRADEMARK OFFICE

UNITED STATES DEPARTMENT OF COMMERCE  
 United States Patent and Trademark Office  
 Address: COMMISSIONER FOR PATENTS  
 P.O. Box 1450  
 Alexandria, Virginia 22313-1450  
 www.uspto.gov

BIB DATA SHEET

CONFIRMATION NO. 9648

SERIAL NUMBER	FILING or 371(c) DATE	CLASS	GROUP ART UNIT	ATTORNEY DOCKET NO.		
13/546,673	07/11/2012	370	2656	17188YX		
<b>APPLICANTS</b> Michael J. Rojas, North Canton, OH;						
<b>** CONTINUING DATA *****</b> This application is a CON of 12/398,063 03/04/2009 PAT 8243723 which is a CON of 10/740,030 12/18/2003 PAT 7535890 * (*)Data provided by applicant is not consistent with PTO records.						
<b>** FOREIGN APPLICATIONS *****</b>						
<b>** IF REQUIRED, FOREIGN FILING LICENSE GRANTED ** ** SMALL ENTITY **</b> 07/23/2012						
Foreign Priority claimed <input type="checkbox"/> Yes <input checked="" type="checkbox"/> No 35 USC 119(a-d) conditions met <input type="checkbox"/> Yes <input checked="" type="checkbox"/> No Verified and /CREIGHTON H SMITH/ Acknowledged Examiner's Signature		<input type="checkbox"/> Met after Allowance Initials	<b>STATE OR COUNTRY</b> OH	<b>SHEETS DRAWINGS</b> 9	<b>TOTAL CLAIMS</b> 1	<b>INDEPENDENT CLAIMS</b> 1
<b>ADDRESS</b> SCULLY SCOTT MURPHY & PRESSER, PC 400 GARDEN CITY PLAZA SUITE 300 GARDEN CITY, NY 11530 UNITED STATES						
<b>TITLE</b> SYSTEM AND METHOD FOR INSTANT VoIP MESSAGING						
<b>FILING FEE RECEIVED</b> 530	FEES: Authority has been given in Paper No. _____ to charge/credit DEPOSIT ACCOUNT No. _____ for following:			<input type="checkbox"/> All Fees <input type="checkbox"/> 1.16 Fees (Filing) <input type="checkbox"/> 1.17 Fees (Processing Ext. of time) <input type="checkbox"/> 1.18 Fees (Issue) <input type="checkbox"/> Other _____ <input type="checkbox"/> Credit		

<b><i>Index of Claims</i></b>  	<b>Application/Control No.</b>  13546673	<b>Applicant(s)/Patent Under Reexamination</b>  ROJAS, MICHAEL J.
	<b>Examiner</b>  CREIGHTON SMITH	<b>Art Unit</b>  2656

✓	<b>Rejected</b>	-	<b>Cancelled</b>	N	<b>Non-Elected</b>	A	<b>Appeal</b>
=	<b>Allowed</b>	÷	<b>Restricted</b>	I	<b>Interference</b>	O	<b>Objected</b>

<input type="checkbox"/> Claims renumbered in the same order as presented by applicant		<input type="checkbox"/> CPA		<input checked="" type="checkbox"/> T.D.		<input type="checkbox"/> R.1.47			
<b>CLAIM</b>			<b>DATE</b>						
Final	Original	06/03/2013							
	1	✓							





UNITED STATES PATENT AND TRADEMARK OFFICE

UNITED STATES DEPARTMENT OF COMMERCE
United States Patent and Trademark Office
Address: COMMISSIONER FOR PATENTS
P.O. Box 1450
Alexandria, Virginia 22313-1450
www.uspto.gov

Table with 4 columns: APPLICATION NUMBER (13/546,673), FILING OR 371(C) DATE (07/11/2012), FIRST NAMED APPLICANT (Michael J. Rojas), ATTY. DOCKET NO./TITLE (17188YX)

CONFIRMATION NO. 9648

PUBLICATION NOTICE

23389
SCULLY SCOTT MURPHY & PRESSER, PC
400 GARDEN CITY PLAZA
SUITE 300
GARDEN CITY, NY 11530



Title:SYSTEM AND METHOD FOR INSTANT VoIP MESSAGING

Publication No.US-2012-0275452-A1

Publication Date:11/01/2012

NOTICE OF PUBLICATION OF APPLICATION

The above-identified application will be electronically published as a patent application publication pursuant to 37 CFR 1.211, et seq. The patent application publication number and publication date are set forth above.

The publication may be accessed through the USPTO's publically available Searchable Databases via the Internet at www.uspto.gov. The direct link to access the publication is currently http://www.uspto.gov/patft/.

The publication process established by the Office does not provide for mailing a copy of the publication to applicant. A copy of the publication may be obtained from the Office upon payment of the appropriate fee set forth in 37 CFR 1.19(a)(1). Orders for copies of patent application publications are handled by the USPTO's Office of Public Records. The Office of Public Records can be reached by telephone at (703) 308-9726 or (800) 972-6382, by facsimile at (703) 305-8759, by mail addressed to the United States Patent and Trademark Office, Office of Public Records, Alexandria, VA 22313-1450 or via the Internet.

In addition, information on the status of the application, including the mailing date of Office actions and the dates of receipt of correspondence filed in the Office, may also be accessed via the Internet through the Patent Electronic Business Center at www.uspto.gov using the public side of the Patent Application Information and Retrieval (PAIR) system. The direct link to access this status information is currently http://pair.uspto.gov/. Prior to publication, such status information is confidential and may only be obtained by applicant using the private side of PAIR.

Further assistance in electronically accessing the publication, or about PAIR, is available by calling the Patent Electronic Business Center at 1-866-217-9197.

Office of Data Management, Application Assistance Unit (571) 272-4000, or (571) 272-4200, or 1-888-786-0101

<b>PATENT APPLICATION FEE DETERMINATION RECORD</b>						Application or Docket Number 13/546,673				
Substitute for Form PTO-875										
<b>APPLICATION AS FILED - PART I</b>										
		(Column 1)	(Column 2)		<b>SMALL ENTITY</b>		OR	<b>OTHER THAN SMALL ENTITY</b>		
FOR	NUMBER FILED	NUMBER EXTRA		RATE(\$)	FEE(\$)			RATE(\$)	FEE(\$)	
BASIC FEE (37 CFR 1.16(a), (b), or (c))	N/A	N/A		N/A	95			N/A		
SEARCH FEE (37 CFR 1.16(k), (l), or (m))	N/A	N/A		N/A	310			N/A		
EXAMINATION FEE (37 CFR 1.16(o), (p), or (q))	N/A	N/A		N/A	125			N/A		
TOTAL CLAIMS (37 CFR 1.16(i))	1	minus 20 =			x 30 =	0.00	OR			
INDEPENDENT CLAIMS (37 CFR 1.16(h))	1	minus 3 =			x 125 =	0.00				
APPLICATION SIZE FEE (37 CFR 1.16(s))	If the specification and drawings exceed 100 sheets of paper, the application size fee due is \$310 (\$155 for small entity) for each additional 50 sheets or fraction thereof. See 35 U.S.C. 41(a)(1)(G) and 37 CFR 1.16(s).					0.00				
MULTIPLE DEPENDENT CLAIM PRESENT (37 CFR 1.16(j))						0.00				
* If the difference in column 1 is less than zero, enter "0" in column 2.				TOTAL	530			TOTAL		
<b>APPLICATION AS AMENDED - PART II</b>										
		(Column 1)	(Column 2)	(Column 3)	<b>SMALL ENTITY</b>		OR	<b>OTHER THAN SMALL ENTITY</b>		
<b>AMENDMENT A</b>	CLAIMS REMAINING AFTER AMENDMENT		HIGHEST NUMBER PREVIOUSLY PAID FOR	PRESENT EXTRA	RATE(\$)	ADDITIONAL FEE(\$)			RATE(\$)	ADDITIONAL FEE(\$)
	Total (37 CFR 1.16(i))	*	Minus	**	x	=	OR	x	=	
	Independent (37 CFR 1.16(h))	*	Minus	***	x	=	OR	x	=	
	Application Size Fee (37 CFR 1.16(s))							OR		
	FIRST PRESENTATION OF MULTIPLE DEPENDENT CLAIM (37 CFR 1.16(j))							OR		
				TOTAL ADD'L FEE			OR	TOTAL ADD'L FEE		
<b>AMENDMENT B</b>	CLAIMS REMAINING AFTER AMENDMENT		HIGHEST NUMBER PREVIOUSLY PAID FOR	PRESENT EXTRA	RATE(\$)	ADDITIONAL FEE(\$)			RATE(\$)	ADDITIONAL FEE(\$)
	Total (37 CFR 1.16(i))	*	Minus	**	x	=	OR	x	=	
	Independent (37 CFR 1.16(h))	*	Minus	***	x	=	OR	x	=	
	Application Size Fee (37 CFR 1.16(s))							OR		
	FIRST PRESENTATION OF MULTIPLE DEPENDENT CLAIM (37 CFR 1.16(j))							OR		
				TOTAL ADD'L FEE			OR	TOTAL ADD'L FEE		
<p>* If the entry in column 1 is less than the entry in column 2, write "0" in column 3.  ** If the "Highest Number Previously Paid For" IN THIS SPACE is less than 20, enter "20".  *** If the "Highest Number Previously Paid For" IN THIS SPACE is less than 3, enter "3".  The "Highest Number Previously Paid For" (Total or Independent) is the highest found in the appropriate box in column 1.</p>										



UNITED STATES PATENT AND TRADEMARK OFFICE

UNITED STATES DEPARTMENT OF COMMERCE
United States Patent and Trademark Office
Address: COMMISSIONER FOR PATENTS
P.O. Box 1450
Alexandria, Virginia 22313-1450
www.uspto.gov

Table with 7 columns: APPLICATION NUMBER, FILING or 371(c) DATE, GRP ART UNIT, FIL FEE REC'D, ATTY.DOCKET.NO, TOT CLAIMS, IND CLAIMS. Row 1: 13/546,673, 07/11/2012, 2472, 530, 17188YX, 1, 1

CONFIRMATION NO. 9648

23389
SCULLY SCOTT MURPHY & PRESSER, PC
400 GARDEN CITY PLAZA
SUITE 300
GARDEN CITY, NY 11530

FILING RECEIPT



\*0C000000055542321\*

Date Mailed: 07/25/2012

Receipt is acknowledged of this non-provisional patent application. The application will be taken up for examination in due course. Applicant will be notified as to the results of the examination. Any correspondence concerning the application must include the following identification information: the U.S. APPLICATION NUMBER, FILING DATE, NAME OF APPLICANT, and TITLE OF INVENTION. Fees transmitted by check or draft are subject to collection. Please verify the accuracy of the data presented on this receipt. If an error is noted on this Filing Receipt, please submit a written request for a Filing Receipt Correction. Please provide a copy of this Filing Receipt with the changes noted thereon. If you received a "Notice to File Missing Parts" for this application, please submit any corrections to this Filing Receipt with your reply to the Notice. When the USPTO processes the reply to the Notice, the USPTO will generate another Filing Receipt incorporating the requested corrections

Applicant(s)

Michael J. Rojas, North Canton, OH;

Assignment For Published Patent Application

Ayalogic, Inc., Ravenna, OH

Power of Attorney:

Leopold Presser--19827 Mark Cohen--32211
William Roch--24972 Edward Grolz--33705
John Sensny--28757 Steven Fischman--34594
Paul Esatto--30749 Thomas Spinelli--39533
Frank DiGiglio--31346 Peter Bernstein--43497

Domestic Priority data as claimed by applicant

This application is a CON of 12/398,063 03/04/2009 PAT 8243723
which is a CON of 10/740,030 12/18/2003 PAT 7535890 \*
(\*)Data provided by applicant is not consistent with PTO records.

Foreign Applications (You may be eligible to benefit from the Patent Prosecution Highway program at the USPTO. Please see http://www.uspto.gov for more information.)

If Required, Foreign Filing License Granted: 07/23/2012

The country code and number of your priority application, to be used for filing abroad under the Paris Convention, is US 13/546,673

Projected Publication Date: 11/01/2012

Non-Publication Request: No

Early Publication Request: No

**\*\* SMALL ENTITY \*\***

**Title**

SYSTEM AND METHOD FOR INSTANT VoIP MESSAGING

**Preliminary Class**

370

## **PROTECTING YOUR INVENTION OUTSIDE THE UNITED STATES**

Since the rights granted by a U.S. patent extend only throughout the territory of the United States and have no effect in a foreign country, an inventor who wishes patent protection in another country must apply for a patent in a specific country or in regional patent offices. Applicants may wish to consider the filing of an international application under the Patent Cooperation Treaty (PCT). An international (PCT) application generally has the same effect as a regular national patent application in each PCT-member country. The PCT process **simplifies** the filing of patent applications on the same invention in member countries, but **does not result** in a grant of "an international patent" and does not eliminate the need of applicants to file additional documents and fees in countries where patent protection is desired.

Almost every country has its own patent law, and a person desiring a patent in a particular country must make an application for patent in that country in accordance with its particular laws. Since the laws of many countries differ in various respects from the patent law of the United States, applicants are advised to seek guidance from specific foreign countries to ensure that patent rights are not lost prematurely.

Applicants also are advised that in the case of inventions made in the United States, the Director of the USPTO must issue a license before applicants can apply for a patent in a foreign country. The filing of a U.S. patent application serves as a request for a foreign filing license. The application's filing receipt contains further information and guidance as to the status of applicant's license for foreign filing.

Applicants may wish to consult the USPTO booklet, "General Information Concerning Patents" (specifically, the section entitled "Treaties and Foreign Patents") for more information on timeframes and deadlines for filing foreign patent applications. The guide is available either by contacting the USPTO Contact Center at 800-786-9199, or it can be viewed on the USPTO website at <http://www.uspto.gov/web/offices/pac/doc/general/index.html>.

For information on preventing theft of your intellectual property (patents, trademarks and copyrights), you may wish to consult the U.S. Government website, <http://www.stopfakes.gov>. Part of a Department of Commerce initiative, this website includes self-help "toolkits" giving innovators guidance on how to protect intellectual property in specific countries such as China, Korea and Mexico. For questions regarding patent enforcement issues, applicants may call the U.S. Government hotline at 1-866-999-HALT (1-866-999-4158).

### **LICENSE FOR FOREIGN FILING UNDER**

**Title 35, United States Code, Section 184**

**Title 37, Code of Federal Regulations, 5.11 & 5.15**

#### **GRANTED**

The applicant has been granted a license under 35 U.S.C. 184, if the phrase "IF REQUIRED, FOREIGN FILING LICENSE GRANTED" followed by a date appears on this form. Such licenses are issued in all applications where

the conditions for issuance of a license have been met, regardless of whether or not a license may be required as set forth in 37 CFR 5.15. The scope and limitations of this license are set forth in 37 CFR 5.15(a) unless an earlier license has been issued under 37 CFR 5.15(b). The license is subject to revocation upon written notification. The date indicated is the effective date of the license, unless an earlier license of similar scope has been granted under 37 CFR 5.13 or 5.14.

This license is to be retained by the licensee and may be used at any time on or after the effective date thereof unless it is revoked. This license is automatically transferred to any related applications(s) filed under 37 CFR 1.53(d). This license is not retroactive.

The grant of a license does not in any way lessen the responsibility of a licensee for the security of the subject matter as imposed by any Government contract or the provisions of existing laws relating to espionage and the national security or the export of technical data. Licensees should apprise themselves of current regulations especially with respect to certain countries, of other agencies, particularly the Office of Defense Trade Controls, Department of State (with respect to Arms, Munitions and Implements of War (22 CFR 121-128)); the Bureau of Industry and Security, Department of Commerce (15 CFR parts 730-774); the Office of Foreign Assets Control, Department of Treasury (31 CFR Parts 500+) and the Department of Energy.

**NOT GRANTED**

No license under 35 U.S.C. 184 has been granted at this time, if the phrase "IF REQUIRED, FOREIGN FILING LICENSE GRANTED" DOES NOT appear on this form. Applicant may still petition for a license under 37 CFR 5.12, if a license is desired before the expiration of 6 months from the filing date of the application. If 6 months has lapsed from the filing date of this application and the licensee has not received any indication of a secrecy order under 35 U.S.C. 181, the licensee may foreign file the application pursuant to 37 CFR 5.15(b).

---

**SelectUSA**

The United States represents the largest, most dynamic marketplace in the world and is an unparalleled location for business investment, innovation and commercialization of new technologies. The USA offers tremendous resources and advantages for those who invest and manufacture goods here. Through SelectUSA, our nation works to encourage, facilitate, and accelerate business investment. To learn more about why the USA is the best country in the world to develop technology, manufacture products, and grow your business, visit [SelectUSA.gov](http://SelectUSA.gov).

**IN THE UNITED STATES PATENT AND TRADEMARK OFFICE**

<b>Applicant(s):</b>	<b>Michael J. Rojas</b>	<b>Examiner:</b>	<b>Unassigned</b>
<b>Serial No:</b>	<b>Unassigned</b>	<b>Art Unit:</b>	<b>Unassigned</b>
<b>Filed:</b>	<b>Herewith</b>	<b>Docket:</b>	<b>17188YX</b>
<b>For:</b>	<b>SYSTEM AND METHOD FOR INSTANT VoIP MESSAGING</b>	<b>Dated:</b>	<b>July 10, 2012</b>

Commissioner for Patents  
P. O. Box 1450  
Alexandria, VA 22313-1450

**INFORMATION DISCLOSURE STATEMENT**

Sir:

In accordance with 37 C.F.R. §§ 1.97 and 1.98, it is requested that the following references, which are also listed on the attached Form PTO-1449, be made of record in the above-identified case.

1. U.S. 6,763,226 dated July 13, 2004 to McZeal, Jr.;
2. U.S. Patent Application Publication 2004/0252679 dated December 16, 2004 to Williams et al.;
3. U.S. Patent Application Publication 2004/0122906 dated June 24, 2004 to Goodman et al.;

---

**CERTIFICATE OF ELECTRONIC TRANSMISSION**

I hereby certify that this document is being electronically filed in the United States Patent and Trademark Office on the date shown below.

Dated: July 10, 2012

/Seth Weinfeld/  
Seth Weinfeld

4. U.S. Patent Application Publication 2005/0053230 dated March 10, 2005 to Gierachf, K.;
5. U.S. Patent Application Publication 2005/0105697 dated May 19, 2005 to Hollowell et al.;
6. U.S. Patent Application Publication 2003/0087632 dated May 8, 2003 to Sagi et al.;
7. U.S. Patent Application Publication 2006/0268750 dated November 30, 2006 to Weiner, M.;
8. U.S. Patent Application Publication 2004/0030046 dated February 12, 2004 to Schultes et al.;
9. U.S. Patent Application Publication 2007/0112925 dated May 17, 2007 to Makik, D.;
10. U.S. Patent Application Publication 2007/0174403 dated July 26, 2007 to Barry, M.;
11. U.S. Patent Application Publication 2006/0167883 dated July 27, 2006 to Boukobza, E.;
12. U.S. Patent Application Publication 2004/0128356 dated July 1, 2004 to Bernstein et al.;
13. U.S. Patent Application Publication 2003/0126207 dated July 3, 2003 to Creamer et al.;
14. [http://www.cisco.com/warp/public/cc/pd/nemnsw/callmn/prodlit/cm33\\_ds.htm](http://www.cisco.com/warp/public/cc/pd/nemnsw/callmn/prodlit/cm33_ds.htm); "Data Sheet Cisco CallManager Version 3.3", November 22, 2002;
15. [http://www.cisco.com/en/US/products/hw/switches/ps1925/products\\_data\\_sheet\\_09186\\_a00800a3c3d.html](http://www.cisco.com/en/US/products/hw/switches/ps1925/products_data_sheet_09186_a00800a3c3d.html); "Data Sheet Cisco MGX 8000 Series" (Date unknown);
16. <http://www.hsteliann.com/english/?zone=3100-V21P>; "Telephone 3100-V21P", 2003;
17. <http://www.linuxdevices.com/articles/AT5199947519.html>; "Device Profile: snom 100 VoIP phone", (May 15, 2002);
18. [http://www.pingtel.com/pr\\_xpressa.jsp](http://www.pingtel.com/pr_xpressa.jsp); "No limits with the advanced industry standard SIP phone, December 8, 2003; and

19. AudioCoded Enabling Technology Products, TPM-1100 VoP Media Gateway Modules; 2003.
20. U.S. Patent Application Publication No. 2004/0014456 A1 published January 22, 2004 to Väänänen;
21. U.S. Patent Application Publication No. 2010/0070275 A1 published March 18, 2012 to Cast;
22. U.S. Patent Application Publication No. 2004/0179092 A1 published September 16, 2004 to LaPoint;
23. U.S. Patent Application Publication No. 2004/0085456 A1 published May 6, 2004 to Kwag et al.
24. U.S. Patent Application Publication No. 2009/0161664 A1 published June 25, 2009 to Michael J. Rojas;
25. U.S. Patent No. 7,535,890 issued May 19, 2009 to Michael J. Rojas;
26. U.S. Patent No. 8,199,747 issued June 12, 2012 to Michael J. Rojas;
27. U.S. Office Action dated October 18, 2011 received in related case, namely, U.S. Serial No. 12/398,063 filed March 4, 2009;
28. U.S. Final Office Action dated January 25, 2012 received in related case, namely, U.S. Serial No. 12/398,063 filed March 4, 2009; and
29. Notice of Allowance dated March 30, 2012 received in related case, namely, U.S. Serial No. 12/398,063 filed March 4, 2009.

Pursuant to 37 C.F.R. §1.98(d), copies of the above listed references are not provided, as references 1-23 were previously submitted in Information Disclosure Statements filed in connection with parent case, U.S. Serial Number: 12/398,063 filed on March 4, 2009. References 24-29 are related to the present application.



---

Inasmuch as this Information Disclosure Statement is being submitted in accordance with the schedule set out in 37 C.F.R §1.97(b), no statement or fee is required.

Respectfully submitted,

/Seth Weinfeld/

Seth Weinfeld  
Registration No. 50,929

Scully, Scott, Murphy & Presser, P.C.  
400 Garden City Plaza, Suite 300  
Garden City, New York 11530  
(516) 742-4343  
SMW:reg

Form PTO-1449 U.S. DEPARTMENT OF COMMERCE (REV. 7-80) PATENT AND TRADEMARK OFFICE		Atty. Docket No. 17188Y		Application No.			
<b>INFORMATION DISCLOSURE CITATION</b>  (Use several sheets if necessary)		Applicant Michael J. Rojas				Group Art Unit	
		Filing Date Herewith					
<b>U.S. PATENT DOCUMENTS</b>							
EXAMINER INITIAL*	DOCUMENT NUMBER	DATE	NAME	CLASS	SUBCLASS	FILING DATE (if appropriate)	
	6,763,226	07-13-2004	McZeal, Jr.				
	7,535,890	05-19-2009	Michael J. Rojas				
	8,199,747	06-12-2012	Michael J. Rojas				
<b>U.S. PATENT PUBLICATION DOCUMENTS</b>							
	2004/0252679	12-16-2004	Williams et al.				
	2004/0122906	06-24-2004	Goodman et al.				
	2005/0053230	03-10-2005	Gierachf, K.				
	2005/0105697	05-19-2005	Hollowell et al.				
	2003/0087632	05-08-2003	Sagi et al.				
	2006/0268750	11-30-2006	Weiner, M.				
	2004/0030046	02-12-2004	Schultes et al.				
	2007/0112925	05-17-2007	Malik, D.				
	2007/0174403	07-26-2007	Barry, M.				
	2006/0167883	07-27-2006	Boukobza, E.				
	2004/0128356	07-01-2004	Bernstein et al.				
	2003/0126207	07-03-2003	Creamer et al.				
<b>FOREIGN PATENT DOCUMENTS</b>							
	DOCUMENT NUMBER	DATE	COUNTRY	CLASS	SUBCLASS	TRANSLATION	
						YES	NO
<b>OTHER PRIOR ART (Including Author, Title, Date, Pertinent Pages, Etc.)</b>							
	<a href="http://www.cisco.com/warp/public/cc/pd/nemnsw/callmn/prodlit/cm33_ds.htm">http://www.cisco.com/warp/public/cc/pd/nemnsw/callmn/prodlit/cm33_ds.htm</a> ; "Data Sheet Cisco CallManager Version 3.3", November 22, 2002;						
	<a href="http://www.cisco.com/en/US/products/hw/switches/ps1925/products_data_sheet_09186_a00800a3c3d.html">http://www.cisco.com/en/US/products/hw/switches/ps1925/products_data_sheet_09186_a00800a3c3d.html</a> ; "Data Sheet Cisco MGX 8000 Series" (Date unknown);						
	U.S. Office Action dated October 18, 2011 received in related case, namely, U.S. Serial No. 12/398,063 filed March 4, 2009						
EXAMINER			DATE CONSIDERED				

Form PTO-1449 U.S. DEPARTMENT OF COMMERCE (REV. 7-80) PATENT AND TRADEMARK OFFICE		<b>Atty. Docket No. (Optional)</b> 17188YX		<b>Application Number</b>				
<b>INFORMATION DISCLOSURE CITATION</b> (Use several sheets if necessary)		<b>Applicant(s)</b> Michael Rojas		<b>Filing Date</b>				
				<b>Group Art Unit</b>				
<b>U.S. PATENT PUBLICATION DOCUMENTS</b>								
		2004/0014456 A1	2004-01-22	Väänänen				
		2010/0070275 A1	2010-03-18	Cast				
		2004/0179092 A1	2004-09-16	La Point				
		2004/0085456 A1	2004-05-06	Kwag et al.				
		2009/0161664 A1	2009-06-25	Michael J. Rojas				
<b>FOREIGN PATENT DOCUMENTS</b>								
	REF	DOCUMENT NUMBER	DATE	COUNTRY	CLASS	SUBCLASS	TRANSLATION	
							YES	NO
<b>OTHER DOCUMENTS</b> (Including Author, Title, Date, Pertinent Pages, Etc.)								
		<a href="http://www.hsteliann.com/english/?zone=3100-V21P">http://www.hsteliann.com/english/?zone=3100-V21P</a> ; "Telephone 3100-V21P", 2003;						
		<a href="http://www.linuxdevices.com/articles/AT5199947519.html">http://www.linuxdevices.com/articles/AT5199947519.html</a> ; "Device Profile: snom 100 VoIP phone", May 15, 2002;						
		<a href="http://www.pingtel.com/pr_xpressa.jsp">http://www.pingtel.com/pr_xpressa.jsp</a> ; "No limits with the advanced industry standard SIP phone, December 8, 2003; and						
		AudioCoded Enabling Technology Products, TPM-1100 VoP Media Gateway Modules; 2003.						
		U.S. Final Office Action dated January 25, 2012 received in related case, namely, U.S. Serial No 12/398,063 filed March 4, 2009						
		Notice of Allowance dated March 30, 2012 received in related case, namely, U.S. Serial No. 12/398,063 filed March 4, 2009						
<b>EXAMINER</b>				<b>DATE CONSIDERED</b>				
* EXAMINER: Initial if reference considered, whether or not citation is in conformance with MPEP 609; draw line through citation if not in conformance and not considered. Include copy of this form with next communication to applicant.								

## Electronic Patent Application Fee Transmittal

<b>Application Number:</b>				
<b>Filing Date:</b>				
<b>Title of Invention:</b>	SYSTEM AND METHOD FOR INSTANT VoIP MESSAGING			
<b>First Named Inventor/Applicant Name:</b>	Michael J. Rojas			
<b>Filer:</b>	Paul J. Esatto			
<b>Attorney Docket Number:</b>	17188YX			
Filed as Small Entity				
<b>Utility under 35 USC 111(a) Filing Fees</b>				
<b>Description</b>	<b>Fee Code</b>	<b>Quantity</b>	<b>Amount</b>	<b>Sub-Total in USD(\$)</b>
<b>Basic Filing:</b>				
Utility filing Fee (Electronic filing)	4011	1	95	95
Utility Search Fee	2111	1	310	310
Utility Examination Fee	2311	1	125	125
<b>Pages:</b>				
<b>Claims:</b>				
<b>Miscellaneous-Filing:</b>				
<b>Petition:</b>				
<b>Patent-Appeals-and-Interference:</b>				

Description	Fee Code	Quantity	Amount	Sub-Total in USD(\$)
<b>Post-Allowance-and-Post-Issuance:</b>				
<b>Extension-of-Time:</b>				
<b>Miscellaneous:</b>				
<b>Total in USD (\$)</b>				<b>530</b>

## Electronic Acknowledgement Receipt

<b>EFS ID:</b>	13225033
<b>Application Number:</b>	13546673
<b>International Application Number:</b>	
<b>Confirmation Number:</b>	9648
<b>Title of Invention:</b>	SYSTEM AND METHOD FOR INSTANT VoIP MESSAGING
<b>First Named Inventor/Applicant Name:</b>	Michael J. Rojas
<b>Customer Number:</b>	23389
<b>Filer:</b>	Paul J. Esatto
<b>Filer Authorized By:</b>	
<b>Attorney Docket Number:</b>	17188YX
<b>Receipt Date:</b>	11-JUL-2012
<b>Filing Date:</b>	
<b>Time Stamp:</b>	16:46:32
<b>Application Type:</b>	Utility under 35 USC 111(a)

### Payment information:

Submitted with Payment	yes
Payment Type	Deposit Account
Payment was successfully received in RAM	\$530
RAM confirmation Number	4103
Deposit Account	191013
Authorized User	

The Director of the USPTO is hereby authorized to charge indicated fees and credit any overpayment as follows:

Charge any Additional Fees required under 37 C.F.R. Section 1.16 (National application filing, search, and examination fees)

Charge any Additional Fees required under 37 C.F.R. Section 1.17 (Patent application and reexamination processing fees)

Charge any Additional Fees required under 37 C.F.R. Section 1.21 (Miscellaneous fees and charges)

**File Listing:**

Document Number	Document Description	File Name	File Size(Bytes)/ Message Digest	Multi Part /.zip	Pages (if appl.)
1	Application Data Sheet	17188YXADSpdf.pdf	965500 c4edd0efd3d9ce9dae3a921a237201dae0a5b622	no	5
<b>Warnings:</b>					
<b>Information:</b>					
2		17188X_ApplnAsFiled.pdf	6743692 14046620a81da052c791f46b69c1090f4355315	yes	50
	<b>Multipart Description/PDF files in .zip description</b>				
	<b>Document Description</b>		<b>Start</b>		<b>End</b>
	Specification		1		48
	Claims		49		49
	Abstract		50		50
<b>Warnings:</b>					
<b>Information:</b>					
3	Drawings-only black and white line drawings	17188X_formaldrawing.pdf	698217 96cfbc62f9522be906668423600f39729bd93452	no	9
<b>Warnings:</b>					
<b>Information:</b>					
4	Oath or Declaration filed	17188X_declaration.pdf	511844 74e40f6626f4fd937e27d719e8b46b9398d4445	no	3
<b>Warnings:</b>					
<b>Information:</b>					
5	Information Disclosure Statement (IDS) Form (SB08)	17188X_IDSasfiled.pdf	490884 7572da5f2e817fdfe80a741713f82ba9aeadd33bd	no	6
<b>Warnings:</b>					
<b>Information:</b>					
This is not an USPTO supplied IDS fillable form					
6	Fee Worksheet (SB06)	fee-info.pdf	32964 ed79165a126bd657e549639b37fa548e2b876ae9	no	2
<b>Warnings:</b>					
<b>Information:</b>					

This Acknowledgement Receipt evidences receipt on the noted date by the USPTO of the indicated documents, characterized by the applicant, and including page counts, where applicable. It serves as evidence of receipt similar to a Post Card, as described in MPEP 503.

**New Applications Under 35 U.S.C. 111**

If a new application is being filed and the application includes the necessary components for a filing date (see 37 CFR 1.53(b)-(d) and MPEP 506), a Filing Receipt (37 CFR 1.54) will be issued in due course and the date shown on this Acknowledgement Receipt will establish the filing date of the application.

**National Stage of an International Application under 35 U.S.C. 371**

If a timely submission to enter the national stage of an international application is compliant with the conditions of 35 U.S.C. 371 and other applicable requirements a Form PCT/DO/EO/903 indicating acceptance of the application as a national stage submission under 35 U.S.C. 371 will be issued in addition to the Filing Receipt, in due course.

**New International Application Filed with the USPTO as a Receiving Office**

If a new international application is being filed and the international application includes the necessary components for an international filing date (see PCT Article 11 and MPEP 1810), a Notification of the International Application Number and of the International Filing Date (Form PCT/RO/105) will be issued in due course, subject to prescriptions concerning national security, and the date shown on this Acknowledgement Receipt will establish the international filing date of the application.



Under the Paperwork Reduction Act of 1995, no persons are required to respond to a collection of information unless it contains a valid OMB control number.

<b>Application Data Sheet 37 CFR 1.76</b>		Attorney Docket Number	17188YX
		Application Number	
Title of Invention	SYSTEM AND METHOD FOR INSTANT VoIP MESSAGING		
<p>The application data sheet is part of the provisional or nonprovisional application for which it is being submitted. The following form contains the bibliographic data arranged in a format specified by the United States Patent and Trademark Office as outlined in 37 CFR 1.76.</p> <p>This document may be completed electronically and submitted to the Office in electronic format using the Electronic Filing System (EFS) or the document may be printed and included in a paper filed application.</p>			

**Secrecy Order 37 CFR 5.2**

Portions or all of the application associated with this Application Data Sheet may fall under a Secrecy Order pursuant to 37 CFR 5.2 (Paper filers only. Applications that fall under Secrecy Order may not be filed electronically.)

**Applicant Information:**

<b>Applicant 1</b>					<input type="button" value="Remove"/>
<b>Applicant Authority</b>		<input checked="" type="radio"/> Inventor		<input type="radio"/> Legal Representative under 35 U.S.C. 117	
		<input type="radio"/> Party of Interest under 35 U.S.C. 118			
<b>Prefix</b>	<b>Given Name</b>	<b>Middle Name</b>	<b>Family Name</b>	<b>Suffix</b>	
	Michael	J.	Rojas		
<b>Residence Information (Select One)</b> <input checked="" type="radio"/> US Residency <input type="radio"/> Non US Residency <input type="radio"/> Active US Military Service					
<b>City</b>	North Canton, Stark County	<b>State/Province</b>	OH	<b>Country of Residence i</b>	US
<b>Citizenship under 37 CFR 1.41(b) i</b>		US			
<b>Mailing Address of Applicant:</b>					
<b>Address 1</b>	2828 Barclay Circle				
<b>Address 2</b>					
<b>City</b>	North Canton, Stark County	<b>State/Province</b>	OH		
<b>Postal Code</b>	44720	<b>Country i</b>	US		
All Inventors Must Be Listed - Additional Inventor Information blocks may be generated within this form by selecting the <b>Add</b> button.					<input type="button" value="Add"/>

**Correspondence Information:**

Enter either Customer Number or complete the Correspondence Information section below. For further information see 37 CFR 1.33(a).			
<input type="checkbox"/> An Address is being provided for the correspondence information of this application.			
<b>Customer Number</b>	23389		
<b>Email Address</b>		<input type="button" value="Add Email"/>	<input type="button" value="Remove Email"/>

**Application Information:**

<b>Title of the Invention</b>	SYSTEM AND METHOD FOR INSTANT VoIP MESSAGING		
<b>Attorney Docket Number</b>	17188YX	<b>Small Entity Status Claimed</b>	<input type="checkbox"/>
<b>Application Type</b>	Nonprovisional		
<b>Subject Matter</b>	Utility		
<b>Suggested Class (if any)</b>		<b>Sub Class (if any)</b>	
<b>Suggested Technology Center (if any)</b>			
<b>Total Number of Drawing Sheets (if any)</b>	9	<b>Suggested Figure for Publication (if any)</b>	

<b>Application Data Sheet 37 CFR 1.76</b>	Attorney Docket Number	17188YX
	Application Number	
Title of Invention	SYSTEM AND METHOD FOR INSTANT VoIP MESSAGING	

**Publication Information:**

<input type="checkbox"/> Request Early Publication (Fee required at time of Request 37 CFR 1.219)
<input type="checkbox"/> <b>Request Not to Publish.</b> I hereby request that the attached application not be published under 35 U.S.C. 122(b) and certify that the invention disclosed in the attached application <b>has not and will not</b> be the subject of an application filed in another country, or under a multilateral international agreement, that requires publication at eighteen months after filing.

**Representative Information:**

Representative information should be provided for all practitioners having a power of attorney in the application. Providing this information in the Application Data Sheet does not constitute a power of attorney in the application (see 37 CFR 1.32). Enter either Customer Number or complete the Representative Name section below. If both sections are completed the Customer Number will be used for the Representative Information during processing.

Please Select One:	<input type="radio"/> Customer Number	<input checked="" type="radio"/> US Patent Practitioner	<input type="radio"/> Limited Recognition (37 CFR 11.9)		
Prefix	Given Name	Middle Name	Family Name	Suffix	<input type="button" value="Remove"/>
	Paul	J.	Esatto, Jr.		
Registration Number	30749				
Prefix	Given Name	Middle Name	Family Name	Suffix	<input type="button" value="Remove"/>
	Frank	S.	DiGiglio		
Registration Number	31346				
Prefix	Given Name	Middle Name	Family Name	Suffix	<input type="button" value="Remove"/>
	Peter	I.	Bernstein		
Registration Number	43497				
Prefix	Given Name	Middle Name	Family Name	Suffix	<input type="button" value="Remove"/>
	Mark	J.	Cohen		
Registration Number	32211				
Additional Representative Information blocks may be generated within this form by selecting the <b>Add</b> button.					<input type="button" value="Add"/>

**Domestic Benefit/National Stage Information:**

This section allows for the applicant to either claim benefit under 35 U.S.C. 119(e), 120, 121, or 365(c) or indicate National Stage entry from a PCT application. Providing this information in the application data sheet constitutes the specific reference required by 35 U.S.C. 119(e) or 120, and 37 CFR 1.78(a)(2) or CFR 1.78(a)(4), and need not otherwise be made part of the specification.

Prior Application Status	Pending	<input type="button" value="Remove"/>	
Application Number	Continuity Type	Prior Application Number	Filing Date (YYYY-MM-DD)
Unassigned	Continuation of	12398063	2009-03-04
Prior Application Status	Pending	<input type="button" value="Remove"/>	

Under the Paperwork Reduction Act of 1995, no persons are required to respond to a collection of information unless it contains a valid OMB control number.

<b>Application Data Sheet 37 CFR 1.76</b>		Attorney Docket Number	17188YX
		Application Number	
Title of Invention	SYSTEM AND METHOD FOR INSTANT VoIP MESSAGING		
Application Number	Continuity Type	Prior Application Number	Filing Date (YYYY-MM-DD)
12398063	Continuation of	10740030	2003-12-18
Additional Domestic Benefit/National Stage Data may be generated within this form by selecting the <b>Add</b> button.			<input type="button" value="Add"/>

**Foreign Priority Information:**

This section allows for the applicant to claim benefit of foreign priority and to identify any prior foreign application for which priority is not claimed. Providing this information in the application data sheet constitutes the claim for priority as required by 35 U.S.C. 119(b) and 37 CFR 1.55(a).			
			<input type="button" value="Remove"/>
Application Number	Country <sup>i</sup>	Parent Filing Date (YYYY-MM-DD)	Priority Claimed
			<input type="radio"/> Yes <input checked="" type="radio"/> No
Additional Foreign Priority Data may be generated within this form by selecting the <b>Add</b> button.			<input type="button" value="Add"/>

**Assignee Information:**

Providing this information in the application data sheet does not substitute for compliance with any requirement of part 3 of Title 37 of the CFR to have an assignment recorded in the Office.			
<b>Assignee 1</b>			<input type="button" value="Remove"/>
If the Assignee is an Organization check here. <input checked="" type="checkbox"/>			
Organization Name	Ayalogic, Inc.		
<b>Mailing Address Information:</b>			
Address 1	P.O. Box 773		
Address 2			
City	Ravena	State/Province	OH
Country <sup>i</sup>	US	Postal Code	44266
Phone Number		Fax Number	
Email Address			
Additional Assignee Data may be generated within this form by selecting the <b>Add</b> button.			<input type="button" value="Add"/>

**Signature:**

A signature of the applicant or representative is required in accordance with 37 CFR 1.33 and 10.18. Please see 37 CFR 1.4(d) for the form of the signature.				
Signature	/Paul J. Esatto, Jr. /		Date (YYYY-MM-DD)	2012-07-10
First Name	Paul J. Esatto, Jr.	Last Name	Registration Number	30749

Under the Paperwork Reduction Act of 1995, no persons are required to respond to a collection of information unless it contains a valid OMB control number.

<b>Application Data Sheet 37 CFR 1.76</b>		Attorney Docket Number	17188YX
		Application Number	
Title of Invention	SYSTEM AND METHOD FOR INSTANT VoIP MESSAGING		

This collection of information is required by 37 CFR 1.76. The information is required to obtain or retain a benefit by the public which is to file (and by the USPTO to process) an application. Confidentiality is governed by 35 U.S.C. 122 and 37 CFR 1.14. This collection is estimated to take 23 minutes to complete, including gathering, preparing, and submitting the completed application data sheet form to the USPTO. Time will vary depending upon the individual case. Any comments on the amount of time you require to complete this form and/or suggestions for reducing this burden, should be sent to the Chief Information Officer, U.S. Patent and Trademark Office, U.S. Department of Commerce, P.O. Box 1450, Alexandria, VA 22313-1450. DO NOT SEND FEES OR COMPLETED FORMS TO THIS ADDRESS. **SEND TO: Commissioner for Patents, P.O. Box 1450, Alexandria, VA 22313-1450.**

## Privacy Act Statement

The Privacy Act of 1974 (P.L. 93-579) requires that you be given certain information in connection with your submission of the attached form related to a patent application or patent. Accordingly, pursuant to the requirements of the Act, please be advised that: (1) the general authority for the collection of this information is 35 U.S.C. 2(b)(2); (2) furnishing of the information solicited is voluntary; and (3) the principal purpose for which the information is used by the U.S. Patent and Trademark Office is to process and/or examine your submission related to a patent application or patent. If you do not furnish the requested information, the U.S. Patent and Trademark Office may not be able to process and/or examine your submission, which may result in termination of proceedings or abandonment of the application or expiration of the patent.

The information provided by you in this form will be subject to the following routine uses:

1. The information on this form will be treated confidentially to the extent allowed under the Freedom of Information Act (5 U.S.C. 552) and the Privacy Act (5 U.S.C. 552a). Records from this system of records may be disclosed to the Department of Justice to determine whether the Freedom of Information Act requires disclosure of these records.
2. A record from this system of records may be disclosed, as a routine use, in the course of presenting evidence to a court, magistrate, or administrative tribunal, including disclosures to opposing counsel in the course of settlement negotiations.
3. A record in this system of records may be disclosed, as a routine use, to a Member of Congress submitting a request involving an individual, to whom the record pertains, when the individual has requested assistance from the Member with respect to the subject matter of the record.
4. A record in this system of records may be disclosed, as a routine use, to a contractor of the Agency having need for the information in order to perform a contract. Recipients of information shall be required to comply with the requirements of the Privacy Act of 1974, as amended, pursuant to 5 U.S.C. 552a(m).
5. A record related to an International Application filed under the Patent Cooperation Treaty in this system of records may be disclosed, as a routine use, to the International Bureau of the World Intellectual Property Organization, pursuant to the Patent Cooperation Treaty.
6. A record in this system of records may be disclosed, as a routine use, to another federal agency for purposes of National Security review (35 U.S.C. 181) and for review pursuant to the Atomic Energy Act (42 U.S.C. 218(c)).
7. A record from this system of records may be disclosed, as a routine use, to the Administrator, General Services, or his/her designee, during an inspection of records conducted by GSA as part of that agency's responsibility to recommend improvements in records management practices and programs, under authority of 44 U.S.C. 2904 and 2906. Such disclosure shall be made in accordance with the GSA regulations governing inspection of records for this purpose, and any other relevant (i.e., GSA or Commerce) directive. Such disclosure shall not be used to make determinations about individuals.
8. A record from this system of records may be disclosed, as a routine use, to the public after either publication of the application pursuant to 35 U.S.C. 122(b) or issuance of a patent pursuant to 35 U.S.C. 151. Further, a record may be disclosed, subject to the limitations of 37 CFR 1.14, as a routine use, to the public if the record was filed in an application which became abandoned or in which the proceedings were terminated and which application is referenced by either a published application, an application open to public inspections or an issued patent.
9. A record from this system of records may be disclosed, as a routine use, to a Federal, State, or local law enforcement agency, if the USPTO becomes aware of a violation or potential violation of law or regulation.

**SYSTEM AND METHOD  
FOR INSTANT VoIP MESSAGING**

**CROSS REFERENCE TO RELATED APPLICATION**

5

[0001] This application is a continuation of U.S. Application Serial Number 12/398,063 filed March 4, 2009, which is now U.S. Patent Publication Number 2009/0161664 A1, published June 25, 2009, which is a continuation of U.S. Application Serial Number 10/740,030 filed on December 18, 2003, now U.S. Patent Number 7,535,890, issued May 19, 2009, the entire content and disclosure of which is incorporated by reference.

10

**BACKGROUND OF THE INVENTION**

Technical Field of the Invention

15

The present invention generally relates to Internet telephony (IP telephony). More particularly, the present invention is directed to a system and method for enabling local and global instant VoIP messaging over an IP network, such as the Internet, with PSTN support.

20

Description of the Prior Art

Traditional telephony is based on a public switched telephone network (i.e., "PSTN"). In the PSTN, a telephone terminal is electrically connected to a conventional or legacy switch. The telephone terminal and the legacy switch communicate via a proprietary protocol, which may be different depending on the vendor of the legacy switch. Circuit switching provides a communication path (i.e., dedicated circuit) for a telephone call from the telephone terminal to another device over the PSTN, including another

25

telephone terminal. During the telephone call, voice communication takes place over that communication path.

An alternative to the PSTN is Voice over Internet Protocol (i.e., “VoIP”),  
5 also known as IP telephony or Internet telephony. In the IP telephony, a VoIP terminal device is connected to a packet-switched network (e.g., Internet) and voice communication from the VoIP terminal device is digitized, packetized and transmitted over the packet-switched network to a destination VoIP terminal device, which reconstructs the packets and audibly plays, stores or otherwise processes the transmission. The VoIP terminal device  
10 may be a VoIP telephone or a general-purpose personal computer (PC) enabled for IP telephony. More specifically, the PC is programmed with the software and equipped with audio input/output devices (e.g., a combination of microphone and speaker or a headset) to serve as a VoIP terminal device. The PC so enabled and equipped will herein be referred to as a VoIP terminal device or a VoIP softphone.

15

Figure 1 is an illustrative example of a prior art IP telephony system 100. The IP telephony system 100 comprises a packet-switched IP network 102, such as the Internet, which transmits VoIP traffic from and to a plurality of terminal devices 104, 106 and 110. Terminal device 104 is a VoIP softphone that is enabled for IP telephony over the  
20 network 102. Terminal device 106 is a VoIP telephone, which is connected to the network 102 via a softswitch 108. The VoIP softswitch 108 is disposed on the packet-switched network (e.g., Internet) 102 between an origination terminal device (such as VoIP softphone 104) and a destination terminal device (such as VoIP telephone 106), and routes packets

over the packet-switched IP network 102. The softswitch 108 may also manage and perform administrative functions for the terminal device or devices (e.g., VoIP telephone 106) to which it is connected. Whether the terminal device is a VoIP softphone 104 or a VoIP telephone 106, the terminal device is connected to the IP network 102 via a networking standard such as Ethernet, Bluetooth, IEEE 1394 (also known as “Firewire”), IEEE 802.11 (also known as “WiFi”), or networking over serial communication channels such as the Universal Serial Bus (i.e., “USB”). Data communication over the network then takes place using a connection protocol, e.g., transfer control protocol/Internet protocol (i.e., “TCP/IP”).

10 Further regarding Fig. 1, terminal device 110 is a legacy telephone that is connected to a legacy switch 112 for (circuit-switched) voice communications over the PSTN 116 with other terminal devices. A media gateway 114 may be provided between the legacy switch 112 and the packet-switched network 102 to enable IP telephony between the legacy telephone 110 and a VoIP terminal device, such as a VoIP softphone 104 or VoIP  
15 telephone 106. More specifically, the media gateway 114 converts the audio signal carried over PSTN to packets carried over the packet-switched IP network 102. In addition, a media gateway 118 may be disposed over the PSTN 116 and connected to a softswitch 120 to convert the audio signal from the legacy telephone 110 to packets routed over the IP network 102 via the softswitch 120.

20

Voice messaging in both the VoIP and PSTN is known. More specifically, the foregoing systems may be provided with a facility to allow users to leave voice messages for recipients, which is a feature that is familiar to anyone who uses a telephone.



Conventionally, leaving a voice message involves dialing the recipient's telephone number (often without knowing whether the recipient will answer), waiting for the connection to be established, speaking to an operator or navigating through a menu of options, listening to a greeting message, and recording the message for later pickup by the recipient. In that  
5 message, the user must typically identify himself or herself in order for the recipient to return the call.

Instant text messaging is likewise known. More specifically, a user is provided with a client terminal, which is typically a general-purpose PC programmed with  
10 instant text messaging software and in data communication over an IP network with an instant text-messaging server. The instant text-messaging server presents the user, via the client terminal, with a list of persons who are currently "online" and ready to receive text messages on their own client terminals. The user then uses the client terminal to select one or more persons to whom the message will be sent and types in a text message. The text  
15 message is sent immediately via the text-messaging server to the selected one or more persons and is displayed on their respective client terminals.

However, notwithstanding the foregoing advances in the VoIP/PSTN voice communication and voice/text messaging, there is still a need in the art for providing a  
20 system and method for providing instant VoIP messaging over an IP network. More particularly, there is a need in the art for providing local and global instant voice messaging over VoIP with PSTN support.

## SUMMARY OF THE INVENTION

The present invention is directed to a system and method for enabling local and global instant VoIP messaging over an IP network, such as the Internet.

5

According to an embodiment of the present invention, there is provided an instant voice messaging system for delivering instant messages over a packet-switched network, the system comprising: a client connected to the network, the client selecting one or more recipients, generating an instant voice message therefor, and transmitting the selected recipients and the instant voice message therefor over the network; and a server connected to the network, the server receiving the selected recipients and the instant voice message therefor, and delivering the instant voice message to the selected recipients over the network, the selected recipients being enabled to audibly play the instant voice message.

15

According to another embodiment of the present invention, there is provided an instant voice messaging system for delivering instant messages over a packet-switched network enabling public switched telephone network (PSTN) support, the system comprising: a PSTN telephone connected to the network for providing input audio; a client connected to the network, the client selecting one or more recipients, generating an instant voice message therefor using the input audio provided by the PSTN telephone, and transmitting the selected recipients and the instant voice message therefor over the network; a server connected to the network, the server receiving the selected recipients and the instant voice message therefor, and delivering the instant voice message to the selected recipients

20

over the network, the selected recipients being enabled to audibly play the instant voice message.

According to a further embodiment of the present invention, there is provided  
5 an instant voice messaging system for delivering instant messages over a packet-switched network, the system comprising: a voice-over-internet-protocol (VoIP) telephone connected to the network for providing input audio; a client connected to the network, the client selecting one or more recipients, generating an instant voice message therefor using the input audio provided by the VoIP telephone, and transmitting the selected recipients and the  
10 instant voice message therefor over the network; a server connected to the network, the server receiving the selected recipients and the instant voice message therefor, and delivering the instant voice message to the selected recipients over the network, the selected recipients being enabled to audibly play the instant voice message.

15 According to still another embodiment of the present invention, there is provided an instant voice messaging system for delivering instant messages over a plurality of packet-switched networks, the system comprising: a client connected to a local network, the client selecting one or more external recipients connected to an external network outside the local network, generating an instant voice message therefor, and transmitting the  
20 selected recipients and the instant voice message therefor over the local network and the external network; and a server connected to the external network, the server receiving the selected recipients and the instant voice message therefor, and delivering the instant voice message to the selected recipients over the external network, the selected recipients being

enabled to audibly play the instant voice message.

According to yet another embodiment of the present invention, there is provided an instant voice messaging system for delivering instant messages over a plurality of packet-switched networks enabling public switched telephone network (PSTN) support, the system comprising: a PSTN telephone connected to a local network for providing input audio; a client connected to the local network, the client selecting one or more external recipients connected to an external network outside the local network, generating an instant voice message therefor using the input audio provided by the PSTN telephone, and transmitting the selected recipients and the instant voice message therefor over the local network and the external network; a server connected to the external network, the server receiving the selected recipients and the instant voice message therefor, and delivering the instant voice message to the selected recipients over the external network, the selected recipients being enabled to audibly play the instant voice message.

15

According to yet a further embodiment of the present invention, there is provided an instant voice messaging system for delivering instant messages over a plurality of packet-switched networks, the system comprising: a voice-over-internet-protocol (VoIP) telephone connected to a local network for providing input audio; a client connected to the local network, the client selecting one or more external recipients connected to an external network outside the local network, generating an instant voice message therefor using the input audio provided by the VoIP telephone, and transmitting the selected recipients and the instant voice message therefor over the local network and the external network; an server

connected to the external network, the external server receiving the selected recipients and the instant voice message therefor, and delivering the instant voice message to the selected recipients over the external network, the selected recipients being enabled to audibly play the instant voice message.

5

According to still a further embodiment of the present invention, there is provided an instant voice messaging system for delivering instant messages over a plurality of packet-switched networks, the system comprising: a client connected to an external network, the client selecting one or more recipients connected to a local network, generating  
10 an instant voice message therefor, and transmitting the selected recipients and the instant voice message therefor over the external network; an external server system connected to the external network, the external server system receiving the selected recipients and the instant voice message, and routing the selected recipients and the instant voice message over the external network and the local network; a local server connected to the local network, the  
15 local server receiving the selected recipients and the instant voice message therefor, and delivering the instant voice message to the selected recipients over the local network, the selected recipients being enabled to audibly play the instant voice message.

According to an embodiment of the present invention, there is provided a  
20 method for instant voice messaging over a packet-switched network, the method comprising: selecting one or more recipients for instant voice messaging at a client; generating an instant voice message for the selected recipients at the client; transmitting the selected recipients and the instant voice message therefor over the network from the client to

a server; receiving the selected recipients and the instant voice message therefor at the server; delivering the instant voice message from the server to the selected recipients over the network; and audibly playing the instant voice message at the selected recipients.

5                   According to another embodiment of the present invention, there is provided a method for instant voice messaging over a packet-switched network enabling public switched telephone network (PSTN) support, the method comprising: providing input audio via a PSTN telephone connected over the network; selecting one or more recipients for instant voice messaging at a client; generating an instant voice message using the input  
10 audio from the PSTN telephone for the selected recipients at the client; transmitting the selected recipients and the instant voice message therefor over the network from the client to a server; receiving the selected recipients and the instant voice message therefor at the server; delivering the instant voice message from the server to the selected recipients over the network; and audibly playing the instant voice message at the selected recipients.

15                   According to a further embodiment of the present invention, there is provided a method for instant voice messaging over a packet-switched network, the method comprising: providing input audio via a voice-over-internet-protocol (VoIP) telephone connected over the network; selecting one or more recipients for instant voice messaging at  
20 a client; generating an instant voice message using the input audio from the VoIP telephone for the selected recipients at the client; transmitting the selected recipients and the instant voice message therefor over the network from the client to a server; receiving the selected recipients and the instant voice message therefor at the server; delivering the instant voice

message from the server to the selected recipients over the network; and audibly playing the instant voice message at the selected recipients.

According to still another embodiment of the present invention, there is  
5 provided a method for instant voice messaging over a plurality of packet-switched networks,  
the method comprising: selecting one or more external recipients for instant voice  
messaging at a client connected to a local network, the one or more external recipients  
connected to an external network outside the local network; generating an instant voice  
message for the selected external recipients at the client; transmitting the selected external  
10 recipients and the instant voice message therefor over the local network and the external  
network; receiving the selected external recipients and the instant voice message therefor at  
an external server connected to the external network; delivering the instant voice message to  
the selected external recipients over the external network; and audibly playing the instant  
voice message at the selected external recipients.

15

According to yet another embodiment of the present invention, there is  
provided a method for instant voice messaging system over a plurality of packet-switched  
networks enabling public switched telephone network (PSTN) support, the method  
comprising: providing input audio via a PSTN telephone connected to a local network;  
20 selecting one or more external recipients for instant voice messaging at a client, the one or  
more external recipients connected to an external network outside the local network;  
generating an instant voice message for the one or more external recipients using the input  
audio provided by the PSTN telephone; transmitting the selected recipients and the instant

voice message therefor over the local network and the external network; receiving the selected recipients and the instant voice message therefor at a server connected to the external network; delivering the instant voice message to the selected recipients from the server over the external network; and audibly playing the instant voice message at the  
5 selected recipients.

According to still a further embodiment of the present invention, there is provided a method for instant voice messaging system over a plurality of packet-switched networks, the method comprising: providing input audio via a voice-over-internet-protocol  
10 (VoIP) telephone connected to a local network; selecting one or more external recipients for instant voice messaging at a client, the one or more external recipients connected to an external network outside the local network; generating an instant voice message for the one or more external recipients using the input audio provided by the VoIP telephone; transmitting the selected recipients and the instant voice message therefor over the local  
15 network and the external network; receiving the selected recipients and the instant voice message therefor at a server connected to the external network; delivering the instant voice message to the selected recipients from the server over the external network; and audibly playing the instant voice message at the selected recipients.

20 According to yet a further embodiment of the present invention, there is provided a method for instant voice messaging over a plurality of a plurality of packet-switched networks, the method comprising: selecting one or more recipients connected to a local network at a client connected to an external network; generating an instant voice



message for the selected recipients at the client; transmitting the selected recipients and the instant voice message therefor over the external network from the client to an external server system; receiving the selected recipients and the instant voice message at the external server system; routing the selected recipients and the instant voice message over the external network and the local network; receiving the selected recipients and the instant voice message therefor at a local server connected to the local network; delivering the instant voice message to the selected recipients over the local network; audibly playing the instant voice message at the selected recipients.

10

### **BRIEF DESCRIPTION OF THE DRAWINGS**

The objects, features and advantages of the present invention will become apparent to one skilled in the art, in view of the following detailed description taken in combination with the attached drawings, in which:

15

Figure 1 illustrates an example of a prior art IP telephony system;

Figure 2 illustrates an exemplary local IVM system for enabling instant voice messaging according to the present invention;

Figure 3 illustrates an exemplary IVM client of Figure 2 for enabling instant voice messaging according to the present invention;

20

Figure 4 illustrates an exemplary IVM server of Figure 2 for enabling instant voice messaging according to the present invention;

Figure 5 illustrates an exemplary global IVM system comprising a local IVM system and global IVM clients, according to the present invention;

Fig. 6 illustrates an exemplary global IVM server system depicted in Fig. 5,

according to the present invention;

Fig. 7 illustrates an exemplary transport server depicted in Fig. 6, according to the present invention;

Fig. 8 illustrates an exemplary directory server depicted in Fig. 6, according to the present invention; and

Fig. 9 illustrates an exemplary global IVM system comprising a plurality of local IVM systems and global IVM clients, according to the present invention.

**DETAILED DESCRIPTION OF THE  
PREFERRED EMBODIMENT OF THE INVENTION**

The present invention is directed to a system and method for enabling local and global instant VoIP messaging over an IP network with PSTN support.

Figure 2 is an exemplary illustration of a local instant voice messaging (IVM) system 200 according to the present invention. The instant voice messaging system 200 comprises a local IVM server 202 that provides the core functionality for enabling instant voice messaging with PSTN support according to the present invention. The architecture of the local IVM server 202 will be described in detail hereinbelow with reference to Fig. 4. According to the exemplary IVM system 200, the local IVM server 202 is enabled to provide instant voice messaging to one or more IVM clients 206 and 208, as well support instant voice messaging for PSTN legacy telephones 110. It is noted that although Fig. 2 depicts one of each IVM client 206, 208 and legacy telephone 110 for clarity and brevity, the local IVM server 202 is enabled to support a plurality of each of the foregoing IVM

clients 206, 208 and legacy telephone 110. The local packet-switched IP network 204 interconnects the IVM clients 206, 208 and the legacy telephone 110 to the local IVM server 202 as well as interconnecting the local IVM server 202 to the local IP network 204. The network 204 may be a local area network (LAN), a wide area network (WAN), or the like, which supports both wired and wireless devices. The exemplary IVM client 208 is a VoIP softphone, the architecture of which will be described in detail hereinbelow with reference to Fig. 3. A microphone 212 is connected to the IVM client 208 and enables the recording of an instant voice message according to the present invention into an audio file 210 for transmission to the local IVM server 202 over the network 204. An input device 218 (e.g., a keyboard) is connected to the IVM client 208 to select one or more recipients that are to receive the recorded instant voice message. Although not depicted in Fig. 2, the input device 218 may include a trackball, digitizing pad or mouse, or the like. A display device 216 is connected to the IVM client 208 to display instant voice messages recorded and/or received by a user of the IVM client 208. An audio device 214, such as external speaker, is connected to the IVM client 208 to play received instant voice messages. It is noted that the microphone 212, audio device 214, display device 216 and input device 218 may form integral parts of the IVM client 208.

Further with reference to Fig. 2, IVM client 206 is interconnected via the network 204 to the local IVM server 202. An exemplary IVM client 206 is a VoIP telephone, which comprises a screen display (not shown) capable of displaying instant voice messages recorded and/or received by a user of the IVM client 206 according to the present invention. The VoIP telephone 206 further comprises a handset and/or speakerphone for

recording instant voice messages and listening to instant voice messages received at the VoIP telephone 206 according to the present invention. The VoIP telephones which may be implemented to provide instant voice messaging functionality according to the present invention are commercially available from many vendors, including Alcatel™, Lucent™, 5 NEC™ and Cisco™, to name just a few. In addition to the foregoing IVM clients 206, 208, the IVM system 200 supports a legacy telephone 110 for instant voice messaging according to the present invention. The legacy telephone 110 is connected to a legacy switch 112. The legacy switch 112 is further connected to a media gateway 114. Both the legacy switch 112 and the media gateway 114 interconnect the legacy telephone 110 via the network 204 to the 10 local IVM server 202, thereby facilitating instant voice messaging according to the present invention. The media gateway 114 may be a gateway that supports trunk pack network control (i.e., “TPNCP”) protocol, media gateway control protocol (i.e., “MGCP”), or a media gateway control H.428 protocol (i.e., “MEGACO”). As previously mentioned, the media gateway 114 converts the audio signal carried over PSTN to packets to be transmitted 15 over a packet-switched IP network, such as the local network 204.

The implementation of the instant voice messaging for IVM client 208 will be described first and will be followed by the implementations for IVM client 206 and legacy telephone 110, with reference to the local IVM system 200 depicted in Fig. 2. These 20 implementations implement a “record mode” of the instant voice messaging according to the present invention. There will further be described an “intercom mode” of the instant voice messaging according to the present invention. Therefore, in operation of the IVM client 208 according to Fig. 2, the IVM client (IVM softphone) 208 is connected over the network 204

to the IVM server 202, which as aforementioned enables instant voice messaging functionality over the network 204. The IVM client 208 displays a list of one or more IVM recipients on its display 216, provided and stored by the local IVM server 202, as will be particularly described hereinbelow with reference to Fig. 4. The user operates the IVM

5 client 208 by using the input device 218 to indicate a selection of one or more IVM recipients from the list. The user selection is transmitted to the IVM server 202. The user selection also generates a start signal to the IVM client 208 that the user is ready to begin instant voice messaging according to the present invention. In response to the start signal, the IVM client (softphone) 208 listens to the input audio device 212 and records the user's

10 speech into a digitized audio file 210 (i.e., instant voice message) stored on the IVM client 208. The audio file 210 at the IVM client 208 is finalized via a stop signal, which is generated by the user via the input device 218 or a preset time period without speech input via the input audio device 212 on the IVM client 208. Once the recording of the user's speech is finalized, IVM client 208 generates a send signal indicating that the digitized audio

15 file 210 (instant voice message) is ready to be sent to the selected recipients. The user generates the send signal when the user operates the IVM client 208 via the input device 218, e.g., pressing a key on a keyboard or clicking a button on a mouse. The IVM client 208 transmits the digitized audio file 210 and the send signal to the local IVM server 202. In response to the send signal indicating that the instant voice message is ready to be sent, the

20 IVM client 208 sends the recorded audio file 210 destined for the selected one or more recipients via local IVM server 202. After receiving the audio file 210, the IVM server 202 thereafter delivers the transmitted instant voice message to the selected one or more recipients via the local IP network 204. The one or more recipients are enabled to display an

indication that the instant voice message has been received and audibly play the instant voice message to an associated user. It should be understood that only the available IVM recipients, currently connected to the IVM server 202, will receive the instant voice message. It is noted that if a recipient IVM client is not currently connected to the local IVM server 202 (i.e., is unavailable), the IVM server temporarily saves the instant voice message and delivers it to the IVM client when the IVM client connects to the local IVM server 202 (i.e., is available).

There are several embodiments for the operation of the IVM client (VoIP telephone) 206 within the IVM system 200, according to the present invention. In the first embodiment, the VoIP telephone 206 is a standalone IVM client 206 enabled for instant voice messaging according to the present invention. In the second embodiment, the VoIP telephone 206 operates synchronously either with the IVM client 208 or IVM server 202 to enable instant voice messaging according to the present invention. Thus, in operation according to the first embodiment in Fig. 2, the IVM client (VoIP telephone) 206 is connected over the network 204 to the IVM server 202, which as aforementioned enables instant voice messaging functionality over the local network 204. The IVM client 206 displays a list of one or more IVM recipients on its associated display provided and stored by the local IVM server 202, as will be particularly described hereinbelow with reference to Fig. 4. The user operates the IVM client 206 by using a keypad on the VoIP telephone 206 to indicate a selection of one or more IVM recipients from the list. The VoIP telephone 206 transmits the selection to the IVM server 202. The user selection also generates a start signal to the IVM client 206 indicating the user is ready to begin instant voice messaging

according to the present invention. The user speaks into the handset of the IVM client 206 or a speakerphone on the IVM client 206. Although not shown in Fig. 2, the VoIP telephone 206 may provide a dedicated storage device, which in response to the start signal records an audio file, similar to the audio file 210 in the IVM client 208. The audio file is finalized via a stop signal. The stop signal is generated when the user presses a button on the keypad, a preset time period without speech input to the VoIP telephone 206, or when the user returns the handset to the cradle of the VoIP telephone 206. Once the recording of the user's speech is complete, a send signal is generated indicating that the instant voice message is ready to be sent to the selected recipients. The user generates the send signal when the user presses a button on the keypad or returns the handset of the VoIP telephone 206 to its cradle (on-hook). In response to the send signal, the IVM client 206 sends the recorded audio to the local IVM server 202 via the network 204. The IVM server 202 thereafter delivers the instant voice message to the selected one or more recipients via the IP network 204. As before, the one or more recipients are enabled to display an indication that the instant voice message has been received and audibly play the instant voice message. As aforementioned, if a recipient IVM client is not currently connected to the local IVM server 202, the IVM server 202 temporarily saves the instant voice message and delivers it to the IVM client when the IVM client connects to the local IVM server 202.

In the second embodiment of the IVM client 206 according to Fig. 2, the VoIP telephone 206 operates synchronously either with the IVM client 208 or the IVM server 202 to enable instant voice messaging according to the present invention. Thus, in operation according to the second embodiment, the IVM client (VoIP telephone) 206 is still

connected over the network 204 to the IVM server 202, which as aforementioned enables instant voice messaging functionality over the local network 204. However, VoIP telephone 206 cooperates with the IVM client 208 or IVM server 202 to record and send an instant voice message. More specifically, the VoIP telephone 206 is only used as a

5 recording/listening device for recording or listing to instant voice messages, while the IVM client 208 is used for displaying and selecting instant voice message recipients as described hereinabove. In operation, the IVM client 208 displays a list of IVM recipients on the display device 216 provided and stored by the local IVM server 202. The user operates the IVM client 208 by using the input device 218 on the IVM client 208 to indicate a selection

10 of one or more IVM recipients from the list. The user selection is transmitted to the IVM server 202. The user selection generates a start signal to the IVM server 202 indicating that the user is ready to begin instant voice messaging according to the present invention. In response to receiving the start signal, the IVM server 202 transmits a ring signal to the VoIP telephone 206, thereby indicating to the user the IVM system 200 is ready to record an

15 instant voice message. The IVM server 202 also signals the IVM client 208 to generate audio file 210 to record the instant voice message. As the user picks up the handset of the VoIP telephone 206 (off-hook), a connection is established via the network 204 between the local IVM server 202 and the VoIP telephone 206. Thereafter, the IVM server 202 forwards the user's speech transmitted from VoIP telephone 206 to the IVM client 208 for storage

20 into digitized audio file 210 on the IVM client 208. The audio file 210 is finalized by returning the handset its cradle (on-hook) or by pressing a designated button on the keypad VoIP telephone 206, which transmits the stop signal to the IVM server 202 and further from the IVM server 202 to the IVM client 208. Returning the handset to its cradle preferably



generates a send signal to the IVM server 202, which transmits the signal to the IVM client 208. The IVM client thereafter transmits the recorded audio file 210 (instant voice message) to IVM server 202 for delivery to the selected one or more IVM recipients. Alternatively, the user may press a key on the keyboard 218 to initiate the send signal. In response to the send signal, the IVM client 206 sends the recorded audio to the local IVM server 202 via the network 204. The IVM server 202 thereafter delivers the instant voice message to the selected one or more recipients via the IP network 204. The one or more recipients are enabled to display an indication that the instant voice message has been received and audibly play the instant voice message. If a recipient IVM client is not currently connected to the local IVM server 202, the IVM server 202 temporarily saves the instant voice message and delivers it to the IVM client when the IVM client connects to the local IVM server 202.

In operation of the legacy telephone 110 according to Fig. 2, the legacy telephone 110 is connected to the local IVM server 202 via media gateway 114 and legacy switch 112. The legacy telephone 110 cooperates with the IVM client 208 to record and send an instant voice message. More specifically, the legacy telephone 110 is used as a recording/listening device for recording or listening to instant voice messages, while the IVM client 208 is used for displaying and selecting instant voice message recipients as described hereinabove. Thus, in operation the IVM client 208 displays a list of IVM recipients on the display device 216 provided and stored by the local IVM server 202. The user operates the IVM client 208 by using the input device 218 on the IVM client 208 to indicate a selection of one or more IVM recipients from the list. The user selection is transmitted to the IVM

server 202. The user selection generates a start signal to the IVM server 202 indicating that the user is ready to begin instant voice messaging according to the present invention. In response to receiving the start signal, the IVM server 202 transmits an emulation code to the legacy telephone 110 to ring, thereby indicating to the user the IVM system 200 is ready to  
5 record an instant voice message. As the user picks up the handset of the legacy telephone 110 (off-hook), a connection is established via the network 204 between the legacy telephone 110 and the IVM server 202. Thereafter, the IVM server forwards the user's speech transmitted from the legacy telephone 110 to the IVM client 208 for storage into the digitized audio file 210 (i.e., instant voice message). The audio file on the IVM client 208 is  
10 finalized by returning the handset of the legacy telephone 110 to its cradle (on-hook) or by pressing a designated button on the keypad of the legacy telephone 110, which transmits a stop signal to the IVM server 202 and further to the IVM client 208. Returning the handset to its cradle also generates a send signal to the IVM server to transmit the recorded audio file (instant voice message) to the selected one or more IVM recipients. The IVM server 202  
15 thereafter delivers the instant voice message to the selected one or more recipients via the IP network 204. The one or more recipients are enabled to display an indication that the received instant voice message has been received and audibly play the instant voice message. If a recipient IVM client is not currently connected to the local IVM server 202, the IVM server 202 temporarily saves the instant voice message and delivers it to the IVM  
20 client when the IVM client connects to the local IVM server 202.

Regarding the operational embodiments described with reference to Fig. 2 for recoding and transmitting an instant voice message according to the present invention, the

digitized audio file is preferably compressed by applying a compression algorithm before sending the audio file to the one or more selected recipients. The audio file is preferably compressed within the IVM clients 206, 208 before forwarding the audio file to the IVM server 202 for subsequent delivery to the one or more selected recipients. Alternatively, the compression may be implemented within the IVM server 202 before the audio file is transmitted to the one or more selected recipients. A Lempel-Ziv compression algorithm is preferably used to compress the audio file according to the present invention. It is noted that many suitable compression algorithms are known to persons of skill in the art, including Huffman encoding, audio compression standards promulgated by the Moving Pictures Experts Group ("MPEG"), G.722 wideband speech encoding standard, fractal compression, and wavelet compression. Any of the foregoing compression algorithms may be implemented within the scope of the present invention.

Further regarding the operational embodiments described with reference to Fig. 2 for recoding and transmitting an instant voice message according to the present invention, the digitized audio file (which may or may not be compressed as described above) is further preferably encrypted via an encryption algorithm before transmitting the audio file to the one or more selected recipients. The encryption is preferably implemented within the IVM clients 206, 208 before forwarding the audio file to the IVM server 202 for subsequent delivery to the one or more selected recipients. Alternatively, the encryption may be implemented within the IVM server 202 before the audio file is transmitted to the one or more selected recipients. An AES (Rijndael) encryption algorithm is preferably used to encrypt the audio file according to the present invention. It is noted that many suitable

encryption algorithms are known to persons skilled in the art, including DES, Triple DES, Blowfish, Twofish, Serpent, and the like. Any of the foregoing encryption algorithms may be implemented within the scope of the present invention.

5                   Lastly with reference to Fig. 2, in addition to the “record mode” of instant voice messaging, the instant voice messaging system 200 also supports an “intercom mode” of voice messaging. The “intercom mode” represents real-time instant voice messaging. In the “intercom mode,” instead of creating an audio file 210, one or more buffers (not shown) of a predetermined size are generated in the IVM client 206, 208 or local IVM server 202.

10   The one or more buffers are used to automatically write successive portions of the instant voice message. Once a first buffer is full, i.e., input audio of the predetermined size is written to the buffer, the content of the first buffer is automatically transmitted to the IVM server 202 for transmission to the one or more IVM recipients. A second buffer is

15   meanwhile written with the next successive portion of input audio. Once, the second buffer is full, i.e., input audio of the predetermined size is written to the buffer, the content of the second buffer is transmitted to the IVM server 202 for transmission to the one or more IVM recipients. If the entire instant voice message or a successive portion thereof (such as a last successive portion in the instant voice message) written to either buffer is smaller the predetermined size, then the buffered content of less than the predetermined size is

20   automatically transmitted to the IVM server 202. The foregoing buffering using the first and second buffers is repeated until the entire instant voice message has been transmitted to the IVM server 202 for transmission to the one or more IVM recipients. It is noted that the invention is not limited to a particular number of buffers. The foregoing buffering and

transmission allows a “real-time” instant voice message to be transmitted to the one or more IVM recipients. The “intercom mode” may be designated as a default mode when an IVM recipient is on-line, while the “record mode” may be designated as a default if the IVM recipient is unavailable, i.e., not on-line. The user may easily change the “intercom mode”  
5 to the “record mode” on the respective IVM client 206, 208. Finally, the audio contents of the buffers may be signal processed (for clarity), encrypted and compressed before transmission, as will be described in more detail hereinbelow with reference to Fig. 3.

Fig 3. an exemplary illustration of the architecture in the IVM client 208 for  
10 enabling instant voice messaging according to the present invention. More specifically, the IVM client 208 comprises a client platform 302 for generating an instant voice message and a messaging system 320 for messaging between the IVM client 208 and the IVM server 202 for enabling instant voice messaging according to the present invention. The IVM client 208 is a general-purpose programmable computer equipped with a network interface (not  
15 shown), such as an Ethernet card, to provide connectivity to the network 204. It is noted that any suitable networking protocol, not only Ethernet, could be used to connect the IVM client to a network 204 and thus is considered within the scope of the present invention. The client platform 302 comprises a client engine 304, which controls other components, namely the document handler 306, file manager 308, audio file creation 312, signal processing 314,  
20 encryption/decryption 316, and compression/decompression 318. The messaging system 320 and the client engine 304 communicate via standard inter-process communication. The messaging system 320 and client engine 304 also communicate with the IVM server 202 over the network interface via the network 204. The document handler 306 oversees the

retrieving, sending, receiving and storing of one or more documents (or files) attached to instant voice messages from/to the one or more selected IVM recipients that may be communicating with the IVM client 208. More specifically, when an instant voice message is to be transmitted to the one or more IVM recipients, one or more documents may be attached to the instant voice message to be, stored or displayed by the one or more selected IVM recipients. The file manager accesses a message database 310, in which both the received and recorded instant voice messages are represented as database records, each record comprising a message identifier and the instant voice message. The file manager 308 services requests from the user to record, delete or retrieve messages to/from the message database 310. Audio file creation 312 creates an instant voice message as audio file 210, and is responsible for receiving input speech for the instant voice message from audio input device 212 or via network 204 and storing the input speech into audio file 210. Signal processing 314 performs noise removal and signal optimization in the audio file 210. Encryption/decryption 316 provides for respectively encrypting/decrypting of outgoing/incoming audio files (i.e., instant voice messages), and compression/decompression 318 respectively compresses/decompresses the outgoing/incoming audio files.

Further with reference to Fig. 3, the reception of an instant voice message is described as follows. It is assumed that the local IVM server 202 has determined that the IVM client 208 is available to receive an instant voice message by checking the IVM client's 208 current status, i.e., whether the IVM client 208 is "on-line." The local IVM server 202 maintains the current status of the IVM clients connected to the local IVM server

202, i.e., IVM clients 206, 208. It is further assumed that an IVM client has transmitted an instant voice message to the IVM client 208. The local IVM server 202 receives the instant voice message over the local IP network 204 and forwards the instant voice message to the IVM client 208. Upon receipt at the IVM client 208, the instant voice message is decrypted  
5 at 316, decompressed at 318, and stored in the message database 310 using the file manager 308. Any files attached to the instant voice message are also stored in the message database 310 using the file manager 308. A visual and/or sound effect is initiated to notify a user of the IVM client 208 that a new instant voice message has been received at the IVM client 208. At this point in time, the instant voice message and any file attachments are available  
10 to the user. The user can select the instant voice message from a listing of available instant voice messages displayed on the IVM client 208 and play the newly received instant voice message. The user may also open any file attachments and move or save the files to a separate location on the client using a drag-and-drop process.

15 Still further with reference to Fig. 3, the generation and transmission of an instant voice message is described as follows. The user selects the available one or more IVM recipients and initiates the creation of an instant voice message as described above with reference to Fig. 2. The client engine 304 detects the start signal and invokes audio file creation 312 of the audio file 210. The audio file 210 is initialized and captures the audio  
20 voice message input by the user. Once the client engine 304 detects a stop signal, the instant voice message is finalized in the audio file 210 via audio file creation 312. The audio file 210 is adjusted for gain, and noise is removed via signal processing 314. The audio file 210 is further compressed at 318 and encrypted at 316. The completion of these processes

causes the client engine 304 to inform the user via display 216 that the instant voice message is available to be sent. After the client engine 304 detects the send signal from the user, the instant voice message (audio file 210) is transferred to the local IVM server 202. Before the transmission of the instant voice message (i.e., before the send signal), the user has the option to review the instant voice message, re-record the instant voice message, delete the instant voice, as well as attach one or more files (i.e., documents). The attachment of one or more files is enabled conventionally via a methodology such as “drag-and-drop” and the like, which invokes the document handler 306 to make the appropriate linkages to the one or more files and flags the messaging system 320 that the instant voice message also has the attached one or more files.

Fig 4. an exemplary illustration of the local IVM server 202 for enabling instant voice messaging according to the present invention. The IVM server 202 is a general-purpose programmable computer equipped with a network interface, such as an Ethernet card, to provide connectivity to a network 204. It is noted that any suitable networking protocol may be implemented to connect the IVM server 202 to a network 204. The IVM server 202 comprises a server communication platform 402, a messaging system 436 and a database 414, thereby enabling instant voice messaging according to the present invention. The server communication platform 402 comprises a server engine 404, client manager 406, station manager 408, gateway manager 410, database manager 412 that accesses database 414, supplemental servers 416 (including particular server subsystems 418-424), as well as a control layer 426 (including non-proprietary server subsystems 428, 430 and proprietary server subsystems 432, 434). The messaging system 436 and the server



engine 304 communicate via standard inter-process communication. The messaging system 436 and the server engine are also able to communicate with the IVM clients 206, 208 over the network interface via the network 204. The database 414 stores users (e.g., IVM clients as well as legacy telephone clients) that are known to the IVM server 202 via the database manager 412. The users are represented in the database as records, each record comprising a user name, a password, and a contact list (a list of other users with whom the user wishes to exchange instant voice messages), and other data relating to the user. The database manager 412 services requests to add, update, delete, or retrieve database records to/from the database 414. The password may be stored in the database 414 as plaintext, in encrypted form, or as a hash (e.g., MD5 hash). The messaging system 436 communicates to the server engine 404 via message objects.

A message object comprises an action field, an ID field, a source field, a destination field, and an object field. The content of the action field is selected from a list of permitted actions, which among other actions includes: connect, disconnect, subscribe, unsubscribe, and post message. In addition, the actions include: determining if an IVM client is awake (i.e., pinging), disconnecting from the IVM client, processing an IVM client message, and notifying IVM clients if the IVM server 202 goes down. The client messages include sending an instant voice message portions, checkin message, send message, set status message, send a phone command message, and send control parameters message. The content of the ID field represents a unique identifier for the message object. The content of the source field is a globally unique identifier (“GUID”) that uniquely identifies the sender of the message. This unique identifier can be generated by any known way, including the

Globally Unique ID function call available in the Microsoft Windows and Microsoft .NET environments. In some circumstances, the source field is set to a special value to indicate that the sender of the message object is entitled to special privileges. The senders with special privileges are in fact IVM servers. This allows the IVM servers to broadcast

5 messages to one another, subscribe to special events, and directly send messages to specific IVM servers. These privileges can depend upon whether the IVM servers are local servers or global servers. As an example, there can exist more than one local IVM server, each of these local IVM servers automatically has privileges to communicate to other local IVM server. On a global server system, a directory server can communicate with one or more

10 transport servers. The content of the destination field is a GUID of an intended IVM recipient of the instant voice message. The content of the object field is a block of data being carried by the message object, which may be, for example, a digitized instant voice message. Depending on the circumstances in which the message object is sent, some of the message object fields may be left blank or ignored. For example, the message object may

15 merely require an action to be performed based upon the GUID supplied. In this case, the action does not necessarily require any data to be sent or received and some of the message object's fields may be left blank or ignored.

Connection objects maintain the logical connections between the IVM server 202 and IVM clients 206, 208 connected to the IVM server 202. More specifically, a

20 connection object comprises data representing the state of the connection and code (one or more methods) for establishing and maintaining the logical connections between the IVM server 202 and the IVM clients 206, 208 within the IVM system 200 of Fig. 2. The

connection object can contain both data and/or commands, including information that describes the socket, the size of the data to be transferred, and the priority of the transfer (e.g., high, normal, low, unknown). On start up the local IVM server 202 generates and maintains a list for each IVM client 206, 208. The local IVM server 202 then waits to  
5 receive connection objects from the IVM clients 206, 208 that are stored in the respective lists, decodes the received connection objects to obtain specific requests, and then services the specific requests from the IVM clients 206, 208.

Further with reference to Fig. 4, the server engine 404 controls all other subsystems in the server communication platform 402, and it is responsible for startup and  
10 shutdown of the IVM server 202 and the IVM system 200. The client manager 406 controls the IVM clients 206, 208, providing contact presence (connection) information and message scheduling and delivery. The station manager 408 controls the individual legacy telephone 110 and coordinates its activity to work synchronously with the IVM client 208 and server 202. The gateway manager 410 enables the IVM server 202 to communicate with the  
15 legacy telephones, such as legacy telephone 110. The control layer 426 comprises a plurality of server subsystems 428-434, each of which provides translation services to different proprietary and non-proprietary gateways 114, such as TPNCP, MGCP, and MEGACO gateways. The proprietary server subsystems 428, 430 and non-proprietary server subsystems 432, 434 are connected to respective gateways 114 via the local IP  
20 network 204. The supplemental server subsystems 416 provide a number of required services such as display manager subsystem 418, dynamic host configuration protocol (i.e., “DHCP”) subsystem 420, trivial file transfer protocol (i.e., “TFTP”) server subsystem 422,

and hypertext transfer protocol (i.e., "HTTP"). Each of the supplemental servers 418-424 in the subsystem 416 is used during the initial set-up of the IVM system 200. The boot-up process and allocation of IP addresses to IVM clients 206, 208 are performed through an LCD panel (not shown) associated with the local IVM server 202. The LCD manager 418 supports this boot-up process. The DHCP server 420 is used to allocate IP addresses as required and allows the advanced configuration of network settings in the instant voice messaging system. The TFTP server 422 provides a TCP/IP file transfer capability. Lastly, the HTTP server 424 provides services for a web server.

Figure 5 is an exemplary illustration of a global instant voice messaging (IVM) system 500, according to the present invention. In the global IVM system 500, the local IVM system 200 is depicted as a local IVM system 510, which is connected to a packet-switched network 102 (i.e., Internet). The global IVM system 500 comprises the local IVM system 510, global IVM server system 502, and global IVM clients 506 and 508 that are optionally connected via local IP network 504. The global IVM server system 502 is connected to the IP network (i.e., Internet) 102 for enabling the local IVM clients 206, 208 and legacy telephone 110 in the local IVM system 510 to generate and send instant voice messages to the global IVM clients 506, 508, as well as the local IVM clients 206, 208 to receive instant voice messages from the global IVM clients 506, 508. The implementation of the global instant voice messaging for the IVM client 208 will be described first and will be followed by the implementations for IVM client 206 and legacy telephone 110, with reference to the global IVM system 500 depicted in Fig. 5. Thereafter, instant voice messaging for global clients 506 and 508 will be described according to the

present invention. These implementations implement a “record mode” of the instant voice messaging according to the present invention. Thereafter, there will lastly be described an “intercom mode” of the instant voice messaging according to the present invention.

5                   Therefore, in operation of the IVM client 208 according to Fig. 5, the IVM client 208 is connected via the networks 204, 102 to the global IVM server system 502, which enables the global instant voice messaging functionality outside the local IVM system 510 over the network (i.e., Internet) 102. More specifically, the IVM client 208 requests from the global IVM server system 502 a global contact list (not shown) of global one or  
10 more IVM recipients with which the IVM client 208 may exchange instant voice messages. For the purposes of illustration, it is assumed that global IVM clients 506, 508 are in the contact list. The global IVM server system 502 stores and maintains this contact list. Thus, the global IVM server system 502 responds by transmitting the contact list to the IVM client 208. The IVM client 208 displays the contact list on its display 216. Alternatively, the  
15 global contact list may be replicated to the local IVM server 202 within the local IVM system 510, in which case the local IVM client 208 obtains the global contact list from the local IVM server 202. The user operates the IVM client 208 by using the input device 218 to indicate a selection of one or more IVM recipients from the global contact list. Here, for the purposes of illustration it is again assumed that IVM client 208 selected global IVM  
20 clients 506, 508. The user selection is transmitted to the IVM server 202. The user selection also generates a start signal to the IVM client 208 that the user is ready to begin instant voice messaging. In response to the start signal, the IVM client 208 listens to the input audio device 212 and records the user’s speech into a digitized audio file 210 (i.e.,

instant voice message) stored on the IVM client 208. The audio file 210 is finalized via a stop signal, which is generated by the user via the input device 218 or a preset time period without speech input via the input audio device 212. Once the recording is finalized, the IVM client 208 generates a send signal indicating that the digitized audio file 210 (instant voice message) is ready to be sent to the selected one or more IVM recipients. The user generates the send signal when the user operates the IVM client 208 via the input device 218. The IVM client 208 transmits the digitized audio file 210 and the send signal to the global IVM server system 502 via the local IP network 204 and the global IP network 102. After receiving the audio file 210, the global IVM server system 502 delivers the transmitted instant voice message to the selected one or more recipients (e.g., IVM clients 506 and 508) via the IP network 102. The one or more recipients are enabled to display an indication that the instant voice message has been received and audibly play the instant voice message to an associated user. It is noted that if a recipient IVM client 506, 508 is not currently connected to the global IVM server system 502, the global IVM server system 502 temporarily saves the instant voice message and delivers it to the global IVM client 506, 508 when the IVM client connects to the global IVM server system 502.

There are several embodiments for the operation of the IVM client (VoIP telephone) 206 within the global IVM system 500 of Fig. 5, according to the present invention. In the first embodiment, the VoIP telephone 206 is a standalone IVM client 206 enabled for instant voice messaging according to the present invention. In the second embodiment, the VoIP telephone 206 operates synchronously with the IVM client 208 to enable instant voice messaging according to the present invention. Thus, in operation

according to the first embodiment in Fig. 5, the IVM client 206 is connected via the networks 204, 102 to the global IVM server system 502, which enables instant voice messaging functionality over the IP network (Internet) 102. As mentioned previously, the IVM client 206 is also connected to the local IVM server 202. The IVM client 208 requests

5 from the global IVM server system 502 a global contact list (not shown) of the global one or more IVM recipients with which the IVM client 206 may exchange instant voice messages. For the purposes of illustration, it is assumed that the global IVM clients 506, 508 are in the contact list. The global IVM server system 502 stores and maintains this contact list. Thus, the global IVM server system 502 responds by transmitting the global contact list to the

10 IVM client 206. Alternatively, the global contact list may be replicated to the local IVM server 202 within the local IVM system 510, in which case the local IVM client 206 obtains the global contact list from the local IVM server 202. The IVM client 206 displays a list of the one or more IVM recipients on its associated display. The user operates the IVM client 206 by using a keypad on the VoIP telephone 206 to indicate a selection of one or more

15 IVM recipients from the list. The VoIP telephone 206 transmits the selection to the global IVM server system 502. The user selection also generates a start signal to the IVM client 206 indicating the user is ready to begin instant voice messaging according to the present invention. The user speaks into the handset of the IVM client 206 or a speakerphone on the IVM client 206. Although not shown in Fig. 5, the VoIP telephone 206 may provide a

20 dedicated storage device, which in response to the start signal records an audio file, similar to the audio file 210 in the IVM client 208. The audio file is finalized via a stop signal. The stop signal is generated when the user presses a button on the keypad, a preset time period without speech input to the VoIP telephone 206, or when the user returns the handset to the

cradle of the VoIP telephone 206. Once the recording of the user's speech is complete, a send signal is generated indicating that the instant voice message is ready to be sent to the selected recipients. The user generates the send signal when the user presses a button on the keypad or returns the handset of the VoIP telephone 206 to its cradle. In response to the send signal, the IVM client 206 sends the recorded audio file (instant voice message) to the global IVM server system 502 via the networks 204, 102 for delivery to the selected one or more IVM recipients. The global IVM server 502 thereafter delivers the instant voice message to the selected one or more recipients (e.g., IVM clients 506 and 508) via the IP network 102. As before, the one or more recipients are enabled to display an indication that the instant voice message has been received and audibly play the instant voice message. If a recipient IVM client is not currently connected to the global IVM server system 502, the global IVM server system 502 temporarily saves the instant voice message and delivers it to the IVM client when the IVM client connects to the global IVM server system 502.

In the second embodiment of the IVM client 206 according to Fig. 5, the VoIP telephone 206 operates synchronously with the IVM client 208 to enable global instant voice messaging according to the present invention. Thus, in operation according to the second embodiment in Fig. 5, the VoIP telephone 206 is connected over the network 204 to the IVM client 208 and the IVM client 208 is connected via the networks 204, 102 to the global IVM server system 502, which enables instant voice messaging functionality over the IP network (Internet) 102. The VoIP telephone 206 cooperates with the IVM client 208 to record and send a global instant voice message outside the local IVM system 510. The IVM client 208 displays a global contact list of IVM recipients (not shown) on the display device



216 provided by the global IVM server system 502, as described hereinabove.

Alternatively, the global contact list may be replicated to the local IVM server 202 within the local IVM system 510, in which case the IVM client 208 obtains the global contact list from the local IVM server 202. The user operates the IVM client 208 by using the input

5 device 218 to indicate a selection of one or more IVM recipients from the contact list. The user selection generates a start signal in the IVM client 208 indicating that the user is ready to begin instant voice messaging according to the present invention. In response to the start signal, the IVM client 208 generates audio file 210 to record an instant voice message and transmits a ring signal to the VoIP telephone 206. As the user picks up the handset of the

10 VoIP telephone 206 (off-hook), a connection is established via the network 204 between the local IVM client 208 and the VoIP telephone 206. Thereafter, the VoIP telephone 206 forwards the user's speech to the IVM client 208 for storage into the audio file 210. The audio file 210 is finalized by returning the handset its cradle (on-hook) or by pressing a designated button on the keypad VoIP telephone 206, which transmits the stop signal to the

15 IVM client 208. Returning the handset to its cradle preferably generates a send signal to the IVM client 208. The IVM client thereafter transmits the recorded audio file 210 (instant voice message) to the global IVM server system 502 via networks 204, 102 for delivery to the selected one or more IVM recipients. Alternatively, the user may press a key on the keyboard 218 to initiate the send signal. In response to the send signal, the IVM client 208

20 sends the recorded audio file to the global IVM server system 502 for delivery to the selected one or more IVM recipients. The global IVM server system 502 thereafter delivers the instant voice message to the selected one or more recipients (e.g., IVM clients 506 and 508) via the IP network 102. As before, the one or more IVM recipients are enabled to

display an indication that the instant voice message has been received and audibly play the instant voice message. If a recipient IVM client is not currently connected to the global IVM server system 502, the global IVM server system 502 temporarily saves the instant voice message and delivers it to the IVM client when the IVM client connects to the global  
5 IVM server system 502.

In operation of the legacy telephone 110 according to Fig. 5, the legacy telephone 110 is connected to the local IVM client 208 via media gateway 114, legacy switch 112 and network 204. The legacy telephone 110 cooperates with the IVM client 208  
10 to record and send an instant voice message outside the local IVM system 510. More specifically, the legacy telephone 110 is used as a recording/listening device for recording or listing to instant voice messages, while the IVM client 208 is used for displaying and selecting instant voice message recipients as described hereinabove. Thus, in operation the IVM client 208 requests from the global IVM server system 502 a global contact list of  
15 global one or more IVM recipients with which the IVM client 208 may exchange instant voice messages. Alternatively, the global contact list may be replicated to the local IVM server 202 within the local IVM system 510, in which case the IVM client 208 obtains the global contact list from the local IVM server 202. The IVM client 208 displays the global list of IVM recipients, as described hereinabove. The user operates the IVM client 208 to  
20 indicate a selection of one or more IVM recipients from the global contact list. The IVM client 208 transmits the user selection to the global IVM server system 502. The user selection generates a start signal in the IVM client 208 indicating that the user is ready to begin instant voice messaging according to the present invention. In response to the start

signal, the IVM client 208 transmits an emulation code to the legacy telephone 110 to ring, thereby indicating to the user the global IVM system 500 is ready to record an instant voice message. As the user picks up the handset of the legacy telephone 110 (off-hook), a connection is established via the network 204 between the legacy telephone 110 and the IVM client 208. Thereafter, the user's speech is transmitted from the legacy telephone 110 to the IVM client 208 for storage into the digitized audio file 210 (i.e., instant voice message). The audio file 210 is finalized by returning the handset of the legacy telephone 110 to its cradle (on-hook) or by pressing a designated button on the keypad of the legacy telephone 110, which transmits a stop signal to the IVM client 208. Returning the handset to its cradle may also generate a send signal to the IVM client 208 to transmit the recorded audio file (instant voice message) to the global IVM server system 502 for delivery to the selected one or more IVM recipients. Alternatively, the send signal is preferably generated from the IVM client 208 as described hereinabove. The global IVM server system 502 thereafter delivers the instant voice message to the selected one or more IVM recipients via the IP network (Internet) 102. The one or more recipients are enabled to display an indication that the instant voice message has been received and audibly play the instant voice message. If a recipient IVM client is not currently connected to the global IVM server system 502, the global IVM server system 502 temporarily saves the instant voice message and delivers it to the IVM client when the IVM client connects to the global IVM server 502.

Further with reference to Fig. 5, the instant voice messaging for global clients 506 and 508 will be described according to the present invention. In a first embodiment,

each of the global IVM clients 506, 508 is enabled to independently send an instant voice message. The IVM clients 506, 508 have like peripheral devices and functionality described respectively with reference to local IVM clients 206, 208 in Fig. 2. In second embodiment described below, the VoIP telephone 506 operates in conjunction with the IVM client 508 to send an instant voice message. Therefore, in operation of the global IVM clients 506 and 508 according the first embodiment in Fig. 5, the IVM clients 506, 508 are connected via the networks 204, 102 to the global IVM server system 502, which enables the global instant voice messaging functionality outside the local IVM system 510 over the network (i.e., Internet) 102. Each of the global IVM clients 506, 508 is enabled to request from the global IVM server system 502 a contact list (not shown) of global one or more IVM recipients with which each of the global IVM client 506, 508 may exchange instant voice messages. For the purposes of this illustration, it is assumed that the IVM clients 206 and 208 within the local IVM system 510 are in the contact list for each global IVM client 506, 508. The global IVM server system 502 stores and maintains the foregoing contact list for each global IVM client 506, 508. Upon request, the global IVM server system 502 responds by transmitting the contact list to each of the IVM clients 506, 508. Each of the IVM clients 506, 508 displays the contact list on its display. The user operates the IVM client 506, 508 to indicate a selection of one or more IVM recipients from the contact list. Each of the global IVM clients 506, 508 transmits the user selection to the global IVM server system 502. The user selection also generates a start signal to the IVM clients 506, 508 that the user is ready to begin instant voice messaging. In response to the start signal, the IVM clients 506, 508 record the user's speech into a digitized audio file (i.e., instant voice message) stored on the global IVM clients 506, 508. The audio file is finalized via a stop signal,

which is generated by the user by operating the global IVM client 506, 508. Once the recording is finalized, the IVM client 506, 508 generates a send signal indicating that the digitized audio file (instant voice message) is ready to be sent to the selected one or more recipients. The user generates the send signal when the user operates the global IVM client 506, 508. The IVM client 208 transmits the digitized audio file and the send signal to the global IVM server system 502. After receiving the audio file, the global IVM server system 502 delivers the transmitted instant voice message to the local IVM server 202 in the local IVM system 510 for delivery to the selected one or more recipients (e.g., local IVM clients 206 and 208) via the local IP network 204. The one or more recipients IVM 206, 208 are enabled to display an indication that the instant voice message has been received and audibly play the instant voice message to an associated user. It is noted that if a recipient IVM client 206, 208 is not currently connected to the local IVM server 202, the IVM server 202 temporarily saves the instant voice message and delivers it to the local IVM client 206, 208 when the IVM client connects to the local IVM server 202.

15

In the second embodiment of the IVM client 506 according to Fig. 5, the VoIP telephone 506 operates synchronously with the IVM client 508 to enable global instant voice messaging according to the present invention. In this embodiment, the VoIP telephone 506 and the IVM client 508 may be located in a user's residence and be connected to a local IP network 504. This local IP network 504 can be a WiFi network or a local area network (i.e., LAN), which is also within the user's residence. The local IP network 504 may be connected to the IP network (Internet) 102 via a digital subscriber line (i.e., DSL) connection, cable connection, dialup connection, or the like. As noted above, the IVM

20

clients 506, 508 have like peripheral devices and functionality described respectively with reference to local IVM clients 206, 208 in Fig. 2. Thus, in operation according to this embodiment in Fig. 5, the global IVM client 508 requests from the global IVM server system 502 a contact list of global one or more IVM recipients with which each of the global IVM client 508 may exchange instant voice messages. For the purposes of this illustration, it is assumed that the IVM clients 206 and 208 within the local IVM system 510 are in the contact list for the global IVM client 508. The global IVM server system 502 stores and maintains the foregoing contact list for the global IVM client 508. The IVM client 508 displays a contact list of IVM recipients on the associated display device provided by the global IVM server system 502, as described hereinabove. The user operates the IVM client 508 by using the associated input device to indicate a selection of one or more IVM recipients from the contact list. The user selection generates a start signal in the IVM client 508 indicating that the user is ready to begin instant voice messaging according to the present invention. In response to the start signal, the IVM client 508 generates audio file to record an instant voice message and transmits a ring signal to the VoIP telephone 506 via local IP network 504. As the user picks up the handset of the VoIP telephone 206 (off-hook), a connection is established via the local network 504 between the local IVM client 508 and the VoIP telephone 506. Thereafter, the VoIP telephone 506 forwards the user's speech to the IVM client 508 for storage into the audio file at the IVM client 508. The audio file is finalized by returning the handset its cradle (on-hook) or by pressing a designated button on the keypad associated with the VoIP telephone 506, which transmits the stop signal to the IVM client 508. Returning the handset to its cradle preferably generates a send signal to the IVM client 508. The IVM client thereafter transmits the recorded audio file

(instant voice message) to the global IVM server system 502 for delivery to the selected one or more IVM recipients. Alternatively, the user may press a key on the input device associated with the IVM client 508 to initiate the send signal. In response to the send signal, the IVM client 508 sends the recorded audio file to the global IVM server system 502 for delivery to the selected one or more IVM recipients. The global IVM server system 502 thereafter transmits the instant voice message to the local IVM server 202 for delivery selected one or more recipients (e.g., local IVM clients 206 and 208) via the local IP network 204. As before, the one or more recipients are enabled to display an indication that the instant voice message has been received and audibly play the instant voice message. If a recipient IVM client is not currently connected to the local IVM server 202, the local IVM server 202 temporarily saves the instant voice message and delivers it to the IVM client when the IVM client connects to the local IVM server 202.

Lastly with reference to Fig. 5, in addition to the “record mode” of instant voice messaging as described above, the instant voice messaging system 500 also supports an “intercom mode” of the instant voice messaging. The “intercom mode” represents real-time instant voice messaging. In the “intercom mode,” instead of creating an audio file as described hereinabove, one or more buffers (not shown) of a predetermined size are generated. The buffers may be generated in any one of the IVM clients 206, 208, 506 and 508, depending on how the global IVM system 500 is defined. The one or more buffers are used to automatically write successive portions of the instant voice message. Once a first buffer is full, i.e., input audio of the predetermined size is written to the buffer, the content of the first buffer is automatically transmitted. If the transmission is generated at a local

IVM client 206, 208 and destined for one or more local IVM recipients, the content of the first buffer is transmitted to the local IVM server 202 for delivery to the local one or more recipients. If the transmission is generated at a local IVM client 206, 208 and destined for one or more global IVM recipients 506, 508, the content of the first buffer is transmitted to the global IVM server system 502 for delivery to the one or more global recipients. In addition, if the transmission is generated at a global IVM client 506, 508 and destined for the other global IVM clients, the content of the first buffer is transmitted to the global IVM server system 502, such as for example clients 506, 508. Lastly, if the transmission is generated at a global IVM client 506, 508 and destined for the local IVM clients 206, 208, the content of the first buffer is transmitted to the global IVM server system 502 and further transmitted by the global IVM server 502 to the local IVM server 202 for delivery to clients 206, 208 within the local IVM system 510. A second buffer is meanwhile written with the next successive portion of input audio. Once, the second buffer is full, i.e., input audio of the predetermined size is written to the buffer, the content of the second buffer is transmitted in similar fashion to the first buffer. If the entire instant voice message or a successive portion thereof (such as a last successive portion in the instant voice message) written to either buffer is smaller the predetermined size, then the buffered content of less than the predetermined size is automatically transmitted to the IVM server 202. The foregoing buffering using the first and second buffers is repeated until the entire instant voice message has been transmitted as described above. It is noted that the invention is not limited to a particular number of buffers. The foregoing buffering and transmission allows a “real-time” instant voice message to be transmitted to the one or more local, as well as global, IVM recipients. The “intercom mode” may be designated as a default mode when an IVM



recipient is on-line, while the “record mode” may be designated as a default if the IVM recipient is unavailable, i.e., not on-line. The user may easily change the “intercom mode” to the “record mode” on the respective IVM client 206, 208, 506, 508. Finally, the audio contents of the buffers may be signal processed (for clarity), encrypted and compressed before transmission, as was described previously.

Fig. 6 is an exemplary detailed illustration 600 of the global IVM server system 502 depicted in Fig. 5, according to the present invention. More specifically, the local IVM system 510 described in Fig. 5 is connected via the IP network (Internet) 102 to the global IVM server system 502. The global IVM server system 502 comprises an IVM transport server mesh 602 and an IVM directory server 608. The IVM transport server mesh 602 comprises a plurality of interconnected IVM transport servers 604, 606. Although the mesh 602 is depicted as having two IVM transport servers 604, 606, it is to be understood that as many IVM transport servers as are desired or required for redundancy and load balancing may be interconnected in a mesh. The IVM transport servers 604, 606 may be centrally located and configured to communicate (i.e., forward and receive messages) with local IVM clients 206, 208, local IVM server 202 and global IVM client 506, 508 (not depicted in Fig. 6). The plurality of IVM transport servers 604, 606 in the IVM transport server mesh 602 permits load balancing and redundancy in the global IVM system 500. The directory server 608 maintains a transport server list of all the IVM transport servers 604, 606 currently connecting to the mesh 602. Each of the IVM transport servers 604, 606 first connects to the directory server 608. The directory server 608 informs each of the connecting IVM transport servers 604, 606 of all the other IVM transport servers currently

in the mesh 602 based on an active list (not shown) of transport servers 604, 606 in the mesh 602. The connecting IVM transport server then connects to each of the IVM transport servers in the transport server list, resulting in an interconnected mesh 602 of IVM transport servers 604, 606. The IVM transport servers 604, 606 and the IVM directory server 608  
5 communicate via messages.

Further with reference to Fig. 6, the IVM transport servers 604, 606 connected in the mesh 602 share a database (not shown) of IVM clients, so that each IVM transport server 604, 606 refers to the same client database. It is preferable that each IVM  
10 transport server 604, 606 maintains its own copy of the client database, which is mirrored and replicated conventionally amongst the IVM transport servers 604, 606 in the mesh 602. The client database may further be replicated to the local IVM server 202. Alternatively, the client database is stored on a separate file server (not shown) in data communication with the IVM transport servers 604, 606 over a network (not shown).

15  
Fig. 7 is an exemplary detailed illustration of a transport server 604, 606 depicted in Fig. 6, according to the present invention. The IVM transport server 604, 606 is a general-purpose programmable computer comprising a network interface (not shown) connected to IP network (Internet) 102, a communication platform 702, a message database 712, and a messaging system 714. The communication platform 702 comprises a server  
20 engine 704, which controls a user manager 706, a local server manager 708, and a storage manager 710. The messaging system 714 and the server engine 704 communicate via standard inter-process communication. The storage manager 710 handles retrieving,

sending, and storing of messages, including instant voice messages and attachments thereto, to/from the message database 712. The user manager 706 is responsible for creating/maintaining IVM clients 206, 208, 506, 508, identifying them and relaying their status to the server engine 704. When an IVM client communicates an instant voice message within the global IVM system 500, the user manager 706 notifies the server engine 704 whether the one or more recipients are unavailable, and thereby the instant voice message is saved in the message database 712. When the one or more IVM recipients become available, the user manager 706 notifies the server engine 704, which instructs the storage manager 710 to retrieve any undelivered instant voice messages for the one or more recipients and delivers the instant voice messages to the designated one or more IVM recipients. The local server manager 708 is responsible for creating/maintaining and providing the status of available local IVM servers, such as IVM server 202 in Fig. 2. The availability status of the local IVM servers is checked periodically and updated.

Fig. 8 is an exemplary detailed illustration of a directory server 608 depicted in Fig. 6, according to the present invention. The directory server 608 is a general-purpose programmable computer equipped with a network interface (not shown) connected to IP network (Internet) 102, a messaging system 812, and a communication platform 802. The communication platform 802 comprises a server engine 804, which controls a local server manager 806, a user manager 808, and a transport manager 810. The messaging system 812 and the server engine 804 communicate via standard inter-process communication. The transport manager 810 maintains the status of the IVM transport servers 604, 606 in the IVM transport server mesh 602 within the global IVM system 500 and using a load-

balancing mechanism distributes instant voice messages to available transport server 604, 606 for routing to the one or more IVM recipients. The user manager 808 is responsible for creating/maintaining IVM clients 206, 208, 506, 508, identifying and relaying their status via the server engine 804 to the IVM transport server 604, 606 to be used. The local server manager 806 is responsible for creating/maintaining and providing the status of available local IVM servers, such as IVM server 202 in Fig. 2. The availability status of the local IVM servers is checked periodically and updated.

Fig. 9 illustrates an exemplary a global instant voice messaging (IVM) system 900, which comprises a plurality of local IVM systems and a plurality of global IVM clients, according to the present invention. In the global IVM system 900, there are depicted a plurality of local IVM systems 902, 910 connected to the global IP network 102. The internal representation and functionality of each local IVM system 902, 904 is identical to the local IVM system 510 described with reference to Fig. 5. In global IVM system 900 of Fig. 9, there are also depicted a plurality of global IVM clients 918-928 and a global IVM server system 502 connected to the global IP network (i.e., Internet) 102. The internal representations of the global IVM client 918-928 and the global IVM server system 502 are identical to the respective IVM client 508 (and/or IVM client or 506) and the global IVM server system 502 described with reference to Fig. 5. In the local IVM system 902, each local IVM client 206, 208 is enabled to request local IVM recipients from the local IVM server 202 and global IVM recipients from either the global IVM server system 502 or the local IVM server 202. For example, the local IVM client 1A 208 displays a list 904 to a user, comprising both local and global IVM recipients. More specifically, the list 904

enables IVM client 1A to send instant voice messages according to the present invention to local IVM clients 1B 208 and 1C 206, global IVM client C 922 and global IVM client 2A 208 in the local IVM system 910. Similar lists 906-916 are displayed to the users of the respective IVM clients 1B-1C in local IVM system 902, and 2A-2C in local IVM system 5 910. In addition, the global clients A-F 918-928 are enabled to request IVM recipients from the global IVM server system 502 and display the respective lists of IVM recipients 930-940 on the respective IVM clients 918-928.

While the invention has been particularly shown and described with regard to 10 preferred embodiments thereof, it will be understood by those skilled in the art that the foregoing and other changes in form and details may be made therein without departing from the spirit and scope of the invention.

**CLAIMS:**

What is claimed is:

1. A method for instant voice messaging over a packet-switched network, the method comprising:
  - receiving an instant voice message having one or more recipients;
  - delivering the instant voice message to the one or more recipients over a packet-switched network;
  - temporarily storing the instant voice message if a recipient is unavailable; and
  - delivering the stored instant voice message to the recipient once the recipient becomes available.

**ABSTRACT**

Methods, systems and programs for instant voice messaging over a packet-switched network are provided. A method for instant voice messaging may comprise receiving an instant voice message having one or more recipients, delivering the instant voice message to the one or more recipients over a packet-switched network, temporarily storing the instant voice message if a recipient is unavailable; and delivering the stored instant voice message to the recipient once the recipient becomes available.

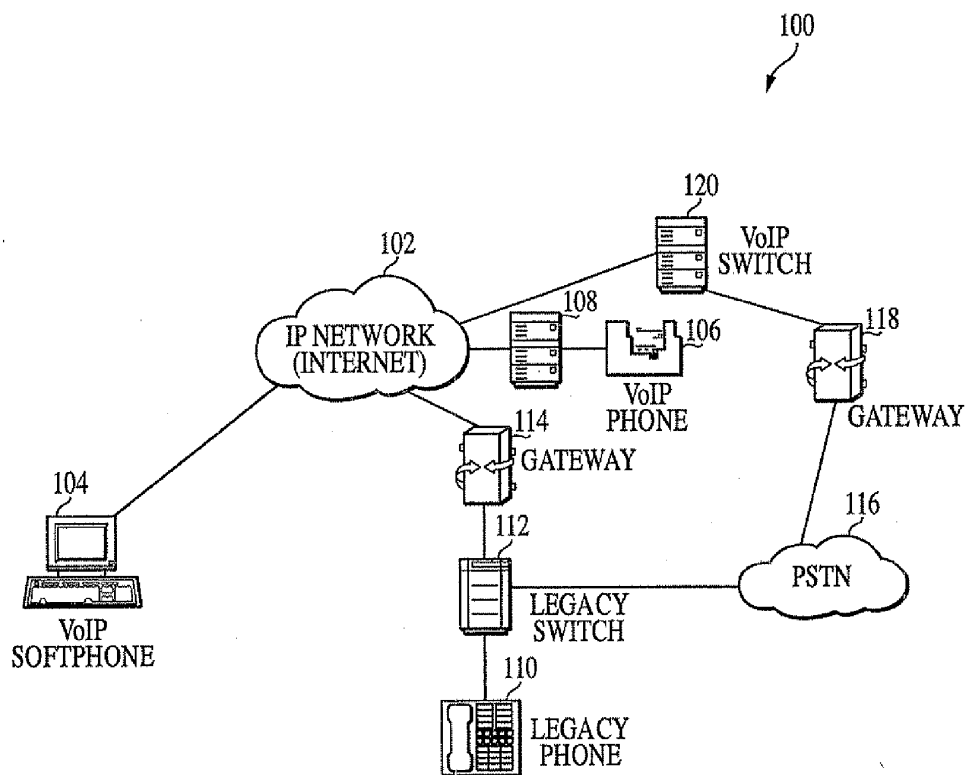

FIG. 1  
(PRIOR ART)



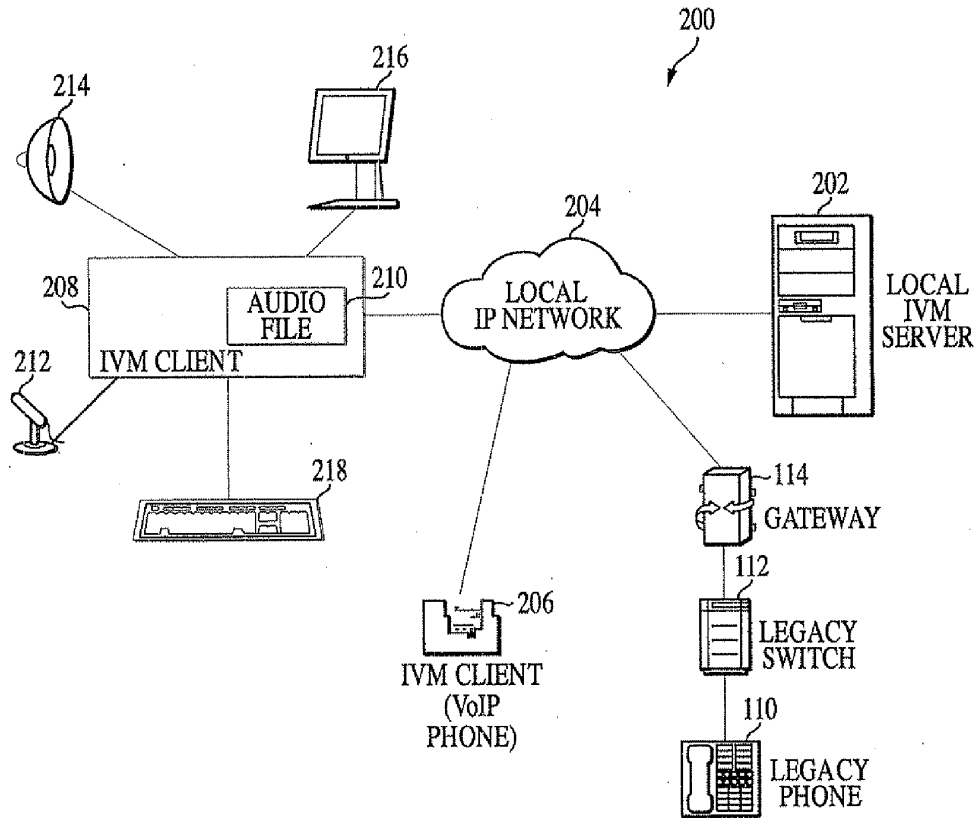

FIG. 2

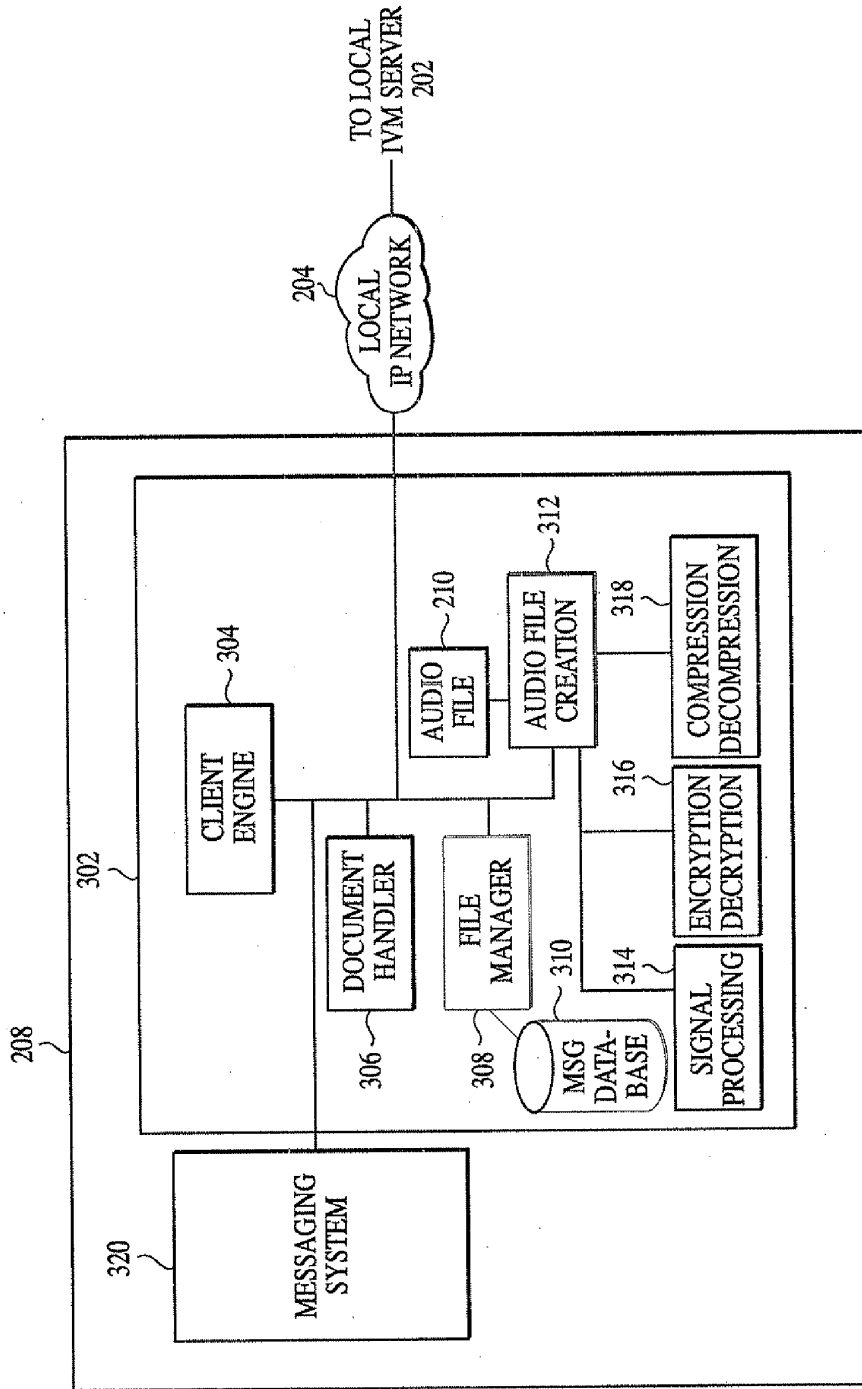

FIG. 3

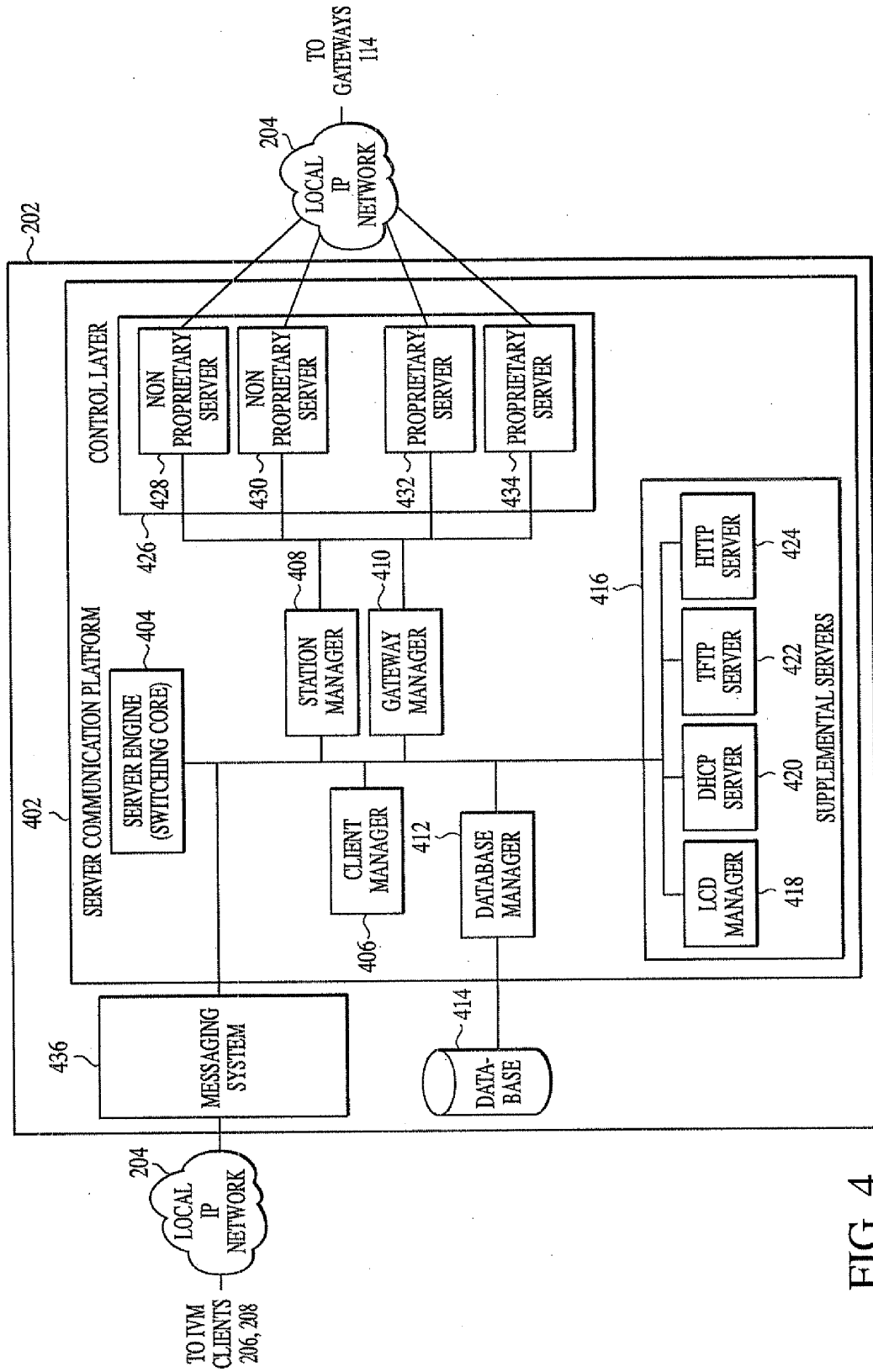

FIG. 4

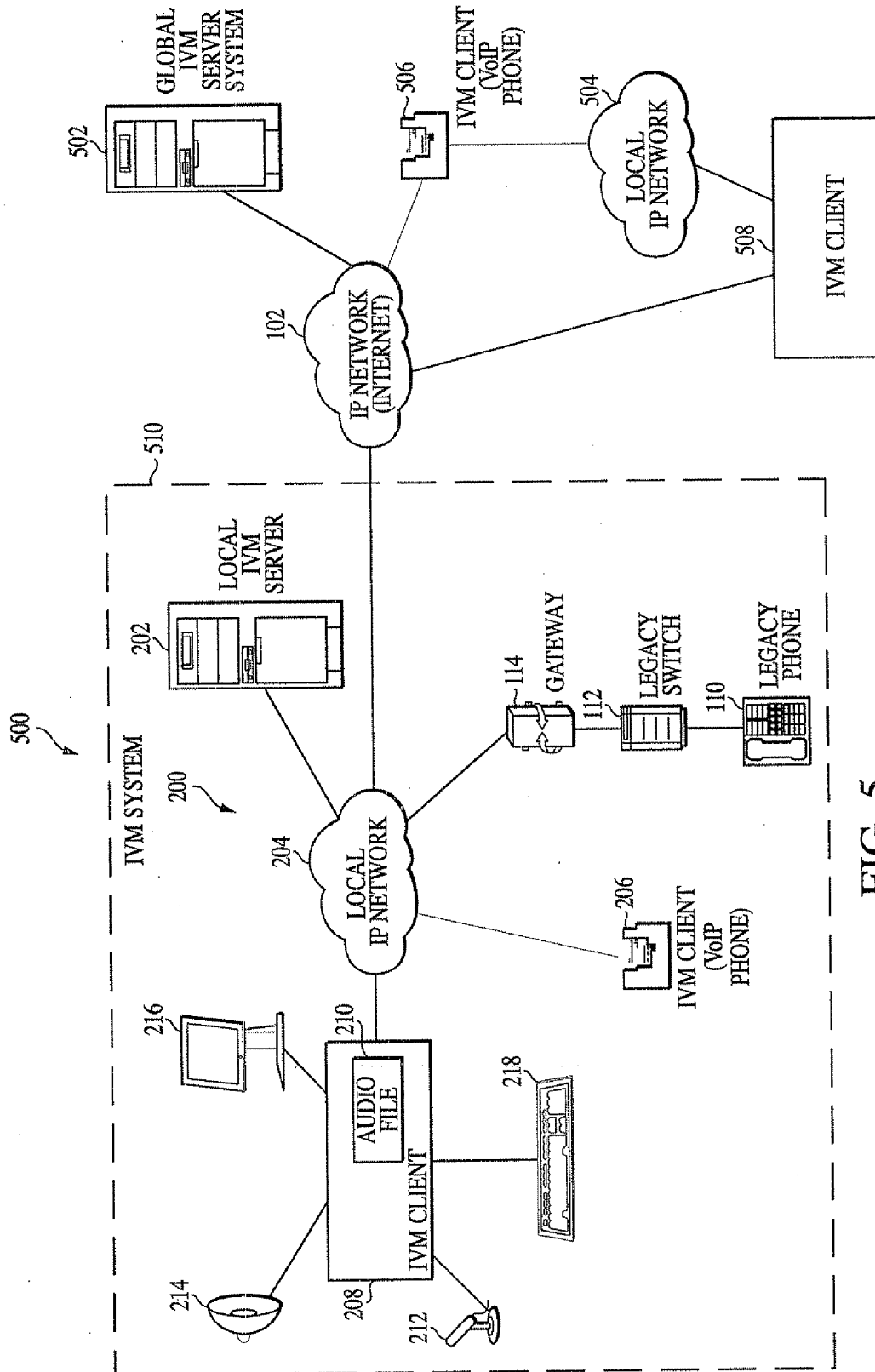

FIG. 5

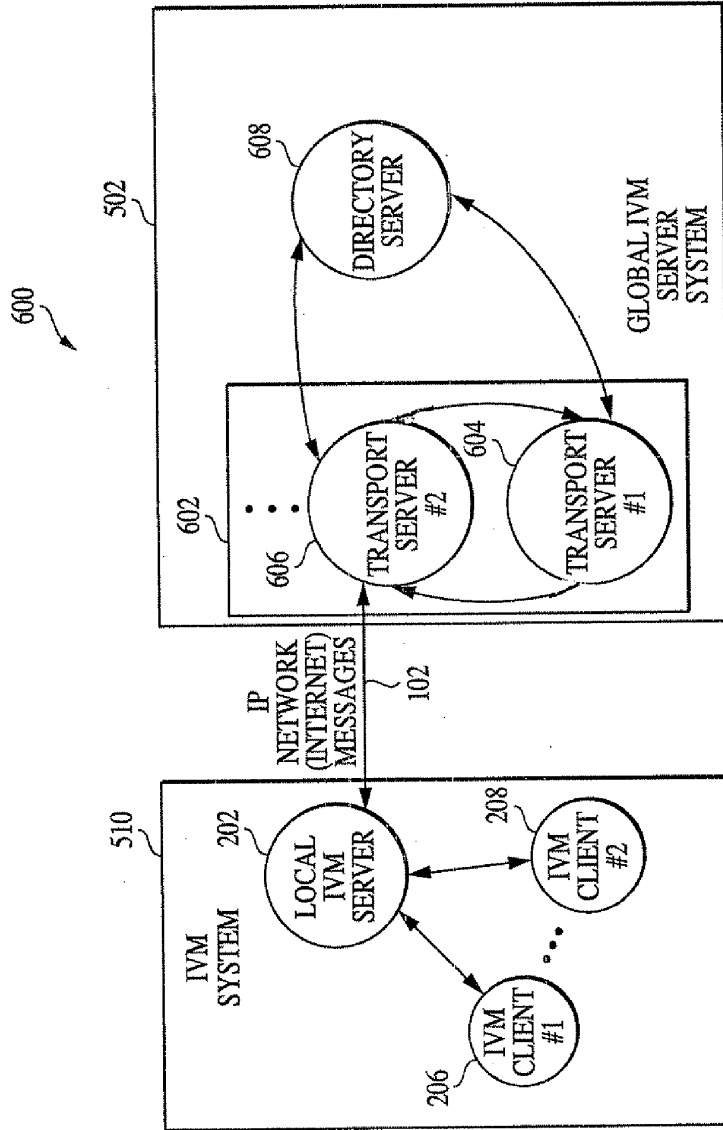

FIG. 6

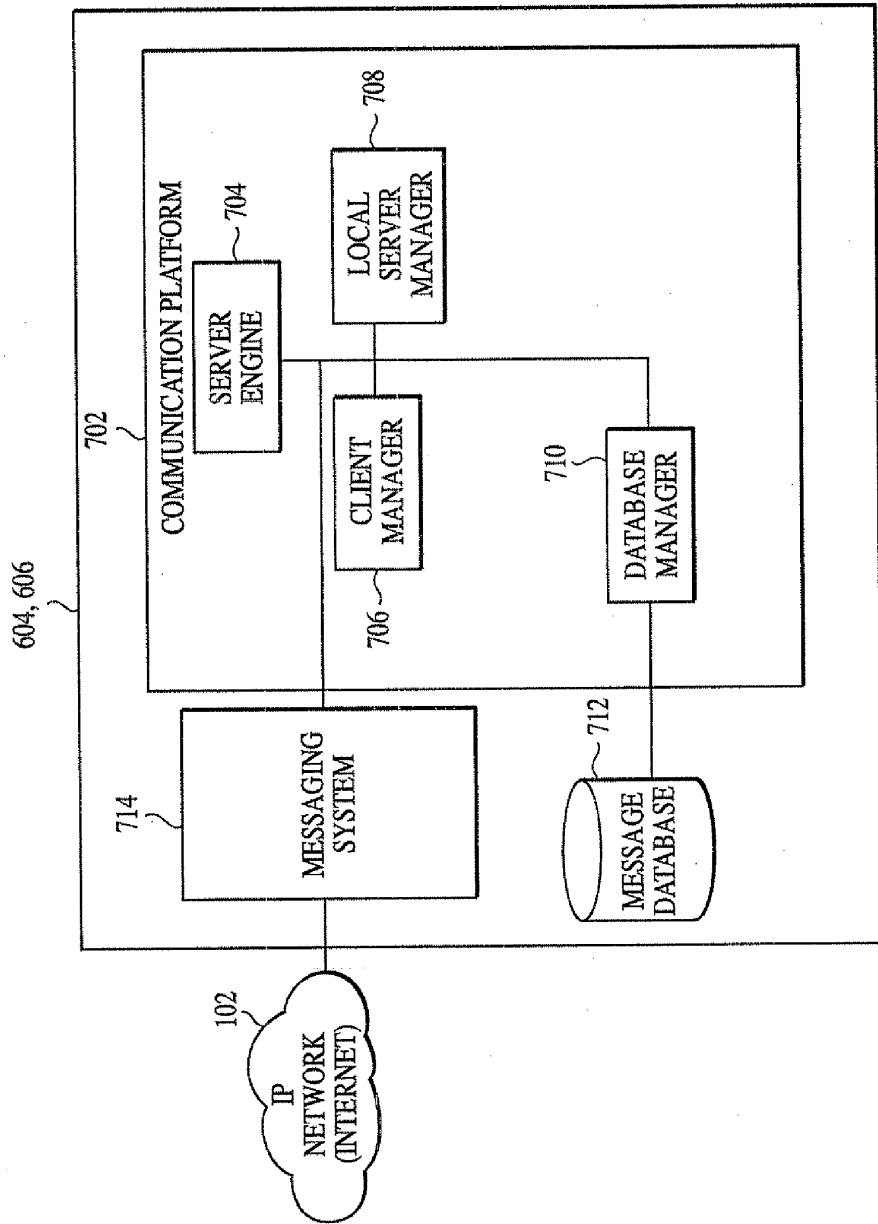

FIG. 7

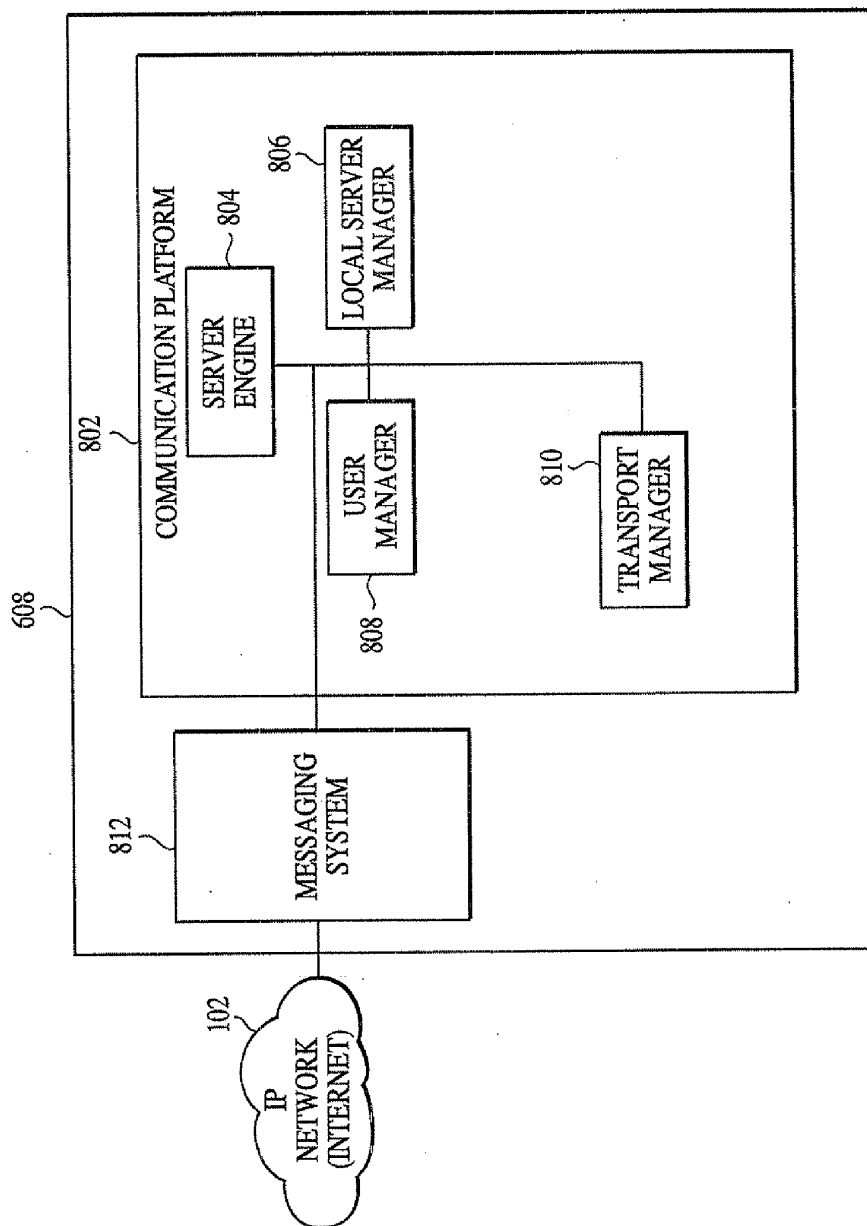

FIG. 8

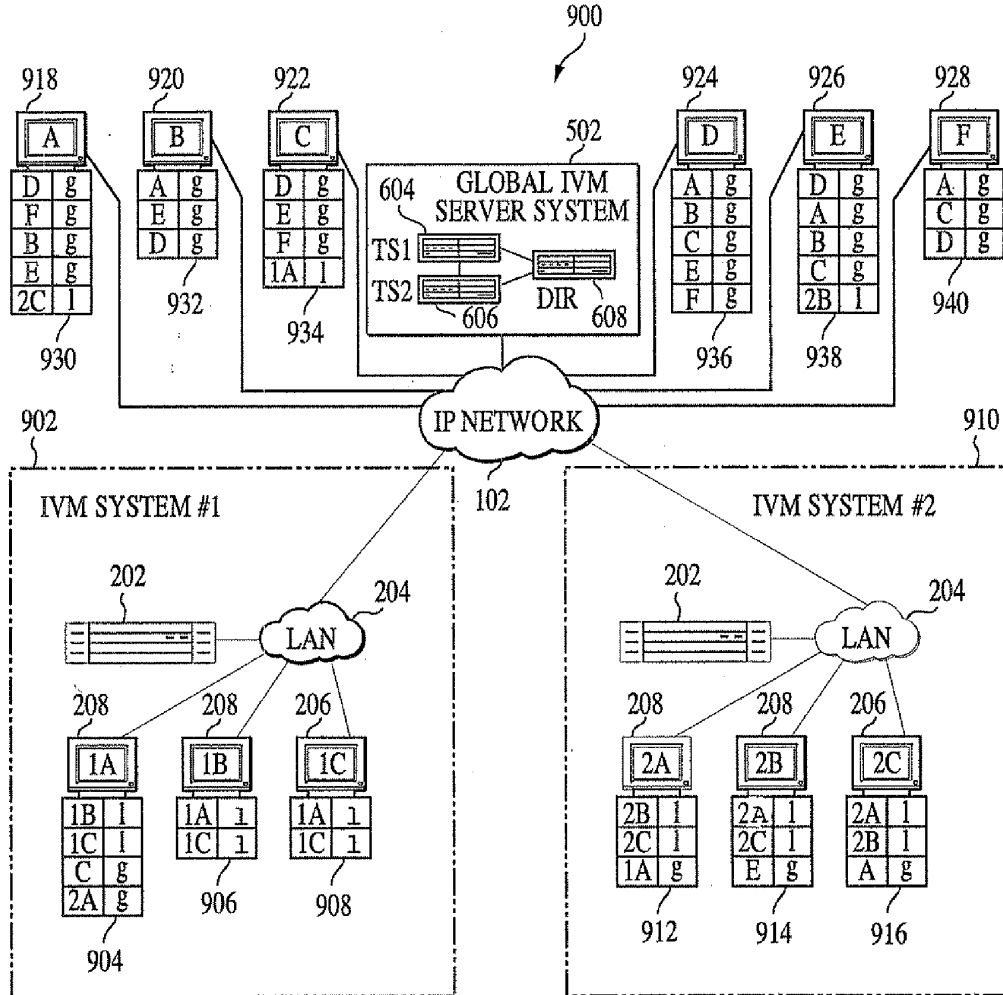

FIG. 9



Docket No.  
17188

### Declaration and Power of Attorney For Patent Application English Language Declaration

As a below named inventor, I hereby declare that:

My residence, post office address and citizenship are as stated below next to my name,

I believe I am the original, first and sole inventor (if only one name is listed below) or an original, first and joint inventor (if plural names are listed below) of the subject matter which is claimed and for which a patent is sought on the invention entitled

**SYSTEM AND METHOD FOR INSTANT VOIP MESSAGING**

the specification of which

(check one)

is attached hereto.

was filed on \_\_\_\_\_ as United States Application No. or PCT International Application Number \_\_\_\_\_

and was amended on \_\_\_\_\_  
(if applicable)

I hereby state that I have reviewed and understand the contents of the above identified specification, including the claims, as amended by any amendment referred to above.

I acknowledge the duty to disclose information which is material to patentability as defined in 37 CFR 1.56, including for continuation-in-part applications, material information which became available between the filing date of the prior application and the national or PCT international filing date of the continuation-in-part application.

I hereby claim foreign priority benefits under 35 U.S.C. 119(a)-(d) or (f), or 365(b) of any foreign application(s) for patent, or plant breeder's rights certificate(s), or 365(a) of any PCT International application which designated at least one country other than the United States of America, listed below and have also identified below, by checking the box, any foreign application for patent, inventor's or plant breeder's rights certificate(s), or any PCT international application having a filing date before that of the application on which priority is claimed.

Prior Foreign Application(s)			Priority Not Claimed
_____ (Number)	_____ (Country)	_____ (Day/Month/Year Filed)	<input type="checkbox"/>
_____ (Number)	_____ (Country)	_____ (Day/Month/Year Filed)	<input type="checkbox"/>
_____ (Number)	_____ (Country)	_____ (Day/Month/Year Filed)	<input type="checkbox"/>

I hereby claim the benefit under 35 U.S.C. Section 119(e) of any United States provisional application(s) listed below:

(Application Serial No.)	(Filing Date)
(Application Serial No.)	(Filing Date)
(Application Serial No.)	(Filing Date)

I hereby claim the benefit under 35 U. S. C. Section 120 of any United States application(s), or Section 365(c) of any PCT International application designating the United States, listed below and, insofar as the subject matter of each of the claims of this application is not disclosed in the prior United States or PCT International application in the manner provided by the first paragraph of 35 U.S.C. Section 112, I acknowledge the duty to disclose to the United States Patent and Trademark Office all information known to me to be material to patentability as defined in Title 37, C. F. R., Section 1.56 which became available between the filing date of the prior application and the national or PCT International filing date of this application:

(Application Serial No.)	(Filing Date)	(Status) (patented, pending, abandoned)
(Application Serial No.)	(Filing Date)	(Status) (patented, pending, abandoned)
(Application Serial No.)	(Filing Date)	(Status) (patented, pending, abandoned)

I hereby declare that all statements made herein of my own knowledge are true and that all statements made on information and belief are believed to be true; and further that these statements were made with the knowledge that willful false statements and the like so made are punishable by fine or imprisonment, or both, under Section 1001 of Title 18 of the United States Code and that such willful false statements may jeopardize the validity of the application or any patent issued thereon.

**POWER OF ATTORNEY:** As a named inventor, I hereby appoint the following attorney(s) and/or agent(s) to prosecute this application and transact all business in the Patent and Trademark Office connected therewith. *(list name and registration number)*

- Frank S. DiGiglio; Reg. No. 31,346
- Leopold Fresser; Reg. No. 19,827
- William C. Roch; Reg. No. 24,972
- Edward W. Grolz; Reg. No. 33,705
- Paul J. Esatto, Jr.; Reg. No. 30,749
- John S. Seney; Reg. No. 28,757
- Mark J. Cohen; Reg. No. 32,211
- Steven Fischman; Reg. No. 34,394
- Peter I. Bernstein; Reg. No. 43,497
- Thomas Spinelli, Reg. No. 39,533

Send Correspondence to: Paul J. Esatto, Jr.  
**SCULLY, SCOTT, MURPHY & PRESSER**  
 400 Garden City Plaza  
 Garden City, New York 11530

Direct Telephone Calls to: *(name and telephone number)*  
 Paul J. Esatto, Jr. (516) 742-4343

Full name of sole or first inventor Michael J. Rojas	
Sole or first inventor's signature 	Date 12-18-2003
Residence 2828 Barclay Circle, North Canton, Stark County, Ohio 44720	
Citizenship U.S.A.	
Post Office Address Same as above	

Full name of second inventor, if any	
Second inventor's signature	Date
Residence	
Citizenship	
Post Office Address	