



US 20050025080A1

(19) **United States**

(12) **Patent Application Publication** (10) **Pub. No.: US 2005/0025080 A1**

Liu (43) **Pub. Date: Feb. 3, 2005**

(54) **POWER SAVING VIA PHYSICAL LAYER ADDRESS FILTERING IN WLANS**

(76) Inventor: **Yonghe Liu**, Dallas, TX (US)

Correspondence Address:
TEXAS INSTRUMENTS INCORPORATED
P O BOX 655474, M/S 3999
DALLAS, TX 75265

(21) Appl. No.: **10/630,437**

(22) Filed: **Jul. 30, 2003**

Publication Classification

(51) **Int. Cl.⁷** **H04L 12/28**

(52) **U.S. Cl.** **370/311; 370/389**

(57) **ABSTRACT**

A system and method is described for saving power in a wireless network, using a physical layer address filtering protocol based on a partial address subset of the complete

destination MAC address. The system comprises a PHY layer filtering protocol for generating the partial address and writing the partial address into a PHY layer header portion (e.g., PLCP header) of a sending station, or reading the partial address from the PHY layer header portion upon transmission of each frame. A receiving station receives and decodes these PHY layer header portion bits, in accordance with the protocol, and compares whether the subset of bits match that of the stations' own partial address. If a station finds a match, the station then continues further decoding the frame at PHY layer and send the complete frame to the MAC layer for further processing. The stations that do not have a match will not activate their MAC layer components. Thus, the stations of the network will avoid wasting power decoding a significant portion of the complete frame of other stations of the wireless local area networks and unnecessary MAC layer processing. When group addressed, control/management frames or other such frames are detected at the sending station, the address filtering protocol may be "disabled" using a partial address containing a predetermined value (e.g., all zeros).

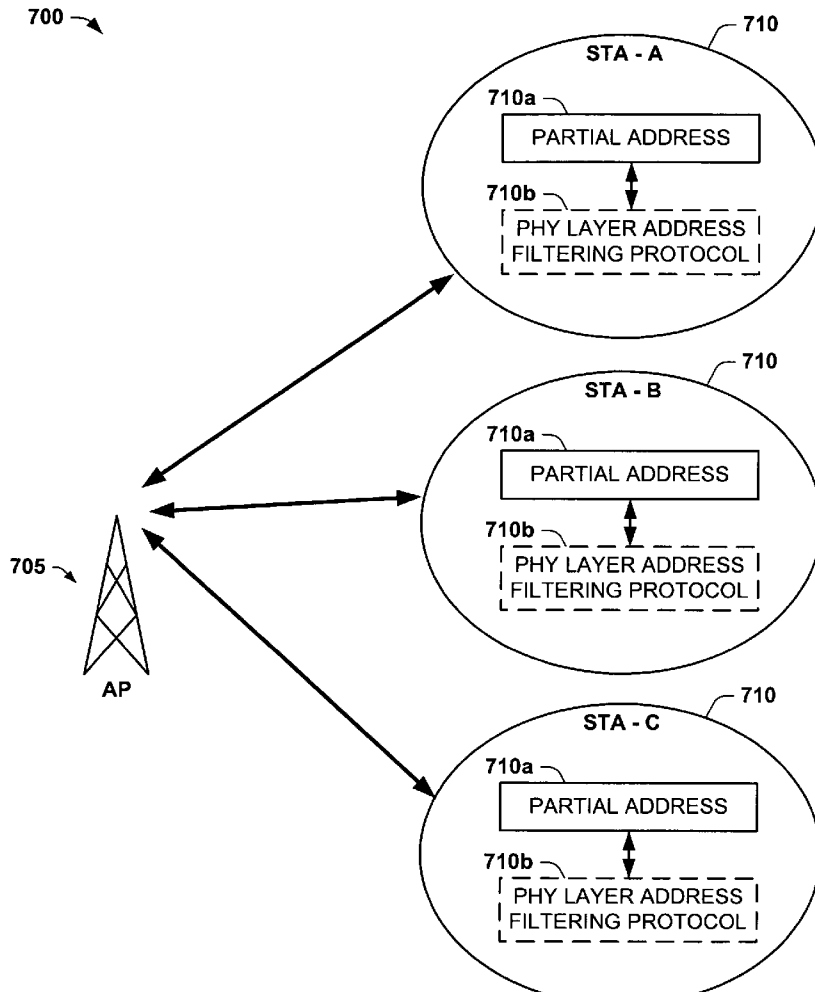

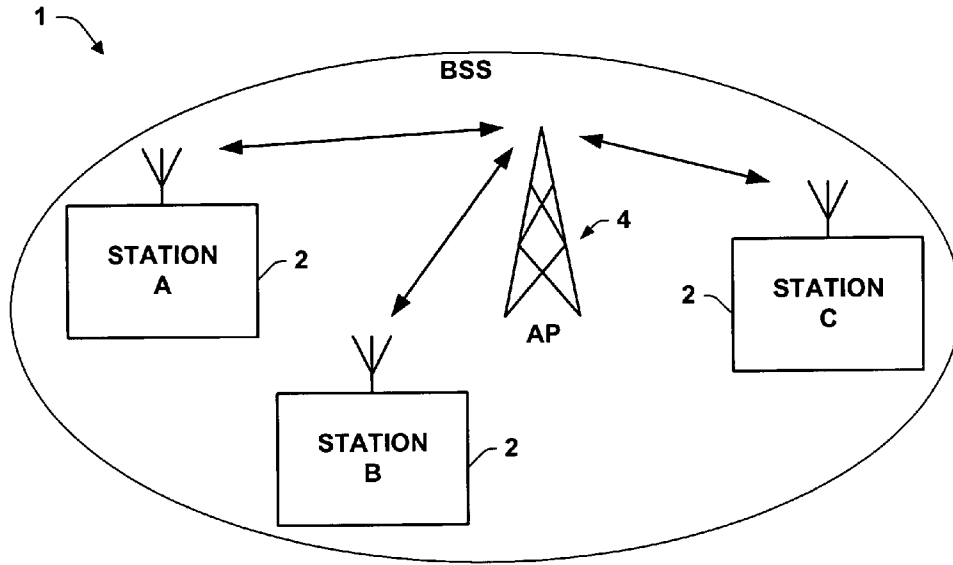

FIG. 1
PRIOR ART

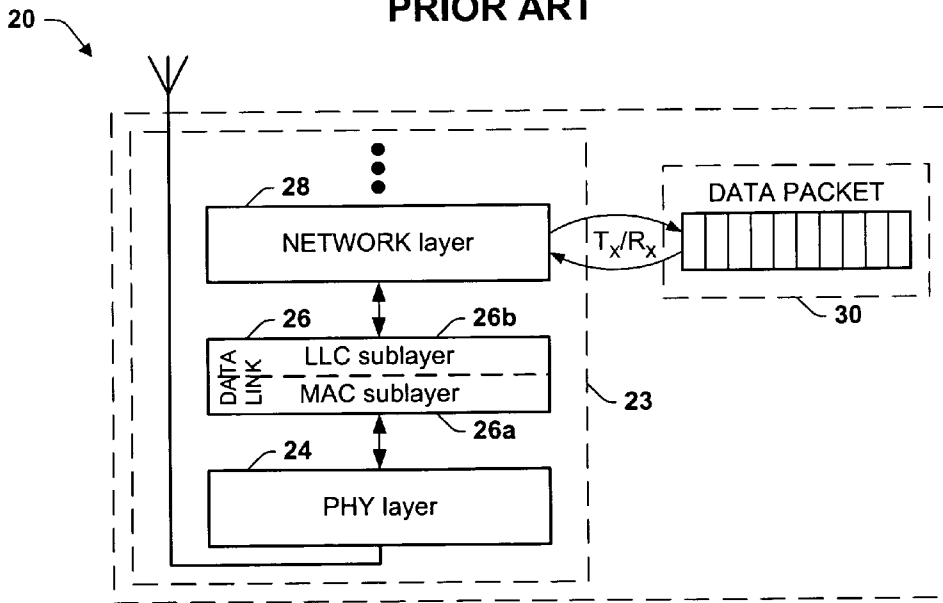

FIG. 2
PRIOR ART

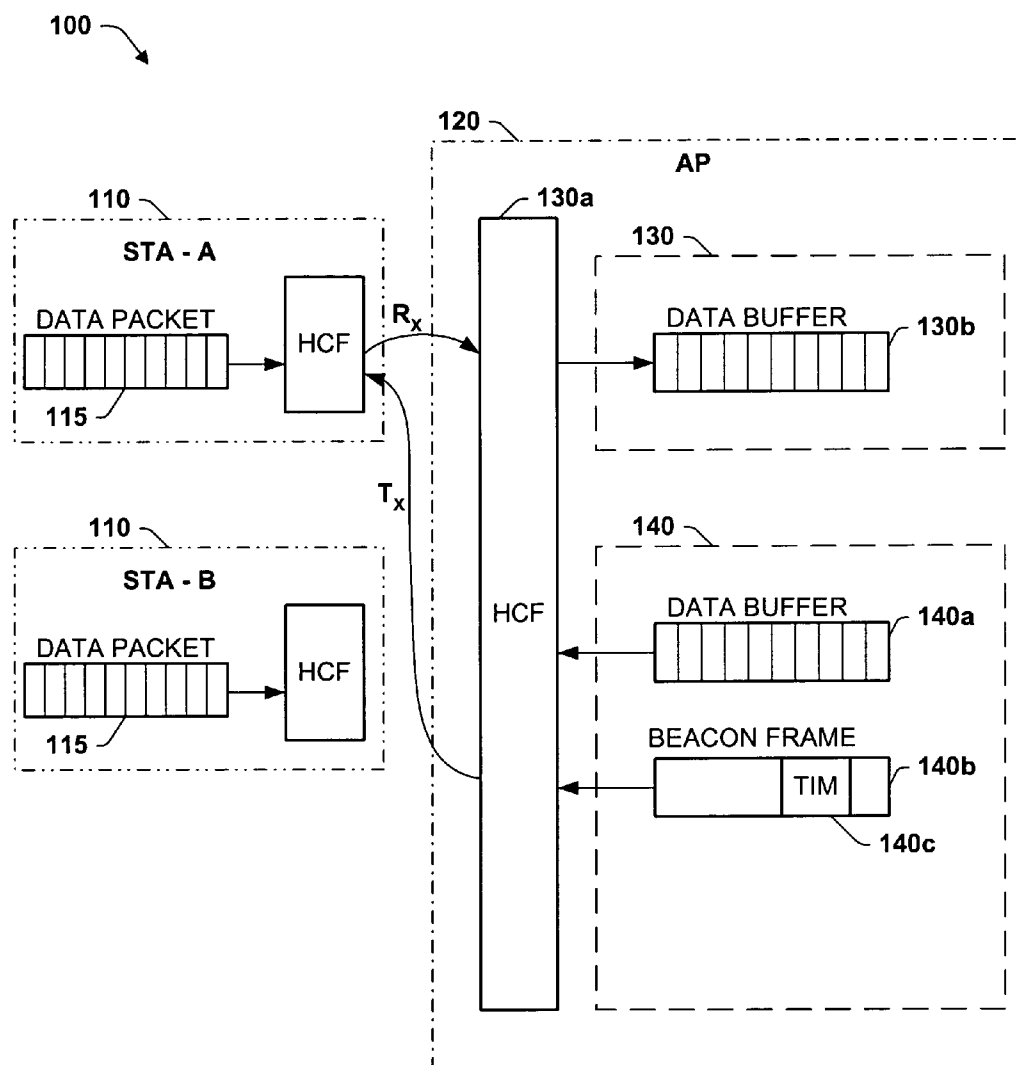

FIG. 3

400 →

Basic Frame Format

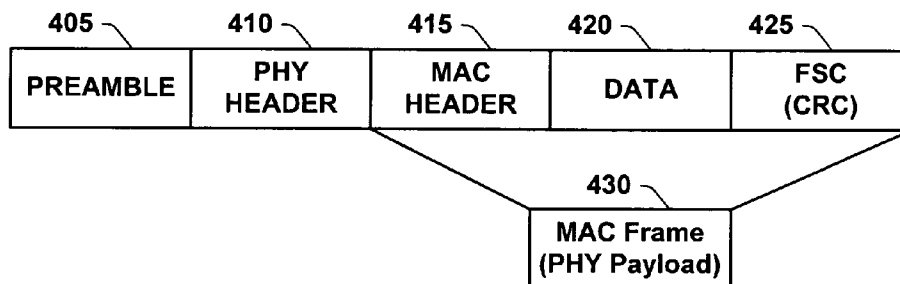

FIG. 4

MAC Frame Format

430 →

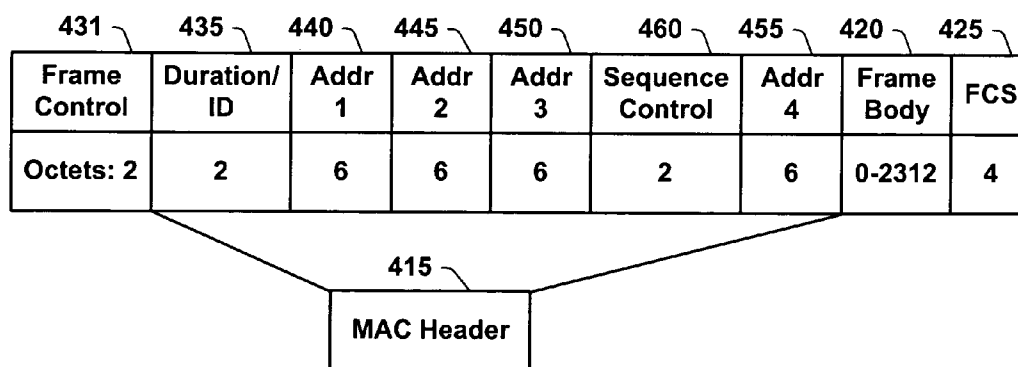

FIG. 5

IEEE 802.11b PHY Frame Format

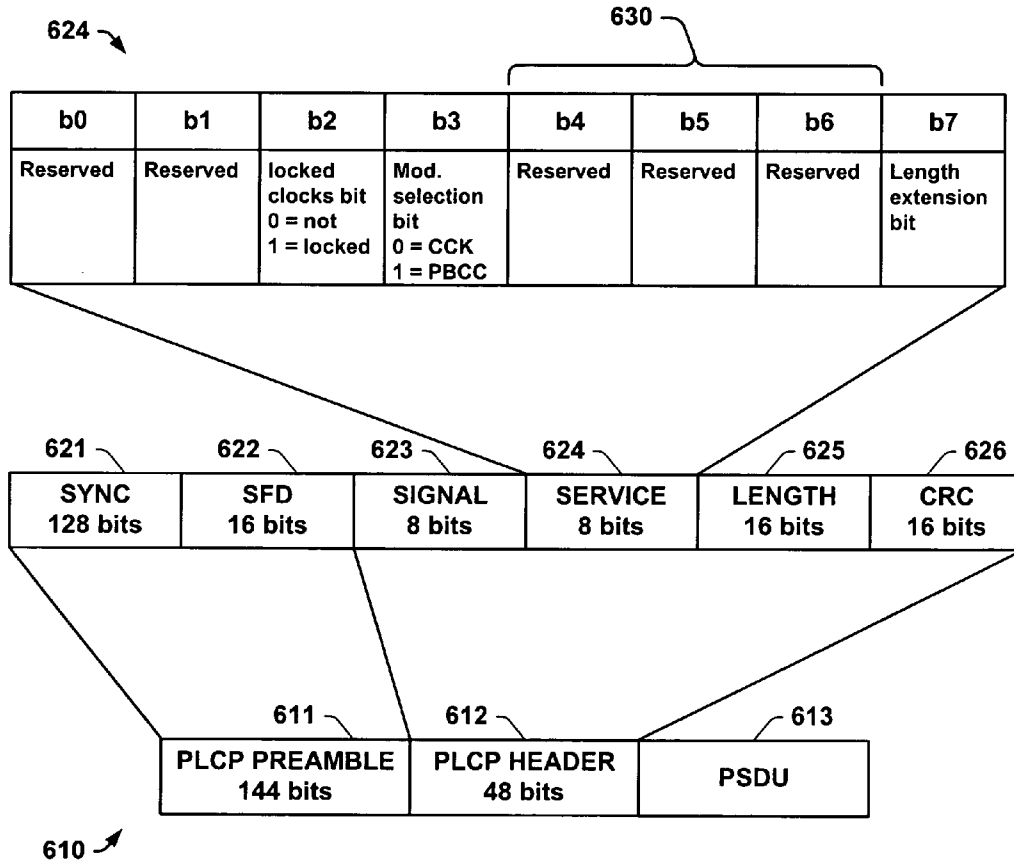

FIG. 6

Explore Litigation Insights

Docket Alarm provides insights to develop a more informed litigation strategy and the peace of mind of knowing you're on top of things.

Real-Time Litigation Alerts



Keep your litigation team up-to-date with **real-time alerts** and advanced team management tools built for the enterprise, all while greatly reducing PACER spend.

Our comprehensive service means we can handle Federal, State, and Administrative courts across the country.

Advanced Docket Research



With over 230 million records, Docket Alarm's cloud-native docket research platform finds what other services can't. Coverage includes Federal, State, plus PTAB, TTAB, ITC and NLRB decisions, all in one place.

Identify arguments that have been successful in the past with full text, pinpoint searching. Link to case law cited within any court document via Fastcase.

Analytics At Your Fingertips



Learn what happened the last time a particular judge, opposing counsel or company faced cases similar to yours.

Advanced out-of-the-box PTAB and TTAB analytics are always at your fingertips.

API

Docket Alarm offers a powerful API (application programming interface) to developers that want to integrate case filings into their apps.

LAW FIRMS

Build custom dashboards for your attorneys and clients with live data direct from the court.

Automate many repetitive legal tasks like conflict checks, document management, and marketing.

FINANCIAL INSTITUTIONS

Litigation and bankruptcy checks for companies and debtors.

E-DISCOVERY AND LEGAL VENDORS

Sync your system to PACER to automate legal marketing.