

IN 7607512



**THE UNITED STATES OF AMERICA**

**TO ALL TO WHOM THESE PRESENTS SHALL COME:**

UNITED STATES DEPARTMENT OF COMMERCE  
United States Patent and Trademark Office

October 29, 2016

THIS IS TO CERTIFY THAT ANNEXED IS A TRUE COPY FROM THE  
RECORDS OF THIS OFFICE OF THE FILE WRAPPER AND CONTENTS  
OF:

APPLICATION NUMBER: *13/955,345*  
FILING DATE: *July 31, 2013*  
PATENT NUMBER: *RE44,913*  
ISSUE DATE: *May 27, 2014*

By Authority of the  
Under Secretary of Commerce for Intellectual Property  
and Director of the United States Patent and Trademark Office

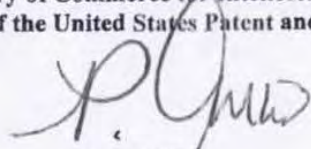

  
P. SWAIN  
Certifying Officer

IN THE UNITED STATES PATENT AND TRADEMARK OFFICE

In re Application of Atty. Docket 2001P00413US01

Matthew J. Bickerton

Original Patent No: 6,885,318

Original Issue date: April 26, 2005

Serial No.: Group Art Unit N/A

Filed: Concurrently Examiner: N/A

Title: TEXT ENTRY METHOD AND DEVICE THEREFOR

**Mail Stop Reissue  
Commissioner for Patents  
P.O. Box 1450  
Alexandria, VA 22313-1450**

PRELIMINARY AMENDMENT

Sir:

Prior to calculation of the filing fee and examination, please amend the Application and consider the remarks as follows:

**IN THE SPECIFICATION**

In the first column before the fourth line, following the title, insert a new paragraph as follows:

This application claims the benefit or priority of and describes the relationships between the following applications: wherein this application is a reissue of U.S. Patent No. 6,885,318, issued 04/26/2005, from U.S. Patent Application Ser. No. 10/156,409, filed 05/28/2002, which claims priority of foreign application GB 0116083.7 filed 06/30/2001, all of which are incorporated herein in whole by reference.

**IN THE CLAIMS**

**A listing of claims will replace all prior versions, and listings, of claims in the application:**

**Listing of Claims:**

1. (Amended) A method for inputting a character to a device, the device [comprising] including a keypad, the keypad [comprising] including a plurality of keys, at least one of [which ] the keys has a primary character, a plurality of secondary characters and [a] an associated display area[ associated with it], the keypad in a default state displaying the primary character associated with [a ] the at least one key in [its respective] the associated display area,

[wherein] the method [comprises the steps] comprising acts of:

in the default state,

returning the primary character as an input character in response to selection of the at least one key for a period shorter than a predetermined time period;

switching to a second state after detecting a first key selection of the at least one key for a period longer than the predetermined time period;

in the second state,

displaying each of the secondary characters associated with the first selected key in a respective display area;

detecting a second key selection;

selecting for the input character the secondary character associated with the

second key selection; and

returning the keypad to the default state.

2. (Amended) [A] The method according to claim 1, [wherein the keypad in a default state] further [displays] comprising an act of displaying by the keypad in the default state associated secondary characters adjacent the primary character, the location of each secondary character providing an indication of which display area will display that secondary character following a first key selection.

3. (Amended) A computer program product stored on a computer readable non-transitory medium [for performing all of the steps of claim 1] that when [the program is] run on a device for receiving character input including a keypad, the keypad including a plurality of keys, at least one of the keys having a primary character, a plurality of secondary characters and an associated display area, the keypad in a default state displaying the primary character associated with the at least one key in the associated display area, performs acts of:

in the default state,

returning the primary character as an input character in response to selection of the at least one key for a period shorter than a predetermined time period;

switching to a second state after detecting a first key selection of the at least one key for a period longer than the predetermined time period;

in the second state.

displaying each of the secondary characters associated with the first selected key in a respective display area;

detecting a second key selection;

selecting for the input character the secondary character associated with the second key selection; and

returning the keypad to the default state.

4. (Amended) A device for receiving character input, comprising;

a keypad having a plurality of keys, at least one of which keys has a primary character, a plurality of secondary characters and [a] an associated display area;

[associated with it, wherein]

means [are provided] for displaying in a default state the primary character associated with [a] the at least one key in [its respective] the associated display area; [,]

in the default state,

means for returning the primary character as an input character in response to selection of the at least one key for a period shorter than a predetermined time period;

means for switching to a second state responsive to a first key selection [are provided] of the at least one key for a period longer than the predetermined time period;

in the second state,

means for displaying each of the secondary characters associated with the selected key in a respective display area; [, and]

means responsive to a second key selection [are provided] for selecting as

the input character the secondary character associated with the second key selection; and  
means for returning the keypad to [its] the default state.

5. (Amended) [A] The device as claimed in claim 4, further comprising a touchscreen on which the keypad is displayed and wherein the display area associated with [a] the at least one key comprises a respective portion of the touchscreen.

6. (Amended) [A] The device as claimed in claim 4, [wherein] comprising a display means within the key for displaying the display area associated with [a] the at least one key [is provided by display means within the key].

7. (Amended) [A] The device as claimed in claim 4, [wherein] comprising a display means adjacent the key for displaying the display area associated with [a] the at least one key [is provided by display means adjacent the key].

8. (New) The device as claimed in claim 4, wherein the means for switching to a second state comprises a means for detecting a sliding across the keypad from the first key selection to the second key selection.

9. (New) The method as claimed in claim 1, the device further including a touchscreen, the method comprising an act of displaying the keypad and the at least one key on the touchscreen.

10. (New) The method as claimed in claim 1, the device further including a display within the at least one key, the method comprising an act of displaying the display area associated with the at least one key on the display.

11. (New) The method as claimed in claim 1, the device further including a display adjacent the key, the method comprising an act of displaying the display area associated with the at least one key on the display.

12. (New) The method according to claim 1, wherein the act of detecting the second key selection comprises an act of detecting a sliding across the keypad from the first key selection to the second key selection.

13. (New) The computer program product as claimed in claim 3, the device further including a touchscreen, the method comprising an act of displaying the keypad and the at least one key on the touchscreen.

14. (New) The computer program product as claimed in claim 3, the device further including a display within the at least one key, the method comprising an act of displaying the display area associated with the at least one key on the display.

15. (New) The computer program product as claimed in claim 3, the device further



including a display adjacent the key, the method comprising an act of displaying the display area associated with the at least one key on the display.

16. (New) The computer program product as claimed in claim 3, wherein the act of detecting the second key selection comprises an act of detecting a sliding across the keypad from the first key selection to the second key selection.

**REMARKS/ARGUMENTS**

Claims 1-7 are pending from the Patent. Claims 8-16 are new claims added herein. Claims 1, 3 and 4 are independent claims. By means of the present amendment, the claims are amended including for better conformance to U.S. practice, such as for clarity, correcting typographical errors, amending dependent claims to begin with "The", eliminating multiple transition phrases (e.g., comprising) as well as correcting certain informalities noted upon review of the claims. By these amendments, it is respectfully submitted that the claims are not amended to address issues of patentability and all rights under the Doctrine of Equivalents are respectfully reserved. Furthermore the right to claim subject matter deleted herein or otherwise disclosed by the Application is respectfully reserved for a later time during the prosecution of this Application or continuing applications.

The specification is amended to add a reference to the priority documents.

This reissue application is filed to correct an error in the patent which was made without any deceptive intention, where, as a result of the error, the Patent is deemed wholly or partly inoperative or invalid. An error in the patent arises out of an error in conduct which was made in the preparation and/or prosecution of the application which became the patent. The error in the patent is caused by the patentee claiming more than he had a right to claim in the patent.

Specifically, the error in the patent is caused by the omission of a narrower claim from a patent that renders the patent partly inoperative by failing to protect the disclosed

invention to the full extent allowed by law (see, *In re Tanaka*, 640 F. 3d 1246, 1251 at 1251, 98 USPQ2d 1331, 1334 at 1334 (Fed. Cir. 2011)).

The Patentee respectfully asserts that the error is corrected by an amendment that adds at least one dependent claim, for example claim 8, which protects the disclosed invention in accordance with the specification of the Patent.

Specifically, claim 8 for example is added to recite that "the means for switching to a second state comprises a means for detecting a sliding across the keypad from the first key selection to the second key selection." Support for the subject matter of the claim is for example provided by the present patent, in the accompanying description contained in col. 3, line 66 through col. 4, line 5. Previously the patentee had neglected, without deceptive intent, to protect this disclosed invention in accordance with the specification of the Patent.

Further, claim 1 is amended to recite that (e.g., see, present patent, FIGs. 1-5 and the accompanying description contained in col. 5, line 65 through col. 6, line 19, changes to the claim element indicated with underlining showing additions) "in the default state, returning the primary character as an input character in response to selection of the at least one key for a period shorter than a predetermined time period; switching to a second state after detecting a first key selection of the at least one key for a period longer than a predetermined time period" thus improving on the state of the art. Claim 1 is further amended "for better conformance to U.S. practice" as indicated above.

Claim 2 is amended "for better conformance to U.S. practice" as discussed above wherein the claim element is rewritten to present a method act. Support for the

amendments to the claim is for example provided by the present patent, FIGs. 5 and 6 and the accompanying description contained in col. 6, lines 27-46.

Claim 3 is similarly amended as claim 1 discussed above and further is amended to be in independent form (i.e., not dependent on a method claim) and "for better conformance to U.S. practice" as further discussed above. Support for the amendments to the claim is for example provided by the present patent, FIGs. 1-5 and the accompanying description contained in col. 4, line 55 through col. 6, line 19.

Claim 4 is similarly amended as claims 1 and 3 discussed above and "for better conformance to U.S. practice" as further discussed above. Support for the amendments to the claim is for example provided by the present patent, FIGs. 1-5 and the accompanying description contained in col. 4, line 55 through col. 6, line 19.

Claim 5 is amended "for better conformance to U.S. practice" as discussed above. Support for the amendments to the claim is for example provided by the present patent, FIGs. 5 and 6 and the accompanying description contained in col. 6, lines 27-46.

Claim 6 is amended "for better conformance to U.S. practice" as discussed above wherein the claim element is rewritten to present a device element. Support for the amendments to the claim is for example provided by the present patent, FIGs. 5 and 6 and the accompanying description contained in col. 6, lines 27-46.

Claim 7 is amended "for better conformance to U.S. practice" as discussed above wherein the claim element is rewritten to present a device element. Support for the amendments to the claim is for example provided by the present patent, FIGs. 3 and 4 and the accompanying description contained in col. 4, lines 14-22 and 55-60.

Claim 8 is added to depend from claim 4 as discussed above.

Claim 9 is added to depend from claim 1 providing "the device further including a touchscreen, the method comprising an act of displaying the keypad and the at least one key on the touchscreen." Support for the limiting subject matter of the claim is for example provided by the present patent, by claim 5, FIGs. 2 and 3 and in the accompanying description contained in col. 4, lines 14-26.

Claim 10 is added to depend from claim 1 providing "the device further including a display within the at least one key, the method comprising an act of displaying the display area associated with the at least one key on the display." Support for the limiting subject matter of the claim is for example provided by the present patent, by claim 5, FIGs. 2 and 3 and in the accompanying description contained in col. 4, lines 14-26.

Claim 11 is added to depend from claim 1 providing "the device further including a display adjacent the key, the method comprising an act of displaying the display area associated with the at least one key on the display." Support for the limiting subject matter of the claim is for example provided by the present patent, FIG. 4 and in the accompanying description contained in col. 4, lines 55-60.

Claim 12 is added to depend from claim 1 providing "wherein the act of detecting the second key selection comprises an act of detecting a sliding across the keypad from the first key selection to the second key selection." Support for the limiting subject matter of the claim is for example provided by the present patent in the accompanying description contained in col. 4, lines 14-26.

Claim 13 is added to depend from claim 3 providing "the device further including a touchscreen, the method comprising an act of displaying the keypad and the at least one key on the touchscreen." Support for the limiting subject matter of the claim is for example provided by the present patent, by claim 5, FIGs. 2 and 3 and in the accompanying description contained in col. 4, lines 14-26.

Claim 14 is added to depend from claim 3 providing "the device further including a display within the at least one key, the method comprising an act of displaying the display area associated with the at least one key on the display." Support for the limiting subject matter of the claim is for example provided by the present patent, by claim 5, FIGs. 2 and 3 and in the accompanying description contained in col. 4, lines 14-26.

Claim 15 is added to depend from claim 3 providing "the device further including a display adjacent the key, the method comprising an act of displaying the display area associated with the at least one key on the display." Support for the limiting subject matter of the claim is for example provided by the present patent, FIG. 4 and in the accompanying description contained in col. 4, lines 55-60.

Claim 16 is added to depend from claim 3 providing "wherein the act of detecting the second key selection comprises an act of detecting a sliding across the keypad from the first key selection to the second key selection." Support for the limiting subject matter of the claim is for example provided by the present patent in the accompanying description contained in col. 4, lines 14-26.

The Patentee believes that the new claims are definite and distinguish from the prior art and respectfully requests the allowance of claims 1-16.

No new matter is added by these amendments in this reissue application. All errors which are being corrected in the reissue application up to the time of filing of the oath/declaration arose without any deceptive intention on the part of the patentee.

The continuing obligation under 37 CFR 1.178(b), to timely apprise the Office of any prior or concurrent proceeding in which Patent No. 6,885,318 is or was involved is acknowledged. The patentee is not aware at this time of any prior or concurrent proceeding in which Patent No. 6,885,318 is or was involved.

The patentee acknowledges the continuing obligation under 37 CFR 1.56, to timely apprise the Office of any information which is material to patentability of the claims under consideration in this reissue application. The patentee is not aware at this time of any additional material to patentability of the claims under consideration in this reissue application that is not already before the Patent Office.

A reissue oath/declaration is submitted under separate cover to this amendment.

The reissue oath/declaration identifies at least one error which is relied upon to support the reissue application. Specifically, the reissue oath/declaration identifies the error which is relied upon to support the reissue application and states:

The patentee believes the original patent to be wholly or partly inoperative or invalid by reason of the patentee claiming more than the patentee had the right to claim in the patent. Specifically, the error in the patent is caused by the omission of a narrower claim from the patent that renders the patent partly inoperative by failing to protect the disclosed invention to the full extent allowed by law.

The Patentee respectfully asserts that the error is corrected by an amendment that adds at least one dependent claim, for example claim 8, which protects the disclosed invention in accordance with the specification of the Patent, thus improving on the state of the art. Previously the patentee had neglected, without deceptive intent, to protect this disclosed invention in accordance with the specification of the Patent.

No new matter is added by this amendment in this reissue application. All errors in the patent being corrected in the present reissue application up to the time of filing this oath/declaration, that are not covered by a prior oath/declaration submitted in this application, arose without any deceptive intention on the part of the patentee.

Accordingly, the reissue oath/declaration identifies the error which is relied upon to support the reissue application as "the error in the patent is caused by the omission of a narrower claim from a patent that renders the patent partly inoperative by failing to protect the disclosed invention to the full extent allowed by law." This at least one error is relied upon to support the reissue application in that at least added dependent claim 8 protects the disclosed invention in accordance with the specification of the Patent, thus improving on the state of the art.

It is respectfully submitted that the reissue oath/declaration is proper and an indication to that effect is respectfully requested.



A diligent and sincere effort to place this Patent back in condition for immediate allowance is made herein and notice to this effect is earnestly solicited.

Respectfully submitted,

By /Gregory L. Thorne/

Gregory L. Thorne, Reg. 39,398  
Attorney for Applicant(s)

**THORNE & HALAJIAN, LLP**

111 West Main Street  
Bay Shore, NY 11706  
Tel: (631) 665-5139  
Fax: (631) 665-5101

**Please direct all inquiries and correspondence to:**

Michael E. Belk, Reg. 33,357  
Philips Intellectual Property & Standards  
P.O. Box 3001  
Briarcliff Manor, NY 10510-8001  
(914) 333-9643

Under the Paperwork Reduction Act of 1995, no persons are required to respond to a collection of information unless it displays a valid OMB control number.

**POWER OF ATTORNEY TO PROSECUTE APPLICATIONS BEFORE THE USPTO**

I hereby revoke all previous powers of attorney given in the application identified in the attached statement under 37 CFR 3.73(b).

I hereby appoint:

Practitioners associated with the Customer Number: 24737

OR

Practitioner(s) named below (if more than ten patent practitioners are to be named, then a customer number must be used):

Name	Registration Number	Name	Registration Number

as attorney(s) or agent(s) to represent the undersigned before the United States Patent and Trademark Office (USPTO) in connection with any and all patent applications assigned only to the undersigned according to the USPTO assignment records or assignment documents attached to this form in accordance with 37 CFR 3.73(b).

Please change the correspondence address for the application identified in the attached statement under 37 CFR 3.73(b) to:

The address associated with Customer Number: 24737

OR

<input type="checkbox"/> Firm or Individual Name			
Address			
City	State	Zip	
Country			
Telephone	Email		

Assignee Name and Address:

KONINKLIJKE PHILIPS ELECTRONICS N.V.  
 Groenewoudseweg 1  
 5621 BA Eindhoven, The Netherlands

A copy of this form, together with a statement under 37 CFR 3.73(b) (Form PTO/SB/96 or equivalent) is required to be filed in each application in which this form is used. The statement under 37 CFR 3.73(b) may be completed by one of the practitioners appointed in this form if the appointed practitioner is authorized to act on behalf of the assignee, and must identify the application in which this Power of Attorney is to be filed.

**SIGNATURE of Assignee of Record**

The individual whose signature and title is supplied below is authorized to act on behalf of the assignee

Signature		Date	08 APRIL 2010
Name	Michael E. Marion	Telephone	(914) 333-9641
Title	Authorized Representative		

This collection of information is required by 37 CFR 1.31, 1.32 and 1.33. The information is required to obtain or retain a benefit by the public which is to file (and by the USPTO to process) an application. Confidentiality is governed by 35 U.S.C. 122 and 37 CFR 1.11 and 1.14. This collection is estimated to take 3 minutes to complete, including gathering, preparing, and submitting the completed application form to the USPTO. Time will vary depending upon the individual case. Any comments on the amount of time you require to complete this form and/or suggestions for reducing this burden, should be sent to the Chief Information Officer, U.S. Patent and Trademark Office, U.S. Department of Commerce, P.O. Box 1450, Alexandria, VA 22313-1450. DO NOT SEND FEES OR COMPLETED FORMS TO THIS ADDRESS. SEND TO: Commissioner for Patents, P.O. Box 1450, Alexandria, VA 22313-1450.

If you need assistance in completing the form, call 1-800-PTO-9199 and select option 2.

Under the Paperwork Reduction Act of 1995, no persons are required to respond to a collection of information unless it displays a valid OMB control number.

<b>REISSUE APPLICATION: CONSENT OF ASSIGNEE; STATEMENT OF NON-ASSIGNMENT</b>		Docket Number (Optional)  2001P00413US01
This is part of the application for a reissue patent based on the original patent identified below.		
Name of Patentee(s) Matthew J. Bickerton		
Patent Number US 6,885,318	Date Patent Issued April 26, 2005	
Title of Invention TEXT ENTRY METHOD AND DEVICE THEREFOR		
<p>1. <input checked="" type="checkbox"/> Filed herein is a statement under 37 CFR 3.73(b). (Form PTO/SB/96)</p> <p>2. <input type="checkbox"/> Ownership of the patent is in the inventor(s), and no assignment of the patent is in effect.</p> <p>One of boxes 1 or 2 above must be checked. If multiple assignees, complete this form for each assignee. If box 2 is checked, skip the next entry and go directly to "Name of Assignee".</p> <p>The written consent of all assignees and inventors owning an undivided interest in the original patent is included in this application for reissue.</p>		
The assignee(s) owning an undivided interest in said original patent is/are <u>Koninklijke Philips Electronics N</u> , and the assignee(s) consents to the accompanying application for reissue.		
Name of assignee/inventor (if not assigned) Koninklijke Philips Electronics N.V.		
Signature /Michael E. Marion/	Date July 31, 2013	
Typed or printed name and title of person signing for assignee (if assigned)  Michael E. Marion, Authorized Signatory		

This collection of information is required by 37 CFR 1.172. The information is required to obtain or retain a benefit by the public which is to file (and by the USPTO to process) an application. Confidentiality is governed by 35 U.S.C. 122 and 37 CFR 1.14. This collection is estimated to take 6 minutes to complete, including gathering, preparing, and submitting the completed application form to the USPTO. Time will vary depending upon the individual case. Any comments on the amount of time you require to complete this form and/or suggestions for reducing this burden, should be sent to the Chief Information Officer, U.S. Patent and Trademark Office, U.S. Department of Commerce, P.O. Box 1450, Alexandria, VA 22313-1450. DO NOT SEND FEES OR COMPLETED FORMS TO THIS ADDRESS. SEND TO: Commissioner for Patents, P.O. Box 1450, Alexandria, VA 22313-1450.

If you need assistance in completing the form, call 1-800-PTO-9199 and select option 2.

## Privacy Act Statement

The **Privacy Act of 1974 (P.L. 93-579)** requires that you be given certain information in connection with your submission of the attached form related to a patent application or patent. Accordingly, pursuant to the requirements of the Act, please be advised that: (1) the general authority for the collection of this information is 35 U.S.C. 2(b)(2); (2) furnishing of the information solicited is voluntary; and (3) the principal purpose for which the information is used by the U.S. Patent and Trademark Office is to process and/or examine your submission related to a patent application or patent. If you do not furnish the requested information, the U.S. Patent and Trademark Office may not be able to process and/or examine your submission, which may result in termination of proceedings or abandonment of the application or expiration of the patent.

The information provided by you in this form will be subject to the following routine uses:

1. The information on this form will be treated confidentially to the extent allowed under the Freedom of Information Act (5 U.S.C. 552) and the Privacy Act (5 U.S.C. 552a). Records from this system of records may be disclosed to the Department of Justice to determine whether disclosure of these records is required by the Freedom of Information Act.
2. A record from this system of records may be disclosed, as a routine use, in the course of presenting evidence to a court, magistrate, or administrative tribunal, including disclosures to opposing counsel in the course of settlement negotiations.
3. A record in this system of records may be disclosed, as a routine use, to a Member of Congress submitting a request involving an individual, to whom the record pertains, when the individual has requested assistance from the Member with respect to the subject matter of the record.
4. A record in this system of records may be disclosed, as a routine use, to a contractor of the Agency having need for the information in order to perform a contract. Recipients of information shall be required to comply with the requirements of the Privacy Act of 1974, as amended, pursuant to 5 U.S.C. 552a(m).
5. A record related to an International Application filed under the Patent Cooperation Treaty in this system of records may be disclosed, as a routine use, to the International Bureau of the World Intellectual Property Organization, pursuant to the Patent Cooperation Treaty.
6. A record in this system of records may be disclosed, as a routine use, to another federal agency for purposes of National Security review (35 U.S.C. 181) and for review pursuant to the Atomic Energy Act (42 U.S.C. 218(c)).
7. A record from this system of records may be disclosed, as a routine use, to the Administrator, General Services, or his/her designee, during an inspection of records conducted by GSA as part of that agency's responsibility to recommend improvements in records management practices and programs, under authority of 44 U.S.C. 2904 and 2906. Such disclosure shall be made in accordance with the GSA regulations governing inspection of records for this purpose, and any other relevant (*i.e.*, GSA or Commerce) directive. Such disclosure shall not be used to make determinations about individuals.
8. A record from this system of records may be disclosed, as a routine use, to the public after either publication of the application pursuant to 35 U.S.C. 122(b) or issuance of a patent pursuant to 35 U.S.C. 151. Further, a record may be disclosed, subject to the limitations of 37 CFR 1.14, as a routine use, to the public if the record was filed in an application which became abandoned or in which the proceedings were terminated and which application is referenced by either a published application, an application open to public inspection or an issued patent.
9. A record from this system of records may be disclosed, as a routine use, to a Federal, State, or local law enforcement agency, if the USPTO becomes aware of a violation or potential violation of law or regulation.

<b>REISSUE APPLICATION DECLARATION BY THE ASSIGNEE</b>	Docket Number (optional) 2001P00413US01
I hereby declare that: The residence, mailing address and citizenship of the inventors are stated below. I am authorized to act on behalf of the following assignee: <u>KONINKLIJKE PHILIPS ELECTRONICS N.V.</u> and the title of my position with said assignee is: <u>AUTHORIZED SIGNATORY</u> The entire title to the patent identified below is vested in said assignee.	
Inventor <u>Matthew J. Bickerton</u>	Citizenship <u>GB</u>
Residence/Mailing Address <u>Tye Copee Cottage, Blitchingley, GB RH14NE</u>	
Inventor	Citizenship
Residence/Mailing Address	
<input type="checkbox"/> Additional inventors are named on separately numbered sheets attached hereto.	
Patent Number <u>6,885,318</u>	Date of Patent Issued <u>April 26, 2005</u>
I believe said inventor(s) to be the original and first inventor(s) of the subject matter which is described and claimed in said patent, for which a reissue patent is sought on the invention entitled:  <div style="border: 1px solid black; padding: 5px; min-height: 40px;">TEXT ENTRY METHOD AND DEVICE THEREFOR</div>	
the specification of which <input checked="" type="checkbox"/> is attached hereto. <input type="checkbox"/> was filed on _____ as reissue application number _____ / _____ and was amended on _____ (if applicable)	
I have reviewed and understand the contents of the above identified specification, including the claims, as amended by any amendment referred to above.	
I acknowledge the duty to disclose information which is material to patentability as defined in 37 CFR 1.56.	
<input checked="" type="checkbox"/> I hereby claim foreign priority benefits under 35 U.S.C. 119(a)-(d) or (f), or 365(b). Attached is form PTO/SB/02B (or equivalent) listing the foreign applications.	
I verify believe the original patent to be wholly or partly inoperative or invalid, for the reasons described below. (Check all boxes that apply.)	
<input type="checkbox"/> by reason of a defective specification or drawing.	
<input checked="" type="checkbox"/> by reason of the patentee claiming more or less than he had the right to claim in the patent.	
<input type="checkbox"/> by reason of other errors.	

[Page 1 of 2]

This collection of information is required by 37 CFR 1.175. The information is required to obtain or retain a benefit by the public which is to file (and by the USPTO to process) an application. Confidentiality is governed by 35 U.S.C. 122 and 37 CFR 1.11 and 1.14. This collection is estimated to take 30 minutes to complete, including gathering, preparing, and submitting the completed application form to the USPTO. Time will vary depending upon the individual case. Any comments on the amount of time you require to complete this form and/or suggestions for reducing this burden, should be sent to the Chief Information Officer, U.S. Patent and Trademark Office, U.S. Department of Commerce, P.O. Box 1450, Alexandria, VA 22313-1450. DO NOT SEND FEES OR COMPLETED FORMS TO THIS ADDRESS. SEND TO: Commissioner for Patents, P.O. Box 1450, Alexandria, VA 22313-1450.

*If you need assistance in completing the form, call 1-800-PTO-9199 and select option 2.*

<b>REISSUE APPLICATION DECLARATION BY THE ASSIGNEE</b>		Docket Number (Optional) 2001P00413	
At least one error upon which reissue is based is described as follows: The error in the patent is caused by the patentee claiming more than he had a right to claim in the patent. (con't on attached sheet)			
[Attach additional sheets, if needed.]			
All errors corrected in this reissue application arose without any deceptive intention on the part of the applicant.			
I hereby appoint:			
<input checked="" type="checkbox"/> Practitioners associated with Customer Number:		24737	
OR			
<input type="checkbox"/> Practitioner(s) named below:			
Name		Registration Number	
as my/our attorney(s) or agent(s) to prosecute the application identified above, and to transact all business in the United States Patent and Trademark Office connected therewith.			
Correspondence Address: Direct all communications about the application to:			
<input checked="" type="checkbox"/> The address associated with Customer Number:		24737	
OR			
<input type="checkbox"/> Firm or Individual Name			
Address			
City		State	Zip
Country			
Telephone		Email	
<b>WARNING:</b>			
Petitioner/applicant is cautioned to avoid submitting personal information in documents filed in a patent application that may contribute to identity theft. Personal information such as social security numbers, bank account numbers, or credit card numbers (other than a check or credit card authorization form PTO-2038 submitted for payment purposes) is never required by the USPTO to support a petition or an application. If this type of personal information is included in documents submitted to the USPTO, petitioners/applicants should consider redacting such personal information from the documents before submitting them to the USPTO. Petitioner/applicant is advised that the record of a patent application is available to the public after publication of the application (unless a non-publication request in compliance with 37 CFR 1.213(a) is made in the application) or issuance of a patent. Furthermore, the record from an abandoned application may also be available to the public if the application is referenced in a published application or an issued patent (see 37 CFR 1.14). Checks and credit card authorization forms PTO-2038 submitted for payment purposes are not retained in the application file and therefore are not publicly available.			
I hereby declare that all statements made herein of my own knowledge are true and that all statements made on information and belief are believed to be true; and further that these statements were made with the knowledge that willful false statements and the like so made are punishable by fine or imprisonment, or both, under 18 U.S.C. 1001, and that such willful false statements may jeopardize the validity of the application, any patent issuing thereon, or any patent to which this declaration is directed.			
Signature /Michael E. Marion/		Date July 31, 2013	
Full name of person signing (given name, family name) Michael E. Marion			
Address of Assignee P.O. Box 3001, Briarcliff Manor, NY 10510			

ADDITIONAL STATEMENT OF ERROR UPON WHICH REISSUE IS BASED

The patentee believes the original patent to be wholly or partly inoperative or invalid by reason of the patentee claiming more than the patentee had the right to claim in the patent. Specifically, the error in the patent is caused by the omission of a narrower claim from the patent that renders the patent partly inoperative by failing to protect the disclosed invention to the full extent allowed by law.

The Patentee respectfully asserts that the error is corrected by an amendment that adds at least one dependent claim, for example claim 8, which protects the disclosed invention in accordance with the specification of the Patent, thus improving on the state of the art. Previously the patentee had neglected, without deceptive intent, to protect this disclosed invention in accordance with the specification of the Patent.

No new matter is added by this amendment in this reissue application. All errors in the patent being corrected in the present reissue application up to the time of filing this oath/declaration, that are not covered by a prior oath/declaration submitted in this application, arose without any deceptive intention on the part of the patentee.

Doc code: IDS  
 Doc description: Information Disclosure Statement (IDS) Filed

PTO/SB/08a (01-10)  
 Approved for use through 07/31/2012. OMB 0651-0031  
 U.S. Patent and Trademark Office; U.S. DEPARTMENT OF COMMERCE  
 Under the Paperwork Reduction Act of 1995, no persons are required to respond to a collection of information unless it contains a valid OMB control number.

<b>INFORMATION DISCLOSURE STATEMENT BY APPLICANT</b> ( Not for submission under 37 CFR 1.99)	Application Number		
	Filing Date		
	First Named Inventor	Matthew J. Bickerton	
	Art Unit		
	Examiner Name		
	Attorney Docket Number	2001P00413US01	

U.S.PATENTS						Remove
Examiner Initial*	Cite No	Patent Number	Kind Code <sup>1</sup>	Issue Date	Name of Patentee or Applicant of cited Document	Pages, Columns, Lines where Relevant Passages or Relevant Figures Appear
	1	5128672		1992-07-07	KAEHLER	
	2	6009444		1999-12-28	CHEN	
	3	6271835	B1	2001-08-07	HOEKSMAN	
	4	3967273		1976-06-29	KNOWLTON	
	5	4737980		1988-04-12	CURTIN ET AL	
	6	4999795		1991-03-12	LAPEYRE	
	7	5124940		1991-06-23	LAPEYRE	
	8	5818437		1998-10-06	GROVER ET AL	



<b>INFORMATION DISCLOSURE STATEMENT BY APPLICANT</b> ( Not for submission under 37 CFR 1.99)	Application Number		
	Filing Date		
	First Named Inventor	Matthew J. Bickerton	
	Art Unit		
	Examiner Name		
	Attorney Docket Number	2001P00413US01	

	9	5952952		1999-09-14	CHOI ET AL	
	10	6016538		2000-01-18	GUTTAG ET AL	
	11	6169538	B1	2001-01-02	NOWLAN ET AL	
	12	6359572	B1	2002-03-19	VALE	
	13	6473006	B1	2002-10-29	YU ET AL	

If you wish to add additional U.S. Patent citation information please click the Add button. Add

U.S. PATENT APPLICATION PUBLICATIONS							Remove
Examiner Initial*	Cite No	Publication Number	Kind Code <sup>1</sup>	Publication Date	Name of Patentee or Applicant of cited Document	Pages, Columns, Lines where Relevant Passages or Relevant Figures Appear	
	1						

If you wish to add additional U.S. Published Application citation information please click the Add button. Add

FOREIGN PATENT DOCUMENTS								Remove
Examiner Initial*	Cite No	Foreign Document Number <sup>3</sup>	Country Code <sup>2</sup> j	Kind Code <sup>4</sup>	Publication Date	Name of Patentee or Applicant of cited Document	Pages, Columns, Lines where Relevant Passages or Relevant Figures Appear	T <sup>5</sup>
	1	200214996	WO	A1	2002-02-21	MOELGAARD		<input type="checkbox"/>

**INFORMATION DISCLOSURE  
STATEMENT BY APPLICANT**  
( Not for submission under 37 CFR 1.99)

Application Number		
Filing Date		
First Named Inventor	Matthew J. Bickerton	
Art Unit		
Examiner Name		
Attorney Docket Number	2001P00413US01	

2	07200120	JP	A	1995-08-04	KATSUYASU	<input type="checkbox"/>
3	4127310	JP		1992-04-28	UEDA	<input type="checkbox"/>
4	04999794	JP	B2	2012-08-15	ARAI	<input type="checkbox"/>
5	0889388	EP	A1	1999-07-01	LU	<input type="checkbox"/>

If you wish to add additional Foreign Patent Document citation information please click the Add button **Add**

**NON-PATENT LITERATURE DOCUMENTS**

**Remove**

Examiner Initials*	Cite No	Include name of the author (in CAPITAL LETTERS), title of the article (when appropriate), title of the item (book, magazine, journal, serial, symposium, catalog, etc), date, pages(s), volume-issue number(s), publisher, city and/or country where published.	T <sup>5</sup>
	1		<input type="checkbox"/>

If you wish to add additional non-patent literature document citation information please click the Add button **Add**

**EXAMINER SIGNATURE**

Examiner Signature		Date Considered	
--------------------	--	-----------------	--

\*EXAMINER: Initial if reference considered, whether or not citation is in conformance with MPEP 609. Draw line through a citation if not in conformance and not considered. Include copy of this form with next communication to applicant.

<sup>1</sup> See Kind Codes of USPTO Patent Documents at [www.USPTO.GOV](http://www.USPTO.GOV) or MPEP 901.04. <sup>2</sup> Enter office that issued the document, by the two-letter code (WIPO Standard ST.3). <sup>3</sup> For Japanese patent documents, the indication of the year of the reign of the Emperor must precede the serial number of the patent document. <sup>4</sup> Kind of document by the appropriate symbols as indicated on the document under WIPO Standard ST.16 if possible. <sup>5</sup> Applicant is to place a check mark here if English language translation is attached.

**INFORMATION DISCLOSURE  
STATEMENT BY APPLICANT**  
( Not for submission under 37 CFR 1.99)

Application Number	
Filing Date	
First Named Inventor	Matthew J. Bickerton
Art Unit	
Examiner Name	
Attorney Docket Number	2001P00413US01

**CERTIFICATION STATEMENT**

Please see 37 CFR 1.97 and 1.98 to make the appropriate selection(s):

That each item of information contained in the information disclosure statement was first cited in any communication from a foreign patent office in a counterpart foreign application not more than three months prior to the filing of the information disclosure statement. See 37 CFR 1.97(e)(1).

**OR**

That no item of information contained in the information disclosure statement was cited in a communication from a foreign patent office in a counterpart foreign application, and, to the knowledge of the person signing the certification after making reasonable inquiry, no item of information contained in the information disclosure statement was known to any individual designated in 37 CFR 1.56(c) more than three months prior to the filing of the information disclosure statement. See 37 CFR 1.97(e)(2).

See attached certification statement.

Fee set forth in 37 CFR 1.17 (p) has been submitted herewith.

None

**SIGNATURE**

A signature of the applicant or representative is required in accordance with CFR 1.33, 10.18. Please see CFR 1.4(d) for the form of the signature.

Signature	/Michael E. Belk/	Date (YYYY-MM-DD)	2013-07-25
Name/Print	Michael E. Belk	Registration Number	33,357

This collection of information is required by 37 CFR 1.97 and 1.98. The information is required to obtain or retain a benefit by the public which is to file (and by the USPTO to process) an application. Confidentiality is governed by 35 U.S.C. 122 and 37 CFR 1.14. This collection is estimated to take 1 hour to complete, including gathering, preparing and submitting the completed application form to the USPTO. Time will vary depending upon the individual case. Any comments on the amount of time you require to complete this form and/or suggestions for reducing this burden, should be sent to the Chief Information Officer, U.S. Patent and Trademark Office, U.S. Department of Commerce, P.O. Box 1450, Alexandria, VA 22313-1450. **DO NOT SEND FEES OR COMPLETED FORMS TO THIS ADDRESS. SEND TO: Commissioner for Patents, P.O. Box 1450, Alexandria, VA 22313-1450.**

## Privacy Act Statement

The Privacy Act of 1974 (P.L. 93-579) requires that you be given certain information in connection with your submission of the attached form related to a patent application or patent. Accordingly, pursuant to the requirements of the Act, please be advised that: (1) the general authority for the collection of this information is 35 U.S.C. 2(b)(2); (2) furnishing of the information solicited is voluntary; and (3) the principal purpose for which the information is used by the U.S. Patent and Trademark Office is to process and/or examine your submission related to a patent application or patent. If you do not furnish the requested information, the U.S. Patent and Trademark Office may not be able to process and/or examine your submission, which may result in termination of proceedings or abandonment of the application or expiration of the patent.

The information provided by you in this form will be subject to the following routine uses:

1. The information on this form will be treated confidentially to the extent allowed under the Freedom of Information Act (5 U.S.C. 552) and the Privacy Act (5 U.S.C. 552a). Records from this system of records may be disclosed to the Department of Justice to determine whether the Freedom of Information Act requires disclosure of these records.
2. A record from this system of records may be disclosed, as a routine use, in the course of presenting evidence to a court, magistrate, or administrative tribunal, including disclosures to opposing counsel in the course of settlement negotiations.
3. A record in this system of records may be disclosed, as a routine use, to a Member of Congress submitting a request involving an individual, to whom the record pertains, when the individual has requested assistance from the Member with respect to the subject matter of the record.
4. A record in this system of records may be disclosed, as a routine use, to a contractor of the Agency having need for the information in order to perform a contract. Recipients of information shall be required to comply with the requirements of the Privacy Act of 1974, as amended, pursuant to 5 U.S.C. 552a(m).
5. A record related to an International Application filed under the Patent Cooperation Treaty in this system of records may be disclosed, as a routine use, to the International Bureau of the World Intellectual Property Organization, pursuant to the Patent Cooperation Treaty.
6. A record in this system of records may be disclosed, as a routine use, to another federal agency for purposes of National Security review (35 U.S.C. 181) and for review pursuant to the Atomic Energy Act (42 U.S.C. 218(c)).
7. A record from this system of records may be disclosed, as a routine use, to the Administrator, General Services, or his/her designee, during an inspection of records conducted by GSA as part of that agency's responsibility to recommend improvements in records management practices and programs, under authority of 44 U.S.C. 2904 and 2906. Such disclosure shall be made in accordance with the GSA regulations governing inspection of records for this purpose, and any other relevant (i.e., GSA or Commerce) directive. Such disclosure shall not be used to make determinations about individuals.
8. A record from this system of records may be disclosed, as a routine use, to the public after either publication of the application pursuant to 35 U.S.C. 122(b) or issuance of a patent pursuant to 35 U.S.C. 151. Further, a record may be disclosed, subject to the limitations of 37 CFR 1.14, as a routine use, to the public if the record was filed in an application which became abandoned or in which the proceedings were terminated and which application is referenced by either a published application, an application open to public inspections or an issued patent.
9. A record from this system of records may be disclosed, as a routine use, to a Federal, State, or local law enforcement agency, if the USPTO becomes aware of a violation or potential violation of law or regulation.



(12) **EUROPEAN PATENT APPLICATION**

(43) Date of publication:  
**07.01.1999 Bulletin 1999/01**

(51) Int Cl.<sup>6</sup>: **G06F 3/023**

(21) Application number: **98304675.6**

(22) Date of filing: **12.06.1998**

(84) Designated Contracting States:  
**AT BE CH CY DE DK ES FI FR GB GR IE IT LI LU**  
**MC NL PT SE**  
 Designated Extension States:  
**AL LT LV MK RO SI**

(72) Inventor: **Lu, Qi**  
**San Jose, California 95136 (US)**

(30) Priority: **30.06.1997 US 885565**

(74) Representative: **Litherland, David Peter**  
**IBM United Kingdom Limited**  
**Intellectual Property Department**  
**Hursley Park**  
**Winchester, Hampshire SO21 2JN (GB)**

(71) Applicant: **INTERNATIONAL BUSINESS**  
**MACHINES CORPORATION**  
**Armonk, NY 10504 (US)**

(54) **Data input interface for data processing systems**

(57) A user interface is provided for facilitating text entry to a hand-held computer device such as a Personal Digital Assistant. A subset of characters of a character set or alphabet is initially displayed on a touch sensor display. Respective subsets of the remaining characters of the alphabet are associated with the displayed characters. The user, having a particular character in mind to enter, selects the displayed character associated with the subset containing the displayed character. That subset is then displayed, and the user selects the desired character. Since a relatively few characters are displayed at a time, user visibility is good and character selection by means of a stylus is easy. Preferably the initially displayed characters are evenly distributed through the alphabet. For instance, if the initially displayed A represents the subset including A through F, then the user, desiring to enter E, first selects A and then selects E when the subset A through F is displayed.

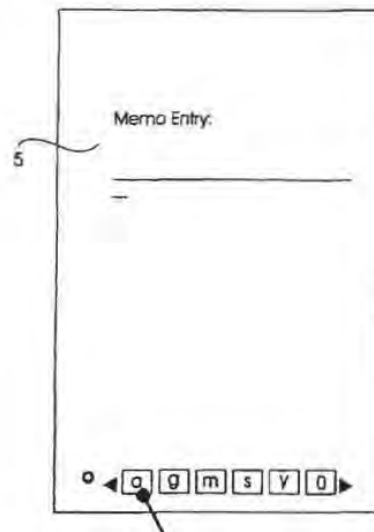

FIG. 3

### Description

The invention generally relates to the field of computer user interfaces. More specifically, the invention relates to interfaces for receiving handwritten data input. The invention has particular applicability to hand-held units such as Personal Digital Assistants.

The present invention addresses the problem of inaccuracy and inefficiency in stylus-based handwriting data input on small hand-held computers and Personal Digital Assistants (PDAs), such as the Apple "Newton" and the US Robotics "Pilot" products.

Since these products are intended to be hand-held and easily portable, they have been designed for small size. As a consequence, display real estate has been small enough that the user interface must take the display size into account.

Due to this limited screen display real estate, the most common form of data input on such products is handwriting. The user writes characters onto an input screen, using a stylus, and the unit employs automatic handwriting recognition.

There are two key, interrelated problems with such stylus-based data input mechanisms. The first is that they are error prone, and the second is that their handwriting recognition algorithms are resource-costly, in terms of memory and CPU cycles. According to usage studies, the error rate of stylus input based on handwriting recognition is often around 10%. As a result, users often have to repeatedly erase and re-try, until the unit correctly recognizes the handwriting. Retrying, causing multiple executions of the recognition algorithm, further increases the total execution time.

Some systems have attempted to improve recognition by requiring the user to learn and use a special format of handwriting. One such special format is the "Graffiti Alphabet" used by the Pilot product. Issues relating to such handwriting recognition are given in Goldberg, D. and Goodisman, A., "Stylus User Interfaces for Manipulating Text," UIST Fourth Annual Symposium on User Interface Software and Technology, Nov, 1991.

The inaccuracy and inefficiency of stylus-based data input has become a critical issue in the wide acceptance of small hand-held computers. While not all of the criticism of the handwriting recognition performance of such products is fully deserved, there is a need for an improved user interface approach, which overcomes the problems of inaccuracy and excessive recognition time. Systems attempting to provide such improved performance must also accommodate the limited input screen real estate.

One possible alternative in the future is to use voice input based on the automatic speech recognition technologies. However, for the present, such systems are likely to suffer the same accuracy problem of automatic handwriting recognition. In addition, speech recognition systems are very expensive in terms of system resources such as special hardware devices, CPU and memory

consumption. Thus, speech recognition technology, in its present form, does not appear to offer the user a better alternative to handwriting recognition.

Another approach is to use an actual, small-sized keyboard. The Microsoft windows CE platform provides an example of such a keyboard. Also, IBM Corporation's PC110 portable computer product has a small form factor user interface, including a reduced-size keyboard.

A more immediate approach is to provide an image of an actual small-sized keyboard on a display of a hand-held computer device. Several possible on-screen keyboard configurations are described in Quill, L.L., and Biers, D.W., "On-Screen Keyboards: Which Arrangements Should Be Used?" Proceedings of the 37th Annual Meeting of the Human Factors and Ergonomics Society, Vol. 2, Seattle, WA, Oct. 1993. Some more unconventional computer display menus, in the form of circular "pies," are given in Hopkins, D., et al., "Pies: Implementation, Evaluation, and Application of Circular Menus."

Although a displayed screen keyboard is an attractive alternative to handwriting systems, different implementations of screen keyboards have had drawbacks relating to the large amount of information content in a displayed keyboard.

Implementations in which a full-sized keyboard is displayed take up a large portion of the display screen just for the keyboard. Very little screen real estate is left for applications. Also, the large-sized display dramatically increases the cost of such computer devices.

Implementations in which a reduced-size keyboard is displayed provide keys which are too small to type using fingers. As a consequence, users must use a stylus, pen or some other hand-held instrument to touch the keyboard keys. This makes such devices very awkward to use.

Accordingly, the problem of how best to provide a user interface for text input on a small hand-held computer device remains to be solved.

It is therefore an object of the invention to provide a user interface, usable with a general purpose display (eg bit-array type) for a small computer device, which facilitates quick and accurate user text input.

It is a further object of the invention to provide a user interface for a small hand-held computer device which displays information on a touch-screen display, the information being large enough to be easily touch-selected by the user.

To achieve these and other objects, there is provided, in accordance with the invention, a computer user interface for facilitating entry of text information by a user to a computer device having a touch screen display. There is further provided a small computer apparatus, such as a portable, hand-held unit, incorporating such a user interface.

The user interface provided by the invention comprises the following components:

First, there is provided means for displaying, on the touch screen display, a first subset of characters from a

character set, each character of the first subset having associated therewith a respective second subset of characters from the character set, each second subset including characters from the character set other than the characters of the first subset. Preferably, the first subset includes characters evenly spaced over the alphabet, such as A, G, M, S, Y, and the numeral 0. Also, the first subset is preferably displayed as large enough symbols to take full advantage of the screen real estate of the computer device. Even with a small, hand-held computer device, the display will be above to display this number of characters, roughly half a dozen, by means of symbols at least comparable in size to typewriter keys.

There is further provided first means for detecting user selection of one of the characters of the first subset. User selection is preferably done by touching the screen, either with fingertips or with a utensil such as a stylus.

There is further provided means, responsive to detection, by the first means for detecting, of user selection of one of the characters of the first subset, for displaying the respective second subset of characters associated with the selected character. In the above example, the respective second subsets include the subset B, C, D, E, and F associated with the index A; the subset H, I, J, K, and L associated with the index G; etc. Thus, again, the number of characters within the second subset associated with the selected character is small enough to allow for good-sized displayed symbols, even on a small computer device with a small display.

There is further provided second means for detecting user selection of one of the characters of the respective second subset. This second means is similar to the above-described first means.

Finally, the invention includes means, responsive to detection, by the second means for detecting, of user selection of one of the characters of the second subset, for treating the selected character of the second subset as input text information.

A user interface in accordance with the invention, or a computer apparatus incorporating such a user interface, is easy for a user to use because of the small number of characters displayed at any one time. This is true despite the small size of the display.

It is a noteworthy feature of this invention that a special layout arrangement of characters, specifically a multi-level layout, is used for the implementation of a screen keyboard. Accordingly, it is only necessary to use a small touch screen display in order to provide easy and efficient data input.

It is understood that a user, to take full advantage of the user interface of the invention, needs to have a comfortable knowledge of which characters of the respective second subset are associated with each of the characters of the first subset. This precondition is met if the indices and subsets are chosen according to some organizing principle, which the user can reasonably be

expected to know. In the case of the Roman or Latin alphabet (used by English and most western languages), the organizing principle is preferably the well-known sequence of the letters of the alphabet. It is preferred that the subsets be characters in contiguous order within the alphabet. Thus, the user will have no trouble finding B within the A subset, because he/she will know that B comes after A but before G.

Accordingly, any Latin letter, digit, or other common keyboard symbol is entered by simply tapping on the screen using the stylus. The accuracy of input is dramatically improved, relative to handwriting recognition systems, because the entered data are chosen from a screen keyboard. Further, because of the improved performance of character selection via a keyboard/menu, users do not have to spend time correcting input errors and learning special input formats.

The efficiency of input is also improved, because each keyboard symbol can be entered with just a few taps. In preferred implementations, the Roman alphabet, numerals, and even a few common punctuation marks may commonly be entered using only two taps. However, within the spirit and scope of the invention, larger symbol sets may be accommodated using more taps.

It is expected that as many as three taps will only rarely be needed. However, it will be understood that the number of characters that can be selected is related to the number of characters per display, raised to the power of the number of taps. Therefore, with a manageably sized number of taps, larger character sets, such as Oriental character sets, may be used.

A preferred embodiment of the invention will now be described, by way of example only, with reference to the accompanying drawings in which:

FIG. 1 is a diagram showing tables of characters organized to show indexes in accordance with a preferred embodiment of the invention;

FIGs. 2, 3, 4, 5, 6, and 7 are illustrations of a display according to the invention, showing a sequence of steps used by a user to input characters as per the indexing scheme of FIG. 1;

FIGs. 8 and 9 show two arrangements of displayed characters on an apparatus according to alternative embodiments of the invention;

FIGs. 10, 11, and 12 are illustrations of a display according to the invention, showing an alternative sequence of steps used by a user to input characters;

FIG. 13 is an illustration of a device which is representative of an alternative class of embodiments of the invention;

FIGs. 14 and 15 are tree graphs illustrating a hierarchical arrangement of character indices and subsets for use with embodiments of the invention such as that of FIG. 13; and

FIG. 16 is an illustration of yet another embodiment of the invention.

The multi-level keyboard layout employed in the present invention can be explained in terms of an example, which is also a preferred embodiment. The normal keyboard symbols, including alphabet, numerics, and standard punctuation marks, are arranged into two tables 2 and 4. The two tables 2 and 4 are shown in FIG. 1. Note, incidentally, that the second table 4 is simply a shift-pressed version of the first table 2. There preferably is a position on the display screen that serves as a toggle shift button for selecting upper case or lower case Latin letters.

On small, hand-held computer devices having small displays, it is infeasible to display the whole table 2 or 4 on the screen, so that each symbol can be selected and entered with just two taps, using a stylus.

However, in accordance with the invention, a trade-off is made between the number of taps needed for entering a symbol and the amount of display real estate. Specifically, the characters within the first (left-most) column of the table are treated as indices into the character set. The index is used to lead to the other symbols of the character set, shown in the rest of the table.

This screen keyboard layout is referred to as a "multi-level" keyboard layout because it essentially divides the entire set of input symbols into two levels. The index characters are referred to as a first, or higher, level subset of the full character set. Each of the index characters corresponds with a second level, or "lower" level, subset of the characters.

There are many possible ways of dividing the character set into the index subset and the different second-level subsets. It is deemed preferable to divide the characters into contiguous subsets, in terms of their order in the alphabet, the first character of each subset being the index character. That is, of course, the approach taken in the tables of FIG. 1. The advantage of this division scheme is that a user, seeking to enter text characters, will be familiar with the order of the alphabet, and will easily be able to tell between which two index characters a desired second-subset character falls.

While two levels are deemed preferable for the character set shown, there is no inherent limitation on the number of levels. For instance, a three-level scheme could be used, in which a second subset, corresponding with a first-level index character, is divided into third-level (i.e., still lower level) subsets and respective second-level index characters.

The initial layout of the screen keyboard only displays the subset of characters which are used as the index of the keyboard, as shown in FIG. 2.

To enter a given desired symbol, the user first selects an index symbol whose corresponding subset (i.e., row of the table of FIG. 1) contains the desired symbol. Selection is done, on a touch-screen display, using a fingertip, stylus, etc.

Responsive to the user's selection of an index character, the subset (i.e., row of the table of FIG. 1) which corresponds with the index character is displayed. It thus may be said that the user's selection of the index character causes the apparatus to display the second-level subset, "overriding" the originally displayed index characters. One of the characters of the second-level subset is (presumably) the user's desired character.

Then, the user selects the intended symbol, again by touching the touch-screen display. The character is then entered into the computer system.

Immediately after the selection is made, the keyboard display will be reset to its initial layout showing only the index symbols.

Note that the display preferably also includes a "back-up" user-selectable control. If the user accidentally touches the wrong index character, he/she may use the back-up control to return to the index character subset. Also, a time-out is preferably provided, so that, if the user fails to select a character from a second-level subset within a specified time, the system automatically returns to the top level index characters. In a preferred embodiment, a tap anywhere on the display outside of the keyboard area will reset the display to the initial state (index characters).

Moreover, where more than two levels of indexing are provided, the system preferably offers a choice of single-level backing up, such as from the third level back to the second level, and a direct return to the top level index characters.

An example of operation of the system according to the invention will now be given, with reference to FIGs. 2, 3, 4, 5, 6, and 7.

Suppose that a user wants to enter the phrase "conference call" into a device according to the invention. The first character to be entered is "c." The initially displayed index characters are as shown in FIG. 2. The user, being a literate person, knows that "c" occurs in the alphabet between the first index character "a" and the second index character "g."

Therefore, from the initially displayed index characters shown in FIG. 2, the user selects "a" (FIG. 3). The selection of "a" causes the device to display the second-level subset shown in FIG. 4, the contiguous characters "a" through "f." The user then touches the position on the display where the letter "c" is displayed. The symbol "c" is correctly entered into a data entry field 5 of the display.

Following entry of the character, the screen keyboard returns to the display of the index characters (FIG. 5). The next desired character, "o," falls between the index characters "m" and "s." The user selects "m," and in response, the device displays the second-level sub-



set associated with the index character "m" (FIG. 6). The user selects "o," and "o" is displayed in the data entry field.

The data entry process proceeds in this fashion, until the entire phrase "conference call," concluding with an "l," is entered and shown in the data entry field (FIG. 7).

While the embodiment described in connection with FIGs. 1 through 7 is preferred, other embodiments, providing other character display information, may also be used in accordance with the invention.

For instance, when an index character is selected, the selected row need not necessarily "override" the original index symbols. Depending on the availability of extra display screen real estate, there can be different ways of arranging the appearance of a selected row.

For example, when an index character is selected, the index characters may remain displayed, and the selected row of second-level subset characters can be displayed in addition to the index symbols. One possible configuration is to display the second-level subset of symbols orthogonally to the index symbols. See, for instance, FIG. 8, while the second-level subset characters of FIG. 9 are shown along one side of the display, they may alternatively be shown as adjacent to their index character, space permitting. See FIG. 9.

Alternatively, the specific layout of the multi-level screen keyboard can be made configurable so that it can be customized to adjust the user's specific needs.

Again, it is a noteworthy feature of the multi-level screen keyboard design, according to the invention, that the index characters and the subsets are chosen and displayed so as to rely on the literate user's ability to recognize the sequence intervals among the 26 Latin letters. Because of the assumption that this knowledge is already possessed by the user, there is no need for user training for understanding and use of an apparatus incorporating this input mechanism.

In preferred embodiments, any pair of Latin letters which are adjacent to each other within the subset of displayed index characters represents a range of Latin letters that falls in between the two, in the familiar ordered sequence of characters. Given any Latin letter that needs to be entered, any user will be able to quickly determine which range it falls into, between which two of the displayed index characters. The user then selects the correct index character, preferably the index character most closely preceding the desired character, to bring out the corresponding second-level subset row containing the desired letter.

In the preferred embodiment of FIG. 1, the last row in the original symbol table is different in length and content from the first five rows. That row contains the ten decimal digits, and other symbols (commonly used punctuation marks).

Because the digits have a natural sequence order among them, i.e., their numerical order, the digits may be dealt with in the same manner as the letters, de-

scribed above.

However, the other symbols do not have a natural sequence which would presumptively be known to the user. (Of course, one possible ordering would be the numerical order of the ASCII codes for the other symbols. However, the great majority of possible users of a device according to the invention would not be familiar enough with the ASCII ordering for this to be useful.) As a consequence, the multi-level layout will not enable most users to quickly select the right index symbol to the get to the right subset containing the desired symbol.

This problem may be solved in a variety of ways.

One possible approach would be to limit the number of punctuation marks offered, so that all offered marks fit on the display together. This approach places an obvious, undesirable limitation on the user's ability to enter text containing a wider variety of marks. To offer an adequately large selection of punctuation marks, another possible approach would be to arbitrarily divide the punctuation marks into subsets, and accept the fact that the user will need to learn, probably by trial and error, which punctuation marks fall within which subsets.

However, in the preferred embodiment of FIG. 1, a different approach, which provides a wide selection of symbols on limited display space, is used. All of the punctuation marks available are bundled into one large row. In this preferred embodiment, the symbols are arranged in the layout similar to the most commonly available commercial keyboards.

In the illustrated embodiment, the punctuation marks and decimal digits are bundled together, and treated as per the following description. Alternatively, the punctuation marks may be in a bundle separate from the decimal digits. This latter separation of the decimal digits from the punctuation marks allows the decimal digits, which have a numerical order, to be treated the same way as the letters of the alphabet were treated (above).

When the index digit 0 is selected from the top-level index set (FIG. 2), the screen keyboard shows the following second-level subset characters:

0	1	2	3	4	5
---	---	---	---	---	---

FIG. 10 is an illustration of a display screen of a hand-held computer device according to the invention, similar to those of FIGs. 2-9, showing these displayed digit symbols.

Referring back to the complete tabulation of characters given in FIG. 1, it will be seen that these symbols are only a portion of the total symbols making up the second-level subset associated with the index symbol "0."

Suppose the user desires to enter the two digits "48". The digit "4" is displayed at this point, and may be selected as described above. FIG. 10 illustrates the selection of the "4" digit and its appearance in the data entry field 5.

Next, the user desires to enter "8." The user knows that "8" is in the subset corresponding with the index "0"

already selected. However, the above display information (FIG. 10) only shows a portion of the numerical sequence that does not include the desired "8."

To allow the user to easily observe the sequence of symbols in this row, and to rapidly reach and select the desired symbol, the preferred user interface/display keyboard design provides two positions on the screen keyboard which serve as sliding buttons for both directions. Referring again to FIG. 10, these slider buttons are preferably displayed on the screen in the form of arrow shapes: "←" and "→", designated by reference numerals 6 and 8 in FIG. 10, to indicate opposite scrolling or sliding directions.

Scrolling may be by the individual character, to give the user a better view of the sequence of symbols. Preferably, a user continuously touches a slider button, and the characters roll by, at a speed chosen so that the user can watch for the desired character, and release the slider button with a reaction time such that the desired symbol is still displayed after the symbol scrolling comes to a stop.

Alternatively, scrolling may be by symbol segments. That is, where six symbols at a time are displayed, and the first through sixth symbols are presently being displayed, then one tap of the right scroll symbol might cause the seventh through twelfth symbols of the row to be displayed.

The latter scrolling arrangement is used in the present, illustrative embodiment. The user taps a sliding button. FIG. 11 illustrates a user tapping the sliding button 6. The subsequently displayed keyboard layout displays the following:

6 7 8 9 - =

These characters are now displayed in FIG. 11.

Reference is now made to FIG. 12. Then, as before, the user taps the position where the digit 8 is displayed, to enter the digit "8" into the date entry field 5.

It will be seen that this preferred embodiment may require more than two taps to enter a digit or a symbol. While this is admittedly a drawback, the drawback may be mitigated by arranging the punctuation marks in a sequence such that the symbols expected to be least frequently used are near the end of the last row. Thus, only in the relatively uncommon cases will the greater number of sliding taps be required.

Since most users will be primarily entering alphanumeric data, this layout will allow the user to enter most of the desired data with only two taps per symbol.

Persons skilled in the art will understand that the ideas of this invention can be applied more generally, in settings other than those discussed above. A few additional aspects of the invention, providing for such more general applications, will now be discussed.

#### SOFTKEY USER INPUT

First, this invention can be used for other than touch- or stylus-based input. It can be also used with

other input mechanisms. For example, an apparatus according to the invention may include a set of physical buttons, which serve as "softkeys" or function keys, comparable to the F1, F2, etc., keys on IBM-compatible computer keyboards. One such button corresponds with each of the entries displayed in the screen keyboard. The user then presses the appropriate button to make a selection.

This "softkey" approach will work well on even smaller devices, such as a hand-held PDA or a pager. For instance, referring to FIG. 13, a pager may be implemented with three buttons 10, 12, and 14.

#### CHARACTER SELECTION ON A HAND-HELD DEVICE BY MEANS OF THREE USER "SOFTKEY" BUTTONS

The following example illustrates how to use a three-entry screen keyboard, or a three-button pager such as that of FIG. 13, to enter any desired one of 26 Latin letters by means of three selections for each letter. Another example, which follows, shows how the invention may be practiced on a pager having only two buttons.

In general, the character set is partitioned, at a succession of levels, into a number of subsets equal to the number of available buttons. At each level, index characters, preferably the first character within each subset, are displayed. The user, again taking advantage of his/her knowledge of the organizing principle or order of the character set, selects character subsets by touching the button corresponding with the appropriate index character, within whose subset the desired character is to be found.

The hierarchy of indices and subsets may conveniently be illustrated in terms of a tree graph, as shown in FIG. 14. Successive branches of the tree, at successively lower levels, illustrate the increasingly smaller subsets of the character set. Also, each subset at each level may conveniently be represented by the set of index characters for that level and that subset. Taken in addition to the discussion given above, such tree graphs will illustrate the succession of index character choices provided to the user.

The user begins at a root node 16 of the tree (the top of the illustrated tree graph), and proceeds, one level at a time, through branch nodes at intermediate levels, to one of the leaf nodes (the bottom of the tree graph), where he/she selects the desired character. That character is then entered at the data entry field of the display, as described above.

At each node of the tree, the user is presented with a number of displayed characters equal to the number of buttons on the hand-held device. The user selects the appropriate index character by pressing the appropriate button. For the sake of the present discussion of the illustrated tree graphs, we will say that the user can press left, middle, and right buttons, corresponding with left-

middle-, and right-displayed index characters. The illustrated tree graphs show, at each node, ordered sets showing the index characters in left, middle, and right positions.

Referring to FIG. 14, the root node 16 (a, j, s) represents a division of the 26-character alphabet into three subsets of 9, 9, and 8 characters, respectively. The subsets are a-i, j-r, and s-z. The index characters, chosen as the first characters of each of the subsets, are a, j, and s.

Second level division, into second-level subsets, is shown in a middle level 18 of the tree graph. For instance, the nine-character subset j-r (shown as a node 20) is divided into three 3-character second-level subsets j-l, m-o, and p-r. The index characters for this second-level subset are j, m, and p.

Finally, at a third (lowest) level 22, the subsets include, at most, only three characters. Therefore, at the third level, the characters may be uniquely specified. This shows that three button presses on a three-button computer device are sufficient to select a character from the 26-character Latin alphabet.

Thus, for instance, if a user desired to enter a "p" character, he/she would do so by pressing (i) the middle button to select the subset j-r, (ii) the right button to select the second-level subset p-r, and finally (iii) the left button to select the "p" character.

#### CHARACTER SELECTION ON A HAND-HELD DEVICE BY MEANS OF TWO USER "SOFTKEY" BUTTONS

Let us next consider text selection on a computer device similar to that of FIG. 13, but instead having only two buttons. The tree graph for a suitable hierarchy of indices and subsets is given in FIG. 15. The root node (a, n) represents a division of the 26-character alphabet into two subsets of 13 characters each. The subsets are a-m and n-z. The index characters, chosen as the first characters of each of the subsets, are a and n.

Second level division, into second-level subsets, is shown in the middle level of the tree graph. For instance, the 13-character subset a-n is divided into two second-level subsets a-g and h-n. The index characters for this second-level subset are a and h.

Successive third and fourth levels of subsets are obtained similarly, as shown.

Finally, at the fifth (lowest) level, the subsets include, at most, only two characters. Therefore, at the fifth level, the characters may be uniquely specified. This shows that five button presses on a two-button computer device are sufficient to select a character from the 26-character Latin alphabet.

Thus, for instance, if a user desired to enter a "p" character, he/she would do so by pressing (i) the right button to select the subset n-z, (ii) the left button to select the second-level subset n-t, (iii) the left button to select the third-level subset n-q, (iv) the right button to

select the fourth-level subset p-q, and finally (v) the left button to select the "p" character.

#### A HAND-HELD DEVICE HAVING ONE SELECT BUTTON AND TWO SLIDER BUTTONS

Still another embodiment of the invention is shown in FIG. 16. The illustrated device has three buttons which are configured as a single select button 24 and two slider buttons 26 and 28. The device is shown as displaying a set of six top-level index characters, as done in the earlier-described embodiments.

The device does not necessarily have a touch-screen display, so user input is made only through the buttons 24, 26, and 28. Note that, unlike the device of FIG. 13, this device displays more selectable symbols at a time than there are buttons. Therefore, the user cannot merely press the third button to select the third index symbol, as was done in connection with the description of FIGs. 13, 14, and 15.

In accordance with the invention, however, the shifting function, controllable by the slider buttons 26 and 28, are on a single symbol basis. The display highlights or otherwise indicates a single, currently selectable index symbol. In this case, the highlighting is indicated by displaying the index symbol "m" in boldface. Other techniques, such as color changing, enclosing the selectable symbol in a box, etc., may alternatively be used.

In operation, the user presses the slider buttons, as appropriate to cause the desired index character to be the currently selectable character, and then selects that character by pressing the select button 24. Then, lower level index subsets, or character subsets, are displayed.

Alternative embodiments, based on the principles just given, are also within the scope of the invention. For instance, a single scroll button may be provided, for scrolling the symbols in a single direction, circularly, so that after the last symbols are displayed, the first symbols are redisplayed. In such embodiments, the direction of scrolling may be left to the discretion of the designer.

Also, there may be more than one select button. For instance, if a device had five buttons, including two scroll buttons and three select buttons, then three symbols would be selectable at a time. The user uses the scroll buttons, as per FIG. 16, to shift the symbol subset until three contiguous symbols, including the desired symbol, were highlighted as being currently selectable. Then, the user presses whichever of the select buttons corresponds with the highlighted position of the desired symbol, as per FIG. 13.

#### ALTERNATIVE SYMBOL SETS

Second, this invention can be applied to symbol sets other than the 26 Latin letters and the 10 digits. In fact, by using a greater number of levels, say, three or four, it is possible to accommodate a much larger char-

acter set.

The basic idea of the present invention may be applied to any symbol set, as long as the symbol set has a user-ascertainable order, or, more broadly, organizing principle, among its symbols. For example, the 50 symbols in the Japanese language can also be entered on a small computing device using a multi-level screen keyboard. An organizing principle can be used for the (huge) Chinese character set based on the organizing principle used by some Chinese-English dictionaries. Such dictionaries classify characters broadly based on the number of calligraphic strokes required to write the character, or on the occurrence of certain basic forms, or "radicals," within more complex characters.

Such large character sets may be implemented in a device according to the invention, by a suitable mix of levels of indexing and/or the above-described scrolling for relatively large subsets. Note, again, that as the number of levels increases, the number of characters that can be accommodated increases by the number of symbols per display raised to the power of the number of index levels. Thus, a huge character set can be accommodated by a relatively modest number of touch selections per character.

#### ANALYSIS OF NUMBER OF REQUIRED USER TOUCH ENTRIES FOR A GIVEN SIZE CHARACTER SET

Suppose that the ordered symbol set is designated S, and that the expression size(S) denotes the number of symbols in S. Suppose further that N is the number of entries to be displayed at one time in the screen keyboard.

Then, the invention can be used for any size character set S and for any number N of displayed entries. Further, it is easily shown that the invention allows any symbol to be entered with M user selections, where M is the smallest integer such that  $N^M$  is larger than size(S). In other words, M is the log of size(S) on the base of N.

Thus, this invention provides a systematic way of doing design trade-offs between screen real estate and keystroke entry efficiency for small computer devices.

#### SELECTION OF INDICES WITHIN AN ORDERED CHARACTER SET

The specific process of creating the indices at different levels, in a preferred embodiment of the invention, will now be described. The description will include a rigorous presentation of the preferred embodiment, given in mathematical terms.

Consider a symbol set S, whose symbols are ordered, in a manner generally known to users of an apparatus according to the invention. A given symbol, the i-th symbol in the ordering scheme, will be expressed, in terms of its position in the ordering scheme, as S[i].

This, the index value i ranges in value from 0 to size(S) - 1.

The basic idea is to divide the symbols S[1], S[2], ..., S[size(S)] into N segments (preferably of substantially equal length), to pick one symbol of each segment, and to present the set of N picked symbols, in order, as the first (or top) level index.

The symbols picked from the segments are preferably the first symbols of each segment. Thus, the index symbols are distributed evenly through the symbol set's ordering.

If the symbol S[j] is selected as an index symbol, that symbol is also denoted as N[j]. Here, j is an index value for the index symbols of the first level index set.

The index value j ranges in value from 0 to N - 1.

The N symbols in the first level index are selected as follows:

Let us define

$$K = \lceil \frac{\text{size}(S)}{N} \rceil \quad (1)$$

If the total number size(S) of symbols happens to be a multiple of the number N of segments or subsets, then K is simply the number of symbols per segment, assuming equal division of the symbol set, and K will have an integral value.

If the total number size(S) of symbols is not a multiple of the number N of segments or subsets, then K will not have an integral value.

In equation (1), the brackets are "ceiling" symbols, and they mean that K's value is the smallest integer greater than or equal to the value of the expression within the "ceiling" symbols.

Given this definition of the variable K, the index symbols N[j] are selected from the total set of symbols S[i] as follows:

$$N[j] = S[(j+1)K+1] \quad (2)$$

for (j = 0, 1, ..., N - 1). There will then be N second level indices.

The second level indices can be built by applying the same process. The first one of the second-level indices can be built as follows: First, equally divide the first-level subset corresponding with the first index, i.e., the subset including the symbols S[1], S[2], ..., S[K], into N segments. These N segments will make up the second-level subsets. Then, the first symbol in each of the second-level segments is taken as the second-level index character.

Other indices of the second level, and indices and subsets for deeper levels, can be built by the same process.

A software implementation of the invention, as described above, has been designed for a US Robotics Pilot platform. It is believed that comparable implemen-

tations can be realized in any of the other commercial hand-held computers currently supporting stylus-based data input.

This invention has the following key advantages over existing and possible future alternatives:

First, the invention offers a completely accurate way of data entry, using a stylus on a touch screen of a hand-held computer device. As soon as the user makes a choice by tapping a specific position on the screen keyboard, the chosen symbol is correctly entered into the system. Accuracy is guaranteed, as long as the user touches the correct symbol position on the touch-screen display. There is no handwriting interpretation error.

Second, the invention does not require that any unconventional additional hardware be included within a hand-held computer device. The invention may be implemented in a hand-held computer device having a conventional touch screen, and employing a conventional stylus.

Third, the invention makes use of the user's knowledge of natural intervals between normal sequencing of the 26 Latin letters. The invention makes no unnecessary cognitive or physical demands on the user, and requires no training or learning.

Fourth, the invention, embodied as per the above description, is efficient, because all alphabet characters and the most commonly used other symbols can be entered with only two taps on the touch screen. It is expected that efficiency improves as the user gains more experience and proficiency with such a hand-held device.

Fifth, the invention may be said to be resource-cost effective, in that a device embodying a user interface according to the invention only requires a very small area of screen real estate. Since conventional handwriting recognition-based input systems require a designated screen area for stylus writing, the invention makes no additional screen space requirement. The invention also eliminates any need for an automatic handwriting recognition system. Such software systems can often be very costly in terms of system memory and CPU processing power.

The invention may be implemented using standard programming and/or engineering techniques using computer programming software, firmware, hardware or any combination or subcombination thereof. Any such resulting program(s), having computer readable program code means, may be embodied or provided within one or more computer readable or usable media such as fixed (hard) drives, disk, diskettes, optical disks, magnetic tape, semiconductor memories such as read-only memory (ROM), etc., or any transmitting/receiving medium such as the Internet or other communication network or link, thereby making a computer program product, i.e., an article of manufacture, according to the invention. The article of manufacture containing the computer programming code may be made and/or used by executing the code directly from one medium, by copy-

ing the code from one medium to another medium, or by transmitting the code over a network.

An apparatus for making, using, or selling the invention may be one or more processing systems including, but not limited to, a central processing unit (CPU), memory, storage devices, communication links, communication devices, servers, I/O devices, or any subcomponents or individual parts of one or more processing systems, including software, firmware, hardware or any combination or subcombination thereof, which embody the invention as set forth in the claims.

User input may be received from the keyboard, mouse, pen, voice, touch screen, or any other means by which a human can input data to a computer, including through other programs such as application programs.

Thus it can be seen that the present invention is new and unique by virtue of a multi-level layout of the screen keyboard. This layout minimizes the screen real estate, while still allowing convenient and speedy data entry at the same time.

One skilled in the art of computer science will easily be able to combine the software created as described with appropriate general purpose or special purpose computer hardware to create a computer system and/or computer subcomponents embodying the invention and to create a computer system and/or computer subcomponents for carrying out the method of the invention, while the preferred embodiment of the present invention has been illustrated in detail. It should be apparent that modifications and adaptations to that embodiment may occur to one skilled in the art without departing from the scope of the present invention as set forth in the following claims.

#### Claims

1. A computer device comprising:

first means for displaying a set of symbols representative of a character set, each displayed symbol having associated therewith a respective second subset of characters from the character set;

first means for detecting user selection of one of the symbols;

second means, responsive to detection, by the first means for detecting, of user selection of one of the symbols, for displaying the respective second subset of characters associated with the selected character;

second means for detecting user selection of one of the characters of the respective second subset; and

means, responsive to detection, by the second means for detecting, of user selection of one of the characters of the second subset, for treating the selected character of the second subset as input text information.

2. A computer device as claimed in claim 1, wherein:

the computer device includes a touch-screen display, different symbols being displayed on respective regions of the touch-screen display; and

the first and second means for detecting user selection include means for detecting a physical contact of the touch-screen display on a region thereof which is displaying one of the symbols which is desired to be selected.

3. A computer device as claimed in claim 1, wherein:

the computer device includes a display and a set of user input buttons; and

the first and second means for detecting include means for detecting the user pressing one of the user input buttons.

4. A computer device as claimed in claim 3, wherein the character set is organized in a tree made up of nodes arranged in a succession of levels, each respective node (i) covering a respective subset of the characters of the character set, (ii) containing a number of index symbols equal to the number of user input buttons, (iii) being coupled to a number of other nodes at a next lower level of the tree, each of the other nodes covering a respective other subset of the characters of the symbol set, each of the other subsets including a number of characters less than or equal to the number of user input buttons, the other subsets together making up the respective subset.

5. A computer device as claimed in claim 3, wherein:

the user input buttons include a select button and a scroll button;

the first and second means for displaying include means for displaying a symbol in a highlighted form to indicate that the symbol is currently selectable, the currently selectable symbol changing responsive to user manipulation of the scroll button; and

responsive to user manipulation of the select button, the currently selectable symbol is selected.

6. A computer device as claimed in claim 1, wherein the means for displaying a set of index symbols includes means for displaying a first subset of the characters of the character set, each of the characters of the first subset being included within a respective one of the second subsets.

7. A computer device as claimed in claim 6, wherein the first means for displaying a set of symbols includes means for displaying a first subset of characters of the character set, the characters of the subset being selected based on an organizing principle of the characters of the character set.

8. A computer device as claimed in claim 7, wherein:

the organizing principle of the characters of the character set includes a predetermined order thereof;

in the means for displaying a first subset, the displayed subset of characters includes characters separated at substantially uniform intervals throughout the predetermined order of the character set; and

the respective subset of characters associated with a given one of the characters of the first subset includes a subset running consecutively from the given character to a next character of the first subset.

9. A method, for use with a user interface of a computer device, for facilitating entry of text information by a user to the computer device, the method comprising the steps of:

displaying a set of symbols representative of a character set, each displayed symbol having associated therewith a respective second subset of characters from the character set;

a first step of detecting user selection of one of the symbols;

responsive to operation of the first step of detecting, selecting one of the symbols, for displaying the respective second subset of characters associated with the selected character;

a second step of detecting user selection of one of the characters of the respective second subset;

responsive to operation of the second step of detecting, selecting one of the characters of the second subset; and

treating the selected character of the second subset as input text information.

5

10

15

20

25

30

35

40

45

50

55

11

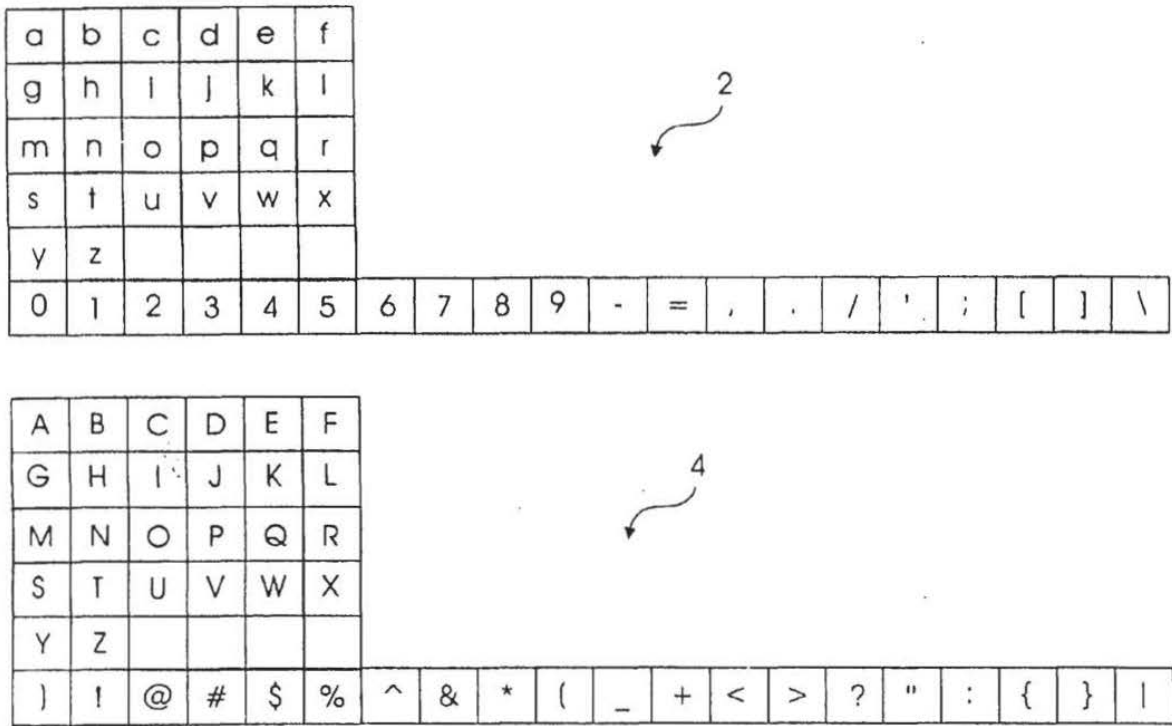

FIG. 1



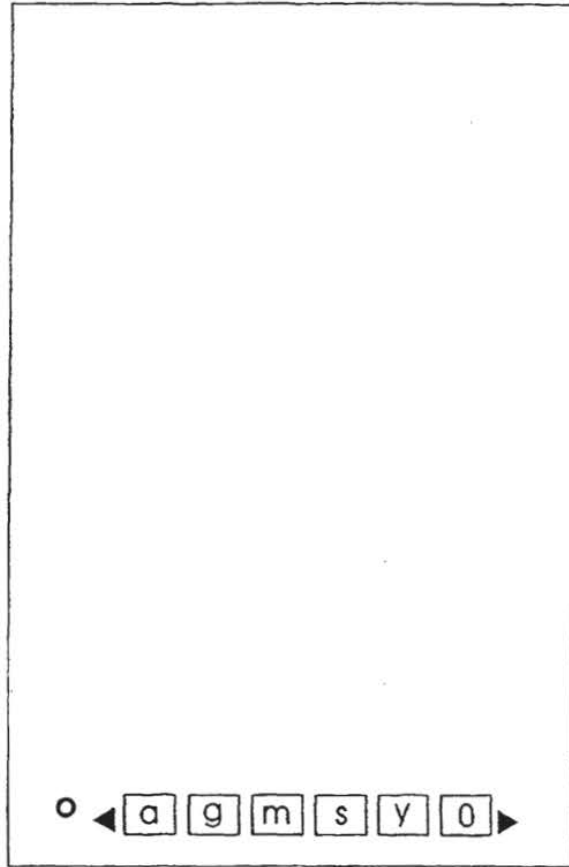

FIG. 2

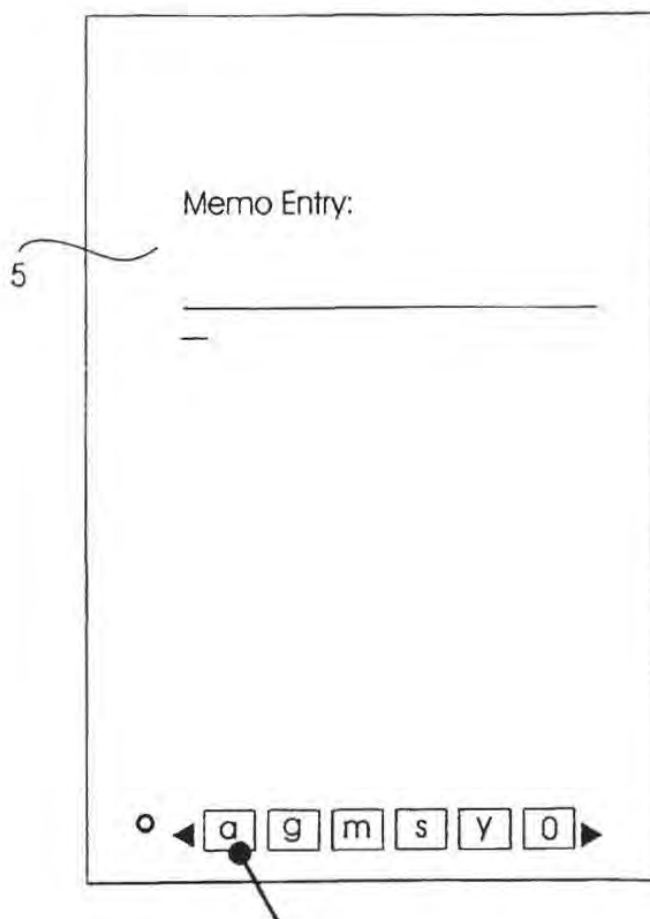

FIG. 3

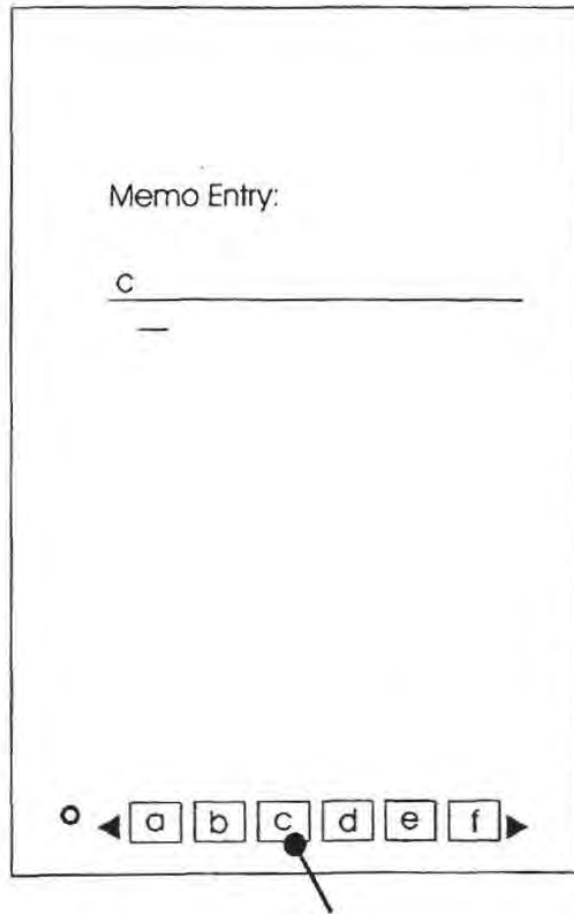

FIG. 4

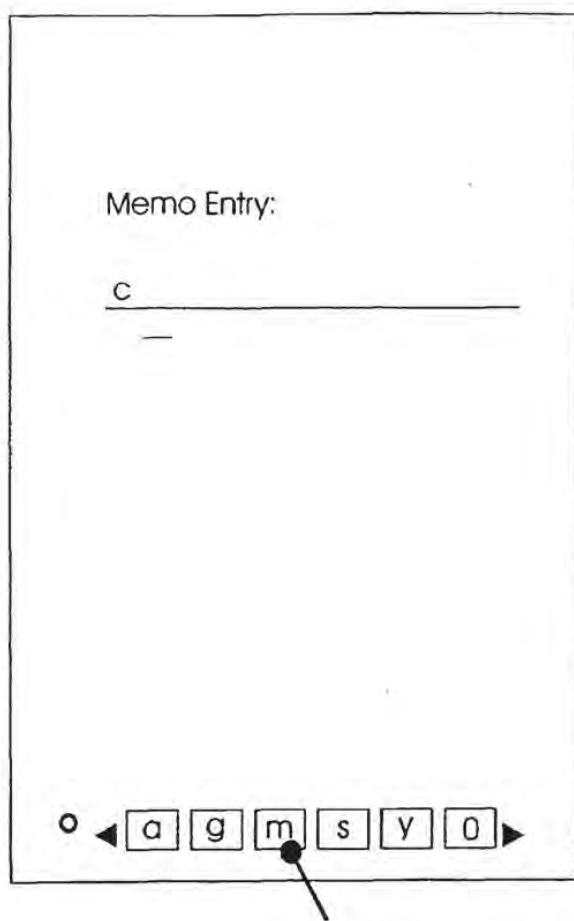

FIG. 5

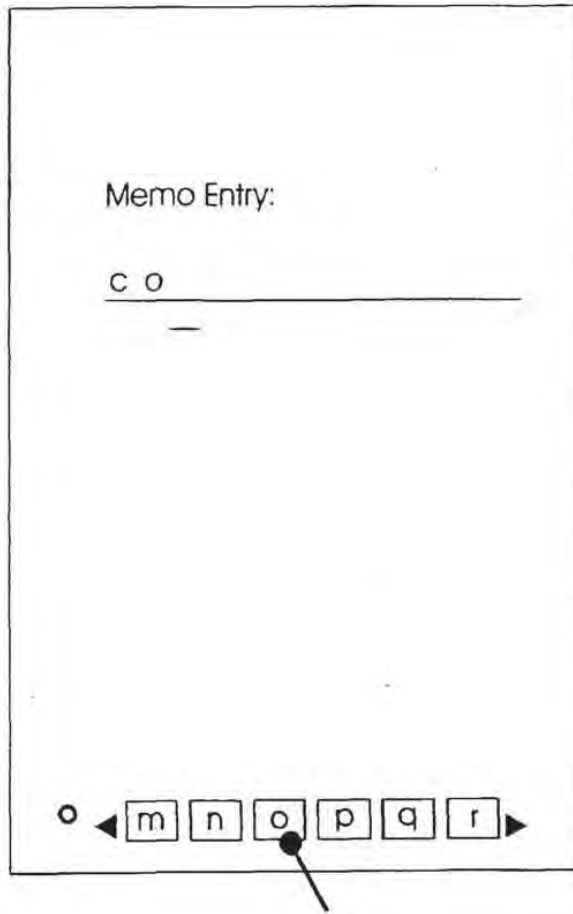

FIG. 6

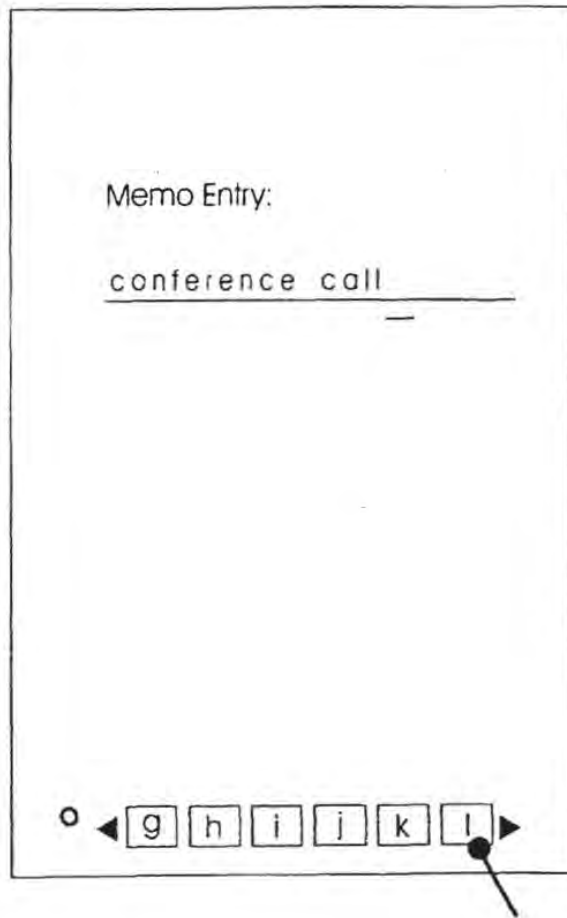

FIG. 7

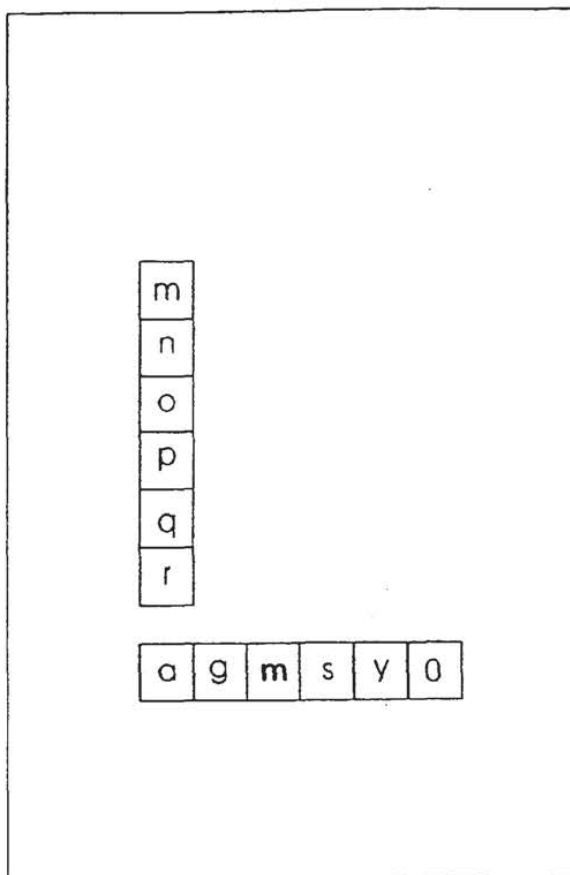

FIG. 8

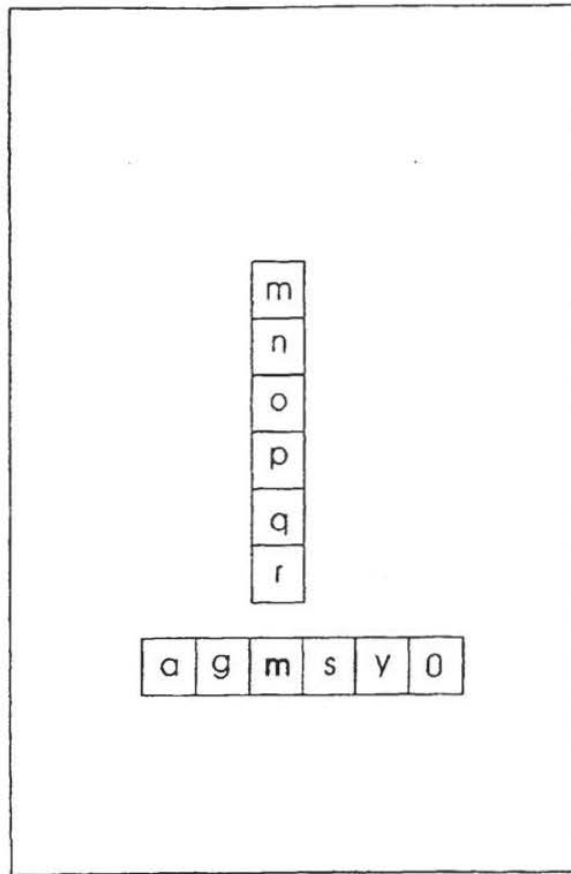

FIG. 9



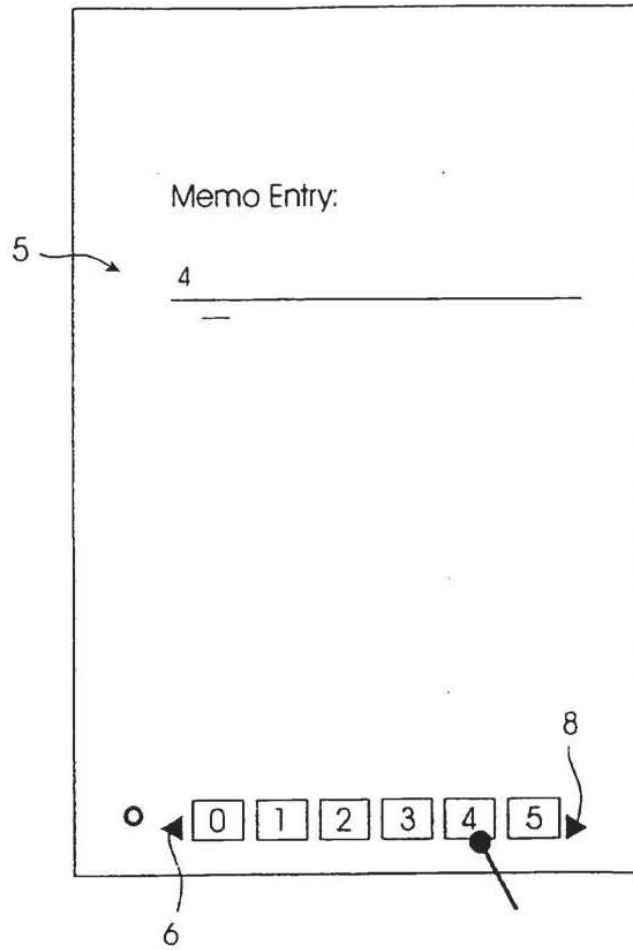

FIG. 10

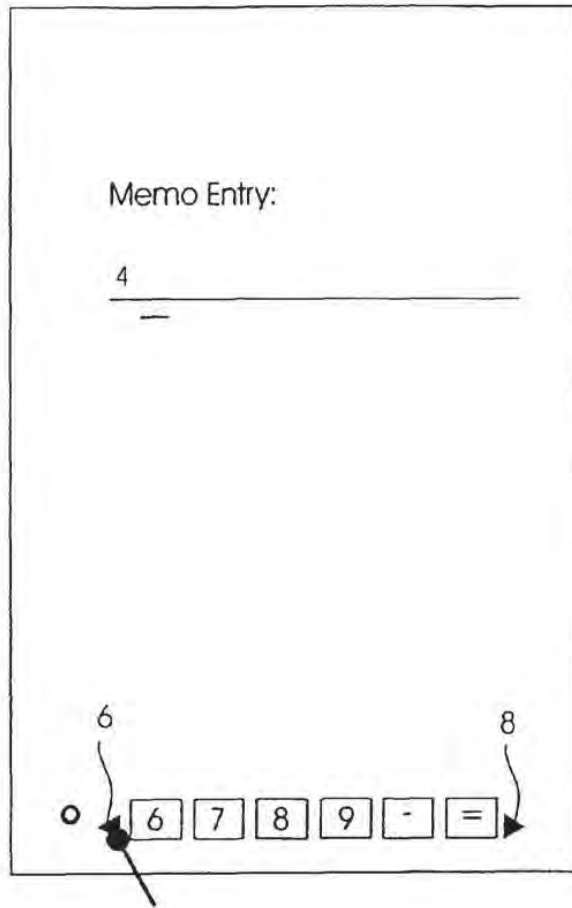

FIG. 11

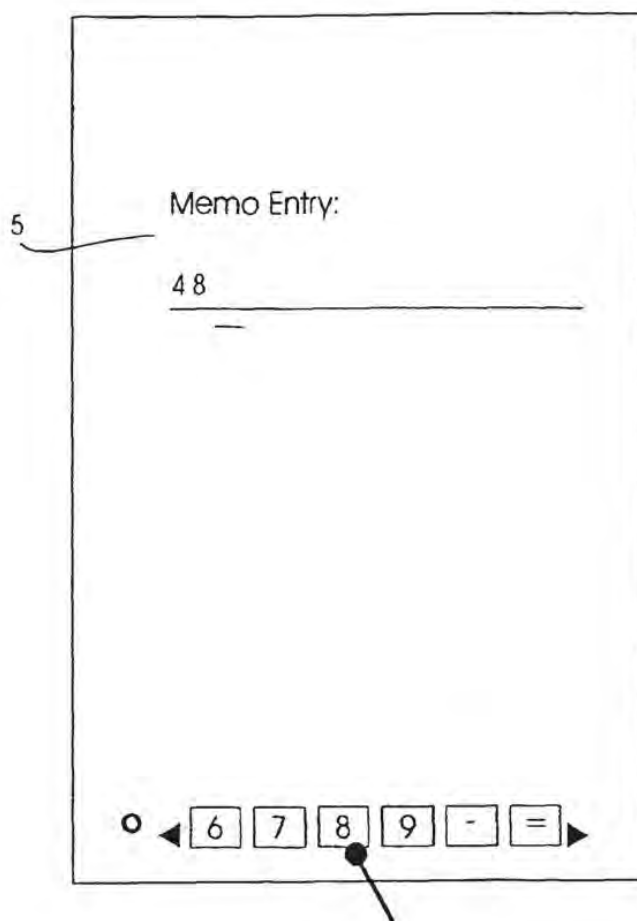

FIG. 12

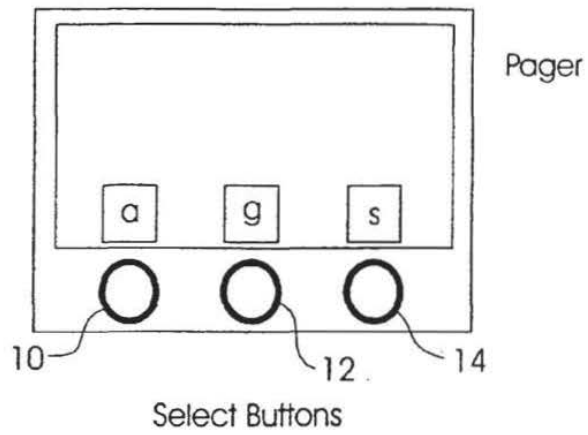

FIG. 13

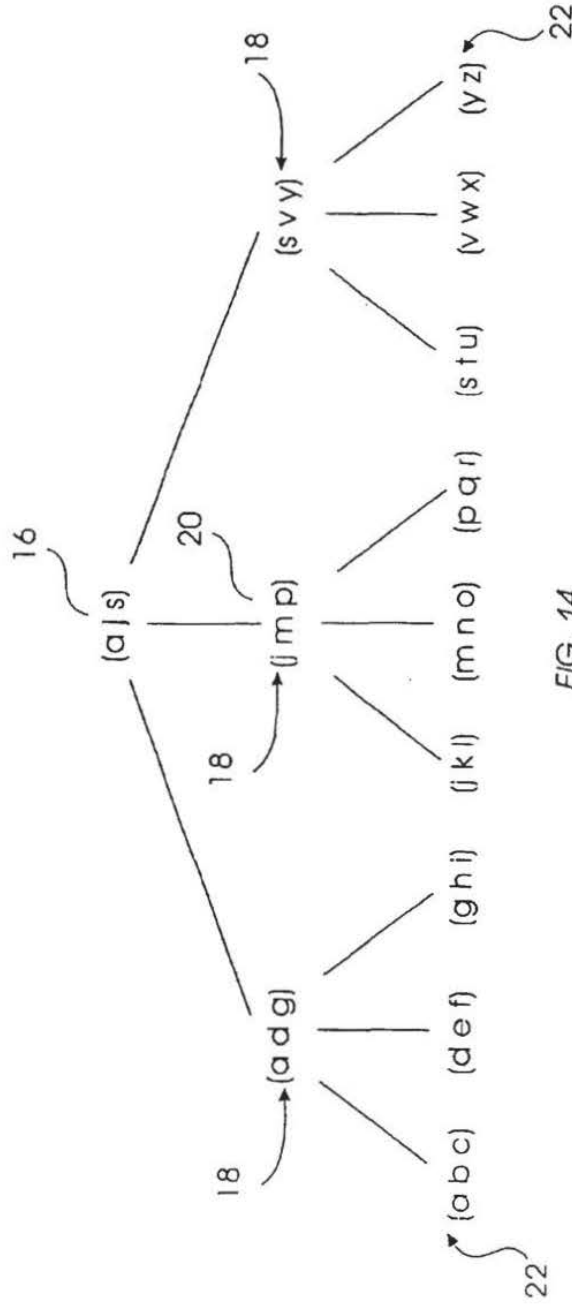

FIG. 14

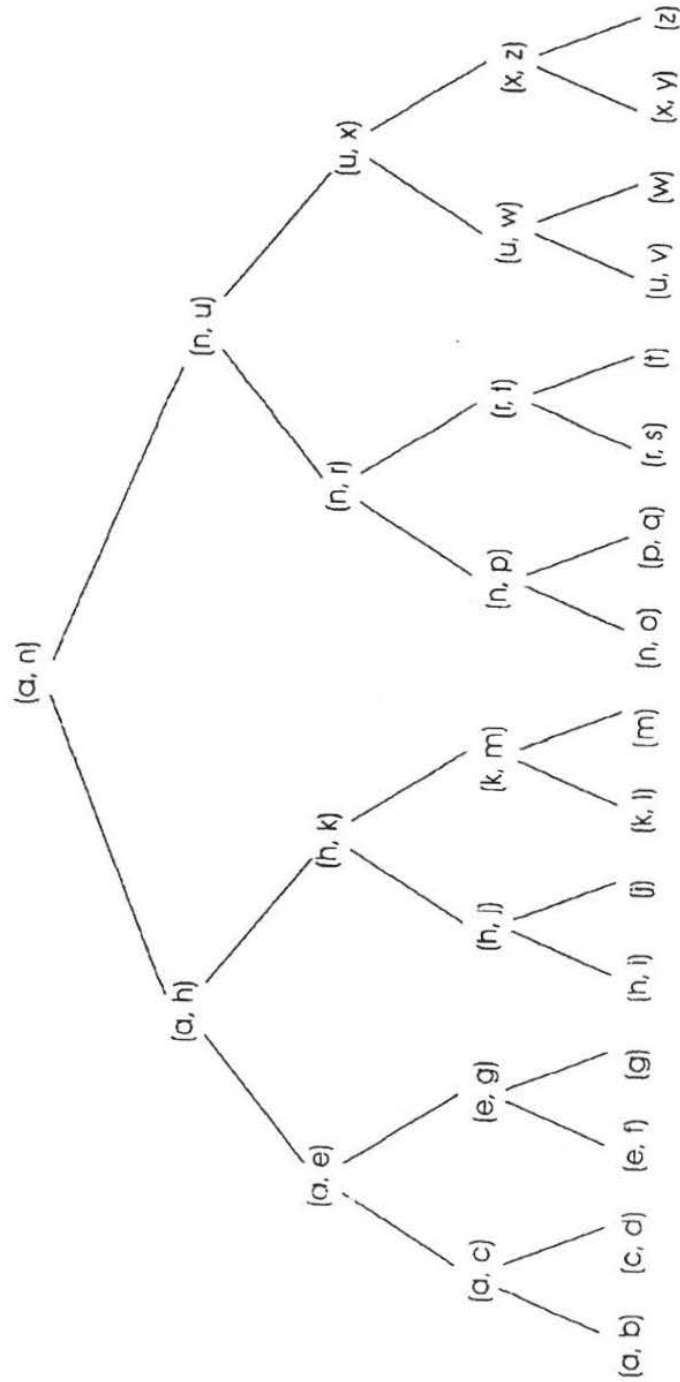

FIG. 15

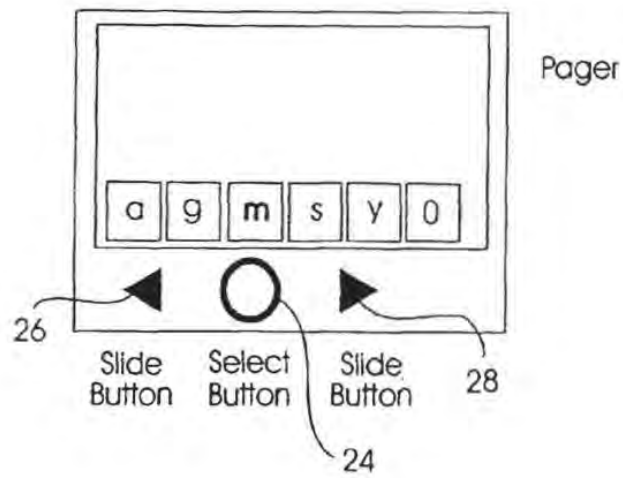

FIG. 16



European Patent Office

EUROPEAN SEARCH REPORT

Application Number  
EP 98 30 4675

DOCUMENTS CONSIDERED TO BE RELEVANT			
Category	Citation of document with indication, where appropriate, of relevant passages	Relevant to claim	CLASSIFICATION OF THE APPLICATION (IPC CL.8)
X	EP 0 313 207 A (HEWLETT PACKARD CO) 26 April 1989 * column 4, line 1 - line 18 * * column 5, line 2 - column 6, line 18 *	1,3,4, 6-9	G06F3/023
Y	---	5	
X	EP 0 733 964 A (XEROX CORP) 25 September 1996 * column 2, line 37 - column 4, line 24 * * column 5, line 58 - column 6, line 35 *	1,2,9	
Y	"CONSISTENT, EASY-TO-USE INTERFACE TO COST-REDUCED PANEL" IBM TECHNICAL DISCLOSURE BULLETIN, vol. 32, no. 108, 1 March 1990, pages 408-411, XP000097934 * page 408 *	5	
A	JOHNSON B ET AL: "CYCLOPS A ONE BUTTON ALPHA-NUMERIC KEYPAD" MOTOROLA TECHNICAL DEVELOPMENTS, vol. 15, 1 May 1992, pages 49-56, XP000306143 * the whole document *	1,5,9	TECHNICAL FIELDS SEARCHED (MCL.8) G06F
The present search report has been drawn up for all claims			
Place of search THE HAGUE		Date of completion of the search 19 October 1998	Examiner Baillas, A
CATEGORY OF CITED DOCUMENTS X : particularly relevant if taken alone Y : particularly relevant if combined with another document of the same category A : technological background O : non-written disclosure P : intermediate document		T : theory or principle underlying the invention E : earlier patent document, but published on, or after the filing date D : document cited in the application L : document cited for other reasons § : member of the same patent family, corresponding document	

EPO FORM 1503 02/92 (F94C01)



(19) [Issuing Country]

Japan Patent Office (JP)

(12) [Type of Publication]

Published Patent Publication (A)

(11) [Publication Number]

Japanese Patent Laid-Open No. H4-127310

(43) [Publication Date]

April 28, 1992

(54) [Title of the Invention]

CHARACTER INPUT METHOD

(51) [International Patent Classification Fifth Edition]

Identification symbol

Japan Patent Office Docket Number

G 06F 3/02 370A 7052-5B

3/023

H 03M 11/04 7052-5B G 06 F 3/023 310 L

[Request for Substantive Examination]

Not Filed

[The Number of Claims]

3

[The Total Number of Pages]

7

(21) [Application Number]

Japanese Patent Application No. H2-249551

(22) [Filing Date]

September 19, 1990

(71) [Applicant]

[Name]

Fujitsu Limited

[Address]

1015, Kamikodanaka, Nakahara-ku, Kawasaki-shi, Kanagawa

(72) [Inventor]

[Name]

Ikuko UEDA

[Address]

c/o Fujitsu Limited,

1015, Kamikodanaka, Nakahara-ku, Kawasaki-shi, Kanagawa,

Kanagawa

(74) [Attorney]

[Patent Attorney]

[Name] Shiro KYOTANI

Specification

1. Title of the Invention

CHARACTER INPUT METHOD

2. Claims

(1) A character input method comprising:

a display;

coordinate value output means for outputting a coordinate value of a point that is pointed when the point on a display screen is pointed with a pen, a finger, or the like; and

a control device,

wherein in an initial state, the control device displays multiple sets of character indications including multiple characters and a frame enclosing the characters on the display screen,

when a set of key indications on the display screen is pointed with the pen, the finger, or the like, the control device looks up an output given by the coordinate value output means to check which set of key indications is pointed,

the control device enlarges each of the multiple characters included in the set of key indications that has been pointed, and encloses each of the enlarged characters with a frame, thus generating multiple unit key indications including a character and a frame enclosing the character, and displaying the unit key indications on the display screen,

when a unit key indication on the display screen is pointed with the pen, the finger, or the like while the multiple unit key indications are displayed on the display screen, the control device looks up an output given by the coordinate value output means to check which unit key indication is pointed, and inputs the character included in the unit key indication that has been pointed.

(2) The character input method according to claim 1, wherein the display is in a flat plate shape, and the coordinate value output means includes an electromagnetic induction-type or electrostatic coupling-type digitizer which is attached to a lower surface of the display.

(3) The character input method according to claim 1, wherein the coordinate value output means includes a transparent touch panel attached to an upper surface of the display.

### 3. Detailed Description of the Invention

#### [Brief Description]

The present invention relates to improvement of character input method, and it is an object of the present invention to provide a character input method which allows a user to reliably input a character with less mistakes in pushing buttons and which provides high degree of operability, and

in an initial state, the control device displays multiple sets of character indications including multiple characters and a frame enclosing the characters on the display screen,

when a set of key indications on the display screen is pointed, the control device checks which set of key indications is pointed,

the control device enlarges each of the multiple characters included in the set of key indications that has been pointed, and displays multiple unit key indications, including a character and a frame enclosing the character, on the display screen,

when a unit key indication on the display screen is pointed

with the pen, the finger, or the like while the multiple unit key indications are displayed on the display screen, the control device inputs the character included in the unit key indication that has been pointed.

[Industrial Applicability]

The present invention relates to a character input method for inputting a character by touching relatively a less number of keys, such as a numeric key pad, multiple times.

In recent years, small personal computers such as electronic organizers are widely prevalent. This kind of personal computer is made small so as to realize portability, and for this reason, this kind of personal computer has much limitation on input keys. Therefore, it is necessary to have a method that can allow accurate input of many characters and symbols using a less number of keys.

[Prior Art]

Fig. 8 is a figure for explaining a conventional character input method using a numeric key pad. This character input method is disclosed in detail in the publication of Japanese Patent Laid-Open No. S58-58634. In the conventional method of Fig. 8, in order to input characters such as Katakana, alphabets, symbols, and the like using a numeric key pad, each of the keys in the numeric key pad is further expressed in a three by three matrix, and a character is input by touching the numeric key pad twice. In the input method, in the first step, a user touches a key corresponding to a number of a key having a character which is to be input. Subsequently, the user touches a number at the

position of the character which is to be input, which is shown in the sections illustrated in Fig. 8(b), within a block which is to be input. More specifically, when the user types "9-5", then a Japanese Katakana "ki" is input into the computer. When the user types "3-7", then an alphabet "G" is input into the computer.

[Problems to be Solved by the Invention]

The above conventional method achieves input of many characters using a less number of keys.

However,

- (1) it is impossible to determine whether any given touch input is a touch in the first step or a touch in the second step and
- (2) in some cases, in the touch for the second step, it may be necessary to touch a key that does not include the character which is to be input.

Because of the above reasons, there is a drawback in that the user does not notice that the user pushes an incorrect button until a character is input by pushing a key for the second step.

The present invention is made in view of the above issue, and it is an object of the present invention to provide a character input method which allows a user to reliably input a character with less mistakes in pushing buttons and which provides high degree of operability.

[Means for Solving the Problems]

Fig. 1 is an explanatory diagram for explaining the principle of the present invention. A character input method according

to the present invention includes:

a display;

coordinate value output means for outputting a coordinate value of a point that is pointed when the point on a display screen is pointed with a pen, a finger, or the like; and

a control device,

wherein in an initial state, the control device displays multiple sets of character indications including multiple characters and a frame enclosing the characters on the display screen,

when a set of key indications on the display screen is pointed with the pen, the finger, or the like, the control device looks up an output given by the coordinate value output means to check which set of key indications is pointed,

the control device enlarges each of the multiple characters included in the set of key indications that has been pointed, and encloses each of the enlarged characters with a frame, thus generating multiple unit key indications including a character and a frame enclosing the character, and displaying the unit key indications on the display screen,

when a unit key indication on the display screen is pointed with the pen, the finger, or the like while the multiple unit key indications are displayed on the display screen, the control device looks up an output given by the coordinate value output means to check which unit key indication is pointed, and inputs the character included in the unit key indication that has been

pointed.

[Actions]

In the initial state, as illustrated in Fig. 1(b), multiple sets of key indications are displayed on the display screen. For example, when a set of key indications at the upper right is pointed with a pen and the like, the display screen is switched to what is shown in Fig. 1(c). In the state as shown in Fig. 1(c), when the unit key indication in the second row of the second column is pointed with a pen and the like, then a Japanese Katakana "ki" is input.

[Embodiment]

Fig. 2 is a figure illustrating an example of configuration of a display input unit. In Fig. 2, numeral 1 denotes a display, numeral 2 denotes a digitizer input pen, and numeral 3 denotes a digitizer.

The display 1 is in a flat plate shape. For example, the display 1 may be a liquid crystal display, a plasma display, or the like. The digitizer 3 is an electromagnetic induction-type or electrostatic coupling-type digitizer, and is fixed to the lower surface of the display 1. The display 1 is connected to a display controller, and the digitizer input pen 2 and the digitizer 3 are connected to the digitizer controller.

Fig. 3 is a figure illustrating an example of configuration of a computer. In Fig. 3, numeral 4 denotes a display controller, numeral 5 denotes a digitizer controller, numeral 6 denotes processing device, numeral 7 denotes a memory. The display



controller 4, the digitizer controller 5, the processing device 6, and the memory 7 are connected to a bus. The display controller 4 transmits data, which are given by the processing device 6, to the display 1 upon converting the data into a form that is suitable for the display 1, and transmits various kinds of control signals to the display 1. The digitizer controller 5 transmits a driving signal and the like to the digitizer, and calculates a coordinate value of a point on the display screen pointed with the digitizer input pen 2 on the basis of a signal that is output from the digitizer 3. The processing device 6 executes a program stored in the memory 7. The memory 7 stores various kinds of programs and data.

Fig. 4 is a figure illustrating overview character input according to the present invention. In the initial state, as illustrated in Fig. 4(a), multiple key top indications are displayed on the display screen. The multiple key top indications include nine characters arranged in a three by three matrix, rectangular frames enclosing the characters, numeral located below the rectangular frames, and diagonal lines located at the right and left of the numerals. For example, in the rectangular frame of the key top indication at the upper right, nine Japanese Katakanas, i.e., "su, ku, u, shi, ki, i, sa, ka, ta", are arranged in a three by three matrix, and a numeral "9" is arranged below the rectangular frame.

When a key top indication "9" (a key top indication at the upper right) is touched with the digitizer input pen 2, the display

screen is switched to what is shown in Fig. 4(b). As shown in Fig. 4(b), each of nine characters included in the rectangular frame of the key top indication of "9" in Fig. 4(a) is enlarged, and the nine enlarged characters are displayed on the display screen in a three by three arrangement, and a rectangular frame is displayed around an enlarged character.

Fig. 4(c) shows a state obtained when a key top indication, "ki", is touched with the digitizer input pen 2 under the state of Fig. 4(b). When key top indication, "ki", is touched with the digitizer input pen 2, "ki" is stored to a predetermined area of the memory 7. The predetermined area means an area that can be accessed by an application program.

Fig. 5 is a functional block diagram illustrating an embodiment of the present invention. In Fig. 5, numeral 11 denotes a display-integrated tablet, numeral 12 denotes an input key determination unit, numeral 13 denotes control unit, numeral 14 denotes a display switching unit, and numeral 15 denotes a key display unit.

The display integrated tablet 11 includes a display 1, a digitizer input pen 2, a digitizer 3, a display controller 4, and a digitizer controller 5, and receives an input of a pen touch and outputs a coordinate value of a position that is touched with the pen. The input key determination unit 12, the control unit 13, the display switching unit 14, and the key display unit 15 exist as functions in the computer made up with the processing device 6 and the memory 7.

The input key determination unit 12 looks up the display table using the coordinate value of the tablet, and determines which key is touched. The display table stores information about coordinate values of the upper left and the lower right of a key and a key number.

The control unit 13 receives an input of a key determined by the input key determination unit 12, and performs appropriate processing. When a character is output, it is displayed on the display as a result. The details of operation of the control unit 13 will be explained later in detail.

When the control unit 13 outputs the first code, the display switching unit 14 outputs a character set that is assigned to a corresponding key based on a two-touch conversion table. The two-touch conversion table is shown in Fig. 7.

The key display unit 15 determines the display position of each of multiple characters constituting the character set by looking up the display table, enlarges each of the characters, displays each of the enlarged characters at the determined display position, and encloses the displayed character with a rectangular frame.

Fig. 6 is a figure illustrating processing flow of the control unit. When the control unit 13 (see Fig. 5) receives a number of a touched key from the input key determination unit 12, the control unit 13 performs the following operation.

(1) The control unit 13 checks whether it is two-touch input mode or not. In a case of Yes, the processing of (2) is performed.

In a case of No, the control unit outputs the code (numeric code) sent from the input key determination unit without any processing of it.

(2) The control unit 13 checks whether it is a mode switching code or not. In a case of Yes, the processing of (4) is performed. The key portion is also provided with a two-touch mode key, a normal mode key, and the like, which are not shown. In a case of No, the processing of (3) is performed.

(3) The control unit 13 checks whether the first code is already input or not. In a case of Yes, the processing of (8) is performed. In a case of No, the processing of (5) is performed.

(4) The control unit 13 sets the normal mode or the two-touch mode in accordance with the type of the mode switching. Thereafter, the control unit 13 sets waits for input.

(5) The control unit 13 sets the first code in the first buffer. Subsequently, the control unit 13 performs the processing of (6).

(6) The control unit 13 turns on the display indicating completion of input of the first code. Subsequently, the control unit 13 performs the processing of (7).

(7) The control unit 13 changes the display of the numeric key pad to redisplay the characters assigned to the first code.

(8) The control unit 13 sets the second code in the second buffer. Subsequently, the control unit 13 performs the processing of (9).

(9) The control unit 13 searches the two-touch conversion table with the contents of the first buffer and the second buffer, reads the corresponding character code, and outputs the corresponding

character code as a conversion output. At the same time, the display of the key is returned back to the original display.

Fig. 7 is a figure illustrating a two-touch conversion table. The first code is a code that is generated with the touch in the first step. The second code is a code that is generated with the touch in the second step. For example, when the first code is nine and the second code is five, then a Japanese character, "ki", is input.

[Advantages of the invention]

As is evident from the above explanation, according to the present invention, the characters assigned to the key touched in the first step are redisplayed, so that the user is more likely to notice mistakes in pushing the button, and the user can reliably input the characters. It should be noted that, instead of the display input unit of Fig. 2, a display input unit integrally made by attaching a transparent touch panel onto a top surface of a display in a flat plate shape may be used.

#### 4. Brief Description of Drawings

Fig. 1 is an explanatory diagram for explaining the principle of the present invention. Fig. 2 is a figure illustrating an example of configuration of a display input unit. Fig. 3 is a figure illustrating an example of configuration of a computer. Fig. 4 illustrates character input according to the present invention. Fig. 5 is a functional block diagram illustrating an embodiment of the present invention. Fig. 6 is a figure illustrating processing flow of the control unit. Fig. 7 is a

figure illustrating a two-touch conversion table.

1... display, 2... digitizer input pen, 3... digitizer, 4...displaycontroller, 5... digitizercontroller, 6...digitizer controller, 7... memory, 11... display-integrated tablet, 12... input key determination unit, 13... control unit, 14... display switching unit, 15... key display unit.

Applicant of Patent: Fujitsu Limited

Patent Attorney: Shiro KYOTANI

#### DRAWINGS

##### FIG. 1

- 1 EXPLANATORY DIAGRAM FOR EXPLAINING THE PRINCIPLE
- 2 CONTROL DEVICE
- 3 DISPLAY
- 4 COORDINATE VALUE OUTPUT MEANS
- 5 SET OF KEY INDICATIONS
- 6 UNIT KEY INDICATIONS

##### FIG. 2

- 1 CONFIGURATION OF DISPLAY INPUT UNIT
- 2 TO DIGITIZER CONTROLLER
- 3 TO DISPLAY CONTROLLER

##### FIG. 3

- 1 CONFIGURATION OF COMPUTER

- 2 TO DISPLAY
- 3 TO DIGITIZER
- 4 DISPLAY CONTROLLER
- 5 DIGITIZER CONTROLLER
- 7 MEMORY
- 8 BUS

FIG. 4

- 1 OVERVIEW OF CHARACTER INPUT ACCORDING TO THE PRESENT INVENTION
- 2 TOUCH "9"
- 3 SWITCH DISPLAY OF KEY TOPS
- 4 TOUCH JAPANESE KATAKANA "KI"

FIG. 5

- 1 FUNCTIONAL BLOCK DIAGRAM OF EMBODIMENT OF THE PRESENT INVENTION
- 2 DISPLAY INFORMATION
- 3 TOUCH WITH PEN
- 4 KEY
- 5 COORDINATE VALUE
- 6 SET OF CHARACTERS
- 7 FIRST CODE
- 8 CHARACTER
- 9 DISPLAY TABLE
- 10 TWO-TOUCH CONVERSION TABLE

- 11 DISPLAY OUTPUT
- 11 DISPLAY-INTEGRATED TABLET
- 12 INPUT KEY DETERMINATION UNIT
- 13 CONTROL UNIT
- 14 DISPLAY SWITCHING UNIT
- 15 KEY DISPLAY UNIT

FIG. 6

- 10 KEY DISPLAY UNIT
- 11 INPUT
- 12 NORMAL OUTPUT
- 13 CONVERSION OUTPUT
- 14 TWO-TOUCH CONVERSION TABLE
- 15 PROCESSING FLOW OF CONTROL UNIT
- (1) TWO-TOUCH INPUT MODE?
- (2) MODE SWITCHING CODE?
- (3) FIRST CODE ALREADY INPUT?
- (4) SWITCH MODE
- (5) SET FIRST CODE IN BUFFER 1
- (6) TURN ON THE DISPLAY INDICATING COMPLETION OF INPUT OF FIRST  
CODE
- (7) SWITCH DISPLAY
- (8) SET SECOND CODE IN BUFFER 2
- (9) NUMERIC KEY PAD TWO-TOUCH CONVERSION UNIT

FIG. 7



- 1 TWO-TOUCH CONVERSION TABLE
- 2 SECOND CODE
- 3 FIRST CODE

FIG. 8

CONVENTIONAL CHARACTER INPUT METHOD USING NUMERIC KEY PAD

Amendment (Formality)

[Applicable]

January 24, 1991

Mr. Satoshi UEMATSU, Commissioner of the Japan Patent Office

1. Indication of case: Japanese Patent Application No.  
H2-249551
2. Title of the Invention: CHARACTER INPUT METHOD
3. Person who makes amendment  
Relationship with the case: applicant of patent  
Address: 1015, Kamikodanaka, Nakahara-ku, Kawasaki-shi,  
Kanagawa  
Name: (522) Fujitsu Limited  
Representative: Tadashi SEKIZAWA
4. Attorney  
Address: Sahara Mansion 3FB  
4-17-1, Nishinippori, Arakawa-ku, Tokyo  
Name: (8089) Shiro KYOTANI, Patent Attorney [Stamp]
5. Date of command of amendment (mailing date): January 22,

1991

6. Target of amendment: Field of brief description of drawings  
in the specification

7. Contents of amendment: as per attached

[Japan Patent Office  
January 25, 1991  
Application Division]

Contents of Amendment

1. The seventh to the eighth lines of the page 15 of the  
specification is amended to read as follows:

"Fig. 7 is a figure illustrating a two-touch conversion  
table. Fig. 8 is a figure for explaining a conventional character  
input method using a numeric key pad."

⑩ 日本国特許庁(J.P.)

⑪ 特許出願公開

⑫ 公開特許公報(A) 平4-127310

⑬ Int.Cl.<sup>9</sup>

識別記号 庁内整理番号

⑭ 公開 平成4年(1992)4月28日

G 06 F 3/02  
3/023  
H 03 M 11/04

370 A 7052-5B

7052-5B G 06 F 3/023 310 L

審査請求 未請求 請求項の数 3 (全7頁)

⑮ 発明の名称 文字入力方式

⑯ 特 願 平2-249551

⑰ 出 願 平2(1990)9月19日

⑱ 発 明 者 植 田 郁 子 神奈川県川崎市中原区上小田中1015番地 富士通株式会社  
内

⑲ 出 願 人 富士通株式会社 神奈川県川崎市中原区上小田中1015番地

⑳ 代 理 人 弁理士 京谷 四郎

明 細 書

1. 発明の名称  
文字入力方式

2. 特許請求の範囲

(1) ディスプレイと、

ディスプレイ画面上の点がペン又は指等でポイントされた時にポイントされた点の座標値を出力する座標値出力手段と、

制御装置と  
を具備し、

制御装置は、

初期状態においては、複数の文字とこれらの文字を取り囲む枠とを持つ集合キー表示の複数値をディスプレイ画面上に表示させ、

ディスプレイ画面上の集合キー表示がペンまたは指等によってポイントされた時には、座標値出力手段の出力を参照して何れの集合キー表示がポイントされたかを調べ、

ポイントされた集合キー表示に含まれる複数の文字のそれぞれを拡大し、拡大された文字のそれぞれを持つ単位キー表示の複数値を生成し、これらの単位キー表示をディスプレイ画面上に表示させ、

複数値の単位キー表示がディスプレイ画面上に表示されている状態の下において、ディスプレイ画面上の単位キー表示がペンまたは指等によってポイントされた時には、座標値出力手段の出力を参照して何れの単位キー表示がポイントされたかを調べ、ポイントされた単位キー表示の中に含まれる文字を入力する

ように構成されている

ことを特徴とする文字入力方式。

(2) ディスプレイが平板状であり、座標値出力手段がディスプレイの下面に取り付けられた電磁誘導型もしくは静電結合型のディジタイザを含むことを特徴とする請求項(1)記載の文字入力方式。

(3) ディスプレイが平板状であり、座標値出力手段がディスプレイの上面に取り付けられた透明タ

タッチパネルを含むことを特徴とする請求項(1)記載の文字入力方式。

### 3. 発明の詳細な説明

#### (概要)

文字入力方式の改良に関し、押し間違いが少なく確実に文字を入力できると共に、操作性の良好な文字入力方式を提供することを目的とし、

初期状態においては、複数の文字とこれらの文字を取り囲む枠とを持つ集合キー表示の複数個をディスプレイ画面上に表示させ、

ディスプレイ画面上の集合キー表示がポイントされた時には、何れの集合キー表示がポイントされたかを調べ、

ポイントされた集合キー表示に含まれる複数の文字のそれぞれを拡大し、拡大された文字とこれを囲む枠とを持つ単位キー表示の複数個をディスプレイ画面上に表示させ、

複数個の単位キー表示がディスプレイ画面上に

それぞれのキーをさらに3×3のマトリックスで表現し、2タッチで1文字を入力する。入力の方法は、第1回目に入力する文字のあるキーの番号に相当するキーをタッチする。次に入力するブロック内で、第8図(4)に示す区分で見た場合のその入力する文字の位置の番号をタッチして入力する。具体的には、「9-5」と打鍵すると「キ」がコンピュータに入力され、「3-7」と打鍵すると「G」がコンピュータに入力される。

#### (発明が解決しようとする課題)

上述の従来方式では、少ないキーで多くの文字を入力することを實現しているが、

- ① 1回目のタッチか2回目のタッチかが判らない。
- ② 2回目のタッチは、入力しようとする文字が含まれていないキーをタッチしなければならない場合がある。

と言う理由から、2回目のキーを押して文字が入力されるまで押し間違いに気付かないと言う欠点がある。

表示されている状態の下において、ディスプレイ画面上の単位キー表示がポイントされた時には、ポイントされた単位キー表示の中に含まれる文字を入力するものである。

#### (産業上の利用分野)

本発明は、テンキーのような比較的少数のキーを複数回タッチして文字を入力する文字入力方式に関する。

近年、電子手帳等の小型のパーソナル・コンピュータが普及している。この種のパーソナル・コンピュータは、携帯性實現のため小型化されており、このため入力キーなどにかかなりの制限がある。そこで、少ないキーで多くの文字や記号を正確に入力できる方式が必要となる。

#### (従来技術)

第8図は従来のテンキーからの文字入力方式を説明する図である。この文字入力方式は、特開昭58-58634号公報に詳しく開示されている。第8図の従来方式では、カナ・英字・記号等の文字をテンキーから入力するためにテンキーのそれ

本発明は、この点に鑑みて制作されたものであって、押し間違いが少なく確実に文字を入力できると共に、操作性の良好な文字入力方式を提供することを目的としている。

#### (課題を解決するための手段)

第1図は本発明の原理説明図である。本発明の文字入力方式は、

ディスプレイと、

ディスプレイ画面上の点がペン又は指等でポイントされた時にポイントされた点の座標値を出力する座標値出力手段と、

制御装置と

を具備し、

制御装置は、

初期状態においては、複数の文字とこれらの文字を取り囲む枠とを持つ集合キー表示の複数個をディスプレイ画面上に表示させ、

ディスプレイ画面上の集合キー表示がペンまたは指等によってポイントされた時には、座標値出力手段の出力を参照して何れの集合キー表示が

### 時間平4-127310 (3)

イントされたかを調べ、

ポイントされた集合キー表示に含まれる複数の文字のそれぞれを拡大し、拡大された文字のそれぞれを枠で囲むことにより、文字とこれを囲む枠とを持つ単位キー表示の複数個を生成し、これらの単位キー表示をディスプレイ画面上に表示させ、複数個の単位キー表示がディスプレイ画面上に表示されている状態の下において、ディスプレイ画面上の単位キー表示がペンまたは指等によってポイントされた時には、座標値出力手段の出力を参照して何れの単位キー表示がポイントされたかを調べ、ポイントされた単位キー表示の中に含まれる文字を入力する

ように構成されている

ことを特徴とするものである。

〔作用〕

初期状態では、第1図(a)に示すように、複数個の集合キー表示がディスプレイ画面に表示されている。例えば、右上の集合キー表示がペン等でポイントされると、ディスプレイ画面は第1図(c)に

・コントローラ4、デジタルイザ・コントローラ5、処理装置6およびメモリ7は、バスに接続されている。ディスプレイ・コントローラ4は、処理装置6から渡されたデータをディスプレイ1に通した形に変換してディスプレイ1に送ると共に、各種の制御信号をディスプレイ1に送る。デジタルイザ・コントローラ5は、デジタルイザに駆動信号等を送ると共に、デジタルイザ3から出力される信号に基づいてデジタルイザ用入力ペン2でポイントされたディスプレイ画面上の点の座標値を計算する。処理装置6は、メモリ7に格納されているプログラムを実行する。メモリ7の中には、各種のプログラムやデータが格納される。

第4図は本発明の文字入力の詳細を説明する図である。初期状態では、第4図(a)に示すように、3×3に配列された9個の文字、これらの文字を囲む四角形枠、四角形枠の下に位置する数字および数字の左右に位置する斜線よりなるキートップ表示の複数個がディスプレイ画面上に表示されている。例えば、右上のキートップ表示の四角形枠

示すように切り替わる。第1図(c)の状態において、2行2列目の単位キー表示がペン等でポイントされると、キと言う文字が入力される。

〔実施例〕

第2図は表示入力部の構成例を示す図である。同図において、1はディスプレイ、2はデジタルイザ用入力ペン、3はデジタルイザをそれぞれ示している。

ディスプレイ1は、平板状のものであり、例えば液晶ディスプレイやプラズマ・ディスプレイ等を使用することが出来る。デジタルイザ3は、電磁誘導型もしくは静電結合型のものであり、ディスプレイ1の下面に固着されている。ディスプレイ1はディスプレイ・コントローラに接続され、デジタルイザ用入力ペン2およびデジタルイザ3はデジタルイザ・コントローラに接続されている。

第3図はコンピュータの構成例を示す図である。同図において、4はディスプレイ・コントローラ、5はデジタルイザ・コントローラ、6は処理装置、7はメモリをそれぞれ示している。ディスプレイ

の中には「スクウシキイサカタ」と言う9個の文字が3×3に配列され、四角形枠の下には9が配置されている。

「9」のキートップ表示(右上のキートップ表示)をデジタルイザ用入力ペン2でタッチすると、ディスプレイ画面は、第4図(b)のように切り替わる。第4図(b)に示すように、第4図(a)の「9」のキートップ表示の四角形枠に含まれる9個の文字のそれぞれが拡大され、拡大された9個の文字が3×3の配置でディスプレイ画面上に表示されると共に拡大された文字の周りに四角形枠が表示される。

第4図(c)は、第4図(b)の状態の下において「キ」のキートップ表示をデジタルイザ用入力ペン2でタッチした状態を示している。「キ」のキートップ表示をデジタルイザ用入力ペン2でタッチすると、「キ」がメモリ7の所定領域に格納される。所定の領域とは、アプリケーション・プログラムによってアクセス可能な領域を意味している。

特開平4-127310 (4)

第5図は本発明の1実施例の機能ブロック図である。同図において、11はディスプレイ一体型タブレット、12は入力キー判定部、13は制御部、14は表示切替部、15はキー表示部をそれぞれ示している。

ディスプレイ一体型タブレット11は、ディスプレイ1、ディジタイザ用入力ペン2、ディジタイザ3、ディスプレイ・コントローラ4、ディジタイザ・コントローラ5で構成されており、ペンタッチを入力として、タッチした座標値を出力する。入力キー判定部12、制御部13、表示切替部14、キー表示部15は、処理装置6およびメモリ7より成る計算機の中に機能として存在するものである。

入力キー判定部12では、タブレットの座標値から表示テーブルを参照してどのキーがタッチされたかを判定する。表示テーブルには、キーの左上及び右下の座標値並びにキーの番号の情報が格納されている。

制御部13では、入力キー判定部12で決定し

たキーを入力とし、通する処理を行う。文字が出力されるとディスプレイに結果として表示される。なお、制御部13の動作の詳細については後述する。

表示切替部14では、制御部13から第1コードが出力されると、2タッチ変換テーブルより該当するキーに割当てられた文字集合を出力する。2タッチ変換テーブルは、第7図に示される。

キー表示部15では、表示テーブルを参照して文字集合を構成する複数個の文字のそれぞれについて表示位置を決定し、文字のそれぞれを拡大し、拡大された文字のそれぞれを決定された表示位置に表示し、表示された文字の周りを四角形枠で囲む。

第6図は制御部の処理フローを示す図である。制御部13(第5図参照)は、入力キー判定部12からタッチしたキーの番号が送られてくると、下記のような動作を行う。

① 2タッチ入力モードか否か調べる。Yesであれば②の処理を行う。Noであれば入力キー

判定部から送られてくるコード(数字コード)をそのまま出力する。

② モード切替コードか否か調べる。Yesであれば④の処理を行う。図示しないが、キー部には、2タッチ・モード・キーや通常モード・キーなども設けられている。Noであれば、③の処理を行う。

③ 第1コードが入力済であるか否か調べる。Yesであれば⑥の処理を行い、Noであれば⑤の処理を行う。

④ モード切替の種類に応じて通常モード又は2タッチ・モードに設定する。その後で入力を持つ。

⑤ 第1コードを第1のバッファにセットし、次に⑥の処理を行う。

⑥ 第1コード入力済の表示をONとする。次に⑦の処理を行う。

⑦ テンキーの表示を第1コードに割当てられた文字に表示直す。

⑧ 第2コードを第2のバッファにセットし、次

に⑨の処理を行う。

⑨ 2タッチ変換テーブルを第1のバッファ及び第2のバッファの内容でサーチし、該当する文字コードを抜き出し、これを変換出力として出力する。同時に、キーの表示をもとに戻す。

第7図は2タッチ変換テーブルを示す図である。第1コードとは第1回目のタッチのときに生成されるコードであり、第2コードとは第2回目のタッチのときに生成されるコードである。例えば、第1コード=9、第2コード=5のときには、「キ」が入力される。

〔発明の効果〕

以上の説明から明らかなように、本発明によれば、1回目にタッチしたキーに割当てられた文字を表示し直すことによって、押し間違いなどに気付きやすくなり、確実に文字を入力することができる。なお、第2図の表示入力部の代わりに、平板状のディスプレイの上面に透明タッチパネルを取り付けて一体化したものをを使用することも出来る。

4. 図面の簡単な説明

第1図は本発明の原理説明図、第2図は表示入力部の構成例を示す図、第3図はコンピュータの構成例を示す図、第4図は本発明による文字入力の様態を示す図、第5図は本発明の1実施例の機能ブロック図、第6図は制御部の処理フローを示す図、第7図は2タッチ変換テーブルを示す図である。

1…ディスプレイ、2…ディジタイザ用入力ペン、3…ディジタイザ、4…ディスプレイ・コントローラ、5…ディジタイザ・コントローラ、6…処理装置、7…メモリ、11…ディスプレイ一体型タブレット、12…入力キー判定部、13…制御部、14…表示切替部、15…キー表示部。

特許出願人 富士通株式会社  
代理人弁理士 京谷 四郎

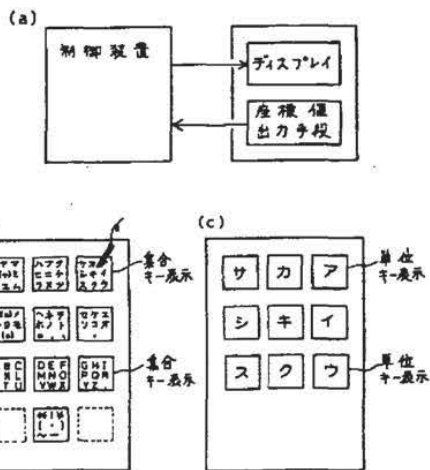

本発明の原理説明図  
第1図

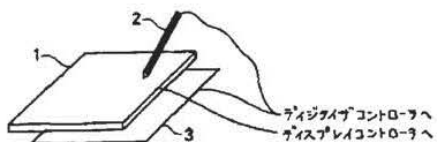

表示入力部の構成  
第2図

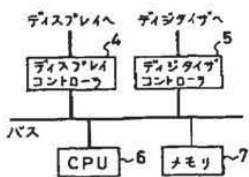

コンピュータの構成  
第3図

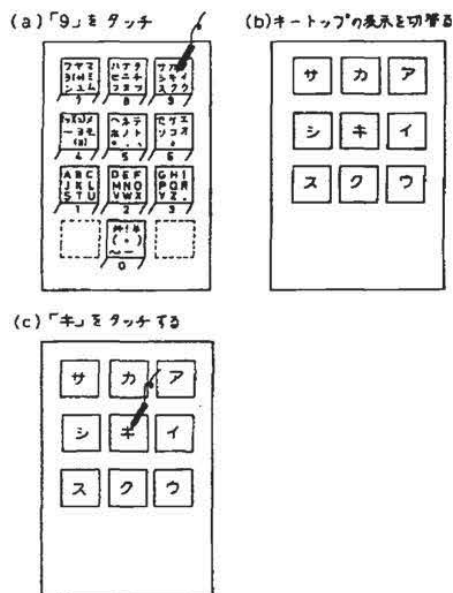

本発明による文字入力の様態 第4図

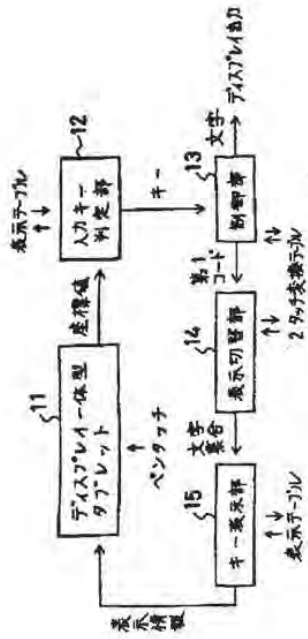

本発明の実施例の機能ブロック図  
第5図

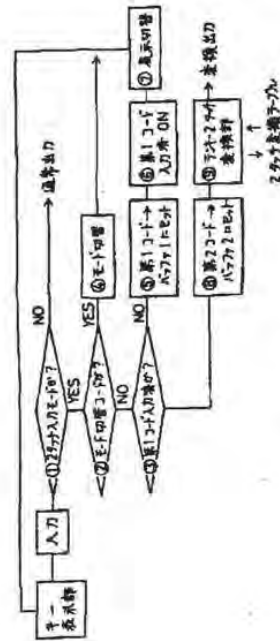

制御部の処理フロー  
第6図

第1 キー	第2 キー	0	1	2	3	4	5	6	7	8	9
0	1	2	3	4	5	6	7	8	9	*	#
1	S	T	U	J	K	L	A	B	C		
2	V	W	X	M	N	O	D	E	F		
3	Y	Z	.	P	Q	R	G	H	I		
4			( )	-	0	1	2	3	4	5	6
5	.	.	.	ホ	ノ	ト	ハ	キ	テ		
6	.	.	.	ソ	コ	セ	ケ	ニ			
7	ン	コ	ム	ヨ	キ	ミ	フ	ヤ	マ		
8	フ	ヌ	ツ	ビ	ニ	チ	ハ	ナ	タ		
9	ス	ク	ウ	シ	キ	イ	サ	カ	ア		

2タッチ変換テーブル  
第7図

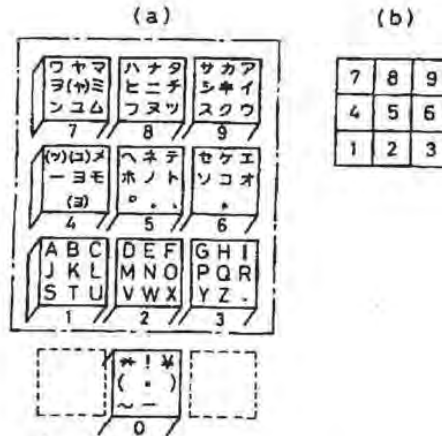

従来のテンキーからの文字入力方式  
第8図



特開平4-127310(7)

手続補正書(方式)



補正の内容

平成03年01月24日

特許庁長官 榎 松 敏 殿

1. 明細書の第15頁第7行~第8行を下記のよ  
うに補正する。

「す図、第7図は2タッチ変換テーブルを示す図、  
第8図は従来のテンキーからの文字入力方式を示  
す図である。

以 上

1. 事件の表示 平成02年特許願第249551号

2. 発明の名称 文字入力方式

3. 補正をする者

事件との関係 特許出願人

住 所 神奈川県川崎市中原区上小田中1015番地

氏 名 (522)富士通株式会社

代表者 関 澤 義

4. 代 理 人

住 所 東京都荒川区西日暮里4丁目17番1号

佐原マンション3FB

氏 名 (8089)弁理士 京 谷 四 郎



5. 補正命令の日付(発送日)平成03年01月22日

6. 補正の対象 明細書の図面の簡単な説明の欄

7. 補正の内容 別紙のとおり

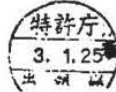

[Print](#) | [Close](#)**Patent Record Full View**

Thursday, July 25 2013

THOMSON INNOVATION

**Patent/Publication: JP04999794B2****Bibliography****DWPI Title**

Method for detecting standing still region of image, involves calculating logical product of foreground regions extracted using background difference and index value difference of input image and background image

**Assignee/Applicant**

Original: NIPPON TELEGRAPH CORP, JP

**DWPI Assignee/Applicant**

NIPPON TELEGRAPH&TELEPHONE CORP (NITE-C)

**DWPI Inventor**

ARAI H; ISO K; JINZENJI K; KOIKE H; KOJIMA A; NAKAZAWA H; SUDO K; YAMASHITA K

**Publication Date (Kind Code)**

2012-08-15 (B2)

**DWPI Accession / Update**

2010-A86150 / 201253

**Application Number / Date**

JP2008176262A / 2008-07-04

**Priority Number / Date / Country**

JP2008176262A / 2008-07-04 / JP

**Abstract****DWPI Abstract**

(JP2010015469A\_)

**Novelty**

A background model having a background image and a threshold image is produced by a background preparation unit (2). A foreground region is extracted based on background difference by comparing input image with background image and a foreground region is calculated based on difference of index values of input image and background image. The foreground region for calculating standing still region is obtained by calculating the logical product of the extracted foreground regions calculated using background difference and index value difference.

**Detailed Description**

INDEPENDENT CLAIMS are included for the following:

1. standing still region detecting apparatus; and
2. recording medium comprising standing still region detecting program.

**Use**

Method for detecting standing still region of image.

**Advantage**

A robust standing-still region is detected based on the conditions with a disturbance factor.

**Drawing Description**

The drawing shows the block diagram of the standing still region detection apparatus. (Drawing includes non-English language text)

- 1 - Input image acquisition process unit.
- 2 - Initial stage background preparation unit.
- 3 - Foreground location extraction unit.
- 4 - Standing still location evaluation unit.
- 5 - Background update process unit.

**Classes/Indexing**

**IPC**

Current IPC	Invention	Version	Additional	Version
Full	G06T 7/20	20060101	-	-
Main Group	-	-	-	-
Subclass	-	-	-	-

Original IPC	Invention	Version	Additional	Version
Advanced/Full	G06T 7/20	20060101	-	-
Core/Main Group	-	-	-	-
Subclass	-	-	-	-

**DWPI Manual Codes**

 Expand DWPI Manual Codes

**Legal Status**

**INPADOC Legal Status**

--	--	--	--	--

Gazette Date	Code	Description
2012-05-28	FPAY +	RENEWAL FEE PAYMENT (PRS DATE IS RENEWAL DATE OF DATABASE) PAYMENT UNTIL: 20150525
2012-05-25	R150 +	CERTIFICATE OF PATENT (=GRANT) OR REGISTRATION OF UTILITY MODEL JAPANESE INTERMEDIATE CODE: R150
2012-05-24	A61 +	FIRST PAYMENT OF ANNUAL FEES (DURING GRANT PROCEDURE) JAPANESE INTERMEDIATE CODE: A61 2012-05-15
2012-05-10	A01 +	WRITTEN DECISION TO GRANT A PATENT OR TO GRANT A REGISTRATION (UTILITY MODEL) JAPANESE INTERMEDIATE CODE: A01
2012-05-09	A01 +	WRITTEN DECISION TO GRANT A PATENT OR TO GRANT A REGISTRATION (UTILITY MODEL) JAPANESE INTERMEDIATE CODE: A01 2012-05-08
2012-04-27	TRDD +	DECISION OF GRANT OR REJECTION WRITTEN
2012-02-14	A521	WRITTEN AMENDMENT JAPANESE INTERMEDIATE CODE: A523 2012-02-13
2011-12-14	A131 -	NOTIFICATION OF REASONS FOR REFUSAL JAPANESE INTERMEDIATE CODE: A131 2011-12-13
2011-12-05	A977	REPORT ON RETRIEVAL JAPANESE INTERMEDIATE CODE: A971007 2011-12-05
2010-07-24	A621 +	WRITTEN REQUEST FOR APPLICATION EXAMINATION JAPANESE INTERMEDIATE CODE: A621 2010-07-23
2010-06-09	RD02	NOTIFICATION OF ACCEPTANCE OF POWER OF ATTORNEY JAPANESE INTERMEDIATE CODE: A7422 2010-06-08

Get Family Legal Status

**Family****Family**
 Collapse INPADOC Family (2)

Publication Number	Publication Date	Inventor	Assignee/Applicant	Title
JP04999794B2	2012-08-15	-	NIPPON TELEGRAPH CORP	-
JP2010015469A	2010-01-21	YAMASHITA KATSUYA	NIPPON TELEGRAPH & TELEPHONE	STILL AREA DETECTION METHOD

 Collapse DWPI Family (2); Countries (1)

Publication	DWPI Update	Publication Date	IPC Code	Language
JP2010015469A	201008	2010-01-21	G06T000720	Japanese
JP04999794B2	201253	2012-08-15	G06T000720	Japanese

**Claims****Claims**

1. It is a standing-still area|region detection method which detects a standing-still area|region from an

Image,

Comprising:

The initial stage background preparation procedure which produces the background model which consists of a background image and the threshold value image whose each pixel value is a standing-still determination threshold value using the image by which the initial stage background preparation means was acquired from the image input device,

The foreground location extraction procedure of a foreground location extraction means comparing the acquired said image with the produced said background model by a background difference calculation, and extracting a foreground region,

The standing-still location evaluation procedure of judging the location where the rest time obtained by a standing-still location evaluation means counting the frequency|count that the extracted said foreground region appeared continuously as a foreground became more than the predetermined standing-still determination threshold value as a standing-still area|region,

The update means of a background uses the acquired said image and the produced said background model sequentially,

The update procedure of a serial|sequential background which produces a background model new about the area|region which was not judged to be a foreground in the said foreground location extraction procedure, and the area|region judged to be a standing-still area|region in the said standing-still location evaluation procedure

It has these,

The said initial stage background preparation procedure,

The procedure which produces the said background image by calculating a weighted-mean image using the several image acquired from the said image input device,

The procedure which produces the said threshold value image by modeling a steady fluctuation by a normal distribution

It has these,

The said foreground location extraction procedure,

The background difference procedure which calculates a foreground by performing difference calculation with the image acquired from the said image input device, and the produced said background image based on the said threshold value image,

The index value calculation difference procedure which calculates a foreground by difference calculation which compares the said both image by calculating the index value based on the image acquired from the said image input device, and the produced said background image,

The foreground determination procedure which calculates a foreground region by calculating the logical product of the foreground calculated in the said background difference procedure, and the foreground calculated in the said index value calculation difference procedure

It has these,

In the said index value calculation difference procedure, the normalization cross correlation and the square of normalization difference are calculated about the area|region of a focused pixel periphery of the image acquired from the said image input device, and the background image produced in the said initial stage background preparation procedure,

According to the weight based on the deviation of the pixel value in the area|region of the said attention area periphery, the weighted sum of the value of the said normalization cross correlation and the value of the said square of normalization difference is calculated as said index value.

The standing-still area|region detection method characterized by these.

 Expand All Claims (6)

## Description

### DWPI Drawing Description

The drawing shows the block diagram of the standing still region detection apparatus. (Drawing includes non-English language text)

1 - Input image acquisition process unit.

2 - Initial stage background preparation unit.

- 3 - Foreground location extraction unit.
- 4 - Standing still location evaluation unit.
- 5 - Background update process unit.

**Drawing Description**

 Expand Drawing Description

**Description**

 Collapse Description

**TECHNICAL FIELD**

This invention relates to the method of detecting an area|region stationary in an image|video, its apparatus, and a program and its recording medium.

**DESCRIPTION OF RELATED ART**

*Image|video monitoring*

WHEREIN:

There exists a function to detect the area|region which rests still in images|videos, such as an object left to stand and a taken-away object.

In order to detect a standing-still area|region from an image|video, generally a background image is produced, a foreground is calculated by comparing a background image with the present image, and the method of evaluating the rest time of a foreground is used.

Becoming a problem here are various disturbances included in an image.

The disturbance which consists a problem in the case of a standing-still area|region detection has AGC:Auto Gain Control, AWB:Auto White Balance of regular noise, such as a shake of the change of lighting environment, such as a sunshine fluctuation|variation, temporary interruption|screening of the moving object by a passerby, and leaves, and a camera, the noise of an image pick-up element, etc., for example.

In order to detect to robust, it is necessary to reduce the said disturbance that compositively|multiply starts efficiently.

Each step which starts the method to remove a disturbance at standing-still area|region detections, such as an adaptive threshold value method in the noise removal process of the high-pass removal filter in an input image, a low-pass removal filter, etc., and the background difference method

WHEREIN:

There exist various methods.

There exists the update method of a background adaptive as a method corresponding to a steady fluctuation or temporary shielding.

For example, although methods of modeling the fluctuation of a background include a nonpatent literature 1 etc., it is difficult to respond|correspond with the sunshine fluctuation|variation which is not steady, and the influence of the shadow of an object only by these methods.

The shadow of sunshine or an object has a thing using a differential as a robust method, and a thing using a correlation.

For example, if a correlation is used, there exist a nonpatent literature 2 etc., but it is difficult for the method of using a correlation and a differential in high frequency noise to exclude the influence of weak noise like a shake of leaves or element noise.

[NONPATENT DOCUMENT 1]

Zoran Zivkovic,Improved Adaptive Gaussian Mixture Model for Background Subtraction,ICPR2004

**[NONPATENT DOCUMENT 2]**

Seiya Ito, Kaneko Shunichi, the high-speed robust image matching by selective normalization correlation, Institute of Electrical Engineers of Japan (The machine vision application technical special number in a real environment), 2004

**[NONPATENT DOCUMENT 3]**

Nara Institute of Science and Technology, OpenCV, programming book production team work, OpenCV, a programming book, 2007

**DISCLOSURE of the INVENTION****PROBLEM to be solved by the Invention**

With the technique of detecting the conventional standing-still area|region as mentioned above, the method only corresponding to one part has various things among the said disturbances, and it is used, However, If it does not respond|correspond to a several disturbance factor simultaneously for using for a real application, a misdetection and the omission in a detection generate|occur|produce, A problem arises in stability.

Even if this invention has a several disturbance simultaneously by using the method of having been made in view of this situation, dividing the process in connection with the detection of a standing-still area|region into a several step, and forcing a disturbance in each, the standing-still area|region detection method which can detect a standing-still area|region stably, and its apparatus, It exists in provision of a program and a recording medium.

**MEANS to solve the Problem**

Then, the standing-still area|region detection method of Claim 1 for solving the said subject is a standing-still area|region detection method which detects a standing-still area|region from an image, Comprising:

The initial stage background preparation procedure which produces the background model which consists of a background image and the threshold value image whose each pixel value is a standing-still determination threshold value using the image by which the initial stage background preparation means was acquired from the image input device,

The foreground location extraction procedure of a foreground location extraction means comparing the acquired said image with the produced said background model by a background difference calculation, and extracting a foreground region,

The standing-still location evaluation procedure of judging the location where the rest time obtained by a standing-still location evaluation means counting the frequency|count that the extracted said foreground region appeared continuously as a foreground became more than the predetermined standing-still determination threshold value as a standing-still area|region,

The update means of a background uses the acquired said image and the produced said background model sequentially,

The update procedure of a serial|sequential background which produces a background model new about the area|region which was not judged to be a foreground in the said foreground location extraction procedure, and the area|region judged to be a standing-still area|region in the said standing-still location evaluation procedure

It has these,

The said initial stage background preparation procedure is a procedure which produces the said background image by calculating a weighted-mean image using the several image acquired from the said image input device,

The procedure which produces the said threshold value image by modeling a steady fluctuation by a normal distribution

It has these,

The said foreground location extraction procedure is a background difference procedure which calculates a foreground by performing difference calculation with the image acquired from the said image input device, and the produced said background image based on the said threshold value image,

The index value calculation difference procedure which calculates a foreground by difference calculation

which compares the said both image by calculating the index value based on the image acquired from the said image input device, and the produced said background image,  
The foreground determination procedure which calculates a foreground region by calculating the logical product of the foreground calculated in the said background difference procedure, and the foreground calculated in the said index value calculation difference procedure  
It has these,

In the said index value calculation difference procedure, the normalization cross correlation and the square of normalization difference are calculated about the area|region of a focused pixel periphery of the image acquired from the said image input device, and the background image produced in the said initial stage background preparation procedure,  
According to the weight based on the deviation of the pixel value in the area|region of the said attention area periphery, the weighted sum of the value of the said normalization cross correlation and the value of the said the square of normalization difference is calculated as said index value.

The standing-still area|region detection method of Claim 2 further has the procedure of detecting the penetration|invasion of the object into the said attention area based on the judged result of the standing-still area|region in the predetermined attention area in the image by which the said standing-still location evaluation procedure is acquired from the said image input device, in the standing-still area|region detection method of Claim 1.

The standing-still area|region detection apparatus of Claim 3 is a standing-still area|region detection apparatus which detects a standing-still area|region from an image,  
Comprising:

An initial stage background preparation means to produce the background model which consists of a background image and the threshold value image whose each pixel value is a standing-still determination threshold value using the image acquired from the image input device,

A foreground location extraction means to compare the image acquired from the said image input device with the produced said background model by a background difference calculation, and to extract a foreground region,

A standing-still location evaluation means to judge the location where the rest time obtained by the extracted said foreground region counting the frequency|count of appearing continuously as a foreground became more than the predetermined standing-still determination threshold value as a standing-still area|region,

The acquired said image and the produced said background model are used,

An update means of a serial|sequential background to produce a background model new about the area|region which was not judged to be a foreground in the said foreground location extraction procedure, and the area|region judged to be a standing-still area|region in the said standing-still location evaluation procedure

It has these,

The said initial stage background preparation means is a means to produce the said background image by calculating a weighted-mean image using the several image acquired from the said image input device,

A means to produce the said threshold value image by modeling a steady fluctuation by a normal distribution

It has these,

The said foreground location extraction means is a background difference means to calculate a foreground by performing difference calculation with the image acquired from the said image input device, and the produced said background image based on the said threshold value image,

An index value calculation difference means to calculate a foreground by difference calculation which compares the said both image by calculating the index value based on the image acquired from the said image input device, and the produced said background image,

The foreground judging means which calculates a foreground region by calculating the logical product of the foreground calculated by the said background difference means, and the foreground calculated by the said index value calculation difference means

It has these,

The said index value calculation difference means calculates the normalization cross correlation and the square of normalization difference about the area|region of a focused pixel periphery of the image acquired from the said image input device, and the background image produced by the said initial stage background preparation means,



According to the weight based on the deviation of the pixel value in the area|region of the said attention area periphery, the weighted sum of the value of the said normalization cross correlation and the value of the said the square of normalization difference is calculated as said index value.

The standing-still area|region detection apparatus of Claim 4 detects the penetration|invasion of the object into the said attention area in the standing-still area|region detection apparatus of Claim 3 based on the judged result of the standing-still area|region in the predetermined attention area in the image by which the said standing-still location evaluation means was acquired from the said image input device.

The program of Claim 5 is a program as which a computer is functioned as each means which comprises the standing-still area|region detection apparatus of Claim 3 or 4.

The recording medium of Claim 6 is a computer-readable recording medium which recorded the program of Claim 5.

#### **ADVANTAGE of the Invention**

According to the above invention, the basis of conditions with a disturbance factor can also detect a standing-still area|region to robust.

#### **Preferred EMBODIMENT of the Invention**

FIG. 1 is the block diagram which showed schematic structure of the standing-still area|region detection apparatus concerning Embodiment.

The standing-still area|region detection apparatus 10 is sequentially provided with the background update part 5 with the input image acquisition process part 1, the initial stage background preparation part 2, the foreground location extraction part 3, and the standing-still location evaluation part 4.

The standing-still area|region detection apparatus 10 is provided with heart ware|wear resources, such as the component of a normal computer, for example, CPU(Central Processor Unit), memory (RAM), a hard-disk drive device, a communication device etc., and the process concerning each said functional blocks 1-5 is performed by cooperation with these hardware resources and the software of installation completed.

And the image acquired by this process can be displayed now in the display (display apparatus) of illustrating omission.

The input image acquisition process part 1 performs the input image acquisition step of S101. Specifically, an image is acquired from image input devices, such as a camera, DVR, and VTR. The input image acquisition part 2 is realizable with the known communication device etc. which were connected with the said image input device.

The initial stage background creation process part 2 performs the initial stage background preparation step of S102.

In S102, a background model is produced using 1 sheet acquired at the input image acquisition step of S101, or a several image.

At this S102, the influence of a steady fluctuation, like the leaves which exist in a background area|region shake by a wind can be modeled by using the method of assuming that the fluctuation of an image makes a normal distribution, and producing a background model.

This method is realizable by the method of the background finite difference method which used the normal distribution of the nonpatent literature 3.

The said background model is comprised from a background image and a threshold value image.

In the threshold value process of an image, the threshold value same in all pixels is usually used.

When using different threshold values for every pixel, this is expressed by the image which records the threshold value corresponding to each pixel.

This image is called the threshold value image.

For example, the threshold value at the time of performing a threshold value process about coordinate (x,y) of the image A is obtained by referring coordinate (x,y) of a threshold value image.

The said background image is calculated by taking a weighted mean of a plurality of image, and a threshold value image is calculated by modeling a steady fluctuation by a normal distribution.

The background image which cannot receive to the influence of a temporary fluctuation easily by this can be produced.

Each pixel value of each threshold value image is calculated|required by calculating the standard deviation of the pixel value for an N frame.

Or you may use the average value of the self-series of the background difference value in each pixel like following Formula.

That is, when the pixel value of T(x,y) and the difference image D is made into D(x,y), pixel value T'(x,y) of new threshold value image T' can already represent the pixel value of a certain threshold value image T with the following formula|equation.

$$T'(x,y)=(1-(\alpha))*T(x,y)+(\alpha)*D(x,y)$$

A background image is calculated|required by weighted mean of an image.

That is, when the pixel value of M(x,y) and the present image I is made into I(x,y), pixel value M'(x,y) of new background image M' can already represent the pixel value of a certain background image M with the following formula|equation.

$$M'(x,y)=(1-(\alpha))*M(x,y)+(\alpha)*I(x,y)$$

The average of 1 sheet acquired initially or a several image should just be used for the initial value of M.

When a threshold value image is set to T, background difference calculation is taken as those with the difference, when the absolute difference D of M and I is larger than the value to which the constant k in a threshold value was applied.

$$D(x,y)=|M(x,y)-I(x,y)|$$

$$D(x,y) \geq k \times T(x,y): \text{Foreground}$$

$$D(x,y) < k \times T(x,y): \text{Background}$$

The foreground location extraction part 3 performs the foreground location extraction step of S103.

In S103, the location which compares the image acquired at the input image acquisition step of S101 with the background already produced, and has the difference is extracted as a foreground.

The foreground location extraction part 3 calculates a foreground more specifically by performing difference calculation with the image acquired by S101, and the background image produced by S102 based on the said threshold value image (background difference procedure).

Next, a foreground is calculated by difference calculation which compares the said both image by calculating the index value based on the image acquired by S101, and the background image produced by S102 (index value calculation difference procedure).

And a foreground region is calculated by calculating the logical product of the foreground calculated in the said background difference procedure, and the foreground calculated in the said index value calculation difference procedure (foreground determination procedure).

As said index value, ratio of the logarithmic differentiation image of the image acquired by S101 and the background image produced by S102 is mentioned, for example.

As other index value, the normalization cross correlation and the square of normalization difference are calculated about the area|region of a focused pixel periphery of the image acquired by S101, and the background image produced by S102,

The weighted sum of the value of the said normalization cross correlation calculated according to the weight based on the standard deviation of the pixel value in the area|region of the said attention area periphery and the value of the said the square of normalization difference is illustrated.

The logical product of the foreground location where the standing-still location was calculated by the method of the background finite difference method which used the normal distribution of the nonpatent

literature 3, and the foreground location calculated by the difference method by logarithmic differentiation,

Or it is calculated by the logical product of the foreground location calculated by the background difference method using the said background model, and the foreground location calculated by the difference method of the correlation base.

About each difference result, you may add an emphasizing processing of an expansion process, the process which takes the sum of a surrounding pixel, etc.

The difference method and the difference method of a correlation base by the logarithmic differentiation applied in the foreground location extraction part 3 are the comparison method which cannot receive to the influence of a brightness change easily.

The difference method by logarithmic differentiation is implement|achieved by combining the process which takes the logarithm of an image as shown by patent document 1, and the process which takes a differential.

First, the difference method by logarithmic differentiation takes the logarithm of the pixel value of an image, and acquires a logarithm image.

Next, a logarithmic differentiation image is acquired by the space derivative of an image.

Ratio of the logarithmic differentiation image calculated|required about the background image and the logarithmic differentiation image calculated|required about the present frame image is taken, and a location with the change beyond a constant value is made into a foreground location.

The difference method by the said logarithmic differentiation is specifically implement|achieved using the following principle.

The pixel value of the image at a certain time is set to  $I$ , and if the pixel value of the image by which the luminance transition by AGC of the brightness change in an environment or a camera, AWB, etc. was added to it is set to  $aI$ , it can describe like the following numerical formula.

[EQUATION 1]  
[MAT\_IMAGE 000002]

However,  $a$  is a coefficient which shows a luminance transition.

Here, if space derivative is taken about the image which took the logarithm, it can describe like the following numerical formula.

[EQUATION 2]  
[MAT\_IMAGE 000003]

Here, if a luminance transition work|functions uniformly in a space direction at linearity, the 1st term of Formula 2 becomes zero by space derivative, and Formula 3 is obtained.

In fact, the said luminance transition is converted into the value which cannot receive to the influence of a luminance transition easily by this, although many nonlinear things do not become zero at exactness|strictness.

Although Formula 2 and Formula 3 have shown the space derivative of the  $x$  direction, they are the same also about a  $y$  direction.

In an image process, you may substitute calculation of space derivative using a sobel filter.

A comparison process is implement|achieved by taking ratio of the image to which the process of Formula 3 is applied from Formula 1 with respect to the background acquired by an image, and S102 or S105 to which the process of Formula 3 is applied from Formula 1 with respect to the image acquired by S101.

Although ratio is calculated by the division of the image of 2 sheets, the process which takes scale conversion, and less than one location add the process which takes a reciprocal number. Furthermore, you may add an emphasizing processing of an expansion process, the process which takes the sum of a surrounding pixel, etc.

Moreover, it is good also considering the presence or absence of a difference as a binary image by predetermined threshold value process.

The above is a principle of the difference method by logarithmic differentiation.

The difference method of a correlation base is calculated by the weighted sum which used the image I of 2 sheets, the normalization cross correlation of I', and two types of correlation values of the square of normalization difference about the pixel value of the area|region of the circumference|surroundings nxn pixel of the focused pixel in an image.

A weight uses the value according to the standard deviation of the area|region of a nxn pixel. However, n is predetermined arbitrary integers.

The normalization cross correlation A is calculated|required by following Formula.

[EQUATION 3]  
[MAT\_IMAGE 000004]

As for the square of normalization, the difference B is calculated|required by following Formula.

[EQUATION 4]  
[MAT\_IMAGE 000005]

As for the said normalization cross correlation A and the square of normalization, weighted sum D of the difference B is calculated in following Formula.

$D = (\alpha)A + (1 - (\alpha)) B$   
( $\alpha$ ) is a constant of the range of 0-1. [ beforehand fixed according to the average value of the standard deviation of  $I_n$ , and the standard deviation of I ]

For example, if a standard deviation is 20 or more and it is ( $\alpha$ )= 0.8 and less than 20, it can decide like ( $\alpha$ )= 0.6.

About how to decide the area|region of a nxn pixel, the nxn pixel of the circumference|surroundings of a pixel may be used about all pixels, and a focused pixel is selected and it is good also as calculation of only the selected focused pixel.

Moreover, according to said D, you may binarize by predetermined threshold value process. For example, using the predetermined threshold value th, in  $D \leq th$ , it is made into a foreground and, in  $D > th$ , the threshold value process made into a background is mentioned as an example.

The standing-still location evaluation part 4 performs the standing-still location evaluation step of S104. S104 evaluates the foreground location calculated at the foreground location extraction step of S103, and it is determined whether it detects as a standing-still area|region.

The time which looked at the foreground location in time series, continued, and was specifically calculated as a foreground location is counted up, and a count determines the location which became more than the predetermined standing-still determination threshold value as a standing-still area|region. Here, you may perform noise removal and the clustering of an area|region using a contraction process, an expansion process, a labeling processing, etc. further.

The background update part 5 performs the update step of a serial|sequential background of S105

sequentially.

In S105, a new background model is produced using the image acquired at the input image acquisition step of S101, and the background already produced.

An update location is the area|region determined as the background area|region calculated as a background at the foreground location extraction step of S103, and a standing-still area|region calculated at the standing-still location evaluation step of S104.

The update of a background model is performed by calculating this background area|region and this standing-still area|region using the method of the background finite difference method which used the normal distribution of the nonpatent literature 3.

Based on the following calculation method of background image M' in S102, and threshold value image T' specifically demonstrated previously, it is calculated only about this background area|region and this standing-still area|region.

$$M'(x,y)=(1-(\alpha))*M(x,y)+(\alpha)*I(x,y)$$

$$T'(x,y)=(1-(\alpha))*T(x,y)+(\alpha)*D(x,y)$$

It becomes detectable [ the area|region stationary for a definite period of time by the above ].

Moreover, this can also be used as a penetration|invasion detection in an area|region which detects the penetration|invasion of the object into the attention area of pinpointing in an image.

When using as a penetration|invasion detection in an area|region, it determines by cutting off an attention area at the time of input image acquisition, or using only the judgment result in an attention area about a standing-still location evaluation result.

Moreover, if the value of the said standing-still determination threshold value is made into a small value, it is also possible to detect immediately the object which penetrate|invaded into the area|region.

FIG. 2 is the block diagram which illustrated the more concrete system configuration|structure of the standing-still area|region detection apparatus 10.

The foreground location extraction part 3 of the standing-still area|region detection apparatus 10 is provided with the functional blocks 31-37, 41-47 as were shown by FIG. 2.

The process concerning the functional blocks 31-37, 41-47 is realizable by cooperation with the hardware resources demonstrated previously and the software of installation completed.

In addition, what is necessary is just to comprise the background holding|maintenance part 31 and the background candidate holding|maintenance part 45 with the apparatus which has memory|storage functions, such as memory of a computer, or a hard disk.

The procedure (S201-S220) of the standing-still area|region detection by the standing-still area|region detection apparatus 10 is demonstrated referring FIG. 2.

S201: The image|video imaged or accumulate|stored from the image input device 11 is output.

As the image input device 11, image|video storage devices, such as imaging devices, such as a camera, DVR, and VTR, or a video delivery apparatus is illustrated.

S202: The input image acquisition process part 1 acquires the image|video output from the image input device 11 in process of S201, and delivers it to the initial stage background creation process part 2, the present image-background difference process part 32, and the logarithmic differentiation expression image-background difference process part 41.

S203: A plurality of image acquired from the input image acquisition process part 1 in process of S202 is used for the initial stage background creation process part 2,

A background model is produced by the method of a background finite difference method using the normal distribution of the above-mentioned nonpatent literature 3.

S204: The background holding|maintenance part 31 hold|maintains the background model produced by S203, S216 (background update process part 46), or the background model updated by S218 (sequentially background update process part 5) to a storage area.

S205: The image acquired in process of S202 and the background model acquired from the background holding|maintenance part 31 are used for the expression image-background difference process part 32, Difference calculation is performed by the method of a background finite difference method using the normal distribution of the above-mentioned nonpatent literature 3, A difference image is output.

S206: A foreground / background mask creation process part 33 produces a foreground region mask image and a background area|region mask image from the difference image calculated by S205 based on the method of a background finite difference method using the normal distribution of the above-mentioned nonpatent literature 3.

S207: The expression image-background candidate difference process part 34 performs difference calculation with the image which acquired the normal distribution of the above-mentioned nonpatent literature 3 in process of S202 based on the used method of a background finite difference method, and the background candidate image acquired from the background candidate holding|maintenance part 45, A difference image is output.

S208: The standing-still candidate mask creation process part 35 produces a standing-still candidate area|region mask image based on the method of a background finite difference method using the normal distribution of the above-mentioned nonpatent literature 3 from the difference image calculated by S207.

S209: The rest time evaluation process part 36 evaluates the rest time of a standing-still location based on the method of a background finite difference method using the normal distribution of the above-mentioned nonpatent literature 3 using the foreground region mask image calculated by S206, and the standing-still candidate area|region mask image calculated by S208, and produces a rest time count image.

S210: The standing-still location mask creation process part 36 produces a standing-still area|region mask image based on the method of a background finite difference method using the normal distribution of the above-mentioned nonpatent literature 3 from the rest time count image produced by S209.

S211: The background model acquired from the image acquired by S202 (input image acquisition process part 1) and the background holding|maintenance part 31 is used for the logarithmic differentiation expression image-background difference process part 41, Difference calculation is performed based on the principle of the difference method by the said logarithmic differentiation, A difference image is output.

S212: The logarithmic differentiation foreground mask creation process part 42 performs the threshold value process based on a predetermined threshold value with respect to the difference image calculated by S211, and calculates the foreground region mask image by logarithmic differentiation.

S213: It evaluates rest time that the logarithmic differentiation rest time evaluation process part 43 counts a mask area|region in time series about the foreground region mask image by the logarithmic differentiation calculated|required by S212, The rest time count image by logarithmic differentiation is produced.

S214: The logarithmic differentiation standing-still location mask creation process part 44 performs the threshold value process based on a predetermined threshold value with respect to the rest time count image by the logarithmic differentiation produced by S213, and produces the standing-still area|region mask image by logarithmic differentiation.

S215: The background candidate holding|maintenance part 45 hold|maintains the background candidate model produced in process of S217 by the background candidate update process part 47 to a storage area.

S216: The image acquired in process of S202 and the background area|region mask image calculated in process of S206 are used for the background update process part 46, A background model is updated based on the method of a background finite difference method using the normal distribution of the above-mentioned nonpatent literature 3.

S217: The image acquired in process of S202 and the background candidate area|region mask image calculated in process of S208 are used for the background candidate update process part 47, A background candidate model is updated based on the method of a background finite difference method using the normal distribution of the said nonpatent literature 3.

S218: The background update process part 5 updates a background model and a background candidate model based on the method of a background finite difference method using the normal distribution of the above-mentioned nonpatent literature 3 about the area|region determined as a standing-still area|region in process of S219 by the standing-still location evaluation process part 4 sequentially. The updated background model is output to the background holding|maintenance part 31 (S204). On the other hand, the updated background candidate model is output to the background candidate holding|maintenance part 45 (S215).

S219: The standing-still location evaluation process part 4 decides a standing-still area|region by taking the logical product of the standing-still area|region mask image produced in process of S210, and the standing-still area|region mask image by the logarithmic differentiation produced in process of S214. In this process, you may combine noise removal and the clustering of an area|region using a contraction process, an expansion process, a labeling processing, etc.

S220: Information, such as a position of the standing-still area|region obtained in process of S219, size, an area|region, and detection time, is output outside. The said information is shown by presentation apparatuses, such as a display which specifically attached to the standing-still area|region detection apparatus 10. Moreover, the said information is recorded on the database stored in the recording device (recording media, such as a hard disk) comprised to the inside or the exterior of the standing-still area|region detection apparatus 10, or is transmitted outside via a network as information, such as a warning to a remote place.

You may replace the process of S211-S214 with the process of S301-S304 respectively performed by the functional blocks 51-57 to which the method of the correlation base illustrated by FIG. 3 is applied. The process concerning the functional blocks 51-54 shown by FIG. 3 is realizable by cooperation with the hardware resources demonstrated previously and the software of installation completed.

S301: The correlation base expression image-background difference process part 51 outputs a difference image by difference calculation based on the principle of the difference method of a correlation base using the background model which the image acquired in process of S202 and S204 acquired.

S302: The correlation base foreground mask creation process part 52 performs the threshold value process based on a predetermined threshold value with respect to the difference image calculated in process of S301, and calculates the foreground region mask image of a correlation base.

S303: The correlation base rest time evaluation process part 53 evaluates rest time by counting a mask area|region in time series about the foreground region mask image of the correlation base produced in process of S302, The rest time count image of a correlation base is produced.

S304: The correlation base standing-still location mask creation process part 54 performs the threshold value process based on a predetermined threshold value with respect to the rest time count image of the correlation base produced in process of S303, and produces the standing-still area|region mask image of a correlation base.

In the method of a background finite difference method of having used the normal distribution of the

nonpatent literature 3, and the method concerning this invention, FIGS. 4-7 judges the location stationary for 30 second as a standing-still area|region about image|video 24 hours of a place by the window without the appearance of standing-still area|region (The area|region where not a background but the foreground rested still for a definite period of time),  
The processed result is shown as it assimilates against the background of the location stationary for 40 second.

FIG. 4 is QVGA and illustrates the one part flame|frame of the image|video for one day from 0:00 image|photographed by about 10 fps(es) to 24:00.

FIG.5 and FIG.6 is the characteristic view which showed the result of having processed the image of FIG. 4 using the background difference method.  
A vertical axis|shaft is the total pixel number of the area|region judged as a standing-still area|region in the whole image, and a vertical axis|shaft is a time-axis.

FIG. 5 is the characteristic view which showed the result of having processed the image of FIG. 4 only using the method of the background finite difference method which used the normal distribution of the nonpatent literature 3.

FIG. 6 is the characteristic view which showed the result of having processed the image of FIG. 4 with the application of the difference method by logarithmic differentiation in the standing-still area|region detection apparatus 10 concerning invention.

FIG. 7 is the characteristic view which showed the result of having processed the image of FIG. 4 with the application of the difference method of a correlation base in the standing-still area|region detection apparatus 10 concerning invention.

Here, the difference of a correlation base divides|segments an image into the area|region of 32x24, and is performing thinning|decimation calculation done the attention area of 10x10.

Since the used image|video is an image|video which image|photographed only the mode of the sunshine fluctuation|variation and interruption|screening, abandonment/taking-away, etc. of an object is a thing which has not been reflected, it is desirable to detect against the background of all the flames|frames ideally.

It is the pixel which misdetected the pixel detected as a standing-still area|region, i.e., a sunshine fluctuation|variation, noting that not a background but the standing-still area|region appeared, and can perform a comparison of the superiority or inferiority of each method by FIGS. 5-7 which shows the misdetected pixel count.

As shown in the characteristic view of FIG. 5, when only the method of a background finite difference method using the normal distribution of the nonpatent literature 3 is used, the fluctuation|variation which is not a temporary change by sunshine fluctuation|variation etc. is misdetected as a standing-still area|region.

According to the standing-still area|region detection apparatus 10 concerning this invention, it turns out that the misdetection by sunshine fluctuation|variation can be suppressed significantly evidently from the comparison with the characteristic view of FIG. 6, FIG. 7, and the characteristic view of FIG. 5.

FIGS. 8-11 is the result of processing against the background of the location which judged the location which rested still the image|video which has QVGA and 20fps in this invention for 30 second as a standing-still area|region, and rested still for 40 second, as it assimilated.

The image|video used for FIG. 8 is shown.

An image|video has abandonment of a standing-still area|region 7 second after after an imaging|photography start here,

Taking-away generate|occur|produces in 2 minutes,

It is an image|video to which a person comes and goes a standing-still area|region front any number of times,

The blind of the background is swinging by the wind,



It is imaging|photography time at the sunset time.  
The camera uses the cheap network camera and AGC and AWB are applied.

FIG. 9 is the characteristic view and image which showed the result processed by the method of the update of real-time of the background of a nonpatent literature 3.

FIG. 10 is the characteristic view and image which showed the process result at the time of using the difference method by logarithmic differentiation in the standing-still area|region detection apparatus 10 concerning invention.

FIG. 11 is the characteristic view and image which showed the process result at the time of using the difference method of a correlation base in the standing-still area|region detection apparatus 10 concerning invention.

In FIGS. 9-11, the total pixel number of the area|region judged as a standing-still area|region which the total pixel number of the area|region judged as a standing-still area|region detected within the mask is outside a correct value and a mask, and was detected is plotted as an incorrect value by setting vicinity on which the standing-still area|region was placed as a correct area mask.

When processed evidently from the characteristic view of FIG. 9 by the update method of real-time of the background concerning a nonpatent literature 3, some incorrect area|region (Wrong) has generate|occur|produced,  
However,  
When [ which used the standing-still area|region detection method concerning this invention like ] FIG.10 and FIG.11 shows, it turns out that only the standing-still area|region is detectable without a misdetection.

In the conventional standing-still area|region detection method, it is easy to generate|occur|produce a misdetection under the influence of several disturbances, such as noise of AGC of the change of lighting environment, temporary interruption|screening of a movement region, regular noise, and a camera, AWB, and an image pick-up element,  
However,  
According to the standing-still area|region detection apparatus 10 concerning Embodiment, on conditions with these various disturbance factors, it becomes robust detectable [ a standing-still area|region ] evidently from the above-mentioned description.

In addition, this invention is good also as an aspect of the program as which a computer is functioned as a process concerning each function blocks 1-5, 31-37, 41-47, 51-54 which are not limited to the above-mentioned embodiment and comprise the standing-still area|region detection apparatus 10.  
The said program can be stored in a computer-readable known recording medium, and can also be provided through provision or a network.

#### **BRIEF DESCRIPTION OF THE DRAWINGS**

[FIG. 1]  
The block diagram which showed schematic structure of the standing-still area|region detection apparatus concerning Embodiment.

[FIG. 2]  
The block diagram which showed the concrete system configuration|structure of the foreground location extraction part concerning Embodiment.

[FIG. 3]  
The block diagram which showed the system configuration|structure which performs the finite difference method of the correlation base applied to the foreground location extraction part concerning Embodiment.

[FIG. 4]  
The figure which illustrated the one part frame|frame for the image|video for one day from 0:00 image|photographed by about 10 fps(es) to 24:00 time-sequentially by QVGA.

[FIG. 5]

The characteristic view which shows the result of having processed the image of FIG. 4 only using the method of a background finite difference method using the normal distribution of the nonpatent literature 3.

[FIG. 6]

The characteristic view which shows the result of having processed the image of FIG. 4 with the application of the difference method by logarithmic differentiation in the standing-still area|region detection apparatus concerning Embodiment.

[FIG. 7]

The characteristic view which shows the result of having processed the image of FIG. 4 with the application of the difference method of a correlation base in the standing-still area|region detection apparatus concerning Embodiment.

[FIG. 8]

The image which displayed the image|video in case abandonment of a standing-still area|region exists 7 second after after an imaging|photography start and taking-away generate|occur|produces in 2 minutes, and the correct area mask.

[FIG. 9]

The characteristic view and image which showed the result processed by the method of the update of real-time of the background of a nonpatent literature 3.

[FIG. 10]

The characteristic view and image which showed the process result at the time of using the difference method by logarithmic differentiation in the standing-still area|region detection apparatus concerning Embodiment.

[FIG. 11]

The characteristic view and image which showed the process result at the time of using the difference method of a correlation base in the standing-still area|region detection apparatus concerning Embodiment.

#### Description of Symbols

- 1... Input image acquisition process part
- 2... Initial stage background creation process part (initial stage background preparation means)
- 3... Foreground location extraction part (foreground location extraction means)
- 4... Standing-still location evaluation part (standing-still location evaluation means)
- 5... It is a background update part (sequentially update means of a background) sequentially.
- 10... Standing-still area|region detection apparatus
- 41... Logarithmic differentiation expression image-background difference process part
- 42... Logarithmic differentiation foreground mask creation process part
- 43... Logarithmic differentiation rest time evaluation process part
- 44... Logarithmic differentiation standing-still location mask creation process part
- 51... Correlation base expression image-background difference process part
- 52... Correlation base foreground mask creation process part
- 53... Correlation base rest time evaluation process part
- 54... Correlation base standing-still location mask creation process part

[FIG. 1]

[MAT\_IMAGE 000006]

[FIG. 2]

[MAT\_IMAGE 000007]

[FIG. 3]

[MAT\_IMAGE 000008]

[FIG. 5]

[MAT\_IMAGE 000009]

[FIG. 6]

[MAT\_IMAGE 000010]

[FIG. 7]

[MAT\_IMAGE 000011]

[FIG. 4]

[MAT\_IMAGE 000012]

[FIG. 8]

[MAT\_IMAGE 000013]  
[FIG. 9]  
[MAT\_IMAGE 000014]  
[FIG. 10]  
[MAT\_IMAGE 000015]  
[FIG. 11]  
[MAT\_IMAGE 000016]

*(Translation from Thomson Reuters)*

**Citations**

**Citation** *Record level*

Citing Patents (0)

Expand Cited Patents (5)

Cited Non-patents (0)

**Other**

**DWPI Title Terms**

METHOD DETECT STAND STILL REGION IMAGE CALCULATE LOGIC PRODUCT FOREGROUND EXTRACT  
BACKGROUND DIFFER INDEX VALUE INPUT

**Custom Fields**

**Philips fam no**

-

**Business Classification**

-

**Technology Classification**

-

**Benchmark company name**

-

**Benchmark living status**

-

**Benchmark PSS**

-

Copyright 2007-2013 THOMSON REUTERS

(10) 日本国特許庁(JP)

(12) 特許公報(B2)

(11) 特許番号

特許第4999794号

(P4999794)

(45) 発行日 平成24年8月15日(2012.8.15)

(24) 登録日 平成24年5月25日(2012.5.25)

(51) Int. Cl.

G06T 7/20 (2008.01)

F 1

G06T 7/20 2008

請求項の数 6 (全 18 頁)

(21) 出願番号	特願2008-176262 (P2008-176262)	(73) 特許権者	000004226 日本電信電話株式会社 東京都千代田区大手町二丁目3番1号
(22) 出願日	平成20年7月4日(2008.7.4)	(74) 代理人	100086232 弁理士 小林 博通
(65) 公開番号	特開2010-15469 (P2010-15469A)	(74) 代理人	100104938 弁理士 橋澤 英久
(43) 公開日	平成22年1月21日(2010.1.21)	(74) 代理人	100140361 弁理士 山口 幸二
審査請求日	平成22年7月23日(2010.7.23)	(74) 代理人	100096459 弁理士 橋本 剛
		(72) 発明者	山下 勝也 東京都千代田区大手町二丁目3番1号 日 本電信電話株式会社内

最終頁に続く

(54) 【発明の名称】 静止領域検出方法とその装置、プログラム及び記録媒体

(57) 【特許請求の範囲】

【請求項1】

画像から静止領域を検出する静止領域検出方法であって、  
 初期背景作成手段が画像入力装置から取得された画像を用いて背景画像と各画素値が静止判定閾値である閾値画像とから成る背景モデルを作成する初期背景作成手順と、  
 前景箇所抽出手段が前記取得された画像と前記作成された背景モデルとを背景差分演算により比較して前景領域を抽出する前景箇所抽出手順と、  
 静止箇所評価手段が前記抽出された前景領域が前景として継続的に現れた回数をカウントして得た静止時間が予め定めた静止判定閾値以上になった箇所を静止領域として判断する静止箇所評価手順と、

10

逐次背景更新手段が、前記取得された画像と前記作成された背景モデルを用いて、前記前景箇所抽出手順で前景と判断されなかった領域と前記静止箇所評価手順で静止領域と判断された領域について新たな背景モデルを作成する逐次背景更新手順と

を有し、

前記初期背景作成手順は、  
 前記画像入力装置から取得された複数の画像を用いて加重平均画像を計算することで前記背景画像を作成する手順と、  
 定常的な揺らぎを正規分布によってモデル化することで前記閾値画像を作成する手順と  
 を有し、

前記前景箇所抽出手順は、

20

\_\_\_\_\_ 10  
\_\_\_\_\_  
\_\_\_\_\_  
\_\_\_\_\_

\_\_\_\_\_ 20

30

40

\_\_\_\_\_ 50  
\_\_\_\_\_  
\_\_\_\_\_  
\_\_\_\_\_

(3)

JP 4999794 B2 2012. 8. 15

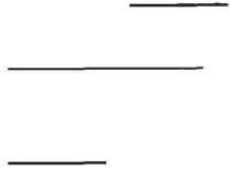

10

20

30

40

50

10

20

30

[Redacted text block]

40

[Redacted text line]

50



\_\_\_\_\_

\_\_\_\_\_

\_\_\_\_\_

\_\_\_\_\_

\_\_\_\_\_

10

\_\_\_\_\_

\_\_\_\_\_

\_\_\_\_\_

\_\_\_\_\_

20

\_\_\_\_\_

\_\_\_\_\_

30

40

50

(6)

JP 4999794 B2 2012. 8. 15

10

20

30

40

50

10

$$\log aI = \log a + \log I \quad \dots \text{式 1}$$

20

$$\frac{\partial}{\partial x} \log aI = \frac{\partial}{\partial x} \log a + \frac{\partial}{\partial x} \log I \quad \dots \text{式 2}$$

30

$$= \frac{\partial}{\partial x} \log I \quad \dots \text{式 3}$$

40

50

10

$$A = \frac{\sum_n (I_n - \bar{I})(I'_n - \bar{I}')}{\sqrt{\sum_n (I_n - \bar{I})^2 + 1} \sqrt{\sum_n (I'_n - \bar{I}')^2 + 1}}$$

20

$I, I'$  は、異なる2枚の画像の注目領域内の画素値である。  
 $\bar{I}, \bar{I}'$  は、それぞれの画像における注目領域内の画素値の平均である。

30

$$B = 1 - \frac{\sum_n (I_n - I'_n)^2}{\sqrt{\sum_n (I_n + 1)^2} \sqrt{\sum_n (I'_n + 1)^2}}$$

40

50

(9)

JP 4999794 B2 2012. 8. 15

10

20

30

40

50

(10)

JP 4999794 B2 2012. 8. 15

10

20

30

40

50

10

20

30

40

50

10

20

30

40

50



10

20

30

40

50

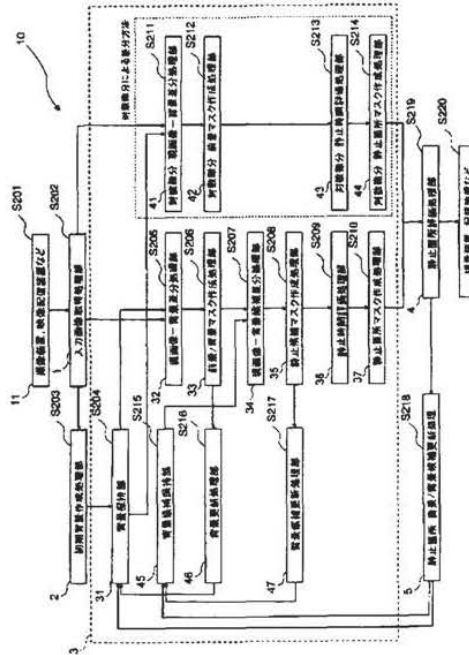
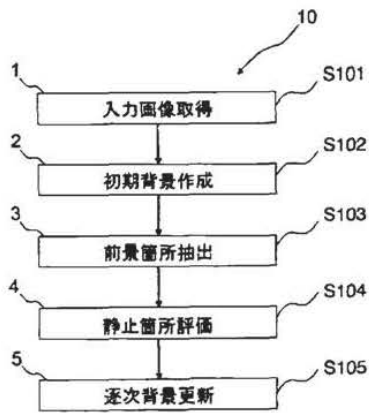

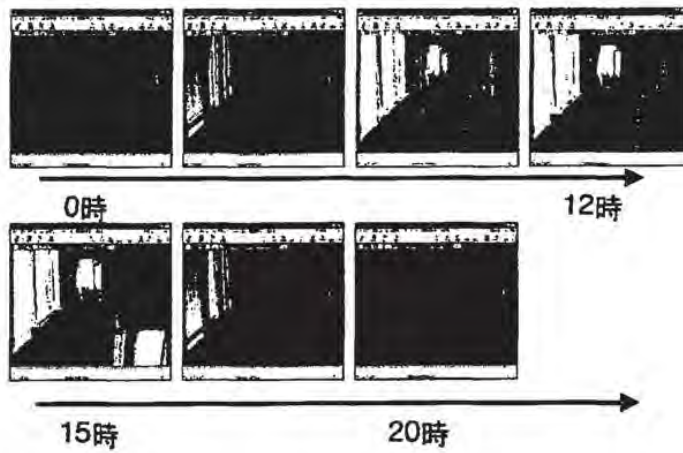
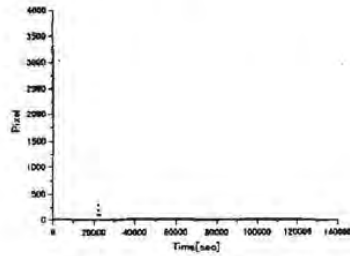
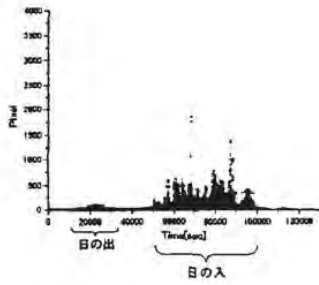
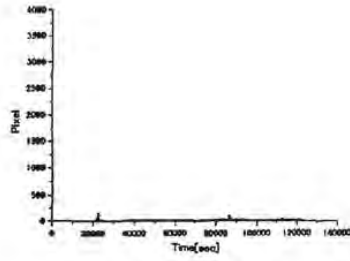
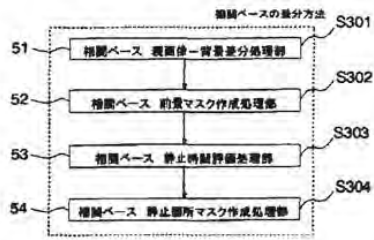

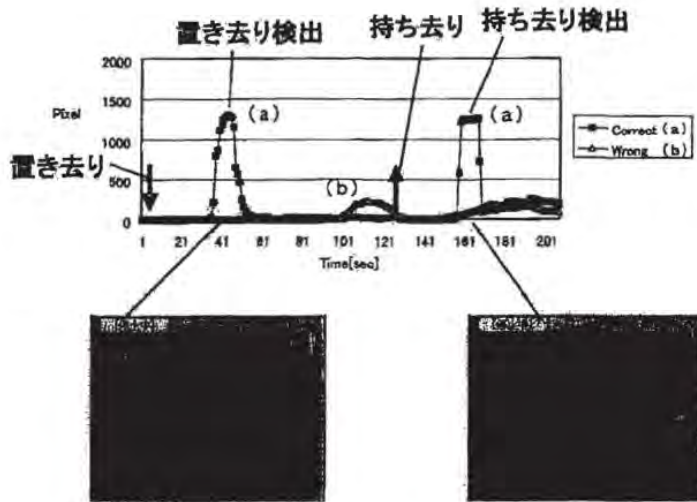

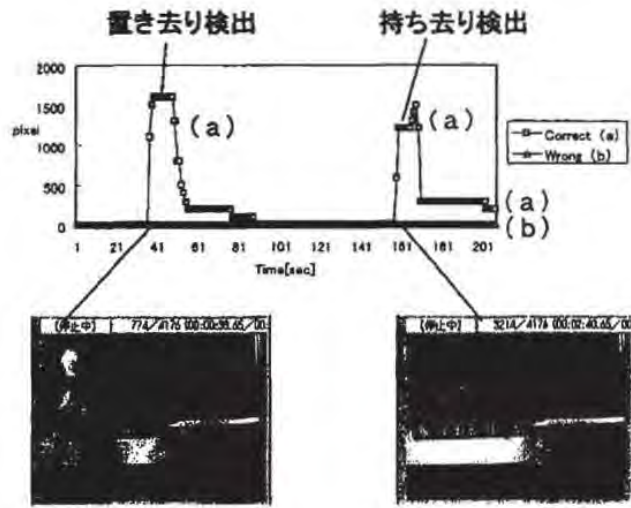
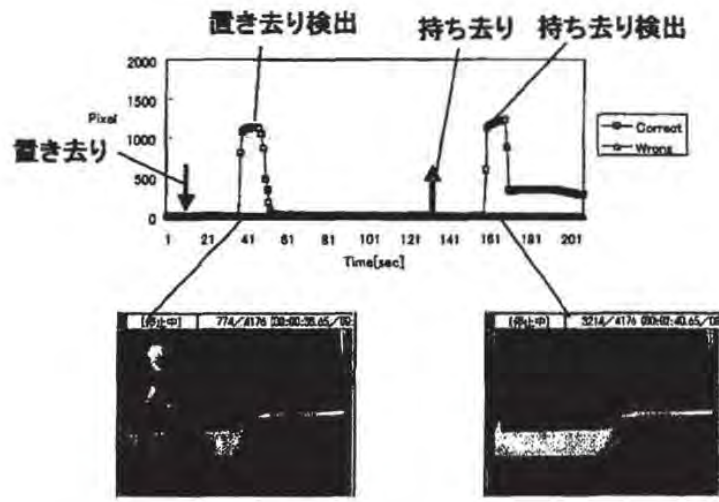

フロントページの続き

- (72)発明者 新井 啓之  
東京都千代田区大手町二丁目3番1号 日本電信電話株式会社内
- (72)発明者 磯 和之  
東京都千代田区大手町二丁目3番1号 日本電信電話株式会社内
- (72)発明者 秦泉寺 久美  
東京都千代田区大手町二丁目3番1号 日本電信電話株式会社内
- (72)発明者 小島 明  
東京都千代田区大手町二丁目3番1号 日本電信電話株式会社内
- (72)発明者 仲澤 斉  
東京都千代田区大手町二丁目3番1号 日本電信電話株式会社内
- (72)発明者 数藤 恭子  
東京都千代田区大手町二丁目3番1号 日本電信電話株式会社内
- (72)発明者 小池 秀樹  
東京都千代田区大手町二丁目3番1号 日本電信電話株式会社内

審査官 板垣 有紀

- (56)参考文献 特開平10-111944 (JP, A)  
特開2004-227527 (JP, A)  
特開2008-047991 (JP, A)  
特開2007-108965 (JP, A)  
特開2004-241945 (JP, A)

- (58)調査した分野(Int.Cl., DB名)
- |      |      |
|------|------|
| G06T | 7/20 |
| H04N | 7/18 |
| G06T | 1/00 |

No documents available for this priority number.



**Espacenet**

**Bibliographic data: JPH07200120 (A) — 1995-08-04**

**ADJACENT CHARACTER DISPLAY KEYBOARD**

**Inventor(s):** ONO KATSUYASU ± (ONO KATSUYASU)  
**Applicant(s):** ONO KATSUYASU ± (ONO KATSUYASU)  
**Classification:** - **International:** G06F3/02; G06F3/023; H03M11/08; (IPC1-7): G06F3/02; G06F3/023; H03M11/08  
 - **cooperative:**  
**Application number:** JP19930355185 19931228  
**Priority number (s):** JP19930355185 19931228

**Abstract of JPH07200120 (A)**

**PURPOSE:**To easily and speedily input characters on a ten-key as to a personal computer, electronic calculator, electronic pocketbook, word processor, telephone set, etc. **CONSTITUTION:**For two-touch character input, characters for which the first key touch is operated by the same key, are put in the same group, and the key is decided as a group key. Then, 2nd key touches are made adjacent to the group key. The positions of the characters displayed on the group key indicate the positions of the 2nd key touch. Thus, the characters are displayed on the keyboard.

Q	W	E	R	T	Y	U	I	O	P
A	S	D	F	G	H	J	K	L	
Z	X	C	V	B	N	M			

Last updated: 13.03.2013 Worldwide Database 5.8.8.8.92p

(19)日本国特許庁 (J P)

(12) 公開特許公報 (A)

(11)特許出願公開番号

特開平7-200120

(43)公開日 平成7年(1996)8月4日

(51)Int.Cl. <sup>6</sup>	識別記号	庁内整理番号	F I	技術表示箇所
G 0 6 F 3/02	3 1 0 D			
	3/023			
H 0 3 M 11/08				

G 0 6 F 3/ 023 3 1 0 K

審査請求 未請求 請求項の数1 書面 (全 4 頁)

(21)出願番号 特願平5-355185

(22)出願日 平成5年(1993)12月28日

(71)出願人 594009623  
小野 勝康  
東京都小金井市前原町3丁目40番1-1005

(72)発明者 小野 勝康  
東京都小金井市前原町3丁目40番1-1005

(54)【発明の名称】 隣接文字表示キーボード

(57)【要約】

【目的】 パソコン、電卓、電子手帳、ワープロ、電話等でテンキーから文字入力を簡単に早く行なう。

【構成】 2タッチ文字入力で、1番目のキータッチが同じキーになる文字をグループとし、そのキーをグループキーとする。2番目のキータッチをグループキーに隣接させる。グループキー上で表示された文字の位置が2番目のキータッチの位置を示すよう表示する。この様に文字を表示したキーボード。

Q	W	E	R	T	Y	U	I	O	P
A	S	D	F	G	H	J	K	L	
Z	X	C	V	B	N	M			



## 【特許請求の範囲】

【請求項1】 2タッチ文字入力で、1番目のキータッチが同じキーになる文字をグループとし、そのキーをグループキーとすると、2番目のキータッチをグループキーに隣接させ、グループキー上に表示された文字の位置が2番目のキータッチの位置を示すようにしたキーボード。

## 【発明の詳細な説明】

## 【0001】

【産業上の利用分野】本発明は、パソコン、電卓、電子手帳、ワープロ、電話等フルキーボードやテンキーボードが使用されている分野にて利用できる。

## 【0002】

【従来の技術】従来は、ノートパソコンであればキー入力装置として例えば、フルキーボードが用いられていた、或は、ペン入力装置が用いられていた。電子手帳であれば例えば、長方形に数多くのキーを配置しそのなかから文字を選択していた。電卓であれば例えば、テンキーボードを使用し同一キーを何回か押すことによって文字を選択していた。

## 【0003】

【発明が解決しようとする課題】これらの文字入力方法には次のような問題点があった。

(1) フルキーボードはキーボードを小さくすることが困難であった。

(2) ペン入力装置は入力速度が遅かった。

(3) 電子手帳はキー入力速度が遅くブラインドタッチが困難であった。

(4) 電卓のように1つのキーに複数の文字を割り当てたものは入力が面倒で速度にも問題があった。

本発明はこれらの問題点を解決するものである。

## 【0004】

【課題を解決するための手段】

(1) 例えば、横3行×縦4列(3×4)のテンキーを用いる。

(2) 2タッチで1文字を入力する。

(3) グループとグループキーを決める。

(4) グループ内の文字の2番目のキータッチの位置をグループキーに隣接させる。

(5) グループキー上に表示された文字の位置が2番目のキータッチの位置を示すようにする。

## 【0005】

【作用】キーボードを見ながらあるいはブラインドタッチで1文字を2タッチ入力する。

## 【0006】

## 【実施例】

(1) アルファベットを入力する為に「図1」の様に表示した3×4のテンキーボード。例えば、(E, R, T, D, F, G, C, V, B)はグループである。例えば、Fを入力するには第1タッチでFが表示されているグループキーを押し第2タッチで再びFが表示されているキーを押す。Rを入力するには第1タッチでRが表示されているグループキーを押し第2タッチでRが表示されているグループキーでRが表示されている方向、即ち、1つ上のキーを押す。Cを入力するには第1タッチでCが表示されているグループキーを押し第2タッチでCが表示されているグループキーでCが表示されている方向、即ち、左斜め下のキーを押す。このようにして、テンキーであるからブラインドタッチが簡単である。キーボード上の表示も簡明であるからキーボードを見ながらの入力も簡単である。

(2) 日本語を入力する為に「図2」の様に表示した3×4のテンキーボード。このようにして数多くの国の文字に対応することができる。必要に応じてテンキーの配列を5×4等に拡張できる。また、モード変換キーを設けて大文字小文字のモード切り替えや英文字や仮名のモード切り替えを行なうこともできる。

(3) 日本語とアルファベットを統一したキーボードの例を「図3」に示す。ここでは、下2段のキーに特殊機能キーを持たせている。

## 【0007】

【発明の効果】本発明は、この様な構造であるので、

(1) パソコン、電卓、電子手帳、ワープロ、電話等でテンキーでフルキー並の文字入力ができる。

(2) ブラインドタッチが簡単である。

(3) 入力速度が早い。

(4) キーボードの表示を見るだけで1タッチ目の位置2タッチ目の位置がわかる。

## 【図面の簡単な説明】

【図1】アルファベットを入力するテンキーボードの1例

【図2】ひらがなを入力するテンキーボードの1例

【図3】英文字と日本語を入力するテンキーボードの1例



×4のテンキーボード。このようにして数多くの国の文字に対応することができる。必要に応じてテンキーの配列を5×4等に拡張できる。また、モード変換キーを設けて大文字小文字のモード切り替えや英文字や仮名のモード切り替えを行なうこともできる。

(3) 日本語とアルファベットを統一したキーボードの例を「図3」に示す。ここでは、下2段のキーに特殊機能キーを持たせている。

(4) パソコン等表示装置のある機器においては表示装置上にキーボードの文字のイメージを表示し、それを随時切り替えることにより入力の利便の向上を計ることが出来る。

【0007】

【発明の効果】本発明は、この様な構造であるので、

(1) パソコン、電卓、電子手帳、ワープロ、電話等でテンキーでフルキーなみの文字入力ができる。

(2) ブラインドタッチが簡単である。

(3) 入力速度が早い。

(4) キーボードの表示を見るだけで1タッチ目の位置2タッチ目の位置がわかる。

【図面の簡単な説明】

【図1】アルファベットを入力するテンキーボードの1例

【図2】ひらがなを入力するテンキーボードの1例

【図3】英文字と日本語を入力するテンキーボードの1例

(12) INTERNATIONAL APPLICATION PUBLISHED UNDER THE PATENT COOPERATION TREATY (PCT)

(19) World Intellectual Property Organization  
International Bureau



(43) International Publication Date  
21 February 2002 (21.02.2002)

PCT

(10) International Publication Number  
WO 02/14996 A2

- (51) International Patent Classification<sup>7</sup>: G06F 3/00
- (21) International Application Number: PCT/DK01/00501
- (22) International Filing Date: 16 July 2001 (16.07.2001)
- (25) Filing Language: English
- (26) Publication Language: English
- (30) Priority Data:  
PA 2000 01225 17 August 2000 (17.08.2000) DK
- (71) Applicant and  
(72) Inventor: MØLGAARD, John [DK/DK]; Sortemosen 36, DK-3450 Alsted (DK).
- (74) Agent: PLOUGMANN & VINGTOFT A/S; Sankt Annæ Plads 11, P.O. Box 3007, DK-1021 Copenhagen K (DK).
- (81) Designated States (national): AF, AG, AI., AM, AT, AT (utility model), AU, AZ, BA, BB, BG, BR, BY, BZ, CA,

CH, CN, CO, CR, CU, CZ, CZ (utility model), DE, DE (utility model), DK, DK (utility model), DM, DZ, EC, EE, EE (utility model), ES, FI, FI (utility model), GB, GD, GE, GH, GM, HR, HU, ID, IL, IN, IS, JP, KE, KG, KP, KR, KZ, LC, LK, LR, LS, LT, LU, LV, MA, MD, MG, MK, MN, MW, MX, MZ, NO, NZ, PL, PT, RO, RU, SD, SE, SG, SI, SK, SK (utility model), SL, TJ, TM, TR, TT, TZ, UA, UG, US, UZ, VN, YU, ZA, ZW.

- (84) Designated States (regional): ARIPO patent (GH, GM, KE, LS, MW, MZ, SD, SL, SZ, TZ, UG, ZW), Eurasian patent (AM, AZ, BY, KG, KZ, MD, RU, TJ, TM), European patent (AT, BE, CH, CY, DE, DK, ES, FI, FR, GB, GR, IE, IT, LU, MC, NL, PT, SE, TR), OAPI patent (BF, BJ, CF, CG, CI, CM, GA, GN, GW, ML, MR, NE, SN, TD, TG).

Declaration under Rule 4.17:

— of inventorship (Rule 4.17(iv)) for US only

Published:

— without international search report and to be republished upon receipt of that report

[Continued on next page]

(54) Title: A GRAPHICAL USER INTERFACE

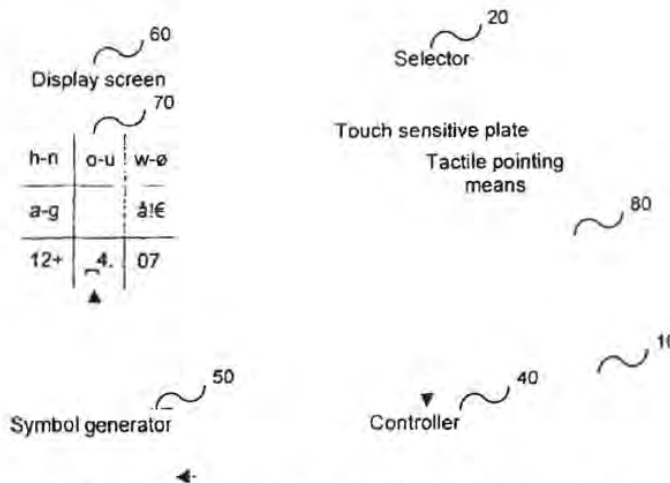

(57) Abstract: An apparatus for selection of characters to be displayed on a display screen. Has input actuators with associated fields containing graphical symbols representing the characters. The user is guided during selection of a character via the display. The selection procedure is sufficiently simple to allow a user to memorise the steps needed in order to select a specific character. Uses a limited number of actuators, and a character is selected using a sequence of actuations. Actuations may e.g. be keystrokes or movement by tactile pointing means on a touch sensitive device. Preferably, a character is selected by drawing one or two linear segments on a touch sensitive device. The displayed graphical symbols are preferably rearranged upon actuation. Suitable for use in electronic devices, in particular hand held devices having a small display screen, such as communication equipment, such as portable phones, e.g. mobile phones, or computers.

WO 02/14996 A2



---

*For two-letter codes and other abbreviations, refer to the "Guidance Notes on Codes and Abbreviations" appearing at the beginning of each regular issue of the PCT Gazette.*

## A GRAPHICAL USER INTERFACE

### FIELD OF THE INVENTION

The present invention relates to a graphical user interface with a display screen for displaying graphical symbols in fields that may be selected by a user for input to an apparatus. More specifically, the present invention relates to a graphical user interface allowing a large number of symbols to be selected for input to an apparatus utilising a small number of fields, in particular for use in connection with communication equipment, such as portable phones and computers, e.g. with a WAP or a SMS interface.

### BACKGROUND OF THE INVENTION

10 The development of mobile phones and portable phones and computers with an interface operating according to the Wireless Application Protocol (WAP) has increased the need for a user interface allowing a large number of options to be displayed on a small screen for selection, e.g., using a keyboard with a small number of keys.

It is well known to provide portable phones and computers with a small display screen and a small keyboard, e.g., with a navigation key to move a cursor on the display screen, so that a user is able to input data to the equipment and to select functions to be performed by the equipment. A large variety of approaches are known facilitating selection of a large number of alphanumeric characters and functions using a small keyboard together with a small screen.

20 For example in US 6,016,142, a user interface is disclosed facilitating selection of a large number of characters with a 4 by 3 numeric keyboard well-known from telephones. The selectable characters are displayed on a screen in three 3 by 3 matrices located adjacent to each other. The keys ".", "0" and "#" are used for navigation between the three matrices, activation of the "." key causing a new alphabet to be displayed in the three  
25 matrices.

US 5,457,454 discloses a user interface comprising a virtual keyboard. A keyboard is drawn on a screen and keys are activated by positioning a cursor at the key to be activated, e.g. with a mouse, and clicking the mouse. Characters that require more than

one key to be activated in a physical keyboard are activated by positioning the cursor at the key to be activated and then drawing the key in a certain direction.

In US 4.910.697, a keyboard with 16 keys is disclosed, wherein numerical digits can be selected with a single key activation while alphabetic characters and functions can be  
5 selected with a sequence of two key activations.

In US 5.008.847, a user interface of a CAD system is disclosed, having a virtual keyboard with keys that are selected with a mouse controlled cursor. As in US 4.910.697, numerical digits can be selected with a single key activation while alphabetic characters and functions can be selected with a sequence of two key activations.

10 EP 1 067 784 discloses a method of selecting alphanumeric characters via a remote control. A first depression of one of the buttons of the remote control causes the display on a screen of a number of segments, each segment including a plurality of letters, numbers and/or characters and an identifying number or character for each segment. The depression of the appropriate number on the remote control for the selected segment,  
15 causes the visual display to change to show the characters of the selected segment, each character positioned in a sub-segment. Subsequent depression of the appropriate number on the remote control causes the selection of the corresponding character.

EP 0 889 388 discloses a data input interface. A subset of characters is initially displayed on a touch sensor display. Respective subsets of the remaining characters of the alphabet  
20 are associated with the displayed characters. The user, having a particular character in mind, selects the displayed character associated with the subset containing the particular character. That subset is then displayed, and the user selects the desired character.

GB 2 332 293 discloses an input device for inputting instructions or data into an apparatus having a display. The display displays at least one menu item as a plurality of  
25 subsequentially selectable submenu items. Responsive to the selection of a submenu item, the display indicates the selectability of the submenu items. A selector can be used for the subsequent selection of the submenu items and data or instructions are input based on a selected menu item of submenu item.

## SUMMARY OF THE INVENTION

Although many attempts have been made to facilitate user selection of an input among a large number of alphanumeric characters and a large variety of functions on a small display screen with a limited set of display fields, there is still a need for an efficient user interface providing a well-arranged display of available selections that is easy to grasp and manage by a user. The user interface must be easy to operate after a short learning period, yet able to perform all the necessary single and combined data entries which will be required in a modern communication equipment, such as phones with a WAP interface, a SMS interface, etc. Furthermore, there is a need for a user interface which trains the user during use, i.e. which does not require a separate learning facility in order to teach the user how to use the interface and become an expert user.

According to a first aspect of the present invention these and other objects are fulfilled by

- a method of inputting data to an apparatus with an input device comprising a selector for selection of characters and having input actuators with associated fields containing first graphical symbols, at least one of the first graphical symbols indicating a first set of alphabetic characters in alphabetic order, the apparatus further comprising a display screen, a symbol generator for displaying the fields containing the first set of graphical symbols in an arrangement on the display screen, and a controller that is operatively connected to the symbol generator and the selector, the method comprising the steps of:
- actuation of an input actuator with an associated field containing a symbol indicating a first set of alphabetic characters in alphabetic order, and
- allocation of each of the alphabetic characters in the first set of alphabetic characters to a specific input actuator so that actuation of that input actuator results in selection of the allocated alphabetic character,
- the steps being performed in such a way that a user is guided by the apparatus during selection of an alphabetic character, and in such a way that selection of a specific alphabetic character is sufficiently simple to allow a user to memorise the selection procedure.



According to a second aspect of the invention the above-mentioned and other objects are fulfilled by an apparatus with an input device comprising a selector for selection of characters and having input actuators with associated fields containing first graphical symbols,

5 characterised in that

the apparatus further comprises

a display screen,

a symbol generator for displaying the fields containing the first set of graphical symbols in an arrangement on the display screen, and

10 a controller that is operatively connected to the symbol generator and the selector,

and in that at least one of the first graphical symbols indicates a first set of alphabetic characters in alphabetic order and in that actuation of the corresponding input actuator results in allocation of each of the alphabetic characters in the first set of alphabetic

15 selection of the allocated alphabetic character, and in that the apparatus comprises means for guiding a user during selection of an alphabetic character, and in that selection of specific alphabetic characters is sufficiently simple to allow a user to memorise the selection procedure.

For example, the selector may comprise a keyboard with keys constituting the input  
20 actuators. Further, the first graphical symbols may be printed on the respective keys.

The user is preferably guided during selection of an alphabetic character by means of the display, preferably by displaying a small number of well-arranged symbols or characters on the display in such a way that it is easy to grasp which actuator should be actuated in order to eventually reach a desired character. On the other hand, the system is sufficiently  
25 simple that a skilled user can memorise the selection procedures for at least the characters which are most frequently used. This may, e.g., be achieved by providing an apparatus in which a small number of operations is needed in order to select each

character, the operations being easy to memorise. Such operations may, e.g., be a combination of a few strokes on a keyboard, a combination of a few actuations on a touch sensitive device, etc.

The apparatus may further comprise a sound generator for generation of a specific sound  
5 upon actuation of a corresponding actuator to provide audio feedback to the user of the apparatus of the actual actuation. The sound generator may be a sound transducer, such as a loud speaker, a piezoelectric transducer, etc. The specific sound may be a specific tone, a sequence of specific tones, a specific chord, a sequence of specific chords, etc., that is associated with actuation of a specific actuator, such as movement of a moving  
10 cursor in a specific direction as will be further described later.

The controller may be adapted to control the symbol generator to display a second set of graphical symbols in the fields in response to actuation of an actuator with an associated field with a symbol that indicates a first set of alphabetic characters in alphabetic order, the second set of graphical symbols comprising graphical symbols corresponding to the  
15 respective characters of the first set of alphabetic characters.

As will be understood from the following discussion, these features permit an extremely simple and safe, yet very effective and advanced, operation of the user interface.

It is an important advantage of the present invention that display of selectable symbols indicating a set of alphabetic characters in alphabetic order provides a clear indication of  
20 the options that will be available to the user upon activation of the symbol in question. Hereby very little support from the memory of the user is required. However, the operations needed in order to select a specific character is preferably easy to memorise for the skilled user.

It is a further advantage of the present invention that it is possible to type any character  
25 which is immediately available from a conventional keyboard of a computer or typewriter. Furthermore, special characters, such as "æ", "ø", "å", "£", space, etc., as well as strings of characters, such as ". (space)" "carriage return, line feed", etc., may be selected just as easily as any other character. Thus, according to the present invention a smaller number of operations is needed in order to select a desired character, as compared to prior art  
30 methods.

The display screen may be any screen that is suitable for displaying alphanumeric characters and other symbols in an arrangement, such as a matrix arrangement. For example, the display screen may be a LCD screen, a CRT, a plasma screen, a TFT screen, etc., and further the screen may be touch sensitive.

- 5 The graphical symbols may be alphanumeric characters, Greek characters, Cyrillic characters, Japanese characters, Chinese characters, mathematical symbols and operators, icons, etc. Further, the graphical symbols may be constituted by any sequence of such characters and combinations of such characters, e.g. "a-g", "h-n", "o-u", etc.

- A selectable graphical symbol may be displayed in a distinct field that may be graphically distinguished from its surroundings by means of, e.g., a boundary, a background colour, a background pattern, etc., or any combination of such graphical distinguishing features.
- 10

The selector may comprise a touch sensitive device, such as a touch sensitive screen, in which case a specific directional movement on said touch sensitive device by a tactile pointing means corresponds to selection of a specific actuator.

- 15 The tactile pointing means may be a pen or a stylus, or it may simply be a finger. In this embodiment a character may be selected by a couple of simple strokes, preferably by drawing a few substantially linear segments on the touch sensitive device.

- The apparatus may be a hand held apparatus, such as a portable phone or computer, in which case the touch sensitive device may be positioned on a surface of the apparatus being opposite the surface exhibiting the display. In case the apparatus is a portable phone, the touch sensitive device may be positioned on the back side of the phone, i.e. the side opposite to the side where the display and the keys are positioned. Thus, a user may easily select characters to be displayed on the display while holding the phone in his/her hand, using a finger of the hand holding the phone, while at the same time viewing the display. This applies in a similar way to other hand held apparatuses.
- 20
- 25

Alternatively, the selector may comprise a number of keys corresponding to the actuators, in which case actuation of a specific key corresponds to actuation of the corresponding actuator, and said keys are positioned on a surface of the apparatus being opposite the surface exhibiting the display. The remarks set forth above apply equally in this case.

One or more of the second symbols may indicate a second set of alphabetic characters in alphabetic order and the controller may be further adapted to control the symbol generator to display graphical symbols corresponding to the characters of the second set of alphabetic characters in response to the selection of such a symbol.

- 5 The second set of alphabetic characters may be a case shifted version of the first set of alphabetic characters of the selected first symbol. For example, if the selected first set of characters is "o-u" (lower case), one of the second symbols may be "O-U" (upper case). Preferably the second symbol "O-U" is positioned at the same relative position in the matrix arrangement as the first symbol "o-u" for further ease of operation.
- 10 The displayed symbols may be arranged on the display screen in any suitable arrangement providing a well-arranged and clear display of options available to the user. In this manner the user is guided during the selection of a character in an efficient and easy to grasp manner. Preferably, the displayed symbols are arranged in a matrix arrangement, e.g., exhibiting rows and columns. It has been found that a 3 by 3 matrix
- 15 arrangement provides a clear display of options that is well-suited for the display screen of a portable or mobile phone.

- The selector may comprise a keyboard with keys having relative positions in the keyboard that correspond to the relative positions of displayed symbols in the arrangement on the display screen. In this case, each of the displayed fields containing a selectable symbol
- 20 constitutes an input actuator which is activated by activation of the key with the corresponding position in the keyboard.

- The selector may comprise a touch sensitive device, such as a touch sensitive display screen or plate, allowing a graphical symbol to be selected by any kind of external interaction with the field containing the symbol. The selection is suitably performed using
- 25 a tactile pointing means, such as simply a finger or pointer touching and/or pressing against at least part of the area occupied by the field containing the symbol to be selected. Thus, each of the displayed fields containing a selectable symbol constitutes an input actuator which is activated by tactile pointing means.

- Alternatively, the selector may comprise a moveable cursor that is displayed on the
- 30 display screen, a cursor controller for manually controlling the position of the cursor on the

display screen, and a click actuator for selection of the symbol at the current cursor position. The cursor controller may be a mouse, a track ball, a digitising pen, a light pen operating directly on the display screen, a keyboard, a part of a keyboard, a touch sensitive plate, etc. The click actuator may be a switch positioned on the mouse, track  
5 ball, digitising pen, light pen, keyboard, etc. When the cursor controller is a touch sensitive plate, a tactile pointing means, such as simply a finger, touching and/or lightly pressing against the touch sensitive plate is used to move the cursor on the display screen by moving the pointing means in the direction of desired cursor movement. In this case a click actuator is not necessary since the selection of a character may be performed by  
10 simply interrupting the connection between the tactile pointing means and the touch sensitive plate, i.e. by simply lifting the tactile pointing means. Alternatively to displaying the cursor on the display, a line segment connecting a centre point and the current cursor position may be displayed. Additionally, one or more of the previously drawn line segments may be displayed, so as to display the line segments corresponding to the  
15 character which is currently being selected. Thus, the line segments shown when a character has been selected corresponds to the line segments which it is necessary to draw in order to select that character again. This helps the user to acquire expert skills since it visualises the typing process.

Alternatively, the selector may comprise any combination of the above, e.g. a keyboard as  
20 well as a touch sensitive device. Thus, a user may choose whether he/she wishes to use the keyboard or the touch sensitive device for the selection procedure. When the user is in a 'relaxed' environment, e.g. at home, at the desk in the office, etc., he/she may choose the touch sensitive device since this may be quicker. When the user is in a more 'disturbing' environment, such as a train, a bus or in another environment in which  
25 vibrations or other disturbances makes it difficult to use the touch sensitive device in a sufficiently accurate manner, the user may choose to use the keyboard instead in order to minimise the errors during selection of characters. Furthermore, it may be desirable to use the keyboard rather than the touch sensitive device in case the user is wearing gloves.

Selection of an input to the apparatus is preferably performed by positioning the cursor  
30 within the boundary of a specific symbol, e.g. a specific character, and actuating the click actuator. When a touch sensitive plate is used, a symbol is selected for input to the apparatus by, e.g., increasing the pressure against the touch sensitive plate, decreasing the pressure, or completely removing the pressure, the click actuator being constituted by

the area of the touch sensitive plate receiving the increased/decreased/removed pressure. Thus, each of the displayed fields containing a symbol selectable for input constitutes an input actuator which is activated by positioning a cursor in the respective field and actuating the click actuator.

- 5 Preferably, symbols that upon selection result in display of fields containing a new set of symbols are selected simply by positioning of the cursor within the boundaries of the respective fields. More preferred, such symbols are selected by positioning the cursor within a part of the area occupied by the respective field of the symbol to be selected. For example, in a 3 by 3 matrix of fields containing symbols, when a new image of fields with  
10 symbols is displayed, the cursor is typically positioned at the centre field. A new symbol may be selected by moving the cursor outside the boundaries of an octagon that is larger than and covers the centre field before selection is enabled. Hereby, selection of fields positioned at the corners of the 3 by 3 matrix is facilitated. Likewise, if the cursor is positioned at a field with a symbol that may be selected with actuation of the click  
15 actuator, i.e. a field with an alphanumeric character, and the operator of the apparatus does not want to select that symbol, a new symbol may be selected by moving the cursor outside the boundaries of an octagon that is larger than and covers the current field. Thus, when the cursor is positioned within the boundaries of a field with a symbol that desirably is not selected, another symbol may be selected by moving the cursor outside a polygon,  
20 e.g. an octagon, that is greater than and covers the field currently containing the cursor. Hereby, a hysteresis is provided that makes selection easier to perform. The polygon need not be a regular polygon, for example if the fields are rectangular, the polygon preferably has a height to width ratio that corresponds to the height to width ratio of a field.
- 25 Alternatively, the boundaries for defining the selection area need not form a polygon. Other shapes which allow easy discrimination are also feasible. Thus, the shape could, e.g., be such that the apparent angular opening of each selection possibility is similar. The boundaries may, e.g., follow a parabolic curve. Furthermore, in order to ease selection, the scaling, e.g. the movement of the tactile pointing means and the movement of the  
30 cursor on the display, might be anisotropic. Typically, the x-axis may be scaled between 1.4 and 1.6 times while the y-axis is not scaled, thus mapping a square on the touch sensitive device into a rectangular shape on the display area. This makes it easier for the user to discriminate by pointing in different directions with the finger.

In the field of computers, it is well known to use context sensitive menus that are activated by actuation of a click actuator, such as a click of the right button on a mouse. Upon activation, a menu that is related to the actual user context is displayed. Likewise, the display of the apparatus according to the present invention may be used for a specific purpose, such as display of a string of previously selected characters that have been input to the apparatus, until actuation of a specific input actuator, such as touching of a touch sensitive plate or display, activation of a cursor controller, etc. Upon such actuation the first set of graphical symbols is displayed in the display. When a new character has been selected, as previously described, the new character is appended to the string of previously selected characters and the updated string is displayed. Thus, the present invention has the inherent capability to allow use of the display in a manner alternating between the text being written and the means for inputting new characters, and the alternation may be performed by the actuation of a specific actuator, similar to the manner in which context sensitive menus are normally used in the field of computers.

15 The cursor controller may comprise a key for movement of the cursor one step in a specific direction in the matrix arrangement. For example, the cursor controller may comprise eight separate keys for moving the cursor one step to the "east", "south-east", "south", "south-west", "west", "north-west", "north", and "north-east" respectively in the matrix arrangement. If the keys used are designated numeric values as well, then these values might be used to indicate the direction, e.g. if a numeric keypad arrangement is used with the numbers 1-9, then direction "1" might be the same as "north-west", the direction "2" might be the same as "north", etc. The key "5", in this embodiment, does not correspond to any direction, but might still be used as an activation means. Using such a keyboard facilitates memorising of the directions by using the numeric values. Thus, it might be easier to accomplish 'expert skills' using this embodiment. Alternatively, the cursor controller may comprise a key having a plurality of pressure sensitive regions for individual selection of the desired direction of cursor movement.

Upon selection of a specific symbol from the first set of graphical symbols, a second set of symbols may be displayed in an arrangement that is similar to the arrangement of the first set of symbols. The cursor may automatically be re-positioned at the centre of the arrangement, or the cursor may be maintained at the same relative position in the arrangement of the displayed set of graphical symbols as the position of the selected symbol in the arrangement of the previously displayed set of symbols.

At start-up, the input actuators are associated with fields containing first graphical symbols. The fields may for example be displayed on a display screen. Upon selection of symbols new graphical symbols are allocated to the input actuators as for example displayed on the display screen. The apparatus may comprise an input actuator for re-  
5 allocating the fields containing the first graphical symbols to the respective input actuators, e.g. thereby displaying the start-up image on the display again. This allows the user to abandon previous selections without inputting data to the apparatus.

Likewise, at least three consecutive actuations of one of the input actuators with associated fields containing first graphical symbols may result in re-allocation of the fields  
10 containing the first graphical symbols to the respective input actuators. Thus, in the example with a display, e.g., three or four consecutive selections of the same actuator leads to display of the start-up image. Again this allows the user to browse through the layers of selections and abandon previous selections without inputting data to the apparatus.

15 It is preferred that upon selection of an individual character, the fields containing the first graphical symbols are re-allocated to the respective input actuators. Thus, in the exemplary embodiment with a display, the start-up image is displayed upon selection of a character for input to the apparatus.

At least one of the fields containing graphical symbols and associated with respective  
20 input actuators may remain unchanged upon activation of a specific input actuator. For example, as further described with reference to Fig. 4, the input actuators may function as numerical keys during inputting of a decimal number to the keyboard, or specific input actuators may function as navigation (i.e. arrow) keys for a cursor during movement of the cursor.

25 The apparatus may further comprise an input actuator for switching between a first graphical symbol and a second graphical symbol in a field. For example, as further described below with reference to Fig. 4, an input actuator may cause shifting between upper and lower case symbols displayed in the fields.

A field may contain a string of characters, such as "point, space", for selection by  
30 actuation of the corresponding actuator.



Further, a field may contain a string of control characters, such as "carriage return, line feed" for selection by actuation of the corresponding actuator.

The selected characters may be appended successively in a string of characters that are input to the apparatus, and the string of selected characters may be displayed on the display, e.g. in a specific area of the display. Alternatively, the string may be displayed in an area of the display also used for display of the fields associated with input actuators. In this case, the string is displayed upon selection of a character. The fields may then be displayed again upon activation of an input actuator. Thus, the display may alternate between displaying the string of selected characters and the fields containing graphical symbols. This is very desirable when using small apparatuses, such as mobile phones, portable computers etc., where only a limited amount of space is available for display purposes. In this case the display is normally relatively small, and it is a great advantage that the display area is reused.

An edit cursor may be provided within the string of selected characters, and an input actuator may further be provided with an associated field containing a symbol of a cursor control character for controlling the positioning of the edit cursor in the string of selected characters by actuation of the input actuator. If the input device of the apparatus comprising a pointing device, the edit cursor may be directly controlled by the pointing device. Thus, if a pointing device, such as a touch sensitive plate, is used for input, the edit cursor might be controlled directly such that text can be added or deleted at the position of the edit cursor.

The set of characters may preferably be specifically tailored to suit the geographic area in which the apparatus is intended for use. Thus, it can be adapted to a specific national set of characters in order to avoid frequent use of accents. Thus, when the user is German it should be possible to write the letters ß, ä, ö, and ü directly. Similarly, if the user is Danish, it should be possible to write the letters æ, ø, and å directly, etc.

It is seen that in an embodiment of the present invention comprising a cursor and a cursor controller, a specific symbol, such as an alphabetic character, is selected by drawing a graphical sign constituted by one or two linear segments with the cursor. Thus, a user may enter words and numbers by drawing simple graphical signs on the touch sensitive device in a simple handwriting way. This will enable the user to quickly learn how to enter

specific symbols without referring to the displayed symbols whereby an extremely efficient and easy to learn user interface is provided. In embodiments comprising a sound generator, a specific sound, such as a specific tone, may be generated for each linear segment drawn by the cursor. For example, a first tone may be generated upon drawing a  
5 vertical line to the north, a second sound may be generated upon drawing a horizontal line to the east, etc. Thus, in a 3 by 3 matrix, each selection of a symbol for input to the apparatus results in generation of a unique sound signature, such as a sequence of two or three tones.

The invention is well adapted for use in communication equipment, e.g. with a WAP  
10 interface, equipped with a small screen, such as a telephone, such as a mobile phone, a portable phone, etc., a remote controller, e.g. for video or audio equipment, or for other house appliances, a portable computer, a portable electronic calendar, etc.

The invention may also be advantageously applied in systems with user interfaces incorporating a large display screen or a large keyboard to adapt the system for use by a  
15 disabled person who can only operate a small part of the keyboard or use a small part of the display screen, or who needs a crude resolution on the screen due to visual impairment.

Further, the invention may also be advantageously applied in systems with user interfaces that are adapted for use by disabled users, for example systems with pointing plates, or  
20 pointers that are moved by the head or a foot, etc.

Further, the invention may be used as a communication means for blind people. Because it is very simple to learn to enter characters by means of a few strokes by a tactile pointing means on a touch sensitive device or by means of a few simple keyboard operations, blind people could easily acquire the necessary skills, and, thus, be able to type quickly  
25 using the invention. Furthermore, an audio feedback would in this case be very useful since this would provide the user with the possibility of checking whether errors occur during the typing. The present invention might also constitute a new means for reading as an alternative to the Braille alphabet. The characters may basically be formed by one or two connected vector(s) which might be implemented in cuneiform or using a dot for the  
30 starting point on the line which might be sensed similar to Braille.

According to another aspect of the invention there is provided an apparatus with an input device comprising a selector for selection of characters and having input actuators with associated fields containing graphical symbols, the apparatus further comprising a display screen and a symbol generator for displaying the fields containing the first set of graphical  
5 symbols in an arrangement on the display screen

characterised in that

the display is positioned on a first surface of the apparatus, and

the selector is positioned on a second surface of the apparatus, said second surface being arranged opposite said first surface.

10 Thus, according to this aspect of the invention, the display and the selector are positioned on opposite surfaces of the apparatus, e.g. a 'front surface' and a 'back surface' of the apparatus, respectively.

The selector may comprise a touch sensitive device, such as a touch sensitive display and/or a number of keys, e.g. arranged in a keyboard.

15 In ordinary small electronic devices, such as mobile phones, WAP phones, palmtop computers, pocket calculators and/or remote control units for electronic appliances, the selector, i.e. the touch sensitive device and/or the keys, is often organised below the display on the front of the device. Therefore, the device has to be large enough to accommodate a display as well as a selector on one side of the device. Alternatively, the  
20 display and/or the selector is/are made relatively small in order to make the whole device smaller. According to the present invention, however, the display and the selector are positioned on opposite surfaces of the apparatus. Therefore the apparatus may be made smaller without sacrificing the size of either the display or the selector. Alternatively, the display and/or the selector may be made larger without increasing the overall size of the  
25 apparatus.

It is a great advantage that the finger of the person operating the apparatus does not obscure the display or the keys labels since this makes it more clear which key will be

selected by a certain operation, thus minimising the risk of erroneous selections or operations.

An apparatus according to this aspect of the invention is very easily and naturally operated by one hand since the operator can easily operate the selector positioned on the  
5 'back surface' of the apparatus while looking at the display positioned on the 'front surface' of the apparatus.

The display preferably shows the selection possibilities to the user, e.g. in a matrix arrangement corresponding to the selector on the opposite side. Thus, the display operates as labelling for the actuators, e.g. keys.

10 A cursor may be displayed on the display, said cursor indicating the operations performed by means of the selector.

In case the selector comprises a touch sensitive device, it may be operated using a finger for pointing while the cursor shows the current position of the finger on the display. When the cursor is pointing at a certain key label this may be selected, e.g. by pressing harder  
15 or by removing the finger from the touch sensitive device.

At least the display and the selector may be made from a transparent material. Preferably, any components etc. which might be positioned between the display and the selector is also made from a transparent material, thus making the apparatus transparent, at least in a region containing the display and the selector. Thus, the operator can simultaneously  
20 look at the display and the movements of his/her finger on the selector.

The apparatus is preferably adapted for use in a hand held device, such as a mobile phone or a remote controller, e.g. a remote controller for audio or video equipment.

It may be possible to tailor the apparatus 'on the fly' for different applications, e.g. the TV loads the programme for a remote controller into a mobile phone, e.g. using wireless  
25 technology similar to the technology used when browsing the Internet on a computer. Thus, the mobile phone may be used as remote controller.

#### BRIEF DESCRIPTION OF THE DRAWINGS

The invention will now be described in greater detail with reference to the drawings, in which

Fig. 1 shows a blocked schematic of a first embodiment of the present invention,

5 Fig. 2 illustrates the operation of the first embodiment of the present invention,

Fig. 3 illustrates how signs of selected characters are drawn by cursor movement, and

Fig. 4 illustrates the operation of a second embodiment of the present invention.

#### DETAILED DESCRIPTION OF PREFERRED EMBODIMENTS

Fig. 1 shows a blocked schematic of an input device or a user interface 10 according to  
10 the present invention. The input device 10 comprises a display screen 60, and a symbol generator 50 for displaying a first set of graphical symbols 70 in an arrangement, in this embodiment a 3 by 3 matrix arrangement, on the display screen 60. It has been found that a 3 by 3 matrix arrangement provides a clear display of options that is well-suited for the display screen of a portable or mobile phone. Each of the selectable graphical  
15 symbols 70 is displayed in a distinct field that is graphically distinguished from its surroundings by means of a boundary forming a rectangle.

The input device 10 further comprises a selector 20 for selection of a symbol among symbols 70 displayed on the display screen 60. The selector 20 comprises a moveable cursor (not shown) that is displayed on the display screen, and a touch sensitive plate for  
20 manually controlling the position of the cursor on the display screen. The touch sensitive plate may for example be mounted at the back of communication equipment, e.g. at the back of a mobile phone. A tactile pointing means 80, such as simply a finger 80 as indicated in Fig. 1, touching and/or lightly pressing against the touch sensitive plate is used to move the cursor on the display screen 60 by moving the finger in the direction of  
25 desired cursor movement. When the cursor is positioned within the boundary of a specific symbol to be selected for input to the apparatus, that symbol may be selected, e.g.,

simply by stopping touching the plate, or by increasing the pressure against the touch sensitive plate.

The input device 10 further comprises a controller 40 that is operatively connected to the symbol generator 50 and the selector 20. As further described below with reference to  
5 Figs. 2-4, the controller 40 is adapted to control the symbol generator 50 to display a second set of graphical symbols in response to a selection of a symbol 70 from the first set of graphical symbols. Such a selection is performed simply by positioning of the cursor within the boundaries of the respective fields. In the present example, a symbol 70 may be selected by moving the cursor outside the boundaries of an octagon surrounding the  
10 present field before the said selection is enabled. Hereby, especially selection of fields positioned at the corners of the 3 by 3 matrix is facilitated.

In the illustrated embodiment some of the symbols 70 of the first set of symbols indicates a first set of alphabetic characters in alphabetic order, i.e. h-n, o-u, w-ø, a-g. The second set of graphical symbols displayed in response to the selection of one of these symbols  
15 comprises graphical symbols corresponding to the characters of the selected first set of alphabetic characters.

Fig. 2 illustrates the operation of the first embodiment of the invention wherein selectable graphical symbols 70 are displayed in a 3 by 3 matrix 100. Fig. 2 illustrates selection of characters typically provided on a standard Danish keyboard which is similar to an English  
20 keyboard with addition of the three national characters "æ", "ø", and "å" in both lower case and upper case versions.

The start-up image 100 displayed on the display screen 60 is shown at the centre of Fig. 2 and contains a first set of graphical symbols 70 in a 3 by 3 matrix arrangement. As indicated in Fig. 2, it is possible to select any alphabetic character, the digits 0-9, and  
25 various other keyboard symbols, such as ".", ",", ";", space, etc. The eight second display images 110-180 shown adjacent to and surrounding the start-up display image 100 are images that are displayed on the display screen 60 upon selection of the corresponding symbols 70 in display image 100 as indicated by the corresponding lines connecting display image 100 and respective second display images 110-180. The eight second  
30 display images 110-180 contain the respective second sets of graphical symbols to be

displayed in response to a selection of the corresponding symbol from the first set of symbols 100.

For example, if the symbol "h-n" is selected, the second image 110 immediately above and to the left of the centre image 100 will be displayed, wherein each of the characters h, i, j, k, l, m, and n is displayed in a separate field for individual selection. When the new image 110 is displayed, the cursor is automatically repositioned to the centre of the image, i.e. in this example the cursor is re-positioned at "h". If it is desired to select the letter "j", the cursor is moved down to "j" and the symbol "j" is selected, e.g., simply by stop touching the plate as previously described.

10 It should be noted that each of the second sets of graphical symbols displayed in second display images 110, 120, 130, and 180 contains a symbol that is a case shifted version of the first set of alphabetic characters of the selected first symbol. For example in second display image 110, one of the displayed fields contains a symbol "H-N" for selection of the previously selected characters in upper case. The symbol "H-N" is positioned at the same  
15 relative position in the displayed image as the previously selected symbol "h-n" so that the upper case characters can be selected by continuing the movement of the cursor in the same direction as the previous direction of cursor movement that lead to the actual symbol selection. Thus, to select capital "J", the cursor is moved from its centre position in image 100 "north-west" to the symbol "h-n" and the symbol "h-n" is selected. In the new  
20 second displayed image 110, the cursor is moved further "north-west" to the symbol "H-N" that is selected, and in the third display image 190, the cursor is moved "south-west" to the symbol "J" that is selected.

In a first mode of operation, the start-up image 100 is displayed with the cursor automatically re-positioned at the centre of the start-up image 100 ready for selection of  
25 the next desired character upon selection of an individual character, such as "A", "=", "£", etc., or the selection of a combination of characters, such as ". (space)" 162, or " (space)" 164.

It should be noted that a previously displayed image may be displayed again by moving the cursor in the opposite direction of the previous cursor movement. For example in  
30 second display image 110, moving the cursor from its centre position at the symbol "h" to the north-west symbol "H-N" and selecting this symbol results in the display of third

display image 190. Moving the cursor back in direction south-east from symbol "H" to symbol "h-n" and selecting this symbol results in the re-display of second display image 110. This allows the user to browse the symbols available for selection without performing a selection. Similarly, if the input actuators are constituted by keyboard keys, a previously  
5 displayed image may be selected by actuation of a key that is a mirror of the previously actuated key with respect to a centre of the keyboard. For example, in a 3 by 3 keyboard, if an image is displayed upon actuation of the north-west key, the previously displayed image may be displayed again by actuation of the south-east key.

Selection of symbol 76 results in display of image 100. It should be noted that symbol 76  
10 is positioned so that three successive movements of the cursor in the same direction from image 100 results in re-display of image 100 without a selection of a character. Similarly, if the input actuators are constituted by keyboard keys, three consecutive actuations of the same key may result in re-display of image 100.

The selected characters may be appended in a character string, e.g. for transmission as a  
15 SMS message. The character string may be showed in a separate area of the display 60, or in the same display area of the display 60 where the first set of graphical symbols 70 is shown. The character string may be scrolled by selection of corresponding scroll symbols from one of the displayed set of graphical symbols 220. To delete a character that has  
20 been appended to the character string, the backspace symbol 151 of image 150 may be selected. Further, an edit cursor may be displayed within the displayed character string to allow editing of the character string, and input actuators 222, 224, 226, 228 may be provided for movement of the edit cursor.

It should be noted that the input device may be adapted to display any desired number of selectable graphical symbols by adapting the system to display further new images with  
25 new sets of symbols upon selection of displayed symbols of the currently displayed image that have previously been described to lead to selection of an input to the apparatus. For example in Fig. 2 four optional third display images 200, 210, 220, 230 are shown. Further (not shown in Fig. 2), selection of specific symbols displayed in a third display image may lead to display of a fourth display image with a fourth set of selectable graphical symbols,  
30 etc.



The input device may operate in a second mode of operation that is different from the first mode described previously. For example, upon selection of one of the edit cursor arrows 222, 224, 226, 228 displayed in third display image 220 for navigation of the edit cursor within the text string being input to the apparatus, the third display image 220 is displayed  
5 until the desired edit cursor position is obtained by sequential selections of the appropriate arrow symbols 222, 224, 226, 228 and the apparatus returns to the first mode upon selection of the symbol 76 and the start-up image 100 is displayed.

In an alternative embodiment of the present invention, the movement of the edit cursor may be controlled with a small keyboard with 8 separate logic keys for moving the edit  
10 cursor one step to the "east", "south-east", "south", "south-west", "west", "north-west", "north", and "north-east" in the matrix arrangement, or the keyboard may contain a single key with 8 pressure sensitive regions for individual selection of the desired direction of edit cursor movement.

In Fig. 3 character selection is illustrated in another way to more clearly show how  
15 selected characters are drawn by movement of the cursor. It is shown that a specific symbol, such as "s", and "P", is selected by drawing a graphical sign constituted by two linear segments with the cursor. Thus, a user may enter words and numbers by drawing simple signs constituted by one or two linear segments on the input device. This will enable the user to quickly learn how to enter specific symbols without referring to the  
20 displayed symbols whereby an extremely efficient and easy to learn user interface is provided.

It should be noted that repeated drawing of a graphical sign selects the same character, regardless of the starting point for the movement on the display screen.

Fig. 4 illustrates the operation of another apparatus according to the invention with a  
25 selector 200 that includes a 3 by 3 keyboard 202 of the type typically provided with a telephone, such as a mobile phone. The selector 200 further includes three keys 205, 206, 207 designated mode keys 204. Selected characters are appended to a string of characters that is displayed in a specific area of the display screen of the apparatus.

Selectable graphical symbols are displayed in 3 by 3 matrices as indicated in frames 210,  
30 220, and 230. Upon initiation of the apparatus, frame 220 is displayed on the display of

the apparatus. Activation of mode key 205 toggles the display between frame 220 and 230, and activation of mode key 207 toggles the display between frame 210 and actual frame 220 or 230.

When frame 210 is displayed, one of the digits 1-9 may be selected by pressing the  
5 corresponding one of the selector keys 202. Pressing key 206 results in selection of digit 0.

When frame 220 or 230 is displayed, key 206 acts as a space key.

The possible character selections when frame 220 is displayed are illustrated in Fig. 4b ,  
frames 221-229. For example, if key "5jkl" is pressed, frame 225 is displayed and thus,  
10 pressing key "6mno" leads to selection of the character ")".

It should be noted that control characters are included in the set of selectable characters,  
e.g. pressing key "5jkl" twice when frame 220, or 230, is displayed results in selection of  
control characters "carriage return" and "line feed".

It is also possible to select a string of characters. For example, pressing key "8tuv" twice  
15 when frame 220 is displayed results in selection of a character string consisting of ".",  
"space", and "upper case". This string is intended for selection at the end of a sentence  
since a "." is often followed by a space and the first letter of the next sentence starts with a  
capital character.

The possible character selections when frame 230 is displayed are illustrated in the lower  
20 part of Fig. 4 in frames 231-239. For example, if key "2abc" is pressed, frame 232 is  
displayed and thus, pressing key "3def" leads to selection of the character "C".

## CLAIMS

1. An apparatus with an input device comprising a selector for selection of characters and having input actuators with associated fields containing first graphical symbols,

characterised in that

5 the apparatus further comprises

a display screen,

a symbol generator for displaying the fields containing the first set of graphical symbols in an arrangement on the display screen, and

a controller that is operatively connected to the symbol generator and the selector,

10 and in that at least one of the first graphical symbols indicates a first set of alphabetic characters in alphabetic order and in that actuation of the corresponding input actuator results in allocation of each of the alphabetic characters in the first set of alphabetic characters to a specific input actuator so that actuation of that input actuator results in selection of the allocated alphabetic character, and in that the apparatus comprises  
15 means for guiding a user during selection of an alphabetic character, and in that selection of specific alphabetic characters is sufficiently simple to allow a user to memorise the selection procedure.

2. An apparatus according to claim 1, further comprising a sound generator for generation of a specific sound upon actuation of a corresponding actuator.

20 3. An apparatus according to claim 1 or 2, wherein the selector comprises a keyboard with keys constituting the input actuators.

4. An apparatus according to claim 3, wherein the first graphical symbols are printed on the respective keys.

5. An apparatus according to any of the preceding claims, wherein the controller is adapted to control the symbol generator to display a second set of graphical symbols in the fields in response to actuation of an actuator with an associated field with a symbol that indicates a first set of alphabetic characters in alphabetic order, the second set of  
5 graphical symbols comprising graphical symbols corresponding to the respective characters of the first set of alphabetic characters.
6. An apparatus according to any of the preceding claims, wherein the selector comprises a touch sensitive device, and wherein a specific directional movement on said touch sensitive device by a tactile pointing means corresponds to selection of a specific  
10 actuator.
7. An apparatus according to claim 6, said apparatus being a hand held apparatus, wherein the touch sensitive device is positioned on a surface of the apparatus being opposite the surface exhibiting the display.
8. An apparatus according to any of claims 1-5, wherein the selector comprises a number  
15 of keys corresponding to the actuators, and wherein actuation of a specific key corresponds to actuation of the corresponding actuator, wherein said keys are positioned on a surface of the apparatus being opposite the surface exhibiting the display.
9. An apparatus according to any of claims 5-8, wherein the fields containing the first set of graphical symbols are displayed upon actuation of a specific actuator.
- 20 10. An apparatus according to any of claims 5-9, wherein at least one second symbol of the second set of symbols indicates a second set of alphabetic characters in alphabetic order and wherein the controller is further adapted to control the symbol generator to display graphical symbols in the fields corresponding to the respective characters of the second set of alphabetic characters in response to actuation of the actuator with the  
25 associated field containing the at least one second symbol.
11. An apparatus according to claim 10, wherein the second set of alphabetic characters is a case shifted version of the first set of alphabetic characters of the selected first symbol.

12. An apparatus according to claim 11, wherein the second symbol is displayed at the same relative position in the arrangement as the selected first symbol.
13. An apparatus according to any of claims 5-12, wherein the arrangement constitutes a 3 by 3 matrix.
- 5 14. An apparatus according to any of claims 5-13 as dependant on claims 2 or 3, wherein the arrangement of displayed symbols corresponds to a key matrix arrangement of the keyboard.
15. An apparatus according to any of claims 5-14, wherein the display is a touch sensitive display for selection of a graphical symbol by tactile interaction with the field containing  
10 the symbol.
16. An apparatus according to any of claims 5-15, wherein the selector comprises a moveable cursor that is displayed on the display screen, a cursor controller for manually controlling the position of the cursor on the display screen, and a click actuator for selection of the symbol at the current cursor position.
- 15 17. An apparatus according to claim 16, wherein symbols that upon selection result in display of fields containing a new set of symbols are selected simply by positioning of the cursor within the boundaries of the respective fields.
18. An apparatus according to claim 17, wherein symbols that upon selection result in display of fields containing a new set of symbols are selected by positioning of the cursor  
20 within a part of the area occupied by the respective field.
19. An apparatus according to claim 18, wherein the part of the area occupied by the respective field is positioned outside a polygon, such as an octagon, that is larger than and covers a selectable field of the arrangement.
20. An apparatus according to any of the preceding claims, further comprising a sound  
25 generator for generation of a specific sound upon actuation of a corresponding actuator to provide feedback to the user of the apparatus of the actual actuation.

21. An apparatus according to any of claims 16-20, wherein the cursor controller comprises a key for movement of the cursor one step in a specific direction in the matrix arrangement.
22. An apparatus according to claim 21, wherein the key has a plurality of pressure  
5 sensitive regions for individual selection of the desired direction of cursor movement.
23. An apparatus according to claim 21 or 22, further comprising 8 separate logic keys for moving the cursor one step to the "east", "south-east", "south", "south-west", "west", "north-west", "north", and "north-east" respectively in the matrix arrangement.
24. An apparatus according to any of claims 15-23, wherein the moveable cursor,  
10 immediately upon selection of a symbol, is repositioned at a centre of the arrangement of the displayed set of symbols.
25. An apparatus according to any of claims 15-23, wherein the moveable cursor, immediately upon selection of a symbol, is maintained at the same relative position in the arrangement of the displayed set of graphical symbols as the position of the selected  
15 symbol in the arrangement of the previously displayed set of symbols.
26. An apparatus according to any of the preceding claims, further comprising an input actuator for re-allocating the fields containing the first graphical symbols to the respective input actuators.
27. An apparatus according to any of the preceding claims, wherein at least three  
20 consecutive actuations of one of the input actuators with associated fields containing first graphical symbols results in re-allocation of the fields containing the first graphical symbols to the respective input actuators.
28. An apparatus according to any of the preceding claims, wherein selection of an individual character results in re-allocation of the fields containing the first graphical  
25 symbols to the respective input actuators.

29. An apparatus according to any of the preceding claims, wherein at least one of the fields containing graphical symbols and associated with respective input actuators remain unchanged upon activation of a specific input actuator.
30. An apparatus according to any of the preceding claims, further comprising an input  
5 actuator for switching between a first graphical symbol and a second graphical symbol in a field.
31. An apparatus according to any of the preceding claims, further comprising an input actuator with an associated field containing a string of characters for selection by actuation of the actuator.
- 10 32. An apparatus according to any of the preceding claims, further comprising an input actuator with an associated field containing a string of control characters for selection by actuation of the actuator.
33. An apparatus according to any of the preceding claims, wherein selected characters are appended successively in a string of characters that are input to the apparatus.
- 15 34. An apparatus according to claim 33, wherein the string of selected characters is displayed on the display.
35. An apparatus according to claim 34, wherein the string is displayed upon selection of a character.
36. An apparatus according to claim 34 or 35, wherein the display may alternate between  
20 displaying the string of selected characters and the fields containing graphical symbols.
37. An apparatus according to any of claims 34-36, further comprising an edit cursor within the string of selected characters.
38. An apparatus according to claim 37, further comprising an input actuator with an associated field containing a symbol of a cursor control character for controlling the  
25 positioning of the edit cursor in the string of selected characters by actuation of the input actuator.

39. An apparatus according to claim 37 or 38, the input device of the apparatus comprising a pointing device, wherein the edit cursor is directly controlled by the pointing device.
40. An apparatus according to any of the preceding claims that is adapted for use in a  
5 telephone.
41. An apparatus according to any of the preceding claims that is adapted for use in a remote controller.
42. An apparatus according to any of the preceding claims that is adapted for use in a remote controller for video equipment.
- 10 43. An apparatus according to any of the preceding claims that is adapted for use in a WAP device or any kind of computer or microcomputer.
44. A method of inputting data to an apparatus with an input device comprising a selector for selection of characters and having input actuators with associated fields containing first graphical symbols, at least one of the first graphical symbols indicating a first set of  
15 alphabetic characters in alphabetic order, the apparatus further comprising a display screen, a symbol generator for displaying the fields containing the first set of graphical symbols in an arrangement on the display screen, and a controller that is operatively connected to the symbol generator and the selector, the method comprising the steps of:
- 20 actuation of an input actuator with an associated field containing a symbol indicating a first set of alphabetic characters in alphabetic order, and
- allocation of each of the alphabetic characters in the first set of alphabetic characters to a specific input actuator so that actuation of that input actuator results in selection of the allocated alphabetic character,
- 25 the steps being performed in such a way that a user is guided by the apparatus during selection of an alphabetic character, and in such a way that selection of a specific alphabetic character is sufficiently simple to allow a user to memorise the selection procedure.



45. A method according to claim 44, further comprising a sound generator for generation of a specific sound upon actuation of a corresponding actuator.
46. A method according to claim 44 or 45, wherein the selector comprises a keyboard with keys constituting the input actuators.
- 5 47. A method according to claim 46, wherein the first graphical symbols are printed on the respective keys.
48. A method according to any of claims 44-47, further comprising the steps of
- displaying the fields containing the first set of graphical symbols in an arrangement on the display screen,
- 10 displaying a second set of graphical symbols in the fields in response to actuation of an actuator with an associated field with a symbol that indicates a first set of alphabetic characters in alphabetic order, the second set of graphical symbols comprising graphical symbols corresponding to the respective characters of the first set of alphabetic characters.
- 15 49. A method according to claim 48, wherein the fields containing the first set of graphical symbols are displayed upon actuation of a specific actuator.
50. A method according to claim 48 or 49, wherein at least one second symbol of the second set of symbols indicates a second set of alphabetic characters in alphabetic order and further comprising the step of displaying graphical symbols in the fields corresponding
- 20 to the respective characters of the second set of alphabetic characters in response to actuation of the actuator with the associated field containing the at least one second symbol.
51. A method according to claim 50, wherein the second set of alphabetic characters is a case shifted version of the first set of alphabetic characters of the selected first symbol.
- 25 52. A method according to claim 51, wherein the second symbol is displayed at the same relative position in the arrangement as the selected first symbol.

53. A method according to any of claims 48-52, wherein the arrangement constitutes a 3 by 3 matrix.
54. A method according to any of claims 48-53 as dependant on claims 46 or 47, wherein the arrangement of displayed symbols corresponds to a key matrix arrangement of the  
5 keyboard.
55. A method according to any of claims 44-54, further comprising the steps of displaying a moveable cursor on the display screen, manually controlling the position of the cursor on the display screen, and selecting the symbol at the current cursor position.
56. A method according to claim 55, wherein symbols that upon selection result in display  
10 of fields containing a new set of symbols are selected simply by positioning of the cursor within the boundaries of the respective fields.
57. A method according to claim 56, wherein symbols that upon selection result in display of fields containing a new set of symbols are selected by positioning of the cursor within a part of the area occupied by the respective field.
- 15 58. A method according to claim 57, wherein the part of the area occupied by the respective field is positioned outside a polygon, such as an octagon, that is larger than and covers a centre field of the arrangement.
59. A method according to any of claims 44-58, further comprising a sound generator for generation of a specific sound upon actuation of a specific actuator.
- 20 60. A method according to any of claims 55-59, further comprising the step of moving the cursor one step in a specific direction in the matrix arrangement using a key.
61. A method according to claim 60, wherein the key has a plurality of pressure sensitive regions for individual selection of the desired direction of cursor movement.
62. A method according to claim 60 or 61, further comprising the step of moving the  
25 cursor one step to the "east", "south-east", "south", "south-west", "west", "north-west", "north", and "north-east" in the matrix arrangement using eight separate respective keys.

63. A method according to any of claims 55-62, further comprising the step of repositioning the moveable cursor, immediately upon selection of a symbol, at a centre of the arrangement of the displayed set of symbols.

64. A method according to any of claims 55-62, further comprising the step of maintaining  
5 the moveable cursor, immediately upon selection of a symbol, at the same relative position in the arrangement of the displayed set of graphical symbols as the position of the selected symbol in the arrangement of the previously displayed set of symbols.

65. A method according to any of claims 44-64, further comprising the step of re-allocating the fields containing the first graphical symbols to the respective input actuators upon  
10 actuation of a specific input actuator.

66. A method according to any of claims 44-65, further comprising the step of re-allocation of the fields containing the first graphical symbols to the respective input actuators upon three consecutive actuations of one of the input actuators with associated fields containing first graphical symbols.

15 67. A method according to any of claims 44-66, further comprising the step of re-allocation of the fields containing the first graphical symbols to the respective input actuators upon selection of an individual character.

68. A method according to any of claims 44-67, wherein at least one of the fields containing graphical symbols and associated with respective input actuators remain  
20 unchanged upon activation of a specific input actuator.

69. A method according to any of claims 44-68, further comprising the step of switching between a first graphical symbol and a second graphical symbol in a field upon actuation of a input actuator.

70. A method according to any of claims 44-69, further comprising the step of displaying a  
25 field containing a string of characters for selection.

71. A method according to any of claims 44-70, further comprising the step of displaying a field containing a string of control characters for selection.

72. A method according to any of claims 44-71, further comprising the step of appending selected characters successively in a string of characters that are input to the apparatus.

73. A method according to claim 72 as dependant on any of claims 48-71, further comprising the step of displaying the string of selected characters on the display.

5 74. A method according to claim 73, wherein the string is displayed upon selection of a character.

75. A method according to claim 73 or 74, wherein the display may alternate between displaying the string of selected characters and the fields containing graphical symbols.

76. A method according to any of claims 73-75, further comprising the step of displaying  
10 an edit cursor within the string of selected characters.

77. A method according to claim 76, further comprising the step of displaying a field containing a symbol of a cursor control character for controlling the positioning of the edit cursor in the string of selected characters.

78. An apparatus with an input device comprising a selector for selection of characters  
15 and having input actuators with associated fields containing graphical symbols, the apparatus further comprising a display screen and a symbol generator for displaying the fields containing the first set of graphical symbols in an arrangement on the display screen

characterised in that

the display is positioned on a first surface of the apparatus, and

20 the selector is positioned on a second surface of the apparatus, said second surface being arranged opposite said first surface.

79. An apparatus according to claim 78, wherein the selector comprises a touch sensitive device.

80. An apparatus according to claim 78 or 79, wherein the selector comprises a number of keys.

81. An apparatus according to any of claims 78-80, wherein a cursor is displayed on the display, said cursor indicating the operations performed by means of the selector.

5 82. An apparatus according to any of claims 78-81, wherein at least the display and the selector are made from a transparent material.

83. An apparatus according to any of claims 78-82 that is adapted for use in a hand held device.

84. An apparatus according to any of claims 78-83 that is adapted for use in a mobile  
10 phone.

85. An apparatus according to any of claims 78-83 that is adapted for use in a remote controller.

1/6

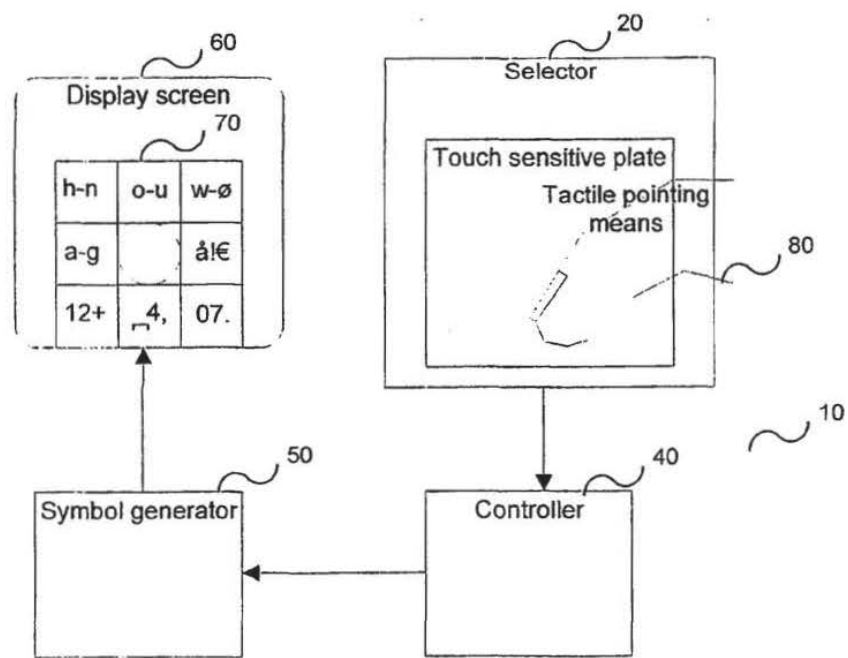

Fig. 1

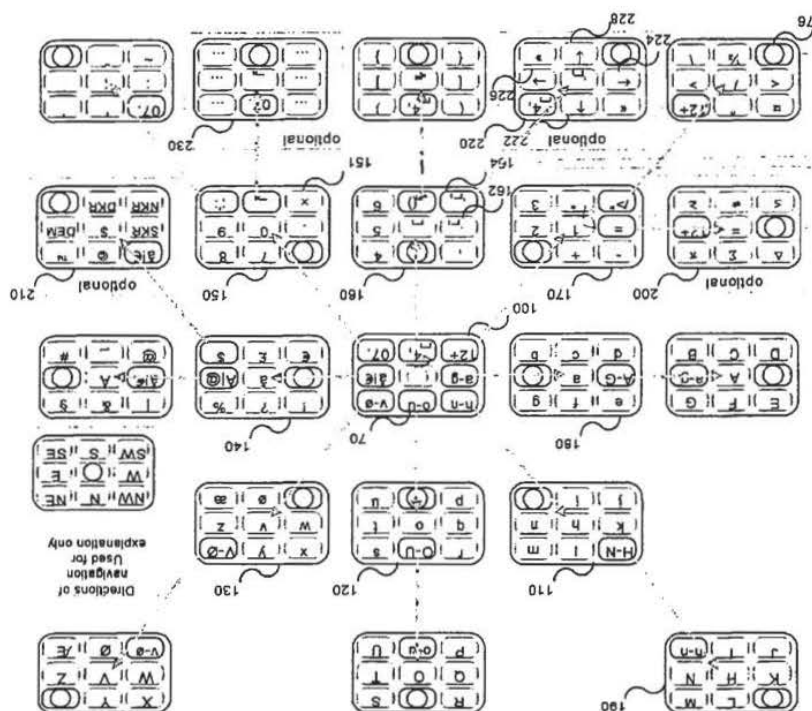

Fig. 2

3/6

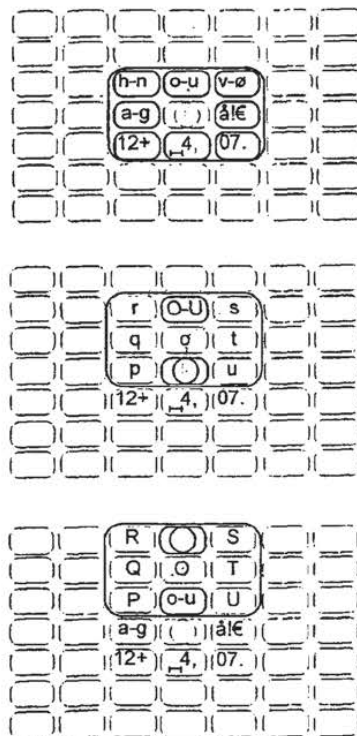

Fig. 3



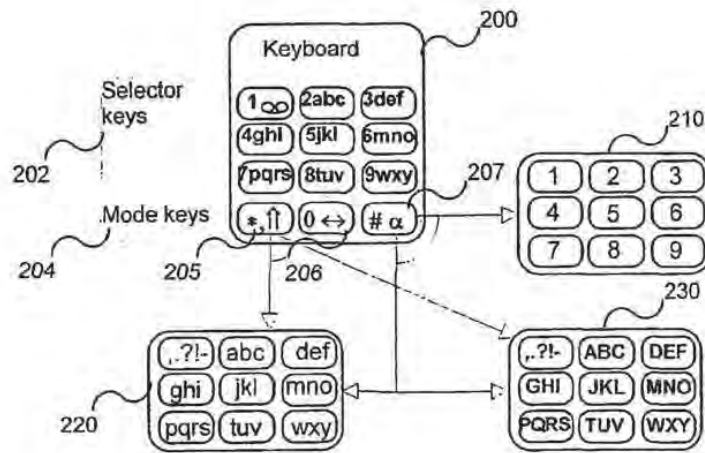

Fig. 4a

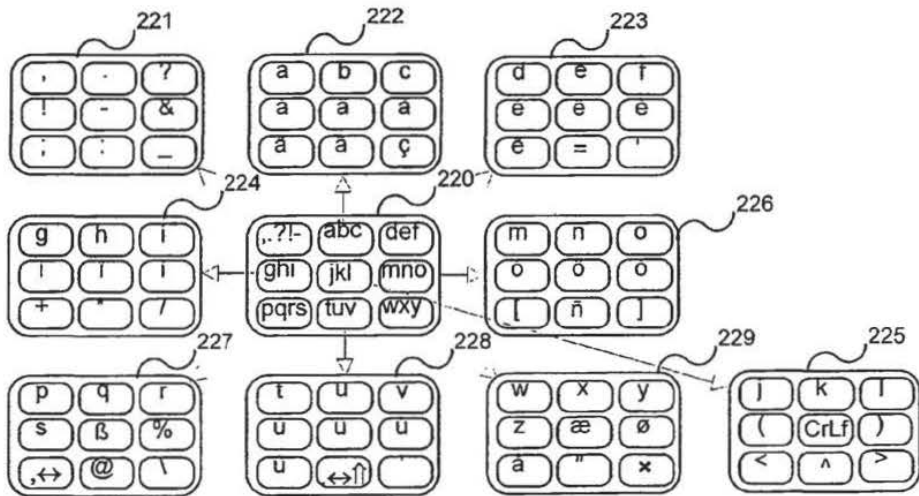

Fig. 4b

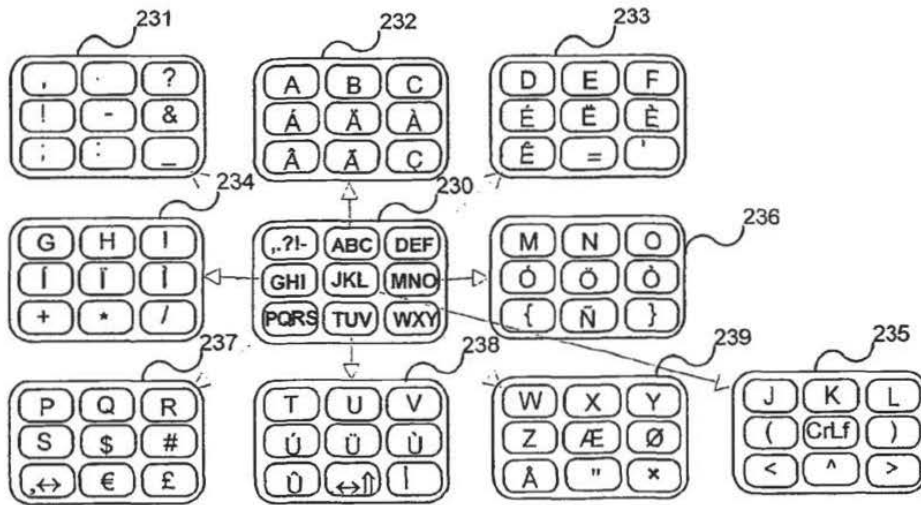

Fig. 4c

Electronic Patent Application Fee Transmittal				
<b>Application Number:</b>				
<b>Filing Date:</b>				
<b>Title of Invention:</b>		TEXT ENTRY METHOD AND DEVICE THEREFOR		
<b>First Named Inventor/Applicant Name:</b>		Matthew J. Bickerton		
<b>Filer:</b>		Michael E. Belk/Elissa DeLuccy		
<b>Attorney Docket Number:</b>		2001P00413US01		
Filed as Large Entity				
<b>Reissue (Utility) Filing Fees</b>				
Description	Fee Code	Quantity	Amount	Sub-Total in USD(\$)
<b>Basic Filing:</b>				
Utility Reissue Basic	1014	1	280	280
Design and Utility Reissue Basic	1114	1	600	600
Design and utility Reissue Basic	1314	1	2160	2160
<b>Pages:</b>				
<b>Claims:</b>				
<b>Miscellaneous-Filing:</b>				
<b>Petition:</b>				
<b>Patent-Appeals-and-Interference:</b>				

Description	Fee Code	Quantity	Amount	Sub-Total in USD(\$)
<b>Post-Allowance-and-Post-Issuance:</b>				
<b>Extension-of-Time:</b>				
<b>Miscellaneous:</b>				
<b>Total in USD (\$)</b>				<b>3040</b>

### Electronic Acknowledgement Receipt

<b>EFS ID:</b>	16464743
<b>Application Number:</b>	13955345
<b>International Application Number:</b>	
<b>Confirmation Number:</b>	6652
<b>Title of Invention:</b>	TEXT ENTRY METHOD AND DEVICE THEREFOR
<b>First Named Inventor/Applicant Name:</b>	Matthew J. Bickerton
<b>Customer Number:</b>	24737
<b>Filer:</b>	Michael E. Belk/Elissa DeLuccy
<b>Filer Authorized By:</b>	Michael E. Belk
<b>Attorney Docket Number:</b>	2001P00413US01
<b>Receipt Date:</b>	31-JUL-2013
<b>Filing Date:</b>	
<b>Time Stamp:</b>	13:59:11
<b>Application Type:</b>	Reissue (Utility)

#### Payment information:

Submitted with Payment	yes
Payment Type	Deposit Account
Payment was successfully received in RAM	\$ 3040
RAM confirmation Number	276
Deposit Account	141270
Authorized User	

The Director of the USPTO is hereby authorized to charge indicated fees and credit any overpayment as follows:

Charge any Additional Fees required under 37 C.F.R. Section 1.16 (National application filing, search, and examination fees)

Charge any Additional Fees required under 37 C.F.R. Section 1.17 (Patent application and reexamination processing fees)

Charge any Additional Fees required under 37 C.F.R. Section 1.19 (Document supply fees)					
Charge any Additional Fees required under 37 C.F.R. Section 1.21 (Miscellaneous fees and charges)					
<b>File Listing:</b>					
Document Number	Document Description	File Name	File Size(Bytes)/ Message Digest	Multi Part /.zip	Pages (if appl.)
1	Application Data Sheet	2001P00413US01_ADS.pdf	967808 db7e1ae1d1a14ee9512555621c5c6abdb40a75c	no	4
<b>Warnings:</b>					
<b>Information:</b>					
2	Specification	2001P00413US_Patent_US6885318B2.pdf	473633 f946ee8eade952cd5b109b627c52fbc640233f8	no	11
<b>Warnings:</b>					
<b>Information:</b>					
3	Assignee showing of ownership per 37 CFR 3.73.	2001P00413US01_373_Statement.pdf	395640 6174f148f0e029767880c90297f505d9c41c3	no	2
<b>Warnings:</b>					
<b>Information:</b>					
4	Power of Attorney	2001P00413US01_POA.pdf	119153 90dec697ae7dbd55b406435c3785d2c9cd54e9a	no	1
<b>Warnings:</b>					
<b>Information:</b>					
5	Consent of Assignee accompanying the declaration	2001P00413US01_Consent_of_Assignee.pdf	245229 37d0ce1c6d430cc0e5f8542fbae76e290ca8b346	no	2
<b>Warnings:</b>					
<b>Information:</b>					
6	Reissue dec filed in accordance with MPEP 1414	2001P00413US01_Declaration.pdf	587935 0f2d16e4a71c255cfc1ca2a7b7e8b8b962017e22	no	3
<b>Warnings:</b>					
<b>Information:</b>					
7		2001P00413US01_PrelimAmd.pdf	2126705 d77596f222f11ab568eb9db43b85c8b8ce8e0126	yes	16
<b>Multipart Description/PDF files in .zip description</b>					
<b>Document Description</b>			<b>Start</b>	<b>End</b>	
Preliminary Amendment			1	1	
Specification			2	2	

	Claims		3		8
	Applicant Arguments/Remarks Made in an Amendment		9		16
<b>Warnings:</b>					
<b>Information:</b>					
8	Information Disclosure Statement (IDS) Form (SB08)	2001P00413US01_IDS_2013_July_25.pdf	612949 92cd08a945a3ed636560459f494d14b87353e29e	no	5
<b>Warnings:</b>					
<b>Information:</b>					
9	Foreign Reference	EP0889388A1.pdf	2545987 46bc13a9ab0cf1336cad35e909585cbe8ba69fb6	no	28
<b>Warnings:</b>					
<b>Information:</b>					
10	Foreign Reference	JP4127310A.pdf	545046 c1f329ec785ba6f123b55207a86a467c2769367a	no	25
<b>Warnings:</b>					
<b>Information:</b>					
11	Foreign Reference	JP4999794B1.pdf	1084229 e1f49ce6bb33d5141096035a84d828e7a64d32b5	no	37
<b>Warnings:</b>					
<b>Information:</b>					
12	Foreign Reference	JP07200120A.pdf	426337 345604950c24b57387e68b750844430df39bf633	no	5
<b>Warnings:</b>					
<b>Information:</b>					
13	Foreign Reference	WO0214996A2.pdf	4981149 37b25bc768545cab99c2a9d7a67cc3ada938a0e0	no	40
<b>Warnings:</b>					
<b>Information:</b>					
14	Fee Worksheet (SB06)	fee-info.pdf	32768 c94b34fcc729c1f9j16ed43e80b52edce0bcffc	no	2
<b>Warnings:</b>					
<b>Information:</b>					
<b>Total Files Size (in bytes):</b>			15144568		