



US005151871A

United States Patent [19] Matsumura et al.

[11] Patent Number: **5,151,871**
[45] Date of Patent: **Sep. 29, 1992**

- [54] **METHOD FOR HEAT-PROCESSING SEMICONDUCTOR DEVICE AND APPARATUS FOR THE SAME**
- [75] Inventors: **Kimiharu Matsumura, Kumamoto; Hiroyuki Sakai, Nishigoshi; Masaaki Murakami, Kumamoto; Tetsuya Oda, Tamana; Chizo Yamaguchi, Sencho, all of Japan**
- [73] Assignees: **Tokyo Electron Limited, Tokyo; Tokyo Electron Kyushu Limited, Kumamoto, both of Japan**

- [21] Appl. No.: **538,710**
- [22] Filed: **Jun. 15, 1990**
- [30] **Foreign Application Priority Data**

Jun. 16, 1989 [JP] Japan 1-154119
 Oct. 24, 1989 [JP] Japan 1-276564

- [51] Int. Cl.⁵ **H05B 3/68**
- [52] U.S. Cl. **364/557; 219/457; 219/464**
- [58] Field of Search **364/557, 505, 477; 219/405, 411, 388, 390, 457, 464, 465**

[56] References Cited

U.S. PATENT DOCUMENTS

4,481,406 11/1984 Muka 219/405 X
 4,504,730 3/1985 Shimizu 219/405 X
 4,688,180 8/1987 Motomiya 364/557 X
 4,690,569 9/1987 Veitch 364/557 X

4,794,217 12/1988 Quan et al. 219/10.67 X
 4,881,591 11/1989 Rignall 364/557 X
 4,958,061 9/1990 Wakabayashi et al. 219/411
 4,982,347 1/1991 Rackerby et al. 364/557
 5,001,327 3/1991 Hirasawa et al. 219/390

FOREIGN PATENT DOCUMENTS

58-21332 2/1983 Japan .
 61-12030 1/1986 Japan .
 61-23321 1/1986 Japan .
 61-67224 4/1986 Japan .
 61-201426 9/1986 Japan .
 61-235835 10/1986 Japan .
 61-271834 12/1986 Japan .

Primary Examiner—Joseph L. Dixon
 Attorney, Agent, or Firm—Oblon, Spivak, McClelland, Maier & Neustadt

[57] ABSTRACT

CPU stores information showing a time-temperature relationship and applicable for either heating a semiconductor wafer to a hold temperature for a predetermined period of time or cooling the wafer from the hold temperature over a predetermined period of time, or for both, read the information. A conductive thin film heats the wafer in accordance with the information. A sensor detects the temperature of the wafer. A control system controls either the heating of the wafer or the cooling thereof, or both, in accordance with the detected temperature signal and the information.

12 Claims, 8 Drawing Sheets

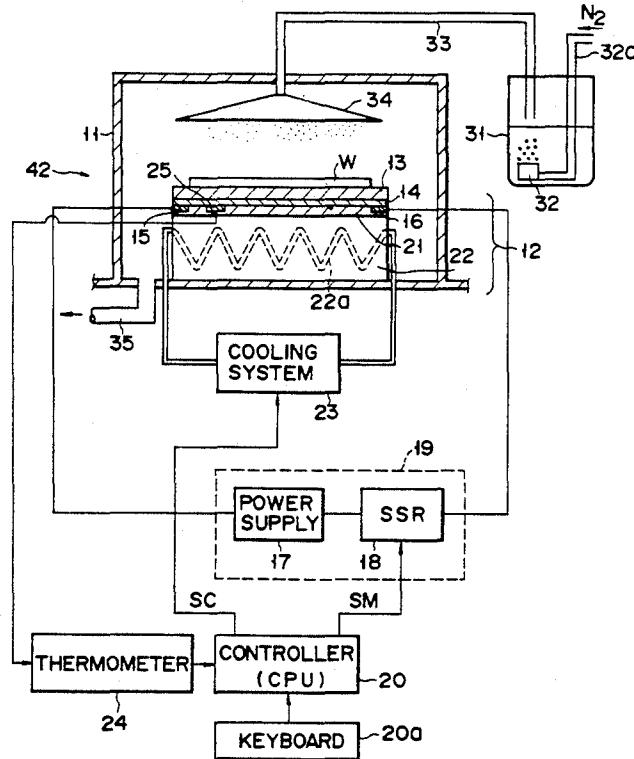

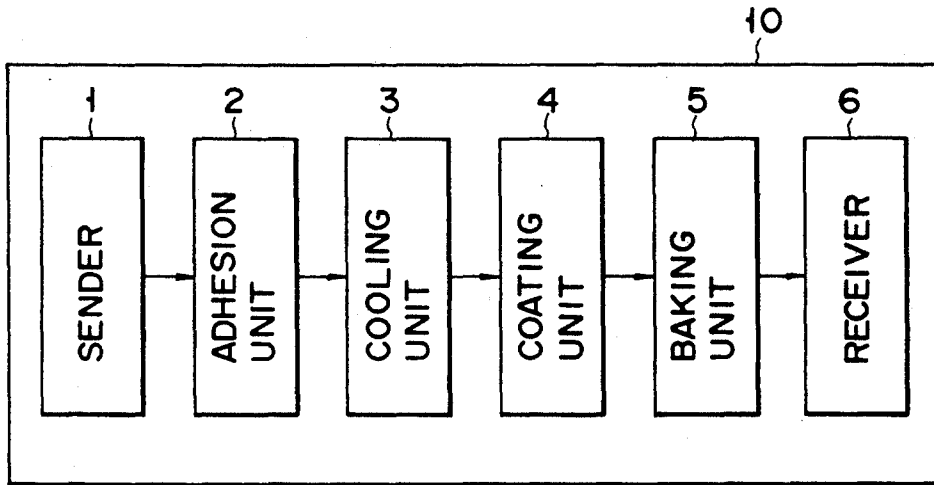

PRIOR ART

FIG. 1

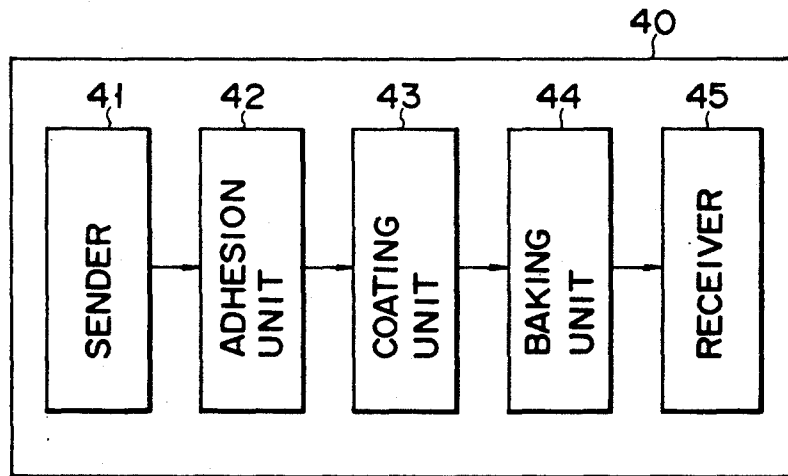
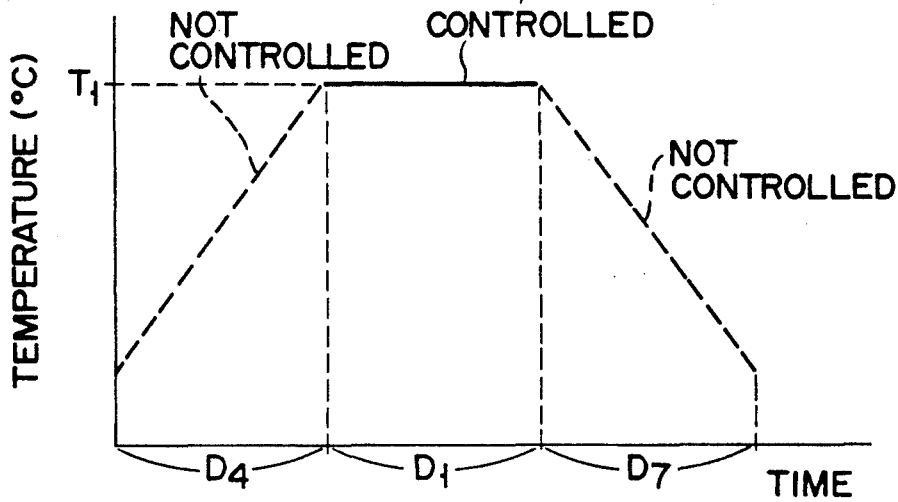
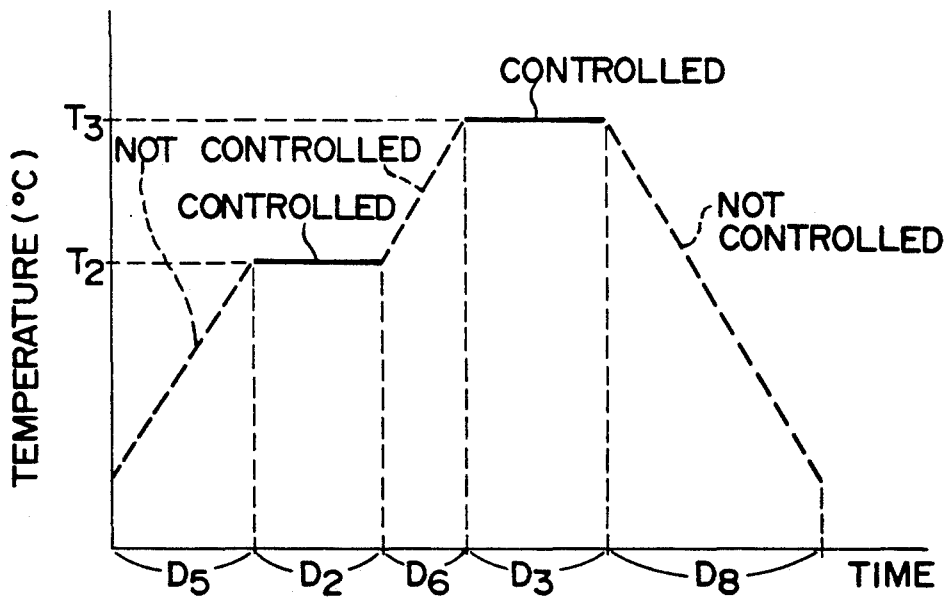

FIG. 4



PRIOR ART
FIG. 2



PRIOR ART
FIG. 3

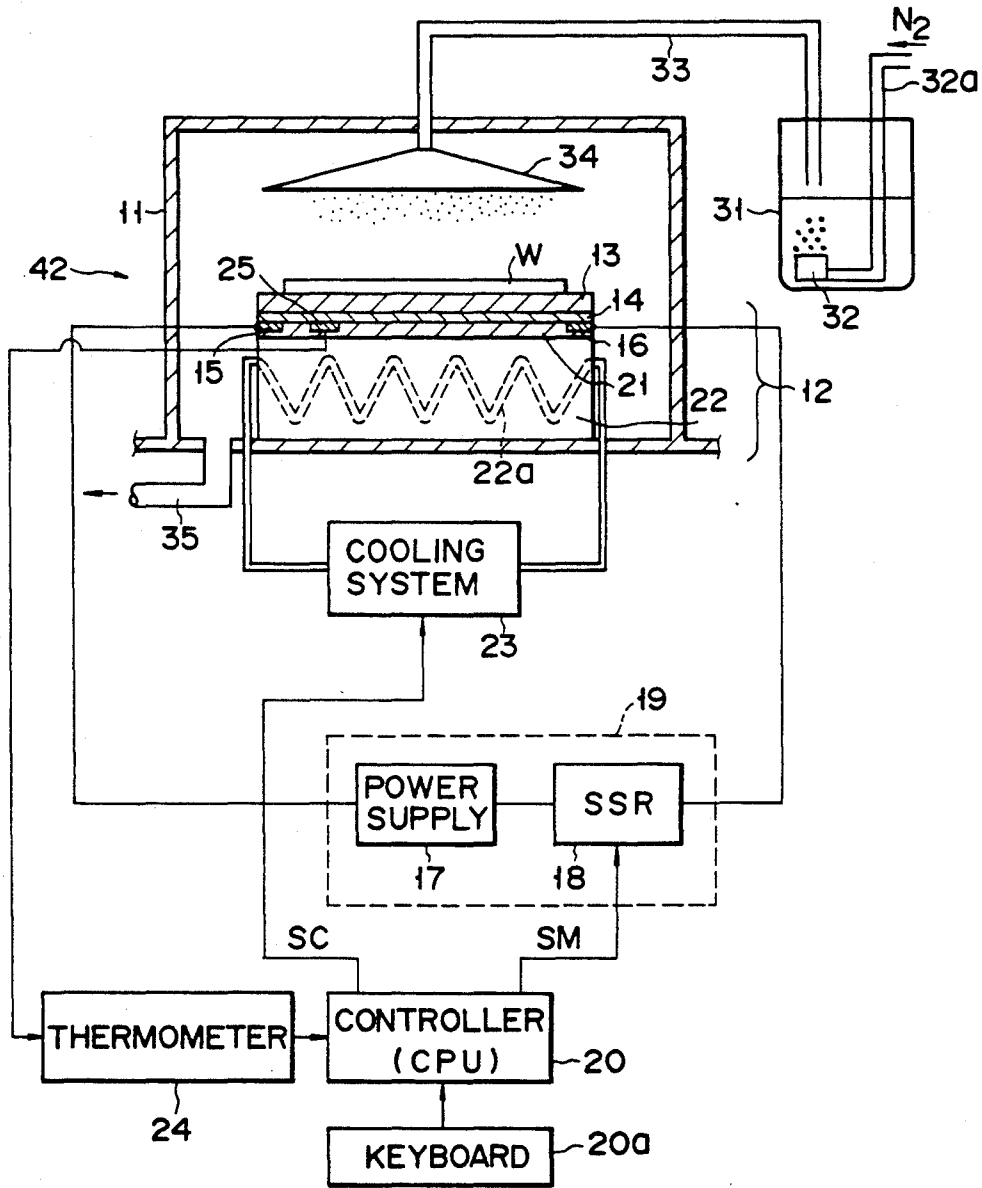

FIG. 5A

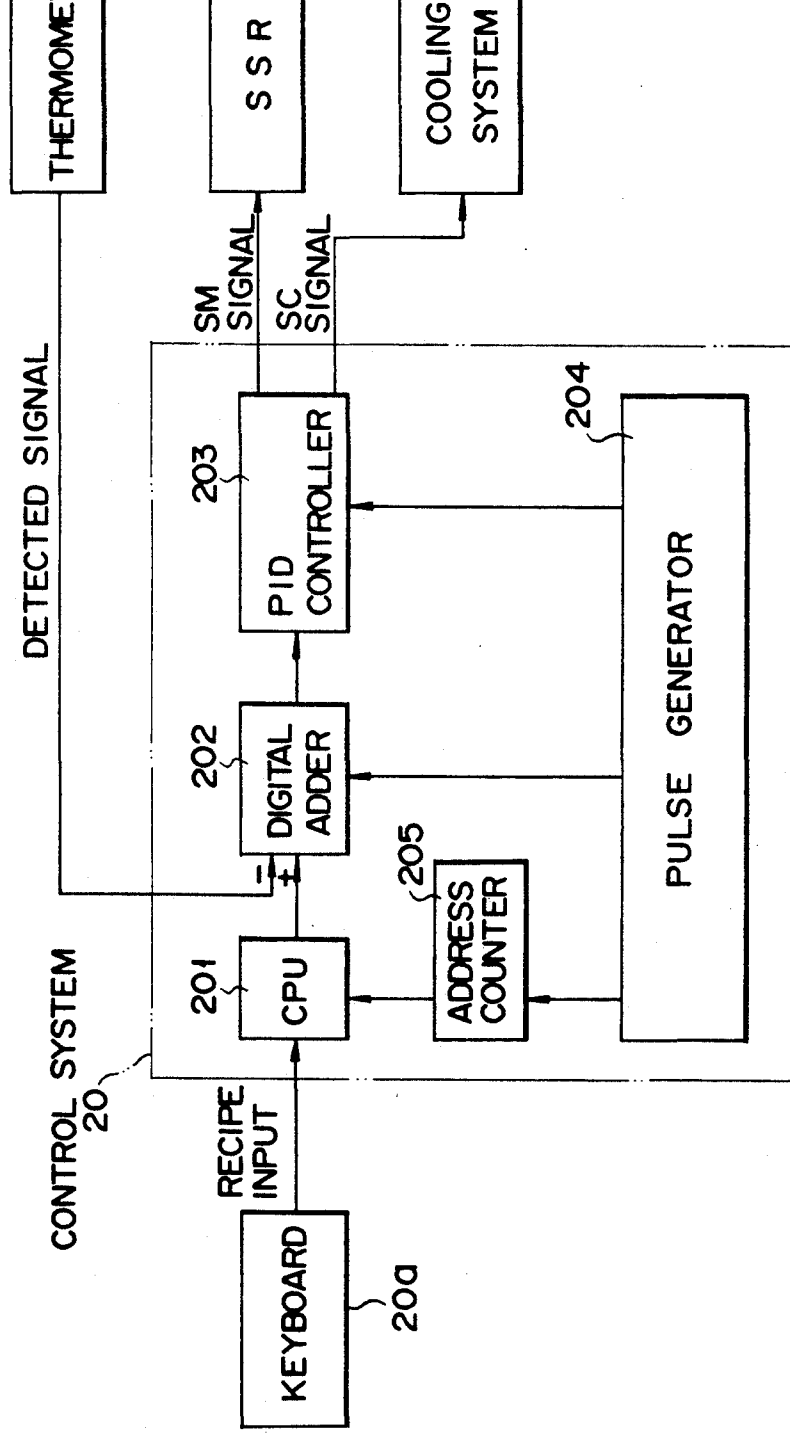

FIG. 5B

Explore Litigation Insights

Docket Alarm provides insights to develop a more informed litigation strategy and the peace of mind of knowing you're on top of things.

Real-Time Litigation Alerts



Keep your litigation team up-to-date with **real-time alerts** and advanced team management tools built for the enterprise, all while greatly reducing PACER spend.

Our comprehensive service means we can handle Federal, State, and Administrative courts across the country.

Advanced Docket Research



With over 230 million records, Docket Alarm's cloud-native docket research platform finds what other services can't. Coverage includes Federal, State, plus PTAB, TTAB, ITC and NLRB decisions, all in one place.

Identify arguments that have been successful in the past with full text, pinpoint searching. Link to case law cited within any court document via Fastcase.

Analytics At Your Fingertips



Learn what happened the last time a particular judge, opposing counsel or company faced cases similar to yours.

Advanced out-of-the-box PTAB and TTAB analytics are always at your fingertips.

API

Docket Alarm offers a powerful API (application programming interface) to developers that want to integrate case filings into their apps.

LAW FIRMS

Build custom dashboards for your attorneys and clients with live data direct from the court.

Automate many repetitive legal tasks like conflict checks, document management, and marketing.

FINANCIAL INSTITUTIONS

Litigation and bankruptcy checks for companies and debtors.

E-DISCOVERY AND LEGAL VENDORS

Sync your system to PACER to automate legal marketing.