



[54] METHODS AND APPARATUS FOR GENERATING PLASMA

[75] Inventor: Robert D. Dible, Fremont, Calif.

[73] Assignee: Lam Research Corporation, Fremont, Calif.

[21] Appl. No.: 536,574

[22] Filed: Sep. 29, 1995

[51] Int. Cl.⁶ C23C 16/00

[52] U.S. Cl. 118/723 MP; 118/723 E; 118/723 I; 156/643.1; 427/569

[58] Field of Search 118/723 E, 723 ER, 118/723 MP, 723 I, 723 IR; 156/643.1, 345, 627.1; 216/68, 71; 204/298.34, 298.08, 298.06, 298.12; 427/569

[56] References Cited

U.S. PATENT DOCUMENTS

4,539,068	9/1985	Takagi et al.	156/614
5,116,482	5/1992	Setoyama et al.	204/298.08
5,147,493	9/1992	Nishimura et al.	156/345
5,228,939	7/1993	Chu	156/345
5,273,610	12/1993	Thomas, III et al.	156/345
5,316,645	5/1994	Yamagami et al.	204/298.06
5,332,880	7/1994	Kubota et al.	219/121.52
5,414,324	5/1994	Roth et al.	315/111.21
5,433,813	7/1995	Kuwabara	156/345
5,436,424	7/1995	Nakayama et al.	219/121.43

Assistant Examiner—Joni Y. Chang
Attorney, Agent, or Firm—Hickman Beyer & Weaver

[57] ABSTRACT

A device for generating plasma for use in semiconductor fabrication, which includes a first radio frequency excitation source for outputting a first excitation current having a first phase and a first amplitude. The device further includes a second radio frequency excitation source for outputting a second excitation current having a second phase and a second amplitude and a plasma generating element having a first end and a second end for receiving respectively the first excitation current and the second excitation current. Moreover, the inventive device includes a control circuit having a control input for receiving a user-variable signal indicative of a desired phase difference between the first phase and the second phase. The control circuit, responsive to the control input, outputs a control signal to one of the first radio frequency excitation source and the second radio frequency excitation source for controlling respectively one of the first phase and the second phase, thereby causing an actual phase difference between the first phase and the second phase to substantially approximate the desired phase difference. In so doing, the device becomes essentially an inductive coupling device when the first phase and the second phase are opposite in phase. When the first phase and the second phase are in phase, the device becomes essentially a capacitive coupling device. Finally, when the first phase and the second phase differs by an angle that is between in phase and opposite in phase, the device becomes a combination inductive and capacitive coupling device.

Primary Examiner—R. Bruce Breneman

23 Claims, 7 Drawing Sheets

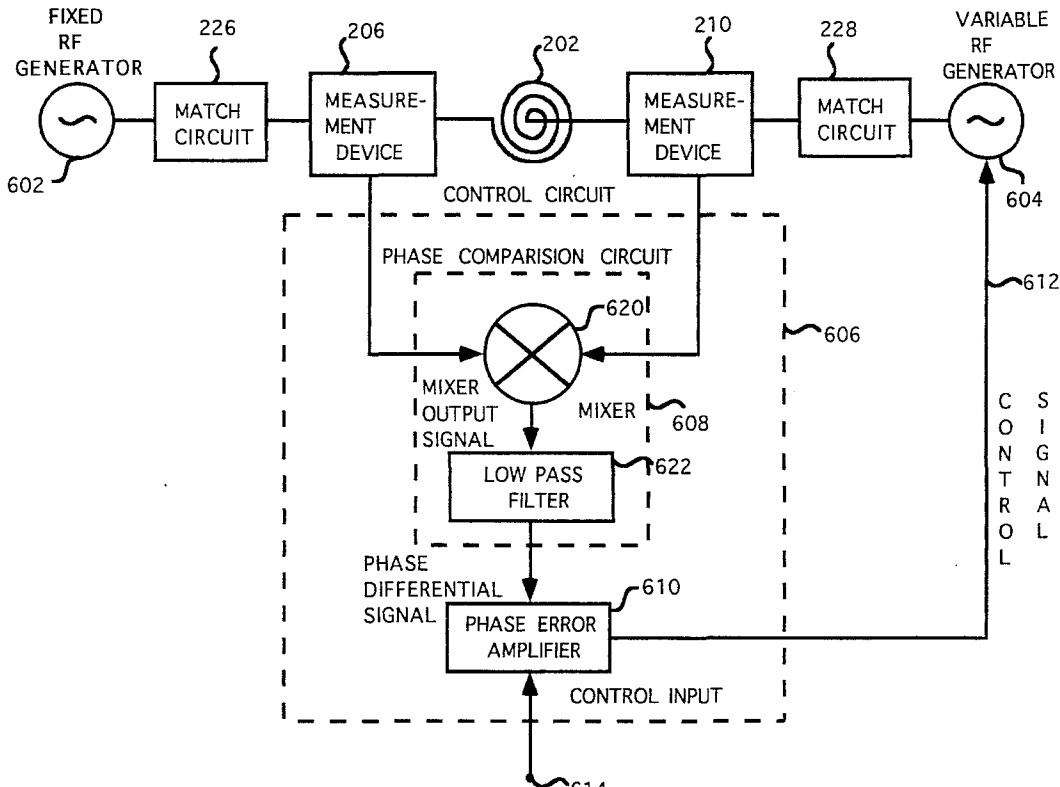

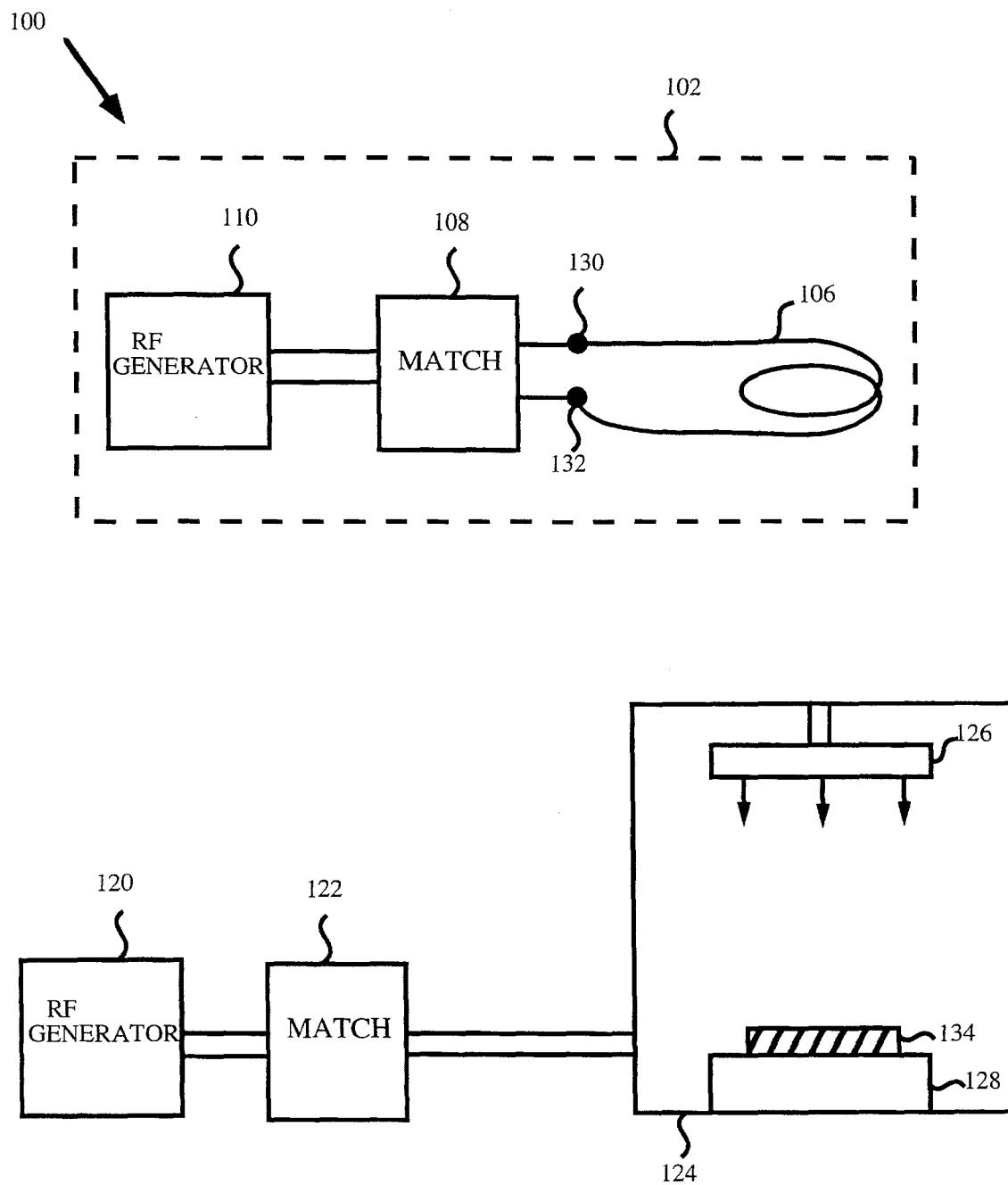

FIG. 1

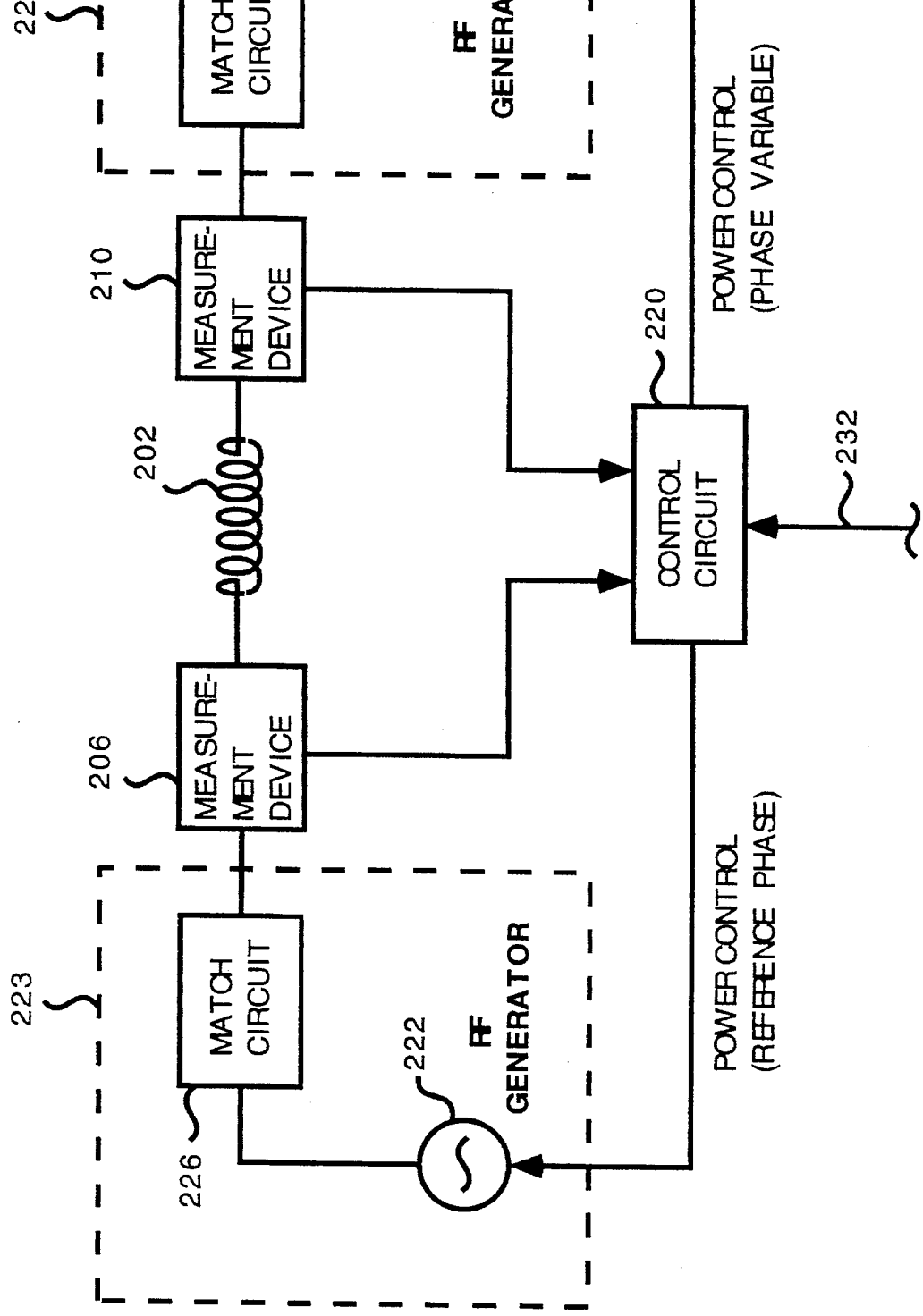

FIG. 2

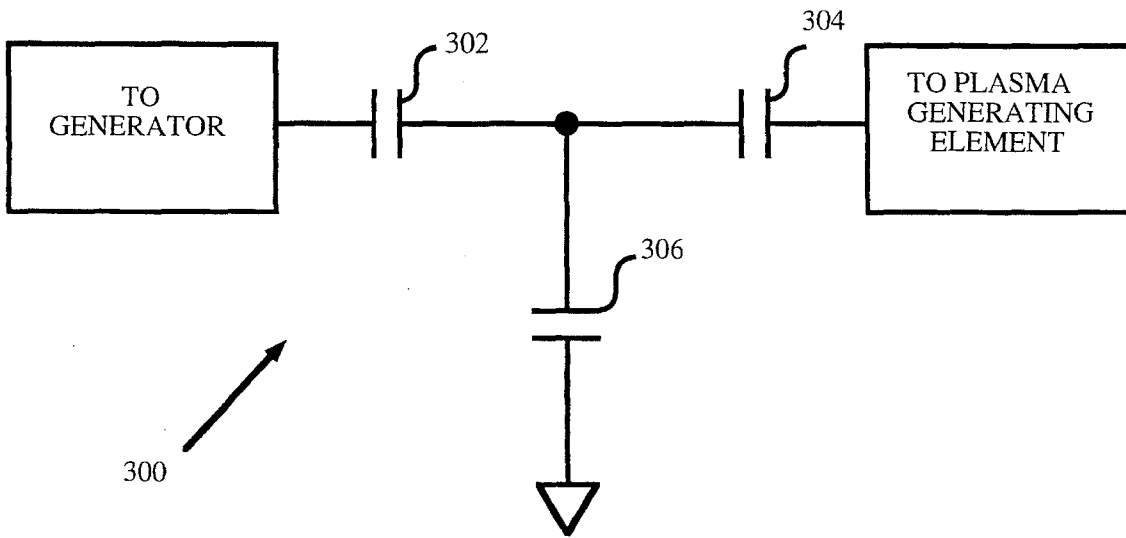

FIG. 3

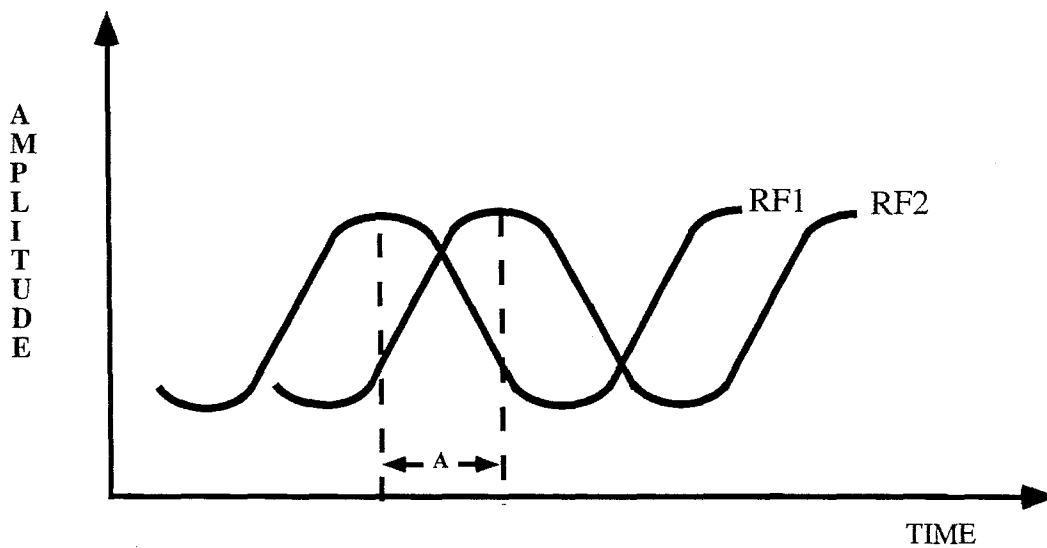
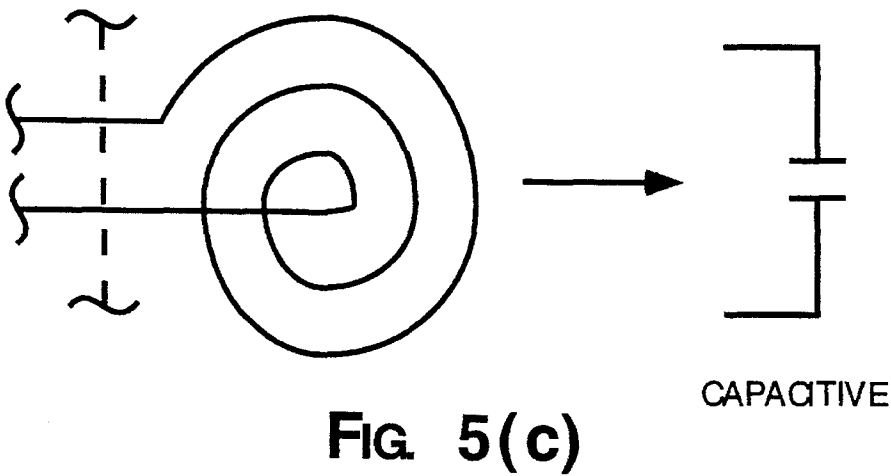
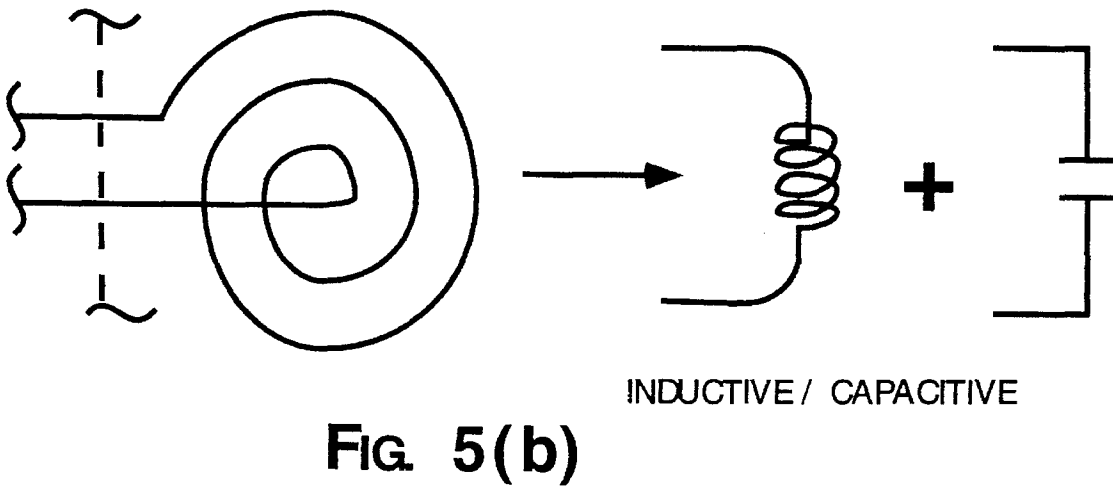
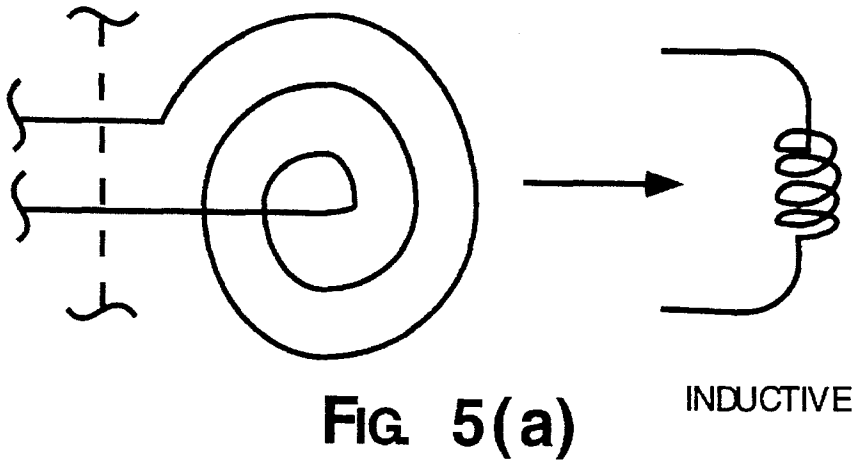

FIG. 4



Explore Litigation Insights

Docket Alarm provides insights to develop a more informed litigation strategy and the peace of mind of knowing you're on top of things.

Real-Time Litigation Alerts



Keep your litigation team up-to-date with **real-time alerts** and advanced team management tools built for the enterprise, all while greatly reducing PACER spend.

Our comprehensive service means we can handle Federal, State, and Administrative courts across the country.

Advanced Docket Research



With over 230 million records, Docket Alarm's cloud-native docket research platform finds what other services can't. Coverage includes Federal, State, plus PTAB, TTAB, ITC and NLRB decisions, all in one place.

Identify arguments that have been successful in the past with full text, pinpoint searching. Link to case law cited within any court document via Fastcase.

Analytics At Your Fingertips



Learn what happened the last time a particular judge, opposing counsel or company faced cases similar to yours.

Advanced out-of-the-box PTAB and TTAB analytics are always at your fingertips.

API

Docket Alarm offers a powerful API (application programming interface) to developers that want to integrate case filings into their apps.

LAW FIRMS

Build custom dashboards for your attorneys and clients with live data direct from the court.

Automate many repetitive legal tasks like conflict checks, document management, and marketing.

FINANCIAL INSTITUTIONS

Litigation and bankruptcy checks for companies and debtors.

E-DISCOVERY AND LEGAL VENDORS

Sync your system to PACER to automate legal marketing.