

**DISTRONIC PLUS**

**General notes:**

DISTRONIC PLUS regulates the speed and automatically helps you maintain the distance to the vehicle detected in front. Vehicles are detected with the aid of the radar sensor system. DISTRONIC PLUS brakes automatically so that the set speed is not exceeded.

(See, e.g., Ex. Mercedes-Benz-2 at 201; Ex. Mercedes-Benz-3 at 157; Ex. Mercedes-Benz-4 at 173; Ex. Mercedes-Benz-5 at 298; Ex. Mercedes-Benz-6 at 164; Ex. Mercedes-Benz-7 at 177; Ex. Mercedes-Benz-8 at 191; Ex. Mercedes-Benz-9 at 191; Ex. Mercedes-Benz-10 at 177; Ex. Mercedes-Benz-11 at 203; Ex. Mercedes-Benz-12 at 175; Ex. Mercedes-Benz-13 at 194; Ex. Mercedes-Benz-14 at 186; Ex. Mercedes-Benz-15 at 169; Ex. Mercedes-Benz-16 at 186).

17B7. Blind Spot Assist/Active Blind Spot Assist.

**Active Blind Spot Assist**

**General notes:**

Active Blind Spot Assist uses a radar sensor system, pointed toward the rear of the vehicle, to monitor the area to the sides of the vehicle which the driver is unable to see. A warning display in the exterior mirrors draws your attention to vehicles detected in the monitored area. If you then switch on the corresponding turn signal to change lane, you will also receive an optical and audible warning, if a risk of lateral collision is

Claim 17	Corresponding Element in Mercedes-Benz Vehicles
	<p>detected, corrective braking may help you avoid a collision. Active Blind Spot Assist evaluates the free space in the direction of travel and to the side before making a course-correcting brake application. For this, Active Blind Spot Assist uses radar sensors which are pointed in the direction of travel. Active Blind Spot Assist supports you from a speed of approximately 20 mph (30 km/h).</p> <p>(See, e.g., Ex. Mercedes-Benz-2 at 240-43; Ex. Mercedes-Benz-3 at 177-78, 180-81; Ex. Mercedes-Benz-4 at 193-94, 197-99; Ex. Mercedes-Benz-5 at 327-30; Ex. Mercedes-Benz-6 at 188-90; Ex. Mercedes-Benz-7 at 207-09, 211-13; Ex. Mercedes-Benz-8 at 221-23, 225-27; Ex. Mercedes-Benz-9 at 221-23, 225-27; Ex. Mercedes-Benz-10 at 185-87; Ex. Mercedes-Benz-11 at 243-44, 247-50; Ex. Mercedes-Benz-12 at 202-03, 206-09; Ex. Mercedes-Benz-13 at 233-35, 237-40; Ex. Mercedes-Benz-14 at 218-21; Ex. Mercedes-Benz-15 at 187-88; Ex. Mercedes-Benz-16 at 145-47).</p> <p><b>Radar sensors</b></p> <p>The Active Blind Spot Assist radar sensors are integrated into the front and rear bumpers and behind a cover in the radiator grill. Make sure that the bumpers and the cover in the radiator grill are free of dirt, ice or slush. The rear sensors must not be covered, e.g. by bicycle racks or overhanging loads. Following a severe impact or in the event of damage to the bumpers, have the function of the radar sensors checked at a qualified specialist workshop. Active Blind Spot Assist may otherwise no longer work properly.</p>

Claim 17	Corresponding Element in Mercedes-Benz Vehicles
<p>17C. at least one sensor coupled to said vehicle for monitoring operation thereof, said at least one sensor including a road speed sensor, a manifold pressure sensor, a throttle position sensor and an engine speed sensor;</p>	<p>(See, e.g., Ex. Mercedes-Benz-2 at 240-43; Ex. Mercedes-Benz-3 at 177-78, 180-81; Ex. Mercedes-Benz-4 at 193-94, 197-99; Ex. Mercedes-Benz-5 at 327-30; Ex. Mercedes-Benz-6 at 188-90; Ex. Mercedes-Benz-7 at 207-09, 211-13; Ex. Mercedes-Benz-8 at 221-23, 225-27; Ex. Mercedes-Benz-9 at 221-23, 225-27; Ex. Mercedes-Benz-10 at 185-87; Ex. Mercedes-Benz-11 at 243-44, 247-50; Ex. Mercedes-Benz-12 at 202-03, 206-09; Ex. Mercedes-Benz-13 at 233-35, 237-40; Ex. Mercedes-Benz-14 at 218-21; Ex. Mercedes-Benz-15 at 187-88; Ex. Mercedes-Benz-16 at 145-47).</p> <p>The accused Mercedes-Benz vehicles include at least one sensor coupled to said vehicle for monitoring operation thereof, said at least one sensor including a road speed sensor, a manifold pressure sensor, a throttle position sensor and an engine speed sensor.</p> <p>See, e.g., citations for claim element 1B.</p>
<p>17D. a processor subsystem, coupled to said radar detector and said at least one sensor, to receive data therefrom;</p>	<p>The accused Mercedes-Benz vehicles include a processor subsystem, coupled to said radar detector and said at least one sensor, to receive data therefrom.</p> <p>See, e.g., citations for claim element 1C.</p>
<p>17E. a memory subsystem, coupled to said processor subsystem, said memory subsystem storing a first vehicle speed/stopping distance table, a manifold pressure set point, an RPM set point, a present level for each one of said at least one sensor and a prior level for each one of said at least one sensor.</p>	<p>The accused Mercedes-Benz vehicles include a memory subsystem, coupled to said processor subsystem, said memory subsystem storing a first vehicle speed/stopping distance table, a manifold pressure set point, an RPM set point, a present level for each one of said at least one sensor and a prior level for each one of said at least one sensor.</p> <p>See, e.g., citations for claim elements 1A-1D.</p> <p>For example, on information and belief, the accused Mercedes-Benz vehicles include one or more systems that use one or more vehicle speed/stopping distance tables stored in one or more</p>

Claim 17	Corresponding Element in Mercedes-Benz Vehicles
<p>sensor and a prior level for each one of said at least one sensor;</p>	<p>memories.</p> <p>17E1. PRE-SAFE/PRE-SAFE PLUS:</p> <p><b>Function</b></p> <p>PRE-SAFE® PLUS intervenes in certain situations if the radar sensor system detects an imminent head-on or rear-end collision.</p> <p>PRE-SAFE® PLUS takes the following measures depending on the hazardous situation detected:</p> <ul style="list-style-type: none"> <li>• if the radar sensor system detects that a head-on collision is imminent, the seat belts are pre-tensioned.</li> <li>• if the radar sensor system detects that a rear-end collision is imminent: <ul style="list-style-type: none"> <li>- the brake pressure is increased if the driver applies the brakes when the vehicle is stationary.</li> <li>- the seat belts are pre-tensioned.</li> </ul> </li> </ul> <p>The PRE-SAFE® PLUS braking application is canceled in the following situations:</p> <ul style="list-style-type: none"> <li>• if the accelerator pedal is depressed when a gear is engaged</li> <li>• if the risk of a collision passes or is no longer detected</li> <li>• if DISTRONIC PLUS indicates an intention to pull away</li> </ul> <p>If the hazardous situation passes without resulting in an accident, the original settings are restored.</p>

Claim 17	Corresponding Element in Mercedes-Benz Vehicles
	<p>(See, e.g., Ex. Mercedes-Benz-2 at 56; Ex. Mercedes-Benz-3 at 50; Ex. Mercedes-Benz-4 at 52; Ex. Mercedes-Benz-5 at 55; Ex. Mercedes-Benz-7 at 54-55; Ex. Mercedes-Benz-8 at 55-56; Ex. Mercedes-Benz-9 at 54-55; Ex. Mercedes-Benz-11 at 54-55; Ex. Mercedes-Benz-13 at 54; Ex. Mercedes-Benz-14 at 61; Ex. Mercedes-Benz-15 at 50).</p> <p>17E2. BAS PLUS (Brake Assist System PLUS):</p> <p><b>Function</b></p> <p>To avoid a collision, BAS PLUS calculates the brake force necessary if:</p> <ul style="list-style-type: none"> <li>• you approach an obstacle, and</li> <li>• BAS PLUS has detected a risk of collision</li> </ul> <p><b>When driving at a speed under 20 mph (30 km/h):</b> if you depress the brake pedal, BAS PLUS is activated. The increase in brake pressure will be carried out at the last possible moment.</p> <p><b>When driving at a speed above 20 mph (30 km/h):</b> if you depress the brake pedal sharply, BAS PLUS automatically raises the brake pressure to a value adapted to the traffic situation.</p> <p>BAS PLUS provides braking assistance in hazardous situations with vehicles in front within a speed range between 4 mph (7 km/h) and 155 mph (250 km/h).</p>

<p><b>Claim 17</b></p>	<p style="text-align: center;"><b>Corresponding Element in Mercedes-Benz Vehicles</b></p> <p>At speeds of up to approximately 44 mph (70 km/h), BAS PLUS reacts to:</p> <ul style="list-style-type: none"> <li>• stationary objects in the path of your vehicle, e.g. stopped or parked vehicles</li> <li>• pedestrians in the path of your vehicle</li> <li>• objects crossing your path</li> </ul> <p>● If BAS PLUS demands particularly high braking force, preventative passenger protection measures (PRE-SAFE<sup>®</sup>) are activated simultaneously.</p> <p>▶ Keep the brake pedal depressed until the emergency braking situation is over. ABS prevents the wheels from locking.</p> <p>BAS PLUS is deactivated and the brakes function as usual again, if:</p> <ul style="list-style-type: none"> <li>• you release the brake pedal.</li> <li>• there is no longer a risk of collision.</li> <li>• no obstacle is detected in front of your vehicle.</li> <li>• you depress the accelerator pedal.</li> <li>• you activate kickdown.</li> </ul> <p>(See, e.g., Ex. Mercedes-Benz-2 at 72; Ex. Mercedes-Benz-3 at 63; Ex. Mercedes-Benz-4 at 66; Ex. Mercedes-Benz-5 at 66; Ex. Mercedes-Benz-7 at 67; Ex. Mercedes-Benz-8 at 70; Ex. Mercedes-Benz-9 at 68; Ex. Mercedes-Benz-11 at 68; Ex. Mercedes-Benz-12 at 68; Ex. Mercedes-Benz-13 at 68; Ex. Mercedes-Benz-14 at 72; Ex. Mercedes-Benz-15 at 60; Ex. Mercedes-Benz-16 at 72).</p>
------------------------	--

**Claim 17**

**Corresponding Element in Mercedes-Benz Vehicles**

17E3. COLLISION PREVENTION ASSIST/Distance Warning Function.

**Function**

► **To activate/deactivate:** activate or deactivate the distance warning function in the on-board computer (→ page Z61).

If the distance warning function is not activated, the  symbol appears in the assistance graphics display.

The distance warning function can help you to minimize the risk of a front-end collision with a vehicle ahead or reduce the effects of such a collision. If the distance warning function detects that there is a risk of a collision, you will be warned visually and acoustically. The distance warning function cannot prevent a collision without your intervention.

<p><b>Claim 17</b></p>	<p style="text-align: center;"><b>Corresponding Element in Mercedes-Benz Vehicles</b></p> <p>Starting at a speed of around 4 mph (7 km/h), the distance warning function warns you if you rapidly approach a vehicle in front. An intermittent warning tone will then sound and the  distance warning lamp will light up in the instrument cluster.</p> <ul style="list-style-type: none"> <li>▶ Brake immediately in order to increase the distance from the vehicle in front.</li> </ul> <p>or</p> <ul style="list-style-type: none"> <li>▶ Take evasive action, provided it is safe to do so.</li> </ul> <p>Due to the nature of the system, particularly complicated but non-critical driving conditions may also cause the system to display a warning.</p> <p>With the help of the radar sensor system, the distance warning function can detect obstacles that are in the path of your vehicle for an extended period of time.</p> <p><i>(See, e.g., Ex. Mercedes-Benz-2 at 74; Ex. Mercedes-Benz-6 at 62-64; Ex. Mercedes-Benz-8 at 70-71; Ex. Mercedes-Benz-9 at 70-71; Ex. Mercedes-Benz-11 at 69-70; Ex. Mercedes-Benz-13 at 69-70).</i></p> <p>17E4. COLLISION PREVENTION ASSIST/Adaptive Brake Assist.</p>
------------------------	--



**Claim 17**

**Corresponding Element in Mercedes-Benz Vehicles**

Adaptive Brake Assist aids you in braking during hazardous situations at speeds above 4 mph (7 km/h) and uses the radar sensor system to evaluate the traffic situation.

With the help of Adaptive Brake Assist, the distance warning signal can detect obstacles that are in the path of your vehicle for an extended period of time.

Should you approach an obstacle and Adaptive Brake Assist has detected a risk of collision, Adaptive Brake Assist calculates the braking force necessary to avoid a rear-end collision. Should you apply the brakes vigorously, Adaptive Brake Assist will automatically increase the braking force to a level suitable for the traffic conditions.

- ▶ Keep the brake pedal depressed until the emergency braking situation is over. ABS prevents the wheels from locking.

(See, e.g., Ex. Mercedes-Benz-2 at 75; Ex. Mercedes-Benz-6 at 64-66; Ex. Mercedes-Benz-8 at 71-72; Ex. Mercedes-Benz-9 at 71-72; Ex. Mercedes-Benz-11 at 71-72; Ex. Mercedes-Benz-13 at 70-71).

17E5. PRE-SAFE Brake.

**Function**

- ▶ **To activate/deactivate:** activate or deactivate PRE-SAFE® Brake in the on-board computer (see page 260).  
If the PRE-SAFE® Brake is not activated, the  symbol appears in the multifunction display.

Starting at a speed of around 4 mph (7 km/h), this function warns you if you rapidly approach a vehicle in front. An intermittent warning tone will then sound and the  distance warning lamp will light up in the instrument cluster.

- ▶ Brake immediately to defuse the situation.
- or
- ▶ Take evasive action provided it is safe to do so.

 If there is an increased risk of collision, preventive passenger protection measures (PRE-SAFE®) are activated.

(See, e.g., Ex. Mercedes-Benz-2 at 78; Ex. Mercedes-Benz-3 at 67; Ex. Mercedes-Benz-4 at 71; Ex. Mercedes-Benz-5 at 68; Ex. Mercedes-Benz-7 at 72; Ex. Mercedes-Benz-8 at 76-77; Ex. Mercedes-Benz-9 at 76-77; Ex. Mercedes-Benz-11 at 75; Ex. Mercedes-Benz-12 at 72; Ex. Mercedes-Benz-13 at 74; Ex. Mercedes-Benz-14 at 77; Ex. Mercedes-Benz-15 at 65; Ex. Mercedes-Benz-16 at 77).

17E6. DISTRONIC PLUS:

<p><b>Claim 17</b></p>	<p><b>Corresponding Element in Mercedes-Benz Vehicles</b></p> <p><b>Setting the specified minimum distance</b></p> <p>You can set the specified minimum distance for DISTRONIC PLUS by varying the time span between one and two seconds. With this function, you can set the minimum distance that DISTRONIC PLUS keeps to the vehicle in front, dependent on vehicle speed. You can see this distance in the multifunction display (► page 207).</p> <p> Make sure that you maintain the minimum distance to the vehicle in front as</p>
------------------------	---

**Claim 17**

**Corresponding Element in Mercedes-Benz Vehicles**

required by law. Adjust the distance to the vehicle in front if necessary.

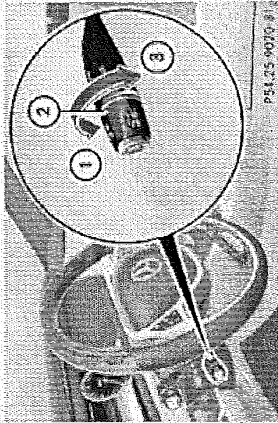

▶ To **increase**: turn control ② in direction

③

DISTRONIC PLUS then maintains a greater distance between your vehicle and the vehicle in front.

▶ To **decrease**: turn control ② in

direction ①.

DISTRONIC PLUS then maintains a shorter distance between your vehicle and the vehicle in front.

(See, e.g., Ex. Mercedes-Benz-2 at 201; Ex. Mercedes-Benz-3 at 157; Ex. Mercedes-Benz-4 at 173; Ex. Mercedes-Benz-5 at 298; Ex. Mercedes-Benz-6 at 164; Ex. Mercedes-Benz-7 at 177; Ex. Mercedes-Benz-8 at 191; Ex. Mercedes-Benz-9 at 191; Ex. Mercedes-Benz-10 at 177; Ex. Mercedes-Benz-11 at 203; Ex. Mercedes-Benz-12 at 175; Ex. Mercedes-Benz-13 at 194; Ex. Mercedes-Benz-14 at 186; Ex. Mercedes-Benz-15 at 169; Ex. Mercedes-Benz-16 at 186)

17E7: Blind Spot Assist/Active Blind Spot Assist:

Claim 17

Corresponding Element in Mercedes-Benz Vehicles

Active Blind Spot Assist

General notes

Active Blind Spot Assist uses a radar sensor system, pointed toward the rear of the vehicle, to monitor the area to the sides of the vehicle which the driver is unable to see. A warning display in the exterior mirrors draws your attention to vehicles detected in the monitored area. If you then switch on the corresponding turn signal to change lane, you will also receive an optical and audible warning. If a risk of lateral collision is detected, corrective braking may help you avoid a collision. Active Blind Spot Assist evaluates the free space in the direction of travel and to the side before making a course-correcting brake application. For this, Active Blind Spot Assist uses radar sensors which are pointed in the direction of travel.

Active Blind Spot Assist supports you from a speed of approximately 20 mph (30 km/h).

(See, e.g., Ex. Mercedes-Benz-2 at 240-43; Ex. Mercedes-Benz-3 at 177-78, 180-81; Ex. Mercedes-Benz-4 at 193-94, 197-99; Ex. Mercedes-Benz-5 at 327-30; Ex. Mercedes-Benz-6 at 188-90; Ex. Mercedes-Benz-7 at 207-09, 211-13; Ex. Mercedes-Benz-8 at 221-23, 225-27; Ex. Mercedes-Benz-9 at 221-23, 225-27; Ex. Mercedes-Benz-10 at 185-87; Ex. Mercedes-Benz-11 at 243-44, 247-50; Ex. Mercedes-Benz-12 at 202-03, 206-09; Ex. Mercedes-Benz-13 at 233-35, 237-40; Ex. Mercedes-Benz-14 at 218-21; Ex. Mercedes-Benz-15 at 187-88; Ex. Mercedes-Benz-16 at 145-47).

**Claim 17**

**Corresponding Element in Mercedes-Benz Vehicles**

**Monitoring area**

**⚠ WARNING**

Active Blind Spot Assist does not detect all traffic situations and road users. There is a risk of an accident. Always make sure that there is sufficient distance on the side for other traffic or obstacles.

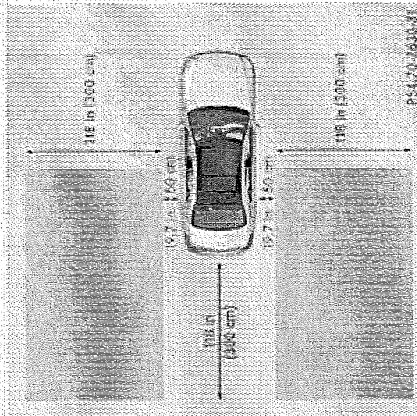

Active Blind Spot Assist monitors the area up to 10 ft (3.0 m) behind your vehicle and directly next to your vehicle, as shown in the diagram.

(See, e.g., Ex. Mercedes-Benz-2 at 240-43; Ex. Mercedes-Benz-3 at 177-78, 180-81; Ex. Mercedes-Benz-4 at 193-94, 197-99; Ex. Mercedes-Benz-5 at 327-30; Ex. Mercedes-Benz-6 at

Claim 17	Corresponding Element in Mercedes-Benz Vehicles
<p>17F. a vehicle proximity alarm circuit coupled to said processor subsystem, said vehicle proximity alarm circuit issuing an alarm that said vehicle is too close to an object;</p>	<p>188-90; Ex. Mercedes-Benz-7 at 207-09, 211-13; Ex. Mercedes-Benz-8 at 221-23, 225-27; Ex. Mercedes-Benz-9 at 221-23, 225-27; Ex. Mercedes-Benz-10 at 185-87; Ex. Mercedes-Benz-11 at 243-44, 247-50; Ex. Mercedes-Benz-12 at 202-03, 206-09; Ex. Mercedes-Benz-13 at 233-35, 237-40; Ex. Mercedes-Benz-14 at 218-21; Ex. Mercedes-Benz-15 at 187-88; Ex. Mercedes-Benz-16 at 145-47).</p> <p>On information and belief, additional vehicle systems, including but not limited to electronic brake control systems (e.g., ABS, TCS, BAS, ESC, etc.) and speed control systems (e.g., electronic speed control (ESC) systems) included in the accused Mercedes-Benz vehicles, and safety and performance testing systems use vehicle speed/stopping distance tables stored in memory.</p>
<p>The accused Mercedes-Benz vehicles include a vehicle proximity alarm circuit coupled to said processor subsystem, said vehicle proximity alarm circuit issuing an alarm that said vehicle is too close to an object.</p> <p>For example, the accused Mercedes-Benz vehicles include one or more systems that include circuits that issue an alarm to indicate that the vehicle is too close to an object.</p> <p>17F1. PRE-SAFE/PRE-SAFE PLUS:</p>	<p>The accused Mercedes-Benz vehicles include a vehicle proximity alarm circuit coupled to said processor subsystem, said vehicle proximity alarm circuit issuing an alarm that said vehicle is too close to an object.</p> <p>For example, the accused Mercedes-Benz vehicles include one or more systems that include circuits that issue an alarm to indicate that the vehicle is too close to an object.</p> <p>17F1. PRE-SAFE/PRE-SAFE PLUS:</p>

Claim 17	Corresponding Element in Mercedes-Benz Vehicles
	<p><b>Function</b></p> <p>PRE-SAFE® PLUS intervenes in certain situations if the radar sensor system detects an imminent head-on or rear-end collision. PRE-SAFE® PLUS takes the following measures depending on the hazardous situation detected:</p> <ul style="list-style-type: none"> <li>• if the radar sensor system detects that a head-on collision is imminent, the seat belts are pre-tensioned.</li> <li>• if the radar sensor system detects that a rear-end collision is imminent: <ul style="list-style-type: none"> <li>- the brake pressure is increased if the driver applies the brakes when the vehicle is stationary.</li> <li>- the seat belts are pre-tensioned.</li> </ul> </li> </ul> <p>The PRE-SAFE® PLUS braking application is canceled in the following situations:</p> <ul style="list-style-type: none"> <li>• if the accelerator pedal is depressed when a gear is engaged</li> <li>• if the risk of a collision passes or is no longer detected</li> <li>• if DISTRONIC PLUS indicates an intention to pull away</li> </ul> <p>If the hazardous situation passes without resulting in an accident, the original settings are restored.</p>

(See, e.g., Ex. Mercedes-Benz-2 at 56; Ex. Mercedes-Benz-3 at 50; Ex. Mercedes-Benz-4 at 52;



**Claim 17**

**Corresponding Element in Mercedes-Benz Vehicles**

Ex. Mercedes-Benz-5 at 55; Ex. Mercedes-Benz-7 at 54-55; Ex. Mercedes-Benz-8 at 55-56; Ex. Mercedes-Benz-9 at 54-55; Ex. Mercedes-Benz-11 at 54-55; Ex. Mercedes-Benz-13 at 54; Ex. Mercedes-Benz-14 at 61; Ex. Mercedes-Benz-15 at 50)

**17F2. COLLISION PREVENTION ASSIST/Distance Warning Function.**

**Function**

► **To activate/deactivate:** activate or deactivate the distance warning function in the on-board computer (p. page 261).

If the distance warning function is not activated, the  symbol appears in the assistance graphics display.

The distance warning function can help you to minimize the risk of a front-end collision with a vehicle ahead or reduce the effects of such a collision. If the distance warning function detects that there is a risk of a collision, you will be warned visually and acoustically. The distance warning function cannot prevent a collision without your intervention.

**Claim 17**

**Corresponding Element in Mercedes-Benz Vehicles**

Starting at a speed of around 4 mph (7 km/h), the distance warning function warns you if you rapidly approach a vehicle in front. An intermittent warning tone will then sound and the  distance warning lamp will light up in the instrument cluster.

▶ Brake immediately in order to increase the distance from the vehicle in front.

or

▶ Take evasive action, provided it is safe to do so.

Due to the nature of the system, particularly complicated but non-critical driving conditions may also cause the system to display a warning.

With the help of the radar sensor system, the distance warning function can detect obstacles that are in the path of your vehicle for an extended period of time.

(See, e.g., Ex. Mercedes-Benz-2 at 74; Ex. Mercedes-Benz-6 at 62-64; Ex. Mercedes-Benz-8 at 70-71; Ex. Mercedes-Benz-9 at 70-71; Ex. Mercedes-Benz-11 at 69-70; Ex. Mercedes-Benz-13 at 69-70).

I7F3: COLLISION PREVENTION ASSIST/Adaptive Brake Assist

<p><b>Claim 17</b></p>	<p><b>Corresponding Element in Mercedes-Benz Vehicles</b></p> <p>Adaptive Brake Assist aids you in braking during hazardous situations at speeds above 4 mph (7 km/h) and uses the radar sensor system to evaluate the traffic situation.</p> <p>With the help of Adaptive Brake Assist, the distance warning signal can detect obstacles that are in the path of your vehicle for an extended period of time.</p> <p>Should you approach an obstacle and Adaptive Brake Assist has detected a risk of collision, Adaptive Brake Assist calculates the braking force necessary to avoid a rear-end collision. Should you apply the brakes vigorously, Adaptive Brake Assist will automatically increase the braking force to a level suitable for the traffic conditions.</p> <ul style="list-style-type: none"> <li>▶ Keep the brake pedal depressed until the emergency braking situation is over. ABS prevents the wheels from locking.</li> </ul> <p>(See, e.g., Ex. Mercedes-Benz-2 at 75; Ex. Mercedes-Benz-6 at 64-66; Ex. Mercedes-Benz-8 at 71-72; Ex. Mercedes-Benz-9 at 71-72; Ex. Mercedes-Benz-11 at 71-72; Ex. Mercedes-Benz-13 at 70-71).</p> <p>17F4, PRE-SAFE Brake.</p>
------------------------	---

Claim 17

Corresponding Element in Mercedes-Benz Vehicles

Function

- ▶ To activate/deactivate: activate or deactivate PRE-SAFE® Brake in the on-board computer (▶ page 260).  
If the PRE-SAFE® Brake is not activated, the  symbol appears in the multifunction display.

Starting at a speed of around 4 mph (7 km/h), this function warns you if you rapidly approach a vehicle in front. An intermittent warning tone will then sound and the  distance warning lamp will light up in the instrument cluster.

- ▶ Brake immediately to defuse the situation.
- or
- ▶ Take evasive action provided it is safe to do so.
- ⓘ If there is an increased risk of collision, preventive passenger protection measures (PRE-SAFE®) are activated.

(See, e.g., Ex. Mercedes-Benz-2 at 78; Ex. Mercedes-Benz-3 at 67; Ex. Mercedes-Benz-4 at 71; Ex. Mercedes-Benz-5 at 68; Ex. Mercedes-Benz-7 at 72; Ex. Mercedes-Benz-8 at 76-77; Ex. Mercedes-Benz-9 at 76-77; Ex. Mercedes-Benz-11 at 75; Ex. Mercedes-Benz-12 at 72; Ex. Mercedes-Benz-13 at 74; Ex. Mercedes-Benz-14 at 77; Ex. Mercedes-Benz-15 at 65; Ex. Mercedes-Benz-16 at 77).

17F5, DISTRONIC PLUS:

Claim 17	Corresponding Element in Mercedes-Benz Vehicles
	<p>IF DISTRONIC PLUS detects that there is a risk of a collision, you will be warned visually and acoustically. DISTRONIC PLUS cannot prevent a collision without your intervention. An intermittent warning tone will then sound and the distance warning lamp will light up in the instrument cluster. Brake immediately in order to increase the distance to the vehicle in front or take evasive action provided it is safe to do so.</p> <p>DISTRONIC PLUS operates in range between 0 mph (0 km/h) and 120 mph (200 km/h).</p> <p>Do not use DISTRONIC PLUS while driving on roads with steep gradients.</p> <p>(See, e.g., Ex. Mercedes-Benz-2 at 201; Ex. Mercedes-Benz-3 at 157; Ex. Mercedes-Benz-4 at 173; Ex. Mercedes-Benz-5 at 298; Ex. Mercedes-Benz-6 at 164; Ex. Mercedes-Benz-7 at 177; Ex. Mercedes-Benz-8 at 191; Ex. Mercedes-Benz-9 at 191; Ex. Mercedes-Benz-10 at 177; Ex. Mercedes-Benz-11 at 203; Ex. Mercedes-Benz-12 at 175; Ex. Mercedes-Benz-13 at 194; Ex. Mercedes-Benz-14 at 186; Ex. Mercedes-Benz-15 at 169; Ex. Mercedes-Benz-16 at 186).</p> <p>17F6 Blind Spot Assist/Active Blind Spot Assist:</p>

**Claim 17**

**Corresponding Element in Mercedes-Benz Vehicles**

**Warning display**

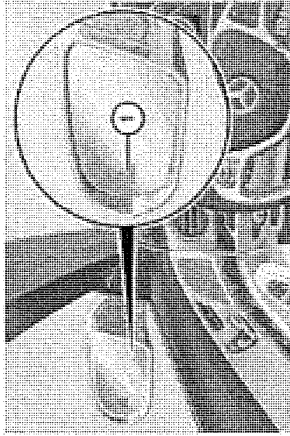



**① Warning display**

Active Blind Spot Assist is not operational at speeds below approximately 20 mph (30 km/h). Vehicles in the monitoring range are then not indicated.

If a vehicle is detected within the blind spot monitoring range at speeds above 20 mph (30 km/h), warning lamp ① on the corresponding side lights up red. This warning is always emitted when a vehicle enters the blind spot monitoring range from behind or from the side. When you overtake a vehicle, the warning only occurs if the difference in speed is less than 7 mph (12 km/h).

(See, e.g., Ex. Mercedes-Benz-2 at 240-43; Ex. Mercedes-Benz-3 at 177-78, 180-81; Ex. Mercedes-Benz-4 at 193-94, 197-99; Ex. Mercedes-Benz-5 at 327-30; Ex. Mercedes-Benz-6 at 188-90; Ex. Mercedes-Benz-7 at 207-09, 211-13; Ex. Mercedes-Benz-8 at 221-23, 225-27; Ex. Mercedes-Benz-9 at 221-23, 225-27; Ex. Mercedes-Benz-10 at 185-87; Ex. Mercedes-Benz-11 at

Claim 17	Corresponding Element in Mercedes-Benz Vehicles
<p>243-44, 247-50; Ex. Mercedes-Benz-12 at 202-03, 206-09; Ex. Mercedes-Benz-13 at 233-35, 237-40; Ex. Mercedes-Benz-14 at 218-21; Ex. Mercedes-Benz-15 at 187-88; Ex. Mercedes-Benz-16 at 145-47).</p> <p><b>Visual and acoustic collision warning</b></p> <p>If you switch on the turn signals to change lanes and a vehicle is detected in the side monitoring range, you receive a visual and acoustic collision warning. You will then hear a double warning tone and red warning lamp  flashes. If the turn signal remains on, detected vehicles are indicated by the flashing of red warning lamp . There are no further warning tones.</p> <p>(See, e.g., Ex. Mercedes-Benz-2 at 240-43; Ex. Mercedes-Benz-3 at 177-78, 180-81; Ex. Mercedes-Benz-4 at 193-94, 197-99; Ex. Mercedes-Benz-5 at 327-30; Ex. Mercedes-Benz-6 at 188-90; Ex. Mercedes-Benz-7 at 207-09, 211-13; Ex. Mercedes-Benz-8 at 221-23, 225-27; Ex. Mercedes-Benz-9 at 221-23, 225-27; Ex. Mercedes-Benz-10 at 185-87; Ex. Mercedes-Benz-11 at 243-44, 247-50; Ex. Mercedes-Benz-12 at 202-03, 206-09; Ex. Mercedes-Benz-13 at 233-35, 237-40; Ex. Mercedes-Benz-14 at 218-21; Ex. Mercedes-Benz-15 at 187-88; Ex. Mercedes-Benz-16 at 145-47).</p>	<p>The accused Mercedes-Benz vehicles include a fuel overinjection circuit coupled to said processor subsystem, said fuel overinjection circuit issuing a notification that excessive fuel is being supplied to said engine of said vehicle.</p> <p>See, e.g., citations for claim element 1E.</p>
<p>17G. a fuel overinjection circuit coupled to said processor subsystem, said fuel overinjection circuit issuing a notification that excessive fuel is being supplied to said engine of</p>	<p>The accused Mercedes-Benz vehicles include a fuel overinjection circuit coupled to said processor subsystem, said fuel overinjection circuit issuing a notification that excessive fuel is being supplied to said engine of said vehicle.</p> <p>See, e.g., citations for claim element 1E.</p>

<b>Claim 17</b>	<b>Corresponding Element in Mercedes-Benz Vehicles</b>
<p>said vehicle;</p> <p>17H. an upshift notification circuit coupled to said processor subsystem, said upshift notification circuit issuing a notification that said engine of said vehicle is being operated at an excessive speed;</p> <p>17I. said processor subsystem determining, based upon data received from said radar detector, said at least one sensor and said memory subsystem, when to activate said fuel overinjection circuit, and when to activate said upshift notification circuit.</p>	<p>The accused Mercedes-Benz vehicles include an upshift notification circuit coupled to said processor subsystem, said upshift notification circuit issuing a notification that said engine of said vehicle is being operated at an excessive speed.</p> <p><i>See, e.g.,</i> citations for claim element 1F.</p>
<p>17J. said processor subsystem determining, based upon data received from said radar detector, said at least one sensor and said memory subsystem, when to activate said fuel overinjection circuit, and when to activate said upshift notification circuit.</p>	<p>On information and belief, the accused Mercedes-Benz vehicles include a processor subsystem determining, based upon data received from said radar detector, said at least one sensor and said memory subsystem, when to activate said vehicle proximity alarm circuit, when to activate said fuel overinjection circuit, and when to activate said upshift notification circuit.</p> <p><i>See, e.g.,</i> citations for claim elements 1G, 17F.</p>



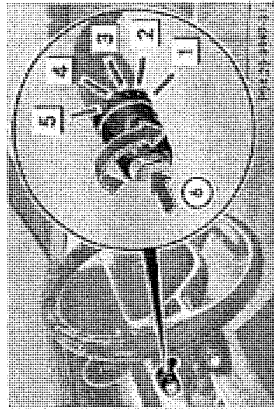

Claim 18	Corresponding Element in Mercedes-Benz Vehicles
<p>18A. Apparatus for optimizing operation of a vehicle according to claim 17 wherein:</p>	<p>The accused Mercedes-Benz vehicles include an apparatus for optimizing operation of a vehicle according to claim 17.  See, e.g., citations for claim 17.</p>
<p>18B. said at least one sensor further includes a windshield wiper sensor for indicating whether a windshield wiper of said vehicle is activated; and</p>	<p>The accused Mercedes-Benz vehicles include at least one sensor further including a windshield wiper sensor for indicating whether a windshield wiper of said vehicle is activated.  For example, the accused Mercedes-Benz vehicles include a windshield wiper sensor that determines when the wipers are turned on.</p> <p><b>■</b> Vehicles with a rain sensor: if the windshield becomes dirty in dry weather conditions, the windshield wipers may be activated inadvertently. This could then damage the windshield wiper blades or scratch the windshield.  For this reason, you should always switch off the windshield wipers in dry weather.</p>



- 1 0 Windshield wiper off
  - 2 ... Intermittent wipe, low (rain sensor set to low sensitivity)
  - 3 .... Intermittent wipe, high (rain sensor set to high sensitivity)
  - 4 — Continuous wipe, slow
  - 5 ≡ Continuous wipe, fast
  - 6 [Washer Symbol] To wipe the windshield using washer fluid
- ▶ Switch on the power supply with the Start/Stop button or the SmartKey (→ page 171).
- ▶ Turn the combination switch to the corresponding position.
- In the [ ] or [ ] position, the appropriate wiping frequency is set automatically according to the intensity of the rain. In the [ ] position, the rain sensor is more sensitive than in the [ ] position, causing the windshield wipers to wipe more frequently.

<b>Claim 18</b>	<b>Corresponding Element in Mercedes-Benz Vehicles</b>
18C. said memory subsystem further storing a second vehicle speed/stopping distance table.	<p>(<i>See, e.g.,</i> Ex. Mercedes-Benz-2 at 146; Ex. Mercedes-Benz-3 at 116; Ex. Mercedes-Benz-4 at 125; Ex. Mercedes-Benz-5 at 257; Ex. Mercedes-Benz-6 at 115; Ex. Mercedes-Benz-7 at 125; Ex. Mercedes-Benz-8 at 143; Ex. Mercedes-Benz-9 at 138; Ex. Mercedes-Benz-10 at 114; Ex. Mercedes-Benz-11 at 140; Ex. Mercedes-Benz-12 at 122; Ex. Mercedes-Benz-13 at 132; Ex. Mercedes-Benz-14 at 134; Ex. Mercedes-Benz-15 at 117; Ex. Mercedes-Benz-16 at 101).</p> <p>The accused Mercedes-Benz vehicles include a memory subsystem further storing a second vehicle speed/stopping distance table.</p> <p>On information and belief, the accused Mercedes-Benz vehicles store a second vehicle speed/stopping distance table.</p> <p><i>See, e.g.,</i> citations for claim element 17E.</p>

<b>Claim 19</b>	<b>Corresponding Element in Mercedes-Benz Vehicles</b>
19A. Apparatus for optimizing operation of a vehicle according to claim 17 and further comprising:	The accused Mercedes-Benz vehicles include an apparatus for optimizing operation of a vehicle according to claim 17.  <i>See, e.g., citations for claim 17.</i>
19B. a throttle controller for controlling a throttle of said engine of said vehicle; and	The accused Mercedes-Benz vehicles include a throttle controller for controlling a throttle of said engine of said vehicle.  <i>See, e.g., citations for claim element 1B.</i>
19C. said processor subsystem selectively reducing said throttle based upon data received from said radar detector, said at least one sensor and said memory subsystem.	On information and belief, the accused Mercedes-Benz vehicles include a processor subsystem that selectively reduces said throttle based upon data received from said radar detector, said at least one sensor and said memory subsystem.  <i>See, e.g., citations for claim element 1G and 17E1.</i>



Claim 20	Corresponding Element in Mercedes-Benz Vehicles
<p>20. Apparatus for optimizing operation of a vehicle according to claim 19 wherein said at least one sensor further includes a brake sensor for indicating whether a brake system of said vehicle is activated.</p>	<p>The accused Mercedes-Benz vehicles include an apparatus for optimizing operation of a vehicle according to claim 19 wherein said at least one sensor further includes a brake sensor for indicating whether a brake system of said vehicle is activated.</p> <p>For example, the accused Mercedes-Benz vehicles include a brake sensor that determines when the brake system is activated (e.g., as indicated by various instrument displays and by the accused vehicles' brake lights.)</p>
	<p><b>Function</b></p>
	<ul style="list-style-type: none"> <li>▶ <b>To activate/deactivate:</b> activate or deactivate PRE-SAFE® Brake in the on-board computer (▷ page 260).</li> </ul> <p>If the PRE-SAFE® Brake is not activated, the  symbol appears in the multifunction display.</p>
	<p>Starting at a speed of around 4 mph (7 km/h), this function warns you if you rapidly approach a vehicle in front. An intermittent warning tone will then sound and the  distance warning lamp will light up in the instrument cluster.</p>
	<ul style="list-style-type: none"> <li>▶ Brake immediately to defuse the situation.</li> <li>or</li> <li>▶ Take evasive action provided it is safe to do so.</li> </ul>
	<p>(See, e.g., Ex. Mercedes-Benz-2 at 78; Ex. Mercedes-Benz-3 at 67; Ex. Mercedes-Benz-4 at 71;</p>

Claim 20	Corresponding Element in Mercedes-Benz Vehicles
	Ex. Mercedes-Benz-5 at 68; Ex. Mercedes-Benz-7 at 72; Ex. Mercedes-Benz-8 at 76-77; Ex. Mercedes-Benz-9 at 76-77; Ex. Mercedes-Benz-11 at 75; Ex. Mercedes-Benz-12 at 72; Ex. Mercedes-Benz-13 at 74; Ex. Mercedes-Benz-14 at 77; Ex. Mercedes-Benz-15 at 65; Ex. Mercedes-Benz-16 at 77).

Claim 21	Corresponding Element in Mercedes-Benz Vehicles
<p>21A. Apparatus for optimizing operation of a vehicle according to claim 19 wherein said processor subsystem further comprises:</p> <p>21B. means for counting a total number of vehicle proximity alarms determined by said processor subsystem;</p>	<p>The accused Mercedes-Benz vehicles include an apparatus for optimizing operation of a vehicle according to claim 19 wherein said processor subsystem further comprises:</p> <p><i>See, e.g., citations for claims 1, 19.</i></p> <p>The accused Mercedes-Benz vehicles include a means for counting a total number of vehicle proximity alarms determined by said processor subsystem.</p> <p>21B1. COLLISION PREVENTION ASSIST/Distance Warning Function:</p>
	<p><b>Function</b></p> <p>► <b>To activate/deactivate:</b> activate or deactivate the distance warning function in the on-board computer (→ page Z61).</p> <p>If the distance warning function is not activated, the  symbol appears in the assistance graphics display.</p> <p>The distance warning function can help you to minimize the risk of a front-end collision with a vehicle ahead or reduce the effects of such a collision. If the distance warning function detects that there is a risk of a collision, you will be warned visually and acoustically. The distance warning function cannot prevent a collision without your intervention.</p>

Claim 21	Corresponding Element in Mercedes-Benz Vehicles
<p>Starting at a speed of around 4 mph (7 km/h), the distance warning function warns you if you rapidly approach a vehicle in front. An intermittent warning tone will then sound and the  distance warning lamp will light up in the instrument cluster.</p> <ul style="list-style-type: none"> <li>▶ Brake immediately in order to increase the distance from the vehicle in front.</li> </ul> <p>or</p> <ul style="list-style-type: none"> <li>▶ Take evasive action, provided it is safe to do so.</li> </ul> <p>Due to the nature of the system, particularly complicated but non-critical driving conditions may also cause the system to display a warning.</p> <p>With the help of the radar sensor system, the distance warning function can detect obstacles that are in the path of your vehicle for an extended period of time.</p> <p>(See, e.g., Ex. Mercedes-Benz-2 at 74; Ex. Mercedes-Benz-6 at 62-64; Ex. Mercedes-Benz-8 at 70-71; Ex. Mercedes-Benz-9 at 70-71; Ex. Mercedes-Benz-11 at 69-70; Ex. Mercedes-Benz-13 at 69-70).</p> <p>21B2. PRE-SAFE Brake:</p>	



Claim 21	Corresponding Element in Mercedes-Benz Vehicles
	<p><b>Function</b></p> <ul style="list-style-type: none"> <li>▶ <b>To activate/deactivate:</b> activate or deactivate PRE-SAFE® Brake in the on-board computer (→ page 260).</li> <li>▶ If the PRE-SAFE® Brake is not activated, the  symbol appears in the multifunction display.</li> </ul> <p>Starting at a speed of around 4 mph (7 km/h), this function warns you if you rapidly approach a vehicle in front. An intermittent warning tone will then sound and the  distance warning lamp will light up in the instrument cluster.</p> <ul style="list-style-type: none"> <li>▶ Brake immediately to defuse the situation.</li> <li>or</li> <li>▶ Take evasive action provided it is safe to do so.</li> </ul> <p> If there is an increased risk of collision, preventive passenger protection measures (PRE-SAFE®) are activated.</p> <p>(See, e.g., Ex. Mercedes-Benz-2 at 78; Ex. Mercedes-Benz-3 at 67; Ex. Mercedes-Benz-4 at 71; Ex. Mercedes-Benz-5 at 68; Ex. Mercedes-Benz-7 at 72; Ex. Mercedes-Benz-8 at 76-77; Ex. Mercedes-Benz-9 at 76-77; Ex. Mercedes-Benz-11 at 75; Ex. Mercedes-Benz-12 at 72; Ex. Mercedes-Benz-13 at 74; Ex. Mercedes-Benz-14 at 77; Ex. Mercedes-Benz-15 at 65; Ex. Mercedes-Benz-16 at 77).</p> <p>21B3. DISTRONIC PLUS:</p>

Claim 21	Corresponding Element in Mercedes-Benz Vehicles
	<p>IF DISTRONIC PLUS detects that there is a risk of a collision, you will be warned visually and acoustically. DISTRONIC PLUS cannot prevent a collision without your intervention. An intermittent warning tone will then sound and the distance warning lamp will light up in the instrument cluster. Brake immediately in order to increase the distance to the vehicle in front or take evasive action provided it is safe to do so.</p> <p>DISTRONIC PLUS operates in range between 0 mph (0 km/h) and 120 mph (200 km/h).</p> <p>Do not use DISTRONIC PLUS while driving on roads with steep gradients.</p> <p>(See, e.g., Ex. Mercedes-Benz-2 at 201; Ex. Mercedes-Benz-3 at 157; Ex. Mercedes-Benz-4 at 173; Ex. Mercedes-Benz-5 at 298; Ex. Mercedes-Benz-6 at 164; Ex. Mercedes-Benz-7 at 177; Ex. Mercedes-Benz-8 at 191; Ex. Mercedes-Benz-9 at 191; Ex. Mercedes-Benz-10 at 177; Ex. Mercedes-Benz-11 at 203; Ex. Mercedes-Benz-12 at 175; Ex. Mercedes-Benz-13 at 194; Ex. Mercedes-Benz-14 at 186; Ex. Mercedes-Benz-15 at 169; Ex. Mercedes-Benz-16 at 186).</p> <p>21B4. Blind Spot Assist/Active Blind Spot Assist.</p>

**Claim 21**

**Corresponding Element in Mercedes-Benz Vehicles**

**Warning display**

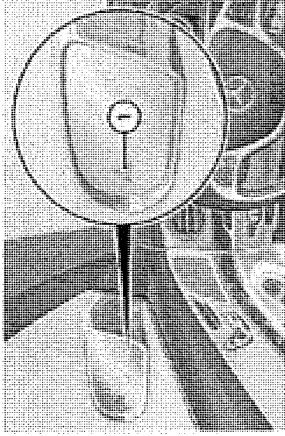



**① Warning display**

Active Blind Spot Assist is not operational at speeds below approximately 20 mph (30 km/h). Vehicles in the monitoring range are then not indicated.

If a vehicle is detected within the blind-spot monitoring range at speeds above 20 mph (30 km/h), warning lamp ① on the corresponding side lights up red. This warning is always emitted when a vehicle enters the blind-spot monitoring range from behind or from the side. When you overtake a vehicle, the warning only occurs if the difference in speed is less than 7 mph (12 km/h).

(See, e.g., Ex. Mercedes-Benz-2 at 240-43; Ex. Mercedes-Benz-3 at 177-78, 180-81; Ex. Mercedes-Benz-4 at 193-94, 197-99; Ex. Mercedes-Benz-5 at 327-30; Ex. Mercedes-Benz-6 at 188-90; Ex. Mercedes-Benz-7 at 207-09, 211-13; Ex. Mercedes-Benz-8 at 221-23, 225-27; Ex. Mercedes-Benz-9 at 221-23, 225-27; Ex. Mercedes-Benz-10 at 185-87; Ex. Mercedes-Benz-11 at

Claim 21	Corresponding Element in Mercedes-Benz Vehicles
<p>243-44, 247-50; Ex. Mercedes-Benz-12 at 202-03, 206-09; Ex. Mercedes-Benz-13 at 233-35, 237-40; Ex. Mercedes-Benz-14 at 218-21; Ex. Mercedes-Benz-15 at 187-88; Ex. Mercedes-Benz-16 at 145-47).</p> <p><b>Visual and acoustic collision warning</b>            If you switch on the turn signals to change lanes and a vehicle is detected in the side monitoring range, you receive a visual and acoustic collision warning. You will then hear a double warning tone and red warning lamp  flashes. If the turn signal remains on, detected vehicles are indicated by the flashing of red warning lamp . There are no further warning tones.</p> <p>(See, e.g., Ex. Mercedes-Benz-2 at 240-43; Ex. Mercedes-Benz-3 at 177-78, 180-81; Ex. Mercedes-Benz-4 at 193-94, 197-99; Ex. Mercedes-Benz-5 at 327-30; Ex. Mercedes-Benz-6 at 188-90; Ex. Mercedes-Benz-7 at 207-09, 211-13; Ex. Mercedes-Benz-8 at 221-23, 225-27; Ex. Mercedes-Benz-9 at 221-23, 225-27; Ex. Mercedes-Benz-10 at 185-87; Ex. Mercedes-Benz-11 at 243-44, 247-50; Ex. Mercedes-Benz-12 at 202-03, 206-09; Ex. Mercedes-Benz-13 at 233-35, 237-40; Ex. Mercedes-Benz-14 at 218-21; Ex. Mercedes-Benz-15 at 187-88; Ex. Mercedes-Benz-16 at 145-47).</p> <p>To the extent that 35 U.S.C. §112(6) applies to this claim limitation, the structure(s), act(s), or materials(s) that perform the claimed function of “counting a total number of vehicle proximity alarms determined by said processor subsystem” are described in, for example, Figures 1 and 2 and associated text relating to the expression programmed in the Processor Subsystem 12.</p> <p>On information and belief, the accused Mercedes-Benz vehicles include a means for selectively reducing said throttle based upon said total number of vehicle proximity alarms.</p>	<p>21C. means for selectively reducing said throttle based upon said total number of</p>

<b>Claim 21</b>	<b>Corresponding Element in Mercedes-Benz Vehicles</b>
vehicle proximity alarms.	<p><i>See, e.g.,</i> citations for claim element 21B.</p> <p>To the extent that 35 U.S.C. §112(6) applies to this claim limitation, the structure(s), act(s), or materials(s) that perform the claimed function of “counting a total number of vehicle proximity alarms determined by said processor subsystem” are described in, for example, Figures 1 and 2 and associated text relating to the expression programmed in the Processor Subsystem 12.</p>

<b>Claim 22</b>	<b>Corresponding Element in Mercedes-Benz Vehicles</b>
<p>22A. Apparatus for optimizing operation of a vehicle according to claim 17 and further comprising:</p> <p>22B. a downshift notification circuit coupled to said processor subsystem, said downshift notification circuit issuing a notification that said engine of an insufficient engine speed;</p> <p>and</p> <p>22C. said processor subsystem determining, based upon data received from said plurality of sensors, when to activate said downshift notification circuit.</p>	<p>The accused Mercedes-Benz vehicles include an apparatus for optimizing operation of a vehicle according to claim 17 and further comprising:</p> <p><i>See, e.g.,</i> citations for claim 17.</p> <p>The accused Mercedes-Benz vehicles include a downshift notification circuit coupled to said processor subsystem, said downshift notification circuit issuing a notification that said engine of said vehicle is being operated at an insufficient engine speed.</p> <p><i>See, e.g.,</i> citations for claim element 7F.</p>
	<p>The accused Mercedes-Benz vehicles include a processor subsystem that determines, based upon data received from said plurality of sensors, when to activate said downshift notification circuit.</p> <p><i>See, e.g.,</i> citations for claim elements 1B, 1G.</p>

<b>Claim 23</b>	<b>Corresponding Element in Mercedes-Benz Vehicles</b>
23A. Apparatus for optimizing operation of a vehicle, comprising:	The accused Mercedes-Benz vehicles include an apparatus for optimizing operation of a vehicle. <i>See, e.g.,</i> citations for claims 1, 17.
23B. a radar detector, said radar detector determining a distance separating a vehicle having an engine and an object in front of said vehicle;	The accused Mercedes-Benz vehicles include a radar detector that determines a distance separating a vehicle having an engine and another object in front of the accused vehicles. <i>See, e.g.,</i> citations for claim element 17B.
23C. a plurality of sensors coupled to a vehicle having an engine, said plurality of sensors, which collectively monitor operation of said vehicle, including a road speed sensor, and engine speed sensor, and engine speed sensor, a manifold pressure sensor and a throttle position sensor;	The accused Mercedes-Benz vehicles include a plurality of sensors coupled to a vehicle having an engine, said plurality of sensors, which collectively monitor operation of said vehicle, including a road speed sensor, and engine speed sensor, a manifold pressure sensor and a throttle position sensor. <i>See, e.g.,</i> citations for claim element 1B.
23D. a processor subsystem, coupled to said radar detector and each one of said plurality of sensors, to receive data therefrom;	The accused Mercedes-Benz vehicles include a processor subsystem, coupled to said radar detector and each one of said plurality of sensors, to receive data therefrom; <i>See, e.g.,</i> citations for claim element 1C.
23E. a memory subsystem, coupled to said processor subsystem, said memory subsystem storing therein a first vehicle speed/stopping distance table, a first vehicle speed/stopping distance table, a manifold pressure set point, an RPM set point, and present and prior levels for each one of said plurality of sensors.	The accused Mercedes-Benz vehicles include a memory subsystem, coupled to said processor subsystem, said memory subsystem storing therein a first vehicle speed/stopping distance table, a manifold pressure set point, an RPM set point, and present and prior levels for each one of said plurality of sensors.

Claim 23	Corresponding Element in Mercedes-Benz Vehicles
pressure set point, an RPM set point, and present and prior levels for each one of said plurality of sensors;	<i>See, e.g., citations for claim element 17E.</i>
23F. a fuel overinjection notification circuit coupled to said processor subsystem, said fuel overinjection notification circuit issuing a notification that excessive fuel is being supplied to said engine of said vehicle;	The accused Mercedes-Benz vehicles include a fuel overinjection notification circuit coupled to said processor subsystem, said fuel overinjection notification circuit issuing a notification that excessive fuel is being supplied to said engine of said vehicle.  <i>See, e.g., citations for claim element 1E.</i>
23G. an upshift notification circuit coupled to said processor subsystem, said upshift notification circuit issuing a notification that said engine of said vehicle is being operated at an excessive speed;	The accused Mercedes-Benz vehicles include an upshift notification circuit coupled to said processor subsystem, said upshift notification circuit issuing a notification that said engine of said vehicle is being operated at an excessive speed.  <i>See, e.g., citations for claim element 1F.</i>
23H. said processor subsystem determining, based upon data received from said plurality of sensors, when to activate said fuel overinjection circuit and when to activate said upshift notification circuit;	The accused Mercedes-Benz vehicles include a processor subsystem that determines, based upon data received from said plurality of sensors, when to activate said fuel overinjection circuit and when to activate said upshift notification circuit.  <i>See, e.g., citations for claim element 1G.</i>
23I. a vehicle proximity	The accused Mercedes-Benz vehicles include a vehicle proximity alarm circuit coupled to said



<b>Claim 23</b>	<b>Corresponding Element in Mercedes-Benz Vehicles</b>
<p>alarm circuit coupled to said processor subsystem, said vehicle proximity alarm circuit issuing an alarm that said vehicle is too close to said object;</p>	<p>processor subsystem, said vehicle proximity alarm circuit issuing an alarm that said vehicle is too close to said object.  See, e.g., citations for claim 17F.</p>
<p>23J. said processor subsystem determining, based upon data received from said radar detector, said at least one sensor and said memory subsystem, when to activate said vehicle proximity alarm circuit.</p>	<p>The accused Mercedes-Benz vehicles includes a processor subsystem that determines, based upon data received from said radar detector, said at least one sensor and said memory subsystem, when to activate said vehicle proximity alarm circuit.  See, e.g., citations for claim element 17I.</p>

Claim 24	Corresponding Element in Mercedes-Benz Vehicles
24A. Apparatus for optimizing operation of a vehicle according to claim 23 wherein said processor subsystem further comprises:	The accused Mercedes-Benz vehicles include an apparatus for optimizing operation of a vehicle according to claim 23 wherein said processor subsystem further comprises:  <i>See, e.g.,</i> citations for claim 23.
24B. means for determining when road speed for said vehicle is increasing or decreasing;	The accused Mercedes-Benz vehicles include a means for determining when road speed for said vehicle is increasing or decreasing.  <i>See, e.g.,</i> citations for claim element 15B.
24C. means for determining when throttle position for said vehicle is increasing or decreasing; and	The accused Mercedes-Benz vehicles include a means for determining when throttle position for said vehicle is increasing or decreasing.  <i>See, e.g.,</i> citations for claim element 2C.  To the extent that 35 U.S.C. §112(6) applies to this claim limitation, the structure(s), act(s), or materials(s) that perform the claimed function of “determining when throttle position for said vehicle is increasing or decreasing” are described in, for example, Figures 1 and 2 and associated text of the ’781 patent relating to Throttle Sensor 24, Memory Subsystem 14, and Processor Subsystem 12.
24D. means for comparing manifold pressure to said manifold pressure set point;	The accused Mercedes-Benz vehicles include a means for comparing manifold pressure to said manifold pressure set point.  <i>See, e.g.,</i> citations for claim element 2D.
24E. means for determining when manifold pressure for said vehicle is increasing or decreasing; and	The accused Mercedes-Benz vehicles include a means for determining when manifold pressure for said vehicle is increasing or decreasing.  <i>See, e.g.,</i> citations for claim element 4D.

Claim 24	Corresponding Element in Mercedes-Benz Vehicles
<p>To the extent that 35 U.S.C. §112(6) applies to this claim limitation, the structure(s), act(s), or materials(s) that perform the claimed function of “determining when manifold pressure for said vehicle is increasing or decreasing” are described in, for example, Figures 1 and 2 and associated text of the '781 patent relating to Manifold PSI Sensor 22, Memory Subsystem 14, and Processor Subsystem 12.</p>	<p>The accused Mercedes-Benz vehicles include a means for determining when engine speed for said vehicle is increasing or decreasing.</p> <p><i>See, e.g.</i>, citations for claim element 15G.</p>
<p>24F. means for determining when engine speed for said vehicle is increasing or decreasing;</p>	<p>On information and belief, the accused Mercedes-Benz vehicles include a processor subsystem that activates said fuel overinjection notification circuit if both road speed and throttle position for said vehicle are increasing and manifold pressure for said vehicle is above said manifold pressure set point or if both throttle position and manifold pressure for said vehicle are increasing and road speed and engine speed for said vehicle are decreasing.</p> <p><i>See, e.g.</i>, citations for claim element 1G.</p>
<p>24G. said processor subsystem activating said fuel overinjection notification circuit if both road speed and throttle position for said vehicle are increasing and manifold pressure for said vehicle is above said manifold pressure set point or if both throttle position and manifold pressure for said vehicle are increasing and road speed and engine speed for said vehicle are decreasing.</p>	<p>On information and belief, the accused Mercedes-Benz vehicles include a processor subsystem that activates said fuel overinjection notification circuit if both road speed and throttle position for said vehicle are increasing and manifold pressure for said vehicle is above said manifold pressure set point or if both throttle position and manifold pressure for said vehicle are increasing and road speed and engine speed for said vehicle are increasing and road speed and engine speed for said vehicle are decreasing.</p> <p><i>See, e.g.</i>, citations for claim element 1G.</p>

<b>Claim 25</b>	<b>Corresponding Element in Mercedes-Benz Vehicles</b>
25A. Apparatus for optimizing operation of a vehicle according to claim 23 wherein said processor subsystem further comprises:	The accused Mercedes-Benz vehicles include an apparatus for optimizing operation of a vehicle according to claim 23 wherein said processor subsystem further comprises:  <i>See, e.g., citations for claim 23.</i>
25B. means for determining when road speed for said vehicle is increasing;	The accused Mercedes-Benz vehicles include a means for determining when road speed for said vehicle is increasing.  <i>See, e.g., citations for claim element 2B.</i>
25C. means for determining when throttle position for said vehicle is increasing; and	The accused Mercedes-Benz vehicles include a means for determining when throttle position for said vehicle is increasing.  <i>See, e.g., citations for claim element 2C.</i>
25D. means for comparing manifold pressure to said manifold pressure set point;	The accused Mercedes-Benz vehicles include a means for comparing manifold pressure to said manifold pressure set point.  <i>See, e.g., citations for claim element 2D.</i>
25E. means for comparing engine speed to said RPM set point;	The accused Mercedes-Benz vehicles include a means for comparing engine speed to said RPM set point.  <i>See, e.g., citations for claim element 5E.</i>
25F. said processor subsystem activating said upshift notification circuit if both road speed and throttle position for said vehicle are increasing, manifold	On information and belief, the accused Mercedes-Benz vehicles include a processor subsystem that activates said upshift notification circuit if both road speed and throttle position for said vehicle are increasing, manifold pressure for said vehicle is at or below said manifold pressure set point and engine speed for said vehicle is at or above said RPM set point.  <i>See, e.g., citations for claim element 5F.</i>

Claim 25	Corresponding Element in Mercedes-Benz Vehicles
pressure for said vehicle is at or below said manifold pressure set point and engine speed for said vehicle is at or above said RPM set point.	

<b>Corresponding Element in Mercedes-Benz Vehicles</b>	
<b>Claim 26</b>	The accused Mercedes-Benz vehicles include an apparatus for optimizing operation of a vehicle.
26A. Apparatus for optimizing operation of a vehicle, comprising:	<i>See, e.g., citations for claims 1, 17.</i>
26B. a radar detector, said radar detector determining a distance separating a vehicle having an engine and an object in front of said vehicle;	The accused Mercedes-Benz vehicles include a radar detector that determines a distance separating a vehicle having an engine and another object in front of the accused vehicles.  <i>See, e.g., citations for claim element 17B.</i>
26C. a plurality of sensors coupled to a vehicle having an engine, said plurality of sensors, which collectively monitor operation of said vehicle, including a road speed sensor, and engine speed sensor, a manifold pressure sensor and a throttle position sensor;	The accused Mercedes-Benz vehicles include a plurality of sensors coupled to a vehicle having an engine, said plurality of sensors, which collectively monitor operation of said vehicle, including a road speed sensor, and engine speed sensor, a manifold pressure sensor and a throttle position sensor.  <i>See, e.g., citations for claim element 1B.</i>
26D. a processor subsystem, coupled to said radar detector and each one of said plurality of sensors, to receive data therefrom;	The accused Mercedes-Benz vehicles include a processor subsystem, coupled to said radar detector and each one of said plurality of sensors, to receive data therefrom;  <i>See, e.g., citations for claim element 1C.</i>
26E. a memory subsystem, coupled to said processor subsystem, said memory subsystem storing therein a first vehicle speed/stopping distance table, a first vehicle speed/stopping distance table, a manifold pressure set point, RPM set point, and present and prior levels for each one of said plurality of sensors.	The accused Mercedes-Benz vehicles include a memory subsystem, coupled to said processor subsystem, said memory subsystem storing therein a first vehicle speed/stopping distance table, a manifold pressure set point, RPM set point, and present and prior levels for each one of said plurality of sensors.

<b>Claim 26</b>	<b>Corresponding Element in Mercedes-Benz Vehicles</b>
pressure set point, RPM set point, and present and prior levels for each one of said plurality of sensors;	<i>See, e.g.</i> , citations for claim element 17E.
26F. a fuel overinjection notification circuit coupled to said processor subsystem, said fuel overinjection notification circuit issuing a notification that excessive fuel is being supplied to said engine of said vehicle;	The accused Mercedes-Benz vehicles include a fuel overinjection notification circuit coupled to said processor subsystem, said fuel overinjection notification circuit issuing a notification that excessive fuel is being supplied to said engine of said vehicle.  <i>See, e.g.</i> , citations for claim element 1E.
26G. a downshift notification circuit coupled to said processor subsystem, said downshift notification circuit issuing a notification that said engine of said vehicle is being operated at an insufficient engine speed;	The accused Mercedes-Benz vehicles include a downshift notification circuit coupled to said processor subsystem, said downshift notification circuit issuing a notification that said engine of said vehicle is being operated at an insufficient engine speed;  <i>See, e.g.</i> , citations for claim element 7F.
26H. said processor subsystem determining, based upon data received from said plurality of sensors, when to activate said fuel overinjection circuit and when to activate said downshift notification circuit;	The accused Mercedes-Benz vehicles include a processor subsystem that determines, based upon data received from said plurality of sensors, when to activate said fuel overinjection circuit and when to activate said downshift notification circuit.  <i>See, e.g.</i> , citations for claim element 7G.
26I. a vehicle proximity	The accused Mercedes-Benz vehicles include a vehicle proximity alarm circuit coupled to said

<b>Claim 26</b>	<b>Corresponding Element in Mercedes-Benz Vehicles</b>
<p>alarm circuit coupled to said processor subsystem, said vehicle proximity alarm circuit issuing an alarm that said vehicle is too close to said object;</p> <p>26J. said processor subsystem determining, based upon data received from said radar detector, said at least one sensor and said memory subsystem, when to activate said vehicle proximity alarm circuit.</p>	<p>processor subsystem, said vehicle proximity alarm circuit issuing an alarm that said vehicle is too close to said object.</p> <p><i>See, e.g.,</i> citations for claim element 17F.</p> <p>The accused Mercedes-Benz vehicles includes a processor subsystem that determines, based upon data received from said radar detector, said at least one sensor and said memory subsystem, when to activate said vehicle proximity alarm circuit.</p> <p><i>See, e.g.,</i> citations for claim element 17I.</p>



Claim 27	Corresponding Element in Mercedes-Benz Vehicles
27A. Apparatus for optimizing operation of a vehicle according to claim 26 wherein said processor subsystem further comprises:	The accused Mercedes-Benz vehicles include an apparatus for optimizing operation of a vehicle according to claim 26 wherein said processor subsystem further comprises:  <i>See, e.g.,</i> citations for claims 1, 26.
27B. means for determining when road speed for said vehicle is decreasing;	The accused Mercedes-Benz vehicles include a means for determining when road speed for said vehicle is decreasing.  <i>See, e.g.,</i> citations for claim element 4B.
27C. means for determining when throttle position for said vehicle is increasing; and	The accused Mercedes-Benz vehicles include a means for determining when throttle position for said vehicle is increasing.  <i>See, e.g.,</i> citations for claim element 4C.
27D. means for determining when manifold pressure for said vehicle is increasing; and	The accused Mercedes-Benz vehicles include a means for determining when manifold pressure for said vehicle is increasing.  <i>See, e.g.,</i> citations for claim element 4D.
27E. means for determining when engine speed for said vehicle is decreasing;	The accused Mercedes-Benz vehicles include a means for determining when engine speed for said vehicle is decreasing.  <i>See, e.g.,</i> citations for claim element 4E.
27F. said processor subsystem activating said downshift notification circuit if both road speed and engine speed are	On information and belief, the accused Mercedes-Benz vehicles include a processor subsystem that activates said downshift notification circuit if both road speed and engine speed are decreasing and both throttle position and manifold pressure for said vehicle are increasing.  <i>See, e.g.,</i> citations for claim element 10F.

<b>Claim 27</b>	<b>Corresponding Element in Mercedes-Benz Vehicles</b>
decreasing and both throttle position and manifold pressure for said vehicle are increasing.	

Claim 28	Corresponding Element in Mercedes-Benz Vehicles
28A. Apparatus for optimizing operation of a vehicle, comprising:	The accused Mercedes-Benz vehicles include an apparatus for optimizing operation of a vehicle. <i>See, e.g.,</i> citations for claim 1.
28B. a plurality of sensors coupled to a vehicle having an engine, said plurality of sensors, which collectively monitor operation of said vehicle, including a road speed sensor, an engine speed sensor, a manifold pressure sensor and a throttle position sensor;	The accused Mercedes-Benz vehicles include a plurality of sensors coupled to the vehicle having an engine, said plurality of sensors, which collectively monitor operation of said vehicle, including a road speed sensor, an engine speed sensor, a manifold pressure sensor and a throttle position sensor <i>See, e.g.,</i> citations for claim element 1B.
28C. a processor subsystem, coupled to each one of said plurality of sensors, to receive data therefrom;	The accused Mercedes-Benz vehicles include a processor subsystem, coupled to each one of said plurality of sensors, to receive data therefrom. <i>See, e.g.,</i> citations for claim element 1C.
28D. a fuel overinjection notification circuit coupled to said processor subsystem, said fuel overinjection notification circuit issuing a notification that excessive fuel is being supplied to said engine of said vehicle;	The accused Mercedes-Benz vehicles include a fuel overinjection notification circuit coupled to said processor subsystem, said fuel overinjection notification circuit issuing a notification that excessive fuel is being supplied to said engine of said vehicle. <i>See, e.g.,</i> citations for claim element 1E.
28E. said processor subsystem determining whether to activate said fuel overinjection notification	The accused Mercedes-Benz vehicles include a processor subsystem that determines whether to activate said fuel overinjection notification sensor based upon data received from said road speed sensor, said throttle position sensor and said manifold pressure sensor.

Claim 28	Corresponding Element in Mercedes-Benz Vehicles
<p>sensor based upon data received from said road speed sensor, said throttle position sensor and said manifold pressure sensor.</p>	<p>See, e.g., citations for claim element 1G.</p>

Claim 29	Corresponding Element in Mercedes-Benz Vehicles
<p>29A. Apparatus according to claim 28 and further comprising:</p>	<p>The accused Mercedes-Benz vehicles include an apparatus according to claim 28 and further comprising:  <i>See, e.g.,</i> citations for claim 1, 28.</p>
<p>29B. a memory subsystem, coupled to said processor subsystem, said memory subsystem maintaining a manifold pressure set point;</p>	<p>The accused Mercedes-Benz vehicles include a memory subsystem, coupled to said processor subsystem, said memory subsystem maintaining a manifold pressure set point.  <i>See, e.g.,</i> citations for claim element 1D.</p>
<p>29C. said processor subsystem activating said fuel overinjection notification circuit upon determining that: (1) based upon data received from said road speed sensor, road speed of said vehicle is increasing; (2) based upon data received from said throttle position sensor, throttle position for said vehicle is increasing; and (3) based upon data received from said manifold pressure sensor, manifold pressure for said vehicle exceeds said manifold pressure set point.</p>	<p>On information and belief, the accused Mercedes-Benz vehicles include a processor subsystem that activates said fuel overinjection notification circuit upon determining that: (1) based upon data received from said road speed sensor, road speed of said vehicle is increasing; (2) based upon data received from said throttle position sensor, throttle position for said vehicle is increasing; and (3) based upon data received from said manifold pressure sensor, manifold pressure for said vehicle exceeds said manifold pressure set point.  <i>See, e.g.,</i> citations for claim element 1G.</p>

Claim 30	Corresponding Element in Mercedes-Benz Vehicles
<p>30A. Apparatus according to claim 28, wherein:</p>	<p>The accused Mercedes-Benz vehicles include an apparatus according to claim 28.</p> <p><i>See, e.g.,</i> citations for claims 1, 28.</p>
<p>30B. said plurality of sensors coupled to said vehicle further include an engine speed sensor;</p>	<p>The accused Mercedes-Benz vehicles include a plurality of sensors coupled to said vehicle further including an engine speed sensor;</p> <p><i>See, e.g.,</i> citations for claim element 1B.</p>
<p>30C. said processor subsystem activating said fuel overinjection notification circuit upon determining that: (1) based upon data received from said road speed sensor, road speed of said vehicle is decreasing; (2) based upon data received from said throttle position sensor, throttle position for said vehicle is increasing; (3) based upon data received from said manifold pressure sensor, manifold pressure for said vehicle is increasing; and (4) based upon data received from said engine speed sensor, engine speed for said vehicle is decreasing.</p>	<p>On information and belief, the accused Mercedes-Benz vehicles include a processor subsystem that activates said fuel overinjection notification circuit upon determining that: (1) based upon data received from said road speed sensor, road speed of said vehicle is decreasing; (2) based upon data received from said throttle position sensor, throttle position for said vehicle is increasing; (3) based upon data received from said manifold pressure sensor, manifold pressure for said vehicle is increasing; and (4) based upon data received from said engine speed sensor, engine speed for said vehicle is decreasing.</p> <p><i>See, e.g.,</i> citations for claim element 1G.</p>

Claim 30	Corresponding Element in Mercedes-Benz Vehicles
said engine speed sensor, engine speed for said vehicle is decreasing.	

<b>Claim 31</b>	<b>Corresponding Element in Mercedes-Benz Vehicles</b>
31A. Apparatus for optimizing operation of a vehicle, comprising:	The accused Mercedes-Benz vehicles include an apparatus for optimizing operation of a vehicle. <i>See, e.g., citations for claims 1, 17.</i>
31B. a radar detector, said radar detector determining a distance separating a vehicle having an engine and an object in front of said vehicle;	The accused Mercedes-Benz vehicles include a radar detector that determines a distance separating a vehicle having an engine and another object in front of the accused vehicles. <i>See, e.g., citations for claim element 17B.</i>
31C. at least one sensor coupled to said vehicle for monitoring operation thereof, said at least one sensor including a road speed sensor.	The accused Mercedes-Benz vehicles include at least one sensor coupled to said vehicle for monitoring operation thereof, said at least one sensor including a road speed sensor. <i>See, e.g., citations for claim element 1B.</i>
31D. a processor subsystem, coupled to said radar detector and said at least one sensor, to receive data therefrom;	The accused Mercedes-Benz vehicles include a processor subsystem, coupled to said radar detector and said at least one sensor, to receive data therefrom. <i>See, e.g., citations for claim element 17D.</i>
31E. a memory subsystem, coupled to said processor subsystem, said memory subsystem storing a first vehicle speed/stopping distance table.	The accused Mercedes-Benz vehicles include a memory subsystem, coupled to said processor subsystem, said memory subsystem storing a first vehicle speed/stopping distance table. <i>See, e.g., citations for claim element 17E.</i>
31F. a vehicle proximity	The accused Mercedes-Benz vehicles include a vehicle proximity alarm circuit coupled to said



<b>Corresponding Element in Mercedes-Benz Vehicles</b>	
<b>Claim 31</b> alarm circuit coupled to said processor subsystem, said vehicle proximity alarm circuit issuing an alarm that said vehicle is too close to said object; <i>See, e.g.,</i> citations for claim element 17F.	processor subsystem, said vehicle proximity alarm circuit issuing an alarm that said vehicle is too close to said object. <i>See, e.g.,</i> citations for claim element 17F.
31G. said processor subsystem determining whether to activate said vehicle proximity alarm circuit based upon separation distance data received from said radar detector, vehicle speed data received from said road speed sensor and said first vehicle speed/stopping distance table stored in said memory subsystem. <i>See, e.g.,</i> citations for claim element 17I.	On information and belief, the accused Mercedes-Benz vehicles includes a processor subsystem that determines whether to activate said vehicle proximity alarm circuit based upon separation distance data received from said radar detector, vehicle speed data received from said road speed sensor and said first vehicle speed/stopping distance table stored in said memory subsystem. <i>See, e.g.,</i> citations for claim element 17I.

<b>Corresponding Element in Mercedes-Benz Vehicles</b>	
<b>Claim 32</b> 32A. Apparatus for optimizing operation of a vehicle according to claim 31 wherein: 31 wherein:	The accused Mercedes-Benz vehicles include an apparatus for optimizing operation of a vehicle according to claim 31. <i>See, e.g.,</i> citations for claim 31.
32B. said at least one sensor	The accused Mercedes-Benz vehicles include at least one sensor further including a windshield

Claim 32	Corresponding Element in Mercedes-Benz Vehicles
<p>further includes a windshield wiper sensor for indicating whether a windshield wiper of said vehicle is activated; and</p> <p>32C. said memory subsystem further storing a second vehicle speed/stopping distance table.</p>	<p>wiper sensor for indicating whether a windshield wiper of said vehicle is activated.</p> <p><i>See, e.g.</i>, citations for claim element 18B.</p> <p>The accused Mercedes-Benz vehicles include a memory subsystem further storing a second vehicle speed/stopping distance table.</p> <p><i>See, e.g.</i>, citations for claim element 18C.</p>
<p>32D. if said windshield wiper sensor indicates that said windshield wiper is deactivated, said processor subsystem determining whether to activate said vehicle proximity alarm circuit based upon data received from said radar detector, said road speed sensor and said first vehicle speed/stopping distance table stored in said memory subsystem;</p> <p>vehicle proximity alarm circuit based upon data received from said radar detector, said road speed sensor and said first vehicle speed/stopping distance table stored in said memory subsystem;</p>	<p>On information and belief, the accused Mercedes-Benz vehicles include an apparatus for optimizing operation of a vehicle according to claim 31 wherein if said windshield wiper sensor indicates that said windshield wiper is deactivated, said processor subsystem determining whether to activate said vehicle proximity alarm circuit based upon data received from said radar detector, said road speed sensor and said first vehicle speed/stopping distance table stored in said memory subsystem.</p> <p><i>See, e.g.</i>, citations for claim element 17I.</p>
<p>32E. if said windshield wiper sensor indicates that said windshield wiper is activated, said processor subsystem determining whether to activate said</p>	<p>On information and belief, the accused Mercedes-Benz vehicles include an apparatus for optimizing operation of a vehicle according to claim 31 wherein if said windshield wiper sensor indicates that said windshield wiper is activated, said processor subsystem determining whether to activate said vehicle proximity alarm circuit based upon data received from said radar detector, said road speed sensor and said second vehicle speed/stopping distance table stored in said memory subsystem.</p>

Claim 32	Corresponding Element in Mercedes-Benz Vehicles
<p>vehicle proximity alarm circuit based upon data received from said radar detector, said road speed sensor and said second vehicle speed/stopping distance table stored in said memory subsystem.</p>	<p><i>See, e.g., citations for claim element 17I.</i></p>

## **EXHIBIT 8**

**IN THE UNITED STATES DISTRICT COURT  
FOR THE NORTHERN DISTRICT OF ILLINOIS**

**EASTERN DIVISION**

VELOCITY PATENT LLC,	)	
	)	
<i>Plaintiff,</i>	)	Civil Action No. 1:13-cv-08419
	)	
v.	)	Hon. John W. Darrah
	)	
CHRYSLER GROUP, LLC	)	<b>JURY TRIAL DEMANDED</b>
	)	
	)	
<i>Defendant.</i>	)	
	)	

**VELOCITY PATENT LLC’S INITIAL INFRINGEMENT CONTENTIONS PURSUANT  
TO LOCAL PATENT RULE 2.2**

Plaintiff Velocity Patent LLC (“Velocity”) hereby provides, pursuant to N.D. Ill. Local Patent Rule 2.2 of the Northern District of Illinois, the following Initial Infringement Contentions. Velocity contends that each of the identified claims is infringed by Chrysler Group, LLC (“Chrysler”). The following contentions are based on knowledge and information in Velocity’s possession, custody and control after a reasonable investigation of publicly-available sources and the limited number of documents produced by Chrysler pursuant to Local Patent Rule 2.1. The accused Chrysler products implement some of the infringing functionality in whole or in part using circuitry and associated programs, which are neither publicly available nor described in Chrysler’s production to date. Therefore, Velocity reserves the right to revise, amend and supplement these contentions as discovery progresses and new information becomes available.

**A. Identification of Infringed Claims and Applicable Statutory Section of 35 U.S.C. § 271**

Claims 1-2, 4-5, 7-8, 10, 12-13, 15, and 17-32 of U.S. Patent No. 5,954,781 are directly infringed under 35 U.S.C § 271(a) by the accused Chrysler vehicles identified below.

**B. Identification of Accused Instrumentalities By Claim**

As set forth in the accompanying claim chart, the Dodge Challenger (including SRT models), Dodge Charger (including SRT models), Dodge Dart (including SRT models), Dodge Nitro, Dodge Magnum (including SRT models), Dodge Grand Caravan, Dodge Durango, Dodge Aspen, Dodge Aspen Hybrid, Chrysler Sebring, Chrysler Town & Country, Chrysler 300 (including SRT models), Jeep Wrangler, Jeep Commander, Jeep Grand Cherokee (including SRT models), Jeep Cherokee, RAM 1500/2500/3500, RAM Promaster, RAM Chassis, and RAM Cargo Van vehicles that include the identified features, infringe one or more of the claims identified above. On a claim-by-claim basis, the following Chrysler vehicles are accused of infringement by Velocity:

Claim 1 - Dodge Challenger, Dodge Journey, Dodge Dart, Dodge Nitro, Dodge Magnum, Dodge Grand Caravan, Dodge Charger, Dodge Durango, Chrysler Sebring, Chrysler Town & Country, Chrysler 300, Jeep Wrangler, Jeep Commander, Jeep Grand Cherokee, Jeep Cherokee, RAM 1500/2500/3500, RAM Promaster, RAM Chassis and RAM Cargo Van;

Claim 2 - Dodge Challenger, Dodge Journey, Dodge Dart, Dodge Nitro, Dodge Magnum, Dodge Grand Caravan, Dodge Charger, Dodge Durango, Chrysler Sebring, Chrysler Town & Country, Chrysler 300, Jeep Wrangler, Jeep Commander, Jeep Grand Cherokee, Jeep Cherokee, RAM 1500/2500/3500, RAM Promaster, RAM Chassis and RAM Cargo Van;

Claim 4 - Dodge Challenger, Dodge Journey, Dodge Dart, Dodge Nitro, Dodge Magnum, Dodge Grand Caravan, Dodge Charger, Dodge Durango, Chrysler Sebring, Chrysler Town & Country, Chrysler 300, Jeep Wrangler, Jeep Commander, Jeep Grand Cherokee, Jeep Cherokee, RAM 1500/2500/3500, RAM Promaster, RAM Chassis and RAM Cargo Van;

Claim 5 - Dodge Challenger, Dodge Journey, Dodge Dart, Dodge Nitro, Dodge Magnum, Dodge Grand Caravan, Dodge Charger, Dodge Durango, Chrysler Sebring, Chrysler Town & Country, Chrysler 300, Jeep Wrangler, Jeep Commander, Jeep Grand Cherokee, Jeep Cherokee, RAM 1500/2500/3500, RAM Promaster, RAM Chassis and RAM Cargo Van;

Claim 7 - Dodge Challenger, Dodge Journey, Dodge Dart, Dodge Nitro, Dodge Magnum, Dodge Charger, Dodge Durango, Chrysler Sebring, Chrysler 300, Jeep Wrangler, Jeep Grand Cherokee and Jeep Cherokee;

Claim 8 - Dodge Challenger, Dodge Journey, Dodge Dart, Dodge Nitro, Dodge Magnum, Dodge Charger, Dodge Durango, Chrysler Sebring, Chrysler 300, Jeep Wrangler, Jeep Grand Cherokee and Jeep Cherokee;

Claim 10 - Dodge Challenger, Dodge Journey, Dodge Dart, Dodge Nitro, Dodge Magnum, Dodge Charger, Dodge Durango, Chrysler Sebring, Chrysler 300, Jeep Wrangler, Jeep Grand Cherokee and Jeep Cherokee;

Claim 12 - Dodge Challenger, Dodge Journey, Dodge Dart, Dodge Nitro, Dodge Magnum, Dodge Charger, Dodge Durango, Chrysler Sebring, Chrysler 300, Jeep Wrangler, Jeep Grand Cherokee and Jeep Cherokee

Claim 13 - Dodge Challenger, Dodge Journey, Dodge Dart, Dodge Nitro, Dodge Magnum, Dodge Charger, Dodge Durango, Chrysler Sebring, Chrysler 300, Jeep Wrangler, Jeep Grand Cherokee and Jeep Cherokee;

Claim 15 - Dodge Challenger, Dodge Journey, Dodge Dart, Dodge Nitro, Dodge Magnum, Dodge Charger, Dodge Durango, Chrysler Sebring, Chrysler 300, Jeep Wrangler, Jeep Grand Cherokee and Jeep Cherokee;

Claim 17 - Dodge Challenger, Dodge Journey, Dodge Dart, Dodge Nitro, Dodge Magnum, Dodge Grand Caravan, Dodge Charger, Dodge Durango, Chrysler Sebring, Chrysler Town & Country, Chrysler 300, Jeep Wrangler, Jeep Grand Cherokee, Jeep Cherokee and RAM Cargo Van;

Claim 18 - Dodge Challenger, Dodge Journey, Dodge Dart, Dodge Nitro, Dodge Magnum, Dodge Grand Caravan, Dodge Charger, Dodge Durango, Chrysler Sebring, Chrysler Town & Country, Chrysler 300, Jeep Wrangler, Jeep Grand Cherokee, Jeep Cherokee and RAM Cargo Van;

Claim 19 - Dodge Challenger, Dodge Journey, Dodge Dart, Dodge Nitro, Dodge Magnum, Dodge Grand Caravan, Dodge Charger, Dodge Durango, Chrysler Sebring, Chrysler Town & Country, Chrysler 300, Jeep Wrangler, Jeep Grand Cherokee, Jeep Cherokee and RAM Cargo Van;

Claim 20 - Dodge Challenger, Dodge Journey, Dodge Dart, Dodge Nitro, Dodge Magnum, Dodge Grand Caravan, Dodge Charger, Dodge Durango, Chrysler Sebring,

Chrysler Town & Country, Chrysler 300, Jeep Wrangler, Jeep Grand Cherokee, Jeep Cherokee and RAM Cargo Van;

Claim 21 - Dodge Challenger, Dodge Journey, Dodge Dart, Dodge Nitro, Dodge Magnum, Dodge Grand Caravan, Dodge Charger, Dodge Durango, Chrysler Sebring, Chrysler Town & Country, Chrysler 300, Jeep Wrangler, Jeep Grand Cherokee, Jeep Cherokee and RAM Cargo Van;

Claim 22 - Dodge Challenger, Dodge Journey, Dodge Dart, Dodge Nitro, Dodge Magnum, Dodge Charger, Dodge Durango, Chrysler Sebring, Chrysler 300, Jeep Wrangler, Jeep Grand Cherokee and Jeep Cherokee;

Claim 23 - Dodge Challenger, Dodge Journey, Dodge Dart, Dodge Nitro, Dodge Magnum, Dodge Grand Caravan, Dodge Charger, Dodge Durango, Chrysler Sebring, Chrysler Town & Country, Chrysler 300, Jeep Wrangler, Jeep Grand Cherokee, Jeep Cherokee and RAM Cargo Van;

Claim 24 - Dodge Challenger, Dodge Journey, Dodge Dart, Dodge Nitro, Dodge Magnum, Dodge Grand Caravan, Dodge Charger, Dodge Durango, Chrysler Sebring, Chrysler Town & Country, Chrysler 300, Jeep Wrangler, Jeep Grand Cherokee, Jeep Cherokee and RAM Cargo Van;

Claim 25 - Dodge Challenger, Dodge Journey, Dodge Dart, Dodge Nitro, Dodge Magnum, Dodge Grand Caravan, Dodge Charger, Dodge Durango, Chrysler Sebring, Chrysler Town & Country, Chrysler 300, Jeep Wrangler, Jeep Grand Cherokee, Jeep Cherokee and RAM Cargo Van;

Claim 26 - Dodge Challenger, Dodge Journey, Dodge Dart, Dodge Nitro, Dodge Magnum, Dodge Charger, Dodge Durango, Chrysler Sebring, Chrysler 300, Jeep Wrangler, Jeep Grand Cherokee and Jeep Cherokee;

Claim 27 - Dodge Challenger, Dodge Journey, Dodge Dart, Dodge Nitro, Dodge Magnum, Dodge Charger, Dodge Durango, Chrysler Sebring, Chrysler 300, Jeep Wrangler, Jeep Grand Cherokee and Jeep Cherokee;

Claim 28 - Dodge Challenger, Dodge Journey, Dodge Dart, Dodge Nitro, Dodge Magnum, Dodge Grand Caravan, Dodge Charger, Dodge Durango, Dodge Aspen, Dodge Aspen Hybrid, Chrysler Sebring, Chrysler Town & Country, Chrysler 300, Jeep Wrangler, Jeep Commander, Jeep Grand Cherokee, Jeep Cherokee, RAM 1500/2500/3500, RAM Promaster, RAM Chassis and RAM Cargo Van;

Claim 29 - Dodge Challenger, Dodge Journey, Dodge Dart, Dodge Nitro, Dodge Magnum, Dodge Grand Caravan, Dodge Charger, Dodge Durango, Dodge Aspen, Dodge Aspen Hybrid, Chrysler Sebring, Chrysler Town & Country, Chrysler 300, Jeep Wrangler, Jeep Commander, Jeep Grand Cherokee, Jeep Cherokee, RAM 1500/2500/3500, RAM Promaster, RAM Chassis and RAM Cargo Van;



Claim 30 - Dodge Challenger, Dodge Journey, Dodge Dart, Dodge Nitro, Dodge Magnum, Dodge Grand Caravan, Dodge Charger, Dodge Durango, Dodge Aspen, Dodge Aspen Hybrid, Chrysler Sebring, Chrysler Town & Country, Chrysler 300, Jeep Wrangler, Jeep Commander, Jeep Grand Cherokee, Jeep Cherokee, RAM 1500/2500/3500, RAM Promaster, RAM Chassis and RAM Cargo Van;

Claim 31 - Dodge Challenger, Dodge Journey, Dodge Dart, Dodge Nitro, Dodge Magnum, Dodge Grand Caravan, Dodge Charger, Dodge Durango, Chrysler Sebring, Chrysler Town & Country, Chrysler 300, Jeep Wrangler, Jeep Grand Cherokee, Jeep Cherokee and RAM Cargo Van;

Claim 32 - Dodge Challenger, Dodge Journey, Dodge Dart, Dodge Nitro, Dodge Magnum, Dodge Grand Caravan, Dodge Charger, Dodge Durango, Chrysler Sebring, Chrysler Town & Country, Chrysler 300, Jeep Wrangler, Jeep Grand Cherokee, Jeep Cherokee and RAM Cargo Van.

**C. Claim Chart Comparing Each Element of the Asserted Claims to the Accused Instrumentalities**

A claim chart identifying where each element of each asserted claim is found within each Accused Chrysler vehicle is attached.

**D. Identification of Whether Each Element of Each Asserted Claim is Present in the Accused Instrumentalities Literally or Under the Doctrine of Equivalents**

Unless otherwise noted in the attached chart, Velocity asserts that all of the asserted claim elements are literally present in the Accused Chrysler vehicles. Where applicable, Velocity has identified alternative doctrine of equivalents assertions in the attached claim chart.

At this time, sections (e)-(f) of Local Patent Rule 2.2 are not applicable. Velocity expressly reserves the right to revise, amend and supplement these contentions as discovery progresses and new information becomes available.

Dated: March 12, 2014

Respectfully submitted,

/s/ James A. Shimota

James A. Shimota

James A. Shimota (IL Bar No. 6270603)  
Howard E. Levin (IL Bar No. 6286712)  
Adam R. Brausa (IL Bar No. 6292447)  
Aaron C. Taggart (IL Bar No. 6302068)  
MAVRAKAKIS LAW GROUP LLP  
180 North LaSalle Street, Suite 2215  
Chicago, Illinois 60601  
Telephone: 312-216-1620  
Facsimile: 312-216-1621  
jshimota@mavllp.com  
hlevin@mavllp.com  
abrausa@mavllp.com  
ataggart@mavllp.com

*Counsel for Plaintiff Velocity Patent LLC*

**PROOF OF SERVICE**

The undersigned hereby certifies that a true and correct copy of the above and foregoing document has been served on March 12, 2014, by electronic mail to:

<b>DICKSTEIN SHAPIRO LLP</b>  Marla H. Kanemitsu Frank C. Cimino Jr. Charles J. Monterio, Jr. 1825 Eye Street NW Washington, DC 20006-5403 (202) 420-4859 (202) 420-3601 (202) 420-5167 kanemitsum@dicksteinshapiro.com ciminof@dicksteinshapiro.com monterioc@dicksteinshapiro.com  <b>Served by Electronic Mail</b>	<b>SWANSON, MARTIN &amp; BELL, LLP</b>  P. Stephen Fardy Brian W. Bell 330 North Wabash, Suite 3300 Chicago, IL 60611 (312) 923-8247 (312) 321-8424 sfardy@smbtrials.com bbell@smbtrials.com  <b>Served by Electronic Mail</b>
---	---

Attorneys for Defendant  
Chrysler Group, LLC

*/s/ James C. Rally*

Project Assistant  
Mavrakakis Law Group LLP

**Velocity Patent LLC Preliminary Infringement Contentions Against Chrysler Pursuant to N.D. Ill. LPR 2.1**

Claim 1	Corresponding Element in Chrysler Vehicles
<p>1.A. Apparatus for optimizing operation of a vehicle, comprising:<sup>2</sup></p>	<p>The accused Chrysler vehicles<sup>3</sup> include an apparatus for optimizing operation of a vehicle.</p> <p>For example, the accused Chrysler vehicles include computer-controlled vehicle systems with one or more computer processors that monitor various vehicle systems and optimize the fuel economy, safety and performance of the vehicle.</p> <p><b>ONBOARD DIAGNOSTIC SYSTEM — OBD II</b></p> <p>Your vehicle is equipped with a sophisticated onboard diagnostic system called OBD II. This system monitors the performance of the emissions, engine, and automatic transmission control systems. When these systems are operating properly, your vehicle will provide excellent performance and fuel economy, as well as engine emissions well within current government regulations.</p>

<sup>1</sup> Velocity contends that each element of the asserted claims is literally and directly infringed by the accused vehicles. Additionally, where noted below, Velocity alternatively contends that certain elements are infringed under the doctrine of equivalents.

<sup>2</sup> Velocity's citations related to any claim preamble in this claim chart should not be interpreted as an admission that the preamble is limiting.

<sup>3</sup> The accused features and vehicles identified in these preliminary contentions are representative only. Velocity accuses all Chrysler vehicle models for model years 2007 to 2014 that incorporate features that are similar to the accused features identified in these preliminary contentions. The accused Chrysler vehicles identified in these preliminary contentions are representative only, and include: (1) Dodge Challenger, Charger, Dart, Durango, Grand Caravan, Journey, Magnum, Nitro, Sprinter, Sprinter Cargo Van, and Viper, including all associated SRT models; (2) Chrysler 300, Aspen, Aspen Hybrid, Sebring, and Town & Country, including all associated SRT models; (3) Jeep Grand Cherokee, Cherokee, Wrangler, and Commander including all associated unlimited and SRT models; and (4) RAM 1500, 2500, 3500, Chassis, Promaster, and Cargo Van. Discovery has just begun in this case. Velocity reserves the right to supplement and identify additional infringing models (e.g., 2015 models currently being tested) as it learns facts through discovery.

Claim 1	Corresponding Element in Chrysler Vehicles <sup>1</sup>
	<p>Diagnostic Procedure Manuals</p> <p>Diagnostic Procedure Manuals are filled with diagrams, charts and detailed illustrations. These practical manuals make it easy for students and technicians to find and fix problems on computer-controlled vehicle systems and features. They show exactly how to find and correct problems the first time, using step-by-step troubleshooting and drivability procedures, proven diagnostic tests and a complete list of all tools and equipment.</p> <p>(See, e.g., Ex. Dodge-1A, 2014 Dodge Challenger Owner's Manual at 431, 502; Ex. Dodge-IB, 2014 Dodge Charger Owner's Manual [CHRY_VEL0001698] at 541, 612; Ex. Dodge-1C, 2014 Dodge Grand Caravan Owner's Manual at 594, 656; Ex. Dodge-ID, 2014 Dodge Journey Owner's Manual at 545, 618; Ex. Dodge-IE, 2014 Dodge Dart Owner's Manual at 560, 626; Ex. Dodge-IF, 2014 Dodge Durango Owner's Manual [CHRY_VEL0003641] at 561, 630; Ex. Dodge-1G, 2011 Dodge Nitro Owner's Manual at 403, 470; Ex. Dodge-IH, 2008 Dodge Magnum Owner's Manual at 387, 455.)</p> <p>(See, e.g., Ex. RAM-1A, 2014 RAM 1500/2500/3500 Owner's Manual at 681, 766; Ex. RAM-1B, 2014 RAM Promaster Owner's Manual at 314, 376; Ex. RAM 1C, 2014 RAM Chassis Owner's Manual at 443, 520; Ex. RAM-ID, 2014 RAM Cargo Van Owner's Manual at 576, 640.)</p> <p>(See, e.g., Ex. Chrysler-1A, 2014 Chrysler 300 Owner's Manual [CHRY_VEL0000001] at 521; Ex. Chrysler-1B, 2010 Chrysler Sebring Owner's Manual at 344; Ex. Chrysler-1C, 2014 Chrysler Town &amp; Country Owner's Manual at 618.)</p> <p>(See, e.g., Ex. Jeep-1A, 2014 Jeep Grand Cherokee Owner's Manual [CHRY_VEL0004297] at 569; Ex. Jeep-1B, 2014 Jeep Cherokee Owner's Manual [CHRY_VEL0002946] at 589; Ex. Jeep-1C, 2014 Jeep Wrangler Owner's Manual at 576; Ex. Jeep-ID, 2010 Jeep Commander Owner's Manual at 359.)</p>

Claim 1	Corresponding Element in Chrysler Vehicles <sup>1</sup>
<p>1B. a plurality of sensors coupled to a vehicle having an engine, said plurality of sensors, which collectively monitor operation of said vehicle, including a road speed sensor, an engine speed sensor, a manifold pressure sensor and a throttle position sensor,</p>	<p>The accused Chrysler vehicles include a plurality of sensors coupled to the vehicle having an engine, said plurality of sensors, which collectively monitor operation of said vehicle, including a road speed sensor, an engine speed sensor, a manifold pressure sensor and a throttle position sensor.</p> <p>See, e.g., citations for claim element 1A (describing processor controlled vehicle systems that monitor vehicle system characteristics and operations)</p> <p>1B1. The accused Chrysler vehicles include one or more road speed sensors</p>
<p>3. <i>Speedometer</i></p>	<p>Indicates vehicle speed.</p>
	<p>(See, e.g., Ex. Dodge-1A, 2014 Dodge Challenger Owner's Manual at 206; Ex. Dodge-1B, 2014 Dodge Charger Owner's Manual at 324; Ex. Dodge-1C, 2014 Dodge Grand Caravan Owner's Manual at 313; Ex. Dodge-1D, 2014 Dodge Journey Owner's Manual at 305; Ex. Dodge-1E, 2014 Dodge Dart Owner's Manual at 314; Ex. Dodge-1F, 2014 Dodge Durango Owner's Manual at 291; Ex. Dodge-1G, 2011 Dodge Nitro Owner's Manual at 200; Ex. Dodge-1H, 2008 Dodge Magnum Owner's Manual at 174.)</p> <p>(See, e.g., Ex. RAM-1A, 2014 RAM 1500/2500/3500 Owner's Manual at 181, 283; Ex. RAM-1B, 2014 RAM Promaster Owner's Manual at 92, 118; Ex. RAM 1C, 2014 RAM Chassis Owner's Manual at 167, 201; Ex. RAM-1D, 2014 RAM Cargo Van Owner's Manual at 219, 302.)</p>
	<p>(See, e.g., Ex. Chrysler-1A, 2014 Chrysler 300 Owner's Manual at 316; Ex. Chrysler-1B, 2010 Chrysler Sebring Owner's Manual at 145; Ex. Chrysler-1C, 2014 Chrysler Town &amp; Country Owner's Manual at 328.)</p>

Claim 1	Corresponding Element in Chrysler Vehicles <sup>1</sup>
	<p>(See, e.g., Ex. Jeep-1A, 2014 Jeep Grand Cherokee Owner's Manual at 289; Ex. Jeep-1B, 2014 Jeep Cherokee Owner's Manual at 325; Ex. Jeep-1C, 2014 Jeep Wrangler Owner's Manual at 302; Ex. Jeep-1D, 2010 Jeep Commander Owner's Manual at 160.)</p>
	<p>1B2. The accused Chrysler vehicles include one or more engine speed sensors.</p>
	<p><b>5. Tachometer</b></p>
	<p>The red segments indicate the maximum permissible engine revolutions per minute (RPM x 1000) for each gear range. Ease up on the accelerator before reaching the red area.</p>
	<p>(See, e.g., Ex. Dodge-1A, 2014 Dodge Challenger Owner's Manual at 206; Ex. Dodge-1B, 2014 Dodge Charger Owner's Manual at 324; Ex. Dodge-1C, 2014 Dodge Grand Caravan Owner's Manual at 306; Ex. Dodge-1D, 2014 Dodge Journey Owner's Manual at 298; Ex. Dodge-1E, 2014 Dodge Dart Owner's Manual at 308; Ex. Dodge-1F, 2014 Dodge Durango Owner's Manual at 290; Ex. Dodge-1G, 2011 Dodge Nitro Owner's Manual at 206; Ex. Dodge-1H, 2008 Dodge Magnum Owner's Manual at 174.)</p>
	<p>(See, e.g., Ex. RAM-1A, 2014 RAM 1500/2500/3500 Owner's Manual at 278; Ex. RAM-1B, 2014 RAM Promaster Owner's Manual at 121; Ex. RAM 1C, 2014 RAM Chassis Owner's Manual at 196; Ex. RAM-1D, 2014 RAM Cargo Van Owner's Manual at 295.)</p>
	<p>(See, e.g., Ex. Chrysler-1A, 2014 Chrysler 300 Owner's Manual at 312; Ex. Chrysler-1B, 2010 Chrysler Sebring Owner's Manual at 149; Ex. Chrysler-1C, 2014 Chrysler Town &amp; Country Owner's Manual at 321.)</p>
	<p>(See, e.g., Ex. Jeep-1A, 2014 Jeep Grand Cherokee Owner's Manual at 288; Ex. Jeep-1B, 2014</p>

**Claim 1**

**Corresponding Element in Chrysler Vehicles'**

Jeep Cherokee Owner's Manual at 320; Ex. Jeep-1C, 2014 Jeep Wrangler Owner's Manual at 306; Ex. Jeep-1D, 2010 Jeep Commander Owner's Manual at 163.)

1B3. Upon information and belief, Chrysler uses manifold pressure sensors for the electronic fuel injection (EFI) system included in all of the accused Chrysler vehicles. *See, e.g.* Ex. Chrysler-3, Steve V. Hatch, Computerized Engine Controls (2012) at 475. *See also, e.g.,* <http://www.mopar.com> listing various MAP sensor related parts for the accused vehicles.

1B4. The accused Chrysler vehicles include one or more throttle position sensors. For example, the accused Chrysler vehicles include a throttle position sensor that provides information to the Electronic Throttle Control (ETC) system.

**7. Electronic Throttle Control (ETC) Warning Light**



This light will turn on briefly as a bulb check when the ignition switch is placed in the ON/RUN position. This light will also turn on while the engine is running if there is a problem with the Electronic Throttle Control (ETC) system.

(*See, e.g.,* Ex. Dodge-1A, 2014 Dodge Challenger Owner's Manual at 207; Ex. Dodge-1B, 2014 Dodge Charger Owner's Manual at 336; Ex. Dodge-1C, 2014 Dodge Grand Caravan Owner's Manual at 320; Ex. Dodge-1D, 2014 Dodge Journey Owner's Manual at 314; Ex. Dodge-1E, 2014 Dodge Dart Owner's Manual at 315; Ex. Dodge-1F, 2014 Dodge Durango Owner's Manual at 309; Ex. Dodge-1G, 2011 Dodge Nitro Owner's Manual at 203; Ex. Dodge-1H, 2008 Dodge Magnum Owner's Manual at 175.)

(*See, e.g.,* Ex. RAM-1A, 2014 RAM 1500/2500/3500 Owner's Manual at 310; Ex. RAM-1B,



Claim 1	Corresponding Element in Chrysler Vehicles <sup>1</sup>
	<p>2014 RAM Promaster Owner's Manual at 126; Ex. RAM 1C, 2014 RAM Chassis Owner's Manual at 206; Ex. RAM-1D, 2014 RAM Cargo Van Owner's Manual at 307.)</p> <p>(<i>See, e.g.</i>, Ex. Chrysler-1A, 2014 Chrysler 300 Owner's Manual at 329; Ex. Chrysler-1B, 2010 Chrysler Sebring Owner's Manual at 152; Ex. Chrysler-1C, 2014 Chrysler Town &amp; Country Owner's Manual at 334.)</p> <p>(<i>See, e.g.</i>, Ex. Jeep-1A, 2014 Jeep Grand Cherokee Owner's Manual at 308; Ex. Jeep-1B, 2014 Jeep Cherokee Owner's Manual at 343; Ex. Jeep-1C, 2014 Jeep Wrangler Owner's Manual at 316; Ex. Jeep-1D, 2010 Jeep Commander Owner's Manual at 169.)</p>
<p>1C. a processor subsystem, coupled to each one of said plurality of sensors, to receive data therefrom;</p>	<p>The accused Chrysler vehicles include a processor subsystem, coupled to each one of said plurality of sensors, to receive data therefrom.</p> <p><i>See, e.g.</i>, citations for claim elements 1A (describing processor controlled vehicle systems that monitor vehicle system characteristics and operations) and 1B (describing sensors that measure system characteristics).</p>
<p>1D. a memory subsystem, coupled to said processor subsystem, said memory subsystem storing therein a manifold pressure set point, an RPM set point, and present and prior levels for each one of said plurality of sensors;</p>	<p>On information and belief, the accused Chrysler vehicles have a memory subsystem, coupled to said processor subsystem, said memory subsystem storing therein a manifold pressure set point, an RPM set point, and present and prior levels for each one of said plurality of sensors.</p> <p>For example, the accused Chrysler vehicles include one or more memories that form a memory subsystem for storing information relating to vehicle system operations and features described in the vehicle manuals. <i>See, e.g.</i>, citations for claim elements 1A-C.</p>
<p>1E. a fuel overinjection notification circuit coupled to said processor subsystem, said fuel overinjection notification circuit issuing a notification that excessive fuel is being supplied to said engine of said vehicle.</p>	<p>The accused Chrysler vehicles include a fuel overinjection notification circuit coupled to said processor subsystem, said fuel overinjection notification circuit issuing a notification that excessive fuel is being supplied to said engine of said vehicle.</p>

**Claim 1**

notification circuit issuing a notification that excessive fuel is being supplied to said engine of said vehicle;

**Corresponding Element in Chrysler Vehicles<sup>1</sup>**

For example, the accused Chrysler vehicles include one or more fuel overinjection notification circuits coupled to said processor subsystem:

**ECC**

- The ECC message will appear in your EVIC display whenever you are driving in a fuel efficient manner.
- This feature allows you to monitor when you are driving in a fuel efficient manner, and it can be used to modify driving habits in order to increase fuel economy.

(See, e.g., Ex. Dodge-2A, 2014 Dodge Challenger/Charger SRT User's Guide at 71; Ex. Dodge-2B, 2014 Dodge Charger/Charger SRT User's Guide at 65; Ex. Dodge-2F, 2014 Dodge Durango User's Guide at 109; Ex. Dodge-2G, 2011 Dodge Nitro User's Guide at 40.)

- Average Fuel Economy/Fuel Saver Mode — If Equipped

Shows the average fuel economy since the last reset. When the fuel economy is reset, the display will read "RESET" or show dashes for two seconds. Then, the history information will be erased, and the averaging will continue from the last fuel average reading before the reset.

The FUEL SAVER MODE message will display above the average fuel economy in the EVIC display. This message will appear whenever the Multi-Displacement System (MDS) (if equipped) allows the engine to operate on four cylinders, or if you are driving in a fuel efficient manner.

**EXAMPLE ONLY**



**FUEL SAVER MODE**

**AVERAGE MPG**

**23.5 ▲ RESET**

**114.8 mi**

04100327

Fuel Saver Mode-On

• This feature allows you to monitor when you are driving in a fuel efficient manner, and it can be used to modify driving habits in order to increase fuel economy.

(See, e.g., Ex. Dodge-1A, 2014 Dodge Challenger Owner's Manual at 223-24; Ex. Dodge-1B, 2014 Dodge Charger Owner's Manual at 340; Ex. Dodge-1D, 2014 Dodge Journey Owner's

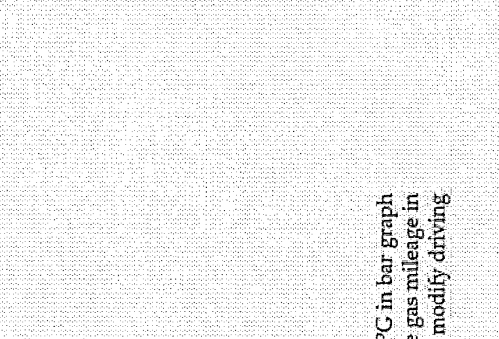
Claim 1	Corresponding Element in Chrysler Vehicles' Manual at 335; Ex. Dodge-1H, 2008 Dodge Magnum Owner's Manual at 189-90.)
	<p><b>Average Fuel Economy Display</b></p> <p><b>Miles Per Gallon (MPG)</b></p> <p>This display shows the instantaneous MPG in bar graph form while driving. This will monitor the gas mileage in real-time as you drive and can be used to modify driving habits in order to increase fuel economy.</p> <p>(Ex. Dodge-1B, 2014 Dodge Charger Owner's Manual at 340; Ex. Dodge-1C, 2014 Dodge Grand Caravan Owner's Manual at 330-31; Ex. Dodge-ID, 2014 Dodge Journey Owner's Manual at 317; Ex. Dodge-1E, 2014 Dodge Dart Owner's Manual at 344, 349; Ex. Dodge-1F, 2014 Dodge Durango Owner's Manual at 315-316.)</p> <p>(See, e.g., Ex. RAM-2A, 2014 RAM 1500/2500/3500 User's Guide at 119; Ex. RAM-1B, 2014 RAM Promaster Owner's Manual at 136-37; Ex. RAM 1C, 2014 RAM Chassis Owner's Manual at 245; Ex. RAM-1D, 2014 RAM Cargo Van Owner's Manual at 320. See also, e.g.,</p>

Claim 1	Corresponding Element in Chrysler Vehicles <sup>1</sup>
<p>IF. an upshift notification circuit coupled to said processor subsystem, said upshift notification circuit issuing a notification that said engine of said vehicle is being operated at an excessive speed;</p>	<p>Ex. RAM-3A, 2010 RAM 1500/2500/3500 Owner's Manual at 207-208; Ex. RAM-4A, 2010 RAM 1500/2500/3500 User's Guide at 7.)  (See, e.g., Ex. Chrysler-1A, 2014 Chrysler 300 Owner's Manual at 334; Ex. Chrysler-1B, 2010 Chrysler Sebring Owner's Manual at 162; Ex. Chrysler-1C, 2014 Chrysler Town &amp; Country Owner's Manual at 347.)  (See, e.g., Ex. Jeep-1A, 2014 Jeep Grand Cherokee Owner's Manual at 312; Ex. Jeep-1B, 2014 Jeep Cherokee Owner's Manual at 364; Ex. Jeep-1C, 2014 Jeep Wrangler Owner's Manual at 328; Ex. Jeep-1D, 2010 Jeep Commander Owner's Manual at 177.)</p>
<p>IF. an upshift notification circuit coupled to said processor subsystem, said upshift notification circuit issuing a notification that said engine of said vehicle is being operated at an excessive speed;</p>	<p>The accused Chrysler vehicles include an upshift notification circuit coupled to said processor subsystem, said upshift notification circuit issuing a notification that said engine of said vehicle is being operated at an excessive speed.  For example, the accused Chrysler vehicles include one or more upshift notification circuits coupled to said processor subsystem, said upshift notification circuit issuing a notification that said engine of said vehicle is being operated at an excessive speed.</p>

Claim 1	Corresponding Element in Chrysler Vehicles
	<ul style="list-style-type: none"> <li>• Key not Programmed</li> <li>• Vehicle Not in Park</li> <li>• Key Fob Not Detected</li> <li>• Press Brake &amp; Push Button to Start</li> <li>• Push Button or Insert Key/Turn To Run (refer to "Remote Starting System" in "Things to Know Before Starting Your Vehicle")</li> <li>• 1-4 SKIPSHIFT</li> </ul> <p><b>Gear Shift Indicator (GSI) — If Equipped</b></p> <p>The Gear Shift Indicator (GSI) system is enabled on vehicles with a manual transmission, or when a vehicle with an automatic transmission is in manual shift mode. The GSI provides the driver with a visual indication within the EVIC when the recommended gear shift point has been reached. This indication notifies the driver that changing gear will allow a reduction in fuel consumption.</p> <p><b>Engine Oil Change Indicator System</b></p> <p><b>Oil Change Required</b></p> <p>Your vehicle is equipped with an engine oil change indicator system. The "Oil Change Required" message will flash in the EVIC display for approximately 10 seconds after a single chime has sounded, to indicate the next scheduled oil change interval. The engine oil change</p>

(See, e.g., Ex. Dodge-1A, 2014 Dodge Challenger Owner's Manual at 221; Ex. Dodge-1B, 2014 Dodge Charger Owner's Manual at 337-338.)

(See, e.g., Ex. Chrysler-1A, 2014 Chrysler 300 Owner's Manual at 321-22.)

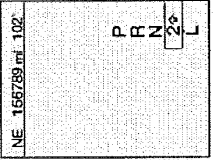
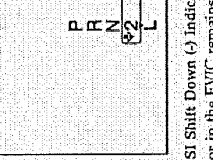
Claim 1	Corresponding Element in Chrysler Vehicles
<p>When the shift up indicator (+) is shown on the display, the GSI is advising the driver to engage a higher gear.</p>	<p>NE_1667389.mf.102</p>  <p>0449010654</p> <p>GSI Shift Up (+) Indicator</p> <p>When the shift down indicator (-) is shown on the display, the GSI is advising the driver to engage a lower gear.</p>
<p>When the shift down indicator (-) is shown on the display, the GSI is advising the driver to engage a higher gear.</p>	<p>NE_1557389.mf.102</p>  <p>0449010655</p> <p>GSI Shift Down (-) Indicator</p> <p>The GSI indicator in the EVIC remains illuminated until the driver changes gear, or the driving conditions return to a situation where changing gear is not required to improve fuel consumption.</p>

(See, e.g., Ex. Dodge-1B, 2014 Dodge Charger Owner's Manual at 338.)

As another example, the accused Chrysler vehicles include one or more upshift notification circuits coupled to said processor subsystem, said upshift notification circuit issuing a notification that said engine of said vehicle is being operated at an excessive speed.

Claim 1	Corresponding Element in Chrysler Vehicles
	<p>AutoStick® mode will retain the current gear. When AutoStick® is active, the current transmission gear is displayed in the instrument cluster. In AutoStick® mode, the transmission will shift up or down when (+/-) is manually selected by the driver (using the shift lever, or the shift paddles (if equipped)), unless an engine lugging or overspeed condition would result. It will remain in the selected gear until another upshift or downshift is chosen, except as described below.</p> <ul style="list-style-type: none"> <li>• If AutoStick® is engaged while in DRIVE mode, the transmission will automatically shift up when maximum engine speed is reached.</li> <li>• If AutoStick® is engaged while in SPORT mode, the transmission will remain in the selected gear even when maximum engine speed is reached. The transmission will upshift only when commanded by the driver. Engine overspeed protection will be provided by fuel cut off at or near redline.</li> </ul> <p>(See, e.g., Ex. Dodge-1A, 2014 Dodge Challenger Owner's Manual at 310; Ex. Dodge-1B, 2014 Dodge Charger Owner's Manual at 421, 423; Ex. Dodge-1D, 2014 Dodge Journey Owner's Manual at 312, 424-425; Ex. Dodge-1E, 2014 Dodge Dart Owner's Manual at 438, 317; Ex. Dodge-1F, 2014 Dodge Durango Owner's Manual at 420-21; Ex. Dodge-1G, 2011 Dodge Nitro Owner's Manual at 301; Ex. Dodge-1H, 2008 Dodge Magnum Owner's Manual at 286.)</p> <p>(See, e.g., Ex. Chrysler-1A, 2014 Chrysler 300 Owner's Manual at 401-2; Ex. Chrysler-1B, 2010 Chrysler Sebring Owner's Manual at 248-9.)</p> <p>(See, e.g., Ex. Jeep-1C, 2014 Jeep Wrangler Owner's Manual at 432.)</p>

Claim 1	Corresponding Element in Chrysler Vehicles <sup>1</sup>
	<ul style="list-style-type: none"> <li>An "UPSHIFT" message will appear in the Electronic Vehicle Information Center (EVIC) portion of the instrument cluster when using AutoStick®, to alert the driver to upshift to the next gear. The "UPSHIFT" message will appear when approaching the maximum engine speed.</li> </ul> <p>(See, e.g., Ex. Dodge-1A12, 2012 Dodge Challenger Owner's Manual at 274.)</p> <p>(See, e.g., Ex. Chrysler-2A12, 2012 Chrysler 300 User's Guide at 63.)</p> <ul style="list-style-type: none"> <li>An UPSHIFT message will appear in the Electronic Vehicle Information Center (EVIC) portion of the instrument cluster when using AutoStick®. This message appears in order to alert the driver to upshift to the next gear. The UPSHIFT message will display while operating the vehicle at higher engine revolutions per minute (RPM).</li> </ul> <p>(See, e.g., Ex. Dodge-1A08, 2008 Dodge Challenger SRT8 Owner's Manual at 228; Ex. Dodge-1B07, 2007 Dodge Charger SRT8 Owner's Manual at 201.)</p> <p>As another example, the accused Chrysler vehicles include one or more upshift notification circuits coupled to said processor subsystem, said upshift notification circuit issuing a notification that said engine of said vehicle is being operated at an excessive speed.</p>



• **Electronic Range Select (ERS) Status**

The shift lever status "5.4.3.2.1" are displayed indicating the shift lever position. Telltales "5.4.3.2.1" indicate the Electronic Range Select (ERS) feature has been engaged and the gear selected is displayed. For further information on ERS, refer to "Starting And Operating".

The transmission shift lever has only PARK, REVERSE, NEUTRAL, and DRIVE shift positions. Manual downshifts can be made using the Electronic Range Select (ERS) shift control (described later in this section). Moving the shift lever to the left or right (-/+ ) while in the DRIVE position will select the highest available transmission gear, and will display that gear in the instrument cluster as 1, 2, 3, etc.

**NOTE:** Even if the transmission can be reset, we recommend that you visit your authorized dealer at your earliest possible convenience. Your authorized dealer has diagnostic equipment to determine if the problem could recur.

If the transmission cannot be reset, authorized dealer service is required.

**Electronic Range Select (ERS) Operation**

The Electronic Range Select (ERS) shift control allows the driver to limit the highest available gear when the shift lever is in the DRIVE position. For example, if you shift the transmission into 3 (third gear), the transmission will not shift above third gear (except to prevent engine overspeed), but will shift down into second and first gears normally.

You can switch between DRIVE and ERS mode at any vehicle speed. When the shift lever is in the DRIVE

position, the transmission will operate automatically, shifting between all available gears. Tapping the shift lever to the left (-) will activate ERS mode, display the current gear in the instrument cluster, and maintain that gear as the top available gear. Once in ERS mode, tapping the shift lever to the left (-) or right (+) will change the top available gear.

To exit ERS mode, simply press and hold the shift lever to the right (+) until "D" is once again displayed in the instrument cluster.

**WARNING!**

Do not downshift for additional engine braking on a slippery surface. The drive wheels could lose their grip and the vehicle could skid, causing a collision or personal injury.

Claim 1	Corresponding Element in Chrysler Vehicles <sup>1</sup>
	<p>(See, e.g., Ex. Dodge-1C, 2014 Dodge Grand Caravan Owner's Manual at 325, 459, 465; Ex. Dodge-1G, 2011 Dodge Nitro Owner's Manual at 301.)</p> <p>(See, e.g., Ex. RAM-1A, 2014 RAM 1500/2500/3500 Owner's Manual at 294, 413-415; Ex. RAM-1B, 2014 RAM Promaster Owner's Manual at 119, 194; Ex. RAM-1C, 2014 RAM Chassis Owner's Manual at 212, 304; Ex. RAM-1D, 2014 RAM Cargo Van Owner's Manual at 314, 455.)</p> <p>(See, e.g., Ex. Chrysler-1C, 2014 Chrysler Town &amp; Country Owner's Manual at 343, 484-5.)</p> <p>(See, e.g., Ex. Jeep-1B, 2014 Jeep Cherokee Owner's Manual at 429-30; Ex. Jeep-1D, 2010 Jeep Commander Owner's Manual at 250-1.)</p> <p>As another example, the accused Chrysler vehicles include one or more upshift notification circuits coupled to said processor subsystem, said upshift notification circuit issuing a notification that said engine of said vehicle is being operated at an excessive speed.</p> <p><b>1-4 Skip Shift</b></p> <p>There are times when you must shift the transmission directly from first gear to fourth gear instead of from first gear to second gear. This is to help you get the best possible fuel economy from your vehicle. This occurs when the engine coolant (antifreeze) is higher than 106°F (41°C), vehicle speed is greater than 19 mph (30 km/h) but less than 21 mph (34 km/h), and the transmission is in first gear, and the accelerator is at ¼ throttle or less. The "1-4 Skip Shift Indicator Message" will be displayed during these times.</p>

**Claim 1**

**Corresponding Element in Chrysler Vehicles<sup>1</sup>**

(See, e.g., Ex. Dodge-1A, 2014 Dodge Challenger Owner's Manual at 298.)

As another example, the accused Chrysler vehicles include one or more upshift notification circuits coupled to said processor subsystem, said upshift notification circuit issuing a notification that said engine of said vehicle is being operated at an excessive speed.

**Operation.**

When the transmission is in DRIVE or SPORT mode, it will operate automatically, shifting between the eight available gears. To engage Paddle Shift mode, simply tap one of the steering wheel-mounted shift paddles (+/-) while in DRIVE or SPORT mode. Tapping (+) to enter Paddle Shift mode will downshift the transmission to the next lower gear, while using (-) to enter Paddle Shift mode will retain the current gear. When Paddle Shift mode is active, the current transmission gear is displayed in the instrument cluster.

In Paddle Shift mode, the transmission will shift up or down when (+/-) is manually selected by the driver, unless an engine lugging or overspeed condition would result. If will remain in the selected gear until another upshift or downshift is chosen, except as described below:

- The transmission will automatically downshift as the vehicle slows (to prevent engine lugging) and will display the current gear.
- The transmission will automatically downshift to first gear when coming to a stop. After a stop, the driver should manually upshift (+) the transmission as the vehicle is accelerated.
- You can start out from a stop, in first or second gear (or third gear, in 4LO range, Snow mode, or Sand mode). Tapping (+) at a stop will allow starting in second gear. Starting out in second gear is helpful in snowy or icy conditions.

- If a requested downshift would cause the engine to over-speed, that shift will not occur.
- The system will ignore attempts to upshift at too low of a vehicle speed.
- Holding the (-) paddle depressed will progressively downshift the transmission to the lowest gear possible at the current speed.
- Transmission shifting will be more noticeable when Paddle Shift mode is enabled.
- The system may revert to automatic shift mode if a fault or overheat condition is detected.

**NOTE:** When Selec-Speed or Hill Descent Control is enabled, Paddle Shift mode is not active. Pressing the (+/-) shift paddles in Selec-Speed or Hill Descent Control simply limits the highest allowed gear. Shifts below and up to that gear will occur automatically.

Claim 1	Corresponding Element in Chrysler Vehicles <sup>1</sup>
	(See, e.g., Ex. Jeep-1A, 2014 Jeep Grand Cherokee Owner's Manual at 416-417.)
<p>IG. said processor subsystem determining, based upon data received from said plurality of sensors, when to activate said fuel overinjection circuit and when to activate said upshift notification circuit.</p>	<p>On information and belief, the accused Chrysler vehicles include a processor subsystem that determines based upon data received from said plurality of sensors, when to activate said fuel overinjection circuit and when to activate said upshift notification circuit.</p> <p>See, e.g., citations for elements 1A-1F.</p>

Claim 2	Corresponding Element in Chrysler Vehicles
2A. Apparatus for optimizing operation of a vehicle according to claim 1 wherein said processor subsystem further comprises:	<p>The accused Chrysler vehicles include an apparatus for optimizing operation of a vehicle according to claim 1 wherein said processor subsystem further comprises:</p> <p><i>See, e.g.,</i> citations for claim 1.</p>
2B. means for determining when road speed for said vehicle is increasing;	<p>The accused Chrysler vehicles include a means for determining when road speed for said vehicle is increasing.</p> <p><i>See, e.g.,</i> citations for claim elements 1B-1D.</p> <p>To the extent that 35 U.S.C. §112(6) applies to this claim limitation, the structure(s), act(s), or materials(s) that perform the claimed function of “determining when road speed for said vehicle is increasing” are described in, for example, Figures 1 and 2 and associated text of the '781 patent relating to Road Speed Sensor 18, Memory Subsystem 14, and Processor Subsystem 12.</p>
2C. means for determining when throttle position for said vehicle is increasing; and	<p>The accused Chrysler vehicles include a means for determining when throttle position for said vehicle is increasing.</p> <p><i>See, e.g.,</i> citations for claim elements 1B-1D.</p> <p>To the extent that 35 U.S.C. §112(6) applies to this claim limitation, the structure(s), act(s), or materials(s) that perform the claimed function of “determining when throttle position for said vehicle is increasing” are described in, for example, Figures 1 and 2 and associated text of the '781 patent relating to Throttle Sensor 24, Memory Subsystem 14, and Processor Subsystem 12.</p>
2D. means for comparing	<p>The accused Chrysler vehicles include a means for comparing manifold pressure to said</p>

<b>Corresponding Element in Chrysler Vehicles</b>	
<p><b>Claim 2</b></p> <p>manifold pressure to said manifold pressure set point;</p>	<p>manifold pressure set point.</p> <p><i>See, e.g.,</i> citations for claim elements 1B-1D.</p> <p>To the extent that 35 U.S.C. §112(6) applies to this claim limitation, the structure(s), act(s), or materials(s) that perform the claimed function of “comparing manifold pressure to said manifold pressure set point” are described in, for example, Figures 1 and 2 and associated text of the '781 patent relating to Manifold PSI Sensor 22, Memory Subsystem 14, and Processor Subsystem 12.</p>
<p>2E. said processor subsystem activating said fuel overinjection notification circuit if both road speed and throttle position for said vehicle are increasing and manifold pressure for said vehicle is above said manifold pressure set point.</p>	<p>On information and belief, the accused Chrysler vehicles include a processor subsystem that activates said fuel overinjection notification circuit if both road speed and throttle position for said vehicle are increasing and manifold pressure for said vehicle is above said manifold pressure set point.</p> <p><i>See, e.g.,</i> citations for claim elements 1E, 1G.</p>

Claim 4	Corresponding Element in Chrysler Vehicles
4A. Apparatus for optimizing operation of a vehicle according to claim 1 wherein said processor subsystem further comprises:	<p>The accused Chrysler vehicles include an apparatus for optimizing operation of a vehicle according to claim 1 wherein said processor subsystem further comprises:</p> <p><i>See, e.g., citations for claim 1.</i></p>
4B. means for determining when road speed for said vehicle is decreasing;	<p>The accused Chrysler vehicles include a means for determining when road speed for said vehicle is decreasing.</p> <p><i>See, e.g., citations for claim element 2B.</i></p> <p>To the extent that 35 U.S.C. §112(6) applies to this claim limitation, the structure(s), act(s), or materials(s) that perform the claimed function of “determining when road speed for said vehicle is decreasing” are described in, for example, Figures 1 and 2 and associated text of the '781 patent relating to Road Speed Sensor 18, Memory Subsystem 14, and Processor Subsystem 12.</p>
4C. means for determining when throttle position for said vehicle is increasing; and	<p>The accused Chrysler vehicles include a means for determining when throttle position for said vehicle is increasing.</p> <p><i>See, e.g., citations for claim element 2C.</i></p>
4D. means for determining when manifold pressure for said vehicle is increasing; and	<p>The accused Chrysler vehicles include a means for determining when manifold pressure for said vehicle is increasing.</p> <p><i>See, e.g., citations for claim elements 1B-1D.</i></p>

Claim 4	Corresponding Element in Chrysler Vehicles
<p>4E. means for determining when engine speed for said vehicle is decreasing;</p>	<p>To the extent that 35 U.S.C. §112(6) applies to this claim limitation, the structure(s), act(s), or materials(s) that perform the claimed function of “determining when manifold pressure for said vehicle is increasing” are described in, for example, Figures 1 and 2 and associated text of the '781 patent relating to Manifold PSI Sensor 22, Memory Subsystem 14, and Processor Subsystem 12.</p> <p>The accused Chrysler vehicles include a means for determining when engine speed for said vehicle is decreasing.</p> <p><i>See, e.g.,</i> citations for claim elements 1B-1D.</p> <p>To the extent that 35 U.S.C. §112(6) applies to this claim limitation, the structure(s), act(s), or materials(s) that perform the claimed function of “determining when engine speed for said vehicle is decreasing” are described in, for example, Figures 1 and 2 and associated text of the '781 patent relating to RPM Sensor 20, Memory Subsystem 14, and Processor Subsystem 12.</p>
<p>4F. said processor subsystem activating said fuel overinjection notification circuit if both throttle position and manifold pressure for said vehicle are increasing and road speed and engine speed for said vehicle are decreasing.</p>	<p>On information and belief, the accused Chrysler vehicles include a processor subsystem that activates said fuel overinjection notification circuit if both throttle position and manifold pressure for said vehicle are increasing and road speed and engine speed for said vehicle are decreasing.</p> <p><i>See, e.g.,</i> citations for claim elements 1E, 1G.</p>



Claim 5	Corresponding Element in Chrysler Vehicles
5A. Apparatus for optimizing operation of a vehicle according to claim 1 wherein said processor subsystem further comprises:	The accused Chrysler vehicles include an apparatus for optimizing operation of a vehicle according to claim 1 wherein said processor subsystem further comprises:  <i>See, e.g., citations for claim 1.</i>
5B. means for determining when road speed for said vehicle is increasing;	The accused Chrysler vehicles include a means for determining when road speed for said vehicle is increasing.  <i>See, e.g., citations for claim element 2B.</i>
5C. means for determining when throttle position for said vehicle is increasing; and	The accused Chrysler vehicles include a means for determining when throttle position for said vehicle is increasing.  <i>See, e.g., citations for claim element 2C.</i>
5D. means for comparing manifold pressure to said manifold pressure set point;	The accused Chrysler vehicles include a means for comparing manifold pressure to said manifold pressure set point.  <i>See, e.g., citations for claim element 2D.</i>
5E. means for comparing engine speed to said RPM set point;	The accused Chrysler vehicles include a means for comparing engine speed to said RPM set point.  <i>See, e.g., citations for claim elements 1B-1D.</i>

Claim 5	Corresponding Element in Chrysler Vehicles
<p>5F, said processor subsystem activating said upshift notification circuit if both road speed and throttle position for said vehicle are increasing, manifold pressure for said vehicle is at or below said manifold pressure set point and engine speed for said vehicle is at or above said RPM set point.</p>	<p>To the extent that 35 U.S.C. §112(6) applies to this claim limitation, the structure(s), act(s), or materials(s) that perform the claimed function of “determining when engine speed for said vehicle is decreasing” are described in, for example, Figures 1 and 2 and associated text of the '781 patent relating to RPM Sensor 20, Memory Subsystem 14, and Processor Subsystem 12.</p> <p>On information and belief, the accused Chrysler vehicles include a processor subsystem that activates said upshift notification circuit if both road speed and throttle position for said vehicle are increasing, manifold pressure for said vehicle is at or below said manifold pressure set point and engine speed for said vehicle is at or above said RPM set point.</p> <p>See, e.g., citations for claim elements 1F, 1G.</p>

<b>Claim 7</b>	<b>Corresponding Element in Chrysler Vehicles</b>
7A. Apparatus for optimizing operation of a vehicle, comprising:	The accused Chrysler vehicles include an apparatus for optimizing operation of a vehicle. <i>See, e.g.,</i> citations for claim 1.
7B. a plurality of sensors coupled to a vehicle having an engine, said plurality of sensors, which collectively monitor operation of said vehicle, including a road speed sensor, a manifold pressure sensor and a throttle position sensor;	The accused Chrysler vehicles include a plurality of sensors coupled to a vehicle having an engine, said plurality of sensors, which collectively monitor operation of said vehicle, including a road speed sensor, a manifold pressure sensor and a throttle position sensor; <i>See, e.g.,</i> citations for claim element 1B.
7C. a processor subsystem, coupled to each one of said plurality of sensors, to receive data therefrom;	The accused Chrysler vehicles include a processor subsystem, coupled to each one of said plurality of sensors, to receive data therefrom. <i>See, e.g.,</i> citations for claim element 1C.
7D. a memory subsystem, coupled to said processor subsystem, said memory subsystem storing therein a manifold pressure set point and present and prior levels for each one of said plurality of sensors;	The accused Chrysler vehicles include a memory subsystem, coupled to said processor subsystem, said memory subsystem storing therein a manifold pressure set point and present and prior levels for each one of said plurality of sensors; <i>See, e.g.,</i> citations for claim element 1D.
7E. a fuel overinjection notification circuit coupled	The accused Chrysler vehicles include a fuel overinjection notification circuit coupled to said processor subsystem, said fuel overinjection notification circuit issuing a notification that

<b>Claim 7</b>		<b>Corresponding Element in Chrysler Vehicles</b>
<p>to said processor subsystem, said fuel overinjection notification circuit issuing a notification that excessive fuel is being supplied to said engine of said vehicle;</p>	<p>excessive fuel is being supplied to said engine of said vehicle;</p> <p><i>See, e.g.,</i> citations for claim element 1E.</p>	
<p>7F. a downshift notification circuit coupled to said processor subsystem, said downshift notification circuit issuing a notification that said engine of said vehicle is being operated at an insufficient engine speed;</p> <p>and</p>	<p>The accused Chrysler vehicles include a downshift notification circuit coupled to said processor subsystem, said downshift notification circuit issuing a notification that said engine of said vehicle is being operated at an insufficient engine speed; and</p> <p>For example, the accused Chrysler vehicles include one or more downshift notification circuits coupled to said processor subsystem, said downshift notification circuit issuing a notification that said engine of said vehicle is being operated at an insufficient speed.</p>	
	<ul style="list-style-type: none"> <li>• Key not Programmed</li> <li>• Vehicle Not in Park</li> <li>• Key Fob Not Detected</li> <li>• Press Brake &amp; Push Button to Start</li> <li>• Push Button or Insert Key/Turn To Run (refer to "Remote Starting System" in "Things To Know Before Starting Your Vehicle")</li> <li>• 1-4 SKIPSHIFT</li> </ul> <p><b>Gear Shift Indicator (GSI) — If Equipped</b></p> <p>The Gear Shift Indicator (GSI) system is enabled on vehicles with a manual transmission, or when a vehicle with an automatic transmission is in manual shift mode. The GSI provides the driver with a visual indication within the EVIC when the recommended gear shift point has been reached. This indication notifies the driver that changing gear will allow a reduction in fuel consumption.</p>	<p>When the shift up indicator (+) is shown on the display, the GSI is advising the driver to engage a higher gear.</p> <p>When the shift down indicator (-) is shown on the display, the GSI is advising the driver to engage a lower gear.</p> <p>The GSI indicator in the EVIC remains illuminated until the driver changes gear, or the driving conditions return to a situation where changing gear is not required, to improve fuel consumption.</p> <p><b>Engine Oil Change Indicator System</b></p> <p><b>Oil Change Required</b></p> <p>Your vehicle is equipped with an engine oil change indicator system. The "Oil Change Required" message will flash in the EVIC display for approximately 10 seconds after a single chime has sounded, to indicate the next scheduled oil change interval. The engine oil change</p>

**Claim 7**

**Corresponding Element in Chrysler Vehicles**

(See, e.g., Ex. Dodge-1A, 2014 Dodge Challenger Owner's Manual at 221; Ex. Dodge-1B, 2014 Dodge Charger Owner's Manual at 337-338.)

(See, e.g., Ex. Chrysler-1A, 2014 Chrysler 300 Owner's Manual at 321-22.)

When the shift up indicator (+) is shown on the display, the CSI is advising the driver to engage a higher gear.

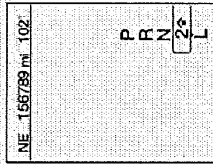

CSI Shift Up (+) Indicator

When the shift down indicator (-) is shown on the display, the CSI is advising the driver to engage a lower gear.

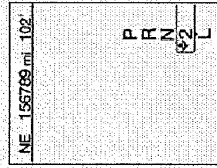

GSI Shift Down (-) Indicator

The GSI indicator in the EVTC remains illuminated until the driver changes gear, or the driving conditions return to a situation where changing gear is not required to improve fuel consumption.

(See, e.g., Ex. Dodge-1B, 2014 Dodge Charger Owner's Manual at 338.)

**Claim 7**

**Corresponding Element in Chrysler Vehicles**

As another example, the accused Chrysler vehicles include one or more downshift notification circuits coupled to said processor subsystem, said downshift notification circuit issuing a notification that said engine of said vehicle is being operated at an insufficient speed.

- AutoStick® mode will retain the current gear. When AutoStick® is active, the current transmission gear is displayed in the instrument cluster. In AutoStick® mode, the transmission will shift up or down when (+/-) is manually selected by the driver (using the shift lever, or the shift paddles [if equipped]), unless an engine lugging or overspeed condition would result. It will remain in the selected gear until another upshift or downshift is chosen, except as described below.
- If AutoStick® is engaged while in DRIVE mode, the transmission will automatically shift up when maximum engine speed is reached.
- If AutoStick® is engaged while in SPORT mode, the transmission will remain in the selected gear, even when maximum engine speed is reached. The transmission will upshift only when commanded by the driver. Engine overspeed protection will be provided by fuel cut off at or near redline.
- The transmission will automatically downshift as the vehicle slows (to prevent engine lugging) and will display the current gear.
- The transmission will automatically downshift to first gear when coming to a stop. After a stop, the driver should manually upshift (+) the transmission as the vehicle is accelerated.
- You can start out, from a stop, in first or second gear. Tapping (+) (at a stop) will allow starting in second gear. Starting out in second gear is helpful in snowy or icy conditions.
- The system will ignore attempts to upshift at too low of a vehicle speed.
- Avoid using speed control when AutoStick® is engaged.
- Transmission shifting will be more noticeable when AutoStick® is engaged.

(See, e.g., Ex. Dodge-1A, 2014 Dodge Challenger Owner's Manual at 310; Ex. Dodge-1B, 2014 Dodge Charger Owner's Manual at 421, 423-24; Ex. Dodge-1D, 2014 Dodge Journey Owner's Manual at 312, 424-425; Ex. Dodge-1E, 2014 Dodge Dart Owner's Manual at 438-439, 317; Ex. Dodge-1F, 2014 Dodge Durango Owner's Manual at 420-21; Ex. Dodge-1G, 2011 Dodge Nitro Owner's Manual at 301; Ex. Dodge-1H, 2008 Dodge Magnum Owner's

Claim 7	Corresponding Element in Chrysler Vehicles
	<p data-bbox="342 1268 370 1444">Manual at 286.)</p> <p data-bbox="402 474 461 1444">(See, e.g., Ex. Chrysler-1A, 2014 Chrysler 300 Owner's Manual at 401-2; Ex. Chrysler-1B, 2010 Chrysler Sebring Owner's Manual at 248-9.)</p> <p data-bbox="493 701 521 1444">(See, e.g., Ex. Jeep-1C, 2014 Jeep Wrangler Owner's Manual at 432.)</p> <p data-bbox="553 443 644 1444">As another example, the accused Chrysler vehicles include one or more downshift notification circuits coupled to said processor subsystem, said downshift notification circuit issuing a notification that said engine of said vehicle is being operated at an insufficient speed.</p> <p data-bbox="669 1268 691 1360">Operation</p> <p data-bbox="704 877 938 1360">When the transmission is in DRIVE or SPORT mode, it will operate automatically, shifting between the eight available gears. To engage Paddle Shift mode, simply tap one of the steering wheel-mounted shift paddles (+/-) while in DRIVE or SPORT mode. Tapping (-) to enter Paddle Shift mode will downshift the transmission to the next lower gear, while using (+) to enter Paddle Shift mode will retain the current gear. When Paddle Shift mode is active, the current transmission gear is displayed in the instrument cluster.</p>

Claim 7	Corresponding Element in Chrysler Vehicles
<p>In Paddle Shift mode, the transmission will shift up or down when (+/-) is manually selected by the driver, unless an engine lugging or overspeed condition would result. It will remain in the selected gear until another upshift or downshift is chosen, except as described below.</p> <ul style="list-style-type: none"> <li>The transmission will automatically downshift as the vehicle slows (to prevent engine lugging) and will display the current gear.</li> <li>The transmission will automatically downshift to first gear when coming to a stop. After a stop, the driver should manually upshift (+) the transmission as the vehicle is accelerated.</li> <li>You can start out, from a stop, in first or second gear (or third gear, in 4LO range, Snow mode, or Sand mode). Tapping (+) at a stop will allow starting in second gear. Starting out in second gear is helpful in snowy or icy conditions.</li> </ul> <p>(See, e.g., Ex. Jeep-1A, 2014 Jeep Grand Cherokee Owner's Manual at 416-417.)</p>	<ul style="list-style-type: none"> <li>If a requested downshift would cause the engine to overspeed, that shift will not occur.</li> <li>The system will ignore attempts to upshift at too low of a vehicle speed.</li> <li>Holding the (-) paddle depressed will progressively downshift the transmission to the lowest gear possible at the current speed.</li> <li>Transmission shifting will be more noticeable when Paddle Shift mode is enabled.</li> <li>The system may revert to automatic shift mode if a fault or overheat condition is detected.</li> </ul> <p>NOTE: When Selec-Speed or Hill Descent Control is enabled, Paddle Shift mode is not active. Pressing the (+/-) shift paddles in Selec-Speed or Hill Descent Control simply limits the highest allowed gear. Shifts below and up to that gear will occur automatically.</p>
<p>7G, said processor subsystem determining, based upon data received from said plurality of sensors, when to activate said fuel overinjection circuit and when to activate said downshift notification circuit.</p>	<p>On information and belief, the accused Chrysler vehicles include a processor subsystem that determines, based upon data received from said plurality of sensors, when to activate said fuel overinjection circuit and when to activate said downshift notification circuit.</p> <p>See, e.g., citations for elements 1G, 7F.</p>



Claim 8	Corresponding Element in Chrysler Vehicles
<p>8A. Apparatus for optimizing operation of a vehicle according to claim 7 wherein said processor subsystem further comprises:</p> <p>8B. means for determining when road speed for said vehicle is increasing;</p>	<p>The accused Chrysler vehicles include an apparatus for optimizing operation of a vehicle according to claim 7 wherein said processor subsystem further comprises:</p> <p><i>See, e.g., citations for claim 1.</i></p>
<p>8C. means for determining when throttle position for said vehicle is increasing; and</p>	<p>The accused Chrysler vehicles include a means for determining when road speed for said vehicle is increasing.</p> <p><i>See, e.g., citations for claim element 2B.</i></p>
<p>8D. means for comparing manifold pressure to said manifold pressure set point;</p>	<p>The accused Chrysler vehicles include a means for determining when throttle position for said vehicle is increasing.</p> <p><i>See, e.g., citations for claim element 2C.</i></p>
<p>8E. said processor subsystem activating said fuel overinjection notification circuit if both road speed and throttle position for said vehicle are increasing and manifold</p>	<p>The accused Chrysler vehicles include a means for comparing manifold pressure to said manifold pressure set point.</p> <p><i>See, e.g., citations for claim element 2D.</i></p>
<p>On information and belief, the accused Chrysler vehicles include a processor subsystem that activates said fuel overinjection notification circuit if both road speed and throttle position for said vehicle are increasing and manifold pressure for said vehicle is above said manifold pressure set point.</p> <p><i>See, e.g., citations for claim element 2E.</i></p>	<p>On information and belief, the accused Chrysler vehicles include a processor subsystem that activates said fuel overinjection notification circuit if both road speed and throttle position for said vehicle are increasing and manifold pressure for said vehicle is above said manifold pressure set point.</p> <p><i>See, e.g., citations for claim element 2E.</i></p>

<b>Claim 8</b>	<b>Corresponding Element in Chrysler Vehicles</b>
pressure for said vehicle is above said manifold pressure set point.	

<b>Claim 10</b>	<b>Corresponding Element in Chrysler Vehicles</b>
10A. Apparatus for optimizing operation of a vehicle according to claim 7 wherein said processor subsystem further comprises:	The accused Chrysler vehicles include an apparatus for optimizing operation of a vehicle according to claim 7 wherein said processor subsystem further comprises:  <i>See, e.g.,</i> citations for claim element 1.
10B. means for determining when road speed for said vehicle is decreasing;	The accused Chrysler vehicles include a means for determining when road speed for said vehicle is decreasing.  <i>See, e.g.,</i> citations for claim element 4B.
10C. means for determining when throttle position for said vehicle is increasing; and	The accused Chrysler vehicles include a means for determining when throttle position for said vehicle is increasing.  <i>See, e.g.,</i> citations for claim element 2C.
10D. means for determining when manifold pressure for said vehicle is increasing; and	The accused Chrysler vehicles include a means for determining when manifold pressure for said vehicle is increasing.  <i>See, e.g.,</i> citations for claim element 4D.
10E. means for determining when engine speed for said vehicle is decreasing;	The accused Chrysler vehicles include a means for determining when engine speed for said vehicle is decreasing.  <i>See, e.g.,</i> citations for claim element 4E.

Claim 10	Corresponding Element in Chrysler Vehicles
<p>10F. said processor subsystem activating said downshift notification circuit if both road speed and engine speed are decreasing and both throttle position and manifold pressure for said vehicle are increasing.</p>	<p>On information and belief, the accused Chrysler vehicles include a processor subsystem that activates said downshift notification circuit if both road speed and engine speed are decreasing and both throttle position and manifold pressure for said vehicle are increasing.</p> <p><i>See, e.g., citations for claim elements 1G, 7F.</i></p>

Claim 12	Corresponding Element in Chrysler Vehicles
12A. Apparatus for optimizing operation of a vehicle according to claim 7 wherein said processor subsystem further comprises:	The accused Chrysler vehicles include an apparatus for optimizing operation of a vehicle according to claim 7 wherein said processor subsystem further comprises:  <i>See, e.g., citations for claim 1.</i>
12B. means for determining when road speed for said vehicle is decreasing;	The accused Chrysler vehicles include a means for determining when road speed for said vehicle is decreasing.  <i>See, e.g., citations for claim element 4B.</i>
12C. means for determining when throttle position for said vehicle is increasing; and	The accused Chrysler vehicles include a means for determining when throttle position for said vehicle is increasing.  <i>See, e.g., citations for claim element 2C.</i>
12D. means for determining when manifold pressure for said vehicle is increasing; and	The accused Chrysler vehicles include a means for determining when manifold pressure for said vehicle is increasing.  <i>See, e.g., citations for claim element 4D.</i>
12E. means for determining when engine speed for said vehicle is decreasing;	The accused Chrysler vehicles include a means for determining when engine speed for said vehicle is decreasing.  <i>See, e.g., citations for claim element 4E.</i>
12F. said processor	On information and belief, the accused Chrysler vehicles include a processor subsystem that

<b>Claim 12</b>	<b>Corresponding Element in Chrysler Vehicles</b>
<p>subsystem activating said fuel overinjection notification circuit if both throttle position and manifold pressure for said vehicle are increasing and engine speed for said vehicle are decreasing.</p>	<p>activates said fuel overinjection notification circuit if both throttle position and manifold pressure for said vehicle are increasing and road speed and engine speed for said vehicle are decreasing.</p> <p><i>See, e.g., citations for claim elements 1E, 1G.</i></p>

<b>Claim 13</b>	<b>Corresponding Element in Chrysler Vehicles</b>
13A. Apparatus for optimizing operation of a vehicle, comprising:	The accused Chrysler vehicles include an apparatus for optimizing operation of a vehicle. <i>See, e.g.,</i> citations for claim 1.
13B. a plurality of sensors coupled to a vehicle having an engine, said plurality of sensors, which collectively monitor operation of said vehicle, including a road speed sensor, an engine speed sensor, a manifold pressure sensor and a throttle position sensor;	The accused Chrysler vehicles include a plurality of sensors coupled to the vehicle having an engine, said plurality of sensors, which collectively monitor operation of said vehicle, including a road speed sensor, an engine speed sensor, a manifold pressure sensor and a throttle position sensor <i>See, e.g.,</i> citations for claim element 1B.
13C. a processor subsystem, coupled to each one of said plurality of sensors, to receive data therefrom;	The accused Chrysler vehicles include a processor subsystem, coupled to each one of said plurality of sensors, to receive data therefrom. <i>See, e.g.,</i> citations for claim element 1C.
13D. a memory subsystem, coupled to said processor subsystem, said memory subsystem storing therein a manifold pressure set point, an engine speed set point, and present and prior levels for each one of said plurality of sensors;	The accused Chrysler vehicles have a memory subsystem, coupled to said processor subsystem, said memory subsystem storing therein a manifold pressure set point, an engine speed set point, and present and prior levels for each one of said plurality of sensors. <i>See, e.g.,</i> citations for claim element 1D.
13E. a fuel overinjection	The accused Chrysler vehicles include a fuel overinjection notification circuit coupled to said

<p><b>Claim 13</b></p> <p>notification circuit coupled to said processor subsystem, said fuel overinjection notification circuit issuing a notification that excessive fuel is being supplied to said engine of said vehicle;</p> <p>13F. an upshift notification circuit coupled to said processor subsystem, said upshift notification circuit issuing a notification that said engine of said vehicle is being operated at an excessive speed;</p> <p>13G. a downshift notification circuit coupled to said processor subsystem, said downshift notification circuit issuing a notification that said engine of said vehicle is being operated at an insufficient engine speed; and</p> <p>13H. said processor subsystem determining, based upon data received from said plurality of sensors, when to activate said fuel overinjection</p>	<p><b>Corresponding Element in Chrysler Vehicles</b></p> <p>processor subsystem, said fuel overinjection notification circuit issuing a notification that excessive fuel is being supplied to said engine of said vehicle.</p> <p><i>See, e.g., citations for claim element 1E.</i></p> <p>The accused Chrysler vehicles include an upshift notification circuit coupled to said processor subsystem, said upshift notification circuit issuing a notification that said engine of said vehicle is being operated at an excessive speed.</p> <p><i>See, e.g., citations for claim element 1F.</i></p> <p>The accused Chrysler vehicles include a downshift notification circuit coupled to said processor subsystem, said downshift notification circuit issuing a notification that said engine of said vehicle is being operated at an insufficient engine speed; and</p> <p><i>See, e.g., citations for claim element 7F.</i></p> <p>The accused Chrysler vehicles include a processor subsystem that determines based upon data received from said plurality of sensors, when to activate said fuel overinjection circuit, said upshift notification circuit and said downshift notification circuit.</p> <p><i>See, e.g., citations for claim element 1G.</i></p>



	Corresponding Element in Chrysler Vehicles
<p><b>Claim 13</b> circuit, said upshift notification circuit and said downshift notification circuit.</p>	

<b>Corresponding Element in Chrysler Vehicles</b>	
<b>Claim 15</b>	<b>Corresponding Element in Chrysler Vehicles</b>
15A. Apparatus for optimizing operation of a vehicle according to claim 13 wherein said processor subsystem further comprises:	The accused Chrysler vehicles include an apparatus for optimizing operation of a vehicle according to claim 13 wherein said processor subsystem further comprises:  <i>See, e.g., citations for claim 1.</i>
15B. means for determining when road speed for said vehicle is increasing or decreasing;	The accused Chrysler vehicles include a means for determining when road speed for said vehicle is increasing or decreasing.  <i>See, e.g., citations for claim element 2B.</i>  To the extent that 35 U.S.C. §112(6) applies to this claim limitation, the structure(s), act(s), or materials(s) that perform the claimed function of “determining when road speed for said vehicle is increasing or decreasing” are described in, for example, Figures 1 and 2 and associated text of the '781 patent relating to Road Speed Sensor 18, Memory Subsystem 14, and Processor Subsystem 12.
15C. means for determining when throttle position for said vehicle is increasing;	The accused Chrysler vehicles include a means for determining when throttle position for said vehicle is increasing.  <i>See, e.g., citations for claim element 2C.</i>
15D. means for comparing manifold pressure to said manifold pressure set point;	The accused Chrysler vehicles include a means for comparing manifold pressure to said manifold pressure set point.  <i>See, e.g., citations for claim element 2D.</i>
15E. means for comparing	The accused Chrysler vehicles include a means for comparing engine speed to said RPM set

Claim 15	Corresponding Element in Chrysler Vehicles
<p>engine speed to said RPM set point;</p>	<p>point. <i>See, e.g.</i>, citations for claim element 5E.</p>
<p>15F. means for determining when manifold pressure is increasing;</p>	<p>The accused Chrysler vehicles include a means for determining when manifold pressure is increasing. <i>See, e.g.</i>, citations for claim element 4D.</p>
<p>15G. means for determining when engine speed is increasing or decreasing;</p>	<p>The accused Chrysler vehicles include a means for determining when engine speed is increasing or decreasing. <i>See, e.g.</i>, citations for claim element 4E.  To the extent that 35 U.S.C. §112(6) applies to this claim limitation, the structure(s), act(s), or materials(s) that perform the claimed function of “determining when engine speed for said vehicle is increasing or decreasing”, are described in, for example, Figures 1 and 2 and associated text of the '781 patent relating to RPM Sensor 20, Memory Subsystem 14, and Processor Subsystem 12.</p>
<p>15H. said processor subsystem activating said fuel overinjection notification circuit if both road speed and throttle position for said vehicle are increasing and manifold pressure for said vehicle is</p>	<p>On information and belief, the accused Chrysler vehicles include a processor subsystem that activates said fuel overinjection notification circuit if both road speed and throttle position for said vehicle are increasing and manifold pressure for said vehicle is above said manifold pressure set or if both throttle position and manifold pressure for said vehicle are increasing and road speed and engine speed for said vehicle are decreasing.  <i>See, e.g.</i>, citations for claim elements 1E, 1G.</p>

Claim 15	Corresponding Element in Chrysler Vehicles
<p>above said manifold pressure set or if both throttle position and manifold pressure for said vehicle are increasing and road speed and engine speed for said vehicle are decreasing;</p> <p>15I. said processor subsystem activating said upshift notification circuit if both road speed and throttle position for said vehicle are increasing, manifold pressure for said vehicle is at or below said manifold pressure set point and engine speed for said vehicle is at or above said RPM set point; and</p>	<p>On information and belief, the accused Chrysler vehicles include a processor subsystem that activates said upshift notification circuit if both road speed and throttle position for said vehicle are increasing, manifold pressure for said vehicle is at or below said manifold pressure set point and engine speed for said vehicle is at or above said RPM set point.</p> <p><i>See, e.g., citations for claim elements 1F, 1G.</i></p>
<p>15J. said processor subsystem activating said downshift notification circuit if both road speed and engine speed are decreasing and both throttle position and manifold pressure for said vehicle are increasing.</p>	<p>On information and belief, the accused Chrysler vehicles include a processor subsystem that activates said downshift notification circuit if both road speed and engine speed are decreasing and both throttle position and manifold pressure for said vehicle are increasing.</p> <p><i>See, e.g., citations for claim element 10F.</i></p>

Claim 17	Corresponding Element in Chrysler Vehicles
17A. Apparatus for optimizing operation of a vehicle, comprising:	<p>The accused Chrysler vehicles include an apparatus for optimizing operation of a vehicle</p> <p><i>See, e.g., citations for claim 1.</i></p>
17B. a radar detector, said radar detector determining a distance separating a vehicle having an engine and an object in front of said vehicle;	<p>The accused Chrysler vehicles include a radar detector that determines a distance separating a vehicle having an engine and another object in front of the accused vehicles.</p> <p>For example, the accused Chrysler vehicles include one or more systems with radar detectors that determine a distance separating a vehicle having an engine and another object in front of the accused vehicles.</p>
17B1. Adaptive Cruise Control (ACC):	<p>ACC will allow you to keep cruise control engaged in light to moderate traffic conditions without the constant need to reset your cruise control. ACC utilizes a radar sensor designed to detect a vehicle directly ahead of you.</p> <p>NOTE:</p> <ul style="list-style-type: none"> <li>• If the sensor does not detect a vehicle ahead of you, ACC will maintain a fixed set speed.</li> <li>• If the ACC sensor detects a vehicle ahead, ACC will apply limited braking or acceleration (not to exceed the original set speed) automatically to maintain a preset following distance, while matching the speed of the vehicle ahead.</li> </ul>
	<p>(<i>See, e.g., Ex. Dodge-1B, 2014 Dodge Charger Owner's Manual at 247; Ex. Dodge-1F, 2014 Dodge Durango Owner's Manual at 197.</i>)</p> <p>(<i>See, e.g., Ex. Chrysler-1A, 2014 Chrysler 300 Owner's Manual at 226.</i>)</p> <p>(<i>See, e.g., Ex. Jeep-1A, 2014 Jeep Grand Cherokee Owner's Manual at 190; Ex. Jeep-1B, 2014 Jeep Cherokee Owner's Manual at 189.</i>)</p>

Claim 17	Corresponding Element in Chrysler Vehicles
<p>17B2. Forward Collision Warning (FCW):</p> <ul style="list-style-type: none"> <li>You turn off the ignition.</li> <li>You switch off ESC.</li> </ul> <p>If the Cruise Control system is turned off and reactivated, the system will return to the last driver setting (ACC or Normal Cruise Control).</p> <p><b>Forward Collision Warning – If Equipped:</b></p> <p>The Forward Collision Warning (FCW) system provides the driver with audible and visual warnings (within the EVIC) when it detects a potential frontal collision. The warnings are intended to provide the driver with enough time to react and avoid the potential collision.</p> <p>FCW monitors the information from the forward looking sensor as well as the Electronic Brake Controller (EBC), wheel speed sensors, i.e., to calculate a probable rear-end collision. When the system determines that a rear-end collision is probable a warning message (both audible and visual) will be displayed on the EVIC. When the</p>	<p>system determines a collision with the vehicle in front of you is no longer probable, the warning message will be deactivated.</p> <p>NOTE: The minimum speed for FCW activation is 10 mph (16 km/h).</p> <div style="border: 1px solid black; padding: 5px;"> <p><b>WARNING!</b></p> <p>Forward Collision Warning (FCW) is not intended to avoid a collision on its own, nor can FCW detect every type of potential collision. The driver has the responsibility to avoid a collision by controlling the vehicle via braking and steering. Failure to follow this warning could lead to serious injury or death.</p> </div> <ul style="list-style-type: none"> <li><b>Forward Collision Warning (FCW) OFF</b> This feature informs the driver that the Forward Collision Warning feature is Off. The feature is On when the front radar sensor is blocked and requires cleaning, the ACC/FCW sensors require service, or the ACC/FCW system is unavailable because of a system error. For further information, refer to "Adaptive Cruise Control (ACC)" in "Understanding The Features Of Your Vehicle."</li> </ul> <p>(See, e.g., Ex. Dodge-1B, 2014 Dodge Charger Owner's Manual at 272, 334; Ex. Dodge-1F, 2014 Dodge Durango Owner's Manual at 212, 222-23.)</p> <p>(See, e.g., Ex. Chrysler-1A, 2014 Chrysler 300 Owner's Manual at 252.)</p> <p>(See, e.g., Ex. Jeep-1A, 2014 Jeep Grand Cherokee Owner's Manual at 205; Ex. Jeep-1B, 2014 Jeep Cherokee Owner's Manual at 215.)</p>

**Claim 17**

**Corresponding Element in Chrysler Vehicles**

**17B3. Blind Spot Monitoring (BSM):**

**BLIND SPOT MONITORING (BSM) – IF EQUIPPED**

The Blind Spot Monitoring (BSM) system uses two radar-based sensors, located inside the rear bumper fascia, to detect highway licensable vehicles (automobiles, trucks, motorcycles, etc.) that enter the blind spot zones from the rear/front/side of the vehicle.

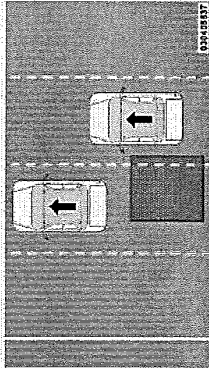

(See, e.g., Ex. Dodge-1B, 2014 Dodge Charger Owner's Manual at 116, 118, 120; Ex. Dodge-1C, 2014 Dodge Grand Caravan Owner's Manual at 134, 136; Ex. Dodge-1E, 2014 Dodge Dart Owner's Manual at 124, 127; Ex. Dodge-1F, 2014 Dodge Durango Owner's Manual at 131, 135.)

(See, e.g., Ex. RAM-1D, 2014 RAM Cargo Van Owner's Manual at 120.)

(See, e.g., Ex. Chrysler-1A, 2014 Chrysler 300 Owner's Manual at 118; Ex. Chrysler-1C, 2014 Chrysler Town & Country Owner's Manual at 142.)

(See, e.g., Ex. Jeep-1A, 2014 Jeep Grand Cherokee Owner's Manual at 132; Ex. Jeep-1B, 2014

Claim 17	Corresponding Element in Chrysler Vehicles
	<p>Jeep Cherokee Owner's Manual at 138.)</p> <p>17B4. Rear Cross Path (RCP):</p> <p><b>Rear Cross Path</b></p> <p>The Rear Cross Path (RCP) feature is intended to aid the drivers when backing out of parking spaces where their vision of oncoming vehicles may be blocked. Proceed slowly and cautiously out of the parking space until the rear end of the vehicle is exposed. The RCP system will then have a clear view of the cross traffic and if an oncoming vehicle is detected, alert the driver.</p>
	<p>(See, e.g., Ex. Dodge-1B, 2014 Dodge Charger Owner's Manual at 122; Ex. Dodge-1C, 2014 Dodge Grand Caravan Owner's Manual at 140; Ex. Dodge-1E, 2014 Dodge Dart Owner's Manual at 130; Ex. Dodge-1F, 2014 Dodge Durango Owner's Manual at 137.)</p>
	<p>(See, e.g., Ex. RAM-1D, 2014 RAM Cargo Van Owner's Manual at 126.)</p>
	<p>(See, e.g., Ex. Chrysler-1A, 2014 Chrysler 300 Owner's Manual at 124; Ex. Chrysler-1C, 2014 Chrysler Town &amp; Country Owner's Manual at 149.)</p>
	<p>(See, e.g., Ex. Jeep-1A, 2014 Jeep Grand Cherokee Owner's Manual at 138; Ex. Jeep-1B, 2014 Jeep Cherokee Owner's Manual at 144.)</p>
	<p>In the alternative, for each of the above proximity alert systems, the limitation is at least satisfied under the doctrine of equivalents. For example, on information and belief, these systems include detectors that are substantially different from the claimed radar detector, that perform substantially the same function (determining a distance separating a vehicle having an engine and another object in the path of the vehicle) in substantially the same way (e.g., using a radar sensor to determine distance) to achieve the same result (identification of an object in the path of</p>



Claim 17	Corresponding Element in Chrysler Vehicles
<p>17C. at least one sensor coupled to said vehicle for monitoring operation thereof, said at least one sensor including a road speed sensor, a manifold pressure sensor, a throttle position sensor, a throttle position sensor and an engine speed sensor;</p>	<p>a vehicle).</p> <p>The accused Chrysler vehicles include at least one sensor coupled to said vehicle for monitoring operation thereof, said at least one sensor including a road speed sensor, a manifold pressure sensor, a throttle position sensor and an engine speed sensor.</p> <p><i>See, e.g., citations for claim element 1B.</i></p>
<p>17D. a processor subsystem, coupled to said radar detector and said at least one sensor, to receive data therefrom;</p>	<p>The accused Chrysler vehicles include a processor subsystem, coupled to said radar detector and said at least one sensor, to receive data therefrom.</p> <p><i>See, e.g., citations for claim element 1C.</i></p>
<p>17E. a memory subsystem, coupled to said processor subsystem, said memory subsystem storing a first vehicle speed/stopping distance table, a manifold pressure set point, an RPM set point, a present level for each one of said at least one sensor and a prior level for each one of said at least one sensor;</p>	<p>The accused Chrysler vehicles include a memory subsystem, coupled to said processor subsystem, said memory subsystem storing a first vehicle speed/stopping distance table, a manifold pressure set point, an RPM set point, a present level for each one of said at least one sensor and a prior level for each one of said at least one sensor.</p> <p><i>See, e.g., citations for claim elements 1A-1D.</i></p> <p>For example, on information and belief, the accused Chrysler vehicles include one or more systems that use one or more vehicle speed/stopping distance tables stored in one or more memories.</p>

17E1. Adaptive Cruise Control (ACC)

ACC will allow you to keep cruise control engaged in light to moderate traffic conditions without the constant need to reset your cruise control. ACC utilizes a radar sensor designed to detect a vehicle directly ahead of you.

NOTE:

- If the sensor does not detect a vehicle ahead of you, ACC will maintain a fixed set speed.
- If the ACC sensor detects a vehicle ahead, ACC will apply limited braking or acceleration (not to exceed the original set speed) automatically to maintain a preset following distance, while matching the speed of the vehicle ahead.

Setting The Following Distance In ACC

The specified following distance for ACC can be set by varying the distance setting between 3 (long), 2 (medium), and 1 (short). Using this distance setting and the vehicle speed, ACC calculates and sets the distance to the vehicle ahead. This distance setting displays in the EVIC.

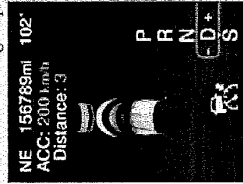

03203707

Distance Set 3 (long)

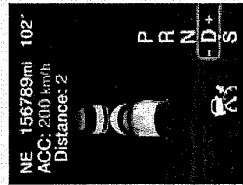

03203708

Distance Set 2 (medium)

Corresponding Element in Chrysler Vehicles

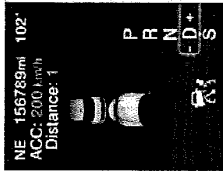

same lane, the EVIC displays the "Sensed Vehicle Indicator" icon, and the system adjusts vehicle speed automatically to maintain the distance setting, regardless of the set speed.

The vehicle will then maintain the set distance until:

- The vehicle ahead accelerates to a speed above the set speed.
- The vehicle ahead moves out of your lane or view of the sensor.
- The vehicle ahead slows to a speed below 15 mph (25 km/h) and the system automatically disengages itself.
- The distance setting is changed.
- The system disengages. (Refer to the information on ACC Activation).

Distance Set 1 (short)

To change the distance setting, press the Distance button and release. Each time the button is pressed, the distance setting adjusts between 3 (long), 2 (medium), and 1 (short).

If there is no vehicle ahead, the vehicle will maintain the set speed. If a slower moving vehicle is detected in the

NOTE: The brake lights will illuminate whenever the ACC system applies the brakes.

A Proximity Warning will alert the driver if ACC predicts that its maximum braking level is not sufficient to maintain the set distance. If this occurs, a visual alert "BRAKE" will flash in the EVIC and a chime will sound while ACC continues to apply its maximum braking capacity. When this occurs, you should immediately apply the brakes as needed to maintain a safe distance from the vehicle ahead.

(See, e.g., Ex. Dodge-1B, 2014 Dodge Charger Owner's Manual at 247, 257-259; Ex. Dodge-1F, 2014 Dodge Durango Owner's Manual at 197, 206-212.)

(See, e.g., Ex. Chrysler-1A, 2014 Chrysler 300 Owner's Manual at 236.)

(See, e.g., Ex. Jeep-1A, 2014 Jeep Grand Cherokee Owner's Manual at 199; Ex. Jeep-1B, 2014 Jeep Cherokee Owner's Manual at 198.)

**Claim 17**

**Corresponding Element in Chrysler Vehicles**

**17E2. Forward Collision Warning (FCW):**

**Changing FCW Status**

The FCW feature can be set to far, set to near or turned off using the Uconnect® System; refer to "Uconnect® Settings" in "Understanding Your Instrument Panel" for further information. The FCW Status Off, Near or Far will be displayed in the Uconnect® display.

The default status of FCW is the "Far" setting; this allows the system to warn you of a possible collision with the vehicle in front of you when you are further away. This gives you the most reaction time.

Changing the FCW status to the "Near" setting, allows the system to warn you of a possible collision with the vehicle in front of you when you are much closer. This setting provides less reaction time than the "Far" setting, which allows for a more dynamic driving experience.

Changing the FCW status to "Off" prevents the system from warning you of a possible collision with the vehicle in front of you.

**NOTE:**

- In the "Off" setting, FCW OFF will be displayed on the Uconnect® display.
- The system will retain the last setting selected by the driver after ignition shut down.
- FCW will not react to irrelevant objects such as overhead objects, ground reflections, objects not in the path of the car, stationary objects that are far away, oncoming traffic, or leading vehicles with the same or higher rate of speed.
- If the FCW becomes disabled then a warning will display on the EVIC screen.

(See, e.g., Ex. Dodge-1B, 2014 Dodge Charger Owner's Manual at 273; Ex. Dodge-1F, 2014 Dodge Durango Owner's Manual at 226.)

(See, e.g., Ex. Chrysler-1A, 2014 Chrysler 300 Owner's Manual at 253.)

(See, e.g., Ex. Jeep-1A, 2014 Jeep Grand Cherokee Owner's Manual at 218; Ex. Jeep-1B, 2014 Jeep Cherokee Owner's Manual at 218.)

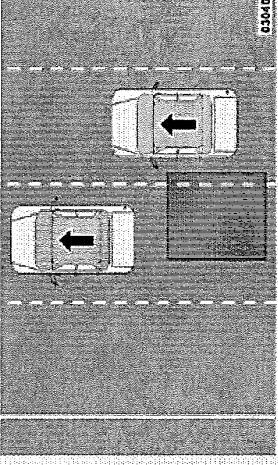
Claim 17	Corresponding Element in Chrysler Vehicles
	<p data-bbox="344 445 376 1444">17E3. Blind Spot Monitoring (BSM):</p> <p data-bbox="441 1192 467 1360"><b>Overtaking Traffic</b></p> <p data-bbox="474 865 620 1360">If you pass another vehicle slowly (with a relative speed of less than 15 mph (24 km/h) and the vehicle remains in the blind spot for approximately 1.5 seconds, the warning light will be illuminated. If the difference in speed between the two vehicles is greater than 15 mph (24 km/h), the warning light will not illuminate.</p>  <p data-bbox="727 499 750 718">Overtaking/Approaching</p> <p data-bbox="792 436 912 1444">(See, e.g., Ex. Dodge-1B, 2014 Dodge Charger Owner's Manual at 116, 118, 120; Ex. Dodge-1C, 2014 Dodge Grand Caravan Owner's Manual at 134, 136; Ex. Dodge-1E, 2014 Dodge Dart Owner's Manual at 124, 127; Ex. Dodge-1F, 2014 Dodge Durango Owner's Manual at 131, 135.)</p> <p data-bbox="945 655 977 1444">(See, e.g., Ex. RAM-1D, 2014 RAM Cargo Van Owner's Manual at 124.)</p> <p data-bbox="1010 436 1058 1444">(See, e.g., Ex. Chrysler-1A, 2014 Chrysler 300 Owner's Manual at 118; Ex. Chrysler-1C, 2014 Chrysler Town &amp; Country Owner's Manual at 142.)</p> <p data-bbox="1091 436 1140 1444">(See, e.g., Ex. Jeep-1A, 2014 Jeep Grand Cherokee Owner's Manual at 132; Ex. Jeep-1B, 2014 Jeep Cherokee Owner's Manual at 139.)</p>

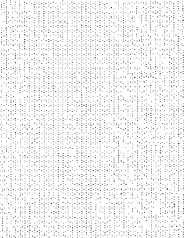
Claim 17	Corresponding Element in Chrysler Vehicles
17E4. Rear Cross Path (RCP):	 <p data-bbox="600 541 730 777">RCP monitors the rear detection zones on both sides of the vehicle for objects that are moving toward the side of the vehicle with a minimum speed of approximately 3 mph (5 km/h), to objects moving a maximum of approximately 20 mph (32 km/h), such as in parking lot situations.</p>
17F. a vehicle proximity	<p data-bbox="483 541 516 1642">(See, e.g., Ex. Dodge-1B, 2014 Dodge Charger Owner's Manual at 123; Ex. Dodge-1C, 2014 Dodge Grand Caravan Owner's Manual at 140-41; Ex. Dodge-1E, 2014 Dodge Dart Owner's Manual at 130-1; Ex. Dodge-1F, 2014 Dodge Durango Owner's Manual at 137-8.)</p> <p data-bbox="516 541 548 1642">(See, e.g., Ex. RAM-1D, 2014 RAM Cargo Van Owner's Manual at 127.)</p> <p data-bbox="548 541 581 1642">(See, e.g., Ex. Chrysler-1A, 2014 Chrysler 300 Owner's Manual at 124; Ex. Chrysler-1C, 2014 Chrysler Town &amp; Country Owner's Manual at 149.)</p> <p data-bbox="581 541 613 1642">(See, e.g., Ex. Jeep-1A, 2014 Jeep Grand Cherokee Owner's Manual at 138; Ex. Jeep-1B, 2014 Jeep Cherokee Owner's Manual at 145.)</p> <p data-bbox="613 541 730 1642">On information and belief, additional vehicle systems, including but not limited to electronic brake control systems (e.g., ABS, TCS, BAS, ESC, etc.) and speed control systems (e.g., electronic speed control (ESC) systems) included in the accused Chrysler vehicles, and safety and performance testing systems use vehicle speed/stopping distance tables stored in memory.</p> <p data-bbox="730 541 763 1642">The accused Chrysler vehicles include a vehicle proximity alarm circuit coupled to said</p>

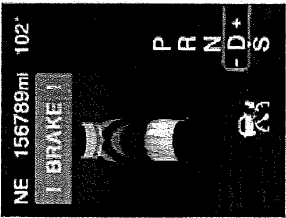
<p><b>Claim 17</b></p> <p>alarm circuit coupled to said processor subsystem, said vehicle proximity alarm circuit issuing an alarm that said vehicle is too close to an object,</p>	<p style="text-align: center;"><b>Corresponding Element in Chrysler Vehicles</b></p> <p>processor subsystem, said vehicle proximity alarm circuit issuing an alarm that said vehicle is too close to an object.</p> <p>For example, the accused Chrysler vehicles include one or more systems that include circuits that issue an alarm to indicate that the vehicle is too close to an object.</p> <p>17F1. Adaptive Cruise Control (ACC):</p> <p>The maximum braking applied by ACC is limited; however, the driver can always apply the brakes manually, if necessary.</p> <p>NOTE: The brake lights will illuminate whenever the ACC system applies the brakes.</p> <p>A Proximity Warning will alert the driver if ACC predicts that its maximum braking level is not sufficient to maintain the set distance. If this occurs, a visual alert "BRAKE" will flash in the EVIC and a chime will sound while ACC continues to apply its maximum braking capacity. When this occurs, you should immediately apply the brakes as needed to maintain a safe distance from the vehicle ahead.</p>	 <p style="text-align: center;">032 Brake Alert 3</p>
---	---	--

**Claim 17**

**Corresponding Element in Chrysler Vehicles**

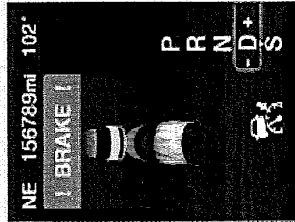

01235711

Brake Alert 2

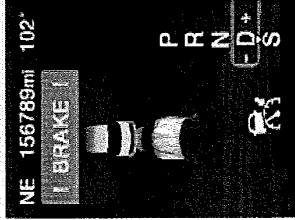

01235712

Brake Alert 1

(See, e.g., Ex. Dodge-1B, 2014 Dodge Charger Owner's Manual at 259-60; Ex. Dodge-1F, 2014 Dodge Durango Owner's Manual at 197.)

(See, e.g., Ex. Chrysler-1A, 2014 Chrysler 300 Owner's Manual at 228.)

(See, e.g., Ex. Jeep-1A, 2014 Jeep Grand Cherokee Owner's Manual at 202; Ex. Jeep-1B, 2014 Jeep Cherokee Owner's Manual at 201.)



Claim 17	Corresponding Element in Chrysler Vehicles
	<p data-bbox="342 436 375 1778">17F2. Forward Collision Warning (FCW):</p> <p data-bbox="435 436 467 1778"><b>Forward Collision Warning – If Equipped</b></p> <p data-bbox="472 436 602 1778">The Forward Collision Warning (FCW) system provides the driver with audible and visual warnings (within the EVIC) when it detects a potential frontal collision. The warnings are intended to provide the driver with enough time to react and avoid the potential collision.</p> <p data-bbox="646 436 711 1778"><i>(See, e.g., Ex. Dodge-1B, 2014 Dodge Charger Owner’s Manual at 272; Ex. Dodge-1F, 2014 Dodge Durango Owner’s Manual at 223.)</i></p> <p data-bbox="735 436 768 1778"><i>(See, e.g., Ex. Chrysler-1A, 2014 Chrysler 300 Owner’s Manual at 253.)</i></p> <p data-bbox="792 436 857 1778"><i>(See, e.g., Ex. Jeep-1A, 2014 Jeep Grand Cherokee Owner’s Manual at 215; Ex. Jeep-1B, 2014 Jeep Cherokee Owner’s Manual at 215.)</i></p>

17F3. Blind Spot Monitoring (BSM):

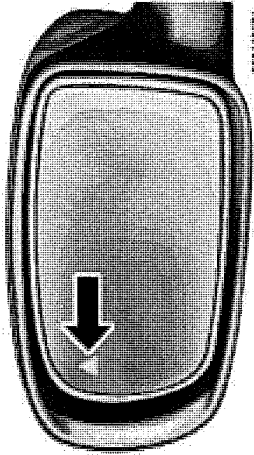

**BSM Warning Light**

The BSM detection zone covers approximately one lane on both sides of the vehicle (12 ft or 3.8 m). The zone starts at the outside rear view mirror and extends approximately 23 ft (7 m) to the rear of the vehicle. The BSM system monitors the detection zones on both sides of the

The BSM system notifies the driver of objects in the detection zones by illuminating the BSM warning light located in the outside mirrors in addition to sounding an audible (chime) alert and reducing the radio volume. Refer to "Modes Of Operation" for further information.

The BSM system monitors the detection zone from three different entry points (side, rear, front) while driving to see if an alert is necessary. The BSM system will issue an alert during these types of zone entries.

(See, e.g., Ex. Dodge-1B, 2014 Dodge Charger Owner's Manual at 117-118; Ex. Dodge-1C, 2014 Dodge Grand Caravan Owner's Manual at 135-136; Ex. Dodge-1E, 2014 Dodge Dart Owner's Manual at 125-26; Ex. Dodge-1F, 2014 Dodge Durango Owner's Manual at 133.)

Claim 17	Corresponding Element in Chrysler Vehicles
	<p>(See, e.g., Ex. RAM-1D, 2014 RAM Cargo Van Owner's Manual at 122-123.)</p>
	<p>(See, e.g., Ex. Chrysler-1A, 2014 Chrysler 300 Owner's Manual at 119-20; Ex. Chrysler-1C, 2014 Chrysler Town &amp; Country Owner's Manual at 144.)</p>
	<p>(See, e.g., Ex. Jeep-1A, 2014 Jeep Grand Cherokee Owner's Manual at 323; Ex. Jeep-1B, 2014 Jeep Cherokee Owner's Manual at 139.)</p>
	<p>17F4. Rear Cross Path (RCP):</p>
	<p><b>Rear Cross Path</b></p> <p>The Rear Cross Path (RCP) feature is intended to aid the drivers when backing out of parking spaces where their vision of oncoming vehicles may be blocked. Proceed slowly and cautiously out of the parking space until the rear end of the vehicle is exposed. The RCP system will then have a clear view of the cross traffic and if an oncoming vehicle is detected, alert the driver.</p>
	<p>When RCP is on and the vehicle is in REVERSE, the driver is alerted using both the visual and audible alarms, including reducing the radio volume.</p>
	<p>(See, e.g., Ex. Dodge-1B, 2014 Dodge Charger Owner's Manual at 122-23; Ex. Dodge-1C, 2014 Dodge Grand Caravan Owner's Manual at 140; Ex. Dodge-1E, 2014 Dodge Dart Owner's Manual at 130; Ex. Dodge-1F, 2014 Dodge Durango Owner's Manual at 137-8.)</p> <p>(See, e.g., Ex. RAM-1D, 2014 RAM Cargo Van Owner's Manual at 127.)</p> <p>(See, e.g., Ex. Chrysler-1A, 2014 Chrysler 300 Owner's Manual at 125; Ex. Chrysler-1C, 2014</p>

<b>Corresponding Element in Chrysler Vehicles</b>	
<b>Claim 17</b>	Chrysler Town & Country Owner's Manual at 148-9.)  ( <i>See, e.g., Ex. Jeep-1A, 2014 Jeep Grand Cherokee Owner's Manual at 139; Ex. Jeep-1B, 2014 Jeep Cherokee Owner's Manual at 145.</i> )
17G. a fuel overinjection circuit coupled to said processor subsystem, said fuel overinjection circuit issuing a notification that excessive fuel is being supplied to said engine of said vehicle;	The accused Chrysler vehicles include a fuel overinjection circuit coupled to said processor subsystem, said fuel overinjection circuit issuing a notification that excessive fuel is being supplied to said engine of said vehicle.  <i>See, e.g., citations for claim element 1E.</i>
17H. an upshift notification circuit coupled to said processor subsystem, said upshift notification circuit issuing a notification that said engine of said vehicle is being operated at an excessive speed;	The accused Chrysler vehicles include an upshift notification circuit coupled to said processor subsystem, said upshift notification circuit issuing a notification that said engine of said vehicle is being operated at an excessive speed.  <i>See, e.g., citations for claim element 1F.</i>
17I. said processor subsystem determining, based upon data received from said radar detector, said at least one sensor and said memory subsystem, when to activate said vehicle proximity alarm circuit, when to activate said fuel overinjection circuit, and when to activate said upshift notification circuit;	On information and belief, the accused Chrysler vehicles include a processor subsystem determining, based upon data received from said radar detector, said at least one sensor and said memory subsystem, when to activate said vehicle proximity alarm circuit, when to activate said fuel overinjection circuit, and when to activate said upshift notification circuit.  <i>See, e.g., citations for claim elements 1G, 17F.</i>

<b>Claim 17</b>	<b>Corresponding Element in Chrysler Vehicles</b>
circuit, when to activate said fuel overinjection circuit, and when to activate said upshift notification circuit.	

Claim 18	Corresponding Element in Chrysler Vehicles
18A. Apparatus for optimizing operation of a vehicle according to claim 17 wherein:	<p>The accused Chrysler vehicles include an apparatus for optimizing operation of a vehicle according to claim 17.</p> <p><i>See, e.g.,</i> citations for claim 17.</p>
18B. said at least one sensor further includes a windshield wiper sensor for indicating whether a windshield wiper of said vehicle is activated;	<p>The accused Chrysler vehicles include at least one sensor further including a windshield wiper sensor for indicating whether a windshield wiper of said vehicle is activated.</p> <p>For example, the accused Chrysler vehicles include a windshield wiper sensor that determines when the wipers are turned on.</p> <p><b>Headlights On With Wipers (Available With Automatic Headlights Only)</b></p> <p>When this feature is active, the headlights will turn on approximately 10 seconds after the wipers are turned on if the headlights switch is placed in the AUTO position. In addition, the headlights will turn off when the wipers are turned off if they were turned on by this feature.</p>
	<p>(<i>See, e.g.,</i> Ex. Dodge-1A, 2014 Dodge Challenger Owner's Manual at 160; Ex. Dodge-1B, 2014 Dodge Charger Owner's Manual at 350; Ex. Dodge-1C, 2014 Dodge Grand Caravan Owner's Manual at 340; Ex. Dodge-1D, 2014 Dodge Journey Owner's Manual at 223-4; Ex. Dodge-1E, 2014 Dodge Dart Owner's Manual at 235; Ex. Dodge-1F, 2014 Dodge Durango Owner's Manual at 329.)</p> <p>(<i>See, e.g.,</i> Ex. RAM-1D, 2014 RAM Cargo Van Owner's Manual at 205.)</p> <p>(<i>See, e.g.,</i> Ex. Chrysler-1A, 2014 Chrysler 300 Owner's Manual at 213; Ex. Chrysler-1C, 2014 Chrysler Town &amp; Country Owner's Manual at 227.)</p> <p>(<i>See, e.g.,</i> Ex. Jeep-1A, 2014 Jeep Grand Cherokee Owner's Manual at 167, 325; Ex. Jeep-1B,</p>

Claim 18	Corresponding Element in Chrysler Vehicles
18C. said memory subsystem further storing a second vehicle speed/stopping distance table.	<p>2014 Jeep Cherokee Owner's Manual at 376.)</p> <p>The accused Chrysler vehicles include a memory subsystem further storing a second vehicle speed/stopping distance table.</p> <p>On information and belief, the accused Chrysler vehicles store a second vehicle speed/stopping distance table.</p> <p><i>See, e.g.,</i> citations for claim element 17E.</p>

Claim 19	Corresponding Element in Chrysler Vehicles
19A. Apparatus for optimizing operation of a vehicle according to claim 17 and further comprising:	The accused Chrysler vehicles include an apparatus for optimizing operation of a vehicle according to claim 17.  <i>See, e.g., citations for claim 17.</i>
19B. a throttle controller for controlling a throttle of said engine of said vehicle; and	The accused Chrysler vehicles include a throttle controller for controlling a throttle of said engine of said vehicle.  <i>See, e.g., citations for claim element 1B.</i>
19C. said processor subsystem selectively reducing said throttle based upon data received from said radar detector, said at least one sensor and said memory subsystem.	On information and belief, the accused Chrysler vehicles include a processor subsystem that selectively reduces said throttle based upon data received from said radar detector, said at least one sensor and said memory subsystem.  <i>See, e.g., citations for claim element 1G and 17E1.</i>



Claim 20	Corresponding Element in Chrysler Vehicles
<p>20. Apparatus for optimizing operation of a vehicle according to claim 19 wherein said at least one sensor further includes a brake sensor for indicating whether a brake system of said vehicle is activated.</p> <p>19 wherein said at least one sensor further includes a brake sensor for indicating whether a brake system of said vehicle is activated.</p> <p>For example, the accused Chrysler vehicles include a brake sensor that determines when the brake system is activated (e.g., as indicated by brake lights.)</p> <p><b>Lights</b></p> <p>Have someone observe the operation of brake lights and exterior lights while you work the controls. Check turn signal and high beam indicator lights on the instrument panel.</p>	<p>(See, e.g., Ex. Dodge-1B, 2014 Dodge Charger Owner's Manual at 101; Ex. Dodge-1C, 2014 Dodge Grand Caravan Owner's Manual at 119; Ex. Dodge-1E, 2014 Dodge Dart Owner's Manual at 111; Ex. Dodge-1F, 2014 Dodge Durango Owner's Manual at 114.)</p> <p>(See, e.g., Ex. RAM-1D, 2014 RAM Cargo Van Owner's Manual at 105.)</p> <p>(See, e.g., Ex. Chrysler-1A, 2014 Chrysler 300 Owner's Manual at 104; Ex. Chrysler-1C, 2014 Chrysler Town &amp; Country Owner's Manual at 128.)</p> <p>(See, e.g., Ex. Jeep-1A, 2014 Jeep Grand Cherokee Owner's Manual at 111; Ex. Jeep-1B, 2014 Jeep Cherokee Owner's Manual at 145.)</p>

<b>Corresponding Element in Chrysler Vehicles</b>	
<b>Claim 21</b>	The accused Chrysler vehicles include an apparatus for optimizing operation of a vehicle according to claim 19 wherein said processor subsystem further comprises:  <i>See, e.g., citations for claims 1, 19.</i>
21A. Apparatus for optimizing operation of a vehicle according to claim 19 wherein said processor subsystem further comprises:	On information and belief, the accused Chrysler vehicles include a means for counting a total number of vehicle proximity alarms determined by said processor subsystem.  To the extent that 35 U.S.C. §112(6) applies to this claim limitation, the structure(s), act(s), or materials(s) that perform the claimed function of “counting a total number of vehicle proximity alarms determined by said processor subsystem” are described in, for example, Figures 1 and 2 and associated text relating to the expression programmed in the Processor Subsystem 12.
21B. means for counting a total number of vehicle proximity alarms determined by said processor subsystem;	On information and belief, the accused Chrysler vehicles include a means for selectively reducing said throttle based upon said total number of vehicle proximity alarms.  To the extent that 35 U.S.C. §112(6) applies to this claim limitation, the structure(s), act(s), or materials(s) that perform the claimed function of “selectively reducing said throttle based upon said total number of vehicle proximity alarms” are described in, for example, Figures 1 and 2 and associated text relating to the Processor Subsystem 12 and Throttle Controller 26.
21C. means for selectively reducing said throttle based upon said total number of vehicle proximity alarms.	On information and belief, the accused Chrysler vehicles include a means for selectively reducing said throttle based upon said total number of vehicle proximity alarms.  To the extent that 35 U.S.C. §112(6) applies to this claim limitation, the structure(s), act(s), or materials(s) that perform the claimed function of “selectively reducing said throttle based upon said total number of vehicle proximity alarms” are described in, for example, Figures 1 and 2 and associated text relating to the Processor Subsystem 12 and Throttle Controller 26.

<b>Corresponding Element in Chrysler Vehicles</b>	
<p><b>Claim 22</b></p> <p>22A. Apparatus for optimizing operation of a vehicle according to claim 17 and further comprising:</p>	<p>The accused Chrysler vehicles include an apparatus for optimizing operation of a vehicle according to claim 17 and further comprising:</p> <p><i>See, e.g.,</i> citations for claim 17.</p>
<p>22B. a downshift notification circuit coupled to said processor subsystem, said downshift notification circuit issuing a notification that said engine of said vehicle is being operated at an insufficient engine speed;</p> <p>and</p>	<p>The accused Chrysler vehicles include a downshift notification circuit coupled to said processor subsystem, said downshift notification circuit issuing a notification that said engine of said vehicle is being operated at an insufficient engine speed.</p> <p><i>See, e.g.,</i> citations for claim element 7F.</p>
<p>22C. said processor subsystem determining, based upon data received from said plurality of sensors, when to activate said downshift notification circuit.</p>	<p>The accused Chrysler vehicles include a processor subsystem that determines, based upon data received from said plurality of sensors, when to activate said downshift notification circuit. selectively reduces said throttle based upon data received from said radar detector, said at least one sensor and said memory subsystem.</p> <p><i>See, e.g.,</i> citations for claim elements 1B, 1G.</p>

<b>Claim 23</b>		<b>Corresponding Element in Chrysler Vehicles</b>	
<p>23A. Apparatus for optimizing operation of a vehicle, comprising:</p>		<p>The accused Chrysler vehicles include an apparatus for optimizing operation of a vehicle. <i>See, e.g.,</i> citations for claims 1, 17.</p>	
<p>23B. a radar detector, said radar detector determining a distance separating a vehicle having an engine and an object in front of said vehicle;</p>		<p>The accused Chrysler vehicles include a radar detector that determines a distance separating a vehicle having an engine and another object in front of the accused vehicles. <i>See, e.g.,</i> citations for claim element 17B.</p>	
<p>23C. a plurality of sensors coupled to a vehicle having an engine, said plurality of sensors, which collectively monitor operation of said vehicle, including a road speed sensor, and engine speed sensor, a manifold pressure sensor and a throttle position sensor;</p>		<p>The accused Chrysler vehicles include a plurality of sensors coupled to a vehicle having an engine, said plurality of sensors, which collectively monitor operation of said vehicle, including a road speed sensor, and engine speed sensor, a manifold pressure sensor and a throttle position sensor <i>See, e.g.,</i> citations for claim element 1B.</p>	
<p>23D. a processor subsystem, coupled to said radar detector and each one of said plurality of sensors, to receive data therefrom;</p>		<p>The accused Chrysler vehicles include a processor subsystem, coupled to said radar detector and each one of said plurality of sensors, to receive data therefrom; <i>See, e.g.,</i> citations for claim element 1C.</p>	
<p>23E. a memory subsystem, coupled to said processor</p>		<p>The accused Chrysler vehicles include a memory subsystem, coupled to said processor</p>	

Claim 23	Corresponding Element in Chrysler Vehicles
<p>subsystem, said memory subsystem storing therein a first vehicle speed/stopping distance table, a manifold pressure set point, an RPM set point, and present and prior levels for each one of said plurality of sensors;</p>	<p>subsystem, said memory subsystem storing therein a first vehicle speed/stopping distance table, a manifold pressure set point, an RPM set point, and present and prior levels for each one of said plurality of sensors.</p> <p><i>See, e.g., citations for claim element 17E.</i></p>
<p>23F. a fuel overinjection notification circuit coupled to said processor subsystem, said fuel overinjection notification circuit issuing a notification that excessive fuel is being supplied to said engine of said vehicle;</p>	<p>The accused Chrysler vehicles include a fuel overinjection notification circuit coupled to said processor subsystem, said fuel overinjection notification circuit issuing a notification that excessive fuel is being supplied to said engine of said vehicle.</p> <p><i>See, e.g., citations for claim element 1E.</i></p>
<p>23G. an upshift notification circuit coupled to said processor subsystem, said upshift notification circuit issuing a notification that said engine of said vehicle is being operated at an excessive speed;</p>	<p>The accused Chrysler vehicles include an upshift notification circuit coupled to said processor subsystem, said upshift notification circuit issuing a notification that said engine of said vehicle is being operated at an excessive speed.</p> <p><i>See, e.g., citations for claim element 1F.</i></p>
<p>23H. said processor subsystem determining, based upon data received from said plurality of</p>	<p>The accused Chrysler vehicles include a processor subsystem that determines, based upon data received from said plurality of sensors, when to activate said fuel overinjection circuit and when to activate said upshift notification circuit.</p>

<b>Claim 23</b>	<b>Corresponding Element in Chrysler Vehicles</b>
<p>sensors, when to activate said fuel overinjection circuit and when to activate said upshift notification circuit;</p> <p>23I. a vehicle proximity alarm circuit coupled to said processor subsystem, said vehicle proximity alarm circuit issuing an alarm that said vehicle is too close to said object;</p>	<p>See, e.g., citations for claim element 1G.</p> <p>The accused Chrysler vehicles include a vehicle proximity alarm circuit coupled to said processor subsystem, said vehicle proximity alarm circuit issuing an alarm that said vehicle is too close to said object.</p> <p>See, e.g., citations for claim 17F.</p>
<p>23J. said processor subsystem determining, based upon data received from said radar detector, said at least one sensor and said memory subsystem, when to activate said vehicle proximity alarm circuit.</p>	<p>The accused Chrysler vehicles includes a processor subsystem that determines, based upon data received from said radar detector, said at least one sensor and said memory subsystem, when to activate said vehicle proximity alarm circuit.</p> <p>See, e.g., citations for claim element 17I.</p>

<b>Claim 24</b>	<b>Corresponding Element in Chrysler Vehicles</b>
24A. Apparatus for optimizing operation of a vehicle according to claim 23 wherein said processor subsystem further comprises:	The accused Chrysler vehicles include an apparatus for optimizing operation of a vehicle according to claim 23 wherein said processor subsystem further comprises:  <i>See, e.g.,</i> citations for claim 23.
24B. means for determining when road speed for said vehicle is increasing or decreasing;	The accused Chrysler vehicles include a means for determining when road speed for said vehicle is increasing or decreasing.  <i>See, e.g.,</i> citations for claim element 15B.
24C. means for determining when throttle position for said vehicle is increasing or decreasing; and	The accused Chrysler vehicles include a means for determining when throttle position for said vehicle is increasing or decreasing.  <i>See, e.g.,</i> citations for claim element 2C.  To the extent that 35 U.S.C. §112(6) applies to this claim limitation, the structure(s), act(s), or materials(s) that perform the claimed function of “determining when throttle position for said vehicle is increasing or decreasing” are described in, for example, Figures 1 and 2 and associated text of the ’781 patent relating to Throttle Sensor 24, Memory Subsystem 14, and Processor Subsystem 12.
24D. means for comparing manifold pressure to said manifold pressure set point;	The accused Chrysler vehicles include a means for comparing manifold pressure to said manifold pressure set point.  <i>See, e.g.,</i> citations for claim element 2D.
24E. means for determining	The accused Chrysler vehicles include a means for determining when manifold pressure for said

Claim 24	Corresponding Element in Chrysler Vehicles
<p>when manifold pressure for said vehicle is increasing or decreasing, and</p>	<p>vehicle is increasing or decreasing.  <i>See, e.g.,</i> citations for claim element 4D.             To the extent that 35 U.S.C. §112(6) applies to this claim limitation, the structure(s), act(s), or materials(s) that perform the claimed function of “determining when manifold pressure for said vehicle is increasing or decreasing” are described in, for example, Figures 1 and 2 and associated text of the '781 patent relating to Manifold PSI Sensor 22, Memory Subsystem 14, and Processor Subsystem 12.</p>
<p>24F. means for determining when engine speed for said vehicle is increasing or decreasing;</p>	<p>The accused Chrysler vehicles include a means for determining when engine speed for said vehicle is increasing or decreasing.  <i>See, e.g.,</i> citations for claim element 15G.</p>
<p>24G. said processor subsystem activating said fuel overinjection notification circuit if both road speed and throttle position for said vehicle are increasing and manifold pressure for said vehicle is above said manifold pressure set point or if both throttle position and manifold pressure for said vehicle are increasing and road speed and engine speed for said vehicle are decreasing.</p>	<p>On information and belief, the accused Chrysler vehicles include a processor subsystem that activates said fuel overinjection notification circuit if both road speed and throttle position for said vehicle are increasing and manifold pressure for said vehicle is above said manifold pressure set point or if both throttle position and manifold pressure for said vehicle are increasing and road speed and engine speed for said vehicle are decreasing.  <i>See, e.g.,</i> citations for claim element 1G.</p>



Claim 24	Corresponding Element in Chrysler Vehicles
decreasing.	
<p><b>Claim 25</b></p> <p>25A. Apparatus for optimizing operation of a vehicle according to claim 23 wherein said processor subsystem further comprises:</p> <p>25B. means for determining when road speed for said vehicle is increasing;</p> <p>25C. means for determining when throttle position for said vehicle is increasing; and</p> <p>25D. means for comparing manifold pressure to said manifold pressure set point;</p> <p>25E. means for comparing engine speed to said RPM set point;</p>	<p><b>Corresponding Element in Chrysler Vehicles</b></p> <p>The accused Chrysler vehicles include an apparatus for optimizing operation of a vehicle according to claim 23 wherein said processor subsystem further comprises:</p> <p><i>See, e.g., citations for claim 23.</i></p> <p>The accused Chrysler vehicles include a means for determining when road speed for said vehicle is increasing.</p> <p><i>See, e.g., citations for claim element 2B.</i></p> <p>The accused Chrysler vehicles include a means for determining when throttle position for said vehicle is increasing.</p> <p><i>See, e.g., citations for claim element 2C.</i></p> <p>The accused Chrysler vehicles include a means for comparing manifold pressure to said manifold pressure set point.</p> <p><i>See, e.g., citations for claim element 2D.</i></p> <p>The accused Chrysler vehicles include a means for comparing engine speed to said RPM set point.</p>

Claim 25	Corresponding Element in Chrysler Vehicles
<p>25F. said processor subsystem activating said upshift notification circuit if both road speed and throttle position for said vehicle are increasing, manifold pressure for said vehicle is at or below said manifold pressure set point and engine speed for said vehicle is at or above said RPM set point.</p>	<p><i>See, e.g., citations for claim element 5E.</i></p> <p>On information and belief, the accused Chrysler vehicles include a processor subsystem that activates said upshift notification circuit if both road speed and throttle position for said vehicle are increasing, manifold pressure for said vehicle is at or below said manifold pressure set point and engine speed for said vehicle is at or above said RPM set point.</p> <p><i>See, e.g., citations for claim element 5F.</i></p>

Claim 26	Corresponding Element in Chrysler Vehicles
26A. Apparatus for optimizing operation of a vehicle, comprising:	The accused Chrysler vehicles include an apparatus for optimizing operation of a vehicle. <i>See, e.g.</i> , citations for claims 1, 17.
26B. a radar detector, said radar detector determining a distance separating a vehicle having an engine and an object in front of said vehicle;	The accused Chrysler vehicles include a radar detector that determines a distance separating a vehicle having an engine and another object in front of the accused vehicles. <i>See, e.g.</i> , citations for claim element 17B.
26C. a plurality of sensors coupled to a vehicle having an engine, said plurality of sensors, which collectively monitor operation of said vehicle, including a road speed sensor, and engine speed sensor, which collectively monitor operation of said vehicle, including a road speed sensor, and engine speed sensor, a manifold pressure sensor and a throttle position sensor;	The accused Chrysler vehicles include a plurality of sensors coupled to a vehicle having an engine, said plurality of sensors, which collectively monitor operation of said vehicle, including a road speed sensor, and engine speed sensor, a manifold pressure sensor and a throttle position sensor. <i>See, e.g.</i> , citations for claim element 1B.
26D. a processor subsystem, coupled to said radar detector and each one of said plurality of sensors, to receive data therefrom;	The accused Chrysler vehicles include a processor subsystem, coupled to said radar detector and each one of said plurality of sensors, to receive data therefrom; <i>See, e.g.</i> , citations for claim element 1C.
26E. a memory subsystem, coupled to said processor	The accused Chrysler vehicles include a memory subsystem, coupled to said processor

<p align="center"><b>Claim 26</b></p>	<p align="center"><b>Corresponding Element in Chrysler Vehicles</b></p>
<p>subsystem, said memory subsystem storing therein a first vehicle speed/stopping distance table, a manifold pressure set point, RPM set point, and present and prior levels for each one of said plurality of sensors;</p>	<p>subsystem, said memory subsystem storing therein a first vehicle speed/stopping distance table, a manifold pressure set point, RPM set point, and present and prior levels for each one of said plurality of sensors.  <i>See, e.g., citations for claim element 17E.</i></p>
<p>26F. a fuel overinjection notification circuit coupled to said processor subsystem, said fuel overinjection notification circuit issuing a notification that excessive fuel is being supplied to said engine of said vehicle;</p>	<p>The accused Chrysler vehicles include a fuel overinjection notification circuit coupled to said processor subsystem, said fuel overinjection notification circuit issuing a notification that excessive fuel is being supplied to said engine of said vehicle.  <i>See, e.g., citations for claim element 1E.</i></p>
<p>26G. a downshift notification circuit coupled to said processor subsystem, said downshift notification circuit issuing a notification that said engine of said vehicle is being operated at an insufficient engine speed;</p>	<p>The accused Chrysler vehicles include a downshift notification circuit coupled to said processor subsystem, said downshift notification circuit issuing a notification that said engine of said vehicle is being operated at an insufficient engine speed;  <i>See, e.g., citations for claim element 7F.</i></p>
<p>26H. said processor subsystem determining, based upon data received from said plurality of sensors, when to activate said downshift notification circuit.</p>	<p>The accused Chrysler vehicles include a processor subsystem that determines, based upon data received from said plurality of sensors, when to activate said fuel overinjection circuit and when to activate said downshift notification circuit.</p>

Claim 26	Corresponding Element in Chrysler Vehicles
<p>sensors, when to activate said fuel overinjection circuit and when to activate said downshift notification circuit;</p>	<p><i>See, e.g.,</i> citations for claim element 7G.</p>
<p>26I. a vehicle proximity alarm circuit coupled to said processor subsystem, said vehicle proximity alarm circuit issuing an alarm that said vehicle is too close to said object;</p>	<p>The accused Chrysler vehicles include a vehicle proximity alarm circuit coupled to said processor subsystem, said vehicle proximity alarm circuit issuing an alarm that said vehicle is too close to said object.</p> <p><i>See, e.g.,</i> citations for claim element 17F.</p>
<p>26J. said processor subsystem determining, based upon data received from said radar detector, said at least one sensor and said memory subsystem, when to activate said vehicle proximity alarm circuit.</p>	<p>The accused Chrysler vehicles includes a processor subsystem that determines, based upon data received from said radar detector, said at least one sensor and said memory subsystem, when to activate said vehicle proximity alarm circuit.</p> <p><i>See, e.g.,</i> citations for claim element 17I.</p>

Claim 27	Corresponding Element in Chrysler Vehicles
27A. Apparatus for optimizing operation of a vehicle according to claim 26 wherein said processor subsystem further comprises:	The accused Chrysler vehicles include an apparatus for optimizing operation of a vehicle according to claim 26 wherein said processor subsystem further comprises:  <i>See, e.g., citations for claims 1, 26.</i>
27B. means for determining when road speed for said vehicle is decreasing;	The accused Chrysler vehicles include a means for determining when road speed for said vehicle is decreasing.  <i>See, e.g., citations for claim element 4B.</i>
27C. means for determining when throttle position for said vehicle is increasing; and	The accused Chrysler vehicles include a means for determining when throttle position for said vehicle is increasing.  <i>See, e.g., citations for claim element 4C.</i>
27D. means for determining when manifold pressure for said vehicle is increasing; and	The accused Chrysler vehicles include a means for determining when manifold pressure for said vehicle is increasing.  <i>See, e.g., citations for claim element 4D.</i>
27E. means for determining when engine speed for said vehicle is decreasing;	The accused Chrysler vehicles include a means for determining when engine speed for said vehicle is decreasing.  <i>See, e.g., citations for claim element 4E.</i>
27F. said processor subsystem activating said	On information and belief, the accused Chrysler vehicles include a processor subsystem that activates said downshift notification circuit if both road speed and engine speed are decreasing

<p><b>Claim 27</b> downshift notification circuit if both road speed and engine speed are decreasing and both throttle position and manifold pressure for said vehicle are increasing.</p>	<p style="text-align: center;"><b>Corresponding Element in Chrysler Vehicles</b></p> <p>and both throttle position and manifold pressure for said vehicle are increasing. <i>See, e.g., citations for claim element 10F.</i></p>
--	--

<b>Claim 28</b>		<b>Corresponding Element in Chrysler Vehicles</b>
28A. Apparatus for optimizing operation of a vehicle, comprising:		<p>The accused Chrysler vehicles include an apparatus for optimizing operation of a vehicle.</p> <p><i>See, e.g.,</i> citations for claim 1.</p> <p><i>See, also, e.g.,</i> Ex. Chrysler-1D, 2009 Aspen Owner's Manual at 387; Ex. Chrysler-1E, 2009 Aspen Hybrid Owner's Manual at 31.</p>
28B. a plurality of sensors coupled to a vehicle having an engine, said plurality of sensors, which collectively monitor operation of said vehicle, including a road speed sensor, an engine speed sensor, a manifold pressure sensor and a throttle position sensor,		<p>The accused Chrysler vehicles include a plurality of sensors coupled to the vehicle having an engine, said plurality of sensors, which collectively monitor operation of said vehicle, including a road speed sensor, an engine speed sensor, a manifold pressure sensor and a throttle position sensor</p> <p><i>See, e.g.,</i> citations for claim element 1B.</p> <p><i>See, also, e.g.,</i> Ex. Chrysler-1D, 2009 Aspen Owner's Manual at 206, 207, 2010; Ex. Chrysler-1E, 2009 Aspen Hybrid Owner's Manual at 24, 25, 30.</p>
28C. a processor subsystem, coupled to each one of said plurality of sensors, to receive data therefrom;		<p>The accused Chrysler vehicles include a processor subsystem, coupled to each one of said plurality of sensors, to receive data therefrom.</p> <p><i>See, e.g.,</i> citations for claim element 1C.</p> <p><i>See, also, e.g.,</i> Ex. Chrysler-1D, 2009 Aspen Owner's Manual at 387; Ex. Chrysler-1E, 2009 Aspen Hybrid Owner's Manual at 31.</p>
28D. a fuel overinjection notification circuit coupled to said processor subsystem, said fuel overinjection notification circuit issuing a notification that excessive fuel is being supplied to said engine of said vehicle		<p>The accused Chrysler vehicles include a fuel overinjection notification circuit coupled to said processor subsystem, said fuel overinjection notification circuit issuing a notification that excessive fuel is being supplied to said engine of said vehicle.</p> <p><i>See, e.g.,</i> citations for claim element 1E.</p>

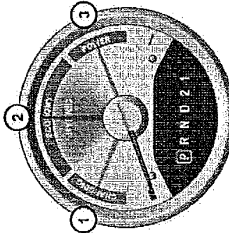

<b>Corresponding Element in Chrysler Vehicles</b>	
<p><b>Claim 28</b></p> <p>notification that excessive fuel is being supplied to said engine of said vehicle;</p>	<p><i>See, also, e.g., Ex. Chrysler-1D, 2009 Aspen Owner's Manual at 168; Ex. Chrysler-1E, 2009 Aspen Hybrid Owner's Manual at 35:</i></p> <p><b>31. TOW/HAUL</b> The TOW/HAUL button is located at the end of the shift lever. This light will illuminate when the TOW/HAUL button has been selected. Refer to "When To Use TOW/HAUL Mode" under "2-Mode Hybrid Transmission Ranges" in Section 5 of this supplement for further information.</p> <p><b>32. Odometer/Trip Odometer Button</b> Press this button to toggle between the odometer and the trip odometer display. Holding the button in resets the trip odometer reading.</p> <p><b>HYBRID GAUGE</b> The Hybrid Gauge, located on the instrument cluster, has three different zones to indicate how the vehicle is being operated in the sense of fuel savings.</p> <p><b>NOTE:</b> Driving with the gauge pointer in the 12 O'clock (ECONOMY) position is the optimal Hybrid location.</p> <div style="text-align: center;">  </div> <p style="text-align: center;"><b>Hybrid Gauge</b></p> <p>1 — CHARGING — Indicates that the high-voltage battery is being charged during braking or certain driving conditions. 2 — ECONOMY — Indicates the HEV vehicle is being propelled forward in electric mode, Hybrid mode or Fuel Saver mode (MDS) operation. 3 — POWER — Indicates that the accelerator pedal is being applied for additional power, which is not the most fuel efficient mode of operation.</p>
<p><b>Claim 29</b></p> <p>28E. said processor subsystem determining whether to activate said fuel overinjection notification sensor based upon data received from said road speed sensor, said throttle position sensor and said manifold pressure sensor.</p>	<p>The accused Chrysler vehicles include a processor subsystem that determines whether to activate said fuel overinjection notification sensor based upon data received from said road speed sensor, said throttle position sensor and said manifold pressure sensor.</p> <p><i>See, e.g., citations for claim element 1G.</i></p> <p><i>See, also, e.g., Ex. Chrysler-1D, 2009 Aspen Owner's Manual at 387; Ex. Chrysler-1E, 2009 Aspen Hybrid Owner's Manual at 31; citations for claim elements 28A-28D.</i></p>
<b>Corresponding Element in Chrysler Vehicles</b>	

<b>Corresponding Element in Chrysler Vehicles</b>	
<b>Claim 29</b>	<b>The accused Chrysler vehicles include an apparatus according to claim 28 and further comprising:</b>
29A. Apparatus according to claim 28 and further comprising:	<i>See, e.g., citations for claim 1, 28.</i>
29B. a memory subsystem, coupled to said processor subsystem, said memory subsystem maintaining a manifold pressure set point;	The accused Chrysler vehicles include a memory subsystem, coupled to said processor subsystem, said memory subsystem maintaining a manifold pressure set point.  <i>See, e.g., citations for claim element 1D and claim 28.</i>
29C. said processor subsystem activating said fuel overinjection notification circuit upon determining that: (1) based upon data received from said road speed sensor, road speed of said vehicle is increasing; (2) based upon data received from said throttle position sensor, throttle position for said vehicle is increasing; and (3) based upon data received from said manifold pressure sensor, manifold pressure for said vehicle exceeds said manifold pressure set point.	On information and belief, the accused Chrysler vehicles include a processor subsystem that activates said fuel overinjection notification circuit upon determining that: (1) based upon data received from said road speed sensor, road speed of said vehicle is increasing; (2) based upon data received from said throttle position sensor, throttle position for said vehicle is increasing; and (3) based upon data received from said manifold pressure sensor, manifold pressure for said vehicle exceeds said manifold pressure set point.  <i>See, e.g., citations for claim element 1G and claim 28.</i>

<b>Claim 30</b>	<b>Corresponding Element in Chrysler Vehicles</b>
30A. Apparatus according to claim 28, wherein:	<p>The accused Chrysler vehicles include an apparatus according to claim 28.</p> <p><i>See, e.g.,</i> citations for claims 1, 28.</p>
30B. said plurality of sensors coupled to said vehicle further include an engine speed sensor;	<p>The accused Chrysler vehicles include a plurality of sensors coupled to said vehicle further including an engine speed sensor;</p> <p><i>See, e.g.,</i> citations for claim element 1B and claim 28.</p>
30C. said processor subsystem activating said fuel overinjection notification circuit upon determining that: (1) based upon data received from said road speed sensor, road speed of said vehicle is decreasing; (2) based upon data received from said throttle position sensor, throttle position for said vehicle is increasing; (3) based upon data received from said manifold pressure sensor, manifold pressure for said vehicle is increasing; and (4) based upon data received from said engine speed sensor, engine speed for said vehicle is decreasing.	<p>On information and belief, the accused Chrysler vehicles include a processor subsystem that activates said fuel overinjection notification circuit upon determining that: (1) based upon data received from said road speed sensor, road speed of said vehicle is decreasing; (2) based upon data received from said throttle position sensor, throttle position for said vehicle is increasing; (3) based upon data received from said manifold pressure sensor, manifold pressure for said vehicle is increasing; and (4) based upon data received from said engine speed sensor, engine speed for said vehicle is decreasing.</p> <p><i>See, e.g.,</i> citations for claim element 1G and claim 28.</p>

Claim 30	Corresponding Element in Chrysler Vehicles
<p>sensor, manifold pressure for said vehicle is increasing; and (4) based upon data received from said engine speed sensor, engine speed for said vehicle is decreasing.</p>	

Claim 31	Corresponding Element in Chrysler Vehicles
31A. Apparatus for optimizing operation of a vehicle, comprising:	The accused Chrysler vehicles include an apparatus for optimizing operation of a vehicle. <i>See, e.g.,</i> citations for claims 1, 17.
31B. a radar detector, said radar detector determining a distance separating a vehicle having an engine and an object in front of said vehicle;	The accused Chrysler vehicles include a radar detector that determines a distance separating a vehicle having an engine and another object in front of the accused vehicles. <i>See, e.g.,</i> citations for claim element 17B.
31C. at least one sensor coupled to said vehicle for monitoring operation thereof, said at least one sensor including a road speed sensor.	The accused Chrysler vehicles include at least one sensor coupled to said vehicle for monitoring operation thereof, said at least one sensor including a road speed sensor. <i>See, e.g.,</i> citations for claim element 1B.
31D. a processor subsystem, coupled to said radar detector and said at least one sensor, to receive data therefrom;	The accused Chrysler vehicles include a processor subsystem, coupled to said radar detector and said at least one sensor, to receive data therefrom. <i>See, e.g.,</i> citations for claim element 17D.
31E. a memory subsystem, coupled to said processor subsystem, said memory subsystem storing a first vehicle speed/stopping distance table.	The accused Chrysler vehicles include a memory subsystem, coupled to said processor subsystem, said memory subsystem storing a first vehicle speed/stopping distance table.

Claim 31	Corresponding Element in Chrysler Vehicles
<p>subsystem storing a first vehicle speed/stopping distance table.</p>	<p>See, e.g., citations for claim element 17E.</p>
<p>31F. a vehicle proximity alarm circuit coupled to said processor subsystem, said vehicle proximity alarm circuit issuing an alarm that said vehicle is too close to said object;</p>	<p>The accused Chrysler vehicles include a vehicle proximity alarm circuit coupled to said processor subsystem, said vehicle proximity alarm circuit issuing an alarm that said vehicle is too close to said object.</p> <p>See, e.g., citations for claim element 17F.</p>
<p>31G. said processor subsystem determining whether to activate said vehicle proximity alarm circuit based upon separation distance data received from said radar detector, vehicle speed data received from said road speed sensor and said first vehicle speed/stopping distance table stored in said memory subsystem.</p>	<p>On information and belief, The accused Chrysler vehicles includes a processor subsystem that determines whether to activate said vehicle proximity alarm circuit based upon separation distance data received from said radar detector, vehicle speed data received from said road speed sensor and said first vehicle speed/stopping distance table stored in said memory subsystem.</p> <p>See, e.g., citations for claim element 17I.</p>

<b>Claim 32</b>	<b>Corresponding Element in Chrysler Vehicles</b>
32A. Apparatus for optimizing operation of a vehicle according to claim 31 wherein:	<p>The accused Chrysler vehicles include an apparatus for optimizing operation of a vehicle according to claim 31.</p> <p><i>See, e.g., citations for claim 31.</i></p>
32B. said at least one sensor further includes a windshield wiper sensor for indicating whether a windshield wiper of said vehicle is activated; and	<p>The accused Chrysler vehicles include at least one sensor further including a windshield wiper sensor for indicating whether a windshield wiper of said vehicle is activated.</p> <p><i>See, e.g., citations for claim element 18B.</i></p>
32C. said memory subsystem further storing a second vehicle speed/stopping distance table.	<p>The accused Chrysler vehicles include a memory subsystem further storing a second vehicle speed/stopping distance table.</p> <p><i>See, e.g., citations for claim element 18C.</i></p>
32D. if said windshield wiper sensor indicates that said windshield wiper is deactivated, said processor subsystem determining whether to activate said vehicle proximity alarm circuit based upon data received from said radar detector, said road speed sensor and said first vehicle speed/stopping distance table stored in said memory	<p>On information and belief, the accused Chrysler vehicles include an apparatus for optimizing operation of a vehicle according to claim 31 wherein if said windshield wiper sensor indicates that said windshield wiper is deactivated, said processor subsystem determining whether to activate said vehicle proximity alarm circuit based upon data received from said radar detector, said road speed sensor and said first vehicle speed/stopping distance table stored in said memory subsystem.</p> <p><i>See, e.g., citations for claim element 17I.</i></p>

<b>Claim 32</b> table stored in said memory subsystem;	<b>Corresponding Element in Chrysler Vehicles</b>
<p>32E. if said windshield wiper sensor indicates that said windshield wiper is activated, said processor subsystem determining whether to activate said vehicle proximity alarm circuit based upon data received from said radar detector, said road speed sensor and said second vehicle speed/stopping distance table stored in said memory subsystem.</p>	<p>On information and belief, the accused Chrysler vehicles include an apparatus for optimizing operation of a vehicle according to claim 31 wherein if said windshield wiper sensor indicates that said windshield wiper is activated, said processor subsystem determining whether to activate said vehicle proximity alarm circuit based upon data received from said radar detector, said road speed sensor and said second vehicle speed/stopping distance table stored in said memory subsystem.</p> <p><i>See, e.g., citations for claim element 17I.</i></p>



## **EXHIBIT 9**

IN THE UNITED STATES DISTRICT COURT  
FOR THE NORTHERN DISTRICT OF ILLINOIS

EASTERN DIVISION

VELOCITY PATENT LLC,	)	
	)	
<i>Plaintiff,</i>	)	Civil Action No. 1:13-cv-08421
	)	
v.	)	Hon. John W. Darrah
	)	
JAGUAR LAND ROVER NORTH AMERICA, LLC	)	<b>JURY TRIAL DEMANDED</b>
	)	
	)	
<i>Defendant.</i>	)	
	)	

**VELOCITY PATENT LLC’S INITIAL INFRINGEMENT CONTENTIONS PURSUANT  
TO LOCAL PATENT RULE 2.2**

Plaintiff Velocity Patent LLC (“Velocity”) hereby provides, pursuant to N.D. Ill. Local Patent Rule 2.2 of the Northern District of Illinois, the following Initial Infringement Contentions. Velocity contends that each of the identified claims is infringed by Jaguar Land Rover North America, LLC (“JLR”). The following contentions are based on knowledge and information in Velocity’s possession, custody and control after a reasonable investigation of publicly-available sources and the limited number of documents produced by JLR pursuant to Local Patent Rule 2.1. The accused JLR products implement some of the infringing functionality in whole or in part using circuitry and associated programs, which are neither publicly available nor described in JLR’s production to date. Therefore, Velocity reserves the right to revise, amend and supplement these contentions as discovery progresses and new information becomes available.

VEL00020812

**A. Identification of Infringed Claims and Applicable Statutory Section of 35 U.S.C. § 271**

Claims 1-2, 4-5, 7-8, 10, 12-13, 15, and 17-32 of U.S. Patent No. 5,954,781 are directly infringed under 35 U.S.C § 271(a) by the accused JLR vehicles identified below.

**B. Identification of Accused Instrumentalities By Claim**

As set forth in the accompanying claim chart, Jaguar X150, X250, X351 and F-Type and Land Rover L319, L320, L322, L405, L494 and L538 vehicles that include the identified features, infringe one or more of the claims identified above. On a claim-by-claim basis, the following JLR vehicles are accused of infringement by Velocity:

- Claim 1 – Land Rover’s L405, L494 and L538;
- Claim 2 - Land Rover’s L405, L494 and L538;
- Claim 4 - Land Rover’s L405, L494 and L538;
- Claim 5 - Land Rover’s L405, L494 and L538;
- Claim 7 - Land Rover’s L405, L494 and L538;
- Claim 8 - Land Rover’s L405, L494 and L538;
- Claim 10 - Land Rover’s L405, L494 and L538;
- Claim 12 - Land Rover’s L405, L494 and L538;
- Claim 13 - Land Rover’s L405, L494 and L538;
- Claim 15 - Land Rover’s L405, L494 and L538;
- Claim 17 - Land Rover’s L405, L494 and L538;
- Claim 18 - Land Rover’s L405, L494 and L538;
- Claim 19 - Land Rover’s L405, L494 and L538;
- Claim 20 - Land Rover’s L405, L494 and L538;
- Claim 21 - Land Rover’s L405, L494 and L538;

Claim 22 - Land Rover's L405, L494 and L538;

Claim 23 - Land Rover's L405, L494 and L538;

Claim 24 - Land Rover's L405, L494 and L538;

Claim 25 - Land Rover's L405, L494 and L538;

Claim 26 - Land Rover's L405, L494 and L538;

Claim 27 - Land Rover's L405, L494 and L538;

Claim 28 - Land Rover's L405, L494 and L538;

Claim 29 - Land Rover's L405, L494 and L538;

Claim 30 - Land Rover's L405, L494 and L538;

Claim 31 - Jaguar's X150, X250, X351 and F-Type; Land Rover's L319, L320, L322, L405, L494 and L538;

Claim 32 - Jaguar's X150, X250, X351 and F-Type; Land Rover's L319, L320, L322, L405, L494 and L538.

**C. Claim Chart Comparing Each Element of the Asserted Claims to the Accused Instrumentalities**

Claim charts identifying where each element of each asserted claim is found within each Accused JLR vehicle is attached.

**D. Identification of Whether Each Element of Each Asserted Claim is Present in the Accused Instrumentalities Literally or Under the Doctrine of Equivalents**

Unless specifically noted in the attached claim charts, Velocity asserts that all of the asserted claim elements are literally present in the Accused JLR vehicles.

At this time, sections (e)-(f) of Local Patent Rule 2.2 are not applicable. Velocity expressly reserves the right to revise, amend and supplement these contentions as discovery progresses and new information becomes available.

Dated: March 12, 2014

Respectfully submitted,

*/s/ James A. Shimota*

James A. Shimota

James A. Shimota (IL Bar No. 6270603)  
Howard E. Levin (IL Bar No. 6286712)  
Adam R. Brausa (IL Bar No. 6292447)  
Aaron C. Taggart (IL Bar No. 6302068)  
MAVRAKAKIS LAW GROUP LLP  
180 North LaSalle Street, Suite 2215  
Chicago, Illinois 60601  
Telephone: 312-216-1620  
Facsimile: 312-216-1621  
jshimota@mavllp.com  
hlevin@mavllp.com  
abrausa@mavllp.com  
ataggart@mavllp.com

*Counsel for Plaintiff Velocity Patent LLC*

**PROOF OF SERVICE**

The undersigned hereby certifies that a true and correct copy of the above and foregoing document has been served on March 12, 2014, by electronic mail to:

**LATHAM & WATKINS LLP**

Kristopher R. Davis  
233 South Wacker Dr. Suite 5800  
Chicago, IL 60606  
(312) 876-7653  
Kris.davis@lw.com

Cassius K. Sims  
Clement J. Naples  
885 Third Avenue  
New York, NY 10022  
(212) 906-1794  
(212) 906-1331  
Cassius.sims@lw.com  
Clement.naples@lw.com

Matthew J. Moore  
555 Eleventh Street NW Suite 1000  
Washington, DC 20004-01304  
(202) 637-2278  
Matthew.moore@lw.com

**Served by Electronic Mail**

Attorneys for Defendant  
Jaguar Land Rover North America, LLC

*/s/ James C. Rally*

Project Assistant  
Mavrakakis Law Group LLP

**Velocity Patent LLC Preliminary Infringement Contentions Against Jaguar Land Rover Pursuant to N.D. Ill. LPR 2.1 – Jaguar Vehicles**

<b>Claim 31</b>	<b>Corresponding Element in Jaguar Vehicles<sup>1</sup></b>
31A. Apparatus for optimizing operation of a vehicle, comprising: <sup>2</sup>	<p>The accused Jaguar vehicles<sup>3</sup> include an apparatus for optimizing operation of a vehicle.</p> <p>For example, upon information and belief, the accused Jaguar vehicles include computer-controlled vehicle systems with one or more processors that monitor various vehicle systems and optimize fuel economy, safety and performance of the vehicle. For example, the Jaguar vehicles include an onboard diagnostic system called OBD II that monitors the performance of multiple components of the vehicle.</p>
31B. a radar detector, said radar detector determining a distance separating a vehicle having an engine and an object in front of said vehicle;	<p>The accused Jaguar vehicles include a radar detector that determines a distance separating a vehicle having an engine and another object in front of the accused vehicles.</p> <p>For example, the accused Jaguar vehicles include one or more systems (e.g., Adaptive Cruise Control, Forward Collision Alert, Blind Spot Monitoring, etc.) with radar detectors that determine a distance separating a vehicle having an engine and another object in front of the accused vehicles.</p> <p>31B1. Adaptive Cruise Control (ACC):</p>

<sup>1</sup> Velocity contends that each element of the asserted claims is literally and directly infringed by the accused vehicles. Additionally, where noted below, Velocity alternatively contends that certain elements are infringed under the doctrine of equivalents.

<sup>2</sup> Velocity's citations related to any claim preamble in this claim chart should not be interpreted as an admission that the preamble is limiting.

<sup>3</sup> The accused features and vehicles identified in these preliminary contentions are representative only. Velocity accuses all Jaguar vehicle models for model years 2007 to 2014 that incorporate features that are similar to the accused features identified in these preliminary contentions. The accused Jaguar vehicles identified in these preliminary contentions are representative only, and include the Jaguar X150, X250, X351 and F-Type. Discovery has just begun in this case. Velocity reserves the right to supplement and identify additional infringing models (e.g., 2015 models currently being tested) as it learns facts through discovery.

Claim 31	Corresponding Element in Jaguar Vehicles <sup>1</sup>
	<p>The ACC system uses a radar sensor, which projects a beam directly forward of the vehicle to detect objects ahead.</p> <p>(See, e.g., Ex. 1, 2014 Jaguar X150 Owner's Handbook, at 93; Ex. 2, 2014 Jaguar X250 Owner's Handbook, at 92; Ex. 3, Jaguar X351 Owner's Handbook, at 104.)</p> <p>31B2. Forward Collision Alert (FCA):</p> <p>Limited detection and warning of objects ahead, is provided during ACC operation by the ACC <b>Forward Alert</b> warning. The enhanced forward alert feature additionally provides warnings when ACC is not engaged; if an object is detected close ahead, then the warning tone and message will be issued. The brakes will not be applied.</p> <p>(See, e.g., Ex. 1, 2014 Jaguar X150 Owner's Handbook, at 97; Ex. 2, 2014 Jaguar X250 Owner's Handbook, at 96; Ex. 3, Jaguar X351 Owner's Handbook.)</p> <p>31B3. Blind Spot Monitoring (BSM):</p>



**Claim 31**

**Corresponding Element in Jaguar Vehicles**

The Blind Spot Monitor (BSM) is designed to operate most effectively when driving on multi-lane highways. It uses radar on each side of the vehicle to monitor blind spot areas (1) that are not easily visible to the driver.

(See, e.g., Ex. 2, 2014 Jaguar X250 Owner's Handbook, at 58; Ex. 3, Jaguar X351 Owner's Handbook, at 62; Ex. 4, 2014 Jaguar F-Type Owner's Handbook, at 48.)

31B4. Closing Vehicle Detection (CVD)

**The radar sensors may be impaired by mud, rain, frost, ice, snow or road spray. This may affect the system's ability to reliably detect an approaching vehicle.**

(See, e.g., Ex. 4, 2014 F-Type Owner's Handbook, at 50.)

In the alternative, for each of the above proximity alert systems, the limitation is at least satisfied under the doctrine of equivalents. For example, on information and belief, these systems include detectors that are insubstantially different from the claimed radar detector, that perform substantially the same function (determining a distance separating a vehicle having an engine and another object in the path of the vehicle) in substantially the same way (e.g., using a radar sensor to determine distance) to achieve the same result (identification of an object in the path of a vehicle).

Claim 31	Corresponding Element in Jaguar Vehicles <sup>1</sup>
<p>31C. at least one sensor coupled to said vehicle for monitoring operation thereof, said at least one sensor including a road speed sensor.</p>	<p>The accused Jaguar vehicles include at least one sensor coupled to said vehicle for monitoring operation thereof, said at least one sensor including a road speed sensor.</p> <p>The accused Jaguar vehicles include one or more road speed sensors. For example, certain Jaguar vehicles include an AJ133 engine.</p> <p><b>The ECM uses a torque-based strategy to generate the torque required by driver demand and the other vehicle control modules, using input from various sensors to calculate the required torque. The ECM also interfaces with other vehicle electronic control modules to obtain additional information (road speed from the ABS control module, for example). The ECM processes these signals and determines how much torque to generate, using various actuators to supply air, fuel, and spark to the engine (electronic throttle, injectors, coils, etc.).</b></p> <p>(Ex. 5, AJ133 Technical Introduction, at 3-2.) Upon information and belief, all Jaguar engine similarly include one or more road speed sensors that are inputs to the ABS, ECM, etc.</p> <p>Further, upon information and belief, road speed is an input to the ACC, FCA, BSM and CVD algorithms. Upon information and belief, one or more road speed sensors supply that input.</p>
<p>31D. a processor subsystem, coupled to said radar detector and said at least one sensor, to receive</p>	<p>The accused Jaguar vehicles include a processor subsystem, coupled to said radar detector and said at least one sensor, to receive data therefrom.</p>

Claim 31	Corresponding Element in Jaguar Vehicles'
<p>data therefrom;</p> <p>31E. a memory subsystem, coupled to said processor subsystem, said memory subsystem storing a first vehicle speed/stopping distance table.</p>	<p>Upon information and belief, the ACC, FCA, BSM and CVD features are controlled by the onboard computer that includes one or more processors.</p> <p>(See, e.g., Ex. 1, 2014 Jaguar X150 Owner's Handbook, at 97; Ex. 2, 2014 Jaguar X250 Owner's Handbook, at 96; Ex. 3, Jaguar X351 Owner's Handbook, at 108; Ex. 4, 2014 Jaguar F-Type Owner's Handbook, at 48 &amp; 50.)</p> <p>The accused Jaguar vehicles include a memory subsystem, coupled to said processor subsystem, said memory subsystem storing a first vehicle speed/stopping distance table.</p> <p>31E1. Adaptive Cruise Control (ACC):</p> <p><b>It is the driver's responsibility to select a gap appropriate to the driving conditions.</b></p> <p>4 gap settings are available and the selected gap setting will be displayed in the Message center when the gap adjustment thumbwheel is used.</p> <p>(See, e.g., Ex. 1, 2014 Jaguar X150 Owner's Handbook, at 94; Ex. 2, 2014 Jaguar X250 Owner's Handbook, at 93-94; Ex. 3, Jaguar X351 Owner's Handbook, at 104.)</p> <p>31E2. Forward Collision Alert (FCA):</p>

Claim 31	Corresponding Element in Jaguar Vehicles <sup>1</sup>
<p>The sensitivity of the warning can only be adjusted with ACC disengaged. Adjust as follows:</p> <ul style="list-style-type: none"> <li>• Roll the gap adjustment control downwards to decrease the sensitivity of the alert.</li> <li>• Roll the gap adjustment control upwards to increase the sensitivity of the alert.</li> </ul> <p>(See, e.g., Ex. 1, 2014 Jaguar X150 Owner's Handbook, at 97; Ex. 2, 2014 Jaguar X250 Owner's Handbook, at 96; Ex. 3, Jaguar X351 Owner's Handbook, at 108.)</p> <p>31E3. Blind Spot Monitoring (BSM)</p> <p>Upon information and belief, the memory in the Jaguar vehicles stores a speed/stopping distance table used in association with the Blind Spot Monitoring feature.</p> <p>(See, e.g., Ex. 2, 2014 Jaguar X250 Owner's Handbook, at 58-59; Ex. 3, Jaguar X351 Owner's Handbook, at 62; Ex. 4, 2014 Jaguar F-Type Owner's Handbook, at 48.)</p> <p>31E4. Closing Vehicle Detection (CVD)</p>	

Claim 31	Corresponding Element in Jaguar Vehicles
<p>31F, a vehicle proximity alarm circuit coupled to said processor subsystem, said vehicle proximity alarm circuit issuing an alarm that said vehicle is too close to said object;</p>	<p><b>2.</b> If a vehicle is detected approaching rapidly, an amber warning icon will flash in the relevant exterior mirror to indicate that there is a potential danger.</p> <p>(See, e.g., Ex. 4, 2014 F-Type Owner's Handbook, at 50.)</p>
<p>31F1, a vehicle proximity alarm circuit coupled to said processor subsystem, said vehicle proximity alarm circuit issuing an alarm that said vehicle is too close to said object;</p> <p>31F1. Adaptive Cruise Control (ACC):</p> <p>If ACC predicts that its maximum braking level will not be sufficient, then an audible warning will sound while ACC continues to brake.</p> <p><b>DRIVER INTERVENE</b> will be displayed in the Message center. Take immediate action.</p> <p>(See, e.g., Ex. 1, 2014 Jaguar X150 Owner's Handbook, at 94; Ex. 2, 2014 Jaguar X250 Owner's Handbook, at 93; Ex. 3, Jaguar X351 Owner's Handbook, at 105.)</p> <p>31F2. Forward Collision Alert (FCA):</p>	<p>The accused Jaguar vehicles include a vehicle proximity alarm circuit coupled to said processor subsystem, said vehicle proximity alarm circuit issuing an alarm that said vehicle is too close to said object.</p> <p>31F1. Adaptive Cruise Control (ACC):</p> <p>If ACC predicts that its maximum braking level will not be sufficient, then an audible warning will sound while ACC continues to brake.</p> <p><b>DRIVER INTERVENE</b> will be displayed in the Message center. Take immediate action.</p> <p>(See, e.g., Ex. 1, 2014 Jaguar X150 Owner's Handbook, at 94; Ex. 2, 2014 Jaguar X250 Owner's Handbook, at 93; Ex. 3, Jaguar X351 Owner's Handbook, at 105.)</p> <p>31F2. Forward Collision Alert (FCA):</p>

Claim 31	Corresponding Element in Jaguar Vehicles <sup>1</sup>
	<p>The forward alert system does not initiate any action. The driver must take appropriate action when the <b>Forward Alert</b> message is displayed. However, the system monitors driver actions (e.g. braking, steering or indicating) and may not initiate the warning display if the appropriate action has been taken early enough.</p> <p>(See, e.g., Ex. 1, 2014 Jaguar X150 Owner's Handbook, at 97; Ex. 2, 2014 Jaguar X250 Owner's Handbook, at 96; Ex. 3, Jaguar X351 Owner's Handbook, at 108.)</p> <p>31F3. Blind Spot Monitor (BSM):</p> <p>If an overtaking vehicle/object is identified on either side, an amber warning icon (2) will illuminate in the relevant exterior mirror. This alerts the driver to a potential hazard in the relevant blind spot area and a lane change may be dangerous.</p> <p>(See, e.g., Ex. 2, 2014 Jaguar X250 Owner's Handbook, at 58-59; Ex. 3, Jaguar X351 Owner's Handbook, at 62; Ex. 4, 2014 Jaguar F-Type Owner's Handbook, at 48.)</p>

Claim 31	Corresponding Element in Jaguar Vehicles'
<p>31F4. Closing Vehicle Detection (CVD):</p> <p><b>2. If a vehicle is detected approaching rapidly, an amber warning icon will flash in the relevant exterior mirror to indicate that there is a potential danger.</b></p>	<p>(See, e.g., Ex. 4, 2014 F-Type Owner's Handbook, at 50.)</p> <p>On information and belief, The accused Jaguar vehicles includes a processor subsystem that determines whether to activate the multiple vehicle proximity alarm circuits based upon separation distance data received from said radar detector, vehicle speed data received from said road speed sensor and said first vehicle speed/stopping distance table stored in said memory subsystem.</p> <p>(See, e.g., Ex. 1, 2014 X150 Owner's Handbook, at 93-94 &amp; 97; Ex. 2, 2014 Jaguar X250 Owner's Handbook, at 58-59, 93 &amp; 97; Ex. 3, Jaguar X351 Owner's Handbook, at 62, 104-105 &amp; 108; Ex. 4, 2014 Jaguar F-Type Owner's Handbook, at 48 &amp; 50.)</p>
<p>31G. said processor subsystem determining whether to activate said vehicle proximity alarm circuit based upon separation distance data received from said radar detector, vehicle speed data received from said road speed sensor and said first vehicle speed/stopping distance table stored in said memory subsystem.</p>	

Claim 32	Corresponding Element in Jaguar Vehicles
<p>32A. Apparatus for optimizing operation of a vehicle according to claim 31 wherein:</p>	<p>The accused Jaguar vehicles include an apparatus for optimizing operation of a vehicle according to claim 31.</p> <p><i>See, e.g.,</i> citations for claim 31.</p>
<p>32B. said at least one sensor further includes a windshield wiper sensor for indicating whether a windshield wiper of said vehicle is activated; and</p>	<p>The accused Jaguar vehicles include at least one sensor further including a windshield wiper sensor for indicating whether a windshield wiper of said vehicle is activated.</p> <p>For example, the Jaguar vehicles include rain sensing wipers that automatically activate when moisture is detected. Upon information and belief, the Jaguar vehicles include a windshield wiper sensor that indicates whether the wipers of the Jaguar vehicles have been activated.</p> <p>The Rain sensor is mounted on the inside of the windshield, behind the rear-view mirror. The sensor is able to detect the presence and amount of water on the windshield, and automatically activate the windshield wipers accordingly.</p> <p>(See, e.g., Ex. 1, 2014 X150 Owner's Handbook, at 41-42; Ex. 2, 2014 Jaguar X250 Owner's Handbook, at 56; Ex. 3, Jaguar X351 Owner's Handbook, at 59; Ex. 4, 2014 Jaguar F-Type Owner's Handbook, at 44-45.)</p>



<b>Claim 32</b>	<b>Corresponding Element in Jaguar Vehicles</b>
<p>32C. said memory subsystem further storing a second vehicle speed/stopping distance table.</p>	<p>The accused Jaguar vehicles include a memory subsystem further storing a second vehicle speed/stopping distance table.</p> <p>On information and belief, the accused Land Rover vehicles store a second vehicle speed/stopping distance table.</p> <p><i>See, e.g.,</i> citations for claim element 31E.</p>
<p>32D. if said windshield wiper sensor indicates that said windshield wiper is deactivated, said processor subsystem determining whether to activate said vehicle proximity alarm circuit based upon data received from said radar detector, said road speed sensor and said first vehicle speed/stopping distance table stored in said memory subsystem;</p>	<p>On information and belief, the accused Jaguar vehicles include an apparatus for optimizing operation of a vehicle according to claim 31 wherein if said windshield wiper sensor indicates that said windshield wiper is deactivated, said processor subsystem determining whether to activate said vehicle proximity alarm circuit based upon data received from said radar detector, said road speed sensor and said first vehicle speed/stopping distance table stored in said memory subsystem.</p> <p><i>See, e.g.,</i> citations for claim element 31G.</p>
<p>32E. if said windshield wiper sensor indicates that said windshield wiper is activated, said processor subsystem determining whether to activate said vehicle proximity alarm circuit based upon data received from said radar detector, said road speed sensor and said second vehicle speed/stopping distance table stored in said memory subsystem.</p>	<p>On information and belief, the accused Jaguar vehicles include an apparatus for optimizing operation of a vehicle according to claim 31 wherein if said windshield wiper sensor indicates that said windshield wiper is activated, said processor subsystem determining whether to activate said vehicle proximity alarm circuit based upon data received from said radar detector, said road speed sensor and said second vehicle speed/stopping distance table stored in said memory subsystem.</p> <p><i>See, e.g.,</i> citations for claim element 31G.</p>

**Velocity Patent LLC Preliminary Infringement Contentions Against  
Jaguar Land Rover Defendants Pursuant to N.D. Ill. LPR 2.1 – Land Rover Vehicles**

<b>Claim 1</b>	<b>Corresponding Element in Land Rover Vehicles<sup>1</sup></b>
<p>1A. Apparatus for optimizing operation of a vehicle, comprising:<sup>2</sup></p>	<p>The accused Land Rover vehicles<sup>3</sup> include an apparatus for optimizing operation of a vehicle.</p> <p>For example, upon information and belief, the accused Land Rover vehicles include computer-controlled vehicle systems with one or more computer processors that monitor various vehicle systems and optimize the fuel economy, safety and performance of the vehicle. For example, the Land Rover vehicles includes an onboard diagnostic system called OBD II that monitors the performance of multiple components of the vehicle.</p>
<p>1B. a plurality of sensors coupled to a vehicle having an engine, said plurality of sensors, which collectively monitor operation of said vehicle, including a road speed sensor, an engine speed sensor, a manifold pressure sensor and a throttle position sensor;</p>	<p>The accused Land Rover vehicles include a plurality of sensors coupled to the vehicle having an engine, said plurality of sensors, which collectively monitor operation of said vehicle, including a road speed sensor, an engine speed sensor, a manifold pressure sensor and a throttle position sensor.</p> <p>Upon information and belief, the Land Rover vehicles include an engine. More specifically, upon information and belief, the Land Rover engines are a 4.2L supercharged V8, a 4.4 L V8, a 5.0L V8, 5.0L supercharged V8 (designated “AJ</p>

<sup>1</sup> Velocity contends that each element of the asserted claims is literally and directly infringed by the accused vehicles. Additionally, where noted below, Velocity alternatively contends that certain elements are infringed under the doctrine of equivalents.

<sup>2</sup> Velocity’s citations related to any claim preamble in this claim chart should not be interpreted as an admission that the preamble is limiting.

<sup>3</sup> The accused features and vehicles identified in these preliminary contentions are representative only. Velocity accuses all Land Rover vehicle models for model years 2007 to 2014 that incorporate features that are similar to the accused features identified in these preliminary contentions. The accused Land Rover vehicles identified in these preliminary contentions are representative only, and include the Land Rover L319, L320, L322, L405, L494 and L538. Discovery has just begun in this case. Velocity reserves the right to supplement and identify additional infringing models (e.g., 2015 models currently being tested) as it learns facts through discovery.

Claim 1	Corresponding Element in Land Rover Vehicles
<p>133") and a 2.0L EcoBoost. Further, upon information and belief, all the Land Rover vehicles include a road speed sensor, a manifold pressure sensor, a throttle position sensor and an engine speed sensor.</p> <p>1B1. The accused Land Rover vehicles include one or more road speed sensors:</p> <p style="padding-left: 40px;">The ECM uses a torque-based strategy to generate the torque required by driver demand and the other vehicle control modules, using input from various sensors to calculate the required torque. The ECM also interfaces with other vehicle electronic control modules to obtain additional information (road speed from the ABS control module, for example). The ECM processes these signals and determines how much torque to generate, using various actuators to supply air, fuel, and spark to the engine (electronic throttle, injectors, coils, etc.).</p> <p>(Ex. 1, AJ133 Technical Introduction, at 3-2.)</p> <p>1B2. The accused Land Rover vehicles include one or more engine speed sensors. For example, the Technical Training Manual for the AJ133 states that the Engine Control Module ("ECM") accepts inputs from a crankshaft position sensor that measures engine speed. (See Ex. 1, AJ133 Technical Introduction, at 3-11 &amp; 3-12.)</p> <p>1B3. The accused Land Rover vehicles include one or more manifold pressure sensors. For example, the Technical Training Manual for the AJ133 states that the Engine Control Module ("ECM") accepts inputs from a manifold pressure sensor ("MAP"). (See Ex. 1, AJ133 Technical Introduction, at 3-16.)</p>	

Claim 1	Corresponding Element in Land Rover Vehicles <sup>1</sup>
<p>1C. a processor subsystem, coupled to each one of said plurality of sensors, to receive data therefrom;</p>	<p>1B4. The accused Land Rover vehicles include one or more throttle position sensors. For example, the Technical Training Manual for the AJ133 states that the Engine Control Module ("ECM") accepts inputs from a manifold pressure sensor ("MAP"). (See Ex. 1, AJ133 Technical Introduction, at 3-19.)</p> <p>The accused Land Rover vehicles include a processor subsystem, coupled to each one of said plurality of sensors, to receive data therefrom.</p> <p>(See, e.g., Ex. 1, AJ133 Technical Introduction, at 3-2.)</p>
<p>1D. a memory subsystem, coupled to said processor subsystem, said memory subsystem storing therein a manifold pressure set point, an RPM set point, and present and prior levels for each one of said plurality of sensors;</p>	<p>On information and belief, the accused Land Rover vehicles have a memory subsystem, coupled to said processor subsystem, said memory subsystem storing therein a manifold pressure set point, an RPM set point, and present and prior levels for each one of said plurality of sensors.</p> <p>For example, the accused Land Rover vehicles include one or more memories that form a memory subsystem for storing information relating to vehicle system operations and features described in the vehicle manuals. See, e.g., citations for claim elements 1A-C.</p>
<p>1E. a fuel overinjection notification circuit coupled to said processor subsystem, said fuel overinjection notification circuit issuing a notification that excessive fuel is being supplied to said engine of said vehicle;</p>	<p>The accused Land Rover vehicles include a fuel overinjection notification circuit coupled to said processor subsystem, said fuel overinjection notification circuit issuing a notification that excessive fuel is being supplied to said engine of said vehicle.</p> <p>For example, the accused Land Rover vehicles include one or more fuel overinjection notification circuits coupled to said processor subsystem. More specifically, the Rover includes an Eco Data System that displays the following information:</p>

Claim 1	Corresponding Element in Land Rover Vehicles
<p>IF, an upshift notification circuit coupled to said processor subsystem, said upshift notification circuit issuing a notification that said engine of said vehicle is being operated at an excessive speed,</p>	<ul style="list-style-type: none"> <li>• <b>Impact on fuel:</b> This option displays the impact electrical loads are having on fuel economy.</li> <li>• <b>Driving style:</b> This option displays the impact driving style is having on fuel economy.</li> <li>• <b>Advanced trip:</b> This option displays details on the last 3 trips.</li> <li>• <b>Eco tips:</b> This option displays hints and tips on how to improve fuel economy.</li> </ul> <p>(Ex. 2, 2014 Land Rover L405 Owner's Guide, at 111; Ex. 3, Land Rover L494 Owner's Guide, at 102; Ex. 4, Land Rover L538 Owner's Guide, at 90.)</p>
<p>IF, an upshift notification circuit coupled to said processor subsystem, said upshift notification circuit issuing a notification that said engine of said vehicle is being operated at an excessive speed,</p>	<p>The accused Land Rover vehicles include an upshift notification circuit coupled to said processor subsystem, said upshift notification circuit issuing a notification that said engine of said vehicle is being operated at an excessive speed. Specifically, the Rover includes an gear shift indicator that is active in the manual mode of the automatic transmission, which tells the driver to shift up to a fuel efficient gear.</p> <p style="text-align: center;"><b>GEAR SHIFT (GREEN)</b></p> <div style="text-align: center;">  </div> <p>The gear shift indicator illuminates briefly at the recommended gear change point (upshift).</p> <p>(Ex. 2, 2014 Land Rover L405 Owner's Guide, at 59 &amp; 114; Ex. 3, Land Rover L494 Owner's Guide, at 58 &amp; 104-105; Ex. 4, Land Rover L538 Owner's Guide, at 49 &amp; 92.)</p>

Claim 1	Corresponding Element in Land Rover Vehicles <sup>1</sup>
<p>1G. said processor subsystem determining, based upon data received from said plurality of sensors, when to activate said fuel overinjection circuit and when to activate said upshift notification circuit.</p>	<p>As a further example, the accused Land Rover vehicles include one or more upshift notification circuits coupled to said processor subsystem, upshift notification circuit issuing a notification that said engine of said vehicle is being operated at an excessive speed.</p> <ul style="list-style-type: none"> <li>• Continuous illumination confirms the driver's gear change request has been recognized and selected.</li> <li>• On/off flashing confirms the driver's gear change request has been recognized, but not selected.</li> </ul> <p>(Ex. 3 Land Rover L494 Owner's Guide, at 105.)</p>
<p>1G. said processor subsystem determining, based upon data received from said plurality of sensors, when to activate said fuel overinjection circuit and when to activate said upshift notification circuit.</p>	<p>On information and belief, the accused Land Rover vehicles include a processor subsystem that determines based upon data received from said plurality of sensors, when to activate said fuel overinjection circuit and when to activate said upshift notification circuit.</p> <p>See, e.g., citations for elements 1A-1F.</p>

<b>Claim 2</b>	<b>Corresponding Element in Land Rover Vehicles</b>
2A. Apparatus for optimizing operation of a vehicle according to claim 1 wherein said processor subsystem further comprises:	<p>The accused Land Rover vehicles include an apparatus for optimizing operation of a vehicle according to claim 1 wherein said processor subsystem further comprises:</p> <p><i>See, e.g., citations for claim 1.</i></p>
2B. means for determining when road speed for said vehicle is increasing;	<p>The accused Land Rover vehicles include a means for determining when road speed for said vehicle is increasing.</p> <p><i>See, e.g., citations for claim elements 1B-1D.</i></p> <p>To the extent that 35 U.S.C. §112(6) applies to this claim limitation, the structure(s), act(s), or materials(s) that perform the claimed function of “determining when road speed for said vehicle is increasing” are described in, for example, Figures 1 and 2 and associated text of the '781 patent relating to Road Speed Sensor 18, Memory Subsystem 14, and Processor Subsystem 12.</p>
2C. means for determining when throttle position for said vehicle is increasing; and	<p>The accused Land Rover vehicles include a means for determining when throttle position for said vehicle is increasing.</p> <p><i>See, e.g., citations for claim elements 1B-1D.</i></p> <p>To the extent that 35 U.S.C. §112(6) applies to this claim limitation, the structure(s), act(s), or materials(s) that perform the claimed function of “determining when throttle position for said vehicle is increasing” are described in, for example, Figures 1 and 2 and associated text of the '781 patent relating to Throttle Sensor 24, Memory Subsystem 14, and Processor Subsystem 12.</p>
2D. means for comparing manifold pressure to said manifold pressure set point;	<p>The accused Land Rover vehicles include a means for comparing manifold pressure to said manifold pressure set point.</p> <p><i>See, e.g., citations for claim elements 1B-1D.</i></p>

Claim 2	Corresponding Element in Land Rover Vehicles
<p>2E. said processor subsystem activating said fuel overinjection notification circuit if both road speed and throttle position for said vehicle are increasing and manifold pressure for said vehicle is above said manifold pressure set point.</p>	<p>To the extent that 35 U.S.C. §112(6) applies to this claim limitation, the structure(s), act(s), or materials(s) that perform the claimed function of “comparing manifold pressure to said manifold pressure set point” are described in, for example, Figures 1 and 2 and associated text of the '781 patent relating to Manifold PSI Sensor 22, Memory Subsystem 14, and Processor Subsystem 12.</p> <p>On information and belief, the accused Land Rover vehicles include a processor subsystem that activates said fuel overinjection notification circuit if both road speed and throttle position for said vehicle are increasing and manifold pressure for said vehicle is above said manifold pressure set point.</p> <p><i>See, e.g.,</i> citations for claim elements 1E, 1G.</p>



Claim 4	Corresponding Element in Land Rover Vehicles
4A. Apparatus for optimizing operation of a vehicle according to claim 1 wherein said processor subsystem further comprises:	The accused Land Rover vehicles include an apparatus for optimizing operation of a vehicle according to claim 1 wherein said processor subsystem further comprises:  <i>See, e.g.,</i> citations for claim 1.
4B. means for determining when road speed for said vehicle is decreasing;	The accused Land Rover vehicles include a means for determining when road speed for said vehicle is decreasing.  <i>See, e.g.,</i> citations for claim element 2B.  To the extent that 35 U.S.C. §112(6) applies to this claim limitation, the structure(s), act(s), or materials(s) that perform the claimed function of “determining when road speed for said vehicle is decreasing” are described in, for example, Figures 1 and 2 and associated text of the '781 patent relating to Road Speed Sensor 18, Memory Subsystem 14, and Processor Subsystem 12.
4C. means for determining when throttle position for said vehicle is increasing; and	The accused Land Rover vehicles include a means for determining when throttle position for said vehicle is increasing.  <i>See, e.g.,</i> citations for claim element 2C.
4D. means for determining when manifold pressure for said vehicle is increasing; and	The accused Land Rover vehicles include a means for determining when manifold pressure for said vehicle is increasing.  <i>See, e.g.,</i> citations for claim elements 1B-1D.  To the extent that 35 U.S.C. §112(6) applies to this claim limitation, the structure(s), act(s), or materials(s) that perform the claimed function of

Claim 4	Corresponding Element in Land Rover Vehicles
4E. means for determining when engine speed for said vehicle is decreasing;	<p>“determining when manifold pressure for said vehicle is increasing” are described in, for example, Figures 1 and 2 and associated text of the '781 patent relating to Manifold PSI Sensor 22, Memory Subsystem 14, and Processor Subsystem 12.</p> <p>The accused Land Rover vehicles include a means for determining when engine speed for said vehicle is decreasing.</p> <p><i>See, e.g.</i>, citations for claim elements 1B-1D.</p> <p>To the extent that 35 U.S.C. §112(6) applies to this claim limitation, the structure(s), act(s), or materials(s) that perform the claimed function of “determining when engine speed for said vehicle is decreasing” are described in, for example, Figures 1 and 2 and associated text of the '781 patent relating to RPM Sensor 20, Memory Subsystem 14, and Processor Subsystem 12.</p>
4F. said processor subsystem activating said fuel overinjection notification circuit if both throttle position and manifold pressure for said vehicle are increasing and road speed and engine speed for said vehicle are decreasing.	<p>On information and belief, the accused Land Rover vehicles include a processor subsystem that activates said fuel overinjection notification circuit if both throttle position and manifold pressure for said vehicle are increasing and road speed and engine speed for said vehicle are decreasing.</p> <p><i>See, e.g.</i>, citations for claim elements 1E, 1G.</p>

<b>Claim 5</b>	<b>Corresponding Element in Land Rover Vehicles</b>
5A. Apparatus for optimizing operation of a vehicle according to claim 1 wherein said processor subsystem further comprises:	The accused Land Rover vehicles include an apparatus for optimizing operation of a vehicle according to claim 1 wherein said processor subsystem further comprises:  <i>See, e.g.,</i> citations for claim 1.
5B. means for determining when road speed for said vehicle is increasing;	The accused Land Rover vehicles include a means for determining when road speed for said vehicle is increasing.  <i>See, e.g.,</i> citations for claim element 2B.
5C. means for determining when throttle position for said vehicle is increasing; and	The accused Land Rover vehicles include a means for determining when throttle position for said vehicle is increasing.  <i>See, e.g.,</i> citations for claim element 2C.
5D. means for comparing manifold pressure to said manifold pressure set point;	The accused Land Rover vehicles include a means for comparing manifold pressure to said manifold pressure set point.  <i>See, e.g.,</i> citations for claim element 2D.
5E. means for comparing engine speed to said RPM set point;	The accused Land Rover vehicles include a means for comparing engine speed to said RPM set point.  <i>See, e.g.,</i> citations for claim elements 1B-1D.
5F. said processor subsystem activating said upshift notification circuit if both	To the extent that 35 U.S.C. §112(g) applies to this claim limitation, the structure(s), act(s), or material(s) that perform the claimed function of “determining when engine speed for said vehicle is decreasing” are described in, for example, Figures 1 and 2 and associated text of the ‘781 patent relating to RPM Sensor 20, Memory Subsystem 14, and Processor Subsystem 12. On information and belief, the accused Land Rover vehicles include a processor subsystem that activates said upshift notification circuit if both road speed and

<p><b>Claim 5</b>  road speed and throttle position for said vehicle are increasing, manifold pressure for said vehicle is at or below said manifold pressure set point and engine speed for said vehicle is at or above said RPM set point.</p>	<p><b>Corresponding Element in Land Rover Vehicles</b>  throttle position for said vehicle are increasing, manifold pressure for said vehicle is at or below said manifold pressure set point and engine speed for said vehicle is at or above said RPM set point.   <i>See, e.g., citations for claim elements 1F, 1G.</i></p>
--	---

<b>Claim 7</b>	<b>Corresponding Element in Land Rover Vehicles</b>
7A. Apparatus for optimizing operation of a vehicle, comprising:	The accused Land Rover vehicles include an apparatus for optimizing operation of a vehicle.  <i>See, e.g.,</i> citations for claim 1.
7B. a plurality of sensors coupled to a vehicle having an engine, said plurality of sensors, which collectively monitor operation of said vehicle, including a road speed sensor, a manifold pressure sensor and a throttle position sensor;	The accused Land Rover vehicles include a plurality of sensors coupled to a vehicle having an engine, said plurality of sensors, which collectively monitor operation of said vehicle, including a road speed sensor, a manifold pressure sensor and a throttle position sensor;  <i>See, e.g.,</i> citations for claim element 1B.
7C. a processor subsystem, coupled to each one of said plurality of sensors, to receive data therefrom;	The accused Land Rover vehicles include a processor subsystem, coupled to each one of said plurality of sensors, to receive data therefrom.  <i>See, e.g.,</i> citations for claim element 1C.
7D. a memory subsystem, coupled to said processor subsystem, said memory subsystem storing therein a manifold pressure set point and present and prior levels for each one of said plurality of sensors;	The accused Land Rover vehicles include a memory subsystem, coupled to said processor subsystem, said memory subsystem storing therein a manifold pressure set point and present and prior levels for each one of said plurality of sensors;  <i>See, e.g.,</i> citations for claim element 1D.
7E. a fuel overinjection notification circuit coupled to said processor subsystem, said fuel overinjection notification circuit issuing a notification that excessive fuel is being supplied to said engine of said vehicle;	The accused Land Rover vehicles include a fuel overinjection notification circuit coupled to said processor subsystem, said fuel overinjection notification circuit issuing a notification that excessive fuel is being supplied to said engine of said vehicle;  <i>See, e.g.,</i> citations for claim element 1E.
7F. a downshift notification circuit	The accused Land Rover vehicles include a downshift notification circuit coupled

<p><b>Claim 7</b></p>	<p><b>Corresponding Element in Land Rover Vehicles</b></p>
<p>coupled to said processor subsystem, said downshift notification circuit issuing a notification that said engine of said vehicle is being operated at an insufficient engine speed; and</p>	<p>to said processor subsystem, said downshift-notification circuit issuing a notification that said engine of said vehicle is being operated at an insufficient engine speed. For example, the accused Land Rover vehicles include one or more downshift notification circuits coupled to said processor subsystem, said vehicle is being operated at an insufficient speed.</p> <ul style="list-style-type: none"> <li>• Continuous illumination confirms the driver's gear change request has been recognized and selected.</li> <li>• On/off flashing confirms the driver's gear change request has been recognized, but not selected.</li> </ul>
<p>7G. said processor subsystem determining, based upon data received from said plurality of sensors, when to activate said fuel overinjection circuit and when to activate said downshift notification circuit.</p>	<p>(Ex. 3, Land Rover L494 Owner's Guide, at 105.)</p> <p>On information and belief, the accused Land Rover vehicles include a processor subsystem that determines, based upon data received from said plurality of sensors, when to activate said fuel overinjection circuit and when to activate said downshift notification circuit.</p> <p>See, e.g., citations for elements 1G, 7F</p>

<b>Claim 8</b>	<b>Corresponding Element in Land Rover Vehicles</b>
8A. Apparatus for optimizing operation of a vehicle according to claim 7 wherein said processor subsystem further comprises:	The accused Land Rover vehicles include an apparatus for optimizing operation of a vehicle according to claim 7 wherein said processor subsystem further comprises:  <i>See, e.g., citations for claim 1.</i>
8B. means for determining when road speed for said vehicle is increasing;	The accused Land Rover vehicles include a means for determining when road speed for said vehicle is increasing.  <i>See, e.g., citations for claim element 2B.</i>
8C. means for determining when throttle position for said vehicle is increasing; and	The accused Land Rover vehicles include a means for determining when throttle position for said vehicle is increasing.  <i>See, e.g., citations for claim element 2C.</i>
8D. means for comparing manifold pressure to said manifold pressure set point;	The accused Land Rover vehicles include a means for comparing manifold pressure to said manifold pressure set point.  <i>See, e.g., citations for claim element 2D.</i>
8E. said processor subsystem activating said fuel overinjection notification circuit if both road speed and throttle position for said vehicle are increasing and manifold pressure for said vehicle is above said manifold pressure set point.	On information and belief, the accused Land Rover vehicles include a processor subsystem that activates said fuel overinjection notification circuit if both road speed and throttle position for said vehicle are increasing and manifold pressure for said vehicle is above said manifold pressure set point.  <i>See, e.g., citations for claim element 2E.</i>

Claim 10	Corresponding Element in Land Rover Vehicles
10A. Apparatus for optimizing operation of a vehicle according to claim 7 wherein said processor subsystem further comprises:	The accused Land Rover vehicles include an apparatus for optimizing operation of a vehicle according to claim 7 wherein said processor subsystem further comprises:  <i>See, e.g.,</i> citations for claim element 1.
10B. means for determining when road speed for said vehicle is decreasing;	The accused Land Rover vehicles include a means for determining when road speed for said vehicle is decreasing.
10C. means for determining when throttle position for said vehicle is increasing; and	<i>See, e.g.,</i> citations for claim element 4B. The accused Land Rover vehicles include a means for determining when throttle position for said vehicle is increasing.
10D. means for determining when manifold pressure for said vehicle is increasing; and	<i>See, e.g.,</i> citations for claim element 2C. The accused Land Rover vehicles include a means for determining when manifold pressure for said vehicle is increasing.
10E. means for determining when engine speed for said vehicle is decreasing;	<i>See, e.g.,</i> citations for claim element 4D. The accused Land Rover vehicles include a means for determining when engine speed for said vehicle is decreasing.
10F. said processor subsystem activating said downshift notification circuit if both road speed and engine speed are decreasing and both throttle position and manifold pressure for said vehicle are increasing.	<i>See, e.g.,</i> citations for claim element 4E. On information and belief, the accused Land Rover vehicles include a processor subsystem that activates said downshift notification circuit if both road speed and engine speed are decreasing and both throttle position and manifold pressure for said vehicle are increasing.  <i>See, e.g.,</i> citations for claim elements 1G, 7F.



Claim 12	Corresponding Element in Land Rover Vehicles
12A. Apparatus for optimizing operation of a vehicle according to claim 7 wherein said processor subsystem further comprises:	The accused Land Rover vehicles include an apparatus for optimizing operation of a vehicle according to claim 7 wherein said processor subsystem further comprises:  <i>See, e.g.,</i> citations for claim 1.
12B. means for determining when road speed for said vehicle is decreasing;	The accused Land Rover vehicles include a means for determining when road speed for said vehicle is decreasing.  <i>See, e.g.,</i> citations for claim element 4B.
12C. means for determining when throttle position for said vehicle is increasing; and	The accused Land Rover vehicles include a means for determining when throttle position for said vehicle is increasing.  <i>See, e.g.,</i> citations for claim element 2C.
12D. means for determining when manifold pressure for said vehicle is increasing; and	The accused Land Rover vehicles include a means for determining when manifold pressure for said vehicle is increasing.  <i>See, e.g.,</i> citations for claim element 4D.
12E. means for determining when engine speed for said vehicle is decreasing;	The accused Land Rover vehicles include a means for determining when engine speed for said vehicle is decreasing.  <i>See, e.g.,</i> citations for claim element 4E.
12F. said processor subsystem activating said fuel overinjection notification circuit if both throttle position and manifold pressure for said vehicle are increasing and road speed and engine speed for said vehicle are decreasing.	On information and belief, the accused Land Rover vehicles include a processor subsystem that activates said fuel overinjection notification circuit if both throttle position and manifold pressure for said vehicle are increasing and road speed and engine speed for said vehicle are decreasing.  <i>See, e.g.,</i> citations for claim elements 1E, 1G.

Claim 13	Corresponding Element in Land Rover Vehicles
13A. Apparatus for optimizing operation of a vehicle, comprising:	The accused Land Rover vehicles include an apparatus for optimizing operation of a vehicle.
13B. a plurality of sensors coupled to a vehicle having an engine, said plurality of sensors, which collectively monitor operation of said vehicle, including a road speed sensor, an engine speed sensor, a manifold pressure sensor and a throttle position sensor	<i>See, e.g., citations for claim 1.</i> The accused Land Rover vehicles include a plurality of sensors coupled to the vehicle having an engine, said plurality of sensors, which collectively monitor operation of said vehicle, including a road speed sensor, an engine speed sensor, a manifold pressure sensor and a throttle position sensor <i>See, e.g., citations for claim element 1B.</i>
13C. a processor subsystem, coupled to each one of said plurality of sensors, to receive data therefrom;	The accused Land Rover vehicles include a processor subsystem, coupled to each one of said plurality of sensors, to receive data therefrom.
13D. a memory subsystem, coupled to said processor subsystem, said memory subsystem storing therein a manifold pressure set point, an engine speed set point, and present and prior levels for each one of said plurality of sensors;	<i>See, e.g., citations for claim element 1C.</i> The accused Land Rover vehicles have a memory subsystem, coupled to said processor subsystem, said memory subsystem storing therein a manifold pressure set point, an engine speed set point, and present and prior levels for each one of said plurality of sensors.
13E. a fuel overinjection notification circuit coupled to said processor subsystem, said fuel overinjection notification circuit issuing a notification that excessive fuel is being supplied to said engine of said vehicle;	<i>See, e.g., citations for claim element 1D.</i> The accused Land Rover vehicles include a fuel overinjection notification circuit coupled to said processor subsystem, said fuel overinjection notification circuit issuing a notification that excessive fuel is being supplied to said engine of said vehicle.
13F. an upshift notification circuit coupled to said processor subsystem,	<i>See, e.g., citations for claim element 1E.</i> The accused Land Rover vehicles include an upshift notification circuit coupled to said processor subsystem, said upshift notification circuit issuing a notification

<b>Claim 13</b>	<b>Corresponding Element in Land Rover Vehicles</b>
<p>said upshift notification circuit issuing a notification that said engine of said vehicle is being operated at an excessive speed;</p>	<p>that said engine of said vehicle is being operated at an excessive speed. <i>See, e.g.,</i> citations for claim element 1F.</p>
<p>13G. a downshift notification circuit coupled to said processor subsystem, said downshift notification circuit issuing a notification that said engine of said vehicle is being operated at an insufficient engine speed; and</p>	<p>The accused Land Rover vehicles include a downshift notification circuit coupled to said processor subsystem, said downshift notification circuit issuing a notification that said engine of said vehicle is being operated at an insufficient engine speed; and <i>See, e.g.,</i> citations for claim element 7F.</p>
<p>13H. said processor subsystem determining, based upon data received from said plurality of sensors, when to activate said fuel overinjection circuit, said upshift notification circuit and said downshift notification circuit.</p>	<p>The accused Land Rover vehicles include a processor subsystem that determines based upon data received from said plurality of sensors, when to activate said fuel overinjection circuit, said upshift notification circuit and said downshift notification circuit. <i>See, e.g.,</i> citations for claim element 1G.</p>

<b>Claim 15</b>	<b>Corresponding Element in Land Rover Vehicles</b>
15A. Apparatus for optimizing operation of a vehicle according to claim 13 wherein said processor subsystem further comprises:	The accused Land Rover vehicles include an apparatus for optimizing operation of a vehicle according to claim 13 wherein said processor subsystem further comprises:  <i>See, e.g., citations for claim 1.</i>
15B. means for determining when road speed for said vehicle is increasing or decreasing;	The accused Land Rover vehicles include a means for determining when road speed for said vehicle is increasing or decreasing.  <i>See, e.g., citations for claim element 2B.</i>  To the extent that 35 U.S.C. §112(6) applies to this claim limitation, the structure(s), act(s), or materials(s) that perform the claimed function of “determining when road speed for said vehicle is increasing or decreasing” are described in, for example, Figures 1 and 2 and associated text of the ‘781 patent relating to Road Speed Sensor 18, Memory Subsystem 14, and Processor Subsystem 12.
15C. means for determining when throttle position for said vehicle is increasing;	The accused Land Rover vehicles include a means for determining when throttle position for said vehicle is increasing.  <i>See, e.g., citations for claim element 2C.</i>
15D. means for comparing manifold pressure to said manifold pressure set point;	The accused Land Rover vehicles include a means for comparing manifold pressure to said manifold pressure set point.  <i>See, e.g., citations for claim element 2D.</i>
15E. means for comparing engine speed to said RPM set point;	The accused Land Rover vehicles include a means for comparing engine speed to said RPM set point.  <i>See, e.g., citations for claim element 5E.</i>
15F. means for determining when	The accused Land Rover vehicles include a means for determining when

<b>Claim 15</b>	<b>Corresponding Element in Land Rover Vehicles</b>
manifold pressure is increasing;	manifold pressure is increasing.
15G. means for determining when engine speed is increasing or decreasing;	<p><i>See, e.g.</i>, citations for claim element 4D.</p> <p>The accused Land Rover vehicles include a means for determining when engine speed is increasing or decreasing.</p> <p><i>See, e.g.</i>, citations for claim element 4E.</p> <p>To the extent that 35 U.S.C. §112(6) applies to this claim limitation, the structure(s), act(s), or materials(s) that perform the claimed function of “determining when engine speed for said vehicle is increasing or decreasing” are described in, for example, Figures 1 and 2 and associated text of the ’781 patent relating to RPM Sensor 20, Memory Subsystem 14, and Processor Subsystem 12.</p>
15H. said processor subsystem activating said fuel overinjection notification circuit if both road speed and throttle position for said vehicle are increasing and manifold pressure for said vehicle is above said manifold pressure set or if both throttle position and manifold pressure for said vehicle are increasing and road speed and engine speed for said vehicle are decreasing;	<p>On information and belief, the accused Land Rover vehicles include a processor subsystem that activates said fuel overinjection notification circuit if both road speed and throttle position for said vehicle are increasing and manifold pressure for said vehicle is above said manifold pressure set or if both throttle position and manifold pressure for said vehicle are increasing and road speed and engine speed for said vehicle are decreasing.</p> <p><i>See, e.g.</i>, citations for claim elements 1E, 1G.</p>
15I. said processor subsystem activating said upshift notification circuit if both road speed and throttle position for said vehicle are increasing, manifold pressure for said vehicle is at or below said manifold pressure set point and engine speed for said vehicle is at or below said manifold pressure set point and engine manifold pressure set point and engine	<p>On information and belief, the accused Land Rover vehicles include a processor subsystem that activates said upshift notification circuit if both road speed and throttle position for said vehicle are increasing, manifold pressure for said vehicle is at or below said manifold pressure set point and engine speed for said vehicle is at or above said RPM set point.</p>

Claim 15	Corresponding Element in Land Rover Vehicles
speed for said vehicle is at or above said RPM set point; and	<i>See, e.g.,</i> citations for claim elements 1F, 1G.
15J. said processor subsystem activating said downshift notification circuit if both road speed and engine speed are decreasing and both throttle position and manifold pressure for said vehicle are increasing.	On information and belief, the accused Land Rover vehicles include a processor subsystem that activates said downshift notification circuit if both road speed and engine speed are decreasing and both throttle position and manifold pressure for said vehicle are increasing.  <i>See, e.g.,</i> citations for claim element 10F.

<b>Claim 17</b>	<b>Corresponding Element in Land Rover Vehicles</b>
17A. Apparatus for optimizing operation of a vehicle, comprising:	<p>The accused Land Rover vehicles include an apparatus for optimizing operation of a vehicle.</p> <p><i>See, e.g.,</i> citations for claim 1.</p>
17B. a radar detector, said radar detector determining a distance separating a vehicle having an engine and an object in front of said vehicle;	<p>The accused Land Rover vehicles include a radar detector that determines a distance separating a vehicle having an engine and another object in front of the accused vehicles.</p> <p>For example, the accused Land Rover vehicles include one or more systems (<i>e.g.</i>, Adaptive Cruise Control, Forward Collision Alert, Blind Spot Monitoring, Closing Vehicle Detection, Reverse Traffic Detection, etc.) with radar detectors that determine a distance separating a vehicle having an engine and another object in front of the accused vehicles.</p>
	<p>17B1. Adaptive Cruise Control (ACC):</p> <p>The ACC system uses a radar sensor, which projects a beam directly forward of the vehicle to detect objects ahead.</p> <p>(<i>See, e.g.,</i> Ex. 2, 2014 Land Rover L405 Owner's Guide, at 139; Ex. 3, Land Rover L494 Owner's Guide, at 127; Ex. 4, Land Rover L538 Owner's Guide, at 110.)</p> <p>17B2. Forward Collision Alert (FCA):</p> <p>Upon information and belief, the FCA feature uses the same radar sensor used by the ACC system.</p>

**Claim 17**

**Corresponding Element in Land Rover Vehicles**

(See, e.g., Ex. 2, 2014 Land Rover L405 Owner's Guide, at 143; Ex. 3, Land Rover L494 Owner's Guide, at 131-132; Ex. 4, Land Rover L538 Owner's Guide, at 115.)

17B3. Blind Spot Monitoring (BSM):

**The BSM uses radar sensors which may be impaired by rain, snow or road spray. This may affect the system's ability to reliably detect a road user within the blind spot.**

(See, e.g., Ex. 2, 2014 Land Rover L405 Owner's Guide, at 71-72; Ex. 3, Land Rover L494 Owner's Guide, at 70-71; Ex. 4, Land Rover L538 Owner's Guide, at 62-63.)

17B4. Closing Vehicle Detection (CSD):

The radar monitors the area extending from the exterior mirror rearwards, to approximately 230 ft (70 meters) behind the rear wheels, and up to 8 ft (2.5 meters) from the side of the vehicle.

(See, e.g., Ex. 2, 2014 Land Rover L405 Owner's Guide, at 73; Ex. 3, Land Rover L494 Owner's Guide, at 72; Ex. 4, Land Rover L538 Owner's Guide, at 64.)



Claim 17	Corresponding Element in Land Rover Vehicles
	<p>17B5. Reverse Traffic Detection.</p> <p>If a fault with a radar sensor is detected, an amber warning indicator dot will illuminate in the exterior mirrors and the message <b>Reverse Traffic Detection System Not Available</b> is displayed in the Message center.</p> <p>(See, e.g., Ex. 2, 2014 Land Rover L405 Owner's Guide, at 130; Ex. 3, Land Rover L494 Owner's Guide, at 119; Ex. 4, Land Rover L538 Owner's Guide, at 104.)</p> <p>In the alternative, for each of the above proximity alert systems, the limitation is at least satisfied under the doctrine of equivalents. For example, on information and belief, these systems include detectors that are substantially different from the claimed radar detector, that perform substantially the same function (determining a distance separating a vehicle having an engine and another object in the path of the vehicle) in substantially the same way (e.g., using a radar sensor to determine distance) to achieve the same result (identification of an object in the path of a vehicle).</p>
<p>17C. at least one sensor coupled to said vehicle for monitoring operation thereof, said at least one sensor including a road speed sensor, a manifold pressure sensor, a throttle position sensor and an engine speed sensor;</p>	<p>The accused Land Rover vehicles include at least one sensor coupled to said vehicle for monitoring operation thereof, said at least one sensor including a road speed sensor, a manifold pressure sensor, a throttle position sensor and an engine speed sensor.</p> <p>See, e.g., citations for claim element 1B.</p>
<p>17D. a processor subsystem, coupled</p>	<p>The accused Land Rover vehicles include a processor subsystem, coupled to said</p>

Claim 17	Corresponding Element in Land Rover Vehicles
<p>to said radar detector and said at least one sensor, to receive data therefrom;</p> <p>17E, a memory subsystem, coupled to said processor subsystem, said memory subsystem storing a first vehicle speed/stopping distance table, a manifold pressure set point, an RPM set point, a present level for each one of said at least one sensor and a prior level for each one of said at least one sensor;</p>	<p>radar detector and said at least one sensor, to receive data therefrom.</p> <p><i>See, e.g.,</i> citations for claim element 1C.</p> <p>The accused Land Rover vehicles include a memory subsystem, coupled to said processor subsystem, said memory subsystem storing a first vehicle speed/stopping distance table, a manifold pressure set point, an RPM set point, a present level for each one of said at least one sensor and a prior level for each one of said at least one sensor.</p> <p><i>See, e.g.,</i> citations for claim elements 1A-ID.</p> <p>For example, on information and belief, the accused Land Rover vehicles include one or more systems (e.g., Adaptive Cruise Control, Forward Collision Alert, Blind Spot Monitoring, Closing Vehicle Detection, Reverse Traffic Detection, anti-lock braking, etc.) that use one or more vehicle speed/stopping distance tables stored in one or more memories.</p>
	<p>17E1, Adaptive Cruise Control (ACC):</p> <p>4 gap settings are available. The selected gap setting is displayed on the Message center when the gap adjustment buttons are operated.</p> <p>If a vehicle ahead enters the same lane or a slower vehicle is ahead in the same lane, your vehicle speed will be adjusted automatically until the gap to the vehicle ahead corresponds to the gap setting. The vehicle is now in <b>follow mode</b>.</p>

Claim 17	Corresponding Element in Land Rover Vehicles
	<p>(See, e.g., Ex. 2, 2014 Land Rover L405 Owner's Guide, at 140; Ex. 3, Land Rover L494 Owner's Guide, at 128; Ex. 4, Land Rover L538 Owner's Guide, at 110-11.)</p> <p>17E2. Forward Collision Alert (FCA).</p> <p>Forward alert provides limited detection and warning of objects close ahead while the vehicle is moving forwards. See <b>59, FORWARD ALERT (GREEN)</b>. If a vehicle or object ahead is within the user defined sensitivity area, a warning tone will sound and the <b>FORWARD ALERT</b> message will be displayed in the Message center.</p>

**Claim 17**

**Corresponding Element in Land Rover Vehicles**

Sensitivity of the function can be adjusted only when ACC is disengaged. Adjust as follows:

- Using the steering wheel ACC buttons, press the gap decrease button to display the current setting in the Message center and then press again to decrease the sensitivity of the alert.

(See, e.g., Ex. 2, 2014 Land Rover L405 Owner's Guide, at 143; Ex. 3, Land Rover L494 Owner's Guide, at 131; Ex. 4, Land Rover L538 Owner's Guide, at 115.)

17E3. Blind Spot Monitoring (BSM):

(See, e.g., Ex. 2, 2014 Land Rover L405 Owner's Guide, at 71-72; Ex. 3, Land Rover L494 Owner's Guide, at 70-71; Ex. 4, Land Rover L538 Owner's Guide, at 62-63.)

Claim 17	Corresponding Element in Land Rover Vehicles
	<p>17E4. Closing Vehicle Detection (CVD):</p> <p>In addition to the functionality provided by the BSM, the closing vehicle detection system monitors a larger area behind the vehicle (1). If a vehicle is identified by the system as being a rapidly approaching vehicle (2), the amber warning icon will repeatedly illuminate in the relevant mirror to indicate that there is a potential hazard and therefore, that a lane change might be dangerous. When the vehicle reaches the area monitored by the BSM (3), the amber warning icon will illuminate continuously.</p> <p>(See, e.g., Ex. 2, 2014 Land Rover L405 Owner's Guide, at 73; Ex. 3, Land Rover L494 Owner's Guide, at 72; Ex. 4, Land Rover L538 Owner's Guide, at 64.)</p> <p>17E5. Reverse Traffic Detection:</p> <p>In addition to the functionality provided by the rear view camera, the RTD system provides a warning to the driver of any moving vehicle, at either side, that may pose an accident risk during a reversing maneuver.</p> <p>(See, e.g., Ex. 2, 2014 Land Rover L405 Owner's Guide, at 130; Ex. 3, Land Rover</p>

Claim 17	Corresponding Element in Land Rover Vehicles
<p>17F. a vehicle proximity alarm circuit coupled to said processor subsystem, said vehicle proximity alarm circuit issuing an alarm that said vehicle is too close to an object;</p>	<p>L494 Owner's Guide, at 119; Ex. 4, Land Rover L538 Owner's Guide, at 104.)</p> <p>On information and belief, additional vehicle systems, including but not limited to electronic brake control systems (e.g., ABS, TCS, BAS, ESC, etc.) and speed control systems (e.g., electronic speed control (ESC) systems) included in the accused Land Rover vehicles, and safety and performance testing systems use vehicle speed/stopping distance tables stored in memory.</p> <p>The accused Land Rover vehicles include a vehicle proximity alarm circuit coupled to said processor subsystem, said vehicle proximity alarm circuit issuing an alarm that said vehicle is too close to an object.</p> <p>For example, the accused Land Rover vehicles include one or more systems (e.g., Adaptive Cruise Control, Forward Collision Alert, Blind Spot Monitoring, Closing Vehicle Detection, Reverse Traffic Detection, etc.) that include circuits that issue an alarm to indicate that the vehicle is too close to an object.</p> <p>17F1. Adaptive Cruise Control(ACC):</p> <p>If the ACC system predicts that its maximum braking level will not be sufficient, then an audible warning will sound while the ACC continues to brake. <b>DRIVER INTERVENE</b> will be displayed in the Message center. Take immediate action.</p> <p>(See, e.g., Ex. 2, 2014 Land Rover L405 Owner's Guide, at 140; Ex. 3, Land Rover L494 Owner's Guide, at 128; Ex. 4, Land Rover L538 Owner's Guide, at 110-11.)</p>

Claim 17	Corresponding Element in Land Rover Vehicles
	<p>17E2. Forward Collision Alert (FCA):</p> <p>Forward alert provides limited detection and warning of objects close ahead while the vehicle is moving forwards. See <b>59, FORWARD ALERT (GREEN)</b>. If a vehicle or object ahead is within the user defined sensitivity area, a warning tone will sound and the <b>FORWARD ALERT</b> message will be displayed in the Message center.</p> <p>(See, e.g., Ex. 2, 2014 Land Rover L405 Owner's Guide, at 143; Ex. 3, Land Rover L494 Owner's Guide, at 131; Ex. 4, Land Rover L538 Owner's Guide, at 115.)</p>
	<p>17F3. Blind Spot Monitoring (BSM):</p> <p>If an object is identified by the system as being an overtaking vehicle/object, an amber warning icon (1) illuminates in the relevant exterior mirror, to alert the driver that there is a potential hazard in the vehicle's blind spot and therefore, that a lane change might be dangerous.</p> <p>(See, e.g., Ex. 2, 2014 Land Rover L405 Owner's Guide, at 71-72; Ex. 3, Land Rover L494 Owner's Guide, at 70-71; Ex. 4, Land Rover L538 Owner's Guide, at 62-63.)</p>

Claim 17	Corresponding Element in Land Rover Vehicles
	<p>17F4. Closing Vehicle Detection (CVD):</p> <p>In addition to the functionality provided by the BSM, the closing vehicle detection system monitors a larger area behind the vehicle (1). If a vehicle is identified by the system as being a rapidly approaching vehicle (2), the amber warning icon will repeatedly illuminate in the relevant mirror to indicate that there is a potential hazard and therefore, that a lane change might be dangerous. When the vehicle reaches the area monitored by the BSM (3), the amber warning icon will illuminate continuously.</p> <p>(See, e.g., Ex. 2, 2014 Land Rover L405 Owner's Guide, at 73; Ex. 3, Land Rover L494 Owner's Guide, at 72; Ex. 4, Land Rover L538 Owner's Guide, at 64.)</p> <p>17F5. Reverse Traffic Detection (RTD):</p> <p>In addition to the functionality provided by the rear view camera, the RTD system provides a warning to the driver of any moving vehicle, at either side, that may pose an accident risk during a reversing maneuver.</p>



Claim 17	Corresponding Element in Land Rover Vehicles
<p>17G. a fuel overinjection circuit coupled to said processor subsystem, said fuel overinjection circuit issuing a notification that excessive fuel is being supplied to said engine of said vehicle;</p> <p>17H. an upshift notification circuit coupled to said processor subsystem, said upshift notification circuit issuing a notification that said engine of said vehicle is being operated at an excessive speed;</p> <p>17I. said processor subsystem determining, based upon data received from said radar detector, said at least one sensor and said memory subsystem, when to activate said vehicle proximity alarm circuit, when to activate said fuel overinjection circuit, and when to activate said upshift notification circuit.</p>	<p>(<i>See, e.g., Ex. 2, 2014 Land Rover L405 Owner's Guide, at 130; Ex. 3, Land Rover L494 Owner's Guide, at 119; Ex. 4, Land Rover L538 Owner's Guide, at 104.</i>)</p> <p>The accused Land Rover vehicles include a fuel overinjection circuit coupled to said processor subsystem, said fuel overinjection circuit issuing a notification that excessive fuel is being supplied to said engine of said vehicle.</p> <p><i>See, e.g., citations for claim element 1E.</i></p> <p>The accused Land Rover vehicles include an upshift notification circuit coupled to said processor subsystem, said upshift notification circuit issuing a notification that said engine of said vehicle is being operated at an excessive speed.</p> <p><i>See, e.g., citations for claim element 1F.</i></p> <p>On information and belief, the accused Land Rover vehicles include a processor subsystem determining, based upon data received from said radar detector, said at least one sensor and said memory subsystem, when to activate said vehicle proximity alarm circuit, when to activate said fuel overinjection circuit, and when to activate said upshift notification circuit.</p> <p><i>See, e.g., citations for claim elements 1G, 17F.</i></p>

<b>Claim 18</b>	<b>Corresponding Element in Land Rover Vehicles</b>
<p>18A. Apparatus for optimizing operation of a vehicle according to claim 17 wherein:</p>	<p>The accused Land Rover vehicles include an apparatus for optimizing operation of a vehicle according to claim 17.</p> <p><i>See, e.g.,</i> citations for claim 17.</p>
<p>18B. said at least one sensor further includes a windshield wiper sensor for indicating whether a windshield wiper of said vehicle is activated; and</p>	<p>The accused Land Rover vehicles include at least one sensor further including a windshield wiper sensor for indicating whether a windshield wiper of said vehicle is activated.</p> <p>For example, the accused Land Rover vehicles include a windshield wiper sensor that determines when the wipers are turned on. Upon information and belief, in order to utilize the rain sensor (and other features), the onboard computer of the Land Rover includes one or more windshield wiper sensors that detect whether the wipers have been activated.</p> <p>The rain sensor is mounted on the inside of the windshield, behind the rear view mirror. The sensor is able to detect the presence and amount of water on the windshield and automatically activate the windshield wipers accordingly.</p>
	<p>(<i>See, e.g.,</i> Ex. 2, 2014 Land Rover L405 Owner's Guide, at 67; Ex. 3, Land Rover L494 Owner's Guide, at 66; Ex. 4, Land Rover L538 Owner's Guide, at 58.)</p>

<b>Claim 18</b>	<b>Corresponding Element in Land Rover Vehicles</b>
<p>18C. said memory subsystem further storing a second vehicle speed/stopping distance table.</p>	<p>The accused Land Rover vehicles include a memory subsystem further storing a second vehicle speed/stopping distance table.</p> <p>On information and belief, the accused Land Rover vehicles store a second vehicle speed/stopping distance table.</p> <p>See, e.g., citations for claim element 17E.</p>

<b>Claim 19</b>	<b>Corresponding Element in Land Rover Vehicles</b>
19A. Apparatus for optimizing operation of a vehicle according to claim 17 and further comprising:	The accused Land Rover vehicles include an apparatus for optimizing operation of a vehicle according to claim 17.  <i>See, e.g., citations for claim 17.</i>
19B. a throttle controller for controlling a throttle of said engine of said vehicle, and	The accused Land Rover vehicles include a throttle controller for controlling a throttle of said engine of said vehicle.  <i>See, e.g., citations for claim element 1B.</i>
19C. said processor subsystem selectively reducing said throttle based upon data received from said radar detector, said at least one sensor and said memory subsystem.	On information and belief, the accused Land Rover vehicles include a processor subsystem that selectively reduces said throttle based upon data received from said radar detector, said at least one sensor and said memory subsystem.  For example, the Adaptive Cruise Control feature selectively reduces the throttle based upon data received from the radar detector
	<p>The Adaptive Cruise Control (ACC) system is designed to maintain a gap from the vehicle ahead or a set road speed if there is no slower vehicle ahead. A speed may be set at between 20 mph (32 km/h) and 124 mph (200 km/h).</p> <p>The system acts by regulating the speed of the vehicle, using engine control and the brakes.</p> <p>(<i>See, e.g., Ex. 2, 2014 Land Rover L405 Owner's Guide, at 139; Ex. 3, Land Rover L494 Owner's Guide, at 127; Ex. 4, Land Rover L538 Owner's Guide, at 110.</i>)</p>

Claim 19	Corresponding Element in Land Rover Vehicles
	<p>A further example of an infringing feature is the Queue Assist enhancement to Adaptive Cruise Control.</p> <p>Queue assist is an enhancement of Adaptive cruise control and, when active, will follow a vehicle ahead to a standstill. It is intended for use in lines of traffic on main roads where minimal steering is required.</p> <p>If a vehicle ahead slows to a halt, Queue assist will bring the vehicle to a stop and hold it stationary.</p> <p>(See, e.g., Ex. 2, 2014 Land Rover L405 Owner's Guide, at 141; Ex. 3, Land Rover L494 Owner's Guide, at 129; Ex. 4, Land Rover L538 Owner's Guide, at 112.)</p> <p>Upon information and belief, a further infringing feature is the Land Rover's Intelligent Emergency Braking.</p> <p>The system will aim to stop a collision impact at vehicle speeds of up to 5 mph (8 km/h), and reduce a collision impact between 5 mph (8 km/h) and 8 mph (13 km/h).</p> <p>(See, e.g., Ex. 2, 2014 Land Rover L405 Owner's Guide, at 123.)</p>

Claim 20	Corresponding Element in Land Rover Vehicles
<p>20. Apparatus for optimizing operation of a vehicle according to claim 19 wherein said at least one sensor further includes a brake sensor for indicating whether a brake system of said vehicle is activated.</p>	<p>The accused Land Rover vehicles include an apparatus for optimizing operation of a vehicle according to claim 19 wherein said at least one sensor further includes a brake sensor for indicating whether a brake system of said vehicle is activated.</p>
<p></p>	<p>For example, upon information and belief, to implement the Emergency Brake Assist feature (among many others), the Land Rover vehicles include one or more brake sensor that indicate whether the brake system has been activated.</p>
<p></p>	<p>If the driver rapidly applies the brakes, EBA automatically boosts the braking force to its maximum, in order to bring the vehicle to a halt as quickly as possible. If the driver applies the brakes slowly, but conditions mean that ABS operates on the front wheels, EBA will increase the braking force in order to apply ABS control to the rear wheels.</p>
<p></p>	<p>(See, e.g., Ex. 2, 2014 Land Rover L405 Owner's Guide, at 122; Ex. 3, Land Rover L494 Owner's Guide, at 129; Ex. 4, Land Rover L538 Owner's Guide, at 112.)</p>

<b>Claim 21</b>	<b>Corresponding Element in Land Rover Vehicles</b>
<p>21A. Apparatus for optimizing operation of a vehicle according to claim 19 wherein said processor subsystem further comprises:</p>	<p>The accused Land Rover vehicles include an apparatus for optimizing operation of a vehicle according to claim 19 wherein said processor subsystem further comprises:  <i>See, e.g., citations for claims 1, 19.</i></p>
<p>21B. means for counting a total number of vehicle proximity alarms determined by said processor subsystem;</p>	<p>On information and belief, the accused Land Rover vehicles include a means for counting a total number of vehicle proximity alarms determined by said processor subsystem.  To the extent that 35 U.S.C. §112(6) applies to this claim limitation, the structure(s), act(s), or materials(s) that perform the claimed function of “counting a total number of vehicle proximity alarms determined by said processor subsystem” are described in, for example, Figures 1 and 2 and associated text relating to the expression programmed in the Processor Subsystem 12.</p>
<p>21C. means for selectively reducing said throttle based upon said total number of vehicle proximity alarms.</p>	<p>On information and belief, the accused Land Rover vehicles include a means for selectively reducing said throttle based upon said total number of vehicle proximity alarms.  To the extent that 35 U.S.C. §112(6) applies to this claim limitation, the structure(s), act(s), or materials(s) that perform the claimed function of “selectively reducing said throttle based upon said total number of vehicle proximity alarms” are described in, for example, Figures 1 and 2 and associated text relating to the Processor Subsystem 12 and Throttle Controller 26.</p>

<b>Claim 22</b>	<b>Corresponding Element in Land Rover Vehicles</b>
22A. Apparatus for optimizing operation of a vehicle according to claim 17 and further comprising:	The accused Land Rover vehicles include an apparatus for optimizing operation of a vehicle according to claim 17 and further comprising:  <i>See, e.g., citations for claim 17.</i>
22B. a downshift notification circuit coupled to said processor subsystem, said downshift notification circuit issuing a notification that said engine of said vehicle is being operated at an insufficient engine speed; and	The accused Land Rover vehicles include a downshift notification circuit coupled to said processor subsystem, said downshift notification circuit issuing a notification that said engine of said vehicle is being operated at an insufficient engine speed.  <i>See, e.g., citations for claim element 7F.</i>
22C. said processor subsystem determining, based upon data received from said plurality of sensors, when to activate said downshift notification circuit.	The accused Land Rover vehicles include a processor subsystem that determines, based upon data received from said plurality of sensors, when to activate said downshift notification circuit.  selectively reduces said throttle based upon data received from said radar detector, said at least one sensor and said memory subsystem.  <i>See, e.g., citations for claim elements 1B, 1G.</i>



<b>Claim 23</b>	<b>Corresponding Element in Land Rover Vehicles</b>
23A. Apparatus for optimizing operation of a vehicle, comprising:	The accused Land Rover vehicles include an apparatus for optimizing operation of a vehicle.  <i>See, e.g.,</i> citations for claims 1, 17.
23B. a radar detector, said radar detector determining a distance separating a vehicle having an engine and an object in front of said vehicle;	The accused Land Rover vehicles include a radar detector that determines a distance separating a vehicle having an engine and another object in front of the accused vehicles.  <i>See, e.g.,</i> citations for claim element 17B.
23C. a plurality of sensors coupled to a vehicle having an engine, said plurality of sensors, which collectively monitor operation of said vehicle, including a road speed sensor, and engine speed sensor, a manifold pressure sensor and a throttle position sensor;	The accused Land Rover vehicles include a plurality of sensors coupled to a vehicle having an engine, said plurality of sensors, which collectively monitor operation of said vehicle, including a road speed sensor, and engine speed sensor, a manifold pressure sensor and a throttle position sensor.  <i>See, e.g.,</i> citations for claim element 1B.
23D. a processor subsystem, coupled to said radar detector and each one of said plurality of sensors, to receive data therefrom;	The accused Land Rover vehicles include a processor subsystem, coupled to said radar detector and each one of said plurality of sensors, to receive data therefrom;  <i>See, e.g.,</i> citations for claim element 1C.
23E. a memory subsystem, coupled to said processor subsystem, said memory subsystem storing therein a first vehicle speed/stopping distance table, a manifold pressure set point, an RPM set point, and present and prior levels for each one of said plurality of sensors;	The accused Land Rover vehicles include a memory subsystem, coupled to said processor subsystem, said memory subsystem storing therein a first vehicle speed/stopping distance table, a manifold pressure set point, an RPM set point, and present and prior levels for each one of said plurality of sensors.  <i>See, e.g.,</i> citations for claim element 17E.
23F. a fuel overinjection notification circuit coupled to said processor	The accused Land Rover vehicles include a fuel overinjection notification circuit coupled to said processor subsystem, said fuel overinjection notification circuit

Claim 23	Corresponding Element in Land Rover Vehicles
<p>subsystem, said fuel overinjection notification circuit issuing a notification that excessive fuel is being supplied to said engine of said vehicle;</p>	<p>issuing a notification that excessive fuel is being supplied to said engine of said vehicle. <i>See, e.g.,</i> citations for claim element 1E.</p>
<p>23G. an upshift notification circuit coupled to said processor subsystem, said upshift notification circuit issuing a notification that said engine of said vehicle is being operated at an excessive speed;</p>	<p>The accused Land Rover vehicles include an upshift notification circuit coupled to said processor subsystem, said upshift notification circuit issuing a notification that said engine of said vehicle is being operated at an excessive speed. <i>See, e.g.,</i> citations for claim element 1F.</p>
<p>23H. said processor subsystem determining, based upon data received from said plurality of sensors, when to activate said fuel overinjection circuit and when to activate said upshift notification circuit;</p>	<p>The accused Land Rover vehicles include a processor subsystem that determines, based upon data received from said plurality of sensors, when to activate said fuel overinjection circuit and when to activate said upshift notification circuit. <i>See, e.g.,</i> citations for claim element 1G.</p>
<p>23I. a vehicle proximity alarm circuit coupled to said processor subsystem, said vehicle proximity alarm circuit issuing an alarm that said vehicle is too close to said object;</p>	<p>The accused Land Rover vehicles include a vehicle proximity alarm circuit coupled to said processor subsystem, said vehicle proximity alarm circuit issuing an alarm that said vehicle is too close to said object. <i>See, e.g.,</i> citations for claim 17F.</p>
<p>23J. said processor subsystem determining, based upon data received from said radar detector, said at least one sensor and said memory subsystem, when to activate said vehicle proximity alarm circuit.</p>	<p>The accused Land Rover vehicles includes a processor subsystem that determines, based upon data received from said radar detector, said at least one sensor and said memory subsystem, when to activate said vehicle proximity alarm circuit. <i>See, e.g.,</i> citations for claim element 17I.</p>

<b>Claim 24</b>	<b>Corresponding Element in Land Rover Vehicles</b>
24A. Apparatus for optimizing operation of a vehicle according to claim 23 wherein said processor subsystem further comprises:	The accused Land Rover vehicles include an apparatus for optimizing operation of a vehicle according to claim 23 wherein said processor subsystem further comprises:  <i>See, e.g., citations for claim 23.</i>
24B. means for determining when road speed for said vehicle is increasing or decreasing;	The accused Land Rover vehicles include a means for determining when road speed for said vehicle is increasing or decreasing.  <i>See, e.g., citations for claim element 15B.</i>
24C. means for determining when throttle position for said vehicle is increasing or decreasing; and	The accused Land Rover vehicles include a means for determining when throttle position for said vehicle is increasing or decreasing.  <i>See, e.g., citations for claim element 2C.</i>  To the extent that 35 U.S.C. §112(6) applies to this claim limitation, the structure(s), act(s), or materials(s) that perform the claimed function of “determining when throttle position for said vehicle is increasing or decreasing” are described in, for example, Figures 1 and 2 and associated text of the ’781 patent relating to Throttle Sensor 24, Memory Subsystem 14, and Processor Subsystem 12.
24D. means for comparing manifold pressure to said manifold pressure set point;	The accused Land Rover vehicles include a means for comparing manifold pressure to said manifold pressure set point.  <i>See, e.g., citations for claim element 2D.</i>

Claim 24	Corresponding Element in Land Rover Vehicles
<p>24E. means for determining when manifold pressure for said vehicle is increasing or decreasing; and</p>	<p>The accused Land Rover vehicles include a means for determining when manifold pressure for said vehicle is increasing or decreasing. <i>See, e.g.</i>, citations for claim element 4D.  To the extent that 35 U.S.C. §112(6) applies to this claim limitation, the structure(s), act(s), or material(s) that perform the claimed function of “determining when manifold pressure for said vehicle is increasing or decreasing” are described in, for example, Figures 1 and 2 and associated text of the '781 patent relating to Manifold PSI Sensor 22, Memory Subsystem 14, and Processor Subsystem 12.</p>
<p>24F. means for determining when engine speed for said vehicle is increasing or decreasing;</p>	<p>The accused Land Rover vehicles include a means for determining when engine speed for said vehicle is increasing or decreasing. <i>See, e.g.</i>, citations for claim element 15G.</p>
<p>24G. said processor subsystem activating said fuel overinjection notification circuit if both road speed and throttle position for said vehicle are increasing and manifold pressure for said vehicle is above said manifold pressure set point or if both throttle position and manifold pressure for said vehicle are increasing and road speed and engine speed for said vehicle are decreasing.</p>	<p>On information and belief, the accused Land Rover vehicles include a processor subsystem that activates said fuel overinjection notification circuit if both road speed and throttle position for said vehicle are increasing and manifold pressure for said vehicle is above said manifold pressure set point or if both throttle position and manifold pressure for said vehicle are increasing and road speed and engine speed for said vehicle are decreasing. <i>See, e.g.</i>, citations for claim element 1G.</p>

<b>Claim 25</b>	<b>Corresponding Element in Land Rover Vehicles</b>
25A. Apparatus for optimizing operation of a vehicle according to claim 23 wherein said processor subsystem further comprises:	The accused Land Rover vehicles include an apparatus for optimizing operation of a vehicle according to claim 23 wherein said processor subsystem further comprises:  <i>See, e.g., citations for claim 23.</i>
25B. means for determining when road speed for said vehicle is increasing;	The accused Land Rover vehicles include a means for determining when road speed for said vehicle is increasing.  <i>See, e.g., citations for claim element 2B.</i>
25C. means for determining when throttle position for said vehicle is increasing; and	The accused Land Rover vehicles include a means for determining when throttle position for said vehicle is increasing.  <i>See, e.g., citations for claim element 2C.</i>
25D. means for comparing manifold pressure to said manifold pressure set point;	The accused Land Rover vehicles include a means for comparing manifold pressure to said manifold pressure set point.  <i>See, e.g., citations for claim element 2D.</i>
25E. means for comparing engine speed to said RPM set point;	The accused Land Rover vehicles include a means for comparing engine speed to said RPM set point.  <i>See, e.g., citations for claim element 5E.</i>
25F. said processor subsystem activating said upshift notification circuit if both	On information and belief, the accused Land Rover vehicles include a processor subsystem that activates said upshift notification circuit if both road speed and

Claim 25	Corresponding Element in Land Rover Vehicles
<p>road speed and throttle position for said vehicle are increasing, manifold pressure for said vehicle is at or below said manifold pressure set point and engine speed for said vehicle is at or above said RPM set point.</p>	<p>throttle position for said vehicle are increasing, manifold pressure for said vehicle is at or below said manifold pressure set point and engine speed for said vehicle is at or above said RPM set point.  See, e.g., citations for claim element 5F.</p>

<b>Claim 26</b>	<b>Corresponding Element in Land Rover Vehicles</b>
26A. Apparatus for optimizing operation of a vehicle, comprising:	The accused Land Rover vehicles include an apparatus for optimizing operation of a vehicle.  <i>See, e.g.</i> , citations for claims 1, 17.
26B. a radar detector, said radar detector determining a distance separating a vehicle having an engine and an object in front of said vehicle;	The accused Land Rover vehicles include a radar detector that determines a distance separating a vehicle having an engine and another object in front of the accused vehicles.  <i>See, e.g.</i> , citations for claim element 17B.
26C. a plurality of sensors coupled to a vehicle having an engine, said plurality of sensors, which collectively monitor operation of said vehicle, including a road speed sensor, and engine speed sensor, a manifold pressure sensor and a throttle position sensor;	The accused Land Rover vehicles include a plurality of sensors coupled to a vehicle having an engine, said plurality of sensors, which collectively monitor operation of said vehicle, including a road speed sensor, and engine speed sensor, a manifold pressure sensor and a throttle position sensor.  <i>See, e.g.</i> , citations for claim element 1B.
26D. a processor subsystem, coupled to said radar detector and each one of said plurality of sensors, to receive data therefrom;	The accused Land Rover vehicles include a processor subsystem, coupled to said radar detector and each one of said plurality of sensors, to receive data therefrom;  <i>See, e.g.</i> , citations for claim element 1C.
26E. a memory subsystem, coupled to said processor subsystem, said memory subsystem storing therein a first vehicle speed/stopping distance table, a manifold pressure set point, RPM set point, and present and prior levels for each one of said plurality of sensors;	The accused Land Rover vehicles include a memory subsystem, coupled to said processor subsystem, said memory subsystem storing therein a first vehicle speed/stopping distance table, a manifold pressure set point, RPM set point, and present and prior levels for each one of said plurality of sensors.  <i>See, e.g.</i> , citations for claim element 17E.
26F. a fuel overinjection notification	The accused Land Rover vehicles include a fuel overinjection notification circuit

<b>Claim 26</b>	<b>Corresponding Element in Land Rover Vehicles</b>
circuit coupled to said processor subsystem, said fuel overinjection notification circuit issuing a notification that excessive fuel is being supplied to said engine of said vehicle;	coupled to said processor subsystem, said fuel overinjection notification circuit issuing a notification that excessive fuel is being supplied to said engine of said vehicle.  <i>See, e.g.,</i> citations for claim element 1E.
26G. a downshift notification circuit coupled to said processor subsystem, said downshift notification circuit issuing a notification that said engine of said vehicle is being operated at an insufficient engine speed;	The accused Land Rover vehicles include a downshift notification circuit coupled to said processor subsystem, said downshift notification circuit issuing a notification that said engine of said vehicle is being operated at an insufficient engine speed;  <i>See, e.g.,</i> citations for claim element 7F.
26H. said processor subsystem determining, based upon data received from said plurality of sensors, when to activate said fuel overinjection circuit and when to activate said downshift notification circuit;	The accused Land Rover vehicles include a processor subsystem that determines, based upon data received from said plurality of sensors, when to activate said fuel overinjection circuit and when to activate said downshift notification circuit.  <i>See, e.g.,</i> citations for claim element 7G.
26I. a vehicle proximity alarm circuit coupled to said processor subsystem, said vehicle proximity alarm circuit issuing an alarm that said vehicle is too close to said object;	The accused Land Rover vehicles include a vehicle proximity alarm circuit coupled to said processor subsystem, said vehicle proximity alarm circuit issuing an alarm that said vehicle is too close to said object.  <i>See, e.g.,</i> citations for claim element 17F.
26J. said processor subsystem determining, based upon data received from said radar detector, said at least one sensor and said memory subsystem, when to activate said vehicle proximity alarm circuit.	The accused Land Rover vehicles includes a processor subsystem that determines, based upon data received from said radar detector, said at least one sensor and said memory subsystem, when to activate said vehicle proximity alarm circuit.  <i>See, e.g.,</i> citations for claim element 17I.



<b>Claim 27</b>	<b>Corresponding Element in Land Rover Vehicles</b>
27A. Apparatus for optimizing operation of a vehicle according to claim 26 wherein said processor subsystem further comprises:	The accused Land Rover vehicles include an apparatus for optimizing operation of a vehicle according to claim 26 wherein said processor subsystem further comprises:  <i>See, e.g.,</i> citations for claims 1, 26.
27B. means for determining when road speed for said vehicle is decreasing;	The accused Land Rover vehicles include a means for determining when road speed for said vehicle is decreasing.
27C. means for determining when throttle position for said vehicle is increasing; and	<i>See, e.g.,</i> citations for claim element 4B. The accused Land Rover vehicles include a means for determining when throttle position for said vehicle is increasing.
27D. means for determining when manifold pressure for said vehicle is increasing; and	<i>See, e.g.,</i> citations for claim element 4C. The accused Land Rover vehicles include a means for determining when manifold pressure for said vehicle is increasing.
27E. means for determining when engine speed for said vehicle is decreasing;	<i>See, e.g.,</i> citations for claim element 4D. The accused Land Rover vehicles include a means for determining when engine speed for said vehicle is decreasing.
27F. said processor subsystem activating said downshift notification circuit if both road speed and engine speed are decreasing and both throttle position and manifold pressure for said vehicle are increasing.	<i>See, e.g.,</i> citations for claim element 4E. On information and belief, the accused Land Rover vehicles include a processor subsystem that activates said downshift notification circuit if both road speed and engine speed are decreasing and both throttle position and manifold pressure for said vehicle are increasing.
	<i>See, e.g.,</i> citations for claim element 10F.

<b>Claim 28</b>	<b>Corresponding Element in Land Rover Vehicles</b>
28A. Apparatus for optimizing operation of a vehicle, comprising:	The accused Land Rover vehicles include an apparatus for optimizing operation of a vehicle.  <i>See, e.g.,</i> citations for claim 1.
28B. a plurality of sensors coupled to a vehicle having an engine, said plurality of sensors, which collectively monitor operation of said vehicle, including a road speed sensor, an engine speed sensor, a manifold pressure sensor and a throttle position sensor;	The accused Land Rover vehicles include a plurality of sensors coupled to the vehicle having an engine, said plurality of sensors, which collectively monitor operation of said vehicle, including a road speed sensor, an engine speed sensor, a manifold pressure sensor and a throttle position sensor.  <i>See, e.g.,</i> citations for claim element 1B.
28C. a processor subsystem, coupled to each one of said plurality of sensors, to receive data therefrom;	The accused Land Rover vehicles include a processor subsystem, coupled to each one of said plurality of sensors, to receive data therefrom.  <i>See, e.g.,</i> citations for claim element 1C.
28D. a fuel overinjection notification circuit coupled to said processor subsystem, said fuel overinjection notification circuit issuing a notification that excessive fuel is being supplied to said engine of said vehicle;	The accused Land Rover vehicles include a fuel overinjection notification circuit coupled to said processor subsystem, said fuel overinjection notification circuit issuing a notification that excessive fuel is being supplied to said engine of said vehicle.  <i>See, e.g.,</i> citations for claim element 1E.
28E. said processor subsystem determining whether to activate said fuel overinjection notification sensor based upon data received from said road speed sensor, said throttle position sensor and said manifold pressure sensor.	The accused Land Rover vehicles include a processor subsystem that determines whether to activate said fuel overinjection notification sensor based upon data received from said road speed sensor, said throttle position sensor and said manifold pressure sensor.  <i>See, e.g.,</i> citations for claim element 1G.

<b>Claim 29</b>	<b>Corresponding Element in Land Rover Vehicles</b>
29A. Apparatus according to claim 28 and further comprising:	The accused Land Rover vehicles include an apparatus according to claim 28 and further comprising:  <i>See, e.g., citations for claim 1, 28.</i>
29B. a memory subsystem, coupled to said processor subsystem, said memory subsystem maintaining a manifold pressure set point;	The accused Land Rover vehicles include a memory subsystem, coupled to said processor subsystem, said memory subsystem maintaining a manifold pressure set point.  <i>See, e.g., citations for claim element 1D.</i>
29C. said processor subsystem activating said fuel overinjection notification circuit upon determining that: (1) based upon data received from said road speed sensor, road speed of said vehicle is increasing; (2) based upon data received from said throttle position sensor, throttle position for said vehicle is increasing; and (3) based upon data received from said manifold pressure sensor, manifold pressure for said vehicle exceeds said manifold pressure set point.	On information and belief, the accused Land Rover vehicles include a processor subsystem that activates said fuel overinjection notification circuit upon determining that: (1) based upon data received from said road speed sensor, road speed of said vehicle is increasing; (2) based upon data received from said throttle position sensor, throttle position for said vehicle is increasing; and (3) based upon data received from said manifold pressure sensor, manifold pressure for said vehicle exceeds said manifold pressure set point.  <i>See, e.g., citations for claim element 1G.</i>

Claim 30	Corresponding Element in Land Rover Vehicles
30A. Apparatus according to claim 28, wherein:	The accused Land Rover vehicles include an apparatus according to claim 28. <i>See, e.g.,</i> citations for claims 1, 28.
30B. said plurality of sensors coupled to said vehicle further include an engine speed sensor;	The accused Land Rover vehicles include a plurality of sensors coupled to said vehicle further including an engine speed sensor; <i>See, e.g.,</i> citations for claim element 1B.
30C. said processor subsystem activating said fuel overinjection notification circuit upon determining that: (1) based upon data received from said road speed sensor, road speed of said vehicle is decreasing; (2) based upon data received from said throttle position sensor, throttle position for said vehicle is increasing; (3) based upon data received from said manifold pressure sensor, manifold pressure for said vehicle is increasing; and (4) based upon data received from said engine speed sensor, engine speed for said vehicle is decreasing.	On information and belief, the accused Land Rover vehicles include a processor subsystem that activates said fuel overinjection notification circuit upon determining that: (1) based upon data received from said road speed sensor, road speed of said vehicle is decreasing; (2) based upon data received from said throttle position sensor, throttle position for said vehicle is increasing; (3) based upon data received from said manifold pressure sensor, manifold pressure for said vehicle is increasing; and (4) based upon data received from said engine speed sensor, engine speed for said vehicle is decreasing. <i>See, e.g.,</i> citations for claim element 1G.

<b>Claim 31</b>	<b>Corresponding Element in Land Rover Vehicles</b>
31A. Apparatus for optimizing operation of a vehicle, comprising:	The accused Land Rover vehicles include an apparatus for optimizing operation of a vehicle.  <i>See, e.g.,</i> citations for claims 1, 17.
31B. a radar detector, said radar detector determining a distance separating a vehicle having an engine and an object in front of said vehicle;	The accused Land Rover vehicles include a radar detector that determines a distance separating a vehicle having an engine and another object in front of the accused vehicles.  <i>(See, e.g.,</i> citations for claim element 17B; <i>see also</i> Ex. 5, 2014 L319 Owner's Guide, at 63 & 109; Ex. 6, 2013 L320 Owner's Guide, at 92; Ex. 7, 2012 L322 Owner's Guide, at 54 & 107.)
31C. at least one sensor coupled to said vehicle for monitoring operation thereof, said at least one sensor including a road speed sensor.	The accused Land Rover vehicles include at least one sensor coupled to said vehicle for monitoring operation thereof, said at least one sensor including a road speed sensor.  <i>See, e.g.,</i> citations for claim element 1B.
31D. a processor subsystem, coupled to said radar detector and said at least one sensor, to receive data therefrom;	The accused Land Rover vehicles include a processor subsystem, coupled to said radar detector and said at least one sensor, to receive data therefrom.  <i>See, e.g.,</i> citations for claim element 17D.
31E. a memory subsystem, coupled to said processor subsystem, said memory subsystem storing a first vehicle speed/stopping distance table.	The accused Land Rover vehicles include a memory subsystem, coupled to said processor subsystem, said memory subsystem storing a first vehicle speed/stopping distance table.  <i>(See, e.g.,</i> citations for claim element 17E; <i>see also</i> Ex. 5, 2014 L319 Owner's Guide, at 64-65 & 109; Ex. 6, 2013 L320 Owner's Guide, at 93 & 95-96; Ex. 7, 2012 L322 Owner's Guide, at 54-55, 108 & 111.)
31F. a vehicle proximity alarm circuit coupled to said processor subsystem,	The accused Land Rover vehicles include a vehicle proximity alarm circuit coupled to said processor subsystem, said vehicle proximity alarm circuit issuing

<b>Corresponding Element in Land Rover Vehicles</b>	
<p><b>Claim 31</b></p> <p>said vehicle proximity alarm circuit issuing an alarm that said vehicle is too close to said object;</p>	<p>an alarm that said vehicle is too close to said object.</p> <p>(<i>See, e.g.</i>, citations for claim element 17F; <i>see also</i> Ex. 5, 2014 L319 Owner's Guide, at 64-65 &amp; 109; Ex. 6, 2013 L320 Owner's Guide, at 93 &amp; 95-96; Ex. 7, 2012 L322 Owner's Guide, at 54-55, 108 &amp; 111.)</p>
<p>31G. said processor subsystem determining whether to activate said vehicle proximity alarm circuit based upon separation distance data received from said radar detector, vehicle speed data received from said road speed sensor and said first vehicle speed/stopping distance table stored in said memory subsystem.</p>	<p>On information and belief, The accused Land Rover vehicles includes a processor subsystem that determines whether to activate said vehicle proximity alarm circuit based upon separation distance data received from said radar detector, vehicle speed data received from said road speed sensor and said first vehicle speed/stopping distance table stored in said memory subsystem.</p> <p>(<i>See, e.g.</i>, citations for claim element 17I; <i>see also</i> Ex. 5, 2014 L319 Owner's Guide, at 64-65 &amp; 109; Ex. 6, 2013 L320 Owner's Guide, at 93 &amp; 95-96; Ex. 7, 2012 L322 Owner's Guide, at 54-55, 108 &amp; 111.)</p>

Claim 32	Corresponding Element in Land Rover Vehicles
32A. Apparatus for optimizing operation of a vehicle according to claim 31 wherein:	The accused Land Rover vehicles include an apparatus for optimizing operation of a vehicle according to claim 31. <i>See, e.g.,</i> citations for claim 31.
32B. said at least one sensor further includes a windshield wiper sensor for indicating whether a windshield wiper of said vehicle is activated; and	The accused Land Rover vehicles include at least one sensor further including a windshield wiper sensor for indicating whether a windshield wiper of said vehicle is activated. <i>See, e.g.,</i> citations for claim element 18B.
32C. said memory subsystem further storing a second vehicle speed/stopping distance table.	The accused Land Rover vehicles include a memory subsystem further storing a second vehicle speed/stopping distance table. <i>See, e.g.,</i> citations for claim element 18C.
32D. if said windshield wiper sensor indicates that said windshield wiper is deactivated, said processor subsystem determining whether to activate said vehicle proximity alarm circuit based upon data received from said radar detector, said road speed sensor and said first vehicle speed/stopping distance table stored in said memory subsystem;	On information and belief, the accused Land Rover vehicles include an apparatus for optimizing operation of a vehicle according to claim 31 wherein if said windshield wiper sensor indicates that said windshield wiper is deactivated, said processor subsystem determining whether to activate said vehicle proximity alarm circuit based upon data received from said radar detector, said road speed sensor and said first vehicle speed/stopping distance table stored in said memory subsystem. <i>See, e.g.,</i> citations for claim element 17I.
32E. if said windshield wiper sensor is activated, said processor subsystem determining whether to activate said vehicle proximity alarm circuit based upon data received from said radar detector, said road speed sensor and said second vehicle speed/stopping distance table stored in said memory subsystem.	On information and belief, the accused Land Rover vehicles include an apparatus for optimizing operation of a vehicle according to claim 31 wherein if said windshield wiper sensor indicates that said windshield wiper is activated, said processor subsystem determining whether to activate said vehicle proximity alarm circuit based upon data received from said radar detector, said road speed sensor and said second vehicle speed/stopping distance table stored in said memory subsystem.

<p><b>Claim 32</b> table stored in said memory subsystem.</p>	<p><b>Corresponding Element in Land Rover Vehicles</b> <i>See, e.g.,</i> citations for claim element 17I.</p>
---	---



## **EXHIBIT 10**

<b>LIST OF DOCUMENTS CITED BY THIRD PARTY REQUESTER IN EX PARTE REEXAMINATION</b>	PATENT NO. 5,954,781	PATENTEE Harvey SLEPIAN et al.
	PATENT DATE September 21, 1999	

**U. S. PATENT DOCUMENTS**

EXAM. INITIAL	PATENT/ PUBLICATION NUMBER	NAME	PATENT/ PUBLICATION DATE	CLASS	SUBCLASS	FILING DATE
	4,901,701	Chasteen	February 20, 1990			
	4,631,515	Blee et al.	December 23, 1986			
	5,708,584	Doi et al.	January 13, 1998			
	5,477,452	Milunas et al.	December 19, 1995			
	4,559,599	Habu et al.	December 17, 1985			
	5,357,438	Davidian	October 18, 1994			
	4,061,055	Iizuka et al.	December 6, 1977			
	5,121,324	Rini et al.	June 9, 1992			

**FOREIGN PATENT DOCUMENTS**

EXAMINER INITIAL	DOCUMENT NUMBER	COUNTRY	DATE	NAME	SUBCLASS	TRANSLATION	
						YES	NO
	29 26 070*	DE	January 15, 1981			X	
	96/02853	WO	February 1, 1996				

\* - Certified English-language translation is provided.

**OTHER DOCUMENTS**

EXAMINER INITIAL	Name
	"First Amended Complaint for Patent Infringement" filed on January 30, 2014 in <i>VELOCITY PATENT LLC v. AUDI OF AMERICA, INC.</i> , Case No. 1:13-cv-08418-JGB (N.D. Ill.)
	Velocity Patent LLC's Initial Infringement Contentions Pursuant to Local Patent Rule 2.2 to Audi
	Velocity Patent LLC's Initial Infringement Contentions Pursuant to Local Patent Rule 2.2 to Mercedes-Benz
	Velocity Patent LLC's Initial Infringement Contentions Pursuant to Local Patent Rule 2.2 to Chrysler
	Velocity Patent LLC's Initial Infringement Contentions Pursuant to Local Patent Rule 2.2 to Jaguar Land Rover

EXAMINER	DATE CONSIDERED
EXAMINER: Initial if citation considered, whether or not citation is in conformance with M.P.E.P. 609; draw line through citation if not in conformance and not considered. Include copy of this form with next communication to applicant.	

<b>LIST OF DOCUMENTS CITED BY THIRD PARTY REQUESTER IN <i>EX PARTE</i> REEXAMINATION</b>	PATENT NO. 5,954,781	PATENTEE Harvey SLEPIAN et al.
	PATENT DATE September 21, 1999	

**U. S. PATENT DOCUMENTS**

EXAM. INITIAL	PATENT/ PUBLICATION NUMBER	NAME	PATENT/ PUBLICATION DATE	CLASS	SUBCLASS	FILING DATE
	3,925,753	Auman et al.	December 9, 1975			

**FOREIGN PATENT DOCUMENTS**

EXAMINER INITIAL	DOCUMENT NUMBER	COUNTRY	DATE	NAME	SUBCLASS	TRANSLATION	
						YES	NO

**OTHER DOCUMENTS**

EXAMINER INITIAL	Name
	"Automotive Electronics Handbook," pgs. 2.5-2.9, 3.16, 7.6-7.8, 7.21-7.26, 11.3-11.4, 11.24-11.31, 11.55, 12.1-12.36, 13.1-13.21, 14.1-14.9, and 22.1-22.20, published in 1995, by Ronald Jurgen
	Certified English-language translation of German Patent Application Publication No. 29 26 070

EXAMINER	DATE CONSIDERED
EXAMINER: Initial if citation considered, whether or not citation is in conformance with M.P.E.P. 609; draw line through citation if not in conformance and not considered. Include copy of this form with next communication to applicant.	

## **EXHIBIT 11**



# **AUTOMOTIVE ELECTRONICS HANDBOOK**

**RONALD JURGEN**

**Library of Congress Cataloging-in-Publication Data**

Automotive electronics handbook / Ronald Jurgen, editor in chief.

p. cm.

Includes index.

ISBN 0-07-033189-8

1. Automobiles—Electronic equipment. I. Jurgen, Ronald K.  
TL272.5.A982 1994  
629.25'49—dc

94-39724

CIP

Copyright © 1995 by McGraw-Hill, Inc. All rights reserved. Printed in the United States of America. Except as permitted under the United States Copyright Act of 1976, no part of this publication may be reproduced or distributed in any form or by any means, or stored in a data base or retrieval system, without the prior written permission of the publisher.

2 3 4 5 6 7 8 9 0 AGM/AGM 9 0 9 8 7 6 5

ISBN 0-07-033189-8

*The sponsoring editor for this book was Stephen S. Chapman, the editing supervisor was Virginia Carroll, and the production supervisor was Suzanne W. B. Rapcavage. It was set in Times Roman by North Market Street Graphics.*

*Printed and bound by Arcata Graphics/Martinsburg.*

McGraw-Hill books are available at special quantity discounts to use as premiums and sales promotions, or for use in corporate training programs. For more information, please write to the Director of Special Sales, McGraw-Hill, Inc., 11 West 19th Street, New York, NY 10011. Or contact your local bookstore.

Information contained in this work has been obtained by McGraw-Hill, Inc. from sources believed to be reliable. However, neither McGraw-Hill nor its authors guarantee the accuracy or completeness of any information published herein, and neither McGraw-Hill nor its authors shall be responsible for any errors, omissions, or damages arising out of use of this information. This work is published with the understanding that McGraw-Hill and its authors are supplying information, but are not attempting to render engineering or other professional services. If such services are required, the assistance of an appropriate professional should be sought.

*This book is printed on acid-free paper.*

---

# CONTENTS

---

Contributors xv  
Preface xvii

## Part 1 Introduction

---

### Chapter 1: Introduction *Ronald K. Jurgen* 1.3

- 1.1 The Dawn of a New Era / 1.3
- 1.2 The Microcomputer Takes Center Stage / 1.4
- 1.3 Looking to the Future / 1.5
- References / 1.6

## Part 2 Sensors and Actuators

---

### Chapter 2: Pressure Sensors *Randy Frank* 2.3

- 2.1 Automotive Pressure Measurements / 2.3
- 2.2 Automotive Applications for Pressure Sensors / 2.5
- 2.3 Technologies for Sensing Pressure / 2.15
- 2.4 Future Pressure-Sensing Developments / 2.23
- Glossary / 2.24
- Bibliography / 2.24

---

### Chapter 3: Linear and Angle Position Sensors *Paul Nickson* 3.1

- 3.1 Introduction / 3.1
- 3.2 Classification of Sensors / 3.1
- 3.3 Position Sensor Technologies / 3.2
- 3.4 Interfacing Sensors to Control Systems / 3.16
- Glossary / 3.17
- References / 3.17

---

### Chapter 4: Flow Sensors *Robert E. Bicking* 4.1

- 4.1 Introduction / 4.1
- 4.2 Automotive Applications of Flow Sensors / 4.1
- 4.3 Basic Classification of Flow Sensors / 4.3
- 4.4 Applicable Flow Measurement Technologies / 4.4
- Glossary / 4.8
- Bibliography / 4.9

vii

**Chapter 5. Temperature, Heat, and Humidity Sensors** *Randy Frank* 5.1

- 5.1 Temperature, Heat, and Humidity / 5.1
- 5.2 Automotive Temperature Measurements / 5.5
- 5.3 Humidity Sensing and Vehicle Performance / 5.12
- 5.4 Sensors for Temperature / 5.14
- 5.5 Humidity Sensors / 5.21
- 5.6 Conclusions / 5.22
- Glossary / 5.23
- Bibliography / 5.23

**Chapter 6. Exhaust Gas Sensors** *Hans-Martin Wiedenmann, Gerhard Hötzel, Harald Neumann, Johann Riegel, and Helmut Weyl* 6.1

- 6.1 Basic Concepts / 6.1
- 6.2 Principles of Exhaust Gas Sensors for Lambda Control / 6.5
- 6.3 Technology of Ceramic Exhaust Gas Sensors / 6.11
- 6.4 Factors Affecting the Control Characteristics of Lambda = 1 Sensors / 6.14
- 6.5 Applications / 6.18
- 6.6 Sensor Principles for Other Exhaust Gas Components / 6.20
- Bibliography / 6.22

**Chapter 7. Speed and Acceleration Sensors** *William C. Dunn* 7.1

- 7.1 Introduction / 7.1
- 7.2 Speed-Sensing Devices / 7.2
- 7.3 Automotive Applications for Speed Sensing / 7.6
- 7.4 Acceleration Sensing Devices / 7.8
- 7.5 Automotive Applications for Accelerometers / 7.18
- 7.6 New Sensing Devices / 7.22
- 7.7 Future Applications / 7.24
- 7.8 Summary / 7.26
- Glossary / 7.27
- References / 7.28

**Chapter 8. Engine Knock Sensors** *William G. Wolber* 8.1

- 8.1 Introduction / 8.1
- 8.2 The Knock Phenomenon / 8.2
- 8.3 Technologies for Sensing Knock / 8.4
- 8.4 Summary / 8.9
- Glossary / 8.9
- References / 8.9

**Chapter 9. Engine Torque Sensors** *William G. Wolber* 9.1

- 9.1 Introduction / 9.1
- 9.2 Automotive Applications of Torque Measurement / 9.3
- 9.3 Direct Torque Sensors / 9.6
- 9.4 Inferred Torque Measurement / 9.8
- 9.5 Summary / 9.13
- Glossary / 9.13
- References / 9.14



5.1

**Chapter 10. Actuators** *Klaus Müller* 10.1

- 10.1 Preface / 10.1
- 10.2 Types of Electromechanical Actuators / 10.2
- 10.3 Automotive Actuators / 10.19
- 10.4 Technology for Future Application / 10.27
- Acknowledgments / 10.30
- Glossary / 10.30
- Bibliography / 10.31

6.1

**Part 3 Control Systems****Chapter 11. Automotive Microcontrollers** *David S. Boehmer* 11.3

- 11.1 Microcontroller Architecture and Performance Characteristics / 11.3
- 11.2 Memory / 11.24
- 11.3 Low-Speed Input/Output Ports / 11.31
- 11.4 High-Speed I/O Ports / 11.36
- 11.5 Serial Communications / 11.41
- 11.6 Analog-to-Digital Converter / 11.45
- 11.7 Failsafe Methodologies / 11.49
- 11.8 Future Trends / 11.51
- Glossary / 11.54
- Bibliography / 11.55

7.1

**Chapter 12. Engine Control** *Gary C. Hirschlieb, Gottfried Schiller, and Shari Stottler* 12.1

- 12.1 Objectives of Electronic Engine Control Systems / 12.1
- 12.2 Spark Ignition Engines / 12.5
- 12.3 Compression Ignition Engines / 12.32

8.1

**Chapter 13. Transmission Control** *Kurt Neuffer, Wolfgang Bullmer, and Werner Brehm* 13.1

- 13.1 Introduction / 13.1
- 13.2 System Components / 13.2
- 13.3 System Functions / 13.7
- 13.4 Communications with Other Electronic Control Units / 13.17
- 13.5 Optimization of the Drivetrain / 13.18
- 13.6 Future Developments / 13.19
- Glossary / 13.20
- References / 13.20

9.1

**Chapter 14. Cruise Control** *Richard Valentine* 14.1

- 14.1 Cruise Control System / 14.1
- 14.2 Microcontroller Requirements for Cruise Control / 14.3
- 14.3 Cruise Control Software / 14.4
- 14.4 Cruise Control Design / 14.6
- 14.5 Future Cruise Concepts / 14.7
- Glossary / 14.8
- Bibliography / 14.8

**Chapter 15. Braking Control** *Jerry L. Cage* 15.1

---

- 15.1 Introduction / 15.1
- 15.2 Vehicle Braking Fundamentals / 15.1
- 15.3 Antilock Systems / 15.8
- 15.4 Future Vehicle Braking Systems / 15.14
- Glossary / 15.15
- References / 15.16

**Chapter 16. Traction Control** *Armin Czinczel* 16.1

---

- 16.1 Introduction / 16.1
- 16.2 Forces Affecting Wheel Traction: Fundamental Concepts / 16.3
- 16.3 Controlled Variables / 16.5
- 16.4 Control Modes / 16.6
- 16.5 Traction Control Components / 16.11
- 16.6 Applications on Heavy Commercial Vehicles / 16.13
- 16.7 Future Trends / 16.14
- Glossary / 16.14
- Bibliography / 16.15

**Chapter 17. Suspension Control** *Akatsu Yohsuke* 17.1

---

- 17.1 Shock Absorber Control System / 17.1
- 17.2 Hydropneumatic Suspension Control System / 17.4
- 17.3 Electronic Leveling Control System / 17.5
- 17.4 Active Suspension / 17.8
- 17.5 Conclusion / 17.17
- Glossary / 17.18
- Nomenclature / 17.18
- Bibliography / 17.18

**Chapter 18. Steering Control** *Makoto Sato* 18.1

---

- 18.1 Variable-Assist Steering / 18.1
- 18.2 Four-Wheel Steering Systems (4WS) / 18.15
- Glossary / 18.33
- References / 18.33

**Chapter 19. Lighting, Wipers, Air Conditioning/Heating** *Richard Valentine* 19.1

---

- 19.1 Lighting Controls / 19.1
- 19.2 Windshield Wiper Control / 19.9
- 19.3 Air Conditioner/Heater Control / 19.15
- 19.4 Miscellaneous Load Control Reference / 19.20
- 19.5 Future Load Control Concepts / 19.25
- Glossary / 19.26
- Bibliography / 19.27

15.1

**Part 4 Displays and Information Systems****Chapter 20. Instrument Panel Displays** *Ronald K. Jurgen* 20.3

- 20.1 The Evolution to Electronic Displays / 20.3
- 20.2 Vacuum Fluorescent Displays / 20.3
- 20.3 Liquid Crystal Displays / 20.4
- 20.4 Cathode-Ray Tube Displays / 20.6
- 20.5 Head-up Displays / 20.6
- 20.6 Electronic Analog Displays / 20.8
- 20.7 Reconfigurable Displays / 20.9
- References / 20.9

16.1

**Chapter 21. Trip Computers** *Ronald K. Jurgen* 21.1

- 21.1 Trip Computer Basics / 21.1
- 21.2 Specific Trip Computer Designs / 21.2
- 21.3 Conclusion / 21.4
- References / 21.6

17.1

**Chapter 22. On- and Off-Board Diagnostics** *Wolfgang Bremer, Frieder Heintz, and Robert Hugel* 22.1

- 22.1 Why Diagnostics? / 22.1
- 22.2 On-Board Diagnostics / 22.6
- 22.3 Off-Board Diagnostics / 22.7
- 22.4 Legislation and Standardization / 22.8
- 22.5 Future Diagnostic Concepts / 22.15
- Glossary / 22.18
- References / 22.19

18.1

**Part 5 Safety, Convenience, Entertainment, and Other Systems****Chapter 23. Passenger Safety and Convenience** *Bernhard K. Mattes* 23.3

- 23.1 Passenger Safety Systems / 23.3
- 23.2 Passenger Convenience Systems / 23.11
- Glossary / 23.13
- Bibliography / 23.13

19.1

**Chapter 24. Antitheft Systems** *Shinichi Kato* 24.1

- 24.1 Vehicle Theft Circumstances / 24.1
- 24.2 Overview of Antitheft Regulations / 24.2
- 24.3 A Basic Antitheft System / 24.3

**Chapter 25. Entertainment Products** *Tom Chrapkiewicz* 25.1

- 25.1 Fundamentals of Audio Systems / 25.1
- 25.2 A Brief History of Automotive Entertainment / 25.4
- 25.3 Contemporary Audio Systems / 25.5
- 25.4 Future Trends / 25.12
- Glossary / 25.17
- References / 25.18

**Chapter 26. Multiplex Wiring Systems** *Fred Meisterfeld* 26.1

- 26.1 Vehicle Multiplexing / 26.1
- 26.2 Encoding Techniques / 26.9
- 26.3 Protocols / 26.23
- 26.4 Summary and Conclusions / 26.53
- Glossary / 26.56
- References / 26.64

**Part 6. Electromagnetic Interference and Compatibility**

**Chapter 27. Electromagnetic Standards and Interference**  
*James P. Muccioli* 27.3

- 27.1 SAE Automotive EMC Standards / 27.3
- 27.2 IEEE Standards Related to EMC / 27.11
- 27.3 The Electromagnetic Environment of an Automobile Electronic System / 27.13
- Bibliography / 27.18

**Chapter 28. Electromagnetic Compatibility** *James P. Muccioli* 28.1

- 28.1 Noise Propagation Modes / 28.1
- 28.2 Cabling / 28.2
- 28.3 Components / 28.4
- 28.4 Printed Circuit Board EMC Checklist / 28.9
- 28.5 Integrated Circuit Decoupling—A Key Automotive EMI Concern / 28.10
- 28.6 IC Process Size Affects EMC / 28.14
- Bibliography / 28.19

**Part 7. Emerging Technologies**

**Chapter 29. Navigation Aids and Intelligent Vehicle-Highway Systems** *Robert L. French* 29.3

- 29.1 Background / 29.3
- 29.2 Automobile Navigation Technologies / 29.4
- 29.3 Examples of Navigation Systems / 29.10
- 29.4 Other IVHS Systems and Services / 29.15
- References / 29.18

25.1

---

**Chapter 30. Electric and Hybrid Vehicles** *George G. Karady, Tracy Blake, Raymond S. Hobbs, and Donald B. Karner* **30.1**

---

- 30.1 Introduction / 30.1
- 30.2 System Description / 30.5
- 30.3 Charger and Protection System / 30.6
- 30.4 Motor Drive System / 30.8
- 30.5 Battery / 30.17
- 30.6 Vehicle Control and Auxiliary Systems / 30.19
- 30.7 Infrastructure / 30.21
- 30.8 Hybrid Vehicles / 30.23
- Glossary / 30.24
- References / 30.25

26.1

---

**Chapter 31. Noise Cancellation Systems** *Jeffrey N. Denenberg* **31.1**

---

- 31.1 Noise Sources / 31.1
- 31.2 Applications / 31.5
- Glossary / 31.10
- Bibliography / 31.10

27.3

---

**Chapter 32. Future Vehicle Electronics** *Randy Frank and Salim Momin* **32.1**

---

- 32.1 Retrospective / 32.1
- 32.2 IC Technology / 32.1
- 32.3 Other Semiconductor Technologies / 32.5
- 32.4 Enabling the Future / 32.11
- 32.5 Impact on Future Automotive Electronics / 32.15
- 32.6 Conclusions / 32.20
- Glossary / 32.21
- Bibliography / 32.23

28.1

Index / LI

rt L

29.3

---

## CONTRIBUTORS

---

- Robert E. Bicking** *Honeywell, Micro Switch Division* (CHAP. 4)  
**Tracy Blake** *Arizona State University* (CHAP. 30)  
**David S. Boehmer** *Intel Corporation* (CHAP. 11)  
**Werner Brehm** *Robert Bosch GmbH* (CHAP. 13)  
**Wolfgang Bremer** *Robert Bosch GmbH* (CHAP. 22)  
**Wolfgang Bullmer** *Robert Bosch GmbH* (CHAP. 13)  
**Jerry L. Cage** *Allied Signal, Inc.* (CHAP. 15)  
**Tom Chrapkiewicz** *Philips Semiconductor* (CHAP. 25)  
**Armin Czinczel** *Robert Bosch GmbH* (CHAP. 16)  
**Jeffrey N. Denenberg** *Noise Cancellation Technologies, Inc.* (CHAP. 31)  
**William C. Dunn** *Motorola Semiconductor Products* (CHAP. 7)  
**Randy Frank** *Motorola Semiconductor Products* (CHAPS. 2, 5, 32)  
**Robert L. French** *R. L. French & Associates* (CHAP. 29)  
**Frieder Heintz** *Robert Bosch GmbH* (CHAP. 22)  
**Gary C. Hirschlieb** *Robert Bosch GmbH* (CHAP. 12)  
**Raymond S. Hobbs** *Arizona Public Service Company* (CHAP. 30)  
**Gerhard Hötzel** *Robert Bosch GmbH* (CHAP. 6)  
**Robert Hügel** *Robert Bosch GmbH* (CHAP. 22)  
**Ronald K. Jurgen** *Editor* (CHAPS. 1, 20, 21)  
**George G. Karady** *Arizona State University* (CHAP. 30)  
**Donald B. Karner** *Electric Transportation Application* (CHAP. 30)  
**Shinichi Kato** *Nissan Motor Co., Ltd.* (CHAP. 24)  
**Bernhard K. Mattes** *Robert Bosch GmbH* (CHAP. 23)  
**Fred Mliesterfeld** *Chrysler Corporation* (CHAP. 26)  
**Salim Momin** *Motorola Semiconductor Products* (CHAP. 32)  
**James P. Muccioli** *JASTECH* (CHAPS. 27, 28)  
**Klaus Müller** *Robert Bosch GmbH* (CHAP. 10)  
**Kurt Neuffer** *Robert Bosch GmbH* (CHAP. 13)  
**Harald Neumann** *Robert Bosch GmbH* (CHAP. 6)  
**Paul Nickson** *Analog Devices, Inc.* (CHAP. 3)  
**Johann Riegel** *Robert Bosch GmbH* (CHAP. 6)

xvi CONTRIBUTORS

- Makoto Sato** *Honda R&D Co., Ltd.* (CHAP. 18)  
**Gottfried Schiller** *Robert Bosch GmbH* (CHAP. 12)  
**Shari Stottler** *Robert Bosch GmbH* (CHAP. 12)  
**Richard Valentine** *Motorola Inc.* (CHAPS. 14, 19)  
**Helmut Weyl** *Robert Bosch GmbH* (CHAP. 6)  
**Hans-Martin Wiedenmann** *Robert Bosch GmbH* (CHAP. 6)  
**William G. Wolber** *Cummins Electronics Co., Inc.* (CHAPS. 8, 9)  
**Akatsu Yohsuke** *Nissan Motor Co., Ltd.* (CHAP. 17)

---

## PREFACE

---

Automotive electronics as we know it today encompasses a wide variety of devices and systems. Key to them all, and those yet to come, is the ability to sense and measure accurately automotive parameters. Equally important at the output is the ability to initiate control actions accurately in response to commands. In other words, sensors and actuators are the heart of any automotive electronics application. That is why they have been placed first in this handbook where they are described in technical depth. In other chapters, application-specific discussions of sensors and actuators can be found.

The importance of sensors and actuators cannot be overemphasized. The future growth of automotive electronics is arguably more dependent on sufficiently accurate and low-cost sensors and actuators than on computers, controls, displays, and other technologies. Yet it is those nonsensor, nonactuator technologies that are to many engineers the more "glamorous" and exciting areas of automotive electronics.

In the section on control systems, a key in-depth chapter deals with automotive microcontrollers. Without them, all of the controls described in the chapters that follow in that section—engine, transmission, cruise, braking, traction, suspension, steering, lighting, windshield wipers, air conditioner/heater—would not be possible. Those controls, of course, are key to car operation and they have made cars over the years more drivable, safe, and reliable.

Displays, trip computers, and on- and off-board diagnostics are described in another section, as are systems for passenger safety and convenience, antitheft, entertainment, and multiplex wiring. Displays and trip computers enable the driver to readily obtain valuable information about the car's operation and anticipated trip time. On- and off-board diagnostics have of necessity become highly sophisticated to keep up with highly sophisticated electronic controls. Passenger safety and convenience items and antitheft devices add much to the feeling of security and pleasure in owning an automobile. Entertainment products are what got automotive electronics started and they continue to be in high demand by car buyers. And multiplex wiring, off to a modest start in production cars, holds great promise for the future in reducing the cumbersome wiring harnesses presently used.

The section on electromagnetic interference and compatibility emphasizes that interference from a variety of sources, if not carefully taken into account early on, can raise havoc with what otherwise would be elegant automotive electronic designs. And automotive systems themselves, if not properly designed, can cause interference both inside and outside the automobile.

In the final section on emerging technologies, some key newer areas are presented:

- Navigation aids and intelligent vehicle-highway systems are of high interest worldwide since they hold promise to alleviate many of vehicle-caused problems and frustrations in our society.
- While it may be argued that electric vehicles are not an emerging technology, since they have been around for many years, it certainly is true that they have yet to come into their own in any really meaningful way.
- Electronic noise cancellation is getting increasing attention from automobile designers seeking an edge over their competitors.



The final chapter on future vehicle electronics is an umbrella discussion that runs the gamut of trends in future automotive electronics hardware and software. It identifies potential technology developments and trends for future systems.

Nearly every chapter contains its own glossary of terms. This approach, rather than one overall unified glossary, has the advantage of allowing terms to be defined in a more application-specific manner—in the context of the subject of each chapter. It should also be noted that there has been no attempt in this handbook to cover, except peripherally, purely mechanical and electrical devices and systems. To do so would have restricted the number of pages available for automotive electronics discussions.

Finally, the editor would like to thank all contributors to the handbook and particularly two individuals: Otto Holzinger of Robert Bosch GmbH in Stuttgart, Germany and Randy Frank of Motorola Semiconductor Products in Phoenix, Arizona. Holzinger organized the many contributions to this handbook from his company. Frank, in addition to contributing two chapters himself and cocontributing a third, organized the other contributions from Motorola. Without their help, this handbook would not have been possible.

*Ronald K. Jurgen*



---

**AUTOMOTIVE  
ELECTRONICS  
HANDBOOK**

---

Typically, the pressure differential is only a small percentage of the total line pressure and a system fault can expose one side of the sensor to the full line pressure. This must be taken into account when choosing the sensor and determining the rated pressure range that will be required. Differential pressure is frequently indicated by psid.

#### 2.1.4 Liquid Level Measurements

The height of a column of liquid can be measured by a pressure sensor. The term *head* is frequently used in hydraulics to denote pressure. Measurements of inches or feet of water and centimeters of mercury are direct indications of the effect of pressure on liquid level. Other liquid levels are dependent on their specific weight and can be calculated by  $h = (P_L - P_H)/w$ , where  $(P_L - P_H)$  is the pressure differential caused by the height of the fluid column and  $w$  is the specific weight of the liquid. The vapor pressure in a sealed enclosure will have an effect on the measurement of liquid height. Returning the reference side of a differential pressure sensor to the top of the enclosure will compensate for vapor pressure.

#### 2.1.5 Pressure Switch

A pressure switch is typically achieved by mounting an electric contact on a diaphragm (rubber or any elastic material). The application of sufficient pressure (or vacuum) on one side of the diaphragm causes the movable contact to meet a stationary contact and close the circuit.

A pressure switch can also be achieved by any of the previously described techniques merely by establishing a reference threshold voltage that is calibrated to indicate the point that the pressure changes from an acceptable to unacceptable (or low to high) level. Once the threshold voltage is achieved, additional electronic circuits can be used to produce an electronic switch that can control loads such as an indicator lamp.

## 2.2 AUTOMOTIVE APPLICATIONS FOR PRESSURE SENSORS

Automotive requirements for pressure measurements range from the basic—oil pressure—to the sophisticated—air pressure differential from one side of the vehicle to the other. This section elaborates on the various possibilities for pressure measurements that exist either in the development, laboratory, or pilot phases of the vehicle, to actual volume production. Table 2.2 lists a number of potential pressure measurements versus vehicle systems and provides an indication of the pressure range and type of measurement.

Automotive specification and testing guidelines have been developed and published by the Society of Automotive Engineers (SAE) specifically for manifold absolute pressure (MAP) sensors. These documents are intended to assist in establishing test methods and specifications for other sensors. Other SAE documents that may apply to sensors are summarized in Table 2.3.

The packaging and testing requirements for automotive sensors can represent 50 to 80 percent of the sensor cost and over 90 percent of the warranty and in-service problems. The pressure-sensing applications that are presented in the following sections will include packaging requirements that are of particular concern.

### 2.2.1 Existing Applications for Pressure Sensors

A late twentieth century production vehicle is likely to have a number of pressure sensors for measurements such as manifold pressure and engine oil pressure, and has the potential for

2.6 SENSORS AND ACTUATORS

TABLE 2.2 Pressure Sensing Requirements for Various Vehicle Systems

System	Parameter	Pressure range	Type
Engine control	Manifold absolute pressure	100 kPa	Absolute
	Turbo boost pressure	200 kPa	Absolute
	Barometric pressure (altitude)	100 kPa	Absolute
	EGR pressure	7.5 psi	Gage
	Fuel pressure	15 psi—450 kPa	Gage
	Fuel vapor pressure	15 in H <sub>2</sub> O	Gage
	Mass air flow		Differential
	Combustion pressure	100 Bar, 16.7 Mpa	Differential
	Exhaust gas pressure	100 kPa	Gage
	Secondary air pressure	100 kPa	Gage
Elect transmission (continuously variable transmission)	Transmission oil pressure	80 psi	Gage
	Vacuum modulation	100 kPa	Absolute
Idle speed control	AC clutch sensor/switch	300–500 psi	Absolute*
	Power steering pressure	500 psi	Absolute*
Elect power steering (also elect assisted)	Hydraulic pressure	500 psi	Absolute*
Antiskid brakes/ traction control	Brake pressure	500 psi	Absolute*
	Fluid level	12 in H <sub>2</sub> O	Gage
Air bags	Bag pressure	7.5 psi	Gage
Suspension	Pneumatic spring pressure	1 MPa	Absolute*
Security/keyless entry	Passenger compartment pressure	100 kPa	Absolute
HVAC (climate control)	Air flow (PC) Compressor pressure	300–500 psi	Absolute*
Driver information	Oil pressure	80 psi	Gage
	Fuel level	15 in H <sub>2</sub> O	Gage
	Oil level	15 in H <sub>2</sub> O	Gage
	Coolant pressure	200 kPa	Gage
	Coolant level	24 in H <sub>2</sub> O	Gage
	Windshield washer level	12 in H <sub>2</sub> O	Gage
	Transmission oil level	12 in H <sub>2</sub> O	Gage
	Tire pressure	50 psi	Gage/absolute
	Battery fluid level	1–2 in below	Optical
	Lumbar pressure	7.5 psi	Gage
Memory seat			
Multiplex/diagnostics	Multiple usage of sensors		

\* Gage measurement but absolute sensors used for failsafe.

TABLE 2.3 SAE Specifications That Effect Pressure Sensors

Recommended environmental practices for electronic equipment design	SAE J1211
Performance levels and methods of measurement of electromagnetic radiation from vehicles and devices	SAEJ551
Performance levels and methods of measurement of EMR from vehicles and devices (narrowband RF)	SAEJ1816
Electromagnetic susceptibility procedures for vehicle components (except aircraft)	SAE J1113
Vehicle electromagnetic radiated susceptibility testing using a large TEM cell	SAE J1407
Open-field whole-vehicle radiated susceptibility 10 kHz–18 GHz, electric field	SAE J1338
Class B data communication network interface	SAE J1850
Diagnostic acronyms, terms, and definitions for electrical/electronic components	SAE J1930
Failure mode severity classification	SAE J1812
Guide to manifold absolute pressure transducer representative test method	SAE J1346
Guide to manifold absolute pressure transducer representative specification	SAE J1347

several other pressure measurements. Tighter emissions control and improved efficiency may necessitate further sensor use in future systems.

**Manifold, Barometric and Turbo Boost Pressure.** Manifold absolute pressure (MAP) is used as an input to fuel and ignition control in internal combustion engine control systems. The speed-density system that uses the MAP sensor has been preferred over mass air flow (MAF) control because it's less expensive, but stricter emission standards are causing more manufacturers to use mass air flow for future models.

Higher resolution from 32-bit engine controllers, with greater analog-to-digital (A/D) conversion capability and higher operating frequencies, will provide greater accuracy for a given MAP sensor during the critical transitions of the engine cycle. As shown in Fig. 2.2, previous changes from 8-bit to 16-bit controllers have resulted in a two-time improvement in resolution in the digital conversion for the intake manifold pressure. The 8-bit control unit performed the A/D conversion on a 4-ms timer interrupt in order to maintain a balance with other controls, with the resulting 1.1-ms lag time (worst case) during periods of overlapping interrupts. The 16-bit microcontroller performs the A/D conversion every 2 ms, which reduces the lag time to 0.3 ms. The actual system improvements that can result from using the higher performing microcontrol units is a result of other factors such as more precise and faster control of fuel injectors and sparkplugs, and additional and/or more accurate sensors and control algorithms.

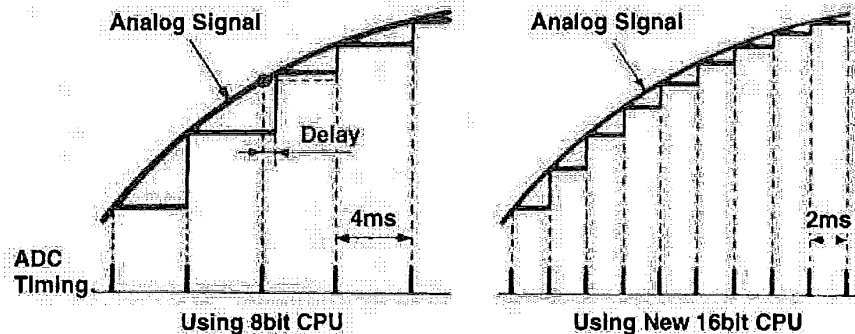

FIGURE 2.2 Effect of A-D on pressure measurements.

The MAP error band is also being tightened with a goal of 1 percent accuracy over the entire automotive temperature range. Existing specifications allow tolerances to increase as shown by the bowtie specification in Fig. 2.3 with associated multiplier(s).

The need for barometric pressure is often desirable in MAF systems to provide altitude information to the engine control computer. The barometric pressure range is typically from 60 to 115 kPa with accuracy on the order of 1.5 percent over the operating pressure range. The error band tolerance increases by a temperature multiplier of up to 2 $\times$  outside the 0 to 85  $^{\circ}$ C range. MAP and barometric pressure sensors are frequently mounted inside control modules making the mounting technique a key consideration for manufacturability. The increased usage of surface mount technology, and the need to reduce space so that additional features can be included in control modules are factors that will affect next-generation sensor designs.

A typical turbocharger can provide boost pressure in the range of 80 kPa over the naturally aspirated internal combustion engine. This increases the maximum rating for the sensor to 200 kPa absolute, but other requirements are scaled appropriately.

MPX4100 • MPX4101 SERIES

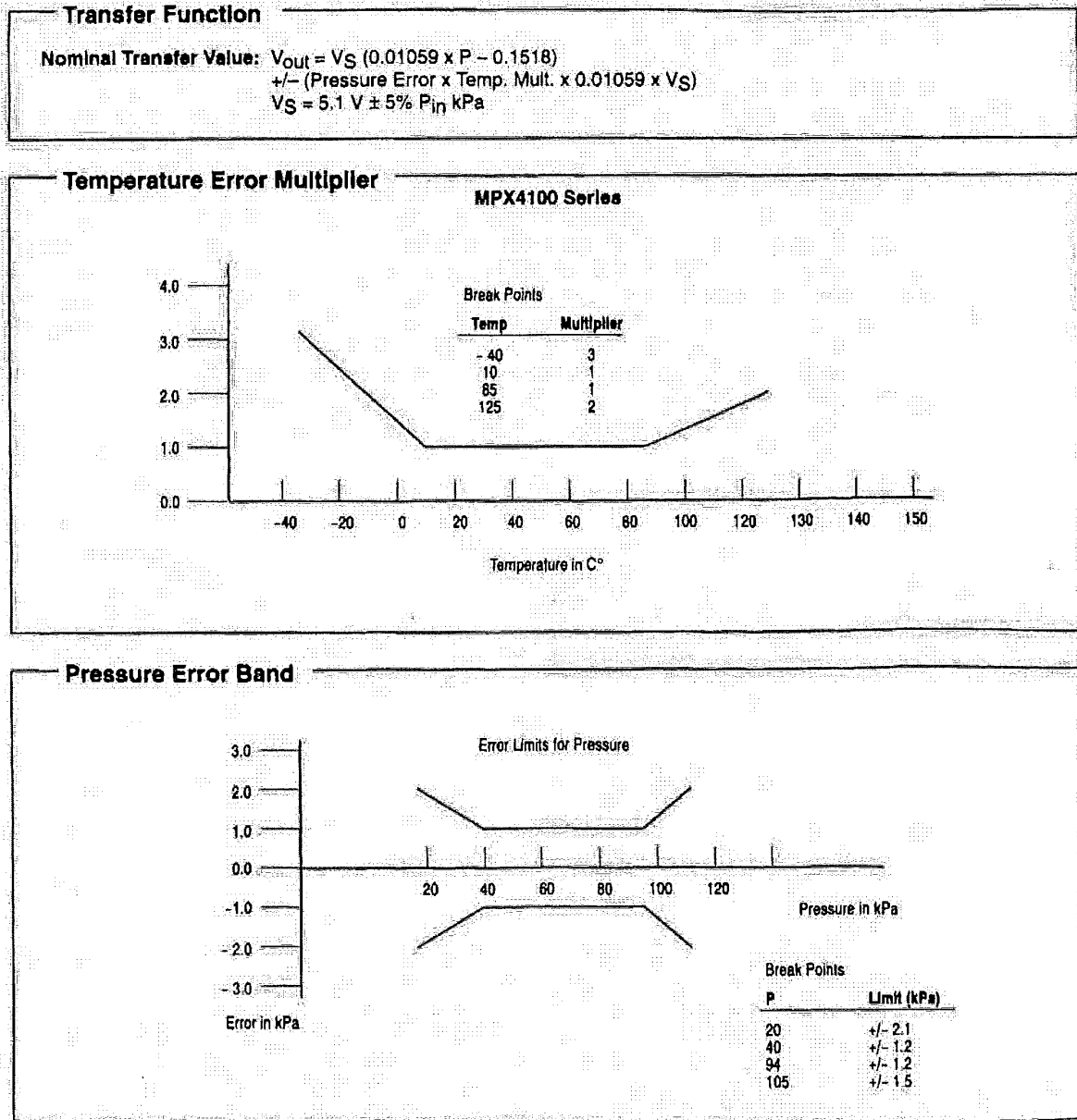

FIGURE 2.3 Error band for MAP sensor.

**Oil Pressure.** Oil pressure on automobiles has traditionally been measured by the deflection of a rubber diaphragm which closes a set of contacts (switch) providing a lamp indication with low oil pressure or moves a potentiometer to provide an analog signal for a gage.

A replacement for the conventional electromechanical oil pressure sending unit is an electronic device such as the one designed by Chrysler's Acustar Division. In addition to a silicon

piezoresistive pressure sensor, the unit contains transient protection circuitry, signal amplification for the sensor output, and output drivers for both an electromagnetic gauge and a fuel pump. The FET output drivers are capable of handling 10 A based on the heat dissipated through a heatsink that is integral to the sensor package.

The unit utilizes a supply voltage from 9 to 16 V and operates over a media temperature range of  $-40$  to  $+150$  °C. The overall accuracy is  $\pm 3.25$  percent with linearity  $\leq \pm 0.25$  percent over the entire operating pressure range of 200 psi. The switch point for the low pressure indication is  $4 \text{ psi} \pm 1.5 \text{ psi}$ .

The sensor package was specially designed for easy assembly. The housing interfaces to the sensor with an extremely reliable O-ring seal that can withstand a burst pressure over 400 psi. Special materials were used for both the package and the protective gel that covers the sensor, which allow it to survive qualification tests with over 1 million pressure cycles, including portions conducted at high temperatures. This exceeds the number of cycles that can be achieved with traditional diaphragm-driven potentiometers that have been used for providing the indication of oil pressure. The sensor has been designed for a 10-year/100,000-mile life that could be required for future vehicle warranties.

**Media Compatibility in Automotive Measurements.** Pressure sensors frequently have to interface with an environment that is more demanding than other electronic components. For example, the measurement of engine oil pressure, transmission oil pressure, fuel pressure, and so on, or fluid level (oil, gas, coolant, etc.) requires the sensor package to be exposed to one or more fluids that are detrimental to the operation of semiconductor circuitry. Each of these media interface problems is addressed separately, depending on the application. Automotive cost requirements usually limit the usage of stainless steel as the isolation technique. Instead, more cost-effective protective polymers and chemically tolerant plastic and rubber materials have been developed for sensor packages.

### 2.2.2 New Applications for Pressure Sensing

The list of potential applications for sensing pressure in the automobile includes several new applications. These measurements are frequently made during the development of new vehicle systems. Their actual use on the vehicle is determined by factors such as cost, legislated requirements, need for diagnostics, and value added to the system. Applications in this section will identify areas of concern, range of pressure measurement, and factors that affect the usage of a pressure sensor.

**Transmission Oil Pressure and Brake Pressure.** Transmission pressure is required as an input in computer-controlled transmission shift points. This pressure can be measured with sensors similar to those developed for engine oil pressure.

Pressure in a hydraulic system, such as the master cylinder of an antilock brake system (ABS), is much higher than transmission oil pressure typically requiring a sensor with minimum rating of 500 psig. Pressures in other locations in the ABS system can be lower. The dynamic pressures in brake tubing can be of interest during the development phase of passenger vehicles and may be of interest in heavy duty commercial vehicles. These pressures can be below 150 psig.

The ABS system controls front and rear tire slip. Tradeoffs that exist in developing an ABS system for a particular vehicle include stopping deceleration to achieve the shortest possible stopping distance versus more steering control. Increased yaw stability can be obtained by reducing the deceleration rate of the rear wheels. The addition of traction control to the system improves stability during acceleration and provides independent control of each wheel during a variety of driving maneuvers for improved vehicle performance.

Passenger vehicles may have a single pressure sensor to monitor the pressure in the hydraulic system. One system, General Motors' ABS-VI, provides information on the brake pressure by detecting the current going to motors in the system. For the ABS-VI system, a pres-

stripes of aluminum at 45° to the long axis. Two series-connected elements, which are mirror images of each other (reflected about the long axis), form a potential divider. Magnetoresistive sensors generally exhibit high sensitivity, but this leaves them prone to interference from unwanted fields and, therefore, they are unsuitable for some applications.

**Magnetostrictive.** Magnetostriction is a property of materials that respond to a change of magnetic flux by developing an elastic deformation of their crystal structure. Magnetostrictive linear displacement sensors utilize this phenomenon by launching a compression wave down a cylindrical waveguide using electromagnetic means, usually a current pulse. The waveguide passes through a movable permanent magnet ring at some distance from a receiver site. The compression wave generated at the magnet position travels to the receiver site at approximately 2800 m/s where it causes a change of flux and generates a voltage pulse in a sense coil. The time of flight of the pulse can be measured to determine the distance of the movable ring magnet down the wire. Transducers with stroke lengths in excess of 7.5 m are available that use this technique.

### 3.3.5 Other Technologies

A number of other technologies can be applied to position-sensing problems, limited only by engineering ingenuity. Some, like capacitive-sensing techniques, are not tolerant of the automotive environment due to sensitivity to humidity, vibration, or temperature or pressure extremes. Others, like resolvers of traditional construction, are sufficiently rugged but prohibitively expensive unless low-cost manufacturing techniques can be found. Occasionally, a nonobvious method finds a niche. An example is a fuel-level sensor disclosed by workers at Bosch,<sup>17</sup> which, in principle, could be applied as a position sensor. The device operates by exciting a metal rod with acoustic waves such that it resonates. One end of the rod is immersed in the fuel. The resonant frequency is a function of the depth of immersion and the fuel level can be determined by suitable electronics.

A significant influence in the selection of technologies for automotive use is the mandatory inclusion of safety systems. Microwave or laser-ranging techniques can be applied to anti-collision systems to anticipate obstacles at nighttime or in poor-visibility driving conditions. These will be a ubiquitous component of automobiles in years to come.

## 3.4 INTERFACING SENSORS TO CONTROL SYSTEMS

All sensors, whether they have digital or analog outputs, provide measurement of real-world phenomena that are then interpreted by another system to either indicate a value, a warning, or close a control loop. It is vitally important that the integrity of the data is maintained by the proper choice of interface.

Cost and reliability in automotive systems are primary drivers in the choice of interface. For a given performance, the sensor that requires the fewer connections will always be selected. In some cases, such as LVDTs where the basic sensor requires 5 or 6 wires, it may be advantageous to locate the signal-conditioning electronics with the sensor and communicate the processed data to a remote controller via a simple serial interface. Interfacing incremental or serial binary data to a microcontroller is straightforward. In the case of incremental data, typically the mechanical system being monitored is moved until some limit or index is detected. Knowledge of the absolute position of the mechanical component is then known. A counter or register can be set to an initial nonzero value or reset to zero. As the motion is detected, pulses from the incremental sensor can be counted and stored as a measure of position. The indexing cycle must be performed each time power is applied. Binary serial data can be read into a register and used directly with no further processing.



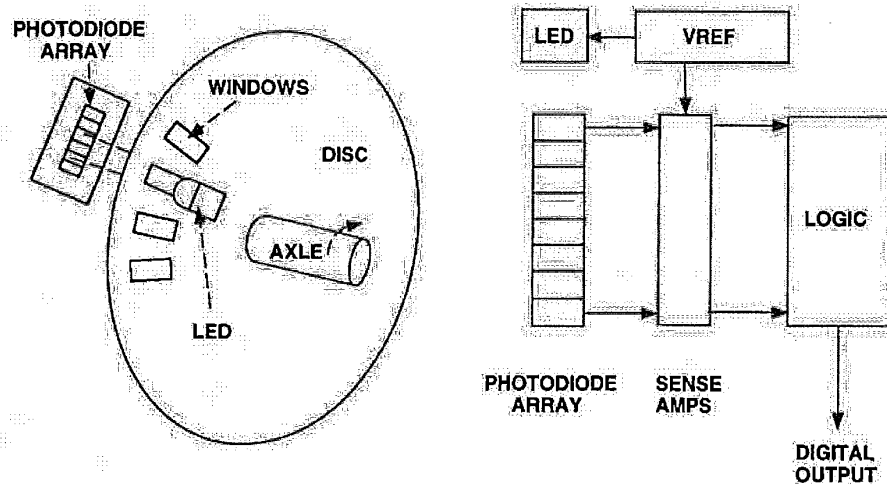

FIGURE 7.5 Optical sensor.

Optical and radio frequency (RF) devices are used for object detection, linear approach speed, and distance measurements in crash avoidance systems where distances greater than about 10 m are involved. These devices use the same principles as the ultrasonic devices. Optical devices normally use lasers or infrared devices for the transmitting source and optical sensors for the receivers. RF devices use gallium arsenide or Gunn devices to obtain the power and high frequency (about 100 GHz) required in the transmitter. The high operating frequency is set to a large extent by the need for a small antenna. These applications are under development and are discussed in Sec. 7.7.2.

### 7.3 AUTOMOTIVE APPLICATIONS FOR SPEED SENSING

There are several applications for rotational speed sensing. First it is necessary to monitor engine speed. This information is used for transmission control, engine control, cruise control, and possibly for a tachometer. Electronics and electronic sensing in the automobile were brought about by the need for higher-efficiency engines, better fuel economy, increased power and performance, and lower emissions. Second, wheel speed sensing is required for use in transmissions, cruise control, speedometers, antilock brake systems (ABS), traction control (ASR), variable ratio power steering assist, four-wheel steering, and possibly in inertial navigation and air bag deployment applications.

Linear speed sensing can be used to measure the ground speed. This measurement also has the possibility of use in ABS, ASR, and inertial navigation. Similar types of sensors can be used in crash avoidance, proximity, and obstacle detection applications.

#### 7.3.1 Rotational Applications

The high timing accuracy that can be obtained with fuel injection systems and replacement of points by sensors have made cost-effective engine control and low maintenance a reality. Adjustment of the stoichiometric ratio of air to fuel, accurate ignition timing, and oxygen sensors in the exhaust system, have vastly improved engine performance and greatly reduced emissions over widely varying operating conditions. The two important factors in engine con-

control are the engine speed in rpm and the crank angle. These signals are used by the engine control MCU for determination of fuel injection and ignition timing. The engine rpm measurement range is from 50 to (say) 8000 rpm. A resolution of about 10 rpm is required for an accuracy of about 0.2 percent. For injection and ignition control in a six-cylinder engine, the interval between combustion at maximum rpm is 2.5 ms, so that this time sets the injection period. In practice, a crank angle accuracy of between 1 and 2 degrees per revolution is required. Newer systems with sequential fuel injection, may also require information on TDC (top dead center) for each cylinder to determine the timing. With the low frequencies involved in this application, either Hall effect or MRE devices can be used for monitoring both the engine rpm and crank angle.

Vehicle speed measurements are in the range 0 to 180 km/h (120 mph) and digital displays must have an accuracy of 1 km/h. Some systems have a mechanical pickoff from the drive shaft, which can then use optical sensors for the measurement of road speed. However, newer systems have a pickoff located directly on the drive shaft, which makes optical devices less practical. It is preferred to eliminate the remote sensing via mechanical coupling to save the cost of the associated mechanical components, seals, maintenance, and so on. One method of pickoff is a ring magnet with between 4 and 20 magnetic poles (depending on the required resolution). Figure 7.6 shows such a system using an MRE sensing device. The magnetic flux changes are sensed by an MRE bridge sensor when the magnet disc is rotating. The bridge is supplied from a voltage reference circuit, and its output is amplified and shaped to give a frequency output that is proportional to shaft rotation speed. A ferrous toothed wheel pickoff with magnet and flux concentrator can also be used (see Fig. 7.2). Vehicle speed sensing can be performed with Hall effect, MRE, or VR devices. The number of pulses  $P$  per second from the detector are counted to measure speed  $S$ , from the following relationship:

$$P = N \times S \times K \tag{7.2}$$

where  $N$  = the number of magnetic poles on ring magnet or wheel teeth  
 $K$  = a constant determined by axle ratio and wheel size

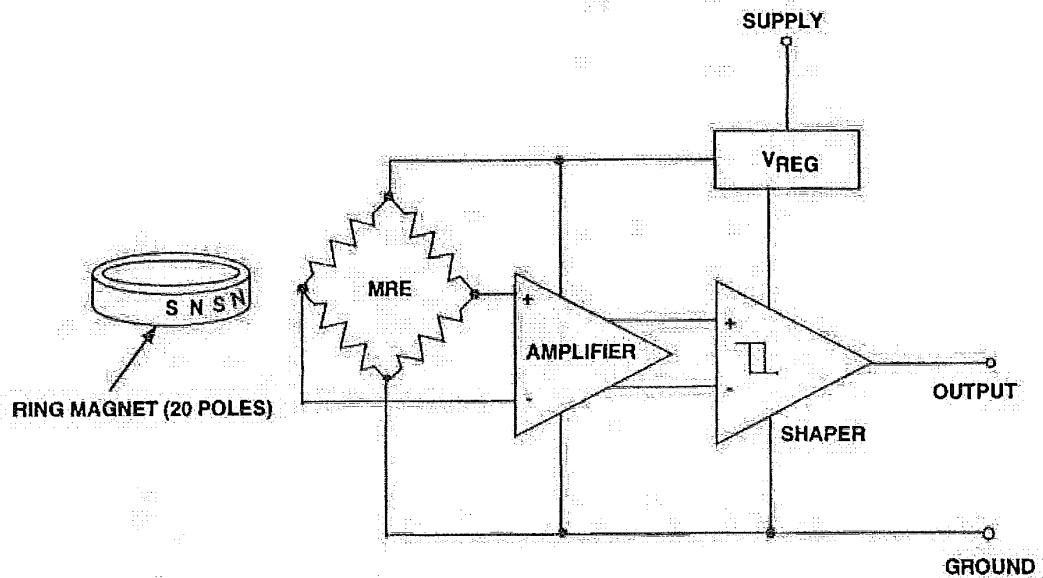

FIGURE 7.6 MRE speed-sensing module.

The resolution in vehicle speed is then:

$$\frac{P}{S} = N \times K \quad (7.3)$$

The typical system requirements are an operating temperature of  $-40$  to  $120$  °C, rotational speed detection of 5 to 3000 rpm (1000 p/s), and a duty cycle ratio of  $50 \pm 10\%$ .

In applications such as ABS, ASR, and four-wheel steering, additional speed sensors are attached to all four wheels so that the slip differential between the wheels can be measured. VR devices have been used and are very cost effective in this application. But the cost of other devices is dropping and as they become cost effective, they are being designed into new systems. In electronic transmission applications, information from the road and engine speed sensors, as well as torque data and throttle position are required for the MCU to select the optimum gear ratio. Electronic control can ensure smooth transition between gear ratios. Transmissions using electronic control are also smaller than conventional automatic transmissions, thus enabling more gear ratios for better performance, higher torque, efficiency, and acceleration.

Cruise control systems require information from the road and engine speed sensors to control the throttle position, and possibly the optimum selection of transmission ratios. Variable ratio assisted power steering also requires information from the wheel speed sensors for adjustment of the steering ratios for ease of turning at low speeds and good road control at high speeds. If automatic tire pressure adjustment becomes a reality, this system may also require information from the wheel speed sensors.

Another application for rotational speed sensing is to control the speed of the radiator cooling fan. The speed of the fan is determined by the coolant temperature. Hall effect devices (MRE can also be used) have been used to monitor the position of the armature and speed of the cooling fan motor. The motor controller uses this information to modulate the power to the motor through a three-phase bridge driving circuit for the control of the fan motor speed.

### 7.3.2 Linear Applications

Under linear applications are the detection of obstacles close to the vehicle, crash avoidance, distance of the chassis relative to the ground for ride control, measurement of ground speed for ABS, ASR, and inertial navigation. Ultrasonic devices are normally used for short distance measurements ( $<10$  m) and RF devices for long distance measurements (see Sec. 7.6.2). For the measurement of objects from 0.5 to 2 m using ultrasonics, a pulse repetition rate of about 15 Hz is used. The reflected pulses take from 3 to 12 ms to return. The return time  $T$  is given by

$$L = C \times \frac{T}{2} \quad (7.4)$$

where  $L$  = distance to target

$C$  = the transmission speed [given by  $C = 331 + 0.6 t$  (m/sec)]

$T$  = temperature (at 15 °C), the speed of ultrasonic waves is 340 m/s.

In the case of chassis-to-ground measurements for ride control and ground speed measurements, the distance to be measured is from 15 to 50 cm and a higher pulse repetition rate can be used (up to 50 Hz). In this case, the reflected pulse takes from 0.9 to 3 ms to return. For ride control applications, an accelerometer has an advantage over distance measurement, in that it is unaffected by varying distance measurements over rough terrain.

## 7.4 ACCELERATION SENSING DEVICES

Acceleration sensors vary widely in their construction and operation. In applications such as crash sensors for air bag deployment, mechanical devices (simple mechanical switches) have

the chassis remains at its static level. After the object has been traversed, oil is pumped back into the cylinder to reestablish the static load conditions.

An alternative to the active suspension is the adaptive suspension system. In this case, information from the front wheels is gathered and used to predict road conditions for the control of the rear wheels. The advantage over the fully active suspension is one of cost, as the number of acceleration sensors is halved. During cornering, oil is also pumped into the outside wheel cylinders to minimize roll angle.<sup>7</sup>

A combination of sensors is used for active suspension. These are accelerometers, wheel speed sensors, chassis-to-ground sensing, and piston-level sensing in the suspension system. The low g accelerometers used on the axles of the four wheels to detect the load changes on the wheels have the following specifications:  $\pm 2$  g full-scale, accuracy  $\pm 5$  percent over temperature, bandwidth dc to 10 Hz, and cross-axis sensitivity  $< 3$  percent. The acceleration information and data from the wheel speed sensors is used to provide the information necessary for the MCU to operate the servo control valves. Hall effect, MRE, and opto sensors have been used for monitoring the level of the pistons in the wheel stations cylinders.

### 7.5.3 Vibration Applications

Lean-burn engines are being developed for improved emission levels and for better fuel economy (10 to 15 percent improvement). NO<sub>x</sub> emissions are greatly reduced to meet federal standards. Lean-burn engines use high stoichiometric ratios; 20:1 and higher are necessary. At these ratios, combustion becomes unstable and torque fluctuations large. Consequently, anti-knock and vibration sensors are required to supply the information necessary to the MCU so that it can adjust the injected fuel amount and ignition timing for stability over widely varying conditions.

There are two types of solid state sensors that can be used in this application: piezoelectric devices and capacitively coupled vibration sensors. A typical vibration sensor contains a number of fingers of varying length which vibrate at their resonant frequencies when those frequencies are encountered. The resonance is capacitively coupled to the sensing circuit, and the outputs as shown are obtained. Optical sensors have also been used as antiknock sensors. In this case, the ignition spectrum is monitored for the detection of misfiring or knocking. Vibration sensors can also be used for vibration monitoring in maintenance applications.

### 7.5.4 Antilock Brake System Applications

In antilock brake systems, speed sensors are attached to all wheels to determine wheel rotation speed and slip differential between wheels. VR devices, as well as Hall effect and MRE devices, can be used in this application, as zero speed sensing is not required. VR devices have been used and shown to be cost effective in this application, but Hall effect and MRE devices are now being designed into these systems. Pressure sensors are used to monitor brake fluid pressure, and an accelerometer or ground-speed sensor can be used to provide information on changes in the vehicular speed. Brake pedal position and brake fluid pressure information are also required for control. All of this information is fed to an MCU, which processes the data and adjusts the brake fluid pressure to each wheel for optimum braking. Many of the elements of the ABS system can be used for the detection of lateral slippage on high-speed cornering, and can be used for traction and the direction of power to the wheels. Traction control applies in particular to slippery surfaces and with four-wheel-drive vehicles. Additional information over that used in ABS systems is required by the MCU for ASR applications, such as engine speed and throttle angle. In this application, servo feedback to the throttle may also be necessary.

A more cost-effective, but less accurate, system for ABS and ASR is the adaptive control system in which accelerometers are normally used to measure deceleration when braking, and

f 18 cm or  
d air bag.  
ten the air  
s: a piezo-

es over its  
ired buss-  
n improve-  
lerometer  
improved  
dge in this  
rements of  
tion, a typ-  
r tempera-  
the crash.

four wheel  
ed cylinder  
rame from  
th conven-  
l increases  
up. With a  
to transfer  
ier. Conse-  
c level and

## 7.22 SENSORS AND ACTUATORS

acceleration when the throttle is opened. If skidding occurs during braking, the brake pressure is reduced and adjusted for maximum deceleration, or the throttle adjusted for maximum traction. Typical specifications for the accelerometer required in this application are:  $\pm 1$  g full-scale output, accuracy  $\pm 5$  percent over temperature, bandwidth 0.5 to 50 Hz, and cross-axis sensitivity  $< 3$  percent.

## 7.6 NEW SENSING DEVICES

New cost-effective sensors are continually being developed. The technology and cost are often pushed by the application and volume requirements of the automotive industry and federal mandates. Today's silicon sensors and control electronics are limited in operating temperature to 150 °C to ensure long life of the devices. This operational temperature is adequate for most applications, but higher temperature operation may be required for sensors mounted in the engine compartment. The limit on the operating temperature of silicon devices can be extended to between 200 and 250 °C by the use of special isolation techniques such as dielectric isolation (this operating temperature applies to surface micromachined devices). For higher-temperature operation, alternative materials such as GaAs or SiC are being developed, but the cost of these devices limits their use at present.

A list of semiconductor conductor materials and maximum practical operating temperatures is given in Table 7.3. Higher operating temperatures have been reported but with poor longevity.

TABLE 7.3 Device Operating Temperatures

Material	Maximum practical operating temperature, °C
Si	150
Si (dielectric iso.)	250
GaAs	300
AlGaAs	350
GaP	400
SiC	500

7.6.2 Ne

### 7.6.1 New Rotational Speed-Sensing Devices

A number of new devices are being investigated to detect magnetic fields. These are flux gate, Weigand effect, magnetic transistor, and magnetic diode. The magnetic transistor at present is showing the most promise. The device operates on a similar principle to the Hall effect device. That is, the current division between split collectors (bipolar) or split drains (MOS) can be changed by a magnetic field. This current differential can then be detected and amplified to give an output voltage proportional to magnetic field strength. These devices can use either majority or minority carriers, and can be either vertical or lateral bipolar or MOS devices. The magnetic transistor has the potential of higher sensitivity than the Hall effect device.

Figure 7.21 shows the cross section of a lateral PNP magnetic transistor. The current from each collector is equal until a magnetic field is applied perpendicular to the surface of the device. The magnetic field causes an imbalance of current between the two collectors. Sensitivities with this type of structure have been reported as being an order of magnitude greater than in the Hall effect device.<sup>8</sup> Magnetic transistors and diodes can be directly integrated with the signal-conditioning circuits, which could make them very cost effective in future applications. A comparison of the magnetic transistor to other practical devices is given in Table 7.2.

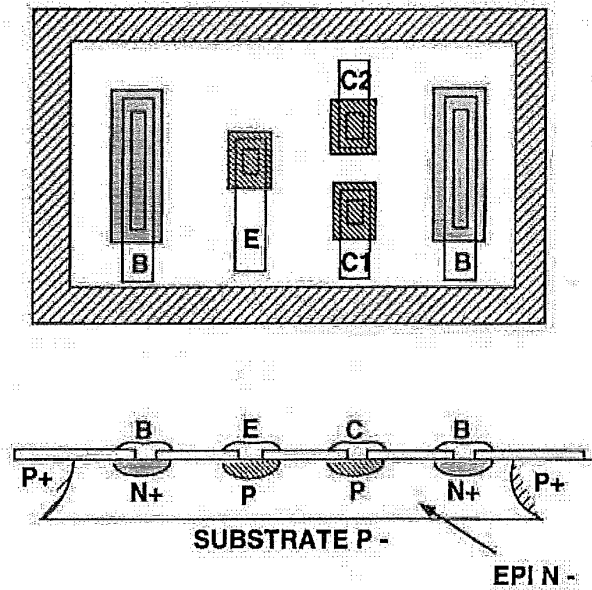

FIGURE 7.21 Cross section of a field-assisted PNP magnetic transistor.

7.6.2 New Linear Speed-Sensing Devices

A number of different sensing technologies can be used for distance, object detection, and approach speed measurements. Shown in Fig. 7.22 are the areas covered by blind-spot, rear, and forward-looking sensors. Ultrasonics, infrared, laser, and microwaves (radar) can be used in the detection of objects behind vehicles and in the blind areas. From a practical standpoint, no technology has come to the forefront. However, with new innovations in technology the situation may change very rapidly. Ultrasonics and infrared sensors are cost effective but degrade with inclement weather conditions such as ice, rain, snow, and the accumulation of road grime. Infrared devices are also color-sensitive, in that the sensitivity to shiny black objects is very low compared to other colors. Microwave devices appear to have the edge

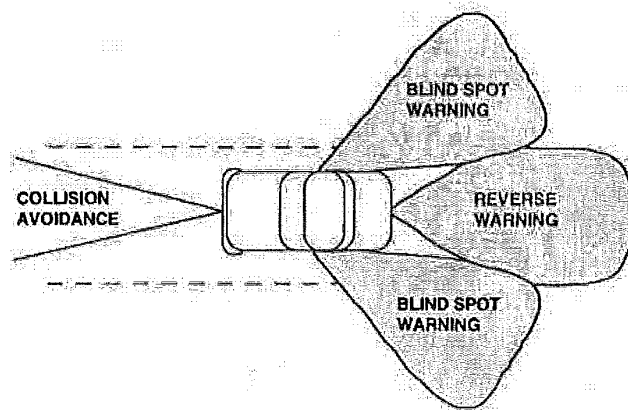

FIGURE 7.22 Collision-avoidance patterns.

when considering environmental conditions,<sup>9</sup> but are expensive, and radar can be affected by false return signals and clutter.

For the detection of obstacles and vehicles in front of a vehicle, the choice is between laser and microwaves due to the distances involved (up to 90 m). Microwaves have the disadvantage of high cost and large antenna size when considering available devices in the 60 GHz range. Frequencies greater than 100 GHz are preferred for acceptable antenna size. However, collision avoidance radar in the 76/77-GHz band has been developed in Europe. Collision avoidance radar in the 77, 94, and 144 GHz is being considered in the United States. A typical system uses a 38.5-GHz VCO (voltage controlled oscillator) with frequency-doubling to obtain about 40 mW of power at 77 GHz. A frequency-modulated continuous wave or pulse-modulated system can be used. The system uses GaAs devices to meet the frequency and power requirements. Lasers can be cost effective in this application, but also have their drawbacks: degradation of performance by fog, reflections from other light sources (sun, etc.), build-up of road grime on sensor surfaces, and poor reflecting surfaces at laser frequencies, such as grimy and shiny black surfaces.

### 7.6.3 New Inertial and Acceleration-Sensing Devices

Recent developments in solid state technology have made possible very small cost-effective devices to sense angular rotation. The implementation of one such gyroscopic device is shown in Fig. 7.23. This device is fabricated on a silicon substrate using surface micromachining techniques. In this case, three layers of polysilicon are used, with the first and third layers being fixed and the second layer free to vibrate about its center. The center is held in position by four spring arms attached to four mounting posts as shown. This device can sense rotation about the *X* and *Y* axes and sense acceleration in the direction of the *Z* axis. The center layer of polysilicon, driven by electrostatic forces, vibrates about the *Z* axis. These forces are produced by voltages applied between the fixed comb fingers and the comb fingers of the second polysilicon. Capacitor plates as shown are formed between the first and third polysilicon on the *X* and *Y* axes, and the second layer of polysilicon. Differential capacitive sensing techniques can then be used to sense any displacement of the vibrating disc caused by angular rotation. For example, if angular rotation takes place about the *X* axis, Coriolis forces produce a deflection of the disc about the *Y* axis. This deflection can be detected by the capacitor plates on the *X* axis. The sensing of the three functions is achieved by using a common sensing circuit that alternatively senses the *X* rotation, *Y* rotation, and acceleration. The gyroscope is designed to have a resolution of <10 degrees per hour for angular rate measurements, and an acceleration resolution of 0.5 mg.

## 7.7 FUTURE APPLICATIONS

New applications to increase creature comfort and safety are constantly being developed, but their rate of introduction will depend on the cost effectiveness of the technology, demand, and government mandates. Other concerns of automotive manufacturers are size, weight, power requirements, and adverse effects on styling and appearance. Many of the new sensor technologies are in their infancy, and thus are not yet cost effective on medium- and low-priced automobiles, but are being made available as options on luxury cars.

### 7.7.1 Future Rotational Speed-Sensing Applications

A future application for speed-sensing devices will be in continuously variable transmissions. In this application, engine and wheel speed, as well as torque, will be measured, and the infor-

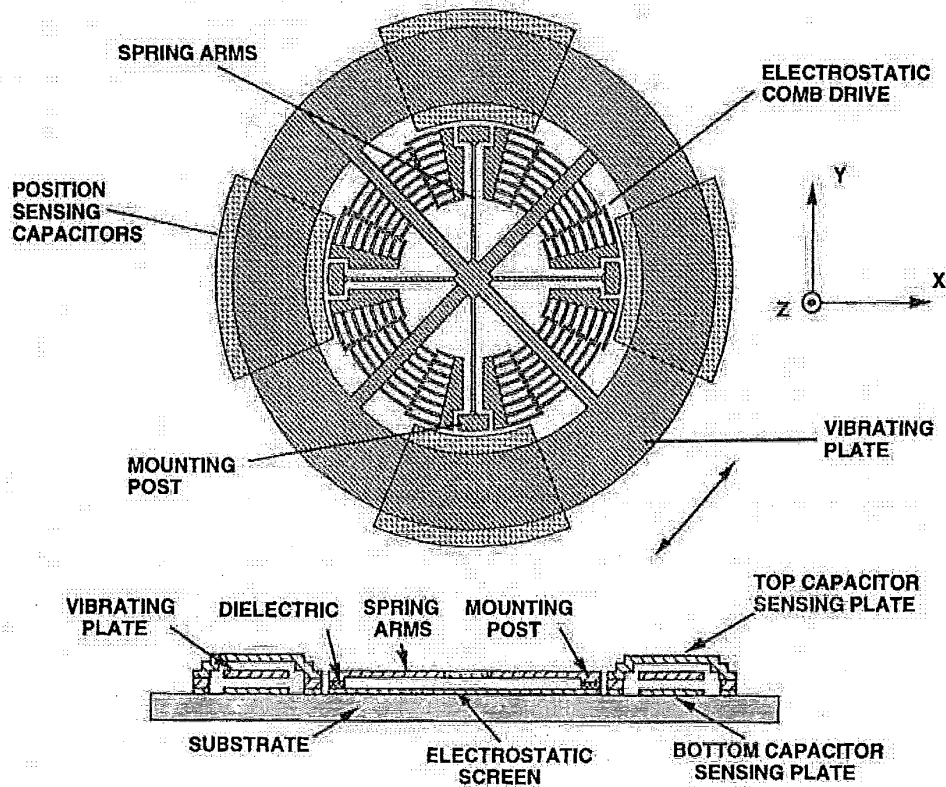

FIGURE 7.23 Solid state gyroscope.

mation processed by an MCU to optimize transmission ratios for engine performance and efficiency. All-wheel steering is also under development, and requires speed-sensing information, in addition to steering, front-, and rear-wheel angle position data for processing and control.

### 7.7.2 Future Linear Speed-Sensing Applications

Another application that has been developed is the use of speed- and distance-measuring devices for collision avoidance. These devices fall into three categories: near-obstacle detection (rear), blind-spot detection, and semiautomatic frontal object detection and control<sup>9</sup> (see Fig. 7.22).

Near-obstacle detection is used to prevent accidents during reversing. Blind-spot detection is used to prevent accidents due to careless lane changing, and when backing out of a driveway, garage, or alley into traffic. The semiautomatic frontal detection is a long-range system. The distance and closing speed between vehicles, or between a vehicle and a fixed object, can be measured and the speed adjusted as necessary to avoid a collision,<sup>10</sup> or the driver can be warned of impending danger. An addition to this is to monitor road surface conditions for friction—for example, dry roads compared to wet or icy roads—and also to use this information to adjust approach speeds and distance. Without collision avoidance, road condition monitoring can be used to caution vehicle operators. Collision avoidance systems can be used to minimize collisions, or can be used to operate protection systems before an unavoidable collision happens to protect the automobile passengers. In this case, vehicles closing at or approaching an obstacle at 80 km/h will be less than 7 m apart before a collision-is-imminent



determination can be made. This gives 200 ms decision-making time for the system MCU. This is, however, long compared to today's air bag deployment systems, which have 20 ms decision-making time after the event. In the future, an idealistic system may be a combination of the two systems.

### 7.7.3 Future Acceleration Applications

One of the future applications being considered is the expansion of the air bag system to include side impact protection. The sensor used for crash sensing is unidirectional, so that it can only detect forward impact. A similar sensor, mounted perpendicular to the air bag sensor, can be added to the system to detect side impact and to deploy protection for the passengers. This device will typically require a 250-g accelerometer. Another application for accelerometers is to detect slippage during cornering in advanced steering systems. These systems will employ a low-g accelerometer (1–2 g).

### 7.7.4 Inertial Navigation Applications

A number of inertial navigation systems are being developed for short- and long-range travel. Long-range inertial navigation systems normally obtain their location by using a triangulation method. This method references three navigation satellites with known locations in fixed orbits. However, there are certain conditions under which contact with all three satellites is lost. This occurs when the vehicle is in the shadow of tall buildings or high hills, and triangulation is not possible. Under these conditions, the guidance system has to rely on such devices as gyroscopes, which sense angular rotation or change in direction, and/or monitor vehicular motion relative to the road.

Short-range inertial navigation systems or inertial measurement units (IMU) rely to a large extent on high-accuracy accelerometers and gyroscopes. A typical accelerometer specification for this application is:  $\pm 2$ -g full-scale output, accuracy 0.5 percent over temperature, bandwidth dc to 20 Hz, and a cross-axis sensitivity <0.5 percent. A centrally located IMU can be expanded to cover other applications such as suspension, ABS, ASR, and working with crash avoidance sensors. This may be the way to handle cost-effective system design in the future. The IMU can also be designed to provide location data for intelligent vehicle highway systems. These systems (Prometheus,<sup>11</sup> Amtics<sup>12</sup>) improve travel efficiency and reduce fuel consumption and pollution by selecting the optimum route to a given destination. The route is chosen to avoid traffic congestion, road construction, and accidents (see Chap. 29).

## 7.8 SUMMARY

In this chapter, a number of speed-sensing devices, both rotary and linear, have been described, together with potential applications. VR, MRE, Hall effect, and opto devices (possibly magnetic transistor in future applications) can be used in rotational applications for engine control, transmission, and wheel speed sensing. Of these devices, Hall effect, VR, and opto have been widely used. With the tendency for direct pickoff, optical devices may become impractical. MRE devices are being designed in and will become a serious contender to the Hall effect device. In linear applications for crash avoidance, microwave devices have the edge over performance and optical devices in terms of cost. However, as the cost of microwave devices declines, they could become cost effective. For blind-area alert and reversing obstacle detection, ultrasonics and infrared devices are cost effective, but performance degrades during inclement weather.

---

# CHAPTER 11

---

# AUTOMOTIVE MICROCONTROLLERS

---

**David S. Boehmer**  
*Senior Applications Engineer*  
*Intel Corporation*

A microcontroller can be found at the heart of almost any automotive electronic control module or ECU in production today. Automotive systems such as antilock braking control (ABS), engine control, navigation, and vehicle dynamics all incorporate at least one microcontroller within their ECU to perform necessary control functions. Understanding the various features and offerings of microcontrollers that are available on the market today is important when making a selection for an application. This chapter is intended to provide a look at various microcontroller features and provide some insight into their characteristics from an automotive application point of view.

## **11.1 MICROCONTROLLER ARCHITECTURE AND PERFORMANCE CHARACTERISTICS**

---

A microcontroller can essentially be thought of as a single-chip computer system and is often referred to as a single-chip microcomputer. It detects and processes input signals, and responds by asserting output signals to the rest of the ECU. Fabricated upon this highly integrated, single piece of silicon are all of the features necessary to perform embedded control functions. Microcontrollers are fabricated by many manufacturers and are offered in just about any imaginable mix of memory, I/O, and peripheral sets. The user customizes the operation of the microcontroller by programming it with his or her own unique program. The program configures the microcontroller to detect external events, manipulate the collected data, and respond with appropriate output. The user's program is commonly referred to as code and typically resides on-chip in either ROM or EPROM. In some cases where an excessive amount of code space is required, memory may exist off-chip on a separate piece of silicon. After power-up, a microcontroller executes the user's code and performs the desired embedded control function.

Microcontrollers differ from microprocessors in several ways. Microcontrollers can be thought of as a complete microcomputer on a chip that integrates a CPU with memory and various peripherals such as analog-to-digital converters (A/D), serial communication units (SIO, SSIO), high-speed input and output units (HSIO, EPA, PWM), timer/counter units, and

11.3

standard low-speed input/output ports (LSIO). Microcontrollers are designed to be embedded within event-driven control applications and generally have all necessary peripherals integrated onto the same piece of silicon. Microcontrollers are utilized in applications ranging from automotive ABS to household appliances in which the microcontroller's function is pre-defined and limited user interface is required.

Microprocessors, on the other hand, typically require external peripheral devices to perform their intended function and are not suited to be utilized in single-chip designs. Microprocessors basically consist of a CPU with register arrays and interrupt handlers. Peripherals such as A/D and HSIO are rarely integrated onto microprocessor silicon. Microprocessors are designed to process large quantities of data and have the capability to handle large amounts of external memory. Although microprocessors are typically utilized in applications which are much more human-interface and I/O intensive such as personal computers and office workstations, they are beginning to find their way into embedded applications.

Choosing a microcontroller for an application is a process that takes careful investigation and thought. Items such as memory size, frequency, bus size, I/O requirements, and temperature range are all basic requirements that must be considered when choosing a microcontroller. The microcontroller family must possess the performance capability necessary to successfully accomplish the intended task. The family should also provide a memory, I/O, and frequency growth path that allows easy upgradability to meet market demands. Additionally, the microcontroller must meet the application's thermal requirements in order to guarantee functionality over the intended operating temperature range. Items such as these must all be considered when choosing a microcontroller for an automotive application.

### 11.1.1 Block Diagram

Usually the first item a designer will see when opening a microcontroller data book or data sheet is a block diagram. A block diagram provides a high-level pictorial representation of a microcontroller and depicts the various peripherals, I/O, and memory functions the microcontroller has to offer. The block diagram gives the designer a quick indication if the particular microcontroller will meet the basic memory, I/O, and peripheral needs of their application. Figure 11.1 shows a block diagram for a state-of-the-art microcontroller. It depicts 32 Kbytes

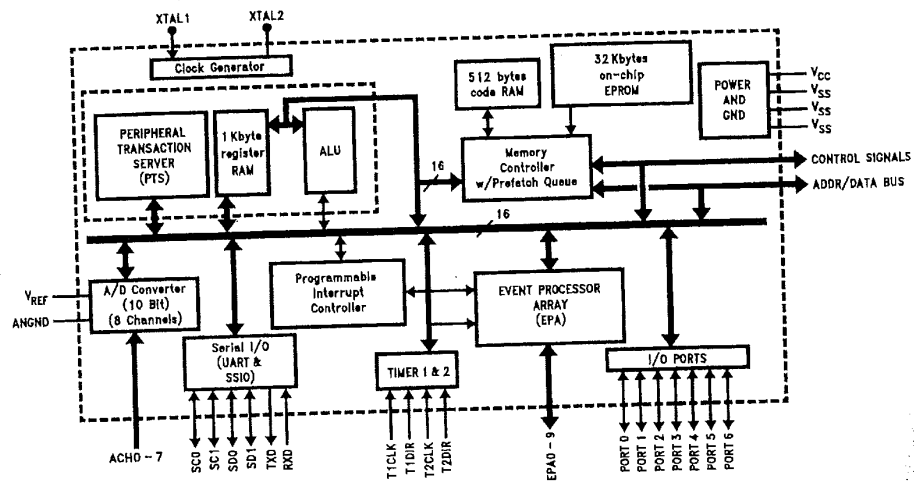

FIGURE 11.1 Microcontroller block diagram.

Ambient temperature under bias (TA) refers to the temperature range that the microcontroller is guaranteed to operate at within a given application. While powered-up or operating, a microcontroller must not be subjected to temperatures that exceed its specified ambient temperature range. The most common ambient temperature ranges in industry are:

- Commercial     0 to +70 °C
- Extended        -40 to +85 °C
- Automotive      -40 to +125 °C

**11.2 MEMORY**

Microcontrollers execute customized programs that are written by the user. These programs are stored in either on-chip or off-chip memory and are often referred to as the *user's code*. On-chip memory is actually integrated onto the same piece of silicon as the microcontroller and is accessed over the internal data bus. Off-chip memory exists on a separately packaged piece of silicon and is typically accessed by the microcontroller over an external address/data bus.

A memory map shows how memory addresses are arranged in a particular microcontroller. Figure 11.19 shows a typical microcontroller memory map.

Address	Memory Function		
0FFFFh 0A000h	External Memory		
9FFFh 2080h 207Fh	Internal ROM/EPROM or External Memory		
2000h	Internal ROM/EPROM or External Memory (Interrupt vectors, CCB's, Security Key, Reserved locations, etc.)		
1FFFh 1F00h 1EFFh	Internal Special Function Registers (SFR's)		
0600h 05FFh	External Memory		
0400h	INTERNAL RAM (Address with indirect or indexed modes.) (Also know as Code RAM)		
03FFh 0100h 00FFh	Register RAM	Upper Register File (Address with indirect or indexed modes or through windows.)	Register File
0018h 0017h 0000h	Register RAM	Lower Register File (Address with direct, indirect or indexed modes.)	
	CPU SFRs		

FIGURE 11.19 Microcontroller memory map.

Memory is commonly referred to in terms of Kbytes of memory. One Kbyte is defined as 1024 bytes of data. Memory is most commonly arranged in bytes which consist of 8 bits of data. For instance, a common automotive EPROM is referred to as a "256k × 8 EPROM". This EPROM contains 256-Kbytes 8-bit memory locations or 2,097,152 bits of information.

### 11.2.1 On-Chip Memory

On-chip microcontroller memory consists of some mix of five basic types: random access memory (RAM), read-only memory (ROM), erasable ROM (EPROM), electrically erasable ROM (EEPROM), and flash memory. RAM is typically utilized for run-time variable storage and SFRs. The various types of ROM are generally used for code storage and fixed data tables.

The advantages of on-chip memory are numerous, especially for automotive applications, which are very size and cost conscious. Utilizing on-chip memory eliminates the need for external memory and the "glue" logic necessary to implement an address/data bus system. External memory systems are also notorious generators of switching noise and RFI due to their high clock rates and fast switching times. Providing sufficient on-chip memory helps to greatly reduce these concerns.

**RAM.** RAM may be defined as memory that has both read and write capabilities so that the stored information can be retrieved (read) and changed by applying new information to the cell (write). RAM found on microcontrollers is that of the static type that uses transistor cells connected as flip-flops. A typical six-transistor CMOS RAM cell is shown in Fig. 11.20. It consists of two cross-coupled CMOS inverters to store the data and two transmission gates, which provide the data path into or out of the cell. The most significant characteristic of static memory is that it loses its memory contents once power is removed. After power is removed, and once it is reapplied, static microcontroller RAM locations will revert to their default state of a logic "0". Because of the number of transistors used to construct a single cell, RAM memory is typically larger per bit than EPROM or ROM memory.

Although code typically cannot be executed from register RAM, a special type of RAM often referred to as *code RAM* is useful for downloading small segments of executable code. The difference between code and register RAM is that code RAM can be accessed via the

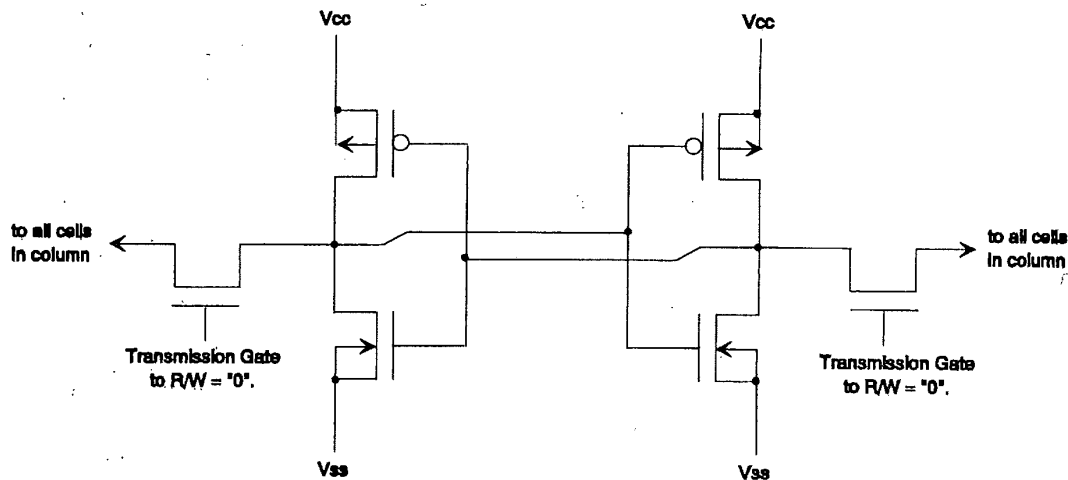

FIGURE 11.20 CMOS RAM memory cell.

memory controller, thus allowing code to be executed from it. Code RAM is especially useful for end-of-line testing during ECU manufacturing by allowing test code to be downloaded via the serial port peripheral.

**ROM.** Read-only memory (ROM), as the name implies, is memory that can be read but not written to. ROM is used for storage of user code or data that does not change since it is a non-volatile memory that retains its contents after power is removed. Code or data is either entered during the manufacturing process (masked ROM, or MROM) or by later programming (programmable ROM, or PROM); either way, once entered it is unalterable.

A ROM cell by itself (Fig. 11.21) is nothing more than a transistor. ROM cells must be used in a matrix of word and bit lines (as shown in Fig. 11.22) in order to store information. The word lines are connected to the address decoder and the bit lines are connected to output buffers. The user's code is permanently stored by including or omitting individual cells at word and bit line junctions within the ROM array. For MROMs, this is done during wafer fabrication. For PROMs, this is done by blowing a fuse in the source/drain connection of each cell. To read an address within the array, the address decoder applies the address to the memory matrix. For any given intersection of a word and bit line, the absence of a cell transistor allows no current to flow and causes the transistor to be off. This indicates an unprogrammed ROM cell. The presence of a complete cell conducts and is sensed as a logical "0", indicating a programmed cell. The stored data on the bit lines is then driven to the output buffers.

MROMs are typically used for applications whose code is stable and in volume production. After the development process is complete and the user's program has been verified, the user submits the ROM code to the microcontroller manufacturer. The microcontroller manufacturer then produces a mask that is used during manufacturing to permanently embed the program within the microcontroller. This mask layer either enables or disables individual ROM cells at the junctions of the word and bit lines. An advantage of MROM microcontrollers is that they come with user code embedded, which saves time and money since post-production programming is not necessary. A disadvantage of MROM devices is that, since the mask with the user code has to be supplied early in the manufacturing process, throughput time (TPT) is longer.

Some versions of ROM (such as Intel's Quick-ROM) are actually not ROMs, but rather EPROMs, which are programmed at the factory. These devices are packaged in plastic devices, which prevents them from being erased since ultraviolet light cannot be applied to the actual EPROM array. Throughput time for QROMs is faster since the user code isn't required until after the actual manufacturing of the microcontroller is complete. As with

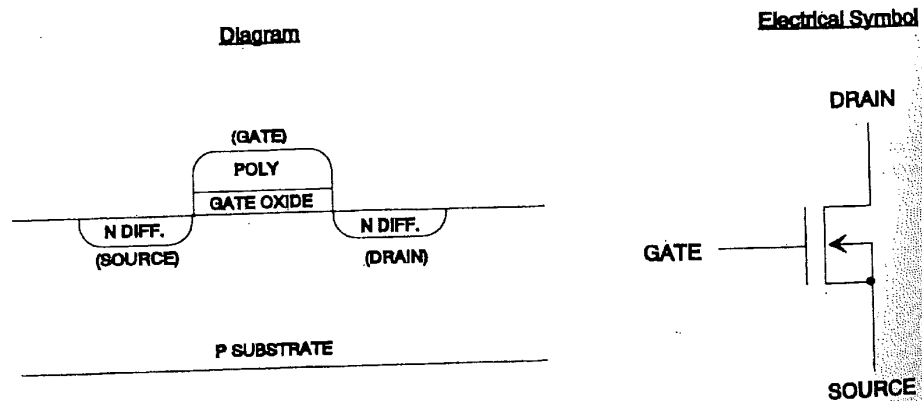

FIGURE 11.21 ROM memory cell.

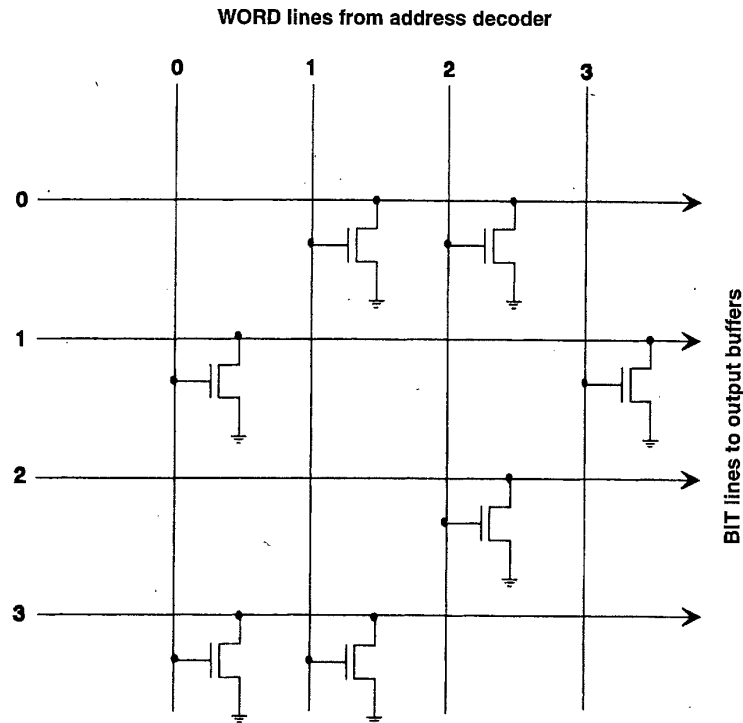

FIGURE 11.22 Simplified ROM memory matrix.

MROMs, the user supplies the ROM code to the microcontroller manufacturer. Instead of creating a mask with the ROM code, the manufacturer programs it into the device just prior to final test.

**EPROM.** EPROM devices are typically used during application development since this is when user code is changed often. EPROMs are delivered to the user unprogrammed. This allows the user to program the code into memory just prior to installation into an ECU module. Many EPROM microcontrollers actually provide a mechanism for in-module programming. This feature allows the user to program the device via the serial port while it is installed in the module. EPROM devices come assembled in packages either with or without a transparent window. Windowed devices are true EPROM devices that allow the user to erase the memory contents by exposing the EPROM array to ultraviolet light. These devices may be reprogrammed over and over again and thus are ideally suited for system development and debug during which code is changed often. EPROM devices assembled in a package without a window are commonly referred to as *one-time programmable devices* or OTPs. OTPs may only be programmed once, since the absence of a transparent window prevents UV erasure. OTPs are suited for limited production validation (PV) builds in which the code will not be erased.

A typical EPROM cell is shown in Fig. 11.23. It is basically an N-channel transistor that has an added poly1 floating gate to store charge. This floating gate is not connected and is surrounded by insulating oxide that prevents electron flow. The mechanism used to program an EPROM cell is known as *hot electron injection*. Hot electron injection occurs when very high drain (9-V) and select gate (12-V) voltages are applied. This gives the negatively charged electrons enough energy to surmount the oxide barrier and allows them to be stored on the gate.

This has the same effect as a negative applied gate voltage and turns the transistor off. When the cell is unprogrammed, it can be turned on like a normal transistor by applying 5 V to the poly2 select gate. When it is programmed, the 5 V will not turn on the cell. The state of the cell is determined by attempting to turn on the cell and detecting if it turns on. Erasure is performed through the application of ultraviolet (UV) light, which gives just the right amount of energy necessary for negatively charged electrons to surmount the oxide barrier and leave the floating gate.

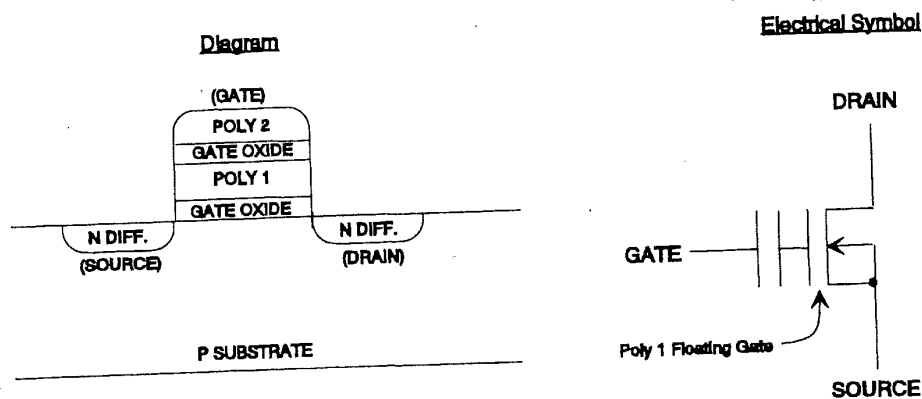

FIGURE 11.23 EPROM memory cell.

**Flash.** Flash memory is the newest nonvolatile memory technology and is very similar to EPROM. The key difference is that flash memory can be electrically erased. Once programmed, flash memory contents remain intact until an erase cycle is initiated via software. Like EEPROM, flash memory requires a programming and erase voltage of approximately 12.0 V. Since a clean, regulated 12-V reference is not readily available in automotive environments, this need is often provided for through the incorporation of an on-chip charge pump. The charge pump produces the voltage and current necessary for programming and erasure from the standard 5-V supply voltage. The advantage of flash is in its capability to be programmed and erased in-module without having to be removed. In-module reprogrammability is desirable since in-vehicle validation testing doesn't always allow for easy access to the microcontroller. Flash also allows for last-minute code changes, data table upgrades, and general code customization during ECU assembly. Since a flash cell is nearly identical in size to that of an EPROM cell, the high reliability and high device density capable with EPROM is retained. The main disadvantage of flash is the need for an on-chip charge pump and special program and erase circuitry, which adds cost.

A flash memory cell is essentially the same as an EPROM cell, with the exception of the floating gate. The difference is a thin oxide layer which allows the cell to be electrically erased. The mechanism used to erase data is known as *Fowler-Nordheim tunneling*, which allows the charge to be transferred from the floating gate when a large enough field is created. Hot electron injection is the mechanism used to program a cell, exactly as is done with EPROM cells. When the floating gate is positively charged, the cell will read a "1", when negatively charged, the cell will read a "0".

**EEPROM.** EEPROM (electrically erasable and programmable ROM, commonly referred to as E<sup>2</sup>ROM) is a ROM that can be electrically erased and programmed. Once programmed, EEPROM contents remain intact until an erase cycle is initiated via software. Like flash, programming and erase voltages of approximately 12 V are required. Since a clean, regulated 12-V reference is not readily available in automotive environments, this requirement is satisfied using an on-chip charge pump as is done for flash memory arrays. Like flash, the advantage of EEPROM is its



capability to be programmed and erased in-module. This allows the user to erase and program the device in the module without having to remove it. EEPROM's most significant disadvantage is the need for an on-chip charge pump. Special program and erase circuitry also adds cost.

An EEPROM cell is essentially the same as an EPROM cell with the exception of the floating gate being isolated by a thin oxide layer. The main difference from flash is that Fowler-Nordheim electron tunneling is used for *both* programming and erasure. This mechanism allows charge to be transferred to or from the floating gate (depending upon the polarity of the field) when a large enough field is created. When the floating gate is positively charged, the cell will read a "1"; when negatively charged, the cell will read a "0".

### 11.2.2 Off-Chip Memory

Off-chip memory offers the most flexibility to the system designer, but at a price; it takes up additional PCB real estate as well as additional I/O pins. In cost- and size-conscious applications, such as automotive ABS, system designers almost exclusively use on-chip memory. However, when memory requirements grow to sizes in excess of what is offered on-chip (such as is common in electronic engine control), the system designer must implement an off-chip memory system. Off-chip memory is flexible because the user can implement various memory devices in the configuration of his choice. Most microcontrollers on the market today offer a wide variety of control pins and timing modes to allow the system designer flexibility when interfacing to a wide range of external memory systems.

**Accessing External Memory.** If circuit designers must use external memory in their applications, the type of external address/data bus incorporated onto the microcontroller should be considered. If external memory is not used, this will have, if any, impact upon the application. There are two basic types of interfaces used in external memory systems. Both of these are parallel interfaces in which bits of data are moved in a parallel fashion and are referred to as *multiplexed* and *demultiplexed* address/data buses.

**Multiplexed Address/Data Buses.** As the name implies, multiplexed address/data buses allow the address as well as the data to be passed over the same microcontroller pins by multiplexing the two in time. Figure 11.24 illustrates a typical multiplexed 16-bit address/data bus system as is implemented with Intel's 8XC196Kx family of microcontrollers.

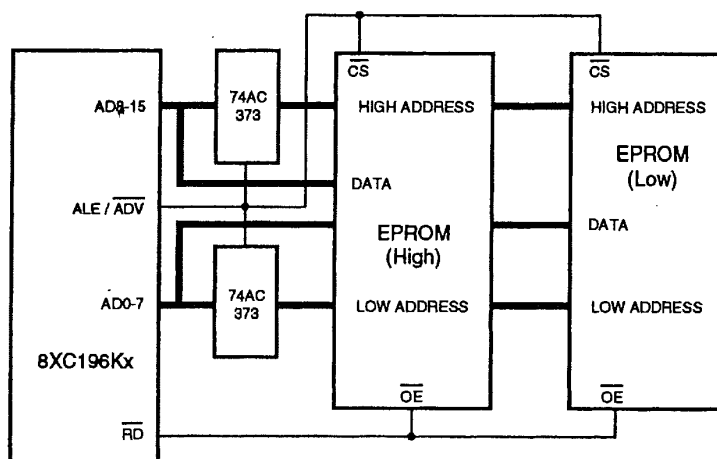

FIGURE 11.24 Multiplexed address/data bus system.

During a multiplexed bus cycle (refer to Fig. 11.25), the address is placed on the bus during the first half of the bus cycle and then latched by an external address data latch. The signal to latch the address comes from a signal generated by the microcontroller, called address latch enable (ALE). The address must be present on the bus for a specified amount of time prior to ALE being asserted. After the address is latched, the microcontroller asserts either a read (RD#) or a write (WR#) signal to the external memory device.

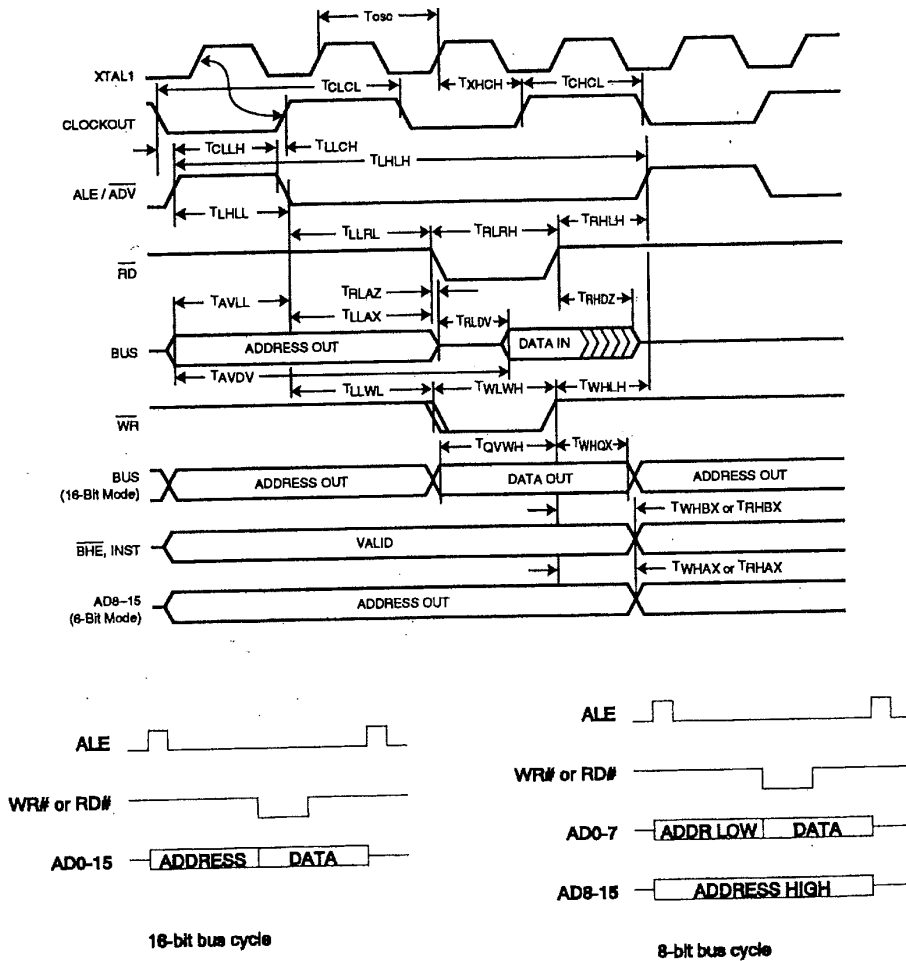

FIGURE 11.25 Multiplexed bus cycle and timing diagram.

For a read cycle, the microcontroller will pull its RD# output pin low and float the bus to allow the memory device to output the data located at the address latched on its address pins. The data returned from external RD memory must be on the bus and stable for a specified setup time before the rising edge of RD#, which is when the microcontroller latches the data. For a write cycle, the microcontroller will pull its WR# pin low and then output data on the bus to be written to the external memory. After a specified setup time, the microcontroller will

release its WR# signal, which signals to the memory device to latch the data on the bus into the address location present on its address pins.

Advantages of multiplexed address/data bus systems are that fewer microcontroller pins are required since address and data share the same pins. For a true 16-bit system, this translates into a multiplexed system requiring 16 fewer pins (for address and data) than would be required by a demultiplexed system. A disadvantage is that an external latch is required to hold the address during the second half of the bus cycle; this adds to the component count.

**Demultiplexed Address/Data Buses.** Microcontrollers with demultiplexed address/data buses implement separate, dedicated address and data buses as shown in Fig. 11.26.

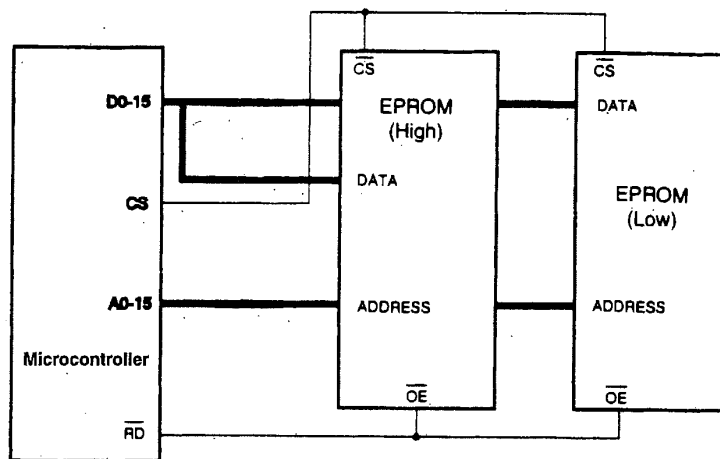

FIGURE 11.26 Typical demultiplexed address/data bus system.

The operation of a demultiplexed address/data bus is basically the same as the multiplexed type with the exception of not having an ALE signal to latch the address for the second half of the bus cycle. The operation of the RD#, WR#, address, and data lines is essentially the same as for that of a multiplexed system.

During a demultiplexed bus cycle, the microcontroller places the address on the address bus and holds it there for the entire bus cycle. For a read of external memory, the microcontroller asserts the RD# signal (or WR# for a write signal) just as would be done for a multiplexed bus cycle. The memory device will respond accordingly by either placing the data to be read on the data bus or by latching the data to be written off of the data bus. Figure 11.27 illustrates a simplified demultiplexed bus cycle.

An advantage of multiplexed address/data bus systems is that external data latches are not necessary, which saves on system component count. A disadvantage, as mentioned earlier, is that more microcontroller pins must be allocated for the interface, which leaves fewer pins for other I/O purposes.

### 11.3 LOW-SPEED INPUT/OUTPUT PORTS

Low-speed input/output (LSIO) ports allow the microcontroller to read input signals as well as provide output signals to and from other electronic components such as sensors, power drivers,

**Program status word (PSW)** A microcontroller register that contains a set of boolean flags which are used to retain information regarding the state of the user's program.

**Pulse-width modulation (PWM)** The precise and timely creation of negative and positive waveform edges to achieve a waveform with a specific frequency and duty cycle.

**Random access memory (RAM)** A memory device which has both read and write capabilities so that the stored information (write) can be retrieved (reread) and be changed by applying new information to the inputs.

**Read-only memory (ROM)** A memory that can only be read and not written to. Data is either entered during the manufacturing process or by later programming; once entered, it is unalterable.

**Register/arithmetical logic unit (RALU)** A component of register-direct microcontroller architectures that allows the ALU to operate directly upon the entire register file.

**Serial input/output (SIO)** A method of digital communication in which a group of data bits is transferred one at a time, sequentially over a single data line.

**Special function register (SFR)** A microcontroller RAM register which has a specific, dedicated function assigned to it.

## BIBLIOGRAPHY

- ASM96 Assembler User's Manual*, Intel Corp., 1992.  
*Automotive Electrics/Electronics*, Robert Bosch GmbH, 1988.  
*Automotive Handbook*, Intel Corporation, 1994.  
*Automotive Handbook*, 2d ed., Robert Bosch GmbH, 1986.  
 Corell, Roger J., "How are semiconductor suppliers responding to the growing demand for automotive safety features?," *Intel Corp.*, 1993.  
 Davidson, Lee S., and Robert M. Kowalczyk, "Microcontroller technology enhancements to meet ever-increasing engine control requirements," *Intel Corp.*, 1992.  
 Fink, Donald G., and Donald Christiansen, *Electronics Engineers' Handbook*, 3d ed. McGraw-Hill, 1989.  
*iC-96 Compiler User's Manual*, Intel Corp., 1992.  
*Introduction to MOSFETS and EPROM Memories*, Intel Corp., 1990.  
*MCS@-51 Microcontroller Family User's Manual*, Intel Corp., 1993.  
 Millman, Jacob, and Arvin Grabel, *Microelectronics*, McGraw-Hill, 1987.  
*Packaging Handbook*, Intel Corporation, 1994.  
 Ribbens, William B., *Understanding Automotive Electronics*, Howard Sams Company, Carmel, Ind. 1992.  
*8XC196Kx User's Manual*, Intel Corporation, 1992.  
*8XC196KC/8XC196KD User's Manual*, Intel Corp., 1992.

## ABOUT THE AUTHOR

David S. Boehmer is currently a senior technical marketing engineer for the Automotive Operation of Intel's Embedded Microprocessor Division located in Chandler, Ariz. He is a member of SAE.

---

# CHAPTER 12

---

## ENGINE CONTROL

---

**Gary C. Hirschlieb, Gottfried Schiller, and Shari Stottler**  
*Robert Bosch GmbH*

### 12.1 OBJECTIVES OF ELECTRONIC ENGINE CONTROL SYSTEMS

---

The electronic engine control system consists of sensing devices which continuously measure the operating conditions of the engine, an electronic control unit (ECU) which evaluates the sensor inputs using data tables and calculations and determines the output to the actuating devices, and actuating devices which are commanded by the ECU to perform an action in response to the sensor inputs.

The motive for using an electronic engine control system is to provide the needed accuracy and adaptability in order to minimize exhaust emissions and fuel consumption, provide optimal driveability for all operating conditions, minimize evaporative emissions, and provide system diagnosis when malfunctions occur.

In order for the control system to meet these objectives, considerable development time is required for each engine and vehicle application. A substantial amount of development must occur with an engine installed on an engine dynamometer under controlled conditions. Information gathered is used to develop the ECU data tables. A considerable amount of development effort is also required with the engine installed in the vehicle. Final determination of the data tables occurs during vehicle testing.

#### 12.1.1 Exhaust Emissions

**Exhaust Components.** The engine exhaust consists of products from the combustion of the air and fuel mixture. Fuel is a mixture of chemical compounds, termed hydrocarbons (HC). The various fuel compounds are a combination of hydrogen and carbon. Under perfect combustion conditions, the hydrocarbons would combine in a thermal reaction with the oxygen in the air to form carbon dioxide ( $\text{CO}_2$ ) and water ( $\text{H}_2\text{O}$ ). Unfortunately, perfect combustion does not occur and in addition to  $\text{CO}_2$  and  $\text{H}_2\text{O}$ , carbon monoxide (CO), oxides of nitrogen ( $\text{NO}_x$ ), and hydrocarbons (HC) occur in the exhaust as a result of the combustion reaction. Additives and impurities in the fuel also contribute minute quantities of pollutants such as lead oxides, lead halogenides, and sulfur oxides. In compression ignition (diesel) engines, there is also an appreciable amount of soot (particulates) created. Federal statutes regulate the allowable amount of HC,  $\text{NO}_x$ , and CO emitted in a vehicle's exhaust. On diesel engines, the amount of particulates emitted is also regulated.

### Spark Ignition Engines

**Air/fuel Ratio.** The greatest effect on the combustion process, and therefore on the exhaust emissions, is the mass ratio of air to fuel. The air/fuel mixture ratio must lie within a certain range for optimal ignition and combustion. For a spark ignition engine, the mass ratio for complete fuel combustion is 14.7:1; i.e., 14.7 kg of air to 1 kg of fuel. This ratio is known as the stoichiometric ratio. In terms of volume, approximately 10,000 liters of air would be required for 1 liter of fuel. The air/fuel ratio is often described in terms of the excess-air factor known as lambda ( $\lambda$ ). Lambda indicates the deviation of the actual air/fuel ratio from the theoretically required ratio:

$$\lambda = \frac{\text{quantity of air supplied}}{\text{theoretical requirement (14.7 for gasoline)}}$$

At stoichiometry:  $\lambda = 1$

For a mixture with excess air (lean):  $\lambda > 1$

For a mixture with deficient air (rich):  $\lambda < 1$

#### Effect of Air/Fuel Ratio on Emissions

**CO emissions.** In the rich operating range ( $\lambda < 1$ ), CO emissions increase almost linearly with an increasing amount of fuel. In the lean range ( $\lambda > 1$ ), CO emissions are at their lowest. With an engine operating at ( $\lambda = 1$ ), the CO emissions can be influenced by the cylinder distribution. If some cylinders are operating rich and others lean with the summation achieving  $\lambda = 1$ , the average CO emissions will be higher than if all cylinders were operating at  $\lambda = 1$ .

**HC emissions.** As with CO emissions, HC emissions increase with an increasing amount of fuel. The minimum HC emissions occur at  $\lambda = 1.1 \dots 1.2$ . At very lean air/fuel ratios, the HC emissions again increase due to less than optimal combustion conditions resulting in unburned fuel.

**NO<sub>x</sub> emissions.** The effect of the air/fuel ratio on NO<sub>x</sub> emissions is the opposite of HC and CO on the rich side of stoichiometry. As the air content increases, the oxygen content increases and the result is more NO<sub>x</sub>. On the lean side of stoichiometry, NO<sub>x</sub> emissions decrease with increasing air because the decreasing density lowers the combustion chamber temperature. The maximum NO<sub>x</sub> emissions occur at  $\lambda = 1.05 \dots 1.1$ .

**Catalytic Converters.** To reduce the exhaust gas emission concentration, a catalytic converter is installed in the exhaust system. Chemical reactions occur in the converter that transform the exhaust emissions to less harmful chemical compounds. The most commonly used converter for a spark ignition engine is the three-way converter (TWC). As the name implies, it simultaneously reduces the concentration of all three regulated exhaust gases: HC, CO, and NO<sub>x</sub>. The catalyst promotes reactions that oxidize HC and CO, converting them into CO<sub>2</sub> and H<sub>2</sub>O, while reducing NO<sub>x</sub> emissions into N<sub>2</sub>. The actual chemical reactions that occur are:

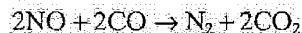
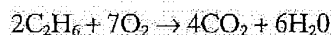

In order for the catalytic converter to operate at the highest efficiency for conversion for all three gases (HC, CO, NO<sub>x</sub>), the average air/fuel ratio must be maintained within less than 1 percent of stoichiometry. This small operating range is known as the *lambda window* or *catalytic converter window*. Figure 12.1 is a graph of lambda ( $\lambda$ ) versus the exhaust emissions both before and after the catalytic converter. Up to 90 percent of the exhaust gases are converted to less harmful compounds by the catalytic converter.

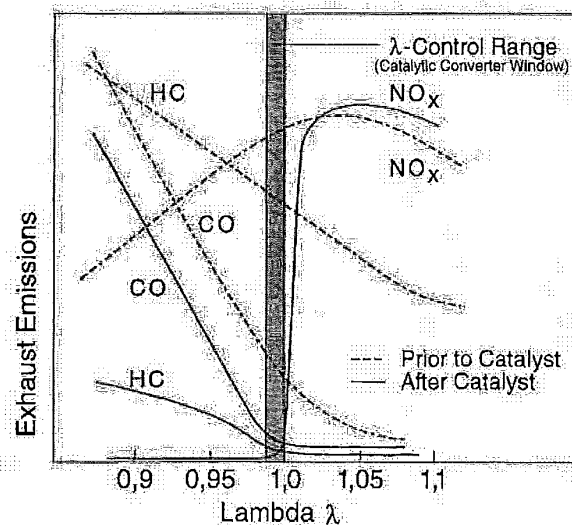

**FIGURE 12.1** Lambda effect on exhaust emissions prior to and after catalyst treatment.

To remain within the catalytic converter window, the air/fuel ratio is controlled by the lambda closed-loop fuel control system, which is part of the electronic engine control system. The key component in this system is the lambda sensor. This sensor is installed in the exhaust system upstream of the catalytic converter and responds to the oxygen content in the exhaust gas. The oxygen content is a measure of the excess air (or deficiency of air) in the exhaust gases. A detailed discussion of the lambda closed-loop control system occurs in Sec. 12.2.1.

**Ignition Timing.** The ignition timing is defined as the crankshaft angle before top dead center (TDC) at which the ignition spark occurs. The ignition timing of the air/fuel mixture has a decisive influence on the exhaust emissions.

*Effect of ignition timing on exhaust emissions.*

- CO emissions are almost completely independent of the ignition timing and are primarily a function of the air/fuel ratio.
- In general, the more the ignition is advanced, the higher the emissions of HCs. Reactions initiated in the combustion chamber continue to occur after the exhaust valve opens, which depletes the remaining HCs. With advanced timing due to lower exhaust temperatures, these postreactions do not readily occur.
- With increased timing advance, the combustion chamber temperatures increase. The temperature increase causes an increase in  $\text{NO}_x$  emissions regardless of air/fuel ratio.

To provide the optimal ignition timing for exhaust emissions, precise control of the ignition timing is required. It is imperative that the ignition timing be coordinated with the air/fuel ratio since they have a combined effect on exhaust emissions as well as fuel consumption and driveability. Ignition timing is generally controlled by the ECU. Ignition timing control is discussed in detail in Sec. 12.2.1.

**Exhaust Gas Recirculation (EGR).** Exhaust gas recirculation (EGR) is a method of reducing emissions of oxides of nitrogen. A portion of the exhaust gas is recirculated back to the combustion chamber. Exhaust gas is an inert gas and, in the combustion chamber, it lowers the peak combustion temperature. Depending on the amount of EGR,  $\text{NO}_x$  emissions can be reduced by up to 60 percent, although an increase in HC emissions would occur at such high levels of EGR.

Some internal EGR occurs due to the overlap of the exhaust and intake valves. Additional quantities are supplied by a separate system linking the exhaust manifold to the intake mani-

fold. The quantity of EGR flow to the intake system is metered by a pneumatic or electronic valve. The EGR valve is controlled by the ECU. The maximum flow of EGR is limited by an increase in HC emissions, fuel consumption, and engine roughness. EGR control is discussed in detail in Sec. 12.2.1.

**Compression Ignition (Diesel) Engines.** There are some key distinctions between an SI engine and a CI engine. The CI engine uses high pressure and temperature instead of a spark to ignite the combustible air/fuel mixture. To achieve this, the CI engine compression ratio is in the range of 21:1, as opposed to roughly 10:1 for an SI engine. In a CI engine, the fuel is injected directly into the cylinder near the top of the compression stroke. Mixing of the fuel and air, therefore, occurs directly in the cylinder.

*Air/fuel ratio.* Diesel engines always operate with excess air ( $\lambda > 1$ ). Where:

$$\lambda = \frac{\text{quantity of air supplied}}{\text{theoretical requirement}}$$

The excess air ( $\lambda = 1.1 \dots 1.2$ ) reduces the amount of soot (particulates), HC, and CO emissions.

*Catalytic Converters.* An oxidizing catalyst is used that converts CO and HC to  $\text{CO}_2$  and  $\text{H}_2\text{O}$ . The  $\text{NO}_x$  reduction that occurs for an SI engine three-way catalyst (TWC) is not possible with a diesel because the diesel operates with excess air. The optimal conversion of  $\text{NO}_x$  requires a stoichiometric ratio ( $\lambda = 1$ ) or a deficiency of air ( $\lambda < 1$ ).

*Injection Timing.* In a compression ignition engine, the start of combustion is determined by the start of fuel injection. In general, retarding the injection timing decreases  $\text{NO}_x$  emissions, while overretarding results in an increase in HC emissions. A  $1^\circ$  (crankshaft angle) deviation in injection timing can increase  $\text{NO}_x$  emissions by 5 percent and HC emissions by as much as 15 percent. Precise control of injection timing is critical. Injection timing on some systems is controlled by the ECU. Feedback on injection timing can be provided by a sensor installed on the injector nozzle. Further discussion on injection timing occurs in Sec. 12.3.1.

*Exhaust Gas Recirculation (EGR).* As with an SI engine, exhaust gas can be recirculated to the combustion chamber to significantly reduce  $\text{NO}_x$  emissions. The quantity of EGR allowed to enter the intake is metered by the EGR valve. If the quantity is too high, HC emissions, CO emissions, and soot (particulates) increase as a result of an insufficient quantity of air. The EGR valve is controlled by the ECU, which determines how much EGR is tolerable under the current engine operating conditions.

### 12.1.2 Fuel Consumption

Federal statutes are currently in effect that require each automobile manufacturer to achieve a certain average fuel economy for all their models produced in one model year. The requirement is known as *corporate average fuel economy* or CAFE. The fuel economy for each vehicle type is determined during the federal test procedure, the same as for exhaust emissions determination, conducted on a chassis dynamometer. Because of the CAFE requirement, it is critical that fuel consumption be minimized for every vehicle type produced.

The electronic engine control system provides the fuel metering and ignition timing precision required to minimize fuel consumption. Optimum fuel economy occurs near  $\lambda = 1.1$ . However, as discussed previously, lean engine operation affects exhaust emissions and  $\text{NO}_x$  is at its maximum at  $\lambda = 1.1$ .

During coasting and braking, fuel consumption can be further reduced by shutting off the fuel until the engine speed decreases to slightly higher than the set idle speed. The ECU determines when fuel shutoff can occur by evaluating the throttle position, engine RPM, and vehicle speed.

The influence of ignition timing on fuel consumption is the opposite of its influence on exhaust emissions. As the air/fuel mixture becomes leaner, the ignition timing must be advanced to compensate for a slower combustion speed. However, as discussed previously,



advancing the ignition timing increases the emissions of HC and NO<sub>x</sub>. A sophisticated ignition control strategy permitting optimization of the ignition at each operating point is necessary to reach the compromise between fuel consumption and exhaust emissions. The electronic engine control system can provide this sophisticated strategy.

### 12.1.3 Driveability

Another requirement of the electronic engine control system is to provide acceptable driveability under all operating conditions. No stalls, hesitations, or other objectionable roughness should occur during vehicle operation. Driveability is influenced by almost every operation of the engine control system and, unlike exhaust emissions or fuel economy, is not easily measured. A significant contribution to driveability is determined by the fuel metering and ignition timing. When determining the best fuel and ignition compromises for fuel consumption and exhaust emissions, it is important to evaluate the driveability. Other factors that influence driveability are the idle speed control, EGR control, and evaporative emissions control.

### 12.1.4 Evaporative Emissions

Hydrocarbon (HC) emissions in the form of fuel vapors escaping from the vehicle are closely regulated by federal statutes. The prime source of these emissions is the fuel tank. Due to ambient heating of the fuel and the return of unused hot fuel from the engine, fuel vapor is generated in the tank. The evaporative emissions control system (EECS) is used to control the evaporative HC emissions. The fuel vapors are routed to the intake manifold via the EECS and they are burned in the combustion process. The quantity of fuel vapors delivered to the intake manifold must be metered such that exhaust emissions and driveability are not adversely affected. The metering is provided by a purge control valve whose function is controlled by the ECU. Further discussion on the operation of the evaporative emissions control system occurs in Sec. 12.2.1.

### 12.1.5 System Diagnostics

The purpose of system diagnostics is to provide a warning to the driver when the control system determines a malfunction of a component or system and to assist the service technician in identifying and correcting the failure (see Chap. 22). To the driver, the engine may appear to be operating correctly, but excessive amounts of pollutants may be emitted. The ECU determines a malfunction has occurred when a sensor signal received during normal engine operation or during a system test indicates there is a problem. For critical operations such as fuel metering and ignition control, if a required sensor input is faulty, a substitute value may be used by the ECU so that the engine will continue to operate.

When a failure occurs, the malfunction indicator light (MIL), visible to the driver, is illuminated. Information on the failure is stored in the ECU. A service technician can retrieve the information on the failure from the ECU and correct the problem. Detailed examples of system diagnostics are discussed in Sec. 12.2.3.

## 12.2 SPARK IGNITION ENGINES

---

### 12.2.1 Engine Control Functions

**Fuel Control.** For the purpose of discussing fuel control strategies, a multipoint pulsed fuel injection system is assumed. Additional discussions of fuel control for different types of fuel

systems such as carburetors, single-point injection, and multipoint continuous injection appear in Sec. 12.2.4 (Fuel Delivery Systems).

In order for the fuel metering system to provide the appropriate amount of fuel for the engine operating conditions, the mass flow rate of incoming air, known as the air charge, must be determined.

$$F_m = \frac{A_m}{\text{requested air-fuel ratio}}$$

where  $F_m$  = fuel mass flow rate

$A_m$  = air mass flow rate

The air mass flow rate can be calculated from:

$$A_m = A_v A_d$$

where  $A_v$  = volume flow rate of intake air

$A_d$  = air density

There are three methods commonly used for determining the air charge: speed density, air flow measurement, and air mass measurement. In the speed density method, the air charge is calculated by the engine electronic control unit based on the measurement of air inlet temperature, intake manifold pressure, and engine RPM. The temperature and pressure are used to determine the air density and the RPM is used to determine the volume flow rate. The engine acts as an air pump during the intake stroke. The calculated volume flow rate can be determined as follows:

$$A_{\text{RPM}} = \frac{\text{RPM}}{60} \times \frac{D}{2} \times V_E$$

where RPM = engine speed

$D$  = engine displacement

$V_E$  = volumetric efficiency

In an engine using exhaust gas recirculation (EGR), the volume flow rate of EGR must be subtracted from the calculated volume flow rate.

$$A_v = A_{\text{RPM}} - A_{\text{EGR}}$$

The volume flow rate of EGR can be determined empirically based on the EGR valve flow rate and the EGR control strategy being used.

In the air flow measurement method, the air flow is measured using a vane type meter and air density changes are compensated for by an air inlet temperature sensor. The vane meter uses the force of the incoming air to move a flap through a defined angle. This angular movement is converted by a potentiometer to a voltage ratio. Because only the fresh air charge is measured, no compensation is required for EGR.

In the air mass measurement method, the air charge is measured directly using a hot-wire or hot-film air mass flow sensor. The inlet air passes a heated element, either wire or film. The element is part of a bridge circuit that keeps the element at a constant temperature above the inlet air temperature. By measuring the heating current required by the bridge circuit and converting this to a voltage via a resistor, the air mass flow passing the element can be determined. Again, because only the fresh air charge is measured, no compensation for EGR is required. However, sensing errors may occur due to strong intake manifold reversion pulses, which occur under certain operating conditions. In such cases, a correction factor must be determined and applied.

**Calculation of Injector Pulse Width.** The base pulse width is determined from the required fuel mass flow rate ( $F_m$ ) and an empirical injector constant. The injector constant is determined by the design of the injector and is a function of the energized time versus the flow volume. This constant is normally determined with a constant differential pressure across the injector (from fuel rail to intake manifold). When the pressure across the injector does not remain constant (i.e., there is no pressure regulator intake manifold vacuum reference), an entire map of injector constants for different manifold pressures may be required.

The effective injector pulse width is a modification of the base pulse width. The base pulse width is adjusted by a number of correction factors depending on operating conditions. For example, a battery voltage correction is required to compensate for the electromechanical characteristics of the fuel injectors. Injector opening and closing rates differ depending on the voltage applied to the injector, which affects the amount of fuel injected for a given pulse width. Other common correction factors may include hot restart, cold operation, and transient operation corrections. Figure 12.2 is a flowchart of a typical injector effective pulse-width calculation method.

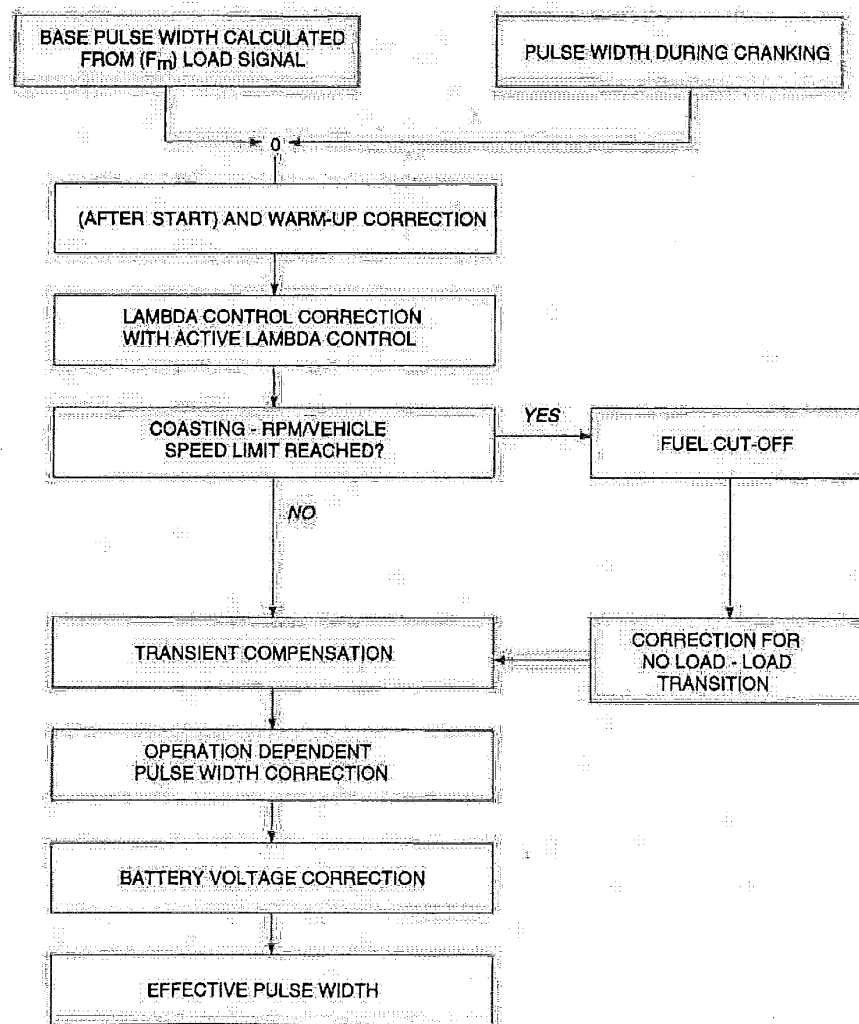
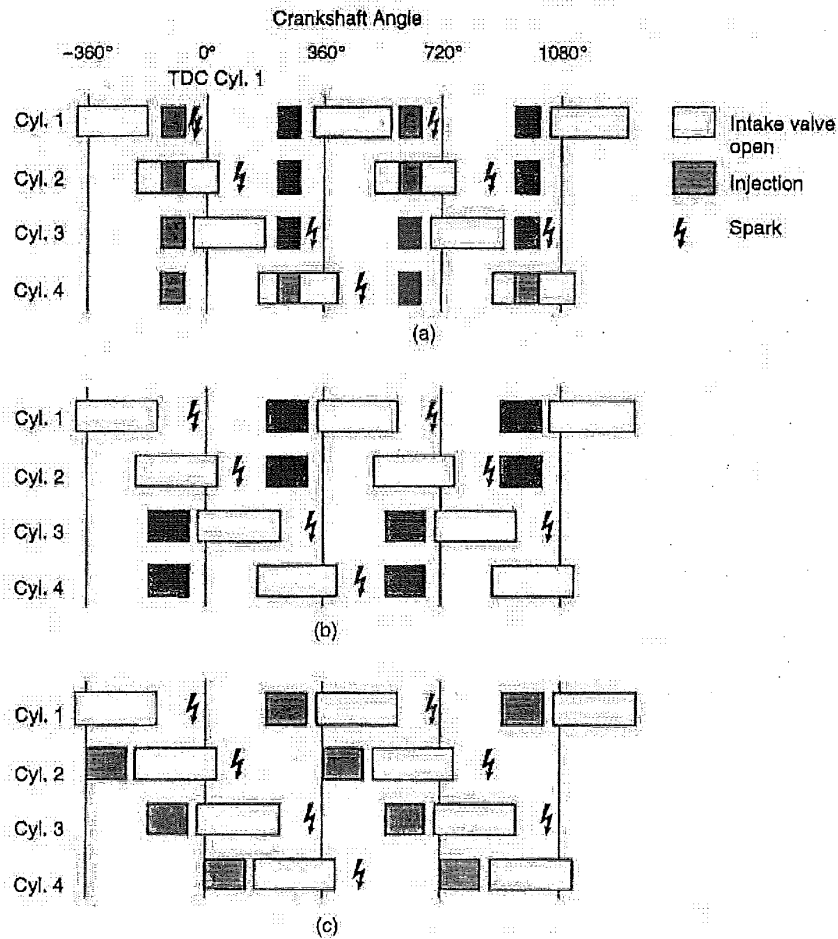

FIGURE 12.2 Determination of effective injector pulse width.

**Injection Strategies.** There are three commonly used fuel injection strategies for multi-point fuel metering systems: simultaneous injection, group injection, and sequential injection. Figure 12.3 is a diagram of the different strategies. Some engines use simultaneous injection during crank and switch over to sequential after the engine is running. This allows for shorter starting times since no synchronization with the camshaft is necessary before fuel injection begins. A description of each strategy follows.



**FIGURE 12.3** Fuel injection strategies: (a) simultaneous injection, (b) group injection, and (c) sequential injection.

**Simultaneous injection.** Injection of fuel occurs at the same time for all cylinders every revolution of the crankshaft. Therefore, fuel is injected twice within each four-stroke cycle. The injection timing is fixed with respect to crank/camshaft position.

**Group injection.** The injectors are divided into two groups that are controlled separately. Each group injects once per four-stroke cycle. The offset between the groups is one crankshaft revolution. This arrangement allows for injection timing selection that eliminates spraying fuel into an open intake valve.

**Sequential injection.** Each injector is controlled separately. Injection timing, both with reference to crank/camshaft position and pulse width, can be optimized for each individual cylinder.

**Lambda Control.** A subsystem of the fuel control system is lambda closed-loop control. Lambda ( $\lambda$ ) is defined as the excess-air factor that indicates the deviation of the actual air/fuel ratio from the theoretically required ratio:

$$\lambda = \frac{\text{quantity of air supplied}}{\text{theoretical requirement (14.7 for gasoline)}}$$

The lambda sensor, or exhaust gas oxygen sensor, is installed in the engine exhaust stream upstream of the catalytic converter. The sensor responds to the oxygen content of the exhaust gas. The signal from the lambda sensor serves as feedback to the fuel control system. This provides the fine-tuning needed to remain within the limited catalytic converter window for optimal catalyst performance. (See Sec. 12.1.1 for more discussion on the catalytic converter window.) For a lean mixture ( $\lambda > 1$ ), sensor voltage is approximately 100 mV. For a rich mixture ( $\lambda < 1$ ), the sensor voltage is approximately 800 mV. At roughly  $\lambda = 1$  (a stoichiometric mixture), the sensor switches rapidly between the two voltages. The input from the lambda sensor is used to modify the base pulse width to achieve  $\lambda = 1$ .

Lambda closed-loop control requires an operationally ready lambda sensor, typically one which has reached an operating temperature threshold. Sensor output is monitored by the ECU to determine when the sensor is supplying usable information. An active sensor signal, along with other requirements, such as engine temperature, must be achieved before lambda closed-loop control will be activated.

Under steady state conditions, the lambda control system oscillates between rich and lean around the lambda window. As the lambda sensor switches, the injector pulse width is adjusted by the amount determined by a control factor until the lambda sensor switches again to the opposite condition. The control factor can be defined as the allowable increase or decrease in the commanded fuel injector pulse width. The frequency of oscillation is determined by the gas transport time and the magnitude of the control factor. The gas transport time is defined as the time from air/fuel mixture formation to lambda sensor measurement.

Under transient conditions, the gas transport time results in a delay before the lambda sensor can indicate that the operating conditions have changed. Using only the lambda sensor for closed-loop fuel control would result in poor driveability and exhaust emissions because of this delay. Therefore, the engine control unit uses an anticipatory control strategy that uses engine load and RPM to determine the approximate fuel requirement. The engine load information is provided by the manifold pressure sensor for speed density systems and by the air meter for air flow and air mass measurement systems and by the throttle valve position sensor. The engine control unit contains data tables for combinations of load and RPM. This allows for rapid response to changes in operating conditions. The lambda sensor still provides the feedback correction for each load/RPM point. The data used for these data tables are largely developed from system modeling and engine development testing.

Due to production variations in engines, variations in fuel and changes due to wear and aging, the control system must be able to adapt to function properly for every engine over the engine's life. Therefore, the electronic control unit has a feature for adapting changes in the fuel required for the load/RPM points. At each load/RPM point, the lambda sensor continuously provides information that allows the system to adjust the fuel to the commanded A/F ratio. The corrected information is stored in RAM (random access memory) so that the next time the engine reaches that operating point (load/RPM), the anticipatory value will require less correction. These values remain stored in the electronic control unit even after the engine is shut off. Only if power to the electronic control unit is disrupted (i.e., due to a dead battery), will the correction be lost. In that case, the electronic control unit will revert back to the original production values that are written in ROM (read-only memory).

Lambda sensors do not switch symmetrically from lean to rich and rich to lean. Because of this, the control strategy is modified to account for the asymmetry. This can be accomplished either by delaying the modification by the control factor after the sensor switches or by using control factors of different magnitudes for rich-to-lean and lean-to-rich switching.

**Ignition Timing Control.** The goal of the engine control system for ignition timing is to provide spark advance which optimizes engine torque, exhaust emissions, fuel economy, and driveability, and which minimizes engine knock. Data tables with the base ignition timing, depending on engine load and RPM, are stored in ROM in the electronic control unit. The values in these tables are optimized for fuel economy, exhaust emissions, and engine torque. They are developed through engine experimentation, usually with an engine dynamometer. Corrections to the base timing values are needed for temperature effects, EGR, hot restart, barometric pressure, and engine knock. In addition, some systems use ignition timing to vary the engine torque for improvement in automatic transmission shift quality or for idle speed control. Figure 12.4 is a flowchart of a typical ignition timing calculation method.

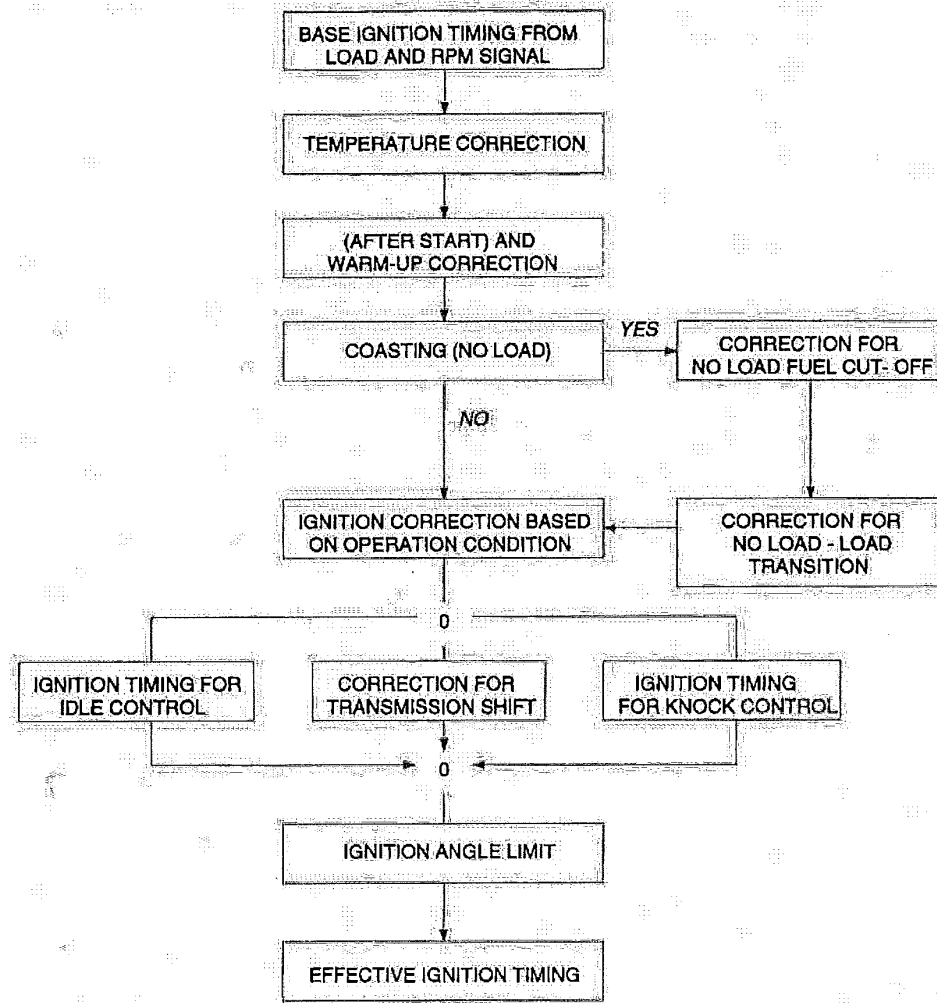
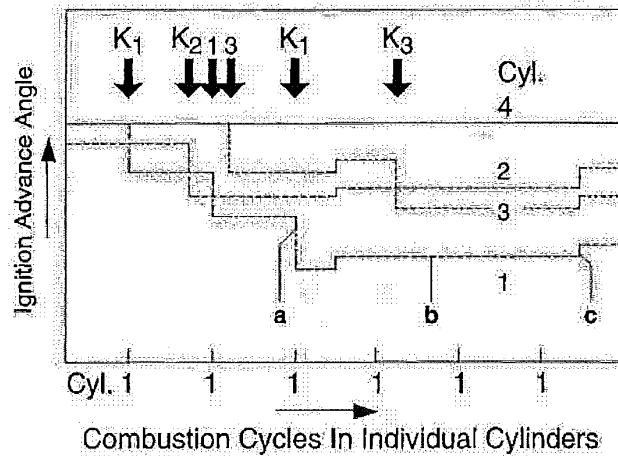

FIGURE 12.4 Determination of effective ignition timing.

**Dwell Angle Control.** The dwell angle performance map stored in the electronic control unit controls the charging time of the ignition coil, depending on RPM and battery voltage. The dwell angle is controlled so that the desired primary current is reached at the end of the charging time just prior to the ignition point. This assures the necessary primary current, even with quick transients in RPM. A limit on the charge time in the upper RPM ranges allows for the necessary spark duration.

**Knock Control.** The ignition timing for optimization of torque, fuel economy, and exhaust emissions is in close proximity to the ignition timing that results in engine knock. Engine knock occurs when the ignition timing is advanced too far for the engine operating conditions and causes uncontrolled combustion that can lead to engine damage, depending on the severity and frequency. If a factor of safety was used when developing the base timing map for all conditions that contribute to knock, such as fuel quality and variations in compression ratio, the ignition timing would be significantly retarded from the optimum level, resulting in a significant loss in torque and fuel economy. To avoid this, a knock sensor (one or more) is installed on the engine to detect knocking (see Chap. 8). Knock sensors are usually acceleration sensors that provide an electric signal to the electronic control unit. From this signal, the engine control unit algorithm determines which cylinder or cylinders are knocking. Ignition timing is modified (retarded) for those cylinders until the knock is no longer detected. The ignition timing is then advanced again until knock is detected. (See Fig. 12.5.) Information on the amount of spark retard required to eliminate the knock for each cylinder under each load/RPM condition is saved in the electronic control unit RAM. This allows for quick access to the appropriate "learned" ignition timing for each condition. With this control system, the base timing can be more advanced for improved fuel economy and torque.

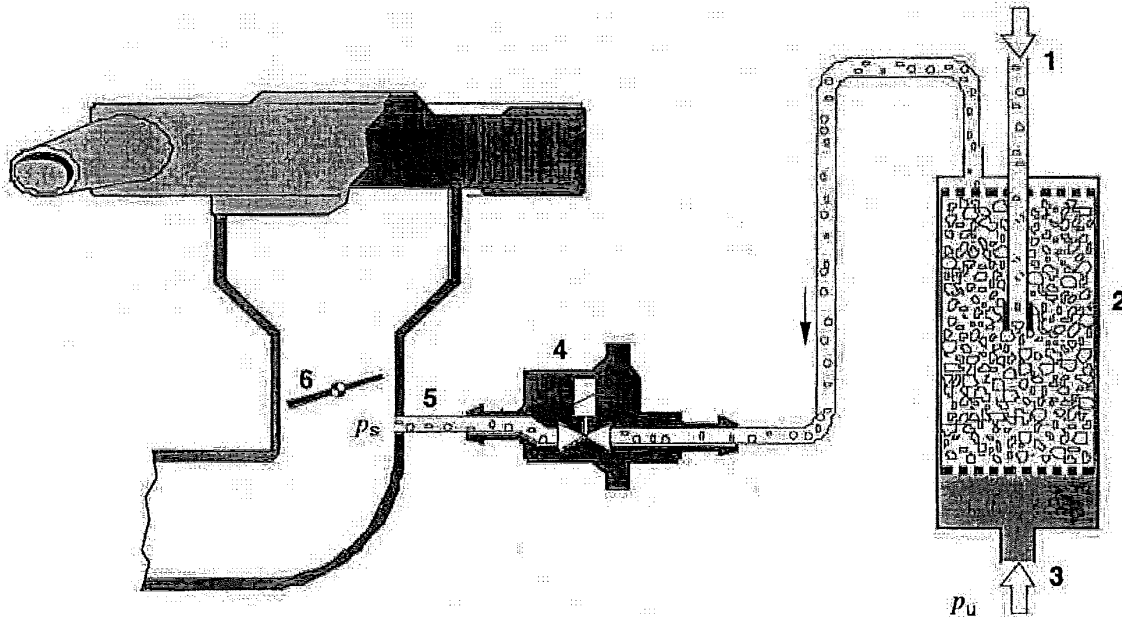

**FIGURE 12.5** Knock control. Control algorithm for ignition adjustments for a four-cylinder engine.  $K_1 \dots K_3$  (knock in cylinders 1...3), cylinder number four (no knock), (a) (ignition retard), (b) (delay before return to original point), (c) (spark advance).

**Evaporative Emissions Control.** Hydrocarbon (HC) emissions in the form of fuel vapors escaping from the vehicle, primarily from the fuel tank, are closely regulated by federal statutes. There are two principal causes of fuel vapor in the fuel tank: increasing ambient temperature and return of unused hot fuel from the engine. In order to control the release of these emissions to the atmosphere, the evaporative emissions control system was developed.

**Evaporative Emissions Control System.** A vapor ventilation line exits the fuel tank and enters the fuel vapor canister. The canister consists of an active charcoal element which absorbs the vapor and allows only air to escape to the atmosphere. Only a certain volume of fuel vapor can be contained by the canister. The vapors in the canister must therefore be purged from and burned by the engine so that the canister can continue to store vapors as they are generated. To accomplish this, another line leads from the charcoal canister to the intake manifold. Included in this line is the canister purge solenoid valve. Figure 12.6 shows a layout of a typical evaporative emissions control system.

During engine operation, vacuum in the intake manifold causes flow through the charcoal canister because the canister vent opening, at the charcoal filter end, is at atmospheric pres-



**FIGURE 12.6** Evaporative emission control system: fuel vapor from fuel tank (1), charcoal canister (2), ambient air (3), canister purge control valve (4), purge line to intake manifold (5), throttle valve (6),  $p_s$  is intake manifold vacuum, and  $p_u$  is atmospheric pressure.

sure. The canister purge valve meters the amount of flow from the canister. The amount of fuel vapor in the canister and, therefore, contained in the flow stream, is not known. Therefore, it is critical that the lambda control system is operating and adjusting the fuel requirement as the vapors are being purged. Purge vapors could otherwise result in up to a 30 percent increase in air/fuel mixture richness in the engine.

*Purge Valve Control.* Control of the purge valve must allow for two criteria:

- There must be enough vapor flow so that the charcoal canister does not become saturated and leak fuel vapors to the atmosphere
- Purge flow must generally occur under lambda closed-loop control so that the effect of the purge vapors on A/F ratio can be detected and the fuel metering corrected

When the electronic control unit commands the purge valve to meter vapor from the canister, it requests a duty cycle (ratio of ON time to total ON and OFF time). This allows the amount of vapor flow to be regulated depending on the engine operating conditions. When lambda control is not operating, only low duty cycles and, therefore, small amounts of purge vapors, are allowed. Under deceleration fuel cutoff, the purge valve is closed entirely to minimize the possibility of unburned HCs in the exhaust.

*Turbocharger Boost Pressure Control.* The exhaust turbocharger consists of a compressor and an exhaust turbine arranged on a common shaft. Energy from the exhaust gas is converted to rotational energy by the exhaust turbine, which then drives the compressor. The compressed air leaves the compressor and passes through the air cooler (optional), throttle valve, intake manifold, and into the cylinders. In order to achieve near-constant air charge pressure over a wide RPM range, the turbocharger uses a circuit that allows for the bypass of the exhaust gases away from the exhaust turbine. The valve that regulates the bypass opens at a specified air charge pressure and is known as the wastegate.



Engines that have turbochargers benefit significantly from electronic boost pressure control. If only a pneumatic-mechanical wastegate is used, only one boost pressure point for the entire operating range is used to divert the exhaust gas. This creates a compromise for part-load conditions, which results in increased exhaust backpressure, more turbocharger work, more residual exhaust gas in the cylinders, and higher-charge air temperatures.

By controlling the wastegate with a pulse-width modulated solenoid valve, different wastegate opening pressures can be specified, depending on the engine operating conditions (Fig. 12.7). Therefore, only the level of air charge pressure required is developed. The electronic control unit uses information on engine load from either manifold pressure or the air meter and RPM and throttle position. From this information, a data table is referenced and the proper boost pressure (actually a duty cycle of the control valve) is determined. On systems using manifold pressure sensors, a closed-loop control system can be developed to compare the specified value with the measured value.

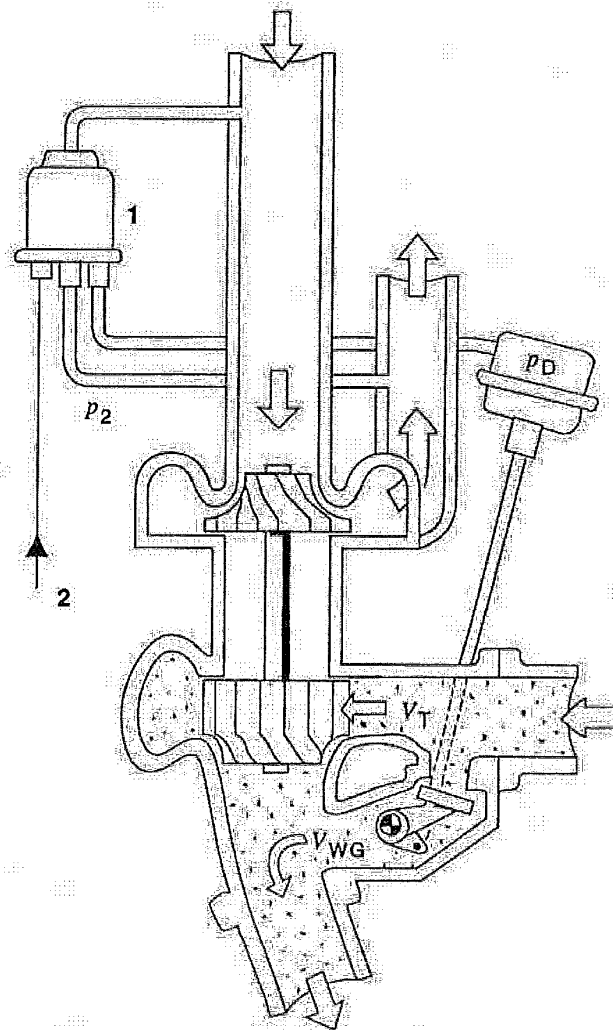

**FIGURE 12.7** Electronic turbocharger boost control: solenoid valve (1), control signal from ECU (2), boost pressure ( $p_D$ ), volume flow through turbine ( $V_T$ ), volume flow through wastegate ( $V_{WG}$ ).

The boost pressure control system is usually used in combination with knock control for turbocharged engines. When the ignition timing is retarded due to knock, an increase in already high exhaust temperatures for turbocharged engines occurs. To counteract the temperature increase, the boost pressure is reduced when the ignition timing is retarded past a predetermined threshold.

**Engine/Vehicle Speed Control.** Using the inputs of engine RPM and vehicle speed to the electronic control unit, thresholds can be established for limiting these variables with fuel cut-off. When the maximum speed is achieved, the fuel injectors are shut off. When the speed decreases below the threshold, fuel injection resumes.

**EGR Control.** By mixing a portion of the exhaust gas with the fresh intake air/fuel mixture, oxides of nitrogen ( $\text{NO}_x$ ) can be reduced by lowering the peak combustion temperatures. However, the addition of exhaust gas can degrade driveability by causing combustion instability, especially at idle and low speeds and with a cold engine. The ECU references an engine RPM/load table of optimal EGR valve openings. The data table is developed on the engine dynamometer by analyzing the exhaust emissions. With increasing EGR, a point is reached where hydrocarbon (HC) emissions begin to increase. The optimal percent of EGR is just prior to that point.

The electronic control unit regulates a pneumatic- or solenoid-type valve to meter a certain quantity of exhaust gas back to the intake manifold. Typically, an engine coolant temperature threshold is also required before EGR is activated to avoid poor driveability. Under acceleration and at idle, EGR is deactivated.

**Camshaft Control.** There are two types of camshaft controls: phasing (i.e., overlap or intake/exhaust valve opening point) and valve lift and opening duration.

**Camshaft Phasing Control.** Valve overlap is a function of the rotation of the intake camshaft with respect to the exhaust camshaft. Overlap can be controlled by an electrohydraulic actuator. At idle and at high RPM, it is desirable to have the intake valves open and close later, which reduces the overlap. For idle, this reduces the residual exhaust gases that return with the fresh charge air and improves idle stability. At high RPM, late closing of the intake valve provides the best condition for maximum cylinder filling and, therefore, maximum output. For partial loads, a large valve overlap, where the intake opens early, is desirable. This allows for an increase in residual exhaust gas for improved exhaust emissions (Fig. 12.8).

**Valve Lift and Opening Duration Control.** Control of the valve lift and opening duration is accomplished by switching between two camshaft profiles. An initial cam specifies the optimal lift and duration for the low to middle RPM range. A second cam profile controls a higher valve lift and duration for high-RPM operation. By monitoring engine load and RPM, the ECU actuates the electrohydraulic device that switches from one cam profile to the other (Fig. 12.9).

**Variable Intake Manifold Control.** The goal of the engine design is to achieve the highest possible torque at low engine RPM as well as high output at high engine RPM. The torque curve of an engine is proportional to the air charge at any given engine speed. Therefore, a primary influence on the torque is the intake manifold geometric design. The simplest type of air charging uses the dynamics of the drawn-in air. The standard intake manifolds for multipoint engines consist of several intake runners and collectors converging at the throttle valve.

In general, short intake runners result in a high output at high RPM with a simultaneous loss of torque at low RPM. Long intake runners have the opposite effect. Due to intake valve and piston dynamics, pressure waves occur that oscillate within the intake manifold. Proper selection of runner lengths and collector sizes can result in the pressure waves arriving at the intake valves just before they are closing. This has a supercharging effect. The limitation of this method is that, for a given intake manifold configuration, the tuning peak can only occur at one operating point.

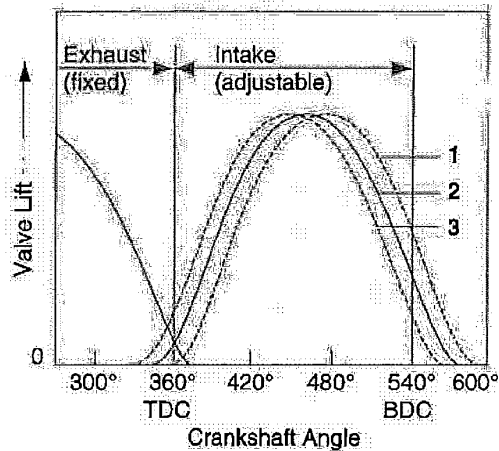

FIGURE 12.8 Adjustment angle for intake camshaft: retard (1), standard (2), advance (3).

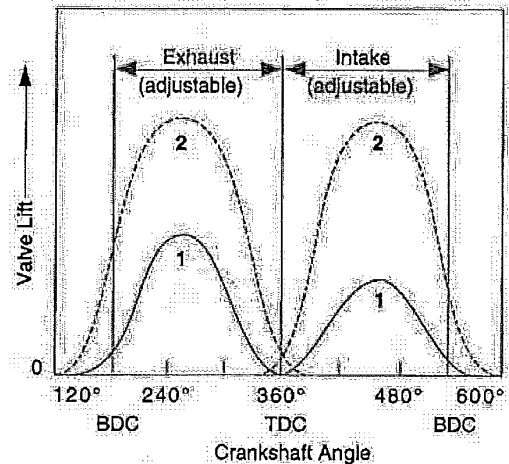

FIGURE 12.9 Selective camshaft lobe actuation: base cam lobe (1), auxiliary cam lobe (2).

**Variable Intake Systems.** To optimize the benefits of intake manifold charging, several systems have been developed that allow for changes in runner length and collector volume, depending on engine operating conditions. This allows for tuning peaks at more than one operating point. One method developed uses electronically controlled valves to close off areas of the intake manifold (Fig. 12.10). Inputs of engine load, RPM, and throttle angle determine the position of the valves.

### 12.2.2 Engine Control Modes

**Engine Crank and Start.** During engine cranking, the goal is to get the engine started with the minimal amount of delay. To accomplish this, fuel must be delivered that meets the requirements for starting for any combination of engine coolant and ambient temperatures. For a cold engine, an increase in the commanded air/fuel ratio is required due to poor fuel vaporization and “wall wetting,” which decreases the amount of usable fuel. Wall wetting is the condensation of some of the vaporized fuel on the cold metal surfaces in the intake port and combustion chamber. It is critical that the fuel does not wet the spark plugs, which can reduce the effectiveness of the spark plug and prevent the plug from firing. Should plug wetting occur, it may be impossible to start the engine.

**Fuel Requirement.** Within the ECU ROM there are specific data tables to establish cold-start fuel based on engine coolant temperature. For two reasons, the lambda sensor output cannot be used during crank: the lambda sensor is below its minimum operating temperature and the air/fuel ratio required is outside the lambda sensor control window.

Many starting sequences use a front-loading strategy for fueling whereby the quantity of fuel is reduced after a speed threshold (RPM) is achieved, after a certain number of revolutions or at a defined time after the initial crank. Some systems also switch over from simultaneous injection to sequential injection after a speed threshold is achieved. For cold temperature starting, the fuel mixture may remain richer than  $\lambda = 1$  after starting, due to the continuing poor mixture formation in the cold induction system.

**Ignition Timing Requirement.** Ignition timing is controlled by the ECU during crank and is determined by engine coolant temperature and cranking speed. For a cold engine with low cranking speeds, ideal timing is near TDC. For higher cranking speeds, a slightly more advanced timing is optimal. Timing advance must be limited during cranking to avoid igniting

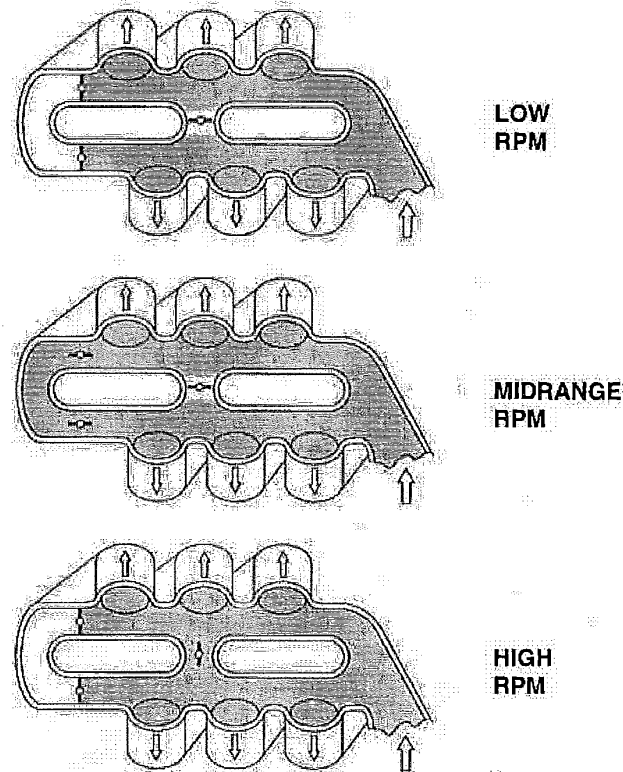

FIGURE 12.10 Variable configuration intake manifold.

the air/fuel mixture before the crankshaft reaches top dead center (TDC). A damaging torque reversal could occur that would damage the starter. After the engine starts, ignition timing is advanced to improve cold engine running as well as to reduce the need for fuel enrichment.

**Engine Warm-Up.** During the warm-up phase, there are three conflicting objectives: keep the engine operating smoothly (i.e., no stalls or driveability problems), increase exhaust temperature to quickly achieve operational temperature for catalyst (light-off) and lambda sensor so that closed-loop fuel control can begin operating, and keep exhaust emissions and fuel consumption to a minimum. The best method for achieving these objectives is very dependent on the specific engine application.

If the engine is still cold, fuel enrichment will be required to keep the engine running smoothly due, again, to poor fuel vaporization and wall wetting effects. The amount of enrichment is dependent on engine temperature and is a correction factor to the injector pulse width. This enrichment, combined with secondary air injection, also helps achieve the desired increase in catalyst temperature. To provide secondary air injection, an external air pump delivers fresh air downstream of the exhaust valves for a short time after start. The excess air causes oxidation (burning) of the excess HC and CO from the rich mixture in the exhaust manifold, which rapidly increases the temperature of the catalytic converter. The oxidation also removes harmful pollutants from the exhaust stream.

It is possible to increase the exhaust temperature by increasing the idle speed during warm-up. The increased idle speed may also be combined with a slightly retarded ignition timing, which increases temperatures in the exhaust, thereby promoting rapid warm-up of the catalyst.

**Transient Compensation.** During transitions such as acceleration or deceleration, the objective of the engine control system is to provide a smooth transition from one engine operating condition to another (i.e., no hesitations, stalls, bumps, or other objectionable driveability concerns), and keep exhaust emissions and fuel consumption to a minimum.

**Acceleration Enrichment.** When an increase in engine load and throttle angle occurs, a corresponding increase in fuel mixture richness is required to compensate for the increased wall wetting. The sudden increase in air results in a lean mixture that must be corrected swiftly to obtain good transitional response. The rate of change of engine load and throttle angle are used to determine the quantity of fuel during acceleration enrichment. The amount of fuel must be enough to provide the desired performance, but not so much as to degrade exhaust emissions and fuel economy.

During acceleration enrichment, the ignition timing is set for maximum torque without knocking. Additionally, when a large change in engine load occurs, some systems delay the ignition timing advance briefly to prevent engine knock, which may arise from a momentary lean mixture or from transient ignition timing errors.

**Deceleration Enleanment.** During deceleration modes, such as coasting or braking, there is no torque requirement. Therefore, the fuel may be shut off until either an increase in throttle angle is detected or the engine speed falls to a speed slightly above the idle RPM. Fuel shut-off or cutoff can decrease exhaust emissions by eliminating unburned HC and CO and may also improve fuel consumption. Fuel cutoff is also used to protect the catalytic converter from extreme high temperatures during extended overrun conditions. During transition to fuel cutoff, the ignition timing is retarded from its current setting to reduce engine torque and to assist in engine braking. The fuel is then shut off. During the transition, the throttle bypass valve or the main throttle valve may remain open for a short period to allow fresh air to oxidize the remaining unburned HC and CO to further reduce exhaust emissions. During development of the fuel cutoff strategy, the advantage of reduced emission effects and catalyst temperature control must be balanced against driveability requirements. The use of fuel cutoff may change the perceived amount of engine braking felt by the driver. In addition, care must be taken to avoid a "bump" feel when entering the fuel cutoff mode, due to the change in torque.

**Full Load.** Under steady state full-load conditions, such as for climbing a grade, it is desirable to control the air/fuel mixture and ignition timing to obtain maximum power and to also limit engine and exhaust temperatures. The best engine torque is typically delivered at about  $\lambda = 0.9$  to 0.95. When the ECU determines the engine is operating at full load via the throttle valve sensor (at WOT), the commanded air/fuel mixture, if required, can be enriched. The lambda sensor signal cannot be used to provide correction to the air/fuel mixture because the rich operating point lies outside the lambda control window.

The ignition timing at full load is set to achieve the maximum torque without knocking. This initial value is determined through engine dynamometer testing. With a knock control system (see Sec. 12.2.1), the ignition timing is modified (retarded) when engine knock occurs. The modification required to eliminate the knock may be saved in the ECU so that the next time that engine RPM/load point occurs, less knocking will occur and less correction will be required.

**Idle Speed Control.** The objectives of the engine control system during idle are:

- Provide a balance between the engine torque produced and the changing engine loads, thus achieving a consistent idle speed even with various load changes due to accessories (i.e., air conditioning, power steering, and electrical loads) being turned on and off and during engagement of the automatic transmission. In addition, the idle speed control must be able to compensate for long-term changes in engine load, such as the reduction in engine friction that occurs with engine break-in.
- Provide the lowest idle speed that allows smooth running to achieve the lowest exhaust emissions and fuel consumption (up to 30 percent of a vehicle's fuel consumption in city driving occurs during idling).

To control the idle speed, the ECU uses inputs from the throttle position sensor, air conditioning, automatic transmission, power steering, charging system, engine RPM, and vehicle speed. There are currently two strategies used to control idle speed: air control and ignition control.

*Air Control.* The amount of air entering the intake manifold is controlled either by a bypass valve or by an actuator acting directly on the throttle valve. The bypass valve uses, for example, an electronically controlled motor controlled by the ECU that opens or closes a fixed amount. For large throttle valves, it may be desirable to use a bypass valve because a small change in throttle angle may result in a large change in air flow and, therefore, idle speed may be difficult to control. Using engine RPM feedback input, the ECU adjusts the air flow to increase or decrease the idle speed. A disadvantage to air control is that the response to load changes is relatively slow. To overcome this, air control is often combined with ignition timing control to provide acceptable idle speed control. The fuel quantity required at idle is determined by engine load and RPM. During closed-loop operation, this value is optimized by the lambda sensor closed-loop control.

*Ignition Timing Control.* Engine torque may be increased or decreased by advancing or retarding the ignition timing within an established window. This principle can be employed to help control idle speed. Ignition timing control is particularly desirable for responding to idle load changes because engine torque output changes more rapidly in response to a change in ignition timing than to a change in air valve position. Using the same inputs as for air control, the ECU adjusts the spark advance to either raise or lower the idle speed.

*Anticipating Accessory Loads.* Specific electric inputs to the ECU, such as a pressure switch located in the power steering system, are used to anticipate accessory loads so that the idle control system can compensate more quickly. This "feed forward" strategy allows better idle control than a strictly feedback system which does not respond until the idle speed begins to fall. When an accessory can be controlled by the ECU, further improvement in idle speed control is obtained. By delaying the load briefly after it is requested, the compensation sequence can begin before the load is actually applied. Such a load delay strategy is effective for controlling air conditioning compressor loads, for example. In this case, when the air conditioner is requested, the ECU begins to increase the idle speed first and then activates the A/C compressor.

### 12.2.3 Engine Control Diagnostics

The purpose of system diagnostics is to provide a warning to the driver when the control system determines that a malfunction of a component or system has occurred and to assist the service technician in identifying and correcting the failure (see Chap. 22). In many cases, to the driver, the engine may appear to be operating correctly, but excessive amounts of pollutants may be emitted. The ECU determines that a malfunction has occurred when a sensor signal received during normal engine operation or during a system test indicates there is a problem. For critical operations such as fuel metering and ignition control, if a required sensor input is faulty, a substitute value may be used by the ECU so that the engine will continue to operate, but likely not at optimal performance. It is also possible to apply an emergency measure if the failure of a component may result in engine or emission system damage. For example, if repeated misfires are detected in one cylinder, perhaps due to an ignition failure, the fuel injector feeding that cylinder can be shut off to avoid damage to the catalytic converter. When a failure occurs, the malfunction indicator light (MIL), visible to the driver, is illuminated. Information on the failure is stored in the ECU. A service technician can retrieve the information on the failure from the ECU and correct the problem.

*Air Mass Sensor.* For air mass measurement systems, the pulse width of the fuel injectors is calculated in the ECU from the air mass sensor input. As a comparison, the pulse width is also calculated from the throttle valve sensor and the engine RPM. If the pulse width values devi-

ate by a predetermined amount, the discrepancy is stored in the ECU. Then, while the vehicle is being driven, plausibility tests determine which input is incorrect. When this has been determined, the appropriate failure code is saved in the ECU.

**Misfire Detection.** Misfiring is the lack of combustion in the cylinder. Misfiring can be caused by several factors including fouled or worn spark plugs, poor fuel metering, or faulty electrical connections. Even a small number of misfires may result in excessive exhaust emissions due to the unburned mixture. Increased misfire rates can damage the catalytic converter.

To determine if the engine is experiencing a misfire, the crankshaft speed fluctuation is monitored. If a misfire occurs, no torque is created during the power stroke of the cylinder(s) that is misfiring. A small decrease in the rotational speed of the crankshaft occurs. Because the change in speed is very small, highly accurate sensing of the crankshaft speed is required. In addition, a fairly complicated calculation process is required in order to distinguish misfiring from other influences on crankshaft speed. As was mentioned previously, if a cylinder repeatedly misfires, it is possible to shut off the fuel to that cylinder to prevent damage to the catalytic converter.

**Catalytic Converter Monitoring.** During the useful life of a catalytic converter, its efficiency decreases. If subjected to engine misfire, the decrease in efficiency occurs more rapidly. A loss in efficiency results in an increase in exhaust pollutants. For this reason, the catalytic converter is monitored. A properly operating catalytic converter transforms  $O_2$ , HC, CO, and  $NO_x$  into  $H_2O$ ,  $CO_2$ , and  $N_2$ . The incoming air/fuel ratio oscillates from rich to lean due to the lambda closed-loop control strategy discussed in Sec. 12.2.1. Only a properly functioning catalytic converter is able to dampen these oscillations by storing and converting the incoming components. As the catalyst ages, this storage effect is diminished. To monitor the catalytic converter, an additional lambda sensor is installed downstream of the catalyst. The ECU compares the signal of the lambda sensor upstream with the lambda sensor downstream and determines if the catalytic converter is operating properly. If not, the ECU illuminates the malfunction indicator light (MIL) and stores a failure code.

**Lambda Sensor Monitoring.** To minimize exhaust emissions, the engine must operate within the catalytic converter window for air/fuel ratio (see Sec. 12.1.1 for a detailed description of the catalytic converter window). Output from the lambda sensor serves as feedback to the ECU to control the fuel within that window. When a lambda sensor is exposed to high heat for a long period of time, it may respond more slowly to changes in the air/fuel mixture. This can cause a deviation in the air/fuel mixture from the window, which would affect the exhaust emissions.

If the upstream lambda sensor operation is determined to be too slow, which can be detected by the system operation frequency, the ECU illuminates the malfunction indicator light (MIL) and a failure code is stored. Additionally, the ECU compares the output signal of the additional lambda sensor downstream of the catalytic converter with the lambda sensor signal upstream. With this, the ECU is able to detect deviations of the average value in air/fuel ratio.

For heated lambda sensors, the electric current and voltage of the heater circuit is monitored. To accomplish this, the heater is directly controlled by the ECU, not through a relay.

**Fuel System Monitoring.** To provide the correct air/fuel ratio, the ECU uses a preset data map with the optimal fuel required for each load and RPM point. The lambda closed-loop control system (see Sec. 12.2.1) provides feedback to the ECU on the necessary correction to the preset data points. The corrected information is stored in the ECU's RAM so that the next time that operating point is reached, less correction of the air/fuel ratio will be required. If the ECU correction passes a predetermined threshold, it is an indication that some component in the fuel supply system is outside of its operating range. Some examples are defective pressure regulator, defective manifold pressure sensor, intake system leakage, or exhaust system leakage. When the ECU determines a problem exists, the MIL is illuminated and a code is stored in the ECU.

**Exhaust Gas Recirculation (EGR) Monitoring.** There are currently two methods used to monitor EGR operation. One method confirms that hot exhaust gases are returning to the intake manifold during EGR operation by use of a temperature sensor in the intake manifold. The second method requires the EGR valve to be fully opened during coast operation, where high intake manifold vacuum occurs. The exhaust gas flowing into the manifold causes a measurable increase in pressure. Thus, if a measured increase in pressure does not occur, the EGR system is not operating.

**Evaporative Emissions Control System (EECS) Monitoring.** In general, a valve will be installed at the atmospheric side of the purge canister. During idle, this valve would close and the purge valve would open. Intake manifold vacuum would occur in the entire EECS. A pressure sensor in the fuel tank would provide a pressure profile during this test to the ECU, which would then determine if a leak existed in the system.

12.2.4 Fuel Delivery Systems

**Overview.** Fuel management in the spark ignition engine consists of metering the fuel, formation of the air/fuel mixture, transportation of the air/fuel mixture, and distribution of the air/fuel mixture. The driver operates the throttle valve, which determines the quantity of air inducted by the engine. The fuel delivery system must provide the proper quantity of fuel to create a combustible mixture in the engine cylinder. In general, two fuel delivery system configurations exist: *single-point* and *multi-point* (Fig. 12.11).

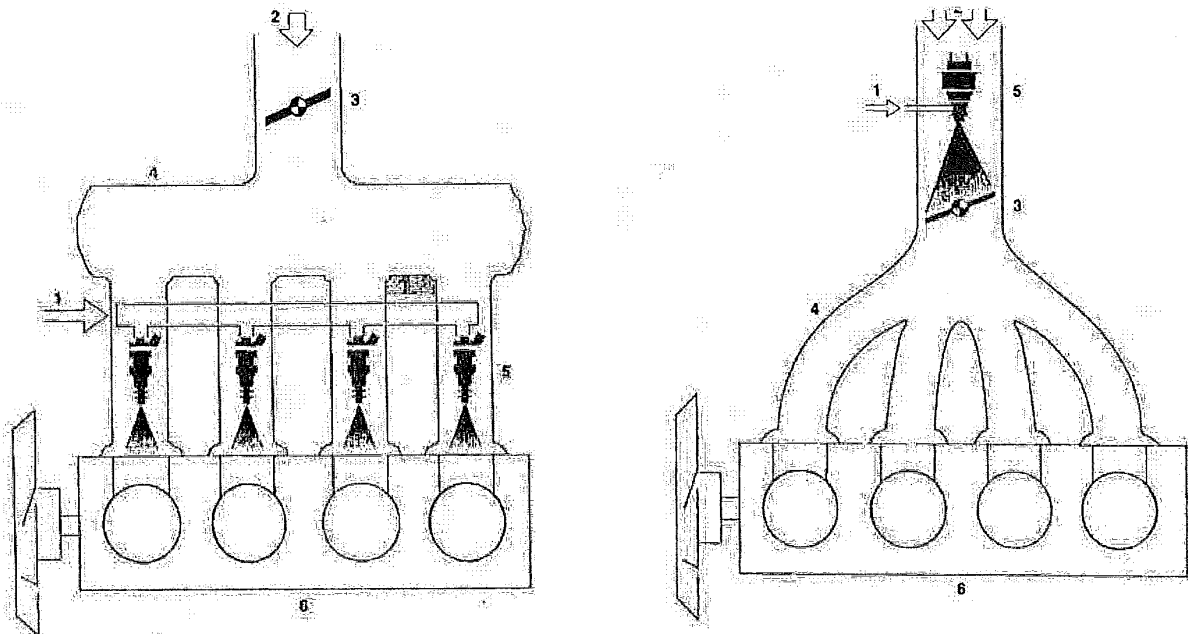

FIGURE 12.11 Air-fuel mixture preparation: right, single-point fuel injection; left, multipoint fuel injection with fuel (1), air (2), throttle valve (3), intake manifold (4), injector(s) (5), and engine (6).



For single-point systems such as carburetors or single-point fuel injection, the fuel is metered in the vicinity of the throttle valve. Mixture formation occurs in the intake manifold. Some of the fuel droplets evaporate to form fuel vapor (desirable) while others condense to form a film on the intake manifold walls (undesirable). Mixture transport and distribution is a function of intake manifold design. Uniform distribution under all operating conditions is difficult to achieve in a single-point system.

For multipoint systems, the fuel is injected near the intake valve. Mixture formation is supplemented by the evaporation of the fuel on the back of the hot intake valve. Mixture transport and distribution occurs only in the vicinity of the intake valve. The influence of the intake manifold design on uniform mixture distribution is minimized. Since mixture transport and distribution is not an issue, the intake manifold design can be optimized for air flow.

**Single-Point Injection Systems** A single-point injection system uses one or, in some cases, two electronic fuel injectors to inject fuel into the intake air stream. The main component is the fuel injection unit which is located upstream of the intake manifold.

**Component Description.** An electric fuel pump provides fuel at a medium pressure (typically 0.7 to 1.0 bar) to the electronic fuel injection unit (Fig. 12.12). The fuel injection unit houses the solenoid-operated fuel injector, which is located in the intake air flow above the throttle valve. This allows for homogeneous mixture formation and distribution. The injector spray pattern is designed to allow fuel to pass between the throttle valve and the throttle bore. To prevent vapor lock of the injector, fuel flows through the injector at all times. Fuel not used by the engine is returned to the fuel tank. The injector is activated in relation to the speed of the engine, typically once per ignition event. The length of the pulse width determines the quantity of fuel provided.

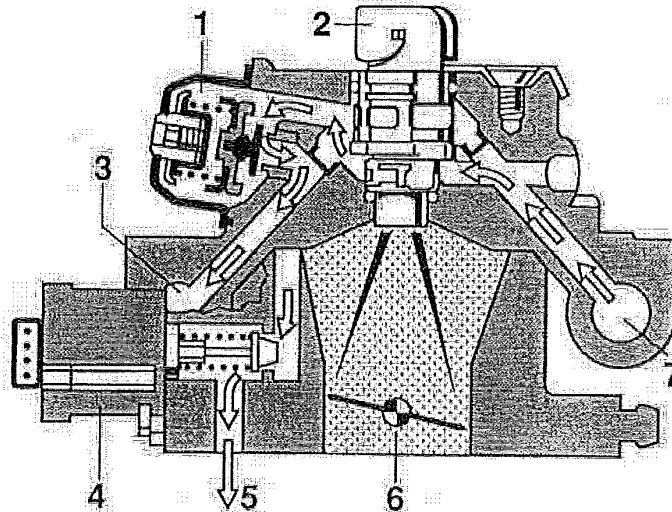

**FIGURE 12.12** Single-point injection unit: pressure regulator (1), injector (2), fuel return (3), stepper motor for idle speed control (4), to intake manifold (5), throttle valve (6), and fuel inlet (7).

The electronic injection unit also houses the throttle position sensor and, in some cases, an inlet air temperature sensor which provides operating condition information to the ECU. The throttle valve actuator and fuel pressure regulator are also mounted on the injection unit. In addition, some units contain an air bypass valve for idle speed control. Engine temperature, battery voltage, and engine speed via the ignition system are all inputs to the ECU. The single-

point injection system also uses lambda closed-loop fuel control to optimize fuel metering within the lambda control window (see Sec. 12.2.1).

*Adaptation to Operating Conditions.* For cold-start and engine warm-up, the ECU uses engine temperature information to determine the correct amount of fuel and commands the fuel injector via a pulse width. Due to wall wetting and poor fuel vaporization when the engine is cold, an increase in mixture richness is required. As the engine warms up to operating temperature, the commanded pulse width is reduced.

During an acceleration transition, the ECU adds a correction factor (an increase) to the commanded injector pulse width. The sudden increase in air results in a lean mixture which must be corrected swiftly to obtain good transitional response. During a deceleration transition, the fuel can be shut off by simply not providing a pulse width signal to the injector to minimize exhaust emissions and fuel consumption.

During full-load operation, the air/fuel mixture can be enriched ( $\lambda < 1$ ) to deliver maximum torque. The ECU determines full-load operation by the throttle position sensor (at or near wide-open throttle) and adds a correction to the injector pulse width to achieve the desired air/fuel mixture richness.

The single-point system can control the idle speed by ECU control of either a throttle valve actuator or a bypass valve. Idle speed is a function of engine operating temperature, whether the transmission is in drive, and what accessories are in use. Fuel metering at idle is determined by engine RPM and load as well as lambda closed-loop control.

**Multipoint Fuel Injection Systems.** A multipoint fuel injection system supplies fuel to each cylinder individually via a mechanical or solenoid-operated fuel injector located just upstream of the intake valve. Advantages of this system type compared to SPI systems are numerous:

- *Increased fuel economy.* On an SPI engine, due to the intake manifold configuration, mixture formation will differ at each cylinder. To provide adequate fuel for the leanest cylinder, too much fuel must be metered overall. In addition, during engine load changes, a film of fuel is deposited on the intake manifold walls. This leads to further variations in mixture from cylinder to cylinder. Multipoint injection provides the same quantity of fuel to each cylinder.
- *Higher power output.* With the fuel being injected near the intake valve, the rest of the intake manifold can be optimized for maximum air flow. The result is increased torque.
- *Improved throttle response.* Because the fuel is injected onto the intake valves, responses to increases in throttle position are swift. With an SPI system, the increased fuel required must travel the length of the intake manifold before entering the cylinder.
- *Lower exhaust emissions.* As was discussed for fuel economy, mixture variation in an SPI system creates increased exhaust emissions. Metering of the fuel at the intake valve decreases this variation. In addition, the system transport time is reduced, increasing the frequency at which the lambda closed-loop control system can switch air/fuel ratio. Catalytic converter efficiency is increased.

Although there are numerous advantages of the MPI systems over the SPI systems, there is still one important advantage the SPI systems have over the MPI systems. In general, SPI systems have better fuel preparation, similar to a carburetor.

*Mechanically Controlled Continuous Injection System.* This type of system meters the fuel as a function of the intake air quantity and injects it continuously onto the intake valves. This is accomplished by measuring the air flow as it passes through the air flow meter by means of deflection of a meter plate. The fuel is supplied through a fuel accumulator to the fuel distributor by an electric fuel pump. A primary-pressure regulator in the fuel distributor maintains constant fuel pressure. The fuel distributor, through its interface with the air flow meter and warm-up regulator, meters fuel to the continuously flowing fuel injectors.

**Component Description**

*Mixture control unit.* The mixture control unit houses the air flow meter and the fuel distributor. In the air flow meter, the measurement of the intake air serves as the basis for

determining the amount of fuel to be metered to the injectors. The air flow meter is located upstream of the throttle valve so that it measures all the air entering the engine. It consists of an air funnel, in which a sensor plate is free to pivot. Intake air flowing through the funnel causes a deflection of the sensor plate. The sensor plate is mechanically linked to a control plunger and movement of the plate results in movement of the control plunger. The control plunger movement determines the amount of fuel to be injected.

In the fuel distributor, the control plunger moves up and down in a cylindrically shaped device (barrel) with rectangular openings (metering slit), one for each engine cylinder. Increased air flow causes the control plunger to move upward, uncovering a larger area of the metering slit and increasing the fuel metered. Downstream of each metering slit is a differential-pressure valve that maintains a constant pressure drop across the metering slits at different flow rates. Due to the constant pressure, the fuel flow through the slits is directly proportional to the position of the control plunger (Fig. 12.13).

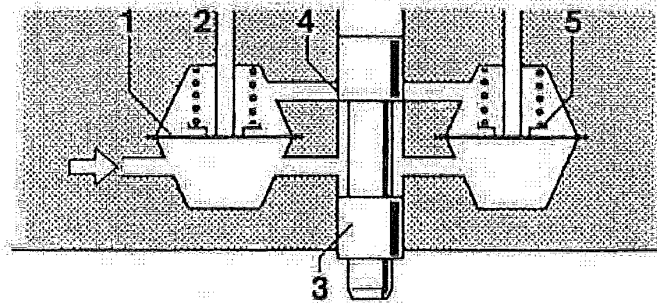

**FIGURE 12.13** Fuel distributor for mixture control unit; diaphragm (1), to injector (2), control plunger (3), metering slot (4), differential pressure regulator (5).

**Warm-up regulator.** The warm-up regulator is used to richen the fuel mixture under cold engine conditions. It consists of a diaphragm valve and an electrically heated bimetallic spring. Under cold conditions, the warm-up regulator lowers the control pressure on the control plunger. The control pressure acts on the opposite end of the plunger from the air flow meter plate. A lower control pressure results in a lower force required to move the meter plate. Therefore, the same air flow causes the meter plate and control plunger to move a greater distance and additional fuel is metered to the injectors.

**Fuel injectors.** The injectors open at a pressure of approximately 3.6 bar. Atomization of the fuel occurs through oscillation (audible chatter) of the valve needle caused by the fuel flowing through it. The injectors remain open as long as fuel is provided above the opening pressure. Fuel is injected continuously into the intake port. When the intake valve opens, the mixture is drawn into the cylinder.

**Auxiliary air valve.** The auxiliary air valve provides additional air to the engine by bypassing the throttle valve during cold engine operation. This creates an increase in the idle speed needed during cold operation.

**Thermo-time switch.** The thermo-time switch controls the cold start valve as a function of time and engine temperature. Fuel enters the intake manifold from the cold start valve and further enriches the mixture to improve cold-starting at low ambient temperatures. When the engine is warm, the contacts in the thermo-time switch open and the cold-start valve is not used in starting the engine.

**Lambda sensor.** With the addition of a lambda sensor in the exhaust stream, a frequency valve, a modified fuel distributor, and an electronic control unit, the mechanically controlled fuel system can operate under lambda closed-loop control. The lambda sensor sig-

nal is read by the ECU. The ECU outputs electric pulses to an electromagnetic (frequency) valve. The frequency valve modulates the pressure to the lower chambers of the differential-pressure valves in the fuel distributor. This results in a modification of the pressure drop across the metering slits, effectively increasing or decreasing the amount of fuel injected. Figure 12.14 is a schematic of a typical mechanically controlled continuous injection system.

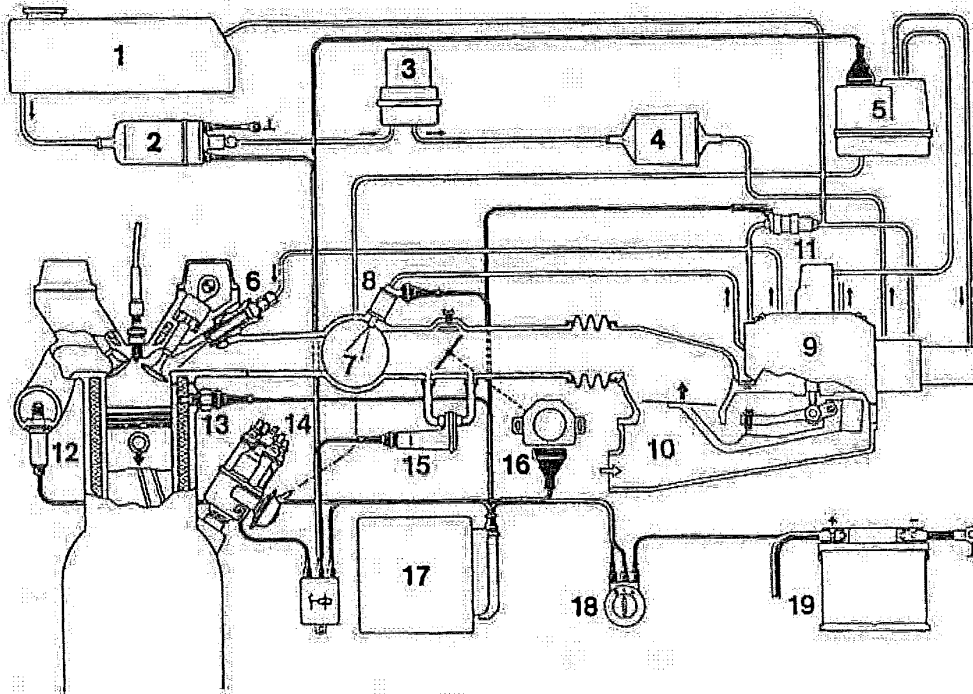

**FIGURE 12.14** Schematic of mechanically controlled continuous injection system: fuel tank (1), electric fuel pump (2), fuel accumulator (3), fuel filter (4), warm-up regulator (5), injector (6), intake plenum (7), cold-start valve (8), fuel distributor (9), air flow sensor (10), electrohydraulic pressure actuator (11), lambda sensor (12), thermo-time switch (13), ignition distributor (14), auxiliary air valve (15), throttle switch (16), ECU (17), ignition switch (18), and battery (19).

Depending on the engine temperature, the cold-start valve injects extra fuel into the intake manifold for a limited period during cold start. The injection period is determined by a combination of time and temperature and is controlled by the thermo-time switch. As the engine temperature increases, this additional enrichment is no longer required and the thermo-time switch turns off the cold-start valve. For repeated start attempts or long cranking, the thermo-time switch turns off the cold-start injector after a given time. This minimizes engine flooding when engine start has not occurred.

As the engine continues to warm up, wall wetting and poor fuel vaporization still occur and mixture enrichment is still required until the engine reaches operating temperature. This enrichment is controlled as a function of temperature by the warm-up regulator. As the temperature increases, the warm-up regulator commands less and less additional fuel by increasing the control pressure.

For acceleration response, the air flow sensor "overswings" during quick throttle increases. This causes an additional quantity of fuel to be injected for acceleration enrichment. For full-load enrichment to achieve maximum power, a special warm-up regulator

that uses intake manifold pressure is required. At increased manifold pressures, i.e., during wide-open throttle, the warm-up regulator lowers the control pressure, which results in an increase in fuel delivery. Deceleration fuel shutoff is accomplished by diverting all intake air through an air bypass around the air flow sensor plate. With no air flow past the air flow sensor plate, the fuel pressure to the injectors is decreased below the opening pressure.

Idle speed for the cold-running engine is increased by the auxiliary air valve. The amount of additional air varies with engine temperature until the auxiliary air valve is closed and the idle speed is then controlled only by the air passing the throttle valve.

*Electronically Controlled Continuous Injection.* The basis of the electronically controlled continuous injection is still the mechanical hydraulic injection system discussed previously. This is supplemented by an electronic control unit (ECU) that allows for an increase in flexibility and the use of additional functions. This system incorporates additional sensors for detecting the engine temperature, the throttle valve position (load signal), and the air flow sensor plate deflection. This information is processed by the ECU, which then commands an electrohydraulic pressure actuator to adapt the injected fuel quantity for the present operating conditions.

In contrast to the mechanical system mentioned previously, the control pressure or counterpressure on the control plunger is not varied by a warm-up regulator. The control pressure remains constant and is the same as the primary pressure. The function of the warm-up regulator is now handled by the ECU and the electrohydraulic pressure actuator. Figure 12.15 is a schematic of a typical electronically controlled continuous injection system.

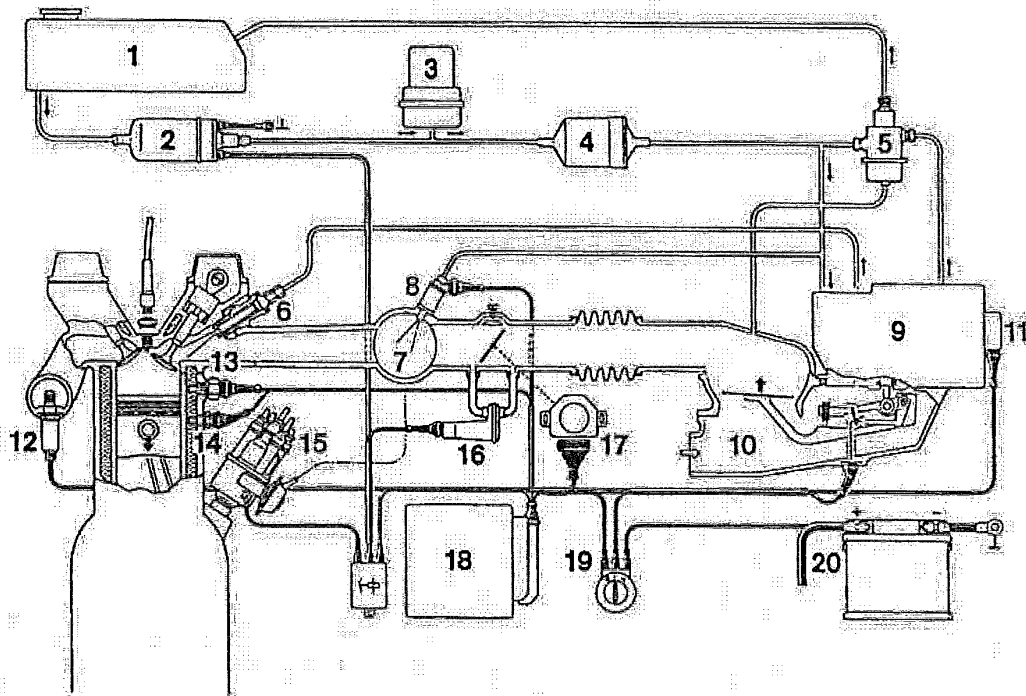

**FIGURE 12.15** Schematic of an electronically controlled continuous fuel injection system: fuel tank (1), electric fuel pump (2), fuel accumulator (3), fuel filter (4), fuel pressure regulator (5), injector (6), intake plenum (7), cold-start valve (8), fuel distributor (9), air flow sensor (10), electrohydraulic pressure actuator (11), lambda sensor (12), thermo-time switch (13), coolant temperature sensor (14), ignition distributor (15), auxiliary air valve (16), throttle valve switch (17), ECU (18), ignition switch (19), and battery (20).

*Component description—electrohydraulic pressure actuator.* The main difference in the componentry between the purely mechanical system and the electronically controlled system is the addition of the electrohydraulic actuator and the elimination of the warm-up regulator. With the addition of the ECU control of fuel metering, the purely mechanical warm-up regulator is no longer required. Depending on the signal received from the ECU, the electrohydraulic pressure actuator varies the pressure in the lower chambers of the differential pressure valves. This changes the amount of fuel delivered to the injectors.

*Lambda closed-loop control.* As with the mechanical system, the lambda sensor signal is processed by the ECU to determine mixture composition. The difference is that the ECU now commands the electrohydraulic actuator to modify the fuel metered, as opposed to the separate frequency valve, which is no longer necessary.

*Adaptation to operating conditions.* Depending on the engine temperature, the cold-start valve injects extra fuel into the intake manifold for a limited period during cold-start. The quantity to be injected is controlled by the ECU and is a function of engine temperature (from the engine temperature sensor). The thermo-time switch controls how long the cold-start valve remains active, depending on engine temperature and time.

*Acceleration enrichment* is controlled by the ECU. Input from the air flow sensor plate position sensor provides the ECU with information on how quickly the engine load has increased. The ECU commands additional enrichment via the electrohydraulic pressure actuator. For full-load enrichment for maximum power, the ECU receives input from the throttle position sensor that the throttle is wide open. The ECU then commands additional enrichment via the electrohydraulic pressure actuator. Deceleration fuel shutoff is also controlled by the ECU when the throttle valve switch indicates the throttle is closed and the engine speed is above idle RPM. The ECU signals the electrohydraulic pressure actuator to interrupt fuel delivery to the injectors.

*Idle speed control* can be a closed-loop function with the addition of the idle actuator valve. This valve is ECU-controlled and the RPM signal from the ignition, combined with the engine temperature signal, is used to determine its position for the correct idle speed.

*Pulsed Fuel Injection Systems.* Pulsed fuel injection systems are a further enhancement of the continuous injection systems. Today, most continuous injection systems have been replaced with pulsed fuel injection systems. Instead of injecting fuel continuously and controlling the quantity of fuel by modifying the delivery volume flow rate, the fuel quantity is controlled by the open time of the solenoid-operated injectors. The injectors are controlled directly by the ECU. For most systems, the fuel pressure drop across the injector, from the fuel rail to the intake manifold, is kept constant by using intake manifold air pressure to compensate the fuel pressure regulator. This type of system allows for still greater precision of fuel control and is usually coupled with an equally precise ignition timing control system.

*Component description.* Several multipoint pulsed injection systems exist in various configurations. The components discussed here serve as a general outline of this system type. Figure 12.16 is a schematic of a typical pulsed fuel injection system.

- *Inlet air sensing.* The inlet air charge can be measured directly using either an air flow meter or a mass air flow meter. The air flow meter is a vane-type meter, which uses the force of the incoming air to move a flap through a defined angle. The angular movement is converted by a potentiometer to a voltage ratio. The air flow meter requires an air inlet temperature sensor to correct for air density changes. The air mass flow meter measures the air mass directly by hot-wire or hot-film element. As the inlet air flow passes the heated element, a bridge circuit keeps the element at a constant temperature above the inlet temperature. The heating current required by the bridge circuit to maintain the element at a constant temperature is measured and converted to an air density value.

The air charge can also be measured indirectly by measuring the inlet air temperature, intake manifold pressure, and engine RPM and then calculating the air charge (see Sec. 12.2.1 for further discussion on the calculation method which is called speed density air measurement).

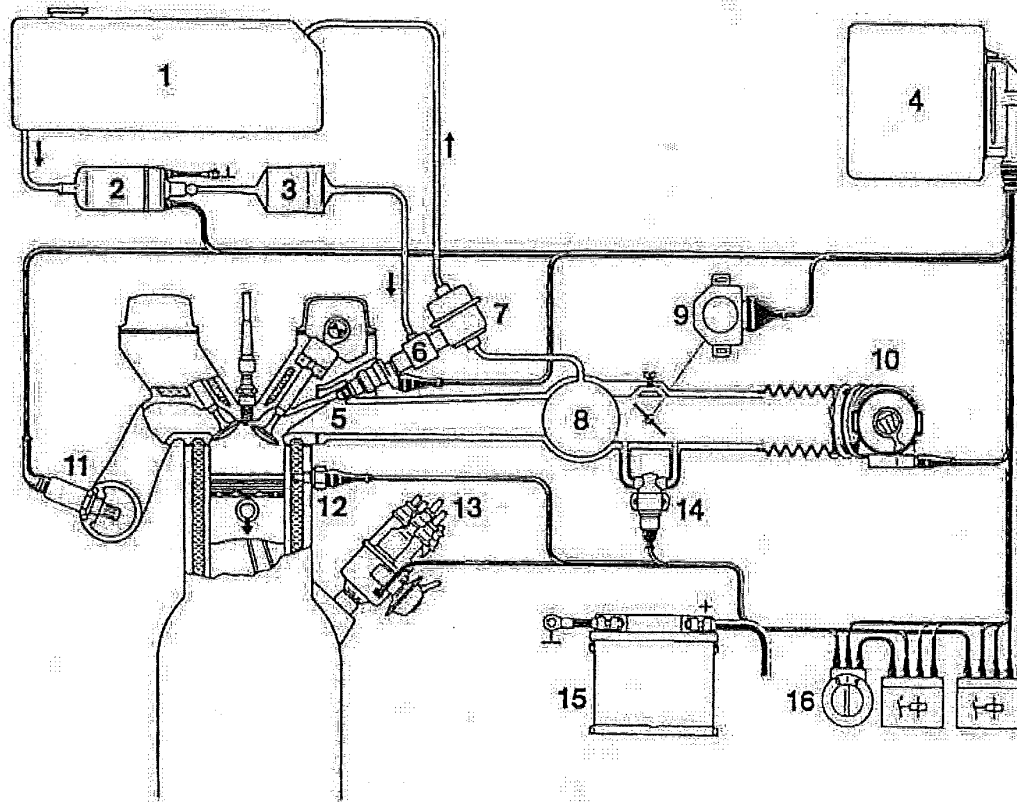

**FIGURE 12.16** Schematic of a pulsed fuel injection system: fuel tank (1), electric fuel pump (2), fuel filter (3), ECU (4), injector (5), fuel distributor (6), fuel pressure regulator (7), intake plenum (8), throttle valve switch (9), hot-wire mass air flow sensor (10), lambda sensor (11), coolant temperature sensor (12), ignition distributor (13), idle speed actuator (14), battery (15), and ignition switch (16).

- Fuel metering.** The fuel supply system includes an electric fuel pump, fuel filter, fuel rail, pressure regulator, and solenoid-operated injectors. The fuel pump provides more fuel than the maximum required by the engine. Fuel not used by the engine is returned to the fuel tank. The fuel rail supplies all injectors with an equal quantity of fuel and ensures the same fuel pressure at all injectors.

The pressure regulator keeps the pressure differential across the injectors constant. It contains a diaphragm that has intake manifold pressure on one side and fuel rail pressure on the other. Normally, it is mounted at the outlet end of the fuel rail. The diaphragm operates a valve which opens at a differential pressure between 2.0 and 3.5 bar and allows excess fuel to return to the fuel tank.

The fuel injectors are solenoid-operated valves that are opened and closed by means of electric pulses from the ECU. The injectors are mounted in the intake manifold and spray onto the back of the intake valves. In general, one injector is used for each cylinder.

In addition, some systems also use a separate cold-start injector mounted in the intake manifold just downstream of the throttle valve. This injector ensures good fuel vaporization during cold-start and supplies the additional enrichment needed to start the cold engine. Control of the cold-start valve is either by the ECU directly or in conjunction with a thermo-time switch.

- *Lambda closed-loop control.* The lambda sensor signal is processed by the ECU. The ECU determines the required injector pulse width to maintain the air/fuel ratio within the lambda control window (see Sec. 12.2.1 for further discussion on lambda closed-loop control).

*Adaptation to operating conditions.* For cranking, the fuel required is determined by a data table in the ECU with reference to engine temperature. The ECU then commands a pulse width for the fuel injectors. The air/fuel mixture is greatly enriched due to poor fuel vaporization and wall wetting, which reduces the amount of usable fuel. After start, the fuel mixture remains rich due to continuing poor air/fuel mixture formation. The amount of enrichment should be minimized to obtain good emission results. The target is to stay close to lambda ( $\lambda$ ) = 1.

For acceleration enrichment, the throttle valve position sensor indicates that the throttle has moved rapidly. The ECU adds a correction factor to increase the pulse width so that a smooth transition occurs. For deceleration, the ECU uses input from the throttle position sensor and engine RPM to indicate that the throttle has closed and the engine speed is above the idle speed. Since no torque is required under this condition, the ECU provides no pulse width to the injectors and they are therefore closed. For full-load enrichment, when necessary, the ECU can provide an injector pulse width that would result in the engine achieving its maximum torque (roughly  $\lambda = 0.9$ ). Fuel metering during idle is primarily controlled by lambda closed-loop control when the engine has reached operating temperature.

### 12.2.5 Ignition Systems

*Overview.* The purpose of the ignition system in the spark ignition engine is to initiate combustion of the air/fuel mixture by delivering a spark at precisely the right moment. The spark consists of an electrical arc generated across the electrodes of the spark plug. Two important factors for proper ignition are the energy of the spark and the point in the four-stroke cycle when the spark occurs (ignition timing).

*Electrical Energy.* The energy required for a spark to ignite an air/fuel mixture at stoichiometry depends on specific engine conditions. If there is insufficient energy available to ignite the air/fuel mixture, misfiring will occur. Misfiring will result in poor engine operation, high exhaust emissions, and possible catalytic converter damage. Therefore, the amount of ignition energy available must always exceed the amount necessary to ensure ignition even under adverse conditions.

Some of the conditions that affect ignitability of the air/fuel mixture are fuel atomization, access of the mixture to the spark, spark duration, and spark physical length. Fuel atomization is controlled by the fuel system and the engine design. Access to the spark depends on combustion chamber and spark plug design. Spark duration is a function of the ignition system. Spark physical length is determined by the spark plug dimensions (gap).

*Ignition Timing.* The ignition timing must be selected to meet the following objectives: maximize engine performance, limit fuel consumption, minimize engine knock, and minimize exhaust emissions. Unfortunately, all of these objectives cannot be achieved simultaneously under all operating conditions and compromises must be made.

It is desirable in the SI engine to have ignition of the combustible mixture occur prior to the piston reaching TDC on the compression stroke to achieve the best engine performance. The ignition spark must occur early enough to ensure that the peak cylinder combustion pressure occurs at the correct point after top dead center (ADC) under all operating conditions. Figure 12.17 is a graph of ignition angle vs. combustion pressure. The length of the combustion process from initial ignition to final combustion is approximately 2 ms. This combustion time remains relatively constant with respect to engine speed. Therefore, as the engine speed increases, the ignition spark must occur earlier in terms of crankshaft angle to ensure complete combustion.



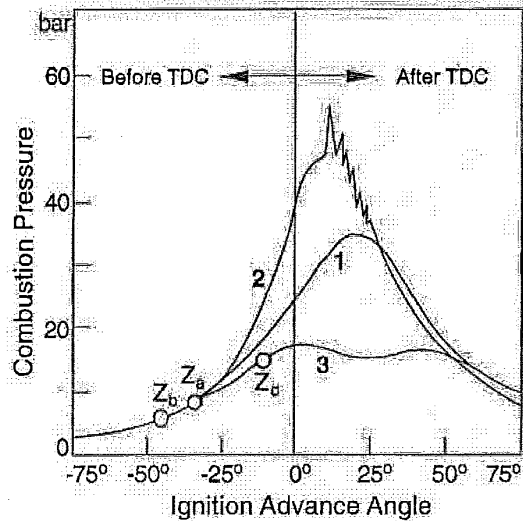

**FIGURE 12.17** Combustion pressure curve for various ignition timing points: correct ignition advance  $Z_a$  (1), excessive ignition advance  $Z_b$  (2), and excessive ignition retard  $Z_c$  (3).

At low engine loads, the lower air charge and the residual gas content, due to valve overlap, serve to lengthen the time required for complete combustion. To compensate for this effect, the ignition timing is advanced at low loads to ensure that complete combustion occurs.

Ignition timing influences exhaust emissions and fuel consumption. With more advanced timing, the emission of unburned hydrocarbons (HC) and of oxides of nitrogen ( $\text{NO}_x$ ) increases. Carbon monoxide (CO) emissions are not influenced greatly by ignition timing. To achieve improvements in fuel consumption, the air/fuel mixture must be lean. To ensure complete combustion for a lean mixture, the ignition timing must be advanced. However, as previously stated, advanced timing increases emissions of HC and  $\text{NO}_x$ .

**Spark Ignition Systems.** The general configuration of an ignition system consists of the following components: energy storage device, ignition timing mechanism, ignition triggering mechanism, spark distribution system, and spark plugs and high tension wires.

Inductive ignition systems use an ignition coil as the energy storage device. The coil also functions as a transformer, boosting the secondary ignition voltage. A typical turns-ratio of the primary to secondary winding is 1:100. Electrical energy is supplied to the coil's primary winding from the vehicle electrical system. Before the ignition point, the coil is charged during the dwell period to its interruption current. Open- or closed-loop dwell angle control ensures a sufficient interruption current even at high speeds. Sufficient ignition energy at the interruption current is ensured by an adequate coil design. At the ignition point, the primary current will be interrupted. The rapid change of the magnetic field induces the secondary voltage in the secondary winding. A distribution system assigns the high voltage to the corresponding spark plug. After exceeding the arcing over voltage at the spark plug, the coil will be discharged during the spark duration.

The ignition timing mechanism, ignition triggering mechanism, and the spark distribution system differ between ignition systems. Further discussion of these will occur within the discussion of each ignition system type.

The spark plugs provide the ignition energy via the high-tension wires to the air/fuel mixture in the cylinder to initiate combustion. The voltage required at the spark plug can be more

than 30 kV. Because the spark plug extends into the combustion chamber, it is exposed to extreme temperature and pressure conditions. Spark plug design and materials are chosen to ensure long-term operation under tough operating conditions.

A typical spark plug consists of a pair of electrodes, called a center and ground electrode, separated by a gap. The size of the gap is important and is specified for each plug type and engine. The center electrode is electrically connected to the top terminal of the plug which is attached to the high-tension wire. The electrical energy travels through the high-tension wire to the top terminal and down to the center electrode. The ground electrode is part of the threaded portion of the spark plug that is installed in the cylinder head. The ground electrode is at electrical ground potential because the negative terminal of the battery is also connected to the engine. The spark is produced when the high-voltage pulse travels to the center electrode and jumps the gap to the ground electrode.

*Ignition System Types:* Table 12.1 summarizes the various ignition systems used on SI engines.

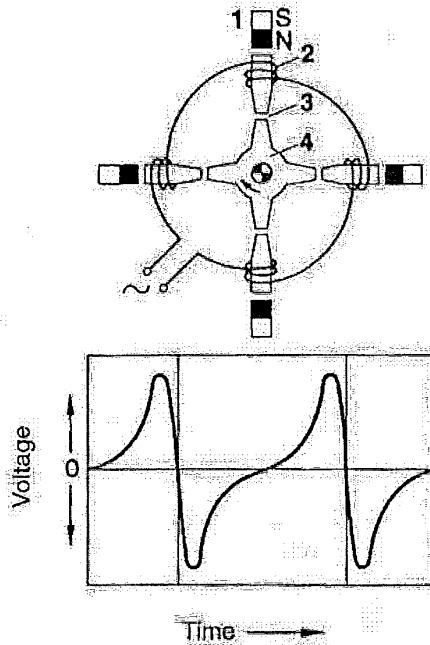

**FIGURE 12.18** Induction-type pulse generator: permanent magnet (1), induction winding with core (2), variable air gap (3), trigger wheel (4).

*Coil ignition.* Breaker-triggered coil ignition systems have been replaced by breakerless transistorized ignition systems and are no longer installed as original equipment.

On breakerless transistorized ignition systems, the contact breaker's function is replaced by a magnetic pulse generator. The pulse generator is installed in the distributor and turns with the distributor shaft. There are commonly two types of pulse generators: induction-type and Hall-type. Induction-type pulse generators consist of a stator and a trigger wheel (Fig. 12.18). The stator consists of a permanent magnet, inductive winding, and core, and remains fixed. The trigger wheel teeth correspond to the number of cylinders, and the trigger wheel turns with the distributor shaft. The operating principle is that as the air gap changes between the stator and the rotor, the magnetic flux changes. The change in magnetic flux induces an ac voltage in the inductive winding. The frequency and magnitude of the alternating current increases with increasing engine speed. The electronic control unit or trigger box uses this information to trigger the ignition timing.

**TABLE 12.1** Overview of Various Ignition Systems

Ignition function	Ignition designation				
	Coil system	Transistorized coil system	Capacitor discharge system	Electronic system with distributor	Electronic distributorless system
Ignition triggering	Mechanical	Electronic	Electronic	Electronic	Electronic
Ignition timing	Mechanical	Mechanical	Electronic	Electronic	Electronic
High-voltage generation	Inductive	Inductive	Capacitive	Inductive	Inductive
Spark distribution to appropriate cylinder	Mechanical	Mechanical	Mechanical	Mechanical	Electronic

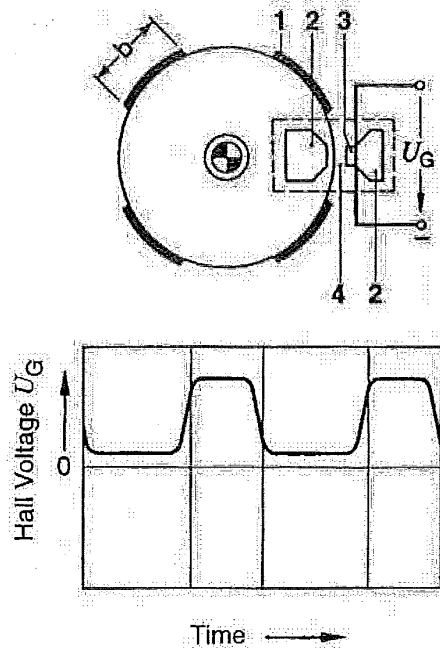

**FIGURE 12.19** Hall-type pulse generator: vane (1), soft magnetic conductive elements (2), Hall IC (3), and air gap,  $U_G$ -Hall sensor voltage (4).

Hall-type pulse generators utilize the Hall effect (Fig. 12.19). As the distributor shaft turns, the vanes of the rotor move through the air gap of the magnetic barrier. When the vane is not in front of the Hall IC, the sensor is subjected to a magnetic field. The magnetic flux density is high and thus the voltage  $U_G$  is at a maximum. As soon as the rotor vane enters the air gap, the magnetic flux runs through the vane area and is largely prevented from reaching the Hall layer. The voltage  $U_G$  is at a minimum. The resulting pulses switch the primary current off and on.

The distributor disburses the ignition pulses to the spark plugs via the high-tension wires in a specific sequence. It also adjusts the ignition timing by means of spark advance mechanisms. The distributor rotor is turned by the engine at one-half the crankshaft speed. The electrical energy is fed to the center of the rotor. While the rotor turns, the rotor electrode aligns with the outer electrodes that are connected to the high-tension wires. One outer electrode and high-tension wire connection exists for each cylinder. When alignment occurs between the center and outer electrode, the spark is distributed to that particular cylinder.

The spark advance mechanisms advance the ignition timing by rotating the distributor plate relative to the distributor shaft. The centrifugal advance increases the spark advance with increasing engine speed. The vacuum advance, using intake manifold vacuum, increases the spark advance at low engine speeds.

**Capacitor discharge ignition system.** The capacitive discharge system differs from the coil-type ignition systems previously discussed. Ignition energy is stored in the electrical field of a capacitor. Capacitance and charge voltage of the capacitor determine the amount of energy that is stored. The ignition transformer converts the primary voltage discharged from the capacitor to the required high voltage.

**Electronic ignition—with distributor.** Electronic ignition calculates the ignition timing electronically (Fig. 12.20). This replaces the function of the centrifugal advance and vacuum advance in the distributor discussed on the previous coil ignition systems. Because the ignition timing is not limited by mechanical devices, the optimal timing can be chosen for each engine operating point. Figure 12.21 is a comparison of an ignition map from a mechanical advance system and a map of an electronically optimized system. Also, additional influences such as engine knock detection can be used to modify the ignition timing. The engine speed input and crankshaft position input can be obtained from a sensor mounted near the crankshaft. Precision is improved over using the distributor-mounted trigger. This input is provided to the electronic control unit (ECU) along with the engine temperature and engine load. The ECU references data tables to determine the optimal spark advance for each engine operating condition. Additional corrections to the spark timing, such as for EGR usage or knock sensor detection, are made in the ECU.

**Electronic ignition—distributorless.** On distributorless ignition systems, the high voltage distribution is accomplished by using either single or double spark ignition coils. Ignition timing is determined by the ECU, as discussed for electronic ignition with distributor. For the double spark ignition coils, one coil exists for two corresponding cylinders. Two high-tension

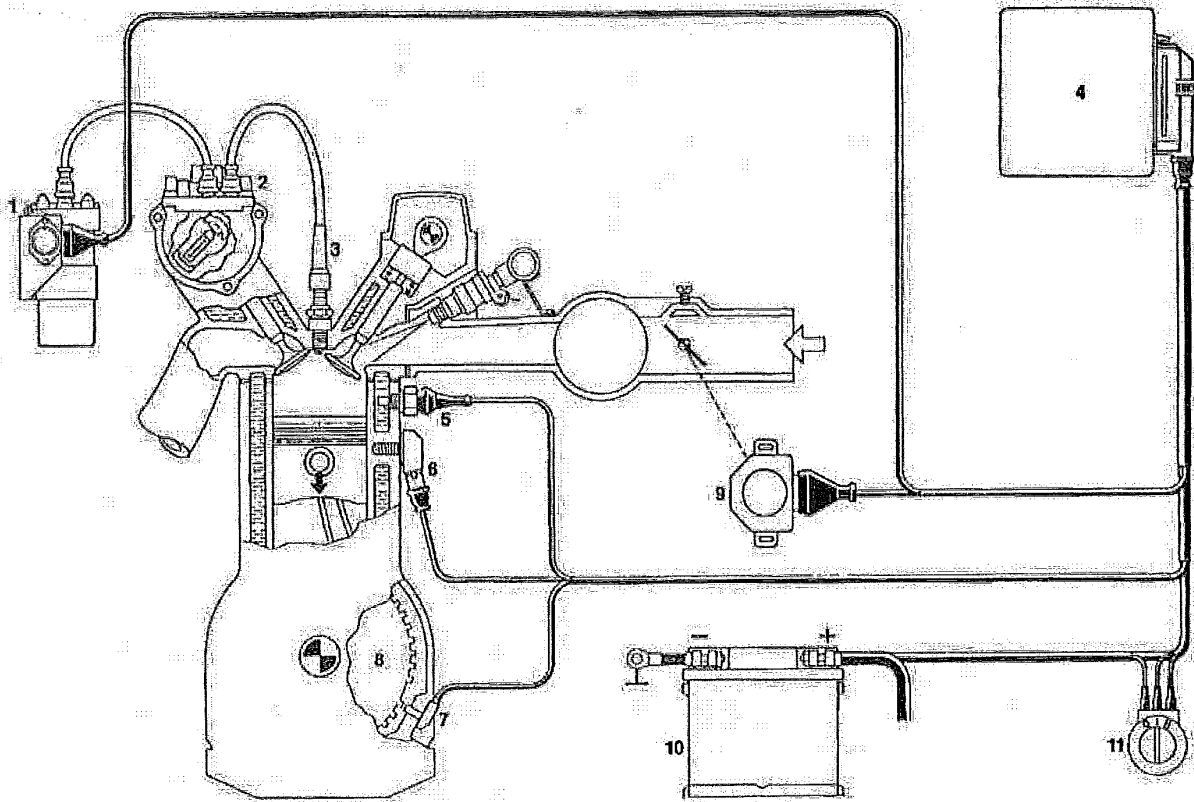

**FIGURE 12.20** Schematic of an electronic ignition system with distributor: ignition coil (1), high-voltage distributor (2), spark plug (3), ECU (4), coolant temperature sensor (5), knock sensor (6), engine speed and crankshaft reference sensor (7), sensor wheel (8), throttle valve (9), battery (10), and ignition switch (11).

wires are routed from each coil to two cylinders, which are  $360^\circ$  out of phase. When the coil output stage is triggered via the ECU, a spark is delivered to both cylinders. One cylinder will be on the compression stroke, the other on the exhaust stroke. Because both cylinders are fired together, for a given crankshaft rotation, one will always be on the compression stroke and the other on the exhaust stroke. Therefore, there is no need to know which cylinder is compressing the ignitable mixture.

On single spark ignition coils, one coil exists for each cylinder. Each coil triggers only once during the four-stroke cycle. Because of this, it must be known which cylinder is on the compression stroke. Synchronization with the camshaft must occur. The information needed on camshaft position is supplied by a phase sensor mounted on the camshaft.

## 12.3 COMPRESSION IGNITION ENGINES

### 12.3.1 Engine Control Functions

Electronic engine controls are now being used on compression ignition (diesel) engines. These controls offer greater precision and control of fuel injection quantity and timing, engine speed, EGR, turbocharger boost pressure, and auxiliary starting devices. The following inputs