

AO 120 (Rev. 08/10)

<p>TO:</p> <p style="text-align: center;">Mail Stop 8 Director of the U.S. Patent and Trademark Office P.O. Box 1450 Alexandria, VA 22313-1450</p>	<p>REPORT ON THE FILING OR DETERMINATION OF AN ACTION REGARDING A PATENT OR TRADEMARK</p>
--	--

In Compliance with 35 U.S.C. § 290 and/or 15 U.S.C. § 1116 you are hereby advised that a court action has been filed in the U.S. District Court Eastern District of Texas, Marshall Division on the following Trademarks or Patents. (the patent action involves 35 U.S.C. § 292.):

DOCKET NO. 2:16-cv-777	DATE FILED 7/15/2016	U.S. DISTRICT COURT Eastern District of Texas, Marshall Division
PLAINTIFF UNILOC USA, INC., and UNILOC LUXEMBOURG, S.A.		DEFENDANT AVAYA INC.,
PATENT OR TRADEMARK NO.	DATE OF PATENT OR TRADEMARK	HOLDER OF PATENT OR TRADEMARK
1 7,535,890	5/19/2009	UNILOC LUXEMBOURG, S.A.
2 8,995,433	3/31/2015	UNILOC LUXEMBOURG, S.A.
3 8,724,622	5/13/2014	UNILOC LUXEMBOURG, S.A.
4 8,243,723	8/14/2012	UNILOC LUXEMBOURG, S.A.
5 8,199,747	6/12/2012	UNILOC LUXEMBOURG, S.A.

In the above—entitled case, the following patent(s)/ trademark(s) have been included:

DATE INCLUDED	INCLUDED BY <input type="checkbox"/> Amendment <input type="checkbox"/> Answer <input type="checkbox"/> Cross Bill <input type="checkbox"/> Other Pleading		
PATENT OR TRADEMARK NO.	DATE OF PATENT OR TRADEMARK	HOLDER OF PATENT OR TRADEMARK	
1			
2			
3			
4			
5			

In the above—entitled case, the following decision has been rendered or judgement issued:

DECISION/JUDGEMENT

CLERK	(BY) DEPUTY CLERK	DATE
-------	-------------------	------

Copy 1—Upon initiation of action, mail this copy to Director Copy 3—Upon termination of action, mail this copy to Director
 Copy 2—Upon filing document adding patent(s), mail this copy to Director Copy 4—Case file copy

AO 120 (Rev. 08/10)

TO: Mail Stop 8 Director of the U.S. Patent and Trademark Office P.O. Box 1450 Alexandria, VA 22313-1450	REPORT ON THE FILING OR DETERMINATION OF AN ACTION REGARDING A PATENT OR TRADEMARK
---	---

In Compliance with 35 U.S.C. § 290 and/or 15 U.S.C. § 1116 you are hereby advised that a court action has been filed in the U.S. District Court Eastern District of Texas, Marshall Division on the following

Trademarks or Patents. (the patent action involves 35 U.S.C. § 292.);

DOCKET NO. 2:16-cv-779	DATE FILED 7/15/2016	U.S. DISTRICT COURT Eastern District of Texas, Marshall Division
PLAINTIFF UNILOC USA, INC., and UNILOC LUXEMBOURG, S.A.		DEFENDANT SHORETEL, INC.
PATENT OR TRADEMARK NO.	DATE OF PATENT OR TRADEMARK	HOLDER OF PATENT OR TRADEMARK
1 7,535,890	5/19/2009	UNILOC LUXEMBOURG, S.A.
2 8,995,433	3/31/2015	UNILOC LUXEMBOURG, S.A.
3 8,724,622	5/13/2014	UNILOC LUXEMBOURG, S.A.
4 8,243,723	8/14/2012	UNILOC LUXEMBOURG, S.A.
5		

In the above—entitled case, the following patent(s)/ trademark(s) have been included:

DATE INCLUDED	INCLUDED BY <input type="checkbox"/> Amendment <input type="checkbox"/> Answer <input type="checkbox"/> Cross Bill <input type="checkbox"/> Other Pleading	
PATENT OR TRADEMARK NO.	DATE OF PATENT OR TRADEMARK	HOLDER OF PATENT OR TRADEMARK
1		
2		
3		
4		
5		

In the above—entitled case, the following decision has been rendered or judgement issued:

DECISION/JUDGEMENT

CLERK	(BY) DEPUTY CLERK	DATE
-------	-------------------	------

Copy 1—Upon initiation of action, mail this copy to Director Copy 3—Upon termination of action, mail this copy to Director
 Copy 2—Upon filing document adding patent(s), mail this copy to Director Copy 4—Case file copy



UNITED STATES PATENT AND TRADEMARK OFFICE

UNITED STATES DEPARTMENT OF COMMERCE
United States Patent and Trademark Office
Address: COMMISSIONER FOR PATENTS
P.O. Box 1450
Alexandria, Virginia 22313-1450
www.uspto.gov

Table with 5 columns: APPLICATION NO., ISSUE DATE, PATENT NO., ATTORNEY DOCKET NO., CONFIRMATION NO.
Row 1: 14/224,125, 03/31/2015, 8995433, EMP0025-US, 5407

67050 7590 03/11/2015
KASHA LAW LLC
14532 Dufief Mill Road
North Potomac, MD 20878

ISSUE NOTIFICATION

The projected patent number and issue date are specified above.

Determination of Patent Term Adjustment under 35 U.S.C. 154 (b)
(application filed on or after May 29, 2000)

The Patent Term Adjustment is 0 day(s). Any patent to issue from the above-identified application will include an indication of the adjustment on the front page.

If a Continued Prosecution Application (CPA) was filed in the above-identified application, the filing date that determines Patent Term Adjustment is the filing date of the most recent CPA.

Applicant will be able to obtain more detailed information by accessing the Patent Application Information Retrieval (PAIR) WEB site (http://pair.uspto.gov).

Any questions regarding the Patent Term Extension or Adjustment determination should be directed to the Office of Patent Legal Administration at (571)-272-7702. Questions relating to issue and publication fee payments should be directed to the Application Assistance Unit (AAU) of the Office of Data Management (ODM) at (571)-272-4200.

APPLICANT(s) (Please see PAIR WEB site http://pair.uspto.gov for additional applicants):

Empire IP LLC, New York, NY, Assignee (with 37 CFR 1.172 Interest);
Michael J. Rojas, North Canton, OH;

The United States represents the largest, most dynamic marketplace in the world and is an unparalleled location for business investment, innovation, and commercialization of new technologies. The USA offers tremendous resources and advantages for those who invest and manufacture goods here. Through SelectUSA, our nation works to encourage and facilitate business investment. To learn more about why the USA is the best country in the world to develop technology, manufacture products, and grow your business, visit SelectUSA.gov.

INFORMATION DISCLOSURE STATEMENT BY APPLICANT (Not for submission under 37 CFR 1.99)	Application Number		14224125	
	Filing Date		2014-03-25	
	First Named Inventor	Michael J. Rojas		
	Art Unit			
	Examiner Name			
	Attorney Docket Number		EMP0025-US	

	14	20040224678	A1	2004-11-11	Dahod et al.	Entire document
	15	20040014456	A1	2004-01-22	Vaananen	Entire document
Change(s) applied to document. /M.H.E./ 2/28/2015	16	20100070275	A1	2012-03-10	Cast March 18, 2010	Entire document
	17	20040179092	A1	2004-09-16	LaPoint	Entire document
	18	20040085456	A1	2004-05-06	Kwag et al.	Entire document
	19	20040223599	A1	2004-11-11	Bear et al.	Entire document
	20	20050117591	A1	2005-06-02	Hurta et al.	Entire document
	21	20130279681	A1	2013-10-24	Weiner	Entire document
	22	20120275452	A1	2012-11-01	Rojas	Entire document

If you wish to add additional U.S. Published Application citation information please click the Add button. [Add](#)

FOREIGN PATENT DOCUMENTS								Remove
Examiner Initial*	Cite No	Foreign Document Number ³	Country Code ² j	Kind Code ⁴	Publication Date	Name of Patentee or Applicant of cited Document	Pages, Columns, Lines where Relevant Passages or Relevant Figures Appear	T ⁵

Electronic Patent Application Fee Transmittal

Application Number:	14224125				
Filing Date:	25-Mar-2014				
Title of Invention:	System and Method for Instant VoIP Messaging				
First Named Inventor/Applicant Name:	Michael J. Rojas				
Filer:	John Kasha				
Attorney Docket Number:	EMP0025-US				
Filed as Small Entity					
Filing Fees for Utility under 35 USC 111(a)					
Description	Fee Code	Quantity	Amount	Sub-Total in USD(\$)	
Basic Filing:					
Pages:					
Claims:					
Miscellaneous-Filing:					
Petition:					
Patent-Appeals-and-Interference:					
Post-Allowance-and-Post-Issuance:					
Utility Appl Issue Fee	2501	1	480	480	

Description	Fee Code	Quantity	Amount	Sub-Total in USD(\$)
Extension-of-Time:				
Miscellaneous:				
Total in USD (\$)				480

Electronic Acknowledgement Receipt

EFS ID:	21616253
Application Number:	14224125
International Application Number:	
Confirmation Number:	5407
Title of Invention:	System and Method for Instant VoIP Messaging
First Named Inventor/Applicant Name:	Michael J. Rojas
Customer Number:	67050
Filer:	John Kasha
Filer Authorized By:	
Attorney Docket Number:	EMP0025-US
Receipt Date:	26-FEB-2015
Filing Date:	25-MAR-2014
Time Stamp:	21:08:40
Application Type:	Utility under 35 USC 111(a)

Payment information:

Submitted with Payment	yes
Payment Type	Deposit Account
Payment was successfully received in RAM	\$480
RAM confirmation Number	8141
Deposit Account	504075
Authorized User	

The Director of the USPTO is hereby authorized to charge indicated fees and credit any overpayment as follows:

- Charge any Additional Fees required under 37 C.F.R. Section 1.16 (National application filing, search, and examination fees)
- Charge any Additional Fees required under 37 C.F.R. Section 1.17 (Patent application and reexamination processing fees)

Charge any Additional Fees required under 37 C.F.R. Section 1.19 (Document supply fees)
 Charge any Additional Fees required under 37 C.F.R. Section 1.20 (Post Issuance fees)
 Charge any Additional Fees required under 37 C.F.R. Section 1.21 (Miscellaneous fees and charges)

File Listing:

Document Number	Document Description	File Name	File Size(Bytes)/ Message Digest	Multi Part /.zip	Pages (if appl.)
1	Issue Fee Payment (PTO-85B)	EMP0025-US_iss_fee_trans.pdf	90378 6a04321b010e74ec2268bd36ebe66f64817bcaf3	no	1

Warnings:

Information:

2	Fee Worksheet (SB06)	fee-info.pdf	29893 a9b6f776a0dd59e12b57701627ebf1d9a67e93e8	no	2
---	----------------------	--------------	---	----	---

Warnings:

Information:

Total Files Size (in bytes): 120271

This Acknowledgement Receipt evidences receipt on the noted date by the USPTO of the indicated documents, characterized by the applicant, and including page counts, where applicable. It serves as evidence of receipt similar to a Post Card, as described in MPEP 503.

New Applications Under 35 U.S.C. 111

If a new application is being filed and the application includes the necessary components for a filing date (see 37 CFR 1.53(b)-(d) and MPEP 506), a Filing Receipt (37 CFR 1.54) will be issued in due course and the date shown on this Acknowledgement Receipt will establish the filing date of the application.

National Stage of an International Application under 35 U.S.C. 371

If a timely submission to enter the national stage of an international application is compliant with the conditions of 35 U.S.C. 371 and other applicable requirements a Form PCT/DO/EO/903 indicating acceptance of the application as a national stage submission under 35 U.S.C. 371 will be issued in addition to the Filing Receipt, in due course.

New International Application Filed with the USPTO as a Receiving Office

If a new international application is being filed and the international application includes the necessary components for an international filing date (see PCT Article 11 and MPEP 1810), a Notification of the International Application Number and of the International Filing Date (Form PCT/RO/105) will be issued in due course, subject to prescriptions concerning national security, and the date shown on this Acknowledgement Receipt will establish the international filing date of the application.



UNITED STATES PATENT AND TRADEMARK OFFICE

UNITED STATES DEPARTMENT OF COMMERCE
United States Patent and Trademark Office
Address: COMMISSIONER FOR PATENTS
P.O. Box 1450
Alexandria, Virginia 22313-1450
www.uspto.gov

NOTICE OF ALLOWANCE AND FEE(S) DUE

67050 7590 02/24/2015
KASHA LAW LLC
14532 Dufief Mill Road
North Potomac, MD 20878

EXAMINER

SMITH, CREIGHTON H

ART UNIT PAPER NUMBER

2656

DATE MAILED: 02/24/2015

Table with 5 columns: APPLICATION NO., FILING DATE, FIRST NAMED INVENTOR, ATTORNEY DOCKET NO., CONFIRMATION NO.

14/224,125 03/25/2014 Michael J. Rojas EMP0025-US 5407

TITLE OF INVENTION: System and Method for Instant VoIP Messaging

Table with 7 columns: APPLN. TYPE, ENTITY STATUS, ISSUE FEE DUE, PUBLICATION FEE DUE, PREV. PAID ISSUE FEE, TOTAL FEE(S) DUE, DATE DUE

nonprovisional SMALL \$480 \$0 \$0 \$480 05/26/2015

THE APPLICATION IDENTIFIED ABOVE HAS BEEN EXAMINED AND IS ALLOWED FOR ISSUANCE AS A PATENT. PROSECUTION ON THE MERITS IS CLOSED. THIS NOTICE OF ALLOWANCE IS NOT A GRANT OF PATENT RIGHTS. THIS APPLICATION IS SUBJECT TO WITHDRAWAL FROM ISSUE AT THE INITIATIVE OF THE OFFICE OR UPON PETITION BY THE APPLICANT. SEE 37 CFR 1.313 AND MPEP 1308.

THE ISSUE FEE AND PUBLICATION FEE (IF REQUIRED) MUST BE PAID WITHIN THREE MONTHS FROM THE MAILING DATE OF THIS NOTICE OR THIS APPLICATION SHALL BE REGARDED AS ABANDONED. THIS STATUTORY PERIOD CANNOT BE EXTENDED. SEE 35 U.S.C. 151. THE ISSUE FEE DUE INDICATED ABOVE DOES NOT REFLECT A CREDIT FOR ANY PREVIOUSLY PAID ISSUE FEE IN THIS APPLICATION. IF AN ISSUE FEE HAS PREVIOUSLY BEEN PAID IN THIS APPLICATION (AS SHOWN ABOVE), THE RETURN OF PART B OF THIS FORM WILL BE CONSIDERED A REQUEST TO REAPPLY THE PREVIOUSLY PAID ISSUE FEE TOWARD THE ISSUE FEE NOW DUE.

HOW TO REPLY TO THIS NOTICE:

I. Review the ENTITY STATUS shown above. If the ENTITY STATUS is shown as SMALL or MICRO, verify whether entitlement to that entity status still applies.

If the ENTITY STATUS is the same as shown above, pay the TOTAL FEE(S) DUE shown above.

If the ENTITY STATUS is changed from that shown above, on PART B - FEE(S) TRANSMITTAL, complete section number 5 titled "Change in Entity Status (from status indicated above)".

For purposes of this notice, small entity fees are 1/2 the amount of undiscounted fees, and micro entity fees are 1/2 the amount of small entity fees.

II. PART B - FEE(S) TRANSMITTAL, or its equivalent, must be completed and returned to the United States Patent and Trademark Office (USPTO) with your ISSUE FEE and PUBLICATION FEE (if required). If you are charging the fee(s) to your deposit account, section "4b" of Part B - Fee(s) Transmittal should be completed and an extra copy of the form should be submitted. If an equivalent of Part B is filed, a request to reapply a previously paid issue fee must be clearly made, and delays in processing may occur due to the difficulty in recognizing the paper as an equivalent of Part B.

III. All communications regarding this application must give the application number. Please direct all communications prior to issuance to Mail Stop ISSUE FEE unless advised to the contrary.

IMPORTANT REMINDER: Utility patents issuing on applications filed on or after Dec. 12, 1980 may require payment of maintenance fees. It is patentee's responsibility to ensure timely payment of maintenance fees when due.

PART B - FEE(S) TRANSMITTAL

**Complete and send this form, together with applicable fee(s), to: Mail Mail Stop ISSUE FEE
 Commissioner for Patents
 P.O. Box 1450
 Alexandria, Virginia 22313-1450
 or Fax (571)-273-2885**

INSTRUCTIONS: This form should be used for transmitting the ISSUE FEE and PUBLICATION FEE (if required). Blocks 1 through 5 should be completed where appropriate. All further correspondence including the Patent, advance orders and notification of maintenance fees will be mailed to the current correspondence address as indicated unless corrected below or directed otherwise in Block 1, by (a) specifying a new correspondence address; and/or (b) indicating a separate "FEE ADDRESS" for maintenance fee notifications.

CURRENT CORRESPONDENCE ADDRESS (Note: Use Block 1 for any change of address)

67050 7590 02/24/2015
KASHA LAW LLC
 14532 Dufief Mill Road
 North Potomac, MD 20878

Note: A certificate of mailing can only be used for domestic mailings of the Fee(s) Transmittal. This certificate cannot be used for any other accompanying papers. Each additional paper, such as an assignment or formal drawing, must have its own certificate of mailing or transmission.

Certificate of Mailing or Transmission

I hereby certify that this Fee(s) Transmittal is being deposited with the United States Postal Service with sufficient postage for first class mail in an envelope addressed to the Mail Stop ISSUE FEE address above, or being facsimile transmitted to the USPTO (571) 273-2885, on the date indicated below.

_____ (Depositor's name)
_____ (Signature)
_____ (Date)

APPLICATION NO.	FILING DATE	FIRST NAMED INVENTOR	ATTORNEY DOCKET NO.	CONFIRMATION NO.
14/224,125	03/25/2014	Michael J. Rojas	EMP0025-US	5407

TITLE OF INVENTION: System and Method for Instant VoIP Messaging

APPLN. TYPE	ENTITY STATUS	ISSUE FEE DUE	PUBLICATION FEE DUE	PREV. PAID ISSUE FEE	TOTAL FEE(S) DUE	DATE DUE
nonprovisional	SMALL	\$480	\$0	\$0	\$480	05/26/2015

EXAMINER	ART UNIT	CLASS-SUBCLASS
SMITH, CREIGHTON H	2656	370-352000

<p>1. Change of correspondence address or indication of "Fee Address" (37 CFR 1.363).</p> <p><input type="checkbox"/> Change of correspondence address (or Change of Correspondence Address form PTO/SB/122) attached.</p> <p><input type="checkbox"/> "Fee Address" indication (or "Fee Address" Indication form PTO/SB/47; Rev 03-02 or more recent) attached. Use of a Customer Number is required.</p>	<p>2. For printing on the patent front page, list</p> <p>(1) The names of up to 3 registered patent attorneys or agents OR, alternatively, _____ 1</p> <p>(2) The name of a single firm (having as a member a registered attorney or agent) and the names of up to 2 registered patent attorneys or agents. If no name is listed, no name will be printed. _____ 2</p> <p>_____ 3</p>
---	---

3. ASSIGNEE NAME AND RESIDENCE DATA TO BE PRINTED ON THE PATENT (print or type)

PLEASE NOTE: Unless an assignee is identified below, no assignee data will appear on the patent. If an assignee is identified below, the document has been filed for recordation as set forth in 37 CFR 3.11. Completion of this form is NOT a substitute for filing an assignment.

(A) NAME OF ASSIGNEE _____ (B) RESIDENCE: (CITY and STATE OR COUNTRY) _____

Please check the appropriate assignee category or categories (will not be printed on the patent): Individual Corporation or other private group entity Government

<p>4a. The following fee(s) are submitted:</p> <p><input type="checkbox"/> Issue Fee</p> <p><input type="checkbox"/> Publication Fee (No small entity discount permitted)</p> <p><input type="checkbox"/> Advance Order - # of Copies _____</p>	<p>4b. Payment of Fee(s): (Please first reapply any previously paid issue fee shown above)</p> <p><input type="checkbox"/> A check is enclosed.</p> <p><input type="checkbox"/> Payment by credit card. Form PTO-2038 is attached.</p> <p><input type="checkbox"/> The director is hereby authorized to charge the required fee(s), any deficiency, or credits any overpayment, to Deposit Account Number _____ (enclose an extra copy of this form).</p>
---	--

5. **Change in Entity Status** (from status indicated above)

Applicant certifying micro entity status. See 37 CFR 1.29

Applicant asserting small entity status. See 37 CFR 1.27

Applicant changing to regular undiscounted fee status.

NOTE: Absent a valid certification of Micro Entity Status (see forms PTO/SB/15A and 15B), issue fee payment in the micro entity amount will not be accepted at the risk of application abandonment.

NOTE: If the application was previously under micro entity status, checking this box will be taken to be a notification of loss of entitlement to micro entity status.

NOTE: Checking this box will be taken to be a notification of loss of entitlement to small or micro entity status, as applicable.

NOTE: This form must be signed in accordance with 37 CFR 1.31 and 1.33. See 37 CFR 1.4 for signature requirements and certifications.

Authorized Signature _____	Date _____
Typed or printed name _____	Registration No. _____



UNITED STATES PATENT AND TRADEMARK OFFICE

UNITED STATES DEPARTMENT OF COMMERCE
United States Patent and Trademark Office
Address: COMMISSIONER FOR PATENTS
P.O. Box 1450
Alexandria, Virginia 22313-1450
www.uspto.gov

Table with 5 columns: APPLICATION NO., FILING DATE, FIRST NAMED INVENTOR, ATTORNEY DOCKET NO., CONFIRMATION NO.
14/224,125 03/25/2014 Michael J. Rojas EMP0025-US 5407

67050 7590 02/24/2015
KASHA LAW LLC
14532 Dufief Mill Road
North Potomac, MD 20878

EXAMINER

SMITH, CREIGHTON H

ART UNIT PAPER NUMBER

2656

DATE MAILED: 02/24/2015

Determination of Patent Term Adjustment under 35 U.S.C. 154 (b)
(Applications filed on or after May 29, 2000)

The Office has discontinued providing a Patent Term Adjustment (PTA) calculation with the Notice of Allowance.

Section 1(h)(2) of the AIA Technical Corrections Act amended 35 U.S.C. 154(b)(3)(B)(i) to eliminate the requirement that the Office provide a patent term adjustment determination with the notice of allowance. See Revisions to Patent Term Adjustment, 78 Fed. Reg. 19416, 19417 (Apr. 1, 2013). Therefore, the Office is no longer providing an initial patent term adjustment determination with the notice of allowance. The Office will continue to provide a patent term adjustment determination with the Issue Notification Letter that is mailed to applicant approximately three weeks prior to the issue date of the patent, and will include the patent term adjustment on the patent. Any request for reconsideration of the patent term adjustment determination (or reinstatement of patent term adjustment) should follow the process outlined in 37 CFR 1.705.

Any questions regarding the Patent Term Extension or Adjustment determination should be directed to the Office of Patent Legal Administration at (571)-272-7702. Questions relating to issue and publication fee payments should be directed to the Customer Service Center of the Office of Patent Publication at 1-(888)-786-0101 or (571)-272-4200.

OMB Clearance and PRA Burden Statement for PTOL-85 Part B

The Paperwork Reduction Act (PRA) of 1995 requires Federal agencies to obtain Office of Management and Budget approval before requesting most types of information from the public. When OMB approves an agency request to collect information from the public, OMB (i) provides a valid OMB Control Number and expiration date for the agency to display on the instrument that will be used to collect the information and (ii) requires the agency to inform the public about the OMB Control Number's legal significance in accordance with 5 CFR 1320.5(b).

The information collected by PTOL-85 Part B is required by 37 CFR 1.311. The information is required to obtain or retain a benefit by the public which is to file (and by the USPTO to process) an application. Confidentiality is governed by 35 U.S.C. 122 and 37 CFR 1.14. This collection is estimated to take 12 minutes to complete, including gathering, preparing, and submitting the completed application form to the USPTO. Time will vary depending upon the individual case. Any comments on the amount of time you require to complete this form and/or suggestions for reducing this burden, should be sent to the Chief Information Officer, U.S. Patent and Trademark Office, U.S. Department of Commerce, P.O. Box 1450, Alexandria, Virginia 22313-1450. DO NOT SEND FEES OR COMPLETED FORMS TO THIS ADDRESS. SEND TO: Commissioner for Patents, P.O. Box 1450, Alexandria, Virginia 22313-1450. Under the Paperwork Reduction Act of 1995, no persons are required to respond to a collection of information unless it displays a valid OMB control number.

Privacy Act Statement

The Privacy Act of 1974 (P.L. 93-579) requires that you be given certain information in connection with your submission of the attached form related to a patent application or patent. Accordingly, pursuant to the requirements of the Act, please be advised that: (1) the general authority for the collection of this information is 35 U.S.C. 2(b)(2); (2) furnishing of the information solicited is voluntary; and (3) the principal purpose for which the information is used by the U.S. Patent and Trademark Office is to process and/or examine your submission related to a patent application or patent. If you do not furnish the requested information, the U.S. Patent and Trademark Office may not be able to process and/or examine your submission, which may result in termination of proceedings or abandonment of the application or expiration of the patent.

The information provided by you in this form will be subject to the following routine uses:

1. The information on this form will be treated confidentially to the extent allowed under the Freedom of Information Act (5 U.S.C. 552) and the Privacy Act (5 U.S.C. 552a). Records from this system of records may be disclosed to the Department of Justice to determine whether disclosure of these records is required by the Freedom of Information Act.
2. A record from this system of records may be disclosed, as a routine use, in the course of presenting evidence to a court, magistrate, or administrative tribunal, including disclosures to opposing counsel in the course of settlement negotiations.
3. A record in this system of records may be disclosed, as a routine use, to a Member of Congress submitting a request involving an individual, to whom the record pertains, when the individual has requested assistance from the Member with respect to the subject matter of the record.
4. A record in this system of records may be disclosed, as a routine use, to a contractor of the Agency having need for the information in order to perform a contract. Recipients of information shall be required to comply with the requirements of the Privacy Act of 1974, as amended, pursuant to 5 U.S.C. 552a(m).
5. A record related to an International Application filed under the Patent Cooperation Treaty in this system of records may be disclosed, as a routine use, to the International Bureau of the World Intellectual Property Organization, pursuant to the Patent Cooperation Treaty.
6. A record in this system of records may be disclosed, as a routine use, to another federal agency for purposes of National Security review (35 U.S.C. 181) and for review pursuant to the Atomic Energy Act (42 U.S.C. 218(c)).
7. A record from this system of records may be disclosed, as a routine use, to the Administrator, General Services, or his/her designee, during an inspection of records conducted by GSA as part of that agency's responsibility to recommend improvements in records management practices and programs, under authority of 44 U.S.C. 2904 and 2906. Such disclosure shall be made in accordance with the GSA regulations governing inspection of records for this purpose, and any other relevant (i.e., GSA or Commerce) directive. Such disclosure shall not be used to make determinations about individuals.
8. A record from this system of records may be disclosed, as a routine use, to the public after either publication of the application pursuant to 35 U.S.C. 122(b) or issuance of a patent pursuant to 35 U.S.C. 151. Further, a record may be disclosed, subject to the limitations of 37 CFR 1.14, as a routine use, to the public if the record was filed in an application which became abandoned or in which the proceedings were terminated and which application is referenced by either a published application, an application open to public inspection or an issued patent.
9. A record from this system of records may be disclosed, as a routine use, to a Federal, State, or local law enforcement agency, if the USPTO becomes aware of a violation or potential violation of law or regulation.

Notice of Allowability	Application No. 14/224,125	Applicant(s) ROJAS, MICHAEL J.	
	Examiner CREIGHTON SMITH	Art Unit 2656	AIA (First Inventor to File) Status No

-- The MAILING DATE of this communication appears on the cover sheet with the correspondence address--

All claims being allowable, PROSECUTION ON THE MERITS IS (OR REMAINS) CLOSED in this application. If not included herewith (or previously mailed), a Notice of Allowance (PTOL-85) or other appropriate communication will be mailed in due course. **THIS NOTICE OF ALLOWABILITY IS NOT A GRANT OF PATENT RIGHTS.** This application is subject to withdrawal from issue at the initiative of the Office or upon petition by the applicant. See 37 CFR 1.313 and MPEP 1308.

1. This communication is responsive to amendment filed on 06 FEB '15.
 A declaration(s)/affidavit(s) under **37 CFR 1.130(b)** was/were filed on _____.
2. An election was made by the applicant in response to a restriction requirement set forth during the interview on _____; the restriction requirement and election have been incorporated into this action.
3. The allowed claim(s) is/are 2-4,6-10 and 12-30. As a result of the allowed claim(s), you may be eligible to benefit from the **Patent Prosecution Highway** program at a participating intellectual property office for the corresponding application. For more information, please see http://www.uspto.gov/patents/init_events/pph/index.jsp or send an inquiry to PPHfeedback@uspto.gov.
4. Acknowledgment is made of a claim for foreign priority under 35 U.S.C. § 119(a)-(d) or (f).

Certified copies:

- a) All b) Some *c) None of the:
1. Certified copies of the priority documents have been received.
 2. Certified copies of the priority documents have been received in Application No. _____.
 3. Copies of the certified copies of the priority documents have been received in this national stage application from the International Bureau (PCT Rule 17.2(a)).

* Certified copies not received: _____.

Applicant has THREE MONTHS FROM THE "MAILING DATE" of this communication to file a reply complying with the requirements noted below. Failure to timely comply will result in ABANDONMENT of this application.

THIS THREE-MONTH PERIOD IS NOT EXTENDABLE.

5. CORRECTED DRAWINGS (as "replacement sheets") must be submitted.
 including changes required by the attached Examiner's Amendment / Comment or in the Office action of Paper No./Mail Date _____.
Identifying indicia such as the application number (see 37 CFR 1.84(c)) should be written on the drawings in the front (not the back) of each sheet. Replacement sheet(s) should be labeled as such in the header according to 37 CFR 1.121(d).
6. DEPOSIT OF and/or INFORMATION about the deposit of BIOLOGICAL MATERIAL must be submitted. Note the attached Examiner's comment regarding REQUIREMENT FOR THE DEPOSIT OF BIOLOGICAL MATERIAL.

Attachment(s)

- | | |
|--|--|
| 1. <input type="checkbox"/> Notice of References Cited (PTO-892) | 5. <input type="checkbox"/> Examiner's Amendment/Comment |
| 2. <input type="checkbox"/> Information Disclosure Statements (PTO/SB/08),
Paper No./Mail Date _____ | 6. <input checked="" type="checkbox"/> Examiner's Statement of Reasons for Allowance |
| 3. <input type="checkbox"/> Examiner's Comment Regarding Requirement for Deposit
of Biological Material | 7. <input type="checkbox"/> Other _____. |
| 4. <input type="checkbox"/> Interview Summary (PTO-413),
Paper No./Mail Date _____. | |

/CREIGHTON SMITH/
Primary Examiner, Art Unit 2656

The present application is being examined under the pre-AIA first to invent provisions.

REASONS FOR ALLOWANCE

The following is an examiner's statement of reasons for allowance: The prior art fails to disclose applicant's instant voice messaging system which stores the instant voice messages in a database with a unique identifier. Neither does the prior art disclose compressing and decompressing instant voice messages for transmission and reception over the packet-switched network/Internet. No obvious combination of references found would have taught one of ordinary skill in the art to make applicant's system as claimed.

Any comments considered necessary by applicant must be submitted no later than the payment of the issue fee and, to avoid processing delays, should preferably accompany the issue fee. Such submissions should be clearly labeled "Comments on Statement of Reasons for Allowance."

Any inquiry concerning this communication or earlier communications from the examiner should be directed to CREIGHTON SMITH whose telephone number is (571)272-7546. The examiner can normally be reached on 5-4-9.

If attempts to reach the examiner by telephone are unsuccessful, the examiner's supervisor, Curt Kuntz can be reached on 27499. The fax phone number for the organization where this application or proceeding is assigned is 571-273-8300.

Information regarding the status of an application may be obtained from the Patent Application Information Retrieval (PAIR) system. Status information for published applications may be obtained from either Private PAIR or Public PAIR. Status information for unpublished applications is available through Private PAIR only. For more information about the PAIR system, see <http://pair-direct.uspto.gov>. Should you have questions on access to the Private PAIR system, contact the Electronic Business Center (EBC) at 866-217-9197 (toll-free). If you would like assistance from a USPTO Customer Service Representative or access to the automated information system, call 800-786-9199 (IN USA OR CANADA) or 571-272-1000.

/CREIGHTON SMITH/
Primary Examiner, Art Unit 2656

15 FEB '15

Search Notes 	Application/Control No. 14224125	Applicant(s)/Patent Under Reexamination ROJAS, MICHAEL J.
	Examiner CREIGHTON SMITH	Art Unit 2656

CPC- SEARCHED		
Symbol	Date	Examiner
H04L 65/40; H04M 3/533; H04M 2203/4536		

CPC COMBINATION SETS - SEARCHED		
Symbol	Date	Examiner

US CLASSIFICATION SEARCHED			
Class	Subclass	Date	Examiner
370	352	29.01.15	chs
709	206	"	"

SEARCH NOTES		
Search Notes	Date	Examiner
EAST	15.10.14	chs
"	29.01.15	"
"	15.02.15	chs

INTERFERENCE SEARCH			
US Class/ CPC Symbol	US Subclass / CPC Group	Date	Examiner
EAST		15.02.15	chs

--	--

Issue Classification 	Application/Control No. 14224125	Applicant(s)/Patent Under Reexamination ROJAS, MICHAEL J.
	Examiner CREIGHTON SMITH	Art Unit 2656

CPC					
Symbol				Type	Version
H04L	51		04	F	2013-01-01
H04L	12		581	I	2013-01-01
H04M	3		53366	I	2013-01-01
H04M	7		006	I	2013-01-01
H04M	2203		4536	A	2013-01-01
H04L	65		40	I	2013-01-01
H04M	3		533	I	2013-01-01

CPC Combination Sets				
Symbol	Type	Set	Ranking	Version

NONE		Total Claims Allowed:	
(Assistant Examiner)	(Date)	27	
/CREIGHTON SMITH/ Primary Examiner.Art Unit 2656	15 FEB '15	O.G. Print Claim(s)	O.G. Print Figure
(Primary Examiner)	(Date)	1	1

Issue Classification 	Application/Control No. 14224125	Applicant(s)/Patent Under Reexamination ROJAS, MICHAEL J.
	Examiner CREIGHTON SMITH	Art Unit 2656

<input type="checkbox"/> Claims renumbered in the same order as presented by applicant																<input type="checkbox"/> CPA		<input type="checkbox"/> T.D.		<input type="checkbox"/> R.1.47	
Final	Original	Final	Original	Final	Original	Final	Original	Final	Original	Final	Original	Final	Original	Final	Original						
	1	14	17																		
1	2	15	18																		
2	3	16	19																		
3	4	17	20																		
	5	18	21																		
4	6	19	22																		
5	7	20	23																		
6	8	21	24																		
7	9	22	25																		
8	10	23	26																		
	11	24	27																		
9	12	25	28																		
10	13	26	29																		
11	14	27	30																		
12	15																				
13	16																				

NONE		Total Claims Allowed:	
		27	
(Assistant Examiner)	(Date)	O.G. Print Claim(s)	O.G. Print Figure
/CREIGHTON SMITH/ Primary Examiner.Art Unit 2656	15 FEB '15	1	1
(Primary Examiner)	(Date)		

EAST Search History

EAST Search History (Prior Art)

Ref #	Hits	Search Query	DBs	Default Operator	Plurals	Time Stamp
L1	4	((("20130066989") or ("7013155") or ("20040064317") or ("20040225524")).PN. or (77/133687).APP.	US-PGPUB; USPAT; USOCR; EPO	OR	OFF	2015/02/15 09:11
L2	126	((@ad<="20131218") or (@rlad<="20131218")) and (ivm or (instant with voice with message)) same (database record) same identifier	US-PGPUB; USPAT; EPO; DERWENT	OR	OFF	2015/02/15 09:46
L3	126	((@ad<="20131218") or (@rlad<="20131218")) and (ivm or (instant with voice with message)) same (database or record) same identifier	US-PGPUB; USPAT; EPO; DERWENT	OR	OFF	2015/02/15 09:46
L4	53	((@ad<="20131218") or (@rlad<="20131218")) and (ivm or (instant with voice with message)) same (database or record) with identifier	US-PGPUB; USPAT; EPO; DERWENT	OR	OFF	2015/02/15 09:46
L5	24	((@ad<="20131218") or (@rlad<="20131218")) and (ivm or (instant with voice with message)) same stor\$3 same (database or record) with identifier	US-PGPUB; USPAT; EPO; DERWENT	OR	OFF	2015/02/15 09:47
L6	15	((@ad<="20131218") or (@rlad<="20131218")) and (ivm or (instant near5 voice near5 message)) same stor\$3 same (database or record) with identifier	US-PGPUB; USPAT; EPO; DERWENT	OR	OFF	2015/02/15 09:47
L7	9	((@ad<="20031218") or (@rlad<="20031218")) and (ivm or (instant with voice with message)) same stor\$3 same (database or record) with identifier	US-PGPUB; USPAT; EPO; DERWENT	OR	OFF	2015/02/15 09:55

EAST Search History (Interference)

Ref #	Hits	Search Query	DBs	Default Operator	Plurals	Time Stamp
L8	2	((@ad<="20031218") or (@rlad<="20031218")) and (ivm or (instant with voice with message)) with stor\$3 with (database or record) with identifier.clm.	US-PGPUB; USPAT; UPAD	OR	OFF	2015/02/15 09:55
L9	92	((@ad<="20031218") or (@rlad<="20031218")) and (ivm or (instant with voice with message)) and compress\$3 same decompress\$3	US-PGPUB; USPAT; UPAD	OR	OFF	2015/02/15 09:56
L10	32	((@ad<="20031218") or (@rlad<="20031218")) and (ivm or (instant near4 voice near4 message)) and compress\$3 same decompress\$3	US-PGPUB; USPAT; UPAD	OR	OFF	2015/02/15 09:57
L11	0	((@ad<="20031218") or	US-	OR	OFF	2015/02/15

EAST Search History

	(@rlad<="20031218")) and (ivm or (instant near4 voice near4 message)) with compress\$3 with decompress\$3.clm.	PGPUB; USPAT; UPAD		10:05
--	--	--------------------------	--	-------

2/ 15/ 2015 10:05:35 AM

C:\ Users\ csmith1\ Documents\ EAST\ Workspaces\ 13648888.wsp

Index of Claims 	Application/Control No. 14224125	Applicant(s)/Patent Under Reexamination ROJAS, MICHAEL J.
	Examiner CREIGHTON SMITH	Art Unit 2656

✓	Rejected	-	Cancelled	N	Non-Elected	A	Appeal
=	Allowed	÷	Restricted	I	Interference	O	Objected

Claims renumbered in the same order as presented by applicant
 CPA
 T.D.
 R.1.47

CLAIM		DATE							
Final	Original	10/15/2014	01/29/2015	02/15/2015					
12	15		=	=					
13	16		=	=					
14	17		=	=					
15	18		=	=					
16	19		=	=					
17	20		=	=					
18	21		=	=					
19	22		=	=					
20	23		=	=					
21	24		=	=					
22	25		=	=					
23	26		=	=					
24	27		=	=					
25	28		=	=					
26	29		=	=					
27	30		=	=					
28	1	✓	✓	-					
1	2	✓	O	=					
2	3	✓	O	=					
3	4	✓	O	=					
	5	✓	-	-					
4	6	✓	✓	=					
5	7	✓	✓	=					
6	8	✓	O	=					
7	9	✓	✓	=					
8	10	✓	✓	=					
	11	✓	-	-					
9	12	✓	=	=					
10	13	✓	=	=					
11	14	✓	=	=					

EMP0025-US

PATENT

IN THE UNITED STATES PATENT AND TRADEMARK OFFICE

In re the Application of: MICHAEL J. ROJAS Serial No.: 14/224,125 Filed: March 25, 2014 For: SYSTEM AND METHOD FOR INSTANT VOIP MESSAGING	Confirmation No.: 5407 Art Unit: 2656 Examiner: Creighton H. Smith
--	--

AMENDMENT

MAIL STOP: AMENDMENTS

Commissioner for Patents
P.O. Box 1450
Alexandria, VA 22313-1450

Sir:

In response to the Office Action of February 5, 2015, please amend the above-identified application as follows:

Amendments to the Claims are reflected in the listing of claims that begins on page 2 of this paper.

Remarks begin on page 8 of this paper.

Amendments to the Claims:

This listing of claims replaces all prior versions and listings of claims in this application.

Listing of the Claims:

1. (Canceled).
2. (Currently amended): ~~The system according to claim 1,~~ A system comprising:
an instant voice messaging application including a client platform system for generating
an instant voice message and a messaging system for transmitting the instant voice message over
a packet-switched network via a network interface;
wherein the instant voice messaging application displays a list of one or more potential
recipients for the instant voice message;
wherein the instant voice messaging application includes a message database storing the
instant voice message, wherein the instant voice message is represented by a database record
including a unique identifier; and
wherein the instant voice messaging application includes a file manager system
performing at least one of storing, deleting and retrieving the instant voice messages from the
message database in response to a user request.
3. (Previously presented): The system according to claim 2, wherein the message database includes a plurality of instant voice messages received over the packet-switched network.
4. (Previously presented): The system according to claim 3, wherein the instant voice messaging application displays at least one of the plurality of instant voice messages stored in the message database.

5. (Canceled).
6. (Currently amended): The system according to claim 21, wherein the instant voice messaging application includes an audio file creation system creating an audio file for the instant voice message based on input received via an audio input device.
7. (Currently Amended): The system according to claim 21, wherein the instant voice messaging application includes an encryption/decryption system for encrypting the instant voice messages to be transmitted over the packet-switched network and decrypting the instant voices messages received over the packet-switched network.
8. (Currently amended): ~~The system according to claim 1,~~ A system comprising:
an instant voice messaging application including a client platform system for generating an instant voice message and a messaging system for transmitting the instant voice message over a packet-switched network via a network interface;
wherein the instant voice messaging application displays a list of one or more potential recipients for the instant voice message;
wherein the instant voice messaging application includes a file manager system performing at least one of storing, deleting and retrieving the instant voice messages from a message database in response to a user request; and
wherein the instant voice messaging application includes a compression/decompression system for compressing the instant voice messages to be transmitted over the packet-switched network and decompressing the instant voice messages received over the packet-switched network.

9. (Currently amended): The system according to claim 24, wherein the instant voice messaging application displays an indicia for each of the one or more potential recipients indicating whether the potential recipient is currently available to receive an instant voice message.
10. (Currently amended): The system according to claim 24, wherein the instant voice message application generates an audible or visual effect indicating receipt of an instant voice message.
11. (Canceled).
12. (Previously presented): A system, comprising:
 - an instant voice messaging application comprising:
 - a client platform system for generating an instant voice message;
 - a messaging system for transmitting the instant voice message over a packet-switched network, andwherein the instant voice message application attaches one or more files to the instant voice message.
13. (Previously presented): The system according to claim 12, wherein the packet-switched network comprises a WiFi network.
14. (Previously presented): The system according to claim 12, wherein the instant voice messaging application displays one or more controls for audibly playing the instant voice message.

15. (Previously Presented): The system according to claim 12, wherein the instant voice messaging application encrypts the instant voice message.
16. (Previously Presented): The system according to claim 12, wherein the instant voice messaging application displays a selectable control for generating an instant voice message using an intercom mode based on a connectivity status of an intended recipient of the instant voice message.
17. (Previously Presented): The system according to claim 12, wherein the instant voice messaging application invokes a document handler to create a link between the instant voice message and the one or more files.
18. (Previously Presented): The system according to claim 12, wherein the instant voice messaging application displays the attachment.
19. (Previously Presented): The system according to claim 12, wherein the instant voice messaging application displays one or more controls for performing at least one of reviewing, re-recording or deleting the instant voice message.
20. (Previously Presented): The system according to claim 12 further comprising an instant voice messaging server receiving the instant voice message and an indication of one or more intended recipients of the instant voice message.
21. (Previously Presented): The system according to claim 20 further comprising one or more buffers, wherein the client platform system buffers each of a plurality of successive portions of the instant voice message into the one or more buffers, and wherein the client platform system

transmits each successive buffered portion to the instant voice messaging server for delivery to the one or more intended recipients.

22. (Previously Presented): The system according to claim 21, wherein the instant voice messaging server transmits each successive buffered portion to an instant voice messaging application.

23. (Previously Presented): The system according to claim 21, wherein the instant voice messaging server transmits each successive buffered portion to a legacy telephone.

24. (Previously Presented): The system of claim 21, wherein the client platform system automatically transmits the content of a first buffer to the instant voice messaging server for delivery to the one or more intended recipients, and wherein the client platform system writes to a second buffer the next successive portion of the instant voice message.

25. (Previously Presented): The system of claim 21, wherein the content of a buffer is encrypted.

26. (Previously Presented): The system of claim 21, wherein the instant voice messaging server transmits a ring signal to an intended recipient.

27. (Previously Presented): The system of claim 26, wherein the instant voice messaging server establishes a connection between the instant voice messaging application and the intended recipient upon detecting an off-hook event.

28. (Previously Presented): The system of claim 20 wherein the instant voice messaging server determines availability of the one or more intended recipients for receipt of the instant voice message.

29. (Previously Presented): The system of claim 28, wherein the instant voice messaging server:

delivers the instant voice message to the one or more intended recipients who are determined to be currently available;

stores the instant voice message for the one or more intended recipients who are not currently available; and

delivers the instant voice message to the one or more intended recipients who are not currently available when the instant voice messaging server determines that the not currently available one or more intended recipients become available.

30. (Previously Presented): The system of claim 29, wherein the instant voice messaging server deletes the instant voice message from the instant voice messaging server after delivery to the one or more intended recipients.

REMARKS

The Applicant thanks the Examiner for indicating that claims 12-30 are allowed and that claims 2-4 and 8 would be allowable if rewritten in independent form including all of the limitations of the base claim and any intervening claims.

Claims 1-4, 6-10, and 12-30 are pending. By this amendment, claim 1 is cancelled, and claims 2 and 6-10 are amended. Claims 2 and 8 have been rewritten in independent form, and claims 6, 7, 9 and 10 have been amended to depend from claim 2. No new matter is introduced. Claims 2-4, 6-10 and 12-30 will remain pending herein upon entry of this Response.

35 U.S. C. § 103(a) Rejections

Claims 1 and 9 stand rejected under 35 U.S.C. § 103(a) as unpatentable over U.S. Patent Application Publication No. 2013/0066989 to Enete et al. ("Enete") in view of U.S. Patent No. 7,013,155 to Ruf et al. ("Ruf")

Claim 6 is rejected under 35 U.S.C. § 103(a) as unpatentable over Enete in view of Ruf, and further in view of U.S. Patent Application Publication No. 2004/0064317 to Othmer et al.

Claim 7 is rejected under 35 U.S.C. § 103(a) as unpatentable over Enete in view of Ruf, and further in view of U.S. Patent Application Publication No. 2004/0225524 to Narasimhan et al.

Claim 10 stands rejected under 35 U.S.C. § 103(a) as unpatentable over Enete in view of Ruf, and further in view of U.S. Patent No. 7,133,687 to El-Fishaway et al.

These rejections are respectfully traversed. However, to advance prosecution, and without any admission, express or implied, that any of the cited references qualify as prior art or

render the pending claims unpatentable, the Applicant has canceled claim 1, and has amended claims 6, 7, 9 and 10 to depend from claim 2, which (as described above) has been rewritten in independent form.

Accordingly, withdrawal of the rejection of claims 6, 7, 9 and 10 is respectfully requested.

Allowable Subject Matter

The Applicant thanks the Examiner for indicating that claims 12-30 are allowed and that claims 2-4 and 8 would be allowable if rewritten in independent form including all of the limitations of the base claim and any intervening claims. Office Action of February 5, 2015, p. 4. Claims 2 and 8 have been rewritten in independent form, including all of the limitations of the base claim (claim 1). Claims 3 and 4 depend from claim 2. Allowance of claims 2-4 and 8 is respectfully requested.

Conclusion

Should the Examiner have any questions or determine that any further action is desirable to place this application in even better condition for issue, the Examiner is encouraged to telephone the Applicant's undersigned representative at the number listed below.

KASHA LAW LLC
14532 Dufief Mill Rd.
North Potomac, MD 20878
Tel. 240-423-8431
Date: February 6, 2015

Respectfully submitted,
By: /Kelly L. Kasha/
Kelly L. Kasha
Registration No. 47,743

Customer No. 67050

Electronic Acknowledgement Receipt

EFS ID:	21420275
Application Number:	14224125
International Application Number:	
Confirmation Number:	5407
Title of Invention:	System and Method for Instant VoIP Messaging
First Named Inventor/Applicant Name:	Michael J. Rojas
Customer Number:	67050
Filer:	John Kasha
Filer Authorized By:	
Attorney Docket Number:	EMP0025-US
Receipt Date:	06-FEB-2015
Filing Date:	25-MAR-2014
Time Stamp:	11:12:02
Application Type:	Utility under 35 USC 111(a)

Payment information:

Submitted with Payment	no
------------------------	----

File Listing:

Document Number	Document Description	File Name	File Size(Bytes)/ Message Digest	Multi Part /.zip	Pages (if appl.)
1	Amendment/Req. Reconsideration-After Non-Final Reject	EMP0025-US_resp_02_06_2015.pdf	98209 99571fe1914c4b35e2ce1716da7c5cb37b9e1a0	no	9

Warnings:

Information:

This Acknowledgement Receipt evidences receipt on the noted date by the USPTO of the indicated documents, characterized by the applicant, and including page counts, where applicable. It serves as evidence of receipt similar to a Post Card, as described in MPEP 503.

New Applications Under 35 U.S.C. 111

If a new application is being filed and the application includes the necessary components for a filing date (see 37 CFR 1.53(b)-(d) and MPEP 506), a Filing Receipt (37 CFR 1.54) will be issued in due course and the date shown on this Acknowledgement Receipt will establish the filing date of the application.

National Stage of an International Application under 35 U.S.C. 371

If a timely submission to enter the national stage of an international application is compliant with the conditions of 35 U.S.C. 371 and other applicable requirements a Form PCT/DO/EO/903 indicating acceptance of the application as a national stage submission under 35 U.S.C. 371 will be issued in addition to the Filing Receipt, in due course.

New International Application Filed with the USPTO as a Receiving Office

If a new international application is being filed and the international application includes the necessary components for an international filing date (see PCT Article 11 and MPEP 1810), a Notification of the International Application Number and of the International Filing Date (Form PCT/RO/105) will be issued in due course, subject to prescriptions concerning national security, and the date shown on this Acknowledgement Receipt will establish the international filing date of the application.

Under the Paperwork Reduction Act of 1995, no persons are required to respond to a collection of information unless it displays a valid OMB control number.

PATENT APPLICATION FEE DETERMINATION RECORD Substitute for Form PTO-875				Application or Docket Number 14/224,125	Filing Date 03/25/2014	<input type="checkbox"/> To be Mailed
ENTITY: <input type="checkbox"/> LARGE <input checked="" type="checkbox"/> SMALL <input type="checkbox"/> MICRO						
APPLICATION AS FILED – PART I						
(Column 1)			(Column 2)			
FOR	NUMBER FILED	NUMBER EXTRA	RATE (\$)	FEE (\$)		
<input type="checkbox"/> BASIC FEE <small>(37 CFR 1.16(a), (b), or (c))</small>	N/A	N/A	N/A			
<input type="checkbox"/> SEARCH FEE <small>(37 CFR 1.16(k), (l), or (m))</small>	N/A	N/A	N/A			
<input type="checkbox"/> EXAMINATION FEE <small>(37 CFR 1.16(o), (p), or (q))</small>	N/A	N/A	N/A			
TOTAL CLAIMS <small>(37 CFR 1.16(i))</small>	minus 20 =	*	X \$	=		
INDEPENDENT CLAIMS <small>(37 CFR 1.16(h))</small>	minus 3 =	*	X \$	=		
<input type="checkbox"/> APPLICATION SIZE FEE <small>(37 CFR 1.16(s))</small>	If the specification and drawings exceed 100 sheets of paper, the application size fee due is \$310 (\$155 for small entity) for each additional 50 sheets or fraction thereof. See 35 U.S.C. 41(a)(1)(G) and 37 CFR 1.16(s).					
<input type="checkbox"/> MULTIPLE DEPENDENT CLAIM PRESENT <small>(37 CFR 1.16(j))</small>						
* If the difference in column 1 is less than zero, enter "0" in column 2.			TOTAL			
APPLICATION AS AMENDED – PART II						
(Column 1)		(Column 2)		(Column 3)		
AMENDMENT	02/06/2015	CLAIMS REMAINING AFTER AMENDMENT	HIGHEST NUMBER PREVIOUSLY PAID FOR	PRESENT EXTRA	RATE (\$)	ADDITIONAL FEE (\$)
	Total (37 CFR 1.16(i))	* 26	Minus	** 28	= 0	X \$40 = 0
	Independent (37 CFR 1.16(h))	* 3	Minus	***3	= 0	X \$210 = 0
	<input type="checkbox"/> Application Size Fee (37 CFR 1.16(s))					
	<input type="checkbox"/> FIRST PRESENTATION OF MULTIPLE DEPENDENT CLAIM (37 CFR 1.16(j))					
					TOTAL ADD'L FEE 0	
(Column 1)		(Column 2)		(Column 3)		
AMENDMENT	CLAIMS REMAINING AFTER AMENDMENT	HIGHEST NUMBER PREVIOUSLY PAID FOR	PRESENT EXTRA	RATE (\$)	ADDITIONAL FEE (\$)	
	Total (37 CFR 1.16(i))	*	Minus	**	=	X \$ =
	Independent (37 CFR 1.16(h))	*	Minus	***	=	X \$ =
	<input type="checkbox"/> Application Size Fee (37 CFR 1.16(s))					
	<input type="checkbox"/> FIRST PRESENTATION OF MULTIPLE DEPENDENT CLAIM (37 CFR 1.16(j))					
					TOTAL ADD'L FEE	
<p>* If the entry in column 1 is less than the entry in column 2, write "0" in column 3. ** If the "Highest Number Previously Paid For" IN THIS SPACE is less than 20, enter "20". *** If the "Highest Number Previously Paid For" IN THIS SPACE is less than 3, enter "3". The "Highest Number Previously Paid For" (Total or Independent) is the highest number found in the appropriate box in column 1.</p>						

LIE
/MARGARET BYARS/

This collection of information is required by 37 CFR 1.16. The information is required to obtain or retain a benefit by the public which is to file (and by the USPTO to process) an application. Confidentiality is governed by 35 U.S.C. 122 and 37 CFR 1.14. This collection is estimated to take 12 minutes to complete, including gathering, preparing, and submitting the completed application form to the USPTO. Time will vary depending upon the individual case. Any comments on the amount of time you require to complete this form and/or suggestions for reducing this burden, should be sent to the Chief Information Officer, U.S. Patent and Trademark Office, U.S. Department of Commerce, P.O. Box 1450, Alexandria, VA 22313-1450. DO NOT SEND FEES OR COMPLETED FORMS TO THIS ADDRESS. **SEND TO: Commissioner for Patents, P.O. Box 1450, Alexandria, VA 22313-1450.**

If you need assistance in completing the form, call 1-800-PTO-9199 and select option 2.



UNITED STATES PATENT AND TRADEMARK OFFICE

UNITED STATES DEPARTMENT OF COMMERCE
United States Patent and Trademark Office
Address: COMMISSIONER FOR PATENTS
P. O. Box 1450
Alexandria, Virginia 22313-1450
www.uspto.gov

Table with 5 columns: APPLICATION NO., FILING DATE, FIRST NAMED INVENTOR, ATTORNEY DOCKET NO., CONFIRMATION NO.
14/224,125 03/25/2014 Michael J. Rojas EMP0025-US 5407

67050 7590 02/05/2015
KASHA LAW LLC
14532 Dufief Mill Road
North Potomac, MD 20878

Table with 1 column: EXAMINER

SMITH, CREIGHTON H

Table with 2 columns: ART UNIT, PAPER NUMBER

2656

Table with 2 columns: NOTIFICATION DATE, DELIVERY MODE

02/05/2015

ELECTRONIC

Please find below and/or attached an Office communication concerning this application or proceeding.

The time period for reply, if any, is set in the attached communication.

Notice of the Office communication was sent electronically on above-indicated "Notification Date" to the following e-mail address(es):

JOHN.KASHA@KASHALAW.COM

Office Action Summary	Application No. 14/224,125	Applicant(s) ROJAS, MICHAEL J.	
	Examiner CREIGHTON SMITH	Art Unit 2656	AIA (First Inventor to File) Status No

-- The MAILING DATE of this communication appears on the cover sheet with the correspondence address --

Period for Reply

A SHORTENED STATUTORY PERIOD FOR REPLY IS SET TO EXPIRE 3 MONTHS FROM THE MAILING DATE OF THIS COMMUNICATION.

- Extensions of time may be available under the provisions of 37 CFR 1.136(a). In no event, however, may a reply be timely filed after SIX (6) MONTHS from the mailing date of this communication.
- If NO period for reply is specified above, the maximum statutory period will apply and will expire SIX (6) MONTHS from the mailing date of this communication.
- Failure to reply within the set or extended period for reply will, by statute, cause the application to become ABANDONED (35 U.S.C. § 133). Any reply received by the Office later than three months after the mailing date of this communication, even if timely filed, may reduce any earned patent term adjustment. See 37 CFR 1.704(b).

Status

- 1) Responsive to communication(s) filed on 21 & 22 JAN '15.
 A declaration(s)/affidavit(s) under **37 CFR 1.130(b)** was/were filed on _____.
- 2a) This action is **FINAL**. 2b) This action is non-final.
- 3) An election was made by the applicant in response to a restriction requirement set forth during the interview on _____; the restriction requirement and election have been incorporated into this action.
- 4) Since this application is in condition for allowance except for formal matters, prosecution as to the merits is closed in accordance with the practice under *Ex parte Quayle*, 1935 C.D. 11, 453 O.G. 213.

Disposition of Claims*

- 5) Claim(s) 1-4,6-10 and 12-30 is/are pending in the application.
5a) Of the above claim(s) _____ is/are withdrawn from consideration.
- 6) Claim(s) 12-30 is/are allowed.
- 7) Claim(s) 1,6,7,9 and 10 is/are rejected.
- 8) Claim(s) 2-4, 8, is/are objected to.
- 9) Claim(s) _____ are subject to restriction and/or election requirement.

* If any claims have been determined allowable, you may be eligible to benefit from the **Patent Prosecution Highway** program at a participating intellectual property office for the corresponding application. For more information, please see http://www.uspto.gov/patents/init_events/pph/index.jsp or send an inquiry to PPHfeedback@uspto.gov.

Application Papers

- 10) The specification is objected to by the Examiner.
- 11) The drawing(s) filed on _____ is/are: a) accepted or b) objected to by the Examiner.
Applicant may not request that any objection to the drawing(s) be held in abeyance. See 37 CFR 1.85(a).
Replacement drawing sheet(s) including the correction is required if the drawing(s) is objected to. See 37 CFR 1.121(d).

Priority under 35 U.S.C. § 119

- 12) Acknowledgment is made of a claim for foreign priority under 35 U.S.C. § 119(a)-(d) or (f).

Certified copies:

- a) All b) Some** c) None of the:
1. Certified copies of the priority documents have been received.
2. Certified copies of the priority documents have been received in Application No. _____.
3. Copies of the certified copies of the priority documents have been received in this National Stage application from the International Bureau (PCT Rule 17.2(a)).

** See the attached detailed Office action for a list of the certified copies not received.

Attachment(s)

- 1) Notice of References Cited (PTO-892)
- 2) Information Disclosure Statement(s) (PTO/SB/08a and/or PTO/SB/08b)
Paper No(s)/Mail Date _____.
- 3) Interview Summary (PTO-413)
Paper No(s)/Mail Date. _____.
- 4) Other: _____.

The present application is being examined under the pre-AIA first to invent provisions.

DETAILED ACTION

The following is a quotation of pre-AIA 35 U.S.C. 103(a) which forms the basis for all obviousness rejections set forth in this Office action:

(a) A patent may not be obtained though the invention is not identically disclosed or described as set forth in section 102 of this title, if the differences between the subject matter sought to be patented and the prior art are such that the subject matter as a whole would have been obvious at the time the invention was made to a person having ordinary skill in the art to which said subject matter pertains. Patentability shall not be negated by the manner in which the invention was made.

Claims 1, 9 are rejected under pre-AIA 35 U.S.C. 103(a) as being unpatentable over Enete et al (“Enete”), USPAP #2013/0066989 in view of Ruf et al (“Ruf”), US Pat. #7,013,155.

Enete discloses in P.0065 that a sender 602a designates at least one recipient 602b to receive an instant message (IM). The IM may be a text IM or other non-video IM (e.g., voice message). In P.0050 Enete discloses that a subscriber can use the IM client application to view whether particular subscribers (buddies) are online and in P.0056 discloses the subscriber’s buddy list. Ruf discloses in claim 1 an IVR system receiving a request for a stored instant voice message and transmitting the stored instant voice message from the IVR system to the recipient wireless station. Ruf’s IVR reads upon applicant’s file manager system. To have provided Ruf’s teaching of a user retrieving an instant voice message by the user sending a request to the IVR for retrieval of that message in Enete’s instant voice messaging system would have been obvious to a person having ordinary skill in the art.

Regarding claim 9, Enete discloses in P.0065 a screen name associated with an intended recipient 602b has been identified as a “buddy” of the sender 602a, and a UI (graphical user interface) that indicates the online status and capabilities of the recipient 602b is displayed to the sender 602a.

Claim 6 is rejected under pre-AIA 35 U.S.C. 103(a) as being unpatentable over Enete et al in view of Ruf et al as applied to claim 1 above, and further in view of Othmer et al (“Othmer”), USPAP #2004/0064317.

Othmer discloses in P.0039 that audio file source messaging system may indicate where the audio file was transmitted from such as an instant voice messaging system, which means that the audio file was created from an IVM. To have provided Othmer’s teaching of an audio file coming from an IVM in Enete’s IVM system would have been obvious to a person having ordinary skill in this art because both references are teaching IVM systems.

Claims 7 is rejected under pre-AIA 35 U.S.C. 103(a) as being unpatentable over Enete et al in view of Ruf et al as applied to claim 1 and further in view of Narasimhan et al (“Narasimhan”), USPAP #2004/0225524.

Narasimhan discloses in P.0077 that additional types of information assets may include voice instant messages, and that information asset may be encapsulated through encryption. To have provided Narasimhan’s teaching of encrypting instant voice messages in Enete’s system of instant voice messages would have been obvious to a person having ordinary skill in the art.

Claim 10 is rejected under pre-AIA 35 U.S.C. 103(a) as being unpatentable over Enete et al in view of Ruf et al as applied to claim 1 and further in view of El-Fishaway et al (“EF”), U.S. Pat. #7133687

EF discloses in col. 3 , lines 34 et seq. that a recipient may initiate delivery of a reply to the received instant voice message in the audio format. By the recipient sending an audio reply to a sender’s IVM, the audio reply is an indication that the recipient received the sender’s IVM. To have provided EF’s teaching of an audio reply/effect that indicates receipt of a sender’s IVM in Enete’s IVM system would have been obvious to a person having ordinary skill in the art.

Claims 2-4, 8-9 are objected to as being dependent upon a rejected base claim, but would be allowable if rewritten in independent form including all of the limitations of the base claim and any intervening claims.

Claims 12-29 are allowed.

Any inquiry concerning this communication should be directed to CREIGHTON SMITH at telephone number (571)272-7546.

/CREIGHTON SMITH/

Primary Examiner, Art Unit 2656

29 JAN '15

Notice of References Cited	Application/Control No. 14/224,125	Applicant(s)/Patent Under Reexamination ROJAS, MICHAEL J.	
	Examiner CREIGHTON SMITH	Art Unit 2656	Page 1 of 1

U.S. PATENT DOCUMENTS

*	Document Number Country Code-Number-Kind Code	Date MM-YYYY	Name	Classification
*	A US-7,013,155	03-2006	Ruf et al.	455/466
*	B US-7,317,929	01-2008	El-Fishawy et al.	455/466
C	US-			
D	US-			
E	US-			
F	US-			
G	US-			
H	US-			
I	US-			
J	US-			
K	US-			
L	US-			
M	US-			

FOREIGN PATENT DOCUMENTS

*	Document Number Country Code-Number-Kind Code	Date MM-YYYY	Country	Name	Classification
N					
O					
P					
Q					
R					
S					
T					

NON-PATENT DOCUMENTS

*	Include as applicable: Author, Title Date, Publisher, Edition or Volume, Pertinent Pages)
U	
V	
W	
X	

*A copy of this reference is not being furnished with this Office action. (See MPEP § 707.05(a).)
Dates in MM-YYYY format are publication dates. Classifications may be US or foreign.

Search Notes 	Application/Control No. 14224125	Applicant(s)/Patent Under Reexamination ROJAS, MICHAEL J.
	Examiner CREIGHTON SMITH	Art Unit 2656

CPC- SEARCHED		
Symbol	Date	Examiner

CPC COMBINATION SETS - SEARCHED		
Symbol	Date	Examiner

US CLASSIFICATION SEARCHED			
Class	Subclass	Date	Examiner
370	352	29.01.15	chs
709	206	"	"

SEARCH NOTES		
Search Notes	Date	Examiner
EAST	15.10.14	chs
"	29.01.15	"

INTERFERENCE SEARCH			
US Class/ CPC Symbol	US Subclass / CPC Group	Date	Examiner

--	--

Index of Claims 	Application/Control No. 14224125	Applicant(s)/Patent Under Reexamination ROJAS, MICHAEL J.
	Examiner CREIGHTON SMITH	Art Unit 2656

✓	Rejected	-	Cancelled	N	Non-Elected	A	Appeal
=	Allowed	÷	Restricted	I	Interference	O	Objected

Claims renumbered in the same order as presented by applicant
 CPA
 T.D.
 R.1.47

CLAIM		DATE							
Final	Original	10/15/2014	01/29/2015						
	15		=						
	16		=						
	17		=						
	18		=						
	19		=						
	20		=						
	21		=						
	22		=						
	23		=						
	24		=						
	25		=						
	26		=						
	27		=						
	28		=						
	29		=						
	30		=						
	1	✓	✓						
	2	✓	O						
	3	✓	O						
	4	✓	O						
	5	✓	-						
	6	✓	✓						
	7	✓	✓						
	8	✓	O						
	9	✓	✓						
	10	✓	✓						
	11	✓	-						
	12	✓	=						
	13	✓	=						
	14	✓	=						

EAST Search History**EAST Search History (Prior Art)**

Ref #	Hits	Search Query	DBs	Default Operator	Plurals	Time Stamp
L1	4	((@ad<="20031218") or (@rlad<="20031218")) and (ivm or (instant near6 voice near6 message)) same (database or record) same unique near5 identifier	US-PGPUB; USPAT; EPO; DERWENT	OR	OFF	2015/01/29 14:25
L2	14	((@ad<="20031218") or (@rlad<="20031218")) and (ivm or (instant near6 voice near6 message)) same (database or record) same identifier	US-PGPUB; USPAT; EPO; DERWENT	OR	OFF	2015/01/29 14:27
S7	1	("20140204935").PN.	US-PGPUB; USPAT; USOCR; EPO	OR	OFF	2015/01/29 12:00
S8	4	(("20140204935") or ("8724622") or ("8243723") or ("7535890")).PN.	US-PGPUB; USPAT; USOCR; EPO	OR	OFF	2015/01/29 12:01
S9	22	((@ad<="20031218") or (@rlad<="20031218")) and (ivm or (instant near6 voice near6 message)) same (stor\$3 or delet\$3 or retriev\$3) with request	US-PGPUB; USPAT; EPO; DERWENT	OR	OFF	2015/01/29 12:10

EAST Search History (Interference)

Ref #	Hits	Search Query	DBs	Default Operator	Plurals	Time Stamp
S10	0	((@ad<="20031218") or (@rlad<="20031218")) and (ivm or (instant near6 voice near6 message)) with (stor\$3 or delet\$3 or retriev\$3) with "request.clm"	US-PGPUB; USPAT; UPAD	OR	OFF	2015/01/29 12:09

1/29/2015 3:08:51 PM

C:\Users\csmith1\Documents\EAST\Workspaces\13648888.wsp

IN THE UNITED STATES PATENT AND TRADEMARK OFFICE

In re the Application of: MICHAEL J. ROJAS Serial No.: 14/224,125 Filed: March 25, 2014 For: SYSTEM AND METHOD FOR INSTANT VOIP MESSAGING	Confirmation No.: 5407 Art Unit: 2656 Examiner: Creighton H. Smith
--	--

SUPPLEMENTAL AMENDMENT**MAIL STOP: AMENDMENTS**

Commissioner for Patents
P.O. Box 1450
Alexandria, VA 22313-1450

Sir:

In response to the Office Action of October 21, 2014, please further amend the above-identified application as follows:

No fees are believed to be due. However, any fee necessary for consideration of this response is hereby authorized to be charged to Deposit Account Number 50-4075.

Amendments to the Claims are reflected in the listing of claims that begins on page 2 of this paper.

Remarks begin on page 8 of this paper.

Amendments to the Claims:

This listing of claims replaces all prior versions and listings of claims in this application.

Listing of the Claims:

1. (Previously Presented): A system comprising:
 - an instant voice messaging application including a client platform system for generating an instant voice message and a messaging system for transmitting the instant voice message over a packet-switched network via a network interface;
 - wherein the instant voice messaging application displays a list of one or more potential recipients for the instant voice message; and
 - wherein the instant voice messaging application includes a file manager system performing at least one of storing, deleting and retrieving the instant voice messages from a message database in response to a user request.
2. (Previously presented): The system according to claim 1, wherein the instant voice messaging application includes a message database storing the instant voice message, wherein the instant voice message is represented by a database record including a unique identifier.
3. (Previously presented): The system according to claim 2, wherein the message database includes a plurality of instant voice messages received over the packet-switched network.
4. (Previously presented): The system according to claim 3, wherein the instant voice messaging application displays at least one of the plurality of instant voice messages stored in the message database.
5. (Canceled).

6. (Previously presented): The system according to claim 1, wherein the instant voice messaging application includes an audio file creation system creating an audio file for the instant voice message based on input received via an audio input device.

7. (Previously presented): The system according to claim 1, wherein the instant voice messaging application includes an encryption/decryption system for encrypting the instant voice messages to be transmitted over the packet-switched network and decrypting the instant voices messages received over the packet-switched network.

8. (Previously presented): The system according to claim 1, wherein the instant voice messaging application includes a compression/decompression system for compressing the instant voice messages to be transmitted over the packet-switched network and decompressing the instant voice messages received over the packet-switched network.

9. (Previously presented): The system according to claim 1, wherein the instant voice messaging application displays an indicia for each of the one or more potential recipients indicating whether the potential recipient is currently available to receive an instant voice message.

10. (Previously presented): The system according to claim 1, wherein the instant voice message application generates an audible or visual effect indicating receipt of an instant voice message.

11. (Canceled).

12. (Previously presented): A system, comprising:
an instant voice messaging application comprising:

a client platform system for generating an instant voice message;
a messaging system for transmitting the instant voice message over a packet-switched network, and

wherein the instant voice message application attaches one or more files to the instant voice message.

13. (Previously presented): The system according to claim 12, wherein the packet-switched network comprises a WiFi network.

14. (Previously presented): The system according to claim 12, wherein the instant voice messaging application displays one or more controls for audibly playing the instant voice message.

15. (Previously Presented): The system according to claim 12, wherein the instant voice messaging application encrypts the instant voice message.

16. (Previously Presented): The system according to claim 12, wherein the instant voice messaging application displays a selectable control for generating an instant voice message using an intercom mode based on a connectivity status of an intended recipient of the instant voice message.

17. (Previously Presented): The system according to claim 12, wherein the instant voice messaging application invokes a document handler to create a link between the instant voice message and the one or more files.

18. (Previously Presented): The system according to claim 12, wherein the instant voice messaging application displays the attachment.

19. (Previously Presented): The system according to claim 12, wherein the instant voice messaging application displays one or more controls for performing at least one of reviewing, re-recording or deleting the instant voice message.

20. (Previously Presented): The system according to claim 12 further comprising an instant voice messaging server receiving the instant voice message and an indication of one or more intended recipients of the instant voice message.

21. (Previously Presented): The system according to claim 20 further comprising one or more buffers, wherein the client platform system buffers each of a plurality of successive portions of the instant voice message into the one or more buffers, and wherein the client platform system transmits each successive buffered portion to the instant voice messaging server for delivery to the one or more intended recipients.

22. (Previously Presented): The system according to claim 21, wherein the instant voice messaging server transmits each successive buffered portion to an instant voice messaging application.

23. (Previously Presented): The system according to claim 21, wherein the instant voice messaging server transmits each successive buffered portion to a legacy telephone.

24. (Previously Presented): The system of claim 21, wherein the client platform system automatically transmits the content of a first buffer to the instant voice messaging server for delivery to the one or more intended recipients, and wherein the client platform system writes to a second buffer the next successive portion of the instant voice message.

25. (Previously Presented): The system of claim 21, wherein the content of a buffer is encrypted.
26. (Previously Presented): The system of claim 21, wherein the instant voice messaging server transmits a ring signal to an intended recipient.
27. (Previously Presented): The system of claim 26, wherein the instant voice messaging server establishes a connection between the instant voice messaging application and the intended recipient upon detecting an off-hook event.
28. (Currently Amended): The system of claim ~~20~~ 24 wherein the instant voice messaging server determines availability of the one or more intended recipients for receipt of the instant voice message.
29. (Previously Presented): The system of claim 28, wherein the instant voice messaging server:
- delivers the instant voice message to the one or more intended recipients who are determined to be currently available;
 - stores the instant voice message for the one or more intended recipients who are not currently available; and
 - delivers the instant voice message to the one or more intended recipients who are not currently available when the instant voice messaging server determines that the not currently available one or more intended recipients become available.

Serial No.: 14/224,125
Art Unit: 2656

Attorney's Docket No.: EMP0025-US
Page 7

30. (Previously Presented): The system of claim 29, wherein the instant voice messaging server deletes the instant voice message from the instant voice messaging server after delivery to the one or more intended recipients.

Serial No.: 14/224,125
Art Unit: 2656

Attorney's Docket No.: EMP0025-US
Page 8

REMARKS

Claims 1-4, 6-10, and 12-30 are pending. By this amendment, claim 28 is amended to correct a typographical error. Specifically, claim 28 has been amended to depend from claim 20 instead of claim 21. No new matter is introduced. Claims 1-4, 6-10, and 12-30 will remain pending herein upon entry of this Response.

Conclusion

Should the Examiner have any questions or determine that any further action is desirable to place this application in even better condition for issue, the Examiner is encouraged to telephone the Applicant's undersigned representative at the number listed below.

KASHA LAW LLC
14532 Dufief Mill Rd.
North Potomac, MD 20878
Tel. 240-423-8431
Date: January 22, 2015

Respectfully submitted,

By: /Kelly L. Kasha/
Kelly L. Kasha
Registration No. 47,743

Customer No. 67050

Electronic Acknowledgement Receipt

EFS ID:	21285939
Application Number:	14224125
International Application Number:	
Confirmation Number:	5407
Title of Invention:	System and Method for Instant VoIP Messaging
First Named Inventor/Applicant Name:	Michael J. Rojas
Customer Number:	67050
Filer:	John Kasha
Filer Authorized By:	
Attorney Docket Number:	EMP0025-US
Receipt Date:	22-JAN-2015
Filing Date:	25-MAR-2014
Time Stamp:	20:26:51
Application Type:	Utility under 35 USC 111(a)

Payment information:

Submitted with Payment	no
------------------------	----

File Listing:

Document Number	Document Description	File Name	File Size(Bytes)/ Message Digest	Multi Part /.zip	Pages (if appl.)
1	Supplemental Response or Supplemental Amendment	EMP0025-US_supp_resp_01_22_2015.pdf	91702 e427174b495d630a6f853babe26cb5323a5686c	no	8

Warnings:

Information:

This Acknowledgement Receipt evidences receipt on the noted date by the USPTO of the indicated documents, characterized by the applicant, and including page counts, where applicable. It serves as evidence of receipt similar to a Post Card, as described in MPEP 503.

New Applications Under 35 U.S.C. 111

If a new application is being filed and the application includes the necessary components for a filing date (see 37 CFR 1.53(b)-(d) and MPEP 506), a Filing Receipt (37 CFR 1.54) will be issued in due course and the date shown on this Acknowledgement Receipt will establish the filing date of the application.

National Stage of an International Application under 35 U.S.C. 371

If a timely submission to enter the national stage of an international application is compliant with the conditions of 35 U.S.C. 371 and other applicable requirements a Form PCT/DO/EO/903 indicating acceptance of the application as a national stage submission under 35 U.S.C. 371 will be issued in addition to the Filing Receipt, in due course.

New International Application Filed with the USPTO as a Receiving Office

If a new international application is being filed and the international application includes the necessary components for an international filing date (see PCT Article 11 and MPEP 1810), a Notification of the International Application Number and of the International Filing Date (Form PCT/RO/105) will be issued in due course, subject to prescriptions concerning national security, and the date shown on this Acknowledgement Receipt will establish the international filing date of the application.

Under the Paperwork Reduction Act of 1995, no persons are required to respond to a collection of information unless it displays a valid OMB control number.

PATENT APPLICATION FEE DETERMINATION RECORD Substitute for Form PTO-875				Application or Docket Number 14/224,125	Filing Date 03/25/2014	<input type="checkbox"/> To be Mailed		
ENTITY: <input type="checkbox"/> LARGE <input checked="" type="checkbox"/> SMALL <input type="checkbox"/> MICRO								
APPLICATION AS FILED – PART I								
(Column 1)			(Column 2)					
FOR	NUMBER FILED	NUMBER EXTRA	RATE (\$)	FEE (\$)				
<input type="checkbox"/> BASIC FEE <small>(37 CFR 1.16(a), (b), or (c))</small>	N/A	N/A	N/A					
<input type="checkbox"/> SEARCH FEE <small>(37 CFR 1.16(k), (l), or (m))</small>	N/A	N/A	N/A					
<input type="checkbox"/> EXAMINATION FEE <small>(37 CFR 1.16(o), (p), or (q))</small>	N/A	N/A	N/A					
TOTAL CLAIMS <small>(37 CFR 1.16(i))</small>	minus 20 =	*	X \$	=				
INDEPENDENT CLAIMS <small>(37 CFR 1.16(h))</small>	minus 3 =	*	X \$	=				
<input type="checkbox"/> APPLICATION SIZE FEE <small>(37 CFR 1.16(s))</small>	If the specification and drawings exceed 100 sheets of paper, the application size fee due is \$310 (\$155 for small entity) for each additional 50 sheets or fraction thereof. See 35 U.S.C. 41(a)(1)(G) and 37 CFR 1.16(s).							
<input type="checkbox"/> MULTIPLE DEPENDENT CLAIM PRESENT <small>(37 CFR 1.16(j))</small>								
* If the difference in column 1 is less than zero, enter "0" in column 2.			TOTAL					
APPLICATION AS AMENDED – PART II								
(Column 1)		(Column 2)		(Column 3)				
AMENDMENT	01/22/2015	CLAIMS REMAINING AFTER AMENDMENT		HIGHEST NUMBER PREVIOUSLY PAID FOR	PRESENT EXTRA	RATE (\$)	ADDITIONAL FEE (\$)	
	Total (37 CFR 1.16(i))	* 28	Minus	** 28	= 0	X \$40 =	0	
	Independent (37 CFR 1.16(h))	* 2	Minus	***3	= 0	X \$210 =	0	
	<input type="checkbox"/> Application Size Fee (37 CFR 1.16(s))							
	<input type="checkbox"/> FIRST PRESENTATION OF MULTIPLE DEPENDENT CLAIM (37 CFR 1.16(j))							
				TOTAL ADD'L FEE			0	
(Column 1)		(Column 2)		(Column 3)				
AMENDMENT		CLAIMS REMAINING AFTER AMENDMENT		HIGHEST NUMBER PREVIOUSLY PAID FOR	PRESENT EXTRA	RATE (\$)	ADDITIONAL FEE (\$)	
	Total (37 CFR 1.16(i))	*	Minus	**	=	X \$	=	
	Independent (37 CFR 1.16(h))	*	Minus	***	=	X \$	=	
	<input type="checkbox"/> Application Size Fee (37 CFR 1.16(s))							
	<input type="checkbox"/> FIRST PRESENTATION OF MULTIPLE DEPENDENT CLAIM (37 CFR 1.16(j))							
				TOTAL ADD'L FEE				
<p>* If the entry in column 1 is less than the entry in column 2, write "0" in column 3. ** If the "Highest Number Previously Paid For" IN THIS SPACE is less than 20, enter "20". *** If the "Highest Number Previously Paid For" IN THIS SPACE is less than 3, enter "3". The "Highest Number Previously Paid For" (Total or Independent) is the highest number found in the appropriate box in column 1.</p>								

LIE
/ROZENIA HARMON/

This collection of information is required by 37 CFR 1.16. The information is required to obtain or retain a benefit by the public which is to file (and by the USPTO to process) an application. Confidentiality is governed by 35 U.S.C. 122 and 37 CFR 1.14. This collection is estimated to take 12 minutes to complete, including gathering, preparing, and submitting the completed application form to the USPTO. Time will vary depending upon the individual case. Any comments on the amount of time you require to complete this form and/or suggestions for reducing this burden, should be sent to the Chief Information Officer, U.S. Patent and Trademark Office, U.S. Department of Commerce, P.O. Box 1450, Alexandria, VA 22313-1450. DO NOT SEND FEES OR COMPLETED FORMS TO THIS ADDRESS. **SEND TO: Commissioner for Patents, P.O. Box 1450, Alexandria, VA 22313-1450.**
 If you need assistance in completing the form, call 1-800-PTO-9199 and select option 2.

Doc Code: DIST.E.FILE Document Description: Electronic Terminal Disclaimer - Filed		PTO/SB/26 U.S. Patent and Trademark Office Department of Commerce
Electronic Petition Request	TERMINAL DISCLAIMER TO OBVIATE A DOUBLE PATENTING REJECTION OVER A "PRIOR" PATENT	
Application Number	14224125	
Filing Date	25-Mar-2014	
First Named Inventor	Michael Rojas	
Attorney Docket Number	EMP0025-US	
Title of Invention	System and Method for Instant VoIP Messaging	
<input checked="" type="checkbox"/> Filing of terminal disclaimer does not obviate requirement for response under 37 CFR 1.111 to outstanding Office Action <input checked="" type="checkbox"/> This electronic Terminal Disclaimer is not being used for a Joint Research Agreement.		
Owner	Percent Interest	
EMPIRE IP LLC	100%	
<p>The owner(s) with percent interest listed above in the instant application hereby disclaims, except as provided below, the terminal part of the statutory term of any patent granted on the instant application which would extend beyond the expiration date of the full statutory term of prior patent number(s)</p> <p>7535890</p> <p>as the term of said prior patent is presently shortened by any terminal disclaimer. The owner hereby agrees that any patent so granted on the instant application shall be enforceable only for and during such period that it and the prior patent are commonly owned. This agreement runs with any patent granted on the instant application and is binding upon the grantee, its successors or assigns.</p> <p>In making the above disclaimer, the owner does not disclaim the terminal part of the term of any patent granted on the instant application that would extend to the expiration date of the full statutory term of the prior patent, "as the term of said prior patent is presently shortened by any terminal disclaimer," in the event that said prior patent later:</p> <ul style="list-style-type: none"> - expires for failure to pay a maintenance fee; - is held unenforceable; - is found invalid by a court of competent jurisdiction; - is statutorily disclaimed in whole or terminally disclaimed under 37 CFR 1.321; - has all claims canceled by a reexamination certificate; - is reissued; or - is in any manner terminated prior to the expiration of its full statutory term as presently shortened by any terminal disclaimer. <p><input checked="" type="radio"/> Terminal disclaimer fee under 37 CFR 1.20(d) is included with Electronic Terminal Disclaimer request.</p>		

I certify, in accordance with 37 CFR 1.4(d)(4), that the terminal disclaimer fee under 37 CFR 1.20(d) required for this terminal disclaimer has already been paid in the above-identified application.

Applicant claims the following fee status:

- Small Entity
- Micro Entity
- Regular Undiscounted

I hereby declare that all statements made herein of my own knowledge are true and that all statements made on information and belief are believed to be true; and further that these statements were made with the knowledge that willful false statements and the like so made are punishable by fine or imprisonment, or both, under Section 1001 of Title 18 of the United States Code and that such willful false statements may jeopardize the validity of the application or any patent issued thereon.

THIS PORTION MUST BE COMPLETED BY THE SIGNATORY OR SIGNATORIES

I certify, in accordance with 37 CFR 1.4(d)(4) that I am:

- An attorney or agent registered to practice before the Patent and Trademark Office who is of record in this application

Registration Number 47743
- A sole inventor
- A joint inventor; I certify that I am authorized to sign this submission on behalf of all of the inventors as evidenced by the power of attorney in the application
- A joint inventor; all of whom are signing this request

Signature	/Kelly Kasha/
Name	Kelly Kasha

*Statement under 37 CFR 3.73(b) is required if terminal disclaimer is signed by the assignee (owner).
Form PTO/SB/96 may be used for making this certification. See MPEP § 324.

Electronic Patent Application Fee Transmittal

Application Number:	14224125			
Filing Date:	25-Mar-2014			
Title of Invention:	System and Method for Instant VoIP Messaging			
First Named Inventor/Applicant Name:	Michael J. Rojas			
Filer:	John Kasha			
Attorney Docket Number:	EMP0025-US			
Filed as Small Entity				
Filing Fees for Utility under 35 USC 111(a)				
Description	Fee Code	Quantity	Amount	Sub-Total in USD(\$)
Basic Filing:				
Statutory or Terminal Disclaimer	1814	1	160	160
Pages:				
Claims:				
Miscellaneous-Filing:				
Petition:				
Patent-Appeals-and-Interference:				
Post-Allowance-and-Post-Issuance:				

Description	Fee Code	Quantity	Amount	Sub-Total in USD(\$)
Extension-of-Time:				
Miscellaneous:				
Total in USD (\$)				160

Doc Code: DISQ.E.FILE

Document Description: Electronic Terminal Disclaimer – Approved

Application No.: 14224125

Filing Date: 25-Mar-2014

Applicant/Patent under Reexamination: Rojas et al.

Electronic Terminal Disclaimer filed on January 21, 2015

APPROVED

This patent is subject to a terminal disclaimer

DISAPPROVED

Approved/Disapproved by: Electronic Terminal Disclaimer automatically approved by EFS-Web

U.S. Patent and Trademark Office

Electronic Acknowledgement Receipt

EFS ID:	21272573
Application Number:	14224125
International Application Number:	
Confirmation Number:	5407
Title of Invention:	System and Method for Instant VoIP Messaging
First Named Inventor/Applicant Name:	Michael J. Rojas
Customer Number:	67050
Filer:	John Kasha
Filer Authorized By:	
Attorney Docket Number:	EMP0025-US
Receipt Date:	21-JAN-2015
Filing Date:	25-MAR-2014
Time Stamp:	20:42:24
Application Type:	Utility under 35 USC 111(a)

Payment information:

Submitted with Payment	yes
Payment Type	Deposit Account
Payment was successfully received in RAM	\$160
RAM confirmation Number	8370
Deposit Account	504075
Authorized User	

The Director of the USPTO is hereby authorized to charge indicated fees and credit any overpayment as follows:

Charge any Additional Fees required under 37 C.F.R. Section 1.16 (National application filing, search, and examination fees)

Charge any Additional Fees required under 37 C.F.R. Section 1.17 (Patent application and reexamination processing fees)

Charge any Additional Fees required under 37 C.F.R. Section 1.19 (Document supply fees)
 Charge any Additional Fees required under 37 C.F.R. Section 1.20 (Post Issuance fees)
 Charge any Additional Fees required under 37 C.F.R. Section 1.21 (Miscellaneous fees and charges)

File Listing:

Document Number	Document Description	File Name	File Size(Bytes)/ Message Digest	Multi Part /.zip	Pages (if appl.)
1	Electronic Terminal Disclaimer-Filed	eTerminal-Disclaimer.pdf	33439 47291d2a65288cb35edf5c25f9ae43a7b28e551a	no	2

Warnings:

Information:

2	Fee Worksheet (SB06)	fee-info.pdf	29863 c794e9e79b35d2d17eef197090dd12f083ef346a	no	2
---	----------------------	--------------	---	----	---

Warnings:

Information:

Total Files Size (in bytes): 63302

This Acknowledgement Receipt evidences receipt on the noted date by the USPTO of the indicated documents, characterized by the applicant, and including page counts, where applicable. It serves as evidence of receipt similar to a Post Card, as described in MPEP 503.

New Applications Under 35 U.S.C. 111

If a new application is being filed and the application includes the necessary components for a filing date (see 37 CFR 1.53(b)-(d) and MPEP 506), a Filing Receipt (37 CFR 1.54) will be issued in due course and the date shown on this Acknowledgement Receipt will establish the filing date of the application.

National Stage of an International Application under 35 U.S.C. 371

If a timely submission to enter the national stage of an international application is compliant with the conditions of 35 U.S.C. 371 and other applicable requirements a Form PCT/DO/EO/903 indicating acceptance of the application as a national stage submission under 35 U.S.C. 371 will be issued in addition to the Filing Receipt, in due course.

New International Application Filed with the USPTO as a Receiving Office

If a new international application is being filed and the international application includes the necessary components for an international filing date (see PCT Article 11 and MPEP 1810), a Notification of the International Application Number and of the International Filing Date (Form PCT/RO/105) will be issued in due course, subject to prescriptions concerning national security, and the date shown on this Acknowledgement Receipt will establish the international filing date of the application.

IN THE UNITED STATES PATENT AND TRADEMARK OFFICE

<p>In re the Application of:</p> <p>MICHAEL J. ROJAS</p> <p>Serial No.: 14/224,125</p> <p>Filed: March 25, 2014</p> <p>For: SYSTEM AND METHOD FOR INSTANT VOIP MESSAGING</p>	<p>Confirmation No.: 5407</p> <p>Art Unit: 2656</p> <p>Examiner: Creighton H. Smith</p>
--	---

AMENDMENT

MAIL STOP: AMENDMENTS
 Commissioner for Patents
 P.O. Box 1450
 Alexandria, VA 22313-1450

Sir:

In response to the Office Action of October 21, 2014, please amend the above-identified application as follows:

Fees for 8 extra claims are being filed herewith. No other fees are believed to be due. However, any fee necessary for consideration of this response is hereby authorized to be charged to Deposit Account Number 50-4075.

Amendments to the Claims are reflected in the listing of claims that begins on page 2 of this paper.

Remarks begin on page 7 of this paper.

Amendments to the Claims:

This listing of claims replaces all prior versions and listings of claims in this application.

Listing of the Claims:

1. (Currently amended): A system comprising:

an instant voice messaging application including a client platform system for generating an instant voice message and a messaging system for transmitting the instant voice message over a packet-switched network via a network interface; ~~and~~

wherein the instant voice messaging application displays a list of one or more potential recipients for the instant voice message; and

wherein the instant voice messaging application includes a file manager system performing at least one of storing, deleting and retrieving the instant voice messages from a message database in response to a user request.
2. (Previously presented): The system according to claim 1, wherein the instant voice messaging application includes a message database storing the instant voice message, wherein the instant voice message is represented by a database record including a unique identifier.
3. (Previously presented): The system according to claim 2, wherein the message database includes a plurality of instant voice messages received over the packet-switched network.
4. (Previously presented): The system according to claim 3, wherein the instant voice messaging application displays at least one of the plurality of instant voice messages stored in the message database.
5. (Canceled).

6. (Previously presented): The system according to claim 1, wherein the instant voice messaging application includes an audio file creation system creating an audio file for the instant voice message based on input received via an audio input device.

7. (Previously presented): The system according to claim 1, wherein the instant voice messaging application includes an encryption/decryption system for encrypting the instant voice messages to be transmitted over the packet-switched network and decrypting the instant voices messages received over the packet-switched network.

8. (Previously presented): The system according to claim 1, wherein the instant voice messaging application includes a compression/decompression system for compressing the instant voice messages to be transmitted over the packet-switched network and decompressing the instant voice messages received over the packet-switched network.

9. (Previously presented): The system according to claim 1, wherein the instant voice messaging application displays an indicia for each of the one or more potential recipients indicating whether the potential recipient is currently available to receive an instant voice message.

10. (Previously presented): The system according to claim 1, wherein the instant voice message application generates an audible or visual effect indicating receipt of an instant voice message.

11. (Canceled).

12. (Previously presented): A system, comprising:
an instant voice messaging application comprising:

a client platform system for generating an instant voice message;
a messaging system for transmitting the instant voice message over a packet-switched network, and

wherein the instant voice message application attaches one or more files to the instant voice message.

13. (Previously presented): The system according to claim 12, wherein the packet-switched network comprises a WiFi network.

14. (Previously presented): The system according to claim 12, wherein the instant voice messaging application displays one or more controls for audibly playing the instant voice message.

15. (New): The system according to claim 12, wherein the instant voice messaging application encrypts the instant voice message.

16. (New): The system according to claim 12, wherein the instant voice messaging application displays a selectable control for generating an instant voice message using an intercom mode based on a connectivity status of an intended recipient of the instant voice message.

17. (New): The system according to claim 12, wherein the instant voice messaging application invokes a document handler to create a link between the instant voice message and the one or more files.

18. (New): The system according to claim 12, wherein the instant voice messaging application displays the attachment.

19. (New): The system according to claim 12, wherein the instant voice messaging application displays one or more controls for performing at least one of reviewing, re-recording or deleting the instant voice message.
20. (New): The system according to claim 12 further comprising an instant voice messaging server receiving the instant voice message and an indication of one or more intended recipients of the instant voice message.
21. (New): The system according to claim 20 further comprising one or more buffers, wherein the client platform system buffers each of a plurality of successive portions of the instant voice message into the one or more buffers, and wherein the client platform system transmits each successive buffered portion to the instant voice messaging server for delivery to the one or more intended recipients.
22. (New): The system according to claim 21, wherein the instant voice messaging server transmits each successive buffered portion to an instant voice messaging application.
23. (New): The system according to claim 21, wherein the instant voice messaging server transmits each successive buffered portion to a legacy telephone.
24. (New): The system of claim 21, wherein the client platform system automatically transmits the content of a first buffer to the instant voice messaging server for delivery to the one or more intended recipients, and wherein the client platform system writes to a second buffer the next successive portion of the instant voice message.
25. (New): The system of claim 21, wherein the content of a buffer is encrypted.

26. (New): The system of claim 21, wherein the instant voice messaging server transmits a ring signal to an intended recipient.

27. (New): The system of claim 26, wherein the instant voice messaging server establishes a connection between the instant voice messaging application and the intended recipient upon detecting an off-hook event.

28. (New): The system of claim 21 wherein the instant voice messaging server determines availability of the one or more intended recipients for receipt of the instant voice message.

29. (New): The system of claim 28, wherein the instant voice messaging server:

delivers the instant voice message to the one or more intended recipients who are determined to be currently available;

stores the instant voice message for the one or more intended recipients who are not currently available; and

delivers the instant voice message to the one or more intended recipients who are not currently available when the instant voice messaging server determines that the not currently available one or more intended recipients become available.

30. (New): The system of claim 29, wherein the instant voice messaging server deletes the instant voice message from the instant voice messaging server after delivery to the one or more intended recipients.

REMARKS

Claims 1-14 are pending. By this amendment, claims 5 and 11 have been cancelled, claim 1 has been amended to incorporate the allowable subject matter of claim 5, and new claims 15-30 have been added. No new matter is introduced. Claims 1-4, 6-10, and 12-30 will remain pending herein upon entry of this Response. Support for new claims can be found at least in the specification of the present application, i.e., U.S. Publication No. 2014/0204935, as detailed below.

The subject matter of new claim 15 is described in the specification at, for example, paragraph [0045].

The subject matter of new claim 16 is described in the specification at, for example, paragraphs [0046] and [0061].

The subject matter of new claim 17 is described in the specification at, for example, paragraphs [0047] and [0049].

The subject matter of new claim 18 is described in the specification at, for example, paragraph [0048].

The subject matter of new claim 19 is described in the specification at, for example, paragraph [0049].

The subject matter of new claim 20 is described in the specification at, for example, paragraphs [0045], [0046] and [0051].

The subject matter of new claim 21 is described in the specification at, for example, paragraph [0061].

The subject matter of new claim 22 is described in the specification at, for example, paragraph [0061].

The subject matter of new claim 23 is described in the specification at, for example, paragraphs [0054] and [0058].

The subject matter of new claim 24 is described in the specification at, for example, paragraph [0061].

The subject matter of new claim 25 is described in the specification at, for example, paragraph [0061].

The subject matter of new claim 26 is described in the specification at, for example, paragraphs [0042], [0057] and [0060].

The subject matter of new claim 27 is described in the specification at, for example, paragraphs [0042], [0057], [0058] and [0060].

The subject matter of new claim 28 is described in the specification at, for example, paragraphs [0040], [0048] and [0064].

The subject matter of new claim 29 is described in the specification at, for example, paragraphs [0040] - [0043], [0056], [0057] and [0058].

The subject matter of new claim 30 is described in the specification at, for example, paragraphs [0040] - [0043], [0056], [0057] and [0058].

Double Patenting Rejections

Claims 1-14 are rejected on the ground of non-statutory obviousness-type double patenting as being unpatentable over claims 1-70 of U.S. Patent No. 7,535,890 (hereinafter the “‘890 patent”).

Claims 5 and 11 have been cancelled, rendering the rejection of these claims moot.

The Applicant files herewith a Terminal Disclaimer over the ‘890 patent. As set forth in the MPEP, a Terminal Disclaimer may be used to overcome a rejection based on obviousness-type double patenting (MPEP § 804.02(II)). Further, in legal principle, the filing of a Terminal Disclaimer simply serves the statutory function of removing the rejection of obviousness-type double patenting, and does not raise a presumption on the merits of the rejection. It is improper to view the simple expedient of “obviation” as an admission or acquiescence on the merits. *Ortho Pharmaceutical Corp. v. Smith*, 22 USPQ2d 1119, 1124 (Fed. Cir. 1992), citing *Quad Envtl. Technologies Corp. v. Union Sanitary Dist.*, 946 F.2d 870, 874, 20 USPQ2d 1392, 1394-95 (Fed. Cir. 1991).

Withdrawal of the rejection of claims 1-4, 6-10 and 12-14 based on the judicially created doctrine of double patenting is respectfully requested.

35 U.S. C. § 102(e) and 103(a) Rejections

Claims 1 and 9 stand rejected under 35 U.S.C. § 102(e) as unpatentable over U.S. Patent Application Publication No. 2013/0066989 to Enete et al. (“Enete”).

Claim 6 stands rejected under 35 U.S.C. § 103(a) as unpatentable over Enete in view of U.S. Patent Application Publication No. 2004/0064317 to Othmer et al. (“Othmer”).

Claims 7 and 11 stands rejected under 35 U.S.C. § 103(a) as unpatentable over Enete in view of U.S. Patent Application Publication No. 2004/0225524 to Narasimhan et al. (“Narasimhan”).

Claim 10 stands rejected under 35 U.S.C. § 103(a) as unpatentable over Enete in view of U.S. Patent No. 7,133,687 to El-Fishaway et al. (“EF”).

These rejections are respectfully traversed. However, to move prosecution forward, the Applicant incorporates the allowable subject matter of claim 5 into independent claim 1, as described below. Further, the Applicant has canceled claim 11, rendering the rejection of this claim moot. The Applicant reserves the right to pursue previously filed claims in a continuation application, and this amendment does not indicate express or implicit agreement with the Examiner's rejections of previously presented claims.

Claim 1 has been amended to incorporate the allowable subject matter of claim 5. It is respectfully submitted that claim 1 is thus allowable in view of this amendment.

Claims 6, 7, 9 and 10 depend from independent claim 1. Accordingly, it is respectfully submitted that claim 6, 7, 9 and 10 are allowable in view of the amendment to claim 1 incorporating the allowable subject matter of claim 5.

Withdrawal of the rejection of claims 1, 6, 7, 9 and 10 under 35 U.S.C. § 102(e) and 103(a) is respectfully requested.

Serial No.: 14/224,125
Art Unit: 2656

Attorney's Docket No.: EMP0025-US
Page 11

New Claims

New claims 15-30 depend directly or indirectly from independent claim 12. Thus, it is respectfully submitted that new claims 15-30 are allowable at least for the reason that claim 12 is allowable.

Conclusion

Should the Examiner have any questions or determine that any further action is desirable to place this application in even better condition for issue, the Examiner is encouraged to telephone the Applicant's undersigned representative at the number listed below.

KASHA LAW LLC
14532 Dufief Mill Rd.
North Potomac, MD 20878
Tel. 240-423-8431
Date: January 21, 2015

Respectfully submitted,
By: /Kelly L. Kasha/
Kelly L. Kasha
Registration No. 47,743

Customer No. 67050

Electronic Patent Application Fee Transmittal

Application Number:	14224125				
Filing Date:	25-Mar-2014				
Title of Invention:	System and Method for Instant VoIP Messaging				
First Named Inventor/Applicant Name:	Michael J. Rojas				
Filer:	John Kasha				
Attorney Docket Number:	EMP0025-US				
Filed as Small Entity					
Filing Fees for Utility under 35 USC 111(a)					
Description	Fee Code	Quantity	Amount	Sub-Total in USD(\$)	
Basic Filing:					
Pages:					
Claims:					
Claims in excess of 20	2202	8	40	320	
Miscellaneous-Filing:					
Petition:					
Patent-Appeals-and-Interference:					
Post-Allowance-and-Post-Issuance:					

Description	Fee Code	Quantity	Amount	Sub-Total in USD(\$)
Extension-of-Time:				
Miscellaneous:				
Total in USD (\$)				320

Electronic Acknowledgement Receipt

EFS ID:	21272634
Application Number:	14224125
International Application Number:	
Confirmation Number:	5407
Title of Invention:	System and Method for Instant VoIP Messaging
First Named Inventor/Applicant Name:	Michael J. Rojas
Customer Number:	67050
Filer:	John Kasha
Filer Authorized By:	
Attorney Docket Number:	EMP0025-US
Receipt Date:	21-JAN-2015
Filing Date:	25-MAR-2014
Time Stamp:	20:47:57
Application Type:	Utility under 35 USC 111(a)

Payment information:

Submitted with Payment	yes
Payment Type	Deposit Account
Payment was successfully received in RAM	\$320
RAM confirmation Number	8398
Deposit Account	504075
Authorized User	

The Director of the USPTO is hereby authorized to charge indicated fees and credit any overpayment as follows:

- Charge any Additional Fees required under 37 C.F.R. Section 1.16 (National application filing, search, and examination fees)
- Charge any Additional Fees required under 37 C.F.R. Section 1.17 (Patent application and reexamination processing fees)

Charge any Additional Fees required under 37 C.F.R. Section 1.19 (Document supply fees)
 Charge any Additional Fees required under 37 C.F.R. Section 1.20 (Post Issuance fees)
 Charge any Additional Fees required under 37 C.F.R. Section 1.21 (Miscellaneous fees and charges)

File Listing:

Document Number	Document Description	File Name	File Size(Bytes)/ Message Digest	Multi Part /.zip	Pages (if appl.)
1	Amendment/Req. Reconsideration-After Non-Final Reject	EMP0025-US_resp_01_21_2015.pdf	121852 <small>58ce98454ea7c6aa4cd0d8d35418cce11f617b45</small>	no	11

Warnings:

Information:

2	Fee Worksheet (SB06)	fee-info.pdf	29773 <small>826369ff188a50482e53621c37015e5ad55b5cbe</small>	no	2
---	----------------------	--------------	--	----	---

Warnings:

Information:

Total Files Size (in bytes): 151625

This Acknowledgement Receipt evidences receipt on the noted date by the USPTO of the indicated documents, characterized by the applicant, and including page counts, where applicable. It serves as evidence of receipt similar to a Post Card, as described in MPEP 503.

New Applications Under 35 U.S.C. 111

If a new application is being filed and the application includes the necessary components for a filing date (see 37 CFR 1.53(b)-(d) and MPEP 506), a Filing Receipt (37 CFR 1.54) will be issued in due course and the date shown on this Acknowledgement Receipt will establish the filing date of the application.

National Stage of an International Application under 35 U.S.C. 371

If a timely submission to enter the national stage of an international application is compliant with the conditions of 35 U.S.C. 371 and other applicable requirements a Form PCT/DO/EO/903 indicating acceptance of the application as a national stage submission under 35 U.S.C. 371 will be issued in addition to the Filing Receipt, in due course.

New International Application Filed with the USPTO as a Receiving Office

If a new international application is being filed and the international application includes the necessary components for an international filing date (see PCT Article 11 and MPEP 1810), a Notification of the International Application Number and of the International Filing Date (Form PCT/RO/105) will be issued in due course, subject to prescriptions concerning national security, and the date shown on this Acknowledgement Receipt will establish the international filing date of the application.

Under the Paperwork Reduction Act of 1995, no persons are required to respond to a collection of information unless it displays a valid OMB control number.

PATENT APPLICATION FEE DETERMINATION RECORD Substitute for Form PTO-875			Application or Docket Number 14/224,125	Filing Date 03/25/2014	<input type="checkbox"/> To be Mailed
ENTITY: <input type="checkbox"/> LARGE <input checked="" type="checkbox"/> SMALL <input type="checkbox"/> MICRO					
APPLICATION AS FILED – PART I					
(Column 1)		(Column 2)			
FOR	NUMBER FILED	NUMBER EXTRA	RATE (\$)	FEE (\$)	
<input type="checkbox"/> BASIC FEE <small>(37 CFR 1.16(a), (b), or (c))</small>	N/A	N/A	N/A		
<input type="checkbox"/> SEARCH FEE <small>(37 CFR 1.16(k), (l), or (m))</small>	N/A	N/A	N/A		
<input type="checkbox"/> EXAMINATION FEE <small>(37 CFR 1.16(o), (p), or (q))</small>	N/A	N/A	N/A		
TOTAL CLAIMS <small>(37 CFR 1.16(i))</small>	minus 20 =	*	X \$ =		
INDEPENDENT CLAIMS <small>(37 CFR 1.16(h))</small>	minus 3 =	*	X \$ =		
<input type="checkbox"/> APPLICATION SIZE FEE <small>(37 CFR 1.16(s))</small>	If the specification and drawings exceed 100 sheets of paper, the application size fee due is \$310 (\$155 for small entity) for each additional 50 sheets or fraction thereof. See 35 U.S.C. 41(a)(1)(G) and 37 CFR 1.16(s).				
<input type="checkbox"/> MULTIPLE DEPENDENT CLAIM PRESENT <small>(37 CFR 1.16(j))</small>					
* If the difference in column 1 is less than zero, enter "0" in column 2.			TOTAL		

APPLICATION AS AMENDED – PART II								
(Column 1)		(Column 2)		(Column 3)				
AMENDMENT	01/21/2015	CLAIMS REMAINING AFTER AMENDMENT		HIGHEST NUMBER PREVIOUSLY PAID FOR	PRESENT EXTRA	RATE (\$)	ADDITIONAL FEE (\$)	
	Total (37 CFR 1.16(i))	* 28	Minus	** 20	= 8	X \$40 =	320	
	Independent (37 CFR 1.16(h))	* 2	Minus	***3	= 0	X \$210 =	0	
	<input type="checkbox"/> Application Size Fee (37 CFR 1.16(s))							
	<input type="checkbox"/> FIRST PRESENTATION OF MULTIPLE DEPENDENT CLAIM (37 CFR 1.16(j))							
						TOTAL ADD'L FEE	320	

(Column 1)		(Column 2)		(Column 3)				
AMENDMENT		CLAIMS REMAINING AFTER AMENDMENT		HIGHEST NUMBER PREVIOUSLY PAID FOR	PRESENT EXTRA	RATE (\$)	ADDITIONAL FEE (\$)	
	Total (37 CFR 1.16(i))	*	Minus	**	=	X \$ =		
	Independent (37 CFR 1.16(h))	*	Minus	***	=	X \$ =		
	<input type="checkbox"/> Application Size Fee (37 CFR 1.16(s))							
	<input type="checkbox"/> FIRST PRESENTATION OF MULTIPLE DEPENDENT CLAIM (37 CFR 1.16(j))							
						TOTAL ADD'L FEE		

* If the entry in column 1 is less than the entry in column 2, write "0" in column 3.
 ** If the "Highest Number Previously Paid For" IN THIS SPACE is less than 20, enter "20".
 *** If the "Highest Number Previously Paid For" IN THIS SPACE is less than 3, enter "3".
 The "Highest Number Previously Paid For" (Total or Independent) is the highest number found in the appropriate box in column 1.

LIE
/ROZENIA HARMON/

This collection of information is required by 37 CFR 1.16. The information is required to obtain or retain a benefit by the public which is to file (and by the USPTO to process) an application. Confidentiality is governed by 35 U.S.C. 122 and 37 CFR 1.14. This collection is estimated to take 12 minutes to complete, including gathering, preparing, and submitting the completed application form to the USPTO. Time will vary depending upon the individual case. Any comments on the amount of time you require to complete this form and/or suggestions for reducing this burden, should be sent to the Chief Information Officer, U.S. Patent and Trademark Office, U.S. Department of Commerce, P.O. Box 1450, Alexandria, VA 22313-1450. DO NOT SEND FEES OR COMPLETED FORMS TO THIS ADDRESS. **SEND TO: Commissioner for Patents, P.O. Box 1450, Alexandria, VA 22313-1450.**
 If you need assistance in completing the form, call 1-800-PTO-9199 and select option 2.



UNITED STATES PATENT AND TRADEMARK OFFICE

UNITED STATES DEPARTMENT OF COMMERCE
United States Patent and Trademark Office
Address: COMMISSIONER FOR PATENTS
P.O. Box 1450
Alexandria, Virginia 22313-1450
www.uspto.gov

Table with 5 columns: APPLICATION NO., FILING DATE, FIRST NAMED INVENTOR, ATTORNEY DOCKET NO., CONFIRMATION NO.
14/224,125 03/25/2014 Michael J. Rojas EMP0025-US 5407

67050 7590 10/21/2014
KASHA LAW LLC
14532 Dufief Mill Road
North Potomac, MD 20878

Table with 1 column: EXAMINER

SMITH, CREIGHTON H

Table with 2 columns: ART UNIT, PAPER NUMBER

2656

Table with 2 columns: NOTIFICATION DATE, DELIVERY MODE

10/21/2014

ELECTRONIC

Please find below and/or attached an Office communication concerning this application or proceeding.

The time period for reply, if any, is set in the attached communication.

Notice of the Office communication was sent electronically on above-indicated "Notification Date" to the following e-mail address(es):

JOHN.KASHA@KASHALAW.COM

Office Action Summary	Application No. 14/224,125	Applicant(s) ROJAS, MICHAEL J.	
	Examiner CREIGHTON SMITH	Art Unit 2656	AIA (First Inventor to File) Status No

-- The MAILING DATE of this communication appears on the cover sheet with the correspondence address --

Period for Reply

A SHORTENED STATUTORY PERIOD FOR REPLY IS SET TO EXPIRE 3 MONTHS FROM THE MAILING DATE OF THIS COMMUNICATION.

- Extensions of time may be available under the provisions of 37 CFR 1.136(a). In no event, however, may a reply be timely filed after SIX (6) MONTHS from the mailing date of this communication.
- If NO period for reply is specified above, the maximum statutory period will apply and will expire SIX (6) MONTHS from the mailing date of this communication.
- Failure to reply within the set or extended period for reply will, by statute, cause the application to become ABANDONED (35 U.S.C. § 133). Any reply received by the Office later than three months after the mailing date of this communication, even if timely filed, may reduce any earned patent term adjustment. See 37 CFR 1.704(b).

Status

- 1) Responsive to communication(s) filed on _____.
 A declaration(s)/affidavit(s) under **37 CFR 1.130(b)** was/were filed on _____.
- 2a) This action is **FINAL**. 2b) This action is non-final.
- 3) An election was made by the applicant in response to a restriction requirement set forth during the interview on _____; the restriction requirement and election have been incorporated into this action.
- 4) Since this application is in condition for allowance except for formal matters, prosecution as to the merits is closed in accordance with the practice under *Ex parte Quayle*, 1935 C.D. 11, 453 O.G. 213.

Disposition of Claims*

- 5) Claim(s) 1-14 is/are pending in the application.
5a) Of the above claim(s) _____ is/are withdrawn from consideration.
- 6) Claim(s) _____ is/are allowed.
- 7) Claim(s) 1-14 is/are rejected.
- 8) Claim(s) _____ is/are objected to.
- 9) Claim(s) _____ are subject to restriction and/or election requirement.

* If any claims have been determined allowable, you may be eligible to benefit from the **Patent Prosecution Highway** program at a participating intellectual property office for the corresponding application. For more information, please see http://www.uspto.gov/patents/init_events/pph/index.jsp or send an inquiry to PPHfeedback@uspto.gov.

Application Papers

- 10) The specification is objected to by the Examiner.
- 11) The drawing(s) filed on _____ is/are: a) accepted or b) objected to by the Examiner.
Applicant may not request that any objection to the drawing(s) be held in abeyance. See 37 CFR 1.85(a).
Replacement drawing sheet(s) including the correction is required if the drawing(s) is objected to. See 37 CFR 1.121(d).

Priority under 35 U.S.C. § 119

- 12) Acknowledgment is made of a claim for foreign priority under 35 U.S.C. § 119(a)-(d) or (f).

Certified copies:

- a) All b) Some** c) None of the:
1. Certified copies of the priority documents have been received.
2. Certified copies of the priority documents have been received in Application No. _____.
3. Copies of the certified copies of the priority documents have been received in this National Stage application from the International Bureau (PCT Rule 17.2(a)).

** See the attached detailed Office action for a list of the certified copies not received.

Attachment(s)

- 1) Notice of References Cited (PTO-892)
- 2) Information Disclosure Statement(s) (PTO/SB/08a and/or PTO/SB/08b)
Paper No(s)/Mail Date _____.
- 3) Interview Summary (PTO-413)
Paper No(s)/Mail Date. _____.
- 4) Other: _____.

The present application is being examined under the pre-AIA first to invent provisions.

DETAILED ACTION

The nonstatutory double patenting rejection is based on a judicially created doctrine grounded in public policy (a policy reflected in the statute) so as to prevent the unjustified or improper timewise extension of the “right to exclude” granted by a patent and to prevent possible harassment by multiple assignees. A nonstatutory double patenting rejection is appropriate where the claims at issue are not identical, but at least one examined application claim is not patentably distinct from the reference claim(s) because the examined application claim is either anticipated by, or would have been obvious over, the reference claim(s). See, e.g., *In re Berg*, 140 F.3d 1428, 46 USPQ2d 1226 (Fed. Cir. 1998); *In re Goodman*, 11 F.3d 1046, 29 USPQ2d 2010 (Fed. Cir. 1993); *In re Longi*, 759 F.2d 887, 225 USPQ 645 (Fed. Cir. 1985); *In re Van Ornum*, 686 F.2d 937, 214 USPQ 761 (CCPA 1982); *In re Vogel*, 422 F.2d 438, 164 USPQ 619 (CCPA 1970); and *In re Thorington*, 418 F.2d 528, 163 USPQ 644 (CCPA 1969).

A timely filed terminal disclaimer in compliance with 37 CFR 1.321(c) or 1.321(d) may be used to overcome an actual or provisional rejection based on a nonstatutory double patenting ground provided the reference application or patent either is shown to be commonly owned with this application, or claims an invention made as a result of activities undertaken within the scope of a joint research agreement. A terminal disclaimer must be signed in compliance with 37 CFR 1.321(b).

The USPTO internet Web site contains terminal disclaimer forms which may be used. Please visit <http://www.uspto.gov/forms/>. The filing date of the application will determine what form should be used. A web-based eTerminal Disclaimer may be filled out completely online using web-screens. An eTerminal Disclaimer that meets all requirements is auto-processed and approved immediately upon submission. For more information about eTerminal Disclaimers, refer to <http://www.uspto.gov/patents/process/file/efs/guidance/eTD-info-I.jsp>.

Claims 1-14 are rejected on the ground of nonstatutory double patenting as being unpatentable over claims 1-70 of U.S. Patent No. 7,355,890. Although the claims at issue are not identical, they are not patentably distinct from each other because the elements of the application's claim 1 are found in the '890 patent's claims 1 and 4. Claim 8 of the application is found in claim 7 of the patent. Claim 6 of the application is found in claim 6 of the patent. Claim 7 of the application is found in claim 7 of the patent. Claim 12 of the application is found in claim 9 of the patent.

The following is a quotation of the appropriate paragraphs of pre-AIA 35 U.S.C. 102 that form the basis for the rejections under this section made in this Office action:

A person shall be entitled to a patent unless –

(e) the invention was described in (1) an application for patent, published under section 122(b), by another filed in the United States before the invention by the applicant for patent or (2) a patent granted on an application for patent by another filed in the United States before the invention by the applicant for patent, except that an international application filed under the treaty defined in section 351(a) shall have the effects for purposes of this subsection of an application filed in the United States only if the international application designated the United States and was published under Article 21(2) of such treaty in the English language.

Claims 1, 9, are rejected under pre-AIA 35 U.S.C. 102E as being anticipated by Enete et al ("Enete"), USPAP #2013/0066989.

Enete discloses in P.0065 that a sender 602a designates at least one recipient 602b to receive an instant message (IM). The IM may be a text IM or other non-video IM (e.g., voice message). In P.0050 Enete discloses that a subscriber can use the IM client application to view whether particular subscribers (buddies) are online and in P.0056 discloses the subscriber's buddy list.

Regarding claim 9, Enete discloses in P.0065 a screen name associated with the intended recipient 602b has been identified as a "buddy" of the sender 602a, and a UI (graphical user interface) that indicates the online status and capabilities of the recipient 602b is displayed to the sender 602a.

The following is a quotation of pre-AIA 35 U.S.C. 103(a) which forms the basis for all obviousness rejections set forth in this Office action:

(a) A patent may not be obtained though the invention is not identically disclosed or described as set forth in section 102 of this title, if the differences between the subject matter sought to be patented and the prior art are such that the subject matter as a whole would have been obvious at the time the invention was made to a person having ordinary skill in the art to which said subject matter pertains. Patentability shall not be negated by the manner in which the invention was made.

Claim 6 is rejected under pre-AIA 35 U.S.C. 103(a) as being unpatentable over Enete et al in view of Othmer et al, USPAP #2004/0064317.

Othmer discloses in P.0039 that audio file source messaging system may indicate where the audio file was transmitted from such as an instant voice messaging system, which means that the audio file was created from an IVM. To have provided Othmer's teaching of an audio file coming from an IVM in Enete's IVM system would

have been obvious to a person having ordinary skill in this art because both references are teaching IVM systems.

Claims 7, 11 are rejected under pre-AIA 35 U.S.C. 103(a) as being unpatentable over Enete et al in view of Narasimhan et al (“Narasimhan”), USPAP #2004/0225524.

Narasimhan discloses in P.0077 that additional types of information assets may include voice instant messages, and that information asset may be encapsulated through encryption. To have provided Narasimhan’s teaching of encrypting instant voice messages in Enete’s system of instant voice messages would have been obvious to a person having ordinary skill in the art.

Claim 10 is rejected under pre-AIA 35 U.S.C. 103(a) as being unpatentable over Enete et al in view of El-Fishaway et al (“EF”), U.S. Pat. #7133687

EF discloses in col. 3 , lines 34 et seq. that a recipient may initiate delivery of a reply to the received instant voice message in the audio format. By the recipient sending an audio reply to a sender’s IVM, the audio reply is an indication that the recipient received the sender’s IVM. To have provided EF’s teaching of an audio reply/effect that indicates receipt of a sender’s IVM in Enete’s IVM system would have been obvious to a person having ordinary skill in the art.

Any inquiry concerning this communication should be directed to CREIGHTON SMITH at telephone number (571)272-7546.

/CREIGHTON SMITH/

Primary Examiner, Art Unit 2656

15 OCT '14

Application/Control Number: 14/224,125
Art Unit: 2656

Page 6

Notice of References Cited	Application/Control No. 14/224,125	Applicant(s)/Patent Under Reexamination ROJAS, MICHAEL J.	
	Examiner CREIGHTON SMITH	Art Unit 2656	Page 1 of 1

U.S. PATENT DOCUMENTS

*	Document Number Country Code-Number-Kind Code	Date MM-YYYY	Name	Classification
*	A US-2013/0066989	03-2013	Enete et al.	709/206
*	B US-2004/0064317	04-2004	Othmer et al.	704/260
*	C US-2004/0225524	11-2004	Narasimhan et al.	705/001
*	D US-7,133,687	11-2006	El-Fishawy et al.	455/466
*	E US-2006/0094472	05-2006	Othmer et al.	455/563
	F US-			
	G US-			
	H US-			
	I US-			
	J US-			
	K US-			
	L US-			
	M US-			

FOREIGN PATENT DOCUMENTS

*	Document Number Country Code-Number-Kind Code	Date MM-YYYY	Country	Name	Classification
	N				
	O				
	P				
	Q				
	R				
	S				
	T				

NON-PATENT DOCUMENTS

*	Include as applicable: Author, Title Date, Publisher, Edition or Volume, Pertinent Pages)
U	
V	
W	
X	

*A copy of this reference is not being furnished with this Office action. (See MPEP § 707.05(a).)
Dates in MM-YYYY format are publication dates. Classifications may be US or foreign.

INFORMATION DISCLOSURE STATEMENT BY APPLICANT (Not for submission under 37 CFR 1.99)	Application Number		14224125	
	Filing Date		2014-03-25	
	First Named Inventor	Michael J. Rojas		
	Art Unit			
	Examiner Name			
	Attorney Docket Number		EMP0025-US	

U.S. PATENTS						Remove
Examiner Initial*	Cite No	Patent Number	Kind Code ¹	Issue Date	Name of Patentee or Applicant of cited Document	Pages, Columns, Lines where Relevant Passages or Relevant Figures Appear
	1	6763226	B1	2004-07-13	McZela, Jr.	Entire document
	2	7535890	B2	2009-05-19	Rojas	Entire document
	3	8199747	B2	2012-06-12	Rojas	Entire document
	4	8243723	B2	2012-08-14	Rojas	Entire document

If you wish to add additional U.S. Patent citation information please click the Add button. **Add**

U.S. PATENT APPLICATION PUBLICATIONS						Remove
Examiner Initial*	Cite No	Publication Number	Kind Code ¹	Publication Date	Name of Patentee or Applicant of cited Document	Pages, Columns, Lines where Relevant Passages or Relevant Figures Appear
	1	20040252679	A1	2004-12-16	Williams et al.	Entire document
	2	20040122906	A1	2004-06-24	Goodman et al.	Entire document

INFORMATION DISCLOSURE STATEMENT BY APPLICANT (Not for submission under 37 CFR 1.99)	Application Number		14224125	
	Filing Date		2014-03-25	
	First Named Inventor	Michael J. Rojas		
	Art Unit			
	Examiner Name			
	Attorney Docket Number		EMP0025-US	

	3	20050053230	A1	2005-03-10	Gierachf	Entire document
	4	20050105697	A1	2005-05-19	Hollowell et al.	Entire document
	5	20030087632	A1	2003-05-08	Sagi et al.	Entire document
	6	20060268750	A1	2006-11-30	Weiner	Entire document
	7	20040030046	A1	2004-02-12	Schultes et al.	Entire document
	8	20070112925	A1	2007-05-17	Malik	Entire document
	9	20070174403	A1	2007-07-26	Barry	Entire document
	10	20060167883	A1	2006-07-27	Boukobza	Entire document
	11	20040128356	A1	2004-07-01	Bernstein et al.	Entire document
	12	20030126207	A1	2003-07-03	Creamer et al.	Entire document
	13	20080298309	A1	2008-12-04	DePietro et al.	Entire document

INFORMATION DISCLOSURE STATEMENT BY APPLICANT (Not for submission under 37 CFR 1.99)	Application Number		14224125	
	Filing Date		2014-03-25	
	First Named Inventor	Michael J. Rojas		
	Art Unit			
	Examiner Name			
	Attorney Docket Number		EMP0025-US	

	14	20040224678	A1	2004-11-11	Dahod et al.	Entire document
	15	20040014456	A1	2004-01-22	Vaananen	Entire document
	16	20100070275	A1	2012-03-18	Cast	Entire document
	17	20040179092	A1	2004-09-16	LaPoint	Entire document
	18	20040085456	A1	2004-05-06	Kwag et al.	Entire document
	19	20040223599	A1	2004-11-11	Bear et al.	Entire document
	20	20050117591	A1	2005-06-02	Hurta et al.	Entire document
	21	20130279681	A1	2013-10-24	Weiner	Entire document
	22	20120275452	A1	2012-11-01	Rojas	Entire document

If you wish to add additional U.S. Published Application citation information please click the Add button. [Add](#)

FOREIGN PATENT DOCUMENTS								Remove
Examiner Initial*	Cite No	Foreign Document Number ³	Country Code ² j	Kind Code ⁴	Publication Date	Name of Patentee or Applicant of cited Document	Pages, Columns, Lines where Relevant Passages or Relevant Figures Appear	T ⁵

**INFORMATION DISCLOSURE
STATEMENT BY APPLICANT**
(Not for submission under 37 CFR 1.99)

Application Number	14224125
Filing Date	2014-03-25
First Named Inventor	Michael J. Rojas
Art Unit	
Examiner Name	
Attorney Docket Number	EMP0025-US

1								<input type="checkbox"/>
---	--	--	--	--	--	--	--	--------------------------

If you wish to add additional Foreign Patent Document citation information please click the Add button **Add**

NON-PATENT LITERATURE DOCUMENTS

Remove

Examiner Initials*	Cite No	Include name of the author (in CAPITAL LETTERS), title of the article (when appropriate), title of the item (book, magazine, journal, serial, symposium, catalog, etc), date, pages(s), volume-issue number(s), publisher, city and/or country where published.	T ⁵
	1	http://www.cisco.com/warp/public/cc/pd/nemnsw/callmn/prodlit/cm33_ds.htm; "Data Sheet Cisco CallManager Version 3.3".	<input checked="" type="checkbox"/>
	2	http://www.cisco.com/en/US/products/hw/switches/ps1925/products_data_sheet_09186_a00800a3c3d.html; "Data Sheet Cisco MGX 8000 Series".	<input checked="" type="checkbox"/>
	3	http://www.hsteliann.com/english/?zone=3100.V21P; "Telephone 3100.V21P"	<input checked="" type="checkbox"/>
	4	http://www.linuxdevices.com/articles/AT5100047510.html; "Device Profile: snom 100 VoIP phone"	<input checked="" type="checkbox"/>
	5	http://www.pingtel.com/pr_xpressca.jsp; "No limits with the advanced industry standard SIP phone"	<input checked="" type="checkbox"/>
	6	AudioCoded Enabling Technology Products TPM-1100 VoP Media Gateway Modules	<input checked="" type="checkbox"/>

If you wish to add additional non-patent literature document citation information please click the Add button **Add**

EXAMINER SIGNATURE

Examiner Signature	/Creighton Smith/	Date Considered	10/15/2014
--------------------	-------------------	-----------------	------------

*EXAMINER: Initial if reference considered, whether or not citation is in conformance with MPEP 609. Draw line through a citation if not in conformance and not considered. Include copy of this form with next communication to applicant.

INFORMATION DISCLOSURE STATEMENT BY APPLICANT (Not for submission under 37 CFR 1.99)	Application Number	14224125
	Filing Date	2014-03-25
	First Named Inventor	Michael J. Rojas
	Art Unit	
	Examiner Name	
	Attorney Docket Number	EMP0025-US

¹ See Kind Codes of USPTO Patent Documents at www.USPTO.GOV or MPEP 901.04. ² Enter office that issued the document, by the two-letter code (WIPO Standard ST.3). ³ For Japanese patent documents, the indication of the year of the reign of the Emperor must precede the serial number of the patent document. ⁴ Kind of document by the appropriate symbols as indicated on the document under WIPO Standard ST.16 if possible. ⁵ Applicant is to place a check mark here if English language translation is attached.

INFORMATION DISCLOSURE STATEMENT BY APPLICANT (Not for submission under 37 CFR 1.99)	Application Number	14224125
	Filing Date	2014-03-25
	First Named Inventor	Michael J. Rojas
	Art Unit	
	Examiner Name	
	Attorney Docket Number	EMP0025-US

CERTIFICATION STATEMENT

Please see 37 CFR 1.97 and 1.98 to make the appropriate selection(s):

That each item of information contained in the information disclosure statement was first cited in any communication from a foreign patent office in a counterpart foreign application not more than three months prior to the filing of the information disclosure statement. See 37 CFR 1.97(e)(1).

OR

That no item of information contained in the information disclosure statement was cited in a communication from a foreign patent office in a counterpart foreign application, and, to the knowledge of the person signing the certification after making reasonable inquiry, no item of information contained in the information disclosure statement was known to any individual designated in 37 CFR 1.56(c) more than three months prior to the filing of the information disclosure statement. See 37 CFR 1.97(e)(2).

See attached certification statement.

The fee set forth in 37 CFR 1.17 (p) has been submitted herewith.

A certification statement is not submitted herewith.

SIGNATURE

A signature of the applicant or representative is required in accordance with CFR 1.33, 10.18. Please see CFR 1.4(d) for the form of the signature.

Signature	/Kelly L. Kasha/	Date (YYYY-MM-DD)	2014-03-25
Name/Print	Kelly L. Kasha	Registration Number	47743

This collection of information is required by 37 CFR 1.97 and 1.98. The information is required to obtain or retain a benefit by the public which is to file (and by the USPTO to process) an application. Confidentiality is governed by 35 U.S.C. 122 and 37 CFR 1.14. This collection is estimated to take 1 hour to complete, including gathering, preparing and submitting the completed application form to the USPTO. Time will vary depending upon the individual case. Any comments on the amount of time you require to complete this form and/or suggestions for reducing this burden, should be sent to the Chief Information Officer, U.S. Patent and Trademark Office, U.S. Department of Commerce, P.O. Box 1450, Alexandria, VA 22313-1450. **DO NOT SEND FEES OR COMPLETED FORMS TO THIS ADDRESS. SEND TO: Commissioner for Patents, P.O. Box 1450, Alexandria, VA 22313-1450.**

Privacy Act Statement

The Privacy Act of 1974 (P.L. 93-579) requires that you be given certain information in connection with your submission of the attached form related to a patent application or patent. Accordingly, pursuant to the requirements of the Act, please be advised that: (1) the general authority for the collection of this information is 35 U.S.C. 2(b)(2); (2) furnishing of the information solicited is voluntary; and (3) the principal purpose for which the information is used by the U.S. Patent and Trademark Office is to process and/or examine your submission related to a patent application or patent. If you do not furnish the requested information, the U.S. Patent and Trademark Office may not be able to process and/or examine your submission, which may result in termination of proceedings or abandonment of the application or expiration of the patent.

The information provided by you in this form will be subject to the following routine uses:

1. The information on this form will be treated confidentially to the extent allowed under the Freedom of Information Act (5 U.S.C. 552) and the Privacy Act (5 U.S.C. 552a). Records from this system of records may be disclosed to the Department of Justice to determine whether the Freedom of Information Act requires disclosure of these records.
2. A record from this system of records may be disclosed, as a routine use, in the course of presenting evidence to a court, magistrate, or administrative tribunal, including disclosures to opposing counsel in the course of settlement negotiations.
3. A record in this system of records may be disclosed, as a routine use, to a Member of Congress submitting a request involving an individual, to whom the record pertains, when the individual has requested assistance from the Member with respect to the subject matter of the record.
4. A record in this system of records may be disclosed, as a routine use, to a contractor of the Agency having need for the information in order to perform a contract. Recipients of information shall be required to comply with the requirements of the Privacy Act of 1974, as amended, pursuant to 5 U.S.C. 552a(m).
5. A record related to an International Application filed under the Patent Cooperation Treaty in this system of records may be disclosed, as a routine use, to the International Bureau of the World Intellectual Property Organization, pursuant to the Patent Cooperation Treaty.
6. A record in this system of records may be disclosed, as a routine use, to another federal agency for purposes of National Security review (35 U.S.C. 181) and for review pursuant to the Atomic Energy Act (42 U.S.C. 218(c)).
7. A record from this system of records may be disclosed, as a routine use, to the Administrator, General Services, or his/her designee, during an inspection of records conducted by GSA as part of that agency's responsibility to recommend improvements in records management practices and programs, under authority of 44 U.S.C. 2904 and 2906. Such disclosure shall be made in accordance with the GSA regulations governing inspection of records for this purpose, and any other relevant (i.e., GSA or Commerce) directive. Such disclosure shall not be used to make determinations about individuals.
8. A record from this system of records may be disclosed, as a routine use, to the public after either publication of the application pursuant to 35 U.S.C. 122(b) or issuance of a patent pursuant to 35 U.S.C. 151. Further, a record may be disclosed, subject to the limitations of 37 CFR 1.14, as a routine use, to the public if the record was filed in an application which became abandoned or in which the proceedings were terminated and which application is referenced by either a published application, an application open to public inspections or an issued patent.
9. A record from this system of records may be disclosed, as a routine use, to a Federal, State, or local law enforcement agency, if the USPTO becomes aware of a violation or potential violation of law or regulation.

ALL REFERENCES CONSIDERED EXCEPT WHERE LINED THROUGH. /C.S./

EAST Search History

EAST Search History (Prior Art)

Ref #	Hits	Search Query	DBs	Default Operator	Plurals	Time Stamp
L1	17	((@ad<="20031218") or (@rlad<="20031218")) and ((instant near4 voice near4 messag\$3) or ivm) same (encrypt\$3 or decrypt\$3)	US-PGPUB; USPAT; EPO; DERWENT	OR	OFF	2014/10/15 15:05
L2	10	((@ad<="20031218") or (@rlad<="20031218")) and ((instant near4 voice near4 messag\$3) or ivm) same compress\$3 same decompress\$3	US-PGPUB; USPAT; EPO; DERWENT	OR	OFF	2014/10/15 15:14
L3	9	((@ad<="20031218") or (@rlad<="20031218")) and ((instant near4 voice near4 messag\$3) or ivm) same (display\$3 or show\$3) with (indicat\$3 or indicia or mark\$3) with recipient with (available or online)	US-PGPUB; USPAT; EPO; DERWENT	OR	OFF	2014/10/15 15:20
L4	26	((@ad<="20031218") or (@rlad<="20031218")) and ((instant near4 voice near4 messag\$3) or ivm) same (audio or visual) with (receipt or received or delivery or delivered)	US-PGPUB; USPAT; EPO; DERWENT	OR	OFF	2014/10/15 15:34
L5	10	((@ad<="20031218") or (@rlad<="20031218")) and ((instant near4 voice near4 messag\$3) or ivm) same (attach\$3 or add\$3 or coupl\$3 or fix\$3) with files	US-PGPUB; USPAT; EPO; DERWENT	OR	OFF	2014/10/15 15:59
S1	2	(("8243723") or ("7535890")).PN.	US-PGPUB; USPAT; USOCR; EPO	OR	OFF	2014/10/14 15:40
S2	3	(("8243723") or ("7535890") or ("8724622")).PN.	US-PGPUB; USPAT; USOCR; EPO	OR	OFF	2014/10/15 08:19
S3	16	((@ad<="20031218") or (@rlad<="20031218")) and ((instant near4 voice near4 messag\$3) or ivm) same (display\$3 or show\$3) with list with recipient\$1	US-PGPUB; USPAT; EPO; DERWENT	OR	OFF	2014/10/15 09:49
S4	82	((@ad<="20031218") or (@rlad<="20031218")) and ((instant near4 voice near4 messag\$3) or ivm) same (database or record) same identifi\$6	US-PGPUB; USPAT; EPO; DERWENT	OR	OFF	2014/10/15 12:22
S5	18	((@ad<="20031218") or (@rlad<="20031218")) and ((instant adj voice adj messag\$3) or ivm) same (database or record) same identifi\$6	US-PGPUB; USPAT; EPO;	OR	OFF	2014/10/15 12:23

EAST Search History

			DERWENT			
S6	21	((@ad<="20031218") or (@rlad<="20031218")) and ((instant near4 voice near4 messag\$3) or ivm) same (database or record or manag\$3) same (stor\$3 or delet\$3 or retriev\$3) same request\$3	US- PGPUB; USPAT; EPO; DERWENT	OR	OFF	2014/10/15: 12:36
S7	18	((@ad<="20031218") or (@rlad<="20031218")) and ((instant near4 voice near4 messag\$3) or ivm) same audio near4 file same creat\$3	US- PGPUB; USPAT; EPO; DERWENT	OR	OFF	2014/10/15: 12:47
S8	28	((@ad<="20031218") or (@rlad<="20031218")) and ((instant near4 voice near4 messag\$3) or ivm) same audio near4 file	US- PGPUB; USPAT; EPO; DERWENT	OR	OFF	2014/10/15: 12:48

EAST Search History (Interference)

<This search history is empty>

10/ 15/ 2014 4:20:24 PM

C:\ Users\ csmith1\ Documents\ EAST\ Workspaces\ 13648888.wsp

UNITED STATES PATENT AND TRADEMARK OFFICE

UNITED STATES DEPARTMENT OF COMMERCE
United States Patent and Trademark Office
 Address: COMMISSIONER FOR PATENTS
 P.O. Box 1450
 Alexandria, Virginia 22313-1450
 www.uspto.gov

BIB DATA SHEET
CONFIRMATION NO. 5407

SERIAL NUMBER	FILING or 371(c) DATE RULE	CLASS	GROUP ART UNIT	ATTORNEY DOCKET NO. EMP0025-US		
14/224,125	03/25/2014	370	2656			
APPLICANTS Empire IP LLC, New York, NY, Assignee (with 37 CFR 1.172 Interest); INVENTORS Michael J. Rojas, North Canton, OH; ** CONTINUING DATA ***** This application is a CON of 13/546,673 07/11/2012 PAT 8724622 which is a CON of 12/398,063 03/04/2009 PAT 8243723 which is a CON of 10/740,030 12/18/2003 PAT 7535890 ** FOREIGN APPLICATIONS ***** ** IF REQUIRED, FOREIGN FILING LICENSE GRANTED *** SMALL ENTITY ** 04/15/2014						
Foreign Priority claimed <input type="checkbox"/> Yes <input checked="" type="checkbox"/> No 35 USC 119(a-d) conditions met <input type="checkbox"/> Yes <input checked="" type="checkbox"/> No Verified and /CREIGHTON H SMITH/ Acknowledged Examiner's Signature		<input type="checkbox"/> Met after Allowance Initials	STATE OR COUNTRY OH	SHEETS DRAWINGS 9	TOTAL CLAIMS 14	INDEPENDENT CLAIMS 3
ADDRESS KASHA LAW LLC 14532 Dufief Mill Road North Potomac, MD 20878 UNITED STATES						
TITLE System and Method for Instant VoIP Messaging						
FILING FEE RECEIVED 730	FEES: Authority has been given in Paper No. _____ to charge/credit DEPOSIT ACCOUNT No. _____ for following:		<input type="checkbox"/> All Fees <input type="checkbox"/> 1.16 Fees (Filing) <input type="checkbox"/> 1.17 Fees (Processing Ext. of time) <input type="checkbox"/> 1.18 Fees (Issue) <input type="checkbox"/> Other _____ <input type="checkbox"/> Credit			

<i>Index of Claims</i> 	Application/Control No. 14224125	Applicant(s)/Patent Under Reexamination ROJAS, MICHAEL J.
	Examiner CREIGHTON SMITH	Art Unit 2656

✓	Rejected	-	Cancelled	N	Non-Elected	A	Appeal
=	Allowed	÷	Restricted	I	Interference	O	Objected

Claims renumbered in the same order as presented by applicant
 CPA
 T.D.
 R.1.47

CLAIM		DATE								
Final	Original	10/15/2014								
	1	✓								
	2	✓								
	3	✓								
	4	✓								
	5	✓								
	6	✓								
	7	✓								
	8	✓								
	9	✓								
	10	✓								
	11	✓								
	12	✓								
	13	✓								
	14	✓								

<i>Search Notes</i> 	Application/Control No. 14224125	Applicant(s)/Patent Under Reexamination ROJAS, MICHAEL J.
	Examiner CREIGHTON SMITH	Art Unit 2656

CPC- SEARCHED		
Symbol	Date	Examiner

CPC COMBINATION SETS - SEARCHED		
Symbol	Date	Examiner

US CLASSIFICATION SEARCHED			
Class	Subclass	Date	Examiner

SEARCH NOTES		
Search Notes	Date	Examiner
EAST	15.10.14	chs

INTERFERENCE SEARCH			
US Class/ CPC Symbol	US Subclass / CPC Group	Date	Examiner

--	--



UNITED STATES PATENT AND TRADEMARK OFFICE

UNITED STATES DEPARTMENT OF COMMERCE
United States Patent and Trademark Office
Address: COMMISSIONER FOR PATENTS
P.O. Box 1450
Alexandria, Virginia 22313-1450
www.uspto.gov

Table with 4 columns: APPLICATION NUMBER (14/224,125), FILING OR 371(C) DATE (03/25/2014), FIRST NAMED APPLICANT (Michael J. Rojas), ATTY. DOCKET NO./TITLE (EMP0025-US)

CONFIRMATION NO. 5407

67050
KASHA LAW LLC
14532 Dufief Mill Road
North Potomac, MD 20878

PUBLICATION NOTICE



Title: System and Method for Instant VoIP Messaging

Publication No. US-2014-0204935-A1

Publication Date: 07/24/2014

NOTICE OF PUBLICATION OF APPLICATION

The above-identified application will be electronically published as a patent application publication pursuant to 37 CFR 1.211, et seq. The patent application publication number and publication date are set forth above.

The publication may be accessed through the USPTO's publically available Searchable Databases via the Internet at www.uspto.gov. The direct link to access the publication is currently http://www.uspto.gov/patft/.

The publication process established by the Office does not provide for mailing a copy of the publication to applicant. A copy of the publication may be obtained from the Office upon payment of the appropriate fee set forth in 37 CFR 1.19(a)(1). Orders for copies of patent application publications are handled by the USPTO's Office of Public Records. The Office of Public Records can be reached by telephone at (703) 308-9726 or (800) 972-6382, by facsimile at (703) 305-8759, by mail addressed to the United States Patent and Trademark Office, Office of Public Records, Alexandria, VA 22313-1450 or via the Internet.

In addition, information on the status of the application, including the mailing date of Office actions and the dates of receipt of correspondence filed in the Office, may also be accessed via the Internet through the Patent Electronic Business Center at www.uspto.gov using the public side of the Patent Application Information and Retrieval (PAIR) system. The direct link to access this status information is currently http://pair.uspto.gov/. Prior to publication, such status information is confidential and may only be obtained by applicant using the private side of PAIR.

Further assistance in electronically accessing the publication, or about PAIR, is available by calling the Patent Electronic Business Center at 1-866-217-9197.

Office of Data Management, Application Assistance Unit (571) 272-4000, or (571) 272-4200, or 1-888-786-0101

PATENT APPLICATION FEE DETERMINATION RECORD

Substitute for Form PTO-875

Application or Docket Number
14/224,125

APPLICATION AS FILED - PART I

		(Column 1)	(Column 2)	SMALL ENTITY		OR	OTHER THAN SMALL ENTITY	
FOR		NUMBER FILED	NUMBER EXTRA	RATE(\$)	FEE(\$)		RATE(\$)	FEE(\$)
BASIC FEE (37 CFR 1.16(a), (b), or (c))		N/A	N/A	N/A	70		N/A	
SEARCH FEE (37 CFR 1.16(k), (j), or (m))		N/A	N/A	N/A	300		N/A	
EXAMINATION FEE (37 CFR 1.16(o), (p), or (q))		N/A	N/A	N/A	360		N/A	
TOTAL CLAIMS (37 CFR 1.16(i))		14	minus 20 = *	x 40 =	0.00	OR		
INDEPENDENT CLAIMS (37 CFR 1.16(h))		3	minus 3 = *	x 210 =	0.00			
APPLICATION SIZE FEE (37 CFR 1.16(s))	If the specification and drawings exceed 100 sheets of paper, the application size fee due is \$310 (\$155 for small entity) for each additional 50 sheets or fraction thereof. See 35 U.S.C. 41(a)(1)(G) and 37 CFR 1.16(s).				0.00			
MULTIPLE DEPENDENT CLAIM PRESENT (37 CFR 1.16(j))					0.00			
				TOTAL	730		TOTAL	

* If the difference in column 1 is less than zero, enter "0" in column 2.

APPLICATION AS AMENDED - PART II

		(Column 1)	(Column 2)	(Column 3)	SMALL ENTITY		OR	OTHER THAN SMALL ENTITY		
AMENDMENT A		CLAIMS REMAINING AFTER AMENDMENT	HIGHEST NUMBER PREVIOUSLY PAID FOR	PRESENT EXTRA	RATE(\$)	ADDITIONAL FEE(\$)		RATE(\$)	ADDITIONAL FEE(\$)	
	Total (37 CFR 1.16(i))	*	Minus	**	=	x	=	OR	x	=
	Independent (37 CFR 1.16(h))	*	Minus	***	=	x	=	OR	x	=
	Application Size Fee (37 CFR 1.16(s))							OR		
	FIRST PRESENTATION OF MULTIPLE DEPENDENT CLAIM (37 CFR 1.16(j))							OR		
				TOTAL ADD'L FEE			OR	TOTAL ADD'L FEE		

		(Column 1)	(Column 2)	(Column 3)	SMALL ENTITY		OR	OTHER THAN SMALL ENTITY		
AMENDMENT B		CLAIMS REMAINING AFTER AMENDMENT	HIGHEST NUMBER PREVIOUSLY PAID FOR	PRESENT EXTRA	RATE(\$)	ADDITIONAL FEE(\$)		RATE(\$)	ADDITIONAL FEE(\$)	
	Total (37 CFR 1.16(i))	*	Minus	**	=	x	=	OR	x	=
	Independent (37 CFR 1.16(h))	*	Minus	***	=	x	=	OR	x	=
	Application Size Fee (37 CFR 1.16(s))							OR		
	FIRST PRESENTATION OF MULTIPLE DEPENDENT CLAIM (37 CFR 1.16(j))							OR		
				TOTAL ADD'L FEE			OR	TOTAL ADD'L FEE		

* If the entry in column 1 is less than the entry in column 2, write "0" in column 3.

** If the "Highest Number Previously Paid For" IN THIS SPACE is less than 20, enter "20".

*** If the "Highest Number Previously Paid For" IN THIS SPACE is less than 3, enter "3".

The "Highest Number Previously Paid For" (Total or Independent) is the highest found in the appropriate box in column 1.



UNITED STATES PATENT AND TRADEMARK OFFICE

UNITED STATES DEPARTMENT OF COMMERCE
United States Patent and Trademark Office
Address: COMMISSIONER FOR PATENTS
P.O. Box 1450
Alexandria, Virginia 22313-1450
www.uspto.gov

Table with 7 columns: APPLICATION NUMBER, FILING or 371(c) DATE, GRP ART UNIT, FIL FEE REC'D, ATTY DOCKET NO, TOT CLAIMS, IND CLAIMS. Row 1: 14/224,125, 03/25/2014, 2414, 730, EMP0025-US, 14, 3

CONFIRMATION NO. 5407

FILING RECEIPT

67050
KASHA LAW LLC
14532 Dufief Mill Road
North Potomac, MD 20878



Date Mailed: 04/17/2014

Receipt is acknowledged of this non-provisional patent application. The application will be taken up for examination in due course. Applicant will be notified as to the results of the examination. Any correspondence concerning the application must include the following identification information: the U.S. APPLICATION NUMBER, FILING DATE, NAME OF APPLICANT, and TITLE OF INVENTION. Fees transmitted by check or draft are subject to collection. Please verify the accuracy of the data presented on this receipt. If an error is noted on this Filing Receipt, please submit a written request for a Filing Receipt Correction. Please provide a copy of this Filing Receipt with the changes noted thereon. If you received a "Notice to File Missing Parts" for this application, please submit any corrections to this Filing Receipt with your reply to the Notice. When the USPTO processes the reply to the Notice, the USPTO will generate another Filing Receipt incorporating the requested corrections

Inventor(s)

Michael J. Rojas, North Canton, OH;

Applicant(s)

Empire IP LLC, New York, NY

Assignment For Published Patent Application

EMPIRE IP LLC, New York, NY

Power of Attorney: The patent practitioners associated with Customer Number 67050

Domestic Priority data as claimed by applicant

This application is a CON of 13/546,673 07/11/2012
which is a CON of 12/398,063 03/04/2009 PAT 8243723
which is a CON of 10/740,030 12/18/2003 PAT 7535890

Foreign Applications for which priority is claimed (You may be eligible to benefit from the Patent Prosecution Highway program at the USPTO. Please see http://www.uspto.gov for more information.) - None.

Foreign application information must be provided in an Application Data Sheet in order to constitute a claim to foreign priority. See 37 CFR 1.55 and 1.76.

If Required, Foreign Filing License Granted: 04/15/2014

The country code and number of your priority application, to be used for filing abroad under the Paris Convention, is US 14/224,125

Projected Publication Date: 07/24/2014

Non-Publication Request: No

Early Publication Request: No

** SMALL ENTITY **

Title

System and Method for Instant VoIP Messaging

Preliminary Class

370

Statement under 37 CFR 1.55 or 1.78 for AIA (First Inventor to File) Transition Applications: No

PROTECTING YOUR INVENTION OUTSIDE THE UNITED STATES

Since the rights granted by a U.S. patent extend only throughout the territory of the United States and have no effect in a foreign country, an inventor who wishes patent protection in another country must apply for a patent in a specific country or in regional patent offices. Applicants may wish to consider the filing of an international application under the Patent Cooperation Treaty (PCT). An international (PCT) application generally has the same effect as a regular national patent application in each PCT-member country. The PCT process **simplifies** the filing of patent applications on the same invention in member countries, but **does not result** in a grant of "an international patent" and does not eliminate the need of applicants to file additional documents and fees in countries where patent protection is desired.

Almost every country has its own patent law, and a person desiring a patent in a particular country must make an application for patent in that country in accordance with its particular laws. Since the laws of many countries differ in various respects from the patent law of the United States, applicants are advised to seek guidance from specific foreign countries to ensure that patent rights are not lost prematurely.

Applicants also are advised that in the case of inventions made in the United States, the Director of the USPTO must issue a license before applicants can apply for a patent in a foreign country. The filing of a U.S. patent application serves as a request for a foreign filing license. The application's filing receipt contains further information and guidance as to the status of applicant's license for foreign filing.

Applicants may wish to consult the USPTO booklet, "General Information Concerning Patents" (specifically, the section entitled "Treaties and Foreign Patents") for more information on timeframes and deadlines for filing foreign patent applications. The guide is available either by contacting the USPTO Contact Center at 800-786-9199, or it can be viewed on the USPTO website at <http://www.uspto.gov/web/offices/pac/doc/general/index.html>.

For information on preventing theft of your intellectual property (patents, trademarks and copyrights), you may wish to consult the U.S. Government website, <http://www.stopfakes.gov>. Part of a Department of Commerce initiative, this website includes self-help "toolkits" giving innovators guidance on how to protect intellectual property in specific countries such as China, Korea and Mexico. For questions regarding patent enforcement issues, applicants may call the U.S. Government hotline at 1-866-999-HALT (1-866-999-4258).

LICENSE FOR FOREIGN FILING UNDER
Title 35, United States Code, Section 184
Title 37, Code of Federal Regulations, 5.11 & 5.15

GRANTED

The applicant has been granted a license under 35 U.S.C. 184, if the phrase "IF REQUIRED, FOREIGN FILING LICENSE GRANTED" followed by a date appears on this form. Such licenses are issued in all applications where the conditions for issuance of a license have been met, regardless of whether or not a license may be required as set forth in 37 CFR 5.15. The scope and limitations of this license are set forth in 37 CFR 5.15(a) unless an earlier license has been issued under 37 CFR 5.15(b). The license is subject to revocation upon written notification. The date indicated is the effective date of the license, unless an earlier license of similar scope has been granted under 37 CFR 5.13 or 5.14.

This license is to be retained by the licensee and may be used at any time on or after the effective date thereof unless it is revoked. This license is automatically transferred to any related applications(s) filed under 37 CFR 1.53(d). This license is not retroactive.

The grant of a license does not in any way lessen the responsibility of a licensee for the security of the subject matter as imposed by any Government contract or the provisions of existing laws relating to espionage and the national security or the export of technical data. Licensees should apprise themselves of current regulations especially with respect to certain countries, of other agencies, particularly the Office of Defense Trade Controls, Department of State (with respect to Arms, Munitions and Implements of War (22 CFR 121-128)); the Bureau of Industry and Security, Department of Commerce (15 CFR parts 730-774); the Office of Foreign Assets Control, Department of Treasury (31 CFR Parts 500+) and the Department of Energy.

NOT GRANTED

No license under 35 U.S.C. 184 has been granted at this time, if the phrase "IF REQUIRED, FOREIGN FILING LICENSE GRANTED" DOES NOT appear on this form. Applicant may still petition for a license under 37 CFR 5.12, if a license is desired before the expiration of 6 months from the filing date of the application. If 6 months has lapsed from the filing date of this application and the licensee has not received any indication of a secrecy order under 35 U.S.C. 181, the licensee may foreign file the application pursuant to 37 CFR 5.15(b).

SelectUSA

The United States represents the largest, most dynamic marketplace in the world and is an unparalleled location for business investment, innovation, and commercialization of new technologies. The U.S. offers tremendous resources and advantages for those who invest and manufacture goods here. Through SelectUSA, our nation works to promote and facilitate business investment. SelectUSA provides information assistance to the international investor community; serves as an ombudsman for existing and potential investors; advocates on behalf of U.S. cities, states, and regions competing for global investment; and counsels U.S. economic development organizations on investment attraction best practices. To learn more about why the United States is the best country in the world to develop technology, manufacture products, deliver services, and grow your business, visit <http://www.SelectUSA.gov> or call +1-202-482-6800.

Under the Paperwork Reduction Act of 1995, no persons are required to respond to a collection of information unless it displays a valid OMB control number.

TRANSMITTAL FOR POWER OF ATTORNEY TO ONE OR MORE REGISTERED PRACTITIONERS

NOTE: This form is to be submitted with the Power of Attorney by Applicant form (PTO/AIA/82B) to identify the application to which the Power of Attorney is directed, in accordance with 37 CFR 1.5, unless the application number and filing date are identified in the Power of Attorney by Applicant form. If neither form PTO/AIA/82A nor form PTO/AIA/82B identifies the application to which the Power of Attorney is directed, the Power of Attorney will not be recognized in the application.

Application Number			
Filing Date			
First Named Inventor	ROJAS, Michael J.		
Title	System and Method for Instant VoIP Messaging		
Art Unit			
Examiner Name			
Attorney Docket Number	EMP0025-US		
SIGNATURE of Applicant or Patent Practitioner			
Signature	/Kelly L. Kasha/	Date (Optional)	
Name	Kelly L. Kasha	Registration Number	47743
Title (if Applicant is a juristic entity)			
Applicant Name (if Applicant is a juristic entity)			
<p>NOTE: This form must be signed in accordance with 37 CFR 1.33. See 37 CFR 1.4(d) for signature requirements and certifications. If more than one applicant, use multiple forms.</p>			
<input checked="" type="checkbox"/> Total of <u>1</u> forms are submitted.			

This collection of information is required by 37 CFR 1.131, 1.32, and 1.33. The information is required to obtain or retain a benefit by the public which is to file (and by the USPTO to process) an application. Confidentiality is governed by 35 U.S.C. 122 and 37 CFR 1.11 and 1.14. This collection is estimated to take 3 minutes to complete, including gathering, preparing, and submitting the completed application form to the USPTO. Time will vary depending upon the individual case. Any comments on the amount of time you require to complete this form and/or suggestions for reducing this burden, should be sent to the Chief Information Officer, U.S. Patent and Trademark Office, U.S. Department of Commerce, P.O. Box 1450, Alexandria, VA 22313-1450. DO NOT SEND FEES OR COMPLETED FORMS TO THIS ADDRESS. SEND TO: Commissioner for Patents, P.O. Box 1450, Alexandria, VA 22313-1450.

If you need assistance in completing the form, call 1-800-PTO-9199 and select option 2.

Under the Paperwork Reduction Act of 1995, no persons are required to respond to a collection of information unless it displays a valid OMB control number.

POWER OF ATTORNEY BY APPLICANT

I hereby revoke all previous powers of attorney given in the application identified in either the attached transmittal letter or the boxes below.

Application Number	Filing Date

(Note: The boxes above may be left blank if information is provided on form PTO/AIA/82A.)

- I hereby appoint the Patent Practitioner(s) associated with the following Customer Number as my/our attorney(s) or agent(s), and to transact all business in the United States Patent and Trademark Office connected therewith for the application referenced in the attached transmittal letter (form PTO/AIA/82A) or identified above: 67050
- OR
- I hereby appoint Practitioner(s) named in the attached list (form PTO/AIA/82C) as my/our attorney(s) or agent(s), and to transact all business in the United States Patent and Trademark Office connected therewith for the patent application referenced in the attached transmittal letter (form PTO/AIA/82A) or identified above. (Note: Complete form PTO/AIA/82C.)

Please recognize or change the correspondence address for the application identified in the attached transmittal letter or the boxes above to:

- The address associated with the above-mentioned Customer Number
- OR
- The address associated with Customer Number:
- OR

Firm or Individual Name			
Address			
City	State	Zip	
Country			
Telephone		Email	

I am the Applicant (if the Applicant is a juristic entity, list the Applicant name in the box):

- Inventor or Joint Inventor (title not required below)
- Legal Representative of a Deceased or Legally Incapacitated Inventor (title not required below)
- Assignee or Person to Whom the Inventor is Under an Obligation to Assign (provide signer's title if applicant is a juristic entity)
- Person Who Otherwise Shows Sufficient Proprietary Interest (e.g., a petition under 37 CFR 1.46(b)(2) was granted in the application or is concurrently being filed with this document) (provide signer's title if applicant is a juristic entity)

SIGNATURE of Applicant for Patent

The undersigned (whose title is supplied below) is authorized to act on behalf of the applicant (e.g., where the applicant is a juristic entity).

Signature	Date (Optional)
Name	Denisl Mlby
Title	Authorized Representative, Empire IP LLC

NOTE: Signature - This form must be signed by the applicant in accordance with 37 CFR 1.33. See 37 CFR 1.4 for signature requirements and certifications. If more than one applicant, use multiple forms.

Total of 1 forms are submitted

This collection of information is required by 37 CFR 1.131, 1.32, and 1.33. The information is required to obtain or retain a benefit by the public which is to file (and by the USPTO to process) an application. Confidentiality is governed by 35 U.S.C. 122 and 37 CFR 1.11 and 1.14. This collection is estimated to take 3 minutes to complete, including gathering, preparing, and submitting the completed application form to the USPTO. Time will vary depending upon the individual case. Any comments on the amount of time you require to complete this form and/or suggestions for reducing this burden, should be sent to the Chief Information Officer, U.S. Patent and Trademark Office, U.S. Department of Commerce, P.O. Box 1480, Alexandria, VA 22313-1480. DO NOT SEND FEES OR COMPLETED FORMS TO THIS ADDRESS. SEND TO: Commissioner for Patents, P.O. Box 1480, Alexandria, VA 22313-1480.

If you need assistance in completing the form, call 1-800-PTO-0199 and select option 2.

Under the Paperwork Reduction Act of 1995, no persons are required to respond to a collection of information unless it contains a valid OMB control number.

Application Data Sheet 37 CFR 1.76		Attorney Docket Number	EMP0025-US
		Application Number	
Title of Invention	System and Method for Instant VoIP Messaging		
<p>The application data sheet is part of the provisional or nonprovisional application for which it is being submitted. The following form contains the bibliographic data arranged in a format specified by the United States Patent and Trademark Office as outlined in 37 CFR 1.76. This document may be completed electronically and submitted to the Office in electronic format using the Electronic Filing System (EFS) or the document may be printed and included in a paper filed application.</p>			

Secrecy Order 37 CFR 5.2

<input type="checkbox"/>	Portions or all of the application associated with this Application Data Sheet may fall under a Secrecy Order pursuant to 37 CFR 5.2. (Paper filers only. Applications that fall under Secrecy Order may not be filed electronically.)
--------------------------	--

Inventor Information:

Inventor 1					Remove	
Legal Name						
Prefix	Given Name	Middle Name	Family Name	Suffix		
	Michael	J.	Rojas			
Residence Information (Select One) <input checked="" type="radio"/> US Residency <input type="radio"/> Non US Residency <input type="radio"/> Active US Military Service						
City	North Canton, Stark County	State/Province	OH	Country of Residence i	US	
Mailing Address of Inventor:						
Address 1	2828 Barclay Circle					
Address 2						
City	North Canton, Stark County	State/Province	OH			
Postal Code	44720	Country i	US			
All Inventors Must Be Listed - Additional Inventor Information blocks may be generated within this form by selecting the Add button.						Add

Correspondence Information:

Enter either Customer Number or complete the Correspondence Information section below. For further information see 37 CFR 1.33(a).			
<input type="checkbox"/> An Address is being provided for the correspondence information of this application.			
Customer Number	67050		
Email Address	john.kasha@kashalaw.com	Add Email	Remove Email

Application Information:

Title of the Invention	System and Method for Instant VoIP Messaging		
Attorney Docket Number	EMP0025-US	Small Entity Status Claimed	<input checked="" type="checkbox"/>
Application Type	Nonprovisional		
Subject Matter	Utility		
Total Number of Drawing Sheets (if any)	9	Suggested Figure for Publication (if any)	2

Filing By Reference :

Under the Paperwork Reduction Act of 1995, no persons are required to respond to a collection of information unless it contains a valid OMB control number.

Application Data Sheet 37 CFR 1.76		Attorney Docket Number	EMP0025-US
		Application Number	
Title of Invention	System and Method for Instant VoIP Messaging		

Only complete this section when filing an application by reference under 35 U.S.C. 111(c) and 37 CFR 1.57(a). Do not complete this section if application papers including a specification and any drawings are being filed. Any domestic benefit or foreign priority information must be provided in the appropriate section(s) below (i.e., "Domestic Benefit/National Stage Information" and "Foreign Priority Information").

For the purposes of a filing date under 37 CFR 1.53(b), the description and any drawings of the present application are replaced by this reference to the previously filed application, subject to conditions and requirements of 37 CFR 1.57(a).

Application number of the previously filed application	Filing date (YYYY-MM-DD)	Intellectual Property Authority or Country

Publication Information:

Request Early Publication (Fee required at time of Request 37 CFR 1.219)

Request Not to Publish. I hereby request that the attached application not be published under 35 U.S.C. 122(b) and certify that the invention disclosed in the attached application **has not and will not** be the subject of an application filed in another country, or under a multilateral international agreement, that requires publication at eighteen months after filing.

Representative Information:

Representative information should be provided for all practitioners having a power of attorney in the application. Providing this information in the Application Data Sheet does not constitute a power of attorney in the application (see 37 CFR 1.32). Either enter Customer Number or complete the Representative Name section below. If both sections are completed the customer Number will be used for the Representative Information during processing.

Please Select One:	<input checked="" type="radio"/> Customer Number	<input type="radio"/> US Patent Practitioner	<input type="radio"/> Limited Recognition (37 CFR 11.9)
Customer Number	67050		

Domestic Benefit/National Stage Information:

This section allows for the applicant to either claim benefit under 35 U.S.C. 119(e), 120, 121, or 365(c) or indicate National Stage entry from a PCT application. Providing this information in the application data sheet constitutes the specific reference required by 35 U.S.C. 119(e) or 120, and 37 CFR 1.78.

When referring to the current application, please leave the application number blank.

Prior Application Status	Pending		Remove		
Application Number	Continuity Type	Prior Application Number	Filing Date (YYYY-MM-DD)		
Unassigned	Continuation of	13546673	2012-07-11		
Prior Application Status	Patented		Remove		
Application Number	Continuity Type	Prior Application Number	Filing Date (YYYY-MM-DD)	Patent Number	Issue Date (YYYY-MM-DD)
13546673	Continuation of	12398063	2009-03-04	8243723	2012-08-14
Prior Application Status	Patented		Remove		

Under the Paperwork Reduction Act of 1995, no persons are required to respond to a collection of information unless it contains a valid OMB control number.

Application Data Sheet 37 CFR 1.76		Attorney Docket Number	EMP0025-US		
		Application Number			
Title of Invention	System and Method for Instant VoIP Messaging				
Application Number	Continuity Type	Prior Application Number	Filing Date (YYYY-MM-DD)	Patent Number	Issue Date (YYYY-MM-DD)
12398063	Continuation of	10740030	2003-12-18	7535890	2009-05-19
Additional Domestic Benefit/National Stage Data may be generated within this form by selecting the Add button.					<input type="button" value="Add"/>

Foreign Priority Information:

This section allows for the applicant to claim priority to a foreign application. Providing this information in the application data sheet constitutes the claim for priority as required by 35 U.S.C. 119(b) and 37 CFR 1.55(d). When priority is claimed to a foreign application that is eligible for retrieval under the priority document exchange program (PDX) the information will be used by the Office to automatically attempt retrieval pursuant to 37 CFR 1.55(h)(1) and (2). Under the PDX program, applicant bears the ultimate responsibility for ensuring that a copy of the foreign application is received by the Office from the participating foreign intellectual property office, or a certified copy of the foreign priority application is filed, within the time period specified in 37 CFR 1.55(g)(1).

Application Number	Country ⁱ	Filing Date (YYYY-MM-DD)	Access Code ⁱ (if applicable)

Additional Foreign Priority Data may be generated within this form by selecting the **Add** button.

Statement under 37 CFR 1.55 or 1.78 for AIA (First Inventor to File) Transition Applications

This application (1) claims priority to or the benefit of an application filed before March 16, 2013 and (2) also contains, or contained at any time, a claim to a claimed invention that has an effective filing date on or after March 16, 2013.

NOTE: By providing this statement under 37 CFR 1.55 or 1.78, this application, with a filing date on or after March 16, 2013, will be examined under the first inventor to file provisions of the AIA.

Authorization to Permit Access:

Authorization to Permit Access to the Instant Application by the Participating Offices

Under the Paperwork Reduction Act of 1995, no persons are required to respond to a collection of information unless it contains a valid OMB control number.

Application Data Sheet 37 CFR 1.76		Attorney Docket Number	EMP0025-US
		Application Number	
Title of Invention	System and Method for Instant VoIP Messaging		

If checked, the undersigned hereby grants the USPTO authority to provide the European Patent Office (EPO), the Japan Patent Office (JPO), the Korean Intellectual Property Office (KIPO), the World Intellectual Property Office (WIPO), and any other intellectual property offices in which a foreign application claiming priority to the instant patent application is filed access to the instant patent application. See 37 CFR 1.14(c) and (h). This box should not be checked if the applicant does not wish the EPO, JPO, KIPO, WIPO, or other intellectual property office in which a foreign application claiming priority to the instant patent application is filed to have access to the instant patent application.

In accordance with 37 CFR 1.14(h)(3), access will be provided to a copy of the instant patent application with respect to: 1) the instant patent application-as-filed; 2) any foreign application to which the instant patent application claims priority under 35 U.S.C. 119(a)-(d) if a copy of the foreign application that satisfies the certified copy requirement of 37 CFR 1.55 has been filed in the instant patent application; and 3) any U.S. application-as-filed from which benefit is sought in the instant patent application.

In accordance with 37 CFR 1.14(c), access may be provided to information concerning the date of filing this Authorization.

Applicant Information:

Providing assignment information in this section does not substitute for compliance with any requirement of part 3 of Title 37 of CFR to have an assignment recorded by the Office.

Applicant 1

If the applicant is the inventor (or the remaining joint inventor or inventors under 37 CFR 1.45), this section should not be completed. The information to be provided in this section is the name and address of the legal representative who is the applicant under 37 CFR 1.43; or the name and address of the assignee, person to whom the inventor is under an obligation to assign the invention, or person who otherwise shows sufficient proprietary interest in the matter who is the applicant under 37 CFR 1.46. If the applicant is an applicant under 37 CFR 1.46 (assignee, person to whom the inventor is obligated to assign, or person who otherwise shows sufficient proprietary interest) together with one or more joint inventors, then the joint inventor or inventors who are also the applicant should be identified in this section.

- Assignee
 Legal Representative under 35 U.S.C. 117
 Joint Inventor
- Person to whom the inventor is obligated to assign.
 Person who shows sufficient proprietary interest

If applicant is the legal representative, indicate the authority to file the patent application, the inventor is:

Name of the Deceased or Legally Incapacitated Inventor :

If the Applicant is an Organization check here.

Organization Name

Mailing Address Information:

Address 1	212 East 47th St., STE. 24J		
Address 2			
City	New York	State/Province	NY
Country ⁱ	US	Postal Code	10017
Phone Number		Fax Number	

Under the Paperwork Reduction Act of 1995, no persons are required to respond to a collection of information unless it contains a valid OMB control number.

Application Data Sheet 37 CFR 1.76		Attorney Docket Number	EMP0025-US
		Application Number	
Title of Invention	System and Method for Instant VoIP Messaging		
Email Address	John.Kasha@kashalaw.com		
Additional Applicant Data may be generated within this form by selecting the Add button.			<input type="button" value="Add"/>

Assignee Information including Non-Applicant Assignee Information:

Providing assignment information in this section does not substitute for compliance with any requirement of part 3 of Title 37 of CFR to have an assignment recorded by the Office.			
Assignee 1			
Complete this section if assignee information, including non-applicant assignee information, is desired to be included on the patent application publication. An assignee-applicant identified in the "Applicant Information" section will appear on the patent application publication as an applicant. For an assignee-applicant, complete this section only if identification as an assignee is also desired on the patent application publication.			
			<input type="button" value="Remove"/>
If the Assignee or Non-Applicant Assignee is an Organization check here.			<input checked="" type="checkbox"/>
Organization Name	Empire IP LLC		
Mailing Address Information For Assignee including Non-Applicant Assignee:			
Address 1	212 East 47th St., STE. 24J		
Address 2			
City	New York	State/Province	NY
Country i	US	Postal Code	10017
Phone Number		Fax Number	
Email Address			
Additional Assignee or Non-Applicant Assignee Data may be generated within this form by selecting the Add button.			<input type="button" value="Add"/>

Signature:

NOTE: This form must be signed in accordance with 37 CFR 1.33. See 37 CFR 1.4 for signature requirements and certifications					
Signature	/Kelly L. Kasha/		Date (YYYY-MM-DD)	2014-03-13	
First Name	Kelly L.	Last Name	Kasha	Registration Number	47743
Additional Signature may be generated within this form by selecting the Add button.				<input type="button" value="Add"/>	

Under the Paperwork Reduction Act of 1995, no persons are required to respond to a collection of information unless it contains a valid OMB control number.

Application Data Sheet 37 CFR 1.76		Attorney Docket Number	EMP0025-US
		Application Number	
Title of Invention	System and Method for Instant VoIP Messaging		

This collection of information is required by 37 CFR 1.76. The information is required to obtain or retain a benefit by the public which is to file (and by the USPTO to process) an application. Confidentiality is governed by 35 U.S.C. 122 and 37 CFR 1.14. This collection is estimated to take 23 minutes to complete, including gathering, preparing, and submitting the completed application data sheet form to the USPTO. Time will vary depending upon the individual case. Any comments on the amount of time you require to complete this form and/or suggestions for reducing this burden, should be sent to the Chief Information Officer, U.S. Patent and Trademark Office, U.S. Department of Commerce, P.O. Box 1450, Alexandria, VA 22313-1450. DO NOT SEND FEES OR COMPLETED FORMS TO THIS ADDRESS. **SEND TO: Commissioner for Patents, P.O. Box 1450, Alexandria, VA 22313-1450.**

Privacy Act Statement

The Privacy Act of 1974 (P.L. 93-579) requires that you be given certain information in connection with your submission of the attached form related to a patent application or patent. Accordingly, pursuant to the requirements of the Act, please be advised that: (1) the general authority for the collection of this information is 35 U.S.C. 2(b)(2); (2) furnishing of the information solicited is voluntary; and (3) the principal purpose for which the information is used by the U.S. Patent and Trademark Office is to process and/or examine your submission related to a patent application or patent. If you do not furnish the requested information, the U.S. Patent and Trademark Office may not be able to process and/or examine your submission, which may result in termination of proceedings or abandonment of the application or expiration of the patent.

The information provided by you in this form will be subject to the following routine uses:

1. The information on this form will be treated confidentially to the extent allowed under the Freedom of Information Act (5 U.S.C. 552) and the Privacy Act (5 U.S.C. 552a). Records from this system of records may be disclosed to the Department of Justice to determine whether the Freedom of Information Act requires disclosure of these records.
2. A record from this system of records may be disclosed, as a routine use, in the course of presenting evidence to a court, magistrate, or administrative tribunal, including disclosures to opposing counsel in the course of settlement negotiations.
3. A record in this system of records may be disclosed, as a routine use, to a Member of Congress submitting a request involving an individual, to whom the record pertains, when the individual has requested assistance from the Member with respect to the subject matter of the record.
4. A record in this system of records may be disclosed, as a routine use, to a contractor of the Agency having need for the information in order to perform a contract. Recipients of information shall be required to comply with the requirements of the Privacy Act of 1974, as amended, pursuant to 5 U.S.C. 552a(m).
5. A record related to an International Application filed under the Patent Cooperation Treaty in this system of records may be disclosed, as a routine use, to the International Bureau of the World Intellectual Property Organization, pursuant to the Patent Cooperation Treaty.
6. A record in this system of records may be disclosed, as a routine use, to another federal agency for purposes of National Security review (35 U.S.C. 181) and for review pursuant to the Atomic Energy Act (42 U.S.C. 218(c)).
7. A record from this system of records may be disclosed, as a routine use, to the Administrator, General Services, or his/her designee, during an inspection of records conducted by GSA as part of that agency's responsibility to recommend improvements in records management practices and programs, under authority of 44 U.S.C. 2904 and 2906. Such disclosure shall be made in accordance with the GSA regulations governing inspection of records for this purpose, and any other relevant (i.e., GSA or Commerce) directive. Such disclosure shall not be used to make determinations about individuals.
8. A record from this system of records may be disclosed, as a routine use, to the public after either publication of the application pursuant to 35 U.S.C. 122(b) or issuance of a patent pursuant to 35 U.S.C. 151. Further, a record may be disclosed, subject to the limitations of 37 CFR 1.14, as a routine use, to the public if the record was filed in an application which became abandoned or in which the proceedings were terminated and which application is referenced by either a published application, an application open to public inspections or an issued patent.
9. A record from this system of records may be disclosed, as a routine use, to a Federal, State, or local law enforcement agency, if the USPTO becomes aware of a violation or potential violation of law or regulation.

Under the Paperwork Reduction Act of 1995, no persons are required to respond to a collection of information unless it displays a valid OMB control number.

DECLARATION (37 CFR 1.63) FOR UTILITY OR DESIGN APPLICATION USING AN APPLICATION DATA SHEET (37 CFR 1.76)

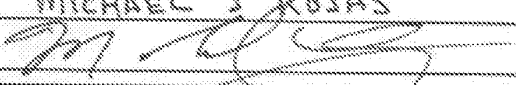
Title of Invention	System and Method for Instant VoIP Messaging
As the below named inventor, I hereby declare that:	
This declaration is directed to:	<input checked="" type="checkbox"/> The attached application, or <input type="checkbox"/> United States application or PCT international application number _____ filed on _____
The above-identified application was made or authorized to be made by me.	
I believe that I am the original inventor or an original joint inventor of a claimed invention in the application.	
I hereby acknowledge that any willful false statement made in this declaration is punishable under 18 U.S.C. 1001 by fine or imprisonment of not more than five (5) years, or both.	
WARNING: Petitioner/applicant is cautioned to avoid submitting personal information in documents filed in a patent application that may contribute to identify theft. Personal information such as social security numbers, bank account numbers, or credit card numbers (other than a check or credit card authorization form PTO-2036 submitted for payment purposes) is never required by the USPTO to support a petition or an application. If this type of personal information is included in documents submitted to the USPTO, petitioners/applicants should consider redacting such personal information from the documents before submitting them to the USPTO. Petitioner/applicant is advised that the record of a patent application is available to the public after publication of the application (unless a non-publication request in compliance with 37 CFR 1.213(a) is made in the application) or issuance of a patent. Furthermore, the record from an abandoned application may also be available to the public if the application is referenced in a published application or an issued patent (see 37 CFR 1.14). Checks and credit card authorization forms PTO-2038 submitted for payment purposes are not retained in the application file and therefore are not publicly available.	
LEGAL NAME OF INVENTOR Inventor: <u>MICHAEL J ROJAS</u> Date (Optional): _____ Signature: 	
Note: An application data sheet (PTO/SD-14 or equivalent), including naming the entire inventive entity, must accompany this form or must have been previously filed. Use an additional PTO/AIA/D1-form for each additional inventor.	

This collection of information is required by 35 U.S.C. 115 and 37 CFR 1.63. The information is required to obtain or retain a benefit by the public which is to be filed (and by the USPTO to process) an application. Confidentiality is governed by 35 U.S.C. 122 and 37 CFR 1.11 and 1.14. This collection is estimated to take 1 minute to complete, including gathering, preparing, and submitting the completed application form to the USPTO. Time will vary depending upon the individual case. Any comments on the amount of time you require to complete this form and/or suggestions for reducing this burden, should be sent to the Chief Information Officer, U.S. Patent and Trademark Office, U.S. Department of Commerce, P.O. Box 1450, Alexandria, VA 22313-1450. DO NOT SEND FEES OR COMPLETED FORMS TO THIS ADDRESS. SEND TO: Commissioner for Patents, P.O. Box 1450, Alexandria, VA 22313-1450.

If you need assistance in completing the form, call 1-800-PTO-6199 and select option 2.

Privacy Act Statement

The Privacy Act of 1974 (P.L. 93-579) requires that you be given certain information in connection with your submission of the attached form related to a patent application or patent. Accordingly, pursuant to the requirements of the Act, please be advised that: (1) the general authority for the collection of this information is 35 U.S.C. 2(b)(2); (2) furnishing of the information solicited is voluntary; and (3) the principal purpose for which the information is used by the U.S. Patent and Trademark Office is to process and/or examine your submission related to a patent application or patent. If you do not furnish the requested information, the U.S. Patent and Trademark Office may not be able to process and/or examine your submission, which may result in termination of proceedings or abandonment of the application or expiration of the patent.

The information provided by you in this form will be subject to the following routine uses:

1. The information on this form will be treated confidentially to the extent allowed under the Freedom of Information Act (5 U.S.C. 552) and the Privacy Act (5 U.S.C. 552a). Records from this system of records may be disclosed to the Department of Justice to determine whether disclosure of these records is required by the Freedom of Information Act.
2. A record from this system of records may be disclosed, as a routine use, in the course of presenting evidence to a court, magistrate, or administrative tribunal, including disclosures to opposing counsel in the course of settlement negotiations.
3. A record in this system of records may be disclosed, as a routine use, to a Member of Congress submitting a request involving an individual, to whom the record pertains, when the individual has requested assistance from the Member with respect to the subject matter of the record.
4. A record in this system of records may be disclosed, as a routine use, to a contractor of the Agency having need for the information in order to perform a contract. Recipients of information shall be required to comply with the requirements of the Privacy Act of 1974, as amended, pursuant to 5 U.S.C. 552a(m).
5. A record related to an International Application filed under the Patent Cooperation Treaty in this system of records may be disclosed, as a routine use, to the International Bureau of the World Intellectual Property Organization, pursuant to the Patent Cooperation Treaty.
6. A record in this system of records may be disclosed, as a routine use, to another federal agency for purposes of National Security review (35 U.S.C. 181) and for review pursuant to the Atomic Energy Act (42 U.S.C. 218(c)).
7. A record from this system of records may be disclosed, as a routine use, to the Administrator, General Services, or his/her designee, during an inspection of records conducted by GSA as part of that agency's responsibility to recommend improvements in records management practices and programs, under authority of 44 U.S.C. 2904 and 2906. Such disclosure shall be made in accordance with the GSA regulations governing inspection of records for this purpose, and any other relevant (i.e., GSA or Commerce) directive. Such disclosure shall not be used to make determinations about individuals.
8. A record from this system of records may be disclosed, as a routine use, to the public after either publication of the application pursuant to 35 U.S.C. 122(b) or issuance of a patent pursuant to 35 U.S.C. 151. Further, a record may be disclosed, subject to the limitations of 37 CFR 1.14, as a routine use, to the public if the record was filed in an application which became abandoned or in which the proceedings were terminated and which application is referenced by either a published application, an application open to public inspection or an issued patent.
9. A record from this system of records may be disclosed, as a routine use, to a Federal, State, or local law enforcement agency, if the USPTO becomes aware of a violation or potential violation of law or regulation.

Electronic Patent Application Fee Transmittal

Application Number:				
Filing Date:				
Title of Invention:	System and Method for Instant VoIP Messaging			
First Named Inventor/Applicant Name:	Michael J. Rojas			
Filer:	John Kasha			
Attorney Docket Number:	EMP0025-US			
Filed as Small Entity				
Utility under 35 USC 111(a) Filing Fees				
Description	Fee Code	Quantity	Amount	Sub-Total in USD(\$)
Basic Filing:				
Utility filing Fee (Electronic filing)	4011	1	70	70
Utility Search Fee	2111	1	300	300
Utility Examination Fee	2311	1	360	360
Pages:				
Claims:				
Miscellaneous-Filing:				
Petition:				
Patent-Appeals-and-Interference:				

Description	Fee Code	Quantity	Amount	Sub-Total in USD(\$)
Post-Allowance-and-Post-Issuance:				
Extension-of-Time:				
Miscellaneous:				
Total in USD (\$)				730

Electronic Acknowledgement Receipt

EFS ID:	18571392
Application Number:	14224125
International Application Number:	
Confirmation Number:	5407
Title of Invention:	System and Method for Instant VoIP Messaging
First Named Inventor/Applicant Name:	Michael J. Rojas
Customer Number:	67050
Filer:	John Kasha
Filer Authorized By:	
Attorney Docket Number:	EMP0025-US
Receipt Date:	25-MAR-2014
Filing Date:	
Time Stamp:	10:09:19
Application Type:	Utility under 35 USC 111(a)

Payment information:

Submitted with Payment	yes
Payment Type	Deposit Account
Payment was successfully received in RAM	\$730
RAM confirmation Number	9270
Deposit Account	504075
Authorized User	

The Director of the USPTO is hereby authorized to charge indicated fees and credit any overpayment as follows:

- Charge any Additional Fees required under 37 C.F.R. Section 1.16 (National application filing, search, and examination fees)
- Charge any Additional Fees required under 37 C.F.R. Section 1.17 (Patent application and reexamination processing fees)

Charge any Additional Fees required under 37 C.F.R. Section 1.19 (Document supply fees)

Charge any Additional Fees required under 37 C.F.R. Section 1.20 (Post Issuance fees)

Charge any Additional Fees required under 37 C.F.R. Section 1.21 (Miscellaneous fees and charges)

File Listing:

Document Number	Document Description	File Name	File Size(Bytes)/ Message Digest	Multi Part /.zip	Pages (if appl.)
1	Specification	EMP0025- US_specification_final.pdf	187961	no	53
			77ca29b48b210e8de49d0e62792890aac8a1a035		
Warnings:					
Information:					
2	Drawings-only black and white line drawings	EMP0025-US_drawings_final.pdf	818200	no	9
			016b46c7b14afd0ae9218c5850a32fa015fe137a		
Warnings:					
Information:					
3	Power of Attorney	EMP0025-US_poa_signed.pdf	4001004	no	2
			e379e58510bf2dd66719dfa87e901ed20fc266fe		
Warnings:					
Information:					
4	Application Data Sheet	EMP0025-US_app_data_sheet.pdf	1561784	no	7
			7550f89eee3c899f34746feaf71ee437ebdec767		
Warnings:					
Information:					
5	Oath or Declaration filed	EMP0025-US_dec_signed.pdf	471643	no	2
			fb306c9d8f0b562b17cb3ad44386a7cb2927180		
Warnings:					
Information:					
6	Fee Worksheet (SB06)	fee-info.pdf	32243	no	2
			39c3c4aca04219cbda84eaf4a9b7783489c26b8a		
Warnings:					
Information:					
Total Files Size (in bytes):			7072835		

This Acknowledgement Receipt evidences receipt on the noted date by the USPTO of the indicated documents, characterized by the applicant, and including page counts, where applicable. It serves as evidence of receipt similar to a Post Card, as described in MPEP 503.

New Applications Under 35 U.S.C. 111

If a new application is being filed and the application includes the necessary components for a filing date (see 37 CFR 1.53(b)-(d) and MPEP 506), a Filing Receipt (37 CFR 1.54) will be issued in due course and the date shown on this Acknowledgement Receipt will establish the filing date of the application.

National Stage of an International Application under 35 U.S.C. 371

If a timely submission to enter the national stage of an international application is compliant with the conditions of 35 U.S.C. 371 and other applicable requirements a Form PCT/DO/EO/903 indicating acceptance of the application as a national stage submission under 35 U.S.C. 371 will be issued in addition to the Filing Receipt, in due course.

New International Application Filed with the USPTO as a Receiving Office

If a new international application is being filed and the international application includes the necessary components for an international filing date (see PCT Article 11 and MPEP 1810), a Notification of the International Application Number and of the International Filing Date (Form PCT/RO/105) will be issued in due course, subject to prescriptions concerning national security, and the date shown on this Acknowledgement Receipt will establish the international filing date of the application.

SYSTEM AND METHOD FOR INSTANT VOIP MESSAGING

CROSS-REFERENCE TO RELATED APPLICATION

[0001] This application is a continuation of U.S. patent application Ser. No. 13/546,673, filed July 11, 2012, which is a continuation of U.S. application Ser. No. 12/398,063 filed March 4, 2009, now U.S. Pat. No. 8,243,723, issued August 14, 2012, which is a continuation of U.S. application Ser. No. 10/740,030 filed on December 18, 2003, now U.S. Pat. No. 7,535,890, issued May 19, 2009, the entire content and disclosure of which is incorporated by reference.

BACKGROUND OF THE INVENTION

Technical Field of the Invention

[0002] The present invention generally relates to Internet telephony (IP telephony). More particularly, the present invention is directed to a system and method for enabling local and global instant VoIP messaging over an IP network, such as the Internet, with PSTN support.

Description of the Prior Art

[0003] Traditional telephony is based on a public switched telephone network (i.e., "PSTN"). In the PSTN, a telephone terminal is electrically connected to a conventional or legacy switch. The telephone terminal and the legacy switch communicate via a proprietary protocol, which may be different depending on the vendor of the legacy switch. Circuit switching provides a communication path (i.e., dedicated circuit) for a telephone call from the telephone terminal to another device

over the PSTN, including another telephone terminal. During the telephone call, voice communication takes place over that communication path.

[0004] An alternative to the PSTN is Voice over Internet Protocol (i.e., “VoIP”), also known as IP telephony or Internet telephony. In the IP telephony, a VoIP terminal device is connected to a packet-switched network (e.g., Internet) and voice communication from the VoIP terminal device is digitized, packetized and transmitted over the packet-switched network to a destination VoIP terminal device, which reconstructs the packets and audibly plays, stores or otherwise processes the transmission. The VoIP terminal device may be a VoIP telephone or a general-purpose personal computer (PC) enabled for IP telephony. More specifically, the PC is programmed with the software and equipped with audio input/output devices (e.g., a combination of microphone and speaker or a headset) to serve as a VoIP terminal device. The PC so enabled and equipped will herein be referred to as a VoIP terminal device or a VoIP softphone.

[0005] FIG. 1 is an illustrative example of a prior art IP telephony system 100. The IP telephony system 100 comprises a packet-switched IP network 102, such as the Internet, which transmits VoIP traffic from and to a plurality of terminal devices 104, 106 and 110. Terminal device 104 is a VoIP softphone that is enabled for IP telephony over the network 102. Terminal device 106 is a VoIP telephone, which is connected to the network 102 via a softswitch 108. The VoIP softswitch 108 is disposed on the packet-switched network (e.g., Internet) 102 between an origination terminal device (such as VoIP softphone 104) and a destination terminal device (such as VoIP telephone 106), and routes packets over the packet-switched IP network 102.

The softswitch 108 may also manage and perform administrative functions for the terminal device or devices (e.g., VoIP telephone 106) to which it is connected. Whether the terminal device is a VoIP softphone 104 or a VoIP telephone 106, the terminal device is connected to the IP network 102 via a networking standard such as Ethernet, Bluetooth, IEEE 1394 (also known as “Firewire”), IEEE 802.11 (also known as “WiFi”), or networking over serial communication channels such as the Universal Serial Bus (i.e., “USB”). Data communication over the network then takes place using a connection protocol, e.g., transfer control protocol/Internet protocol (i.e., “TCP/IP”).

[0006] Further regarding FIG. 1, terminal device 110 is a legacy telephone that is connected to a legacy switch 112 for (circuit-switched) voice communications over the PSTN 116 with other terminal devices. A media gateway 114 may be provided between the legacy switch 112 and the packet-switched network 102 to enable IP telephony between the legacy telephone 110 and a VoIP terminal device, such as a VoIP softphone 104 or VoIP telephone 106. More specifically, the media gateway 114 converts the audio signal carried over PSTN to packets carried over the packet-switched IP network 102. In addition, a media gateway 118 may be disposed over the PSTN 116 and connected to a softswitch 120 to convert the audio signal from the legacy telephone 110 to packets routed over the IP network 102 via the softswitch 120.

[0007] Voice messaging in both the VoIP and PSTN is known. More specifically, the foregoing systems may be provided with a facility to allow users to leave voice messages for recipients, which is a feature that is familiar to anyone who uses a

telephone. Conventionally, leaving a voice message involves dialing the recipient's telephone number (often without knowing whether the recipient will answer), waiting for the connection to be established, speaking to an operator or navigating through a menu of options, listening to a greeting message, and recording the message for later pickup by the recipient. In that message, the user must typically identify himself or herself in order for the recipient to return the call.

[0008] Instant text messaging is likewise known. More specifically, a user is provided with a client terminal, which is typically a general-purpose PC programmed with instant text messaging software and in data communication over an IP network with an instant text-messaging server. The instant text-messaging server presents the user, via the client terminal, with a list of persons who are currently "online" and ready to receive text messages on their own client terminals. The user then uses the client terminal to select one or more persons to whom the message will be sent and types in a text message. The text message is sent immediately via the text-messaging server to the selected one or more persons and is displayed on their respective client terminals.

[0009] However, notwithstanding the foregoing advances in the VoIP/PSTN voice communication and voice/text messaging, there is still a need in the art for providing a system and method for providing instant VoIP messaging over an IP network. More particularly, there is a need in the art for providing local and global instant voice messaging over VoIP with PSTN support.

SUMMARY OF THE INVENTION

[0010] The present invention is directed to a system and method for enabling local and global instant VoIP messaging over an IP network, such as the Internet.

[0011] According to an embodiment of the present invention, there is provided an instant voice messaging system for delivering instant messages over a packet-switched network, the system comprising: a client connected to the network, the client selecting one or more recipients, generating an instant voice message therefor, and transmitting the selected recipients and the instant voice message therefor over the network; and a server connected to the network, the server receiving the selected recipients and the instant voice message therefor, and delivering the instant voice message to the selected recipients over the network, the selected recipients being enabled to audibly play the instant voice message.

[0012] According to another embodiment of the present invention, there is provided an instant voice messaging system for delivering instant messages over a packet-switched network enabling public switched telephone network (PSTN) support, the system comprising: a PSTN telephone connected to the network for providing input audio; a client connected to the network, the client selecting one or more recipients, generating an instant voice message therefor using the input audio provided by the PSTN telephone, and transmitting the selected recipients and the instant voice message therefor over the network; a server connected to the network, the server receiving the selected recipients and the instant voice message therefor, and delivering the instant voice message to the selected recipients over the network, the selected recipients being enabled to audibly play the instant voice message.

[0013] According to a further embodiment of the present invention, there is provided an instant voice messaging system for delivering instant messages over a packet-switched network, the system comprising: a voice-over-internet-protocol (VoIP) telephone connected to the network for providing input audio; a client connected to the network, the client selecting one or more recipients, generating an instant voice message therefor using the input audio provided by the VoIP telephone, and transmitting the selected recipients and the instant voice message therefor over the network; a server connected to the network, the server receiving the selected recipients and the instant voice message therefor, and delivering the instant voice message to the selected recipients over the network, the selected recipients being enabled to audibly play the instant voice message.

[0014] According to still another embodiment of the present invention, there is provided an instant voice messaging system for delivering instant messages over a plurality of packet-switched networks, the system comprising: a client connected to a local network, the client selecting one or more external recipients connected to an external network outside the local network, generating an instant voice message therefor, and transmitting the selected recipients and the instant voice message therefor over the local network and the external network; and a server connected to the external network, the server receiving the selected recipients and the instant voice message therefor, and delivering the instant voice message to the selected recipients over the external network, the selected recipients being enabled to audibly play the instant voice message.

[0015] According to yet another embodiment of the present invention, there is provided an instant voice messaging system for delivering instant messages over a plurality of packet-switched networks enabling public switched telephone network (PSTN) support, the system comprising: a PSTN telephone connected to a local network for providing input audio; a client connected to the local network, the client selecting one or more external recipients connected to an external network outside the local network, generating an instant voice message therefor using the input audio provided by the PSTN telephone, and transmitting the selected recipients and the instant voice message therefor over the local network and the external network; a server connected to the external network, the server receiving the selected recipients and the instant voice message therefor, and delivering the instant voice message to the selected recipients over the external network, the selected recipients being enabled to audibly play the instant voice message.

[0016] According to yet a further embodiment of the present invention, there is provided an instant voice messaging system for delivering instant messages over a plurality of packet-switched networks, the system comprising: a voice-over-internet-protocol (VoIP) telephone connected to a local network for providing input audio; a client connected to the local network, the client selecting one or more external recipients connected to an external network outside the local network, generating an instant voice message therefor using the input audio provided by the VoIP telephone, and transmitting the selected recipients and the instant voice message therefor over the local network and the external network; an server connected to the external network, the external server receiving the selected recipients and the instant voice

message therefor, and delivering the instant voice message to the selected recipients over the external network, the selected recipients being enabled to audibly play the instant voice message.

[0017] According to still a further embodiment of the present invention, there is provided an instant voice messaging system for delivering instant messages over a plurality of packet-switched networks, the system comprising: a client connected to an external network, the client selecting one or more recipients connected to a local network, generating an instant voice message therefor, and transmitting the selected recipients and the instant voice message therefor over the external network; an external server system connected to the external network, the external server system receiving the selected recipients and the instant voice message, and routing the selected recipients and the instant voice message over the external network and the local network; a local server connected to the local network, the local server receiving the selected recipients and the instant voice message therefor, and delivering the instant voice message to the selected recipients over the local network, the selected recipients being enabled to audibly play the instant voice message.

[0018] According to an embodiment of the present invention, there is provided a method for instant voice messaging over a packet-switched network, the method comprising: selecting one or more recipients for instant voice messaging at a client; generating an instant voice message for the selected recipients at the client; transmitting the selected recipients and the instant voice message therefor over the network from the client to a server; receiving the selected recipients and the instant voice message therefor at the server; delivering the instant voice message from the

server to the selected recipients over the network; and audibly playing the instant voice message at the selected recipients.

[0019] According to another embodiment of the present invention, there is provided a method for instant voice messaging over a packet-switched network enabling public switched telephone network (PSTN) support, the method comprising: providing input audio via a PSTN telephone connected over the network; selecting one or more recipients for instant voice messaging at a client; generating an instant voice message using the input audio from the PSTN telephone for the selected recipients at the client; transmitting the selected recipients and the instant voice message therefor over the network from the client to a server; receiving the selected recipients and the instant voice message therefor at the server; delivering the instant voice message from the server to the selected recipients over the network; and audibly playing the instant voice message at the selected recipients.

[0020] According to a further embodiment of the present invention, there is provided a method for instant voice messaging over a packet-switched network, the method comprising: providing input audio via a voice-over-internet-protocol (VoIP) telephone connected over the network; selecting one or more recipients for instant voice messaging at a client; generating an instant voice message using the input audio from the VoIP telephone for the selected recipients at the client; transmitting the selected recipients and the instant voice message therefor over the network from the client to a server; receiving the selected recipients and the instant voice message therefor at the server; delivering the instant voice message from the server to the

selected recipients over the network; and audibly playing the instant voice message at the selected recipients.

[0021] According to still another embodiment of the present invention, there is provided a method for instant voice messaging over a plurality of packet-switched networks, the method comprising: selecting one or more external recipients for instant voice messaging at a client connected to a local network, the one or more external recipients connected to an external network outside the local network; generating an instant voice message for the selected external recipients at the client; transmitting the selected external recipients and the instant voice message therefor over the local network and the external network; receiving the selected external recipients and the instant voice message therefor at an external server connected to the external network; delivering the instant voice message to the selected external recipients over the external network; and audibly playing the instant voice message at the selected external recipients.

[0022] According to yet another embodiment of the present invention, there is provided a method for instant voice messaging system over a plurality of packet-switched networks enabling public switched telephone network (PSTN) support, the method comprising: providing input audio via a PSTN telephone connected to a local network; selecting one or more external recipients for instant voice messaging at a client, the one or more external recipients connected to an external network outside the local network; generating an instant voice message for the one or more external recipients using the input audio provided by the PSTN telephone; transmitting the selected recipients and the instant voice message therefor over the local network and

the external network; receiving the selected recipients and the instant voice message therefor at a server connected to the external network; delivering the instant voice message to the selected recipients from the server over the external network; and audibly playing the instant voice message at the selected recipients.

[0023] According to still a further embodiment of the present invention, there is provided a method for instant voice messaging system over a plurality of packet-switched networks, the method comprising: providing input audio via a voice-over-internet-protocol (VoIP) telephone connected to a local network; selecting one or more external recipients for instant voice messaging at a client, the one or more external recipients connected to an external network outside the local network; generating an instant voice message for the one or more external recipients using the input audio provided by the VoIP telephone; transmitting the selected recipients and the instant voice message therefor over the local network and the external network; receiving the selected recipients and the instant voice message therefor at a server connected to the external network; delivering the instant voice message to the selected recipients from the server over the external network; and audibly playing the instant voice message at the selected recipients.

[0024] According to yet a further embodiment of the present invention, there is provided a method for instant voice messaging over a plurality of a plurality of packet-switched networks, the method comprising: selecting one or more recipients connected to a local network at a client connected to an external network; generating an instant voice message for the selected recipients at the client; transmitting the selected recipients and the instant voice message therefor over the external network

from the client to an external server system; receiving the selected recipients and the instant voice message at the external server system; routing the selected recipients and the instant voice message over the external network and the local network; receiving the selected recipients and the instant voice message therefor at a local server connected to the local network; delivering the instant voice message to the selected recipients over the local network; audibly playing the instant voice message at the selected recipients.

BRIEF DESCRIPTION OF THE DRAWINGS

[0025] The objects, features and advantages of the present invention will become apparent to one skilled in the art, in view of the following detailed description taken in combination with the attached drawings, in which:

[0026] FIG. 1 illustrates an example of a prior art IP telephony system;

[0027] FIG. 2 illustrates an exemplary local IVM system for enabling instant voice messaging according to the present invention;

[0028] FIG. 3 illustrates an exemplary IVM client of FIG. 2 for enabling instant voice messaging according to the present invention;

[0029] FIG. 4 illustrates an exemplary IVM server of FIG. 2 for enabling instant voice messaging according to the present invention;

[0030] FIG. 5 illustrates an exemplary global IVM system comprising a local IVM system and global IVM clients, according to the present invention;

[0031] FIG. 6 illustrates an exemplary global IVM server system depicted in FIG. 5, according to the present invention;

[0032] FIG. 7 illustrates an exemplary transport server depicted in FIG. 6, according to the present invention;

[0033] FIG. 8 illustrates an exemplary directory server depicted in FIG. 6, according to the present invention; and

[0034] FIG. 9 illustrates an exemplary global IVM system comprising a plurality of local IVM systems and global IVM clients, according to the present invention.

DETAILED DESCRIPTION

[0035] The present invention is directed to a system and method for enabling local and global instant VoIP messaging over an IP network with PSTN support.

[0036] FIG. 2 is an exemplary illustration of a local instant voice messaging (IVM) system 200 according to the present invention. The instant voice messaging system 200 comprises a local IVM server 202 that provides the core functionality for enabling instant voice messaging with PSTN support according to the present invention. The architecture of the local IVM server 202 will be described in detail hereinbelow with reference to FIG. 4. According to the exemplary IVM system 200, the local IVM server 202 is enabled to provide instant voice messaging to one or more IVM clients 206 and 208, as well support instant voice messaging for PSTN legacy telephones 110. It is noted that although FIG. 2 depicts one of each IVM client 206, 208 and legacy telephone 110 for clarity and brevity, the local IVM server 202 is enabled to support a plurality of each of the foregoing IVM clients 206, 208 and legacy telephone 110. The local packet-switched IP network 204 interconnects the IVM clients 206, 208 and the legacy telephone 110 to the local IVM server 202 as

well as interconnecting the local IVM server 202 to the local IP network 204. The network 204 may be a local area network (LAN), a wide area network (WAN), or the like, which supports both wired and wireless devices. The exemplary IVM client 208 is a VoIP softphone, the architecture of which will be described in detail hereinbelow with reference to FIG. 3. A microphone 212 is connected to the IVM client 208 and enables the recording of an instant voice message according to the present invention into an audio file 210 for transmission to the local IVM server 202 over the network 204. An input device 218 (e.g., a keyboard) is connected to the IVM client 208 to select one or more recipients that are to receive the recorded instant voice message. Although not depicted in FIG. 2, the input device 218 may include a trackball, digitizing pad or mouse, or the like. A display device 216 is connected to the IVM client 208 to display instant voice messages recorded and/or received by a user of the IVM client 208. An audio device 214, such as external speaker, is connected to the IVM client 208 to play received instant voice messages. It is noted that the microphone 212, audio device 214, display device 216 and input device 218 may form integral parts of the IVM client 208.

[0037] Further with reference to FIG. 2, IVM client 206 is interconnected via the network 204 to the local IVM server 202. An exemplary IVM client 206 is a VoIP telephone, which comprises a screen display (not shown) capable of displaying instant voice messages recorded and/or received by a user of the IVM client 206 according to the present invention. The VoIP telephone 206 further comprises a handset and/or speakerphone for recording instant voice messages and listening to instant voice messages received at the VoIP telephone 206 according to the present

invention. The VoIP telephones which may be implemented to provide instant voice messaging functionality according to the present invention are commercially available from many vendors, including Alcatel.TM., Lucent.TM., NEC.TM. and Cisco.TM., to name just a few. In addition to the foregoing IVM clients 206, 208, the IVM system 200 supports a legacy telephone 110 for instant voice messaging according to the present invention. The legacy telephone 110 is connected to a legacy switch 112. The legacy switch 112 is further connected to a media gateway 114. Both the legacy switch 112 and the media gateway 114 interconnect the legacy telephone 110 via the network 204 to the local IVM server 202, thereby facilitating instant voice messaging according to the present invention. The media gateway 114 may be a gateway that supports trunk pack network control (i.e., "TPNCP") protocol, media gateway control protocol (i.e., "MGCP"), or a media gateway control H.428 protocol (i.e., "MEGACO"). As previously mentioned, the media gateway 114 converts the audio signal carried over PSTN to packets to be transmitted over a packet-switched IP network, such as the local network 204.

[0038] The implementation of the instant voice messaging for IVM client 208 will be described first and will be followed by the implementations for IVM client 206 and legacy telephone 110, with reference to the local IVM system 200 depicted in FIG. 2. These implementations implement a "record mode" of the instant voice messaging according to the present invention. There will further be described an "intercom mode" of the instant voice messaging according to the present invention. Therefore, in operation of the IVM client 208 according to FIG. 2, the IVM client (IVM softphone) 208 is connected over the network 204 to the IVM server 202, which as

aforementioned enables instant voice messaging functionality over the network 204. The IVM client 208 displays a list of one or more IVM recipients on its display 216, provided and stored by the local IVM server 202, as will be particularly described hereinbelow with reference to FIG. 4. The user operates the IVM client 208 by using the input device 218 to indicate a selection of one or more IVM recipients from the list. The user selection is transmitted to the IVM server 202. The user selection also generates a start signal to the IVM client 208 that the user is ready to begin instant voice messaging according to the present invention. In response to the start signal, the IVM client (softphone) 208 listens to the input audio device 212 and records the user's speech into a digitized audio file 210 (i.e., instant voice message) stored on the IVM client 208. The audio file 210 at the IVM client 208 is finalized via a stop signal, which is generated by the user via the input device 218 or a preset time period without speech input via the input audio device 212 on the IVM client 208. Once the recording of the user's speech is finalized, IVM client 208 generates a send signal indicating that the digitized audio file 210 (instant voice message) is ready to be sent to the selected recipients. The user generates the send signal when the user operates the IVM client 208 via the input device 218, e.g., pressing a key on a keyboard or clicking a button on a mouse. The IVM client 208 transmits the digitized audio file 210 and the send signal to the local IVM server 202. In response to the send signal indicating that the instant voice message is ready to be sent, the IVM client 208 sends the recorded audio file 210 destined for the selected one or more recipients via local IVM server 202. After receiving the audio file 210, the IVM server 202 thereafter delivers the transmitted instant voice message to the selected one or more recipients

via the local IP network 204. The one or more recipients are enabled to display an indication that the instant voice message has been received and audibly play the instant voice message to an associated user. It should be understood that only the available IVM recipients, currently connected to the IVM server 202, will receive the instant voice message. It is noted that if a recipient IVM client is not currently connected to the local IVM server 202 (i.e., is unavailable), the IVM server temporarily saves the instant voice message and delivers it to the IVM client when the IVM client connects to the local IVM server 202 (i.e., is available).

[0039] There are several embodiments for the operation of the IVM client (VoIP telephone) 206 within the IVM system 200, according to the present invention. In the first embodiment, the VoIP telephone 206 is a standalone IVM client 206 enabled for instant voice messaging according to the present invention. In the second embodiment, the VoIP telephone 206 operates synchronously either with the IVM client 208 or IVM server 202 to enable instant voice messaging according to the present invention. Thus, in operation according to the first embodiment in FIG. 2, the IVM client (VoIP telephone) 206 is connected over the network 204 to the IVM server 202, which as aforementioned enables instant voice messaging functionality over the local network 204. The IVM client 206 displays a list of one or more IVM recipients on its associated display provided and stored by the local IVM server 202, as will be particularly described hereinbelow with reference to FIG. 4. The user operates the IVM client 206 by using a keypad on the VoIP telephone 206 to indicate a selection of one or more IVM recipients from the list. The VoIP telephone 206 transmits the selection to the IVM server 202. The user selection also generates a

start signal to the IVM client 206 indicating the user is ready to begin instant voice messaging according to the present invention. The user speaks into the handset of the IVM client 206 or a speakerphone on the IVM client 206. Although not shown in FIG. 2, the VoIP telephone 206 may provide a dedicated storage device, which in response to the start signal records an audio file, similar to the audio file 210 in the IVM client 208. The audio file is finalized via a stop signal. The stop signal is generated when the user presses a button on the keypad, a preset time period without speech input to the VoIP telephone 206, or when the user returns the handset to the cradle of the VoIP telephone 206. Once the recording of the user's speech is complete, a send signal is generated indicating that the instant voice message is ready to be sent to the selected recipients. The user generates the send signal when the user presses a button on the keypad or returns the handset of the VoIP telephone 206 to its cradle (on-hook). In response to the send signal, the IVM client 206 sends the recorded audio to the local IVM server 202 via the network 204. The IVM server 202 thereafter delivers the instant voice message to the selected one or more recipients via the IP network 204. As before, the one or more recipients are enabled to display an indication that the instant voice message has been received and audibly play the instant voice message. As aforementioned, if a recipient IVM client is not currently connected to the local IVM server 202, the IVM server 202 temporarily saves the instant voice message and delivers it to the IVM client when the IVM client connects to the local IVM server 202.

[0040] In the second embodiment of the IVM client 206 according to FIG. 2, the VoIP telephone 206 operates synchronously either with the IVM client 208 or the

IVM server 202 to enable instant voice messaging according to the present invention. Thus, in operation according to the second embodiment, the IVM client (VoIP telephone) 206 is still connected over the network 204 to the IVM server 202, which as aforementioned enables instant voice messaging functionality over the local network 204. However, VoIP telephone 206 cooperates with the IVM client 208 or IVM server 202 to record and send an instant voice message. More specifically, the VoIP telephone 206 is only used as a recording/listening device for recording or listing to instant voice messages, while the IVM client 208 is used for displaying and selecting instant voice message recipients as described hereinabove. In operation, the IVM client 208 displays a list of IVM recipients on the display device 216 provided and stored by the local IVM server 202. The user operates the IVM client 208 by using the input device 218 on the IVM client 208 to indicate a selection of one or more IVM recipients from the list. The user selection is transmitted to the IVM server 202. The user selection generates a start signal to the IVM server 202 indicating that the user is ready to begin instant voice messaging according to the present invention. In response to receiving the start signal, the IVM server 202 transmits a ring signal to the VoIP telephone 206, thereby indicating to the user the IVM system 200 is ready to record an instant voice message. The IVM server 202 also signals the IVM client 208 to generate audio file 210 to record the instant voice message. As the user picks up the handset of the VoIP telephone 206 (off-hook), a connection is established via the network 204 between the local IVM server 202 and the VoIP telephone 206. Thereafter, the IVM server 202 forwards the user's speech transmitted from VoIP telephone 206 to the IVM client 208 for storage into digitized

audio file 210 on the IVM client 208. The audio file 210 is finalized by returning the handset its cradle (on-hook) or by pressing a designated button on the keypad VoIP telephone 206, which transmits the stop signal to the IVM server 202 and further from the IVM server 202 to the IVM client 208. Returning the handset to its cradle preferably generates a send signal to the IVM server 202, which transmits the signal to the IVM client 208. The IVM client thereafter transmits the recorded audio file 210 (instant voice message) to IVM server 202 for delivery to the selected one or more IVM recipients. Alternatively, the user may press a key on the keyboard 218 to initiate the send signal. In response to the send signal, the IVM client 206 sends the recorded audio to the local IVM server 202 via the network 204. The IVM server 202 thereafter delivers the instant voice message to the selected one or more recipients via the IP network 204. The one or more recipients are enabled to display an indication that the instant voice message has been received and audibly play the instant voice message. If a recipient IVM client is not currently connected to the local IVM server 202, the IVM server 202 temporarily saves the instant voice message and delivers it to the IVM client when the IVM client connects to the local IVM server 202.

[0041] In operation of the legacy telephone 110 according to FIG. 2, the legacy telephone 110 is connected to the local IVM server 202 via media gateway 114 and legacy switch 112. The legacy telephone 110 cooperates with the IVM client 208 to record and send an instant voice message. More specifically, the legacy telephone 110 is used as a recording/listening device for recording or listening to instant voice messages, while the IVM client 208 is used for displaying and selecting instant voice message recipients as described hereinabove. Thus, in operation the IVM client 208

displays a list of IVM recipients on the display device 216 provided and stored by the local IVM server 202. The user operates the IVM client 208 by using the input device 218 on the IVM client 208 to indicate a selection of one or more IVM recipients from the list. The user selection is transmitted to the IVM server 202. The user selection generates a start signal to the IVM server 202 indicating that the user is ready to begin instant voice messaging according to the present invention. In response to receiving the start signal, the IVM server 202 transmits an emulation code to the legacy telephone 110 to ring, thereby indicating to the user the IVM system 200 is ready to record an instant voice message. As the user picks up the handset of the legacy telephone 110 (off-hook), a connection is established via the network 204 between the legacy telephone 110 and the IVM server 202. Thereafter, the IVM server forwards the user's speech transmitted from the legacy telephone 110 to the IVM client 208 for storage into the digitized audio file 210 (i.e., instant voice message). The audio file on the IVM client 208 is finalized by returning the handset of the legacy telephone 110 to its cradle (on-hook) or by pressing a designated button on the keypad of the legacy telephone 110, which transmits a stop signal to the IVM server 202 and further to the IVM client 208. Returning the handset to its cradle also generates a send signal to the IVM server to transmit the recorded audio file (instant voice message) to the selected one or more IVM recipients. The IVM server 202 thereafter delivers the instant voice message to the selected one or more recipients via the IP network 204. The one or more recipients are enabled to display an indication that the received instant voice message has been received and audibly play the instant voice message. If a recipient IVM client is not currently connected to the local IVM

server 202, the IVM server 202 temporarily saves the instant voice message and delivers it to the IVM client when the IVM client connects to the local IVM server 202.

[0042] Regarding the operational embodiments described with reference to FIG. 2 for recoding and transmitting an instant voice message according to the present invention, the digitized audio file is preferably compressed by applying a compression algorithm before sending the audio file to the one or more selected recipients. The audio file is preferably compressed within the IVM clients 206, 208 before forwarding the audio file to the IVM server 202 for subsequent delivery to the one or more selected recipients. Alternatively, the compression may be implemented within the IVM server 202 before the audio file is transmitted to the one or more selected recipients. A Lempel-Ziv compression algorithm is preferably used to compress the audio file according to the present invention. It is noted that many suitable compression algorithms are known to persons of skill in the art, including Huffman encoding, audio compression standards promulgated by the Moving Pictures Experts Group (“MPEG”), G.722 wideband speech encoding standard, fractal compression, and wavelet compression. Any of the foregoing compression algorithms may be implemented within the scope of the present invention.

[0043] Further regarding the operational embodiments described with reference to FIG. 2 for recoding and transmitting an instant voice message according to the present invention, the digitized audio file (which may or may not be compressed as described above) is further preferably encrypted via an encryption algorithm before transmitting the audio file to the one or more selected recipients. The encryption is

preferably implemented within the IVM clients 206, 208 before forwarding the audio file to the IVM server 202 for subsequent delivery to the one or more selected recipients. Alternatively, the encryption may be implemented within the IVM server 202 before the audio file is transmitted to the one or more selected recipients. An AES (Rijndael) encryption algorithm is preferably used to encrypt the audio file according to the present invention. It is noted that many suitable encryption algorithms are known to persons skilled in the art, including DES, Triple DES, Blowfish, Twofish, Serpent, and the like. Any of the foregoing encryption algorithms may be implemented within the scope of the present invention.

[0044] Lastly with reference to FIG. 2, in addition to the “record mode” of instant voice messaging, the instant voice messaging system 200 also supports an “intercom mode” of voice messaging. The “intercom mode” represents real-time instant voice messaging. In the “intercom mode,” instead of creating an audio file 210, one or more buffers (not shown) of a predetermined size are generated in the IVM client 206, 208 or local IVM server 202. The one or more buffers are used to automatically write successive portions of the instant voice message. Once a first buffer is full, i.e., input audio of the predetermined size is written to the buffer, the content of the first buffer is automatically transmitted to the IVM server 202 for transmission to the one or more IVM recipients. A second buffer is meanwhile written with the next successive portion of input audio. Once, the second buffer is full, i.e., input audio of the predetermined size is written to the buffer, the content of the second buffer is transmitted to the IVM server 202 for transmission to the one or more IVM recipients. If the entire instant voice message or a successive portion thereof (such as

a last successive portion in the instant voice message) written to either buffer is smaller the predetermined size, then the buffered content of less than the predetermined size is automatically transmitted to the IVM server 202. The foregoing buffering using the first and second buffers is repeated until the entire instant voice message has been transmitted to the IVM server 202 for transmission to the one or more IVM recipients. It is noted that the invention is not limited to a particular number of buffers. The foregoing buffering and transmission allows a “real-time” instant voice message to be transmitted to the one or more IVM recipients. The “intercom mode” may be designated as a default mode when an IVM recipient is on-line, while the “record mode” may be designated as a default if the IVM recipient is unavailable, i.e., not on-line. The user may easily change the “intercom mode” to the “record mode” on the respective IVM client 206, 208. Finally, the audio contents of the buffers may be signal processed (for clarity), encrypted and compressed before transmission, as will be described in more detail hereinbelow with reference to FIG. 3.

[0045] FIG. 3 is an exemplary illustration of the architecture in the IVM client 208 for enabling instant voice messaging according to the present invention. More specifically, the IVM client 208 comprises a client platform 302 for generating an instant voice message and a messaging system 320 for messaging between the IVM client 208 and the IVM server 202 for enabling instant voice messaging according to the present invention. The IVM client 208 is a general-purpose programmable computer equipped with a network interface (not shown), such as an Ethernet card, to provide connectivity to the network 204. It is noted that any suitable networking

protocol, not only Ethernet, could be used to connect the IVM client to a network 204 and thus is considered within the scope of the present invention. The client platform 302 comprises a client engine 304, which controls other components, namely the document handler 306, file manager 308, audio file creation 312, signal processing 314, encryption/decryption 316, and compression/decompression 318. The messaging system 320 and the client engine 304 communicate via standard inter-process communication. The messaging system 320 and client engine 304 also communicate with the IVM server 202 over the network interface via the network 204. The document handler 306 oversees the retrieving, sending, receiving and storing of one or more documents (or files) attached to instant voice messages from/to the one or more selected IVM recipients that may be communicating with the IVM client 208. More specifically, when an instant voice message is to be transmitted to the one or more IVM recipients, one or more documents may be attached to the instant voice message to be, stored or displayed by the one or more selected IVM recipients. The file manager accesses a message database 310, in which both the received and recorded instant voice messages are represented as database records, each record comprising a message identifier and the instant voice message. The file manager 308 services requests from the user to record, delete or retrieve messages to/from the message database 310. Audio file creation 312 creates an instant voice message as audio file 210, and is responsible for receiving input speech for the instant voice message from audio input device 212 or via network 204 and storing the input speech into audio file 210. Signal processing 314 performs noise removal and signal optimization in the audio file 210. Encryption/decryption 316 provides for

respectively encrypting/decrypting of outgoing/incoming audio files (i.e., instant voice messages), and compression/decompression 318 respectively compresses/decompresses the outgoing/incoming audio files.

[0046] Further with reference to FIG. 3, the reception of an instant voice message is described as follows. It is assumed that the local IVM server 202 has determined that the IVM client 208 is available to receive an instant voice message by checking the IVM client's 208 current status, i.e., whether the IVM client 208 is "on-line." The local IVM server 202 maintains the current status of the IVM clients connected to the local IVM server 202, i.e., IVM clients 206, 208. It is further assumed that an IVM client has transmitted an instant voice message to the IVM client 208. The local IVM server 202 receives the instant voice message over the local IP network 204 and forwards the instant voice message to the IVM client 208. Upon receipt at the IVM client 208, the instant voice message is decrypted at 316, decompressed at 318, and stored in the message database 310 using the file manager 308. Any files attached to the instant voice message are also stored in the message database 310 using the file manager 308. A visual and/or sound effect is initiated to notify a user of the IVM client 208 that a new instant voice message has been received at the IVM client 208. At this point in time, the instant voice message and any file attachments are available to the user. The user can select the instant voice message from a listing of available instant voice messages displayed on the IVM client 208 and play the newly received instant voice message. The user may also open any file attachments and move or save the files to a separate location on the client using a drag-and-drop process.

[0047] Still further with reference to FIG. 3, the generation and transmission of an instant voice message is described as follows. The user selects the available one or more IVM recipients and initiates the creation of an instant voice message as described above with reference to FIG. 2. The client engine 304 detects the start signal and invokes audio file creation 312 of the audio file 210. The audio file 210 is initialized and captures the audio voice message input by the user. Once the client engine 304 detects a stop signal, the instant voice message is finalized in the audio file 210 via audio file creation 312. The audio file 210 is adjusted for gain, and noise is removed via signal processing 314. The audio file 210 is further compressed at 318 and encrypted at 316. The completion of these processes causes the client engine 304 to inform the user via display 216 that the instant voice message is available to be sent. After the client engine 304 detects the send signal from the user, the instant voice message (audio file 210) is transferred to the local IVM server 202. Before the transmission of the instant voice message (i.e., before the send signal), the user has the option to review the instant voice message, re-record the instant voice message, delete the instant voice, as well as attach one or more files (i.e., documents). The attachment of one or more files is enabled conventionally via a methodology such as “drag-and-drop” and the like, which invokes the document handler 306 to make the appropriate linkages to the one or more files and flags the messaging system 320 that the instant voice message also has the attached one or more files.

[0048] FIG. 4 is an exemplary illustration of the local IVM server 202 for enabling instant voice messaging according to the present invention. The IVM server 202 is a general-purpose programmable computer equipped with a network interface, such as

an Ethernet card, to provide connectivity to a network 204. It is noted that any suitable networking protocol may be implemented to connect the IVM server 202 to a network 204. The IVM server 202 comprises a server communication platform 402, a messaging system 436 and a database 414, thereby enabling instant voice messaging according to the present invention. The server communication platform 402 comprises a server engine 404, client manager 406, station manager 408, gateway manager 410, database manager 412 that accesses database 414, supplemental servers 416 (including particular server subsystems 418-424), as well as a control layer 426 (including non-proprietary server subsystems 428, 430 and proprietary server subsystems 432, 434). The messaging system 436 and the server engine 304 communicate via standard inter-process communication. The messaging system 436 and the server engine are also able to communicate with the IVM clients 206, 208 over the network interface via the network 204. The database 414 stores users (e.g., IVM clients as well as legacy telephone clients) that are known to the IVM server 202 via the database manager 412. The users are represented in the database as records, each record comprising a user name, a password, and a contact list (a list of other users with whom the user wishes to exchange instant voice messages), and other data relating to the user. The database manager 412 services requests to add, update, delete, or retrieve database records to/from the database 414. The password may be stored in the database 414 as plaintext, in encrypted form, or as a hash (e.g., MD5 hash). The messaging system 436 communicates to the server engine 404 via message objects.

[0049] A message object comprises an action field, an ID field, a source field, a destination field, and an object field. The content of the action field is selected from a list of permitted actions, which among other actions includes: connect, disconnect, subscribe, unsubscribe, and post message. In addition, the actions include: determining if an IVM client is awake (i.e., pinging), disconnecting from the IVM client, processing an IVM client message, and notifying IVM clients if the IVM server 202 goes down. The client messages include sending an instant voice message portions, checkin message, send message, set status message, send a phone command message, and send control parameters message. The content of the ID field represents a unique identifier for the message object. The content of the source field is a globally unique identifier (“GUID”) that uniquely identifies the sender of the message. This unique identifier can be generated by any known way, including the Globally Unique ID function call available in the Microsoft Windows and Microsoft .NET environments. In some circumstances, the source field is set to a special value to indicate that the sender of the message object is entitled to special privileges. The senders with special privileges are in fact IVM servers. This allows the IVM servers to broadcast messages to one another, subscribe to special events, and directly send messages to specific IVM servers. These privileges can depend upon whether the IVM servers are local servers or global servers. As an example, there can exist more than one local IVM server, each of these local IVM servers automatically has privileges to communicate to other local IVM server. On a global server system, a directory server can communicate with one or more transport servers. The content of the destination field is a GUID of an intended IVM recipient of the instant voice

message. The content of the object field is a block of data being carried by the message object, which may be, for example, a digitized instant voice message. Depending on the circumstances in which the message object is sent, some of the message object fields may be left blank or ignored. For example, the message object may merely require an action to be performed based upon the GUID supplied. In this case, the action does not necessarily require any data to be sent or received and some of the message object's fields may be left blank or ignored.

[0050] Connection objects maintain the logical connections between the IVM server 202 and IVM clients 206, 208 connected to the IVM server 202. More specifically, a connection object comprises data representing the state of the connection and code (one or more methods) for establishing and maintaining the logical connections between the IVM server 202 and the IVM clients 206, 208 within the IVM system 200 of FIG. 2. The connection object can contain both data and/or commands, including information that describes the socket, the size of the data to be transferred, and the priority of the transfer (e.g., high, normal, low, unknown). On start up the local IVM server 202 generates and maintains a list for each IVM client 206, 208. The local IVM server 202 then waits to receive connection objects from the IVM clients 206, 208 that are stored in the respective lists, decodes the received connection objects to obtain specific requests, and then services the specific requests from the IVM clients 206, 208.

[0051] Further with reference to FIG. 4, the server engine 404 controls all other subsystems in the server communication platform 402, and it is responsible for startup and shutdown of the IVM server 202 and the IVM system 200. The client

manager 406 controls the IVM clients 206, 208, providing contact presence (connection) information and message scheduling and delivery. The station manager 408 controls the individual legacy telephone 110 and coordinates its activity to work synchronously with the IVM client 208 and server 202. The gateway manager 410 enables the IVM server 202 to communicate with the legacy telephones, such as legacy telephone 110. The control layer 426 comprises a plurality of server subsystems 428-434, each of which provides translation services to different proprietary and non-proprietary gateways 114, such as TPNCP, MGCP, and MEGACO gateways. The proprietary server subsystems 428, 430 and non-proprietary server subsystems 432, 434 are connected to respective gateways 114 via the local IP network 204. The supplemental server subsystems 416 provide a number of required services such as display manager subsystem 418, dynamic host configuration protocol (i.e., "DHCP") subsystem 420, trivial file transfer protocol (i.e., "TFTP") server subsystem 422, and hypertext transfer protocol (i.e., "HTTP"). Each of the supplemental servers 418-424 in the subsystem 416 is used during the initial set-up of the IVM system 200. The boot-up process and allocation of IP addresses to IVM clients 206, 208 are performed through an LCD panel (not shown) associated with the local IVM server 202. The LCD manager 418 supports this boot-up process. The DHCP server 420 is used to allocate IP addresses as required and allows the advanced configuration of network settings in the instant voice messaging system. The TFTP server 422 provides a TCP/IP file transfer capability. Lastly, the HTTP server 424 provides services for a web server.

[0052] FIG. 5 is an exemplary illustration of a global instant voice messaging (IVM) system 500, according to the present invention. In the global IVM system 500, the local IVM system 200 is depicted as a local IVM system 510, which is connected to a packet-switched network 102 (i.e., Internet). The global IVM system 500 comprises the local IVM system 510, global IVM server system 502, and global IVM clients 506 and 508 that are optionally connected via local IP network 504. The global IVM server system 502 is connected to the IP network (i.e., Internet) 102 for enabling the local IVM clients 206, 208 and legacy telephone 110 in the local IVM system 510 to generate and send instant voice messages to the global IVM clients 506, 508, as well as the local IVM clients 206, 208 to receive instant voice messages from the global IVM clients 506, 508. The implementation of the global instant voice messaging for the IVM client 208 will be described first and will be followed by the implementations for IVM client 206 and legacy telephone 110, with reference to the global IVM system 500 depicted in FIG. 5. Thereafter, instant voice messaging for global clients 506 and 508 will be described according to the present invention. These implementations implement a “record mode” of the instant voice messaging according to the present invention. Thereafter, there will lastly be described an “intercom mode” of the instant voice messaging according to the present invention.

[0053] Therefore, in operation of the IVM client 208 according to FIG. 5, the IVM client 208 is connected via the networks 204, 102 to the global IVM server system 502, which enables the global instant voice messaging functionality outside the local IVM system 510 over the network (i.e., Internet) 102. More specifically, the IVM client 208 requests from the global IVM server system 502 a global contact list (not

shown) of global one or more IVM recipients with which the IVM client 208 may exchange instant voice messages. For the purposes of illustration, it is assumed that global IVM clients 506, 508 are in the contact list. The global IVM server system 502 stores and maintains this contact list. Thus, the global IVM server system 502 responds by transmitting the contact list to the IVM client 208. The IVM client 208 displays the contact list on its display 216. Alternatively, the global contact list may be replicated to the local IVM server 202 within the local IVM system 510, in which case the local IVM client 208 obtains the global contact list from the local IVM server 202. The user operates the IVM client 208 by using the input device 218 to indicate a selection of one or more IVM recipients from the global contact list. Here, for the purposes of illustration it is again assumed that IVM client 208 selected global IVM clients 506, 508. The user selection is transmitted to the IVM server 202. The user selection also generates a start signal to the IVM client 208 that the user is ready to begin instant voice messaging. In response to the start signal, the IVM client 208 listens to the input audio device 212 and records the user's speech into a digitized audio file 210 (i.e., instant voice message) stored on the IVM client 208. The audio file 210 is finalized via a stop signal, which is generated by the user via the input device 218 or a preset time period without speech input via the input audio device 212. Once the recording is finalized, the IVM client 208 generates a send signal indicating that the digitized audio file 210 (instant voice message) is ready to be sent to the selected one or more IVM recipients. The user generates the send signal when the user operates the IVM client 208 via the input device 218. The IVM client 208 transmits the digitized audio file 210 and the send signal to the global IVM server

system 502 via the local IP network 204 and the global IP network 102. After receiving the audio file 210, the global IVM server system 502 delivers the transmitted instant voice message to the selected one or more recipients (e.g., IVM clients 506 and 508) via the IP network 102. The one or more recipients are enabled to display an indication that the instant voice message has been received and audibly play the instant voice message to an associated user. It is noted that if a recipient IVM client 506, 508 is not currently connected to the global IVM server system 502, the global IVM server system 502 temporarily saves the instant voice message and delivers it to the global IVM client 506, 508 when the IVM client connects to the global IVM server system 502.

[0054] There are several embodiments for the operation of the IVM client (VoIP telephone) 206 within the global IVM system 500 of FIG. 5, according to the present invention. In the first embodiment, the VoIP telephone 206 is a standalone IVM client 206 enabled for instant voice messaging according to the present invention. In the second embodiment, the VoIP telephone 206 operates synchronously with the IVM client 208 to enable instant voice messaging according to the present invention. Thus, in operation according to the first embodiment in FIG. 5, the IVM client 206 is connected via the networks 204, 102 to the global IVM server system 502, which enables instant voice messaging functionality over the IP network (Internet) 102. As mentioned previously, the IVM client 206 is also connected to the local IVM server 202. The IVM client 208 requests from the global IVM server system 502 a global contact list (not shown) of the global one or more IVM recipients with which the IVM client 206 may exchange instant voice messages. For the purposes of

illustration, it is assumed that the global IVM clients 506, 508 are in the contact list. The global IVM server system 502 stores and maintains this contact list. Thus, the global IVM server system 502 responds by transmitting the global contact list to the IVM client 206. Alternatively, the global contact list may be replicated to the local IVM server 202 within the local IVM system 510, in which case the local IVM client 206 obtains the global contact list from the local IVM server 202. The IVM client 206 displays a list of the one or more IVM recipients on its associated display. The user operates the IVM client 206 by using a keypad on the VoIP telephone 206 to indicate a selection of one or more IVM recipients from the list. The VoIP telephone 206 transmits the selection to the global IVM server system 502. The user selection also generates a start signal to the IVM client 206 indicating the user is ready to begin instant voice messaging according to the present invention. The user speaks into the handset of the IVM client 206 or a speakerphone on the IVM client 206. Although not shown in FIG. 5, the VoIP telephone 206 may provide a dedicated storage device, which in response to the start signal records an audio file, similar to the audio file 210 in the IVM client 208. The audio file is finalized via a stop signal. The stop signal is generated when the user presses a button on the keypad, a preset time period without speech input to the VoIP telephone 206, or when the user returns the handset to the cradle of the VoIP telephone 206. Once the recording of the user's speech is complete, a send signal is generated indicating that the instant voice message is ready to be sent to the selected recipients. The user generates the send signal when the user presses a button on the keypad or returns the handset of the VoIP telephone 206 to its cradle. In response to the send signal, the IVM client 206 sends the recorded audio

file (instant voice message) to the global IVM server system 502 via the networks 204, 102 for delivery to the selected one or more IVM recipients. The global IVM server 502 thereafter delivers the instant voice message to the selected one or more recipients (e.g., IVM clients 506 and 508) via the IP network 102. As before, the one or more recipients are enabled to display an indication that the instant voice message has been received and audibly play the instant voice message. If a recipient IVM client is not currently connected to the global IVM server system 502, the global IVM server system 502 temporarily saves the instant voice message and delivers it to the IVM client when the IVM client connects to the global IVM server system 502.

[0055] In the second embodiment of the IVM client 206 according to FIG. 5, the VoIP telephone 206 operates synchronously with the IVM client 208 to enable global instant voice messaging according to the present invention. Thus, in operation according to the second embodiment in FIG. 5, the VoIP telephone 206 is connected over the network 204 to the IVM client 208 and the IVM client 208 is connected via the networks 204, 102 to the global IVM server system 502, which enables instant voice messaging functionality over the IP network (Internet) 102. The VoIP telephone 206 cooperates with the IVM client 208 to record and send a global instant voice message outside the local IVM system 510. The IVM client 208 displays a global contact list of IVM recipients (not shown) on the display device 216 provided by the global IVM server system 502, as described hereinabove. Alternatively, the global contact list may be replicated to the local IVM server 202 within the local IVM system 510, in which case the IVM client 208 obtains the global contact list from the local IVM server 202. The user operates the IVM client 208 by using the input

device 218 to indicate a selection of one or more IVM recipients from the contact list. The user selection generates a start signal in the IVM client 208 indicating that the user is ready to begin instant voice messaging according to the present invention. In response to the start signal, the IVM client 208 generates audio file 210 to record an instant voice message and transmits a ring signal to the VoIP telephone 206. As the user picks up the handset of the VoIP telephone 206 (off-hook), a connection is established via the network 204 between the local IVM client 208 and the VoIP telephone 206. Thereafter, the VoIP telephone 206 forwards the user's speech to the IVM client 208 for storage into the audio file 210. The audio file 210 is finalized by returning the handset its cradle (on-hook) or by pressing a designated button on the keypad VoIP telephone 206, which transmits the stop signal to the IVM client 208. Returning the handset to its cradle preferably generates a send signal to the IVM client 208. The IVM client thereafter transmits the recorded audio file 210 (instant voice message) to the global IVM server system 502 via networks 204, 102 for delivery to the selected one or more IVM recipients. Alternatively, the user may press a key on the keyboard 218 to initiate the send signal. In response to the send signal, the IVM client 208 sends the recorded audio file to the global IVM server system 502 for delivery to the selected one or more IVM recipients. The global IVM server system 502 thereafter delivers the instant voice message to the selected one or more recipients (e.g., IVM clients 506 and 508) via the IP network 102. As before, the one or more IVM recipients are enabled to display an indication that the instant voice message has been received and audibly play the instant voice message. If a recipient IVM client is not currently connected to the global IVM server system 502,

the global IVM server system 502 temporarily saves the instant voice message and delivers it to the IVM client when the IVM client connects to the global IVM server system 502.

[0056] In operation of the legacy telephone 110 according to FIG. 5, the legacy telephone 110 is connected to the local IVM client 208 via media gateway 114, legacy switch 112 and network 204. The legacy telephone 110 cooperates with the IVM client 208 to record and send an instant voice message outside the local IVM system 510. More specifically, the legacy telephone 110 is used as a recording/listening device for recording or listening to instant voice messages, while the IVM client 208 is used for displaying and selecting instant voice message recipients as described hereinabove. Thus, in operation the IVM client 208 requests from the global IVM server system 502 a global contact list of global one or more IVM recipients with which the IVM client 208 may exchange instant voice messages. Alternatively, the global contact list may be replicated to the local IVM server 202 within the local IVM system 510, in which case the IVM client 208 obtains the global contact list from the local IVM server 202. The IVM client 208 displays the global list of IVM recipients, as described hereinabove. The user operates the IVM client 208 to indicate a selection of one or more IVM recipients from the global contact list. The IVM client 208 transmits the user selection to the global IVM server system 502. The user selection generates a start signal in the IVM client 208 indicating that the user is ready to begin instant voice messaging according to the present invention. In response to the start signal, the IVM client 208 transmits an emulation code to the legacy telephone 110 to ring, thereby indicating to the user the global IVM system

500 is ready to record an instant voice message. As the user picks up the handset of the legacy telephone 110 (off-hook), a connection is established via the network 204 between the legacy telephone 110 and the IVM client 208. Thereafter, the user's speech is transmitted from the legacy telephone 110 to the IVM client 208 for storage into the digitized audio file 210 (i.e., instant voice message). The audio file 210 is finalized by returning the handset of the legacy telephone 110 to its cradle (on-hook) or by pressing a designated button on the keypad of the legacy telephone 110, which transmits a stop signal to the IVM client 208. Returning the handset to its cradle may also generate a send signal to the IVM client 208 to transmit the recorded audio file (instant voice message) to the global IVM server system 502 for delivery to the selected one or more IVM recipients. Alternatively, the send signal is preferably generated from the IVM client 208 as described hereinabove. The global IVM server system 502 thereafter delivers the instant voice message to the selected one or more IVM recipients via the IP network (Internet) 102. The one or more recipients are enabled to display an indication that the instant voice message has been received and audibly play the instant voice message. If a recipient IVM client is not currently connected to the global IVM server system 502, the global IVM server system 502 temporarily saves the instant voice message and delivers it to the IVM client when the IVM client connects to the global IVM server 502.

[0057] Further with reference to FIG. 5, the instant voice messaging for global clients 506 and 508 will be described according to the present invention. In a first embodiment, each of the global IVM clients 506, 508 is enabled to independently send an instant voice message. The IVM clients 506, 508 have like peripheral

devices and functionality described respectively with reference to local IVM clients 206, 208 in FIG. 2. In second embodiment described below, the VoIP telephone 506 operates in conjunction with the IVM client 508 to send an instant voice message. Therefore, in operation of the global IVM clients 506 and 508 according the first embodiment in FIG. 5, the IVM clients 506, 508 are connected via the networks 204, 102 to the global IVM server system 502, which enables the global instant voice messaging functionality outside the local IVM system 510 over the network (i.e., Internet) 102. Each of the global IVM clients 506, 508 is enabled to request from the global IVM server system 502 a contact list (not shown) of global one or more IVM recipients with which each of the global IVM client 506, 508 may exchange instant voice messages. For the purposes of this illustration, it is assumed that the IVM clients 206 and 208 within the local IVM system 510 are in the contact list for each global IVM client 506, 508. The global IVM server system 502 stores and maintains the foregoing contact list for each global IVM client 506, 508. Upon request, the global IVM server system 502 responds by transmitting the contact list to each of the IVM clients 506, 508. Each of the IVM clients 506, 508 displays the contact list on its display. The user operates the IVM client 506, 508 to indicate a selection of one or more IVM recipients from the contact list. Each of the global IVM clients 506, 508 transmits the user selection to the global IVM server system 502. The user selection also generates a start signal to the IVM clients 506, 508 that the user is ready to begin instant voice messaging. In response to the start signal, the IVM clients 506, 508 record the user's speech into a digitized audio file (i.e., instant voice message) stored on the global IVM clients 506, 508. The audio file is finalized via a

stop signal, which is generated by the user by operating the global IVM client 506, 508. Once the recording is finalized, the IVM client 506, 508 generates a send signal indicating that the digitized audio file (instant voice message) is ready to be sent to the selected one or more recipients. The user generates the send signal when the user operates the global IVM client 506, 508. The IVM client 208 transmits the digitized audio file and the send signal to the global IVM server system 502. After receiving the audio file, the global IVM server system 502 delivers the transmitted instant voice message to the local IVM server 202 in the local IVM system 510 for delivery to the selected one or more recipients (e.g., local IVM clients 206 and 208) via the local IP network 204. The one or more recipients IVM 206, 208 are enabled to display an indication that the instant voice message has been received and audibly play the instant voice message to an associated user. It is noted that if a recipient IVM client 206, 208 is not currently connected to the local IVM server 202, the IVM server 202 temporarily saves the instant voice message and delivers it to the local IVM client 206, 208 when the IVM client connects to the local IVM server 202.

[0058] In the second embodiment of the IVM client 506 according to FIG. 5, the VoIP telephone 506 operates synchronously with the IVM client 508 to enable global instant voice messaging according to the present invention. In this embodiment, the VoIP telephone 506 and the IVM client 508 may be located in a user's residence and be connected to a local IP network 504. This local IP network 504 can be a WiFi network or a local area network (i.e., LAN), which is also within the user's residence. The local IP network 504 may be connected to the IP network (Internet) 102 via a digital subscriber line (i.e., DSL) connection, cable connection, dialup connection, or

the like. As noted above, the IVM clients 506, 508 have like peripheral devices and functionality described respectively with reference to local IVM clients 206, 208 in FIG. 2. Thus, in operation according to this embodiment in FIG. 5, the global IVM client 508 requests from the global IVM server system 502 a contact list of global one or more IVM recipients with which each of the global IVM client 508 may exchange instant voice messages. For the purposes of this illustration, it is assumed that the IVM clients 206 and 208 within the local IVM system 510 are in the contact list for the global IVM client 508. The global IVM server system 502 stores and maintains the foregoing contact list for the global IVM client 508. The IVM client 508 displays a contact list of IVM recipients on the associated display device provided by the global IVM server system 502, as described hereinabove. The user operates the IVM client 508 by using the associated input device to indicate a selection of one or more IVM recipients from the contact list. The user selection generates a start signal in the IVM client 508 indicating that the user is ready to begin instant voice messaging according to the present invention. In response to the start signal, the IVM client 508 generates audio file to record an instant voice message and transmits a ring signal to the VoIP telephone 506 via local IP network 504. As the user picks up the handset of the VoIP telephone 206 (off-hook), a connection is established via the local network 504 between the local IVM client 508 and the VoIP telephone 506. Thereafter, the VoIP telephone 506 forwards the user's speech to the IVM client 508 for storage into the audio file at the IVM client 508. The audio file is finalized by returning the handset its cradle (on-hook) or by pressing a designated button on the keypad associated with the VoIP telephone 506, which transmits the stop signal to the IVM

client 508. Returning the handset to its cradle preferably generates a send signal to the IVM client 508. The IVM client thereafter transmits the recorded audio file (instant voice message) to the global IVM server system 502 for delivery to the selected one or more IVM recipients. Alternatively, the user may press a key on the input device associated with the IVM client 508 to initiate the send signal. In response to the send signal, the IVM client 508 sends the recorded audio file to the global IVM server system 502 for delivery to the selected one or more IVM recipients. The global IVM server system 502 thereafter transmits the instant voice message to the local WM server 202 for delivery selected one or more recipients (e.g., local IVM clients 206 and 208) via the local IP network 204. As before, the one or more recipients are enabled to display an indication that the instant voice message has been received and audibly play the instant voice message. If a recipient IVM client is not currently connected to the local IVM server 202, the local IVM server 202 temporarily saves the instant voice message and delivers it to the IVM client when the IVM client connects to the local IVM server 202.

[0059] Lastly with reference to FIG. 5, in addition to the “record mode” of instant voice messaging as described above, the instant voice messaging system 500 also supports an “intercom mode” of the instant voice messaging. The “intercom mode” represents real-time instant voice messaging. In the “intercom mode,” instead of creating an audio file as described hereinabove, one or more buffers (not shown) of a predetermined size are generated. The buffers may be generated in any one of the IVM clients 206, 208, 506 and 508, depending on how the global IVM system 500 is defined. The one or more buffers are used to automatically write successive portions

of the instant voice message. Once a first buffer is full, i.e., input audio of the predetermined size is written to the buffer, the content of the first buffer is automatically transmitted. If the transmission is generated at a local IVM client 206, 208 and destined for one or more local IVM recipients, the content of the first buffer is transmitted to the local IVM server 202 for delivery to the local one or more recipients. If the transmission is generated at a local IVM client 206, 208 and destined for one or more global IVM recipients 506, 508, the content of the first buffer is transmitted to the global IVM server system 502 for delivery to the one or more global recipients. In addition, if the transmission is generated at a global IVM client 506, 508 and destined for the other global IVM clients, the content of the first buffer is transmitted to the global IVM server system 502, such as for example clients 506, 508. Lastly, if the transmission is generated at a global IVM client 506, 508 and destined for the local IVM clients 206, 208, the content of the first buffer is transmitted to the global IVM server system 502 and further transmitted by the global IVM server 502 to the local IVM server 202 for delivery to clients 206, 208 within the local IVM system 510. A second buffer is meanwhile written with the next successive portion of input audio. Once, the second buffer is full, i.e., input audio of the predetermined size is written to the buffer, the content of the second buffer is transmitted in similar fashion to the first buffer. If the entire instant voice message or a successive portion thereof (such as a last successive portion in the instant voice message) written to either buffer is smaller the predetermined size, then the buffered content of less than the predetermined size is automatically transmitted to the IVM server 202. The foregoing buffering using the first and second buffers is repeated

until the entire instant voice message has been transmitted as described above. It is noted that the invention is not limited to a particular number of buffers. The foregoing buffering and transmission allows a “real-time” instant voice message to be transmitted to the one or more local, as well as global, IVM recipients. The “intercom mode” may be designated as a default mode when an IVM recipient is on-line, while the “record mode” may be designated as a default if the IVM recipient is unavailable, i.e., not on-line. The user may easily change the “intercom mode” to the “record mode” on the respective IVM client 206, 208, 506, 508. Finally, the audio contents of the buffers may be signal processed (for clarity), encrypted and compressed before transmission, as was described previously.

[0060] FIG. 6 is an exemplary detailed illustration 600 of the global IVM server system 502 depicted in FIG. 5, according to the present invention. More specifically, the local IVM system 510 described in FIG. 5 is connected via the IP network (Internet) 102 to the global IVM server system 502. The global IVM server system 502 comprises an IVM transport server mesh 602 and an IVM directory server 608. The IVM transport server mesh 602 comprises a plurality of interconnected IVM transport servers 604, 606. Although the mesh 602 is depicted as having two IVM transport servers 604, 606, it is to be understood that as many IVM transport servers as are desired or required for redundancy and load balancing may be interconnected in a mesh. The IVM transport servers 604, 606 may be centrally located and configured to communicate (i.e., forward and receive messages) with local IVM clients 206, 208, local IVM server 202 and global IVM client 506, 508 (not depicted in FIG. 6). The plurality of IVM transport servers 604, 606 in the IVM transport

server mesh 602 permits load balancing and redundancy in the global IVM system 500. The directory server 608 maintains a transport server list of all the IVM transport servers 604, 606 currently connecting to the mesh 602. Each of the IVM transport servers 604, 606 first connects to the directory server 608. The directory server 608 informs each of the connecting IVM transport servers 604, 606 of all the other IVM transport servers currently in the mesh 602 based on an active list (not shown) of transport servers 604, 606 in the mesh 602. The connecting IVM transport server then connects to each of the IVM transport servers in the transport server list, resulting in an interconnected mesh 602 of IVM transport servers 604, 606. The IVM transport servers 604, 606 and the IVM directory server 608 communicate via messages.

[0061] Further with reference to FIG. 6, the IVM transport servers 604, 606 connected in the mesh 602 share a database (not shown) of IVM clients, so that each IVM transport server 604, 606 refers to the same client database. It is preferable that each IVM transport server 604, 606 maintains its own copy of the client database, which is mirrored and replicated conventionally amongst the IVM transport servers 604, 606 in the mesh 602. The client database may further be replicated to the local IVM server 202. Alternatively, the client database is stored on a separate file server (not shown) in data communication with the IVM transport servers 604, 606 over a network (not shown).

[0062] FIG. 7 is an exemplary detailed illustration of a transport server 604, 606 depicted in FIG. 6, according to the present invention. The IVM transport server 604, 606 is a general-purpose programmable computer comprising a network interface (not

shown) connected to IP network (Internet) 102, a communication platform 702, a message database 712, and a messaging system 714. The communication platform 702 comprises a server engine 704, which controls a user manager 706, a local server manager 708, and a storage manager 710. The messaging system 714 and the server engine 704 communicate via standard inter-process communication. The storage manager 710 handles retrieving, sending, and storing of messages, including instant voice messages and attachments thereto, to/from the message database 712. The user manager 706 is responsible for creating/maintaining IVM clients 206, 208, 506, 508, identifying them and relaying their status to the server engine 704. When an IVM client communicates an instant voice message within the global IVM system 500, the user manager 706 notifies the server engine 704 whether the one or more recipients are unavailable, and thereby the instant voice message is saved in the message database 712. When the one or more IVM recipients become available, the user manager 706 notifies the server engine 704, which instructs the storage manager 710 to retrieve any undelivered instant voice messages for the one or more recipients and delivers the instant voice messages to the designated one or more IVM recipients. The local server manager 708 is responsible for creating/maintaining and providing the status of available local IVM servers, such as IVM server 202 in FIG. 2. The availability status of the local IVM servers is checked periodically and updated.

[0063] FIG. 8 is an exemplary detailed illustration of a directory server 608 depicted in FIG. 6, according to the present invention. The directory server 608 is a general-purpose programmable computer equipped with a network interface (not shown) connected to IP network (Internet) 102, a messaging system 812, and a

communication platform 802. The communication platform 802 comprises a server engine 804, which controls a local server manager 806, a user manager 808, and a transport manager 810. The messaging system 812 and the server engine 804 communicate via standard inter-process communication. The transport manager 810 maintains the status of the IVM transport servers 604, 606 in the IVM transport server mesh 602 within the global IVM system 500 and using a load-balancing mechanism distributes instant voice messages to available transport server 604, 606 for routing to the one or more IVM recipients. The user manager 808 is responsible for creating/maintaining IVM clients 206, 208, 506, 508, identifying and relaying their status via the server engine 804 to the IVM transport server 604, 606 to be used. The local server manager 806 is responsible for creating/maintaining and providing the status of available local IVM servers, such as IVM server 202 in FIG. 2. The availability status of the local IVM servers is checked periodically and updated.

[0064] FIG. 9 illustrates an exemplary a global instant voice messaging (IVM) system 900, which comprises a plurality of local IVM systems and a plurality of global IVM clients, according to the present invention. In the global IVM system 900, there are depicted a plurality of local IVM systems 902, 910 connected to the global IP network 102. The internal representation and functionality of each local IVM system 902, 904 is identical to the local IVM system 510 described with reference to FIG. 5. In global IVM system 900 of FIG. 9, there are also depicted a plurality of global IVM clients 918-928 and a global IVM server system 502 connected to the global IP network (i.e., Internet) 102. The internal representations of the global IVM client 918-928 and the global IVM server system 502 are identical to

the respective IVM client 508 (and/or IVM client or 506) and the global IVM server system 502 described with reference to FIG. 5. In the local IVM system 902, each local IVM client 206, 208 is enabled to request local IVM recipients from the local IVM server 202 and global IVM recipients from either the global IVM server system 502 or the local IVM server 202. For example, the local IVM client 1A 208 displays a list 904 to a user, comprising both local and global IVM recipients. More specifically, the list 904 enables IVM client 1A to send instant voice messages according to the present invention to local IVM clients 1B 208 and 1C 206, global IVM client C 922 and global IVM client 2A 208 in the local IVM system 910. Similar lists 906-916 are displayed to the users of the respective IVM clients 1B-1C in local IVM system 902, and 2A-2C in local IVM system 910. In addition, the global clients A-F 918-928 are enabled to request IVM recipients from the global IVM server system 502 and display the respective lists of IVM recipients 930-940 on the respective IVM clients 918-928.

[0065] While the invention has been particularly shown and described with regard to preferred embodiments thereof, it will be understood by those skilled in the art that the foregoing and other changes in form and details may be made therein without departing from the spirit and scope of the invention.

WHAT IS CLAIMED IS:

1. A system comprising:
an instant voice messaging application including a client platform system for generating an instant voice message and a messaging system for transmitting the instant voice message over a packet-switched network via a network interface, and
wherein the instant voice messaging application displays a list of one or more potential recipients for the instant voice message.
2. The system according to claim 1, wherein the instant voice messaging application includes a message database storing the instant voice message, wherein the instant voice message is represented by a database record including a unique identifier.
3. The system according to claim 2, wherein the message database includes a plurality of instant voice messages received over the packet-switched network.
4. The system according to claim 3, wherein the instant voice messaging application displays at least one of the plurality of instant voice messages stored in the message database.
5. The system according to claim 1, wherein the instant voice messaging application includes a file manager system performing at least one of storing, deleting and retrieving the instant voice messages from the message database in response to a user request.
6. The system according to claim 1, wherein the instant voice messaging application includes an audio file creation system creating an audio file for the instant voice message based on input received via an audio input device.
7. The system according to claim 1, wherein the instant voice messaging application includes an encryption/decryption system for encrypting the instant voice messages to be

transmitted over the packet-switched network and decrypting the instant voices messages received over the packet-switched network.

8. The system according to claim 1, wherein the instant voice messaging application includes a compression/decompression system for compressing the instant voice messages to be transmitted over the packet-switched network and decompressing the instant voice messages received over the packet-switched network.

9. The system according to claim 1, wherein the instant voice messaging application displays an indicia for each of the one or more potential recipients indicating whether the potential recipient is currently available to receive an instant voice message.

10. The system according to claim 1, wherein the instant voice message application generates an audible or visual effect indicating receipt of an instant voice message.

11. A system, comprising:

an instant voice messaging application comprising:

a client platform system generating an instant voice message;

an encryption component encrypting the instant voice message; and

a messaging system transmitting the encrypted instant voice message over a

packet-switched network via a network interface.

12. A system, comprising:

an instant voice messaging application comprising:

a client platform system for generating an instant voice message;

a messaging system for transmitting the instant voice message over a packet-

switched network, and

wherein the instant voice message application attaches one or more files to the instant voice message.

13. The system according to claim 12, wherein the packet-switched network comprises a WiFi network.

14. The system according to claim 12, wherein the instant voice messaging application displays one or more controls for audibly playing the instant voice message.

ABSTRACT OF THE DISCLOSURE

Methods, systems and programs for instant voice messaging over a packet-switched network are provided. A method for instant voice messaging may comprise receiving an instant voice message having one or more recipients, delivering the instant voice message to the one or more recipients over a packet-switched network, temporarily storing the instant voice message if a recipient is unavailable; and delivering the stored instant voice message to the recipient once the recipient becomes available.

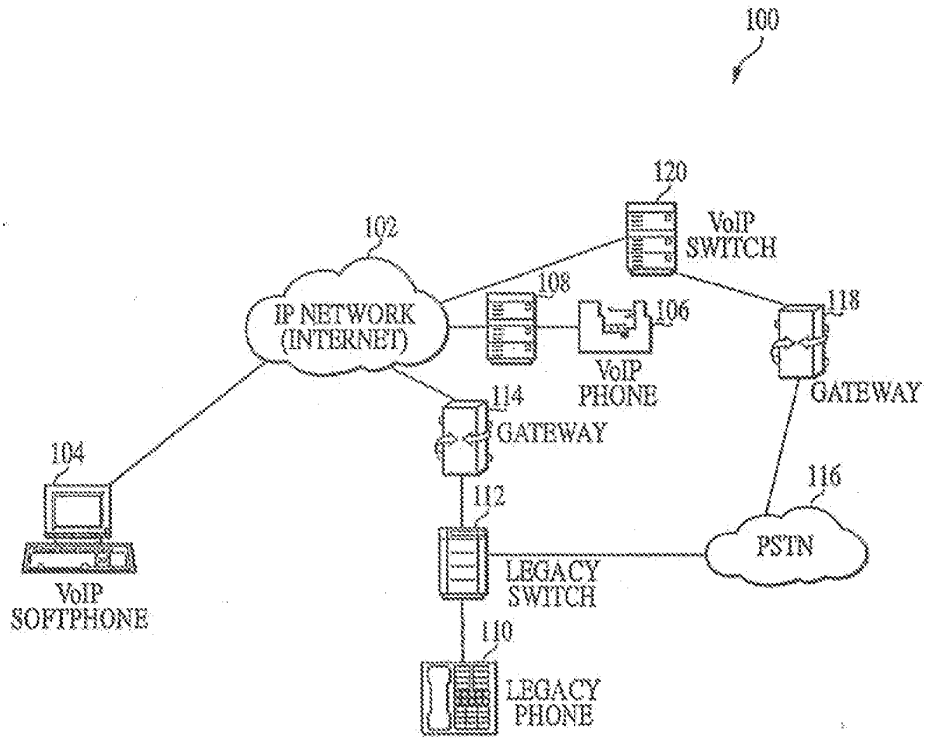

FIG. 1
(PRIOR ART)

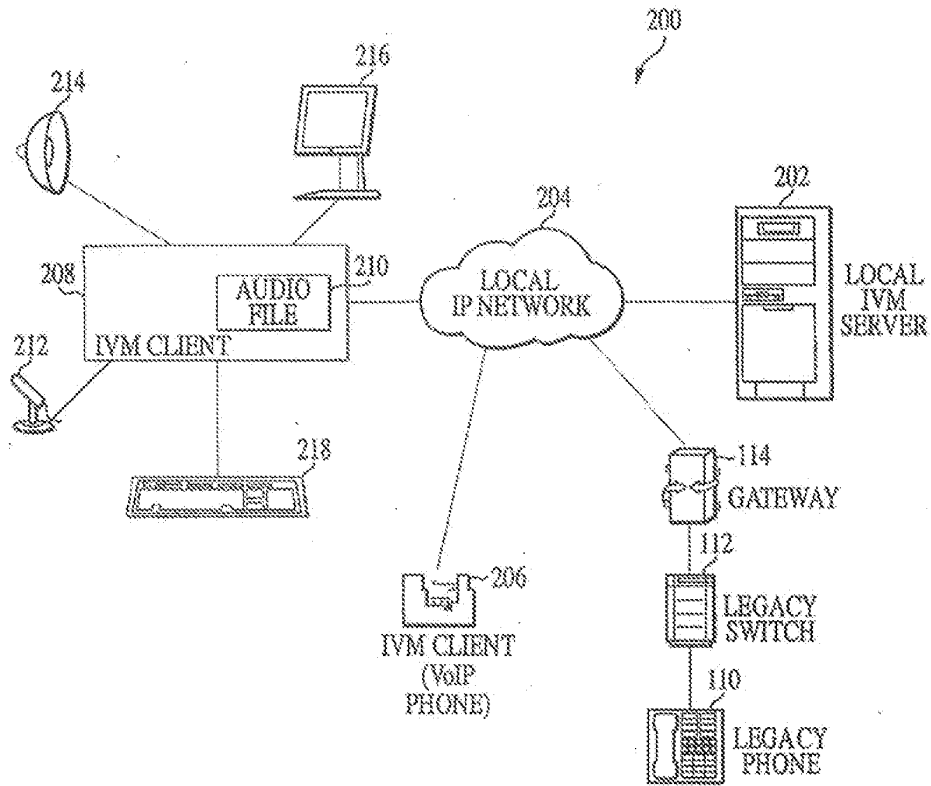

FIG. 2

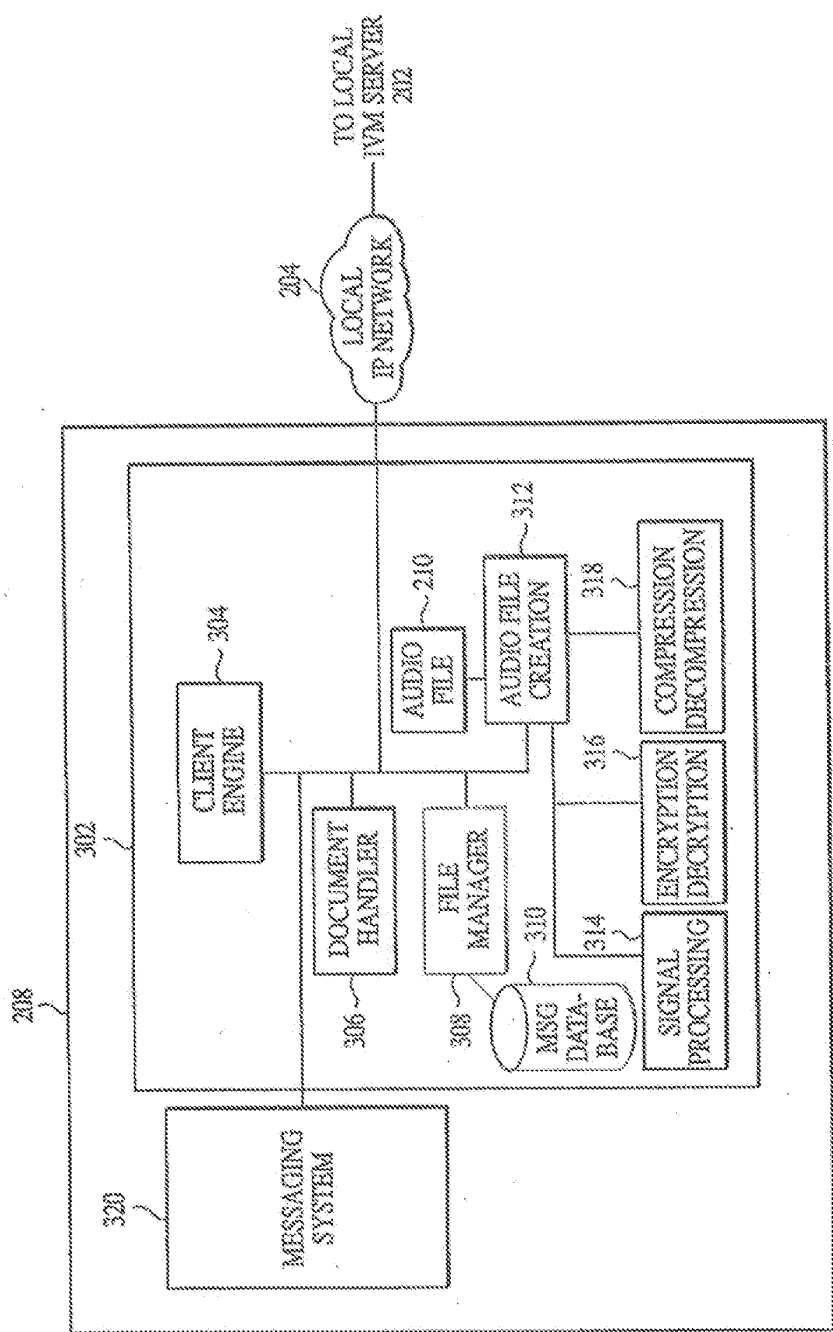

FIG. 3

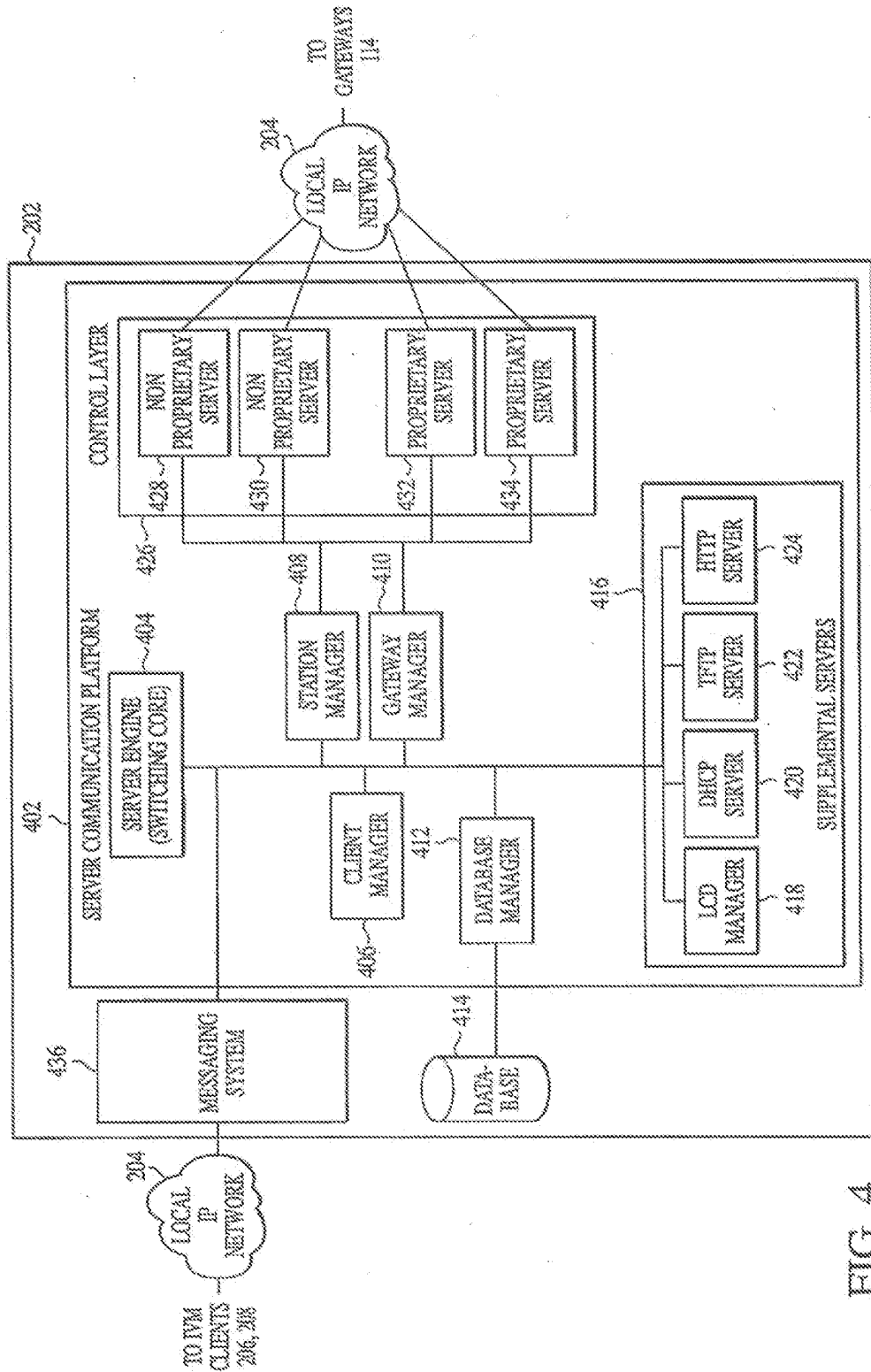

FIG. 4

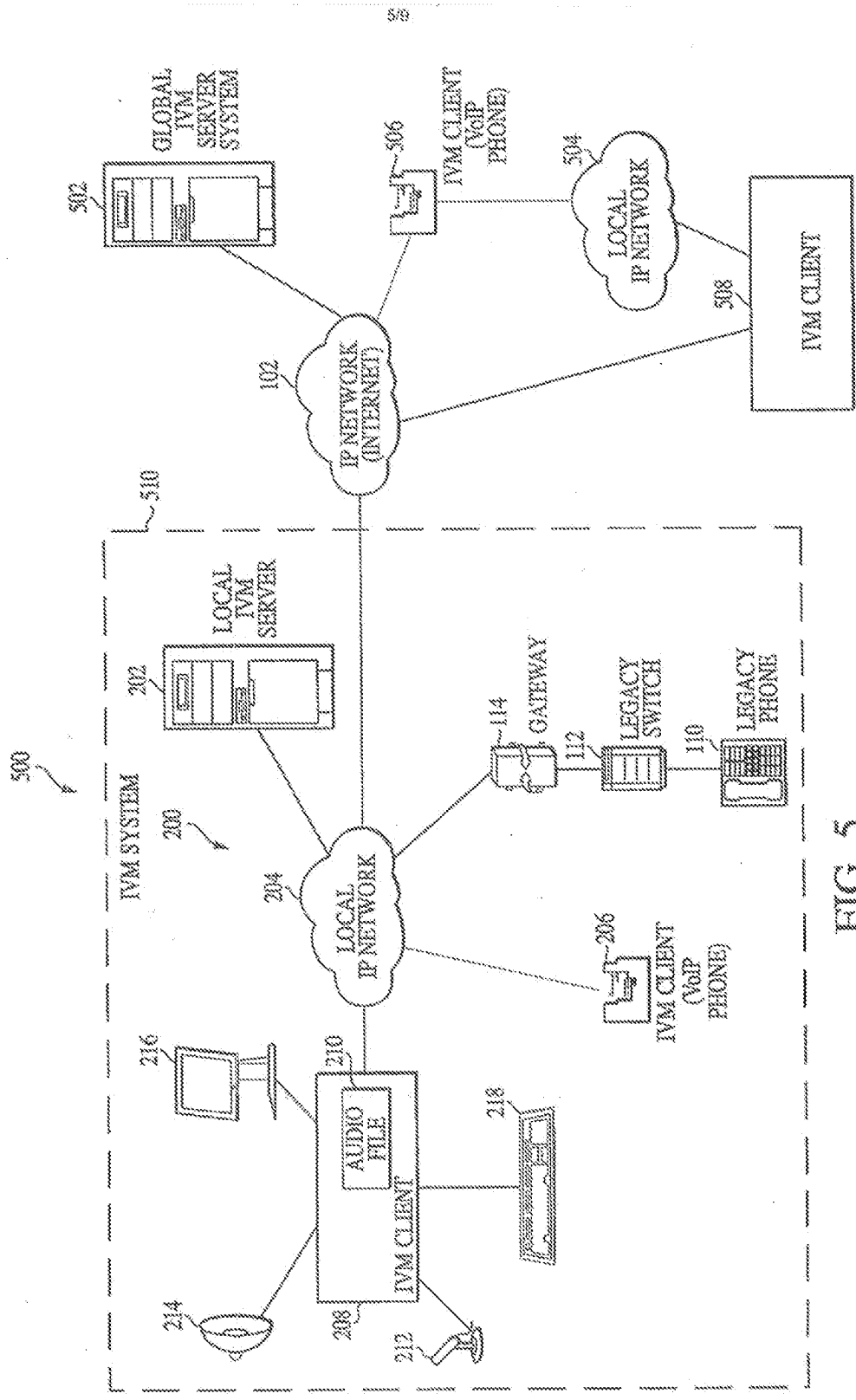

FIG. 5

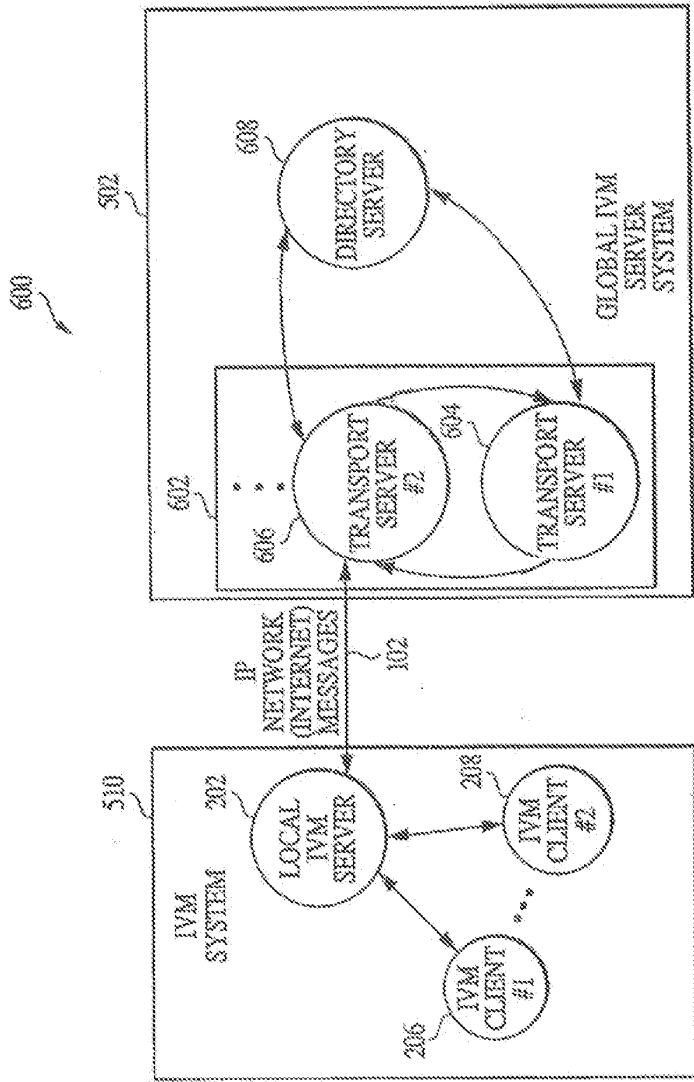

FIG. 6

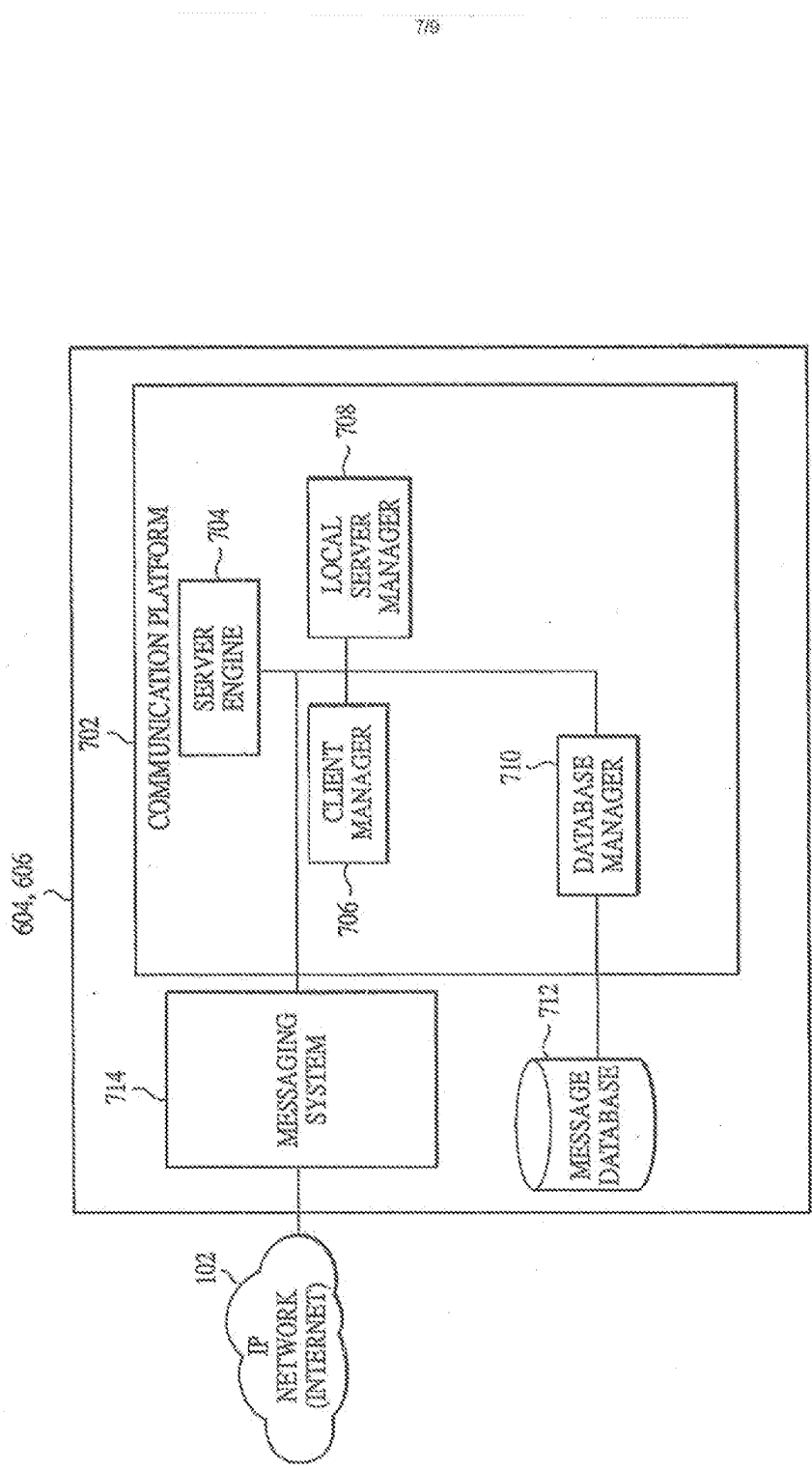

FIG. 7

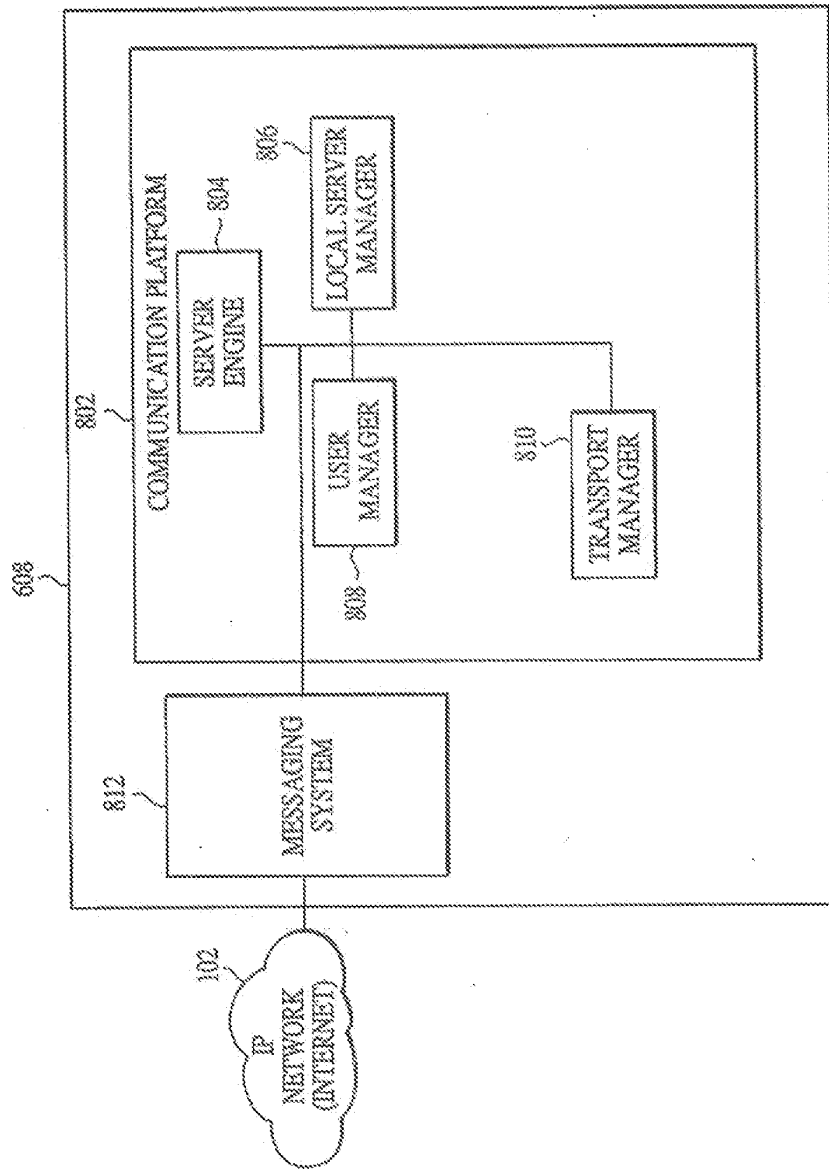

FIG. 8

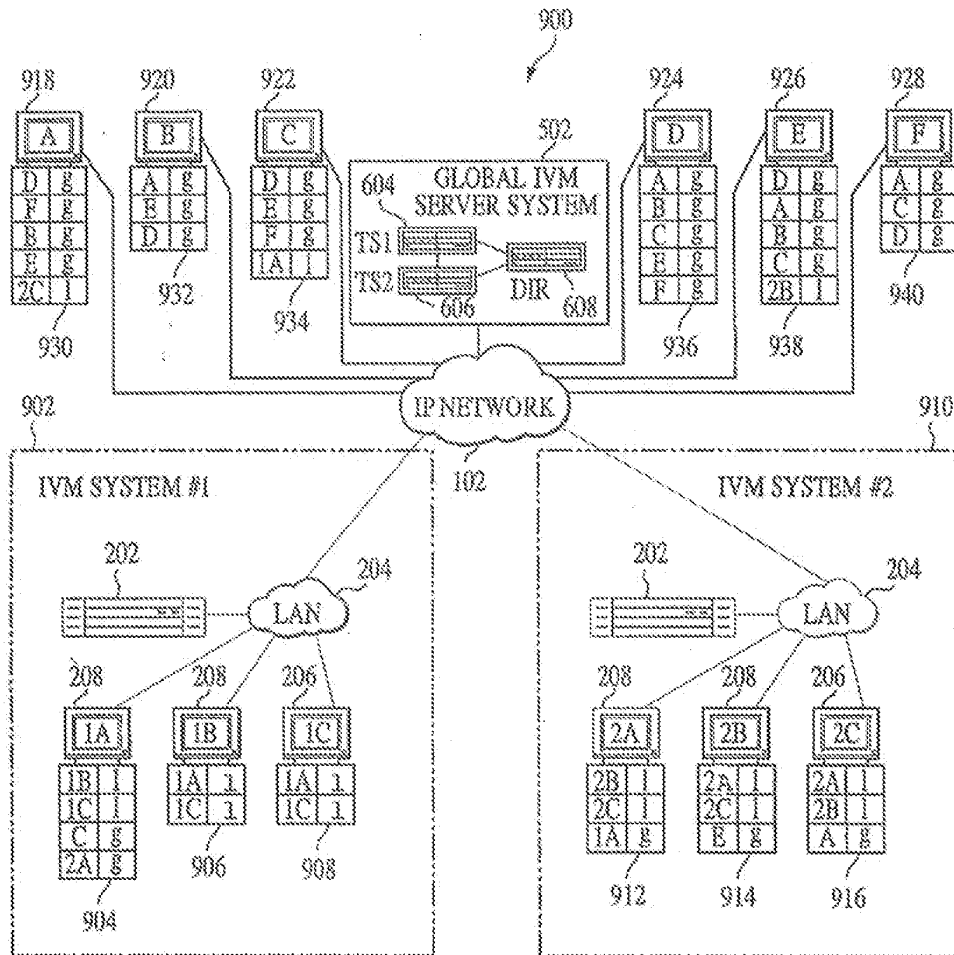

FIG. 9

INFORMATION DISCLOSURE STATEMENT BY APPLICANT (Not for submission under 37 CFR 1.99)	Application Number		14224125	
	Filing Date		2014-03-25	
	First Named Inventor	Michael J. Rojas		
	Art Unit			
	Examiner Name			
	Attorney Docket Number		EMP0025-US	

U.S. PATENTS						Remove
Examiner Initial*	Cite No	Patent Number	Kind Code ¹	Issue Date	Name of Patentee or Applicant of cited Document	Pages, Columns, Lines where Relevant Passages or Relevant Figures Appear
	1	6763226	B1	2004-07-13	McZela, Jr.	Entire document
	2	7535890	B2	2009-05-19	Rojas	Entire document
	3	8199747	B2	2012-06-12	Rojas	Entire document
	4	8243723	B2	2012-08-14	Rojas	Entire document

If you wish to add additional U.S. Patent citation information please click the Add button. **Add**

U.S. PATENT APPLICATION PUBLICATIONS						Remove
Examiner Initial*	Cite No	Publication Number	Kind Code ¹	Publication Date	Name of Patentee or Applicant of cited Document	Pages, Columns, Lines where Relevant Passages or Relevant Figures Appear
	1	20040252679	A1	2004-12-16	Williams et al.	Entire document
	2	20040122906	A1	2004-06-24	Goodman et al.	Entire document

INFORMATION DISCLOSURE STATEMENT BY APPLICANT (Not for submission under 37 CFR 1.99)	Application Number		14224125	
	Filing Date		2014-03-25	
	First Named Inventor	Michael J. Rojas		
	Art Unit			
	Examiner Name			
	Attorney Docket Number		EMP0025-US	

	3	20050053230	A1	2005-03-10	Gierachf	Entire document
	4	20050105697	A1	2005-05-19	Hollowell et al.	Entire document
	5	20030087632	A1	2003-05-08	Sagi et al.	Entire document
	6	20060268750	A1	2006-11-30	Weiner	Entire document
	7	20040030046	A1	2004-02-12	Schultes et al.	Entire document
	8	20070112925	A1	2007-05-17	Malik	Entire document
	9	20070174403	A1	2007-07-26	Barry	Entire document
	10	20060167883	A1	2006-07-27	Boukobza	Entire document
	11	20040128356	A1	2004-07-01	Bernstein et al.	Entire document
	12	20030126207	A1	2003-07-03	Creamer et al.	Entire document
	13	20080298309	A1	2008-12-04	DePietro et al.	Entire document

INFORMATION DISCLOSURE STATEMENT BY APPLICANT (Not for submission under 37 CFR 1.99)	Application Number		14224125	
	Filing Date		2014-03-25	
	First Named Inventor	Michael J. Rojas		
	Art Unit			
	Examiner Name			
	Attorney Docket Number		EMP0025-US	

	14	20040224678	A1	2004-11-11	Dahod et al.	Entire document
	15	20040014456	A1	2004-01-22	Vaananen	Entire document
	16	20100070275	A1	2012-03-18	Cast	Entire document
	17	20040179092	A1	2004-09-16	LaPoint	Entire document
	18	20040085456	A1	2004-05-06	Kwag et al.	Entire document
	19	20040223599	A1	2004-11-11	Bear et al.	Entire document
	20	20050117591	A1	2005-06-02	Hurta et al.	Entire document
	21	20130279681	A1	2013-10-24	Weiner	Entire document
	22	20120275452	A1	2012-11-01	Rojas	Entire document

If you wish to add additional U.S. Published Application citation information please click the Add button. [Add](#)

FOREIGN PATENT DOCUMENTS								Remove
Examiner Initial*	Cite No	Foreign Document Number ³	Country Code ² j	Kind Code ⁴	Publication Date	Name of Patentee or Applicant of cited Document	Pages, Columns, Lines where Relevant Passages or Relevant Figures Appear	T ⁵

INFORMATION DISCLOSURE STATEMENT BY APPLICANT (Not for submission under 37 CFR 1.99)	Application Number	14224125
	Filing Date	2014-03-25
	First Named Inventor	Michael J. Rojas
	Art Unit	
	Examiner Name	
	Attorney Docket Number	EMP0025-US

	1								<input type="checkbox"/>
--	---	--	--	--	--	--	--	--	--------------------------

If you wish to add additional Foreign Patent Document citation information please click the Add button **Add**

NON-PATENT LITERATURE DOCUMENTS

Remove

Examiner Initials*	Cite No	Include name of the author (in CAPITAL LETTERS), title of the article (when appropriate), title of the item (book, magazine, journal, serial, symposium, catalog, etc), date, pages(s), volume-issue number(s), publisher, city and/or country where published.	T ⁵
	1	http://www.cisco.com/warp/public/cc/pd/nemnsw/callmn/prodlit/cm33_ds.htm ; "Data Sheet Cisco CallManager Version 3.3".	<input checked="" type="checkbox"/>
	2	http://www.cisco.com/en/US/products/hw/switches/ps1925/products_data_sheet_09186_a00800a3c3d.html ; "Data Sheet Cisco MGX 8000 Series".	<input checked="" type="checkbox"/>
	3	http://www.hsteliann.com/english/?zone=3100-V21P ; "Telephone 3100-V21P".	<input checked="" type="checkbox"/>
	4	http://www.linuxdevices.com/articles/AT5199947519.html ; "Device Profile: snom 100 VoIP phone".	<input checked="" type="checkbox"/>
	5	http://www.pingtel.com/pr_xpressa.jsp ; "No limits with the advanced industry standard SIP phone".	<input checked="" type="checkbox"/>
	6	AudioCoded Enabling Technology Products, TPM-1100 VoP Media Gateway Modules.	<input checked="" type="checkbox"/>

If you wish to add additional non-patent literature document citation information please click the Add button **Add**

EXAMINER SIGNATURE

Examiner Signature		Date Considered	
--------------------	--	-----------------	--

*EXAMINER: Initial if reference considered, whether or not citation is in conformance with MPEP 609. Draw line through a citation if not in conformance and not considered. Include copy of this form with next communication to applicant.

INFORMATION DISCLOSURE STATEMENT BY APPLICANT (Not for submission under 37 CFR 1.99)	Application Number	14224125
	Filing Date	2014-03-25
	First Named Inventor	Michael J. Rojas
	Art Unit	
	Examiner Name	
	Attorney Docket Number	EMP0025-US

¹ See Kind Codes of USPTO Patent Documents at www.USPTO.GOV or MPEP 901.04. ² Enter office that issued the document, by the two-letter code (WIPO Standard ST.3). ³ For Japanese patent documents, the indication of the year of the reign of the Emperor must precede the serial number of the patent document. ⁴ Kind of document by the appropriate symbols as indicated on the document under WIPO Standard ST.16 if possible. ⁵ Applicant is to place a check mark here if English language translation is attached.

INFORMATION DISCLOSURE STATEMENT BY APPLICANT (Not for submission under 37 CFR 1.99)	Application Number	14224125
	Filing Date	2014-03-25
	First Named Inventor	Michael J. Rojas
	Art Unit	
	Examiner Name	
	Attorney Docket Number	EMP0025-US

CERTIFICATION STATEMENT

Please see 37 CFR 1.97 and 1.98 to make the appropriate selection(s):

That each item of information contained in the information disclosure statement was first cited in any communication from a foreign patent office in a counterpart foreign application not more than three months prior to the filing of the information disclosure statement. See 37 CFR 1.97(e)(1).

OR

That no item of information contained in the information disclosure statement was cited in a communication from a foreign patent office in a counterpart foreign application, and, to the knowledge of the person signing the certification after making reasonable inquiry, no item of information contained in the information disclosure statement was known to any individual designated in 37 CFR 1.56(c) more than three months prior to the filing of the information disclosure statement. See 37 CFR 1.97(e)(2).

See attached certification statement.

The fee set forth in 37 CFR 1.17 (p) has been submitted herewith.

A certification statement is not submitted herewith.

SIGNATURE

A signature of the applicant or representative is required in accordance with CFR 1.33, 10.18. Please see CFR 1.4(d) for the form of the signature.

Signature	/Kelly L. Kasha/	Date (YYYY-MM-DD)	2014-03-25
Name/Print	Kelly L. Kasha	Registration Number	47743

This collection of information is required by 37 CFR 1.97 and 1.98. The information is required to obtain or retain a benefit by the public which is to file (and by the USPTO to process) an application. Confidentiality is governed by 35 U.S.C. 122 and 37 CFR 1.14. This collection is estimated to take 1 hour to complete, including gathering, preparing and submitting the completed application form to the USPTO. Time will vary depending upon the individual case. Any comments on the amount of time you require to complete this form and/or suggestions for reducing this burden, should be sent to the Chief Information Officer, U.S. Patent and Trademark Office, U.S. Department of Commerce, P.O. Box 1450, Alexandria, VA 22313-1450. **DO NOT SEND FEES OR COMPLETED FORMS TO THIS ADDRESS. SEND TO: Commissioner for Patents, P.O. Box 1450, Alexandria, VA 22313-1450.**

Privacy Act Statement

The Privacy Act of 1974 (P.L. 93-579) requires that you be given certain information in connection with your submission of the attached form related to a patent application or patent. Accordingly, pursuant to the requirements of the Act, please be advised that: (1) the general authority for the collection of this information is 35 U.S.C. 2(b)(2); (2) furnishing of the information solicited is voluntary; and (3) the principal purpose for which the information is used by the U.S. Patent and Trademark Office is to process and/or examine your submission related to a patent application or patent. If you do not furnish the requested information, the U.S. Patent and Trademark Office may not be able to process and/or examine your submission, which may result in termination of proceedings or abandonment of the application or expiration of the patent.

The information provided by you in this form will be subject to the following routine uses:

1. The information on this form will be treated confidentially to the extent allowed under the Freedom of Information Act (5 U.S.C. 552) and the Privacy Act (5 U.S.C. 552a). Records from this system of records may be disclosed to the Department of Justice to determine whether the Freedom of Information Act requires disclosure of these records.
2. A record from this system of records may be disclosed, as a routine use, in the course of presenting evidence to a court, magistrate, or administrative tribunal, including disclosures to opposing counsel in the course of settlement negotiations.
3. A record in this system of records may be disclosed, as a routine use, to a Member of Congress submitting a request involving an individual, to whom the record pertains, when the individual has requested assistance from the Member with respect to the subject matter of the record.
4. A record in this system of records may be disclosed, as a routine use, to a contractor of the Agency having need for the information in order to perform a contract. Recipients of information shall be required to comply with the requirements of the Privacy Act of 1974, as amended, pursuant to 5 U.S.C. 552a(m).
5. A record related to an International Application filed under the Patent Cooperation Treaty in this system of records may be disclosed, as a routine use, to the International Bureau of the World Intellectual Property Organization, pursuant to the Patent Cooperation Treaty.
6. A record in this system of records may be disclosed, as a routine use, to another federal agency for purposes of National Security review (35 U.S.C. 181) and for review pursuant to the Atomic Energy Act (42 U.S.C. 218(c)).
7. A record from this system of records may be disclosed, as a routine use, to the Administrator, General Services, or his/her designee, during an inspection of records conducted by GSA as part of that agency's responsibility to recommend improvements in records management practices and programs, under authority of 44 U.S.C. 2904 and 2906. Such disclosure shall be made in accordance with the GSA regulations governing inspection of records for this purpose, and any other relevant (i.e., GSA or Commerce) directive. Such disclosure shall not be used to make determinations about individuals.
8. A record from this system of records may be disclosed, as a routine use, to the public after either publication of the application pursuant to 35 U.S.C. 122(b) or issuance of a patent pursuant to 35 U.S.C. 151. Further, a record may be disclosed, subject to the limitations of 37 CFR 1.14, as a routine use, to the public if the record was filed in an application which became abandoned or in which the proceedings were terminated and which application is referenced by either a published application, an application open to public inspections or an issued patent.
9. A record from this system of records may be disclosed, as a routine use, to a Federal, State, or local law enforcement agency, if the USPTO becomes aware of a violation or potential violation of law or regulation.

Electronic Acknowledgement Receipt

EFS ID:	18571725
Application Number:	14224125
International Application Number:	
Confirmation Number:	5407
Title of Invention:	System and Method for Instant VoIP Messaging
First Named Inventor/Applicant Name:	Michael J. Rojas
Customer Number:	67050
Filer:	John Kasha
Filer Authorized By:	
Attorney Docket Number:	EMP0025-US
Receipt Date:	25-MAR-2014
Filing Date:	
Time Stamp:	10:30:31
Application Type:	Utility under 35 USC 111(a)

Payment information:

Submitted with Payment	no
------------------------	----

File Listing:

Document Number	Document Description	File Name	File Size(Bytes)/ Message Digest	Multi Part /.zip	Pages (if appl.)
1	Information Disclosure Statement (IDS) Form (SB08)	EMP0025-US_ids.pdf	613493 4145add3ed1a8b5f32edfd48e25dca0ca374785	no	7

Warnings:

Information:

2	Non Patent Literature	NPL1_cisco_callmanager.pdf	324296 a6aea42770529b5bd09158b4394ac5518e9b5bd3	no	10
Warnings:					
Information:					
3	Non Patent Literature	NPL2_cisco_mgx8000.pdf	328942 482e87e74cd9819a9dc5fac0a24dca2c82503b74	no	8
Warnings:					
Information:					
4	Non Patent Literature	NPL3_telephone.pdf	70533 c096f72c0691218abf2bb6184d6c005dbe98f62	no	3
Warnings:					
Information:					
5	Non Patent Literature	NPL4_linux.pdf	230478 36c14710441a9efb5f0b9582d5fe8c01f6bc0b70	no	3
Warnings:					
Information:					
6	Non Patent Literature	NPL5_pingtel.pdf	43038 c23dc63d47fb995bbd6d698e93a308256bd5c9d5	no	1
Warnings:					
Information:					
7	Non Patent Literature	NPL6_tpm1100.pdf	229589 6912fa549e16a14bcc00b742e4c2d2d0f3f28c07	no	2
Warnings:					
Information:					
Total Files Size (in bytes):				1840369	

This Acknowledgement Receipt evidences receipt on the noted date by the USPTO of the indicated documents, characterized by the applicant, and including page counts, where applicable. It serves as evidence of receipt similar to a Post Card, as described in MPEP 503.

New Applications Under 35 U.S.C. 111

If a new application is being filed and the application includes the necessary components for a filing date (see 37 CFR 1.53(b)-(d) and MPEP 506), a Filing Receipt (37 CFR 1.54) will be issued in due course and the date shown on this Acknowledgement Receipt will establish the filing date of the application.

National Stage of an International Application under 35 U.S.C. 371

If a timely submission to enter the national stage of an international application is compliant with the conditions of 35 U.S.C. 371 and other applicable requirements a Form PCT/DO/EO/903 indicating acceptance of the application as a national stage submission under 35 U.S.C. 371 will be issued in addition to the Filing Receipt, in due course.

New International Application Filed with the USPTO as a Receiving Office

If a new international application is being filed and the international application includes the necessary components for an international filing date (see PCT Article 11 and MPEP 1810), a Notification of the International Application Number and of the International Filing Date (Form PCT/RO/105) will be issued in due course, subject to prescriptions concerning national security, and the date shown on this Acknowledgement Receipt will establish the international filing date of the application.

Under the Paperwork Reduction Act of 1995, no persons are required to respond to a collection of information unless it displays a valid OMB control number.

PATENT APPLICATION FEE DETERMINATION RECORD Substitute for Form PTO-875				Application or Docket Number 14/224,125		Filing Date 03/25/2014		<input type="checkbox"/> To be Mailed		
ENTITY: <input type="checkbox"/> LARGE <input checked="" type="checkbox"/> SMALL <input type="checkbox"/> MICRO										
APPLICATION AS FILED – PART I										
(Column 1)			(Column 2)							
FOR		NUMBER FILED	NUMBER EXTRA		RATE (\$)		FEE (\$)			
<input type="checkbox"/> BASIC FEE (37 CFR 1.16(a), (b), or (c))		N/A	N/A		N/A					
<input type="checkbox"/> SEARCH FEE (37 CFR 1.16(k), (l), or (m))		N/A	N/A		N/A					
<input type="checkbox"/> EXAMINATION FEE (37 CFR 1.16(o), (p), or (q))		N/A	N/A		N/A					
TOTAL CLAIMS (37 CFR 1.16(j))		minus 20 =	*		X \$ =					
INDEPENDENT CLAIMS (37 CFR 1.16(h))		minus 3 =	*		X \$ =					
<input type="checkbox"/> APPLICATION SIZE FEE (37 CFR 1.16(s))		If the specification and drawings exceed 100 sheets of paper, the application size fee due is \$310 (\$155 for small entity) for each additional 50 sheets or fraction thereof. See 35 U.S.C. 41(a)(1)(G) and 37 CFR 1.16(s).								
<input type="checkbox"/> MULTIPLE DEPENDENT CLAIM PRESENT (37 CFR 1.16(j))										
* If the difference in column 1 is less than zero, enter "0" in column 2.					TOTAL					
APPLICATION AS AMENDED – PART II										
(Column 1)			(Column 2)			(Column 3)				
AMENDMENT	01/22/2014		CLAIMS REMAINING AFTER AMENDMENT		HIGHEST NUMBER PREVIOUSLY PAID FOR	PRESENT EXTRA	RATE (\$)		ADDITIONAL FEE (\$)	
	Total (37 CFR 1.16(i))		* 28	Minus	** 30	= 0	X \$40 =		0	
	Independent (37 CFR 1.16(h))		* 2	Minus	*** 3	= 0	X \$210 =		0	
	<input type="checkbox"/> Application Size Fee (37 CFR 1.16(s))									
	<input type="checkbox"/> FIRST PRESENTATION OF MULTIPLE DEPENDENT CLAIM (37 CFR 1.16(j))									
							TOTAL ADD'L FEE		0	
(Column 1)			(Column 2)			(Column 3)				
AMENDMENT			CLAIMS REMAINING AFTER AMENDMENT		HIGHEST NUMBER PREVIOUSLY PAID FOR	PRESENT EXTRA	RATE (\$)		ADDITIONAL FEE (\$)	
	Total (37 CFR 1.16(i))		*	Minus	**	=	X \$ =			
	Independent (37 CFR 1.16(h))		*	Minus	***	=	X \$ =			
	<input type="checkbox"/> Application Size Fee (37 CFR 1.16(s))									
	<input type="checkbox"/> FIRST PRESENTATION OF MULTIPLE DEPENDENT CLAIM (37 CFR 1.16(j))									
							TOTAL ADD'L FEE			
<p>* If the entry in column 1 is less than the entry in column 2, write "0" in column 3. ** If the "Highest Number Previously Paid For" IN THIS SPACE is less than 20, enter "20". *** If the "Highest Number Previously Paid For" IN THIS SPACE is less than 3, enter "3". The "Highest Number Previously Paid For" (Total or Independent) is the highest number found in the appropriate box in column 1.</p>										

LIE
/DEANNA RORIE/

This collection of information is required by 37 CFR 1.16. The information is required to obtain or retain a benefit by the public which is to file (and by the USPTO to process) an application. Confidentiality is governed by 35 U.S.C. 122 and 37 CFR 1.14. This collection is estimated to take 12 minutes to complete, including gathering, preparing, and submitting the completed application form to the USPTO. Time will vary depending upon the individual case. Any comments on the amount of time you require to complete this form and/or suggestions for reducing this burden, should be sent to the Chief Information Officer, U.S. Patent and Trademark Office, U.S. Department of Commerce, P.O. Box 1450, Alexandria, VA 22313-1450. DO NOT SEND FEES OR COMPLETED FORMS TO THIS ADDRESS. **SEND TO: Commissioner for Patents, P.O. Box 1450, Alexandria, VA 22313-1450.**

If you need assistance in completing the form, call 1-800-PTO-9199 and select option 2.



UNITED STATES PATENT AND TRADEMARK OFFICE

UNITED STATES DEPARTMENT OF COMMERCE
United States Patent and Trademark Office
Address: COMMISSIONER FOR PATENTS
P.O. Box 1450
Alexandria, Virginia 22313-1450
www.uspto.gov

APPLICATION NUMBER	FILING OR 371(C) DATE	FIRST NAMED APPLICANT	ATTY. DOCKET NO./TITLE
14/224,125	03/25/2014	Michael J. Rojas	UN-NP-IT-196

CONFIRMATION NO. 5407

POA ACCEPTANCE LETTER



96051
Uniloc USA Inc.
Legacy Town Center
7160 Dallas Parkway
Suite 380
Plano, TX 75024

Date Mailed: 09/27/2016

NOTICE OF ACCEPTANCE OF POWER OF ATTORNEY

This is in response to the Power of Attorney filed 09/15/2016.

The Power of Attorney in this application is accepted. Correspondence in this application will be mailed to the above address as provided by 37 CFR 1.33.

Questions about the contents of this notice and the requirements it sets forth should be directed to the Office of Data Management, Application Assistance Unit, at (571) 272-4000 or (571) 272-4200 or 1-888-786-0101.

/dtvernon/



UNITED STATES PATENT AND TRADEMARK OFFICE

UNITED STATES DEPARTMENT OF COMMERCE
United States Patent and Trademark Office
Address: COMMISSIONER FOR PATENTS
P.O. Box 1450
Alexandria, Virginia 22313-1450
www.uspto.gov

APPLICATION NUMBER	FILING OR 371(C) DATE	FIRST NAMED APPLICANT	ATTY. DOCKET NO./TITLE
14/224,125	03/25/2014	Michael J. Rojas	EMP0025-US

CONFIRMATION NO. 5407

POWER OF ATTORNEY NOTICE

67050
KASHA LAW LLC
14532 Dufief Mill Road
North Potomac, MD 20878



Date Mailed: 09/27/2016

NOTICE REGARDING CHANGE OF POWER OF ATTORNEY

This is in response to the Power of Attorney filed 09/15/2016.

- The Power of Attorney to you in this application has been revoked by the assignee who has intervened as provided by 37 CFR 3.71. Future correspondence will be mailed to the new address of record(37 CFR 1.33).

Questions about the contents of this notice and the requirements it sets forth should be directed to the Office of Data Management, Application Assistance Unit, at (571) 272-4000 or (571) 272-4200 or 1-888-786-0101.

/dtvernon/

AO 120 (Rev. 08/10)

TO: Mail Stop 8 Director of the U.S. Patent and Trademark Office P.O. Box 1450 Alexandria, VA 22313-1450	REPORT ON THE FILING OR DETERMINATION OF AN ACTION REGARDING A PATENT OR TRADEMARK
---	---

In Compliance with 35 U.S.C. § 290 and/or 15 U.S.C. § 1116 you are hereby advised that a court action has been filed in the U.S. District Court Eastern District of Texas, Marshall Division on the following

Trademarks or Patents. (the patent action involves 35 U.S.C. § 292.):

DOCKET NO. 2:16-cv-989	DATE FILED 9/6/2016	U.S. DISTRICT COURT Eastern District of Texas, Marshall Division
PLAINTIFF UNILOC USA, INC., and UNILOC LUXEMBOURG, S.A.		DEFENDANT HTC AMERICA, INC.
PATENT OR TRADEMARK NO.	DATE OF PATENT OR TRADEMARK	HOLDER OF PATENT OR TRADEMARK
1 7,535,890	5/19/2009	UNILOC LUXEMBOURG, S.A.
2 8,199,747	6/12/2012	UNILOC LUXEMBOURG, S.A.
3 8,724,622	5/13/2014	UNILOC LUXEMBOURG, S.A.
4 8,995,433	3/31/2015	UNILOC LUXEMBOURG, S.A.
5		

In the above—entitled case, the following patent(s)/ trademark(s) have been included:

DATE INCLUDED	INCLUDED BY <input type="checkbox"/> Amendment <input type="checkbox"/> Answer <input type="checkbox"/> Cross Bill <input type="checkbox"/> Other Pleading	
PATENT OR TRADEMARK NO.	DATE OF PATENT OR TRADEMARK	HOLDER OF PATENT OR TRADEMARK
1		
2		
3		
4		
5		

In the above—entitled case, the following decision has been rendered or judgement issued:

DECISION/JUDGEMENT

CLERK	(BY) DEPUTY CLERK	DATE
-------	-------------------	------

Copy 1—Upon initiation of action, mail this copy to Director Copy 3—Upon termination of action, mail this copy to Director
 Copy 2—Upon filing document adding patent(s), mail this copy to Director Copy 4—Case file copy

AO 120 (Rev. 08/10)

TO: Mail Stop 8 Director of the U.S. Patent and Trademark Office P.O. Box 1450 Alexandria, VA 22313-1450	REPORT ON THE FILING OR DETERMINATION OF AN ACTION REGARDING A PATENT OR TRADEMARK
---	---

In Compliance with 35 U.S.C. § 290 and/or 15 U.S.C. § 1116 you are hereby advised that a court action has been filed in the U.S. District Court Eastern District of Texas, Marshall Division on the following

Trademarks or Patents. (the patent action involves 35 U.S.C. § 292.):

DOCKET NO. 2:16-cv-990	DATE FILED 9/6/2016	U.S. DISTRICT COURT Eastern District of Texas, Marshall Division
PLAINTIFF UNILOC USA, INC., and UNILOC LUXEMBOURG, S.A.		DEFENDANT KYOCERA AMERICA, INC. and § KYOCERA COMMUNICATIONS, INC.,
PATENT OR TRADEMARK NO.	DATE OF PATENT OR TRADEMARK	HOLDER OF PATENT OR TRADEMARK
1 7,535,890	5/19/2009	UNILOC LUXEMBOURG, S.A.
2 8,199,747	6/12/2012	UNILOC LUXEMBOURG, S.A.
3 8,724,622	5/13/2014	UNILOC LUXEMBOURG, S.A.
4 8,995,433	3/31/2015	UNILOC LUXEMBOURG, S.A.
5		

In the above—entitled case, the following patent(s)/ trademark(s) have been included:

DATE INCLUDED	INCLUDED BY <input type="checkbox"/> Amendment <input type="checkbox"/> Answer <input type="checkbox"/> Cross Bill <input type="checkbox"/> Other Pleading	
PATENT OR TRADEMARK NO.	DATE OF PATENT OR TRADEMARK	HOLDER OF PATENT OR TRADEMARK
1		
2		
3		
4		
5		

In the above—entitled case, the following decision has been rendered or judgement issued:

DECISION/JUDGEMENT

CLERK	(BY) DEPUTY CLERK	DATE
-------	-------------------	------

Copy 1—Upon initiation of action, mail this copy to Director Copy 3—Upon termination of action, mail this copy to Director
 Copy 2—Upon filing document adding patent(s), mail this copy to Director Copy 4—Case file copy

AO 120 (Rev. 08/10)

TO: Mail Stop 8 Director of the U.S. Patent and Trademark Office P.O. Box 1450 Alexandria, VA 22313-1450	REPORT ON THE FILING OR DETERMINATION OF AN ACTION REGARDING A PATENT OR TRADEMARK
---	---

In Compliance with 35 U.S.C. § 290 and/or 15 U.S.C. § 1116 you are hereby advised that a court action has been filed in the U.S. District Court Eastern District of Texas, Marshall Division on the following

Trademarks or Patents. (the patent action involves 35 U.S.C. § 292.):

DOCKET NO. 2:16-cv-991	DATE FILED 9/6/2016	U.S. DISTRICT COURT Eastern District of Texas, Marshall Division
PLAINTIFF UNILOC USA, INC., and UNILOC LUXEMBOURG, S.A.		DEFENDANT LG ELECTRONICS U.S.A., INC.,
PATENT OR TRADEMARK NO.	DATE OF PATENT OR TRADEMARK	HOLDER OF PATENT OR TRADEMARK
1 7,535,890	5/19/2009	UNILOC LUXEMBOURG, S.A.
2 8,199,747	6/12/2012	UNILOC LUXEMBOURG, S.A.
3 8,724,622	5/13/2014	UNILOC LUXEMBOURG, S.A.
4 8,995,433	3/31/2015	UNILOC LUXEMBOURG, S.A.
5		

In the above—entitled case, the following patent(s)/ trademark(s) have been included:

DATE INCLUDED	INCLUDED BY <input type="checkbox"/> Amendment <input type="checkbox"/> Answer <input type="checkbox"/> Cross Bill <input type="checkbox"/> Other Pleading	
PATENT OR TRADEMARK NO.	DATE OF PATENT OR TRADEMARK	HOLDER OF PATENT OR TRADEMARK
1		
2		
3		
4		
5		

In the above—entitled case, the following decision has been rendered or judgement issued:

DECISION/JUDGEMENT

CLERK	(BY) DEPUTY CLERK	DATE
-------	-------------------	------

Copy 1—Upon initiation of action, mail this copy to Director Copy 3—Upon termination of action, mail this copy to Director
 Copy 2—Upon filing document adding patent(s), mail this copy to Director Copy 4—Case file copy

AO 120 (Rev. 08/10)

TO: Mail Stop 8 Director of the U.S. Patent and Trademark Office P.O. Box 1450 Alexandria, VA 22313-1450	REPORT ON THE FILING OR DETERMINATION OF AN ACTION REGARDING A PATENT OR TRADEMARK
---	---

In Compliance with 35 U.S.C. § 290 and/or 15 U.S.C. § 1116 you are hereby advised that a court action has been filed in the U.S. District Court Eastern District of Texas, Marshall Division on the following

Trademarks or Patents. (the patent action involves 35 U.S.C. § 292.):

DOCKET NO. 2:16-cv-992	DATE FILED 9/6/2016	U.S. DISTRICT COURT Eastern District of Texas, Marshall Division
PLAINTIFF UNILOC USA, INC., and UNILOC LUXEMBOURG, S.A.		DEFENDANT MOTOROLA MOBILITY LLC
PATENT OR TRADEMARK NO.	DATE OF PATENT OR TRADEMARK	HOLDER OF PATENT OR TRADEMARK
1 7,535,890	5/19/2009	UNILOC LUXEMBOURG, S.A.
2 8,199,747	6/12/2012	UNILOC LUXEMBOURG, S.A.
3 8,724,622	5/13/2014	UNILOC LUXEMBOURG, S.A.
4 8,995,433	3/31/2015	UNILOC LUXEMBOURG, S.A.
5		

In the above—entitled case, the following patent(s)/ trademark(s) have been included:

DATE INCLUDED	INCLUDED BY <input type="checkbox"/> Amendment <input type="checkbox"/> Answer <input type="checkbox"/> Cross Bill <input type="checkbox"/> Other Pleading	
PATENT OR TRADEMARK NO.	DATE OF PATENT OR TRADEMARK	HOLDER OF PATENT OR TRADEMARK
1		
2		
3		
4		
5		

In the above—entitled case, the following decision has been rendered or judgement issued:

DECISION/JUDGEMENT

CLERK	(BY) DEPUTY CLERK	DATE
-------	-------------------	------

Copy 1—Upon initiation of action, mail this copy to Director Copy 3—Upon termination of action, mail this copy to Director
 Copy 2—Upon filing document adding patent(s), mail this copy to Director Copy 4—Case file copy

Under the Paperwork Reduction Act of 1995, no persons are required to respond to a collection of information unless it displays a valid OMB control number.

"FEE ADDRESS" INDICATION FORM

Address to:
Mail Stop M Correspondence
Commissioner for Patents
P.O. Box 1450
Alexandria, VA 22313-1450

Fax to:
571-273-6500

- OR -

INSTRUCTIONS: The issue fee must have been paid for application(s) listed on this form. In addition, only an address represented by a Customer Number can be established as the fee address for maintenance fee purposes (hereafter, fee address). A fee address should be established when correspondence related to maintenance fees should be mailed to a different address than the correspondence address for the application. **When to check the first box below:** If you have a Customer Number to represent the fee address. **When to check the second box below:** If you have no Customer Number representing the desired fee address, in which case a completed Request for Customer Number (PTO/SB/125) must be attached to this form. For more information on Customer Numbers, see the Manual of Patent Examining Procedure (MPEP) § 403.

For the following listed application(s), please recognize as the "Fee Address" under the provisions of 37 CFR 1.363 the address associated with:

Customer Number: 96051

OR

The attached Request for Customer Number (PTO/SB/125) form.

PATENT NUMBER (if known)	APPLICATION NUMBER
8,995,433	14/224,125

Completed by (check one):

Applicant/Inventor

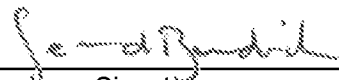

 Signature

Attorney or Agent of record 51,513
 (Reg. No.)

Sean D. Burdick

 Typed or printed name

Assignee of record of the entire interest. See 37 CFR 3.71.
 Statement under 37 CFR 3.73(b) is enclosed.
 (Form PTO/SB/96)

972-905-9580 x227

 Requester's telephone number

Assignee recorded at Reel _____ Frame _____

September 15, 2016

 Date

NOTE: Signatures of all the inventors or assignees of record of the entire interest or their representative(s) are required. Submit multiple forms if more than one signature is required, see below*.

* Total of _____ forms are submitted.

This collection of information is required by 37 CFR 1.363. The information is required to obtain or retain a benefit by the public which is to file (and by the USPTO to process) an application. Confidentiality is governed by 35 U.S.C. 122 and 37 CFR 1.11 and 1.14. This collection is estimated to take 5 minutes to complete, including gathering, preparing, and submitting the completed application form to the USPTO. Time will vary depending upon the individual case. Any comments on the amount of time you require to complete this form and/or suggestions for reducing this burden, should be sent to the Chief Information Officer, U.S. Patent and Trademark Office, U.S. Department of Commerce, P.O. Box 1450, Alexandria, VA 22313-1450. **DO NOT SEND COMPLETE D FORMS TO THIS ADDRESS. SEND TO: Mail Stop M Correspondence, Commissioner for Patents, P.O. Box 1450, Alexandria, VA 22313-1450.**

If you need assistance in completing the form, call 1-800-PTO-9199 and select option 2.

Under the Paperwork Reduction Act of 1995, no persons are required to respond to a collection of information unless it displays a valid OMB control number.

STATEMENT UNDER 37 CFR 3.73(b)

Applicant/Patent Owner: Uniloc Luxembourg S.A.

Application No./Patent No.: 8,995,433 Filed/Issue Date: March 31, 2015

Titled: SYSTEM AND METHOD FOR INSTANT VOIP MESSAGING

Uniloc Luxembourg S.A., a corporation
(Name of Assignee) (Type of Assignee, e.g., corporation, partnership, university, government agency, etc.)

states that it is:

- 1. the assignee of the entire right, title, and interest in;
- 2. an assignee of less than the entire right, title, and interest in
(The extent (by percentage) of its ownership interest is _____ %); or
- 3. the assignee of an undivided interest in the entirety of (a complete assignment from one of the joint inventors was made)

the patent application/patent identified above, by virtue of either:

A. An assignment from the inventor(s) of the patent application/patent identified above. The assignment was recorded in the United States Patent and Trademark Office at Reel _____, Frame _____, or for which a copy therefore is attached.

OR

B. A chain of title from the inventor(s), of the patent application/patent identified above, to the current assignee as follows:

1. From: Michael J. ROJAS To: Ayalogic, Inc.

The document was recorded in the United States Patent and Trademark Office at
Reel 014827, Frame 0059, or for which a copy thereof is attached.

2. From: Ayalogic, Inc. To: Empire IP LLC

The document was recorded in the United States Patent and Trademark Office at
Reel 032519, Frame 0087, or for which a copy thereof is attached.

3. From: Empire IP LLC To: Uniloc Luxembourg S.A.

The document was recorded in the United States Patent and Trademark Office at
Reel 038963, Frame 0343, or for which a copy thereof is attached.

Additional documents in the chain of title are listed on a supplemental sheet(s).

As required by 37 CFR 3.73(b)(1)(i), the documentary evidence of the chain of title from the original owner to the assignee was, or concurrently is being, submitted for recordation pursuant to 37 CFR 3.11.

[NOTE: A separate copy (i.e., a true copy of the original assignment document(s)) must be submitted to Assignment Division in accordance with 37 CFR Part 3, to record the assignment in the records of the USPTO. See MPEP 302.08]

The undersigned (whose title is supplied below) is authorized to act on behalf of the assignee.

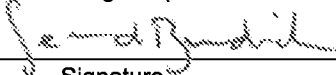
Signature

September 15, 2016
Date

Sean D. Burdick
Printed or Typed Name

IP Counsel for Uniloc Luxembourg S.A.
Title

Electronic Acknowledgement Receipt

EFS ID:	26942782
Application Number:	14224125
International Application Number:	
Confirmation Number:	5407
Title of Invention:	System and Method for Instant VoIP Messaging
First Named Inventor/Applicant Name:	Michael J. Rojas
Customer Number:	67050
Filer:	Sean Dylan Burdick/Kris Pangan
Filer Authorized By:	Sean Dylan Burdick
Attorney Docket Number:	EMP0025-US
Receipt Date:	15-SEP-2016
Filing Date:	25-MAR-2014
Time Stamp:	19:16:14
Application Type:	Utility under 35 USC 111(a)

Payment information:

Submitted with Payment	no
------------------------	----

File Listing:

Document Number	Document Description	File Name	File Size(Bytes)/ Message Digest	Multi Part /.zip	Pages (if appl.)
1	Power of Attorney	IT-196_Executed_POA.pdf	37828 4b4db22e3b09350c1339fa13332f324564339565	no	1

Warnings:

201

Information:					
2	Change of Address	IT-196_Fee_Address_Indication_Form.pdf	268642 9b1b6ea2107621549795660689b7de703e7043f8	no	1
Warnings:					
Information:					
3	Assignee showing of ownership per 37 CFR 3.73	IT-196_Statement_Under_37_CFR.pdf	528029 c0d4ae6cad3f5ce4a694269f584185ff68b136d1	no	1
Warnings:					
Information:					
Total Files Size (in bytes):				834499	
<p>This Acknowledgement Receipt evidences receipt on the noted date by the USPTO of the indicated documents, characterized by the applicant, and including page counts, where applicable. It serves as evidence of receipt similar to a Post Card, as described in MPEP 503.</p> <p><u>New Applications Under 35 U.S.C. 111</u> If a new application is being filed and the application includes the necessary components for a filing date (see 37 CFR 1.53(b)-(d) and MPEP 506), a Filing Receipt (37 CFR 1.54) will be issued in due course and the date shown on this Acknowledgement Receipt will establish the filing date of the application.</p> <p><u>National Stage of an International Application under 35 U.S.C. 371</u> If a timely submission to enter the national stage of an international application is compliant with the conditions of 35 U.S.C. 371 and other applicable requirements a Form PCT/DO/EO/903 indicating acceptance of the application as a national stage submission under 35 U.S.C. 371 will be issued in addition to the Filing Receipt, in due course.</p> <p><u>New International Application Filed with the USPTO as a Receiving Office</u> If a new international application is being filed and the international application includes the necessary components for an international filing date (see PCT Article 11 and MPEP 1810), a Notification of the International Application Number and of the International Filing Date (Form PCT/RO/105) will be issued in due course, subject to prescriptions concerning national security, and the date shown on this Acknowledgement Receipt will establish the international filing date of the application.</p>					

Under the Paperwork Reduction Act of 1995 no persons are required to respond to a collection of information unless it displays a valid OMB control number

PATENT - POWER OF ATTORNEY OR REVOCATION OF POWER OF ATTORNEY WITH A NEW POWER OF ATTORNEY AND CHANGE OF CORRESPONDENCE ADDRESS	Patent Number	8,995,433
	Issue Date	March 31, 2015
	First Named Inventor	Michael J. ROJAS
	Title	SYSTEM AND METHOD FOR INSTANT VOIP MESSAGING
	Attorney Docket No.	UN-NP-IT-196

I hereby revoke all previous powers of attorney given in the above-identified patent.

A Power of Attorney is submitted herewith.

OR

I hereby appoint Practitioner(s) associated with the Customer Number identified in the box at right as my/our attorney(s) or agent(s) with respect to the patent identified above, and to transact all business in the United States Patent and Trademark Office connected therewith: 96051

OR

I hereby appoint Practitioner(s) named below as my/our attorney(s) or agent(s) with respect to the patent identified above, and to transact all business in the United States Patent and Trademark Office connected therewith:

Practitioner(s) Name	Registration Number

Please recognize or change the correspondence address for the above-identified patent to:

The address associated with the above-identified Customer Number.

OR

The address associated with the Customer Number identified in the box at right:

OR

Firm or Individual Name

Address

City	State	Zip
Country		
Telephone	Email	

I am the:

Applicant.

OR

Patent owner.
 Statement under 37 CFR 3.73(c) (Form PTO/AIA/96) submitted herewith or filed on _____

SIGNATURE of Applicant or Patent Owner

Signature		Date	
Name	Craig S. Elanegoyen	Telephone	
Title and Company	CEO of Uniloc Luxembourg S.A.		

NOTE: Signatures of all the applicants or patent owners of the entire interest or their representative(s) are required. If more than one signature is required, submit multiple forms, check the box below, and identify the total number of forms submitted in the blank below.

A total of 1 forms are submitted.

This collection of information is required by 37 CFR 1.31, 1.32, and 1.33. The information is required to obtain or retain a benefit by the public, which is to update (and by the USPTO to process) the file of a patent or reexamination proceeding. Confidentiality is governed by 35 U.S.C. 122 and 37 CFR 1.14. This collection is estimated to take 3 minutes to complete, including gathering, preparing, and submitting the completed application form to the USPTO. Time will vary depending upon the individual case. Any comments on the amount of time you require to complete this form and/or suggestions for reducing this burden, should be sent to the Chief Information Officer, U.S. Patent and Trademark Office, U.S. Department of Commerce, P.O. Box 1450, Alexandria, VA 22313-1450. DO NOT SEND FEES OR COMPLETED FORMS TO THIS ADDRESS. **SEND TO: Commissioner for Patents, P.O. Box 1450, Alexandria, VA 22313-1450.**

If you need assistance in completing the form, call 1-800-PTO-9199 and select option 2.

AO 120 (Rev. 08/10)

TO: Mail Stop 8 Director of the U.S. Patent and Trademark Office P.O. Box 1450 Alexandria, VA 22313-1450	REPORT ON THE FILING OR DETERMINATION OF AN ACTION REGARDING A PATENT OR TRADEMARK
---	---

In Compliance with 35 U.S.C. § 290 and/or 15 U.S.C. § 1116 you are hereby advised that a court action has been filed in the U.S. District Court Eastern District of Texas, Marshall Division on the following

Trademarks or Patents. (the patent action involves 35 U.S.C. § 292.):

DOCKET NO. 2:16-cv-638	DATE FILED 6/14/2016	U.S. DISTRICT COURT Eastern District of Texas, Marshall Division
PLAINTIFF UNILOC USA, INC., and UNILOC LUXEMBOURG, S.A.		DEFENDANT APPLE INC.
PATENT OR TRADEMARK NO.	DATE OF PATENT OR TRADEMARK	HOLDER OF PATENT OR TRADEMARK
1 7,535,890	5/19/2009	UNILOC LUXEMBOURG, S.A.
2 8,995,433	3/31/2015	UNILOC LUXEMBOURG, S.A.
3 8,724,622	5/31/2014	UNILOC LUXEMBOURG, S.A.
4 8,243,723	8/14/2012	UNILOC LUXEMBOURG, S.A.
5		

In the above—entitled case, the following patent(s)/ trademark(s) have been included:

DATE INCLUDED	INCLUDED BY <input type="checkbox"/> Amendment <input type="checkbox"/> Answer <input type="checkbox"/> Cross Bill <input type="checkbox"/> Other Pleading	
PATENT OR TRADEMARK NO.	DATE OF PATENT OR TRADEMARK	HOLDER OF PATENT OR TRADEMARK
1		
2		
3		
4		
5		

In the above—entitled case, the following decision has been rendered or judgement issued:

DECISION/JUDGEMENT

CLERK	(BY) DEPUTY CLERK	DATE
-------	-------------------	------

Copy 1—Upon initiation of action, mail this copy to Director Copy 3—Upon termination of action, mail this copy to Director
 Copy 2—Upon filing document adding patent(s), mail this copy to Director Copy 4—Case file copy

AO 120 (Rev. 08/10)

TO: Mail Stop 8 Director of the U.S. Patent and Trademark Office P.O. Box 1450 Alexandria, VA 22313-1450	REPORT ON THE FILING OR DETERMINATION OF AN ACTION REGARDING A PATENT OR TRADEMARK
---	---

In Compliance with 35 U.S.C. § 290 and/or 15 U.S.C. § 1116 you are hereby advised that a court action has been filed in the U.S. District Court Eastern District of Texas, Marshall Division on the following
 Trademarks or Patents. (the patent action involves 35 U.S.C. § 292.):

DOCKET NO. 2:16-cv-722	DATE FILED 7/5/2016	U.S. DISTRICT COURT Eastern District of Texas, Marshall Division
PLAINTIFF UNILOC USA, INC., and UNILOC LUXEMBOURG, S.A.		DEFENDANT AOL INC.
PATENT OR TRADEMARK NO.	DATE OF PATENT OR TRADEMARK	HOLDER OF PATENT OR TRADEMARK
1 7,535,890	5/19/2009	UNILOC LUXEMBOURG, S.A.
2 8,199,747	6/12/2012	UNILOC LUXEMBOURG, S.A.
3 8,243,723	8/14/2012	UNILOC LUXEMBOURG, S.A.
4 8,724,622	5/13/2014	UNILOC LUXEMBOURG, S.A.
5 8,995,433	3/31/2015	UNILOC LUXEMBOURG, S.A.

In the above—entitled case, the following patent(s)/ trademark(s) have been included:

DATE INCLUDED	INCLUDED BY <input type="checkbox"/> Amendment <input type="checkbox"/> Answer <input type="checkbox"/> Cross Bill <input type="checkbox"/> Other Pleading		
PATENT OR TRADEMARK NO.	DATE OF PATENT OR TRADEMARK	HOLDER OF PATENT OR TRADEMARK	
1			
2			
3			
4			
5			

In the above—entitled case, the following decision has been rendered or judgement issued:

DECISION/JUDGEMENT

CLERK	(BY) DEPUTY CLERK	DATE
-------	-------------------	------

Copy 1—Upon initiation of action, mail this copy to Director Copy 3—Upon termination of action, mail this copy to Director
 Copy 2—Upon filing document adding patent(s), mail this copy to Director Copy 4—Case file copy

AO 120 (Rev. 08/10)

TO: Mail Stop 8 Director of the U.S. Patent and Trademark Office P.O. Box 1450 Alexandria, VA 22313-1450	REPORT ON THE FILING OR DETERMINATION OF AN ACTION REGARDING A PATENT OR TRADEMARK
---	---

In Compliance with 35 U.S.C. § 290 and/or 15 U.S.C. § 1116 you are hereby advised that a court action has been filed in the U.S. District Court Eastern District of Texas, Marshall Division on the following

Trademarks or Patents. (the patent action involves 35 U.S.C. § 292.);

DOCKET NO. 2:16-cv-725	DATE FILED 7/5/2016	U.S. DISTRICT COURT Eastern District of Texas, Marshall Division
PLAINTIFF UNILOC USA, INC., and UNILOC LUXEMBOURG, S.A.		DEFENDANT BEETALK PRIVATE LTD.
PATENT OR TRADEMARK NO.	DATE OF PATENT OR TRADEMARK	HOLDER OF PATENT OR TRADEMARK
1 7,535,890	5/19/2009	UNILOC LUXEMBOURG, S.A.
2 8,199,747	6/12/2012	UNILOC LUXEMBOURG, S.A.
3 8,243,723	8/14/2012	UNILOC LUXEMBOURG, S.A.
4 8,724,622	5/13/2014	UNILOC LUXEMBOURG, S.A.
5 8,995,433	3/31/2015	UNILOC LUXEMBOURG, S.A.

In the above—entitled case, the following patent(s)/ trademark(s) have been included:

DATE INCLUDED	INCLUDED BY <input type="checkbox"/> Amendment <input type="checkbox"/> Answer <input type="checkbox"/> Cross Bill <input type="checkbox"/> Other Pleading		
PATENT OR TRADEMARK NO.	DATE OF PATENT OR TRADEMARK	HOLDER OF PATENT OR TRADEMARK	
1			
2			
3			
4			
5			

In the above—entitled case, the following decision has been rendered or judgement issued:

DECISION/JUDGEMENT

CLERK	(BY) DEPUTY CLERK	DATE
-------	-------------------	------

Copy 1—Upon initiation of action, mail this copy to Director Copy 3—Upon termination of action, mail this copy to Director
 Copy 2—Upon filing document adding patent(s), mail this copy to Director Copy 4—Case file copy

AO 120 (Rev. 08/10)

TO: <p style="text-align: center;">Mail Stop 8 Director of the U.S. Patent and Trademark Office P.O. Box 1450 Alexandria, VA 22313-1450</p>	REPORT ON THE FILING OR DETERMINATION OF AN ACTION REGARDING A PATENT OR TRADEMARK
--	--

In Compliance with 35 U.S.C. § 290 and/or 15 U.S.C. § 1116 you are hereby advised that a court action has been filed in the U.S. District Court Eastern District of Texas, Marshall Division on the following

Trademarks or Patents. (the patent action involves 35 U.S.C. § 292.):

DOCKET NO. 2:16-cv-893	DATE FILED 8/11/2016	U.S. DISTRICT COURT Eastern District of Texas, Marshall Division
PLAINTIFF UNILOC USA, INC., and UNILOC LUXEMBOURG, S.A.		DEFENDANT VONAGE HOLDINGS CORP. & VONAGE AMERICAS, INC.
PATENT OR TRADEMARK NO.	DATE OF PATENT OR TRADEMARK	HOLDER OF PATENT OR TRADEMARK
1 8,724,622	5/31/2014	UNILOC LUXEMBOURG, S.A.
2 8,995,433	3/31/2015	UNILOC LUXEMBOURG, S.A.
3 8,243,723	8/14/2012	UNILOC LUXEMBOURG, S.A.
4 7,535,890	5/19/2009	UNILOC LUXEMBOURG, S.A.
5		

In the above—entitled case, the following patent(s)/ trademark(s) have been included:

DATE INCLUDED	INCLUDED BY <input type="checkbox"/> Amendment <input type="checkbox"/> Answer <input type="checkbox"/> Cross Bill <input type="checkbox"/> Other Pleading		
PATENT OR TRADEMARK NO.	DATE OF PATENT OR TRADEMARK	HOLDER OF PATENT OR TRADEMARK	
1			
2			
3			
4			
5			

In the above—entitled case, the following decision has been rendered or judgement issued:

DECISION/JUDGEMENT

CLERK	(BY) DEPUTY CLERK	DATE
-------	-------------------	------

Copy 1—Upon initiation of action, mail this copy to Director Copy 3—Upon termination of action, mail this copy to Director
 Copy 2—Upon filing document adding patent(s), mail this copy to Director Copy 4—Case file copy

AO 120 (Rev. 08/10)

TO: Mail Stop 8 Director of the U.S. Patent and Trademark Office P.O. Box 1450 Alexandria, VA 22313-1450	REPORT ON THE FILING OR DETERMINATION OF AN ACTION REGARDING A PATENT OR TRADEMARK
---	---

In Compliance with 35 U.S.C. § 290 and/or 15 U.S.C. § 1116 you are hereby advised that a court action has been filed in the U.S. District Court Eastern District of Texas, Marshall Division on the following

Trademarks or Patents. (the patent action involves 35 U.S.C. § 292.);

DOCKET NO. 2:16-cv-892	DATE FILED 8/11/2016	U.S. DISTRICT COURT Eastern District of Texas, Marshall Division
PLAINTIFF UNILOC USA, INC., and UNILOC LUXEMBOURG, S.A.		DEFENDANT TELEGRAM MESSENGER, LLP
PATENT OR TRADEMARK NO.	DATE OF PATENT OR TRADEMARK	HOLDER OF PATENT OR TRADEMARK
1 8,724,622	5/13/2014	UNILOC LUXEMBOURG, S.A.
2 8,995,433	3/31/2015	UNILOC LUXEMBOURG, S.A.
3 7,535,890	5/19/2009	UNILOC LUXEMBOURG, S.A.
4 8,199,747	6/12/2012	UNILOC LUXEMBOURG, S.A.
5 8,243,723	8/14/2012	UNILOC LUXEMBOURG, S.A.

In the above—entitled case, the following patent(s)/ trademark(s) have been included:

DATE INCLUDED	INCLUDED BY <input type="checkbox"/> Amendment <input type="checkbox"/> Answer <input type="checkbox"/> Cross Bill <input type="checkbox"/> Other Pleading		
PATENT OR TRADEMARK NO.	DATE OF PATENT OR TRADEMARK	HOLDER OF PATENT OR TRADEMARK	
1			
2			
3			
4			
5			

In the above—entitled case, the following decision has been rendered or judgement issued:

DECISION/JUDGEMENT

CLERK	(BY) DEPUTY CLERK	DATE
-------	-------------------	------

Copy 1—Upon initiation of action, mail this copy to Director Copy 3—Upon termination of action, mail this copy to Director
 Copy 2—Upon filing document adding patent(s), mail this copy to Director Copy 4—Case file copy

AO 120 (Rev. 08/10)

TO: Mail Stop 8 Director of the U.S. Patent and Trademark Office P.O. Box 1450 Alexandria, VA 22313-1450	REPORT ON THE FILING OR DETERMINATION OF AN ACTION REGARDING A PATENT OR TRADEMARK
---	---

In Compliance with 35 U.S.C. § 290 and/or 15 U.S.C. § 1116 you are hereby advised that a court action has been filed in the U.S. District Court Eastern District of Texas, Marshall Division on the following

Trademarks or Patents. (the patent action involves 35 U.S.C. § 292.):

DOCKET NO. 2:16-cv-645	DATE FILED 6/14/2016	U.S. DISTRICT COURT Eastern District of Texas, Marshall Division
PLAINTIFF UNILOC USA, INC., and UNILOC LUXEMBOURG, S.A.		DEFENDANT WHATSAPP, INC.
PATENT OR TRADEMARK NO.	DATE OF PATENT OR TRADEMARK	HOLDER OF PATENT OR TRADEMARK
1 7,535,890	5/19/2009	UNILOC LUXEMBOURG, S.A.
2 8,199,747	6/12/2012	UNILOC LUXEMBOURG, S.A.
3 8,243,723	8/14/2012	UNILOC LUXEMBOURG, S.A.
4 8,724,622	5/13/2014	UNILOC LUXEMBOURG, S.A.
5 8,995,433	3/31/2015	UNILOC LUXEMBOURG, S.A.

In the above—entitled case, the following patent(s)/ trademark(s) have been included:

DATE INCLUDED	INCLUDED BY <input type="checkbox"/> Amendment <input type="checkbox"/> Answer <input type="checkbox"/> Cross Bill <input type="checkbox"/> Other Pleading	
PATENT OR TRADEMARK NO.	DATE OF PATENT OR TRADEMARK	HOLDER OF PATENT OR TRADEMARK
1		
2		
3		
4		
5		

In the above—entitled case, the following decision has been rendered or judgement issued:

DECISION/JUDGEMENT

CLERK	(BY) DEPUTY CLERK	DATE
-------	-------------------	------

Copy 1—Upon initiation of action, mail this copy to Director Copy 3—Upon termination of action, mail this copy to Director
 Copy 2—Upon filing document adding patent(s), mail this copy to Director Copy 4—Case file copy

AO 120 (Rev. 08/10)

TO: Mail Stop 8 Director of the U.S. Patent and Trademark Office P.O. Box 1450 Alexandria, VA 22313-1450	REPORT ON THE FILING OR DETERMINATION OF AN ACTION REGARDING A PATENT OR TRADEMARK
---	---

In Compliance with 35 U.S.C. § 290 and/or 15 U.S.C. § 1116 you are hereby advised that a court action has been filed in the U.S. District Court Eastern District of Texas, Marshall Division on the following

Trademarks or Patents. (the patent action involves 35 U.S.C. § 292.):

DOCKET NO. 2:16-cv-641	DATE FILED 6/14/2016	U.S. DISTRICT COURT Eastern District of Texas, Marshall Division
PLAINTIFF UNILOC USA, INC., and UNILOC LUXEMBOURG, S.A.		DEFENDANT LINE EURO-AMERICAS CORP. & LINE CORPORATION
PATENT OR TRADEMARK NO.	DATE OF PATENT OR TRADEMARK	HOLDER OF PATENT OR TRADEMARK
1 8,724,622	5/13/2014	UNILOC LUXEMBOURG, S.A.
2 8,995,433	3/31/2015	UNILOC LUXEMBOURG, S.A.
3 7,535,890	5/19/2009	UNILOC LUXEMBOURG, S.A.
4 8,199,747	6/12/2012	UNILOC LUXEMBOURG, S.A.
5 8,243,723	8/14/2012	UNILOC LUXEMBOURG, S.A.

In the above—entitled case, the following patent(s)/ trademark(s) have been included:

DATE INCLUDED	INCLUDED BY <input type="checkbox"/> Amendment <input type="checkbox"/> Answer <input type="checkbox"/> Cross Bill <input type="checkbox"/> Other Pleading	
PATENT OR TRADEMARK NO.	DATE OF PATENT OR TRADEMARK	HOLDER OF PATENT OR TRADEMARK
1		
2		
3		
4		
5		

In the above—entitled case, the following decision has been rendered or judgement issued:

DECISION/JUDGEMENT

CLERK	(BY) DEPUTY CLERK	DATE
-------	-------------------	------

Copy 1—Upon initiation of action, mail this copy to Director Copy 3—Upon termination of action, mail this copy to Director
 Copy 2—Upon filing document adding patent(s), mail this copy to Director Copy 4—Case file copy

AO 120 (Rev. 08/10)

TO: Mail Stop 8 Director of the U.S. Patent and Trademark Office P.O. Box 1450 Alexandria, VA 22313-1450	REPORT ON THE FILING OR DETERMINATION OF AN ACTION REGARDING A PATENT OR TRADEMARK
---	---

In Compliance with 35 U.S.C. § 290 and/or 15 U.S.C. § 1116 you are hereby advised that a court action has been filed in the U.S. District Court Eastern District of Texas, Marshall Division on the following

Trademarks or Patents. (the patent action involves 35 U.S.C. § 292.):

DOCKET NO. 2:16-cv-639	DATE FILED 6/14/2016	U.S. DISTRICT COURT Eastern District of Texas, Marshall Division
PLAINTIFF UNILOC USA, INC., and UNILOC LUXEMBOURG, S.A.		DEFENDANT BLACKBERRY CORPORATION & BLACKBERRY LIMITED
PATENT OR TRADEMARK NO.	DATE OF PATENT OR TRADEMARK	HOLDER OF PATENT OR TRADEMARK
1 8,724,622	5/13/2014	UNILOC LUXEMBOURG, S.A.
2 8,995,433	3/31/2015	UNILOC LUXEMBOURG, S.A.
3 7,535,890	5/19/2009	UNILOC LUXEMBOURG, S.A.
4 8,199,747	6/12/2012	UNILOC LUXEMBOURG, S.A.
5 8,243,723	8/14/2012	UNILOC LUXEMBOURG, S.A.

In the above—entitled case, the following patent(s)/ trademark(s) have been included:

DATE INCLUDED	INCLUDED BY <input type="checkbox"/> Amendment <input type="checkbox"/> Answer <input type="checkbox"/> Cross Bill <input type="checkbox"/> Other Pleading	
PATENT OR TRADEMARK NO.	DATE OF PATENT OR TRADEMARK	HOLDER OF PATENT OR TRADEMARK
1		
2		
3		
4		
5		

In the above—entitled case, the following decision has been rendered or judgement issued:

DECISION/JUDGEMENT

CLERK	(BY) DEPUTY CLERK	DATE
-------	-------------------	------

Copy 1—Upon initiation of action, mail this copy to Director Copy 3—Upon termination of action, mail this copy to Director
 Copy 2—Upon filing document adding patent(s), mail this copy to Director Copy 4—Case file copy

AO 120 (Rev. 08/10)

TO: Mail Stop 8 Director of the U.S. Patent and Trademark Office P.O. Box 1450 Alexandria, VA 22313-1450	REPORT ON THE FILING OR DETERMINATION OF AN ACTION REGARDING A PATENT OR TRADEMARK
---	---

In Compliance with 35 U.S.C. § 290 and/or 15 U.S.C. § 1116 you are hereby advised that a court action has been filed in the U.S. District Court Eastern District of Texas, Marshall Division on the following

Trademarks or Patents. (the patent action involves 35 U.S.C. § 292.):

DOCKET NO. 2:16-cv-728	DATE FILED 7/5/2016	U.S. DISTRICT COURT Eastern District of Texas, Marshall Division
PLAINTIFF UNILOC USA, INC., and UNILOC LUXEMBOURG, S.A.		DEFENDANT FACEBOOK, INC.
PATENT OR TRADEMARK NO.	DATE OF PATENT OR TRADEMARK	HOLDER OF PATENT OR TRADEMARK
1 7,535,890	5/19/2009	UNILOC LUXEMBOURG, S.A.
2 8,199,747	6/12/2012	UNILOC LUXEMBOURG, S.A.
3 8,243,723	8/14/2012	UNILOC LUXEMBOURG, S.A.
4 8,724,622	5/13/2014	UNILOC LUXEMBOURG, S.A.
5 8,995,433	3/31/2015	UNILOC LUXEMBOURG, S.A.

In the above—entitled case, the following patent(s)/ trademark(s) have been included:

DATE INCLUDED	INCLUDED BY <input type="checkbox"/> Amendment <input type="checkbox"/> Answer <input type="checkbox"/> Cross Bill <input type="checkbox"/> Other Pleading		
PATENT OR TRADEMARK NO.	DATE OF PATENT OR TRADEMARK	HOLDER OF PATENT OR TRADEMARK	
1			
2			
3			
4			
5			

In the above—entitled case, the following decision has been rendered or judgement issued:

DECISION/JUDGEMENT

CLERK	(BY) DEPUTY CLERK	DATE

Copy 1—Upon initiation of action, mail this copy to Director Copy 3—Upon termination of action, mail this copy to Director
 Copy 2—Upon filing document adding patent(s), mail this copy to Director Copy 4—Case file copy

AO 120 (Rev. 08/10)

TO: Mail Stop 8 Director of the U.S. Patent and Trademark Office P.O. Box 1450 Alexandria, VA 22313-1450	REPORT ON THE FILING OR DETERMINATION OF AN ACTION REGARDING A PATENT OR TRADEMARK
---	---

In Compliance with 35 U.S.C. § 290 and/or 15 U.S.C. § 1116 you are hereby advised that a court action has been filed in the U.S. District Court Eastern District of Texas, Marshall Division on the following

Trademarks or Patents. (the patent action involves 35 U.S.C. § 292.):

DOCKET NO. 2:16-cv-644	DATE FILED 6/14/2016	U.S. DISTRICT COURT Eastern District of Texas, Marshall Division
PLAINTIFF UNILOC USA, INC., and UNILOC LUXEMBOURG, S.A.		DEFENDANT VOXERNET LLC
PATENT OR TRADEMARK NO.	DATE OF PATENT OR TRADEMARK	HOLDER OF PATENT OR TRADEMARK
1 8,724,622	5/13/2014	UNILOC LUXEMBOURG, S.A.
2 8,995,433	3/31/2015	UNILOC LUXEMBOURG, S.A.
3 7,535,890	5/19/2009	UNILOC LUXEMBOURG, S.A.
4 8,199,747	6/12/2012	UNILOC LUXEMBOURG, S.A.
5 8,243,723	8/14/2012	UNILOC LUXEMBOURG, S.A.

In the above—entitled case, the following patent(s)/ trademark(s) have been included:

DATE INCLUDED	INCLUDED BY <input type="checkbox"/> Amendment <input type="checkbox"/> Answer <input type="checkbox"/> Cross Bill <input type="checkbox"/> Other Pleading	
PATENT OR TRADEMARK NO.	DATE OF PATENT OR TRADEMARK	HOLDER OF PATENT OR TRADEMARK
1		
2		
3		
4		
5		

In the above—entitled case, the following decision has been rendered or judgement issued:

DECISION/JUDGEMENT

CLERK	(BY) DEPUTY CLERK	DATE
-------	-------------------	------

Copy 1—Upon initiation of action, mail this copy to Director Copy 3—Upon termination of action, mail this copy to Director
 Copy 2—Upon filing document adding patent(s), mail this copy to Director Copy 4—Case file copy

AO 120 (Rev. 08/10)

TO: Mail Stop 8 Director of the U.S. Patent and Trademark Office P.O. Box 1450 Alexandria, VA 22313-1450	REPORT ON THE FILING OR DETERMINATION OF AN ACTION REGARDING A PATENT OR TRADEMARK
---	---

In Compliance with 35 U.S.C. § 290 and/or 15 U.S.C. § 1116 you are hereby advised that a court action has been filed in the U.S. District Court Eastern District of Texas, Marshall Division on the following

Trademarks or Patents. (the patent action involves 35 U.S.C. § 292.):

DOCKET NO. 2:16-cv-643	DATE FILED 6/14/2016	U.S. DISTRICT COURT Eastern District of Texas, Marshall Division
PLAINTIFF UNILOC USA, INC., and UNILOC LUXEMBOURG, S.A.		DEFENDANT VIBER MEDIA S.A.R.L.,
PATENT OR TRADEMARK NO.	DATE OF PATENT OR TRADEMARK	HOLDER OF PATENT OR TRADEMARK
1 8,724,622	5/13/2014	UNILOC LUXEMBOURG, S.A.
2 8,995,433	3/31/2015	UNILOC LUXEMBOURG, S.A.
3 7,535,890	5/19/2009	UNILOC LUXEMBOURG, S.A.
4 8,199,747	6/12/2012	UNILOC LUXEMBOURG, S.A.
5 8,243,723	8/14/2012	UNILOC LUXEMBOURG, S.A.

In the above—entitled case, the following patent(s)/ trademark(s) have been included:

DATE INCLUDED	INCLUDED BY <input type="checkbox"/> Amendment <input type="checkbox"/> Answer <input type="checkbox"/> Cross Bill <input type="checkbox"/> Other Pleading	
PATENT OR TRADEMARK NO.	DATE OF PATENT OR TRADEMARK	HOLDER OF PATENT OR TRADEMARK
1		
2		
3		
4		
5		

In the above—entitled case, the following decision has been rendered or judgement issued:

DECISION/JUDGEMENT

CLERK	(BY) DEPUTY CLERK	DATE
-------	-------------------	------

Copy 1—Upon initiation of action, mail this copy to Director Copy 3—Upon termination of action, mail this copy to Director
 Copy 2—Upon filing document adding patent(s), mail this copy to Director Copy 4—Case file copy

AO 120 (Rev. 08/10)

TO: Mail Stop 8 Director of the U.S. Patent and Trademark Office P.O. Box 1450 Alexandria, VA 22313-1450	REPORT ON THE FILING OR DETERMINATION OF AN ACTION REGARDING A PATENT OR TRADEMARK
---	---

In Compliance with 35 U.S.C. § 290 and/or 15 U.S.C. § 1116 you are hereby advised that a court action has been filed in the U.S. District Court Eastern District of Texas, Marshall Division on the following

Trademarks or Patents. (the patent action involves 35 U.S.C. § 292.):

DOCKET NO. 2:16-cv-642	DATE FILED 6/14/2016	U.S. DISTRICT COURT Eastern District of Texas, Marshall Division
PLAINTIFF UNILOC USA, INC., and UNILOC LUXEMBOURG, S.A.		DEFENDANT SAMSUNG ELECTRONICS AMERICA, INC.
PATENT OR TRADEMARK NO.	DATE OF PATENT OR TRADEMARK	HOLDER OF PATENT OR TRADEMARK
1 8,724,622	5/31/2014	UNILOC LUXEMBOURG, S.A.
2 8,995,433	3/31/2015	UNILOC LUXEMBOURG, S.A.
3 8,243,723	8/14/2012	UNILOC LUXEMBOURG, S.A.
4 7,535,890	5/19/2009	UNILOC LUXEMBOURG, S.A.
5		

In the above—entitled case, the following patent(s)/ trademark(s) have been included:

DATE INCLUDED	INCLUDED BY <input type="checkbox"/> Amendment <input type="checkbox"/> Answer <input type="checkbox"/> Cross Bill <input type="checkbox"/> Other Pleading	
PATENT OR TRADEMARK NO.	DATE OF PATENT OR TRADEMARK	HOLDER OF PATENT OR TRADEMARK
1		
2		
3		
4		
5		

In the above—entitled case, the following decision has been rendered or judgement issued:

DECISION/JUDGEMENT

CLERK	(BY) DEPUTY CLERK	DATE
-------	-------------------	------

Copy 1—Upon initiation of action, mail this copy to Director Copy 3—Upon termination of action, mail this copy to Director
 Copy 2—Upon filing document adding patent(s), mail this copy to Director Copy 4—Case file copy

AO 120 (Rev. 08/10)

TO: <p style="text-align: center;">Mail Stop 8 Director of the U.S. Patent and Trademark Office P.O. Box 1450 Alexandria, VA 22313-1450</p>	REPORT ON THE FILING OR DETERMINATION OF AN ACTION REGARDING A PATENT OR TRADEMARK
--	--

In Compliance with 35 U.S.C. § 290 and/or 15 U.S.C. § 1116 you are hereby advised that a court action has been filed in the U.S. District Court Eastern District of Texas, Marshall Division on the following

Trademarks or Patents. (the patent action involves 35 U.S.C. § 292.):

DOCKET NO. 2:16-cv-732	DATE FILED 7/5/2016	U.S. DISTRICT COURT Eastern District of Texas, Marshall Division
PLAINTIFF UNILOC USA, INC., and UNILOC LUXEMBOURG, S.A.		DEFENDANT SONY INTERACTIVE ENTERTAINMENT LLC
PATENT OR TRADEMARK NO.	DATE OF PATENT OR TRADEMARK	HOLDER OF PATENT OR TRADEMARK
1 7,535,890	5/19/2009	UNILOC LUXEMBOURG, S.A.
2 8,243,723	8/14/2012	UNILOC LUXEMBOURG, S.A.
3 8,995,433	3/31/2015	UNILOC LUXEMBOURG, S.A.
4 8,724,622	5/13/2014	UNILOC LUXEMBOURG, S.A.
5		

In the above—entitled case, the following patent(s)/ trademark(s) have been included:

DATE INCLUDED	INCLUDED BY <input type="checkbox"/> Amendment <input type="checkbox"/> Answer <input type="checkbox"/> Cross Bill <input type="checkbox"/> Other Pleading		
PATENT OR TRADEMARK NO.	DATE OF PATENT OR TRADEMARK	HOLDER OF PATENT OR TRADEMARK	
1			
2			
3			
4			
5			

In the above—entitled case, the following decision has been rendered or judgement issued:

DECISION/JUDGEMENT

CLERK	(BY) DEPUTY CLERK	DATE
-------	-------------------	------

Copy 1—Upon initiation of action, mail this copy to Director Copy 3—Upon termination of action, mail this copy to Director
 Copy 2—Upon filing document adding patent(s), mail this copy to Director Copy 4—Case file copy

AO 120 (Rev. 08/10)

TO: Mail Stop 8 Director of the U.S. Patent and Trademark Office P.O. Box 1450 Alexandria, VA 22313-1450	REPORT ON THE FILING OR DETERMINATION OF AN ACTION REGARDING A PATENT OR TRADEMARK
---	---

In Compliance with 35 U.S.C. § 290 and/or 15 U.S.C. § 1116 you are hereby advised that a court action has been filed in the U.S. District Court Eastern District of Texas, Marshall Division on the following

Trademarks or Patents. (the patent action involves 35 U.S.C. § 292.):

DOCKET NO. 2:16-cv-779	DATE FILED 7/15/2016	U.S. DISTRICT COURT Eastern District of Texas, Marshall Division
PLAINTIFF UNILOC USA, INC., and UNILOC LUXEMBOURG, S.A.		DEFENDANT SHORETEL, INC.
PATENT OR TRADEMARK NO.	DATE OF PATENT OR TRADEMARK	HOLDER OF PATENT OR TRADEMARK
1 7,535,890	5/19/2009	UNILOC LUXEMBOURG, S.A.
2 8,995,433	3/31/2015	UNILOC LUXEMBOURG, S.A.
3 8,724,622	5/13/2014	UNILOC LUXEMBOURG, S.A.
4 8,243,723	8/14/2012	UNILOC LUXEMBOURG, S.A.
5		

In the above—entitled case, the following patent(s)/ trademark(s) have been included:

DATE INCLUDED	INCLUDED BY <input type="checkbox"/> Amendment <input type="checkbox"/> Answer <input type="checkbox"/> Cross Bill <input type="checkbox"/> Other Pleading		
PATENT OR TRADEMARK NO.	DATE OF PATENT OR TRADEMARK	HOLDER OF PATENT OR TRADEMARK	
1			
2			
3			
4			
5			

In the above—entitled case, the following decision has been rendered or judgement issued:

DECISION/JUDGEMENT

CLERK	(BY) DEPUTY CLERK	DATE
-------	-------------------	------

Copy 1—Upon initiation of action, mail this copy to Director Copy 3—Upon termination of action, mail this copy to Director
 Copy 2—Upon filing document adding patent(s), mail this copy to Director Copy 4—Case file copy

AO 120 (Rev. 08/10)

TO: Mail Stop 8 Director of the U.S. Patent and Trademark Office P.O. Box 1450 Alexandria, VA 22313-1450	REPORT ON THE FILING OR DETERMINATION OF AN ACTION REGARDING A PATENT OR TRADEMARK
---	---

In Compliance with 35 U.S.C. § 290 and/or 15 U.S.C. § 1116 you are hereby advised that a court action has been filed in the U.S. District Court Eastern District of Texas, Marshall Division on the following
 Trademarks or Patents. (the patent action involves 35 U.S.C. § 292.):

DOCKET NO. 2:16-cv-777	DATE FILED 7/15/2016	U.S. DISTRICT COURT Eastern District of Texas, Marshall Division
PLAINTIFF UNILOC USA, INC., and UNILOC LUXEMBOURG, S.A.		DEFENDANT AVAYA INC.,
PATENT OR TRADEMARK NO.	DATE OF PATENT OR TRADEMARK	HOLDER OF PATENT OR TRADEMARK
1 7,535,890	5/19/2009	UNILOC LUXEMBOURG, S.A.
2 8,995,433	3/31/2015	UNILOC LUXEMBOURG, S.A.
3 8,724,622	5/13/2014	UNILOC LUXEMBOURG, S.A.
4 8,243,723	8/14/2012	UNILOC LUXEMBOURG, S.A.
5 8,199,747	6/12/2012	UNILOC LUXEMBOURG, S.A.

In the above—entitled case, the following patent(s)/ trademark(s) have been included:

DATE INCLUDED	INCLUDED BY <input type="checkbox"/> Amendment <input type="checkbox"/> Answer <input type="checkbox"/> Cross Bill <input type="checkbox"/> Other Pleading		
PATENT OR TRADEMARK NO.	DATE OF PATENT OR TRADEMARK	HOLDER OF PATENT OR TRADEMARK	
1			
2			
3			
4			
5			

In the above—entitled case, the following decision has been rendered or judgement issued:

DECISION/JUDGEMENT

CLERK	(BY) DEPUTY CLERK	DATE
-------	-------------------	------

Copy 1—Upon initiation of action, mail this copy to Director Copy 3—Upon termination of action, mail this copy to Director
 Copy 2—Upon filing document adding patent(s), mail this copy to Director Copy 4—Case file copy

AO 120 (Rev. 08/10)

TO: Mail Stop 8 Director of the U.S. Patent and Trademark Office P.O. Box 1450 Alexandria, VA 22313-1450	REPORT ON THE FILING OR DETERMINATION OF AN ACTION REGARDING A PATENT OR TRADEMARK
---	---

In Compliance with 35 U.S.C. § 290 and/or 15 U.S.C. § 1116 you are hereby advised that a court action has been filed in the U.S. District Court Eastern District of Texas, Marshall Division on the following

Trademarks or Patents. (the patent action involves 35 U.S.C. § 292.):

DOCKET NO. 2:16-cv-733	DATE FILED 7/5/2016	U.S. DISTRICT COURT Eastern District of Texas, Marshall Division
PLAINTIFF UNILOC USA, INC., and UNILOC LUXEMBOURG, S.A.		DEFENDANT TANGOME, INC. d/b/a TANGO
PATENT OR TRADEMARK NO.	DATE OF PATENT OR TRADEMARK	HOLDER OF PATENT OR TRADEMARK
1 7,535,890	5/19/2009	UNILOC LUXEMBOURG, S.A.
2 8,199,747	6/12/2012	UNILOC LUXEMBOURG, S.A.
3 8,243,723	8/14/2012	UNILOC LUXEMBOURG, S.A.
4 8,724,622	5/13/2014	UNILOC LUXEMBOURG, S.A.
5 8,995,433	3/31/2015	UNILOC LUXEMBOURG, S.A.

In the above—entitled case, the following patent(s)/ trademark(s) have been included:

DATE INCLUDED	INCLUDED BY <input type="checkbox"/> Amendment <input type="checkbox"/> Answer <input type="checkbox"/> Cross Bill <input type="checkbox"/> Other Pleading		
PATENT OR TRADEMARK NO.	DATE OF PATENT OR TRADEMARK	HOLDER OF PATENT OR TRADEMARK	
1			
2			
3			
4			
5			

In the above—entitled case, the following decision has been rendered or judgement issued:

DECISION/JUDGEMENT

CLERK	(BY) DEPUTY CLERK	DATE
-------	-------------------	------

Copy 1—Upon initiation of action, mail this copy to Director Copy 3—Upon termination of action, mail this copy to Director
 Copy 2—Upon filing document adding patent(s), mail this copy to Director Copy 4—Case file copy

AO 120 (Rev. 08/10)

TO: Mail Stop 8 Director of the U.S. Patent and Trademark Office P.O. Box 1450 Alexandria, VA 22313-1450	REPORT ON THE FILING OR DETERMINATION OF AN ACTION REGARDING A PATENT OR TRADEMARK
---	---

In Compliance with 35 U.S.C. § 290 and/or 15 U.S.C. § 1116 you are hereby advised that a court action has been filed in the U.S. District Court Eastern District of Texas, Marshall Division on the following

Trademarks or Patents. (the patent action involves 35 U.S.C. § 292.);

DOCKET NO. 2:16-cv-731	DATE FILED 7/5/2016	U.S. DISTRICT COURT Eastern District of Texas, Marshall Division
PLAINTIFF UNILOC USA, INC., and UNILOC LUXEMBOURG, S.A.		DEFENDANT GREEN TOMATO LIMITED
PATENT OR TRADEMARK NO.	DATE OF PATENT OR TRADEMARK	HOLDER OF PATENT OR TRADEMARK
1 7,535,890	5/19/2009	UNILOC LUXEMBOURG, S.A.
2 8,199,747	6/12/2012	UNILOC LUXEMBOURG, S.A.
3 8,243,723	8/14/2012	UNILOC LUXEMBOURG, S.A.
4 8, 724,622	5/13/2014	UNILOC LUXEMBOURG, S.A.
5 8,995,433	3/31/2015	UNILOC LUXEMBOURG, S.A.

In the above—entitled case, the following patent(s)/ trademark(s) have been included:

DATE INCLUDED	INCLUDED BY <input type="checkbox"/> Amendment <input type="checkbox"/> Answer <input type="checkbox"/> Cross Bill <input type="checkbox"/> Other Pleading		
PATENT OR TRADEMARK NO.	DATE OF PATENT OR TRADEMARK	HOLDER OF PATENT OR TRADEMARK	
1			
2			
3			
4			
5			

In the above—entitled case, the following decision has been rendered or judgement issued:

DECISION/JUDGEMENT

CLERK	(BY) DEPUTY CLERK	DATE
-------	-------------------	------

Copy 1—Upon initiation of action, mail this copy to Director Copy 3—Upon termination of action, mail this copy to Director
 Copy 2—Upon filing document adding patent(s), mail this copy to Director Copy 4—Case file copy