

United States Patent [19]
Hall

[11] **Patent Number:** **4,955,379**
 [45] **Date of Patent:** **Sep. 11, 1990**

[54] **MOTION ARTEFACT REJECTION SYSTEM FOR PULSE OXIMETERS**

[75] **Inventor:** Peter R. Hall, Dyfed, United Kingdom

[73] **Assignee:** National Research Development Corporation, London, England

[21] **Appl. No.:** 229,692

[22] **Filed:** Aug. 8, 1988

[30] **Foreign Application Priority Data**
 Aug. 14, 1987 [GB] United Kingdom 8719333

[51] **Int. Cl.⁵** A61B 5/00

[52] **U.S. Cl.** 128/633; 128/664; 128/666; 128/687

[58] **Field of Search** 128/633, 634, 664, 665, 128/666, 687; 356/39, 41

[56] **References Cited**
U.S. PATENT DOCUMENTS

4,109,643	8/1978	Bond et al.	128/666
4,167,331	9/1979	Nielsen	356/41
4,260,951	4/1981	Lewyn	128/690
4,353,152	10/1982	O'Connor et al.	128/666
4,641,658	2/1987	Lepper	128/633
4,651,741	3/1987	Passafaro	128/633
4,723,554	2/1988	Oman	128/633

Primary Examiner—Kyle L. Howell
Assistant Examiner—John C. Hanley
Attorney, Agent, or Firm—Howard F. Mandelbaum

[57] **ABSTRACT**

A pulse oximeter apparatus characterized in that it comprises a bandpass filter adapted selectively to exclude motion artefact from wanted signal is disclosed.

Also disclosed is the use of such an apparatus for the determination of pulse rate and/or arterial blood oxygen saturation.

6 Claims, 4 Drawing Sheets

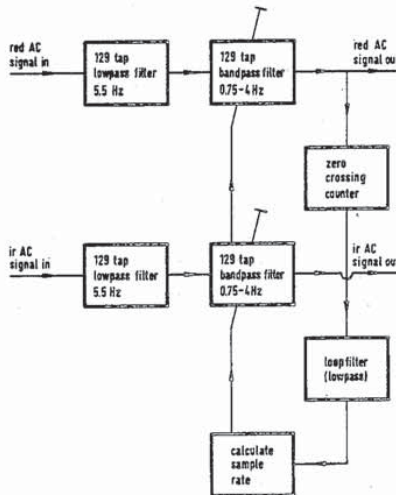

Apple Inc.
 APL1048

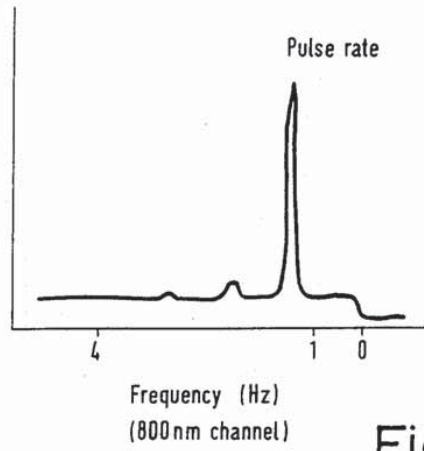

Fig.1

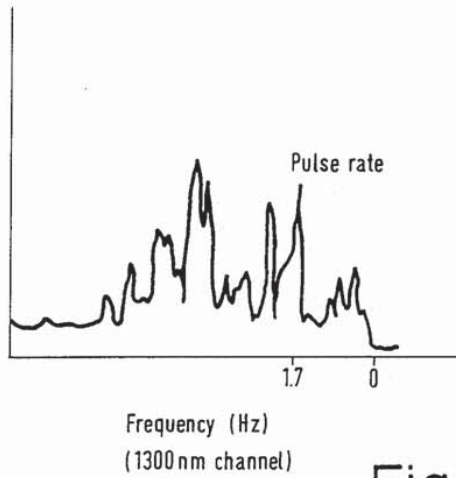

Fig.2

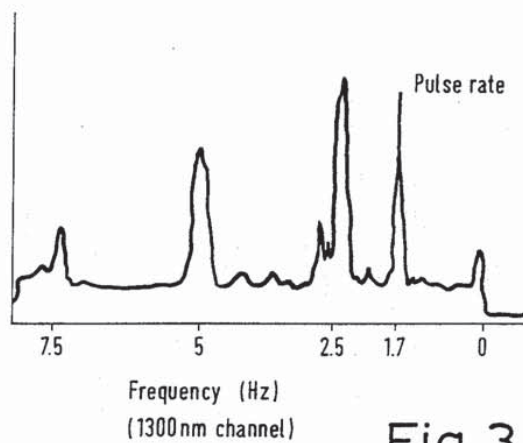

Fig. 3

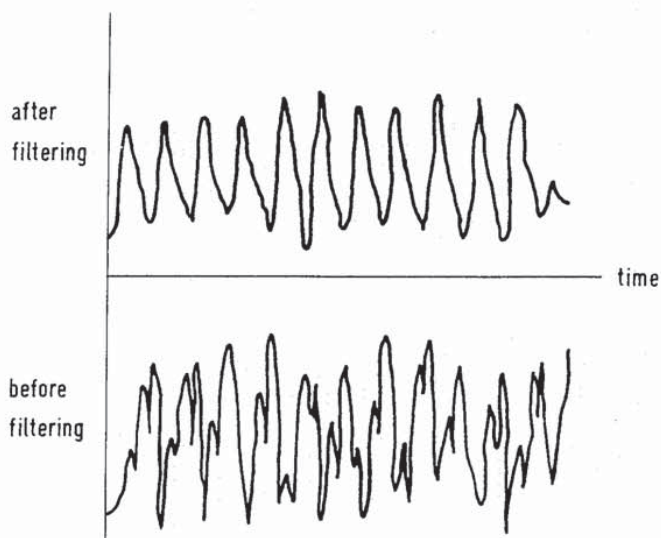

Fig. 4

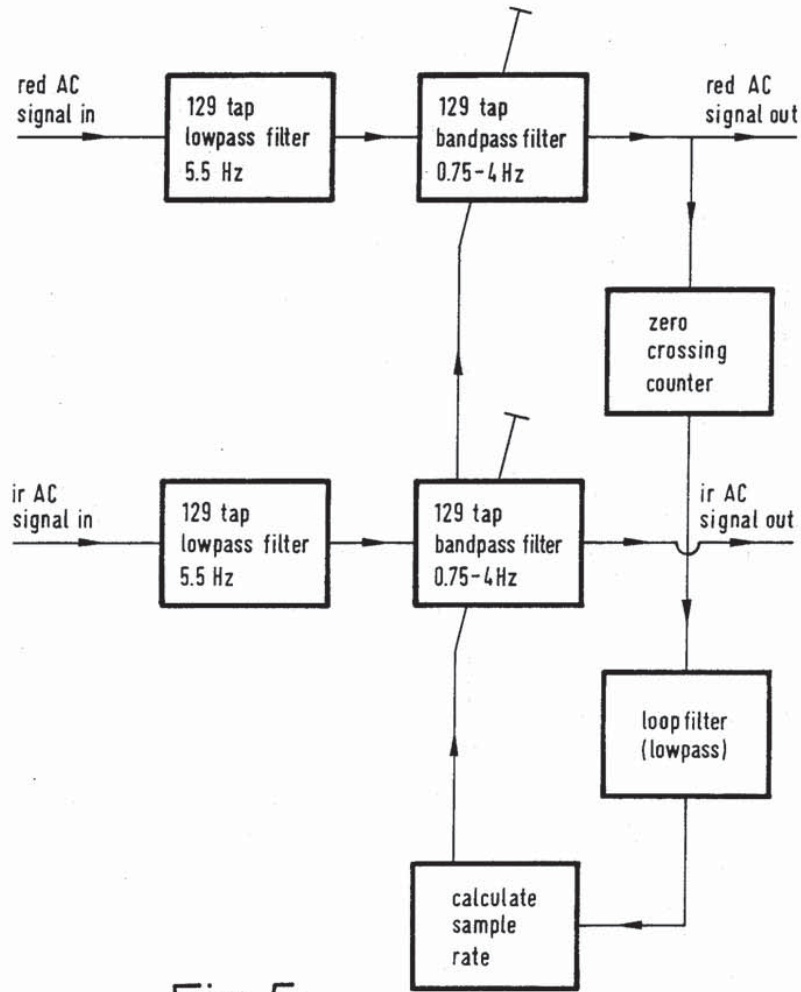
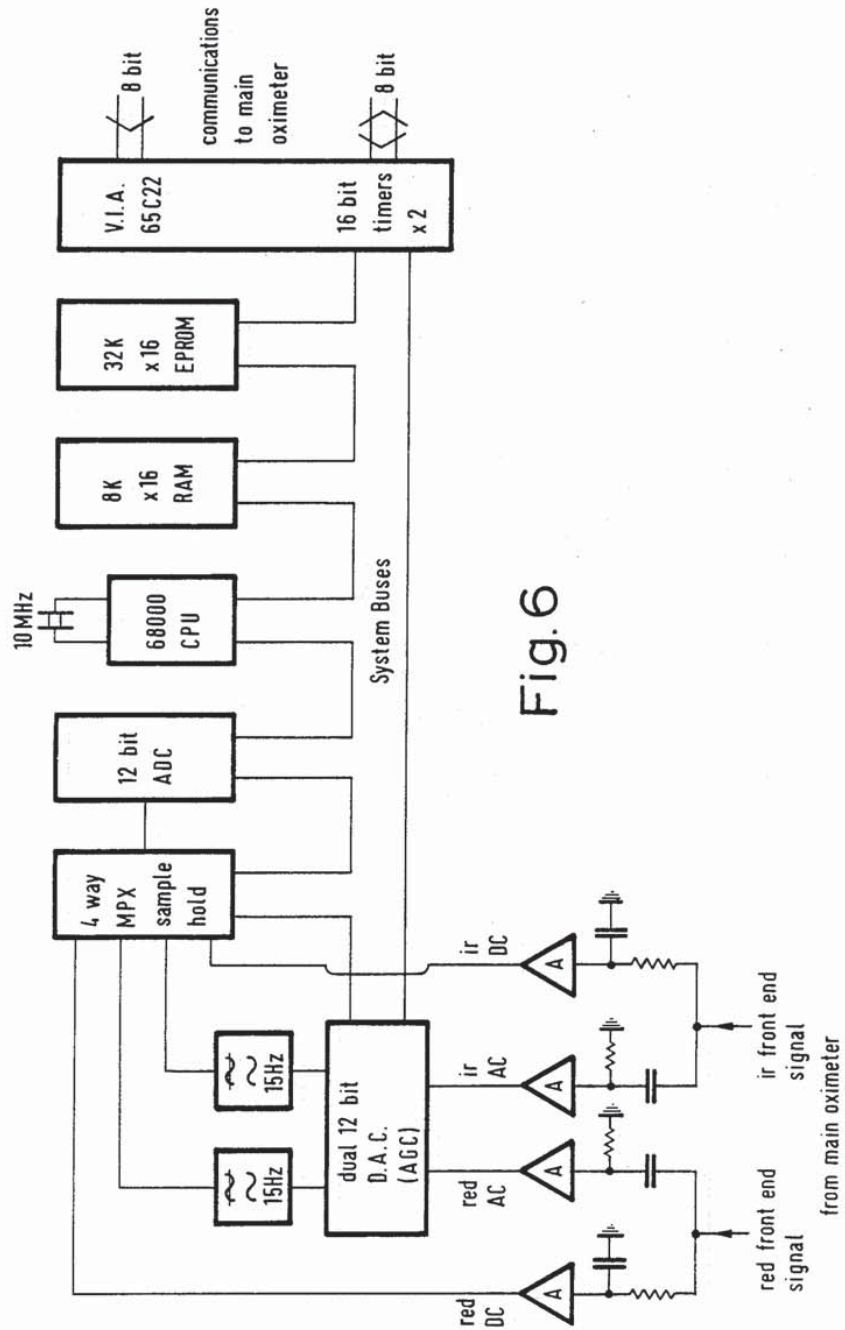

Fig. 5



Explore Litigation Insights

Docket Alarm provides insights to develop a more informed litigation strategy and the peace of mind of knowing you're on top of things.

Real-Time Litigation Alerts



Keep your litigation team up-to-date with **real-time alerts** and advanced team management tools built for the enterprise, all while greatly reducing PACER spend.

Our comprehensive service means we can handle Federal, State, and Administrative courts across the country.

Advanced Docket Research



With over 230 million records, Docket Alarm's cloud-native docket research platform finds what other services can't. Coverage includes Federal, State, plus PTAB, TTAB, ITC and NLRB decisions, all in one place.

Identify arguments that have been successful in the past with full text, pinpoint searching. Link to case law cited within any court document via Fastcase.

Analytics At Your Fingertips



Learn what happened the last time a particular judge, opposing counsel or company faced cases similar to yours.

Advanced out-of-the-box PTAB and TTAB analytics are always at your fingertips.

API

Docket Alarm offers a powerful API (application programming interface) to developers that want to integrate case filings into their apps.

LAW FIRMS

Build custom dashboards for your attorneys and clients with live data direct from the court.

Automate many repetitive legal tasks like conflict checks, document management, and marketing.

FINANCIAL INSTITUTIONS

Litigation and bankruptcy checks for companies and debtors.

E-DISCOVERY AND LEGAL VENDORS

Sync your system to PACER to automate legal marketing.