

and cells were selected for gpt expression. Clones were screened by assaying human antibody production in the culture supernatant by ELISA, and antibody was purified from the best-producing clones. Antibody was purified by passing tissue culture supernatant over a column of staphylococcal protein A-Sepharose CL-4B (Pharmacia). The bound antibodies were eluted with 0.2 M Glycine-HCl, pH 3.0 and neutralized with 1 M Tris pH 8.0. The buffer was exchanged into PBS by passing over a PD10 column (Pharmacia).

The binding of the humanized antibodies to cell types expressing the corresponding antigens was tested: HSV-infected cells for Fd79 and Fd138-80, U937 cells for M195, YTJB cells for mik- β 1 and CMV-infected cells for CMV5. By fluorocytometry, the humanized antibodies bind approximately as well as the original mouse antibodies and the corresponding chimeric antibodies. Moreover, the humanized antibodies compete approximately as well as the corresponding mouse antibodies against the radiolabeled mouse antibodies for binding to the cells, so the humanized antibodies have approximately the same binding affinity as the mouse antibodies, typically within about 2-fold or better, see, e.g., Table 2.

TABLE 2

Binding affinities of murine and humanized antibodies.

	Mouse	Humanized
	K_a (M^{-1})	K_a (M^{-1})
Fd79 (anti-gB)	1.1×10^8	5.3×10^7
Fd138-80 (anti-gD)	5.2×10^7	4.8×10^7

From the foregoing, it will be appreciated that the humanized immunoglobulins of the present invention offer numerous advantages over other antibodies. In comparison to other monoclonal antibodies, the present humanized immunoglobulin can be more economically produced and contain

substantially less foreign amino acid sequences. This reduced likelihood of antigenicity after injection into a human patient represents a significant therapeutic improvement.

5 A detailed description of each humanized immunoglobulin follows.

Example I

Humanized Immunoglobulins to p75

10 In mammals, the immune response is mediated by two types of cells that interact specifically with foreign material, *i.e.*, antigens. One of these cell types, B-cells, are responsible for the production of antibodies. The second cell class, T-cells, include a wide variety of cellular subsets controlling the *in vivo* function of both B-cells and a wide variety of other hematopoietic cells, including T-cells. (See, generally, Paul, W.E., ed., Fundamental Immunology, 2nd ed., Raven Press, New York (1989).)

15 One way in which T-cells exert this control is through the production of a lymphokine known as interleukin-2 (IL-2), originally named T-cell growth factor. IL-2's prime function appears to be the stimulation and maintenance of T-cells. Indeed, some immunologists believe that IL-2 may be at the center of the entire immune response (*see*, Farrar, J., et al., Immunol. Rev. 63, 129-166 (1982)).

20 To exert its biological effects, IL-2 interacts with a specific high-affinity membrane receptor (Greene, W., et al., Progress in Hematology XIV, E. Brown, Ed., Grune and Statton, New York (1986), at pgs. 283 ff and Waldmann, Ann. Rev. Biochem. 58, 875 (1989)). The human IL-2 receptor is a complex multichain glycoprotein, with one chain, known as the Tac peptide or alpha chain, being about 55kD in size (*see*, Leonard, W., et al., J. Biol. Chem. 260, 1872 (1985)). The second chain is known as the p75 or beta chain (Tsuda et al., Proc. Nat. Acad. Sci. USA, 83, 9694 (1986) and Sharon et al., Science 234, 859 (1986)). The p55 or Tac chain and the p75 chain each independently bind IL-2 with low or intermediate affinity, while the IL-2 receptor complex of both chains binds

IL-2 with high affinity. The p75 chain of the human IL-2 receptor will often be called herein simply the p75 protein.

Much of the elucidation of the human IL-2 receptor's structure and function is due to the development of specifically reactive monoclonal antibodies. In particular, one mouse monoclonal antibody, known as anti-Tac (Uchiyama, et al., J. Immunol. 126, 1393 (1981)) has been used to show that IL-2 receptors can be detected on T-cells, but also on cells of the monocyte-macrophage family, Kupffer cells of the liver, Langerhans' cells of the skin and, of course, activated T-cells. Importantly, resting T-cells, B-cells or circulating macrophages typically do not display the IL-2 receptor (Herrmann, et al., J. Exp. Med. 162, 1111 (1985)). Another antibody, mik- β 1, binds to the p75 chain (Tsuda et al., Proc. Nat. Acad. Sci. USA 86, 1982 (1989)).

The anti-Tac monoclonal antibody has also been used to define lymphocyte functions that require IL-2 interaction, and has been shown to inhibit various T-cell functions, including the generation of cytotoxic and suppressor T lymphocytes in cell culture. Also, based on studies with anti-Tac and other antibodies, a variety of disorders are now associated with improper IL-2 receptor expression by T-cells, in particular adult T-cell leukemia.

More recently, the IL-2 receptor has been shown to be an ideal target for novel therapeutic approaches to T-cell mediated diseases. It has been proposed that IL-2 receptor specific antibodies, such as the anti-Tac monoclonal antibody or mik- β 1, can be used either alone or as an immunoconjugate (e.g., with Ricin A, isotopes and the like) to effectively remove cells bearing the IL-2 receptor. These agents can, for example, theoretically eliminate IL-2 receptor-expressing leukemic cells, certain B-cells, or activated T-cells involved in a disease state, yet allow the retention of mature normal T-cells and their precursors to ensure the capability of mounting a normal T-cell immune response as needed. In general, most other T-cell specific agents can destroy essentially all peripheral T-cells, which limits the agents'

therapeutic efficacy. Overall, the use of appropriate monoclonal antibodies specific for the IL-2 receptor may have therapeutic utility in autoimmune diseases, organ transplantation and any unwanted response by activated T-cells. Indeed, clinical trials have been initiated using, e.g., anti-Tac antibodies (Kirkman et al., Transplant. Proc. 21, 1766 (1989) and Waldmann et al., Blood 72, 1805 (1988)).

Unfortunately, the use of anti-Tac, mik- β 1 and other non-human monoclonal antibodies have certain drawbacks, particularly in repeated therapeutic regimens as explained below. Mouse monoclonal antibodies, for example, generally do not fix human complement well, and lack other important immunoglobulin functional characteristics when used in humans. Perhaps more importantly, anti-Tac, mik- β 1 and other non-human monoclonal antibodies contain substantial stretches of amino acid sequences that will be immunogenic when injected into a human patient.

In accordance with the present invention, human-like immunoglobulins specifically reactive with the p75 chain of the human IL-2 receptor are provided. These immunoglobulins, which have binding affinities of at least 10^7 to 10^8 M^{-1} , and preferably 10^9 M^{-1} to 10^{10} M^{-1} or stronger, are capable of, e.g., blocking the binding of IL-2 to human IL-2 receptors. The human-like immunoglobulins will have a human-like framework and can have complementarity determining regions (CDR's) from an immunoglobulin, typically a mouse immunoglobulin, specifically reactive with an epitope on p75 protein. The immunoglobulins of the present invention, which can be produced economically in large quantities, find use, for example, in the treatment of T-cell mediated disorders in human patients by a variety of techniques.

In one aspect, the present invention is directed to recombinant DNA segments encoding the heavy and/or light chain CDR's from an immunoglobulin capable of binding to a desired epitope on the human IL-2 receptor, such as the mik- β 1 monoclonal antibody. The DNA segments encoding these regions will typically be joined to DNA segments encoding appropriate

human-like framework regions. Exemplary DNA sequences, which on expression code for the polypeptide chains comprising the mik- β 1 heavy and light chain CDRs, are included in Fig. 7. Due to codon degeneracy and non-critical amino-acid substitutions, other DNA sequences can be readily substituted for those sequences, as detailed above.

The antibodies will typically find use individually in treating a T-cell mediated disease state. Generally, where the cell linked to a disease has been identified as IL-2 receptor bearing, then the human-like antibodies capable of blocking the binding of IL-2 to the human IL-2 receptor are suitable (see, U.S.S.N. 085,707, entitled "Treating Human Malignancies and Disorders.") For example, typical disease states suitable for treatment include graft-versus-host disease and transplant rejection in patients undergoing an organ transplant, such as heart, lungs, kidneys, liver, etc. Other diseases include autoimmune diseases, such as Type I diabetes, multiple sclerosis, rheumatoid arthritis, systemic lupus erythematosus, and myasthenia gravis.

The human-like antibodies of the present invention may also be used in combination with other antibodies, particularly human monoclonal antibodies reactive with other markers on cells responsible for the disease. For example, suitable T-cell markers can include those grouped into the so-called "Clusters of Differentiation," as named by the First International Leukocyte Differentiation Workshop, Leukocyte Typing, Bernard, et al., Eds., Springer-Verlag, N.Y. (1984). A preferred use is the simultaneous treatment of a patient with a human-like antibody binding to p55 and a human-like antibody binding to p75 of the IL-2 receptor, i.e., humanized anti-Tac plus humanized mik- β 1.

Human-like antibodies of the present invention can further find a wide variety of utilities in vitro. By way of example, the antibodies can be utilized for T-cell typing, for isolating specific IL-2 receptor bearing cells or fragments of the receptor, for vaccine preparation, or the like.

EXPERIMENTAL

Cloning of heavy chain and light chain cDNA.

5 cDNAs for the heavy chain and light chain variable domain genes were cloned using anchored polymerase chain reactions (E.Y. Loh et al., Science 243, 217 (1989)), using 3' primers that hybridized to the constant regions and contained HindIII sites, and 5' primers that hybridized to the dG tails and contained EcoRI sites (scheme shown in Fig. 6). The PCR
10 amplified fragments were digested with EcoRI and HindIII and cloned into the pUC19 vector for sequencing. For mik- β 1, two gamma-2a specific and two kappa specific clones were sequenced. The two gamma-2a clones and two kappa clones are respectively identical in sequence. The cDNA variable domain
15 sequences and the deduced amino acid sequences are shown in Fig. 7.

Construction and expression of chimeric antibody.

20 Two plasmid vectors were prepared for construction and expression of the chimeric antibody genes. The plasmid pVg1-dhfr (Fig. 8A) contains a human cytomegalovirus IE1 promoter and enhancer (M. Boshart et al., Cell 41, 521 (1985)), the human genomic C_γ1 segment including part of the preceding intron, and a dihydrofolate reductase (dhfr) gene
25 (Simonsen et al., Proc. Natl. Acad. Sci. USA 80, 2495 (1983)) for selection. The plasmid pVk (Fig. 8B) is similar to pVg1-dhfr but contains the human genomic C_κ segment and the gpt gene. Derivatives of the mik- β 1 heavy and light chain variable regions were prepared from the cDNAs by polymerase
30 chain reaction. The 5' primers hybridized to the V regions starting at the ATG codons and contained XbaI sites; the 3' primers hybridized to the last 15 nucleotides of the J regions and contained splice donor signals and XbaI sites (see, C. Queen et al., Proc. Natl. Acad. Sci. USA 86, 10029 (1989)).
35 The modified V regions were cloned into the XbaI sites of the respective plasmid vectors between the CMV promoter and the partial introns of the constant regions.

For expression of the chimeric antibody, the heavy chain and kappa chain plasmids were transfected into Sp2/0 mouse myeloma cells by electroporation and cells selected for gpt expression. Clones secreting a maximal amount of complete antibody were detected by ELISA. Purified chimeric mik- β 1 antibody was shown to bind to YTJB cells, which express the p75 antigen, by flow cytometry (Fig. 9).

Computer modeling of humanized antibodies.

In order to retain high binding affinity in the humanized antibodies, the general procedures of Queen et al. were followed (C. Queen et al., Proc. Natl. Acad. Sci. USA 86, 10029 (1989)). The more homologous a human antibody is to the original murine antibody, the less likely will combining the murine CDRs with the human framework be to introduce distortions into the CDRs that could reduce affinity. Normally the heavy chain and light chain from the same human antibody are chosen to provide the framework sequences, so as to reduce the possibility of incompatibility in the assembling of the two chains. Based on sequence database (performed with the MicrorGenie Sequence Analysis Software (Beckman)), the antibody Lay was chosen to provide the framework sequences for humanization of mik- β 1.

The computer program ENCAD (M. Levitt, J. Mol. Biol. 168, 595 (1983)) was used to construct a model of the mik- β 1 variable region. The model was used to determine the amino acids in the mik- β 1 framework that were close enough to the CDRs to potentially interact with them (category 4 below). To design the humanized light and heavy chain mik- β 1 variable regions, at each position the amino acid was chosen to be the same as in the Lay antibody, unless that position fell in one or more of five categories:

- (1) The position fell within a CDR,
- (2) The Lay amino acid was unusual for human antibodies at that position, whereas the mik- β 1 amino acid was typical for human antibodies at that position.

- (3) The position was immediately adjacent to a CDR,
 (4) The model described above suggested that the amino acid may be physically close to the antigen binding region (CDRs).

5 For positions in these categories, the amino acid from the (mouse) mik- β 1 antibody was used. In addition, a position was in the fifth category if

- (5) The Lay amino acid was highly unusual for human antibodies at that position, and the mik- β 1 amino acid was different but also unusual.
 10 Then an amino acid typical for human antibodies at that position may be used.

The amino acids in each category are shown in Table 3. Some amino acids may be in more than one category.
 15 The final sequences of the humanized mik- β 1 light and heavy chain variable domains are shown in Fig. 10, compared with the Lay sequences.

TABLE 3

Category	Light Chain	Heavy Chain
20 1	24-33, 49-55, 88-96	31-35, 50-65, 98-108
2	13	84, 89, 90
3		30, 49
4	70	29, 30, 72, 73
5	41	1

25

For the construction of genes for the humanized antibodies, nucleotide sequences were selected that encode the protein sequences of the humanized heavy and light chains, including the same signal peptides as in the mouse mik- β 1 chains (Fig. 7), generally utilizing codons found in the mouse sequence. Several degenerate codons were changed to create restriction sites or to remove undesirable ones. The nucleotide sequences also included the same splice donor signals used in the chimeric genes and an XbaI site at each end. Each gene was constructed from four overlapping synthetic oligonucleotides. For each variable domain gene,
 30 two pairs of overlapping oligonucleotides on alternating
 35

strands were synthesized that encompassed the entire coding sequences as well as the signal peptide and the splice donor signal (Fig. 11). The oligonucleotides were synthesized on an Applied Biosystems 380B DNA synthesizer. Each oligo was about
5 110-140 base long with about a 20 base overlap. Double stranded DNA fragments were synthesized with sequenase from each pair of oligonucleotides, digested with restriction enzymes, ligated to pBluescriptII KS (+) (Stratagene) vector and sequenced. Two fragments with the respectively correct
10 half-sequences were then ligated into the XbaI sites of the pVg1-dhfr or pVκ expression vectors. In vitro mutagenesis was used to change an Ala amino acid originally encoded by oligonucleotide wps54 to the Glu (E) at position 1 of the humanized heavy chain (Fig. 10B) by changing the nucleotides
15 CT to AG. Reactions were carried out under conditions well-known in the art (Maniatis et al., op. cit.)

The heavy chain and light chain plasmids were transfected into Sp2/0 mouse myeloma cells by electroporation and cells were selected for gpt expression. Clones were
20 screened by assaying human antibody production in the culture supernatant by ELISA, and antibody was purified from the best-producing clones. Antibody was purified by passing tissue culture supernatant over a column of staphylococcal protein A-Sepharose CL-4B (Pharmacia). The bound antibody was eluted
25 with 0.2 M Glycine-HCl, pH3.0 and neutralized with 1 M Tris PH8.0. The buffer was exchanged into PBS by passing over a PD10 column (Pharmacia).

Properties of humanized antibodies.

30 The humanized mik-β1 antibody was characterized in comparison to the murine and chimeric antibodies. The humanized antibody bound to YTJB cells, which express p75 chain at a high level, in a fluorocytometric analysis in a manner similar to the chimeric antibody (Fig. 9), showing that
35 it recognizes the same p75 protein.

The affinity of the humanized antibody was determined by competition with the radio-iodinated mouse

mik- β 1 antibody (Fig. 12). The binding affinities were calculated according to the methods of Berzofsky (J.A. Berzofsky and I.J. Berkower, in Fundamental Immunology (ed. W.E. Paul), Raven Press (New York), 595 (1984)). The binding affinity of the humanized mik- β 1 antibody was within about 2-
5 fold of the affinity of the mouse mik- β 1 antibody.

The ability of humanized mik- β 1 plus humanized anti-Tac antibody (see, WO90/07861 published July 26, 1990) to inhibit IL-2 stimulated proliferation of human lymphocytes was determined. Human mononuclear cells, collected from human
10 blood by centrifugation on Ficoll-Paque (Pharmacia), were diluted to 2×10^6 cells/ml in RPMI medium + 10% fetal calf serum (FCS). A 1/200 volume of phytohemagglutinin P (Difco) was added and the cells were incubated for 4 days. The cells
15 were incubated an additional 4 days in RPMI + 10% FCS + 10 u/ml IL-2. 10^5 of these PHA activated blasts were then incubated with or without 2 μ g each of humanized mik- β 1 and humanized anti-Tac in 150 μ l of RPMI + 10% FCS in wells of a
20 96-well plate for 1 hr, to which various dilutions of IL-2 (Amgen) were then added in 50 μ l medium. The cells were incubated 48 hr, 0.5 μ Ci methyl- 3 H-thymidine (Amersham, 82 Ci/mmol) was added, and the cells were incubated 24 hr. Cells were harvested with a cell harvester and radioactivity
25 determined. The combination of the antibodies greatly inhibited proliferation of the cells in response to IL-2 (Fig. 13), suggesting a combination of the antibodies will have strong immunosuppressive properties. Humanized mik- β 1 plus humanized anti-Tac inhibited proliferation much more strongly than did either antibody alone.

30

Example II

Humanized Immunoglobulins to HSV Antigens

Herpes Simplex Virus types I and II (HSV-1 and HSV-2), are now estimated to be the second most frequent cause of
35 sexually transmitted diseases in the world. Although completely accurate data are not available, infection estimates range from about 20 to 40% of the U.S. population.

A large number of diseases, from asymptomatic to life-threatening, are associated with HSV infection. Of particular clinical interest, encephalitis from HSV-1 infection and transmission of HSV-2 from a pregnant mother to her fetus are often fatal. Immunosuppressed patients are also subject to severe complications when infected with the virus.

More than 50 HSV polypeptides have been identified in HSV-infected cells, including at least seven major cell surface glycoproteins (see, Whitley, R., Chapt. 66, and Roizman and Sears, Chapt. 65, Virology, Eds. Fields et al., 2nd ed., Raven Press, N.Y., N.Y. (1990)). The specific biologic functions of these glycoproteins are not well defined, although gB and gD have been shown to be associated with cell fusion activity (W. Cai et al., J. Virol. 62, 2596 (1988) and Fuller and Spear, Proc. Natl. Acad. Sci. USA 84, 5454 (1987)). gB and gD express both type-specific and type-common antigenic determinants. Oakes and Lausch demonstrated that monoclonal antibodies against gB and gE suppress replication of HSV-1 in trigeminal ganglia (Oakes and Lausch, J. Virol. 51, 656 (1984)). Dix et al. showed that anti-gC and gD antibodies protect mice against acute virus-induced neurological disease (Dix et al., Infect. Immun. 34, 192 (1981)). Whitley and colleagues produced a panel of murine monoclonal antibodies against HSV-1 and showed that several of the antibodies protected mice against encephalitis and death following ocular inoculation with the virus (see, Koga et al., Virology 151, 385 (1986); Metcalf et al., Cur. Eye Res. 6, 173 (1987) and Metcalf et al., Intervirol. 29, 39 (1988)). Clone Fd79 (anti-gB) prevented encephalitis even when immunization was delayed until 48 hours post-infection. Fd79 and Fd138-80 (anti-gD) significantly reduced the severity of epithelial keratitis and lowered the frequency of persistent viral infection in an outbred mouse model.

In accordance with the present invention, humanized immunoglobulins specifically reactive with HSV related epitopes either directly on the virus or on infected cells are provided. These immunoglobulins, which have binding

affinities to HSV specific antigens of at least about $10^7 M^{-1}$, and preferably $10^8 M^{-1}$ to $10^{10} M^{-1}$ or stronger, are capable of, e.g., protecting cells from HSV transmission. The humanized immunoglobulins will have a human framework and will have one or more complementarity determining regions (CDR's) from an immunoglobulin, typically a mouse immunoglobulin, specifically reactive with an HSV protein, such as gB and gD proteins. The immunoglobulins of the present invention, which can be produced economically in large quantities, find use, for example, in the treatment of HSV mediated disorders in human patients by a variety of techniques.

The HSVs are among the most intensively investigated of all viruses, and the HSV virion structure has been shown to contain about 33 proteins. Humanized immunoglobulins utilizing CDR's from monoclonal antibodies reactive with these proteins, particularly the eight surface glycoproteins (e.g., gB, gC, gD, gE, gG, gH and gI), represent preferred embodiments of the present invention (see, Spear, P.G., The Herpesviruses, vol. 3, pp. 315-356 (1984) (Roizman, B., ed), Plenum Press, N.Y., N.Y. and Spear, P.G., Immunochemistry of Viruses. The Basis for Serodiagnosis and Vaccines, pp. 425-446 (1985) (Neurath, A.R., eds.), Amsterdam: Elsevier).

In one aspect, the present invention is directed to recombinant DNA segments encoding the heavy and/or light chain CDR's from an immunoglobulin capable of binding to a desired epitope of an HSV protein, such as monoclonal antibodies reactive with HSV gB and gD glycoproteins. The DNA segments encoding these regions will typically be joined to DNA segments encoding appropriate humanized framework regions. Exemplary DNA sequences code for the polypeptide chains comprising the heavy and light chain hypervariable regions (with human framework regions) from monoclonal antibodies Fd79 and Fd138-80, shown in Fig. 14. Due to codon degeneracy and non-critical amino-acid substitutions, other DNA sequences can be readily substituted for those sequences, as detailed below.

Any humanized immunoglobulins of the present invention may also be used in combination with other

antibodies, particularly humanized antibodies reactive with different HSV antigens. For example, suitable HSV antigens to which a cocktail of humanized immunoglobulins may react include gC, gE, gF, gG and gH (see, Rector, J. et al., *Infect. Immun.* 38, 168 (1982) and Fuller, A. et al., *J. Virol.* 63, 3435 (1989)).

The antibodies can also be used as separately administered compositions given in conjunction with acyclovir or other antiviral agents. Typically, the agents may include idoxuridine or trifluorothymidine, but numerous additional agents (e.g., vidarabine) well-known to those skilled in the art for HSV treatment may also be utilized (see, Corey, L., op. cit.). A preferred pharmaceutical composition of the present invention comprises the use of the subject immunoglobulins in immunotoxins to kill cells infected by HSV.

These humanized antibodies can further find a wide variety of utilities in vitro. By way of example, the antibodies can be utilized for detection of HSV antigens, for isolating specific HSV infected cells or fragments of the virus, for vaccine preparation, or the like.

EXPERIMENTAL

Cloning of heavy chain and light chain cDNA.

cDNAs for the heavy chain and light chain variable domain genes were cloned using anchored polymerase chain regions (E.Y. Loh et al., *Science* 243, 217 (1989)), using 3' primers that hybridized to the constant regions and contained HindIII sites, and 5' primers that hybridized to the dG tails and contained EcoRI sites (scheme shown in Fig. 6). This method yields clones with authentic variable domain sequences, in contrast to other methods using mixed primers designed to anneal to the variable domain sequence (J.W. Larrick et al., *Bio/Technology* 7, 934 (1989) and Y.L. Chiang et al., *BioTech.* 7, 360 (1989)). The PCR amplified fragments were digested with EcoRI and HindIII and cloned into the pUC18 vector for sequencing. For Fd79, two gamma-1 specific and 5 kappa specific clones were sequenced. The two gamma-1 specific

clones are identical in sequence. This heavy chain cDNA fragment encodes a signal peptide of 19 amino acids, a V region in mouse heavy chain subgroup IIIB, a D segment, and a J_H1 segment with 4 alterations compared to the genomic J_H1 sequence. The deduced amino acid sequence is shown in Fig. 14A.

The five kappa specific clones belong to two groups. Two clones are identical and encode a kappa chain in which the conserved amino acid 23 cysteine has been substituted by a tyrosine, probably representing the non-productive allele. The other three clones have an identical sequence encoding a signal peptide sequence of 20 amino acids, a V region in mouse kappa chain subgroup III, and a J_K2 segment with a single alteration compared to the genomic J_K2 sequence (Fig. 14B). The validity of the heavy chain and the kappa chain sequences was subsequently confirmed by the construction and expression of a chimeric antibody as discussed below.

The heavy chain and the kappa chain of Fd138-80 were cloned similarly. Three clones each of the heavy chain and the kappa chain were sequenced. All three heavy chain clones have an identical sequence encoding a signal peptide sequence of 19 amino acids, a V region in mouse heavy chain subgroup II, a D segment and the J_H3 segment (Fig. 14C). The three kappa clones are also identical in sequence. This light chain fragment encodes a signal peptide sequence of 20 amino acids, a V region gene in mouse kappa chain subgroup V and the J_K5 segment (Fig. 14D). Both chains shown no irregularities in coding sequence; their validity was subsequently confirmed by construction and expression of a chimeric antibody.

Construction and expression of chimeric antibodies.

Two plasmid vectors were prepared for construction and expression of the chimeric antibody genes. The plasmid pVg1 (Fig. 15A) contains a human cytomegalovirus IE1 promoter and enhancer (M. Boshart et al., Cell 41, 521 (1985)), the human genomic C_γ1 segment including part of the preceding intron, and the hygromycin gene (Blochlinger et al., Mol.

Cell. Biol. 4, 2929 (1984)) for selection. The plasmid pVk (Fig. 15B) is similar to pVg1 but contains the human genomic C_κ segment and the gpt gene. Derivatives of the Fd79 and Fd138-80 heavy and light chain variable regions were prepared from the cDNAs by polymerase chain reaction. The 5' primers hybridized to the V regions starting at the ATG codons and contained XbaI sites; the 3' primers hybridized to the last 15 nucleotides of the J regions and contained splice donor signals and XbaI sites (see, C. Queen et al., Proc. Natl. Acad. Sci. USA 86, 10029 (1989)). The modified V regions were cloned into the XbaI sites of the respective plasmid vectors between the CMV promoter and the partial introns of the constant regions.

For expression of the chimeric antibodies, the heavy chain and kappa chain plasmids were transfected into Sp2/0 mouse myeloma cells by electroporation and cells selected for gpt expression. Clones secreting a maximal amount of complete antibody were detected by ELISA. Purified chimeric Fd79 and Fd138-80 antibodies were shown to bind to HSV-1 infected vero cells by flow cytometry. Viral neutralization assays also indicated that the chimeric antibodies retain the neutralization activities of the murine antibodies (data not shown, but see below for similar results with humanized antibodies).

Computer modeling of humanized antibodies.

In order to retain high binding affinity in the humanized antibodies, the general procedures of Queen et al. were followed (C. Queen et al., Proc. Natl. Acad. Sci. USA 86, 10029 (1989)). The more homologous a human antibody is to the original murine antibody, the less likely will combining the murine CDRs with the human framework be to introduce distortions into the CDRs that could reduce affinity. Normally the heavy chain and light chain from the same human antibody are chosen to provide the framework sequences, so as to reduce the possibility of incompatibility in the assembling of the two chains. Based on sequence homology search against

the NBRF protein sequence database (performed with the MicroGenie Sequence Analysis Software (Beckman)), the antibody Pom was chosen to provide the framework sequences for humanization of Fd79.

5 The computer program ENCAD (Levitt, J. Mol. Biol. 168, 595 (1983)) was used to construct a model of the Fd79 variable region. Inspection of the refined model of murine Fd79 revealed two amino acid residues in the framework that are close enough to have significant contacts with the CDR residues (Table 4). Lys in light chain NBRF position 49 has contacts with 3 amino acids in CDR2 of the light chain (L50 Tyr, L53 Asn, L55 Glu) and 2 amino acids in CDR3 of the heavy chain (H99 Asp, H100 Tyr). Leu in heavy chain position 93 also shows interactions with 2 amino acids in CDR2 of the heavy chain (H35 Ser, H37 Val) and an amino acid in CDR3 of the heavy chain (H100C Phe). Hence, L49 Lys and H93 Leu were retained in the construction of humanized Fd79, as their replacement with human Pom framework residues would be likely to introduce distortions into the CDRs. Also, 7 other residues in the Pom framework (5 in the light chain and 2 in the heavy chain) were substituted with common human residues (identical to the murine Fd79 sequence in 6 of the choices) because of their rare occurrence in other human antibodies. The elimination of unusual amino acids in the framework may further reduce immunogenicity. The murine Fd79 sequences and the corresponding humanized sequences are shown in Fig. 14A, B. Substituted residues in the Pom framework are underlined.

10

15

20

25

TABLE 4

Residues in the framework sequence showing contacts with residues in the hypervariable regions.

	<u>Residue No.</u> ¹	<u>Amino Acid</u>	<u>Contacting CDR residues</u> ²
5	Fd79		
	L49	Lys	L50Y, L53N, L55E, H99D, H100Y
10	H93	Leu	H35S, H37V, H100CF
	Fd138-80		
15	L36	His	L34V, L89Q
	H27	Tyr	H32H, H34I
	H30	Tyr	H32H, H53R
	H48	Phe	H63F
	H66	Lys	H63F
20	H67	Ala	H63F

1. The amino acid residues are numbered according to the Kabat system (E.A. Kabat et al., Sequences of Proteins of Immunological Interest, National Institutes of Health, Bethesda, MD (1987)): the first letter (H or L) stands for the heavy chain or light chain. The following number is the residue number. The last letter is the amino acid one letter code.

2. The hypervariable regions are defined according to Kabat: Light chain CDR1: residue 24-34; CDR2: 50-56; CDR3: 89-97. Heavy chain CDR1: 31-35; CDR2: 50-65; CDR3: 95-102.

Similarly, the murine heavy chain and light chain sequences of Fd138-80 were subjected to sequence homology search against the NBRF protein sequence database. The sequences of the human antibody Eu were selected to provide the framework sequences for humanized Fd138-80. Inspection of a computer-generated model of Fd138-80 revealed 6 amino acid residues in the framework that are close enough to have important contacts with CDR residues. The residues and their contacting counterparts are listed in Table 4; these murine residues were retained in the construction of humanized Fd138-80. Two other residues (L87 Phe and H37 Met) show significant contacts with L98 Phe, which is immediately adjacent to CDR3,

so these two mouse residues were also retained. Eight amino acids in the Eu framework (2 in the light chain and 6 in the heavy chain) were substituted with the murine residues (which are also consistent with the human consensus residues) because of their rare occurrence in other human antibodies. The murine Fd138-80 sequences and the corresponding humanized sequences are shown in Fig. 14C. Substituted residues in the Eu framework are underlined.

For the construction of genes for the humanized antibodies, nucleotide sequences were selected that encode the protein sequences of the humanized heavy and light chains, including the signal peptides, generally utilizing codons found in the mouse sequence. Several degenerate codons were changed to create restriction sites or to remove undesirable ones. The nucleotide sequences also included the same splice donor signals used in the chimeric genes and an XbaI site at each end. Each gene was constructed from four overlapping synthetic oligonucleotides. For each variable domain gene, two pairs of overlapping oligonucleotides on alternating strands were synthesized that encompassed the entire coding sequences as well as the signal peptide and the splice donor signal. The oligonucleotides were synthesized on an Applied Biosystems 380B DNA synthesizer. Each oligo was about 110-140 bases long with a 15 base overlap. Double stranded DNA fragments were synthesized with Klenow polymerase, digested with restriction enzymes, ligated to pUC18 vector and sequenced. The two fragments with the correct sequences were then ligated into the XbaI sites of pVg1 or pVκ expression vectors.

The synthetic genes were then cloned into the pVg1 and pVκ expression vectors. For each humanized antibody constructed, the heavy chain and light chain plasmids were transfected into Sp2/0 mouse myeloma cells by electroporation and cells were selected for gpt expression. Clones were screened by assaying human antibody production in the culture supernatant by ELISA, and antibody was purified from the best-producing clones. Antibodies were purified by passing tissue

culture supernatant over a column of staphylococcal protein A-Sepharose CL-4B (Pharmacia). The bound antibodies were eluted with 0.2 M Glycine-HCl, pH3.0 and neutralized with 1 M Tris pH8.0. The buffer was exchanged into PBS by passing over a
5 PD10 column (Pharmacia).

Properties of humanized antibodies.

The humanized Fd79 and Fd138-80 antibodies were characterized in comparison to the murine and chimeric
10 antibodies. Both humanized antibodies bind to Vero cells infected with HSV-1 in a fluorocytometric analysis in a manner similar to the chimeric antibodies (Fig. 16), suggesting that they recognize their respective viral antigens. To more quantitatively assess the binding activity, radioiodinated
15 murine antibodies were bound to virally infected cells and Scatchard analysis performed.

The affinities of the humanized antibodies were determined by competition with the iodinated antibodies. Vero cells infected with HSV-1 were used as source of gB and gD
20 antigens. Increasing amounts of competitor antibody (mouse or humanized) were added to 1.5 ng of radioiodinated tracer mouse antibody (2 μ Ci/ μ g) and incubated with 4×10^5 infected Vero cells in 0.2 ml of binding buffer (PBS + 2% FCS + 0.1% azide) for 1 hr. at 4°C. Cells were washed and pelleted, and their
25 radioactivities were measured. The concentrations of bound and free tracer antibody were calculated. The binding affinities were calculated according to the methods of Berzofsky (J.A. Berzofsky and I.J. Berkower, in Fundamental Immunology (ed. W.E. Paul), Raven Press (New York), 595
30 (1984)).

The measurements indicate that there is no significant loss of binding affinities in the humanized antibodies (Table 5). Specifically, there is an approximately 2-fold decrease in affinity in humanized Fd79 compared to the
35 murine Fd79 (K_a of $5.3 \times 10^7 \text{ M}^{-1}$ vs. $1.1 \times 10^8 \text{ M}^{-1}$). The affinity of humanized Fd138-80 is comparable to that of the murine antibody (K_a of $4.8 \times 10^7 \text{ M}^{-1}$ vs $5.2 \times 10^7 \text{ M}^{-1}$).

TABLE 5

Binding affinities of murine and humanized antibodies.

	Mouse	Humanized
	K_a (M^{-1})	K_a (M^{-1})
5 Fd79 (anti-gB)	1.1×10^8	5.3×10^7
10 Fd138-80 (anti-gD)	5.2×10^7	4.8×10^7

15 Murine Fd79 and Fd138-80 have been shown to neutralize HSV-1 in vitro without complement (J. Koga et al., Virology 151, 385 (1986)), so the neutralizing activities of the humanized antibodies were compared with the mouse antibodies. Serial dilutions of equal quantities of murine and humanized antibodies were incubated with virus for 1 hr. before inoculation onto Vero cells. After 4 days, cells were stained with neutral red to visualize plaques. Results from these plaque reduction assays indicated that both humanized Fd79 and Fd138-80 neutralize virus as efficiently as their

20 murine counterparts (Figs. 17A and B). Both humanized and murine Fd79 cause a 90% reduction of plaques at an antibody concentration of 10 nM (1.5 ug/ml). Similarly, humanized and murine Fd138-80 were able to cause a 90% plaque reduction at equivalent levels.

30 The antibodies were also investigated for their ability to protect cells from viral spread in tissue culture. Vero cells were inoculated with virus at 0.1 pfu/cell and allowed to adsorb for 2 hrs. at 37°C before addition of 10 ug/ml antibody. After four days, cells were stained with an

35 anti-gB antibody for detection of viral antigens on infected cells. Results indicated that both murine and humanized Fd79 at 10 ug/ml protected culture cells from infection (Fig. 38A). However, neither murine nor humanized Fd138-80 were able to protect cells against viral spread (Fig. 18B), despite their

40 ability to neutralize virus before inoculation. Both gB and gD are thought to be associated with cell fusion and virus infectivity (W. Cai et al., J. Virol. 62, 2596 (1988) and A.O.

Fuller and P.G. Spear, Proc. Natl. Acad. Sci. USA 84, 5454 (1987)). However, it is possible that Fd79 blocks both the infectivity and cell fusion functions of gB, while Fd138-80 blocks only the infectivity function of gD, so virus can still spread cell-to-cell.

The binding, neutralization and protection results all indicate that the humanized Fd79 and Fd138-80 antibodies have retained the binding activities and the biological properties of the murine monoclonal antibodies. The availability of humanized antibodies with specificity for HSV gB and gD, inter alia, provides an opportunity for studies of the in vivo potency and immunogenicity of humanized antibodies in treating viral diseases. The recognition by Fd79 and Fd138-80 of type-common epitopes of gB and gD (J. Koga et al., Virology 151, 385 (1986)) expands the therapeutic potential to herpes simplex virus type 2 as well as type 1.

Protection from herpes simplex virus type 2 lethal infections in mouse model by humanized Fd79 and Fd138-80.

To determine the efficacy of humanized antibodies against herpes infections in vivo, humanized antibodies were injected into mice before and after inoculation of lethal doses of HSV-2, and the mortality rates were monitored. Groups of animals were treated intraperitoneal with 0.9, 0.3 or 0.1 mg of each of humanized Fd79 or Fd138-80 at 24 hr before or 24 hr. after viral inoculation. Groups of 10 mice were challenged intranasally with lethal doses of HSV-2. Mice were monitored for three weeks. The mortality rates were shown in the following tables.

The results show that significant protection against HSV-2 infection of mice was obtained with humanized Fd79 and humanized Fd138-80.

TABLE 6

EFFECT OF PRE-TREATMENT (-24h)
WITH HSV ANTIBODY ON THE MORTALITY
OF MICE INOCULATED INTRANASALLY WITH HSV-2

	<u>Treatment</u>	<u>Mortality</u>		<u>P-Value</u>
		<u>Number</u>	<u>Percent</u>	
10	Control	13/15	87	---
	Placebo	13/15	87	NS
	Mu Fd 138			
15	0.9 mg	3/10	30	<0.001
	0.3 mg	5/10	50	0.01
	0.1 mg	5/10	50	0.08
	Hu Fd 138			
20	0.9 mg	1/10	10	<0.001
	0.3 mg	8/10	80	NS
	0.1 mg	7/10	70	NS
	Mu Fd 79			
25	0.9 mg	0/10	0	<0.001
	0.3 mg	2/10	20	<0.01
	0.1 mg	4/10	40	<0.05
	Hu Fd 79			
30	0.9 mg	1/10	10	<0.01
	0.3 mg	3/10	30	0.08
	0.1 mg	5/10	50	0.08

TABLE 7

EFFECT OF POST-TREATMENT (+24h)
WITH HSV ANTIBODY ON THE MORTALITY
OF MICE INOCULATED INTRANASALLY WITH HSV-2

	<u>Treatment</u>	<u>Mortality</u>		<u>P-Value</u>
		<u>Number</u>	<u>Percent</u>	
10	Control	12/15	80	---
	Placebo	15/15	100	NS
	Mu Fd 138			
15	0.9 mg	2/10	20	<0.001
	0.3 mg	4/10	40	0.001
	0.1 mg	5/10	50	<0.01
	Hu Fd 138			
20	0.9 mg	3/10	30	<0.001
	0.3 mg	3/10	30	<0.001
	0.1 mg	9/10	90	NS
	Mu Fd 79			
25	0.9 mg	5/10	50	<0.01
	0.3 mg	3/10	30	<0.001
	0.1 mg	6/10	60	<0.05
	Hu Fd 79			
30	0.9 mg	3/10	30	<0.001
	0.3 mg	3/10	30	<0.001
	0.1 mg	9/10	90	NS

35

The use of a combination of two or more humanized antibodies in therapy is important for reducing the development of antibody resistant strains. Combination therapy of humanized antibodies with other antiviral agents such as acyclovir provides further opportunities to combat diseases when chemotherapeutic agents alone have not been effective. As Fd79 and Fd138-80 reduce the frequency of viral persistence in a murine ocular model (J.F. Metcalf et al., Cur. Eye Res. 6, 173 (1987)), the humanized antibodies, typically together with other antiviral agents, are capable of reducing episodes of recurrent genital infection, an area where traditional anti-viral agents have not been effective (L. Corey et al., N. Engl. J. Med. 306, 1313 (1982)). Incorporation of the human constant domains can also enhance

effector functions, such as antibody-dependent cellular cytotoxicity, leading to greater therapeutic efficiency in human patients.

5

Example IIIHumanized Immunoglobulins to CD33 Antigen

There are about 10,000-15,000 new cases of myeloid (also called non-lymphocytic or granulocytic) leukemia in the U.S. per year (Cancer Facts & Figures, American Cancer Society, 1987). There are two major forms of myeloid leukemia: acute myelogenous leukemia (AML) and chronic myelogenous leukemia (CML). Despite treatment with chemotherapy, long-term survival in patients with AML is less than 10-20% (Clarkson et al., CRC Critical Review in Oncology/Hematology 4, 221 (1986)), and survival with CML and related diseases such as chronic myelomonocytic leukemia (CMML), chronic monocytic leukemia (CMMOL) and myelodysplastic syndrome (MDS) is even lower.

The p67 protein or CD33 antigen is found on the surface of progenitors of myeloid cells and of the leukemic cells of most cases of AML, but not on lymphoid cells or non-hematopoietic cells (see, Leucocyte Typing III, ed. by A.J. McMichael, Oxford University Press, pp. 622-629 (1987). Antibodies that are known to bind to the CD33 antigen include L4B3, L1B2 and MY9 (Andrews et al., Blood 62, 124 (1983) and Griffin et al., Leukemia Research 8, 521 (1984)).

Another antibody that binds to CD33 is M195 (Tanimoto et al., Leukemia 3, 339 (1989) and Scheinberg et al., Leukemia 3, 440 (1989)). The reactivity of M195 with a wide variety of cells and tissues was tested. Among normal cells, M195 was reported to bind only to some monocytes and myeloid progenitor cells. The research also reported that it does not bind to other hematopoietic cells or to non-hematopoietic tissues. M195 bound to cells of most cases of AML and all cases of CML in myeloblastic phase.

A phase I clinical trial of M195 in AML has been conducted (Scheinberg et al., Proc. ASCO 9, 207 (1990)). M195

radiolabeled with iodine-131 was found to rapidly and specifically target leukemic cells in both the blood and bone marrow.

In accordance with the present invention, humanized immunoglobulins specifically reactive with CD33 related epitopes are provided. These immunoglobulins, which have binding affinities to CD33 of at least about $10^7 M^{-1}$, and preferably $10^8 M^{-1}$ to $10^{10} M^{-1}$ or stronger, are capable of, e.g., destroying leukemia cells. The humanized immunoglobulins will have a human framework and will have one or more complementarity determining regions (CDR's) from an immunoglobulin, typically a mouse immunoglobulin, specifically reactive with CD33 antigen. In a preferred embodiment, one or more of the CDR's will come from the M195 antibody. Importantly, M195 does not bind to the ultimate hematopoietic stem cells, so M195 used in therapy will minimally interact with and destroy those cells, which are critical for generating all blood cells. Thus, the CD33 specific immunoglobulins of the present invention, which can be produced economically in large quantities, find use, for example, in the treatment of myeloid cell-mediated disorders in human patients by a variety of techniques.

In one aspect, the present invention is directed to recombinant DNA segments encoding the heavy and/or light chain CDR's from an immunoglobulin capable of binding to a desired epitope of CD33 antigen, such as monoclonal antibodies M195, L4B3, L1B2 or MY9. The DNA segments encoding these regions will typically be joined to DNA segments encoding appropriate human framework regions. Exemplary DNA sequences, which on expression code for the polypeptide chains comprising the heavy and light chain CDR's of monoclonal antibody M195 are included in Fig. 19. Due to codon degeneracy and non-critical amino-acid substitutions, other DNA sequences can be readily substituted for those sequences, as detailed below.

The antibodies of the present invention will typically find use individually in treating hematologic malignancies. For example, typical disease states suitable

for treatment include AML, CML, CMML, CMMOL and MDS (see, generally, Hoffbrand & Pettit, Essential Haematology, Blackwell Scientific Publications, Oxford (1980)). The antibodies may also be used for bone marrow ablation prior to
5 bone marrow transplant.

Any humanized immunoglobulins of the present invention may also be used in combination with other antibodies, particularly humanized antibodies reactive with different myeloid antigens. For example, suitable antigens to
10 which a cocktail of humanized immunoglobulins may react include CD13, CD14, CD15, CD16 and CD34 (see, Leukocyte Typing III, *op. cit.*, pp. 576-732).

The antibodies can also be used as separately administered compositions given in conjunction with
15 chemotherapeutic agents. Typically, the agents may include cytosine arabinoside and daunorubicin, but numerous additional agents (e.g., 6-thioguanine) well-known to those skilled in the art for leukemia treatment may also be utilized (see, Hoffbrund & Pettit., *op. cit.*). A preferred pharmaceutical
20 composition of the present invention comprises the use of the subject immunoglobulins in immunotoxins to kill leukemia cells.

Humanized antibodies of the present invention can further find a wide variety of utilities in vitro. By way of
25 example, the antibodies can be utilized for detection of CD33 antigens, for isolating specific myeloid cells, or the like.

It will be understood that although the experiments pertain to the M195 antibody, producing humanized antibodies with high binding affinity for the CD33 antigen is also
30 contemplated using CDR's from L4B3, L1B2, MY9 or other monoclonal antibodies that bind to an epitope of CD33.

EXPERIMENTAL

Cloning of heavy chain and light chain cDNA.

35 cDNAs for the heavy chain and light chain variable domain genes were cloned using anchored polymerase chain reactions (E.Y. Loh et al., Science 243, 217 (1989)), using 3'

primers that hybridized to the constant regions and contained HindIII sites, and 5' primers that hybridized to the dG tails and contained EcoRI sites (scheme shown in Fig. 6). The PCR amplified fragments were digested with EcoRI and HindIII and
5 cloned into the pUC18 vector for sequencing. For M195, two gamma-2a specific and two kappa specific clones were sequenced. The two gamma-2a clones and two kappa clones are respectively identical in sequence. The cDNA variable domain sequences and the deduced amino acid sequences are shown in
10 Fig. 19.

Construction and expression of chimeric antibody.

Two plasmid vectors were prepared for construction and expression of the chimeric antibody genes. The plasmid
15 pVg1-dhfr (Fig. 20A) contains a human cytomegalovirus IE1 promoter and enhancer (M. Boshart et al., Cell 41, 521 (1985)), the human genomic C γ 1 segment including part of the preceding intron, and a dihydrofolate reductase (dhfr) gene (Simonsen et al., Proc. Natl Acad. Sci. USA 80, 2495 (1984))
20 for selection. The plasmid pV κ (Fig. 20B) is similar to pVg1-dhfr but contains the human genomic C κ segment and the gpt gene. Derivatives of the M195 heavy and light chain variable regions were prepared from the cDNAs by polymerase chain reaction. The 5' primers hybridized to the V regions starting
25 at the ATG codons and contained XbaI sites; the 3' primers hybridized to the last 15 nucleotides of the J regions and contained splice donor signals and XbaI sites (see, Queen et al., Proc. Natl. Acad. Sci. USA 86, 10029 (1989)). The modified V regions were cloned into the XbaI sites of the
30 respective plasmid vectors between the CMV promoter and the partial introns of the constant regions.

For expression of the chimeric antibody, the heavy chain and kappa chain plasmids were transfected into Sp2/0 mouse myeloma cells by electroporation and cells selected for
35 gpt expression. Clones secreting a maximal amount of complete antibody were detected by ELISA. Purified chimeric M195

antibody was shown to bind to U937 cells, which express the CD33 antigen, by flow cytometry (Fig. 21).

Computer modeling of humanized antibodies.

5 In order to retain high binding affinity in the humanized antibodies, the general procedures of Queen et al. were followed (see, Queen et al., Proc. Natl. Acad. Sci. USA 86, 10029 (1989) and WO 90/07861). The more homologous a human antibody is to the original murine antibody, the less
10 likely will combining the murine CDR's with the human framework be to introduce distortions into the CDR's that could reduce affinity. Normally the heavy chain and light chain from the same human antibody are chosen to provide the framework sequences, so as to reduce the possibility of
15 incompatibility in the assembling of the two chains. Based on sequence homology search against the NBRF protein sequence database (performed with the MicroGenie Sequence Analysis Software (Beckman)), the antibody Eu was chosen to provide the framework sequences for humanization of M195.

20 The computer program ENCAD (M. Levitt, J. Mol. Biol. 168, 595 (1983)) was used to construct a model of the M195 variable region. The model was used to determine the amino acids in the M195 framework that were close enough to the CDR's to potentially interact with them (category 4 below).
25 To design the humanized light and heavy chain M195 variable regions, at each position the amino acid was chosen to be the same as in the Eu antibody, unless that position fell in one or more of four categories:

- (1) The position fell within a CDR,
- 30 (2) The Eu amino acid was unusual for human antibodies at that position, whereas the M195 amino acid was typical for human antibodies at that position,
- (3) The position was immediately adjacent to a
35 CDR,

- (4) The model described above suggested that the amino acid may be physically close to the antigen binding region (CDR's).

In category (2), "unusual" is interpreted to include amino acids that occur in less than about 20% of the human sequences in the same subgroups (as defined by Kabat et al., op. cit.) as the Eu light and heavy chains, and "typical" is interpreted to include amino acids that occur in more than about 25% but generally more than 50% of the human sequences in those subgroups. For positions in these categories, the amino acid from the mouse M195 antibody was used: The amino acids in each category are shown in Table 8. Some amino acids may be in more than one category. The final sequences of the humanized M195 light and heavy chain variable domains are shown in Fig. 22, compared with the Eu sequences.

TABLE 8

<u>Category</u>	<u>Light Chain</u>	<u>Heavy Chain</u>
1	24-38, 54-60, 93-101	31-35, 50-66, 99-105
2	10, 52, 67, 110	93, 95, 98, 106, 107, 108, 110
3	--	30, 67, 98, 106
4	40, 52, 74	27, 30, 48, 68, 98

For the construction of genes for the humanized antibodies, nucleotide sequences were selected that encode the protein sequences of the humanized heavy and light chains, including the same signal peptides as in the mouse M195 chains (Fig. 19), generally utilizing codons found in the mouse sequence. Several degenerate codons were changed to create restriction sites or to remove undesirable ones. The nucleotide sequences also included the same splice donor signals used in the chimeric genes and an XbaI site at each end. Each gene was constructed from four overlapping synthetic oligonucleotides. For each variable domain gene,

two pairs of overlapping oligonucleotides on alternating strands were synthesized that encompassed the entire coding sequences as well as the signal peptide and the splice donor signal (Fig. 23). The oligonucleotides were synthesized on an Applied Biosystems 380B DNA synthesizer. Each oligo was about 110-140 bases long with about a 15 base overlap. Double stranded DNA fragments were synthesized with Klenow polymerase from each pair of oligonucleotides, digested with restriction enzymes, ligated to the pUC18 vector and sequenced. Two fragments with the respectively correct half-sequences were then ligated into the XbaI sites of the pVg1-dhfr or pVκ expression vectors in the appropriate orientations to produce the complete heavy and light chain genes. Reactions were carried out under conditions well-known in the art (Maniatis et al., op. cit.)

The heavy chain and light chain plasmids were transfected into Sp2/0 mouse myeloma cells by electroporation and cells were selected for gpt expression. Clones were screened by assaying human antibody production in the culture supernatant by ELISA, and antibody was purified from the best-producing clones. Antibody was purified by passing tissue culture supernatant over a column of staphylococcal protein A-Sepharose CL-4B (Pharmacia). The bound antibody was eluted with 0.2 M Glycine-HCl, pH3.0 and neutralized with 1 M Tris PH8.0. The buffer was exchanged into PBS by passing over a PD10 column (Pharmacia).

Properties of humanized antibodies.

The humanized M195 antibody was characterized in comparison to the murine and chimeric antibodies. The humanized antibody bound to U937 cells in a fluorocytometric analysis in a manner similar to the chimeric antibody (Fig. 21), showing that it recognizes the same CD33 antigen.

The affinity of the humanized antibody was determined by competition with the radio-iodinated mouse M195 antibody (Fig. 24). The binding affinities were calculated according to the methods of Berzofsky (J.A. Berzofsky and I.J.

Berkower, in Fundamental Immunology (ed. W.E. Paul), Raven Press (New York), 595 (1984)). The mouse M195 had an affinity comparable to the published value (Tanimoto et al., op. cit.) and the humanized M195 antibody had an affinity the same as
5 the mouse M195 to within experimental error.

Humanized M195 is useful to mediate antibody-dependent cellular cytotoxicity when human effector cells and human CD33-expressing cells are used. This is analogous to other humanized antibodies, such as reported by
10 Junghans et al., Cancer Research 50, 1495 (1990).

Unfortunately, the use of non-human monoclonal antibodies such as M195 have certain drawbacks in human treatment, particularly in repeated therapeutic regimens.

15 Example IV

Humanized Immunoglobulins to CMV Antigens

Cytomegalovirus is a major pathogen of immunocompromised individuals, especially bone marrow transplant recipients, organ transplant recipients, and AIDS
20 patients (see, generally, Fields et al., Eds., Virology, 2nd ed., Raven Press, New York pp. 1981-2010 (1990)). Approximately 15% of bone marrow transplant patients develop CMV pneumonia, with an 85% mortality rate (Meyers, Rev. Inf. Dis. 11 (suppl. 7), S1691 (1989)). About 10% of AIDS patients
25 develop severe CMV disease; and congenitally acquired CMV, often with significant morbidity and mortality, affects 1% of newborns (Fields, op. cit.).

The drug ganciclovir is effective against certain forms of CMV infection, notably chorioretinitis and
30 gastroenteritis, but is not very effective against CMV pneumonia, and it has serious toxicity. Use of pooled human immunoglobulin preparations has shown some beneficial effect for prophylaxis of CMV in bone marrow transplant patients (Meyers, op. cit.), and a combination of high-dose immune
35 globulin and ganciclovir has been reported effective against CMV pneumonia (Emanuel et al., Trans. Proc. XIX (suppl. 7), 132 (1987)). However, the marginal effectiveness, variable

potency and high cost of commercial human immune globulin remain serious problems. Hence, there is a great need for new drugs effective against CMV.

CMV is a member of the herpesvirus family of
5 viruses, and as such, has a large double-stranded DNA core, a protein capsid, and an outer lipid envelope with viral glycoproteins on its surface. At least 8 proteins have been detected on the envelope of CMV (Britt et al., J. Virol. 62, 3309 (1988)) and others have been predicted to exist based on
10 the DNA sequence of CMV (Chee et al., Nature 344, 774 (1990)). Murine monoclonal antibodies have been produced against two especially significant CMV glycoproteins: gB, also called p130/55 or gp55-116, and gH, also called p86 (Rasmussen et al., Virology 163, 308 (1988) and Britt et al., op. cit.) and
15 shown to neutralize infectivity of the virus. Three other neutralizing antibodies to gH are designated CMV5, CMV109 and CMV115. Human monoclonal antibodies to CMV have also been produced (Ehrlich et al., Hybridoma 6, 151 (1987)).

In animal models, murine monoclonal antibodies have
20 been shown effective in treating infections caused by various viruses, including members of the herpesvirus family (see, e.g., Metcalf et al., Intervirology 29, 39 (1988)). Hence, such antibodies may be useful in treatment of CMV infections. Unfortunately, the use of non-human monoclonal antibodies such
25 as CMV5 and CMV115 have certain drawbacks in human treatment, particularly in repeated therapeutic regimens as explained below.

Thus, there is a need for improved forms of humanized immunoglobulins specific for CMV antigen that are
30 substantially non-immunogenic in humans, yet easily and economically produced in a manner suitable for therapeutic formulation and other uses. The present invention fulfills these and other needs.

In accordance with the present invention, humanized
35 immunoglobulins specifically reactive with CMV and CMV-infected cells are provided. These immunoglobulins, which have binding affinities to CMV specific antigens of at least

about $10^7 M^{-1}$, and preferably $10^8 M^{-1}$ to $10^{10} M^{-1}$ or stronger, are capable of, e.g., blocking CMV infection of cells. The humanized immunoglobulins will have a human framework and will have one or more complementarity determining regions (CDR's) from an immunoglobulin, typically a mouse immunoglobulin, specifically reactive with a CMV antigen. In a preferred embodiment, one or more of the CDR's will come from the CMV5, or CMV109 or CMV115 antibodies. The immunoglobulins of the present invention, which can be produced economically in large quantities, find use, for example, in the treatment of CMV-mediated disorders in human patients by a variety of techniques.

In one aspect, the present invention is directed to recombinant DNA segments encoding the heavy and/or light chain CDR's from an immunoglobulin capable of binding to a desired epitope of a CMV antigen, such as monoclonal antibodies CMV5 or CMV115. The DNA segments encoding these regions will typically be joined to DNA segments encoding appropriate human framework regions. Exemplary DNA sequences, which on expression code for the polypeptide chains comprising the heavy and light chain CDR's of monoclonal antibody CMV5 are included in Fig. 25. Due to codon degeneracy and non-critical amino-acid substitutions, other DNA sequences can be readily substituted for those sequences, as detailed below.

Polypeptide fragments comprising only a portion of the primary antibody structure may be produced, which fragments possess one or more immunoglobulin activities (e.g., complement fixation activity). These polypeptide fragments may be produced by proteolytic cleavage of intact antibodies by methods well known in the art, or by inserting stop codons at the desired locations in the vectors pVk and pVg1-dhfr (Fig. 26) using site-directed mutagenesis, such as after CH1 to produce Fab fragments or after the hinge region to produce (Fab')₂ fragments. Single chain antibodies may be produced by joining VL and VH with a DNA linker (see Huston et al., op. cit., and Bird et al., op. cit.).

The antibodies of the present invention will typically find use individually in treating CMV-related disorders. For example, typical disease states suitable for treatment include CMV pneumonia, neonatal CMV infection, CMV mononucleosis and CMV-related chorioretinitis and gastroenteritis. Any humanized immunoglobulins of the present invention may also be used in combination with other antibodies, particularly humanized antibodies reactive with different CMV antigens. For example, suitable antigens to which a cocktail of humanized immunoglobulins may react include the gB and gH proteins. The antibodies can also be used as separately administered compositions given in conjunction with chemotherapeutic agents. Typically, the agents may include acyclovir or ganciclovir, but numerous additional agents well-known to those skilled in the art for CMV treatment may also be utilized. A preferred pharmaceutical composition of the present invention comprises the use of the subject immunoglobulins in immunotoxins to kill CMV-infected cells.

CMV specific humanized antibodies of the present invention can further find a wide variety of utilities in vitro. By way of example, the antibodies can be utilized for detection of CMV antigens, for isolating specific CMV-infected cells, or the like.

In particular, the same method may be used to produce a humanized CMV109, CMV115 or other anti-CMV antibody as used to produce humanized CMV5 herein.

EXPERIMENTAL

Cloning of heavy chain and light chain cDNA.

cDNAs for the heavy chain and light chain variable domain genes were cloned using anchored polymerase chain reactions (E.Y. Loh et al., Science 243, 217 (1989)), using 3' primers that hybridized to the constant regions and contained HindIII sites, and 5' primers that hybridized to the dG tails and contained EcoR I sites (scheme shown in Fig. 6). The PCR amplified fragments were digested with EcoR I and HindIII and

cloned into the pUC18 vector for sequencing. For CMV5, two gamma-2a specific and two kappa specific clones were sequenced. The two gamma-2a clones and two kappa clones are respectively identical in sequence. The cDNA variable domain sequences and the deduced amino acid sequences are shown in Fig. 25A and 25B. Similarly, by using techniques, which are well-known in the art, cDNAs for the CMV109 and CMV115 antibodies may be obtained and their sequence determined.

10 Construction and expression of chimeric antibody.

Two plasmid vectors were prepared for construction and expression of the chimeric antibody genes. The plasmid pVg1-dhfr (Fig. 26A) contains a human cytomegalovirus IE1 promoter and enhancer (M. Boshart et al., Cell 41, 521 (1985)), the human genomic C γ 1 segment including part of the preceding intron, and a dihydrofolate reductase (dhfr) gene (Simonsen et al., Proc. Natl. Acad. Sci. USA 80, 2495 (1983)) for selection. The plasmid pVk (Fig. 26B) is similar to pVg1-dhfr but contains the human genomic C κ segment and the gpt gene. Derivatives of the CMV5 heavy and light chain variable regions were prepared from the cDNAs by polymerase chain reaction. The 5' primers hybridized to the V regions starting at the ATG codons and contained XbaI sites; the 3' primers hybridized to the last 15 nucleotides of the J regions and contained splice donor signals and XbaI sites (see, Queen et al., Proc. Natl. Acad. Sci. USA 86, 10029 (1989)). The modified V regions were cloned into the XbaI sites of the respective plasmid vectors between the cytomegalovirus promoter and the partial introns of the constant regions.

30 For expression of the chimeric antibody, the heavy chain and kappa chain plasmids were transfected into Sp2/0 mouse myeloma cells by electroporation and cells selected for gpt expression. Clones secreting a maximal amount of complete antibody were detected by ELISA. Purified chimeric CMV5 antibody was shown to bind to CMV-infected cells, which express the gH antigen, by immunostaining of CMV-infected human embryonic lung fibroblasts.

Computer modeling of humanized antibodies.

In order to retain high binding affinity in the humanized antibodies, the general procedures of Queen et al. were followed (see, Queen et al., Proc. Natl. Acad. Sci. USA 86, 10029 (1989) and WO 90/07861). The more homologous a human antibody is to the original murine antibody, the less likely will combining the murine CDR's with the human framework be to introduce distortions into the CDR's that could reduce affinity. Normally the heavy chain and light chain from the same human antibody are chosen to provide the framework sequences, so as to reduce the possibility of incompatibility in the assembling of the two chains. Based on sequence homology search against the NBRF protein sequence database (performed with the MicroGenie Sequence Analysis Software (Beckman)), the antibody Wol was chosen to provide the framework sequences for humanization of CMV5.

The computer program ENCAD (M. Levitt, J. Mol. Biol. 168, 595 (1983)) was used to construct a model of the CMV5 variable region. The model was used to determine the amino acids in the CMV5 framework that were close enough to the CDR's to potentially interact with them (category 4 below). To design the humanized light and heavy chain CMV5 variable regions, at each position the amino acid was chosen to be the same as in the Wol antibody, unless that position fell in one or more of five categories:

- (1) The position fell within a CDR,
- (2) The Wol amino acid was unusual for human antibodies at that position, whereas the CMV5 amino acid was typical for human antibodies at that position,
- (3) The position was immediately adjacent to a CDR,
- (4) The model described above suggested that the amino acid may be physically close to the antigen binding region (CDR's).

In category (2), "unusual" is interpreted to include amino acids that occur in less than about 20% of the human sequences

in the same subgroups (as defined by Kabat et al., op. cit.) as the Wol light and heavy chains, and "typical" is interpreted to include amino acids that occur in more than about 25% but generally more than 50% of the human sequences in those subgroups. For positions in these categories, the amino acid from the mouse CMV5 antibody was used. In addition, a position was in the fifth category if the Wol amino acid was highly unusual for human antibodies at that position, and the CMV5 amino acid was different but also unusual. Then an amino acid typical for human antibodies at that position may be used.

The amino acids in each category are shown in Table 1. Some amino acids may be in more than one category. The final sequences of the humanized CMV5 light and heavy chain variable domains are shown in Fig. 27A-B, compared with the Wol sequences.

TABLE 9

Category	Light Chain	Heavy Chain
1	24-34, 50-56, 89-97	31-35, 50-66, 99-108 69, 80
2		69, 80
3	49	30
4		24, 27, 28, 30, 97
5		5

For the construction of genes for the humanized antibodies, nucleotide sequences were selected that encode the protein sequences of the humanized heavy and light chains, including the same signal peptides as in the mouse CMV5 chains (Fig. 25), generally utilizing codons found in the mouse sequence. Several degenerate codons were changed to create restriction sites or to remove undesirable ones. The nucleotide sequences also included the same splice donor signals used in the chimeric genes and an XbaI site at each end. Each gene was constructed from four overlapping

synthetic oligonucleotides. For each variable domain gene, two pairs of overlapping oligonucleotides on alternating strands were synthesized that encompassed the entire coding sequences as well as the signal peptide and the splice donor
5 signal (Fig. 28). The oligonucleotides were synthesized on an Applied Biosystems 380B DNA synthesizer. Each oligo was about 110-140 bases long with about a 15 base overlap. Double
10 stranded DNA fragments were synthesized with Klenow polymerase from each pair of oligonucleotides, digested with restriction enzymes, ligated to the pUC18 vector and sequenced. Two
15 fragments with the respectively correct half-sequences were then ligated into the XbaI sites of the pVg1-dhfr or pVκ expression vectors in the appropriate orientations to produce the complete heavy and light chain genes. Reactions were
carried out under conditions well-known in the art (Maniatis et al., op. cit.)

The heavy chain and light chain plasmids are transfected into Sp2/0 mouse myeloma cells by electroporation and cells are selected for gpt expression. Clones are
20 screened by assaying human antibody production in the culture supernatant by ELISA, and antibody purified from the best-producing clones. Antibody is purified by passing tissue culture supernatant over a column of staphylococcal protein A-
25 Sepharose CL-4B (Pharmacia). The bound antibody is eluted with 0.2 M Glycine-HCl, pH3.0 and neutralized with 1 M Tris
pH8.0. The buffer is exchanged into PBS by passing over a PD10 column (Pharmacia).

Humanized antibody was also produced by transient transfection. The heavy chain and light chain plasmids were
30 transfected into S194 cells (ATCC TIB 19) by the DEAE-dextran method (Queen et al., Mol. Cell. Biol. 4, 1043 (1984)), and humanized CMV5 antibody was purified from the media supernatant as above. Antibody was quantitated by ELISA assay
for human Ig.

35

Properties of humanized antibodies.

The humanized CMV5 antibody was characterized in comparison to the murine and chimeric antibodies. The humanized CMV5 antibody was shown to bind about as well as the mouse and chimeric antibodies to CMV antigen, by immunostaining of CMV-infected human embryonic lung (HEL) cells (ATCC CCL 137). HEL cells monolayers in 96-well plates were infected with CMV at 0.01 pfu/cell, incubated for 4 days, dried at 37°C and stored wrapped at 4°C. 100 µl blotto (5% Carnation Instant Milk in PBS at pH 7.4) was added to each well and incubated at 37°C for 30 min. The blotto was poured off and 75 µl of a series of 2-fold dilutions of mouse, chimeric and humanized CMV5 antibody was added to the wells. The plate was incubated 1 hr at 37°C and washed twice with blotto (each wash was left on for 10 min). Then 75 µl of diluted peroxidase (HRP) conjugated goat anti-mouse or anti-human IgG (Tago) was added to each well and incubated for 1 hr at 37°C. The plate was washed 2x with PBS and 150 µl of HRP substrate solution was added to each well. Color was allowed to develop at room temperature. The plates were washed with water and air dried. The wells were examined under a microscope to determine the highest dilution of the antibodies that formed a colored precipitate on the CMV-infected cells. For all three antibodies, 63 ng/ml was the least amount of antibody that produced a detectable precipitate, indicating that humanized CMV5 binds about as well as the mouse and chimeric antibodies.

To compare the affinities of mouse and humanized CMV5 in another way, a competition experiment was performed. Plates of CMV-infected HEL cells as above were incubated with blotto for 30 min at 37°C. The blotto was poured off and dilutions of mouse or humanized CMV5 were added to each well in 75 µl of PBS. Then 125 µl of radio-iodinated mouse CMV5 (1 µCi/µg) in PBS, containing 28,000 cpm was added to each well and incubated at 37°C for 2.5 hr. The plate was washed 5 times with PBS, and the contents of each well were solubilized with 200 µl of 2% SDS and counted. Increasing concentrations

of mouse and humanized CMV5 inhibited binding of the radiolabeled CMV5 about equally well (Fig. 29), so humanized CMV5 has approximately the same binding affinity as mouse CV5. An irrelevant antibody did not compete in this assay.

5 The ability of humanized CMV5 to neutralize CMV is compared to that of mouse CMV5. Mouse and humanized CMV5 are successively diluted by 2-fold in 100 μ l of DME medium + 2% FCS in wells of a 96-well plate. 100 μ l of CMV, which has been diluted to contain 100 tissue culture infectious dose-50%
10 (TCID₅₀) units, are added to each well and incubated for 60 min at 37°C. Each well of antibody-virus mixture is added to a well of subconfluent HEL cells in a 96-well plate from which the medium has been removed. The cells are incubated for 5 days and cytopathic effect (CPE) is examined in each well
15 under a microscope. The highest dilution of antibody that inhibits CPE by 90% is a measure of the neutralizing ability of the antibody. The humanized CMV5 antibody will neutralize CMV antibody approximately as well as the mouse CMV5 antibody.

20

Example V

In mammals, the immune response is mediated by several types of cells that interact specifically with foreign material, i.e., antigens. One of these cell types, B cells, is responsible for the production of antibodies. Another cell
25 type, T cells, include a wide variety of cellular subsets that destroy virally infected cells or control the in vivo function of both B cells and other hematopoietic cells, including T cells. A third cell type, macrophages, process and present antigens in conjunction with major histocompatibility complex
30 (MHC) proteins to T cells. Communication between these cell types is mediated in a complex manner by lymphokines, such as interleukins 1-6 and γ -IFN (see, generally, Paul, W.E., ed., Fundamental Immunology, 2nd ed., Raven Press, New York (1989)).

35 One important lymphokine is γ -IFN, which is secreted by some T cells. In addition to its anti-viral activity, γ -IFN stimulates natural killer (NK) cells, activates

macrophages, and stimulates the expression of MHC molecules on the surface of cells (Paul, *op. cit.*, pp. 622-624). Hence γ -IFN generally serves to enhance many aspects of immune function, and is a logical candidate for a therapeutic drug in cases where such enhancement is desired, e.g., in treating cancer. Conversely, in disease states where the immune system is over-active, e.g., autoimmune diseases and organ transplant rejection, antagonists of γ -IFN may be used to treat the disease by neutralizing the stimulatory effects of γ -IFN.

10 One class of effective antagonists of γ -IFN are monoclonal antibodies that bind to and neutralize it (*see*, e.g., Van der Meide et al., *J. Gen. Virol*, 67, 1059 (1986)). In in vitro and in vivo mouse models of transplants, anti- γ -IFN antibodies have been shown to delay or prevent rejection
15 (Landolfo et al., *Science* 229, 176 (1985) and Rosenberg et al., *J. Immunol.* 144, 4648 (1990)). Treatment of mice prone to develop a syndrome like systemic lupus erythematosus (SLE) with a monoclonal antibody to γ -IFN significantly delayed onset of the disease (Jacob et al., *J. Exp. Med.* 166, 798
20 (1987)). Under some conditions, an anti- γ -IFN antibody alleviated adjuvant arthritis in rats (Jacob et al., *J. Immunol.* 142, 1500 (1989)), suggesting that anti- γ -IFN may be effective against some cases of rheumatoid arthritis in human patients. Multiple sclerosis (MS) in patients is made worse
25 by treatment with γ -IFN (Panitch et al., *Neurology* 36 (suppl. 1), 285 (1986)), so an anti- γ -IFN antibody may alleviate MS. Thus, an anti- γ -IFN antibody may be effective in treating these and other autoimmune diseases.

For treatment of human patients, a murine monoclonal
30 that binds to and neutralizes human γ -IFN (*see*, e.g., Yamamoto et al., *Microbiol. Immunol.* 32, 339 (1988)) may be used. Another murine monoclonal antibody designated AF2 that neutralizes human γ -IFN, and inhibits binding of γ -IFN to its cellular receptor, is disclosed herein. Unfortunately, the
35 use of non-human monoclonal antibodies such as AF2 have certain drawbacks in human treatment, particularly in repeated therapeutic regimens.

In accordance with the present invention, humanized immunoglobulins specifically reactive with γ -IFN epitopes are provided. These immunoglobulins, which have binding affinities to γ -IFN of at least about $10^7 M^{-1}$, and preferably $10^8 M^{-1}$ to $10^{10} M^{-1}$ or stronger, are capable of, e.g., neutralizing human γ -IFN. The humanized immunoglobulins will have a human framework and will have one or more complementarity determining regions (CDR's) from an immunoglobulin, typically a mouse immunoglobulin, specifically reactive with γ -IFN. In a preferred embodiment, one or more of the CDR's will come from the AF2 antibody. Thus, the immunoglobulins of the present invention, which can be produced economically in large quantities, find use, for example, in the treatment of autoimmune disorders in human patients by a variety of techniques.

In one aspect, the present invention is directed to recombinant DNA segments encoding the heavy and/or light chain CDR's from an immunoglobulin capable of binding to a desired epitope of γ -IFN, such as monoclonal antibody AF2. The DNA segments encoding these regions will typically be joined to DNA segments encoding appropriate human framework regions. Exemplary DNA sequences, which on expression code for the polypeptide chains comprising the heavy and light chain CDR's of monoclonal antibody AF2 are included in Fig. 30. Due to codon degeneracy and non-critical amino-acid substitutions, other DNA sequences can be readily substituted for those sequences, as detailed below.

Alternatively, polypeptide fragments comprising only a portion of the primary antibody structure may be produced, which fragments possess one or more immunoglobulin activities (e.g., complement fixation activity). These polypeptide fragments may be produced by proteolytic cleavage of intact antibodies by methods well known in the art, or by inserting stop codons at the desired locations in the vectors pV_k and pV_{g1-dhfr} (Fig. 31) using site-directed mutagenesis, such as after CH1 to produce Fab fragments or after the hinge region to produce (Fab')₂ fragments. Single chain antibodies may be

produced by joining VL and VH with a DNA linker (see Huston et al., op cit., and Bird et al., op cit.).

The antibodies of the present invention will typically find use individually in treating autoimmune conditions. For example, typical disease states suitable for treatment include graft versus host disease and transplant rejection in patients undergoing an organ transplant, such as heart, lungs, kidneys, liver, etc. Other diseases include autoimmune diseases, such as Type I diabetes, multiple sclerosis, rheumatoid arthritis, systemic lupus erythematosus, and myasthenia gravis.

Humanized immunoglobulins of the present invention may also be used in combination with other antibodies, particularly humanized antibodies reactive with other lymphokines or lymphokine receptors. For example, suitable antigens to which a cocktail of humanized immunoglobulins may react include interleukins 1 through 10 and the p55 and p75 chains of the IL-2 receptor (see, Waldmann, Annu. Rev. Biochem. 58, 875 (1989) and Queen et al., Proc. Natl. Acad. Sci. USA 86, 10029 (1989)). Other antigens include those on cells responsible for the disease, e.g., the so-called "Clusters of Differentiation" (Leucocyte Typing III, ed. by A.J. McMichael, Oxford University Press (1987)).

The antibodies can also be used as separately administered compositions given in conjunction with chemotherapeutic agents. Typically, the agents may include non-steroidal anti-inflammatory agents (e.g., aspirin, ibuprofen), steroids (e.g., prednisone) and immunosuppressants (e.g., cyclosporin A, cytoxan), but numerous additional agents well-known to those skilled in the art may also be utilized. A preferred pharmaceutical composition of the present invention comprises the use of the subject immunoglobulins in immunotoxins, e.g., to kill γ -IFN-secreting cells.

Humanized antibodies of the present invention can further find a wide variety of utilities in vitro. By way of example, the antibodies can be utilized for detection of γ -IFN antigens, or the like.

EXPERIMENTAL

Cloning of heavy chain and light chain cDNA.

cDNAs for the heavy chain and light chain variable domain genes were cloned using anchored polymerase chain reactions (E.Y. Loh et al., Science 243, 217 (1989)), using 3' primers that hybridized to the constant regions and contained HindIII sites, and 5' primers that hybridized to the dG tails and contained EcoR I sites (scheme shown in Fig. 6). The PCR amplified fragments were digested with EcoR I and HindIII and cloned into the pUC18 vector for sequencing. For AF2, two gamma-2b specific and two kappa specific clones were sequenced. The two gamma-2b clones and two kappa clones are respectively identical in sequence. The cDNA variable domain sequences and the deduced amino acid sequences are shown in Fig. 30.

Construction and expression of chimeric antibody.

Two plasmid vectors were prepared for construction and expression of the chimeric antibody genes. The plasmid pVg1-dhfr (Fig. 31A) contains a human cytomegalovirus IE1 promoter and enhancer (M. Boshart et al., Cell 41, 521 (1985)), the human genomic C γ 1 segment including part of the preceding intron, and a dihydrofolate reductase (dhfr) gene (Simonsen et al., Proc. Natl. Acad. Sci. USA 80, 2495 (1984)) for selection. The plasmid pV κ (Fig. 31B) is similar to pVg1-dhfr but contains the human genomic C κ segment and the gpt gene. Derivatives of the AF2 heavy and light chain variable regions were prepared from the cDNAs by polymerase chain reaction. The 5' primers hybridized to the V regions starting at the ATG codons and contained XbaI sites; the 3' primers hybridized to the last 15 nucleotides of the J regions and contained splice donor signals and XbaI sites (see, Queen et al., Proc. Natl. Acad. Sci. USA 86, 10029 (1989)). The modified V regions were cloned into the XbaI sites of the respective plasmid vectors between the CMV promoter and the partial introns of the constant regions.

For expression of the chimeric antibody, the heavy chain and kappa chain plasmids were transfected into Sp2/0 mouse myeloma cells by electroporation and cells selected for gpt expression. Clones secreting a maximal amount of complete antibody were detected by ELISA. Chimeric AF2 antibody was shown to bind to human γ -IFN by ELISA.

Computer modeling of humanized antibodies.

In order to retain high binding affinity in the humanized antibodies, the general procedures of Queen et al. were followed (see, Queen et al., Proc. Natl. Acad. Sci. USA 86, 10029 (1989) and WO 90/07861). The more homologous a human antibody is to the original murine antibody, the less likely will combining the murine CDR's with the human framework be to introduce distortions into the CDR's that could reduce affinity. Normally the heavy chain and light chain from the same human antibody are chosen to provide the framework sequences, so as to reduce the possibility of incompatibility in the assembling of the two chains. Based on sequence homology search against the NBRF protein sequence database (performed with the MicroGenie Sequence Analysis Software (Beckman)), the antibody Eu was chosen to provide the framework sequences for humanization of AF2.

The computer program ENCAD (M. Levitt, J. Mol. Biol. 168, 595 (1983)) was used to construct a model of the AF2 variable region. The model was used to determine the amino acids in the AF2 framework that were close enough to the CDR's to potentially interact with them (category 4 below). To design the humanized light and heavy chain AF2 variable regions, at each position the amino acid was chosen to be the same as in the Eu antibody, unless that position fell in one or more of five categories:

- (1) The position fell within a CDR,
- (2) The Eu amino acid was unusual for human antibodies at that position, whereas the AF2 amino acid was typical for human antibodies at that position,

- (3) The position was immediately adjacent to a CDR,
 (4) The model described above suggested that the amino acid may be physically close to the antigen binding region (CDR's).

5 In category (2), "unusual" is interpreted to include amino acids that occur in less than about 20% of the human sequences in the same subgroups (as defined by Kabat et al., op. cit.) as the Eu light and heavy chains, and "typical" is interpreted to include amino acids that occur in more than about 25% but
 10 generally more than 50% of the human sequences in those subgroups. For positions in these categories, the amino acid from the mouse AF2 antibody was used. In addition, a position was in the fifth category if the Eu amino acid was highly unusual for human antibodies at that position, and the AF2
 15 amino acid was different but also unusual. Then an amino acid typical for human antibodies at that position may be used.

The amino acids in each category are shown in Table 10. Some amino acids may be in more than one category. The final sequences of the humanized AF2 light and heavy chain
 20 variable domains are shown in Fig. 32, compared with the Eu sequences.

TABLE 10

25	<u>Category</u>	<u>Light Chain</u>	<u>Heavy Chain</u>
	1	24-34, 50-56, 89-97	31-35, 50-66, 99-106
30	2	48	93, 95, 98, 107, 108, 109, 111
	3		30, 98, 107
	4	48, 70	27, 28, 30, 98, 107
35	5	63	

40 For the construction of genes for the humanized antibodies, nucleotide sequences were selected that encode the protein sequences of the humanized heavy and light chains, plus typical immunoglobulin signal sequences, generally

utilizing codons found in the mouse sequence. Several degenerate codons were changed to create restriction sites or to remove undesirable ones. The nucleotide sequences also included the same splice donor signals used in the chimeric genes and an XbaI site at each end. Each gene was constructed from four overlapping synthetic oligonucleotides. For each variable domain gene, two pairs of overlapping oligonucleotides on alternating strands were synthesized that encompassed the entire coding sequences as well as the signal peptide and the splice donor signal (Fig. 33) The oligonucleotides were synthesized on an Applied Biosystems 380B DNA synthesizer. Each oligo was about 110-140 bases long with about a 15 base overlap. Double stranded DNA fragments were synthesized with Klenow polymerase from each pair of oligonucleotides, digested with restriction enzymes, ligated to the pUC18 vector and sequenced. Two fragments with the respectively correct half-sequences are then ligated into the XbaI sites of the pVg1-dhfr or pVκ expression vectors in the appropriate orientations to produce the complete heavy and light chain genes. Reactions are carried out under conditions well-known in the art (Maniatis et al., op. cit.)

The heavy chain and light chain plasmids are transfected into Sp2/0 mouse myeloma cells by electroporation and cells selected for gpt expression. Clones are screened by assaying human antibody production in the culture supernatant by ELISA, and antibody purified from the best-producing clones. Antibody is purified by passing tissue culture supernatant over a column of staphylococcal protein A-Sepharose CL-4B (Pharmacia). The bound antibody is eluted with 0.2 M Glycine-HCl, pH3.0 and neutralized with 1 M Tris PH8.0. The buffer is exchanged into PBS by passing over a PD10 column (Pharmacia).

Properties of humanized antibodies.

The humanized AF2 antibody is characterized in comparison to the murine and chimeric antibodies. The humanized antibody will bind to γ -IFN in an ELISA assay in a

manner similar to the mouse and chimeric antibodies, showing that it recognizes γ -IFN.

To compare the binding affinities of mouse AF2 antibody and humanized AF2 antibody, a competitive ELISA assay is performed. An ELISA plate is coated with human recombinant γ -IFN by adding 100 μ l of a 500 ng/ml solution of γ -IFN in PBS to each well and incubating overnight at 4°C. Subsequent steps are carried out at room temperature. The γ -IFN solution is removed and 200 μ l of ELISA buffer (0.1% Tween-20, 1% Bovine serum albumin in PBS) is added to each well and incubated for 1 hr. After removing the solution, varying amounts of competitor antibody (mouse AF2 or humanized AF2) in 100 μ l PBS is added to each well, along with an amount of biotinylated AF2 predetermined to give a good ELISA response. The plate is incubated for 1 hr and then washed 3 times with ELISA buffer. An amount of horseradish peroxidase (HRP)-conjugated strepavidin predetermined to be in excess is added in 100 μ l PBS to each well and incubated for 30 min. The plate is washed 3 times in ELISA buffer, and 100 μ l of substrate solution for HRP is added to each well. The plate is incubated for 10-30 min, and the optical density of each well is determined with an ELISA reader (BioRad). The decrease in optical density with increasing concentrations of competitor antibodies mouse AF2 and humanized AF2 are plotted. Mouse AF2 and humanized AF2 will compete similarly, showing that their binding affinities for γ -IFN are approximately the same. The procedures used are well known in the art (e.g., Harlow and Lane, *op. cit.*).

An important biological activity of γ -IFN is the induction of expression of class II HLA antigens on cells. To determine the ability of mouse and humanized AF2 to neutralize this activity, about 5×10^4 HS294T cells (Basham et al., J. Immunol. 130, 1492 (1983)) are plated in 1.0 ml DMEM medium + 10% FCS in each well of a 24-well plate. After overnight incubation, 0.1 nM interferon and varying amounts of mouse or humanized AF2 are added to the cells, and the plate is incubated for 72 hr. The cells are removed from the plate

with 0.05 M EDTA, stained with monoclonal antibody L243 from the American Type Culture Collection (ATCC) against HLA-D antigen, washed, stained with FITC conjugated goat anti-mouse Ig and analyzed with a FACScan (Becton-Dickinson). Increasing
5 concentrations of mouse AF2 reduce fluorescence of the cells (Fig. 34), indicating the antibody is preventing induction of HLA-D by γ -IFN. The humanized AF2 will act similarly to mouse AF2 in this assay, showing that it neutralizes the biological activity of γ -IFN.

10 From the foregoing, it will be appreciated that the humanized immunoglobulins of the present invention offer numerous advantages over other γ -IFN specific antibodies. In comparison to mouse monoclonal antibodies, the present humanized immunoglobulins can be more economically produced
15 and contain substantially less foreign amino acid sequences. This reduced likelihood of antigenicity after injection into a human patient represents a significant therapeutic improvement.

All publications and patent applications are herein
20 incorporated by reference to the same extent as if each individual publication or patent application was specifically and individually indicated to be incorporated by reference. Although the present invention has been described in some detail by way of illustration and example for purposes of
25 clarity and understanding, it will be apparent that certain changes and modifications may be practiced within the scope of the appended claims.

WHAT IS CLAIMED IS

1. A composition comprising a substantially pure humanized immunoglobulin specifically reactive with the p75 chain of the human IL-2 receptor.
5
2. A composition according to Claim 1, wherein the immunoglobulin exhibits a binding affinity to a human IL-2 receptor of about 10^7 M⁻¹ or stronger.
10
3. A composition according to Claim 1, wherein the immunoglobulin comprises one or more foreign CDRs substantially homologous to a CDR from an immunoglobulin reactive with human p75 protein.
15
4. A composition according to Claim 1, wherein the immunoglobulin is capable of blocking the binding of interleukin-2 (IL-2) to the p75 chain of human IL-2 receptors.
20
5. A composition according to Claim 1, wherein the humanized immunoglobulin comprises the human framework regions having amino acids sequences from at least two human immunoglobulins.
25
6. A humanized immunoglobulin capable of binding to human interleukin-2 receptors, said immunoglobulin comprising one or more complementarity determining regions (CDR's) from mik-β1 antibody in a human framework.
30
7. A humanized immunoglobulin according to Claim 6, wherein the human framework is substantially homologous to an Lay immunoglobulin framework.
35
8. A humanized immunoglobulin according to Claim 6 which is capable of blocking the binding of IL-2 to interleukin-2 receptors on human T-cells.

9. A method of treating T-cell mediated disorders in a human patient, said method comprising administering to said patient a therapeutically effective dose of an immunoglobulin according to Claim 6.

5

10. A humanized immunoglobulin according to Claim 6 which is complexed to a cytotoxic agent.

11. A composition comprising a substantially pure
10 humanized immunoglobulin specifically reactive with a herpes simplex virus-specific epitope.

12. A composition according to claim 11, wherein the epitope is on a viral surface glycoprotein.

15

13. A composition according to claim 12, wherein the glycoprotein is gB or gD.

14. A composition comprising a substantially pure
20 humanized immunoglobulin capable of inhibiting binding of a herpes simplex virus (HSV) protein to a mouse monoclonal antibody specifically reactive with said protein, wherein the humanized immunoglobulin comprises at least one complementarity determining region (CDR) from the mouse
25 monoclonal antibody.

15. A composition according to Claim 14, wherein the humanized immunoglobulin exhibits a binding affinity of about $10^7 M^{-1}$ or stronger.

30

16. A composition according to Claim 14 wherein said immunoglobulin is capable of binding to type 1 or 2 herpes simplex virus (HSV).

35 17. A composition according to Claim 14, wherein the immunoglobulin comprises one or more CDR's substantially

homologous to a CDR from an immunoglobulin reactive with HSV glycoprotein of gB, gD, gG or gH.

18. A composition according to Claim 14, wherein
5 the immunoglobulin is an IgG₁ immunoglobulin isotype.

19. A humanized immunoglobulin capable of binding
to herpes simplex virus, said immunoglobulin comprising one or
more complementarity determining regions (CDR's) from a mouse
10 monoclonal antibody in a human framework, wherein the mouse
antibody is Fd 79 or Fd 138-80.

20. A humanized immunoglobulin according to Claim
19, wherein the human framework is substantially homologous to
15 an Eu or a Pom immunoglobulin framework.

21. A humanized immunoglobulin according to Claim
19 which is capable of neutralizing HSV.

20 22. A method of treating herpes simplex virus
mediated disorders in a human patient, said method comprising
administering to said patient a therapeutically effective dose
of an immunoglobulin according to Claim 14.

25 23. A composition comprising a substantially pure
humanized immunoglobulin specifically reactive with a CD33
antigen epitope.

24. A composition according to Claim 23, wherein a
30 variable region of at least one chain of the immunoglobulin
comprises three complementarity determining regions (CDR's)
from a non-human antibody in a human framework.

25. A composition according to claim 24, wherein
35 the chain is the heavy chain.

26. A composition according to claim 24, wherein the non-human antibody is M195.

27. A composition comprising a substantially pure
5 humanized immunoglobulin capable of inhibiting binding of CD33
antigen to a mouse monoclonal antibody specifically reactive
with said antigen, wherein the humanized immunoglobulin
comprises at least one complementarity determining region
(CDR) from the mouse monoclonal antibody.

10

28. A composition according to Claim 27, wherein the humanized immunoglobulin exhibits a binding affinity of about $10^7 M^{-1}$ or stronger.

15

29. A composition according to Claim 27, which is capable of blocking the binding of mouse M195 antibody to human cells.

30. A composition according to Claim 27, wherein
20 the humanized immunoglobulin comprises a human framework
substantially homologous to Eu immunoglobulin framework.

31. A humanized immunoglobulin according to Claim
27 which is of capable mediating antibody-dependent cellular
25 cytotoxicity in the presence of human target and effector
cells.

32. A method of treating myeloid cell-mediated
disorders in a human patient, said method comprising
30 administering to said patient a therapeutically effective dose
of a composition according to Claim 27.

33. A composition according to claim 27, wherein
the immunoglobulin is conjugated to a cytotoxic agent.

35

34. A composition comprising a substantially pure humanized immunoglobulin specifically reactive with a human cytomegalovirus-specific epitope.

5 35. A composition according to Claim 34, wherein a variable region of at least one chain comprises three complementarity determining regions from a non-human immunoglobulin chain in a human framework.

10 36. A composition according to claim 34, wherein the epitope is on a viral surface glycoprotein.

37. A composition according to claim 36, wherein the glycoprotein is gB or gH.

15

38. A composition comprising a substantially pure humanized immunoglobulin capable of inhibiting binding of a cytomegalovirus (CMV) protein to a mouse monoclonal antibody specifically reactive with said protein, wherein the humanized immunoglobulin comprises at least one complementarity determining region (CDR) from the mouse monoclonal antibody.

20 39. A composition according to Claim 38, wherein the humanized immunoglobulin exhibits a binding affinity of about $10^7 M^{-1}$ or stronger.

30 40. A recombinant immunoglobulin composition comprising a human framework and one or more foreign complementarity determining regions (CDR's) not naturally associated with the framework, wherein said immunoglobulin is capable of binding to CMV.

35 41. A composition according to Claim 40, wherein all of the foreign CDR's are located on heavy chains of the immunoglobulin.

42. A composition according to Claim 40, wherein the immunoglobulin is an IgG₁ immunoglobulin isotype.

43. A composition according to Claim 40 wherein the immunoglobulin is capable of blocking the binding of CMV to human cells.

44. An immunoglobulin according to Claim 40, wherein the framework regions comprise amino acids sequences from at least two human immunoglobulins.

45. A humanized immunoglobulin capable of binding to cytomegalovirus, said immunoglobulin comprising one or more complementarity determining regions (CDR's) from a mouse monoclonal antibody in a human framework, wherein the mouse antibody is CMV5, CMV109 or CMV115.

46. A humanized immunoglobulin according to Claim 45, wherein the human framework is substantially homologous to an Eu or a Wol immunoglobulin framework.

47. A humanized immunoglobulin according to Claim 45 which is capable of neutralizing CMV.

48. A method of treating cytomegalovirus mediated disorders in a human patient, said method comprising administering to said patient a therapeutically effective dose of an immunoglobulin according to Claim 45.

49. A method of treating cytomegalovirus mediated disorders in a human patient, said method comprising administering to said patient a therapeutically effective dose of a combination of two or more immunoglobulins according to Claims 45.

35

50. A composition comprising a substantially pure humanized immunoglobulin specifically reactive with human γ -IFN.

5 51. A composition according to Claim 50, wherein a variable region of at least one chain comprises three complementarity determining regions (CDR's) from a non-human antibody in a human framework.

10 52. A composition according to claim 51, wherein the non-human antibody is AF2.

15 53. A composition according to Claim 50 capable of inhibiting binding of human γ -IFN to a human γ -IFN receptor.

54. A recombinant immunoglobulin composition comprising a human framework and one or more complementarity determining regions (CDR's) not naturally associated with the framework, wherein said immunoglobulin is capable of
20 specifically inhibiting biniding of human γ -IFN to a human γ -IFN receptor.

55. A composition according to Claim 54, wherein one or more of the foreign CDR's are substantially homologous
25 to a CDR from the AF2 antibody.

56. A composition according to Claim 54, wherein the immunoglobulin is an IgG₁ immunoglobulin isotype.

30 57. A composition according to Claim 54, wherein the immunoglobulin is capable of blocking the binding of human γ -IFN antibody to human cells.

35 58. A method of treating autoimmune disorders in a human patient, said method comprising administering to said patient a therapeutically effective dose of a composition according to Claim 54.

59. A composition according to Claim 11, wherein the immunoglobulin is conjugated to a cytotoxic agent.

5 60. A composition according to Claim 40, wherein the immunoglobulin is conjugated to a cytotoxic agent.

10

1 D I V L T Q S P A S L A V S L G Q R A T
 1 E I V M T Q S P A T L S V S P G E R A T
 21 I S C R A S Q S V S T S T Y N Y M H W Y
 21 L S C R A S Q S V S T S T Y N Y M H W Y
 41 Q Q K P G Q P P K L L I K Y A S N L E S
 41 Q Q K P G Q S P R L L I K Y A S N L E S
 61 G V P A R F S G S G F G T D F T L N I H
 61 G I P A R F S G S G S G T E F T L T I S
 81 P V E E E D T V T Y Y C Q H S W E I P Y
 81 R L E S E D F A V Y Y C Q H S W E I P Y
 101 T F G G G T K L E I K
 101 T F G Q G T R V E I K

FIG. 1A

1 E M I L V E S G G G L V K P G A S L K L
 1 E V Q L L E S G G G L V Q P G G S L R L
 21 S C A A S G F T F S N Y G L S W V R Q T
 21 S C A A S G F T F S N Y G L S W V R Q A
 41 S D R R L E W V A S I S R G G G R I Y S
 41 P G K G L E W V A S I S R G G G R I Y S
 61 P D N L K G R F T I S R E D A K N T L Y
 61 P D N L K G R F T I S R N D S K N T L Y
 81 L Q M S S L K S E D T A L Y Y C L R E G
 81 L Q M N S L Q A E D T A L Y Y C L R E G
 101 I Y Y A D Y G F F D V W G T G T T V I V
 101 I Y Y A D Y G F F D V W G Q G T L V T V
 121 S S
 121 S S

FIG. 1B

SUBSTITUTE SHEET

1 D I V M T Q S H K F M S T S V G D R V S
 1 D I Q M T Q S P S T L S A S V G D R V T

 21 I T C K A S Q D V G S A V V W H Q Q K S
 21 I T C K A S Q D V G S A V V W H Q Q K P

 41 G Q S P K L L I Y W A S T R H T G V P D
 41 G K A P K L L I Y W A S T R H T G V P S

 61 R F T G S G S G T D F T L T I T N V Q S
 61 R F T G S G S G T E F T L T I S S L Q P

 81 E D L A D Y F C Q Q Y S I F P L T F G A
 81 D D F A T Y F C Q Q Y S I F P L T F G Q

 101 G T R L E L K
 101 G T K V E V K

FIG. 2A

1 Q V Q L Q Q S D A E L V K P G A S V K I
 1 Q V Q L V Q S G A E V K K P G S S V K V

 21 S C K V S G Y T F T D H T I H W M K Q R
 21 S C K A S G Y T F T D H T I H W M R Q A

 41 P E Q G L E W F G Y I Y P R D G H T R Y
 41 P G Q G L E W F G Y I Y P R D G H T R Y

 61 S E K F K G K A T L T A D K S A S T A Y
 61 A E K F K G K A T I T A D E S T N T A Y

 81 M H L N S L T S E D S A V Y F C A R G R
 81 M E L S S L R S E D T A V Y F C A R G R

 101 D S R E R N G F A Y W G Q G T L V T V S
 101 D S R E R N G F A Y W G Q G T L V T V S

 121 A
 121 S

FIG. 2B

SUBSTITUTE SHEET

1 D I V L T Q S P A S L A V S L G Q R A T
 1 D I Q M T Q S P S S L S A S V G D R V T

21 I S C R A S E S V D N Y G I S F M N W F
 21 I T C R A S E S V D N Y G I S F M N W F

41 Q Q K P G Q P P K L L I Y A A S N Q G S
 41 Q Q K P G K A P K L L I Y A A S N Q G S

61 G V P A R F S G S G S G T D F S L N I H
 61 G V P S R F S G S G S G T D F T L N I S

81 P M E E D D T A M Y F C Q Q S K E V P W
 81 S L Q P D D F A T Y Y C Q Q S K E V P W

101 T F G G G T K L E I K
 101 T F G Q G T K V E I K

FIG. 3A

1 E V Q L Q Q S G P E L V K P G A S V K I
 1 Q V Q L V Q S G A E V K K P G S S V K V

21 S C K A S G Y T F T D Y N M H W V K Q S
 21 S C K A S G Y T F T D Y N M H W V R Q A

41 H G K S L E W I G Y I Y P Y N G G T G Y
 41 P G Q G L E W I G Y I Y P Y N G G T G Y

61 N Q K F K S K A T L T V D N S S S T A Y
 61 N Q K F K S K A T I T A D E S T N T A Y

81 M D V R S L T S E D S A V Y Y C A R G R
 81 M E L S S L R S E D T A V Y Y C A R G R

101 P A M D Y W G Q G T S V T V S S
 101 P A M D Y W G Q G T L V T V S S

FIG. 3B

1 Q I V L T Q S P A I M S A S P G E K V T
 1 D I Q M T Q S P S S L S A S V G D R V T

21 M T C S G S S S V S F M Y W Y Q Q R P G
 21 I T C S G S S S V S F M Y W Y Q Q K P G

41 S S P R L L I Y D T S N L A S G V P V R
 41 K A P K L L I Y D T S N L A S G V P S R

61 F S G S G S G T S Y S L T I S R M E A E
 61 F S G S G S G T D Y T F T I S S L Q P E

81 D A A T Y Y C Q Q W S T Y P L T F G A G
 81 D I A T Y Y C Q Q W S T Y P L T F G Q G

101 T K L E L K
 101 T K V E V K

FIG. 4A

1 Q V Q L K Q S G P G L V Q P S Q S L S I
 1 E V Q L L E S G G G L V Q P G Q S L R L

21 T C T V S G F S V T S Y G V H W I R Q S
 21 S C A A S G F T V T S Y G V H W V R Q A

41 P G K G L E W L G V I W S G G S T D Y N
 41 P G K G L E W V G V I W S G G S T D Y N

61 A A F I S R L T I S K D N S K S Q V F F
 61 A A F I S R F T I S R D N S K N T L Y L

81 K V N S L Q P A D T A I Y Y C A R A G D
 81 Q M N S L Q A E D T A I Y Y C A R A G D

101 Y N Y D G F A Y W G Q G T L V T V S A
 101 Y N Y D G F A Y W G Q G T L V T V S S

FIG. 4B

1 D I V L T Q S P A T L S V T P G D S V S
 1 E I V L T Q S P G T L S L S P G E R A T

 21 L S C R A S Q S I S N N L H W Y Q Q K S
 21 L S C R A S Q S I S N N L H W Y Q Q K P

 41 H E S P R L L I K Y A S Q S I S G I P S
 41 G Q A P R L L I K Y A S Q S I S G I P D

 61 R F S G S G S G T D F T L S V N G V E T
 61 R F S G S G S G T D F T L T I S R L E P

 81 E D F G M Y F C Q Q S N S W P H T F G G
 81 E D F A V Y Y C Q Q S N S W P H T F G Q

 101 G T K L E I K
 101 G T K V E I K

FIG. 5A

1 E V Q L Q Q S G P E L V K P G A S M K I
 1 Q V Q L V Q S G A E V K K P G S S V R V

 21 S C K A S V Y S F T G Y T M N W V K Q S
 21 S C K A S G Y S F T G Y T M N W V R Q A

 41 H G Q N L E W I G L I N P Y N G G T S Y
 41 P G K G L E W V G L I N P Y N G G T S Y

 61 N Q K F K G K A T L T V D K S S N T A Y
 61 N Q K F K G R V T V S L K P S F N Q A Y

 81 M E L L S L T S A D S A V Y Y C T R R G
 81 M E L S S L F S E D T A V Y Y C T R R G

 101 F R D Y S M D Y W G Q G T S V T V S S
 101 F R D Y S M D Y W G Q G T L V T V S S

FIG. 5B

SUBSTITUTE SHEET

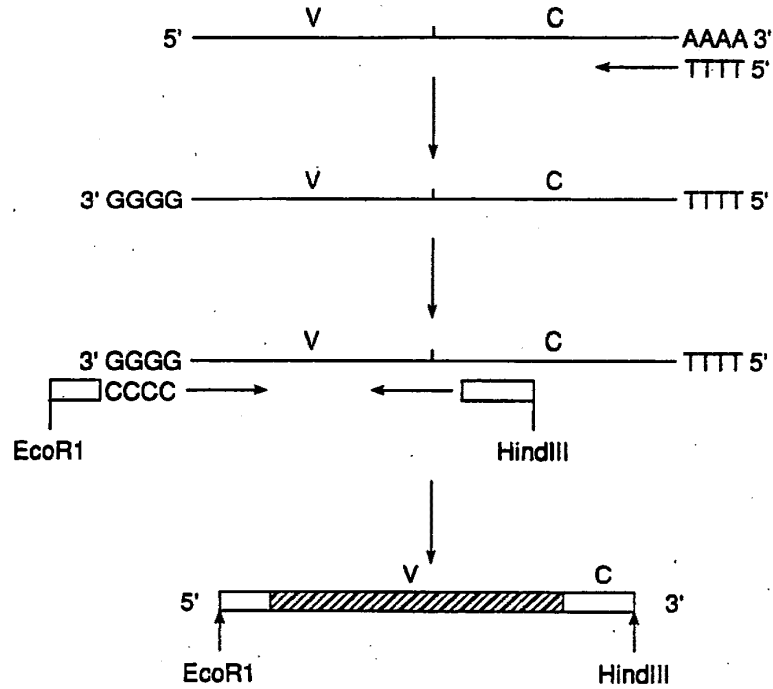

FIG. 6

SUBSTITUTE SHEET

. 30 60
 ATGGATTTTCAAGTGCAGATTTTCAGCTTCCTGCTAATCAGTGCCTCAGTCATACTGTCC
 M D F Q V Q I F S F L L I S A S V I L S

 90 120
 AGAGGACAAATTGTTCTCACCCAGTCTCCAGCAATCATGTCTGCGTCTCCAGGGGCGAAG
 R G Q I V L T Q S P A I M S A S P G E K

 150 180
 GTCACCATGACCTGCAGTGGCAGCTCAAGTGTAAGTTTCAATGTACTGGTACCAGCAGAGG
 V T M T C S G S S S V S F M Y W Y Q Q R

 210 240
 CCAGGATCCTCCCCAGACTCCTGATTTATGACACATCCAACCTGGCTTCTGGAGTCCCT
 P G S S P R L L I Y D T S N L A S G V P

 270 300
 GTTCGCTTCAGTGGCAGTGGGTCTGGGACCTTACTCTCTCACAATCAGCCGAATGGAG
 V R F S G S G S G T S Y S L T I S R M E

 330 360
 GCTGAAGATGCTGCCACTTATTACTGCCAGCAGTGGAGTACTTACCCGCTCACGTTCCGGT
 A E D A A T Y Y C Q Q W S T Y P L T F G

 GCTGGGACCAAGCTGGAGCTGAAA
 A G T K L E L K

FIG. 7A

. 30 60
 ATGGCTGTCTTGGGGCTGCTCTTCTGCCTGGTGACATTCCCAAGCTGTGTCTATCCAG
 M A V L G L L F C L V T F P S C V L S Q

 90 120
 GTGCAGCTGAAGCAGTCAGGACCTGGCCTAGTGCAGCCCTCACAGAGCCTGTCCATCACC
 V Q L K Q S G P G L V Q P S Q S L S I T

 150 180
 TGCACAGTCTCTGGTTTCTCAGTAACAAGTTATGGTGTACTGGATTGCGCCAGTCTCCA
 C T V S G F S V T S Y G V H W I R Q S P

 210 240
 GGAAAGGGTCTGGAGTGGCTGGGAGTGATATGGAGTGGTGGAAAGCACAGACTATAATGCA
 G K G L E W L G V I W S G G S T D Y N A

 270 300
 GCTTTCATATCCAGACTGACCATCAGCAAGGACAACCTCCAAGAGCCAAGTTTCTTTAAA
A F I S R L T I S K D N S K S Q V F F K

 330 360
 GTGAACAGTCTGCAACCTGCTGACACAGCCATATACTATTGTGCCAGAGCTGGGGACTAT
 V N S L Q P A D T A I Y Y C A R A G D Y

 390
AATTACGACGGTTTTGCTTACTGGGGCCAAGGGACTCTGGTCACTGTCTCTGCG
N Y D G F A Y W G Q G T L V T V S A

FIG. 7B

SUBSTITUTE SHEET

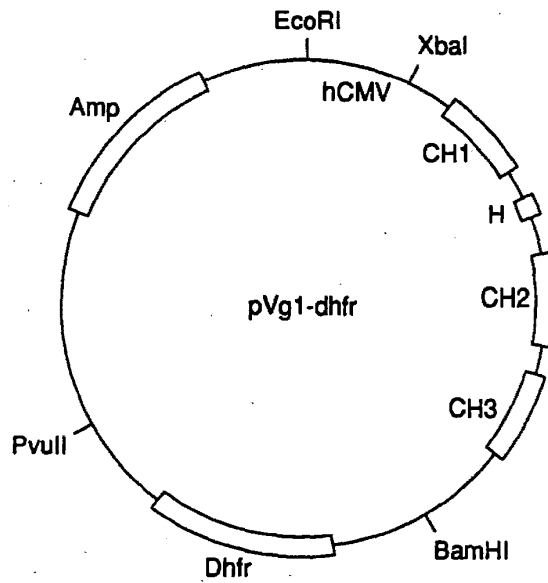

FIG. 8A

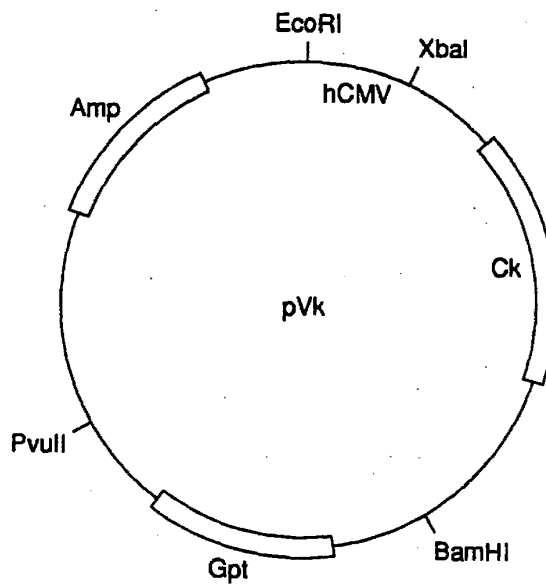

FIG. 8B

SUBSTITUTE SHEET

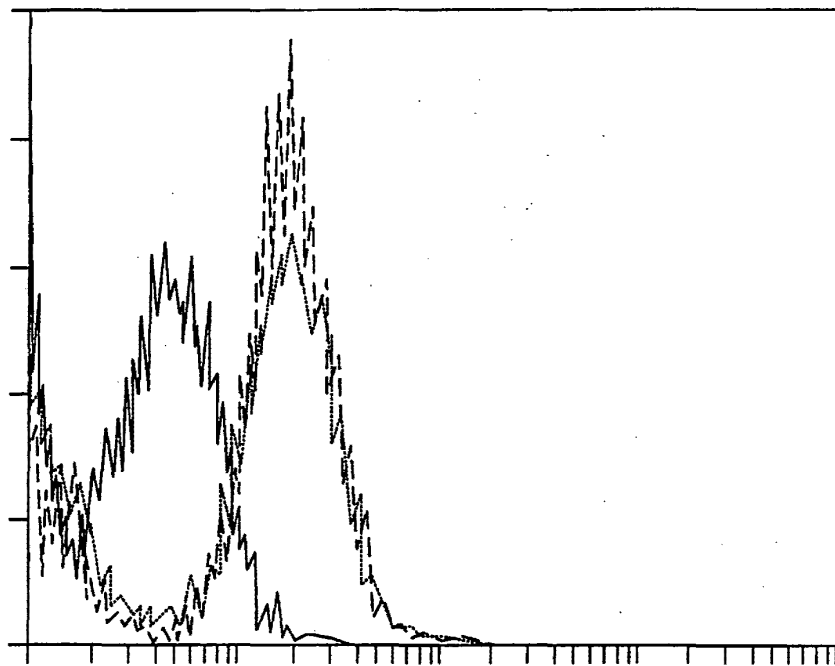

FIG. 9

SUBSTITUTE SHEET

1 D I Q M T Q S P S S L S V S V G D R V T
 1 D I Q M T Q S P S S L S A S V G D R V T

21 I T C Q A S Q N V N A Y L N W Y Q Q K P
 21 I T C S G S S S V S F M Y W Y Q Q K P

41 G L A P K L L I Y G A S T R E A G V P S
 40 G K A P K L L I Y D T S N L A S G V P S

61 R F S G S G S G T D F T F T I S S L Q P
 60 R F S G S G S G T D Y T F T I S S L Q P

81 E D I A T Y Y C Q Q Y N N W P P T F G Q
 80 E D I A T Y Y C Q Q W S T Y P L T F G Q

101 G T K V E V K
 100 G T K V E V K

FIG. 10A

1 A V Q L L E S G G G L V Q P G G S L R L
 1 E V Q L L E S G G G L V Q P G G S L R L

21 S C A A S G F T F S A S A M S W V R Q A
 21 S C A A S G F T V T S Y G V H W V R Q A

41 P G K G L E W V A W K Y E N G N D K H Y
 41 P G K G L E W V G V I W S G G S T D Y

61 A D S V N G R F T I S R N D S K N T L Y
 60 N A A F I S R F T I S R D N S K N T L Y

81 L Q M N G L Q A Z V S A I Y Y C A R D A
 80 L Q M N S L Q A E D T A I Y Y C A R A

101 G P Y V S P T F F A H W G Q G T L V T V
 99 G D Y N Y D G F A Y W G Q G T L V T V

121 S S
 118 S S

FIG. 10B

SUBSTITUTE SHEET

vc13

10 20 30 40 50 60
 TTCTGCTGGT ACCAGTACAT GAAACTTACA CTTGAGCTGC CACTGCAGGT GATGGTGACG
 70 80 90 100
 CGGTCACCCA CTGAGGCACT GAGGCTAGAT GGAGACTGGG TCATTTG

vc14

10 20 30 40 50 60
 CATGTACTGG TACCAGCAGA AGCCAGGAAA AGCTCCGAAA CTTCTGATTT ATGACACATC
 70 80 90 100 110 120
 CAACCTGGCT TCTGGAGTCC CTTCCCGCTT CAGTGGCAGT GGGTCTGGGA CCGATTACAC
 130
 CTTTACAATC TCTTCA

vc15

10 20 30 40 50 60
 TGTGTCTAGA AAAGTGTACT TACGTTTTAC CTCGACCTTG GTCCCTTGAC CGAACGTGAG
 70 80 90 100 110 120
 CGGGTAAGTA CTCCACTGCT GGCAGTAATA AGTGGCTATA TCTTCCGGCT GAAGTGAAGA
 130
 GATTGTAAAG GTGTAAT

vc16

10 20 30 40 50 60
 CACATCTAGA CCACCATGGA TTTTCAAGTG CAGATCTTCA GCTTCCTGCT AATCAGTGCC
 70 80 90 100
 TCAGTCATAC TGTCCAGAGG AGATATTCAA ATGACCCAGT CTCCATCT

FIG. 11A

SUBSTITUTE SHEET

vc11

```

      10      20      30      40      50      60
TAGTCTGTCG ACCCACCCT CCATATCACT CCCACCCACT CGAGTCCCTT TCCAGGAGCC

      70      80      90      100     110     120
TGGCGGACCC AGTGTACACC ATAACTTGTT ACGGTGAAAC CACTGGCGGC ACAAGACAGT

      130
CTCAGAGATC CTCCTGGC

```

vc12

```

      10      20      30      40      50      60
TGGTGGGTCG ACAGACTATA ATGCAGCTTT CATATCCAGA TTTACCATCA GCAGAGACAA

      70      80      90      100     110     120
CAGCAAGAAC ACACTGTATC TCCAAATGAA TAGCCTGCAA GCCGAGGACA CAGCCATATA

```

TTATTG

wps54

```

      10      20      30      40      50      60
ACACTCTAGA CCACCATGGC TGTCTTGGGG CTGCTCTTCT GCCTGGTGAC ATTCCCAAGC

      70      80      90      100     110     120
TGTGTCTTAT CCGCTGTCCA GCTGCTAGAG AGTGGTGGCG GTCTGGTGCA GCCAGGAGGA

      130
TCTCTGAGAC

```

wps57

```

      10      20      30      40      50      60
ACACTCTAGA AGTTAGGACT CACCTGAAGA GACAGTGACC AGAGTCCCTT GGCCCCAGTA

      70      80      90      100     110
AGCAAAACCG TCGTAATTAT AGTCCCCAGC TCTGGCACAA TAATATATGG CTGTGTCC

```

FIG. 11B

SUBSTITUTE SHEET

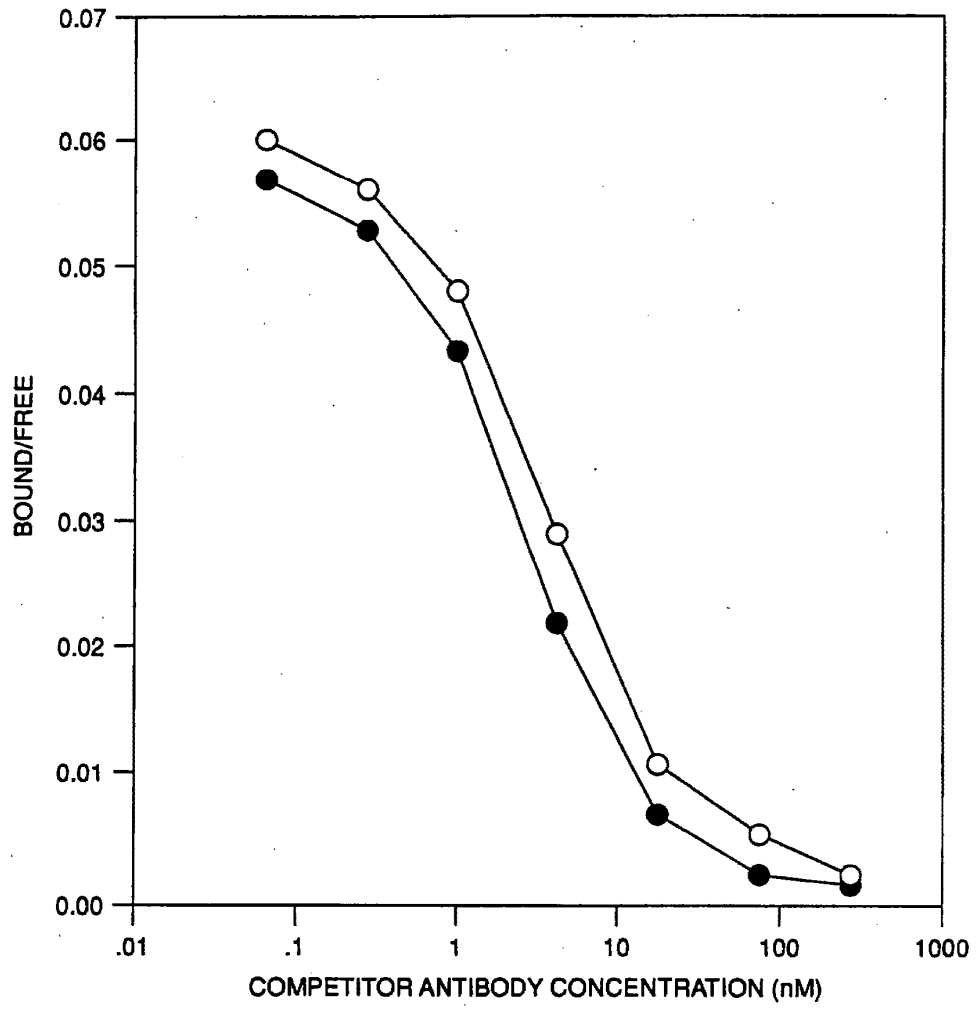

FIG. 12

SUBSTITUTE SHEET

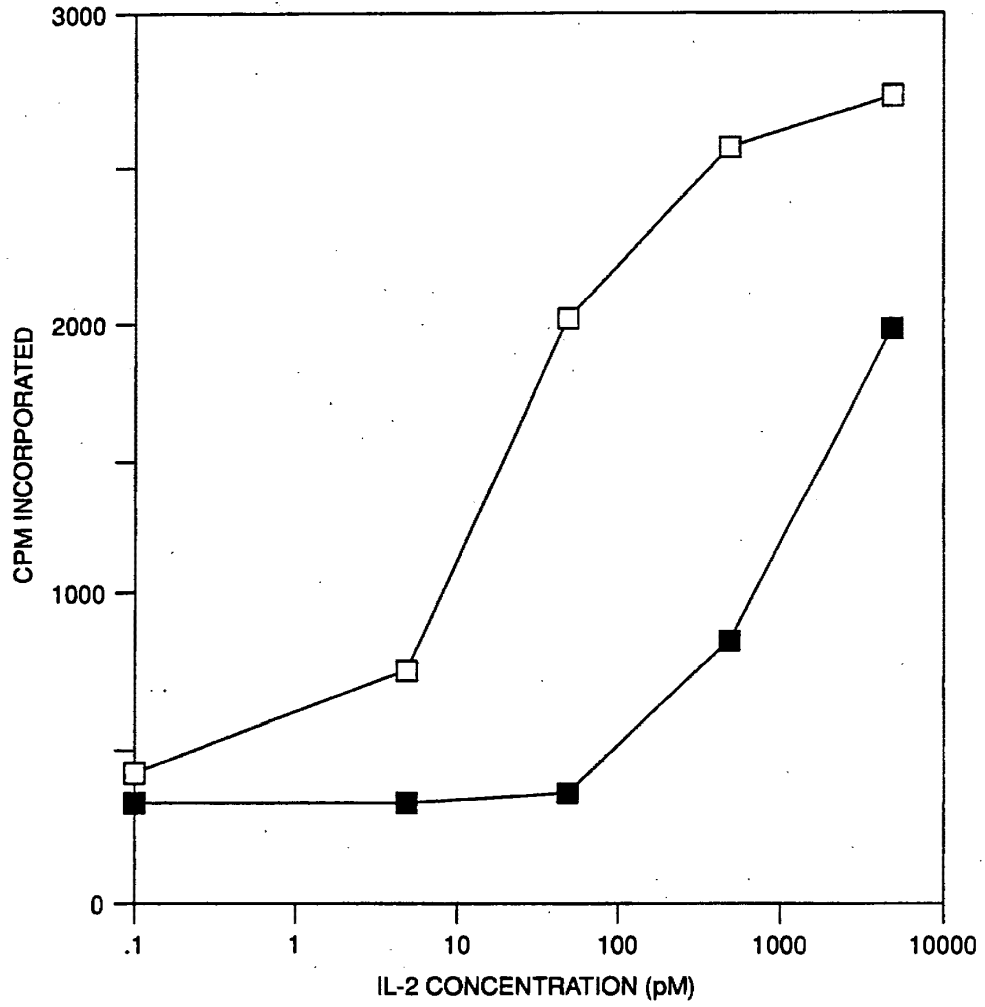

FIG. 13

SUBSTITUTE SHEET

	1	5	10	15	20
1	E M I L V E S G G G L V K P G A S L K L				
1	E V Q L L E S G G G L V Q P G G S L R L				
		25	30	35	40
21	S C A A S G F T F S				
21	S C A A S G F T F S				
		45	50	52 a	55
41	S D R R L E W V A				
41	P G K G L E W V A				
		60	65	70	75
60	P D N L K G				
60	P D N L K G				
		80	82 a b c	85	90
80	L Q M S S L K S E D T A L Y Y C L R				
80	L Q M N S L Q A E D T A L Y Y C L R				
		100 a b c d k	105	110	
97	I Y Y A D Y G F F D V				
97	I Y Y A D Y G F F D V				
		113			
112	S S				
112	S S				

FIG. 14A

	1	5	10	15	20
1	D I V L T Q S P A S L A V S L G Q R A T				
1	E I V M T Q S P A T L S V S P G E R A T				
		25	27 a b c d	30	35
21	I S C				
21	L S C				
		40	45	50	55
37	Q Q K P G Q P P K L L I K				
37	Q Q K P G Q S P R L L I K				
		60	65	70	75
57	G V P A R F S G S G F G T D F T L N I H				
57	G I P A R F S G S G S G T E F T L T I S				
		80	85	90	95
77	P V E E E D T V T Y Y C				
77	R L E S E D F A V Y Y C				
		100	105	107	
97	T F G G G T K L E I K				
97	T F G Q G T R V E I K				

FIG. 14B

SUBSTITUTE SHEET

	1	5	10	15	20															
1	Q	V	Q	L	Q	Q	S	D	A	E	L	V	K	P	G	A	S	V	K	I
1	Q	V	Q	L	V	Q	S	G	A	E	V	K	K	P	G	S	S	V	K	V
		25	30	35	40															
21	S	C	K	V	S	G	Y	T	F	T	D	H	T	I	H	W	M	K	Q	R
21	S	C	K	A	S	G	Y	T	F	T	D	H	T	I	H	W	M	R	Q	A
		45	50	52 a	55															
41	P	E	Q	G	L	E	W	F	G	Y	I	Y	P	R	D	G	H	T	R	Y
41	P	G	Q	G	L	E	W	F	G	Y	I	Y	P	R	D	G	H	T	R	Y
		60	65	70	75															
60	S	E	K	F	K	G	K	A	T	L	T	A	D	K	S	A	S	T	A	Y
60	A	E	K	F	K	G	K	A	T	I	T	A	D	E	S	T	N	T	A	Y
		80	82 a b c	85	90	95														
80	M	H	L	N	S	L	T	S	E	D	S	A	V	Y	F	C	A	R	G	R
80	M	E	L	S	S	L	R	S	E	D	T	A	V	Y	F	C	A	R	G	R
		100 a b c d	105	110																
97	D	S	R	E	R	N	G	F	A	Y	W	G	Q	G	T	L	V	T	V	S
97	D	S	R	E	R	N	G	F	A	Y	W	G	Q	G	T	L	V	T	V	S
113	A																			
113	S																			

FIG. 14C

	1	5	10	15	20															
1	D	I	V	M	T	Q	S	H	K	F	M	S	T	S	V	G	D	R	V	S
1	D	I	Q	M	T	Q	S	P	S	T	L	S	A	S	V	G	D	R	V	T
		25	30	35	40															
21	I	T	C	K	A	S	Q	D	V	G	S	A	V	V	W	H	Q	Q	K	S
21	I	T	C	K	A	S	Q	D	V	G	S	A	V	V	W	H	Q	Q	K	P
		45	50	55	60															
41	G	Q	S	P	K	L	L	I	Y	W	A	S	T	R	H	T	G	V	P	D
41	G	K	A	P	K	L	L	I	Y	W	A	S	T	R	H	T	G	V	P	S
		65	70	75	80															
61	R	F	T	G	S	G	S	G	T	D	F	T	L	T	I	T	N	V	Q	S
61	R	F	T	G	S	G	S	G	T	E	F	T	L	T	I	S	S	L	Q	P
		85	90	95	100															
81	E	D	L	A	D	Y	F	C	Q	Q	Y	S	I	F	P	L	T	F	G	A
81	D	D	F	A	T	Y	F	C	Q	Q	Y	S	I	F	P	L	T	F	G	Q
		105	107																	
101	G	T	R	L	E	L	K													
101	G	T	K	V	E	V	K													

FIG. 14D

SUBSTITUTE SHEET

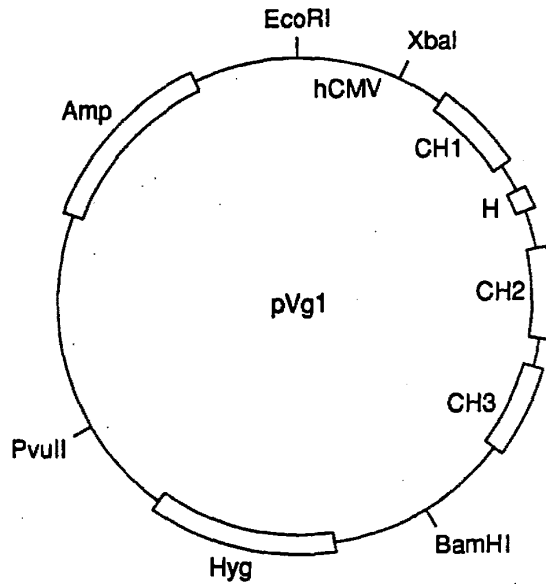

FIG. 15A

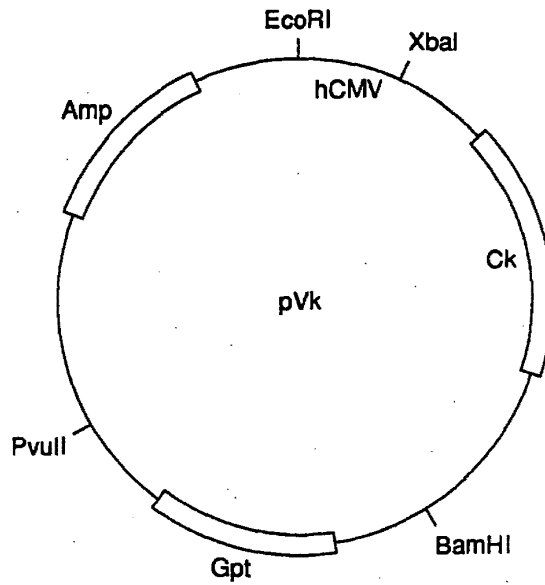

FIG. 15B

SUBSTITUTE SHEET

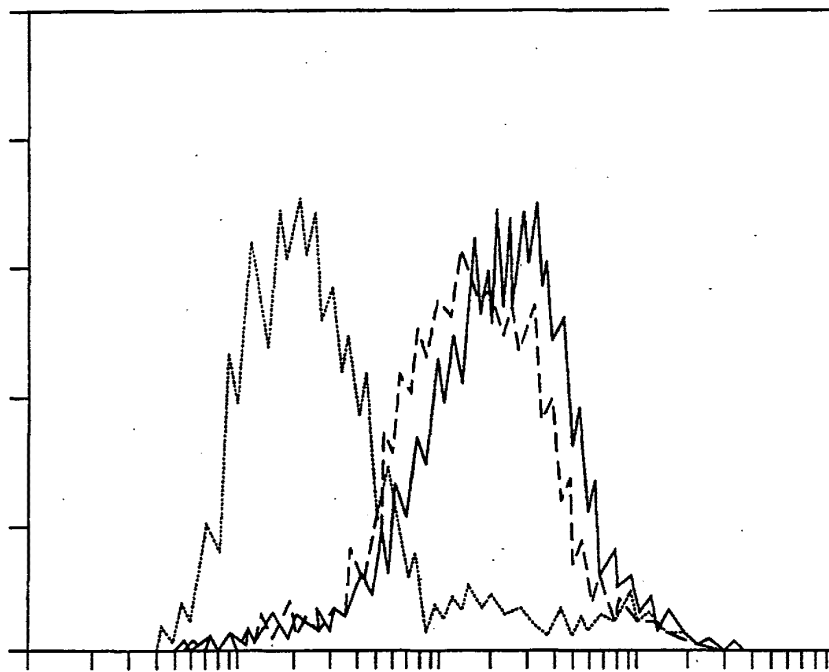

FIG. 16A

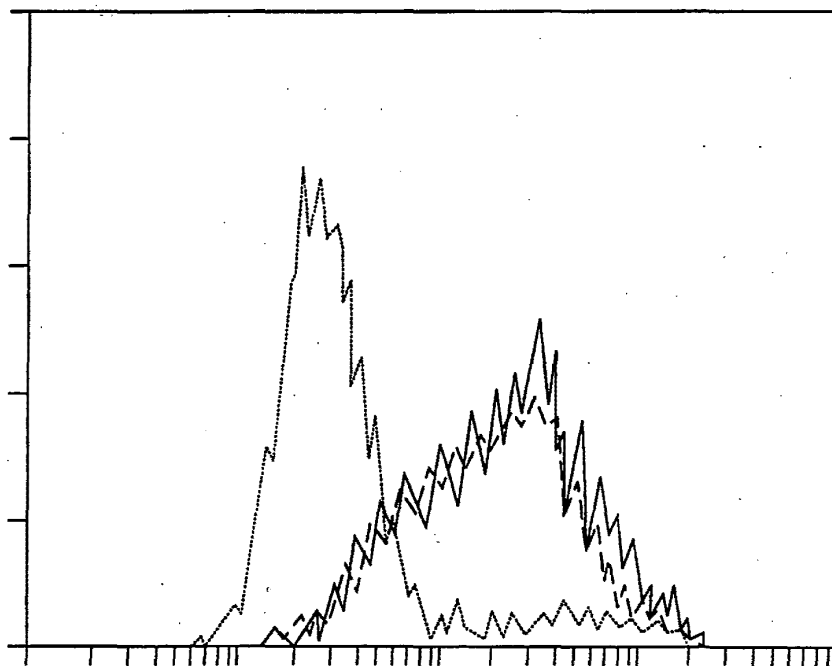

FIG. 16B

SUBSTITUTE SHEET

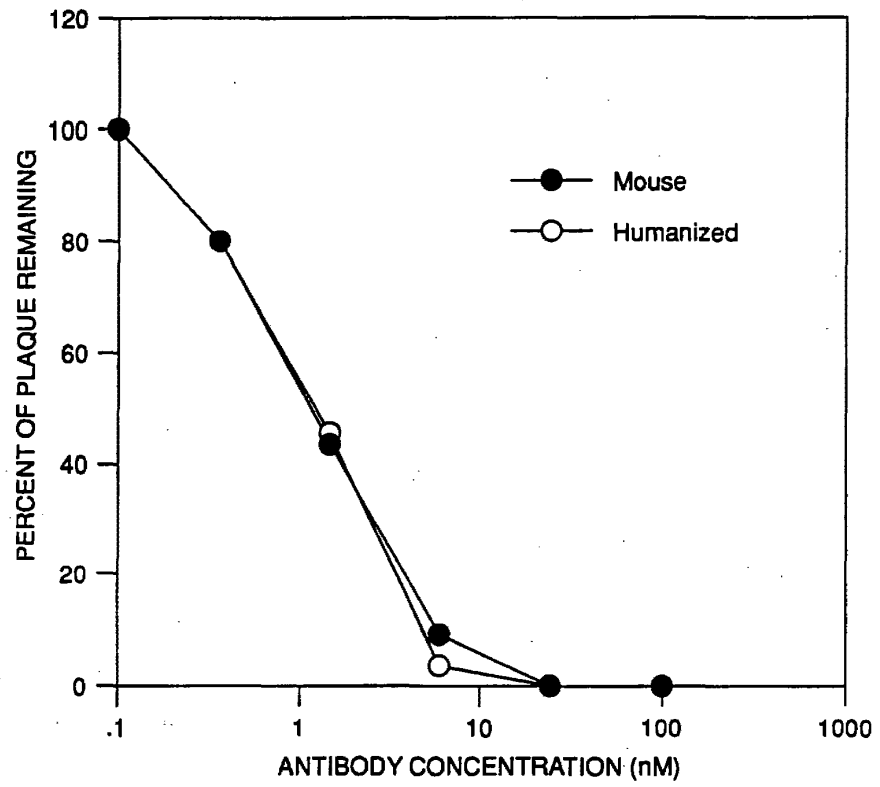

FIG. 17A

SUBSTITUTE SHEET

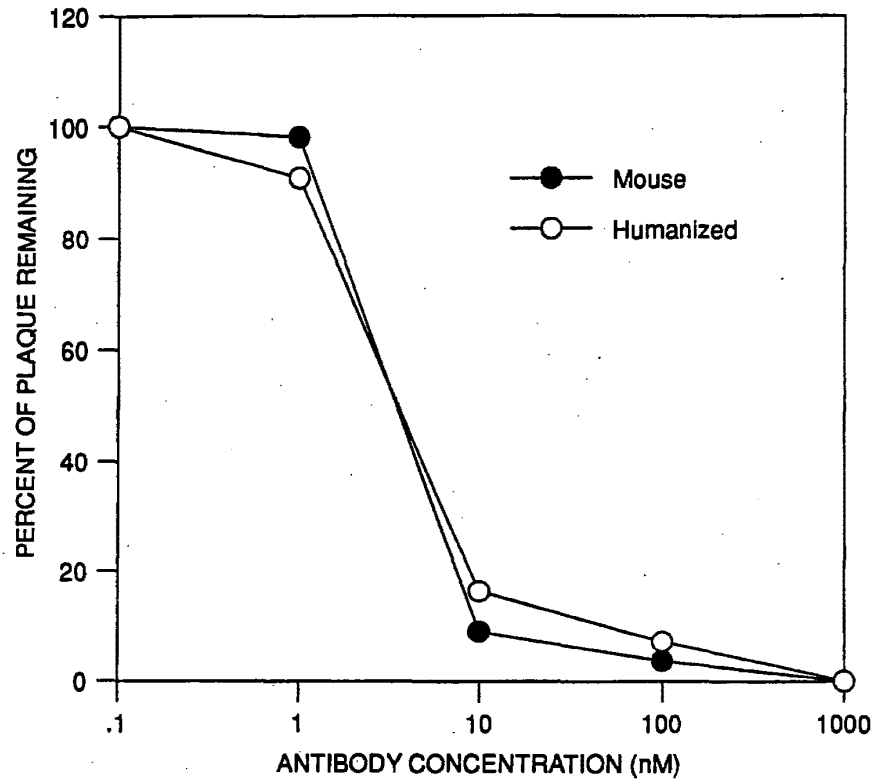

FIG. 17B

SUBSTITUTE SHEET

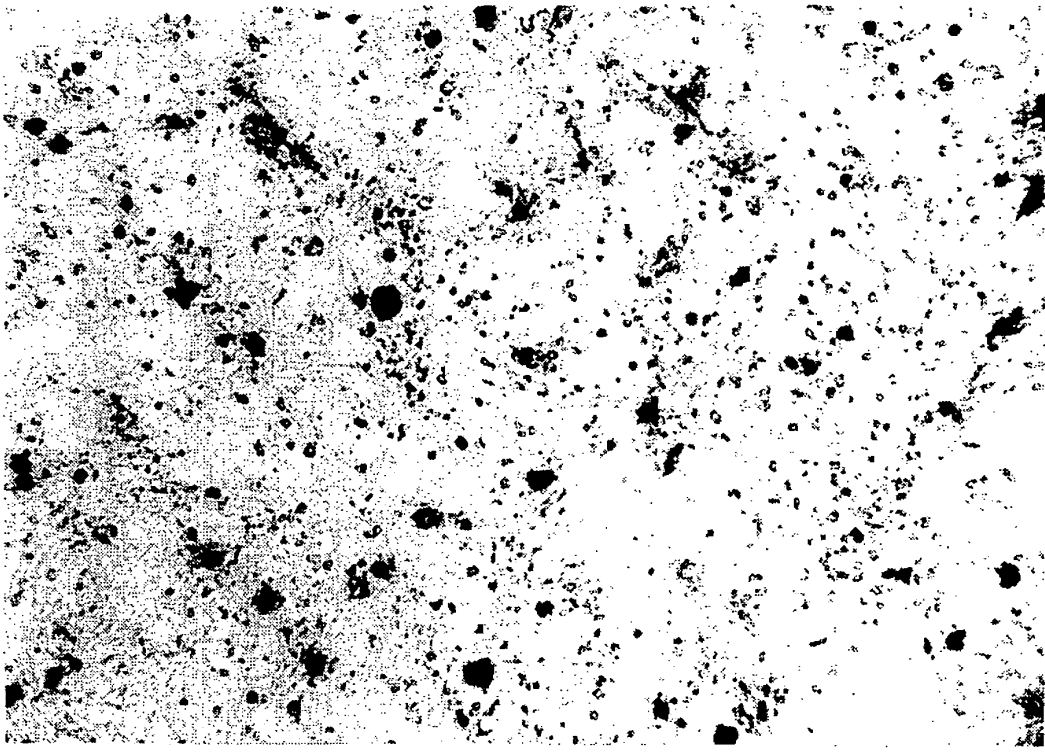

FIG. 18A

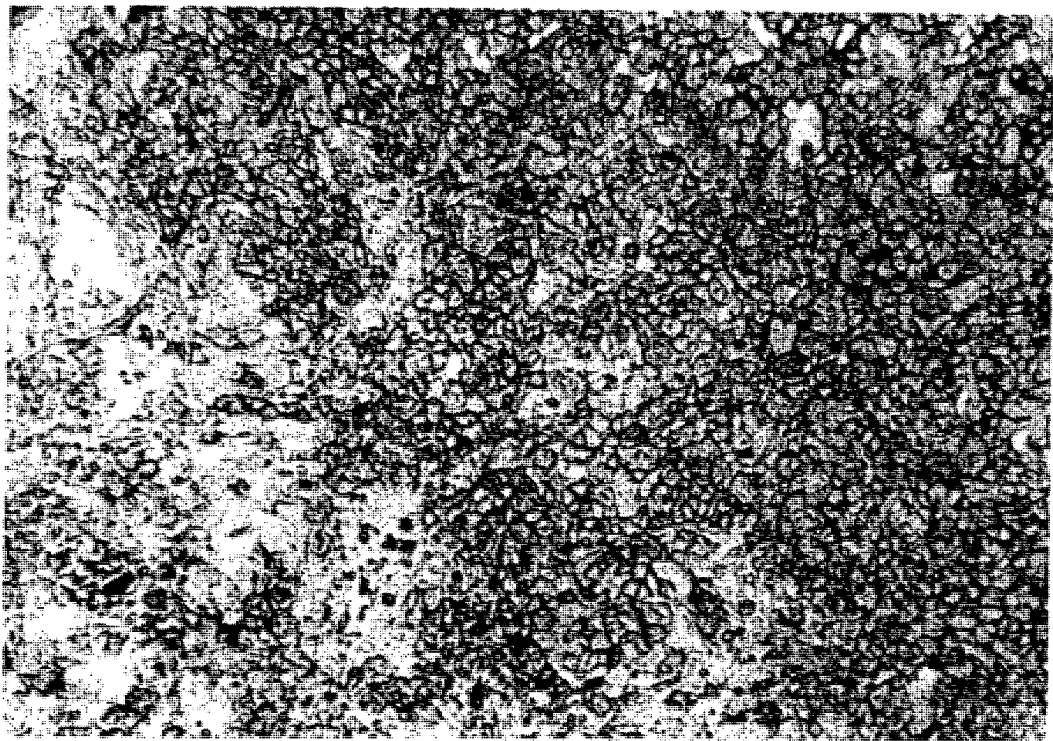

FIG. 18B

. 30 60
 ATGGAGAAAGACACACTCCTGCTATGGGTCCTGCTTCTCTGGGTTCCAGGTTCCACAGGT
 M E K D T L L L W V L L L W V P G S T G

 90 120
 GACATTGTGCTGACCCAATCTCCAGCTTCTTTGGCTGTGTCTCTAGGGCAGAGGGCCACC
 D I V L T Q S P A S L A V S L G Q R A T

 150 180
 ATCTCCTGCAGAGCCAGCGAAAGTGTGATAATTATGGCATTAGTTTTATGAACTGGTTC
 I S C R A S E S V D N Y G I S F M N W F

 210 240
 CAACAGAAACCAGGACAGCCACCCAACTCCTCATCTATGCTGCATCCAACCAAGGATCC
 Q Q K P G Q P P K L L I Y A A S N Q G S

 270 300
 GGGGTCCTGCCAGGTTTAGTGGCAGTGGGCTGGGACAGACTTCAGCCTCAACATCCAT
 G V P A R F S G S G S G T D F S L N I H

 330 360
 CCTATGGAGGAGGATGATACTGCAATGTATTTCTGTCTCAGCAAAGTAAGGAGGTTCCGTGG
 P M E E D D T A M Y F C Q Q S K E V P W

 390
 ACGTTCCGGTGGAGGCACCAAGCTGGAAATCAA
T F G G G T K L E I K

FIG. 19A

. 30 60
 ATGGGATGGAGCTGGATCTTTCTCTTCTCCTGTCAGGAACTGCAGGCGTCCACTCTGAG
 M G W S W I F L F L L S G T A G V H S E

 90 120
 GTCCAGCTTCAGCAGTCAGGACCTGAGCTGGTGAACCTGGGGCCTCAGTGAAGATATCC
 V Q L Q Q S G P E L V K P G A S V K I S

 150 180
 TGCAAGGCTTCTGGATACACATTCACTGACTACAACATGCACTGGGTGAAGCAGAGCCAT
 C K A S G Y T F T D Y N M H W V K Q S H

 210 240
 GGAAAGAGCCTTGAGTGGATTGGATATATTTATCCTTACAATGGTGGTACTGGCTACAAC
 G K S L E W I G Y I Y P Y N G G T G Y N

 270 300
 CAGAAGTTCAAGAGCAAGGCCACATTGACTGTAGACAATTCCTCCAGCACAGCCTACATG
Q K F K S K A T L T V D N S S S T A Y M

 330 360
 GACGTCGCGAGCCTGACATCTGAGGACTCTGCAGTCTATTACTGTGCAAGAGGGCGCCCC
 D V R S L T S E D S A V Y Y C A R G R P

 390
 GCTATGGACTACTGGGGTCAAGGAACCTCAGTCACCGTCTCCTCA
A M D Y W G Q G T S V T V S S

FIG. 19B

SUBSTITUTE SHEET

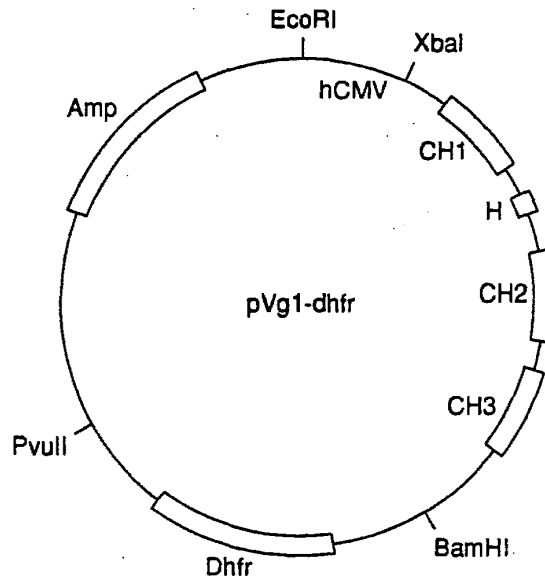

FIG. 20A

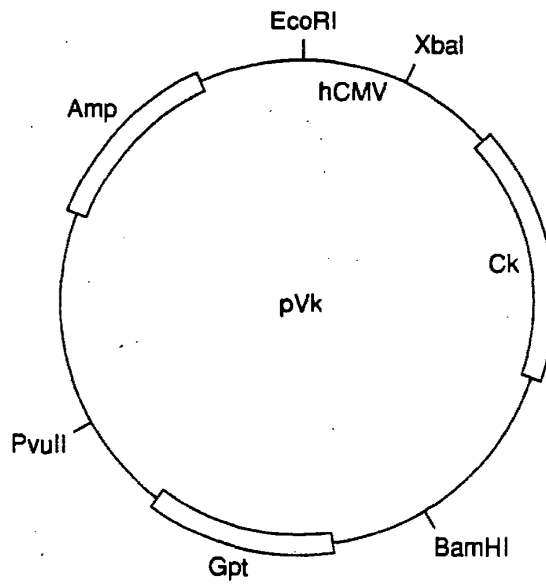

FIG. 20B

SUBSTITUTE SHEET

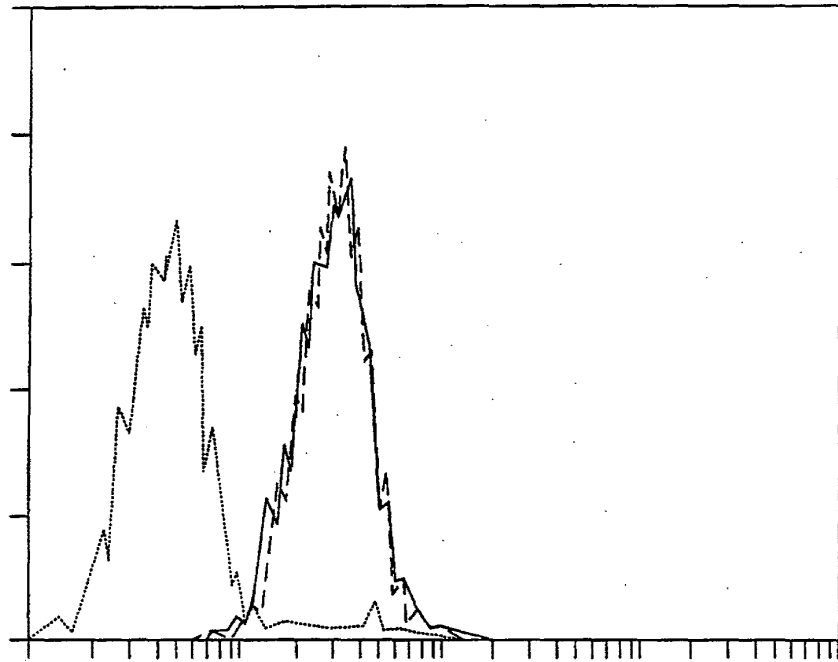

FIG. 21

SUBSTITUTE SHEET

1 D I Q M T Q S P S T L S A S V G D R V T
 1 D I Q M T Q S P S S L S A S V G D R V T
 21 I T C R A S Q S I N T W L A W Y
 21 I T C R A S E S V D N Y G I S F M N W F
 37 Q Q K P G G A P K L L M Y K A S S L E S
 41 Q Q K P G G A P K L L I Y A A S N O G S
 57 G V P S R F I G S G S G T E F T L T I S
 61 G V P S R F S G S G S G T D F T L T I S
 77 S L Q P D D F A T Y Y C Q Q Y N S D S K
 81 S L Q P D D F A T Y Y C Q Q S K E V P W
 97 M F G Q G T K V E V K
 101 T F G Q G T K V E I K

FIG. 22A

1 Q V Q L V Q S G A E V K K P G S S V K V
 1 Q V Q L V Q S G A E V K K P G S S V K V
 21 S C K A S G G T F S R S A I I W V R Q A
 21 S C K A S G Y T F T D Y N M H W V R Q A
 41 P G Q G L E W M G G I V P M F G P P N Y
 41 P G Q G L E W I G Y I Y P Y N G G T G Y
 61 A Q K F Q G R V T I T A D E S T N T A Y
 61 N O K F K S K A T I T A D E S T N T A Y
 81 M E L S S L R S E D T A F Y F C A G G Y
 81 M E L S S L R S E D T A V Y Y C A R G
 101 G I Y S P E E Y N G G L V T V S S
 100 R P A M D Y W G Q G T L V T V S S

FIG. 22B

ma1

```
      10      20      30      40      50      60
TATATCTAGA CCACCATGGG ATGGAGCTGG ATCTTTCTCT TCCTCCTGTC AGGAACTGCT
      70      80      90     100     110     120
GGCGTCCACT CTCAGGTTCA GCTGGTGCAG TCTGGAGCTG AGGTGAAGAA GCCTGGGAGC
      130
TCAGTGAAGG TT
```

ma2

```
      10      20      30      40      50      60
AGCCGGTACC ACCATTGTAA GGATAAATAT ATCCAATCCA TTCCAGGCCT TGGCCAGGAG
      70      80      90     100     110     120
CCTGCCTCAC CCAGTGCATG TTGTAGTCAG TGAAGGTGTA GCCAGAAGCT TTGCAGGAAA
      130
CCTTCACTGA GCT
```

ma3

```
      10      20      30      40      50      60
TGGTGGTACC GGCTACAACC AGAAGTTCAA GAGCAAGGCC ACAATTACAG CAGACGAGAG
      70      80      90     100     110
TACTAACACA GCCTACATGG AACTCTCCAG CCTGAGGTCT GAGGACACTG CA
```

ma4

```
      10      20      30      40      50      60
TATATCTAGA GGCCATTCTT ACCTGAAGAG ACAGTGACCA GAGTCCCTTG GCCCCAGTAG
      70      80      90     100     110
TCCATAGCGG GCGGCCCTCT TGCGCAGTAA TAGACTGCAG TGTCCTCAGA C
```

FIG. 23A

SUBSTITUTE SHEET

ma5

10	20	30	40	50	60
TATATCTAGA	CCACCATGGA	GAAAGACACA	CTCCTGCTAT	GGTCCTGCT	TCTCTGGGTT
70	80	90	100	110	120
CCAGGTTCCA	CAGGTGACAT	TCAGATGACC	CAGTCTCCGA	GCTCTCTGTC	CGCATCAGTA

GG

ma6

10	20	30	40	50	60
TCAGAAGCTT	AGGAGCCTTC	CCGGGTTTCT	GTTGGAACCA	GTCATAAAG	CTAATGCCAT
70	80	90	100	110	120
AATTGTCGAC	ACTTTCGCTG	GCTCTGCATG	TGATGGTGAC	CCTGTCTCCT	ACTGATGCGG

AC

ma7

10	20	30	40	50	60
TCCTAAGCTT	CTGATTTACG	CTGCATCCAA	CCAAGGCTCC	GGGTACCCT	CTCGCTTCTC
70	80	90	100	110	
AGGCAGTGGA	TCTGGGACAG	ACTTCACTCT	CACCATTTC	TCTCTGCAGC	CTGATGACT

ma8

10	20	30	40	50	60
TATATCTAGA	CTTTGGATTC	TACTTACGTT	TGATCTCCAC	CTTGGTCCCT	TGACCGAACG
70	80	90	100	110	
TCCACGGAAC	CTCCTTACTT	TGCTGACAGT	AATAGGTTGC	GAAGTCATCA	GGCTGCAG

FIG. 23B

SUBSTITUTE SHEET

28/41

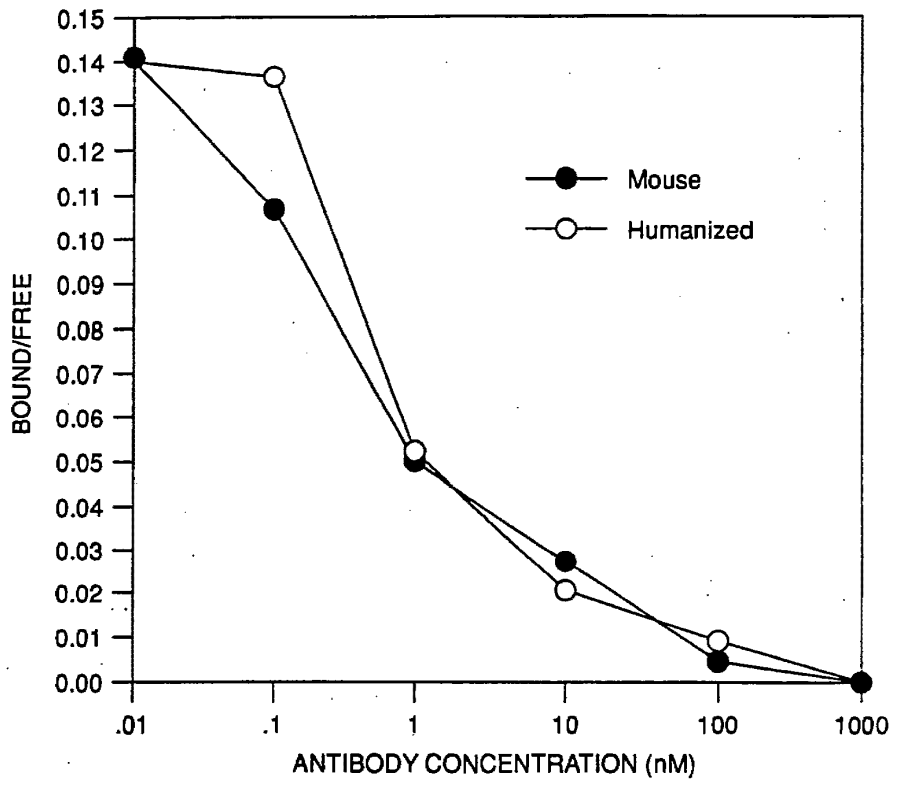

FIG. 24

SUBSTITUTE SHEET

. 30 60
 ATGGTTTTCACACCTCAGATACTTGGACTTATGCTTTTTTGGATTTCAGCCTCCAGAGGT
 M V F T P Q I L G L M L F W I S A S R G
 ↓
 90 120
 GATATTGTGCTAACTCAGTCTCCAGCCACCTGTCTGTGACTCCGGGAGATAGCGTCAGT
 D I V L T Q S P A T L S V T P G D S V S
 150 180
 CTTTCCTGCAGGGCCAGCCAAAAGTATTAGCAACAACCTACACTGGTATCAACAAAAATCA
 L S C R A S O S I S N N L H W Y Q Q K S
 210 240
 CATGAGTCTCCAAGGCTTCTCATCAAGTATGCTTCCCAGTCCATCTCTGGGATCCCCTCC
 H E S P R L L I K Y A S Q S I S G I P S
 270 300
 AGGTTCAAGTGGCAGTGGATCAGGGACAGATTTCACTCTCAGTGTCAACGGTGTGGAGACT
 R F S G S G S G T D F T L S V N G V E T
 330 360
 GAAGATTTTGAATGTATTTCTGTCAACACACTAACAGTTGGCCTCATACGTTCCGGAGGG
 E D F G M Y F C Q Q S N S W P H T F G G

 GGGACCAAGCTGGAAATAAAA
 G T K L E I K

FIG. 25A

. 30 ↓ 60
 ATGGGATGGAGCTGGATCTTTCTTCTCCTCCTGTCAGGAAGTGCAGGTGTCCACTCTGAG
 M G W S W I F L F L L S G T A G V H S E
 90 120
 GTCCAGCTGCAACAGTCTGGACCTGAGCTGGTGAAGCCTGGAGCTTCAATGAAGATATCC
 V Q L Q Q S G P E L V K P G A S M K I S
 150 180
 TGCAAGGCTTCTGTTTACTCATTCACTGGCTACACCATGAACTGGGTGAAGCAGAGCCAT
 C K A S V Y S F T G Y T M N W V K Q S H
 210 240
 GGACAGAACCTTGAGTGGATTGGACTTATTAATCCTTACAATGGTGGTACTAGCTACAAC
 G Q N L E W I G L I N P Y N G G T S Y N
 270 300
 CAGAAGTTCAAGGGGAAGGCCACATTAAGTGTAGACAAGTCATCCAACACAGCCTACATG
Q K F K G K A T L T V D K S S N T A Y M
 330 360
 GAGCTCCTCAGTCTGACATCTGCGGACTCTGCAGTCTATTACTGTACAAGACGGGGGTTT
 E L L S L T S A D S A V Y Y C T R R G F
 390
CGAGACTATTCTATGGACTACTGGGGTCAAGGAACCTCAGTCACCGTCTCCTCA
R D Y S M D Y W G Q G T S V T V S S

FIG. 25B

SUBSTITUTE SHEET

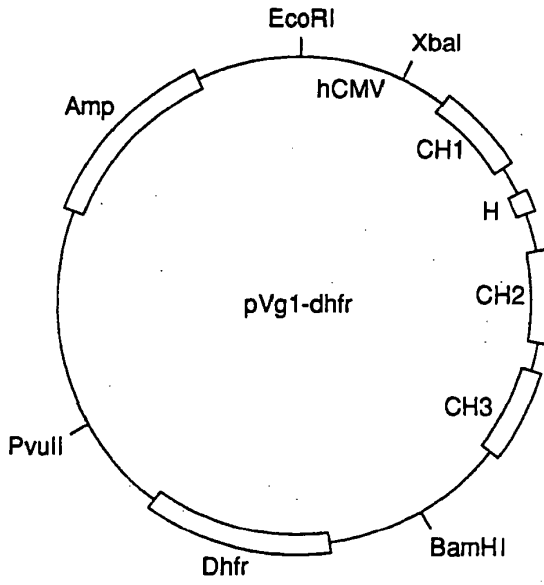

FIG. 26A

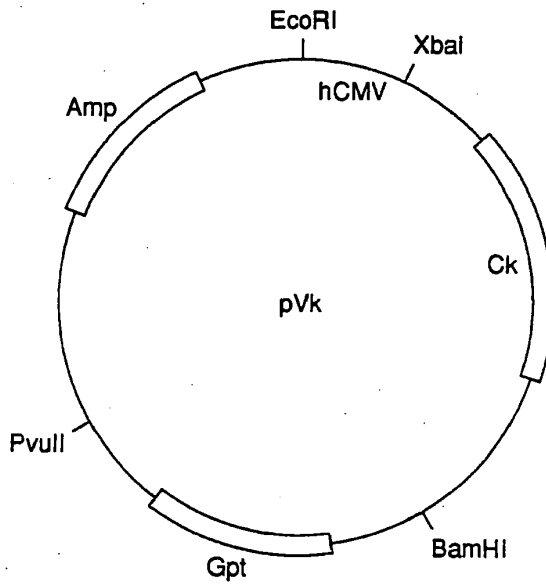

FIG. 26B

SUBSTITUTE SHEET

1 E I V L T Q S P G T L S L S P G E R A T
 1 E I V L T Q S P G T L S L S P G E R A T
 21 L S C R A S Q S V S S G Y L G W Y Q Q K
 21 L S C R A S Q S I S N N L H W Y Q Q K
 41 P G Q A P R L L I Y G A S S R A T G I P
 40 P G Q A P R L L I K Y A S Q S I S G I P
 61 D R F S G S G S G T D F T L T I S R L E
 60 D R F S G S G S G T D F T L T I S R L E
 81 P E D F A V Y Y C Q Q Y G S L G R T F G
 80 P E D F A V Y Y C Q Q S N S W P H T F G
 101 Q G T K V E I K
 100 Q G T K V E I K

FIG. 27A

1 Q V Q L M Q S G A E V K K P G S S V R V
 1 Q V Q L V Q S G A E V K K P G S S V R V
 21 S C K T S G G T F V D Y K G L W V R Q A
 21 S C K A S G Y S F T G Y T M N W V R Q A
 41 P G K G L E W V G Q I P L R F N G E V K
 41 P G K G L E W V G L I N P Y N G G T S Y
 61 N P G S V V R V S V S L K P S F N Q A H
 61 N O K F K G R V T V S L K P S F N Q A Y
 81 M E L S S L F S E D T A V Y Y C A R E Y
 81 M E L S S L F S E D T A V Y Y C T R R
 101 G F D T S D Y Y Y Y W G Q G T L V T V
 100 G F R D Y S M D Y W G Q G T L V T V
 121 S S
 118 S S

FIG. 27B

SUBSTITUTE SHEET

jb16

10 20 30 40 50 60
TAGATCTAGA CCACCATGGT TTTCACACCT CAGATACTAG GACTCATGCT CTTCTGGATT
70 80 90 100 110 120
TCAGCCTCCA GAGGTGAAAT TGTGCTAACT CAGTCTCCAG GCACCCTAAG CTTATCACCG

GGAGAAAGG

jb17

10 20 30 40 50 60
TAGACAGAAT TCACGCGTAC TTGATAAGTA GACGTGGAGC TTGTCCAGGT TTTTGTGGT
70 80 90 100 110 120
ACCAGTGTAG GTTGTGCTA ATACTTTGGC TGGCCCTGCA GGAAAGTGTA GCCCTTTCTC

CCGGTGAT

jb18

10 20 30 40 50 60
AAGAGAATTC ACGCGTCCCA GTCCATCTCT GGAATACCCG ATAGGTTTCAG TGGCAGTGGA
70 80 90 100 110
TCAGGGACAG ATTTCACTCT CACAATAAGT AGGCTCGAGC CGGAAGATTT TGC

jb19

10 20 30 40 50 60
TAGATCTAGA GTTGAGAAGA CTA CTACTTACGT TTTATTTCTA CCTTGGTCCC TTGTCCGAAC
70 80 90 100 110
GTATGAGGCC AACTGTACT CTGTTGACAA TAATACACAG CAAAATCTTC CGGCTC

FIG. 28A

SUBSTITUTE SHEET

jb20

```
      10          20          30          40          50          60
TATATCTAGA CCACCATGGG ATGGAGCTGG ATCTTTCTCT TCCTCCTGTC AGGAACTGCA
      70          80          90         100         110         120
GGTGTCCACT CTCAAGTCCA ACTGGTACAG TCTGGAGCTG AGGTAAAAA GCCTGGAAGT

      130
TCAGTAAGAG TTTC
```

jb21

```
      10          20          30          40          50          60
TATATAGGTA CCACCATTGT AAGGATTAAT AAGTCCAACC CACTCAAGTC CTTTCCAGG
      70          80          90         100         110         120
TGCCTGTCTC ACCCAGTTCA TGGTATACCC AGTGAATGAG TATCCGGAAG CTTTGCAGGA

      130
AACTCTTACT GAAC
```

jb22

```
      10          20          30          40          50          60
TATATAGGTA CCAGCTACAA CCAGAAGTTC AAGGGCACAG TTACAGTTC TTTGAAGCCT
      70          80          90         100         110
TCATTTAACC AGGCCTACAT GGAGCTCAGT AGTCTGTTTT CTGAAGACAC TGCAGT
```

jb23

```
      10          20          30          40          50          60
TATATCTAGA GGCCATTCTT ACCTGAGGAG ACGGTGACTA AGGTTCTTG ACCCCAGTAG
      70          80          90         100         110
TCCATAGAAT AGTCTCGAAA CCCCCGTCTT CTACAGTAAT AGACTGCAGT GTCTTC
```

FIG. 28B

SUBSTITUTE SHEET

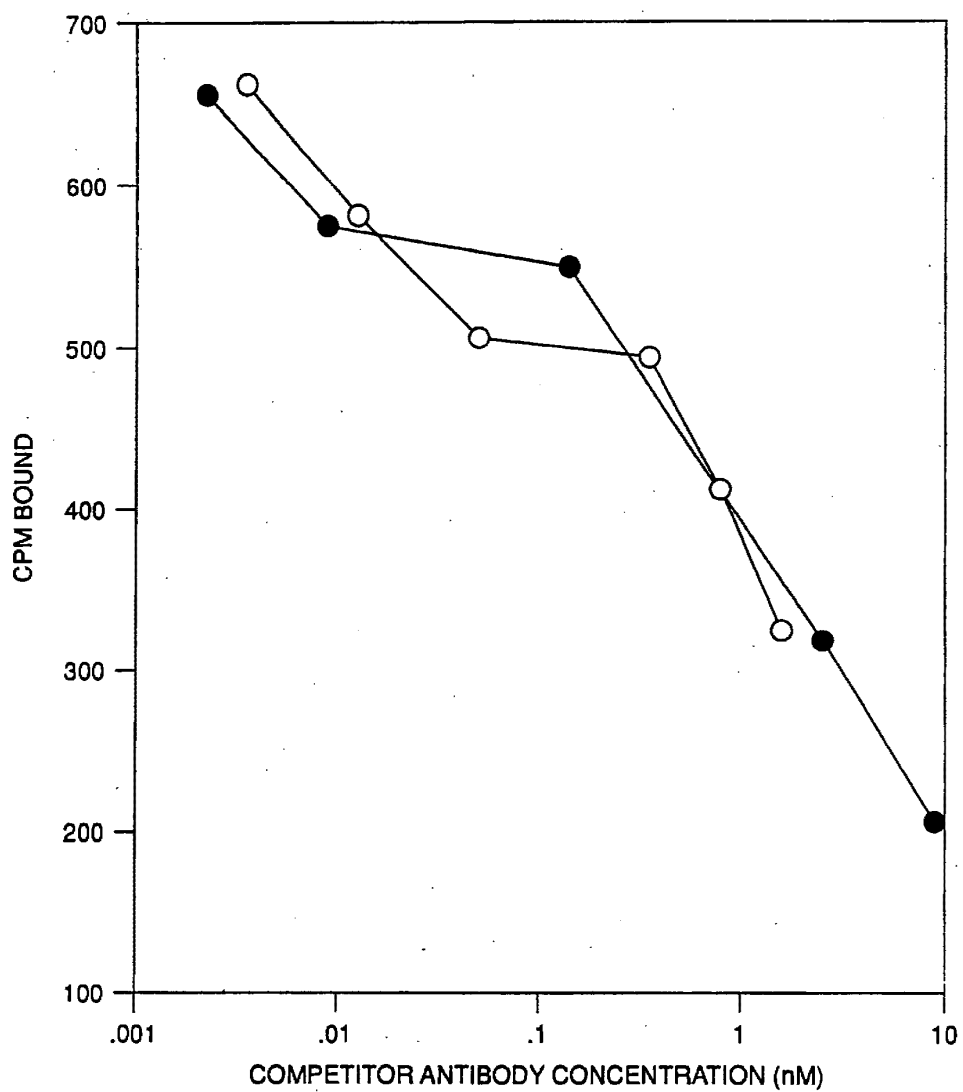

FIG. 29

SUBSTITUTE SHEET

35/41

. 30 60
 ATGACATCACTGTTCTCTCTACAGTTACCGAGCACACAGGACCTCGCCATGGGATGGAGC
 M T S L F S L Q L P S T Q D L A M G W S

. 90 120
 TGTATCATCCTCTTCTTGGTAGCAACAGCTACAGGTGTCCTCTCCCAGGTCCAACCTGCAG
 C I I L F L V A T A T G V L S Q V Q L Q

. 150 180
 CAGCCTGGGGCTGACCTTGTGATGCCTGGGGCTCCAGTGAAGCTGTCCTGCTTGGCTTCT
 Q P G A D L V M P G A P V K L S C L A S

. 210 240
 GGCTACATCTTCACCAGCTCCTGGATAAACTGGGTGAAGCAGAGGCCTGGACGAGGCCTC
 G Y I F T S S S W I N W V K Q R P G R G L

. 270 300
 GAGTGGATTGGAAGGATTGATCCTTCCGATGGTGAAGTTCACTACAATCAAGATTTCAAG
 E W I G R I D P S D G E V H Y N Q D F K

. 330 360
 GACAAGGCCACACTGACTGTAGACAAATCCTCCAGCACAGCCTACATCCAACCTCAACAGC
D K A T L T V D K S S S T A Y I Q L N S

. 390 420
 CTGACATCTGAGGACTCTGCGGTCTATTACTGTGCTAGAGGATTTCTGCCCTGGTTTGCT
 L T S E D S A V Y Y C A R G F L P W F A

. 450
 GACTGGGGCCAAGGGACTCTGGTCACTGTCTCTGCA
D W G Q G T L V T V S A

FIG. 30A

SUBSTITUTE SHEET

36 / 41

ATGCATCAGACCAGCATGGGCATCAAGATGGAATCACAGACTCTGGTCTTCATATCCATA 60
M H Q T S M G I K M E S Q T L V F I S I

CTGCTCTGGTTATATGGTGCTCATGGGAACATTGTTATGACCCAATCTCCCAAATCCATG 120
L L W L Y G A D G N I V M T Q S P K S M

TACGTGTCAATAGGAGAGAGGGTCACCTTGAGCTGCAAGGCCAGTGAAAATGTGGATACT 180
Y V S I G E R V T L S C K A S E N V D T

TATGTATCCTGGTATCAACAGAAACCAGAGCAGTCTCCTAAACTGCTGATATATGGGGCA 240
Y V S W Y Q Q K P E Q S P K L L I Y G A

TCCAACCGGTACACTGGGGTCCACGATCGCTTCACGGGCAGTGGATCTGCAACAGATTTTC 300
S N R Y T G V H D R F T G S G S A T D F

ACTCTGACCATCAGCAGTGTGCAGGCTGAAGACCTTGCAGATTATCACTGTGGACAGAGT 360
T L T I S S V Q A E D L A D Y H C G Q S

TACAACTATCCATTCACGTTCCGGCTCGGGGACAAAGTTGGAAATAAAG 390
Y N Y P F T F G S G T K L E I K

FIG. 30B

SUBSTITUTE SHEET

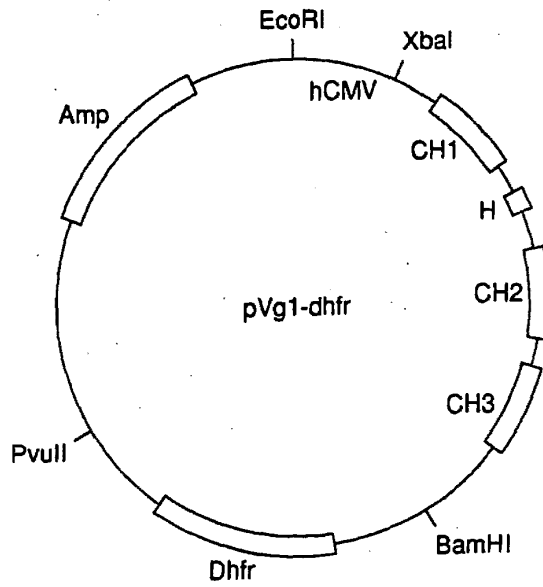

FIG. 31A

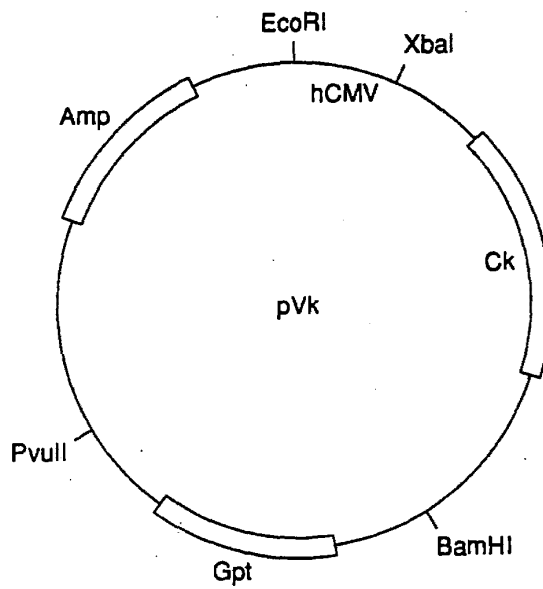

FIG. 31B

SUBSTITUTE SHEET

1 D I Q M T Q S P S T L S A S V G D R V T
 1 D I Q M T Q S P S T L S A S V G D R V T
 21 I T C R A S Q S I N T W L A W Y Q Q K P
 21 I T C K A S E N V D T Y V S W Y Q Q K P
 41 G K A P K L L M Y K A S S L E S G V P S
 41 G K A P K L L I Y G A S N R Y T G V P S
 61 R F I G S G S G T E F T L T I S S L Q P
 61 R F S G S G S G T D F T L T I S S L Q P
 81 D D F A T Y Y C Q Q Y N S D S K M F G
 81 D D F A T Y Y C G Q S Y N Y P F T F G
 100 Q G T K V E V K
 100 Q G T K V E V K

FIG. 32A

1 Q V Q L V Q S G A E V K K P G S S V K V
 1 Q V Q L V Q S G A E V K K P G S S V K V
 21 S C K A S G G T F S R S A I I W V R Q A
 21 S C K A S G Y I F T S S W I N W V R Q A
 41 P G Q G L E W M G G I V P M F G P P N Y
 41 P G Q G L E W M G R I D P S D G E V H Y
 61 A Q K F Q G R V T I T A D E S T N T A Y
 61 N Q D F K D R V T I T A D E S T N T A Y
 81 M E L S S L R S E D T A F Y F C A G G Y
 81 M E L S S L R S E D T A V Y Y C A R G F
 101 G I Y S P E E Y N G G L V T V S S
 101 L P W F A D W G Q G T L V T V S S

FIG. 32B

SUBSTITUTE SHEET

rh10

```
      10      20      30      40      50      60
TTTTTTCTAG ACCACCATGG AGACCGATAC CCTCCTGCTA TGGGTCCTCC TGCTATGGGT
      70      80      90     100     110
CCCAGGATCA ACCGGAGATA TTCAGATGAC CCAGTCTCCG TCGACCCTCT CTGCT
```

rh11

```
      10      20      30      40      50      60
TTTTAAGCTT GGGAGCTTTG CCTGGCTTCT GCTGATACCA GGATACATAA GTATCCACAT
      70      80      90     100     110     120
TTTCACTGGC CTTGCAGGTT ATGGTGACCC TATCCCCGAC GCTAGCAGAG AGGTTCCACG
```

rh12

```
      10      20      30      40      50      60
TTTTAAGCTT CTAATTTATG GGGCATCCAA CCGGTACACT GGGGTACCTT CACGCTTCAG
      70      80      90     100     110
TGGCAGTGGA TCTGGGACCG ATTTACCCTT CACAATCAGC TCTCTGCAGC CAGATGAT
```

rh13

```
      10      20      30      40      50      60
TTTTTTCTAG AGCAAAAGTC TACTTACGTT TGACCTCCAC CTTGGTCCCC TGACCGAACG
      70      80      90     100     110     120
TGAATGGATA GTTGTAAGTC TGTCCGCAGT AATAAGTGGC GAAATCATCT GGCTCCAGAG
```

FIG. 33A

SUBSTITUTE SHEET

rh20

```

      10      20      30      40      50      60
TTTTTCTAGA CCACCATGGG ATGGAGCTGG ATCTTTCTCT TCCTCCTGTC AGGTACCGCG
      70      80      90      100     110
GGCGTGCACT CTCAGGTCCA GCTTGTCCAG TCTGGGGCTG AAGTCAAGAA ACCT

```

rh21

```

      10      20      30      40      50      60
TTTTGAATTC TCGAGACCCT GTCCAGGGGC CTGCCTTACC CAGTTTATCC AGGAGCTAGT
      70      80      90      100     110     120
AAAGATGTAG CCAGAAGCTT TGCAGGAGAC CTTACGGAG CTCCCAGGTT TCTTGACTTC

```

A

rh22

```

      10      20      30      40      50      60
TTTTGAATTC TCGAGTGGAT GGAAGGATT GATCCTCCG ATGGTGAAGT TCACTACAAT
      70      80      90      100     110     120
CAAGATTCA AGGACCGTGT TACAATTACA GCAGACGAAT CCACCAATAC AGCCTACATG
      130
GAACTGAGCA GCCTGAG

```

rh23

```

      10      20      30      40      50      60
TTTTTCTAGA GGTTTTAAGG ACTCACCTGA GGAGACTGTG ACCAGGGTTC CTTGGCCCCA
      70      80      90      100     110     120
GTCAGCAAAC CAGGGCAGAA ATCCTCTTGC ACAGTAATAG ACTGCAGTGT CCTCTGATCT
      130
CAGGCTGCTC AGTT

```

FIG. 33B

SUBSTITUTE SHEET

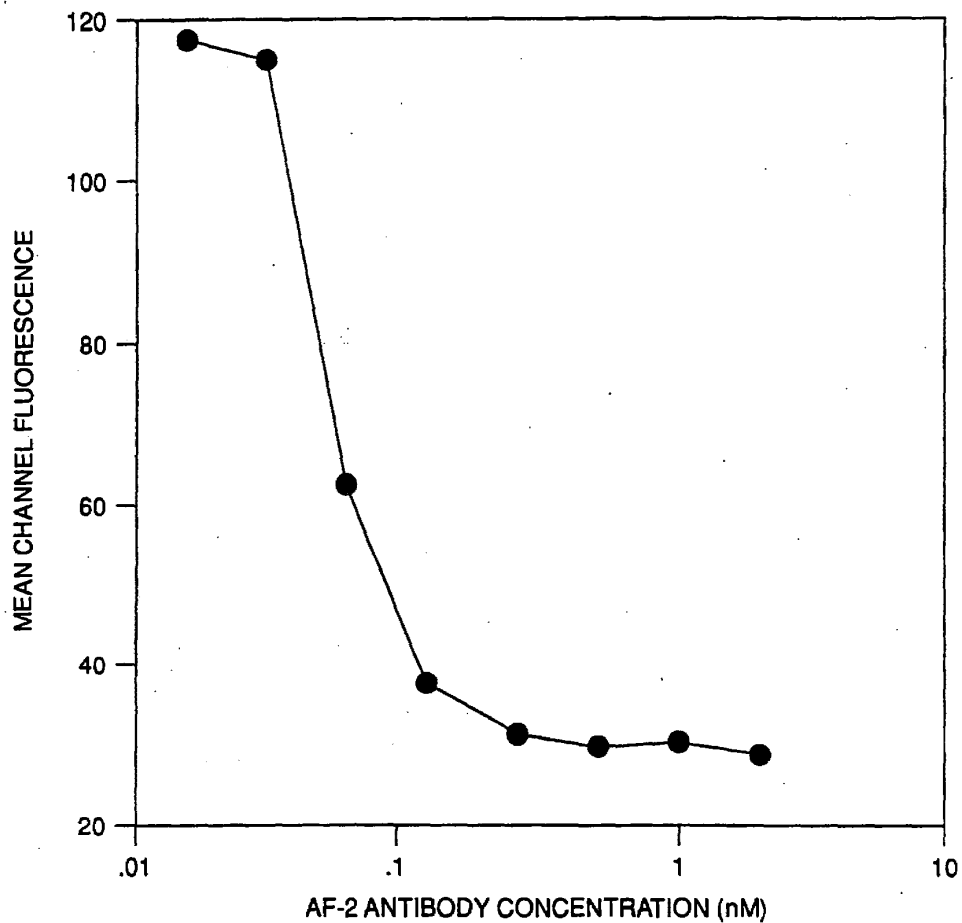

FIG. 34

SUBSTITUTE SHEET

INTERNATIONAL SEARCH REPORT

International Application No. PCT/US91/09711

I. CLASSIFICATION OF SUBJECT MATTER (if several classification symbols apply, indicate all) ³		
According to International Patent Classification (IPC) or to both National Classification and IPC		
IPC (5): A61K 35/14, 39/00; C07K 15/00 US CL : 530/387,391; 424/85.91		
II. FIELDS SEARCHED		
Minimum Documentation Searched ⁴		
Classification System	Classification Symbols	
U.S.	530/387,391; 424/85.91	
Documentation Searched other than Minimum Documentation to the extent that such Documents are included in the Fields Searched ⁵		
III. DOCUMENTS CONSIDERED TO BE RELEVANT ¹⁴		
Category ⁸	Citation of Document, ¹⁶ with indication, where appropriate, of the relevant passages ¹⁷	Relevant to Claim No. ¹⁸
Y	Journal of Biological Chemistry, Volume 260, No. 22, issued 05 October 1985, Lambert et al, "Purified Immunotoxins That are Reactive with Human Lymphoid Cells", pages 12035-12041, see entire document.	10,33,59,60
Y	US. A. 4,845,198 (Urdal et al) 04 July 1989, see columns 8-12.	1-9
Y	Journal of Experimental Medicine, Volume 162, issued July 1985, Kirkman et al, "Administration of an Anti-Interleukin 2 Receptor Monoclonal Antibody Prolongs Cardiac Allograft Survival in Mice", pages 358-362, see entire document.	1-9
Y	The Journal of Immunology, Volume 126, No.4, issued 04 April 1981, Uchiyama et al, "A Monoclonal Antibody (Anti-Tac) Reactive with Activated and Functionally Mature Human T Cells", pages 1393-1397, see pages 1393-1394...	1-10
Y	Nature, Volume 321, issued 29 May 1986, Jones et al, "Replacing the Complementarity Determining Regions in a Human Antibody with Those from a Mouse", pages 522-525, see pages 523-525.	1-9, 11-32, 34-58
<p>* Special categories of cited documents:¹⁸</p> <p>"A" document defining the general state of the art which is not considered to be of particular relevance</p> <p>"E" earlier document but published on or after the international filing date</p> <p>"L" document which may throw doubts on priority claim(s) or which is cited to establish the publication date of another citation or other special reason (as specified)</p> <p>"O" document referring to an oral disclosure, use, exhibition or other means</p> <p>"P" document published prior to the international filing date but later than the priority date claimed</p> <p>"T" later document published after the international filing date or priority date and not in conflict with the application but cited to understand the principle or theory underlying the invention</p> <p>"X" document of particular relevance; the claimed invention cannot be considered novel or cannot be considered to involve an inventive step</p> <p>"Y" document of particular relevance; the claimed invention cannot be considered to involve an inventive step when the document is combined with one or more other such documents, such combination being obvious to a person skilled in the art</p> <p>"&" document member of the same patent family</p>		
IV. CERTIFICATION		
Date of the Actual Completion of the International Search ²		Date of Mailing of this International Search Report ²
06 FEBRUARY 1992		27 FEB 1992
International Searching Authority ¹		Signature of Authorized Officer ²⁰
ISA/US		Lila Feisee <i>Lila Feisee</i>

Form PCT/ISA/210 (second sheet)(May 1986) B

FURTHER INFORMATION CONTINUED FROM THE SECOND SHEET		
Y	Proceedings of the National Academy of Sciences, Volume 86, issued December 1989, Queen et al, "A Humanized Antibody that Binds to the Interleukin-2 Receptor", pages 10029-10033, see entire document.	1-60
Y	WO, A, 88-07869 (Billiau et al) 20 October 1988. See the entire abstract.	50-58
Y	Journal of Interferon Research, Volume 10, No. 2, issued 1990, Jarpe et al, "Structure of an Epitope in an Immunodominant Region of the Interferon-gamma, Molecule that is Involved in Receptor Interaction", pages 243-52, see the entire abstract.	50-58
V. <input type="checkbox"/> OBSERVATIONS WHERE CERTAIN CLAIMS WERE FOUND UNSEARCHABLE¹		
This international search report has not been established in respect of certain claims under Article 17(2) (a) for the following reasons:		
1. <input type="checkbox"/> Claim numbers , because they relate to subject matter (1) not required to be searched by this Authority, namely:		
2. <input type="checkbox"/> Claim numbers , because they relate to parts of the international application that do not comply with the prescribed requirements to such an extent that no meaningful international search can be carried out (1), specifically:		
3. <input type="checkbox"/> Claim numbers , because they are dependent claims not drafted in accordance with the second and third sentences of PCT Rule 6.4(a).		
VI. <input type="checkbox"/> OBSERVATIONS WHERE UNITY OF INVENTION IS LACKING²		
This International Searching Authority found multiple inventions in this international application as follows:		
1. <input type="checkbox"/> As all required additional search fees were timely paid by the applicant, this international search report covers all searchable claims of the international application.		
2. <input type="checkbox"/> As only some of the required additional search fees were timely paid by the applicant, this international search report covers only those claims of the international application for which fees were paid, specifically claims:		
3. <input type="checkbox"/> No required additional search fees were timely paid by the applicant. Consequently, this international search report is restricted to the invention first mentioned in the claims; it is covered by claim numbers:		
4. <input type="checkbox"/> As all searchable claims could be searched without effort justifying an additional fee, the International Search Authority did not invite payment of any additional fee.		
Remark on protest		
<input type="checkbox"/> The additional search fees were accompanied by applicant's protest.		
<input type="checkbox"/> No protest accompanied the payment of additional search fees.		

III. DOCUMENTS CONSIDERED TO BE RELEVANT (CONTINUED FROM THE SECOND SHEET)		
Category*	Citation of Document, ¹⁶ with indication, where appropriate, of the relevant passages ¹⁷	Relevant to Claim No. ¹⁸
Y	Journal of Virology, Volume 62, No. 9, issued 1988, Britt et al, "Induction of Complement -dependant and independent Neutralizing Antibodies by Recombinant-derived Human Cytomegalovirus gp55-116(gB)", pages 3309-3318, see the entire abstract.	34-49
Y	Dist. Markers, Volume 5, No. 4, issued 1987, Favaloro et al, "Characterization of Monoclonal Antibodies to the Human Myeloid-differentiation Antigen, 'gp67' (CD33)", pages 215-225, see the entire abstract.	23-32
Y	Antiviral Research, Volume 10, No. 6, issued 1988, Bernstein et al, "Antibody to Cloned HSV Glycoproteins B and D Plus Adult Human leukocytes Protect Neonatal Mice from Lethal HSV Infection", pages 279-287. See the entire abstract.	11-22



GO 1816

#23
C. D. [unclear]
4/24/96

Patent Docket P0709P1

IN THE UNITED STATES PATENT AND TRADEMARK OFFICE

<p>In re Application of Carter et al.</p> <p>Serial No.: 08/146,206</p> <p>Filed: November 17, 1993</p> <p>For: METHOD FOR MAKING HUMANIZED ANTIBODIES</p>	<p>Group Art Unit: 1816</p> <p>Examiner: D. Adams</p>
	<p>CERTIFICATE OF MAILING I hereby certify that this correspondence is being deposited with the United States Postal Service as first class mail in an envelope addressed to: Assistant Commissioner of Patents, Washington, D.C. 20231 on</p> <p>March 27, 1996</p> <p><i>[Signature]</i> Susan Tafel</p>

146
D
4-10-96

NOTICE OF APPEAL

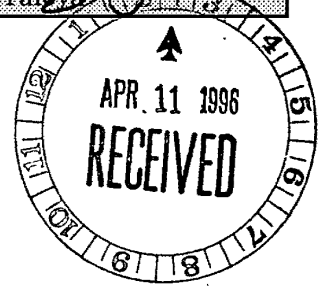

Box AF
Assistant Commissioner of Patents
Washington, D.C. 20231

Sir:

Applicant hereby appeals to the Board of Appeals and Interferences from the decision dated October 27, 1995, of the Primary Examiner finally rejecting claims 1-12, 15 and 19-25.

The Commissioner is hereby authorized to charge Deposit Account No. 07-0630 in the amount of \$290 to cover the fees for this appeal and to charge the deposit account for any further fees in regard to this patent application. A duplicate copy of this Notice is enclosed for this purpose.

A copy of a document pursuant to 37 C.F.R. § 10.9(b) is attached as proof of the authorization of the undersigned to prosecute the above-mentioned application. The original of this document is on file in the Office of Enrollment and Discipline.

Respectfully submitted,
GENENTECH, INC.

By: *[Signature]*
Wendy M. Lee

Date: March 27, 1996

460 Pt. San Bruno Blvd.
So. San Francisco, CA 94080-4990
Phone: (415) 225-1994
Fax: (415) 952-9881

210 28 07 0070 05/00 51 00000000
21021 117 2100000

Corres. and Mail

BOX AF



Patent Docket P0709P1

#22
C. J. H.
4/24/96

IN THE UNITED STATES PATENT AND TRADEMARK OFFICE

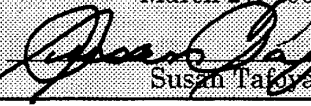
In re Application of Carter et al. Serial No.: 08/146,206	Group Art Unit: 1816 Examiner: D. Adams
Filed: November 17, 1993 For: METHOD FOR MAKING HUMANIZED ANTIBODIES	CERTIFICATE OF MAILING <small>I hereby certify that this correspondence is being deposited with the United States Postal Service as first class mail in an envelope addressed to: Assistant Commissioner of Patents, Washington, D.C. 20231 on</small> March 27, 1996  Susan Tafolla

PETITION AND FEE FOR TWO MONTH EXTENSION OF TIME
(37 CFR 1.136(a))

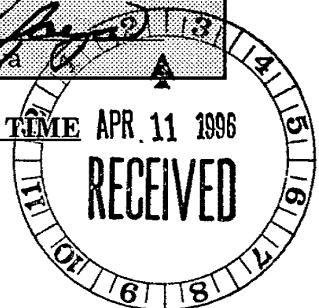

Box AF
Assistant Commissioner of Patents
Washington, D.C. 20231

Sir:

Applicant petitions the Commissioner of Patents and Trademarks to extend the time for response to the Final Office Action dated October 27, 1995 for two (2) months, from January 27, 1996 to March 27, 1996. The extended time for response does not exceed the statutory period.

Please charge Deposit Account No. 07-0630 in the amount of \$380.00 to cover the cost of the extension. Any deficiency or overpayment should be charged or credited to this deposit account. A duplicate of this sheet is enclosed.

A copy of a document pursuant to 37 C.F.R. § 10.9(b) is attached as proof of the authorization of the undersigned to prosecute the above-mentioned application. The original of this document is on file in the Office of Enrollment and Discipline.

Respectfully submitted,
GENENTECH, INC.

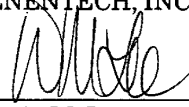
By: 
Wendy M. Lee

Date: March 27, 1996

460 Pt. San Bruno Blvd.
So. San Francisco, CA 94080-4990
Phone: (415) 225-1994
Fax: (415) 952-9881

210 PD 07-0630 4/23/96 08245206
21021 1.6 03610004



UNITED STATES DEPARTMENT OF COMMERCE
Patent and Trademark Office
ASSISTANT SECRETARY AND COMMISSIONER
OF PATENTS AND TRADEMARKS
Washington, D.C. 20231

LIMITED RECOGNITION UNDER 37 CFR § 10.9(b)

Wendy M. Lee is hereby given limited recognition under 37 CFR § 10.9(b) as an employee of Genentech, Inc., to prepare and prosecute patent applications and to represent patent applicants wherein Genentech, Inc., is the assignee of record of the entire interest. This limited recognition shall expire on the date appearing below, or when whichever of the following events first occurs prior to July 15, 1996: (i) Wendy M. Lee ceases to lawfully reside in the United States, (ii) Wendy M. Lee's employment with Genentech, Inc., ceases or is terminated, or (iii) Wendy M. Lee ceases to remain or reside in the United States on a H-1B visa.

This document constitutes proof of such recognition. The original of this document is on file in the Office of Enrollment and Discipline of the U.S. Patent and Trademark Office.

Expires: July 15, 1996

Karen L. Bovard, Director
Office of Enrollment and Discipline



UNITED STATES DEPARTMENT OF COMMERCE
Patent and Trademark Office
 Address: COMMISSIONER OF PATENTS AND TRADEMARKS
 Washington, D.C. 20231

SERIAL NUMBER	FILING DATE	FIRST NAMED APPLICANT	ATTORNEY DOCKETT NO.
---------------	-------------	-----------------------	----------------------

EXAMINER

ART UNIT	PAPER NUMBER
----------	--------------

21

DATE MAILED:

EXAMINER INTERVIEW SUMMARY RECORD

All participants (applicant, applicant's representative, PTO personnel):

- (1) Ms Wendy M. Lu (3) _____
 (2) Donald E. Adams (4) _____

Date of interview 4/8/96

Type: Telephonic Personal (copy is given to applicant applicant's representative).

Exhibit shown or demonstration conducted: Yes No. If yes, brief description: N/A

Agreement was reached with respect to some or all of the claims in question. was not reached.

Claims discussed: All generally

Identification of prior art discussed: All cited art.

Description of the general nature of what was agreed to if an agreement was reached, or any other comments: discussed problems w/spec- identified a difference in format between PTO & generated copies. Discussed Kabat Consensus Sequence & how the method taught by prior art refs teach away from using a consensus sequence. Suggested adding claim 19 originally not entered as a new claim #26 & connecting all previous dependency on claim 12 to claim 26

(A fuller description, if necessary, and a copy of the amendments, if available, which the examiner agreed would render the claims allowable must be attached. Also, where no copy of the amendments which would render the claims allowable is available, a summary thereof must be attached.)

1. It is not necessary for applicant to provide a separate record of the substance of the interview.

Unless the paragraph below has been checked to indicate to the contrary, A FORMAL WRITTEN RESPONSE TO THE LAST OFFICE ACTION IS NOT WAIVED AND MUST INCLUDE THE SUBSTANCE OF THE INTERVIEW (e.g., items 1-7 on the reverse side of this form). If a response to the last Office action has already been filed, then applicant is given one month from this interview date to provide a statement of the substance of the interview.

2. Since the examiner's interview summary above (including any attachments) reflects a complete response to each of the objections, rejections and requirements that may be present in the last Office action, and since the claims are now allowable, this completed form is considered to fulfill the response requirements of the last Office action. Applicant is not relieved from providing a separate record of the substance of the interview unless box 1 above is also checked.

Donald E. Adams
 Examiner's Signature

In re Application of: Paul J. Carter et al.
Serial No.: 08/146,205
Filed On: 17 November 1993
Mailed On: 27 August 1996

Docket No.: P070SP1
By: Wendy M. Lee
Reg. No.: P-40,378

The following has been received in the U.S. Patent Office on the date stamped:

<input checked="" type="checkbox"/> Transmittal (dup)	<input type="checkbox"/> Notice To File Missing Parts (dup)
<input checked="" type="checkbox"/> Extension of Time Request (dup)	<input type="checkbox"/> Declaration/Power of Atty
<input checked="" type="checkbox"/> Submission under 37 CFR 1.129(a)	<input type="checkbox"/> Assignment
<input checked="" type="checkbox"/> Supplemental Information Enclosed Statement	<input type="checkbox"/> Recordation Form
<input checked="" type="checkbox"/> Form 1449 (Rev. 10) Reference	<input type="checkbox"/> Drawings: ___ Sheets
<input type="checkbox"/> Notice of Appeal	<input type="checkbox"/> ___ Informal
<input type="checkbox"/> Issue Fee Transmittal	<input type="checkbox"/> Certificate re: Sequence Listing (Sequence Listing & Diskette)
<input checked="" type="checkbox"/> Certificate of Mailing	<input type="checkbox"/> Fees: \$ ___
<input type="checkbox"/> Certificate of Express Mailing	<input type="checkbox"/> Other: ___
<input type="checkbox"/> Express Mail Label No.:	

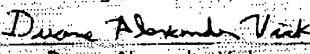

IN THE UNITED STATES PATENT AND TRADEMARK OFFICE

In re Application of Paul J. Carter et al.	Group Art Unit: 1816 Examiner: D. Adams
Serial No.: 08/146,206 Filed: November 17, 1993	CERTIFICATE OF MAILING I hereby certify that the correspondence is being deposited with the United States Postal Service with sufficient postage, as first class mail in an envelope addressed to: Assistant Commissioner of Patents, Washington, D.C. 20231 on August 27, 1996  Duane Alexander Vick
For: METHOD FOR MAKING HUMANIZED ANTIBODIES	

SUBMISSION UNDER 37 CFR 51.129(a)

Assistant Commissioner of Patents
 Washington, D.C. 20231

Sir:

The accompanying papers are being filed in response to the Office Action mailed October 27, 1995 issuing a final rejection of the claims pending in the application. On March 27, 1996, Applicants filed a Notice of Appeal. Submitted herewith is a three month extension of time for making this submission.

The present submission, in the form of a Supplemental Information Disclosure Statement, is being submitted under Section 1.129(a) along with the fee set forth in Section 1.17(r).

Respectfully submitted,
 GENENTECH, INC.

Date: August 27, 1996

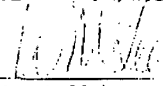
By: 
 Wendy M. Lee
 Reg. No. P-40,378

460 Pt. San Bruno Blvd.
 So. San Francisco, CA 94080 4990
 Phone: (415) 225-1994
 Fax: (415) 952-9881

IN THE UNITED STATES PATENT AND TRADEMARK OFFICE

In re Application of Paul J. Carter et al. Serial No.: 08/146,206	Group Art Unit: 1816 Examiner: D. Adams
Filed: November 17, 1993 For: METHOD FOR MAKING HUMANIZED ANTIBODIES	CERTIFICATE OF MAILING I hereby certify that this correspondence is being deposited with the United States Postal Service with sufficient postage as first class mail in an envelope addressed to: Assistant Commissioner of Patents, Washington, D.C. 20231. August 27, 1986 <i>Duane Alexander Vick</i> Duane Alexander Vick

SUPPLEMENTAL INFORMATION DISCLOSURE STATEMENT

Assistant Commissioner of Patents
 Washington, D.C. 20231

Sir:

Applicants submit herewith patents, publications or other information (attached hereto and listed on the attached Form PTO-1449) of which they are aware, which they believe may be material to the examination of this application and in respect of which there may be a duty to disclose in accordance with 37 CFR §1.56.

This Information Disclosure Statement:

- (a) accompanies the new patent application submitted herewith. 37 CFR §1.97(a).
- (b) is filed within three months after the filing date of the application or within three months after the date of entry of the national stage of a PCT application as set forth in 37 CFR §1.491.
- (c) as far as is known to the undersigned, is filed before the mailing date of a first Office action on the merits.
- (d) is filed after the first Office Action and more than three months after the application's filing date or PCT national stage date of entry filing but, as far as is known to the undersigned, prior to the mailing date of either a final rejection or a notice of allowance, whichever occurs first, and is accompanied by either the fee (\$220) set forth in 37 CFR §1.17(p) or a certification as specified in 37 CFR §1.97(e), as checked below. Should any fee be due, the U.S. Patent and Trademark Office is hereby authorized to charge Deposit Account No. 07-0630 in the amount of \$220.00 to cover the cost of this Information Disclosure Statement. Any deficiency or overpayment should be charged or credited to this deposit account. **A duplicate of this sheet is enclosed.**

Revised (10/20/85)

- (e) is filed after the mailing date of either a final rejection or a notice of allowance, whichever occurred first, and is accompanied by the fee (\$130) set forth in 37 CFR § 1.17(i)(1) and a certification as specified in 37 CFR § 1.97(e), as checked below. **This document is to be considered as a petition requesting consideration of the information disclosure statement.** The U.S. Patent and Trademark Office is hereby authorized to charge Deposit Account No. 07-0630 in the amount of \$130.00 to cover the cost of this Information Disclosure Statement. Any deficiency or overpayment should be charged or credited to this deposit account. **A duplicate of this sheet is enclosed.**
- (f) is filed after the mailing date of a final rejection, but a request to withdraw the finality thereof under 37 CFR § 1.129(a) is submitted herewith. The U.S. Patent and Trademark Office is hereby authorized to charge Deposit Account No. 07-0630 to cover the cost of this Information Disclosure Statement in the event that any fees are due. **A duplicate of this sheet is enclosed.**

[If either of boxes (d) or (e) is checked above, the following "certification" under 37 CFR § 1.97(e) may need to be completed.] The undersigned certifies that:

- Each item of information contained in the information disclosure statement was cited in a communication mailed from a foreign patent office in a counterpart foreign application not more than three months prior to the filing of this information disclosure statement.
- No item of information contained in this information disclosure statement was cited in a communication mailed from a foreign patent office in a counterpart foreign application or, to the knowledge of the undersigned after making reasonable inquiry, was known to any individual designated in 37 CFR § 1.56(e) more than three months prior to the filing of this information disclosure statement.

A list of the patent(s) or publication(s) is set forth on the attached Form PTO-1449 (Modified).

A copy of the items on PTO-1449 is supplied herewith:

each none only those listed below:

Those patent(s) or publication(s) which are marked with an asterisk (*) in the attached PTO-1449 form are not supplied because they were previously cited by or submitted to the Office in a prior application Serial No. 07715,272, filed 14 June, 1991 and relied upon in this application for an earlier filing date under 35 USC § 120.

A concise explanation of relevance of the items listed on PTO-1449 is:

- not given
- given for each listed item
- given for only non-English language listed item(s) [Required]
- in the form of an English language copy of a Search Report from a foreign patent office, issued in a counterpart application, which refers to the relevant portions of the references.

(Revised 11/22/95)

The Examiner is reminded that a "concise explanation of the relevance" of the submitted prior art "may be nothing more than identification of the particular figure or paragraph of the patent or publication which has some relation to the claimed invention," MPEP §609.

While the information and references disclosed in this Information Disclosure Statement may be "material" pursuant to 37 CFR §1.56, it is not intended to constitute an admission that any patent, publication or other information referred to therein is "prior art" for this invention unless specifically designated as such.

In accordance with 37 CFR §1.97(g), the filing of this Information Disclosure Statement shall not be construed to mean that a search has been made or that no other material information as defined in 37 CFR §1.56(a) exists. It is submitted that the Information Disclosure Statement is in compliance with 37 CFR §1.98 and MPEP §609 and the Examiner is respectfully requested to consider the listed references.

Date: August 27, 1996

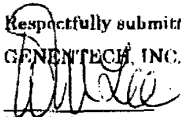
Respectfully submitted,
GENENTECH, INC.
By: 
Wendy M. Lee
Reg. No. P-40,378

160 Pt. San Bruno Blvd.
So. San Francisco, CA 94080-4990
Phone: (415) 225-1994
Fax: (415) 952-9881

Revised (10/20/96)

IN THE UNITED STATES PATENT AND TRADEMARK OFFICE

In re Application of Paul J. Carter et al. Serial No.: 08/146,206 Filed: November 17, 1993 For: METHOD FOR MAKING HUMANIZED ANTIBODIES	Group Art Unit: 1816 Examiner: D. Adams CERTIFICATE OF MAILING I hereby certify that this correspondence is being deposited with the United States Postal Service with sufficient postage as first class mail in an envelope addressed to: Assistant Commissioner of Patents, Washington, D.C. 20231 on August 27, 1996  Duane Alexander Vick
---	--

PETITION AND FEE FOR THREE MONTH EXTENSION OF TIME
(37 CFR 1.136(a))

Assistant Commissioner of Patents
 Washington, D.C. 20231

Sir:

Applicant petitions the Commissioner of Patents and Trademarks to extend the time for response to the Notice of Appeal dated 3/27/96 for 3 month(s) from 5/27/96 to 8/27/96. The extended time for response does not exceed the statutory period.

Please charge Deposit Account No. 07-0630 in the amount of \$ 900.00 to cover the cost of the extension. Any deficiency or overpayment should be charged or credited to this deposit account. A duplicate of this sheet is enclosed.

Respectfully submitted,
 GENENTECH, INC.

Date: August 27, 1996

By: 
 Wendy M. Lee
 Reg. No. P-40,378

460 Pt. San Bruno Blvd.
 So. San Francisco, CA 94080-4990
 Phone: (415) 225-1994
 Fax: (415) 952-9881



GP 1816
#29
D. Plunkett
Patent Docket P0709P1
9/14/96

IN THE UNITED STATES PATENT AND TRADEMARK OFFICE

<p>In re Application of Paul J. Carter et al. Serial No.: 08/146,206 Filed: November 17, 1993 For: METHOD FOR MAKING HUMANIZED ANTIBODIES</p>	<p>Group Art Unit: 1816 Examiner: D. Adams</p> <p>RECEIVED SEP 10 1996 GROUP 1800</p>
<p>CERTIFICATE OF MAILING I hereby certify that this correspondence is being deposited with the United States Postal Service with sufficient postage as first class mail in an envelope addressed to: Assistant Commissioner of Patents, Washington, D.C. 20231 on</p> <p>August 27, 1996</p> <p><i>Duane Alexander Vick</i> Duane Alexander Vick</p>	

SUPPLEMENTAL INFORMATION DISCLOSURE STATEMENT

Assistant Commissioner of Patents
Washington, D.C. 20231

Sir:

Applicants submit herewith patents, publications or other information (attached hereto and listed on the attached Form PTO-1449) of which they are aware, which they believe may be material to the examination of this application and in respect of which there may be a duty to disclose in accordance with 37 CFR §1.56.

This Information Disclosure Statement:

- (a) accompanies the new patent application submitted herewith. 37 CFR §1.97(a).
- (b) is filed within three months after the filing date of the application or within three months after the date of entry of the national stage of a PCT application as set forth in 37 CFR §1.491.
- (c) as far as is known to the undersigned, is filed before the mailing date of a first Office action on the merits.
- (d) is filed after the first Office Action and more than three months after the application's filing date or PCT national stage date of entry filing but, as far as is known to the undersigned, prior to the mailing date of either a final rejection or a notice of allowance, whichever occurs first, and is accompanied by either the fee (\$220) set forth in 37 CFR §1.17(p) or a certification as specified in 37 CFR §1.97(e), as checked below. Should any fee be due, the U.S. Patent and Trademark Office is hereby authorized to charge Deposit Account No. 07-0630 in the amount of \$220.00 to cover the cost of this Information Disclosure Statement. Any deficiency or overpayment should be charged or credited to this deposit account. **A duplicate of this sheet is enclosed.**

Revised (10/20/95)

- (e) is filed after the mailing date of either a final rejection or a notice of allowance, whichever occurred first, and is accompanied by the fee (\$130) set forth in 37 CFR §1.17(i)(1) and a certification as specified in 37 CFR §1.97(e), as checked below. **This document is to be considered as a petition requesting consideration of the information disclosure statement.** The U.S. Patent and Trademark Office is hereby authorized to charge Deposit Account No. 07-0630 in the amount of \$130.00 to cover the cost of this Information Disclosure Statement. Any deficiency or overpayment should be charged or credited to this deposit account. **A duplicate of this sheet is enclosed.**
- (f) is filed after the mailing date of a final rejection, but a request to withdraw the finality thereof under 37 CFR § 1.129(a) is submitted herewith. The U.S. Patent and Trademark Office is hereby authorized to charge Deposit Account No. 07-0630 to cover the cost of this Information Disclosure Statement in the event that any fees are due. **A duplicate of this sheet is enclosed.**

[If either of boxes (d) or (e) is checked above, the following "certification" under 37 CFR §1.97(e) may need to be completed.] The undersigned certifies that:

- Each item of information contained in the information disclosure statement was cited in a communication mailed from a foreign patent office in a counterpart foreign application not more than three months prior to the filing of this information disclosure statement.
- No item of information contained in this information disclosure statement was cited in a communication mailed from a foreign patent office in a counterpart foreign application or, to the knowledge of the undersigned after making reasonable inquiry, was known to any individual designated in 37 CFR §1.56(c) more than three months prior to the filing of this information disclosure statement.

A list of the patent(s) or publication(s) is set forth on the attached Form PTO-1449 (Modified). A copy of the items on PTO-1449 is supplied herewith:

each none only those listed below:

Those patent(s) or publication(s) which are marked with an asterisk (*) in the attached PTO-1449 form are not supplied because they were previously cited by or submitted to the Office in a prior application. Serial No. 07/715,272, filed 14 June 1991 and relied upon in this application for an earlier filing date under 35 USC §120.

A concise explanation of relevance of the items listed on PTO-1449 is:

- not given
- given for each listed item
- given for only non-English language listed item(s) [Required]
- in the form of an English language copy of a Search Report from a foreign patent office, issued in a counterpart application, which refers to the relevant portions of the references.

Revised (10/20/95)

The Examiner is reminded that a "concise explanation of the relevance" of the submitted prior art "may be nothing more than identification of the particular figure or paragraph of the patent or publication which has some relation to the claimed invention," MPEP §609.

While the information and references disclosed in this Information Disclosure Statement may be "material" pursuant to 37 CFR §1.56, it is not intended to constitute an admission that any patent, publication or other information referred to therein is "prior art" for this invention unless specifically designated as such.

In accordance with 37 CFR §1.97(g), the filing of this Information Disclosure Statement shall not be construed to mean that a search has been made or that no other material information as defined in 37 CFR §1.56(a) exists. It is submitted that the Information Disclosure Statement is in compliance with 37 CFR §1.98 and MPEP §609 and the Examiner is respectfully requested to consider the listed references.

Respectfully submitted,

GENENTECH, INC.

Date: August 27, 1996

By: 

Wendy M. Lee
Reg. No. P-40,378

460 Pt. San Bruno Blvd.
So. San Francisco, CA 94080-4990
Phone: (415) 225-1994
Fax: (415) 952-9881



(12) **EUROPEAN PATENT SPECIFICATION**

(45) Date of publication and mention
of the grant of the patent:
10.09.1997 Bulletin 1997/37

(51) Int Cl.⁶: **C07K 16/46**, C12P 21/08,
C12N 15/62, A61K 39/395,
C12N 5/20, A61K 47/48,
C12N 5/10

(21) Application number: **90306178.6**

(22) Date of filing: **07.06.1990**

(54) **Improved monoclonal antibodies against the human alpha/beta t-cell receptor, their production and use**

Monoklonale Antikörper gegen den humanen alpha/beta-T-Zellenrezeptor, ihre Herstellung und Verwendung

Anticorps monoclonaux améliorés contre le récepteur alpha/bêta des cellules T humaines, leur production et leur utilisation

(84) Designated Contracting States:
AT BE CH DE DK ES FR GB GR IT LI LU NL SE

- **Moore, Gordon P.**
Lexington, Massachusetts 02173 (US)
- **Seiler, Fritz**
D-3550 Marburg (DE)

(30) Priority: **07.06.1989 US 362549**
25.05.1990 US 529979

(43) Date of publication of application:
19.12.1990 Bulletin 1990/51

(74) Representative: **Sheard, Andrew Gregory et al**
Kilburn & Strode
30, John Street
London WC1N 2DD (GB)

(73) Proprietors:
• **GENZYME CORPORATION**
Framingham, Massachusetts 01701 (US)
• **BEHRINGWERKE Aktiengesellschaft**
35001 Marburg (DE)

(56) References cited:
WO-A-89/01783

(72) Inventors:
• **Kurrle, Roland**
D-3550 Marburg (DE)
• **Shearman, Clyde W.**
Bellingham, Massachusetts 02019 (US)

- **TRANSPLANTATION PROCEEDINGS** vol. XX,
no. 2(2), 1988, New York, USA pages 103 - 109;
H. SCHLITT et al.: "Evidence for a
cyclosporine-resistant pathway of T cell
activation triggered via the CD3/T cell receptor
complex"

EP 0 403 156 B1

Note: Within nine months from the publication of the mention of the grant of the European patent, any person may give notice to the European Patent Office of opposition to the European patent granted. Notice of opposition shall be filed in a written reasoned statement. It shall not be deemed to have been filed until the opposition fee has been paid. (Art. 99(1) European Patent Convention).

Description

The instant application discloses useful monoclonal antibodies (mAbs) against an epitope within the constant region of the human alpha/beta T-cell receptor (TCR), their production and use for immunosuppressive therapy in organ and bone marrow transplantation, in treatment of autoimmune diseases and for therapeutic applications in immunoregulation.

For decades Anti-leukocyte-antibodies for clinical and experimental use have been generated by immunizing, e. g. horses, rabbits, goats and rats with leukocytes, lymphocytes or subpopulations thereof or with various tumor cell lines. Specificity of such anti-leukocyte-globulin/Antithymocyte-globulin (ALG/ATG) preparations was usually obtained by careful selection of antigen sources or by absorption of undesired antibodies with different cell types such as erythrocytes, B-cells, selected cell lines, etc. This strategy, which resulted in high quality ALG/ATGs, requires a considerable expenditure of laboratory force, quality control, and the necessity to ascertain reproducible specificity from batch-to-batch. Within certain limitations, those ALG/ATGs made it possible to study leukocyte differentiation, the cellular origin of leukemia and lymphoma, to define T-cell subpopulations, and even to prepare antiidiotypic antisera.

The therapeutic efficacy of ALG/ATGs is well known, especially for immunosuppression in organ transplantation. In addition, ALG/ATGs have been used successfully to treat patients with aplastic anemia and for "purging" bone marrow cells within the context of bone marrow transplantation. Despite the success with ALG/ATG preparations it is accepted that even with a reasonable amount of laboratory effort, these polyclonal anti-leukocyte-antibodies might vary from batch-to-batch and the specificity of these antisera is limited.

Once the technique to produce mAbs was developed by Kohler and Milstein (Nature 225(1974)), it was possible to generate antibodies with much higher specificity as compared to ALG/ATG preparations. Since mAbs recognize not only distinct antigens, e.g. on cell surfaces, but also particular epitopes within such an antigen, they can be used with high efficacy to discriminate even between very similar cell populations, and to characterize the biochemical and functional aspects of the recognized antigen.

One use of mAbs is in targeting carcinomas so that they can be treated or diagnosed. This is disclosed in WO89/01783, for example, where a humanised antibody molecule having specificity for the TAG-72 antigen is disclosed. This molecule comprises CDRs of its variable domain which are derived from the mouse monoclonal antibody B72.3. The remaining immunoglobulin parts of the molecule are derived from a human immunoglobulin.

mAbs have been most frequently and successfully used for immunosuppressive therapy in clinical organ transplantation. However, most mAbs have a broad immunosuppressive capacity, thus undesirably influencing functions of a wide spectrum of immune cells presumably not all involved in graft rejection.

Among others, the monoclonal antibody OKT3, directed against mature human T cells, has been extensively used for the treatment of patients undergoing acute allograft rejection after kidney transplantation (Russell P.S., Colvin R. B., Cosimi, A.B.: Annu. Rev. Med. 35:63, (1984) and Cosimi A.B., Burton R.C., Colvin, R.B. *et al.*: Transplantation 32: 535, (1981)). Moreover, OKT3 and rabbit complement were used for purging mature T-cells from donor marrow to prevent acute graft-v-host disease (GVHD) in allogeneic bone marrow transplantation (Prentice, H.G., Blacklock, H. A., Janossy, G. *et al.*: Lancet 1:700, (1982) and Blacklock, H.A., Prentice, H.G., Gilmore, M.J. *et al.*: Exp. Hematol. 11: 37, (1983)). Whereas OKT3 treatment seems to be effective in the prevention of GVHD in allogeneic bone marrow transplantation for acute leukemia, a combined *in vitro/in vivo* treatment with OKT3 failed to prevent GVHD during

therapy for severe combined immunodeficiency (Hayward, A.R. *et al.*: Clin. Lab. Observ. 100:665, (1982)).

Treatment of T-cells with OKT3 elicits several responses inconsistent with immune suppression including T-cell activation, production of immune mediators and T3-modulation. The T3-antigen complex recognized by CD3-mAbs (e. g. OKT3) is postulated to play a crucial role during T-cell activation. Functional studies indicate that the T3-antigen complex is involved in specific immune functions as molecules functionally and physically associated with the respective T-cell receptor. Under physiological conditions the mere binding of OKT3 to T-cells results in T-cell activation. When T-cells are activated in the presence of accessory cells, OKT3 is highly mitogenic for T-cells from all donors, whereas for anti-T3 mAbs of the IgG1 isotype, nonresponsiveness caused by polymorphism in the accessory cell function has been described. Additionally, it has been reported that stimulation of human peripheral blood lymphocytes with OKT3 induces the production of immune mediators such as interferon (alpha-IFN) and interleukin-2 (IL-2) (Pang, R.H., Yip, Y.K., Vilcek, J.: Cell Immunol. 64:304, (1981) and Welte, K., Platzer E. Wang, C.Y., *et al.*: J. Immunol. 131:2356, (1983)). One of the earliest events after the binding of OKT3 to the T-cell membrane is the modulation of the T3 complex. T3 modulation occurs under appropriate conditions *in vitro* as well as *in vivo* and this mechanism, among others, seems to be responsible for the "escape" of T-cells during *in vivo* therapy with OKT3. Also antigenic modulation seems to play a critical role in T-cell activation.

In light of undesired effects of OKT3 described above, there was a need to create new mAbs having a specificity against mature lymphocytes and suitable for clinical application. Still another aspect and goal involves the coupling of such mAbs to cytotoxic agents (radioisotopes, toxins, enzymes, etc.) in order to improve their effectiveness in mediating cytotoxicity.

Another goal involved the modification, via genetic manipulation, of the mAb in order to produce chimeric antibodies having mixed murine and human characteristics in order to improve their effectiveness and/or lower their immunogenicity in patients.

5 Chimeric antibodies offer an additional advantage over murine mAb with regards to immunogenicity in patients. A chimeric antibody would retain the affinity and specificity of the parental murine mAb and eliminate the patient immune response to the murine constant regions. A further refinement involves humanization of the variable regions. Only the complementarity determining regions and selected framework amino acids necessary for antigen binding are maintained murine. The remaining framework regions are converted to human sequences. The resulting mAb of the present invention is thus essentially a human antibody with a much lower immunogenicity in patients.

10 According to the present invention there is provided a chimaeric antibody specific for an epitope on the human alpha/beta T-cell receptor (TCR) which is recognised by mAb BMA 031, the antibody comprising:

- (a) a heavy chain whose variable region comprises the sequence of residues 1 to 120 of CIV-3 as shown in Table 6A; and
- 15 (b) a light chain whose variable region comprises the sequence of residues 1 to 107 of CIV-3 as shown in Table 6B. We have made a useful mAb secreted by the hybridoma cell line designated as BMA 031 by immunizing mice with human peripheral blood T-lymphocytes separated by the E-rosette-technique (so called E⁺-cells). The mAb secreted by BMA 031 (in the following likewise designated as BMA 031) is a murine monoclonal antibody of the IgG2b isotype with a specificity for the alpha- and beta-chain of the TCR/CD3 receptor complex. As compared to
- 20 OKT3 or BMA 030 (both clustered as CD3-antibodies), GMA 031 only very weakly induces mediator release after binding to T-cells. It is highly effective in clinical application, e.g. kidney transplant for patients with increased immunological risk when given post or at the time of the transplant-operation. Since no major side effects were observed with GMA 031 even at doses of up to 50 mg/dose, it may be advantageously given at time of surgery (preferably via a first injection of 50 mg intravenously) followed by a second injection 48 hours after transplantation.
- 25 Graft function was perfect in almost all cases.

BMA 031 defines, therefore, a valuable epitope on the alpha-beta TCR distinct from the epitope on CD3 recognized by OKT3 or by other mAbs against mature T-lymphocytes. In order to completely characterize this mAb and also to permit, by recombinant DNA techniques, exchange of the variable region frameworks outside of the hypervariable regions and exchange of the human constant region in place of the endogenous murine constant region, the DNA coding for the heavy and light chains of BMA 031 was cloned and sequenced.

The present inventors have recognised and defined the epitope on alpha/beta TCR. The present invention is directed to chimaeric antibodies directed against this epitope, having the characteristics set out in claim 1.

Preferred embodiments of the chimaeric antibodies of the present invention are described in claims 2 to 5.

35 A further aspect of the invention concerns the use of these antibodies in clinical application before, during or after transplant surgery, in bone marrow transplantation, in treatment of cancer (direct treatment of leukemic cells and indirect treatment of all types of cancer by activation of T-cell populations) and for therapeutic applications in immunoregulation.

The antibodies of the present invention are also useful in the detection of immunocompetent T-cells.

40 Additional aspects will become apparent upon study of the detailed description set forth below, which includes preferred embodiments of the present invention and which also includes other data for information purposes.

The description refers by way of example to the accompanying drawings, wherein:

- Figure 1 graphically depicts the construction scheme of the BMA 031 genomic library;
- 45 Figure 2 describes the probes used to screen the library;
- Figure 3 graphically sets forth, in linear fashion, the human constant region expression vectors;
- Figures 4A, 4B and 4C show results of competitive immunofluorescence assays with BMA 031 Chimeric Antibodies.
- 50 Figures 5A and 5B show results of T-cell proliferation assays with BMA 031 Chimeric Antibodies.
- Figures 6A, 6B and 6C show results of ADCC assays with the BMA 031 Chimeric Antibodies.
- 55 Figure 7 shows the results of competitive immunofluorescence assays with BMA-EUC1V3 antibody.

As used herein, the term "epitope" refers to the structure recognized by the monoclonal antibody BMA 031 (this antibody has been discussed in *Transplantation Proceedings*, Vol XX, No 2, Suppl 2: 103-109 (April 1988) for example,

which explains that BMA 031 has stimulatory features different from those of several CD3 antibodies), and is generally thought to be independent of the remaining portion of the antigen on which the epitope is located. It is presently unknown exactly how the epitope is formed structurally but it is anticipated that it may be formed by either (i) a part of the amino acid sequence of the antigen molecule; (ii) the three-dimensional structure formed by non-contiguous amino acids within the same molecule; (iii) the three-dimensional structure formed by various molecules within an antigen complex; or (iv) some combination thereof. As used herein the term "monoclonal antibody (mAb)" means an antibody composition having a substantially homogeneous antibody population. It is not intended to be limited as regards to the source of the antibody or the manner in which it is made and in the most preferred embodiments is intended to include recombinant methods of manufacture.

As used herein with respect to the exemplified BMA 031 antibody, the term "functional equivalent" means a monoclonal antibody that: (a) blocks the binding of BMA 031 and whose binding is blocked by bound BMA 031; (b) binds selectively to human T-cells having expressed the alpha/beta TCR but not having expressed TCR-gamma and/or delta-chains; (c) has one of the known isotypes; (d) binds to the same antigen as BMA 031 as determined by immunoprecipitation, western blotting or other biochemical analyses; (e) binds to the same antigen as determined by cells transfected by gene(s) for the alpha/beta TCR or segments thereof.

Example 1. Immunization and cell fusion

Three Balb/c mice (female; age: 6-8 weeks) were twice immunized intraperitoneally with 1.5×10^6 E⁺-cells each. Peripheral blood human T-lymphocytes were separated by the E-rosette-technique (rosette-formation with sheep red blood cells - E⁺-cells) and were derived from the peripheral blood of a healthy donor whose donated blood routinely tested HIV-negative for more than one year after having given the blood for immunization purposes.

Three days after the last immunization, the spleens of all three mice were removed, a single cell suspension was prepared and the lymphocytes were fused with the murine myeloma cell P3X63-Ag8.653 (ATCC # CRL 1580) according to a standard fusion protocol. The myeloma cell P3X63-Ag8.653 is described as an immunoglobulin non-producer mutant derived from the original myeloma cell P3-X63-Ag8 (ATCC # TIB 9).

After fusion, cells (1×10^6 cells/well) were cultured in the presence of HAT-medium (Dulbecco's modified Eagle's medium + 10% FCS + 0.1mM hypoxanthine, 0.4 μ M aminopterin, 16 μ M thymidine) to select for hybridoma cells.

Example 2. Isolation and characterization of the hybridoma clone BMA 031

Supernatants of growing hybridoma cells (fusion number BW 242) were harvested routinely and tested for the presence of murine immunoglobulins in an ELISA test-system designed to measure murine IgG quantitatively. At the same time, the supernatants were tested for antibodies with specificity for human lymphocyte cell surface antigens.

Within this selection process, single cells were picked from the original well (BW 242/1177) and were cultured separately. In subsequent steps these cells were repeatedly cloned by micromanipulation under microscopic control (BW 242/412). During three cloning cycles 100% of growing clones produced monoclonal antibodies with identical binding specificity and identical behavior with respect to biochemical criteria. One clone was selected and designated as BMA 031.

Extensive analyses were carried out to define the specificity and the functional properties of the hybridoma clone, BMA 031.

A master seed bank and a working cell bank were established starting with the hybridoma clone BMA 031. The two cell banks underwent extensive examinations to assure absence of contamination with pathogens (mycoplasmatic, bacterial and viral infections). In addition, starting from the master seed bank, experiments were carried out which showed that even after the 50th culture passage detectable variations in antibody specificity were neither measurable nor could non-producer mutants be detected when analysed by single cell cloning and by calculating antibody production rates in bulk culture.

Example 3. Specificity of BMA 031

Monoclonal antibodies directed to lymphocyte cell surface antigens are usually characterized by a binding assay. To analyse the specificity of BMA 031, cytofluorometric assay systems were used predominantly. In particular, binding assays were carried out as described below.

3.1 Analyses of the binding of BMA 031 with peripheral blood leukocytes

Comparison of mAb reactivity with reference mAbs

5 Defined subpopulations of PBLs were labelled either with a reference mAb and/or with BMA 031. If both mAbs have identical specificity they will stain identical populations of cells. In these studies, the reference mAbs used were those which had been previously characterized in the Workshops for Human Leukocyte Differentiation Antigens I., II. and III. (Paris, 1982; Boston, 1984; Oxford, 1986; Bernard, A.E.: Leukocyte Typing. Springer-Verlag (1984); Reinherz, E.L.E.: Leukocyte Typing II. Springer-Verlag (1986); McMichael, A.J.E.: Leukocyte Typing III. Oxford University Press (1987).

Expression of the antigen on different leukocyte subpopulations

15 Peripheral blood leukocytes were analyzed on an Ortho Cytofluorograph 50H/2150 Computer-system modified for single-step analyses of whole blood. Cells were either directly labelled with BMA 031-FITC and/or with reference mAbs or alternatively stained in a second step with isothiocyanate-fluoresceinated rabbit anti-mouse IgG (Ig-F(ab')₂-FITC). By using cytofluorometric assays, it was discovered that binding of BMA 031 was only detected on cells of the T-cell lineage which express the alpha/beta T-cell receptor. BMA 031 does not react with cells which express the gamma/delta T-cell receptor. BMA 031 can therefore effectively be used to discriminate between alpha/beta-TCR⁺ and gamma/delta-TCR⁺ cells. Presence or absence of distinct TCR chains reflect the status of T-cell differentiation during T-cell ontogeny.

20 In peripheral blood, molecules of the CD3-complex are predominantly expressed in association with the human alpha/beta-TCR (7). In healthy blood donors, the frequency of T-lymphocytes stained by BMA 031 is usually only 1-5% lower than that measured with CD3 mAbs (for normal frequencies of CD3⁺ cells see 1-3). As shown with cloned T-cells, this population of CD3⁺ BMA 031⁻ cells express the gamma/delta TCR instead of the alpha/beta TCR. In pathological situations, however, the frequency of CD3⁺ BMA 031⁻ T-cells can increase to 20% of the CD3⁺ cells in individual patients. On CD3⁺ BMA 031⁺ cells, binding of BMA 031-FITC is blocked by OKT3 and vice versa in competitive immunofluorescence assays. Nevertheless, by analyzing such data in more detail (comparison of fluorescence-histograms) and by blocking studies with anti-idiotypic antisera it can be clearly shown that BMA 031 recognizes a different epitope than all known CD3-mAbs.

Example 4. Characterization of the functional properties of BMA 031

35 BMA 031 is a murine monoclonal antibody of the IgG2b isotype. Due to the unique specificity and the isotype of BMA 031, this antibody triggers a specific pattern of biological functions. After binding to T-cells, BMA 031 does not induce T-cell proliferation comparable to CD3-mAbs of the IgG2a isotype (e.g. BMA 030, OKT3) in a three day thymidine incorporation assay nor does it induce Ca²⁺ influx in resting T-lymphocytes. In contrast to CD3-mAbs such as BMA 030 or OKT3, binding of BMA 031 to T-cells induces antigen modulation only weakly and triggers the release/production of cytokines to a very low extent.

Example 5. Preparation of DNA and RNA from BMA 031

40 For preparation of genomic DNA, approximately 1 x 10⁹ cells were grown in T-flasks. DNA was prepared by lysis in SDS, digestion with proteinase K and RNase A and sequential, gentle, phenol/chloroform extractions in high salt. Low density agarose gels indicated that the average length of the genomic DNA was greater than 50 kilobases (Kb); long length is important in creation of complete genomic clone libraries in lambda phage vectors. The yield was about 10 mg of DNA.

50 Approximately 10⁹ cells were also grown for RNA isolation. Cells were lysed and RNA extracted using guanidinium thiocyanate. RNA yield was about 10 mg and it appeared clean and undegraded on agarose gels. Poly A⁺ RNA was prepared by binding total RNA to oligo dT cellulose. Yield was about 5%, i.e. about 500 µg of poly A⁺ mRNA.

Example 6. Sequencing BMA 031 heavy (H) and light (L) chains by primer extension of mRNA

55 Because of the high abundance of specific mRNA, immunoglobulins can be sequenced by primer extension of total poly A⁺ mRNA: This is also facilitated by their common constant regions which allow synthesis of "universal" primers with which to begin the extension. Subsequent primers can be made as sequence information is gathered. "Universal" H and L chain primers (Light chain "Universal" Primer: 5'TGGATGGTGGGAAGATG³; Heavy chain "Universal" Primer: 5'GGGGGCCAGTGGATAGAC³) were isotopically end labelled with polynucleotide kinase and hybrid-

EP 0 403 156 B1

ized individually to about 7 µg aliquots of BMA 031 poly A⁺ mRNA. The hybridized product was extended using avian reverse transcriptase in the presence of dideoxy nucleoside triphosphates. Reaction products were separated on gradient acrylamide gels and autoradiographed. About 200 nucleotides (NT) of sequence were read from the initial extension. For both H and L chains, two additional primers were synthesized, each 17-18 NT in length, namely

#149 (Light) 5' AGGGACTCCAGAAGCCA^{3'}
#180 (Light) 5' CTGGAGATGCAACATG^{3'}
#179 (Heavy) 5' CTCCATGTAGGCTGTACT^{3'}
#178 (Heavy) 5' CCAGAAGCCTTCAGGA^{3'}

The extension primers as described above generate complete, overlapping sequence (a total of about 440 NT for each gene) specifying the H and L chain variable (V) regions.

The sequences obtained are listed in Table 1A (Heavy) and 1B (Light). Positions of the signal sequence, start of the mature protein, invariant cysteines, complementarity determining regions (CDR), joining region (J), and primers used in sequencing are indicated. These sequences were confirmed by DNA sequencing of isolated lambda clones (see Example 7 below).

Example 7. Construction and Screening of a Genomic Clone library

The general strategy of the library construction is depicted in Figure 1 and Table 2 Parts A and B. Total genomic DNA was partially digested with the restriction enzyme Sau 3A. DNA from the digest in the size range 10-20 Kb was isolated by preparative gel electrophoresis and binding to glass-impregnated paper. The resulting material was ligated with phage "arms" from the lambda vector EMBL-3 (ATCC #37266). Ligated material was packaged into phage particles (cloning efficiency 1 x 10⁶ pfu/µg genomic DNA). Recombinant clones were plated at a density of 10⁵/plate. Replica filter lifts were performed on each plate and the nitrocellulose filter discs were processed for hybridization. These disks were hybridized in duplicate to ³²p-labelled fragment probes derived from the intron between V and C exons of H or L chain (these probes are "universal" Ig probes). Putative positive clones were confirmed and plaque-purified by up to four rounds of rescreening. Rescreening was carried out with radiolabelled, synthesized oligomers (17 - 33 NT) corresponding to hypervariable regions known from Example 6. The approximate relative location of the fragments and oligomers used as probes for screening are indicated in Figure 2.

After exhaustive screening of the library, multiple positive lambda clones were isolated containing BMA 031 H and L chain exons. As listed in Table 2, Part C, of 14 H chain clones initially identified, 4 were true positives; of 27 L chain clones, 7 were real. The genomic sequence of the H and L chains as determined by both Sanger and Maxam-Gilbert sequencing, are listed in Tables 3A and 3B, respectively.

Example 8. Vector construction for expression of chimeric BMA 031

The H chain of chimeric BMA 031 was synthesized by a vector containing the human gamma 1 constant region or a second vector containing the gamma 4 constant region. For the L chain, the vector contained the human kappa constant exon. Each vector also contained an upstream cloning site for the respective BMA V gene, drug selectable markers, and signals necessary to allow replication in bacteria. Restriction maps of these vectors are shown in Figure 3. The V exons of BMA 031 H and L chains were subcloned into the vectors described above.

Example 9. Transfection of chimeric BMA 031 gene into myeloma cells for expression

The chimeric constructs described above were co-transfected into SP2/0 (ATCC #CRL 1581), a non-immunoglobulin-producing murine hybridoma, by electroporation. After a 48 hour expression period, the resultant cells or transfectomas, were placed in media containing both mycophenolic acid (1 µg/ml) and Geneticin (1 mg/ml) (Gibco). Growth of the transfectomas was apparent in about two weeks. The transfection efficiency in double selection was approximately 1 x 10⁻⁵. The proportion of drug-resistant clones secreting antibody was greater than 50% with the level of antibody secretion varying from about 1 µg/ml to about 17 µg/ml.

Example 10. Subcloning of Transfectomas

The BMA 031-G1 and BMA 031-G4 cell lines were subcloned to eliminate genetic heterogeneity that may have arisen since the original transfection. The best subclone of each chimeric transfectoma was isolated and analyzed for antibody production. These final cell lines, BMA031-G1-1 and BMA 031-G4-1, produced antibody at a rate of 7 pg/cell/24 hours for IgG1 and 5 pg/cell/24 hours for IgG4. Saturated cultures accumulate antibody to 35 µg/ml for IgG1 and 15 µg/ml for IgG4.

Example 11. Characterization of chimeric BMA 031

The antibodies, herein referred to as BMA 031-G1 and BMA 031-G4, secreted by BMA 031-G1-1 and BMA 031-G4-1, respectively, were tested to ensure that they were indeed BMA 031 mouse-human chimeric antibodies. Analysis by a series of ELISA assays showed that the antibodies contained human kappa and human gamma constant regions. Moreover, the antibodies did not react with antibodies directed against murine kappa or gamma constant regions. Isotyping reagents also confirmed that the chimeric antibodies were of the IgG1 and IgG4 isotypes.

The purified chimeric antibodies were also shown to be functionally active in an immobilized cell ELISA assay. Both chimeric antibodies bound to PBL-ALL cells in a similar fashion as the original murine BMA 031. Directly labelled chimeric antibodies BMA 031-G1-FITC, and BMA 031-G4-FITC, were used in cytofluorometric assays systems to compare the specificity of these antibodies with murine BMA 031-FITC. A typical reactivity pattern of these antibodies with peripheral blood leukocytes is shown in Table 4. In competitive immunofluorescence assays, preincubation of human lymphocytes with chimeric BMA 031-G1 or BMA 031-G4 blocked binding of murine BMA 031-FITC and vice versa (See Figure 4A-4C). All these data indicate that the specificity of chimeric BMA 031-G1 and BMA 031-G4 is identical to murine BMA 031.

However, the functional properties of chimeric BMA 031-antibodies clearly differ from murine BMA 031 or from CD3-mAbs such as BMA 030. It is well known that most CD3-mAbs (e.g. BMA 030) trigger T-cell proliferation even in low doses but have no mitogenic effect when used in high concentrations (See Figures 5A and 5B). This effect is known as "high dose inhibition".

In contrast to murine BMA 031, both chimeric BMA 031-mAbs are highly effective in triggering T-lymphocyte proliferation as measured in a 3 day or 6 day thymidine incorporation assay without showing any evidence of high dose inhibition effects even in much higher dose ranges. Two representative experiments are shown in Figures 5A and 5B. In such experiments, the height of responsiveness and the optimal concentration for stimulation with BMA 030 or other CD3-mAbs may differ from blood donor to blood donor due to individual differences of the immune status.

As described above (Example 4), in contrast to CD3-mAbs, binding of murine BMA 031 to human T-lymphocytes usually results in the release of only low concentrations of immunomediators. Again, chimeric BMA 031 antibodies differ in this respect from murine BMA 031 as well as from BMA 030 (CD3). In Table 5, a representative experiment is shown, where release of immunomediators is measured by induction of HLA-Dr expression on COLO 205-cells.

It is known from the literature that COLO 205 cells respond with an enhanced expression of HLA-DR antigens after incubation with recombinant immunomediators like gamma-Interferon, Tumor Necrosis Factor or supernatants of activated T-cells which contain such factors. By comparing the enhancement of HLA-DR expression induced by supernatants of activated T-cells with reference values generated by the use of recombinant factors such as gamma-Interferon, the amount of immunomediators in culture supernatants can be determined. The data summarized in Table 5 indicate that the kinetics and the amount of immunomediators released after binding of chimeric BMA 031 antibodies differ from the effects triggered by murine BMA 031 or the CD3-mAb BMA 030.

Since the chimeric BMA 031 antibodies were able to interact efficiently with human Fc receptors in the T cell proliferation assays, there was a strong possibility that they would have high ADCC titers as well. To evaluate the ADCC capacity of these mAbs, they were compared to rabbit anti-GH-1 antiserum selected as the best out of eight rabbit anti-human T cell globulins in ADCC capacity. The data of a representative experiment is shown in Figures 6A-6C. Even at low effector:target cell ratios (Figure 6A) or extremely low antibody concentrations (Figure 6B, 6C), chimeric BMA 031 antibodies are highly potent in killing HPB-ALL cells. In contrast, murine BMA 031 is very poor at ADCC. Accordingly, if cytotoxicity is an important criteria, BMA 031 can be advantageously used conjugated to a cytotoxic moiety.

Example 12. Production of "civilized" BMA 031 AntibodiesDetermination of civilized BMA 031 amino acid sequence

In the past, "humanization" has been associated with chimeric constructions in which murine V regions are expressed with human C regions. To avoid confusion, the term "civilized" is used herein for constructions of "humanized" V regions expressed with human C regions.

To determine the optimal human sequence with which to civilize the murine BMA 031 antibody, the murine BMA 031 amino acid sequence was used to search the NBRF data base for the most homologous human antibody. Since molecular models of antibodies show strong interactions between the heavy and light chains, it was decided to use the heavy and light chains from the same human antibody. The human EU antibody turned out to be the best overall choice. The homology between the BMA 031 and EU FRs (#1-3) was 66% for the H chain and 63% for the L chain. The BMA 031 antibody uses JH3 and Jk5. These are most homologous to human JH4 and Jk4. A first generation civilized BMA 031 antibody would contain BMA 031 CDRs, EU FRs and homologous human J regions. This antibody is referred to as BMA 031-EUCIV1 (Table 6A and 6B).

A refinement to this basic civilized version can advantageously be made in the sequence immediately before and after the CDRs. The CDRs are assigned based on sequence homology data (Kabat et al., 1987). Molecular models of antibodies have shown that the actual CDR loops can contain amino acids up to 4 amino acids away from the "Kabat" CDRs. Therefore, maintaining at least the major amino acid differences (in size or charge) within 4 amino acids of the CDRs as murine may be beneficial. This antibody is referred to as BMA 031-EUCIV2 (Table 6A and 6B). Additionally, all differences within four amino acids of the CDRs could be maintained murine. This antibody has been designated as BMA 031-EUCIV3.

It will be readily recognized that further refinements can be made, but, without complex computer modelling, it is difficult to prioritize their importance. However, a simplified computer model was generated based on sequence homology to other antibodies with solved structures. This model was used to judge proximity of framework amino acids to the CDRs. The results of this analysis are shown in Tables 7A and 7B. These results were used to address the refinements discussed below. For example, several amino acids are either BMA 031 specific or EU specific (ie. different from the consensus sequence within their subgroups). Since these amino acids presumably arose through somatic mutation to enhance their respective activities, it would seem logical to maintain the BMA 031 specific amino acids and change the EU specific amino acids to the human consensus. But this can have potential adverse consequences. Changing an amino acid in one chain may cause changes in the interactions with other amino acids of that chain as well as with amino acids in the other chain. Therefore, extreme caution must be exercised to limit the number of changes. Table 8 outlines these potential changes.

As can be seen, EU differs from the human VH-I subgroup consensus sequence in six positions. Three are within 4 amino acids of the CDRs (#70,95,98), and these are addressed in BMA-EUCIV3. In one position (#93) the human consensus sequence is the same as BMA 031. One could rationalize changing this from EU back to BMA 031, so this change was incorporated into BMA-EUCIV3. For the two remaining positions (#72,74), there is no human consensus. However, the computer model shows that they may be close to the CDRs so it was decided to use the BMA 031 amino acids in BMA-EUCIV4. The light chain had five EU specific amino acids. One is within 4 amino acids of the CDRs (#48) and is maintained as BMA 031 in BMA-EUCIV3. In two positions (#63,81) the human consensus is the same as BMA 031 and therefore could be maintained as BMA 031. These changes were made in BMA-EUCIV4. The other two positions (#10,70) are open to debate. The computer model identified position #70 as being potentially important so this change was made in BMA-EUCIV4. Amino acid #10 was kept as EU. There are eight BMA 031 specific amino acids in the H chain. In two positions (#7,82) the BMA 031 sequence is the same as EU. Position #72 was addressed above. His₉₄ is unique to BMA 031 and very close to CDR3; it was decided to incorporate this change into BMA-EUCIV3. Of the remaining four positions (#1,9,20,40), only #40 is close to the CDRs so this change was made in BMA-EUCIV4. The others were maintained EU. There are no BMA 031 specific amino acids in the L chain. The sequence is identical to the subgroup VI consensus.

The final sequence of BMA-EUCIV4 was determined based on the preliminary computer model. For the heavy chain, two additional positions appear to be close to the CDRs, #77 and #87, and these were changed to the BMA 031 amino acids. For the light chain, two positions (#21,60) appeared to be removed from the CDRs; we decided to use the EU amino acids in this variant. Five additional positions (#1,3,4,42,71,100) were judged to be close enough to the CDRs for interaction, so they were changed to the BMA 031 amino acids.

Synthesis and expression of civilized BMA 031 antibodies

The light and heavy chain variable region exons encoding the civilized antibodies were synthesized and replaced into the previously isolated genomic fragments of BMA 031. These fragments were inserted into mammalian expression vectors containing the human kappa and gamma 1 constant region exons. The civilized genes were transfected into Sp2/0 hybridoma cells by electroporation and transfectomas secreting civilized BMA 031 were isolated. Secretion levels varied up to 7 pg/cell/24 hr.

The BMA-EUCIV1 and BMA-EUCIV2 antibodies were unable to bind to T cells. In contrast, BMA-EUCIV3 bound specifically to T cells and competed effectively with both the murine BMA 031 antibody and the previously constructed chimeric BMA 031-G1 antibody for binding to these cells (Figure 7).

Framework amino acids important for antigen binding

The T cell binding data with the civilized BMA 031 antibodies show the importance of framework amino acids in antigen binding. Inclusion of only the BMA 031 CDRs (BMA-EUCIV1) was not sufficient to maintain affinity for antigen. Twelve amino acid substitutions were made in the heavy chain V region to regain binding affinity (#27,28,30,38,48,67,68,70,93,94,95,98). Of these, six may be more important (#38,48,70,93,94,95) since they represent changes from BMA-EUCIV2, which does not bind well, to BMA-EUCIV3, which does bind well. Similarly, for the light chain V region, five amino acid substitutions were made (#21,46,47,48,60). Of these, three (#21,47,48) were made from BMA-EUCIV2 to BMA-EUCIV3 and thus may be more important.

5
10
15
20
25
30
35
40
45
50
55

TABLE 1A

5 BMA-031 mRNA HEAVY CHAIN VARIABLE REGION SEQUENCE

10 CACTACTCTAACATGGAATGGAGTTGGATATTTCTCTTCTCCTGTCAGG
M E W S W I F L F L L S G
|-----Signal

15 AACTGCAGGTGTCCACTCTGAGGTCCAGCTGCAGCAGTCTGGACCTGAGC
T A G V H S E V Q L Q Q S G P E L
Sequence-----| 1

20 TGTTAAAGCCTGGGGCTTCAGTGAAGATGTCTGCAAGGCTTCTGGATAT
Primer #178
V K P G A S V K M S C K A S G Y
22

25 AAATTCACTAGCTATGTTATGCACTGGGTGAAGCAGAAGCCTGGGCAGGG
K F T S Y V M H W V K Q K P G Q G
|----CDR 1----|

30 CCTTGAGTGGATTGGATATATTAATCCTTACAATGATGTTACTAAGTACA
L E W I G Y I N P Y N D V T K Y N
|-----CDR 2-----

35 ATGAGAAGTTCAAAGGCAAGGCCACACTGACTTCAGACAAATCCTCCAGT
E K F K G K A T L T S D K S S S
-----|

40 Primer #179
ACAGCCTACATGGAGCTCAGCAGCCTGACCTCTGAGGACTCTGCGGTCCA
T A Y M E L S S L T S E D S A V H

45 TTACTGTGCAAGAGGGAGCTACTATGATTACGACGGGTTTGTTTACTGGG
Y C A R G S Y Y D Y D G F V Y W G
92 |-----DSP2.2-----CDR 3-----|

50 GCCAAGGACTCTGGTCACTGTCTCTGCAGCCAAAACAACACCC.....
Q G T L V T V S A A K T T P
JH3 |-----Constant

55 CH Primer
...GTCTATCCACTGGCCCC...
Region-----

TABLE 1B

BMA 031 mRNA Light Chain Variable Region Sequence

5

10

TTAGCTAGGGTCCAAAATTCAAAGACAAAATGGATTTTCAAGTGCAGATT
M D F Q V Q I
|-----Signal

15

TTCAGCTTCTGCTAATCAGTGCCTCAGTCATAATATCCAGAGGACAAAT
F S F L L I S A S V I I S R G Q I
Sequence-----| 1

20

Primer #180
TGTTCTACCCAGTCTCCAGCAATCATGTCTGCATCTCCAGGGGAGAAGG
V L T Q S P A I M S A S P G E K V

25

TCACCATGACCTGCAGTGCACCTCAAGTGTAAAGTTACATGCACTGGTAC
T M T C S A T S S V S Y M H W Y
23|-----CDR 1-----|

30

CAGCAGAAGTCAGGCACCTCCCCAAAAGATGGATTTATGACACATCCAA
Q Q K S G T S P K R W I Y D T S K
|-----CDR 2

35

Primer #149
ACTGGCTTCTGGAGTCCCTGCTCGCTTTCAGTGGCAGTGGGTCTGGGACCT
L A S G V P A R F S G S G S G T S
-----|

40

CTTACTCTCTCACAATCAGCAGCATGGAGGCTGAAGATGCTGCCACTTAT
Y S L T I S S M E A E D A A T Y
TACTGCCAGCAGTGGAGTAGTAACCCGCTCACGTTCCGGTGTGGGACCAA
Y C Q Q W S S N P L T F G A G T K
88|-----CDR 3-----| JK5

45

GCTGGAGCTGAAACGGGCTGATGCTGCACCAACTTG.....
L E L K R A D A A P T
|-----Constant

50

CL Primer
.....CATCTTCCCACCATCCA.....
Region-----

55

TABLE 2

5
A. Construction of BAM 031 Genomic Library

10
Packaging Efficiency
(phage/ μ g DNA)

15	γ DNA	3.6×10^8
	Ligated arms alone	4.0×10^1
	Ligated arms + control insert	6.8×10^6
20	Ligated arms + BMA 031 DNA	1.5×10^6

25
B. Calculated for a Statistically Complete Library

30
$$N = \frac{\ln(1 - P)}{\ln(1 - F)}$$

N = number clones

P = desired probability

35
F = fractional proportion
of genome in a single
clone

40
To achieve a 99% probability of having a particular DNA sequence
represented in a library of 15 Kb fragments of a mammalian genome
(3×10^9 bp), the library must contain 9.2×10^5 clones.

45
C. Screening of the BMA 031 Genomic Library (2×10^6 Phage)

50	Intron Probe		V-region Probe		
	Heavy	Light	Heavy	Light	
	Master	14	27	N.D.	N.D.
	2°	12	20	N.D.	N.D.
	3°	10	19	4	7
55	4°	4	7	4	7

TABLE 3A

BMA 031 Heavy Chain Genomic Sequence

5
10 AAGCTTATCTGTAATCAACATGCTAACATATCCCAGAATAGAGCAACAG
-----+-----+-----+-----+----- 50
TTCGAATAGACATTTAGTGTACCATTGTATAGGGTCTTATCTCGTTGTC
15 ACTAAGGCCAAATATCAACTGAGAGATTTGTCCCTGTAGTTACAACCATA
-----+-----+-----+-----+----- 100
TGATTCCGGTTTATAGTTGACTCTCTAAACAGGGACATCAATGTTGGTAT
20 TCAGCAGTTCAGGACTCATAGAAAGTGTATTGGATGCATTCCTGAGAGA
-----+-----+-----+-----+----- 150
AGTCGTCAAGTCTGAGTATCTTTCACATAACCTACGTAAAGGACTCTCT
25 GGAATTGAATTTAGACTTAACTTCCCTGATGCCTCACCTGTGTCTTTT
-----+-----+-----+-----+----- 200
CCTTAACTTAAATCTGAAATTGAAGGACTACGGAGTGGACACACAGAAAA
30 CAGTCCTTCTCTCCAGTCTTCTCCAGCTGGACTAGGTTCTTATGTAAG
-----+-----+-----+-----+----- 250
GTCAGGAAGGAGAGGTCAAGAAGAGGTCGACCTGATCCAAGAATACATT
35 AAGTCCCCTGCTCATCATTATGCAAATTACCTGAGTCTATGGTGATTAAA
-----+-----+-----+-----+----- 300
TTCAGGGGACGAGTAGTAATACGTTTAAATGGACTCAGATACCACTAATT
40 ACAGGGATGCCACCCCTTTAAATCAACCGACGATCAGTGTCTCTCCA
-----+-----+-----+-----+----- 350
TGTCCCTACAGGTGTGGGAAATTAGTTGGCTGCTAGTCACAGGAGAGGT
45 AAGTCCCTGAACACACTGACTCTAACCATGGAATGGAGTTGGATATTCT
-----+-----+-----+-----+----- 400
TTCAGGGACTTGTGTGACTGAGATTGGTACCTTACCTCAACCTATAAAGA
M E W S W I F L
|-----Signal
50 CTTTCTCCTGTCAGGAACTGCAGGTAAGGGGCTCACCAGTTCAAAATCTG
-----+-----+-----+-----+----- 450
GAAAGAGGACAGTCTTGTGACGTCATTCCCGAGTGGTCAAGTTTTAGAC
F L L S G T A
55 Sequence-----

EP 0 403 156 B1

AAGTGGAGACAGGACCTGAGGTGACAAATGACATCTACTCTGACATTCTCT
-----+-----+-----+-----+-----+-----+-----+-----+-----+-----+
TTCACCTCTGTCCTGGACTCCACTGTTACTGTAGATGAGACTGTAAGAGA 500

5

CCTCAGGTGTCCACTCTGAGGTCCAGCTGCAGCAGTCTGGACCTGAGCTG
-----+-----+-----+-----+-----+-----+-----+-----+-----+-----+
GGAGTCCACAGGTGAGACTCCAGGTCGACGTCGTGACACTGGACTCGAC 550
G V H S E V Q L Q Q S G P E L
-----| 1

10

GTAAGCCTGGGGCTTCAGTGAAGATGTCTGCAAGGCTTCTGGATATAA
-----+-----+-----+-----+-----+-----+-----+-----+-----+-----+
CATTTCGGACCCGGAAGTCACTTCTACAGGACGTTCCGAAGACCTATATT 600
V K P G A S V K N S C K A S G Y K

15

ATCACTAGCTATGTTATGCACTGGGTGAAGCAGAAGCCTGGGCAGGGCC
-----+-----+-----+-----+-----+-----+-----+-----+-----+-----+
TAAGTGATCGATAACAATACGTGACCCACTTCGTCTTCGGACCCGTCGCGG 650
F T S Y V M H W V K Q K P G Q G L
|----CDR 1----|

20

TTGAGTGGATTGGATATATTAACTCTTACAATGATGTTACTAAGTACAAT
-----+-----+-----+-----+-----+-----+-----+-----+-----+-----+
AACTCACCTAACCTATATAATTAGGAATGTTACTACAATGATTCATGTTA 700
B W I G Y I N P Y N D V T K Y N
|-----CDR 2-----|

25

GAGAAGTTCAAAGGCAAGGCCACTGACTTCAGACAAATCCTCCAGTAC
-----+-----+-----+-----+-----+-----+-----+-----+-----+-----+
CTCTTCAAGTTCCGTTCCGGTGTGACTGAAGTCTGTTTAGGAGGTCATG 750
E K F K G K A T L T S D K S S S T
-----|

35

AGCCTACATGGAGCTCAGCAGCCTGACCTCTGAGGACTCTGCGGTCCATT
-----+-----+-----+-----+-----+-----+-----+-----+-----+-----+
TCGGATGTACCTCGAGTCGTGCGACTGGAGACTCCTGAGACGCCAGGTAA 800
A Y M E L S S L T S E D S A V H Y

40

ACTGTGCAAGAGGGAGCTACTATGATTACGACGGGTTTGTGTTACTGGGGC
-----+-----+-----+-----+-----+-----+-----+-----+-----+-----+
TGACAGTTCTCCCTCGATGATACTAATGCTGCCAAACAAATGACCCCG 850
C A R G S Y Y D Y D G F V Y W G
|-----CDR 3-----|

45

CAAGGACTCTGGTCACTGTCTCTGACGGTGGAGTCTTAACTTCTCCATT
-----+-----+-----+-----+-----+-----+-----+-----+-----+-----+
GTTCCCTGAGACCAGTGACAGAGACGTCCAACCTCAGGATTGAAGAGGGTAA 900
Q G T L V T V S A

50

55

JH3

5 CTAAATGCATGTTGGGGGATTCTGAGCCTTCAGGACCAAGATTCTCTGC
-----+-----+-----+-----+-----+ 950
GATTTACGTACAACCCCTAAGACTCGGAAGTCCTGGTTCTAAGAGACG

10 AAACGGGAATCAAGATTCAACCCCTTGTCCCAAAGTTGAGACATGGGTC
-----+-----+-----+-----+-----+ 1000
TTTGCCCTTAGTTCTAAGTTGGGAAACAGGGTTTCAACTCTGTACCCAG

15 TGGGTCAGGGACTCTCTGCCTGCTGGTCTGTGGTGACATTAGAAGTGAAG
-----+-----+-----+-----+-----+ 1050
ACCCAGTCCCTGAGAGACGGACGACCAGACCACTGTAATCTTGACTTC

20 TATGATGAAGGATCTGCCAGAACTGAAGCTTGAAGTCTGAGGCAGAATCT
-----+-----+-----+-----+-----+ 1100
ATACTACTTCTAGACGGTCTTGACTTCGAACTTCAGACTCCGTTCTAGA

25 TGTCCAGGGTCTATCGGACTCTTGTGAGAATTAGGGGCTGACAGTTGATG
-----+-----+-----+-----+-----+ 1150
ACAGGTCCAGATAGCCTGAGAACACTCTTAATCCCGACTGTCAACTAC

30 GTGACAATTTCAGGGTCAGTGACTGTCAGGTTTCTCTGAGGTGAGGCTGG
-----+-----+-----+-----+-----+ 1200
CACTGTTAAAGTCCCAGTCACTGACAGTCCAAGAGACTCCACTCCGACC

35 AATATAGGTCACCTTGAAGACTAAAGAGGGGTCCAGGGGCTTTTCTGCAC
-----+-----+-----+-----+-----+ 1250
TTATATCCAGTGGAATCTGATTCTCCCAGGTCCCCGAAAAGACGTG

40 AGGCAGGGAACAGAATGTGGAACAATGACTTGAATGGTTGATTCTTGTGT
-----+-----+-----+-----+-----+ 1300
TCCGTCCCTTGTCTTACACCTTGTACTGAACTTACCAACTAAGAACACA

45 GACACCAAGAATTGGCATAATGTCTGAGTTGCCAAGGGTGATCTTAGCT
-----+-----+-----+-----+-----+ 1350
CTGTGGTCTTAACCGTATTACAGACTCAACGGGTTCCCACTAGAATCGA

50 AGACTCTGGGGTTTTTGTCCGGTACAGAGGAAAAACCCACTATTGTGATT
-----+-----+-----+-----+-----+ 1400
TCTGAGACCCAAAAACAGCCCATGTCTCCTTTTGGGTGATAACACTAA

55 ACTATGCTATGGACTACTGGGGTCAAGGAACCTCAGTCACCGTCTCCTCA
-----+-----+-----+-----+-----+ 1450
TGATACGATACCTGATGACCCAGTTCCTTGGAGTCAGTGGCAGAGGAGT

5 GGTAAAGATGGCCTCTCCAGGTCTTTATTTTAACTTTGTTATGGAGTT
 -----+-----+-----+-----+-----+ 1500
 CCATTCTTACCGGAGAGGTCCAGAAATAAAAATTGGAAACAATACCTCAA

 10 TTCTGAGCATTGCAGACTAATCTTGGATATTTGCCCTGAGGGAGCCGGCT
 -----+-----+-----+-----+-----+ 1550
 AAGACTCGTAACTCTGATTAGAACCTATAAACGGGACTCCCTCGGCCGA

 15 GAGAGAAGTTGGGAAATAAATCTGTCTAGGGATCTCAGAGCCTTTAGGAC
 -----+-----+-----+-----+-----+ 1600
 CTCTCTTCAACCCTTTATTTAGACAGATCCCTAGAGTCTCGGAAATCCTG

 20 AGATTATCTCCACATCTTTGAAAACTAAGAATCTGTGTGATGGTGTGG
 -----+-----+-----+-----+-----+ 1650
 TCTAATAGAGGTGTAGAACTTTTTGATTCTTAGACACACTACCACAACC

 25 TGGAGTCCCTGGATGATGGGATAGGGACTTTGGAGGCTCATTGAGGGAG
 -----+-----+-----+-----+-----+ 1700
 ACCTCAGGGACCTACTACCCTATCCCTGAAACCTCCGAGTAAACTCCCTC

 30 ATGCTAAAACAATCCTATGGCTGGAGGGATAGTTGGGGCTGTAGTTGGAG
 -----+-----+-----+-----+-----+ 1750
 TACGATTTTGTAGGATACCGACCTCCCTATCAACCCGACATCAACCTC

 35 ATTTTCAGTTTTTAGAATGAAGTATTAGCTGCAACTTCAAGGACCACC
 -----+-----+-----+-----+-----+ 1800
 TAAAAGTCAAAAATCTTACTTCATAATCGACGTTATGAAGTTCTGGTGG

 40 TCTGTGACAACCATTTTATACAGTATCCAGGCATAGGGACAAAAAGTGGGA
 -----+-----+-----+-----+-----+ 1850
 AGACACTGTTGGTAAAATATGTCATAGGTCCGTATCCCTGTTTTTACCT

 45 GTGGGGCACTTTCITTTAGATTTGTGAGGAATGTTCCACACTAGATTGTTT
 -----+-----+-----+-----+-----+ 1900
 CACCCCGTAAAGAAATCTAAACACTCCTTACAAGGTGTGATCTAACAAA

 50 AAAACTTCATTGTTGGAAGGAGCTGTCTTAGTGATTGAGTCAAGGGAGA
 -----+-----+-----+-----+-----+ 1950
 TTTTGAAGTAAACAACCTTCCGACAGAATCACTAACTCAGTTCCTCT

 55 AAGGCATCTAGCCTCGGTCTCAAAGGGTAGTTGCTGTCTAGAGAGGTCT
 -----+-----+-----+-----+-----+ 2000
 TTCCGTAGATCGGAGCCAGAGTTTTCCCATCAACGACAGATCTCTCCAGA

5 GGTGGAGCCTGCAAAAGTCCAGCTTTCAAAGGAACACAGAAGTATGTGTA 2050
 -----+-----+-----+-----+-----+
 CCACCTCGGACGTTTTTCAGGTCGAAAGTTTCCTTGTGTCTTCATACACAT

 10 TGGAATATTAGAAGATGTTGCTTTTACTCTTAAGTTGGTTCCTAGGAAAA 2100
 -----+-----+-----+-----+-----+
 ACCTTATAATCTTCTACAACGAAAATGAGAATTCACCAAGGATCCTTTT

 15 ATAGTTAAATACTGTGACTTTAAAATGTGAGAGGGTTTTCAAGTACTCAT 2150
 -----+-----+-----+-----+-----+
 TATCAATTTATGACACTGAAATTTTACACTCTCCCAAAGTTCATGAGTA

 20 TTTTTAAATGTCCAAAATTTTGTCAATCAATTTGAGGTCTTGTGTTGTG 2200
 -----+-----+-----+-----+-----+
 AAAAAATTTACAGGTTTTAAAAACAGTTAGTTAAACTCCAGAACAAACAC

 25 TAGAACTGACATTACTTAAAGTTTAAACCGAGGAATGGGAGTGAGGCTCTC 2250
 -----+-----+-----+-----+-----+
 ATCTTGACTGTAATGAATTTCAAATTGGCTCCTTACCCTCACTCCGAGAG

 30 TCATACCCTATTCAGAACTGACTTTTAAACAATAATAAATTAAGTTTAAAA 2300
 -----+-----+-----+-----+-----+
 AGTATGGGATAAGTCTTGACIGAAAATGTTATTATTTAATTCAAAATTT

 35 TATTTTTAAATGAATTGAGCAATGTTGAGTTGAGTCAAGATGGCCGATCA 2350
 -----+-----+-----+-----+-----+
 ATAAAAATTTACTTAACTCGTTACAACCAACTCAGTTCACCGGCTAGT

 40 GAACCGGAACACCTGCAGCAGCTGGCAGGAAGCAGGTCATGTGGCAAGGC 2400
 -----+-----+-----+-----+-----+
 CTTGGCCTTGTGGACGTCGTCGACCGTCCTTCGTCCAGTACACCGTTCCG

 45 TATTTGGGAAGGGAAAATAAAACCACTAGGTAAACTTGTAGCTGTGGTT 2450
 -----+-----+-----+-----+-----+
 ATAAACCCCTTCCCTTTTATTTGGTGATCCATTGAACATCGACACCAA

 50 TGAAGAAGTGGTTTTTGAACACTCTGTCCAGCCCCAACCAACCGAAAGTC 2500
 -----+-----+-----+-----+-----+
 ACTTCTTCACCAAAACTTTGTGAGACAGGTCGGGGTGGTTTGGCTTTCAG

 55 CAGGCTGAGCAAAACACCACCTGGGTAATTTGCATTTCTAAAATAAGTTG 2550
 -----+-----+-----+-----+-----+
 GTCCGACTCGTTTTGTGGTGGACCCATTAAACGTAAGATTTTATTCAAC

EP 0 403 156 B1

5
AGGATTCAGCCGAAACTGGAGAGGTCTCTTTTAACTTATTGAGTTCAAC 2600
-----+-----+-----+-----+-----+
TCCTAAGTCGGCTTTGACCTCTCCAGGAGAAAATTGAATAACTCAAGTTG

10
CTTTAATTTTAGCTTGAGTAGTTCTAGTTCCCAAACCTAAGTTTATC 2650
-----+-----+-----+-----+-----+
GAAAATAAAATCGAACTCATCAAGATCAAAGGGGTTTGAATTCAAATAG

15
GACTTCTAAAATGTATTTAGAATC 2675
-----+-----+-----
CTGAAGATTTTACATAAATCTTAAG

20

25

30

35

40

45

50

55

TABLE 3B

BMA 031 Light Chain Genomic Sequence

5

10 AAAGTATTATTTGAAATGGCTCTCGAAATCTCTCAAGGTAATAAATCGAA
 -----+-----+-----+-----+-----+ 50
 TTTCATAATAAACTTTACCGAGAGCTTTAGAGAGTTCATTATTTAGCTT

15 CATGAATTACACAGTTTCAGGGCACATGAAATACTGAGAATGGAGATTGT
 -----+-----+-----+-----+-----+ 100
 GTACTTAATGTGTCAAAGTCCCGTGTACTTTATGACTCTACCTCTAACA

20 TCAGAGTAGTTTTAGATGAGTGCATCTTCATGAATCTCCAGCCCATATTC
 -----+-----+-----+-----+-----+ 150
 AGTCTCATCAAATCTACTCACGTAGAAGTACTTAGAGGTCGGGTATAAG

25 TCCCATGTGTTTATAAGCCAAGAAGTACTAGACTGTATCTTGCTATTTG
 -----+-----+-----+-----+-----+ 200
 AGGGTACACAAATATTCGGTTCTTGACTGATCTGACATAGAACGATAAAC

30 CATATTACATTTTCAGTAACCACAAATATCTCTCAGTTGGTTTAAAGCAA
 -----+-----+-----+-----+-----+ 250
 GTATAATGTAAAAGTCATTGGTGTATAGAGAGTCAACCAAATTCGTT

35 AGTACTTATGAGAATAGCAGTAATTAGCTAGGGACCAAAATTCAAAGACA
 -----+-----+-----+-----+-----+ 300
 TCATGAATACTCTTATCGTCATTAATCGATCCCTGGTTTTAAGTTTCTGT

40 AAATGGATTTTCAAGTGCAGATTTTCAGCTTCTGCTAATCAGTGCCTCA
 -----+-----+-----+-----+-----+ 350
 TTTACCTAAAAGTTCACGTCTAAAAGTCAAGGACGATTAGTCACGGAGT
 M D F Q V Q I F S F L L I S A S
 |-----Signal Sequence-----

45

50 GGTAACAGAGGGCAGGGAATTTGAGATCAGAATACAACCAAAATTTTTT
 -----+-----+-----+-----+-----+ 400
 CCATTGTCTCCCGTCCCTTAAACTCTAGTCTTATGTTGGTTTTAATAAAA

55 CCCTGGGAATTTGTGTCCAAAATACAGTTTTTTCTTTTCTTTTATCTA
 -----+-----+-----+-----+-----+ 450
 GGGACCCCTTAAACACAGTTTTTATGTCAAAAAGAAAAAGAAAATAGAT

EP 0 403 156 B1

5 AATGTTGGGTGGTATAAAATTATTTTTATCTCTATTCTACTAATCCCT
 -----+-----+-----+-----+-----+-----+-----+-----+-----+-----+
 TTACAACCCACCATATTTTAATAAAAAATAGAGATAAAGATGATTAGGGA .500

 10 CTCTCTTTTTTGCTTTTTTCTAGTCATAATATCCAGAGGACAAATTGTT
 -----+-----+-----+-----+-----+-----+-----+-----+-----+-----+
 GAGAGAAAAACGAAAAAGATCAGTATTATAGGTCTCCTGTTAACAAG .550
 V I I S R G Q I V L
 -----| 1

 15 TCACCCAGTCTCCAGCAATCATGTCGTCATCTCCAGGGGAGAAGGTCAAC
 -----+-----+-----+-----+-----+-----+-----+-----+-----+-----+
 AGTGGGTCAGAGGTCGTTAGTACAGACGTAGAGGTCCCCTCTCCAGTGG .600
 T Q S P A I M S A S P G E K V T

 20 ATGACCTGCAGTGCCACCTCAAGTGAAGTTACATGCACTGGTACCAGCA
 -----+-----+-----+-----+-----+-----+-----+-----+-----+-----+
 TACTGGACGTCACGGTGGAGTTCACATTCAATGTACGTGACCATGGTCGT .650
 M T C S A T S S V S Y M H W Y Q Q
 |-----CDR 1-----|

 25
 30 GAAGTCAGGCACCTCCCCAAAAGATGGATTTATGACACATCCAACTGG
 -----+-----+-----+-----+-----+-----+-----+-----+-----+-----+
 CTTCACTCCGTCAGGGGGTTTTCTACCTAAATACTGTGTAGGTTTGACC .700
 K S G T S P K R W I Y D T S K L A
 |-----CDR 2-----|

 35 CTCTGGAGTCCCTGCTCGCTCAGTGGCAGTGGGTCGGGACCTCTTAC
 -----+-----+-----+-----+-----+-----+-----+-----+-----+-----+
 GAAGACCTCAGGACGAGCGAAGTCACCGTCACCCAGACCCTGGAGAATG .750
 S G V P A R F S G S G S G T S Y
 ---|

 40 TCTCTACAATCAGCAGCATGGAGGCTGAAGATGCTGCCACTTATTACTG
 -----+-----+-----+-----+-----+-----+-----+-----+-----+-----+
 AGAGAGTGTAGTCGTCGTACCTCCGACTTCTACGACGGTGAATAATGAC .800
 S L T I S S M E A E D A A T Y Y C

 45
 50 CCAGCAGTGGAGTAGTAACCCGCTCACGTTCCGGTGGTGGACCAAGCTGG
 -----+-----+-----+-----+-----+-----+-----+-----+-----+-----+
 GGTGTCACCTCATATTGGGCGAGTGAAGCCACGACCCTGGTTCGACC .850
 Q Q W S S N P L T F G A G T K L E
 |-----CDR 3-----| JK5

 55 AGCTGAAACGTAAGTACACTTTTCTCATCTTTTTTATGTGTAAGACACA
 -----+-----+-----+-----+-----+-----+-----+-----+-----+-----+
 TCGACTTGCATTTCATGTGAAAAGAGTAGAAAAAATACACATTCTGTGT .900
 L K

5 GGTTTTCATGTTAGGAGTTAAAGTCAGTTCAGAAAATCTTGAGAAAATGG 950
 -----+-----+-----+-----+-----+
 CCAAAAGTACAATCCTCAATTCAGTCAAGTCTTTTAGAACTCTTTTACC

10 AGAGGGCTCATTATCAGTTGACGTGGCATAACAGTGTGAGATTTTCTGTTT 1000
 -----+-----+-----+-----+-----+
 TCTCCCGAGTAATAGTCAACTGCACCGTATGTCACAGTCTAAAAGACAAA

15 ATCAAGCTAGTGAGATTAGGGGCAAAAAGAGGCTTTAGTTGAGAGGAAAG 1050
 -----+-----+-----+-----+-----+
 TAGTTCGATCACTCTAATCCCCGTTTTTCTCCGAAATCAACTCTCCTTTC

20 TAATTAATACTATGGTCACCATCCAAGAGATTGGATCGGAGAATAAGCAT 1100
 -----+-----+-----+-----+-----+
 ATTAATTATGATACCAGTGGTAGGTTCTCTAACCTAGCCTCTTATTTCGTA

25 GAGTAGTTATTGAGATCTGGGTCTGACTGCAGGTAGCGTGGTCTTCTAGA 1150
 -----+-----+-----+-----+-----+
 CTCATCAATAACTCTAGACCCAGACTGACGTCCATCGCACCAGAAGATCT

30 CGTTTAAGTGGGAGATTGGAGGGGATGAGGAATGAAGGAACTTCAGGAT 1200
 -----+-----+-----+-----+-----+
 GCAAATTCACCCTCTAAACCTCCCCTACTCCTTACTTCCTTGAAGTCTTA

35 AGAAAAGGGCTGAAGTCAAGTTCAGCTCCTAAAATGGATGTGGGAGCAAA 1250
 -----+-----+-----+-----+-----+
 TCTTTTCCCGACTTCAGTTCAGTTCGAGGATTTTACCTACACCCTCGTTT

40 CTTTGAAGATAAACTGAATGACCCAGAGGATGAAACAGCGCAGATCAAAG 1300
 -----+-----+-----+-----+-----+
 GAAACTTCTATTGACTTACTGGGTCTCCTACTTTGTGCGGTCTAGTTTC

45 AGGGGCCTAGAGCTCTGAGAAGAGAAGGAGACTCATCCGTGTTGAGTTTC 1350
 -----+-----+-----+-----+-----+
 TCCCCGGATCTCGAGACTCTTCTTTCTTCTGAGTAGGCACAACTCAAAG

50 CACAAGTACTGTCTTGAGTTTTGCAATAAAAAGTGGGATAGCAGAGTTGAG 1400
 -----+-----+-----+-----+-----+
 GTGTTTATGACAGAACTCAAAACGTTATTTTACCCTATCGTCTCAACTC

55 TGTNAGCCGIAGRSTAWRYTCTTTTTGTCTCCTAAGATTTTTATGACTA 1450
 -----+-----+-----+-----+-----+
 ACANTCGGCATCYSATWYRAGAGAAAACAGAGGATTCTAAAATACTGAT

5
 CAAAAATCAGTAGTATGTCCTGAAATAATCATTAAAGCTGTTTGAAAGTAT
 -----+-----+-----+-----+-----+ 1500
 GTTTTTAGTCATCATACAGGACTTTATTAGTAATTCGACAAACTTTCATA

10
 GACTGCTTGCCATGTAGATACCATGGCTTGCTGAATRATCAGAAGAGGTG
 -----+-----+-----+-----+ 1550
 CTGACGAAACGGTACATCTATGGTACCGAACGACTTAYTAGTCTTCTCCAC

15
 TGRCTCTTATTCTAAAATTTGTCACAAAATGTCAAAATGAGAGACTCTGT
 -----+-----+-----+-----+ 1600
 ACYGAGAATAAGATTTTAAACAGTGTTTTACAGTTTACTCTCTGAGACA

20
 AGGRACGAGTCCCTTGACAGACAGCTSMAAGGGGTTTTTTTCCTTTGTCT
 -----+-----+-----+-----+ 1650
 TCCYTGCTCAGGGAACGTCTGTGASKTCCCCAAAAAAGGAAACAGA

25
 CATTTCTACATGAAAGTAAATTTGAAATGATCNTTTTTTATTATAAGAGT
 -----+-----+-----+-----+ 1700
 GTAAAGATGTACTTTCATTTAAACTTTACTAGNAAAAATAATATTCTCA

30
 AGAAATACAGTTGGGTTTGAACATATATGTTTTAATNGGCCNCACGGTTTT
 -----+-----+-----+-----+ 1750
 TCTTTATGTCAACCCAAACTTGATATACAAAATTANCCGGNGTGCCAAAA

35
 GTAAGACATTTGGTCCTTTGTTTTCCAGTTATTACTCGATTGTAATTTT
 -----+-----+-----+-----+ 1800
 CATTCTGTAAACCAGGAAACAAAAGGGTCAATAATGAGCTAACATTAAAA

40
 ATATCGCCAGCAATGGWCTGAAACGGTCNNNNNCGCAACCTCTTCGTTA
 -----+-----+-----+-----+ 1850
 TATAGCGGTCGTTACCCGACTTTGCCAGNNNNNGCGTTGGAGAAGCAAAT

45
 CTAACGGGTGACCTYGCCTGTGCCAGCCATTTGGCGTTCACCCTGCC
 -----+-----+-----+-----+ 1900
 GATTGACCCACTGGARCGCCGACCGTTCGGTAAACCGCAAGTGGGACGG

50
 GCTAAGGGCCNATGWGAACCCCGCGGTAGCATCCCTTGCTCCGCGTGGA
 -----+-----+-----+-----+ 1950
 CGATTCCCGNTACWCTTGGGGCGCCATCGTAGGGAACGAGGCGCACCT

55
 CCACTTTCCTGAGGACACAGTGATAGGAACAGAGCCACTAATCTGAAGAG
 -----+-----+-----+-----+ 2000
 GGTGAAAGGACTCCTGTGTCACATCCTTGTCTCGGTGATTAGACTTCTC

5
 AACAGAGATGTGACAGACTACACTAATGTGAGAAAAACAAGGAAAGGGTG 2050
 -----+-----+-----+-----+-----+
 TTGTCTCTACACTGTCTGATGTGATTACACTCTTTTTGTTCCCTTCCAC
 10
 ACTTATGGAGATTTTCAGAAATAAAATGCATTTATTATTATATCCCTTA 2100
 -----+-----+-----+-----+-----+
 TGAATAACCTCTAAAGTCTTTATTTACGTAAATAATAATAAGGGAAT
 15
 TTTTAATTTTCTATTAGGAATTAGAAAGGCATAAACTGCTTTATCCAG 2150
 -----+-----+-----+-----+-----+
 AAAATTTAAAGATAATCCCTTAATCTTTCCCGTATTGACGAAATAGGTC
 20
 TGTTATATTTAAAGCTTAA 2169
 -----+-----
 ACAATATAATTTTCGAAT

TABLE 4

25

Reactivity Pattern of Chimeric-BMA 031 Antibodies Immunofluorescence Assay with Directly Labelled Antibodies				
Cells Labelled with	Lymphocytes	Monocytes	Granulocytes	Erythrocytes
Medium	2 ± 2 ^a	5 ± 1	3 ± 2	1 ± 1
BMA 031	69 ± 8	6 ± 3 ^b	2 ± 3 ^b	1 ± 1
BMA 031-G1	69 ± 9	6 ± 2 ^b	2 ± 3 ^b	1 ± 1
BMA 031-G4	69 ± 8	5 ± 3 ^b	2 ± 3 ^b	1 ± 1

30

^a: mean values of 3 blood donors

^b: unspecific binding by Fc-receptors was blocked

35

TABLE 5

40

T-cell Activation by Chimeric BMA 031 Antibodies Induction of γ -Interferon Release				
T-cell activation with		T-cell supernatant		
		d1 ^a	d2	d3
medium		<1 ^b	<1	<1
PHA		7	28	>100
(ng/ml)				
BMA 030	500	1	7	76
(CD 3)	50	10	28	>100
	5	65	30	>100
	0,5	3	29	>100
BMA 031	500	<1	2	76
	50	<1	1	2
	5	<1	<1	<1

55

^a: T-cell supernatant was harvested at day 1 after T-cell activation

^b: γ - Interferon (ng/ml) measured by HLA-Dr induction on Colo 205-cells

EP 0 403 156 B1

TABLE 5 (continued)

T-cell Activation by Chimeric BMA 031 Antibodies Induction of γ -Interferon Release				
T-cell activation with		T-cell supernatant		
		d1 ^a	d2	d3
BMA 031-G1	0,5	<1	<1	<1
	500	2	5	>100
	50	4	28	>100
	5	2	6	>100
BMA 031-G4	0,5	<1	<1	58
	500	6	28	>100
	50	5	70	>100
	5	3	28	>100
	0,5	<1	<1	<1

a: T-cell supernatant was harvested at day 1 after T-cell activation

5
10
15
20
25
30
35
40
45
50
55

TABLE 6A

Amino Acid Sequences of Civilized BMA 031 VH Regions

5						
10		1				50
	EU	QVQLVQSGAE	VKKPGSSVKV	SCKASGGTFS	RSATIIVRQA	PGGGLEWMGG
	BMA	EVQLQQSGPE	LVKPGASVKM	SCKASGYKFT	SYVMHWVKOK	PGGGLEWIGY
	CIV-1	QVQLVQSGAE	VKKPGSSVKV	SCKASGGTFS	SYVMHWVRQA	PGGGLEWMGY
15	CIV-2	QVQLVQSGAE	VKKPGSSVKV	SCKASGYKFT	SYVMHWVRQA	PGGGLEWMGY
	CIV-3	QVQLVQSGAE	VKKPGSSVKV	SCKASGYKFT	SYVMHWVQA	PGGGLEWIGY
	CIV-4	QVQLVQSGAE	VKKPGSSVKV	SCKASGYKFT	SYVMHWVKOK	PGGGLEWIGY
				CDR1/		\
20		51				100
	EU	IVPMFGPPNY	AQKFOGRVTI	TADESTNTAY	MELSSLRSED	TAFYFCAGG.
	BMA	INPYNDVTKY	NEKFKGKATL	TSDKSSSTAY	MELSSLTSED	SAVHYCARGS
	CIV-1	INPYNDVTKY	NEKFKGRVTI	TADESTNTAY	MELSSLRSED	TAFYFCAGGS
	CIV-2	INPYNDVTKY	NEKFKGRATI	TADESTNTAY	MELSSLRSED	TAFYFCARGS
25	CIV-3	INPYNDVTKY	NEKFKGKATL	TADESTNTAY	MELSSLRSED	TAVHYCARGS
	CIV-4	INPYNDVTKY	NEKFKGKATL	TSDKSTSTAY	MELSSLTSED	TAVHYCARGS
		-----CDR-2-----/				\-
30		101				120
	EU	YGIYSPEEY.	.NGGLTVVSS			
	BMA	YYDYDGFVYW	GQGLTVVSA			
	CIV-1	YYDYDGFVYW	GQGLTVVSS			
	CIV-2	YYDYDGFVYW	GQGLTVVSS			
	CIV-3	YYDYDGFVYW	GQGLTVVSS			
35	CIV-4	YYDYDGFVYW	GQGLTVVSS			
		-CDR-3--/				
40						
45						
50						
55						

TABLE 6B

Amino Acid Sequences of Civilized BMA 031 VL Regions

5							
		1				50	
10	EU	DIQMTQSPST	LSASVGDRVT	ITCRASQSIN	TWLAWYQOKP	GKAPKLLMYK	
	BMA	QIVLTQSPAI	MSASPGKVT	MTCSATSSV.	SYMHWYQOKS	GTSPKRWIYD	
	CIV-1	DIQMTQSPST	LSASVGDRVT	ITCSATSSV.	SYMHWYQOKP	GKAPKLLMYD	
	CIV-2	DIQMTQSPST	LSASVGDRVT	ITCSATSSV.	SYMHWYQOKP	GKAPKRLMYD	
15	CIV-3	DIQMTQSPST	LSASVGDRVT	MTCSATSSV.	SYMHWYQOKP	GKAPKRWIYD	
	CIV-4	QIVLTQSPST	LSASVGDRVT	ITCSATSSV.	SYMHWYQOKP	GTAPKRWIYD	
				\--CDR-1--/\		\	
		51				100	
20	EU	ASSLESGVPS	RFIGSGSGTE	FTLTISSLQP	DDFATYYCQ	YNSDSKMFQ	
	BMA	TSKLAGVPA	RFIGSGSGTS	YSLTISSMEA	EDAATYYCQ	WSSNPLTFGA	
	CIV-1	TSKLAGVPS	RFIGSGSGTE	FTLTISSLQP	DDFATYYCQ	WSSNPLTFGG	
	CIV-2	TSKLAGVPA	RFIGSGSGTE	FTLTISSLQP	DDFATYYCQ	WSSNPLTFGG	
	CIV-3	TSKLAGVPA	RFIGSGSGTE	FTLTISSLQP	DDFATYYCQ	WSSNPLTFGG	
25	CIV-4	TSKLAGVPS	RFIGSGSGTS	YTLTISSLQP	EDFATYYCQ	WSSNPLTFGA	
		CDR-2/				\--CDR-3--/\	
		101					
30	EU	GTKVEVK					
	BMA	GTKLELK					
	CIV-1	GTKVEIK					
	CIV-2	GTKVEIK					
	CIV-3	GTKVEIK					
35	CIV-4	GTKVEIK					
40							
45							
50							
55							

TABLE 7A

Comparison of BMA-EUCIVH1 and BMA-031 by Computer Modelling

5

10

15

20

25

```

      10          30          50
BMA-031  EVQLQDSGPELVKPGASVKMSCKASGYKFTSYVMHVVKQKPGQGLEWIGY
          ||| ||| ||| ||| ||| ||| ||| ||| ||| ||| ||| ||| ||| ||| |||
BMA-EUCIVH1 QVQLVDSGAEVKKPGSSVKVSKASGGTFSSYVMHVVRRQAPGQGLEWIMGY
          ||| ||| ||| ||| ||| ||| ||| ||| ||| ||| ||| ||| ||| |||
          \CDR/
          1
          70          90
INPYNDVTKYNEKFKGKATLTSKSSSTAYMELSSLTSEDSAVHYCARGS
          ||| ||| ||| ||| ||| ||| ||| ||| ||| ||| ||| ||| ||| |||
INPYNDVTKYNEKFKGRVTITADESTNTAYMELSSLRSEDTAFYFCAGGS
-----CDR-2-----/
          110
          YYDYDGFVYWGQGLTVTVSA
          ||| ||| ||| ||| ||| ||| ||| ||| ||| ||| ||| ||| ||| |||
          YYDYDGFVYWGQGLTVTVSS
          -CDR-3--/
    
```

Amino Acid Difference	EU Amino Acid	BMA Amino Acid	Proximity to CDRs
1	Gln	Glu	+/-
5	Val	Gln	-
9	Ala	Pro	-
11	Val	Leu	-
12	Lys	Val	-
16	Ser	Ala	-
20	Val	Met	+/-
27	Gly	Tyr	+++
28	Thr	Lys	+++
30	Ser	Thr	+
38	Arg	Lys	+
40	Ala	Lys	+++
48	Met	Ile	+
67	Arg	Lys	+
68	Val	Ala	+
70	Ile	Leu	+
72	Ala	Ser	+++
74	Glu	Lys	+++
76	Thr	Ser	-
77	Asn	Ser	+
87	Arg	Thr	+++
91	Thr	Ser	-
93	Phe	Val	+/-
94	Tyr	His	+++
95	Phe	Tyr	+/-
98	Gly	Arg	+/-
120	Ser	Ala	-

TABLE 7B

Comparison of BMA-EUCIVL1 and BMA-031 by Computer Modelling

5

10

15

20

25

```

          10          30          50
BMA-031  QIVLTQSPAINASPGKVTMTCSATSSV.SYMHWYQKSGTSPKRWIYD
          | |||| | |||| | |||| | |||| | |||| | |||| | |||| | |||| |
BMA-EUCIVL1 DIQMTQSPSTLSASVGRVTLTCSATSSV.SYMHWYQKRPKAPKLLMYD
          | |||| | |||| | |||| | |||| | |||| | |||| | |||| |
          \--CDR-1--/
          70          90
          TSKLASGVPARFSGSGGTSYSLTISSMEAEDAATYYCQQWSSNPLTFGA
          ||||| ||||| ||||| ||||| ||||| ||||| ||||| ||||| |||||
          TSKLASGVPSRFISGSGGTEFTLTISLQPDFATYYCQQWSSNPLTFGG
          -CDR2/                                     \-CDR-3-/
          107
          GTKLELK
          |||||
          GTKVEIK
    
```

	Amino Acid Difference	EU Amino Acid	BMA Amino Acid	Proximity to CDRs
30	1	Asp	Gln	+++
	3	Gln	Val	+++
	4	Met	Leu	+++
	9	Ser	Ala	-
35	10	Thr	Ile	-
	11	Leu	Met	-
	15	Val	Pro	-
	17	Asp	Glu	-
	18	Arg	Lys	-
40	21	Ile	Met	-
	40	Pro	Ser	-
	42	Lys	Thr	+
	43	Ala	Ser	+/-
	46	Leu	Arg	+++
45	47	Leu	Trp	+++
	48	Met	Ile	+
	60	Ser	Ala	+/-
	63	Ile	Ser	+/-
	70	Glu	Ser	+
50	71	Phe	Tyr	+++
	72	Thr	Ser	+/-
	78	Leu	Met	-
	79	Gln	Glu	-
	80	Pro	Ala	-
	81	Asp	Glu	+/-
55	83	Phe	Ala	-
	100	Gly	Ala	+++

TABLE 8

Amino Acid Differences Between BMA031 and EU and Their Consensus Sequences				
Amino Acid	EU	Human	BMA031	Mouse
Position	A.A.	A.A.	A.A.	A.A.
Heavy Chain, EU Specific:				
70	Ile	+	Leu	Leu
72	Ala	+	Ser	Val
74	Glu	+	Lys	Lys
93	Phe	Val	Val	Val
95	Phe	Tyr	Tyr	Tyr
98	Gly	Arg	Arg	Arg
Light Chain, EU Specific:				
10	Thr	Ser	Ile	Ile
48	Met	Ile	Ile	Ile
63	Ile	Ser	Ser	Ser
70	Glu	Asp	Ser	Ser
81	Asp	Glu	Glu	Glu
Heavy Chain, BMA Specific:				
1	Gln	Gln	Gln	Gln
7	Ser	Ser	Ser	Pro
9	Ala	Ala	Pro	Ala
20	Val	Val	Met	Leu
40	Ala	Ala	Lys	Arg
72	Ala	+	Ser	Val
82	Glu	Glu	Glu	Gln
94	Tyr	Tyr	His	Tyr
Light Chain, BMA Specific: NONE				

+, variable

Claims

Claims for the following Contracting States : AT, BE, CH, DE, DK, FR, GB, IT, LI, LU, NL, SE

1. A chimeric antibody specific for an epitope on the human alpha/beta T-cell receptor (TCR) which is recognised by mAb BMA 031, the antibody comprising:
 - (a) a heavy chain whose variable region comprises the sequence of residues 1 to 120 of CIV-3 as shown in Table 6A; and
 - (b) a light chain whose variable region comprises the sequence of residues 1 to 107 of CIV-3 as shown in Table 6B.
2. An antibody as claimed in claim 1 wherein the heavy and light chains comprise less than the entire constant region.
3. An antibody as claimed in claim 1 or 2 which comprises a constant region derived from human antibodies.
4. An antibody as claimed in any preceding claim conjugated to a cytotoxic moiety, for example a toxin or a radioisotope.

EP 0 403 156 B1

- 5
6. A pharmaceutical composition comprising an antibody according to any of claims 1 to 4 and a therapeutically acceptable carrier.
7. The use of an antibody as claimed in any of claims 1 to 4 in the preparation of an agent for:
- (a) immunoregulation;
 - 10 (b) immunosuppressive therapy;
 - (c) treating an autoimmune disease; and/or
 - (d) for mediating cytotoxicity, when conjugated to a cytotoxic agent.
8. An antibody as claimed in any of claims 1 to 4 which is conjugated, for example by biochemical or molecular biology techniques, to one or more isotopes and/or proteins.
9. An antibody as claimed in claim 8 wherein at least one of the proteins is an enzyme.
10. A transfectoma cell line that produces an antibody as claimed in any of claims 1 to 3.

Claims for the following Contracting States : ES, GR

1. A process for the production of a chimeric antibody specific for an epitope on the human alpha/beta T-cell receptor (TCR) which is recognised by mAb BMA 031, the antibody comprising:
- (a) a heavy chain whose variable region comprises the sequence of residues 1 to 120 of CIV-3 as shown in Table 6A; and
 - (b) a light chain whose variable region comprises the sequence of residues 1 to 107 of CIV-3 as shown in Table 6B;
- the process comprising harvesting the antibody from a cell producing the antibody.
2. A process as claimed in claim 1 wherein the heavy and light chains in the antibody comprise less than the entire constant region.
3. A process as claimed in claim 1 or 2 wherein the antibody comprises a constant region derived from human antibodies.
4. A process for producing an antibody, the process comprising conjugating an antibody producible by a process as claimed in any preceding claim with a cytotoxic moiety.
5. A process as claimed in any of claims 1 to 4, wherein the cell is a hybridoma cell line.
6. A process for producing a pharmaceutical composition comprising an antibody producible by a process according to any of claims 1 to 4, the process comprising admixing the antibody with a pharmaceutically acceptable carrier.
7. The use of an antibody producible by a process as claimed in any of claims 1 to 4 in the preparation of an agent for:
- (a) immunoregulation;
 - 55 (b) immunosuppressive therapy;
 - (c) treating an autoimmune disease; and/or

EP 0 403 156 B1

(d) for mediating cytolysis, when conjugated to a cytotoxic agent.

8. An antibody produceable by a process as claimed in any of claims 1 to 4 for use in medicine.
- 5 9. A process for the production of an antibody conjugate, the process comprising conjugating, for example by biochemical or molecular biology techniques, an antibody produceable by a process as claimed in any of claims 1 to 4 with one or more isotopes and/or proteins.
- 10 10. A process as claimed in claim 9 wherein at least one of the proteins is an enzyme.
11. A process for the production of a DNA construct comprising at least part of the nucleotide sequences encoding an antibody or one or more parts of an antibody produceable by a process according to any of claims 1 to 4, the process comprising coupling together successive nucleotides, and/or ligating oligo- and/or polynucleotides.
- 15 12. A transfectoma cell line that produces an antibody as described in any of claims 1 to 3.

Patentansprüche

20

Patentansprüche für folgende Vertragsstaaten : AT, BE, CH, DE, DK, FR, GB, IT, LI, LU, NL, SE

- 25 1. Ein für eine antigene Determinante auf dem menschlichen Alpha/Beta-T-Zell-Rezeptor (TCR) spezifischer Rekombinationsantikörper, der vom monoklonalen Antikörper mAb BMA 031 erkannt wird, wobei der Antikörper sich aus folgenden Bestandteilen zusammensetzt:
- a) eine schwere Kette, deren variable Region eine Sequenz von CIV-3-Residuen 1 bis 120 wie in Tabelle 6A gezeigt umfaßt; und
- 30 b) eine leichte Kette, deren variable Region eine Sequenz von CIV-3-Residuen 1 bis 107 wie in Tabelle 6B gezeigt umfaßt.
2. Antikörper wie unter Patentanspruch 1, bei dem die schweren und die leichten Ketten weniger als die gesamte konstante Region umfassen.
- 35 3. Antikörper wie unter Patentanspruch 1 oder 2, der eine von menschlichen Antikörpern stammende konstante Region umfaßt.
4. Antikörper wie unter jedem beliebigen der vorhergehenden Patentansprüche, der mit einem zytotoxischen Teil konjugiert ist, beispielsweise mit einem Toxin oder einem Radioisotop.
- 40 5. Antikörper wie unter jedem beliebigen der vorhergehenden Patentansprüche zur Verwendung in der Medizin.
6. Pharmazeutische Zusammensetzung, bestehend aus einem Antikörper laut jedem beliebigen der Patentansprüche 1 bis 4 und einem vom therapeutischen Gesichtspunkt her akzeptablen Träger.
- 45 7. Benutzung eines Antikörpers laut jedem beliebigen der Patentansprüche 1 bis 4 bei der Herstellung eines Mittels für:
- 50 a) Immunregulation;
- b) Immunsuppression;
- c) Behandlung von Autoimmunerkrankungen; und/oder
- 55 d) zur Herbeiführung von Zellauflösung bei Konjugation mit einem zytotoxischen Mittel.
8. Antikörper wie unter jedem beliebigen der Patentansprüche 1 bis 4, der beispielsweise durch biochemische oder

EP 0 403 156 B1

molekularbiologische Techniken mit einem oder mehreren Isotopen und/oder Proteinen konjugiert ist.

9. Antikörper wie unter Patentanspruch 8, bei dem mindestens eines der Proteine ein Enzym ist.
- 5 10. Transfectoma-Zelllinie, die einen Antikörper wie unter jedem beliebigen der Patentansprüche 1 bis 3 beschrieben produziert.

Patentansprüche für folgende Vertragsstaaten : ES, GB

- 10 1. Verfahren zur Produktion eines für eine antigene Determinante auf dem menschlichen Alpha/Beta-T-Zell-Rezeptor (TCR) spezifischen Rekombinationsantikörpers, der vom monoklonalen Antikörper mAb BMA 031 erkannt wird, wobei der Antikörper sich aus folgenden Bestandteilen zusammensetzt:
- 15 a) eine schwere Kette, deren variable Region eine Sequenz von CIV-3-Residuen 1 bis 120 wie in Tabelle 6A gezeigt umfaßt; und
- b) eine leichte Kette, deren variable Region eine Sequenz von CIV-3-Residuen 1 bis 107 wie in Tabelle 6B gezeigt umfaßt;
- 20 wobei das Verfahren die Ernte des Antikörpers von einer den Antikörper produzierenden Zelle umfaßt.
2. Verfahren wie unter Patentanspruch 1, bei dem die schweren und die leichten Ketten im Antikörper weniger als die gesamte konstante Region umfassen.
- 25 3. Verfahren wie unter Patentanspruch 1 oder 2, bei dem der Antikörper eine von menschlichen Antikörpern stammende konstante Region umfaßt.
4. Verfahren zur Herstellung eines Antikörpers, wobei das Verfahren aus der Konjugation eines nach einem der unter den vorherigen Patentansprüchen angemeldeten Verfahren herstellbaren Antikörpers mit einem zytotoxischen Teil besteht.
- 30 5. Verfahren wie unter jedem beliebigen der Patentansprüche 1 bis 4, bei dem die Zelle eine Hybridomzelllinie ist.
- 35 6. Verfahren zur Herstellung einer pharmazeutischen Zusammensetzung, die einen Antikörper umfaßt, der sich nach einem der unter Patentansprüchen 1 bis 4 erwähnten Verfahren herstellen läßt, wobei das Verfahren das Zuzumischen des Antikörpers mit einem vom pharmazeutischen Gesichtspunkt her akzeptablen Träger einschließt.
- 40 7. Benutzung eines Antikörpers, der sich nach einem der unter Ansprüche 1 bis 4 erwähnten Verfahren herstellen läßt, bei der Herstellung eines Mittels für:
- a) Immunregulation;
- b) Immunsuppression;
- 45 c) Behandlung von Autoimmunerkrankungen; und/oder
- d) zur Herbeiführung von Zellauflösung bei Konjugation mit einem zytotoxischen Mittel.
- 50 8. Nach einem der Verfahren laut Ansprüchen 1 bis 4 herstellbarer Antikörper zur Verwendung in der Medizin.
9. Verfahren zur Herstellung eines Antikörperkonjugats, wobei das Verfahren die Konjugation - beispielsweise durch biochemische oder molekularbiologische Techniken - eines nach einem der unter Ansprüchen 1 bis 4 erwähnten Verfahren herstellbaren Antikörpers mit einem oder mehreren Isotopen und/oder Proteinen einschließt.
- 55 10. Verfahren wie unter Anspruch 9, bei dem mindestens eines der Proteine ein Enzym ist.
11. Verfahren zur Herstellung eines DNA-Gebildes, bestehend aus mindestens einem Teil der Nukleotidsequenzen,

EP 0 403 156 B1

die einen Antikörper oder einen oder mehrere Teile eines Antikörpers kodieren, der sich durch eines der unter Ansprüchen 1 bis 4 erwähnten Verfahren herstellen läßt, wobei das Verfahren die Verbindung aufeinanderfolgender Nukleotide und/oder die Ligierung von Oligo- und/oder Polynukleotiden einschließt.

- 5 12. Transfectoma-Zelllinie, die einen Antikörper wie unter einem der Ansprüche 1 bis 3 beschrieben produziert.

Revendications

10

Revendications pour les Etats contractants suivants : AT, BE, CH, DE, DK, FR, GB, IT, LI, LU, NL, SE

1. Un anticorps chimérique spécifique a un épitope du récepteur des cellules en T humaines, alpha/beta (RCT), reconnu par l'anticorps monoclonale (mAb) BMA 031, l'anticorps comprend:
- 15 (a) une chaîne lourde dont la région variable comprend une séquence de résidus 1 a 120 de CIV-3 comme le montre le tableau 6A; et
- (b) une chaîne légère dont la région variable comprend une séquence de résidus 1 a 107 de CIV-3 comme le
- 20 montre le tableau 6 B.
2. Un anticorps, selon la revendication 1, où les chaînes lourdes et légères constituent moins que la totalité de la région constante.
- 25 3. Un anticorps, selon les revendications 1 ou 2, qui comprend une région constante dérivée d'anticorps humains.
4. Un anticorps, selon toutes les revendications précédentes, conjugué à une moitié cytotoxique, par exemple, une toxine ou un radio-isotope.
- 30 5. Un anticorps, selon toutes les revendications précédentes, pour utilisation en médecine.
6. Une composition pharmaceutique comprenant un anticorps conforme à chacune des revendications 1 à 4 et un porteur thérapeutique acceptable.
- 35 7. L'utilisation d'un anticorps, conforme à chacune des revendications 1 à 4, dans des préparations d'agents pour:
- (a) la régulation immunitaire;
- (b) la thérapie immunosuppressive;
- 40 (c) le traitement d'une maladie auto-immune; et/ou
- d) pour la médiation de la cytolysse, quand il est conjugué à un agent cytotoxique
- 45 8. Un anticorps, conforme à chacune des revendications 1 à 4, qui est conjugué, par exemple par des techniques biochimiques ou de biologie moléculaire, à un ou plusieurs isotopes et/ou protéines.
9. Un anticorps, selon la revendication 8, où au moins une des protéines est une enzyme.
- 50 10. Une lignée de cellules de transfectomes qui produit un anticorps conforme à chacune des revendications de 1 à 3.

Revendications pour les Etats contractants suivants : ES, GR

- 55 1. Un procédé pour la production d'un anticorps chimérique spécifique à un isotope des récepteurs des cellules en T humaines alpha beta (RCT) reconnu par l'anticorps monoclonale (mAb) BMA 031, cet anticorps comprenant:
- a) une chaîne lourde dont la région variable comprend une séquence de résidus 1 a 120 de CIV-3 comme le

EP 0 403 156 B1

montre le tableau 6 A; et

b) une chaîne légère dont la région variable comprend une séquence de résidus 1 à 107 de CIV-3 comme le montre le tableau 6 B;

5

le procédé consiste à récolter des anticorps d'une cellule qui produit l'anticorps.

2. Un procédé, selon la revendication 1, par lequel dans l'anticorps, les chaînes lourdes et légères constituent moins que la totalité de la région constante.
3. Un procédé, selon les revendications 1 et 2, par lequel les anticorps comprennent une région constante dérivée d'anticorps humains.
4. Un procédé pour produire un anticorps, le procédé consistant à conjuguer un anticorps, que l'on peut produire par le procédé conforme à toutes les revendications précédentes, avec une moitié cytotoxique.
5. Un procédé, conforme à chacune des revendications de 1 à 4, où la cellule est une lignée de cellules d'hybridomes.
6. Un procédé pour produire une composition pharmaceutique consistant d'un anticorps qui peut être produit par un procédé conforme à chacune des revendications 1 à 4, ce procédé comprenant l'ajout et le mélange de cet anticorps à un porteur pharmaceutique acceptable.
7. L'utilisation d'un anticorps, produit par un procédé conforme à chacune des revendications 1 à 4, dans la préparation d'un agent pour:
 - (a) la régulation immunitaire
 - (b) la thérapie immunosuppressive;
 - (c) le traitement d'une maladie auto-immune; et/ou
 - (d) pour la médiation de la cytolyse, quand il est conjugué à un agent cytotoxique
8. Un anticorps pour utilisation en médecine, qui peut être produit par un procédé conforme à chacune des revendications de 1 à 4.
9. Un procédé pour la production d'un conjugué d'anticorps, le procédé consistant à conjuguer, par exemple par des techniques biochimiques ou de biologie moléculaire, un anticorps, qui peut être produit par un procédé à chacune des revendications 1 à 4, à un ou plusieurs isotopes et/ou protéines.
10. Un procédé, selon dans la revendication 9, où au moins une des protéines est une enzyme.
11. Un procédé pour la production d'une structure de l'ADN comportant au moins une portion de séquences nucléotides qui encodent un anticorps ou une ou plusieurs parties d'un anticorps produit par un procédé conforme à toutes les revendications de 1 à 4, le procédé consistant en l'accouplement de nucléotides successifs, et/ou en la ligature d'oligo et/ou de poly nucléotides.
12. Une lignée de cellules de transfectomes qui produit un anticorps conforme à chacune des revendications 1 à 3.

50

55

FIGURE 1

Construction of BMA-031 Genomic Library

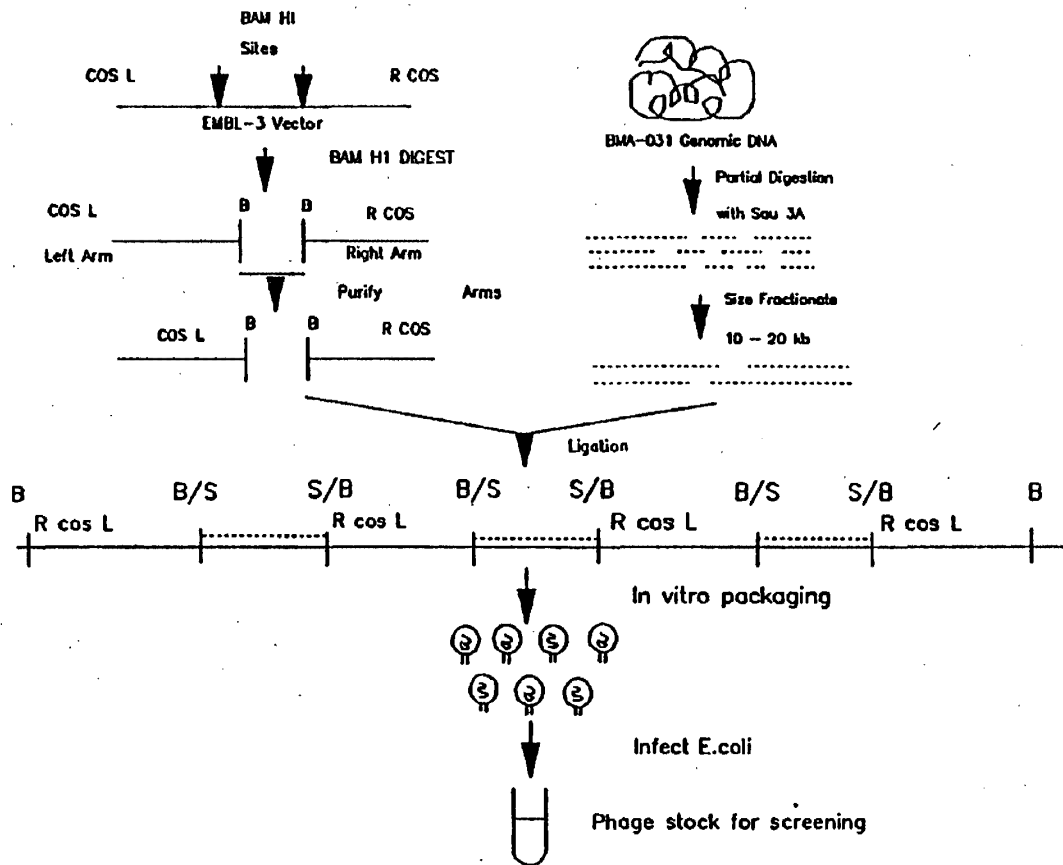

95

EP 0 403 156 B1

FIGURE 2

Probes Used in Screening BMA-031 Library

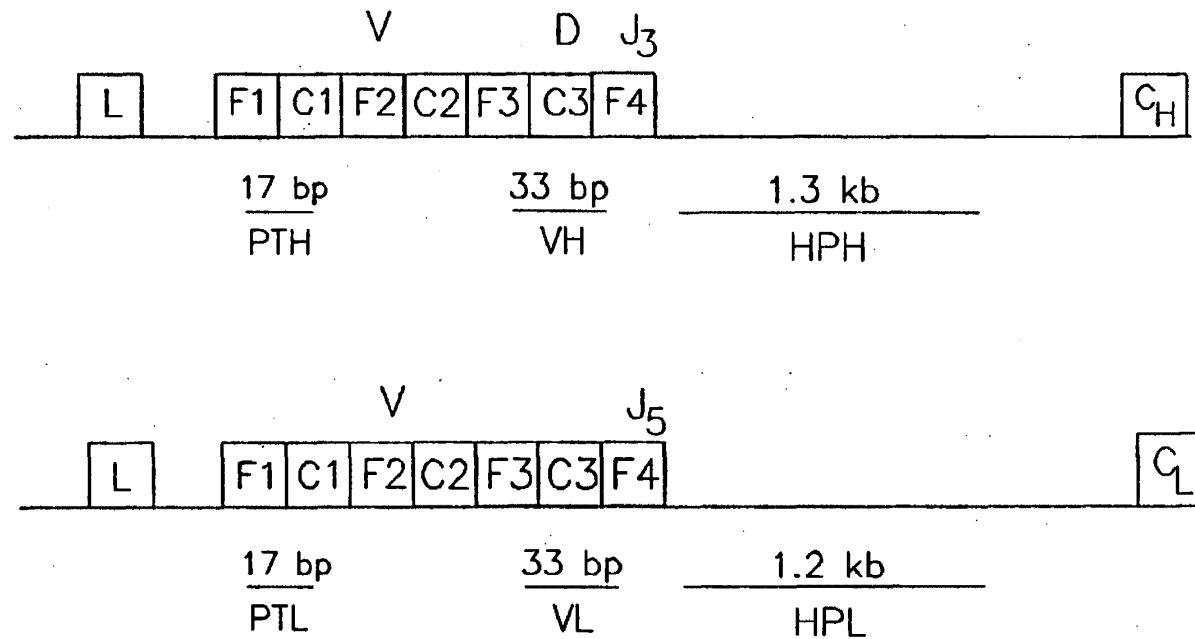

36

EP 0 403 156 B1

FIGURE 3

Human Constant-Region Expression Vectors

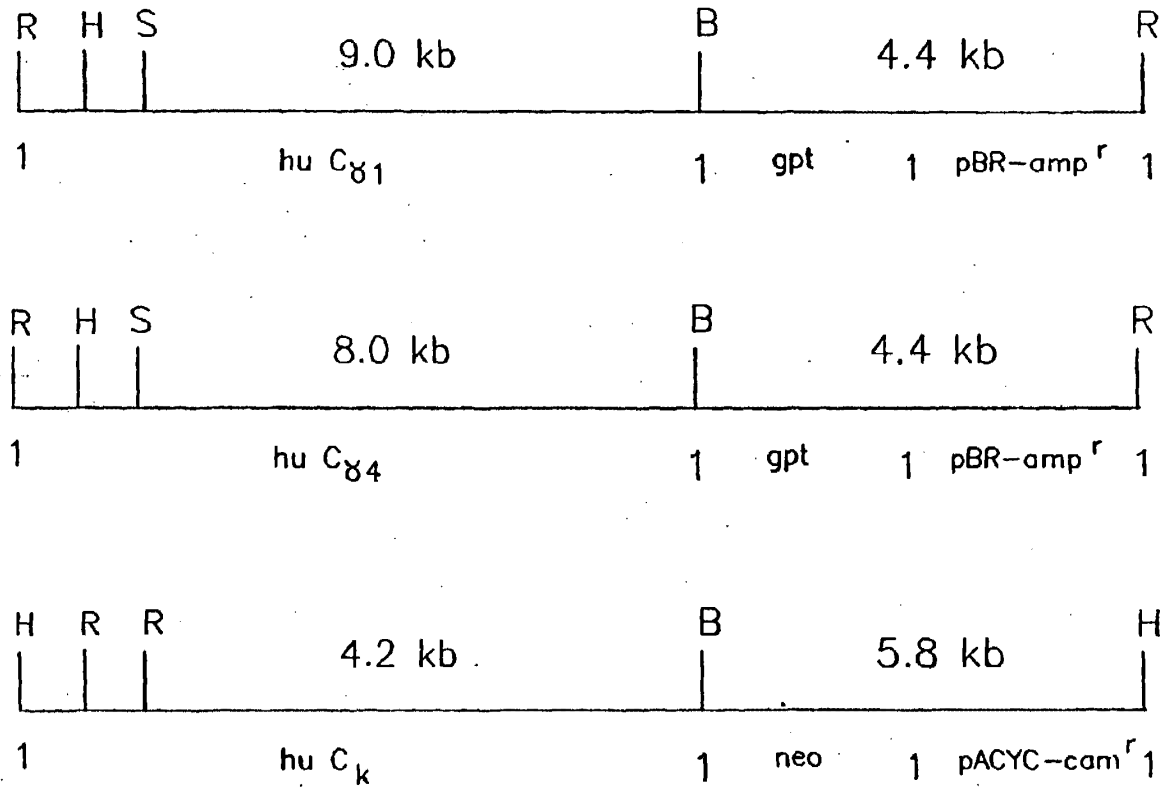

37

EP 0 403 156 B1

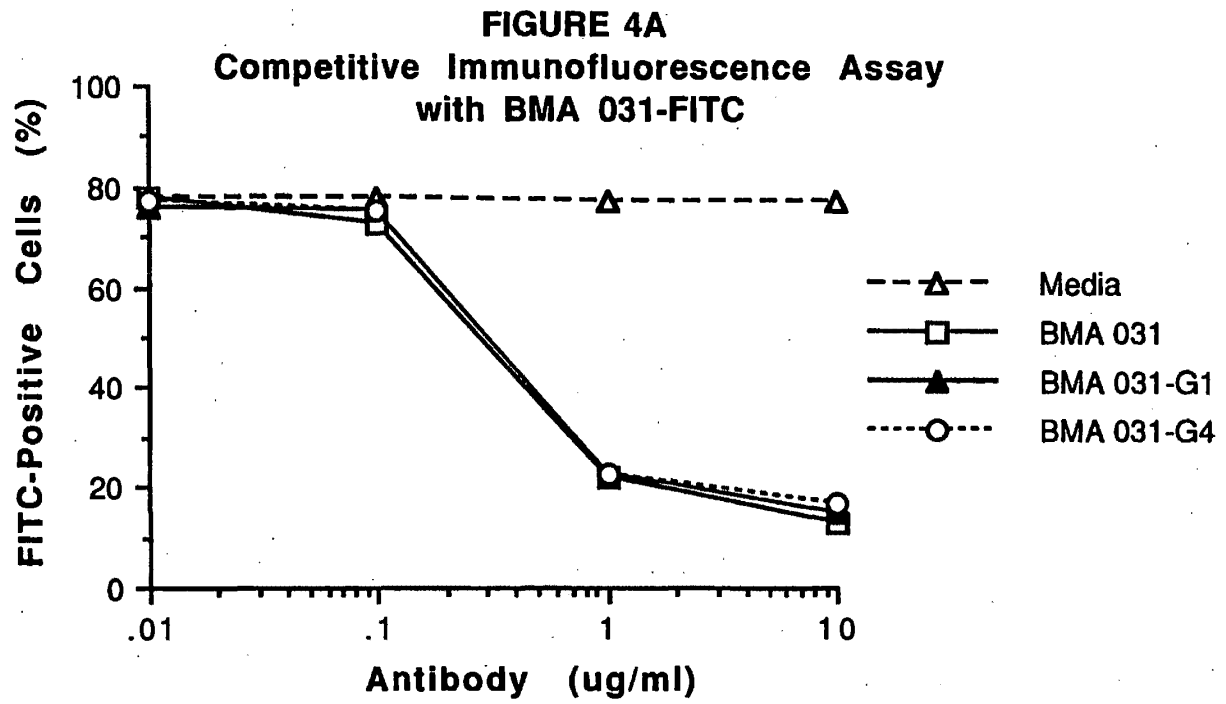

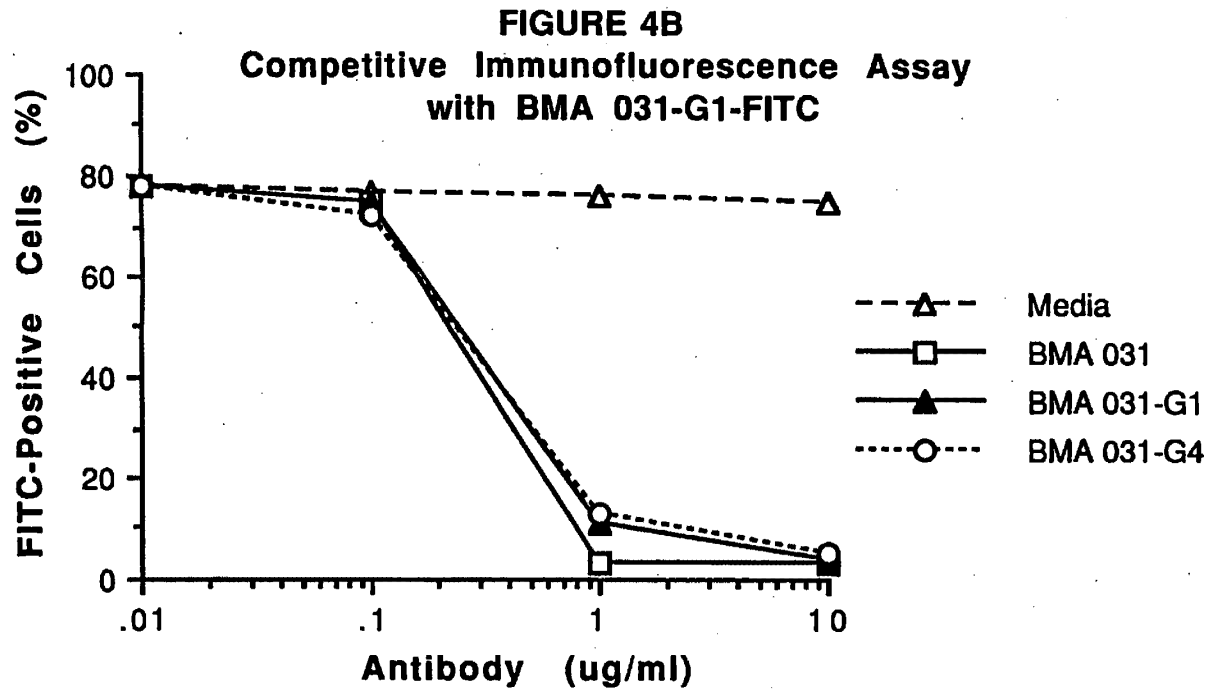

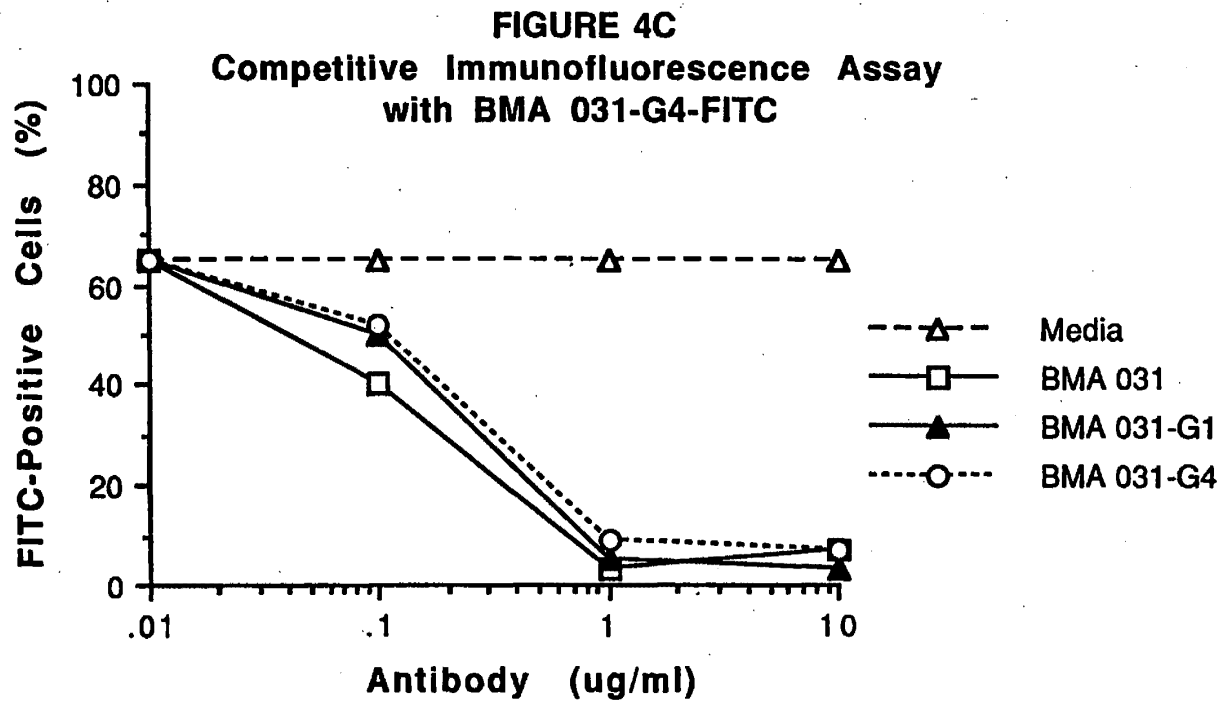

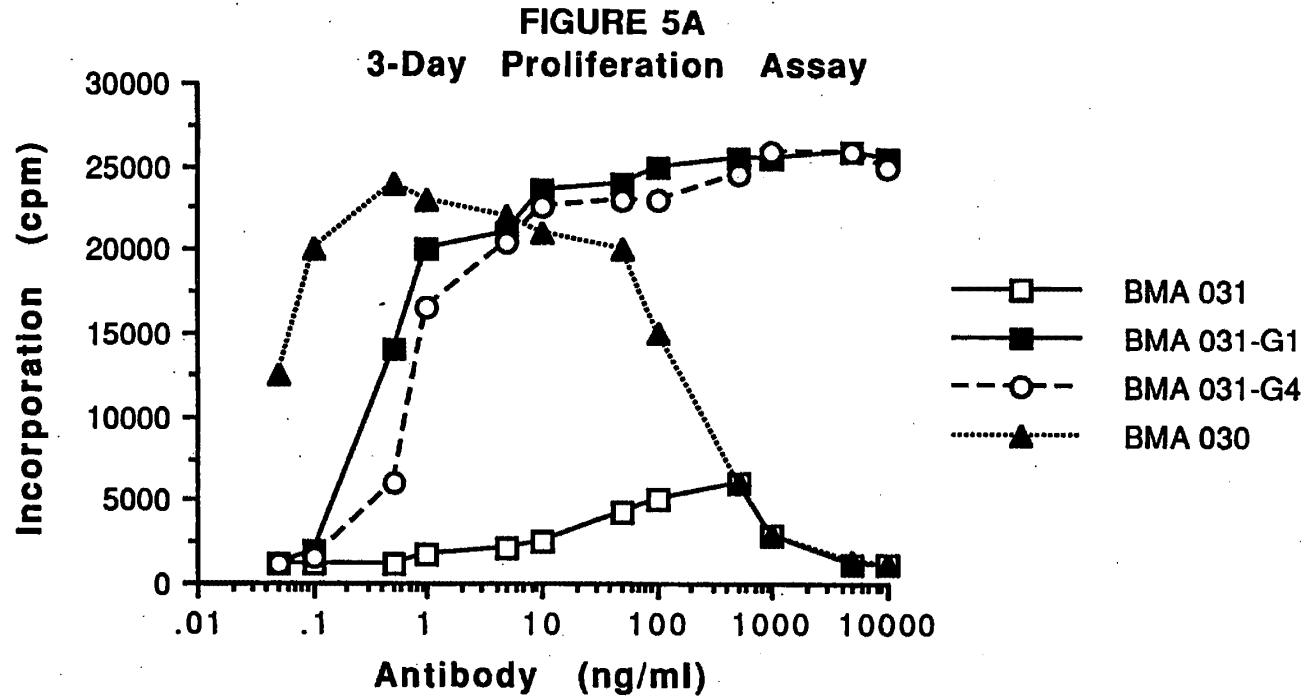

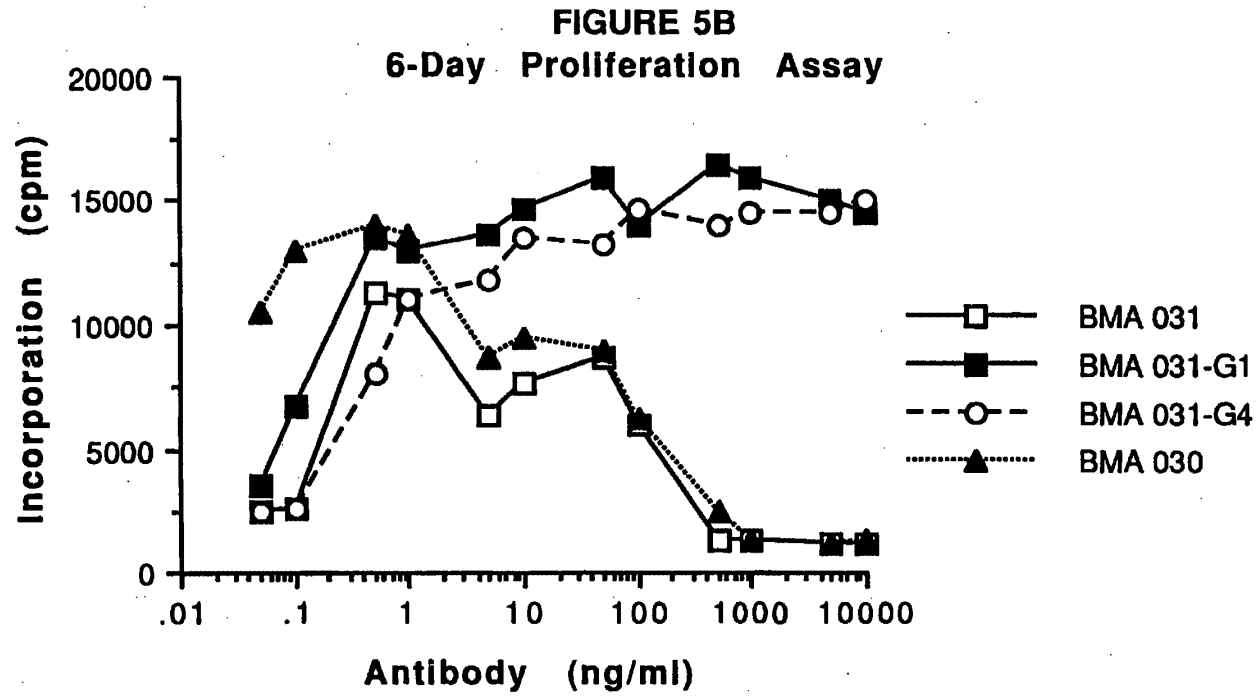

FIGURE 6A
ADCC Assay with BMA 031 Antibodies

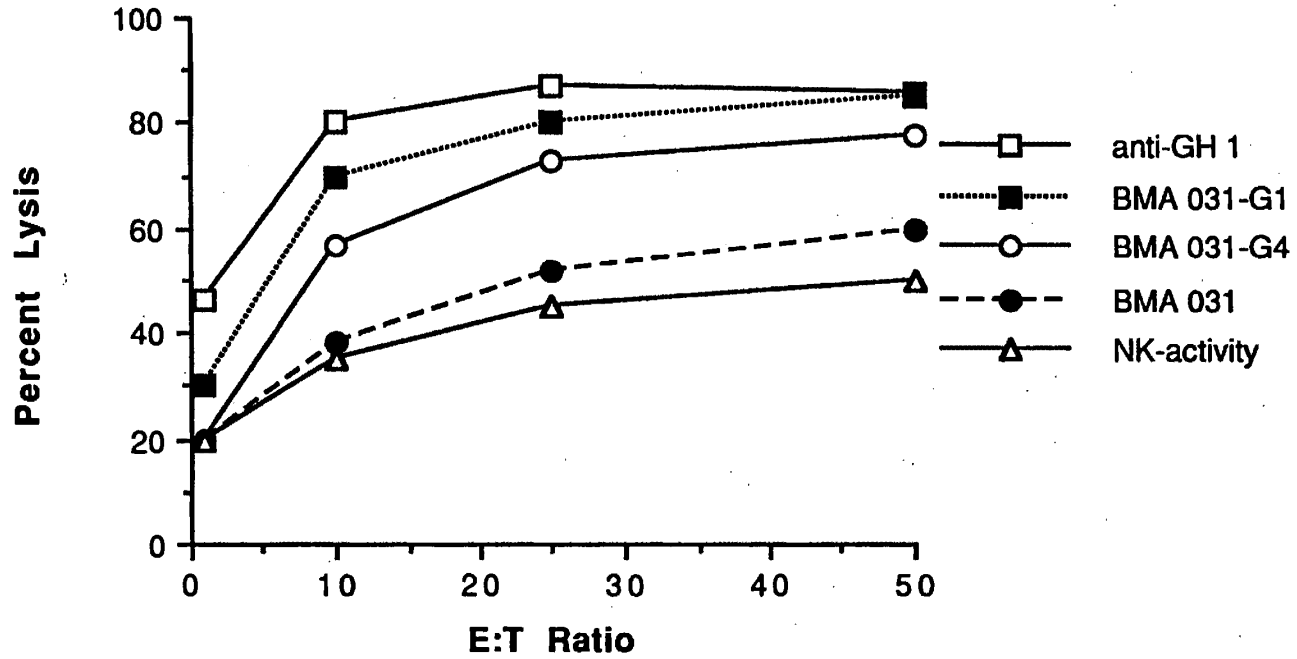

FIGURE 6B
ADCC Assay with BMA 031-G1

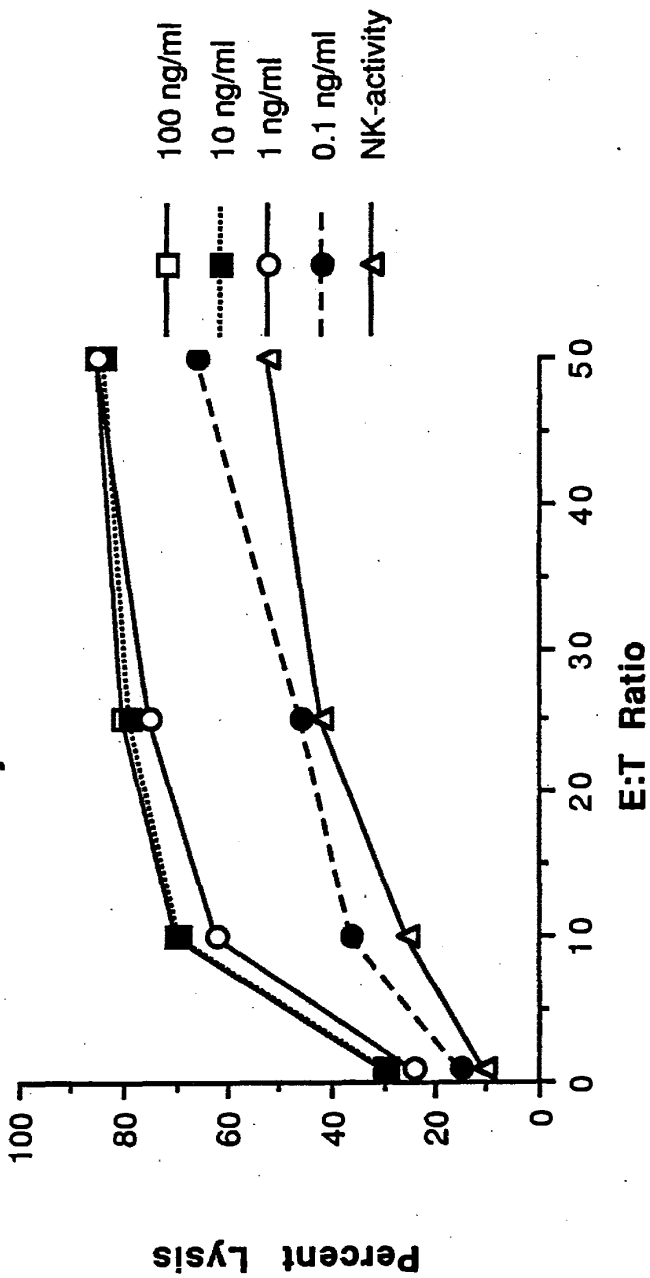
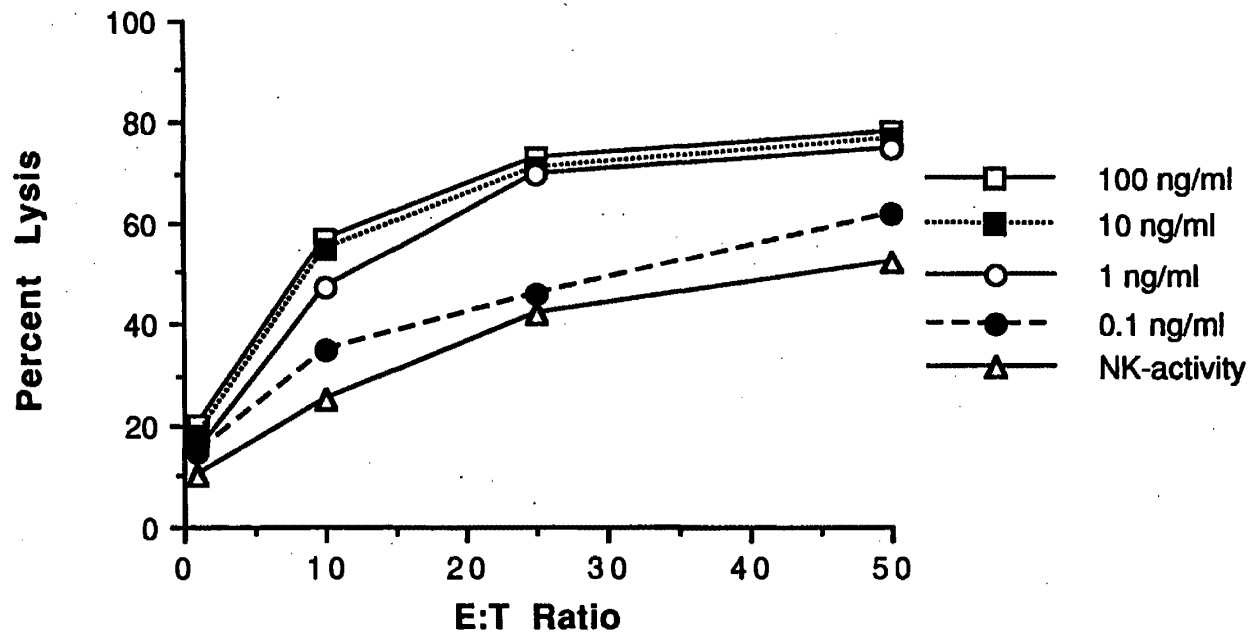
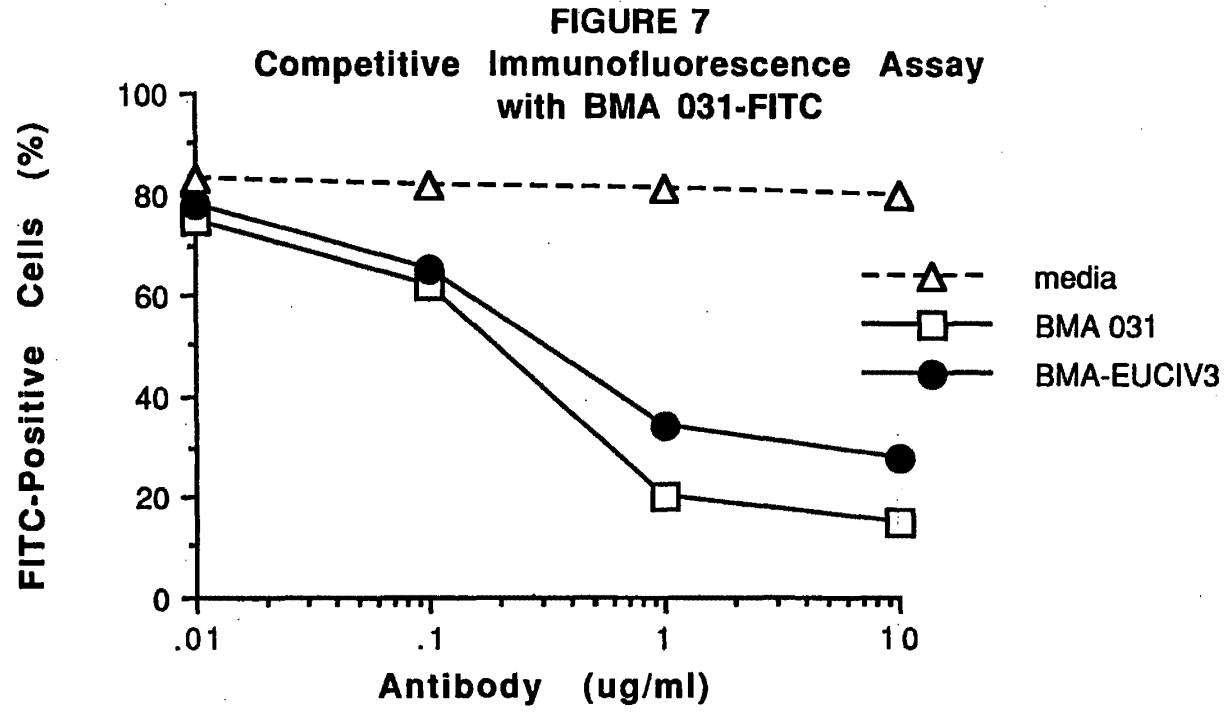

FIGURE 6C
ADCC Assay with BMA 031-G4







⑪ Publication number : **0 438 310 A1**

⑫ **EUROPEAN PATENT APPLICATION**

⑲ Application number : **91300362.0**

⑤① Int. Cl.⁵ : **C12N 15/13, C12P 21/08**

⑳ Date of filing : **17.01.91**

⑳ Priority : **19.01.90 US 467700**
20.12.90 US 627423

④③ Date of publication of application :
24.07.91 Bulletin 91/30

⑧④ Designated Contracting States :
CH DE FR GB IT LI NL

⑦① Applicant : **MERCK & CO. INC.**
126, East Lincoln Avenue P.O. Box 2000
Rahway New Jersey 07065-0900 (US)

⑦② Inventor : **Law, Ming-Fan**
12344 Picrus Street
San Diego, California 92129 (US)
Inventor : **Mark, George E., III**
4 Richmond Court
Princeton Junction, NJ 08550 (US)
Inventor : **Singer, Irwin I.**
18 Lakeridge Drive
Matawan, NJ 07747 (US)
Inventor : **Williamson, Alan R.**
760 Lawrence Avenue
Westfield, NJ 07090 (US)

⑦④ Representative : **Thompson, John Dr. et al**
Merck & Co., Inc. European Patent
Department Terlings Park Eastwick Road
Harlow, Essex CM20 2QR (GB)

⑤④ **Method for producing recombinant immunoglobuline.**

⑤⑦ A method for producing recombinant immunoglobulins in which the unique complementarity determining regions of immunoglobulins from a first animal monoclonal antibody are inserted by recombinant technology into a uniquely selected framework of a second animal, including humans. The recombinant DNA constructs of the invention can be used to transfect cells which will produce the recombinant immunoglobulins.

EP 0 438 310 A1

Jouve, 18, rue Saint-Denis, 75001 PARIS

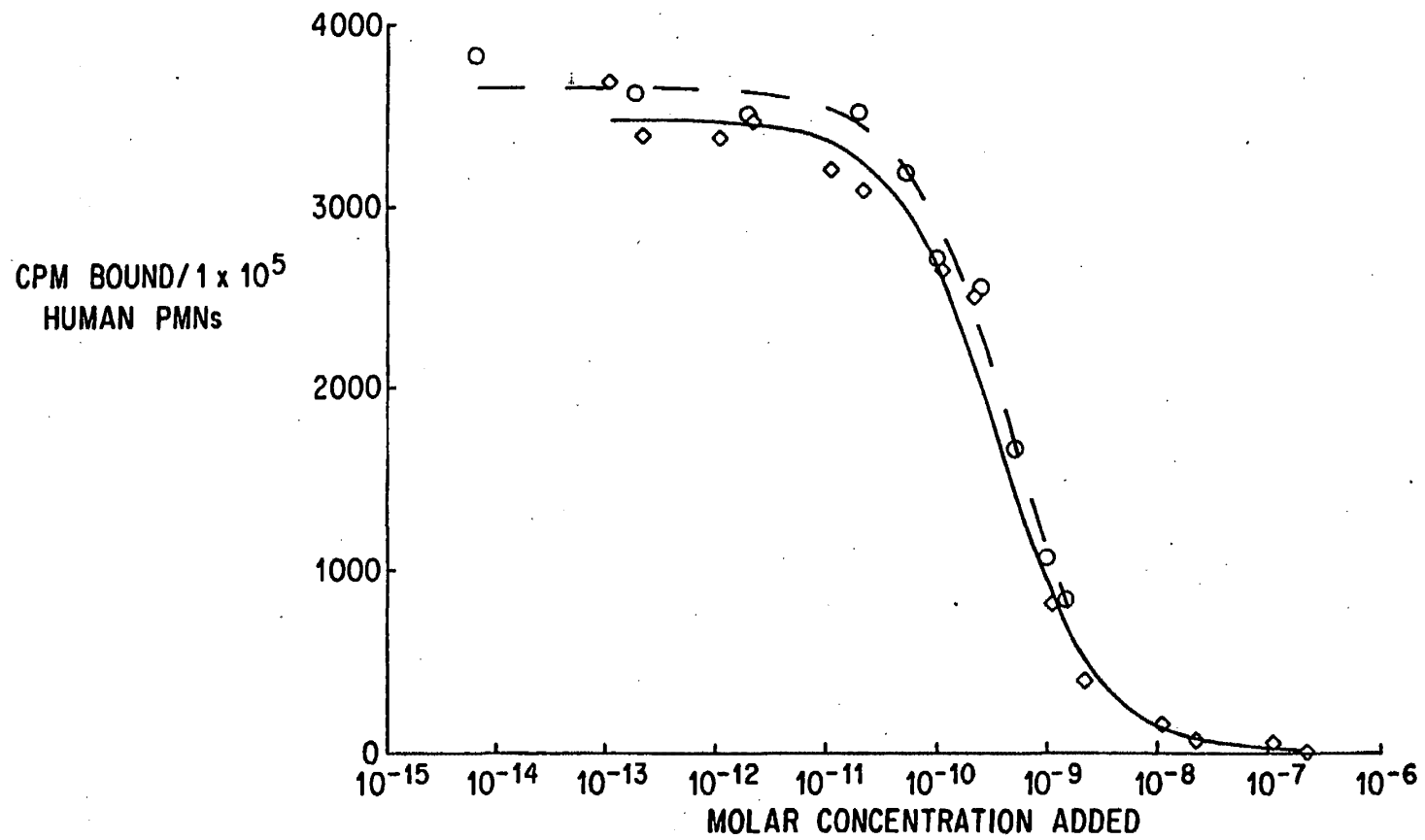

FIG. 13

METHOD FOR PRODUCING RECOMBINANT IMMUNOGLOBULINS

BRIEF DESCRIPTION OF THE DRAWINGS

Figure 1. Primers used to isolate DNA encoding murine kappa light chain variable region and murine IgG2a heavy chain variable region using PCR.

Figure 2. Diagram of antibody structure and PCR products of murine heavy and light chain.

Figure 3. 1B4 amino acid sequence for heavy chain variable region and light chain variable regions 1 and 2 deduced from the nucleic acid sequence of the cloned cDNAs.

Figure 4. Oligodeoxynucleotides used as primers for PCR mutagenesis and amplification of the Rel light chain variable region template so as to graft the CDRs of 1B4 into the Rel light chain variable region.

Figure 5. PCR recombination strategy used in the CDR-grafting of the Rel/1B4 light chain variable region.

Figure 6. Outline of the insertion of light chain variable and constant regions into the light chain expression vector.

Figure 7. Oligodeoxynucleotides used as PCR primers to generate a shortened IgG4 heavy chain. Oligodeoxynucleotide primers used in PCR to re-engineer the thymidine kinase (TK) promoter to facilitate the expression of the neomycin resistance gene. Oligodeoxynucleotide primers used in PCR to clone the IgH enhancer sequence. Oligodeoxynucleotides used as PCR primers to generate a human kappa light chain constant region.

Figure 8. PCR recombination strategy used in the fusing of human signal and intronic sequence to the 1B4 heavy chain variable region.

Figure 9. Oligodeoxynucleotides used as primers for PCR recombination to fuse human signal and intronic sequences onto the 1B4 heavy chain variable region.

Figure 10. Outline of the construction of the neomycin selectable expression vector.

Figure 11. Outline of the insertion of the "chimaeric" 1B4 heavy chain variable region and the shortened human IgG4 heavy chain constant region into the heavy chain expression vector.

Figure 12. Levels of transient expression as determined by trapping ELISA, of the 1B4 chimaeric heavy chain : grafted Rel/1B4 light chain recombinant antibody in CV1, COS 7 and 293 cells.

Figure 13. Competitive binding assay of recombinant "chimaeric"/Rel 1B4 (circles) and native murine 1B4 MAb (diamonds) for CD18 on activated human PMNs.

Figure 14. Amino acid sequence composition of the human heavy and light chain variable regions from which framework regions were used to support the murine 1B4 CDRs.

Figure 15. Oligodeoxynucleotides used in the construction of Gal/1B4 heavy chain variable region and Jon/1B4 heavy chain variable region plus those necessary to fuse the human signal and intronic sequences onto these variable regions.

Figure 16. PCR-recombination strategy used in the CDR-grafting of the Gal/1B4 heavy chain and Jon/1B4 heavy chain variable regions.

Figure 17. DNA sequence and deduced amino acid sequence determined for murine 1B4 heavy chain variable region.

Figure 18. Outline of the construction of the hygromycin selectable expression vector.

Figure 19. Outline of the insertion of the Gal/1B4 heavy chain and the Jon/1B4 heavy chain variable regions into the heavy chain expression vector containing the shortened IgG4 heavy chain constant region.

Figure 20. Summary of the competitive binding activities of murine MAb 1B4 and recombinant human anti-CD18 antibody constructs.

Figure 21. Oligodeoxynucleotides used in the construction of Len/1B4 light chain variable region plus those necessary to fuse the human signal onto the Len light chain variable region.

Figure 22. PCR-recombination strategy used in the CDR-grafting of the Len/1B4 light chain variable region.

Figure 23. Outline of the insertion of the Len/1B4 light chain variable region into an intermediate vector followed by its insertion into the light chain expression vector.

Figure 24. DNA sequence and deduced amino acid sequence determined for murine 1B4 light chain-1 variable region.

Figure 25. DNA sequence and deduced amino acid sequence determined for murine 1B4 light chain-2 variable region.

Figure 26. Oligodeoxynucleotides used in the construction of Gal-m1/1B4 (mutant) heavy chain variable region plus those necessary to fuse the human signal onto the Gal-m1 heavy chain variable region.

Figure 27. PCR-recombination strategy used in the CDR-grafting of the Gal-m1/1B4 (mutant) heavy chain variable region.

Figure 28. Competitive binding assay of native murine 1B4 (diamonds) and Gal/Rel humanized 1B4 (circles).

Figure 29. Competitive binding assay of New/Rel recombinant h1B4 (closed diamonds) and Gal/Rel recombinant h1B4 (open diamonds).

Figure 30. Effects of native murine 1B4 (diamonds) and Gal/Rel recombinant humanized 1B4 (circles) on attachment of human PMNs to human

umbilical vein endothelial cell monolayers *in vitro*.

Figure 31. Comparison of Gal/Rei h1B4 and m1B4 in *in vitro* functional assays.

Figure 32. Immunofluorescence microscopic localization of m1B4 and Gal/Rei h1B4 staining in 5- μ m frozen sections of rabbit tissues.

Figure 33. Double label immunofluorescence microscopic localization of Gal/Rei h1B4 and m1B4 in rabbit bone marrow cells.

Figure 34. Double label immunoelectron microscopic localization of Gal/Rei h1B4 and m1B4 in specific granules of human PMNs.

Figure 35. Dose-dependent inhibition by m1B4 and Gal/Rei h1B4 of C5a (100 pmol)-induced PMN accumulation in rabbit skin.

Figure 36. Dose-dependent inhibition by m1B4 and Gal/Rei h1B4 of C5a (100 pmol)-induced plasma extravasation in rabbit skin.

Figure 37. Outline of the construction of expression system p8962 capable of producing large quantities of recombinant CDR-grafted 1B4 antibodies.

Figure 38. Outline of the construction of expression systems p8968 and p8969 capable of producing large quantities of recombinant CDR-grafted 1B4 antibodies.

BACKGROUND OF THE INVENTION

Murine derived monoclonal antibodies have been utilized as diagnostic and therapeutic agents for numerous human pathologic conditions including acute inflammatory responses associated with numerous diseases. Administration of murine derived monoclonal antibodies (mMAbs) as therapeutic agents in man has been severely limited by the development of antibody within the recipient to the mouse antigens of the murine derived monoclonal antibody. In attempts to circumvent this outcome mMAbs have been restructured by recombinant DNA technology in such a way as to decrease their immunogenicity in humans. Immunoglobulins are well defined both chemically and biologically with the general structures illustrated in Molecular Cell Biology, Darnell, Lodish, and Baltimore, Eds., Scientific American Books, Inc., W.H. Freeman, New York, NY (1986). Initially, this involved the construction of chimaeric antibodies, Morrison *et al.*, Proc. Natl. Acad. Sci. USA 81 : 6851-6855 (1984). Recombinant technology was employed to replace the murine heavy and light chain constant regions with corresponding human constant regions. Upon expression, such interspecies antibody chimaeras yielded molecules with the antigen binding specificities of the parent murine antibody. The following references generally describe chimaeric antibody technology : Lobuglio *et al.*, Proc. Natl. Acad. Sci. USA 86 : 4220-4224 (1989) ; United States Patent 4,816,567 ; PCT International Publication No. WO 87/02671,

published May 7, 1987 ; European Patent Publication No. 255,694, published February 10, 1988 ; European Patent Publication No. 274,394, published July 13, 1988 ; European Patent Publication No. 323,806, published July 12, 1989 ; PCT International Publication No. W0/89/00999, published February 9, 1989 ; European Patent Publication No. 327,000, published August 9, 1989 ; European Patent Publication No. 328,404, published August 16, 1989 ; and European Patent Publication No. 332,424, published September 13, 1989.

The immunogenicity of chimaeric antibodies can be further reduced by grafting rodent hypervariable regions into the variable region frameworks of human light and heavy chains, Jones *et al.*, Nature 321 : 522-525 (1986). These hypervariable regions have also been termed complementarity determining regions (CDR). The technique involves the substitution or recombinant grafting of antigen-specific murine CDR sequences for those existent within "generic" human heavy and light chain variable regions, European Patent Publication No. 239,400, published September 30, 1987. In this approach, little, if any, concern is shown for the variable region frameworks (FRs) within which the murine CDRs are placed. The instant invention illustrates that appropriate supportive structures for the CDRs are vital not only for the assembly of the functional antibody molecules but also for the production of antibody molecules with avidities which allow for the administration of therapeutic doses (about 0.1-1mg/kg).

Recent studies by Queen *et al.*, Proc. Natl. Acad. Sci. USA 86 : 10029-10033 (1989), have shown the CDRs from a murine anti-Tac monoclonal antibody can be grafted into a human framework. The human framework variable regions were chosen to maximize identity with the murine sequence. The authors also utilized a computer model of the mMAb to identify several amino acids which, while outside the CDRs, are close enough to interact with the CDRs or antigen. These residues were mutated to the residue found in the murine sequence. The grafted anti-Tac antibody had an affinity for the antigen which was only about 1/3 that of the murine anti-tac mMAb and maintenance of the human character of this antibody was problematic.

Leukocyte infiltration into an inflammatory site is dependent on the adhesion of the leukocytes to the endothelium prior to extravasation. The rapid binding of polymorphonuclear leukocytes (PMN) to the endothelium and diapedesis occurs within minutes after the introduction of a chemotactic stimulus in tissue, Cybulski *et al.*, Am. J. Pathol. 124 : 367 (1986). This rapid extravasation appears to depend on the response of the PMNs to chemoattractants and on the presence of the CD11/CD18 family of glycoproteins on the leukocyte surface. The family of glycoproteins associated with PMNs are termed leukocyte integrins

and include LFA-1 (CD11a/CD18), Mac-1 (CD11b/CD18) and p150,95 (CD11c/CD18). Each of these heterodimers has a unique alpha chain (CD11 a, b, c) and an invariant beta-2 chain (CD18). Stimulation of PMNs with various chemotactic factors causes increased expression of leukocyte integrins (CD11b/CD18) fostering strong adhesion to unstimulated endothelium *in vitro*, Harlan, *Blood* 65 : 513 (1985), and essentially all of the chemoattractant-induced adhesion is inhibited by treating the PMNs with mMAbs specifically reactive with the CD11/CD18 complex, Harlan *et al.*, *Blood* 66 : 167 (1985); Zimmerman and McIntyre *J. Clin. Invest.* 81 : 531 (1988); Smith *et al.*, *J. Clin. Invest.* 82 : 1746 (1988); and Lo *et al.*, *J. Exp. Med.* 169 : 1779 (1989). Polymorphonuclear leukocytes from patients with leukocyte adhesion deficiency (LAD) fail to express CD18 and fail to bind unstimulated endothelium *in vitro*, Harlan *et al.*, *Blood* 66 : 167 (1985); Lo *et al.*, *J. Exp. Med.* 169 : 1779 (1989).

Murine hybridomas producing monoclonal antibodies reactive with the beta chain common to the Mac-1, LFA-1 and the p150,95 integrins have been described. The mMAbs are designated 1B4, 60.3, TS1/18, H52 and ATCC TIB 218. The 1B4 is an IgG2a antibody and was prepared by Wright *et al.*, *Proc. Natl. Acad. Sci. USA* 80 : 5699-5703 (1983), the 60.3 is also IgG2a and was prepared by Beatty *et al.*, *J. Immunol.* 131 : 2913-2918 (1983), TS1/18 is an IgG1 antibody and was prepared by Sanchez-Madrid *et al.*, *J. Exp. Med.* 158 : 1785-1803 (1983), H52, a MAb against beta 2 (CD18) was prepared by Hildreth and Orentas, *Science* 244 : 1075-1078 (1989) and ATCC TIB 218, a IgG2a kappa prepared by Springer *et al.*, *J. Exp. Med.* 158 : 586-602 (1983). These antibodies appear to be functionally equivalent and cross-react with the beta-2 chain found on human, sheep pig, rabbit, and dog leukocytes but not with the beta-2 chain found on murine and rat leukocytes.

SUMMARY OF THE INVENTION

A method for producing recombinant immunoglobulins in which the unique complementarity determining regions of immunoglobulins from a first animal monoclonal antibody are inserted by recombinant technology into a uniquely selected framework of a second animal, including humans. The recombinant DNA constructs of the invention can be used to transfect cells which will produce the recombinant immunoglobulins.

OBJECT OF THE INVENTION

It is accordingly, an object of the present invention to provide novel DNA sequences for the complementarity determining regions of murine heavy and light chain monoclonal antibody. Another object of the

invention is to provide novel DNA sequences for the complementarity determining regions of murine heavy and light chain monoclonal antibody that immunologically binds to the CD18 integrin or antigen of leukocytes. A further object is to provide novel DNA sequences for recombinant animal antibody. Another object is to provide a vector containing the DNA sequence for recombinant animal antibody. Another object is to provide a mammalian host transformed with a vector containing the DNA sequence for recombinant animal antibody. It is a further object that the animal recombinant antibody be human recombinant antibody. A further objective is to provide recombinant human immunoglobulin that binds to leukocyte integrin. Another object is to provide a process for making recombinant human immunoglobulin. A further object is to provide a process for producing recombinant immunoglobulins.

DETAILED DESCRIPTION OF THE INVENTION

The present invention relates to methods and means for the construction and expression of unique recombinant derived antibody in which complementarity determining regions (CDRs) from a first animal monoclonal antibody of defined specificity are inserted into a second animal, including man, variable heavy and light chain frameworks which show a high degree of sequence similarity with the frameworks of the first animal and present the CDRs in the appropriate configuration to react with the appropriate antigen or ligand. The insertion or grafting is carried out by processes well known in the biotechnical arts, primarily recombinant DNA technology. The unique frameworks (FRs) are selected for their structural compatibility and sequence similarity with the first animal frameworks. This preselection is dependent on one or more of the following criteria: (i) sequence matching to all known human heavy chain variable (V_H) and light chain variable (V_L) framework sequences with the framework sequences of the animal monoclonal antibody from which the CDRs have been removed; (ii) sequence matching as described in (i), but with significant attention paid to interspecies matching of the non-surface exposed amino acid residues; (iii) tertiary and quaternary structural model of human framework sequences with CDRs in place for comparison with models of the original animal monoclonal antibody; and (iv) screening of human genomic DNA with DNA probes corresponding to framework sequences in chosen animal monoclonal antibody. These criteria and the following procedures are used to prepare recombinant DNA sequences which incorporate the CDRs of animal mMAb, both light and heavy chains, into human frameworks that can then be used to transfect mammalian cells for the expression of recombinant human antibody with the antigen specificity of the animal monoclonal antibody.

The present invention further comprises a method for constructing and expressing the altered antibody comprising: (i) mutagenesis and assembly of variable region domains including CDRs and FRs regions; (ii) preparation of an expression vector including at least one variable region which upon transfection into cells results in the secretion of protein sufficient for avidity and specificity determinations; and (iii) co-amplification of heavy and light chain expression vectors in appropriate cell lines.

The present invention provides recombinant methods for incorporating CDRs from animal monoclonal antibodies into human immunoglobulin frameworks so that the resulting recombinant human antibody will be either weakly immunogenic or non-immunogenic when administered to humans. Preferably the recombinant immunoglobulins will be recognized as self proteins when administered for therapeutic purposes. This method of "humanization" will render the recombinant antibodies useful as therapeutic agents because they will be either weakly immunogenic or non-immunogenic when administered to humans. The invention is further contemplated to include the recombinant conversion of any animal monoclonal antibody into a recombinant human monoclonal antibody providing that a suitable framework region can be identified (as described below). It is intended that the present invention include the nucleotide and amino acid sequences of the murine CDR regions and the human framework regions either separately or combined as a light or heavy chain or an intact immunoglobulin and any conservatively modified variants thereof. The animal monoclonals may include, but are not limited to, those murine monoclonal antibodies described by Van-Voorhis et al., *J. Exp. Med.* **158**: 126-145 (1983) which bind to human leukocytes and the appropriate mMAbs produced by hybridomas deposited in the Hybridoma Cell Bank maintained by the American Type Culture Collection (ATCC) and described in the ATCC Catalog of Cell Lines & Hybridomas, No. 6, 1988.

The CDR sequences from the animal monoclonal antibody are derived as follows. Total RNA is extracted from the murine hybridomas, for example the 1B4 myeloma cells described by Wright et al., *Proc. Natl. Acad. Sci. USA* **80**: 5699-5703 (1983), the 60.3 cells described by Beatty et al., *J. Immunol.* **131**: 2913-2918 (1983), the TS1/18 cells described by Sanchez-Madrid et al., *J. Exp. Med.* **158**: 1785-1803 (1983), and other anti-CD18 or CD11 monoclonal antibodies and hybridomas as described in *Leukocyte Typing III*, Springer-Verlag, New York (1988), using standard methods involving cellular solubilization with guanidinium isothiocyanate (Chirgwin et al., *Biochem.* **18**: 5294-5299[1979]). The murine 1B4 mMAb will be used as the primary example of animal MAb that can be "humanized" by the unique process being dis-

closed. The invention is intended to include the conversion of any animal immunoglobulin to a human immunoglobulin. It is further intended that human immunoglobulin (Ig) can contain either kappa or lambda light chains or be one of any of the following heavy chain isotypes (alpha, delta, epsilon, gamma and mu). Pairs of degenerate oligodeoxynucleotide primers (Figure 1) representing sequences within framework 1 of the murine kappa light chain variable region and light chain constant domain, or those within framework 1 of the murine IgG2a heavy chain variable region and heavy chain constant CH1 domain are synthesized on an Applied Biosystem 381A DNA synthesizer, removed from the resin by treatment with concentrated NH_4OH and desalted on a NAP-5 column eluted with H_2O . Total RNA, about 2 μg , is reverse transcribed for about 30 min at about 42° C using Moloney MLV reverse transcriptase, about 200 units (BRL), and about 10 pmoles of the constant region complementary strand primers for either the heavy or light chain. The reverse transcriptase is heat inactivated, about 95° C for about 5 min, and the reactions are made to contain in about 100 μl of PCR buffer about 50 pmoles of each of the paired primers and 25 units of Taq polymerase. About 45 cycles of amplification (2', 94° C; 2', 55° C; 2' 72° C) are followed by gel purification of the anticipated 400+ base pair (bp) DNA fragments (Figure 2). Prior to subcloning those DNAs into a blunt-ended intermediate plasmid such as pSP72 (Promega) they are terminally phosphorylated using T4 polynucleotide kinase. Frozen competent *E. coli* were thawed on ice and 100 μl aliquots were distributed into wet ice chilled polypropylene tubes. DNA (1-10 ng) from the ligation mixture was dispensed with agitation into these tubes and the mixture was incubated on ice for 30 minutes. The *E. coli* cells were heat-shocked by incubation at 42° C for 45 seconds, then chilled for 2 minutes on ice. Room temperature S.O.C. (Hanahan, D., *J. Mol. Biol.* **166**: 557, 1983) was added and the cultures were shaken at 225 RPM at 37° C for 60 minutes. Aliquots of the cultures were spread on LB agar plates containing 100 $\mu\text{g}/\text{mL}$ ampicillin and these plates were incubated overnight at 37° C to allow for colony growth. Multiple clones representing these PCR amplified sequences are grown and submitted to DNA sequence determinations using Sequenase® and T7 and SP6 specific sequencing primers. A unique DNA sequence representing a murine IgG2a heavy chain variable region is obtained, but two kappa light chain variable regions are represented within the cloned population (Figure 3). To distinguish which sequence belongs to the 1B4 mMAb, the 1B4 mMAb is reduced with dithiothreitol (DTT) and purified heavy and light chains are subjected to N-terminal amino acid sequencing using the Applied Biosystems 477A sequencer. Tryptic and cyanogen bromide digested peptides are also sequenced.

Replacement of human variable region CDRs with those unique to mAb 1B4 is accomplished utilizing the following unique processes. An appropriate human framework is determined utilizing the criteria discussed above. A light chain variable region framework such as the REI framework (Orlandi, et al., Proc. Natl. Acad. Sci. USA 86 : 3833-3837[1989]; Riechmann et al., Nature 332 : 323-327[1988]; European Patent Application, Publication No. 239,400), with its leader and 3' intronic sequences, is subcloned into the intermediate vector pGEM3Z (Promega). About eight oligodeoxynucleotide primers (Figure 4) are synthesized representing the primers necessary to generate by polymerase chain reaction (PCR) amplification four DNA fragments. Incorporated into all but the terminal oligodeoxynucleotide primers were those sequences corresponding to MAb 1B4 light chain CDRs and at least 15 bases of 5'-terminal complementarity (see Figure 5). The appropriate primer pair, about 50 pmole each, was combined with about 10 ng of plasmid DNA representing the REI framework, about 2.5 units of Taq DNA polymerase and about thirty (30) cycles of PCR amplification ensued (cycle periods, as above). The products of the four reactions, purified by agarose gel electrophoresis, are combined, about 10 ng of each DNA fragment, along with terminal oligodeoxynucleotide primers (Figure 4) and Taq DNA polymerase and the combined fragments were PCR amplified (see Figure 5). Following restriction endonuclease digestion with HindIII and XbaI the amplified DNA is purified by agarose gel electrophoresis and subcloned into compatible sites of an intermediate vector pSP72 (Promega) which contains the human kappa light chain constant region (see Figure 6). Genomic DNA, about 1 µg, purified from a human B cell line (GM0108A : NIGMS Human Genetic Mutant Cell Repository, Institute for Medical Research, Camden, NJ) is used as a template for PCR amplification (Figure 7) of about a 920 base pair fragment containing the splice acceptor for the kappa light chain constant domain, the exon and a portion of its 3'-untranslated region. The PCR product is purified by agarose gel electrophoresis, digested with BamHI endonuclease, and subcloned into pSP72 previously linearized with BamHI. The individual clones representing the pSP72 intermediate vector containing both the 1B4 grafted variable region derived from REI and the human kappa constant region derived by PCR amplification of human DNA are used to determine the DNA sequence of the grafted light chain variable region.

The chimaeric heavy chain portion of the recombinant antibody is derived from the murine 1B4 heavy chain variable region fused to the human constant region of a gamma 4 subtype obtained from a lambda library constructed by Flanagan and Rabbits, Nature 300 : 709-713 (1982). The variable region of the chimaeric heavy chain is constructed from three DNA

fragments representing a signal sequence, a portion of the murine heavy chain variable region, and an intronic sequence (Figure 8). Oligodeoxynucleotide primer pairs (Figure 9) are synthesized representing the primers necessary to generate by PCR amplification these three DNA fragments from about 10 ng of plasmid DNA templates obtained from M-13VHPCR1 (Orlandi et al., Proc. Natl. Acad. Sci. USA 86 : 3833-3837 [1989]) or the pSP72 intermediate vector containing the IgG2a heavy chain variable region previously used to determine the murine 1B4 CDR sequence. Amplification of the signal fragment, variable region fragment and intron-containing fragment was as described above. The agarose gel purified products are combined, about 10 ng of each product, with terminal oligodeoxynucleotide primer pairs (Figure 9) and the PCR-generated *in vitro*, recombinant template is amplified using the standard procedures described above. Prior to subcloning into a BglII and BamHI digested intermediate vector pSP72 this recombinant product is similarly digested and agarose gel purified. Individual clones are submitted to DNA sequence determination using Sequenase® and T7 and SP6 specific sequencing primers and one is chosen (p8950) for subsequent expression.

The gamma 4 heavy chain constant region is subcloned as about a 6.7 Kb HindIII fragment derived from the plasmid pAT84 (Flanagan and Rabbits, Nature 300 : 709-713 [1982]) into the Hind III site of the intermediate vector pSP72. This plasmid is then used as the template DNA from which a shortened version of the gamma 4 constant region is subcloned using PCR amplification and the primer pairs indicated in Figure 7. Eukaryotic expression vectors are constructed as described below. Expression vectors are defined herein as DNA sequences that are required for the transcription of cloned copies of genes and the translation of their mRNAs in an appropriate host. Such vectors can be used to express eukaryotic genes in a variety of hosts such as bacteria, blue-green algae, plant cells, yeast cells, insect cells and animal cells. The immunoglobulins may also be expressed in a number of virus systems. Specifically designed vectors allow the shuttling of DNA between hosts such as bacteria-yeast or bacteria-animal cells. An appropriately constructed expression vector should contain : an origin of replication for autonomous replication in host cells, selectable markers, a limited number of useful restriction enzyme sites, a potential for high copy number, and strong promoters. A promoter is defined as a DNA sequence that directs RNA polymerase to bind to DNA and initiate RNA synthesis. A strong promoter is one which causes mRNAs to be initiated at high frequency. Expression vectors may include, but are not limited to, cloning vectors, modified cloning vectors, specifically designed plasmids or viruses. The heavy chain immunoglobulin molecule is transcribed from a plasmid carrying

the neomycin (G418) resistance marker while the light chain immunoglobulin is transcribed from a plasmid carrying the hygromycin B resistance marker. With the exception of the drug resistance portion of these plasmids they are identical.

The preferred progenitor of the immunoglobulin expression vectors is the pD5 (Berkner and Sharp, Nucl. Acids Res. 13 : 841-857 [1985]) eukaryotic expression vector which contains the origin of adenovirus replication, the SV40 enhancer domain, the adenovirus major late promoter, the adenovirus 2 tripartite leader, a 5' splice donor from the adenovirus third leader and a 3' splice acceptor derived from an immunoglobulin locus, a multiple cloning site placed in the Bam H1 site subsequent to receipt of the vector, and the SV40 late polyadenylation signal (Figure 10). The origin of replication is removed by digestion with Eco R1 and KpnI and replaced by two fragments representing the neo selectable marker gene (derived from plasmid pCMVIE-AK1-DHFR as an Eco R1/Bam H1 about 1.8 Kb fragment) and the Ig heavy chain enhancer (obtained as a PCR amplified fragment using human DNA as the template, and the oligodeoxynucleotides listed in Figure 7 as the primer pair, following its digestion with Bgl II and Kpn I). The resultant expression vector is found to lack a small portion of the TK promoter responsible for the transcription of the neomycin gene. This is replaced by insertion into the EcoRI site of about a 0.14kb PCR amplified fragment derived from the CMVIE-AK1-DHFR DNA using the primer pair listed in Figure 7. The resultant heavy chain expression vector (p8941) is modified by removal of the indicated HindIII and XbaI sites using standard procedures. To convert this vector into one expressing the hygromycin B selectable marker the neomycin-resistance cassette is removed by digestion first with Eco R1 followed by DNA polymerase-directed fill in of the 5' overhang, then subsequent Sall digestion. The about 1.9 kb hygromycin B expression cassette, TK promoter and TK polyadenylation signal flanking the hygromycin B gene, (obtained as a 1.8 kb BamH1 fragment in plasmid pL690, Gritz and Davies, Gene 25 : 179-188[1981]) is removed from the plasmid pAL-2 by Bam H1 digestion and subcloned into the BamH1 site of the intermediate vector pSP72. The hygromycin B cassette is removed from this vector by digestion with SmaI and Sall and cloned into the expression vector linearized as described above to create a blunt end and Sall end DNA fragment.

Expression of the 1B4 CDR-grafted kappa light chain is accomplished by transferring this cistron from the pSP72-based intermediate cloning vector (p8952) to the hygromycin B selectable eukaryotic expression vector (see Figure 6). An about 1.5 kb DNA fragment resulting from the endonuclease digestion of p8952 with Spe I and Cla I is purified by agarose gel electrophoresis and ligated into the expression vector

which has previously been linearized, following digestion with the same two restriction enzymes, and agarose gel purified. The heavy chain eukaryotic expression vector is constructed in two steps (see Figure 11). First, the p8950 vector containing the modified heavy chain variable region of murine 1B4 Kb fragment is digested with Bgl II and Bam H1. The agarose gel purified 0.75 kb fragment is ligated into the BamH1 site of the p8941 vector and recombinant clones containing this fragment in the proper orientation are identified. Plasmid DNA from one such clone is linearized by Bam H1 digestion and ligated with a 1.78 Kb BamH1 fragment representing a short version of the human gamma 4 constant region, derived from plasmid pAT84 by PCR amplification. Following the identification of clones containing these inserts in the appropriate orientation, plasmid DNAs (one which is referred to as p8953) are grown and purified for transfection into recipient mammalian cells. Host cells for the expression of humanized monoclonal antibodies include, but are not limited to, human cells such as 293 cells, monkey cells such as COS-7 and CV-1P, and other mammalian cells such as CHO and NS0.

Equal amounts, about 10 µg, of the plasmids encoding the chimeric IgG4 heavy chain and the 1B4 CDR-grafted kappa light chain are transfected by standard calcium phosphate precipitation procedures into human 293 cells, and the monkey cells COS-7 and CV-1P. The culture supernatants are assayed by a trapping Elisa (described below) for the secretion of human IgG4/kappa immunoglobulin. This Elisa assay is also employed for the quantitation of the amounts of a humanized 1B4 recombinant antibody expressed in conditioned mammalian cell growth medium.

Immulon-2 (Dynatech Labs.) 96-well plates are coated overnight with about a 5 µg/ml solution of mouse anti-human kappa chain constant domain monoclonal antibody (cat. #MC009, The Binding Site, Inc., San Diego, CA) in about 0.1 M NaHCO₃ buffer (pH 8.2) at about 4°C, and blocked with about 1% bovine serum (BSA) in about 0.1M NaHCO₃ for about 1h at about 25° C. After this and all subsequent steps, washing was performed with phosphate buffered saline (PBS). The wells are then inoculated with conditioned medium containing recombinant anti-CD18 antibody, or with predetermined quantities of human IgG4/kappa purified by protein A Sepharose (Pharmacia Fine Chemicals) chromatography from human IgG4 myeloma serum (cat. #BP026, The Binding Site, Inc.) All samples are diluted in PBS containing about 0.05% Tween-20. About 100 µl aliquots are incubated for about 1h at about 37°C in triplicate, and standard calibration curves are constructed using IgG4 concentrations ranging from about 10 ng/ml to about 100 ng/ml. Bound and fully assembled human IgG4 (either native or recombinant 1B4-human IgG4 constructs) are detected with about 100 µl aliquots of a 1:500

dilution of mouse anti-human IgG4 Fc monoclonal antibody conjugated to alkaline phosphatase (cat #05-3822, Zymed Laboratories, Inc.) in phosphate buffered saline (PBS) containing about 1% BSA. After incubation for about 1h at about 37°C and subsequent washing, the quantities of bound conjugate are detected by incubating all samples with a 1 mg/ml solution of p-nitrophenyl phosphate in 0.1 M 2,2'-amino-methyl-propanediol buffer, pH 10.3, for about 30 min at about 25°C. The adsorbance of the wells is determined with a UV Max ELISA plate reader (Molecular Devices) set at 405 nm. All supernatant fluids from the transfected cells are found to contain this immunoglobulin, though in various amounts (Figure 12). The antibody secreted by the transfected 293 cells is isolated by protein A chromatography and the concentration of recombinant human anti-CD18 antibodies determined by the trapping Elisa described above, are used to compete with the binding of radiolabeled murine 1B4 to the CD18 ligand on the surface of activated human PMNs. Affinities of various recombinant human anti-CD18 (r-h-anti-CD18) antibody constructs are determined using a competitive ¹²⁵I-1B4 soluble binding assay with stimulated human polymorphonuclear leukocytes (PMNs). Purified murine anti-CD18 monoclonal antibody (50 ug) is iodinated using chloramine-T (Hunter and Greenwood, Nature 194: 495-496, 1962), and the radiolabeled antibody purified using a Bio-Sil TSK250 (Biorad) gel filtration HPLC column (which fractionates proteins in the range of 1-300 x 10³ daltons) equilibrated in 0.1 M phosphate buffer, pH 7.0. Effluent radioactivity is monitored with an in-line detector (Beckman Model 170; Beckman) and total protein measured at OD₂₈₀ with a Kratos Spectroflow 757 detector (Kratos). A single ¹²⁵I-1B4 peak composed of coincident OD₂₈₀ and radioactivity tracings characteristically elutes about 6 minutes, 30 seconds following sample injection. Specific activity of the product is generally about 10 μCi/μg protein, and 97-99% of the counts are precipitable with 10% trichloroacetic acid. The binding of this radiolabeled antibody is assessed on human PMNs purified on a discontinuous Ficoll/Hypaque gradient (English and Anderson, J. Immunol. Methods 5: 249-255, 1974) and activated with about 100 ng/ml phorbol myristate acetate for about 20 minutes at about 37°C (Lo et al., J. Exp. Med. 169: 1779-1793, 1989). To determine the avidity of antibodies for CD18 molecules on the PMN surface, about 1 x 10⁵ activated PMNs are incubated in a buffer such as Hanks balanced salt solution containing about 20 mM Hepes (pH 7.2), about 0.14 units aprotinin (Sigma Chemical Co.) and about 2% human serum albumin (binding buffer) containing about 1.3 ng ¹²⁵I-1B4 (2.8 x 10⁻¹¹ M) in the presence of increasing concentrations of unlabeled 1B4 antibody (about 10⁻⁷ to 10⁻¹⁵ M) in about a 300 μl reaction volume for about 1 h at about 4°C with constant agitation. Cell

bound 1B4 is separated from the unbound antibody by centrifugation through a 0.5M sucrose cushion (4,800 x g, 3 minutes); the tubes are frozen on dry ice, and the tips cut off and counted with an LKB gamma counter. The IC₅₀ of the anti-CD18 antibody for the inhibition of ¹²⁵I-1B4 antibody binding is calculated using a four parameter fit program (Rodbard et al., In, "Radioimmunoassay and Related Procedures in Medicine", International Atomic Energy Agency, Vienna, vol 1, 469 - 504, 1978). The affinity of the various recombinant humanized anti-CD18 (r-h-anti-CD18) antibodies for the CD18 ligand is determined in a similar manner using murine ¹²⁵I-1B4 antibody and increasing quantities, as determined by the trapping Elisa, of unlabeled r-h-anti-CD18. The results of the binding assays are shown in Figure 13 and indicate that the avidity of the chimaeric heavy chain/grafted light chain recombinant 1B4 antibody is approximately that of the murine 1B4 monoclonal antibody.

The results described above show that an antibody with human isotype may be recombinantly expressed following the transfer of the antigen binding domains from a first animal (murine) light chain framework to a second animal (human) light chain framework one fused with a human kappa constant region, when combined with a chimaeric heavy chain (murine heavy chain variable region fused to a human gamma 4 constant domain) without loss in avidity for the antigen. It can be inferred from this result that the human REI light chain framework region does not alter the presentation of the murine 1B4 light chain CDRs and/or the contribution of the light chain CDRs to the antibody's avidity is minimal. Many of the examples of construction of recombinant human antibodies containing complementarity regions replaced by those found within murine monoclonal antibodies have resulted in loss of avidity for the ligand or antigen. Thus, although these transmutations are possible, the successful maintenance of avidity is not assured. The procedures described below demonstrate that when strict attention is paid to the framework regions, CDR domains may be transferred to those frameworks without the loss of avidity which accompanies their transfer to the "generic" frameworks employed by Winter, European Patent Publication No. 239,400, published September 30, 1987.

To identify human framework sequences compatible with the CDRs of, say, murine 1B4, human frameworks with a high degree of sequence similarity to those of murine 1B4 were identified. Sequence similarity was measured using identical residues as well as evolutionarily conservative amino acid substitutions. Similarity searches were performed using the murine 1B4 framework sequence from which the CDR sequences had been removed. This sequence was used to query a database of human immunoglo-

bin sequences that had been derived from multiple sources. Sequences with a high degree of sequence similarity were examined individually for their potential as humanizing framework sequences. Special attention must be given to those framework residues which are not located or exposed on the surface of the antibody since these residues will play a critical role in the packing of the CDR supporting scaffolding. In this way, the human homologue providing the murine CDRs with the structure most similar to their native murine framework was selected for subsequent construction of the humanized variable region (see Figure 14). It should be noted that in the present invention the heavy and light chain framework sequences chosen for grafting need not be derived from the same human antibody. That is to say, using the above mentioned criteria for choosing human frameworks the entire accumulated human nucleic acid and protein databases may be searched for the desired matching sequences. The ideal light chain framework may come from one immunoglobulin sequence while the heavy chain framework may come from another. Should human frameworks of sufficient similarity not be identifiable from compiled sequences, it is possible to isolate from human genomic DNA a group of closely related variable regions using recombinant technology. Thus, a degenerate 5' upstream oligodeoxynucleotide primer may be designed from the conserved sequences within the amino-terminus of each of the various human FR1 regions and paired with a degenerate 3' downstream oligodeoxynucleotide primer fashioned from the FR3 sequence determined from the murine monoclonal whose CDRs one wishes to transfer into a human context. These primer pairs are then used to PCR amplify from a human genomic template those DNA sequences which are flanked by the primer pair. The resulting DNAs may then be cloned and the DNA sequence derived from individual members will describe various murine-related human variable regions. The paucity of somatic mutations in framework residues and the conservation of amino acid sequence between mouse and man make this approach possible.

The construction of a complete recombinant human IgG4 antibody, whose heavy and light chain variable domains contain the CDR residues of the murine monoclonal antibody, with complete retention of the specificity and avidity of the parent murine monoclonal antibody is disclosed. The construction of the CDR-grafted light chain framework derived from the human sequence of REI fused with a human kappa light chain constant region is described above.

The murine variable region framework sequence, devoid of CDR sequences, is used to query a database of complete human variable region sequences. The human sequences that are most similar to the murine framework region are then analyzed individually to determine both their sequence identity and

similarity to the murine framework region. In the case of murine 1B4 these sequences include, but are not limited to, Gal and Jon, chosen because of their high degrees of both similarity and identity with the murine 1B4 heavy chain sequence. The Gal FR has been shown to be 85% similar and 79% identical to murine 1B4, while the Jon FR has been shown to be 88% similar and 75% identical to 1B4. These values are based upon the Dayhoff similarity matrix of evolutionarily conserved amino acid substitutions (R. M. Schwartz, M. O. Dayhoff, in *Atlas of Protein sequence and structure* M. O. Dayhoff, Eds. (National Biomedical Research Foundation, Washington, DC [1979]) (see Figure 14). To prepare a recombinant DNA encoding the murine heavy chain CDRs in the context of each of these frameworks the following procedures are performed.

Two sets of four long oligodeoxynucleotides are synthesized. When each set is combined, they encode the 1B4 heavy chain CDRs and the chosen human heavy chain variable region framework. The four oligodeoxynucleotides of a set, about 1 pmole of each, are combined in a PCR reaction with Taq polymerase and about 50 pmoles of each terminal amplifying oligodeoxynucleotide (Figure 15, Figure 16). By virtue of the complementary ends of the single-stranded oligodeoxynucleotides, the polymerization-denaturation-polymerization cycles of the polymerase chain reaction result in the formation, and subsequent amplification, of the combined sequences. Following about 25 cycles of amplification the combined 0.4 Kb fragment is electrophoretically purified from an agarose gel. In parallel, two DNA fragments representing amino terminal sequences encoding the signal peptide and carboxy terminal sequences encoding framework 4, splice donor, and intronic sequences are amplified using oligodeoxynucleotide primer pairs (Figure 15) and the NEWM containing plasmid DNA template M-13VHPCR1 (described above). These two fragments are agarose gel purified, as above, and about 10 ng of each is combined with about 10 ng of the amplified grafted variable region fragment, Taq polymerase, about 50 pmoles of each of the terminal primers (Figure 15) and the mixture was PCR amplified. The resultant 0.85 Kb fragment is digested with restriction enzymes Spe I and BamHI. Following agarose gel electrophoresis, the purified DNA fragment is ligated into the heavy chain expression vector, p8958 (see Figure 11), in place of the chimaeric variable region. In this way, two unique heavy chain frameworks containing the grafted murine CDRs (Jon/1B4 and Gal/1B4) are constructed. Each fully grafted heavy chain expression vector plasmid is co-transfected with the fully grafted REI/1B4 light chain expression vector plasmid into 293 cells and the recombinant human antibody is present in conditioned medium. The Gal/1B4:REI/1B4 heterodimeric human (fully

humanized) recombinant antibody is isolated by protein A chromatography. The avidity of this antibody for the CD18 ligand displayed on the surface of activated human PMNs is compared with that of the chimaeric/grafted antibody, described above, and the 1B4 murine monoclonal antibody parent. Figure 20 shows that although each hetero-dimeric antibody contains the same set of six CDRs, they do not exhibit identical avidity for the ligand. Thus, the avidity of an antibody molecule relies upon the variable region framework structure in which the CDRs are presented. The parent murine monoclonal antibody demonstrates an IC_{50} of about 0.5 nM while the Gal/Rei heterodimer has an IC_{50} of about 1.6 nM.

To determine the relative contribution of the heavy and light chain variable regions to the enhanced avidity of the Gal/REI grafted hetero-dimer, second light chain and heavy chain frameworks were constructed containing the 1B4 CDR sequences. These frameworks, termed Len and mutant Gal or Gal-M1 were chosen from the human immunoglobulin database by virtue of their high degree of similarity to the light chain FR and heavy chain FR of murine 1B4 (Figure 14). The Len FR shows a similarity of 90% and an identity of 81% when compared to murine 1B4. The resulting recombinant antibodies which specifically bind to CD18 antigen or receptor are termed recombinant human anti-CD18 antibodies (r-h-anti-CD18 Abs).

This invention further relates to a method of inhibiting the influx or migration of leukocytes capable of expressing CD18 antigen (leukocyte integrin, beta-2 subunit) on their surface into a site of inflammation or a tissue area or organ that will become inflamed following an influx of the cells. The inflammation which is the target of the method of the present invention may result from an infection with pathogenic microorganisms such as gram-positive and gram-negative bacteria, parasites and fungi. The response may also be induced by viruses and non-infectious means such as trauma or reperfusion following myocardial infarction or stroke, immune responses to foreign antigen and autoimmune responses.

The recombinant human anti-CD18 antibodies are useful in the treatment of inflammation in lung, central nervous system, kidney, joints, endocardium, pericardium, eyes, ears, skin, gastrointestinal tract and urogenital system. Disease states in which the recombinant human anti-CD18 antibodies are useful as therapeutic agents include, but are not limited to: infectious diseases where active infection exists at any body site, such as meningitis; conditions such as chronic or acute secondary inflammations caused by antigen deposition; and other conditions such as, encephalitis; arthritis; uveitis; colitis; glomerulonephritis; dermatitis; psoriasis; and respiratory distress syndrome associated with sepsis and/or trauma. Other inflammatory diseases which

may be responsive to recombinant human anti-CD18 antibody include, but are not limited to, immune disorders and conditions involving T-cell and/or macrophage attachment/recognition, such as acute and delayed hypersensitivity, graft vs. host disease; primary auto-immune conditions such as pernicious anemia; infection related auto-immune conditions such as Type I diabetes mellitus; flares during rheumatoid arthritis; diseases that involve leukocyte diapedesis, such as multiple sclerosis; antigen-antibody complex mediated diseases including certain of the secondary infection states listed above; immunosuppression; and transplant rejection. Inflammatory conditions due to toxic shock or trauma such as adult respiratory distress syndrome and reperfusion injury; and disease states due to leukocyte dyscrasias and metastasis, are included within the scope of this invention.

The present invention is also applicable to the inhibition of leukocyte-endothelial attachment for diagnostic and therapeutic purposes; such as the iatrogenic opening of the endothelium to prevent the ingress of leukocytes during the ingress of a dye or image enhancer into tissue, or to allow the selective entry of a therapeutic drug in the instance of chemotherapy; or to enhance the harvesting of leukocytes from patients.

Recombinant human anti-CD18 antibodies or an active fragment thereof can be used to treat the above mentioned diseases. An active fragment will include the $F(ab')_2$, the Fab and any other fragment that can bind to the CD18 antigen. Recombinant human anti-CD18 antibodies can be administered alone for non-infectious disease states or combined with antibiotics or other anti-infective agents for the treatment of infectious diseases for reasons discussed above. Administration will generally include the antibodies and other substance in a physiologically acceptable medium or pharmaceutical carrier. Such physiologically acceptable media or pharmaceutical carriers include, but are not limited to, physiological saline, phosphate buffered saline, phosphate buffered saline glucose, buffered saline and the like. The antibodies end any anti-infective agent will be administered by parenteral routes which include intravenous, intramuscular, subcutaneous and intraperitoneal injection or delivery.

The amount of the antibodies and the mixture in the dosage form is dependent upon the particular disease state being treated. The amount of the recombinant human anti-CD18 antibody utilized in a dosage form can range from about 1 to about 1,000 mg, with a range of from about 10 mg to about 100 mg being preferred. The antibodies can be administered daily or less than daily as determined by the treating physician.

The following examples illustrate the present invention without, however, limiting the same thereto.

EXAMPLE 1

Preparation of a Grafted / Chimaeric Recombinant Antibody

An antibody was produced in which the variable domain of the light chain comprises the framework regions of a human light chain and the CDRs from a mouse light chain, while the variable domain of the heavy chain is derived entirely from the murine heavy chain. The light chain framework regions were derived from human myeloma protein RE1 (Orlandi, et al., Proc. Natl. Acad. Sci. USA 86 : 3833-3837[1989]; Riechmann et al., Nature 332 : 323-327[1988]; European Patent Application, Publication No. 239,400) for which the crystallographic structure has been determined. The CDR sequences from the murine monoclonal antibody 1B4 which binds to CD18 (the beta subunit of the leukocyte integrin beta-2 family which includes : LFA-1, Mac-1, and p150.95) were derived as follows. The hybridoma designated 1B4 which produces 1B4 monoclonal antibody was deposited under the Budapest Treaty at the International Depository Authority : American Type Culture Collection, 12301 Parklawn Drive, Rockville, MD, 20852. Viability was determined on June 6, 1989 and the hybridoma was designated HB 10164. Previous experiments had determined this antibody to be an IgG 2a with a kappa light chain (Wright et al., Proc. Natl. Acad. Sci. USA 80: 5699-5703 [1983]).

Total RNA was extracted from the 1B4 myeloma cells using standard methods involving cellular solubilization with guanidinium isothiocyanate (Chirgwin et al., Biochem. 18 : 5294-5299[1979]). Sets of degenerate oligonucleotide primers (Figure 1) representing sequences within framework 1 of the murine kappa light chain variable region and kappa light chain constant domain, or those within framework 1 of the murine IgG2a heavy chain variable region and heavy chain constant CH1 domain were synthesized by standard phosphoramidite procedures on an Applied Biosystem 381A DNA synthesizer. Removal of the oligodeoxynucleotides (oligos) from the resin was accomplished by treatment with concentrated NH₄OH followed by desalting on a NAP-5 column (Pharmacia) with H₂O elution (when the oligos were <45 bases in length), or by use of an OPC column (Applied Biosystems Inc) with 20% acetonitrile elution (when the oligos were >45 bases in length), as recommended by the manufacturers. Total RNA (2µg) was reverse transcribed for 30' at 42°C using Moloney MLV reverse transcriptase (200 units, BRL) and 10 pmoles of the constant region complementary strand primers representing either heavy or light chain in a buffer (final volume of 20 µl) containing 50 mM Tris HCl, pH 8.3, 75 mM KCl, 3 mM MgCl₂, 10 mM DTT, and 20 units of RNAsin (Pharmacia). The reverse transcriptase was heat inactivated (95°C, 5') and the reactions

were made to contain in 100 µl of PCR buffer (10 mM Tris HCl, pH 8.3, 50 mM KCl, 1.5 mM MgCl₂, 0.01% gelatin, 200 µM each dNTP), 50 pmoles of each of the paired primers, and 2.5 units of Taq polymerase (Perkin Elmer/Cetus). Polymerase chain reaction (PCR) amplification was carried out essentially as described by Saiki et al., Science 230 : 1350-1354 (1985) and others (Mullis et al., Cold Spring Harbor Symp. Quant. Biol. 51 : 263-273[1986], Dawasaki and Wang, PCR Technology, Principles and Applications for DNA Amplification, Erlich, Ed., Stockton Press, NY, pp. 89-97[1989], Tung et al., ibid. pp. 99-104[1989]). Forty five cycles of amplification by a DNA Thermal Cycler (Perkin Elmer Cetus Instruments) (2', 94°C ; 2', 55°C ; 2' 72°C) were followed by gel purification of the anticipated 400+ base pair (bp) DNA fragments (Figure 2). Prior to subcloning the DNAs into a blunt-ended intermediate plasmid (pSP72, Promega) they were terminally phosphorylated using T4 polynucleotide kinase (Boehringer Mannheim). Frozen competent *E. coli* were thawed on ice and 100 µl aliquots were distributed into wet ice chilled polypropylene tubes. DNA (1-10 ng) from the ligation mixture was dispensed with agitation into these tubes and the mixture was incubated on ice for 30 minutes. The *E. coli* cells were heat-shocked by incubation at 42° C for 45 seconds, then chilled for 2 minutes on ice. Room temperature S.O.C. (Hanahan, D., J.Mol. Biol. 166 : 557[1983]) was added and the cultures were shaken at 225 RPM at 37° C for 60 minutes. Aliquots of the cultures were spread on LB agar plates containing 100 µg/mL ampicillin and these plates were incubated overnight at 37°C to allow for colony growth.

Multiple clones representing these PCR amplified sequences were isolated from DH5 transformed *E. coli* plated on LB agar plates containing 50 µg/ml ampicillin, grown by described procedures (Maniatis et al., Molecular Cloning, A Laboratory Manual, Cold Spring Harbor Laboratory, Cold Spring Harbor, NY, 1982), plasmid DNAs were extracted from the bacteria using the DNA preparation procedures of Birnboim and Doly Nucleic Acid Res. 7 : 1515 (1979), and the double-stranded plasmid DNAs were submitted to DNA sequence determinations using Sequenase® (United States Biochemicals) and T7 and SP6 specific sequencing primers (Boehringer Mannheim) using the protocols recommended by the manufacturer. A unique DNA sequence representing a murine IgG2a heavy chain variable region was obtained, but two kappa light chain variable regions were represented within the cloned population (Figure 3). To distinguish which sequence belonged to the 1B4 MAb, the 1B4 MAb was reduced with DTT and purified light chains were subjected to N-terminal amino acid sequencing using the Applied Biosystems 477A sequencer. Although stretches of amino acid residues were identical to the mMAb 1B4 observed within the 1B4 light chain -1 sequence predicted from the cDNA, 1B4 light

chain -2 (Figure 25) was deemed to be the actual sequence of the MAb 1B4 light chain. This is consistent with the determined DNA sequence of the light chain-1 molecule (Figure 24) which suggests it represents a murine kappa light chain variable region of subgroup III containing a mutation in the CDR3/FR4 region whose consequence is peptide chain termination.

Replacement of the human REI variable region CDRs with those unique to MAb 1B4 took place as follows. The REI framework (obtained as the RF form of the M13 vector M13VKPCR1, Orlandi *et al.*, Proc. Natl. Acad. Sci. USA 86 : 3833 (1989), with its signal peptide leader and intronic sequences, was subcloned into the intermediate vector pGEM3Z (Promega), as was the NEW or NEWM heavy chain variable region framework (obtained in the form of the M13 vector M13VHPCR1, Orlandi *et al.*, *supra*). Eight oligodeoxynucleotides (Figure 4) were synthesized representing the primers necessary to generate by PCR amplification four DNA fragments. Incorporated into all but the terminal oligodeoxynucleotides were those sequences corresponding to the mMAb 1B4 light chain CDRs and at least 15 bases of 5'-terminal complementarity (see Figure 5). The appropriate primer pair (50 pmole each) was combined with 10 ng of REI framework-containing plasmid DNA, 2.5 units of Taq DNA polymerase, PCR reaction components and buffer, and thirty (30) cycles of PCR amplification ensued (cycle periods, as above). The products of the four reactions, purified by agarose gel electrophoresis, were combined (10 ng of each DNA fragment) along with a terminal oligodeoxynucleotide primer pair (amplifier) (Figure 4), Taq DNA polymerase, PCR reaction components and buffer, and the subsequent recombined fragments were amplified, as described above, for thirty cycles (see Figure 5). Following restriction endonuclease digestion with HindIII and XbaI the amplified DNA was purified from an agarose gel and subcloned into these same sites of an intermediate vector pSP72 (Promega) which contained the human kappa light chain constant region, obtained as follows. DNA (1 µg) purified from a human B cell line (GMD1018A ; NIGMS Human Genetic Mutant Cell Repository, Institute for Medical Research, Camden, N.J. 08103) was used as a template for the oligodeoxynucleotide primers described in Figure 7 to PCR amplify a 920 base pair fragment containing the splice acceptor for the human kappa light chain constant domain, the exon and a portion of its 3'-untranslated region (PCR primer pair choice was selected based on the kappa constant region sequence described by Hieter *et al.*, Cell 22 : 197-207[1980]). The PCR product was purified by agarose gel electrophoresis, digested with BamHI endonuclease, and subcloned into pSP72 (Promega) previously linearized with BamHI.

The individual clones (p8982) representing the

pSP72 intermediate vector containing both the 1B4 grafted light chain variable region derived from REI and the human kappa constant region derived by PCR amplification of human DNA were used to verify the DNA sequence of the grafted light chain variable region. The chimaeric heavy chain portion of the recombinant antibody was derived from the murine 1B4 heavy chain variable region fused to the human constant region of gamma 4 subtype obtained from a lambda library constructed by Flanagan and Rabbits, Nature 300 : 709-713 (1982).

The variable region of the chimaeric heavy chain was constructed from three DNA fragments representing a signal sequence, a portion of the murine 1B4 heavy chain variable region, and an intronic sequence (Figure 8). Oligodeoxynucleotide primer pairs (Figure 9) were synthesized representing the primers necessary to generate by PCR amplification these three DNA fragments from 10 ng of plasmid DNA template containing either the NEW heavy chain variable region (M13VHPCR1) or a pSP72 intermediate vector containing the IgG 2a heavy chain region previously used to determine the murine 1B4 CDR sequence. Amplification of the 225 bp signal fragment, 350 bp variable region fragment, and 230 bp intron-containing fragment was performed as described above. The agarose gel purified products were combined (10 ng of each product) with terminal primer pairs (Figure 9) and the PCR-generated *in vitro* recombined template was amplified using the standard procedure described above for recombining the fragments comprising the 1B4 grafted REI light chain variable region. Prior to subcloning into a BglII and BamHI digested intermediate vector (pSP72) (Promega) this recombined product was similarly digested and agarose gel purified. DNA was obtained following growth of individual bacterial clones and submitted to DNA sequence determination using Sequenase® and T7 and SP6 specific sequencing primers in order to verify the sequence of the reconstructed variable region and its flanking domains.

The gamma 4 heavy chain constant region was subcloned as a 6.7 Kb HindIII fragment derived from the plasmid pAT84 (Flanagan and Rabbits, *supra*) into the Hind III site of the intermediate vector pSP72 (Promega). This plasmid (p8947) was then used as the template DNA from which a shortened version of the gamma 4 constant region was obtained using the standard PCR amplification procedures described above and the primer pairs indicated in Figure 7. Eukaryotic expression vectors were constructed as described below such that the heavy chain immunoglobulin molecule was transcribed from a plasmid carrying the neomycin (G418) (Rothstein and Reznikoff, Cell 23 : 191-199[1981]) resistance marker, while the light chain immunoglobulin was transcribed from a plasmid carrying the hygromycin B resistance marker (Gritz and Davies, Gene 25 : 179-188[1983]). With the

exception of the drug resistance portion of these plasmids they are identical.

The progenitor of the immunoglobulin expression vectors was the pD5 eucaryotic expression vector (Berkner and Sharp, Nucl. Acids Res. 13 : 841-857[1985]) which contained the origin of adenovirus replication, the SV40 enhancer domain, the adenovirus major late promoter, the adenovirus 2 tripartite leader, a 5' splice donor from the adenovirus third leader and a 3' splice acceptor derived from an immunoglobulin locus, a multiple cloning site, and the SV40 late polyadenylation signal (Figure 10). The origin of replication was removed by digestion with Eco R1 and KpnI and replaced by two fragments representing the neo selectable marker gene (derived from plasmid pCMVIE-AK1-DHFR (Silberklang et al., Modern Approaches to Animal Cell Technology, Ed. Spier et al., Butterworth, U.K., [1987]) as an Eco R1/Bam H1 1.8 Kb fragment) and the Ig heavy chain enhancer (obtained as a PCR amplified fragment using standard procedures described above and human DNA as the template ; the oligonucleotide primer pair is listed in Figure 7) following its digestion with Bgl II and Kpn I. The resultant expression vector was found to lack a small portion of the TK promoter responsible for the transcription of the neomycin gene. This was replaced by insertion into the EcoRI site of a 0.14 kb PCR amplified fragment derived from the CMVIE-AK1-DHFR DNA using the primer pair also listed in Figure 7. The resultant heavy chain expression vector was subsequently modified by removal of the indicated HindIII and XbaI sites. To convert this neomycin selectable vector (p8941) into one expressing the hygromycin B selectable marker (p8942) (Figure 10) the neomycin-resistance cassette was removed by digestion first with Eco R1 followed by DNA polymerase-directed fill in of the 5' overhang, then subsequent Sall digestion. The 1.9 kb hygromycin B expression cassette [TK promoter and TK polyadenylation signal flanking the hygromycin B gene obtained from Griz and Davies, Gene 25 : 179-188 (1983), as the 1.9 kb BamH1 fragment in plasmid (pLG90)] was removed from the plasmid pAL-2 by Bam H1 digestion and subcloned into the BamH1 site of the intermediate vector pSP72 (Promega). The hygromycin B cassette was removed from this vector by digestion with SmaI and Sall and cloned into the expression vector linearized as described above to create a blunt end and Sall end DNA fragment.

Expression of the 1B4 CDR-grafted kappa light chain was accomplished by transferring this cistron from its position within the pSP72 intermediate vector to the hygromycin B selectable eukaryotic expression vector (Figure 18). A 1.5 kb DNA fragment resulting from the endonuclease digestion of p8952 with SpeI and ClaI was purified by agarose gel electrophoresis and ligated into the expression vector (p8942) which had previously been linearized, by digestion with the

same two restriction enzymes and agarose gel purified.

The heavy chain eukaryotic expression vector (p8958) was constructed in two steps (Figure 11). First, p8949 containing the modified heavy chain variable region of murine 1B4 was digested with Bgl II and Bam H1. The agarose gel purified 0.8 kb fragment was ligated into the BamH1 site of the p8941 vector and recombinants containing this fragment in the proper orientation were identified. One such plasmid was linearized by BamH1 digestion and ligated with the 1.8 Kb BamH1 fragment representing a short version of the human gamma 4 constant region derived from plasmid p8947 by PCR amplification as described above. Following the identification of clones containing these inserts in the appropriate orientation plasmid DNAs were grown (Maniatis et al., supra) and purified for transfection into recipient mammalian cells (Maniatis et al., supra ; Birblion and Doly, supra.

Equal amounts (10µg) of the plasmids encoding the chimaeric IgG4 heavy chain and the 1B4 CDR-grafted kappa light chain were transfected by standard calcium phosphate precipitation procedures into human 293 cells, and the monkey cells COS-7 and CV-1P. The culture supernatant fluids were assayed by a trapping Elisa (described below) for the secretion of a human IgG4/kappa immunoglobulin.

An Elisa was developed for the quantitation of the amounts of a 1B4 recombinant antibody expressed in conditioned mammalian cell growth medium. Immunon-2 (Dynatech Labs.) 96-well plates are coated overnight with a 5 µg/ml solution of mouse anti-human kappa chain constant domain monoclonal antibody (cat. #MC009, The Binding Site, Inc., San Diego, CA) in 0.1 M NaHCO₃ buffer (pH 8.2) at 4° C, and blocked with 1% bovine serum (BSA) in 0.1 M NaHCO₃ for 1 h at 25° C. After this and all subsequent steps, washing was performed with phosphate buffered saline (PBS). The wells are then inoculated with conditioned medium containing recombinant anti-CD18 antibody, or with predetermined quantities of human IgG4/kappa purified by protein A Sepharose (Pharmacia Fine Chemicals) chromatography from human IgG4 myeloma serum (cat. # BP026, The Binding Site, Inc.) All samples are diluted in PBS containing 0.05% Tween-20. 100 µl aliquots are incubated for 1 h at 37° C in triplicate, and standard calibration curves are constructed using IgG4 concentrations ranging from 10 ng/ml to 100 ng/ml. Bound and fully assembled human IgG4 (either native or recombinant 1B4-human IgG4 constructs) is detected with 100 µl aliquots of a 1 :500 dilution of mouse anti-human IgG4 Fc monoclonal antibody conjugated to alkaline phosphatase (cat #05-3822, Zymed Laboratories, Inc.) in phosphate buffered saline (PBS) containing 1% BSA. After incubation for 1h at 37°C and subsequent washing, the quantities of bound conjugate are detected by incubating all samples with a 1 mg/ml solution of p-ni-

trophenyl phosphate in 0.1 M 2,2' amino-methyl-propanediol buffer, pH 10.3, for 30 min at 25°C. The adsorbance of the wells is determined with a UV Max ELISA plate reader (Molecular Devices) set at 405 nm. All supernatant fluids from the transfected cells are found to contain this immunoglobulin, though in various amounts (Figure 12). The antibody secreted by the transfected 293 cells is concentrated by protein A chromatography and the concentrations of the recombinant human anti-CD18 antibodies determined by the trapping Elisa described above, are used to compete with the binding of radiolabeled murine 1B4 to the CD18 ligand on the surface of activated human PMNs. Affinities of various r-h-anti-CD18 antibody constructs are determined using a competitive ¹²⁵I-1B4 soluble binding assay with stimulated human polymorphonuclear leukocytes (PMNs). Purified murine anti-CD18 monoclonal antibody (50 µg) is iodinated using chloramine-T (Hunter, W.M. and Greenwood, F.C., *Nature* 194 : 495-496, 1962), and the radiolabeled antibody purified using a Bio-Sil TSK250 (Biorad, Richmond, CA) gel filtration HPLC column (which fractionates proteins in the range of 1-300 x 10³ daltons) equilibrated in 0.1 M phosphate buffer, pH 7.0. Effluent radioactivity is monitored with an in-line detector (Beckman Model 170 ; Beckman, Fullerton, CA) and total protein measured at OD₂₈₀ with a Kratos Spectroflow 757 detector (Kratos, Mahwah, N.J.). A single ¹²⁵I-1B4 peak composed of coincident OD₂₈₀ and radioactivity tracings characteristically elutes 6 minutes, 30 seconds following sample injection. Specific activity of the product is generally about 10 µCi/µg protein, and 97-99% of the counts are precipitable with 10% trichloroacetic acid. The binding of this radiolabeled antibody is assessed on human PMNs purified on a discontinuous Ficoll/Hypaque gradient (English and Anderson, J. Immunol. Methods 5 : 249-255, 1974) and activated with 100 mg/ml phorbol myristate for 20 minutes at 37°C (Lo et al., J. Exp. Med. 169 : 1779-1793, 1989). To determine the avidity of antibodies for CD18 molecules on the PMN surface, about 1 x 10⁵ activated PMNs are incubated in a buffer such as Hanks balanced salt solution containing 20 mM Hepes (pH 7.2), 0.14 units aprotinin (Sigma Chemical Co.) and 2% human serum albumin (binding buffer) containing 1.3 ng ¹²⁵I-1B4 (2.8 x 10⁻¹¹ M) in the presence of increasing concentrations of unlabeled 1B4 antibody (10⁻⁷ to 10⁻¹⁶ M) in a 300 µl reaction volume for 1 h at 4°C with constant agitation. Cell bound 1B4 was separated from the unbound antibody by centrifugation through a 0.5M sucrose cushion (4,800 x g, 3 minutes) ; the tubes are frozen on dry ice, and the tips cut off and counted with an LKB gamma counter. The IC₅₀ of the anti-CD18 antibody for the inhibition of ¹²⁵I-1B4 antibody binding is calculated using a four parameter filter program (Rodbard, Munson, and DeLean, in "Radioimmunoassay and Related Procedures in Medicine", International Atomic Energy Agency, Vienna, vol I, 469 - 504, 1978). The affinity of the various r-h-anti-CD18 antibodies for the CD18 ligand is determined in a similar manner using murine ¹²⁵I-1B4 antibody and increasing quantities, as determined by the trapping Elisa, of unlabeled r-h-antiCD18. The results of the binding assays are shown in Figure 13 and indicate that the avidity of the chimeric heavy chain/grafted light chain recombinant 1B4 antibody (circles) is approximately that of the murine 1B4 monoclonal antibody (diamonds).

ures in Medicine", International Atomic Energy Agency, Vienna, vol I, 469 - 504, 1978). The affinity of the various r-h-anti-CD18 antibodies for the CD18 ligand is determined in a similar manner using murine ¹²⁵I-1B4 antibody and increasing quantities, as determined by the trapping Elisa, of unlabeled r-h-antiCD18. The results of the binding assays are shown in Figure 13 and indicate that the avidity of the chimeric heavy chain/grafted light chain recombinant 1B4 antibody (circles) is approximately that of the murine 1B4 monoclonal antibody (diamonds).

EXAMPLE 2

Preparation of Fully Grafted Recombinant Human IgG4 Antibodies

This example shows the production of recombinant human IgG4 antibodies, whose variable domains contain the CDR residues of the murine monoclonal antibody 1B4. The construction of the CDR-grafted light chain framework derived from the human sequence of RE1 fused with a human kappa light chain constant region was described in the preceding example (Example 1).

The 1B4-specific heavy chain component of the recombinant antibody was constructed from the IgG4 heavy chain constant region, described in Example 1, fused to a pre-selected human heavy chain variable region framework sequence into which the 1B4 CDR residues were transplanted. The murine 1B4 MAb m1B4 heavy chain was first analyzed to determine the precise position of the CDR sequences. These were determined by visual comparisons with the data sets found in Kabat, Wu, Reid-Miller, Perry, and Gottesman, *Sequences of proteins of immunological interest* (US Dept Health and Human Services, Bethesda, MD, 1987). Once the boundaries of the CDRs were determined these sequences were removed to leave the murine FRs alone. This sequence was then used to query the human immunoglobulin database which was mainly derived from release 22 of the PIR database (George et al., *Nucl. Acids Res.* 14 : 11-16 (1986)). The sequence search was performed using the Profile search system of the GCG sequence analysis package (Devereux et al., *Nuc. Acids Res.* 12 : 387-395[1984]). The matrix used for similarity comparisons was the Dayhoff evolutionary distance matrix (R. M. Schwartz, M. O. Dayhoff, in *Atlas of Protein sequence and structure* M. O. Dayhoff, Eds. (National Biomedical Research Foundation, Washington, DC, 1979)). Additionally, the Risler structural distance matrix (Risler et al., *J. Mol. Biol.* 204 : 1019-1029[1988]) was used to generate the murine sequence profile, and the results of searches with this query were considered with those generated using the Dayhoff matrix. Use of the profile searching system also allowed the weighting of specific residues

within the murine FR that were deemed important based on various criteria. The sequences that repeatedly showed the highest levels of sequence similarity in the database queries were then analyzed using a pairwise comparison to the FRs of murine 1B4. The program Gap of the GCG package was used for this analysis, because it produces an exact measure of both the sequence similarity and identity shared between two sequences. This method was used to select the human sequences Gal and Jon, which shared a similarity of 85% and 88% and identities of 79% and 75% with murine 1B4, respectively (Figure 14). To prepare a recombinant DNA representing the 1B4 heavy chain CDRs within each of these frameworks the following procedures were performed.

Two sets of four long oligonucleotides were synthesized. When each set was combined, they encoded that portion of heavy chain corresponding to the murine 1B4 variable region present in the chimaeric heavy chain expressed in Example 1. The four oligonucleotides of each set (Figure 15, Figure 16), 1 pmole of each, were combined in a standard PCR reaction with 2.5 units of Taq polymerase and 50 pmoles of each terminal amplifying oligodeoxynucleotide (Figure 15, Figure 16). By virtue of the complementary ends of the single-stranded oligonucleotides, the polymerization-denaturation-polymerization cycles of the polymerase chain reaction result in the formation, and subsequent amplification, of the combined sequences. Following 25 cycles of amplification the combined 0.4 Kb fragment was electrophoretically purified and extracted from an agarose gel. In parallel, two DNA fragments representing amino terminal sequences encoding the signal peptide and carboxy terminal sequences encoding framework 4, splice donor, and intronic sequences were amplified using oligodeoxynucleotide primer pairs (Figure 15) and the M13VHPCR1 plasmid DNA template described in example 1. These two DNA fragments were purified by agarose gel electrophoresis, as above, and 10 ng of each was combined with 10 ng of the amplified variable region fragment, 2.5 units of Taq polymerase, 50 pmoles of terminal primers (Figure 15) and the mixture was amplified by 25 cycles of PCR. The resultant 0.8 Kb fragment was digested with restriction enzymes Spe I and BamH1 (Gal) and Hind III and Bam H1 (Jon). Following agarose gel electrophoresis, the purified DNA fragment was ligated into the heavy chain expression vector, p8958, in place of the chimaeric variable region (Figure 11). In this way, two unique heavy chain frameworks containing grafted 1B4 CDRs (1B4/Jon and 1B4/Gal) were constructed. Each fully grafted heavy chain expression vector plasmid was co-transfected with the fully grafted 1B4/REI light chain expression vector (Example 1) plasmid into 293 cells and the antibody present in conditioned medium was

isolated by protein A chromatography. The recombinant humanized 1B4 (h1B4) avidity of these two antibodies for the CD18 ligand displayed on the surface of activated human PMNs was compared with that of the chimaeric/grafted antibody described in Example 1. Figure 20 shows that although each hetero-dimeric antibody contains the same set of six CDRs, they do not exhibit identical avidity for the ligand. Thus, the biological properties of an antibody molecule (ie., its avidity) rely significantly on the variable region framework structure which support the CDR loops.

To determine the relative contribution of the light chain variable region to the enhanced avidity of the Gal/REI grafted hetero-dimer a second light chain framework was constructed containing the 1B4 CDR sequences. The light chain framework Len was identified as a donor framework sequence based upon its selection from the database. Len was identified by using the murine 1B4 light chain framework sequence, with CDRs removed based upon visual identification of the CDRs when compared to Kabat (supra), to query the human immunoglobulin database. The methodology of the query was similar to that described for the heavy chain FRs. Len was shown, by Gap analysis, to be 90% similar and 81% identical to the murine 1B4 light chain FR. Len was thought to be a better choice for grafting of the light chain CDRs than REI, based on its higher levels of both similarity and identity to 1B4 as compared to REI (82% similarity and 65% identity) (see Figure 14). A set of five long oligodeoxynucleotides (Figure 21) representing the Len light chain framework with 1B4 specific CDR sequences and intronic sequences were synthesized using 2.5 units of Taq polymerase and 50 p moles of each terminal amplifying oligodeoxynucleotide primer and combined by PCR, as described above for the Jon and Gal frameworks (Figure 22). Following 25 cycles of amplification the combined 0.6 kb DNA fragment was purified by agarose gel electrophoresis. In parallel, a DNA fragment representing the amino-terminal signal peptide was amplified using a oligodeoxynucleotide primer pair (Figure 21) and the M13VHPCR1 plasmid DNA template, as described in Example 1. This fragment was also purified by agarose gel electrophoresis. These two DNA fragments are placed together, 10 ng of each, with 2.5 units of Taq polymerase, 50 p moles of terminal oligodeoxynucleotide primers (Figure 21) and the entire mixture is subjected to 25 cycles of PCR amplification. The resultant 0.8 kb DNA fragment is digested with restriction enzymes Spe I and Xba I, purified following agarose gel electrophoresis, and ligated into the pSP72/REI 1B4 intermediate vector which is digested with the same two restriction enzymes and electrophoretically purified from its liberated REI/1B4 variable region containing DNA fragment (see Figure 23). The combined light chain variable region and kappa constant region within a sequence verified

clone (p8967) is excised by digestion with restriction enzymes Spe I and Cla I and this 1.5 kb agarose gel electrophoretically purified DNA fragment is cloned into the light chain expression vector p8953, after this latter plasmid is electrophoretically purified from its REI/1B4/kappa light chain insert following digestion with both Spe I and Cla I restriction enzymes. The fully CDR-grafted Gal/1B4 heavy chain expression vector and the fully CDR-grafted Len/1B4 or REI/1B4 light chain expression vector DNAs (10 ug each) are co-transfected into 293 cells and the antibody present in conditioned medium 48 hours later is isolated by protein A Sepharose chromatography. The avidity of these two recombinant antibodies for the CD18 ligand present on the surface of activated human PMNs is determined and compared to that of the murine 1B4 MAAb (Figure 20). The differences between the two humanized 1B4 recombinant antibodies for the ligand, as measured by their IC_{50} s, revealed that a comparison of p values between Gal/Rei and Gal/Len are statistically significant by the students unpaired t-test but the standard deviations of both Mabs overlap (see Figure 20). Thus, although the Len light chain variable region framework sequences, relative to the REI light chain frameworks, show more identical residues and more similar residues when aligned to the murine 1B4 frameworks, this has little, if any, impact on the antibody/antigen interactions measured by avidity. Comparison of the presumed three dimensional structure of these two light chain variable regions (REI and Len) indicates that the alpha carbon trace of the 1B4 CDRs residing within these frameworks are superimposable, again suggesting that the both frameworks identically support the CDRs in space. Does the 1B4 heavy chain variable region play a greater role in avidity of the antibody for its ligand? To address this question, and also to investigate the role of a small number of heavy chain variable region framework sequences, modifications of the Gal/1B4 fully grafted molecule are performed.

Three residues within the heavy chain variable region of Gal/1B4 are chosen to mutate such that they become identical to their counterparts in the murine 1B4 framework (see Figure 14). To accomplish the mutation of three well separated residues simultaneously the following procedures are performed. Four oligodeoxynucleotide primer pairs (Figure 26) are synthesized which incorporate the deoxynucleotide alterations necessary to mutate the amino acid residues located in FR1, FR2, and FR4 of the Gal/1B4 DNA template. In this instance, the polymerase chain reactions needed to produce four overlapping DNA fragments were amplified in such a way as to generate primarily single-stranded DNAs representing the outside two DNA fragments, while the inside two DNA fragments are amplified so as to produce double-stranded DNAs. This approach of combining four amplified DNAs is facilitated by the above modification and,

when combined with the use of terminal amplifying oligodeoxynucleotide primers which are unique to residues found only in the outside amplified DNA fragments, remove the need to purify the PCR products between the first and second round of amplification. Thus, asymmetric PCR is used to amplify the two terminal DNA fragments. Combined into the standard PCR amplification reactions are 50 p moles of primer #S1 and 0.5 p moles of primer #G2 (Figure 26) or 50 p moles of primer #I2 and 0.5 p moles of primer #G2 (Figure 26) and the Gal/1B4 containing plasmid DNA template (10 ng/reaction), 2.5 units of Taq polymerase, and the remaining standard reaction components. The two internal DNA fragments are amplified using the standard procedures which include the presence of 50 p moles of each of the oligodeoxynucleotide primers, 2.5 units of Taq polymerase, and the same template DNA and reaction components described above. Following 25 cycles of amplification (as described previously) the reactions are made to contain 1 ml of H₂O, and each is placed in a Centricon 100 cartridge (Amicon, Danvers, MA), centrifuged for 30 minutes at 3500 x g, at 4° C, and the retentate is resuspended in another 1 ml of H₂O and the centrifugation is repeated. The final retentate is resuspended in 100 µl of H₂O. Each of the four reaction products is combined (1 µl of each of the retained DNA solutions), the standard components are added, 2.5 units of Taq polymerase, and 50 p moles of the PCR recombination amplifying primers (Figure 26), and the reaction is cycled 25 times. The resultant 0.8 kb DNA fragment is phenol extracted, concentrated by ethanol precipitation, and digested with Spe I and Bam H1 restriction enzymes. Following purification of this 0.8 kb DNA fragment by agarose gel electrophoresis it is cloned into the heavy chain expression vector p8958, after this latter plasmid is electrophoretically purified from its Gal/1B4 heavy chain variable region insert liberated by digestion with both Spe I and Bam H1 restriction enzymes. The fully CDR-grafted Gal-m1/1B4 heavy chain expression plasmid DNA is co-transfected (10 ug of each DNA) with the fully CDR-grafted REI/1B4 light chain expression plasmid DNA or the fully CDR-grafted Len/1B4 light chain expression plasmid DNA into 293 cells. The resultant antibodies present in the conditioned medium 48 hours later are isolated by protein A sepharose chromatography and subjected to avidity measurements. Independent of the origin of the light chain variable region framework, the measured avidity for CD18 on the surface of activated human PMNs of the two antibodies is nearly identical. Again the role of the light chain variable region frameworks seems to be minimal. The avidity of the mutated Gal framework (mutated Gal/Rei, Figure 20) is significantly improved relative to the non-mutated Gal heavy chain framework (Gal/Rei in Figure 20) and its avidity is nearly equivalent to that of native m1B4 (Figure 20).

It is concluded that one or more of the three residues mutated contributes to the display of the CDRs (antigen binding sites), thus proper framework choice is critical for optimal humanization of recombinant antibodies. Indeed, it appears that the framework closest to the CDRs dictates the final structural arrangement of the CDRs and thus the ability to bind antigen. Additional comparisons of the heavy chain frameworks reveal major differences between those of New and Jon or Gal when the packing residues are examined (Figure 14). Packing residues as used herein is defined as internal or non-surface exposed residues of the structure that may be involved in intrastrand or interstrand forces. These packing residues are associated with the framework regions adjacent to the CDRs and are involved in the proper orientation of the CDRs for interaction with the substance that induced the antibody formation. Only 27 of 41 internal residues of New match the corresponding residues in the murine 1B4 framework. This is contrasted to the match of 38 of 41 residues by the human Gal framework. The localization of the region of greatest variation to those residues ending framework 2 may explain the differences between the Gal and Jon supported antibodies. This region of framework 2 is where these two differ and where Gal-M1 differs from Gal.

EXAMPLE 3

Enhanced Expression Systems

This example shows expression systems employed to produce large quantities of recombinant CDR-grafted IB4 antibodies as discussed in Example 2. The first expression system applicable to many mammalian cells utilizes the extrachromosomal characteristics of EBNA-1/oriP based DNA plasmids (Yates et al., *Nature* : 313 : 812, 1985). Such a vector, pREP3 described by Hambor et al. (*Proc. Natl. Acad. Sci. USA* 85 : 4010, 1988), containing the hygromycin B selection cassette and the Rous Sarcoma Virus (RSV) LTR for transcription of the gene of interest was modified as disclosed. The RSV LTR, as well as the poly A addition signal, was removed by digestion of the pREP3 plasmid DNA with Sal I and Xba I followed by agarose gel purification of the 9.02 Kb promoterless fragment. DNA from plasmid pD5mcs (see Figure 10), containing the adenovirus major late promoter, a multi-cloning site, and SV40 poly A addition signal was used as the template for the PCR amplification of those sequences beginning with the SV40 enhancer and ending with the SV40 poly A addition signal. In the process of amplification Xba I and Sal I restriction enzyme sites were appended to the product ends by their incorporation into the synthetic PCR oligodeoxynucleotide primers. The expected 1.26 Kb PCR amplified product was agarose gel purified fol-

lowing its digestion with Xba I and Sal I restriction enzymes and ligated into the 9.02 Kb EBNA/oriP backbone vector. The resultant plasmid (p8914) constitutes a versatile mammalian expression vector into which can be ligated either the heavy chain or light chain expression cassette contained within plasmid p8958 (see Figure 19) or p8953 (see Figure 6), respectively. The p8914 plasmid was also the template for the HIVLTR promoter version of the EBNA/oriP backbone vector. In order to switch to the HIVLTR promoter the p8914 plasmid DNA was digested with Bam H1 and Xba I. The 9.35 Kb promoterless backbone was purified by agarose gel electrophoresis. The HIVLTR promoter, from residue -117 to +80 (as found in the vector pCD23 containing this portion of the HIV-1 LTR; (Cullen, *Cell* 46 : 973[1986]) was PCR amplified from the plasmid pCD23 using oligodeoxynucleotide primers which appended to the ends of the product the Spe I and Bcl I restriction sites. Following the digestion of the resulting 0.24 Kb PCR product with these latter enzymes the fragment was agarose gel purified and ligated into the 9.35 Kb DNA promoterless DNA fragment described above. The p8962 plasmid so constructed was also the recipient of the heavy and light chain cassette (Figure 37). To accomplish this the p8962 plasmid DNA was digested within its multicloning site with Not I and Xba I so as to linearize the DNA. The 9.5 Kb linearized expression vector DNA was ligated to either the 2.5 Kb heavy chain cassette obtained by agarose gel purification of Not I and Spe I digested p8960 DNA or the 1.5 Kb light chain cassette obtained similarly following digestion of p8953 DNA with Not I and Spe I. These constructed EBNA/oriP based expression vectors, p8969 and p8968, (Figure 38) were co-transfected into CV1P cells (monkey kidney cells; Figge et al., *Cell* 52 : 713[1988]) which constitutively express the HIV-1 TAT protein by virtue of having previously been transfected with the plasmid pMLTAT (Siekvitz et al., *Science* 238 : 1575[1987]). The cell clones which arose in DMEM medium containing 10% heat inactivated new born calf serum, 200 µg/mL of G418, and 100 µg/ml of hygromycin B were picked using cloning cylinders (Fishney, In, *Culture of Animal Cells*, Alan R. Liss, Inc. New York, 1983) and expanded individually. Clones were screened for the secretion of recombinant antibody using the ELISA assay previously described. Multiple cell clones were expanded and their antibody secretion levels were determined to be in their range of 75 ng - 2 µg of antibody per 96 hours of medium conditioning of 6 well plate cultures. The most productive of these clones was eventually adapted to growth on microcarriers (cytedex 3 and cultisphere GL) and produced approximately 100 mg/L of recombinant antibody each 3 day harvest in serum-free medium at a cell density of 1-2 x 10⁶ cells per ml.

EXAMPLE 4

In Vitro Activity of Recombinant Human Anti-CD18 Antibodies

To increase the precision of avidity determinations, the IB4 competitive binding assay of Example 2 was modified as follows. Both m1B4 (50 µg) or h1B4 (from Examp1s 3) were iodinated using chloramine-T, and the radiolabeled IgG purified over a Bio-Sil TSK250 (Biorad) gel filtration HPLC column that fractionates proteins in the range of 5-300 x 10³ daltons. Effluent radioactivity was monitored with a Beckman #170 in-line gamma counter (Beckman, Fullerton, CA), the total protein was detected by absorbance at 280 nm with a Kratos Spectroflow 757 detector (Kratos, Mahwah, NJ), and the column was equilibrated with 0.1 M phosphate buffer (pH 7.0). A single symmetrical peak of coincident absorbance and radioactivity tracings was routinely observed at 6 min. 30 sec. following sample injection (the retention time characteristic of IgG in this system). Specific activity of the product was usually 10 mCi/mg for m1B4 or 70mCi/mg for h1B4; 96-98% of the counts were trichloroacetic acid-precipitable in either case. SDS-PAGE and autoradiography of ¹²⁵I labeled antibody showed that 1B4 remained intact following radiolabeling. Using these radio-labeled probes, a competitive ¹²⁵I-1B4 suspension binding assay was established to determine the avidity of m1B4 or r-h anti-CD18 (h1B4) for CD18 expressed at the leukocyte surface. Human venous blood was collected freshly into heparin (1.0 unit/ml). PMNs were purified on a Ficol1/Hypaque gradient and activated with 100 ng/ml phorbol myristate acetate in Hanks balanced salt solution containing 20 mM Hepes (pH 7.2), 0.14 units Aprotinin and 2% human serum albumin (binding buffer) for 20 min at 37°C; viability was always >95% by tryan blue exclusion following PMA activation. After washing with binding buffer, aliquots of 1 x 10⁵ stimulated PMNs were incubated in about 2-4 x 10⁻¹¹ M ¹²⁵I-1B4 in the presence of increasing concentrations of unlabeled murine or humanized 1B4 (about 10⁻¹⁶ to 10⁻⁷M) in duplicate or triplicate 300 µl volumes for 1 h at 4°C with constant agitation. The concentrations of purified radio-iodinated 1B4 or unlabeled antibody added as a competitor were determined by U.V. absorption using an E₂₈₀ of 1.35 for m1B4, 1.25 for mutant Gal/REI h1B4, and 1.30 for all other h1B4 constructs [determined by the formula E = A(Ecys) + A (Etryp) + A (Etyr) where A = the number of residues of each amino acid; Gill and von Hippel, Anal. Biochem., 182: 319-328, 1989; the E₂₈₀ of m1B4 and Gal/Rei H1B4 were also verified by quantitative amino acid analysis and differential UV spectroscopy]. After labeling, the ¹²⁵I-1B4 bound to the cells was separated from unbound antibody by underlaying each aliquot of PMNs with 250 µl 0.5 M sucrose

and centrifugation (4,800 x g, 3 min.); the tubes were frozen on dry ice, and the tips cut off and counted with an LKB gamma counter. The quantity of PMN-bound ¹²⁵I-1B4 for each concentration of purified unlabeled competitor IgG was expressed as the mean CPM per 1 x 10⁵ PMNs (± SEM). 1C₅₀s for inhibition of ¹²⁵I-1B4 binding were calculated using a four parameter program ("Filter"; Rodbard, Munson, and Delean in "Radioimmunoassay and Related Procedures in Medicine", International Atomic Energy Agency, Vienna, vol I, 469-504, 1978). The results of the binding assays are illustrated in Figures 13, 20, 28, and 29 (p values are from Student's unpaired t-test). These data indicate that: 1) the avidity of Gal/Rei h1B4 for PMN CD18 is nearly comparable to that of m1B4 (about 2-3 fold weaker); 2) the avidities of Jon/Rei and New/Rei are still weaker than that of Gal/Rei in a rank order that correlates inversely with their degree of homology relative to m1B4 frameworks; 3) the avidity of Gal/Len is nearly equivalent to the avidity of Gal/Rei; and 4) that mutant Gal/Rei and the demi-chimeric construct possess affinities apparently comparable to that of native IB4.

Inhibition of PMN attachment to human umbilical vein endothelial cell (HUVEC) monolayers.

To reach tissue sites and cause inflammatory damage, PMNs must pass out of the bloodstream. This transendothelial migration depends on interaction of PMN CD18-containing receptors with ligands on and within the human endothelium. A direct expression of this process is reflected by attachment of agonist-treated PMNs to the vascular surface. To demonstrate that Gal/Rei h1B4 is a prospective anti-inflammatory agent for use in human disease, we determined whether this construct inhibits adhesion of PMA-stimulated hPMNs to quiescent human endothelial cell monolayers. Human umbilical vein endothelial cells (HUVECs) were grown in T-75 flasks coated with Vitrogen 100 (Collagen Corp., Palo Alto, CA) diluted 1:10 with PBS and dried onto the substrate. The culture medium was MCDB 107 supplemented with 15% FCS, 90 mg/ml heparin (GIBCO), and 150 mg/ml endothelial mitogen (Biomedical Technologies, Inc.); the cells were incubated in 2.5% CO₂ and 97.5% air. Cultures (passages 4-8) were dissociated with trypsin/EDTA, and the HUVECs seeded into 96-well microtiter plates (Costar) pre-coated with a 5 µg/ml solution of purified human plasma fibronectin in 0.1M bicarbonate (pH 8.3); these microcultures were used for the attachment assay upon reaching confluence. Human PMNs were purified from peripheral blood as described above. To measure their attachment to the HUVEC monolayers by fluorescence microscopy, PMNs were labeled with the vital fluorescent dye 1',1'-dioctadecyl-3,3',3'-tetramethylindocarbo-cyanine (Dil) (Molecular Probes, Inc.). PMNs were incubated in a 25 mg/ml sonicated solution of Dil in binding buffer for 10 min.

at 37 °C, washed, and then activated with 50-100 ng/ml PMA or PDB for 10 min. at 37 °C. (These dil-labeled PMNs were tested in the competitive 1B4 binding assay to verify that their CD18 receptors were recognized by h1B4; the IC₅₀s were within the range expected for unlabeled PMNs). PMN aliquots (in quadruplicate) were pretreated with increasing concentrations of either Gal/Rei h1B4, m1B4, or the control Mab OKM-1 (associates with the CD11b component of the CR3 receptor but does not inhibit ligand binding). Incubation was performed for 15 min. at 4 °C with constant agitation, and the cells placed into the microwells containing the HUVEC monolayers (50,000- 100,000 PMNs/well). The PMNs were permitted to settle for 5 min. at 4 °C, and then incubated for 15 min at 37 °C to allow firm adhesion to occur. Unattached PMNs were removed and the cultures fixed by gentle washing with 1% formaldehyde in PBS (4 washes with an Eppendorf Plus 8 multitype pipette). The wells were filled with a solution of 5% n-propyl gallate in glycerol, and the attached PMNs counted at 195 x under rhodamine illumination with an automated Nikon Diaphot inverted fluorescent microscope fitted with an autofocus device, a customized motorized stage, and a video camera (Vidicon #8451) connected to a Model 3000 image analyzer (Image Technology Corp., Deer Park, NY) and an IBM PCXT computer. The mean number of adherent PMNs was determined for each concentration of Mab tested (\pm SEM), and an inhibition curve plus IC₅₀ generated with the "Fitter" program (Rodbard et al. supra.); the data were normalized. The results of these experiments are presented in Figure 30 and Figure 31. Both Gal/Rei h1B4 and m1B4 produced congruent sigmoidal inhibition curves with nearly equivalent IC₅₀s (4-8 nM) that were not significantly different by Students' unpaired t-test. The OKM-1 control IgG did not inhibit PMN attachment. Thus, Gal/Rei h1B4 inhibits adhesion of activated hPMNs to human umbilical vein endothelial cell monolayers to the same extent as native m1B4 in a quantitative homotypic *in vitro* adhesion assay, illustrating anti-inflammatory activity.

Inhibition of CTL-mediated cytotoxicity

Cytotoxic T-lymphocyte (CTL) directed cell killing is an important component of graft rejection following tissue or organ transplantation. Since attachment to and killing of target cells is a CD18-dependent intercellular adhesive event, we determined whether Gal/REI h1B4 inhibits human CTL-mediated cell lysis. Human Q-31 CTL cells were cultivated in RPMI 1640 supplemented with 10% bovine calf serum and 30 units/ml recombinant human IL-2. To induce the differentiated state, fragments of irradiated JY human lymphoblastoid cells were added to the media for 6-7d. The JY cells were propagated as above except without IL-2, and also served as targets for the Q-31

cells. To compare the effects of m1B4 and Gal/Rei h1B4 on cell killing, Q-31 cells were incubated in media with various antibody concentrations for 30 min. at 25 °C before addition of the target cells. To quantify cytotoxicity, JY target cells were labeled with ⁵¹Cr and mixed with effector cells at various E:T ratios of 8:1 to 2.5:1 at 37 °C. After 4h, the percent of ⁵¹Cr liberated into the culture medium for each concentration of antibodies was determined (in triplicate) as an index of cell killing. Cell killing curves that were generated simultaneously with various concentrations of m1B4 (mOKM-1 control) or Gal/Rei h1B4 (hIgG4 control) were utilized to calculate IC₅₀s (Figure 31). Both Gal/Rei h1B4 and m1B4 inhibited JY cell lysis to the same extent. In each case, the mean IC₅₀ was equal to about 2 nM 1B4, and the inhibition curves for both antibodies were superimposable. These results indicate that Gal/Rei 1B4 can prevent the rejection of transplanted tissues and organs.

Tissue and Cellular Specificity of Gal/Rei HhB4

The process of humanization might engender abnormal binding properties that could cause h1B4 to associate with and accumulate in unexpected sites in tissues, cells, and their organelles, with toxic consequences. To ascertain whether the binding properties of Gal/Rei h1B4 were altered, we compared the immunofluorescence microscopic (IF) and immunoelectron microscopic (IEM) localization of Gal/Rei h1B4 and native m1B4 in various rabbit tissues, and in human PMNs, U-937 cells, and fibroblasts.

IF Staining of Tissues and Cells

Healthy 2 kg male New Zealand white rabbits were euthanized, and approximately 1.0 x 1.0 x 0.5 cm³ tissue blocks were excised, immersed in OCT mounting medium (Miles), and frozen rapidly in liquid nitrogen-cooled Freon 22 (Dupont) at ~-150 °C. Samples were obtained from the following organs: bone marrow, cerebrum, kidney, large intestine, liver, lungs, lymph nodes, myocardium, stomach, striated muscle (leg), and spleen, and stored at -80°C. On the day of an experiment, 5 μ m frozen tissue sections were cut with a cryostat at -20 °C, placed on poly-L-lysine-coated glass slides, and air-dried at 25 °C. The sections were immediately immunostained without fixation to avoid denaturation of CD18 antigens. In order to inhibit non-specific binding, slides were washed in 0.1 M Tris-HCl buffer (pH 7.8), and incubated with the clarified supernatant of a solution of 5% non-fat dry milk (Carnation) in 0.1% BSA, 0.1% NaN₃, and 0.1 M phosphate buffer, pH 7.8 for 1 h at 25 °C. All subsequent staining steps were also conducted for 1 h at 25 °C with intermittent washes in 0.1 M Tris-HCl (pH 7.8). For single-labeling experiments, the sec-

tions were stained with a 20 µg/ml solution of primary antibody (m1B4, Gal/Rei h1B4, or hlgG4 control) in staining buffer [0.1% non-fat dry milk, 0.1% BSA, 0.1% Na₂S₂O₈, and 0.1 M phosphate buffer (pH 7.8)]. Bound antibodies were detected indirectly with a 25 µg/ml solution of fluorescein isothiocyanate-conjugated affinity-purified goat anti-mouse IgG, or goat anti-human IgG FITC conjugate (Kirkegaard and Perry, Inc.) in staining buffer. In double-staining experiments, specimens were immunolabeled with a mixture of primary antibodies (1 µg/ml m1B4 and 1 µg/ml h1B4 in staining buffer centrifuged at 12,000xg for 15 min.), followed by a clarified mixed-antibody detection solution [25 µg/ml fluorescein isothiocyanate-conjugated affinity-purified goat anti-human IgG and 25 µg/ml rhodamine isothiocyanate-conjugated affinity-purified goat anti-mouse IgG (Kirkegaard and Perry, Inc.) in staining buffer]. Controls for the dual-labeling experiments were clarified solutions of mixed m1B4 plus hlgG4 (1 µg/ml of each antibody), or m1B4, Gal/Rei h1B4, and hlgG4 dissolved alone at 1 µg/ml IgG in staining buffer; IgGs were localized on the sections with the mixed-antibody detection solution described above. Coverslips were mounted on the slides with a solution of 5% n-propyl gallate in 90% glycerol and 10% 1.0 M Na-bicarbonate, and the sections studied with a Zeiss Photomicroscope III equipped with epifluorescence illumination and fluorescein & rhodamine interference filter combinations. Photomicrographs were taken at 16x or 40x with Zeiss neofluar oil-immersion objective lenses using Ilford HP-5 high-speed film at speeds of 1600-6300 ASA.

The IF staining patterns of Gal/Rei h1B4 and m1B4 in rabbits are summarized in Figure 32. Specific CD18-positive IF labeling for both recombinant and native 1B4 IgGs was observed in tissues known to contain leukocytes. There was no detectable difference in IF distribution or intensity observed with Gal/Rei h1B4 versus m1B4, and control tissues treated with hlgG4 or buffer were always negative. By far, sections of bone marrow presented the most intense CD18 staining with either species of 1B4; 79% of these cells exhibited cytoplasmic labeling. Leukocytes of the spleen and the lymph nodes were stained more irregularly and with lower intensity. A conspicuous population of resident leukocytes was detected in the lungs, and to a much lesser extent in kidney glomeruli. Surprisingly, no CD18 staining was seen in the microglial cells of the cerebrum or in the Kupffer cells of the liver. The other tissues were completely unstained. Titration of the primary antibody solution indicated that a 1.0 µg/ml solution of h1B4 or m1B4 was the minimum concentration of either antibody required to obtain maximum IF staining of bone marrow sections.

Dual IF staining experiments were conducted to determine whether the antigens recognized by

Gal/Rei h1B4 and m1B4 are colocalized in the same cells. Cryosections of bone marrow, spleen, or lymph node were double-labeled with mixtures of Gal/Rei h1B4 and m1B4. As illustrated in Figure 33 for bone marrow, every cell that was positively stained with m1B4 was also labeled with Gal/Rei h1B4. In the control groups, Gal/Rei h1B4 staining (detected under fluorescein optics) was specifically eliminated by substituting hlgG4 for h1B4 in the primary antibody mixture, while retaining the m1B4 labeling (visualized with rhodamine filters). With the converse control, removal of m1B4 from the mixture of primary antibodies ablated the rhodamine labeling, but had no effect on the fluorescein staining generated by Gal/Rei h1B4. These 1B4-colocalization results were therefore highly specific.

These data indicate that native and Gal/Rei humanized 1B4 were localized in the same cells (leukocytes) and exhibited identical staining specificity and intensity in various rabbit tissues. The highest levels of CD18 labeling were observed in those tissues which contain large numbers of leukocytes, with the bone marrow presenting the most intense staining. Therefore, our humanization process has not altered the specificity of 1B4 IgG detectable at the light microscopic level of resolution.

IEM Staining of Human Cell Organelles.

Double label immunoelectron microscopic experiments were conducted to compare the specificity of Gal/Rei h1B4 and m1B4 at the subcellular/supramolecular level of resolution. CD18 antigens have been localized to the specific granules of hPMNs and monocytes via IEM with 60.3 (another Mab that recognizes CD18; Singer et al., *J. Cell Biol.*, 109: 3169-3182 [1989]). Therefore, we determined whether Gal/Rei h1B4 and m1B4 were codistributed in these granules. Human PMNs were isolated from venous blood as described above and prepared for IEM via a modification of a published method (Singer et al, supra). Briefly, the PMNs were fixed with a solution of 3.5% paraformaldehyde and 0.05% glutaraldehyde in 0.1M Na-cacodylate (pH 7.2), 0.1M sucrose, and a mixture of broad spectrum protease inhibitors. Fixation was performed under microwave irradiation until the cells reached 45°C (-45 sec.), followed by quenching with excess buffer at 4°C. Cell pellets were embedded in 7% acrylamide, infiltrated with 2.3M sucrose in 0.1M phosphate (pH 7.2), frozen in liquid propane (-190°C) and cut into ultrathin (~80 nm) cryosections. The specimens were double labeled with Gal/Rei h1B4 and m1B4 using 5 nm and 10 nm protein-A colloidal gold conjugates (Janssen Life Science Products) as described, and analyzed at 29,000x with a JEOL 100CX transmission electron microscope. A summary of the immunostaining results for PMNs is shown in Figure 34. Both Gal/Rei

h1B4 and m1B4 were colocalized in specific granules ; negative controls showed that the colloidal gold probes were not cross-reacting nonspecificly. Further, Gal/Rei h1B4 and m1B4 were also colocalized within a population of cytoplasmic granules in U-937 cells (a human myelomonocytic line), but not in human lung fibroblasts (IMR-90). These observations strongly suggest that the binding specificity of Gal/Rei 1B4 is comparable to that of m1B4 at supramolecular resolution.

EXAMPLE 5

In Vivo Activity Of Recombinant Human Anti-CD18 Antibodies

The in vivo potencies of murine 1B4 (m1B4) and humanized 1B4 (h1B4) (Examples 2 and 4) were compared in the rabbit by assessing their ability to inhibit dermal inflammation, manifest as PMN accumulation and plasma extravasation, elicited by intradermal administration of C5a.

The dorsal hair of female New Zealand White rabbits (2 -2.5 kg) was shaved at least 24 hours prior to experimentation. Rabbits were anesthetized with an intramuscular injection of Ketamine HCl (60 mg) and Xylazine (5 mg). [¹²⁵I]-Bovine serum albumin (10 μCi) was injected into the marginal ear vein, as a marker of plasma extravasation. Groups of animals were then treated with saline, m1B4 administered intravenously at 0.07, 0.21 or 0.7 mg/kg, or h1B4 administered intravenously at 0.1, 0.3 or 1 mg/kg 15 minutes before initiation of the dermal inflammation. Thereafter, human recombinant C5a (100 pmol), or saline, in a volume of 50 μl was injected intradermally into 4 replicate sites in the dorsum. Three hours later, a blood sample (1 ml) was taken and centrifuged (8000g ; 3 min ; 20°C) to prepare cell-free plasma which was aspirated and retained. Animals were then euthanized with approximately 750 μl Socumb (Sodium Pentobarbital 389 mg/ml in 40% isopropyl alcohol), and injection sites were excised using a 6 mm biopsy punch. Radioactivity ([¹²⁵I]) present in skin samples and cell-free plasma (50 μl) was quantified using a gamma counter. By reference to the specific radioactivity of the cell-free plasma, the extent of plasma extravasation was expressed as μl plasma equivalents per 6 mm biopsy. The skin biopsy was then homogenized in 5 ml of 0.5% Hexadecyltrimethyl ammonium bromide (HTAB) using a polytron homogenizer. Chloroform (1 ml) was added to the sample, which was vortexed and centrifuged (1600g ; 15 min. ; 20°C). Four aliquots (50 μl) of the aqueous supernatant were added to wells in a 96 well plate for measurement of myeloperoxidase (MPO) activity, as an index of PMN content. Duplicate wells of the 96 well plate received 200 ml buffer (KH₂PO₄ 44 mM ; K₂HPO₄ 6 mM ; H₂O₂ 0.0015% ; pH 6.0) alone (back-

ground) and duplicate wells received buffer containing MPO substrate (3',3-Dimethoxybenzidine dihydrochloride ; 360 μg/ml). Reactions were allowed to proceed for 15 min. at room temperature, and MPO activity was measured as the change in absorbance at 450 nm measured in a plate reading spectrophotometer. By reference to a standard curve constructed using known quantities of rabbit PMN in HTAB, the extent of PMN accumulation in each skin biopsy was estimated.

The injection of C5a into the skin of rabbits pretreated with saline produced significant increases in PMN accumulation (Figure 35) and plasma extravasation (Figure 36) compared with skin sites injected with saline. In animals pretreated with either m1B4 or h1B4 there was dose-related inhibition of both PMN accumulation (Figure 35) and plasma extravasation (Figure 36). Both antibodies were of comparable potency, as indicated by the estimated ED₅₀ values for inhibition of PMN accumulation and plasma extravasation which were approximately 0.15 mg/kg for both m1B4 and h1B4.

Claims

1. A method for producing a humanized recombinant immunoglobulin comprising :
 - a. preparing polymerase chain reaction primers to amplify the variable portion of the light and heavy chain of a murine antibody which binds to a predefined antigen ;
 - b. using the primers to amplify the variable portions of both heavy and light chains and sequencing the resulting nucleotide chains ;
 - c. determining the murine complimentary determining regions of the heavy and light chains ;
 - d. selecting human variable heavy and light chain frameworks which show a high degree of amino acid similarity with the variable heavy and light chain framework of the murine immunoglobulin ;
 - e. selecting human constant heavy and light chain frameworks ;
 - f. grafting the murine complimentary determining regions of section c to the human framework regions of section e ;
 - g. incorporating the complete DNA sequence for the humanized recombinant immunoglobulin into an appropriate expression vector ;
 - h. transfecting host cells with the expression vector of section g ;
 - i. growing the transfected cells of section g in an environment in which the humanized recombinant immunoglobulin will be produced by the transfected cell ;
 - j. collecting the immunoglobulin.

2. The method of claim 1, section d wherein the selection process will include one or more of the following steps :

- a. comparing the framework sequences of the murine monoclonal antibody from which the CDRs have been removed with all human heavy chain variable and light chain variable framework sequences ; 5
- b. closely comparing the non-surface exposed residues ; 10
- c. comparing the tertiary and quaternary structural model of human framework sequences with CDRs in place for comparison with models of the original animal monoclonal antibody ; 15
- d. screening of human genomic DNA with DNA probes corresponding to framework sequences in chosen animal monoclonal antibody. 20

3. A polymerase chain reaction method for the simultaneous synthesis and assembly of at least four deoxyoligonucleotides. 25

30

35

40

45

50

55

23

MOUSE LIGHT CHAIN VARIABLE REGION

5' UPSTREAM PRIMER - FR1 OF VARIABLE REGION

5'- TCT CGGATC CGA (CT)AT (TC)GT G(AC)T (GC)AC CCA (GA)-3'

BAM HI

3' DOWNSTREAM PRIMER - KAPPA CONSTANT REGION

5'- TCT CAA GCT TTG GTG GCA AGA T(GA)G ATA CAG TTG GTG CAG C -3'

HIND III

MOUSE HEAVY CHAIN VARIABLE REGION

5' UPSTREAM PRIMER - FR1 OF VARIABLE REGION

i) 5'- TTC TGG ATC C(CG)A GGT (GCT)CA (AG)CT G(AC)A G(GC)A GTC (TA)GG -3'

BAM HI

ii) 5'- TTC TGG ATC C(CG)A GGT (GCT)AA GCT GGT G(GC)A GTC (TA)GG -3'

BAM HI

3' DOWNSTREAM PRIMER - IgG2a CH1 REGION

5'- TCT CAA GCT TAC CGA TGG (GA)GC TGT TGT TTT GGC -3'

HIND III

FIG. 1

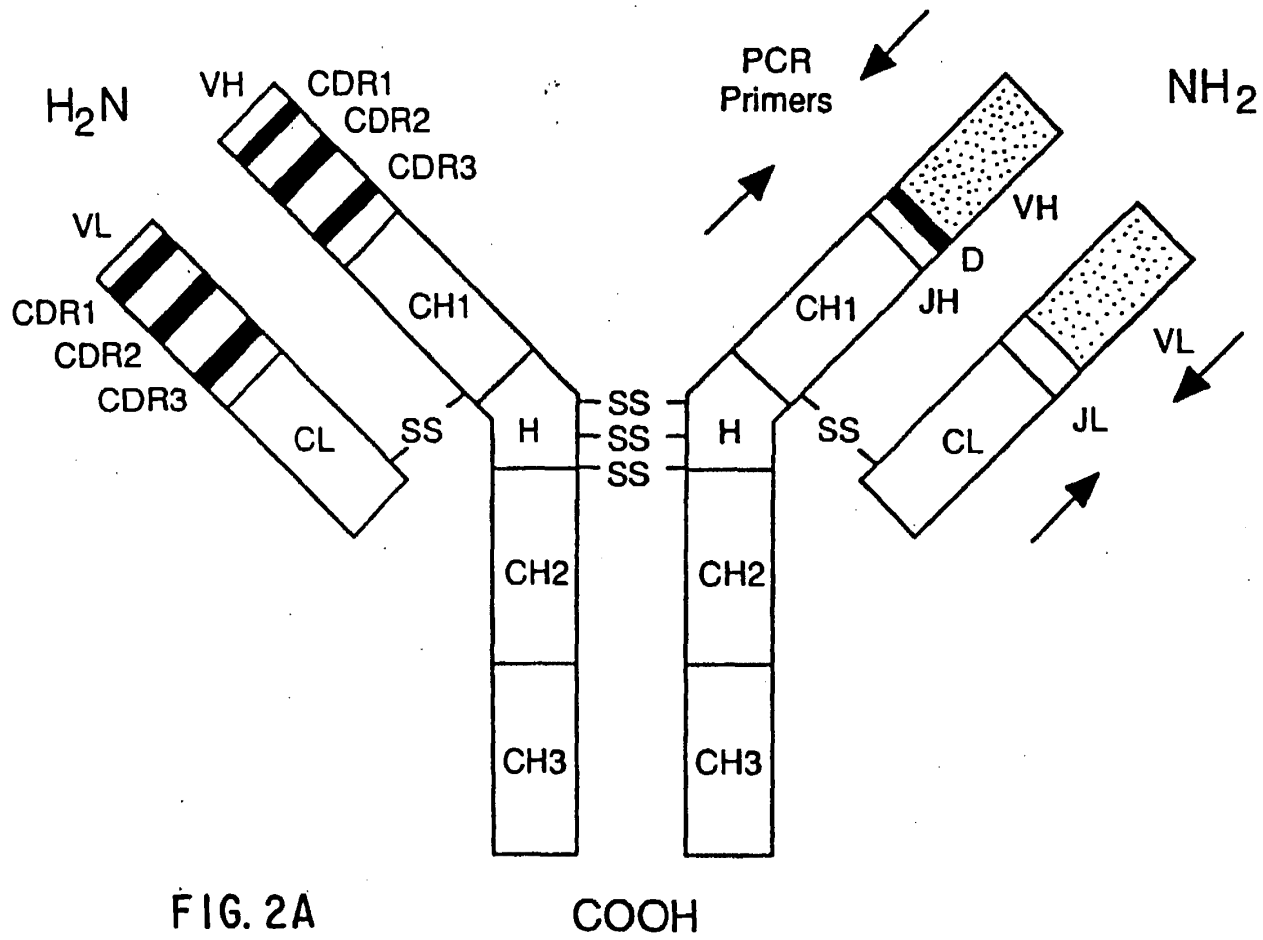

25

EP 0 438 310 A1

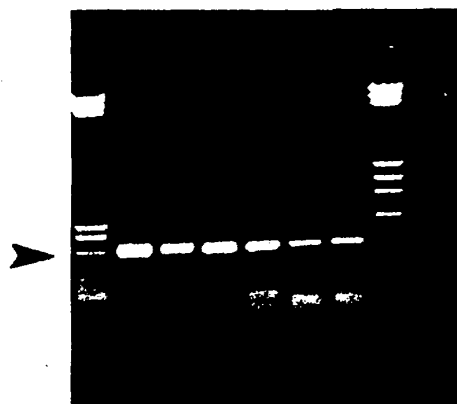

FIG. 2 B

1B4 HEAVY CHAIN

Asp*Val Lys Leu Val Glu Ser Gly Gly Asp Leu Val Lys Leu Gly Gly Ser Leu
Lys Leu Ser Cys Ala Ala Ser Gly Phe Thr Phe Ser [Asp Tyr Tyr Met Ser] Trp
Val Arg Gln Thr Pro Glu Lys Arg Leu Glu Leu Val Ala [Ala Ile Asp Asn Asp
Gly Gly Ser Ile Ser Tyr Pro Asp Thr Val Lys Gly] Arg Phe Thr Ile Ser Arg
Asp Asn Ala Lys Asn Thr Leu Tyr Leu Gln Met Ser Ser Leu Arg Ser Glu Asp
Thr Ala Leu Tyr Tyr Cys Ala Arg [Gln Gly Arg Leu Arg Arg Asp Tyr Phe Asp
Tyr] Trp Gly Gln Gly Thr Thr Leu Thr Val Ser Ser Ala Lys Thr....

1B4 LIGHT CHAIN-1

Asp Ile Val Leu Thr Gln Ser Pro Ala Ser Leu Ala Val Ser Leu Gly Gln Arg Ala
Thr Ile Ser Tyr [Arg Ala Ser Lys Ser Val Ser Thr Ser Gly Tyr Ser Tyr Met
His] Trp Asn Gln Gln Lys Pro Gly Gln Pro Pro Arg Leu Leu Ile Tyr [Leu Val
Ser Asn Leu Glu Ser] Gly Val Pro Ala Arg Phe Ser Gly Ser Gly Ser Arg Thr
Asp Phe Thr Leu Asn Ile His Pro Val Glu Glu Glu Asp Ala Ala Thr Tyr Tyr
Cys [Gln His Ile Arg Glu Leu Thr] Arg Ser Glu Gly Gly Pro Ser Trp Lys ter

FIG. 3A

27

EP 0 438 310 A1

1B4 LIGHT CHAIN-2

Asp Ile Val Leu Thr Gln Ser Pro Ala Ser Leu Ala Val Ser Leu Gly Gln Arg Ala
Thr Ile Ser Cys [Arg Ala Ser Glu Ser Val Asp Ser Tyr Gly Asn Ser Phe Met
His] Trp Tyr Gln Gln Lys Pro Gly Gln Pro Pro Lys Leu Leu Ile Tyr [Arg Ala
Ser Asn Leu Glu Ser] Gly Ile Pro Ala Arg Phe Ser Gly Ser Gly Ser Arg Thr
Asp Phe Thr Leu Thr Ile Asn Pro Val Glu Ala Asp Asp Val Ala Thr Tyr Tyr
Cys [Gln Gln Ser Asn Glu Asp Pro Leu] Thr Phe Gly Ala Gly Thr Lys Leu Glu
Leu Lys Arg Ala Asp...

[CDRs] ; underline = homology to protein sequence

Asp* determined from N-terminal amino acid sequencing; PCR primer
encoded GAG for Glu

FIG. 3B

28

EP 0 438 310 A1

#S1 5'- CAT TCG CTT ACC AGA TCT AAG CTT ACT AGT GAG ATC ACA GTT CTC TCT AC -3'

Bgl II Hind III Spe I

#R1 5'- GCC ATA ACT ATC AAC ACT TTC ACT GGC TCT ACA GGT GAT GGT CAC TCT GTC -3'

#R2 5'- GTG TTG ATA GTT ATG GCA ATT CTT TTA TGC ACT GGT ACC AGC AGA AGC CAG G -3'

#R3 5'- GAT TCT AGG TTG GAT GCA CGG TAG ATC AGC AGC TTT GGA GC -3'

#R4 5'- GCA TCC AAC CTA GAA TCT GGT GTG CCA AGC AGA TTC AGC -3'

#R5 5'- GGA TCC TCA TTA CTT TGC TGG CAG TAG TAG GTG GCG ATG TC -3'

#R6 5'- CAA AGT AAT GAG GAT OCT CTC ACG TTC GGC CAA GGG ACC AAG GTG -3'

#I1 5'- GAA TGT GCC TAC TTT CTA GA G GAT CC A ACT GAG GAA GCA AAG -3'

Xba I Bam H1

PCR RECOMBINATION AMPLIFIERS

#A1 5'- CAT TCG CTT ACC AGA TCT -3'

#A2 5'- GAA TGT GCC TAC TTT CTA G -3'

FIG. 4

29

EP 0 439 310 A1

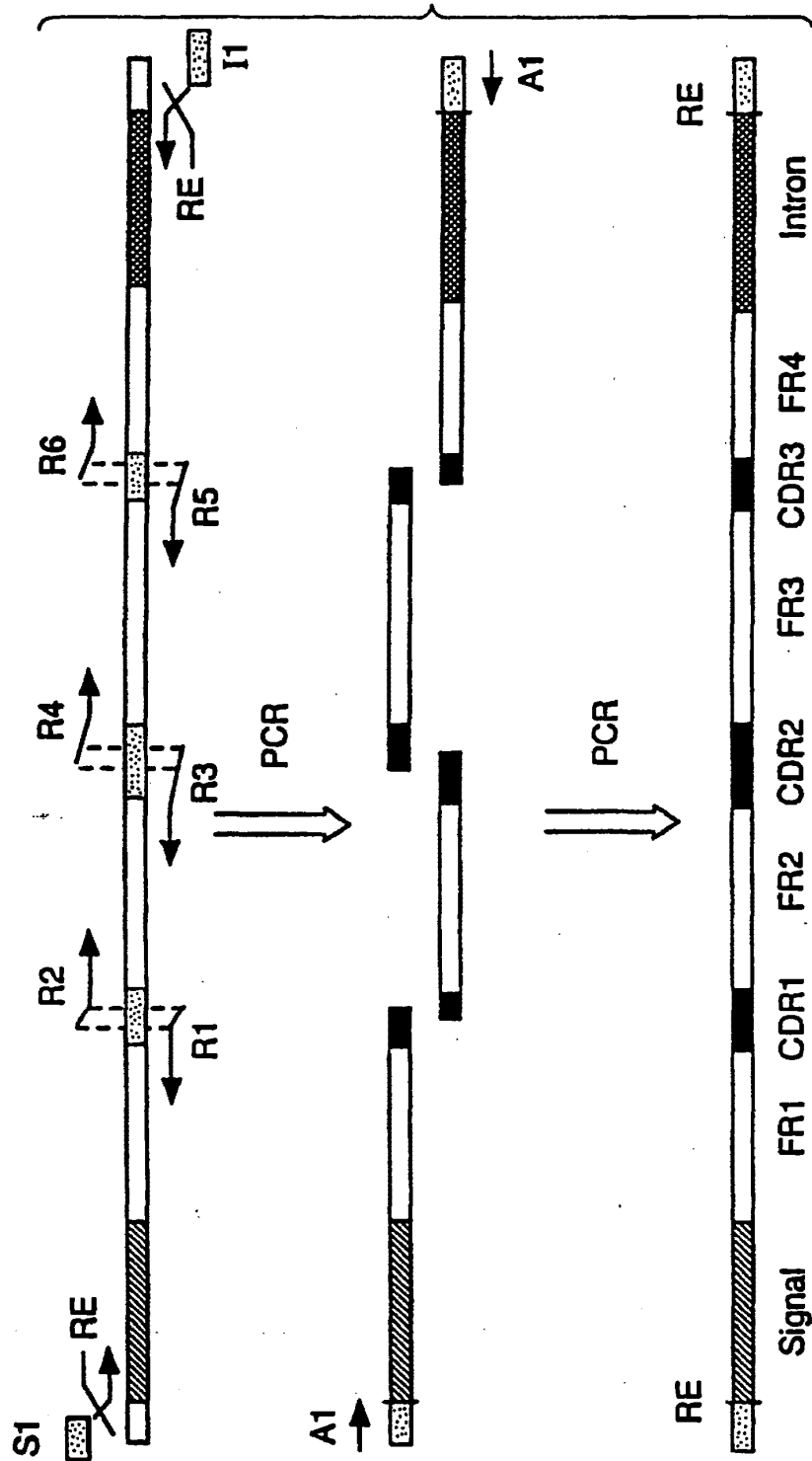

FIG. 5

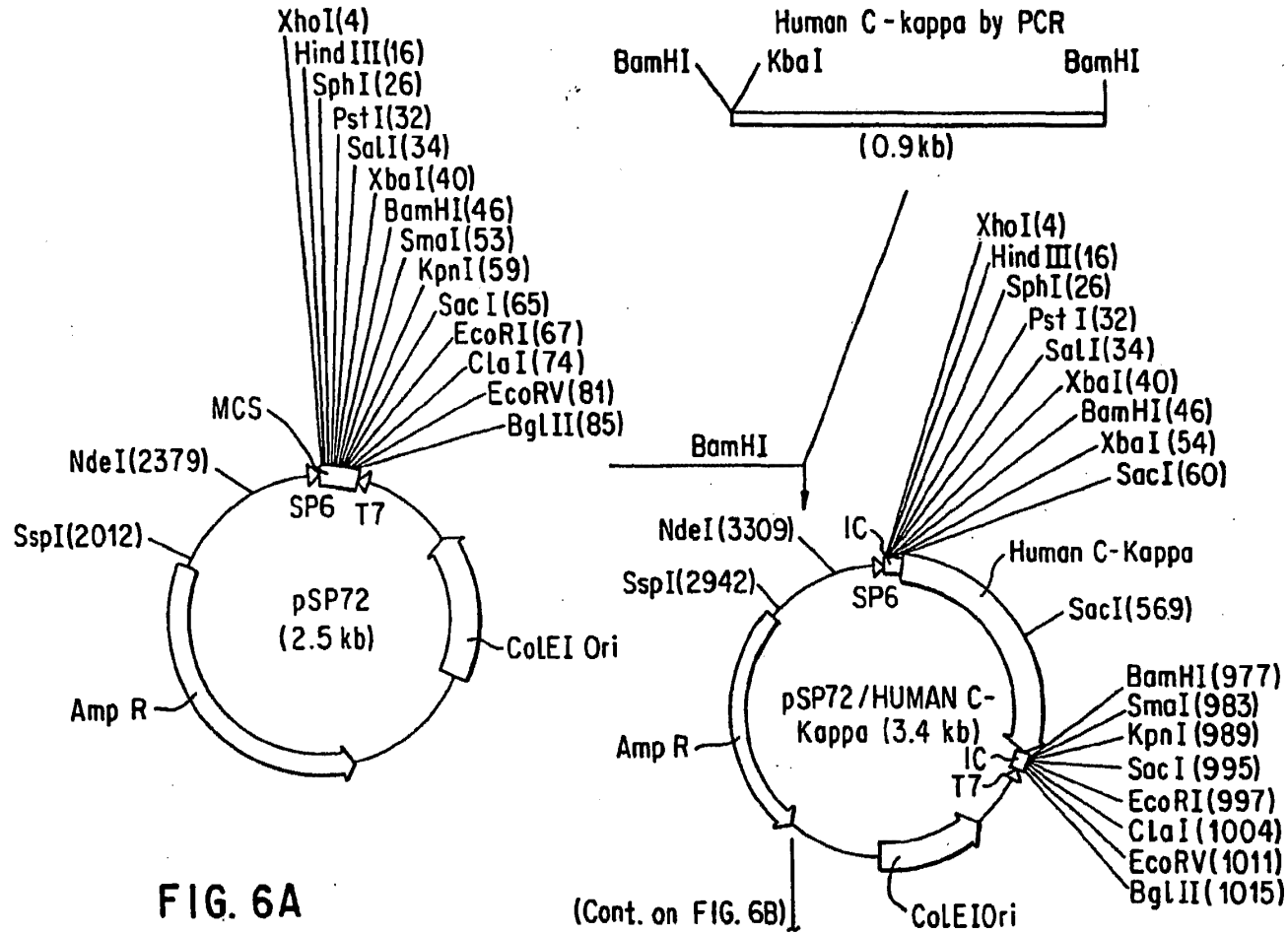
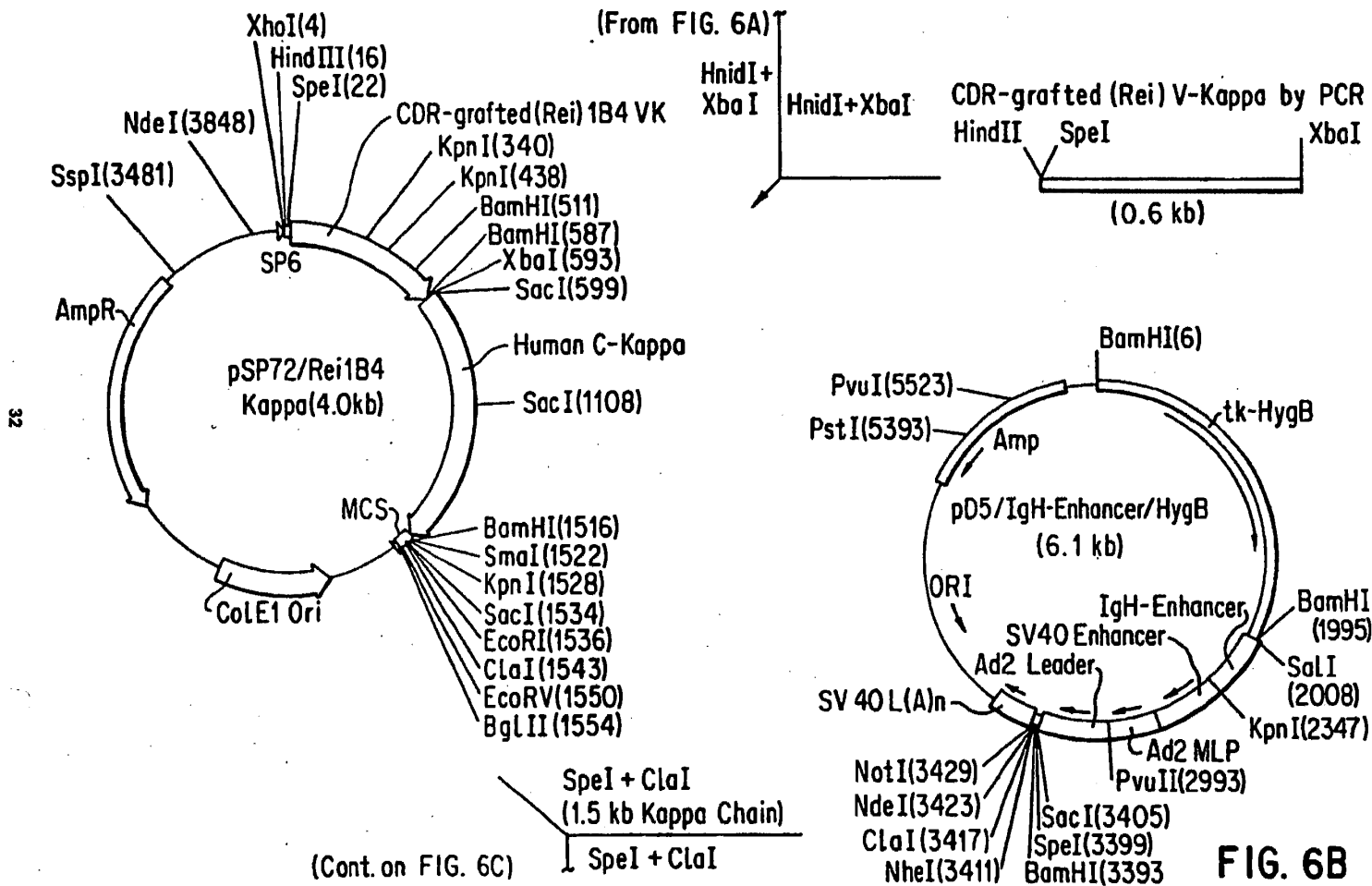

FIG. 6A

(Cont. on FIG. 6B)



EP 0 438 310 A1

FIG. 6B

(From FIG. 6B)

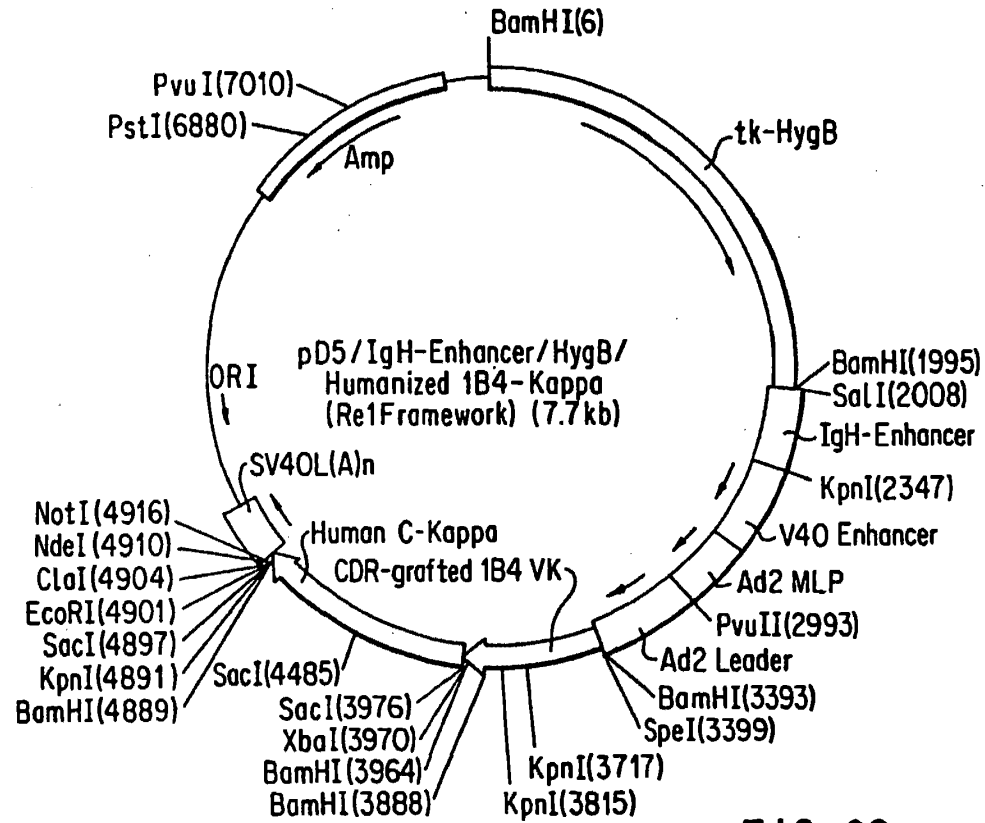

FIG. 6C

33

EP 0 438 310 A1

SHORTEN VERSION OF THE IgG4 HEAVY CHAIN CONSTANT REGION

5'- ATT TGG ATC C TC TAG A CA TCG CGG ATA GAC AAG AAC -3'

Bam H1 Xba I

5'- AAT AAT GCG GCC GC A TCG AT G AGC TCA AGT ATG TAG ACG GGG TAC G -3'

Not I Cla I Sac I

TK PROMOTER FRAGMENT

5'- TAT AGA ATT C GG TAC CCT TCA TCC CCG TGG CCC G -3'

Eco R1 Kpn I

5'- TGC GTG TTC GAA TTC GCC -3'

Eco R1

Ig H ENHANCER

5'- TTT TAG ATC T GT CGA CAG ATG GCC GAT CAG AAC CAG -3'

Bgl II Sal I

5'- TTG GTC GAC GGT ACC AAT ACA TTT TAG AAG TCG AT -3'

Sal I Kpn I

HUMAN KAPPA CONSTANT REGION

5'- TCT CGG ATC CTC TAG AAG AAT GGC TGC AAA GAG C -3'

5'- TCT CGG TAG CGG ATC CTT GCA GAG GAT GAT AGG G -3'

FIG. 7

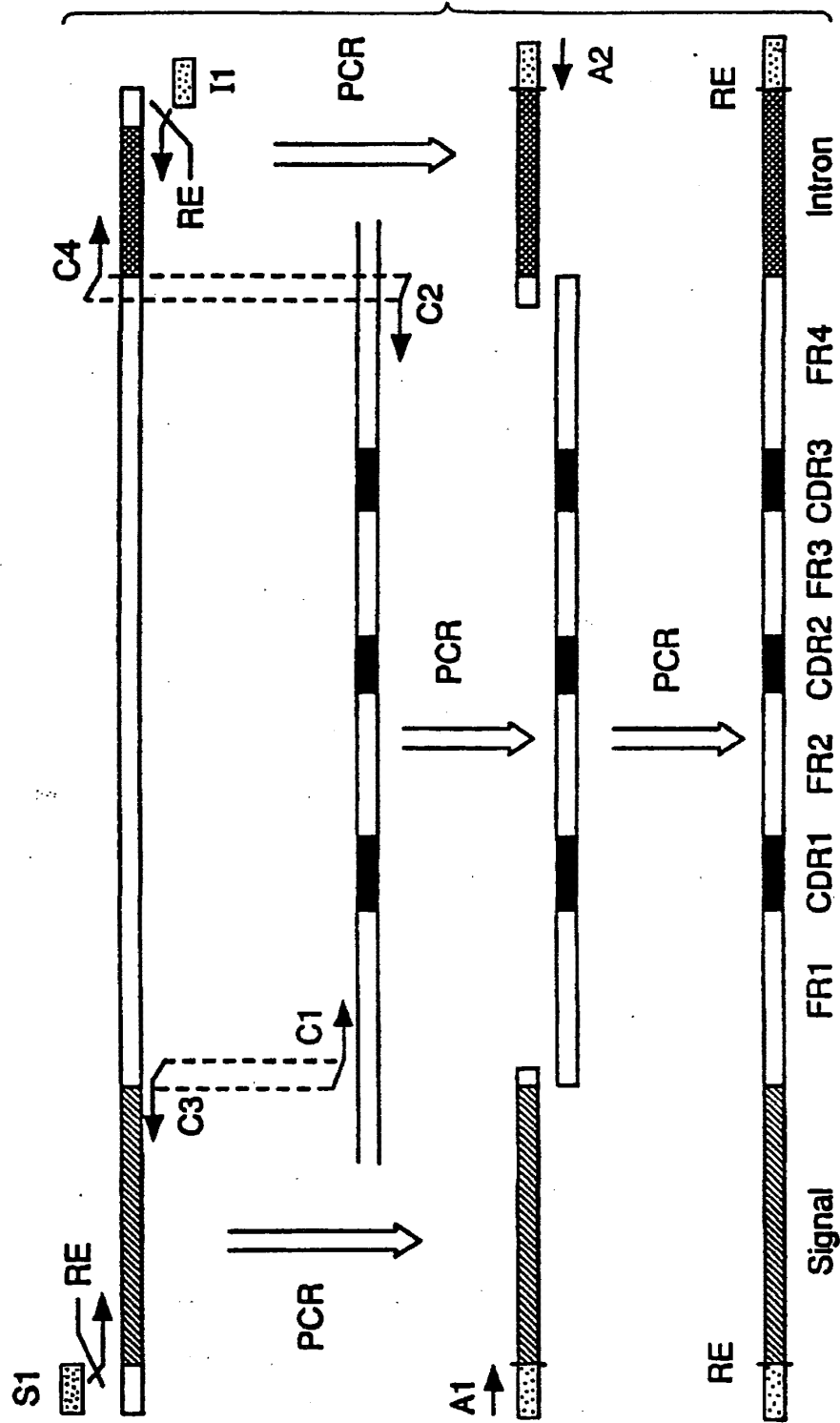

FIG. 8

S1 5'- CAT TCG CTT ACC AGA TCT AAG CTT ACT AGT GAG ATC ACA GTT CTC TCT AC -3'

Bgl II Hind III Spe I

C1 5'- GAT GTG AAG CTG GTG GAG TCA G -3'

C2 5'- CTC CAC CAG CTT CAC ATC GGA GTG GAC ACC TGT GGA GAG -3'

C3 5'- TGA GGA GAC TGT GAG AGT GGT G -3'

C4 5'- CTC TCA CAG TCT CCT CAG GTG AGT CCT TAC AAC CTC TC -3'

I1 5'- GAA TGT GCC TAC TTT CTA GA G GAT CC A ACT GAG GAA GCA AAG -3'

Xba I Bam H1

PCR RECOMBINATION AMPLIFIERS

A1 5'- CAT TCG CTT ACC AGA TCT -3'

A2 5'- GAA TGT GCC TAC TTT CTA G -3'

FIG. 9

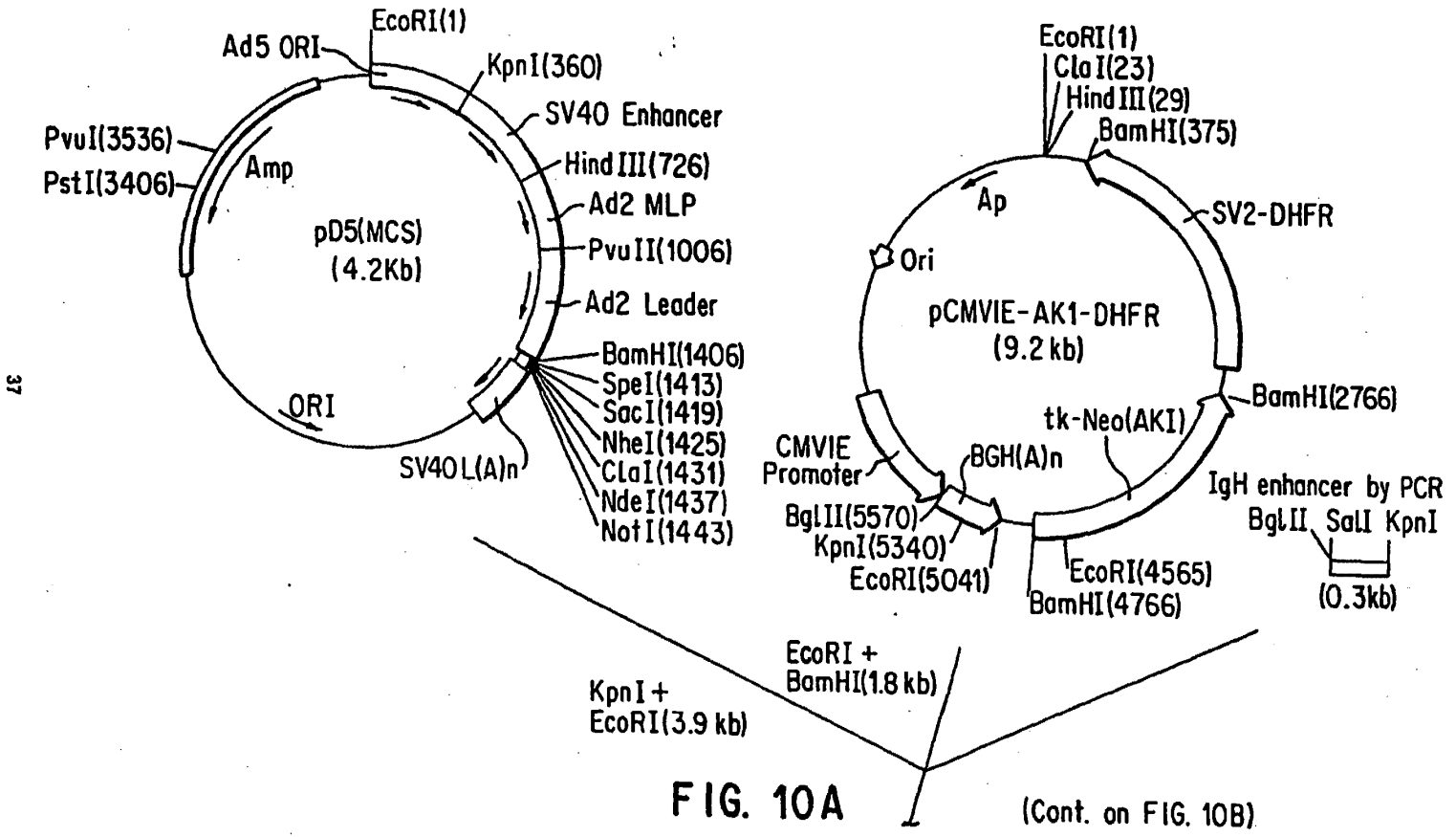

37

EP 0 438 310 A1

FIG. 10A (Cont. on FIG. 10B)

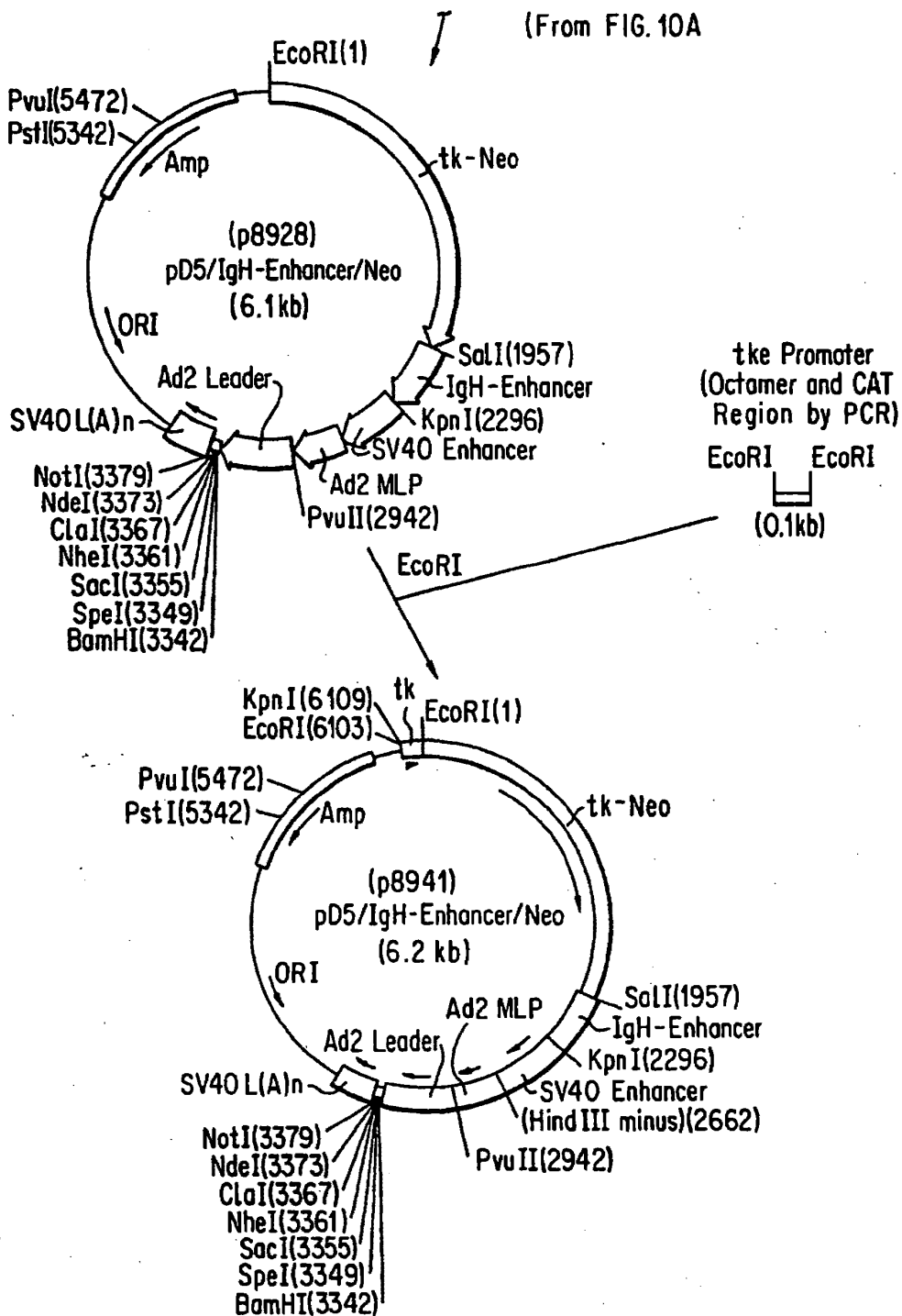
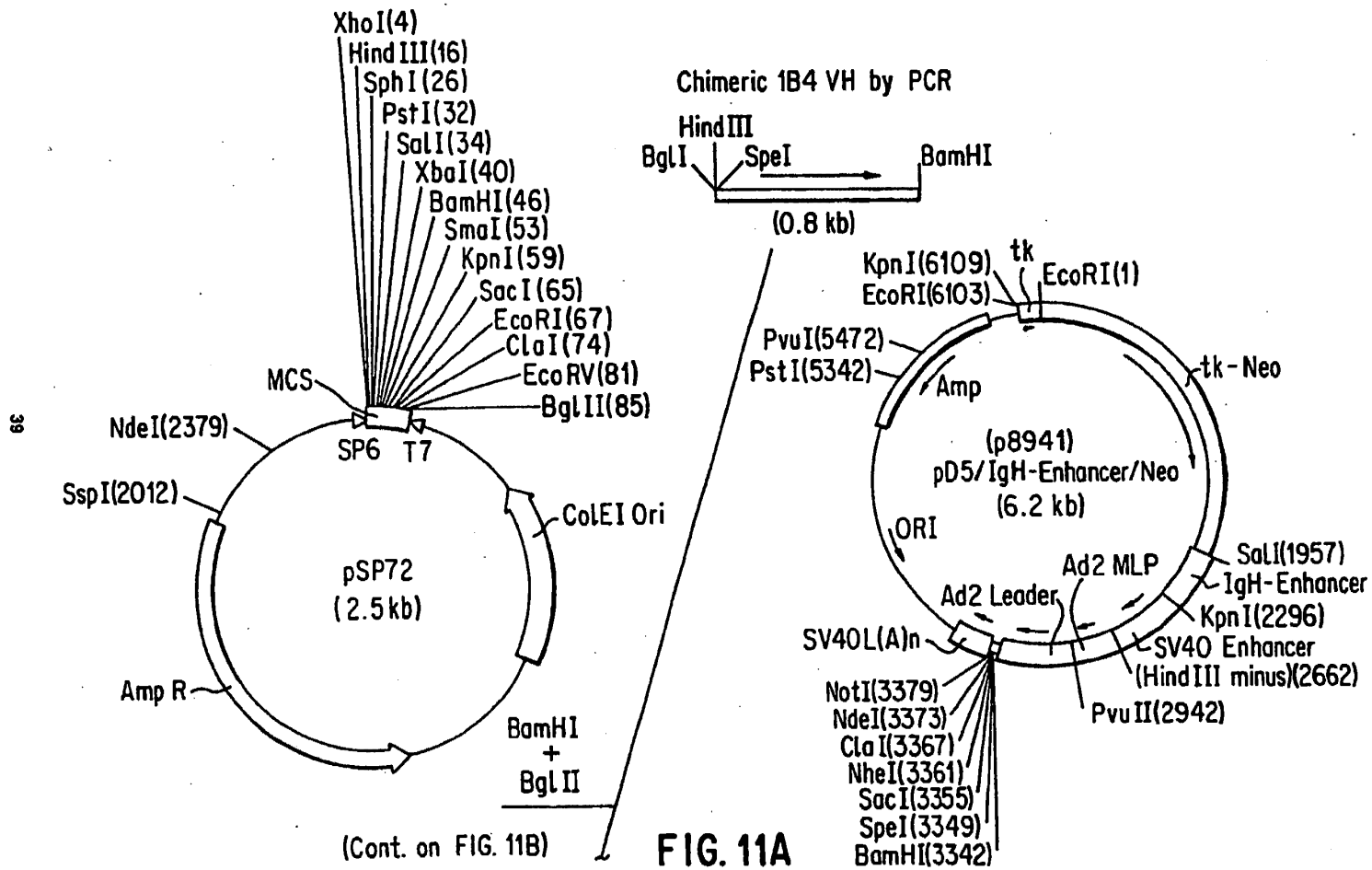

FIG. 10B



EP 0 438 310 A1

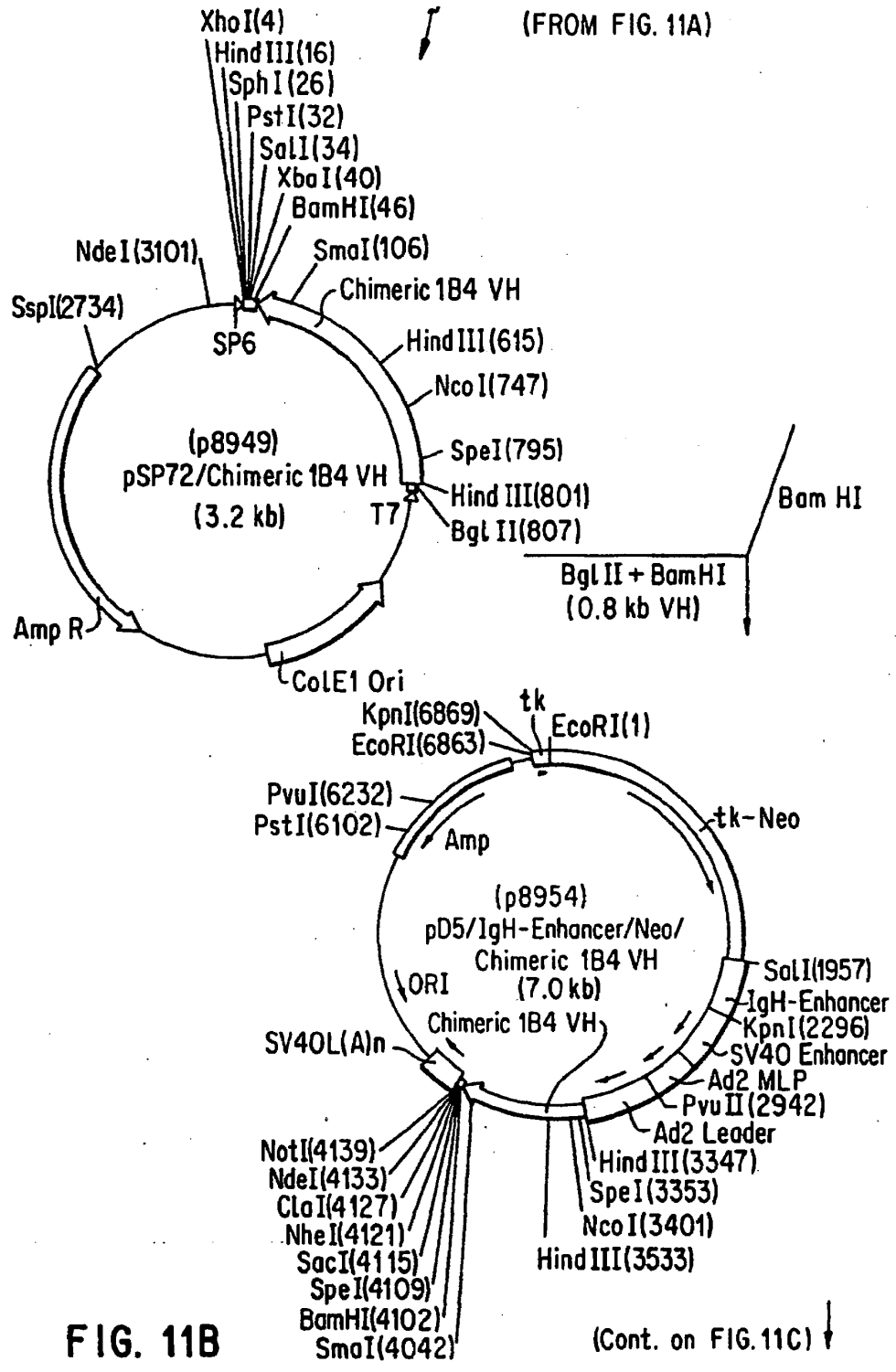

FIG. 11B

(Cont. on FIG. 11C)

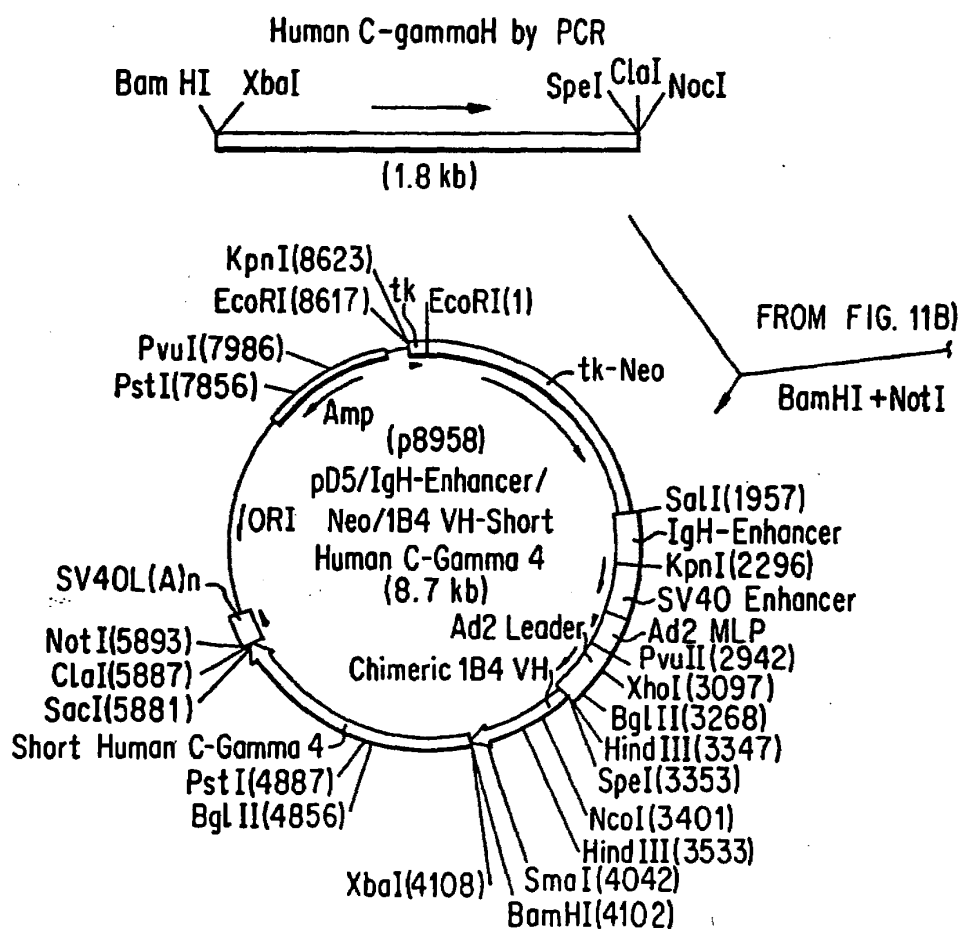

FIG. 11C

TRANSIENT EXPRESSION OF THE 1B4 CHIMERIC HEAVY CHAIN: GRAFTED RE1/1B4 LIGHT CHAIN
RECOMBINANT ANTIBODY IN CV1, COS7, AND 293 CELLS

<u>CELL LINE</u>	<u>ANTIBODY (ng/mL)</u>
CV1	50
CV1	31
COS7	71
COS7	82
293	385
293	207

FIG. 12

42

EP 0 438 310 A1

43

CPM BOUND/ 1×10^5
HUMAN PMNs

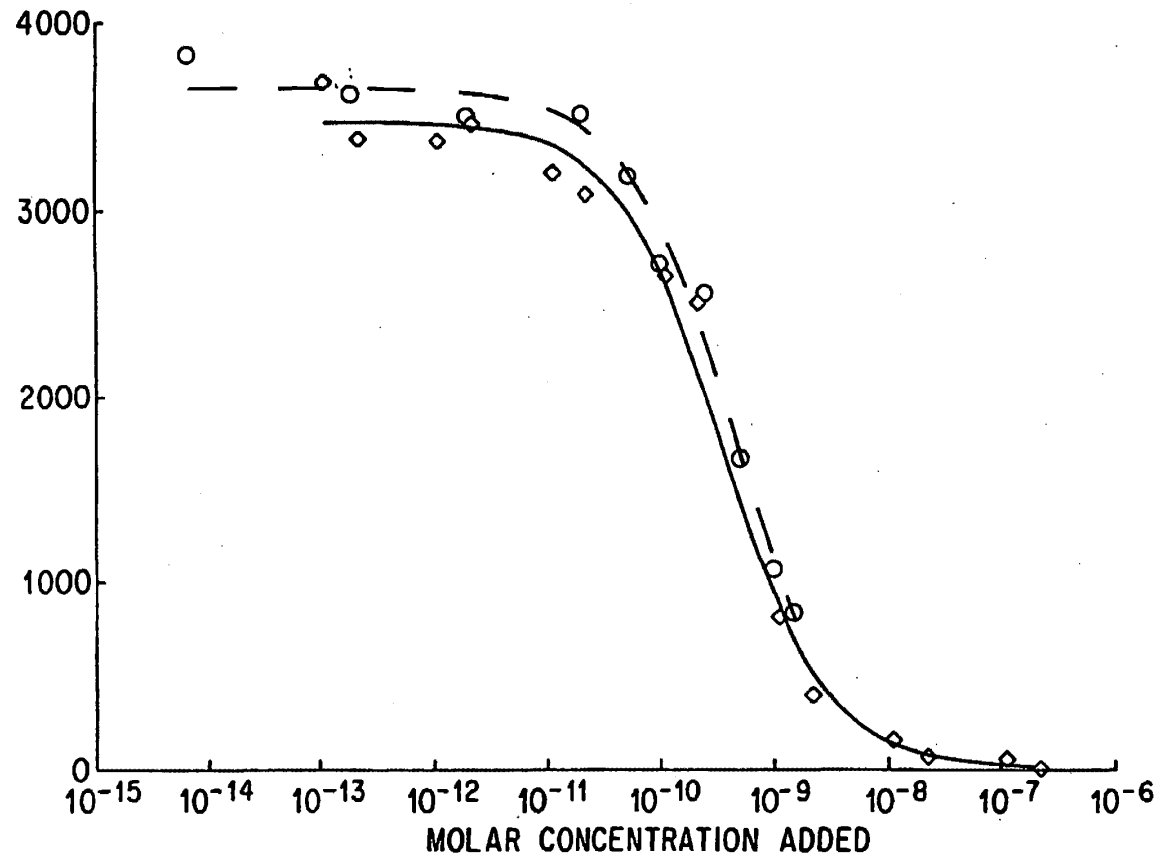

EP 0 438 310 A1

FIG. 13

HEAVY CHAIN

NEW: QVQLQESGPGLV RPSQTL SLTCTVSGFTFS [NDYYT] WVRQPP
1B4: DVKLVESGGDLVKLG GSLKLSCAASGFTFS [DYYS] WVRQTP
Jon: DVQLVESGGGLVKPG GSLRLS CAASGFTFS [TAWMK] WVRQAP
Gal: EVQLVESGGDLVQPGRSLRLS CAASGFTFS [BLGMT] WVRQAP
Gal-M1: G

GRGLEWIG [YVFYHGTSDDTTPLRS-] RFTMLVDTSKNQFSLRL
EKRELVVA [AIDNDGGSISYPDTVKG] RFTISRDNANTLYLQ
GKGLEWVV [WRVEQVVEKAFANSVNG] RFTISRNDKNTLYLQ
GKGLEWVA [NIKZBGSZBYVDSVKG] RFTISRDNKNSLYLQ
L

SSVTAADTAVYYCAR [---NLIAGCIDV]WGQGS LVTVSS... %Id 55
SSLRSED TALYYCAR [-QGR LRRDYFDY]WGQGTTLTVSS... 55
ISVTPEDTAVYYCAR [VPLYGBYRAFNY]WGQGTPVTVSS... 78
NSLRVEDTALYYCAR [-----GWGGGD-]WGQGT LVTVST... 82
L 85

FIG. 14A

EP 0 438 310 A1

LIGHT CHAIN

REI: DIQLTQSPSSLSASVGDRVITC [RASGNIHNYLA-----] WY
1B4: DIVLTQSPASLAVSLGQRATISC [RASESVDSYGNSFMH--] WY
Len: DIVMTQSPNSLAVSLGERATINC [KSSQSVLYSSNSKNYLA] WY

QOKPGKAPKLLIY [YTTTLAD] GVPSRFSGSGSGTDFTFTISSL
QOKPGQPPKLLIY [RASNLES] GIPARFSGSGSRTDFTLTINPV
QOKPGQPPKLLIY [WASTRES] GVPDRFSGSGSGTDFTLTISSL

QPEDIATYYC [QHFSTPRT]	FGQGTKVVIKR...	%Id
EADDVATYYC [QOSNEDPLT]	FGAGTKLELKR...	69
QAEDVAVYYC [QYYSTPYS]	FGQGTKLEIKR...	81

%Id percent identity to 1B4 FRs

FIG. 14B

EP 0 438 310 A1

"GAL"/1B4

#G1 5'- GAG GTG CAG CTG GTG GAG TCT GGG GGA GAC CTG GTC CAG CCT GGG AGG TCT CTG AGA
CTC TCC TGT GCA GCC TCT GGA TTC ACC TTC AGT GAC TAT TAC -3'
#G2 5'- ATA AGA GAT GCT ACC ACC ATC ATT ATC AAT GGC TGC AAC CCA CTC CAG CCC TTT TCC TGG
AGC CTG GCG GAC CCA AGA CAT GTA ATA GTC ACT GAA GGT -3'
#G3 5'- GGT GGT AGC ATC TCT TAT CCA GAC ACT GTG AAG GGC AGA TTC ACC ATC TCC AGA GAT AAT
GCC AAG AAC TCC CTG TAC CTG CAA ATG AAC AGC CTG AGA GTT -3'
#G4 5'- GAC CAG GGT ACC TTG GCC CCA GTA GTC AAA ATA ATC ACG TCG TAA TCT CCC CTG TCT
CGC ACA GTA ATA CAG GGC CGT GTC CTC AAC TCT CAG GCT GTT CAT -3'

8

VARIABLE REGION AMPLIFIERS

#A3 5'- GAG GTG CAG CTG GTG GAG TC -3'
#A4 5'- GAC CAG GGT ACC TTG GCC CC -3'

SIGNAL FRAGMENT

#S1 5'- CAT TCG CTT ACC AGA TCT AAG CTT ACT AGT GAG ATC ACA GTT CTC TCT AC -3'
#G5 5'- CTC CAC CAG CTG CAC CTC GGA GTG GAC ACC TGT GGA GAG -3'

FRAMEWORK 4/INTRON FRAGMENT

#G6 5'- GGC CAA GGT ACC CTG GTC ACA GTC TCC ACA GGT GAG TCC -3'
#I2 5'- GAA TGT GCC TAC TTT CTA GAG GAT CCT ATA AAT CTC TG -3'

FIG. 15A

EP 0 438 310 A1

"JON"/1B4

#J1 5'- GAT GTG CAG CTG GTG GAG TCT GGG GGA GGA CTG GTC AAG CCT GGG GGG TCT CTG AGA
CTC TCC TGT GCA GCC TCT GGA TTC ACC TTC AGT GAC TAT TAC -3'
#J2 5'- ATA AGA GAT GCT ACC ACC ATC ATT ATC AAT GGC CAC AAC CCA CTC CAG CCC TTT TCC TGG
AGC CTG GCG GAC CCA AGA CAT GTA ATA GTC ACT GAA GGT -3'
#J3 5'- GGT GGT AGC ATC TCT TAT CCA GAC ACT GTG AAG GGC AGA TTC ACC ATC TCC AGA AAC GAT
TCA AAG AAC ACG CRG TAC CTG CAA ATG ATC AGC GTG ACC CCC -3'
#J4 5'- GAC AGG GGT ACC TTG GCC CCA GTA GTC AAA ATA ATC ACG TCG TAA TCT CCC CTG TCT
CGC ACA GTA ATA CAC GGC CGT GTC CTC GGG GGT CAC GCT GAT CAT -3'

VARIABLE REGION AMPLIFIERS

#A5 5'- GAT GTG CAG CTG GTG GAG TC -3'
#A6 5'- GAC AGG GGT ACC TTG GCC CC -3'

SIGNAL FRAGMENT

#S1 5'- CAT TCG CTT ACC AGA TCT AAG CTT ACT AGT GAG ATC ACA GTT CTC TCT AC -3'
#J5 5'- CTC CAC CAG CTG CAC ATC GGA GTG GAC ACC TGT GGA GAG -3'

FRAMEWORK 4/INTRON FRAGMENT

#J6 5'- GGC CAA GGT ACC CCT GTC ACA GTC TCC TCA GGT GAG TCC -3'
#I2 5'- GAA TGT GCC TAC TTT CTA GAG GAT CCT ATA AAT CTC TG -3'

PCR RECOMBINATION AMPLIFIERS USED FOR BOTH CONSTRUCTIONS

#A1 5'- CAT TCG CTT ACC AGA TCT -3'
#A2 5'- GAA TGT GCC TAC TTT CTA G -3'

FIG. 15B

EP 0 438 310 A1

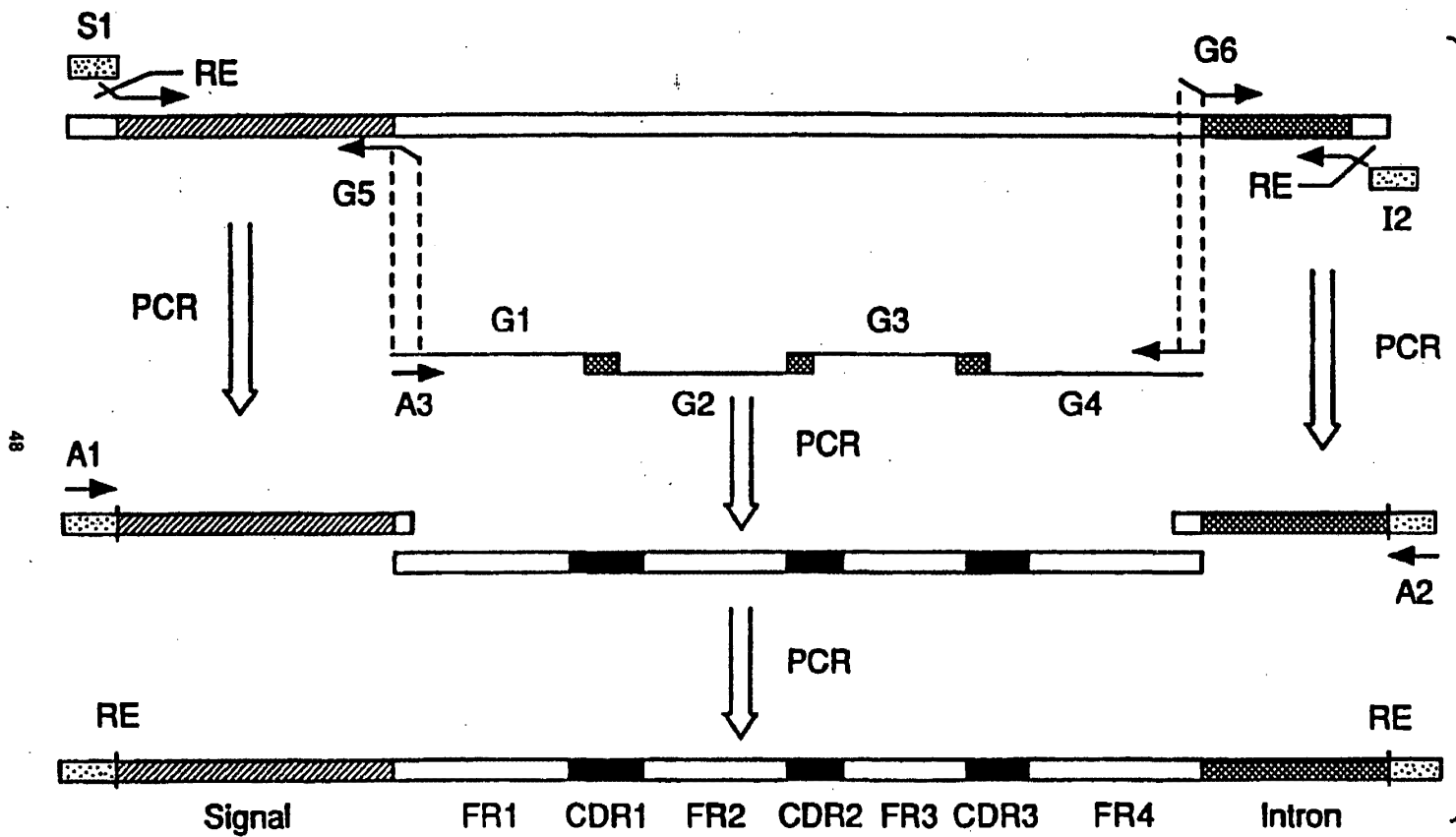

48

EP 0 438 310 A1

FIG. 16

								27									54
GAG	GTG	AAG	CTG	GTG	GAG	TCA	GGG	GGA	GAC	TTA	GTG	AAG	CTT	GGA	GGG	TCC	CTG
Glu	Val	Lys	Leu	Val	Glu	Ser	Gly	Gly	Asp	Leu	Val	Lys	Leu	Gly	Gly	Ser	Leu
								81									108
AAA	CTC	TCC	TGT	GCA	GCC	TCT	GGA	TTC	ACT	TTC	AGT	GAC	TAT	TAC	ATG	TCT	TGG
Lys	Leu	Ser	Cys	Ala	Ala	Ser	Gly	Phe	Thr	Phe	Ser	Asp	Tyr	Tyr	MET	Ser	Trp
								135									162
GTT	CGC	CAG	ACT	CCA	GAG	AAG	AGG	CTG	GAG	TTG	GTC	GCA	GCC	ATT	GAT	AAT	GAT
Val	Arg	Gln	Thr	Pro	Glu	Lys	Arg	Leu	Glu	Leu	Val	Ala	Ala	Ile	Asp	Asn	Asp
								189									216
GGT	GGT	AGC	ATC	TCT	TAT	CCA	GAC	ACT	GTG	AAG	GGC	CGA	TTC	ACC	ATC	TCC	AGA
Gly	Gly	Ser	Ile	Ser	Tyr	Pro	Asp	Thr	Val	Lys	Gly	Arg	Phe	Thr	Ile	Ser	Arg
								243									270
GAC	AAT	GCC	AAG	AAC	ACC	CTG	TAC	CTA	CAA	ATG	AGC	AGT	CTG	AGG	TCT	GAG	GAC
Asp	Asn	Ala	Lys	Asn	Thr	Leu	Tyr	Leu	Gln	MET	Ser	Ser	Leu	Arg	Ser	Glu	Asp
								297									324
ACA	GCC	TTG	TAT	TAC	TGT	GCT	AGA	CAG	GGG	AGA	TTA	CGA	CGT	GAT	TAT	TTT	GAC
Thr	Ala	Leu	Tyr	Tyr	Cys	Ala	Arg	Gln	Gly	Arg	Leu	Arg	Arg	Asp	Tyr	Phe	Asp
								351									
TAC	TGG	GGC	CAA	GGC	ACC	ACT	CTC	ACA	GTC	TCC	TCA	GCC	AAA	ACA	A		
Tyr	Trp	Gly	Gln	Gly	Thr	Thr	Leu	Thr	Val	Ser	Ser	Ala	Lys	Thr			

FIG. 17

EP 0 438 310 A1

50

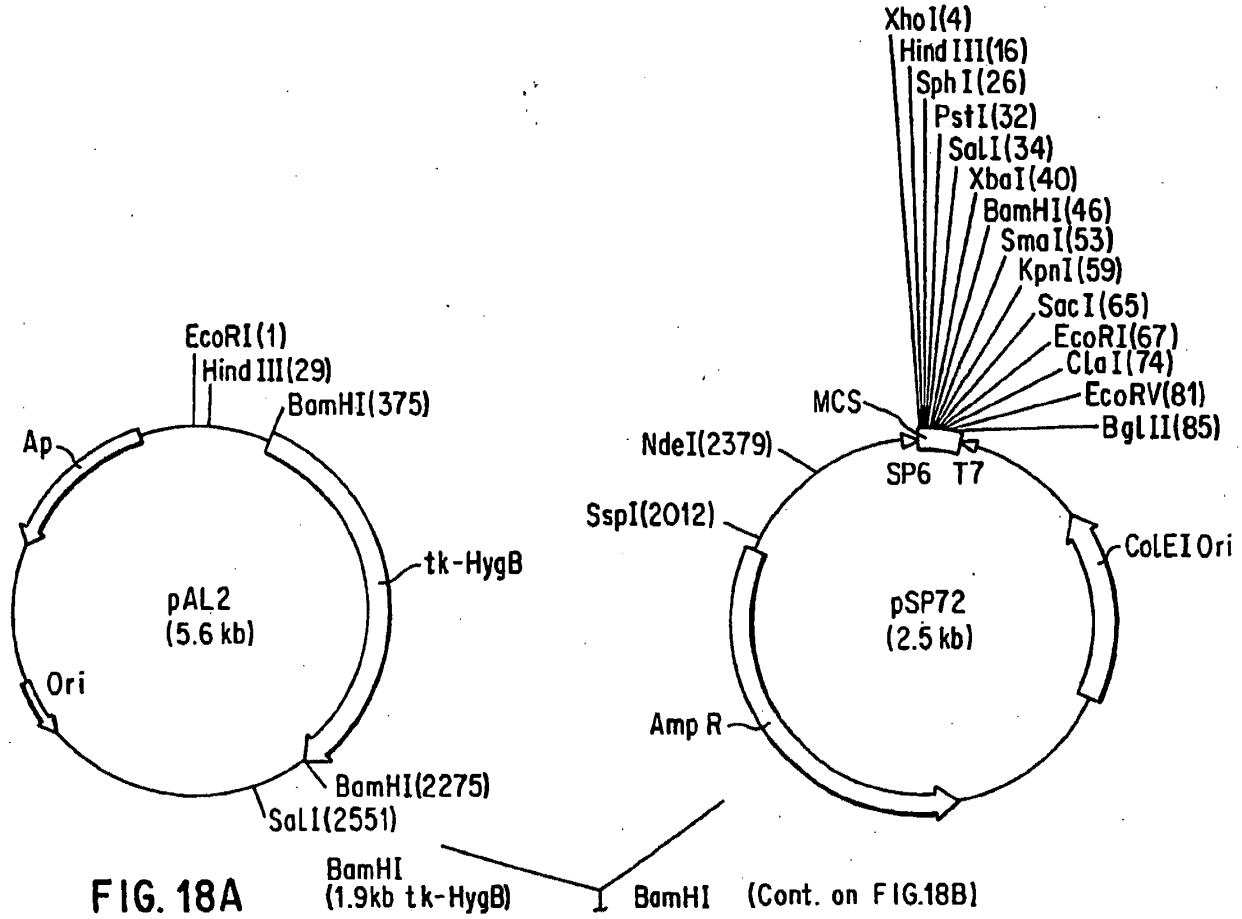

EP 0 438 310 A1

FIG. 18A

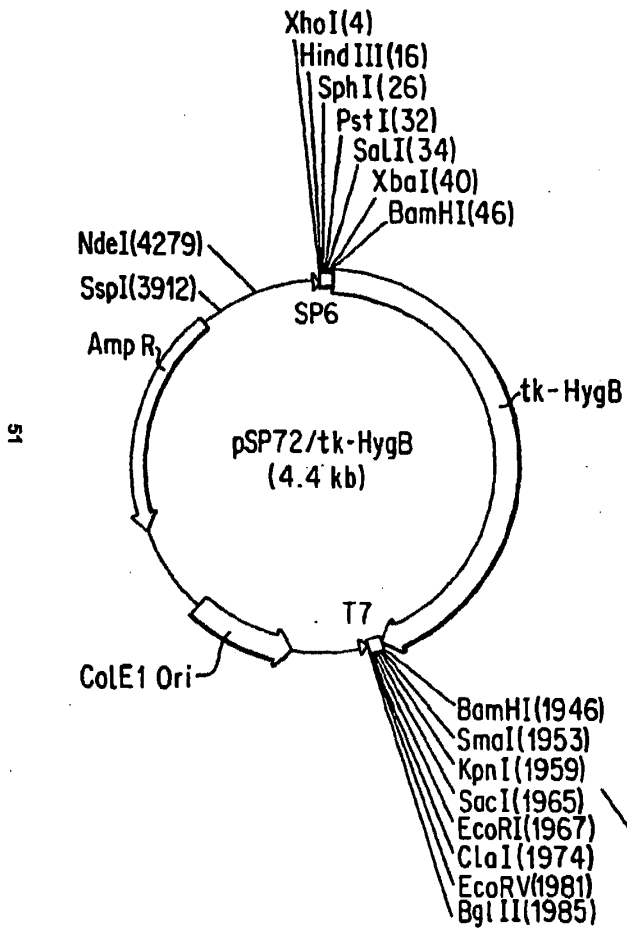

(FROM FIG. 18A)

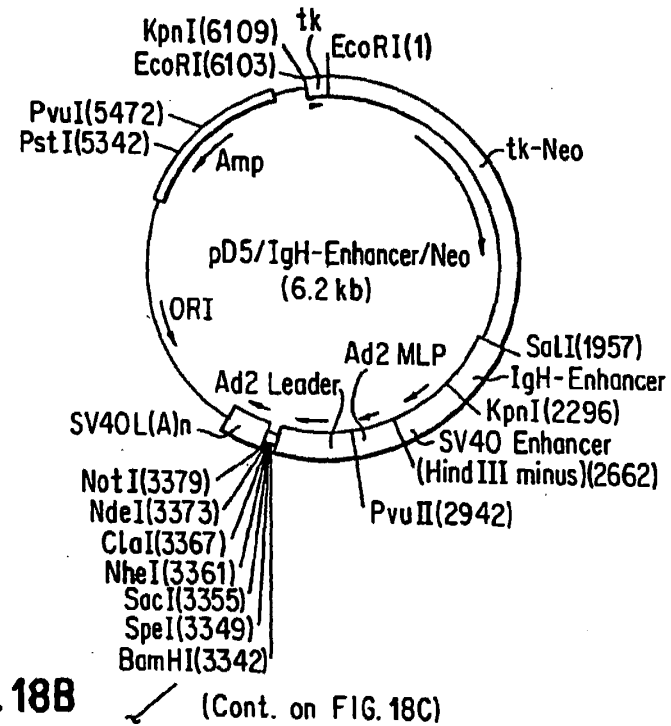

EP 0 438 310 A1

(FROM FIG. 18B)

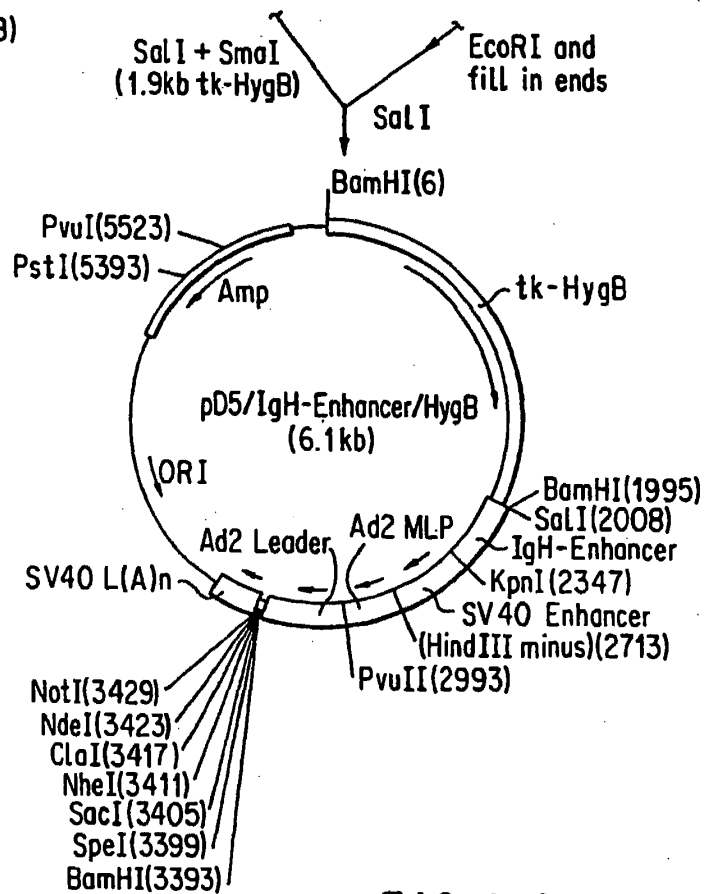
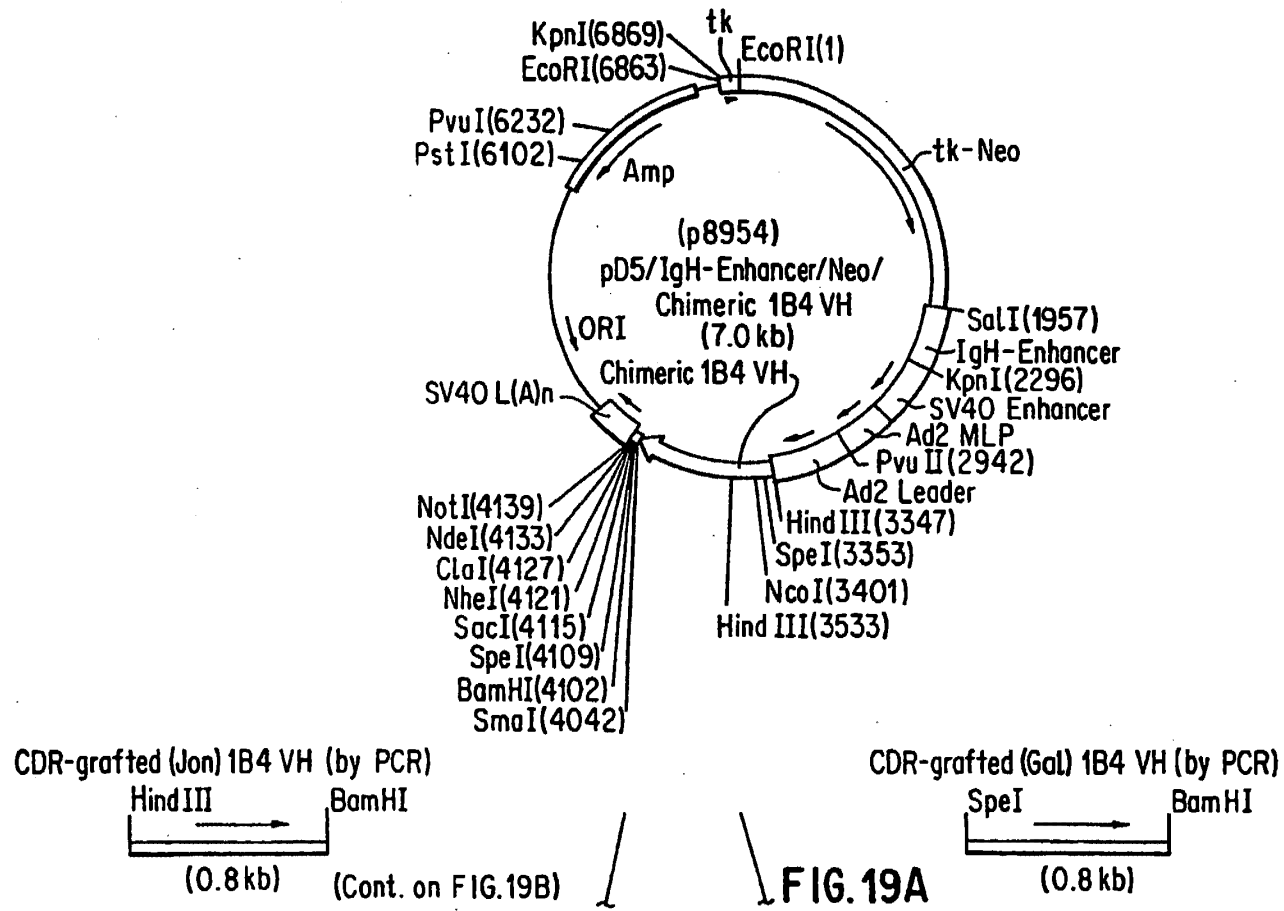

FIG. 18C

52

EP 0 438 310 A1



54

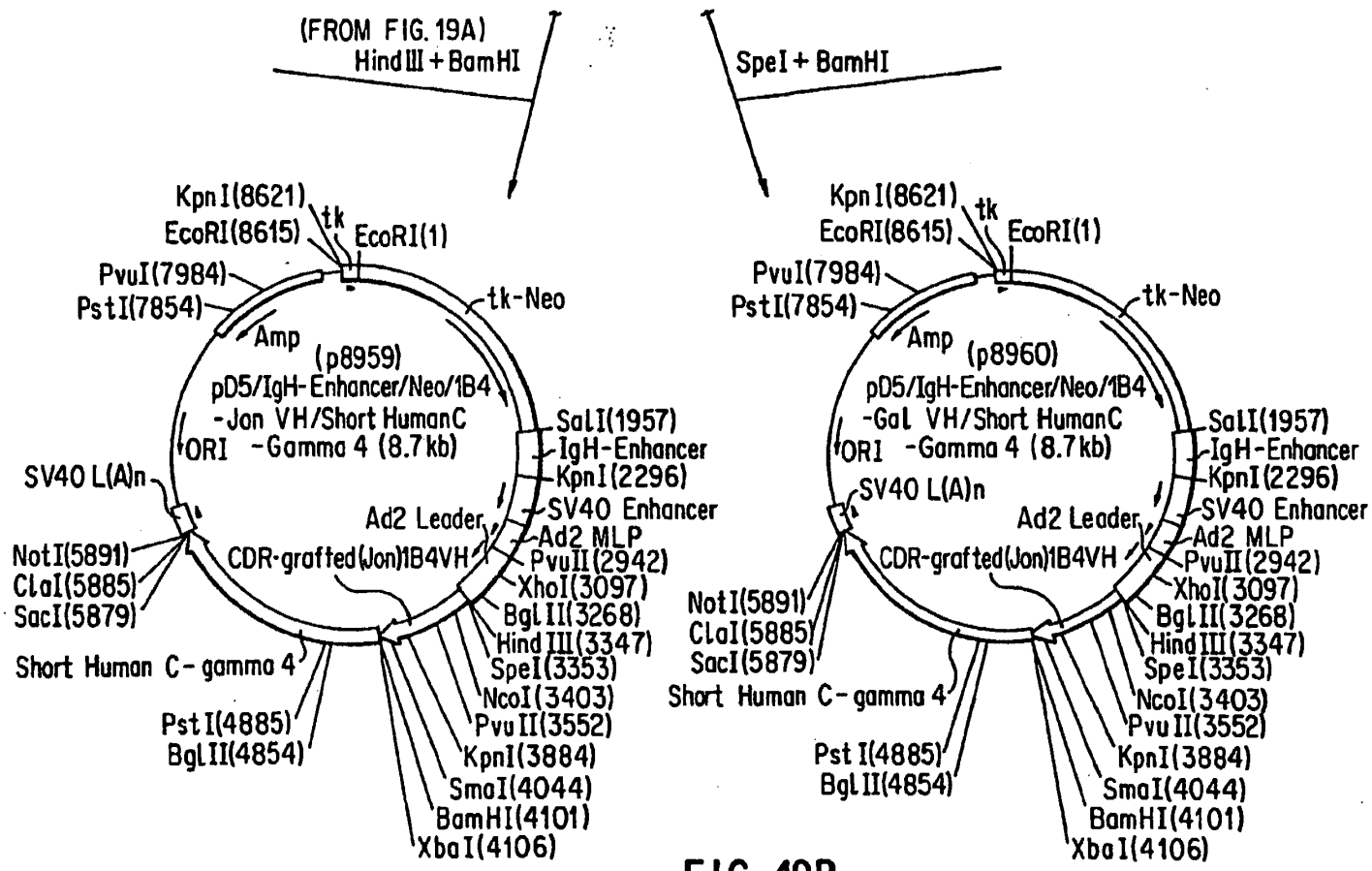

FIG. 19B

EP 0 438 310 A1

55

Summary of Competitive Binding Activities of mIB4 & hIB4 Framework Constructs				
<u>Construct</u>	<u>Mean IC₅₀ nM</u>	<u>SD</u>	<u>N</u>	<u>p (relative)</u>
mIB4	0.52	0.20	9	<0.0005(Gal*)
Gal/Rei	1.68	0.26	19	<0.0005(New)
Gal/Len	2.80	1.04	2	<0.0005(Gal*)
Jon/Rei	5.88	0.13	3	<0.0005(Gal*)
New/Rei	7.99	0.73	3	=0.008(Jon)
mut Gal/Rei	0.67	0.08	4	>0.20(mIB4)
Demichimera	0.46	0.08	3	>0.61(mIB4)
*Gal = Gal/Rei hIB4 construct				

EP 0 438 310 A1

FIG. 20

"LEN"/1B4

- # L1 5'- GAC ATC GTG ATG ACC CAG TCT CCA AAT TCC CTG GCT GTC TCT CTT GGA
GAG AGA GCC ACC ATC AAC TGC AGA GCC AGT GAA AGT GTT GAT -3'
- # L2 5'- ACG ATA GAT CAG GAG CTT AGG AGG CTG CCC TGG TTT CTG CTG ATA CCA GTG CAT
AAA AGA ATT GCC ATA ACT ATC AAC ACT TTC ACT GGC -3'
- # L3 5'- AAG CTC CTG ATC TAT CGT GCA TCC AAC CTA GAA TCT GGG GTC CCA GAC AGG TTC
AGC GGC AGT GGA TCT GGG ACA GAT TTC ACT CTC ACC -3'
- # L4 5'- CGT GAG AGG ATC CTC ATT ACT TTG CTG ACA GTA ATA AAC TGC AAC ATC TTC AGC
CTG CAG GCT GCT GAT GGT GAG AGT GAA ATC TGT -3'
- # L5 5'- TAA TGA GGA TCC TCT CAG GTT CCG CCA AGG GAC CAA GCT GGA GAT CAA ACG TGA
GTA GAA TTT AAA CTT TGC TTC CTC AGT TAA GCT TTC TAG A -3'

VARIABLE REGION AMPLIFIERS

- # A5 5'- GAC ATC GTG ATG ACC CAG TC -3'
- # A6 5'- TGC CTA CTT TCT AGA AAG CTT AAC TGA GG -3'

SIGNAL FRAGMENT

- # S2 5'- AGA TCT ACT AGT AAG CTT GAG ATC ACA GTT CTC TCT AC -3'
- # L6 5'- CTG GGT CAT CAC GAT GTC GGA GTG GAC ACC TGT GGA GAG -3'

PCR RECOMBINATION AMPLIFIERS

- # A7 5'- AGA TCT ACT AGT AAG CTT GAC -3'
 Bgl II Spe I Hind III
- # A8 5'- TGC CTA CTT TCT AGA AAG CTT -3'
 Xba I Hind III

FIG. 21

EP 0 438 310 A1

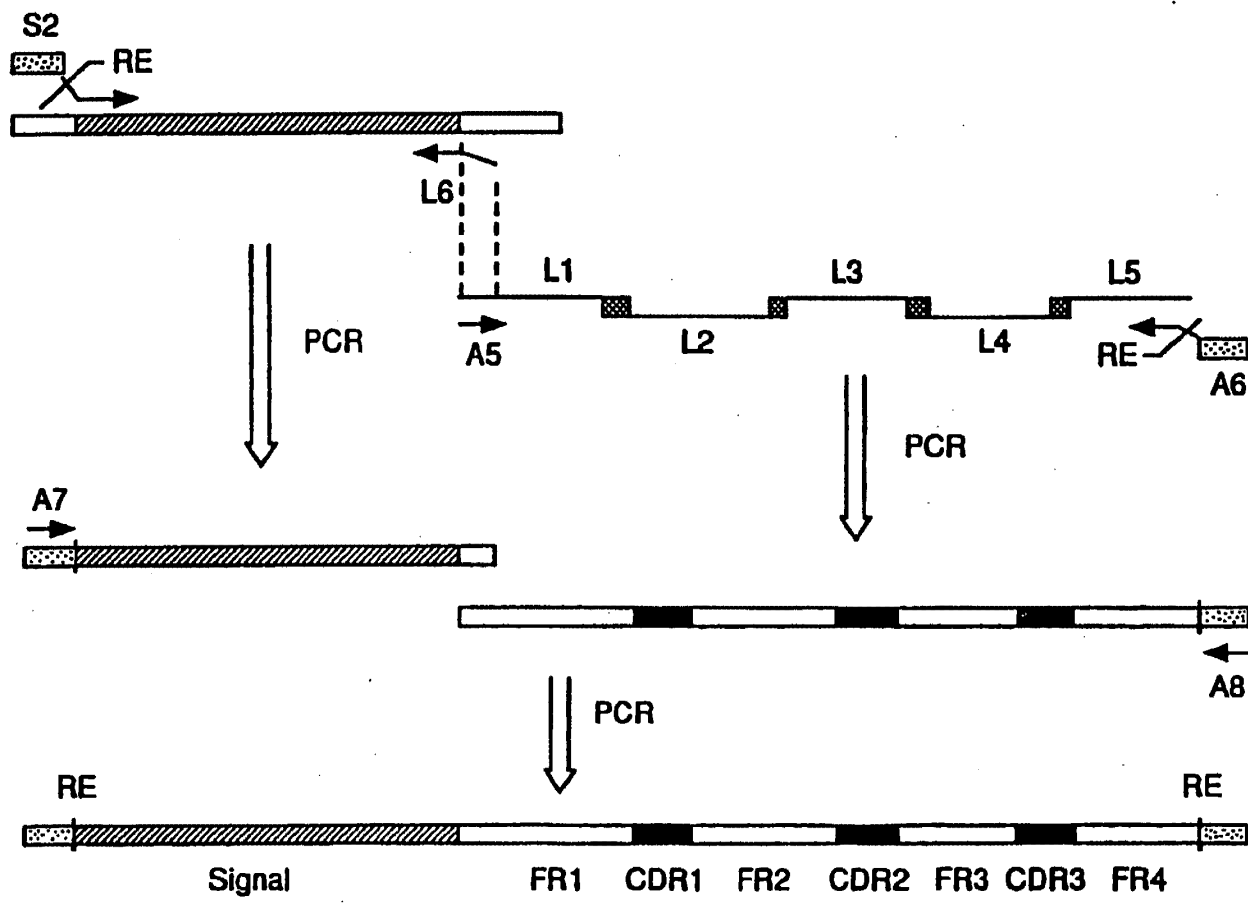

57

EP 0 438 310 A1

FIG. 22

58

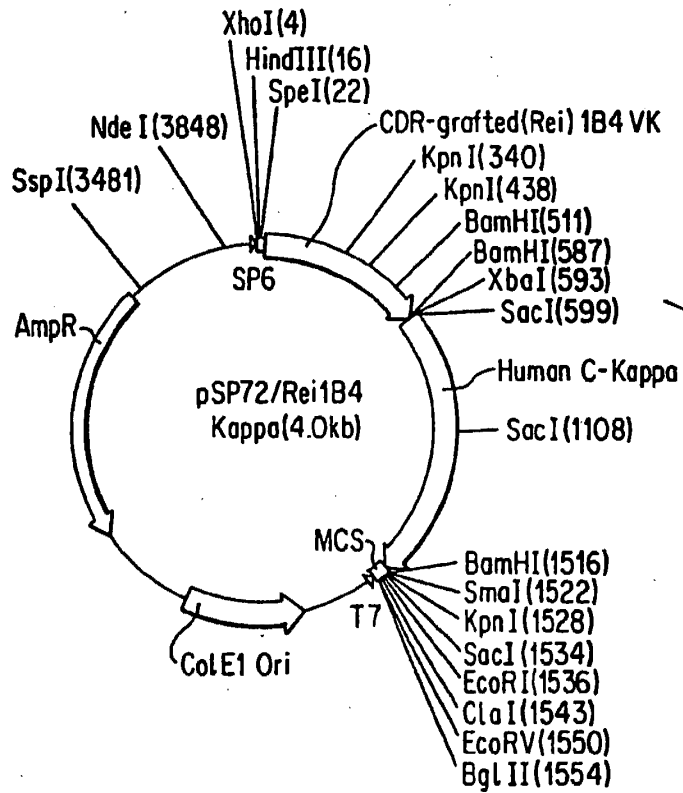
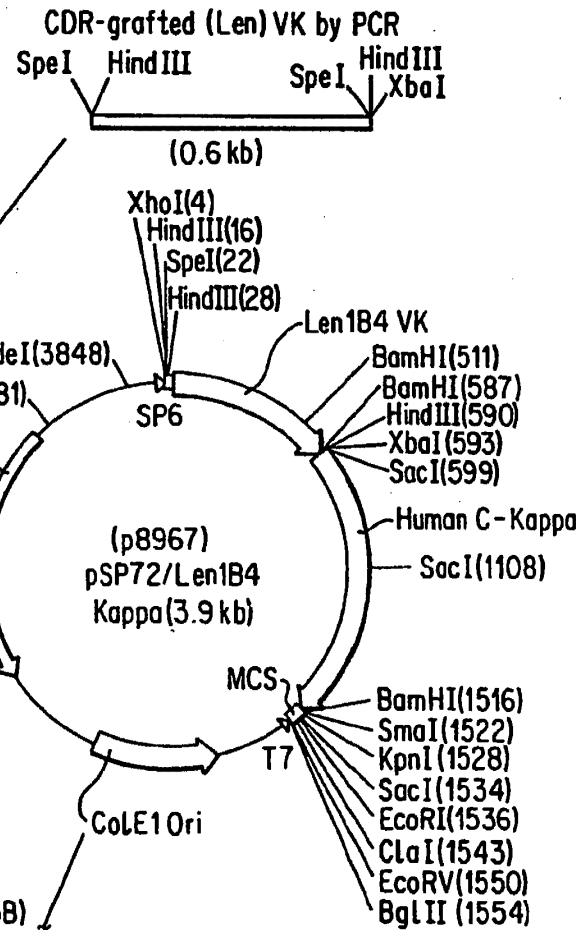
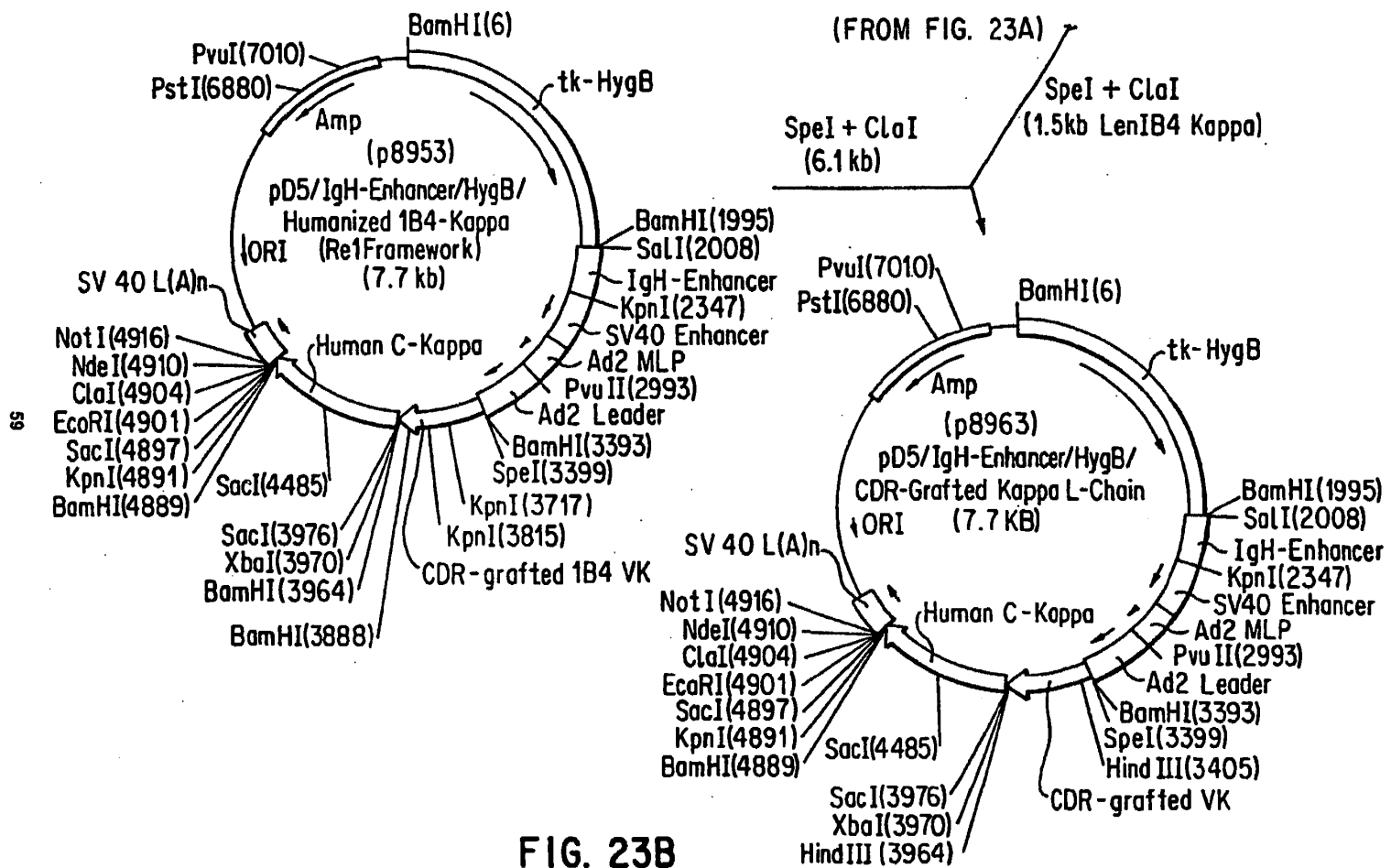

FIG. 23A

(Cont. on FIG. 23B)



EP 0 438 310 A1



EP 0 438 310 A1

								27									54
GAT	ATT	GTG	CTG	ACC	CAG	TCT	CCA	GCT	TCT	TTG	GCT	GTG	TCT	CTA	GGG	CAG	AGG
Asp	Ile	Val	Leu	Thr	Gln	Ser	Pro	Ala	Ser	Leu	Ala	Val	Ser	Leu	Gly	Gln	Arg
								81									108
GCC	ACC	ATA	TCC	TGC	AGA	GCC	AGT	GAA	AGT	GTT	GAT	AGT	TAT	GGC	AAT	TCT	TTT
Ala	Thr	Ile	Ser	Cys	Arg	Ala	Ser	Glu	Ser	Val	Asp	Ser	Tyr	Gly	Asn	Ser	Phe
								135									162
ATG	CAC	TGG	TAC	CAG	CAG	AAA	CCA	GGA	CAG	CCA	CCC	AAG	CTC	CTC	ATC	TAT	CGT
MET	His	Trp	Tyr	Gln	Gln	Lys	Pro	Gly	Gln	Pro	Pro	Lys	Leu	Leu	Ile	Tyr	Arg
								189									216
GCA	TCC	AAC	CTA	GAA	TCT	GGG	ATC	CCT	GCC	AGG	TTC	AGT	GGC	AGT	GGG	TCT	AGG
Ala	Ser	Asn	Leu	Glu	Ser	Gly	Ile	Pro	Ala	Arg	Phe	Ser	Gly	Ser	Gly	Ser	Arg
								243									270
ACA	GAC	TTC	ACC	CTC	ACC	ATT	AAT	CCT	GTG	GAG	GCT	GAT	GAT	GTT	GCA	ACC	TAT
Thr	Asp	Phe	Thr	Leu	Thr	Ile	Asn	Pro	Val	Glu	Ala	Asp	Asp	Val	Ala	Thr	Tyr
								297									324
TAC	TGT	CAG	CAA	AGT	AAT	GAG	GAT	CCT	CTC	ACG	TTC	GGT	GCT	GGG	ACC	AAG	CTG
Tyr	Cys	Gln	Gln	Ser	Asn	Glu	Asp	Pro	Leu	Thr	Phe	Gly	Ala	Gly	Thr	Lys	Leu
GAG	CTG	AAA	CGG														
Glu	Leu	Lys	Arg														

FIG. 25

EP 0 438 310 A1

62

#S1	5'- CAT TCG CTT ACC <u>AGA TCT AAG CTT</u> <u>ACT AGI</u> GAG ATC AC -3'
	Bgl II Hind III Spe I
#G7	5'- <u>AGA TCT CCC CCA GAC TCA</u> ACC AGC TG -3'
#G8	5'- <u>TGA GTC TGG GGG AGA TCT</u> TGT TCA GCC TGG AGG GTC TCT G -3'
#G9	5'- <u>ATC AAT GGC TGC AAC CAG</u> CTC CAG CCC TTT TCC -3'
#G10	5'- <u>CTG GTT GCA GCC ATT GAT</u> AAT -3'
#G11	5'- <u>GGA GAC TGT CAG CAG GGT</u> ACC TTG GCC CCA -3'
#G12	5'- <u>ACC CTG CTG ACA GTC TCC ACA</u> GGT GAG -3'
#I2	5'- GAA TGT GCC TAC TTT <u>CTA GA G GAT CCT</u> ATA AAT CTC TGG CCA TG -3'
	Xba I Bam H1

PCR RECOMBINATION AMPLIFIERS

#A3 5'- CAT TCG CTT ACC AGA TCT -3'
#A4 5'- GAA TGT GCC TAC TTT CTA G -3'

FIG. 26

EP 0 438 310 A1

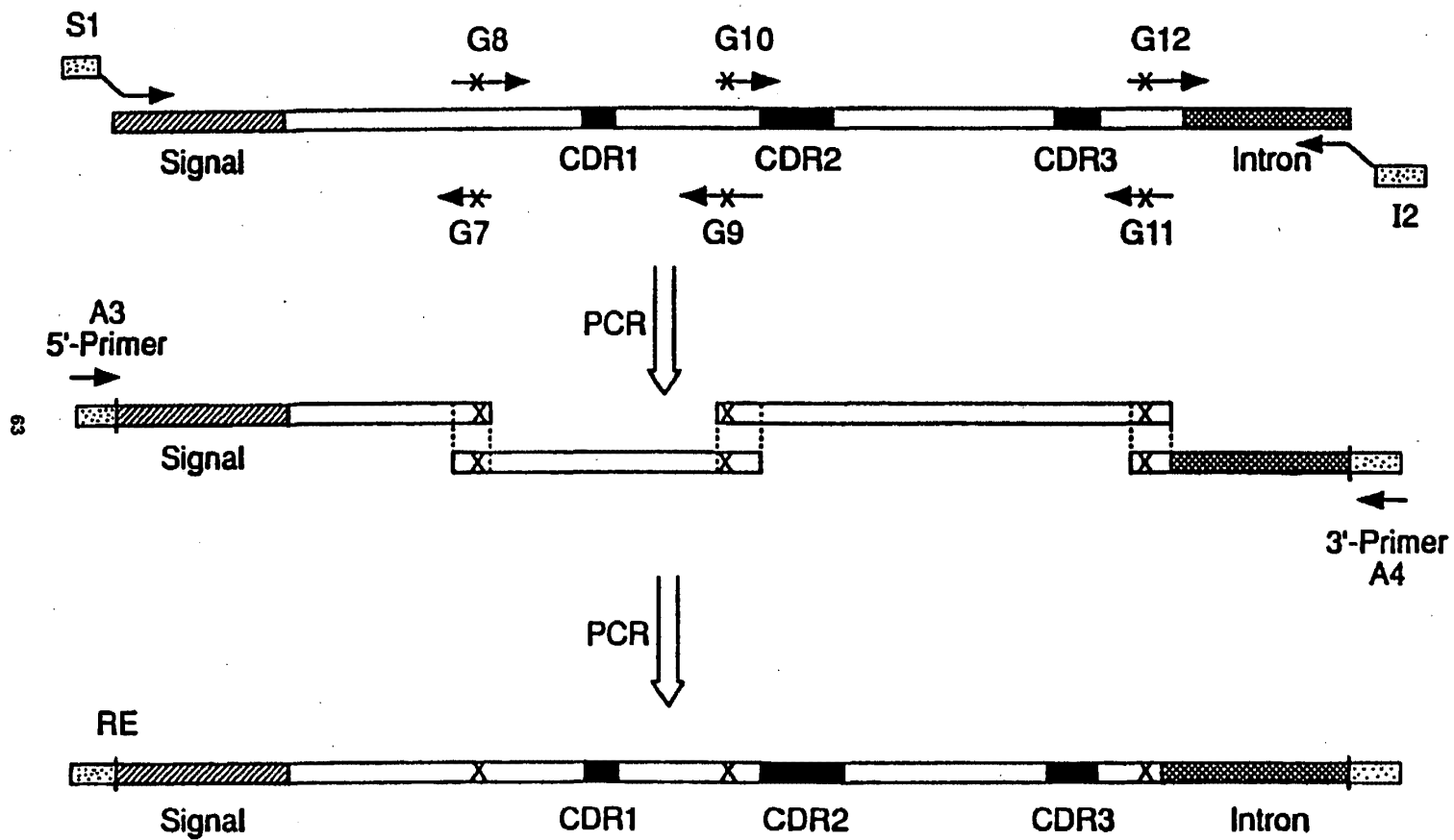
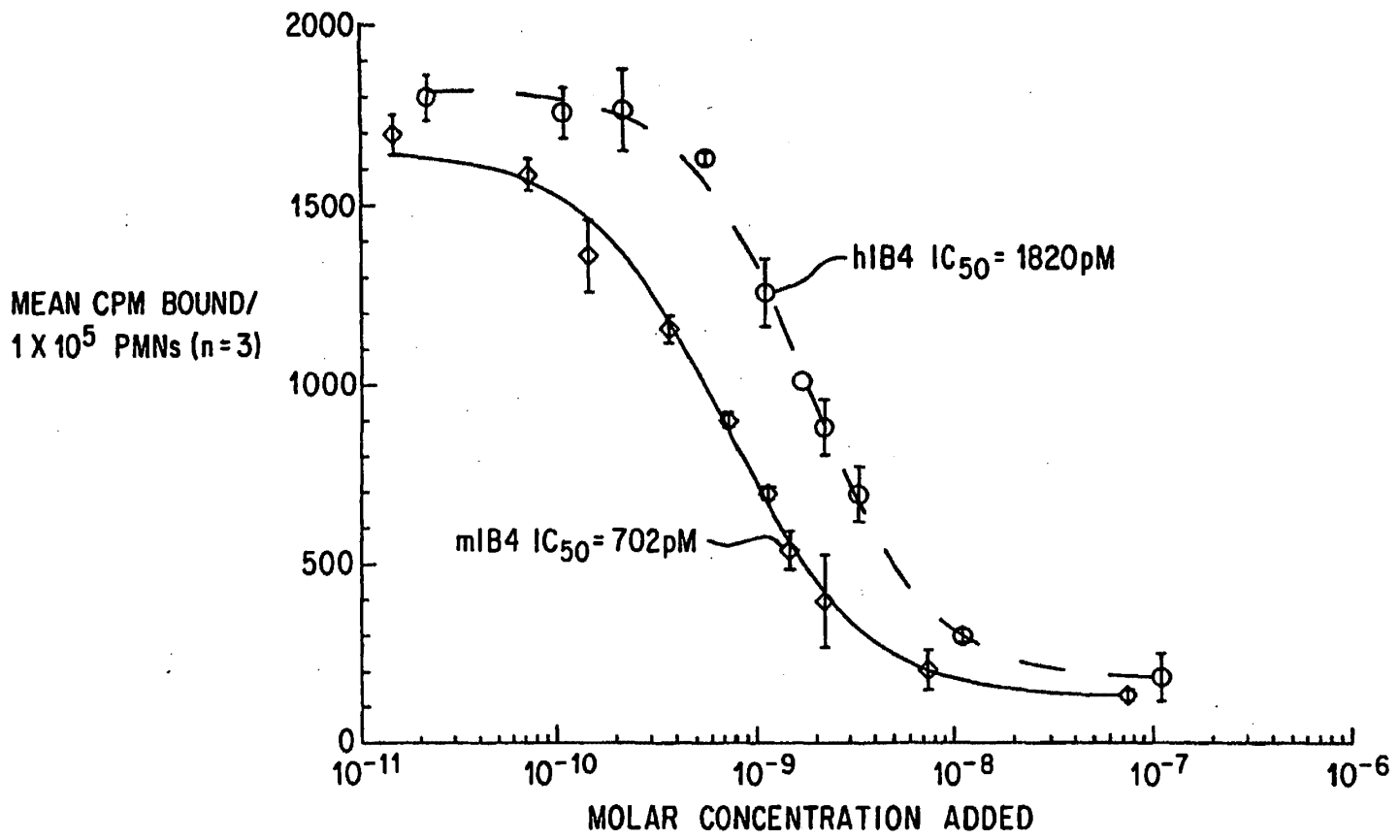

FIG. 27

EP 0 438 310 A1

64



EP 0 438 310 A1

FIG. 28

65

MEAN CPM BOUND/
 1×10^5 PMNs (n=2)

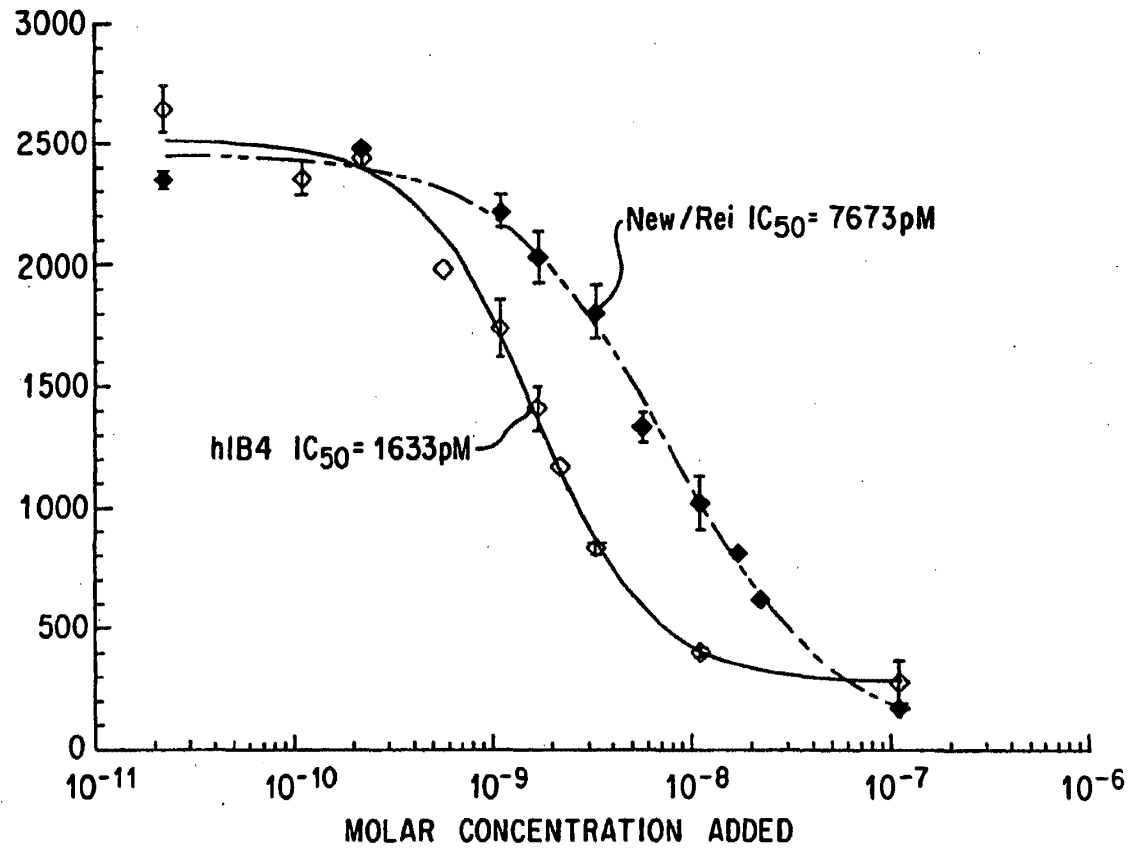

EP 0 438 310 A1

FIG. 29

66

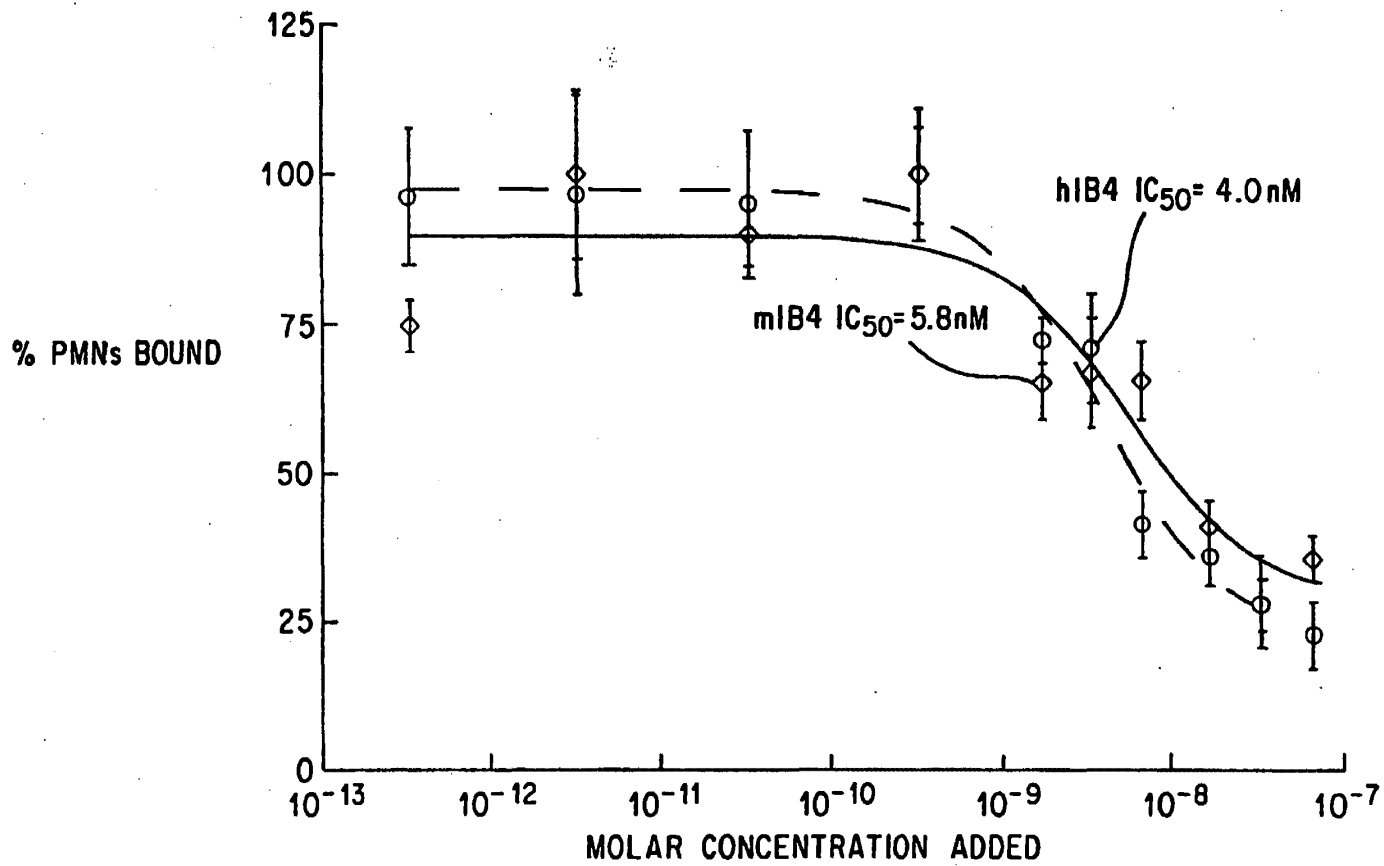

EP 0 438 310 A1

FIG. 30

87

COMPARISON OF Gal/Rel hIB4 AND mIB4 IN IN VITRO FUNCTIONAL ASSAYS					
IC50 (nM)					
	<u>hIB4</u>	<u>n</u>	<u>mIB4</u>	<u>n</u>	<u>P</u>
HUVEC	8.2	9	4.6	9	>.1
CTL	2.0	4	2.0	4	>.5

EP 0 438 310 A1

FIG. 31

IMMUNOFLOURESCENCE MICROSCOPIC LOCALIZATION OF mIB4 AND
Gal/Rei hIB4 STAINING IN 5 μ m FROZEN SECTIONS OF RABBIT
TISSUES.*

<u>TISSUE</u>	<u>mIB4 STAINING</u>	<u>Gal/Rei hIB4 STAINING</u>
BONE MARROW	++++	++++
CEREBRUM	0	0
KIDNEY	+ (LEUKOCYTES ONLY)	+ (LEUKOCYTES ONLY)
LARGE INTESTINE	0	0
LIVER	0	0
LUNGS	++ (LEUKOCYTES ONLY)	++ (LEUKOCYTES ONLY)
LYMPH NODES	++	++
MYOCARDIUM	0	0
STOMACH	0	0
STRIATED MUSCLE (LEG)	0	0
SPLEEN	+++	+++

*CONSECUTIVE TISSUE SECTIONS WERE STAINED INDIVIDUALLY WITH mIB4 OR hIB4.
TWO DOUBLE-BLINDED EXPERIMENTS WERE PERFORMED BY DIFFERENT INVESTIGATORS.
THE DEGREE OF LABELING WAS SCORED AS 0 (NEGATIVE), + (SPARSE), ++ (MODERATE),
+++ (INTENSE), AND ++++ (MARKEDLY INTENSE).

FIG. 32

88

EP 0 438 310 A1

**DOUBLE LABEL IMMUNOFLUORESCENCE MICROSCOPIC
LOCALIZATION OF Gal/Rei HUMANIZED AND MURINE
IB4 IN RABBIT BONE MARROW CELLS***

<u>Primary Antibodies Applied</u>	<u>Gal/Rei hIB4</u>	<u>mIB4</u>
Gal/Rei hIB4 + mIB4	+++	+++
hlgG4 + mIB4	0	+++
Gal/Rei hIB4 + buffer	+++	0
mIB4 + buffer	0	+++
hlgG4 + buffer	0	0

* 5 um frozen sections of rabbit bone marrow were stained with mixtures of Gal/Rei hIB4 and native murine IB4 or controls (hlgG4, buffer). +++ = moderate staining; 0 = negative.

FIG. 33

EP 0 438 310 A1

**DOUBLE LABEL IMMUNOELECTRON MICROSCOPIC
LOCALIZATION OF Gal/Rei HUMANIZED AND MURINE
IB4 IN SPECIFIC GRANULES OF HUMAN PMNs***

<u>PRIMARY ANTIBODIES APPLIED</u>	<u>RELATIVE STAINING INTENSITY</u>	
	<u>Gal/Rei hIB4</u>	<u>mIB4</u>
Gal/Rei hIB4 + mIB4	++++	++++
hIgG4 + mIB4	0	++++
Gal/Rei hIB4 + buffer	++++	0

* 80 nm ultrathin frozen sections of human PMNs were double stained with Gal/Rei hIB4 and native murine IB4 or controls (hIgG4, buffer). + + + + = intense staining; 0 = negative.

70

EP 0 438 310 A1

FIG. 34

71

PMN x 10⁵ / 6mm BIOPSY

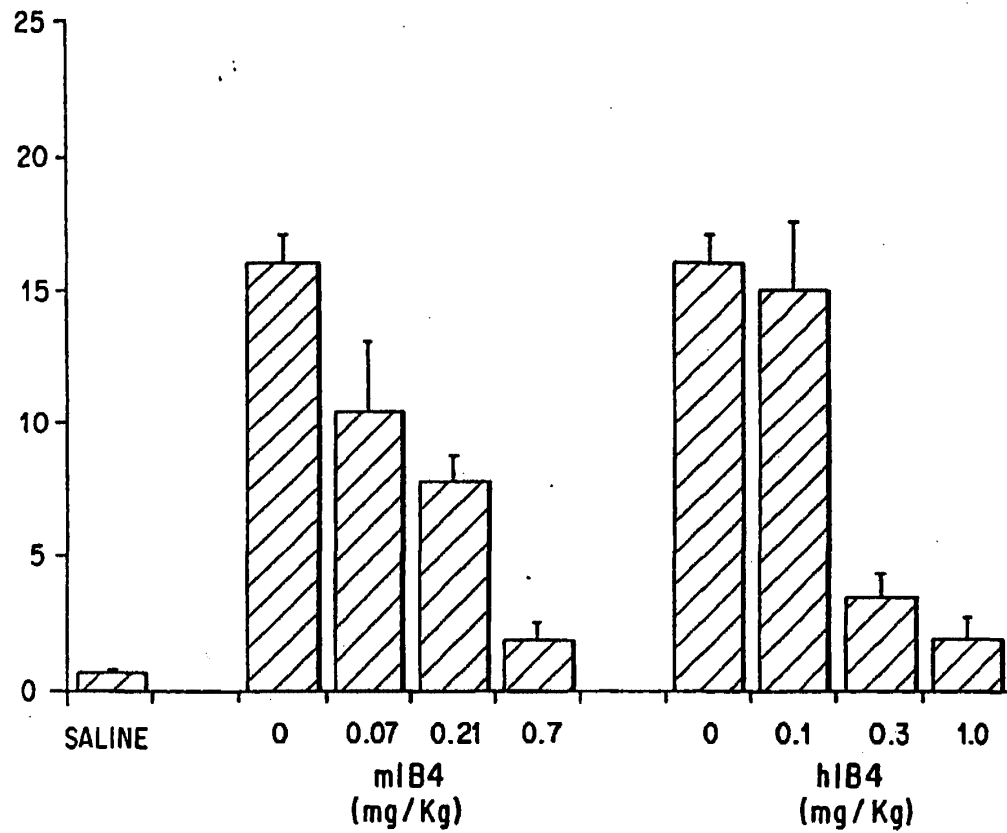

EP 0 438 310 A1

FIG. 35

72

μ l PLASMA / 6mm BIOPSY

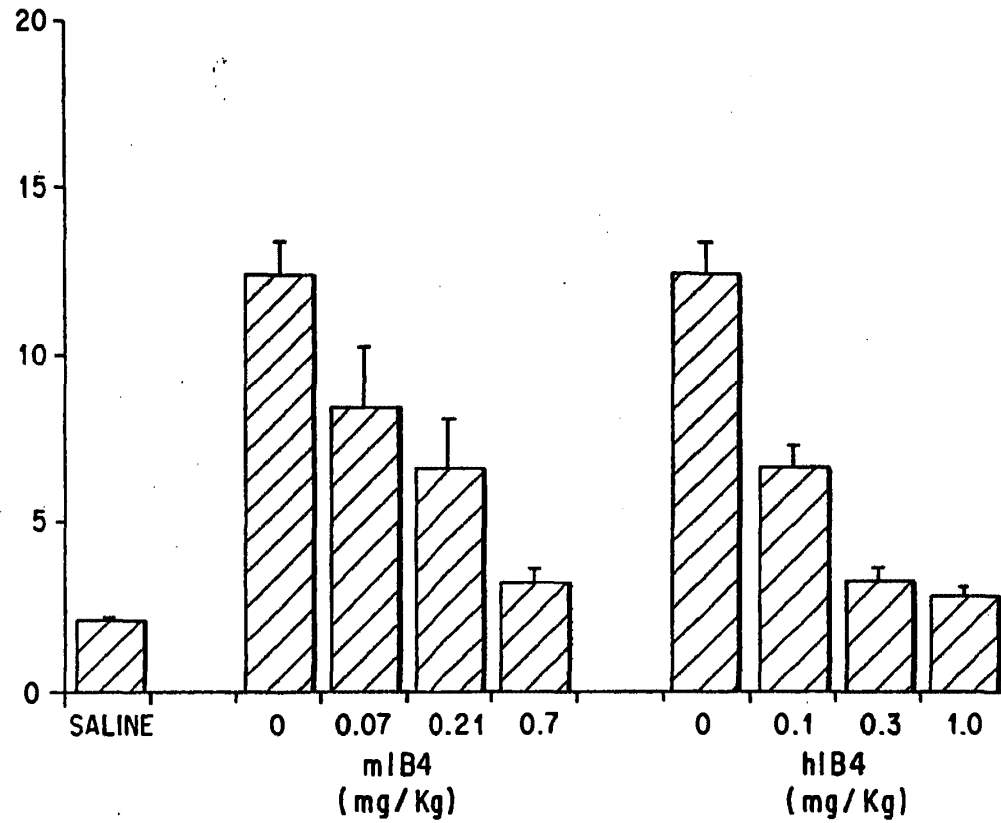

FIG. 36

EP 0 438 310 A1

73

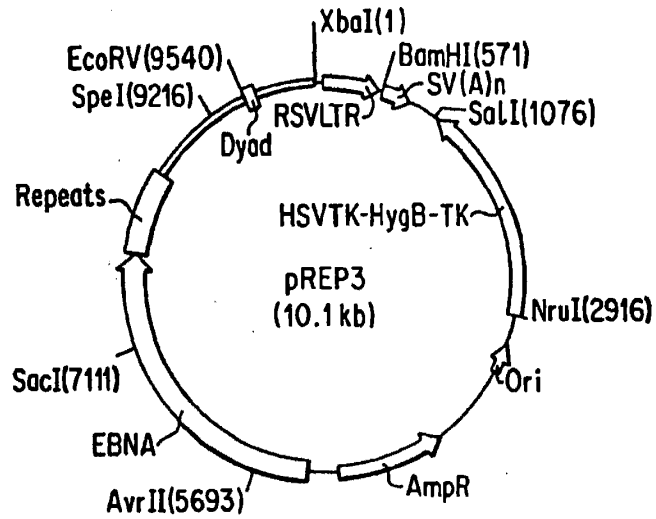
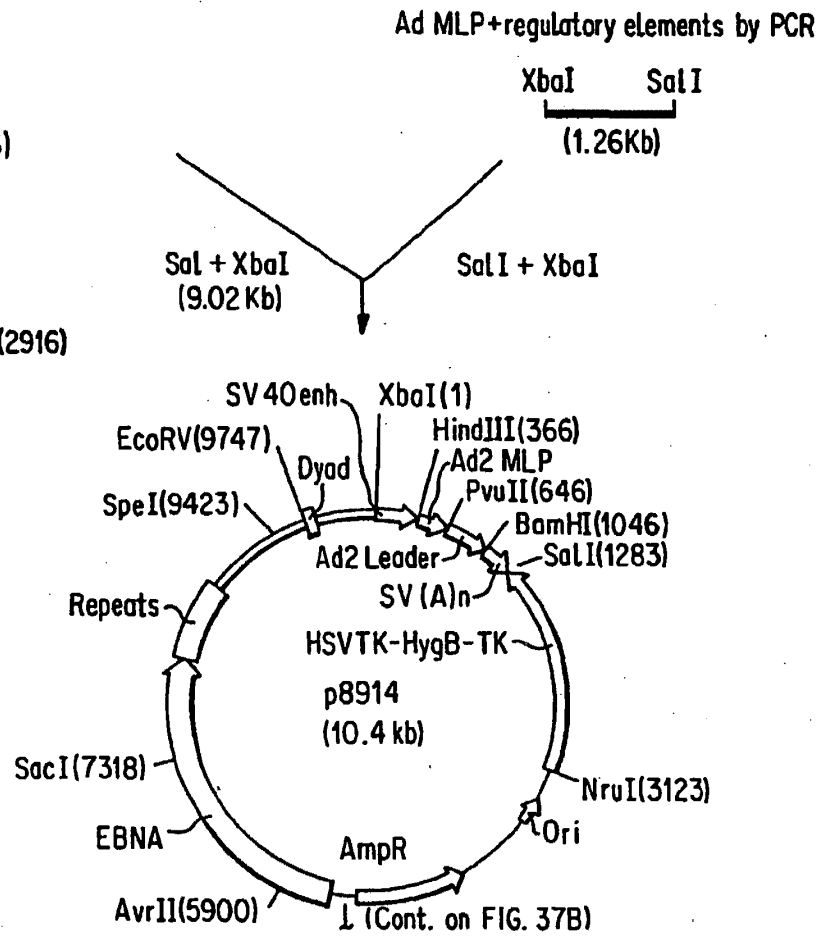

FIG. 37A



EP 0 438 310 A1

(FROM FIG. 37A)

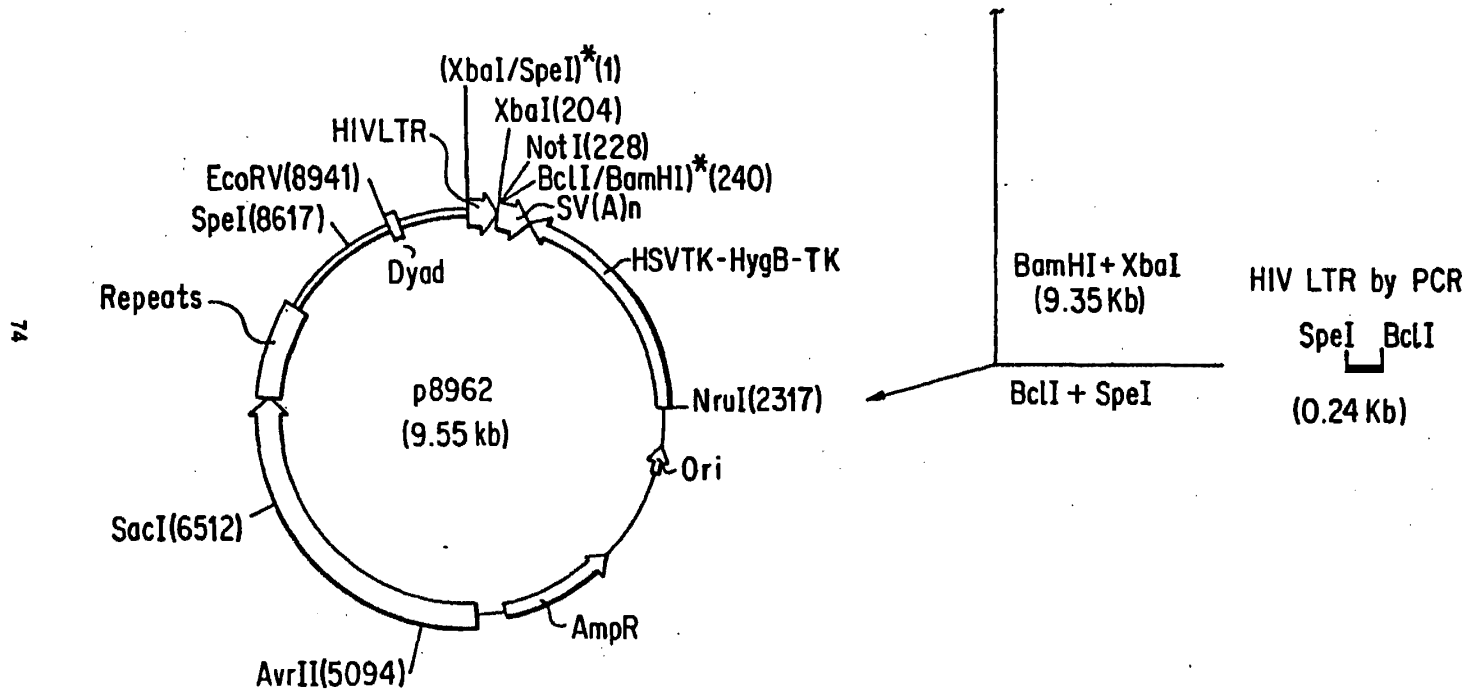
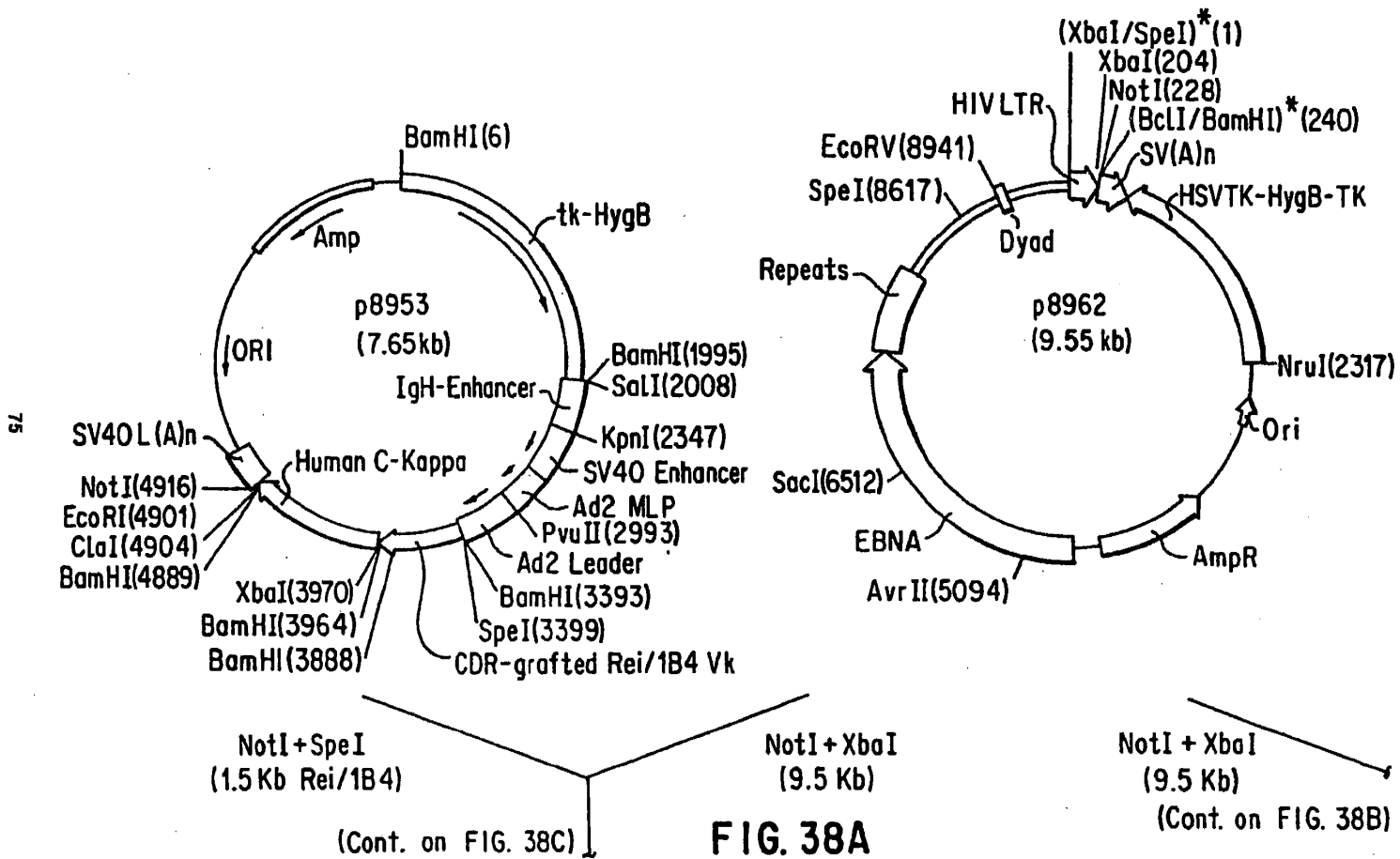

FIG. 37B



EP 0 438 310 A1

FIG. 38A

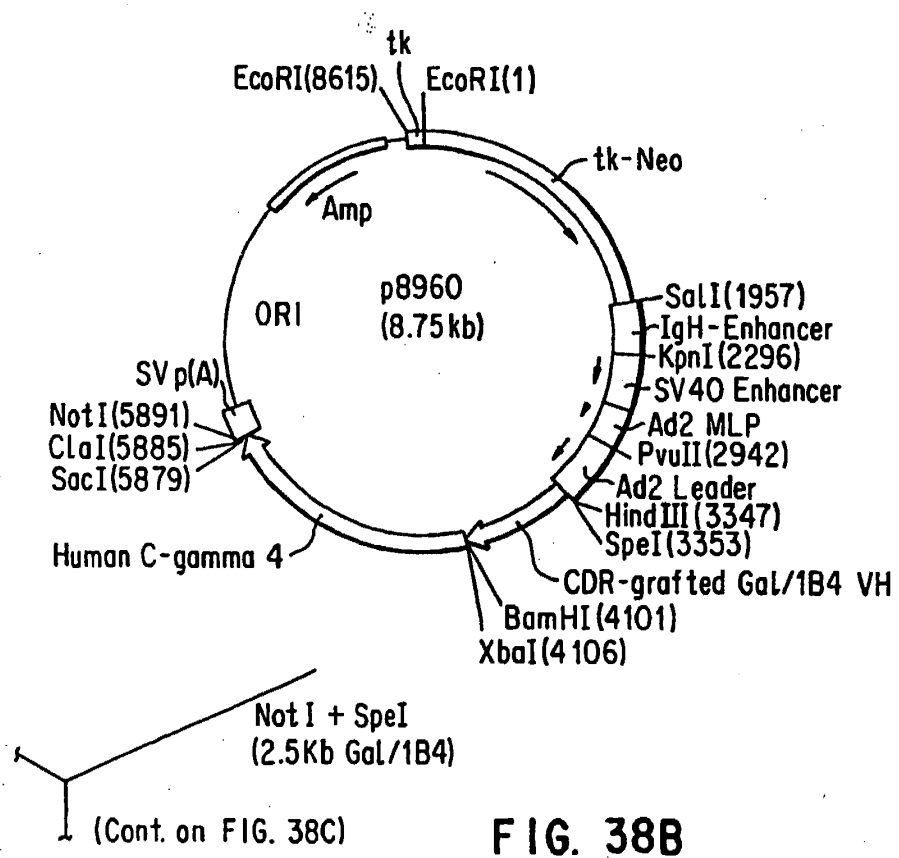

FIG. 38B

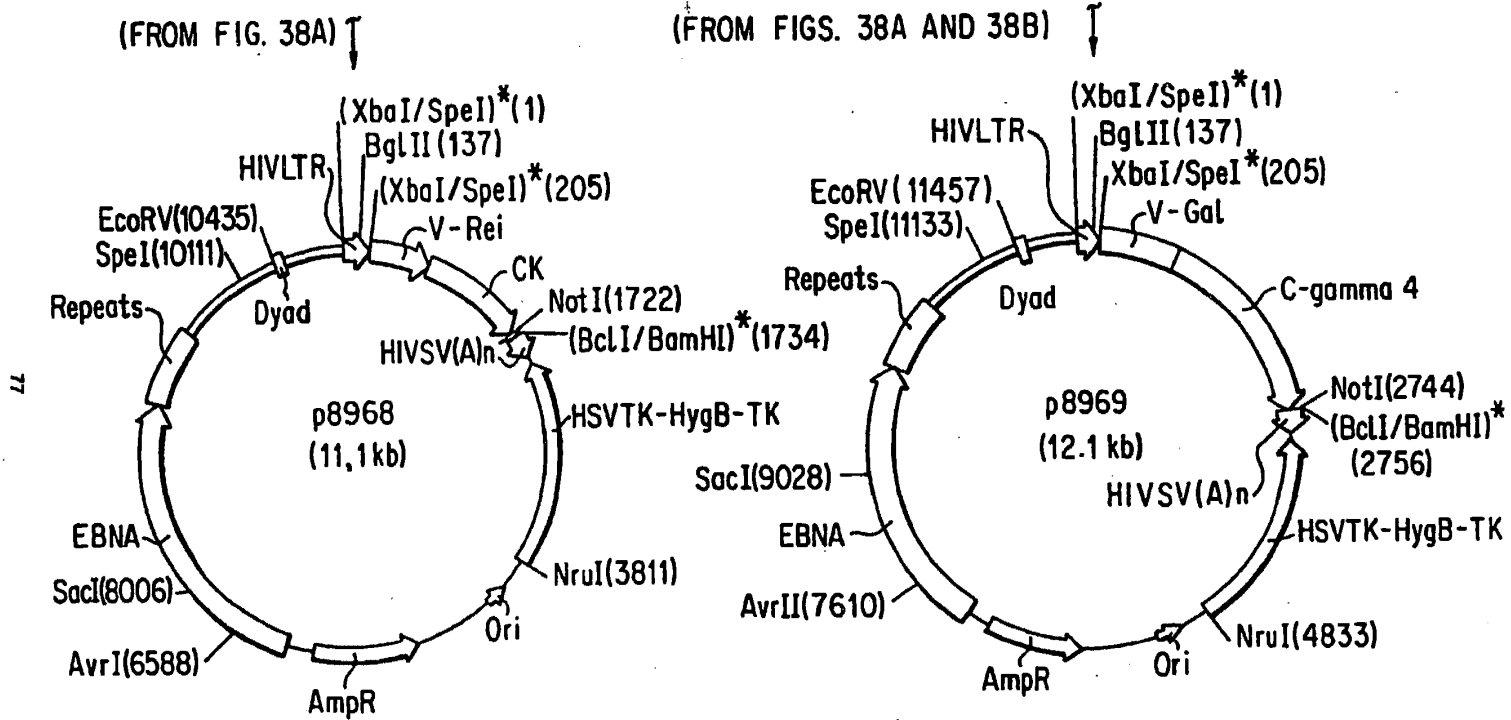

FIG. 38C



European Patent Office

EUROPEAN SEARCH REPORT

Application Number

DOCUMENTS CONSIDERED TO BE RELEVANT			EP 91300362.0
Category	Citation of document with indication, where appropriate, of relevant passages	Relevant to claim	CLASSIFICATION OF THE APPLICATION (Int. Cl.5)
D,A	<p><u>EP - A2 - 0 239 400</u> (WINTER) * Claims 6-10 * --</p>	1, 2	<p>C 12 N 15/13 C 12 P 21/08</p> <hr/> <p>TECHNICAL FIELDS SEARCHED (Int. Cl.5)</p> <p>C 12 N C 12 P</p>
A	<p><u>WO - A2 - 89/01 783</u> (CELLTECH LIMITED) * Claim 7 * --</p>	1, 2	
D,A	<p>PROCEEDINGS OF THE NATIONAL ACADEMY OF SCIENCES OF THE UNITED STATES OF AMERICA, vol. 86, no. 24, December 1989 (Baltimore, USA) C. QUEEN et al. "A humanized antibody that binds to interleukin 2 receptor" pages 10029-10033 * Totality * -----</p>	1, 2	
The present search report has been drawn up for all claims			
Place of search VIENNA		Date of completion of the search 03-04-1991	Examiner WOLF
<p>CATEGORY OF CITED DOCUMENTS</p> <p>X : particularly relevant if taken alone Y : particularly relevant if combined with another document of the same category A : technological background O : non-written disclosure P : intermediate document</p>		<p>T : theory or principle underlying the invention E : earlier patent document, but published on, or after the filing date D : document cited in the application L : document cited for other reasons A : member of the same patent family, corresponding document</p>	

EPO FORM 1501 (06/91)



⑫ **EUROPEAN PATENT APPLICATION**

⑳ Application number: 91300367.9

⑤① Int. Cl.⁵: C12N 15/13, C12N 5/10,
C12P 21/08, A61K 39/395

㉒ Date of filing: 17.01.91

The applicant has filed a statement in accordance with Rule 28 (4) EPC (issue of a sample only to an expert). Accession number(s) of the deposit(s): HB 10164.

③① Priority: 19.01.90 US 467692
20.12.90 US 627421

④③ Date of publication of application:
24.07.91 Bulletin 91/30

⑧④ Designated Contracting States:
CH DE FR GB IT LI NL

⑦① Applicant: MERCK & CO. INC.
126, East Lincoln Avenue P.O. Box 2000
Rahway New Jersey 07065-0900 (US)

⑦② Inventor: Law, Ming-Fan
12344 Picrus Street
San Diego, California 92129 (US)
Inventor: Mark, George E. III
4 Richmond Court
Princeton Junction, NJ 08550 (US)
Inventor: Schmidt, John A.
19 Fairway Drive
Green Brook, NJ 08912 (US)
Inventor: Singer, Irwin I.
18 Lakeridge Drive
Matawan, NJ 07747 (US)

⑦④ Representative: Thompson, John Dr. et al
Merck & Co., Inc. European Patent
Department Terlings Park Eastwick Road
Harlow, Essex CM20 2QR (GB)

⑤④ Recombinant human anti-CD18 antibodies.

⑤⑦ Recombinant immunoglobulin specifically reactive with the CD18 integrin or antigen of leukocytes and methods for the production of the immunoglobulin are disclosed. DNA constructs containing the complementarity determining regions (CDRs) of a murine antibody are recombinantly combined with the chosen frameworks of variable regions of both heavy and light chains of a human antibody. The constructs are transfected into eucaryotic host cells capable of expressing the recombinant immunoglobulin sequence.

EP 0 438 312 A2

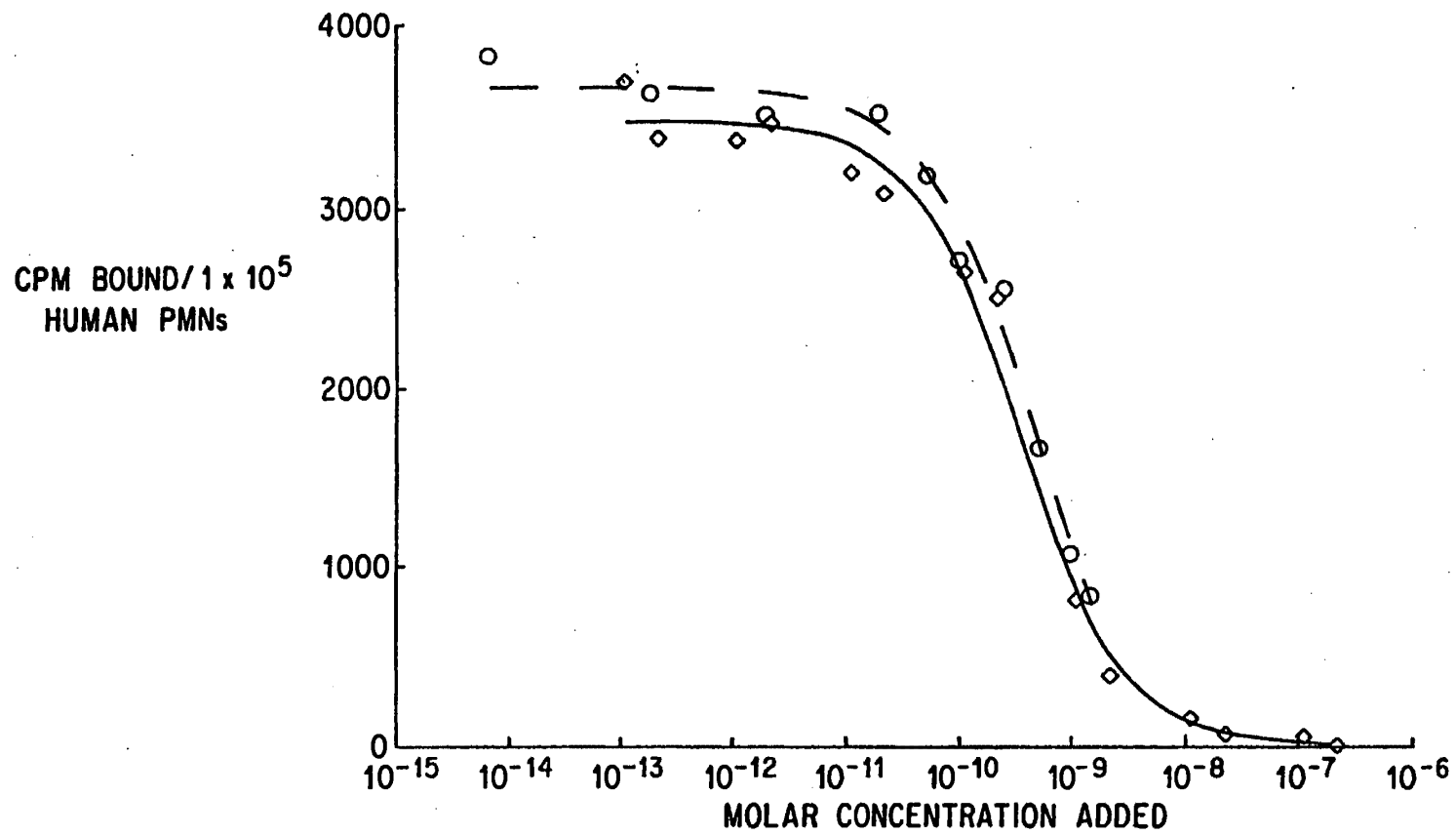

FIG. 13

RECOMBINANT HUMAN ANTI-CD18 ANTIBODIES

BRIEF DESCRIPTION OF THE DRAWINGS

Figure 1. Primers used to isolate DNA encoding murine kappa light chain variable region and murine IgG2a heavy chain variable region using PCR.

Figure 2. Diagram of antibody structure and PCR products of murine heavy and light chain.

Figure 3. 1B4 amino acid sequence for heavy chain variable region and light chain variable regions 1 and 2 deduced from the nucleic acid sequence of the cloned cDNAs.

Figure 4. Oligodeoxynucleotides used as primers for PCR mutagenesis and amplification of the Rel light chain variable region template so as to graft the CDRs of 1B4 into the Rel light chain variable region.

Figure 5. PCR recombination strategy used in the CDR-grafting of the Rel/1B4 light chain variable region.

Figure 6. Outline of the insertion of light chain variable and constant regions into the light chain expression vector.

Figure 7. Oligodeoxynucleotides used as PCR primers to generate a shortened IgG4 heavy chain. Oligodeoxynucleotide primers used in PCR to re-engineer the thymidine kinase (TK) promoter to facilitate the expression of the neomycin resistance gene. Oligodeoxynucleotide primers used in PCR to clone the IgH enhancer sequence. Oligodeoxynucleotides used as PCR primers to generate a human kappa light chain constant region.

Figure 8. PCR recombination strategy used in the fusing of human signal and intronic sequence to the 1B4 heavy chain variable region.

Figure 9. Oligodeoxynucleotides used as primers for PCR recombination to fuse human signal and intronic sequences onto the 1B4 heavy chain variable region.

Figure 10. Outline of the construction of the neomycin selectable expression vector.

Figure 11. Outline of the insertion of the "chimeric" 1B4 heavy chain variable region and the shortened human IgG4 heavy chain constant region into the heavy chain expression vector.

Figure 12. Levels of transient expression as determined by trapping ELISA, of the 1B4 chimeric heavy chain : grafted Rel/1B4 light chain recombinant antibody in CV1, COS 7 and 293 cells.

Figure 13. Competitive binding assay of recombinant "chimeric"/Rel 1B4 (circles) and native murine 1B4 MAb (diamonds) for CD18 on activated human PMNs.

Figure 14. Amino acid sequence composition of the human heavy and light chain variable regions from which framework regions were used to support the murine 1B4 CDRs.

Figure 15. Oligodeoxynucleotides used in the construction of Gal/1B4 heavy chain variable region and Jon/1B4 heavy chain variable region plus those necessary to fuse the human signal and intronic sequences onto these variable regions.

Figure 16. PCR-recombination strategy used in the CDR-grafting of the Gal/1B4 heavy chain and Jon/1B4 heavy chain variable regions.

Figure 17. DNA sequence and deduced amino acid sequence determined for murine 1B4 heavy chain variable region.

Figure 18. Outline of the construction of the hygromycin selectable expression vector.

Figure 19. Outline of the insertion of the Gal/1B4 heavy chain and the Jon/1B4 heavy chain variable regions into the heavy chain expression vector containing the shortened IgG4 heavy chain constant region.

Figure 20. Summary of the competitive binding activities of murine MAb 1B4 and recombinant human anti-CD18 antibody constructs.

Figure 21. Oligodeoxynucleotides used in the construction of Len/1B4 light chain variable region plus those necessary to fuse the human signal onto the Len light chain variable region.

Figure 22. PCR-recombination strategy used in the CDR-grafting of the LEN/1B4 light chain variable region.

Figure 23. Outline of the insertion of the Len/1B4 light chain variable region into an intermediate vector followed by its insertion into the light chain expression vector.

Figure 24. DNA sequence and deduced amino acid sequence determined for murine 1B4 light chain-1 variable region.

Figure 25. DNA sequence and deduced amino acid sequence determined for murine 1B4 light chain-2 variable region.

Figure 26. Oligodeoxynucleotides used in the construction of Gal-m1/1B4 (mutant) heavy chain variable region plus those necessary to fuse the human signal onto the Gal-m1 heavy chain variable region.

Figure 27. PCR-recombination strategy used in the CDR-grafting of the Gal-m1/1B4 (mutant) heavy chain variable region.

Figure 28. Competitive binding assay of native murine 1B4 (diamonds) and Gal/Rel humanized 1B4 (circles).

Figure 29. Competitive binding assay of New/Rel recombinant h1B4 (closed diamonds) and Gal/Rel recombinant h1B4 (open diamonds).

Figure 30. Effects of native murine 1B4 (diamonds) and Gal/Rel recombinant humanized 1B4 (circles) on attachment of human PMNs to human

umbilical vein endothelial cell monolayers *in vitro*.

Figure 31. Comparison of Gal/Rei h1B4 and m1B4 in *in vitro* functional assays.

Figure 32. Immunofluorescence microscopic localization of m1B4 and Gal/Rei h1B4 staining in 5 μ m frozen sections of rabbit tissues.

Figure 33. Double label immunofluorescence microscopic localization of Gal/Rei h1B4 and m1B4 in rabbit bone marrow cells.

Figure 34. Double label immunoelectron microscopic localization of Gal/Rei h1B4 and m1B4 in specific granules of human PMNs.

Figure 35. Dose-dependent inhibition by m1B4 and Gal/Rei h1B4 of C5a (100 pmol)-induced PMN accumulation in rabbit skin.

Figure 36. Dose-dependent inhibition by m1B4 and Gal/Rei h1B4 of C5a (100 pmol)-induced plasma extravasation in rabbit skin.

Figure 37. Outline of the construction of expression system p8962 capable of producing large quantities of recombinant CDR-grafted 1B4 antibodies.

Figure 38. Outline of the construction of expression systems p8968 and p8969 capable of producing large quantities of recombinant CDR-grafted 1B4 antibodies.

BACKGROUND OF THE INVENTION

Murine derived monoclonal antibodies have been utilized as diagnostic and therapeutic agents for numerous human pathologic conditions including acute inflammatory responses associated with numerous diseases. Administration of murine derived monoclonal antibodies (mMAbs) as therapeutic agents in man has been severely limited by the development of antibody within the recipient to the mouse antigens of the murine derived monoclonal antibody. In attempts to circumvent this outcome mMAbs have been restructured by recombinant DNA technology in such a way as to decrease their immunogenicity in humans. Immunoglobulins are well defined both chemically and biologically with the general structures illustrated in *Molecular Cell Biology*, Darnell, Lodish, and Baltimore, Eds., Scientific American Books, Inc., W.H. Freeman, New York, NY (1986). Initially, this involved the construction of chimaeric antibodies, Morrison et al., *Proc. Natl. Acad. Sci. USA* 81 : 6851-6855 (1984). Recombinant technology was employed to replace the murine heavy and light chain constant regions with corresponding human constant regions. Upon expression, such interspecies antibody chimaeras yielded molecules with the antigen binding specificities of the parent murine antibody. The following references generally describe chimaeric antibody technology : Lobuglio et al., *Proc. Natl. Acad. Sci. USA* 86 : 4220-4224 (1989) ; United States Patent 4,816,567 ; PCT International Publication No. WO 87/02671,

published May 7, 1987 ; European Patent Publication No. 255,694, published February 10, 1988 ; European Patent Publication No. 274,394, published July 13, 1988 ; European Patent Publication No. 323,806, published July 12, 1989 ; PCT International Publication No. W0/89/00999, published February 9, 1989 ; European Patent Publication No. 327,000, published August 9, 1989 ; European Patent Publication No. 328,404, published August 16, 1989 ; and European Patent Publication No. 332,424, published September 13, 1989.

The immunogenicity of chimaeric antibodies can be further reduced by grafting rodent hypervariable regions into the variable region frameworks of human light and heavy chains, Jones et al., *Nature* 321 : 522-525 (1986). These hypervariable regions have also been termed complementarity determining regions (CDR). The technique involves the substitution or recombinant grafting of antigen-specific murine CDR sequences for those existent within "generic" human heavy and light chain variable regions, European Patent Publication No. 239,400, published September 30, 1987. In this approach, little, if any, concern is shown for the variable region frameworks (FRs) within which the murine CDRs are placed. The instant invention illustrates that appropriate supportive structures for the CDRs are vital not only for the assembly of the functional antibody molecules but also for the production of antibody molecules with avidities which allow for the administration of therapeutic doses (about 0.1-1mg/kg).

Recent studies by Queen et al., *Proc. Natl. Acad. Sci. USA* 86 : 10029-10033 (1989), have shown the CDRs from a murine anti-Tac monoclonal antibody can be grafted into a human framework. The human framework variable regions were chosen to maximize identity with the murine sequence. The authors also utilized a computer model of the mMAB to identify several amino acids which, while outside the CDRs, are close enough to interact with the CDRs or antigen. These residues were mutated to the residue found in the murine sequence. The grafted anti-Tac antibody had an affinity for the antigen which was only about 1/3 that of the murine anti-tac mMAB and maintenance of the human character of this antibody was problematic.

Leukocyte infiltration into an inflammatory site is dependent on the adhesion of the leukocytes to the endothelium prior to extravasation. The rapid binding of polymorphonuclear leukocytes (PMN) to the endothelium and diapedesis occurs within minutes after the introduction of a chemotactic stimulus in tissue, Cybulski et al., *Am. J. Pathol.* 124 : 367 (1986). This rapid extravasation appears to depend on the response of the PMNs to chemoattractants and on the presence of the CD11/CD18 family of glycoproteins on the leukocyte surface. The family of glycoproteins associated with PMNs are termed leukocyte Integrins

and include LFA-1 (CD11a/CD18), Mac-1 (CD11b-CD18) and p150,95 (CD11c/CD18). Each of these heterodimers has a unique alpha chain (CD11 a, b, c) and an invariant beta-2 chain (CD18). Stimulation of PMNs with various chemotactic factors causes increased expression of leukocyte Integrins (CD11b/CD18) fostering strong adhesion to unstimulated endothelium *in vitro*, Harlan, *Blood* 65 : 513 (1985), and essentially all of the chemoattractant-induced adhesion is inhibited by treating the PMNs with mMABs specifically reactive with the CD11/CD18 complex, Harlan *et al.*, *Blood* 66 : 167 (1985); Zimmerman and McIntyre *J. Clin. Invest.* 81 : 531 (1988); Smith *et al.*, *J. Clin. Invest.* 82 : 1748 (1988); and Lo *et al.*, *J. Exp. Med.* 169 : 1779 (1989). Polymorphonuclear leukocytes from patients with leukocyte adhesion deficiency (LAD) fail to express CD18 and fail to bind unstimulated endothelium *in vitro*, Harlan *et al.*, *Blood* 66 : 167 (1985); Lo *et al.*, *J. Exp. Med.* 169 : 1779 (1989).

Murine hybridomas producing monoclonal antibodies reactive with the beta chain common to the Mac-1, LFA-1 and the p150,95 integrins have been described. The mMABs are designated 1B4, 60.3, TS1/18, H52 and ATCC TIB 218. The 1B4 is an IgG2a antibody and was prepared by Wright *et al.*, *Proc. Natl. Acad. Sci. USA* 80 : 5699-5703 (1983), the 60.3 is also IgG2a and was prepared by Beatty *et al.*, *J. Immunol.* 131 : 2913-2918 (1983), TS1/18 is an IgG1 antibody and was prepared by Sanchez-Madrid *et al.*, *J. Exp. Med.* 158 : 1785-1803 (1983), H52, a MAb against beta 2 (CD18) was prepared by Hildreth and Orentas, *Science* 244 : 1075-1078 (1989) and ATCC TIB 218, a IgG2a kappa prepared by Springer *et al.*, *J. Exp. Med.* 158 : 586-602 (1983). These antibodies appear to be functionally equivalent and cross-react with the beta-2 chain found on human, sheep pig, rabbit, and dog leukocytes but not with the beta-2 chain found on murine and rat leukocytes.

SUMMARY OF THE INVENTION

Recombinant immunoglobulin specifically reactive with the CD18 Integrin or antigen of leukocytes and methods for the production of the immunoglobulin are disclosed. DNA constructs containing the complementarity determining regions (CDRs) of a murine antibody are recombinantly combined with the frameworks of chosen viable regions of both heavy and light chains of a human antibody. The constructs are transfected into eukaryotic host cells capable of expressing the recombinant immunoglobulin sequences.

OBJECT OF THE INVENTION

It is accordingly, an object of the present invention to provide novel DNA sequences for the com-

plementarity determining regions of murine heavy and light chain monoclonal antibody. Another object of the invention is to provide novel DNA sequences for the complementarity determining regions of murine heavy and light chain monoclonal antibody that immunologically binds to the CD18 Integrin or antigen of leukocytes. A further object is to provide novel DNA sequences for recombinant animal antibody. Another object is to provide a vector containing the DNA sequence for recombinant animal antibody. Another object is to provide a mammalian host transformed with a vector containing the DNA sequence for recombinant animal antibody. It is a further object that the animal recombinant antibody be human recombinant antibody. A further objective is to provide recombinant human immunoglobulin that binds to leukocyte Integrin. Another object is to provide a process for making recombinant human immunoglobulin. A further object is to provide a process for producing recombinant immunoglobulins.

DETAILED DESCRIPTION OF THE INVENTION

The present invention relates to methods and means for the construction and expression of unique recombinant derived antibody in which complementarity determining regions (CDRs) from a first animal monoclonal antibody of defined specificity are inserted into a second animal, including man, variable heavy and light chain frameworks which show a high degree of sequence similarity with the framework of the first animal and present the CDRs in the appropriate configuration to react with the appropriate antigen or ligand. The insertion or grafting is carried out by processes well known in the biotechnical arts, primarily recombinant DNA technology. The unique frameworks (FRs) are selected for their structural compatibility and sequence similarity with the first animal frameworks. This preselection is dependent on one or more of the following criteria: (i) sequence matching to all known human heavy chain variable (V_H) and light chain variable (V_L) framework sequences with the framework sequences of the animal monoclonal antibody from which the CDRs have been removed; (ii) sequence matching as described in (i), but with significant attention paid to interspecies matching of the non-surface exposed amino acid residues; (iii) tertiary and quaternary structural model of human framework sequences with CDRs in place for comparison with models of the original animal monoclonal antibody; and (iv) screening of human genomic DNA with DNA probes corresponding to framework sequences in chosen animal monoclonal antibody. These criteria and the following procedures are used to prepare recombinant DNA sequences which incorporate the CDRs of animal mMAB, both light and heavy chains, into human frameworks that can then be used to transfect mammalian cells for the

expression of recombinant human antibody with the antigen specificity of the animal monoclonal antibody.

The present invention further comprises a method for constructing and expressing the altered antibody comprising: (i) mutagenesis and assembly of variable region domains including CDRs and FRs regions; (ii) preparation of an expression vector including at least one variable region which upon transfection into cells results in the secretion of protein sufficient for avidity and specificity determinations; and (iii) co-amplification of heavy and light chain expression vectors in appropriate cell lines.

The present invention provides recombinant methods for incorporating CDRs from animal monoclonal antibodies into human immunoglobulin frameworks so that the resulting recombinant human antibody will be either weakly immunogenic or non-immunogenic when administered to humans. Preferably the recombinant immunoglobins will be recognized as self proteins when administered for therapeutic purposes. This method of "humanization" will render the recombinant antibodies useful as therapeutic agents because they will be either weakly immunogenic or non-immunogenic when administered to humans. The invention is further contemplated to include the recombinant conversion of any animal monoclonal antibody into a recombinant human monoclonal antibody providing that a suitable framework region can be identified (as described below). It is intended that the present invention include the nucleotide and amino acid sequences of the murine CDR regions and the human framework regions either separately or combined as a light or heavy chain or an intact immunoglobulin and any conservatively modified variants thereof. The animal monoclonals may include, but are not limited to, those murine monoclonal antibodies described by Van-Voorhis et al., *J. Exp. Med.* **158**: 126-145 (1983) which bind to human leukocytes and the appropriate mMAbs produced by hybridomas deposited in the Hybridoma Cell Bank maintained by the American Type Culture Collection (ATCC) and described in the ATCC Catalog of Cell Lines & Hybridomas, No. 6, 1988.

The CDR sequences from the animal monoclonal antibody are derived as follows. Total RNA is extracted from the murine hybridomas, for example the 1B4 myeloma cells described by Wright et al., *Proc. Natl. Acad. Sci. USA* **80**: 5699-5703 (1983), the 60.3 cells described by Beatty et al. *J. Immunol.* **131**: 2913-2918 (1983), the TS1/18 cells described by Sanchez-Madrid et al., *J. Exp. Med.* **158**: 1785-1803 (1983), and other anti-CD18 or CD11 monoclonal antibodies and hybridomas as described in *Leukocyte Typing III*, Springer-Verlag, New York (1988), using standard methods involving cellular solubilization with guanidinium isothiocyanate (Chirgwing et al., *Biochem.* **18**: 5294-5299 [1979]). The murine 1B4 mMAb will be

used as the primary example of animal MAb that can be "humanized" by the unique process being disclosed. The invention is intended to include the conversion of any animal immunoglobulin to a human immunoglobulin. It is further intended that human immunoglobulin (Ig) can contain either kappa or lambda light chains or be one of any of the following heavy chain isotypes (alpha, delta, epsilon, gamma and mu). Pairs of degenerate oligodeoxynucleotide primers (Figure 1) representing sequences within framework 1 of the murine kappa light chain variable region and light chain constant domain, or those within framework 1 of the murine IgG2a heavy chain variable region and heavy chain constant CH1 domain are synthesized on an Applied Biosystem 381A DNA synthesizer, removed from the resin by treatment with concentrated NH_4OH and desalted on a NAP-5 column eluted with H_2O . Total RNA, about 2 μg , is reverse transcribed for about 30 min at about 42° C using Moloney MLV reverse transcriptase, about 200 units (BRL), and about 10 pmoles of the constant region complementary strand primers for either the heavy or light chain. The reverse transcriptase is heat inactivated, about 95° C for about 5 min, and the reactions are made to contain in about 100 μl of PCR buffer about 50 pmoles of each of the paired primers and 25 units of Taq polymerase. About 45 cycles of amplification (2', 94° C; 2', 55° C; 2', 72° C) are followed by gel purification of the anticipated 400+ base pair (bp) DNA fragments (Figure 2). Prior to subcloning those DNAs into a blunt-ended intermediate plasmid such as pSP72 (Promega) they are terminally phosphorylated using T4 polynucleotide kinase. Frozen competent *E. coli* were thawed on ice and 100 μl aliquots were distributed into wet ice chilled polypropylene tubes. DNA (1-10 ng) from the ligation mixture was dispensed with agitation into these tubes and incubated on ice was continued for 30 minutes. The *E. coli* cells were heat-shocked by incubation at 42° C for 45 seconds, then chilled for 2 minutes on ice. Room temperature S.O.C. (Hanahan, D., *J. Mol. Biol.* **166**: 557, 1983) was added and the cultures were shaken at 225 RPM at 37° C for 60 minutes. Aliquots of the cultures were spread on LB agar plates containing 100 $\mu\text{g}/\text{mL}$ ampicillin and these plates were incubated overnight at 37° C to allow for colony growth. Multiple clones representing these PCR amplified sequences are grown and submitted to DNA sequence determinations using Sequenase® and T7 and SP6 specific sequencing primers. A unique DNA sequence representing a murine IgG2a heavy chain variable region is obtained, but two kappa light chain variable regions are represented within the cloned population (Figure 3). To distinguish which sequence belongs to the 1B4 mMAb, the 1B4 mMAb is reduced with dithiothreitol (DTT) and purified heavy and light chains are subjected to N-terminal amino acid sequencing using the Applied Biosystems 477A sequ-

encer. Tryptic and cyanogen bromide digested peptides are also sequenced.

Replacement of human variable region CDRs with those unique to mMAb 1B4 is accomplished utilizing the following unique processes. An appropriate human framework is determined utilizing the criteria discussed above. A light chain variable region framework such as the RE1 framework (Orlandi, et al., Proc. Natl. Acad. Sci. USA 86 : 3833-3837 [1989] ; Riechmann et al., Nature 332 : 323-327 [1988] ; European Patent Application, Publication No. 239,400), with its leader and 3' intronic sequences, is subcloned into the intermediate vector pGEM3Z (Promega). About eight oligodeoxynucleotide primers (Figure 4) are synthesized representing the primers necessary to generate by polymerase chain reaction (PCR) amplification four DNA fragments. Incorporated into all but the terminal oligodeoxynucleotide primers were those sequences corresponding to MAb 1B4 light chain CDRs and at least 15 bases of 5'-terminal complementarity (see Figure 5). The appropriate primer pair, about 50 pmole each, was combined with about 10 ng of plasmid DNA representing the RE1 framework, about 2.5 units of Taq DNA polymerase and about thirty (30) cycles of PCR amplification ensued (cycle periods, as above). The products of the four reactions, purified by agarose gel electrophoresis, are combined, about 10 ng of each DNA fragment, along with terminal oligodeoxynucleotide primers (Figure 4) and Taq DNA polymerase and the combined fragments were PCR amplified (see Figure 5). Following restriction endonuclease digestion with HindIII and XbaI the amplified DNA is purified by agarose gel electrophoresis and subcloned into compatible sites of an intermediate vector pSP72 (Promega) which contains the human kappa light chain constant region (see Figure 6). Genomic DNA, about 1 µg, purified from a human B cell line (GM0108A : NIGMS Human Genetic Mutant Cell Repository, Institute for Medical Research, Camden, NJ) is used as a template for PCR amplification (Figure 7) of about a 920 base pair fragment containing the splice acceptor for the kappa light chain constant domain, the exon and a portion of its 3'-untranslated region. The PCR product is purified by agarose gel electrophoresis, digested with BamHI endonuclease, and subcloned into pSP72 previously linearized with BamHI. The individual clones representing the pSP72 intermediate vector containing both the 1B4 grafted variable region derived from RE1 and the human kappa constant region derived by PCR amplification of human DNA are used to determine the DNA sequence of the grafted light chain variable region.

The chimaeric heavy chain portion of the recombinant antibody is derived from the murine 1B4 heavy chain variable region fused to the human constant region of a gamma 4 subtype obtained from a lambda library constructed by Flanagan and Rabbits, Nature

300 : 709-713 (1982). The variable region of the chimaeric heavy chain is constructed from three DNA fragments representing a signal sequence, a portion of the murine heavy chain variable region, and an intronic sequence (Figure 8). Oligodeoxynucleotide primer pairs (Figure 9) are synthesized representing the primers necessary to generate by PCR amplification these three DNA fragments from about 10 ng of plasmid DNA templates obtained from M13VHPCR1 (Orlandi et al., Proc. Natl. Acad. Sci. USA 86 : 3833-3837 [1989]) or the pSP72 intermediate vector containing the IgG2a heavy chain variable region previously used to determine the murine 1B4 CDR sequence. Amplification of the signal fragment, variable region fragment and intron-containing fragment was as described above. The agarose gel purified products are combined, about 10 ng of each product, with terminal oligodeoxynucleotide primer pairs (Figure 9) and the PCR-generated *in vitro* recombined template is amplified using the standard procedures described above. Prior to subcloning into a BglII and BamHI digested intermediate vector pSP72 this recombined product is similarly digested and agarose gel purified. Individual clones are submitted to DNA sequence determination using Sequenase® and T7 and SP6 specific sequencing primers and one is chosen (p8950) for subsequent expression.

The gamma 4 heavy chain constant region is subcloned as about a 6.7 Kb HindIII fragment derived from the plasmid pAT84 (Flanagan and Rabbits, Nature 300 : 709-713 [1982]) into the Hind III site of the intermediate vector pSP72. This plasmid is then used as the template DNA from which a shortened version of the gamma 4 constant region is subcloned using PCR amplification and the primer pairs indicated in Figure 7. Eukaryotic expression vectors are constructed as described below. Expression vectors are defined herein as DNA sequences that are required for the transcription of cloned copies of genes and the translation of their mRNAs in an appropriate host. Such vectors can be used to express eukaryotic genes in a variety of hosts such as bacteria, blue-green algae, plant cells, yeast cells, insect cells and animal cells. The immunoglobulins may also be expressed in a number of virus systems. Specifically designed vectors allow the shuttling of DNA between hosts such as bacteria-yeast or bacteria-animal cells. An appropriately constructed expression vector should contain : an origin of replication for autonomous replication in host cells, selectable markers, a limited number of useful restriction enzyme sites, a potential for high copy number, and strong promoters. A promoter is defined as a DNA sequence that directs RNA polymerase to bind to DNA and initiate RNA synthesis. A strong promoter is one which causes mRNAs to be initiated at high frequency. Expression vectors may include, but are not limited to, cloning vectors, modified cloning vectors, specifically desig-

ned plasmids or viruses. The heavy chain immunoglobulin molecule is transcribed from a plasmid carrying the neomycin (G418) resistance marker while the light chain immunoglobulin is transcribed from a plasmid carrying the hygromycin B resistance marker. With the exception of the drug resistance portion of these plasmids they are identical.

The preferred progenitor of the immunoglobulin expression vectors is the pD5 (Berkner and Sharp, Nucl. Acids Res. 13 : 841-857 [1985]) eukaryotic expression vector which contains the origin of adenovirus replication, the SV40 enhancer domain, the adenovirus major late promoter, the adenovirus 2 tripartite leader, a 5' splice donor from the adenovirus third leader and a 3' splice acceptor derived from an immunoglobulin locus, a multiple cloning site placed in the Bam H1 site subsequent to receipt of the vector, and the SV40 late polyadenylation signal (Figure 10). The origin of replication is removed by digestion with Eco R1 and KpnI and replaced by two fragments representing the neo selectable marker gene (derived from plasmid pCMVIE-AK1-DHFR as an Eco R1/Bam H1 about 1.8 Kb fragment) and the Ig heavy chain enhancer (obtained as a PCR amplified fragment using human DNA as the template, and the oligodeoxynucleotides listed in Figure 7 as the primer pair, following its digestion with Bgl II and Kpn I). The resultant expression vector is found to lack a small portion of the TK promoter responsible for the transcription of the neomycin gene. This is replaced by insertion into the EcoRI site of about a 0.14kb PCR amplified fragment derived from the CMVIE-AK1-DHFR DNA using the primer pair listed in Figure 7. The resultant heavy chain expression vector (p8941) is modified by removal of the indicated HindIII and XbaI sites using standard procedures. To convert this vector into one expressing the hygromycin B selectable marker the neomycin-resistance cassette is removed by digestion first with Eco R1 followed by DNA polymerase-directed fill in of the 5' overhang, then subsequent Sall digestion. The about 1.9 kb hygromycin B expression cassette, TK promoter and TK polyadenylation signal flanking the hygromycin B gene, (obtained as a 1.8 kb BamH1 fragment in plasmid pL690, Gritz and Davies, Gene 25 : 179-188 [1981]) is removed from the plasmid pAL-2 by Bam H1 digestion and subcloned into the BamH1 site of the intermediate vector pSP72. The hygromycin B cassette is removed from this vector by digestion with SmaI and Sall and cloned into the expression vector linearized as described above to create a blunt end and Sall end DNA fragment.

Expression of the 1B4 CDR-grafted kappa light chain is accomplished by transferring this cistron from the pSP72-based intermediate cloning vector (p8952) to the hygromycin B selectable eukaryotic expression vector (see Figure 6). An about 1.5 kb DNA fragment resulting from the endonuclease digestion of p8952

with Spe I and Cla I is purified by agarose gel electrophoresis and ligated into the expression vector which has previously been linearized, following digestion with the same two restriction enzymes, and agarose gel purified. The heavy chain eukaryotic expression vector is constructed in two steps (see Figure 11). First, the p8950 vector containing the modified heavy chain variable region of murine 1B4 Kb fragment is digested with Bgl II and Bam H1. The agarose gel purified 0.75 kb fragment is ligated into the BamH1 site of the p8941 vector and recombinant clones containing this fragment in the proper orientation are identified. Plasmid DNA from one such clone is linearized by Bam H1 digestion and ligated with a 1.78 Kb BamH1 fragment representing a short version of the human gamma 4 constant region, derived from plasmid pAT84 by PCR amplification. Following the identification of clones containing these inserts in the appropriate orientation, plasmid DNAs (one which is referred to as p8953) are grown and purified for transfection into recipient mammalian cells. Host cells for the expression of humanized monoclonal antibodies include, but are not limited to, human cells such as 293 cells, monkey cells such as COS-7 and CV-1P, and other mammalian cells such as CHO and NS0.

Equal amounts, about 10 µg, of the plasmids encoding the chimeric IgG4 heavy chain and the 1B4 CDR-grafted kappa light chain are transfected by standard calcium phosphate precipitation procedures into human 293 cells, and the monkey cells COS-7 and CV-1P. The culture supernants are assayed by a trapping Elisa (described below) for the secretion of human IgG4/kappa immunoglobulin. This Elisa assay is also employed for the quantitation of the amounts of a humanized 1B4 recombinant antibody expressed in conditioned mammalian cell growth medium.

Immulon-2 (Dynatech Labs.) 96-well plates are coated overnight with about a 5 µg/ml solution of mouse anti-human kappa chain constant domain monoclonal antibody (cat. #MC009, The Binding Site, Inc., San Diego, CA) in about 0.1 M NaHCO₃ buffer (pH 8.2) at about 4°C, and blocked with about 1% bovine serum (BSA) in about 0.1M NaHCO₃ for about 1h at about 25° C. After this and all subsequent steps, washing was performed with phosphate buffered saline (PBS). The wells are then inoculated with conditioned medium containing recombinant anti-CD18 antibody, or with predetermined quantities of human IgG4/kappa purified by protein A Sepharose (Pharmacia Fine Chemicals) chromatography from human IgG4 myeloma serum (cat. # BP026, The Binding Site, Inc.) All samples are diluted in PBS containing about 0.05% Tween-20. About 100 µl aliquots are incubated for about 1h at about 37°C in triplicate, and standard calibration curves are constructed using IgG4 concentrations ranging from about 10 ng/ml to about 100 ng/ml. Bound and fully assembled human IgG4 (either

native or recombinant 1B4-human IgG4 constructs) are detected with about 100 μ l aliquots of a 1:500 dilution of mouse anti-human IgG4 Fc monoclonal antibody conjugated to alkaline phosphatase (cat #05-3822, Zymed Laboratories, Inc.) in phosphate buffered saline (PBS) containing about 1% BSA. After incubation for about 1h at about 37°C and subsequent washing, the quantities of bound conjugate are detected by incubating all samples with a 1 mg/ml solution of p-nitrophenyl phosphate in 0.1 M 2,2'-amino-methyl-propanediol buffer, pH 10.3, for about 30 min at about 25°C. The adsorbance of the wells is determined with a UV Max ELISA plate reader (Molecular Devices) set at 405 nm. All supernatant fluids from the transfected cells are found to contain this immunoglobulin, though in various amounts (Figure 12). The antibody secreted by the transfected 293 cells is isolated by protein A chromatography and the concentration of recombinant human anti-CD18 antibodies determined by the trapping Elisa described above, are used to compete with the binding of radiolabeled murine 1B4 to the CD18 ligand on the surface of activated human PMNs. Affinities of various recombinant human anti-CD18 (r-h-anti-CD18) antibody constructs are determined using a competitive ¹²⁵I-1B4 soluble binding assay with stimulated human polymorphonuclear leukocytes (PMNs). Purified murine anti-CD18 monoclonal antibody (50 μ g) is iodinated using chloramine-T (Hunter and Greenwood, Nature 194: 495-496, 1962), and the radiolabeled antibody purified using a Bio-Sil TSK250 (Biorad) gel filtration HPLC column (which fractionates proteins in the range of 1-300 x 10³ daltons) equilibrated in 0.1 M phosphate buffer, pH 7.0. Effluent radioactivity is monitored with an in-line detector (Beckman Model 170; Beckman) and total protein measured at OD₂₈₀ with a Kratos Spectroflow 757 detector (Kratos). A single ¹²⁵I-1B4 peak composed of coincident OD₂₈₀ and radioactivity tracings characteristically elutes about 6 minutes, 30 seconds following sample injection. Specific activity of the product is generally about 10 μ Ci/ μ g protein, and 97-99% of the counts are precipitable with 10% trichloroacetic acid. The binding of this radiolabeled antibody is assessed on human PMNs purified on a discontinuous Ficoll/Hypaque gradient (English and Anderson, J. Immunol. Methods 5: 249-255, 1974) and activated with about 100 ng/ml phorbol myristate acetate for about 20 minutes at about 37°C (Lo et al., J. Exp. Med. 169: 1779-1793, 1989). To determine the avidity of antibodies for CD18 molecules on the PMN surface, about 1 x 10⁶ activated PMNs are incubated in a buffer such as Hanks balanced salt solution containing about 20 mM Hepes (pH 7.2), about 0.14 units aprotinin (Sigma Chemical Co.) and about 2% human serum albumin (binding buffer) containing about 1.3 ng ¹²⁵I-1B4 (2.8 x 10⁻¹¹ M) in the presence of increasing concentrations of unlabeled 1B4 antibody (about

10⁻⁷ to 10⁻¹⁶ M) in about a 300 μ l reaction volume for about 1 h at about 4°C with constant agitation. Cell bound 1B4 is separated from the unbound antibody by centrifugation through a 0.5M sucrose cushion (4,800 x g, 3 minutes); the tubes are frozen on dry ice, and the tips cut off and counted with an LKB gamma counter. The IC₅₀ of the anti-CD18 antibody for the inhibition of ¹²⁵I-1B4 antibody binding is calculated using a four parameter fitter program (Rodbard et al., In, "Radioimmunoassay and Related Procedures in Medicine", International Atomic Energy Agency, Vienna, vol I, 469 - 504, 1978). The affinity of the various recombinant humanized anti-CD18 (r-h-anti-CD18) antibodies for the CD18 ligand is determined in a similar manner using murine ¹²⁵I-1B4 antibody and increasing quantities, as determined by the trapping Elisa, of unlabeled r-h-antiCD18. The results of the binding assays are shown in Figure 13 and indicate that the avidity of the chimaeric heavy chain/grafted light chain recombinant 1B4 antibody is approximately that of the murine 1B4 monoclonal antibody.

The results described above show that an antibody with human isotype may be recombinantly expressed following the transfer of the antigen binding domains from a first animal (murine) light chain framework to a second animal (human) light chain framework one fused with a human kappa constant region, when combined with a chimaeric heavy chain (murine heavy chain variable region fused to a human gamma 4 constant domain) without loss in avidity for the antigen. It can be inferred from this result that the human REI light chain framework region does not alter the presentation of the murine 1B4 light chain CDRs and/or the contribution of the light chain CDRs to the antibody's avidity is minimal. Many of the examples of construction of recombinant human antibodies containing complementarity regions replaced by those found within murine monoclonal antibodies have resulted in loss of avidity for the ligand or antigen. Thus, although these transmutations are possible, the successful maintenance of avidity is not assured. The procedures described below demonstrate that when strict attention is paid to the framework regions, CDR domains may be transferred to those frameworks without the loss of avidity which accompanies their transfer to the "generic" frameworks employed by Winter, European Patent Publication No. 239,400, published September 30, 1987.

To identify human framework sequences compatible with the CDRs of, say, murine 1B4, human frameworks with a high degree of sequence similarity to those of murine 1B4 were identified. Sequence similarity was measured using identical residues as well as evolutionarily conservative amino acid substitutions. Similarity searches were performed using the murine 1B4 framework sequence from which the

CDR sequences had been removed. This sequence was used to query a database of human immunoglobulin sequences that had been derived from multiple sources. Sequences with a high degree of sequence similarity were examined individually for their potential as humanizing framework sequences. Special attention must be given to those framework residues which are not located or exposed on the surface of the antibody since these residues will play a critical role in the packing of the CDR supporting scaffolding. In this way, the human homologue providing the murine CDRs with the structure most similar to their native murine framework was selected for subsequent construction of the humanized variable region (see Figure 14). It should be noted that in the present invention the heavy and light chain framework sequences chosen for grafting need not be derived from the same human antibody. That is to say, using the above mentioned criteria for choosing human frameworks the entire accumulated human nucleic acid and protein databases may be searched for the desired matching sequences. The ideal light chain framework may come from one immunoglobulin sequence while the heavy chain framework may come from another. Should human frameworks of sufficient similarity not be identifiable from compiled sequences, it is possible to isolate from human genomic DNA a group of closely related variable regions using recombinant technology. Thus, a degenerate 5'upstream oligodeoxynucleotide primer may be designed from the conserved sequences within the amino-terminus of each of the various human FR1 regions and paired with a degenerate 3' downstream oligodeoxynucleotide primer fashioned from the FR3 sequence determined from the murine monoclonal whose CDRs one wishes to transfer into a human context. These primer pairs are then used to PCR amplify from a human genomic template those DNA sequences which are flanked by the primer pair. The resulting DNAs may then be cloned and the DNA sequence derived from individual members will describe various murine-related human variable regions. The paucity of somatic mutations in framework residues and the conservation of amino acid sequence between mouse and man make this approach possible.

The construction of a complete recombinant human IgG4 antibody, whose heavy and light chain variable domains contain the CDR residues of the murine monoclonal antibody, with complete retention of the specificity and avidity of the parent murine monoclonal antibody is disclosed. The construction of the CDR-grafted light chain framework derived from the human sequence of RE1 fused with a human kappa light chain constant region is described above.

The murine variable region framework sequence, devoid of CDR sequences, is used to query a database of complete human variable region sequences. The human sequences that are most similar to the

murine framework region are then analyzed individually to determine both their sequence identity and similarity to the murine framework region. In the case of murine 1B4 these sequences include, but are not limited to, Gal and Jon, chosen because of their high degrees of both similarity and identity with the murine 1B4 heavy chain sequence. The Gal FR has been shown to be 85% similar and 79% identical to murine 1B4, while the Jon FR has been shown to be 88% similar and 75% identical to 1B4. These values are based upon the Dayhoff similarity matrix of evolutionarily conserved amino acid substitutions (R. M. Schwartz, M. O. Dayhoff, in *Atlas of Protein sequence and structure* M. O. Dayhoff, Eds. (National Biomedical Research Foundation, Washington, DC [1979]) (see Figure 14). To prepare a recombinant DNA encoding the murine heavy chain CDRs in the context of each of these frameworks the following procedures are performed.

Two sets of four long oligodeoxynucleotides are synthesized. When each set is combined, they encode the 1B4 heavy chain CDRs and the chosen human heavy chain variable region framework. The four oligodeoxynucleotides of a set, about 1 pmole of each, are combined in a PCR reaction with Taq polymerase and about 50 pmoles of each terminal amplifying oligodeoxynucleotide (Figure 15, Figure 16). By virtue of the complementary ends of the single-stranded oligodeoxynucleotides, the polymerization-denaturation-polymerization cycles of the polymerase chain reaction result in the formation, and subsequent amplification, of the combined sequences. Following about 25 cycles of amplification the combined 0.4 Kb fragment is electrophoretically purified from an agarose gel. In parallel, two DNA fragments representing amino terminal sequences encoding the signal peptide and carboxy terminal sequences encoding framework 4, splice donor, and intronic sequences are amplified using oligodeoxynucleotide primer pairs (Figure 15) and the NEWM containing plasmid DNA template M-13VHPCR1 (described above). These two fragments are agarose gel purified, as above, and about 10 ng of each is combined with about 10 ng of the amplified grafted variable region fragment, Taq polymerase, about 50 pmoles of each of the terminal primers (Figure 15) and the mixture was PCR amplified. The resultant 0.85 Kb fragment is digested with restriction enzymes Spe I and BamHI. Following agarose gel electrophoresis, the purified DNA fragment is ligated into the heavy chain expression vector, p8958 (see Figure 11), in place of the chimeric variable region. In this way, two unique heavy chain frameworks containing the grafted murine CDRs (Jon/1B4 and Gal/1B4) are constructed. Each fully grafted heavy chain expression vector plasmid is co-transfected with the fully grafted RE1/1B4 light chain expression vector plasmid into 293 cells and the recombinant

human antibody is present in conditioned medium. The Gal/1B4:REI/1B4 heterodimeric human (fully humanized) recombinant antibody is isolated by protein A chromatography. The avidity of this antibody for the CD18 ligand displayed on the surface of activated human PMNs is compared with that of the chimeric/grafted antibody, described above, and the 1B4 murine monoclonal antibody parent. Figure 20 shows that although each hetero-dimeric antibody contains the same set of six CDRs, they do not exhibit identical avidity for the ligand. Thus, the avidity of an antibody molecule relies upon the variable region framework structure in which the CDRs are presented. The parent murine monoclonal antibody demonstrates an IC_{50} of about 0.5 nM while the Gal/Rei heterodimer has an IC_{50} of about 1.6 nM.

To determine the relative contribution of the heavy and light chain variable regions to the enhanced avidity of the Gal/REI grafted hetero-dimer, second light chain and heavy chain frameworks were constructed containing the 1B4 CDR sequences. These frameworks, termed Len and mutant Gal or Gal-M1 were chosen from the human immunoglobulin database by virtue of their high degree of similarity to the light chain FR and heavy chain FR of murine 1B4 (Figure 14). The Len FR shows a similarity of 90% and an identity of 81% when compared to murine 1B4. The resulting recombinant antibodies which specifically bind to CD18 antigen or receptor are termed recombinant human anti-CD18 antibodies (r-h-anti-CD18 Abs).

This invention further relates to a method of inhibiting the influx or migration of leukocytes capable of expressing CD18 antigen (leukocyte integrin, beta-2 subunit) on their surface into a site of inflammation or a tissue area or organ that will become inflamed following an influx of the cells. The inflammation which is the target of the method of the present invention may result from an infection with pathogenic microorganisms such as gram-positive and gram-negative bacteria, parasites and fungi. The response may also be induced by viruses and non-infectious means such as trauma or reperfusion following myocardial infarction or stroke, immune responses to foreign antigen and autoimmune responses.

The recombinant human anti-CD18 antibodies are useful in the treatment of inflammation in lung, central nervous system, kidney, joints, endocardium, pericardium, eyes, ears, skin, gastrointestinal tract and urogenital system. Disease states in which the recombinant human anti-CD18 antibodies are useful as therapeutic agents include, but are not limited to: infectious diseases where active infection exists at any body site, such as meningitis; conditions such as chronic or acute secondary inflammations caused by antigen deposition; and other conditions such as, encephalitis; arthritis; uveitis; colitis; glomerulonephritis; dermatitis; psoriasis; and res-

piratory distress syndrome associated with sepsis and/or trauma. Other inflammatory diseases which may be responsive to recombinant human anti-CD18 antibody include, but are not limited to, immune disorders and conditions involving T-cell and/or macrophage attachment/recognition, such as acute and delayed hypersensitivity, graft vs. host disease; primary auto-immune conditions such as pernicious anemia; infection related auto-immune conditions such as Type I diabetes mellitus; flares during rheumatoid arthritis; diseases that involve leukocyte diapedesis, such as multiple sclerosis; antigen-antibody complex mediated diseases including certain of the secondary infection states listed above; immunosuppression; and transplant rejection. Inflammatory conditions due to toxic shock or trauma such as adult respiratory distress syndrome and reperfusion injury; and disease states due to leukocyte dyscrasias and metastasis, are included within the scope of this invention.

The present invention is also applicable to the inhibition of leukocyte-endothelial attachment for diagnostic and therapeutic purposes; such as the iatrogenic opening of the endothelium to prevent the ingress of leukocytes during the ingress of a dye or image enhancer into tissue, or to allow the selective entry of a therapeutic drug in the instance of chemotherapy; or to enhance the harvesting of leukocytes from patients.

Recombinant human anti-CD18 antibodies or an active fragment thereof can be used to treat the above mentioned diseases. An active fragment will include the $F(ab')_2$, the Fab and any other fragment that can bind to the CD18 antigen. Recombinant human anti-CD18 antibodies can be administered alone for non-infectious disease states or combined with antibiotics or other anti-infective agents for the treatment of infectious diseases for reasons discussed above. Administration will generally include the antibodies and other substance in a physiologically acceptable medium or pharmaceutical carrier. Such physiologically acceptable media or pharmaceutical carriers include, but are not limited to, physiological saline, phosphate buffered saline, phosphate buffered saline glucose, buffered saline and the like. The antibodies and any anti-infective agent will be administered by parenteral routes which include intravenous, intramuscular, subcutaneous and intraperitoneal injection or delivery.

The amount of the antibodies and the mixture in the dosage form is dependent upon the particular disease state being treated. The amount of the recombinant human anti-CD18 antibody utilized in a dosage form can range from about 1 to about 1,000 mg, with a range of from about 10 mg to about 100 mg being preferred. The antibodies can be administered daily or less than daily as determined by the treating physician.

The following examples illustrate the present invention without, however, limiting the same thereto.

EXAMPLE 1

Preparation of a Grafted / Chimaeric Recombinant Antibody

An antibody was produced in which the variable domain of the light chain comprises the framework regions of a human light chain and the CDRs from a mouse light chain, while the variable domain of the heavy chain is derived entirely from the murine heavy chain. The light chain framework regions were derived from human myeloma protein RE1 (Oriandi, et al., Proc. Natl. Acad. Sci. USA 86 : 3833-3837 [1989]; Riechmann et al., Nature 332 : 323-327 [1988]; European Patent Application, Publication No. 239,400) for which the crystallographic structure has been determined. The CDR sequences from the murine monoclonal antibody 1B4 which binds to CD18 (the beta subunit of the leukocyte integrin beta-2 family which includes : LFA-1, Mac-1, and p150.95) were derived as follows. The hybridoma designated 1B4 which produces 1B4 monoclonal antibody was deposited under the Budapest Treaty at the International Depository Authority : American Type Culture Collection, 12301 Parklawn Drive, Rockville, MD, 20852. Viability was determined on June 6, 1989 and the hybridoma was designated HB 10164. Previous experiments had determined this antibody to be an IgG 2a with a kappa light chain (Wright et al., Proc. Natl. Acad. Sci. USA 80: 5699-5703 [1983]).

Total RNA was extracted from the 1B4 myeloma cells using standard methods involving cellular solubilization with guanidinium isothiocyanate (Chirgwin et al., Biochem. 18 : 5294-5299 [1979]). Sets of degenerate oligonucleotide primers (Figure 1) representing sequences within framework 1 of the murine kappa light chain variable region and kappa light chain constant domain, or those within framework 1 of the murine IgG2a heavy chain variable region and heavy chain constant CH1 domain were synthesized by standard phosphoramidite procedures on an Applied Biosystem 381A DNA synthesizer. Removal of the oligodeoxynucleotides (oligos) from the resin was accomplished by treatment with concentrated NH₄OH followed by desalting on a NAP-5 column (Pharmacia) with H₂O elution (when the oligos were <45 bases in length), or by use of an OPC column (Applied Biosystems Inc) with 20% acetonitrile elution (when the oligos were >45 bases in length), as recommended by the manufacturers. Total RNA (2µg) was reversed transcribed for 30' at 42°C using Moloney MLV reverse transcriptase (200 units, BRL) and 10 pmoles of the constant region complementary strand primers representing either heavy or light chain in a buffer (final volume of 20 µl) containing 50 mM Tris HCl, pH

8.3, 75 mM KCl, 3 mM MgCl₂, 10 mM DTT, and 20 units of RNasin (Pharmacia). The reverse transcriptase was heat inactivated (95°C, 5') and the reactions were made to contain in 100 µl of PCR buffer (10 mM Tris HCl, pH 8.3, 50 mM KCl, 1.5 mM MgCl₂, 0.01% gelatin, 200 µM each dNTP), 50 pmoles of each of the paired primers, and 2.5 units of Taq polymerase (Perkin Elmer/Cetus). Polymerase chain reaction (PCR) amplification was carried out essentially as described by Saiki et al., Science 230 : 1350-1354 (1985) and others (Mullis et al., Cold Spring Harbor Symp. Quant. Biol. 51 : 263-273 [1986], Dawasaki and Wang, PCR Technology, Principles and Applications for DNA Amplification, Erlich, Ed., Stockton Press, NY, pp. 89-97 [1989], Tung et al., ibid. pp. 99-104 [1989]). Forty five cycles of amplification by a DNA Thermal Cycler (Perkin Elmer Cetus Instruments) (2', 94°C; 2', 55°C; 2' 72°C) were followed by gel purification of the anticipated 400+ base pair (bp) DNA fragments (Figure 2). Prior to subcloning the DNAs into a blunt-ended intermediate plasmid (pSP72, Promega) they were terminally phosphorylated using T4 polynucleotide kinase (Boehringer Mannheim). Frozen competent *E. coli* were thawed on ice and 100 µl aliquots were distributed into wet ice chilled polypropylene tubes. DNA (1-10 ng) from the ligation mixture was dispensed with agitation into these tubes and the mixture was incubated on ice for 30 minutes. The *E. coli* cells were heat-shocked by incubation at 42° C for 45 seconds, then chilled for 2 minutes on ice. Room temperature S.O.C. (Hanahan, D., J.Mol. Biol. 166 : 557 [1983]) was added and the cultures were shaken at 225 RPM at 37° C for 60 minutes. Aliquots of the cultures were spread on LB agar plates containing 100 µg/mL ampicillin and these plates were incubated overnight at 37°C to allow for colony growth.

Multiple clones representing these PCR amplified sequences were isolated from DH5 transformed *E. coli* plated on LB agar plates containing 50 µg/ml ampicillin, grown by described procedures (Maniatis et al., Molecular Cloning, A Laboratory Manual, Cold Spring Harbor Laboratory, Cold Spring Harbor, NY, 1982), plasmid DNAs were extracted from the bacteria using the DNA preparation procedures of Birnboim and Doly Nucleic Acid Res. 7 : 1515 (1979), and the double-stranded plasmid DNAs were submitted to DNA sequence determinations using Sequenase® (United States Biochemicals) and T7 and SP6 specific sequencing primers (Boehringer Mannheim) using the protocols recommended by the manufacturer. A unique DNA sequence representing a murine IgG2a heavy chain variable region was obtained, but two kappa light chain variable regions were represented within the cloned population (Figure 3). To distinguish which sequence belonged to the 1B4 MAb, the 1B4 MAb was reduced with DTT and purified light chains were subjected to N-terminal amino acid sequencing using the Applied Biosystems 477A sequencer.

Although stretches of amino acid residues were identical to the mMAB 1B4 observed within the 1B4 light chain -1 sequence predicted from the cDNA, 1B4 light chain -2 (Figure 25) was deemed to be the actual sequence of the MAb 1B4 light chain. This is consistent with the determined DNA sequence of the light chain-1 molecule (Figure 24) which suggests it represents a murine kappa light chain variable region of subgroup III containing a mutation in the CDR3/FR4 region whose consequence is peptide chain termination.

Replacement of the human RE1 variable region CDRs with those unique to MAb 1B4 took place as follows. The RE1 framework (obtained as the RF form of the M13 vector M13VPCR1, Oriandi et al., Proc. Natl. Acad. Sci. USA 86 : 3833 (1989), with its signal peptide leader and intronic sequences, was subcloned into the intermediate vector pGEM3Z (Promega), as was the NEW or NEWM heavy chain variable region framework (obtained in the form of the M13 vector M13VHPCR1, Oriandi et al., supra). Eight oligodeoxynucleotides (Figure 4) were synthesized representing the primers necessary to generate by PCR amplification four DNA fragments. Incorporated into all but the terminal oligodeoxynucleotides were those sequences corresponding to the mMAB 1B4 light chain CDRs and at least 15 bases of 5'-terminal complementarity (see Figure 5). The appropriate primer pair (50 pmole each) was combined with 10 ng of RE1 framework-containing plasmid DNA, 2.5 units of Taq DNA polymerase, PCR reaction components and buffer, and thirty (30) cycles of PCR amplification ensued (cycle periods, as above). The products of the four reactions, purified by agarose gel electrophoresis, were combined (10 ng of each DNA fragment) along with a terminal oligodeoxynucleotide primer pair (amplifier) (Figure 4), Taq DNA polymerase, PCR reaction components and buffer, and the subsequent recombined fragments were amplified, as described above, for thirty cycles (see Figure 5). Following restriction endonuclease digestion with HindIII and XbaI the amplified DNA was purified from an agarose gel and subcloned into these same sites of an intermediate vector pSP72 (Promega) which contained the human kappa light chain constant region, obtained as follows. DNA (1 µg) purified from a human B cell line (GM01018A ; NIGMS Human Genetic Mutant Cell Repository, Institute for Medical Research, Camden, N.J. 08103) was used as a template for the oligodeoxynucleotide primers described in Figure 7 to PCR amplify a 920 base pair fragment containing the splice acceptor for the human kappa light chain constant domain, the exon and a portion of its 3'-untranslated region (PCR primer pair choice was selected based on the kappa constant region sequence described by Hieter et al., Cell 22 : 197-207 [1980]). The PCR product was purified by agarose gel electrophoresis, digested with BamHI endonuclease,

and subcloned into pSP72 (Promega) previously linearized with BamHI.

The individual clones (p8982) representing the pSP72 intermediate vector containing both the 1B4 grafted light chain variable region derived from RE1 and the human kappa constant region derived by PCR amplification of human DNA were used to verify the DNA sequence of the grafted light chain variable region. The chimaeric heavy chain portion of the recombinant antibody was derived from the murine 1B4 heavy chain variable region fused to the human constant region of gamma 4 subtype obtained from a lambda library constructed by Flanagan and Rabbits, Nature 300 709-713 (1982).

The variable region of the chimaeric heavy chain was constructed from three DNA fragments representing a signal sequence, a portion of the murine 1B4 heavy chain variable region, and an intronic sequence (Figure 8). Oligodeoxynucleotide primer pairs (Figure 9) were synthesized representing the primers necessary to generate by PCR amplification these three DNA fragments from 10 ng of plasmid DNA template containing either the NEW heavy chain variable region (M13VHPCR1) or a pSP72 intermediate vector containing the IgG 2a heavy chain region previously used to determine the murine 1B4 CDR sequence. Amplification of the 225 bp signal fragment, 350 bp variable region fragment, and 230 bp intron-containing fragment was performed as described above. The agarose gel purified products were combined (10 ng of each product) with terminal primer pairs (Figure 9) and the PCR-generated *in vitro* recombined template was amplified using the standard procedure described above for recombining the fragments comprising the 1B4 grafted RE1 light chain variable region. Prior to subcloning into a BglII and BamHI digested intermediate vector (pSP72) Promega) this recombined product was similarly digested and agarose gel purified. DNA was obtained following growth of individual bacterial clones and submitted to DNA sequence determination using Sequenase® and T7 and SP6 specific sequencing primers in order to verify the sequence of the reconstructed variable region and its flanking domains.

The gamma 4 heavy chain constant region was subcloned as a 6.7 Kb HindIII fragment derived from the plasmid pAT84 (Flanagan and Rabbits, supra) into the Hind III site of the intermediate vector pSP72 (Promega). This plasmid (p8947) was then used as the template DNA from which a shortened version of the gamma 4 constant region was obtained using the standard PCR amplification procedures described above and the primer pairs indicated in Figure 7. Eukaryotic expression vectors were constructed as described below such that the heavy chain immunoglobulin molecule was transcribed from a plasmid carrying the neomycin (G418) (Rothstein and Reznikoff, Cell 23 : 191-199 [1981]) resistance marker, while the

light chain immunoglobulin was transcribed from a plasmid carrying the hygromycin B resistance marker (Gritz and Davies, *Gene* 25 : 179-188 [1983]). With the exception of the drug resistance portion of these plasmids they are identical.

The progenitor of the immunoglobulin expression vectors was the pD5 eukaryotic expression vector (Berkner and Sharp, *Nucl. Acids Res.* 13 : 841-857 [1985]) which contained the origin of adenovirus replication, the SV40 enhancer domain, the adenovirus major late promoter, the adenovirus 2 tripartite leader, a 5' splice donor from the adenovirus third leader and a 3' splice acceptor derived from an immunoglobulin locus, a multiple cloning site, and the SV40 late polyadenylation signal (Figure 10). The origin of replication was removed by digestion with Eco R1 and KpnI and replaced by two fragments representing the neo selectable marker gene (derived from plasmid pCMVIE-AK1-DHFR (Siberkang et al., *Modern Approaches to Animal Cell Technology*, Ed. Spier et al., Butterworth, U.K., [1987]) as an Eco R1/Bam H1 1.8 Kb fragment) and the Ig heavy chain enhancer (obtained as a PCR amplified fragment using standard procedures described above and human DNA as the template ; the oligonucleotide primer pair is listed in Figure 7) following its digestion with Bgl II and Kpn I. The resultant expression vector was found to lack a small portion of the TK promoter responsible for the transcription of the neomycin gene. This was replaced by insertion into the EcoRI site of a 0.14 kb PCR amplified fragment derived from the CMVIE-AK1-DHFR DNA using the primer pair also listed in Figure 7. The resultant heavy chain expression vector was subsequently modified by removal of the indicated HindIII and XbaI sites. To convert this neomycin selectable vector (p8941) into one expressing the hygromycin B selectable marker (p8942) (Figure 10) the neomycin-resistance cassette was removed by digestion first with Eco R1 followed by DNA polymerase-directed fill in of the 5'overhang, then subsequent Sall digestion. The 1.9 kb hygromycin B expression cassette [TK promoter and TK polyadenylation signal flanking the hygromycin B gene obtained from Gritz and Davies, *Gene* 25 : 179-188 (1983), as the 1.9 kb BamH1 fragment in plasmid (pLG90)] was removed from the plasmid pAL-2 by Bam H1 digestion and subcloned into the BamH1 site of the intermediate vector pSP72 (Promega). The hygromycin B cassette was removed from this vector by digestion with SmaI and Sall and cloned into the expression vector linearized as described above to create a blunt end and Sall end DNA fragment.

Expression of the 1B4 CDR-grafted kappa light chain was accomplished by transferring this cistron from its position within the pSP72 intermediate vector to the hygromycin B selectable eukaryotic expression vector (Figure 18). A 1.5 kb DNA fragment resulting from the endonuclease digestion of p8952 with SpeI

and ClaI was purified by agarose gel electrophoresis and ligated into the expression vector (p8942) which had previously been linearized, by digestion with the same two restriction enzymes and agarose gel purified.

The heavy chain eukaryotic expression vector (p8958) was constructed in two steps (Figure 11). First, p8949 containing the modified heavy chain variable region of murine 1B4 was digested with Bgl II and Bam H1. The agarose gel purified 0.8 kb fragment was ligated into the BamH1 site of the p8941 vector and recombinants containing this fragment in the proper orientation were identified. One such plasmid was linearized by BamH1 digestion and ligated with the 1.8 Kb BamH1 fragment representing a short version of the human gamma 4 constant region derived from plasmid p8947 by PCR amplification as described above. Following the identification of clones containing these inserts in the appropriate orientation plasmid DNAs were grown (Maniatis et al., *supra*) and purified for transfection into recipient mammalian cells (Maniatis et al., *supra* ; Birbion and Doly, *supra*).

Equal amounts (10µg) of the plasmids encoding the chimaeric IgG4 heavy chain and the 1B4 CDR-grafted kappa light chain were transfected by standard calcium phosphate precipitation procedures into human 293 cells, and the monkey cells COS-7 and CV-1P. The culture supernatant fluids were assayed by a trapping Elisa (described below) for the secretion of a human IgG4/kappa immunoglobulin.

An Elisa was developed for the quantitation of the amounts of a 1B4 recombinant antibody expressed in conditioned mammalian cell growth medium. Immulon-2 (Dynatech Labs.) 96-well plates are coated overnight with a 5 µg/ml solution of mouse anti-human kappa chain constant domain monoclonal antibody (cat. #MC009, The Binding Site, Inc., San Diego, CA) in 0.1 M NaHCO₃ buffer (pH 8.2) at 4° C, and blocked with 1% bovine serum (BSA) in 0.1 M NaHCO₃ for 1 h at 25° C. After this and all subsequent steps, washing was performed with phosphate buffered saline (PBS). The wells are then inoculated with conditioned medium containing recombinant anti-CD18 antibody, or with predetermined quantities of human IgG4/kappa purified by protein A Sepharose (Pharmacia Fine Chemicals) chromatography from human IgG4 myeloma serum (cat. # BP026, The Binding Site, Inc.) All samples are diluted in PBS containing 0.05% Tween-20. 100 µl aliquots are incubated for 1 h at 37° C in triplicate, and standard calibration curves are constructed using IgG4 concentrations ranging from 10 ng/ml to 100 ng/ml. Bound and fully assembled human IgG4 (either native or recombinant 1B4-human IgG4 constructs) is detected with 100 µl aliquots of a 1 :500 dilution of mouse anti-human IgG4 Fc monoclonal antibody conjugated to alkaline phosphatase (cat #05-3822, Zymed Laboratories, Inc.) in phosphate buffered saline (PBS) containing 1% BSA.

After incubation for 1h at 37°C and subsequent washing, the quantities of bound conjugate are detected by incubating all samples with a 1 mg/ml solution of p-nitrophenyl phosphate in 0.1 M 2,2'-amino-methyl-propanediol buffer, pH 10.3, for 30 min at 25°C. The adsorbance of the wells is determined with a UV Max ELISA plate reader (Molecular Devices) set at 405 nm. All supernatant fluids from the transfected cells are found to contain this immunoglobulin, though in various amounts (Figure 12). The antibody secreted by the transfected 293 cells is concentrated by protein A chromatography and the concentrations of the recombinant human anti-CD18 antibodies determined by the trapping Elisa described above, are used to compete with the binding of radiolabeled murine 1B4 to the CD18 ligand on the surface of activated human PMNs. Affinities of various r-h-anti-CD18 antibody constructs are determined using a competitive ¹²⁵I-1B4 soluble binding assay with stimulated human polymorphonuclear leukocytes (PMNs). Purified murine anti-CD18 monoclonal antibody (50 µg) is iodinated using chloramine-T (Hunter, W.M. and Greenwood, F.C., *Nature* 194 : 495-496, 1962), and the radiolabeled antibody purified using a Bio-Sil TSK250 (Biorad, Richmond, CA) gel filtration HPLC column (which fractionates proteins in the range of 1-300 x 10³ daltons) equilibrated in 0.1 M phosphate buffer, pH 7.0. Effluent radioactivity is monitored with an in-line detector (Beckman Model 170 ; Beckman, Fullerton, CA) and total protein measured at OD₂₈₀ with a Kratos Spectroflow 757 detector (Kratos, Mahwah, N.J.). A single ¹²⁵I-1B4 peak composed of coincident OD₂₈₀ and radioactivity tracings characteristically elutes 6 minutes, 30 seconds following sample injection. Specific activity of the product is generally about 10 µCi/µg protein, and 97-99% of the counts are precipitable with 10% trichloroacetic acid. The binding of this radiolabeled antibody is assessed on human PMNs purified on a discontinuous Ficoll/Hypaque gradient (English and Anderson, *J. Immunol. Methods* 5 : 249-255, 1974) and activated with 100 mg/ml phorbol myristate for 20 minutes at 37°C (Lo et al., *J. Exp. Med.* 169 : 1779-1793, 1989). To determine the avidity of antibodies for CD18 molecules on the PMN surface, about 1 x 10⁵ activated PMNs are incubated in a buffer such as Hanks balanced salt solution containing 20 mM Hepes (pH 7.2), 0.14 units aprotinin (Sigma Chemical Co.) and 2% human serum albumin (binding buffer) containing 1.3 ng ¹²⁵I-1B4 (2.8 x 10⁻¹¹ M) in the presence of increasing concentrations of unlabeled 1B4 antibody (10⁻⁷ to 10⁻¹⁶ M) in a 300 µl reaction volume for 1 h at 4°C with constant agitation. Cell bound 1B4 was separated from the unbound antibody by centrifugation through a 0.5M sucrose cushion (4,800 x g, 3 minutes) ; the tubes are frozen on dry ice, and the tips cut off and counted with an LKB gamma counter. The IC₅₀ of the anti-CD18 antibody for the inhibition of ¹²⁵I-

1B4 antibody binding is calculated using a four parameter fitter program (Rodbard, Munson, and DeLean, in "Radioimmunoassay and Related Procedures in Medicine", International Atomic Energy Agency, Vienna, vol I, 469 - 504, 1978). The affinity of the various r-h-anti-CD18 antibodies for the CD18 ligand is determined in a similar manner using murine ¹²⁵I-1B4 antibody and increasing quantities, as determined by the trapping Elisa, of unlabeled r-h-anti-CD18. The results of the binding assays are shown in Figure 13 and indicate that the avidity of the chimeric heavy chain/grafted light chain recombinant 1B4 antibody (circles) is approximately that of the murine 1B4 monoclonal antibody (diamonds).

EXAMPLE 2

Preparation of Fully Grafted Recombinant Human IgG4 Antibodies

This example shows the production of recombinant human IgG4 antibodies, whose variable domains contain the CDR residues of the murine monoclonal antibody 1B4. The construction of the CDR-grafted light chain framework derived from the human sequence of RE1 fused with a human kappa light chain constant region was described in the preceding example (Example 1).

The 1B4-specific heavy chain component of the recombinant antibody was constructed from the IgG4 heavy chain constant region, described in Example 1, fused to a pre-selected human heavy chain variable region framework sequence into which the 1B4 CDR residues were transplanted. The murine 1B4 MAb m1B4 heavy chain was first analyzed to determine the precise position of the CDR sequences. These were determined by visual comparisons with the data sets found in Kabat, Wu, Reid-Miller, Perry, and Gottesman, *Sequences of proteins of immunological interest*. (US Dept Health and Human Services, Bethesda, MD, 1987). Once the boundaries of the CDRs were determined these sequences were removed to leave the murine FRs alone. This sequence was then used to query the human immunoglobulin database which was mainly derived from release 22 of the PIR database (George et al., *Nucl. Acids Res.* 14 : 11-16 (1986)). The sequence search was performed using the Profile search system of the GCG sequence analysis package (Devereux et al., *Nuc. Acids Res.* 12 : 387-395 [1984]). The matrix used for similarity comparisons was the Dayhoff evolutionary distance matrix (R. M. Schwartz, M. O. Dayhoff, in *Atlas of Protein sequence and structure* M. O. Dayhoff, Eds. (National Biomedical Research Foundation, Washington, DC, 1979)). Additionally, the Risler structural distance matrix (Risler et al., *J. Mol. Biol.* 204 : 1019-1029 [1988]) was used to generate the murine sequence profile, and the results of searches

with this query were considered with those generated using the Dayhoff matrix. Use of the profile searching system also allowed the weighting of specific residues within the murine FR that were deemed important based on various criteria. The sequences that repeatedly showed the highest levels of sequence similarity in the database queries were then analyzed using a pairwise comparison to the FRs of murine 1B4. The program Gap of the GCG package was used for this analysis, because it produces an exact measure of both the sequence similarity and identity shared between two sequences. This method was used to select the human sequences Gal and Jon, which shared a similarity of 85% and 88% and identities of 79% and 75% with murine 1B4, respectively (Figure 14). To prepare a recombinant DNA representing the 1B4 heavy chain CDRs within each of these frameworks the following procedures were performed.

Two sets of four long oligonucleotides were synthesized. When each set was combined, they encoded that portion of heavy chain corresponding to the murine 1B4 variable region present in the chimaeric heavy chain expressed in Example 1. The four oligonucleotides of each set (Figure 15, Figure 16), 1 pmole of each, were combined in a standard PCR reaction with 2.5 units of Taq polymerase and 50 pmoles of each terminal amplifying oligodeoxynucleotide (Figure 15, Figure 16). By virtue of the complementary ends of the single-stranded oligonucleotides, the polymerization-denaturation-polymerization cycles of the polymerase chain reaction result in the formation, and subsequent amplification, of the combined sequences. Following 25 cycles of amplification the combined 0.4 Kb fragment was electrophoretically purified and extracted from an agarose gel. In parallel, two DNA fragments representing amino terminal sequences encoding the signal peptide and carboxy terminal sequences encoding framework 4, splice donor, and intronic sequences were amplified using oligodeoxynucleotide primer pairs (Figure 15) and the M13VHPCR1 plasmid DNA template described in example 1. These two DNA fragments were purified by agarose gel electrophoresis, as above, and 10 ng of each was combined with 10 ng of the amplified variable region fragment, 2.5 units of Taq polymerase, 50 pmoles of terminal primers (Figure 15) and the mixture was amplified by 25 cycles of PCR. The resultant 0.8 Kb fragment was digested with restriction enzymes Spe I and BamH1 (Gal) and Hind III and Bam H1 (Jon). Following agarose gel electrophoresis, the purified DNA fragment was ligated into the heavy chain expression vector, p8958, in place of the chimaeric variable region (Figure 11). In this way, two unique heavy chain frameworks containing grafted 1B4 CDRs (1B4/Jon and 1B4/Gal) were constructed. Each fully grafted heavy chain expression vector plasmid was co-

transfected with the fully grafted 1B4/REI light chain expression vector (Example 1) plasmid into 293 cells and the antibody present in conditioned medium was isolated by protein A chromatography. The recombinant humanized 1B4 (h1B4) avidity of these two antibodies for the CD18 ligand displayed on the surface of activated human PMNs was compared with that of the chimaeric/grafted antibody described in Example 1. Figure 20 shows that although each hetero-dimeric antibody contains the same set of six CDRs, they do not exhibit identical avidity for the ligand. Thus, the biological properties of an antibody molecule (ie., its avidity) rely significantly on the variable region framework structure which support the CDR loops.

To determine the relative contribution of the light chain variable region to the enhanced avidity of the Gal/REI grafted hetero-dimer a second light chain framework was constructed containing the 1B4 CDR sequences. The light chain framework Len was identified as a donor framework sequence based upon its selection from the database. Len was identified by using the murine 1B4 light chain framework sequence, with CDRs removed based upon visual identification of the CDRs when compared to Kabat (supra), to query the human immunoglobulin database. The methodology of the query was similar to that described for the heavy chain FRs. Len was shown, by Gap analysis, to be 90% similar and 81% identical to the murine 1B4 light chain FR. Len was thought to be a better choice for grafting of the light chain CDRs than REI, based on its higher levels of both similarity and identity to 1B4 as compared to REI (82% similarity and 65% identity) (see Figure 14). A set of five long oligodeoxynucleotides (Figure 21) representing the Len light chain framework with 1B4 specific CDR sequences and intronic sequences were synthesized using 2.5 units of Taq polymerase and 50 p moles of each terminal amplifying oligodeoxynucleotide primer and combined by PCR, as described above for the Jon and Gal frameworks (Figure 22). Following 25 cycles of amplification the combined 0.6 kb DNA fragment was purified by agarose gel electrophoresis. In parallel, a DNA fragment representing the amino-terminal signal peptide was amplified using a oligodeoxynucleotide primer pair (Figure 21) and the M13VHPCR1 plasmid DNA template, as described in Example 1. This fragment was also purified by agarose gel electrophoresis. These two DNA fragments are placed together, 10 ng of each, with 2.5 units of Taq polymerase, 50 p moles of terminal oligodeoxynucleotide primers (Figure 21) and the entire mixture is subjected to 25 cycles of PCR amplification. The resultant 0.8 kb DNA fragment is digested with restriction enzymes Spe I and Xba I, purified following agarose gel electrophoresis, and ligated into the pSP72/REI 1B4 intermediate vector which is digested with the same two restriction enzymes and electrophoretically purified from its liberated REI/1B4

variable region containing DNA fragment (see Figure 23). The combined light chain variable region and kappa constant region within a sequence verified clone (p8967) is excised by digestion with restriction enzymes Spe I and Cla I and this 1.5 kb agarose gel electrophoretically purified DNA fragment is cloned into the light chain expression vector p8953, after this latter plasmid is electrophoretically purified from its REI/1B4/kappa light chain insert following digestion with both Spe I and Cla I restriction enzymes. The fully CDR-grafted Gal/1B4 heavy chain expression vector and the fully CDR-grafted Len/1B4 or REI/1B4 light chain expression vector DNAs (10 ug each) are co-transfected into 293 cells and the antibody present in conditioned medium 48 hours later is isolated by protein A Sepharose chromatography. The avidity of these two recombinant antibodies for the CD18 ligand present on the surface of activated human PMNs is determined and compared to that of the murine 1B4 MAb (Figure 20). The differences between the two humanized 1B4 recombinant antibodies for the ligand, as measured by their IC₅₀s, revealed that a comparison of p values between Gal/Rel and Gal/Len are statistically significant by the students unpaired t-test but the standard deviations of both Mabs overlap (see Figure 20). Thus, although the Len light chain variable region framework sequences, relative to the REI light chain frameworks, show more identical residues and more similar residues when aligned to the murine 1B4 frameworks, this has little, if any, impact on the antibody/antigen interactions measured by avidity. Comparison of the presumed three dimensional structure of these two light chain variable regions (REI and Len) indicates that the alpha carbon trace of the 1B4 CDRs residing within these frameworks are superimposable, again suggesting that the both frameworks identically support the CDRs in space. Does the 1B4 heavy chain variable region play a greater role in avidity of the antibody for its ligand? To address this question, and also to investigate the role of a small number of heavy chain variable region framework sequences, modifications of the Gal/1B4 fully grafted molecule are performed.

Three residues within the heavy chain variable region of Gal/1B4 are chosen to mutate such that they become identical to their counterparts in the murine 1B4 framework (see Figure 14). To accomplish the mutation of three well separated residues simultaneously the following procedures are performed. Four oligodeoxynucleotide primer pairs (Figure 26) are synthesized which incorporate the deoxynucleotide alterations necessary to mutate the amino acid residues located in FR1, FR2, and FR4 of the Gal/1B4 DNA template. In this instance, the polymerase chain reactions needed to produce four overlapping DNA fragments were amplified in such a way as to generate primarily single-stranded DNAs representing the outside two DNA fragments, while the inside two DNA frag-

ments are amplified so as to produce double-stranded DNAs. This approach of combining four amplified DNAs is facilitated by the above modification and, when combined with the use of terminal amplifying oligodeoxynucleotide primers which are unique to residues found only in the outside amplified DNA fragments, remove the need to purify the PCR products between the first and second round of amplification. Thus, asymmetric PCR is used to amplify the two terminal DNA fragments. Combined into the standard PCR amplification reactions are 50 p moles of primer #S1 and 0.5 p moles of primer #G2 (Figure 26) or 50 p moles of primer #I2 and 0.5 p moles of primer #G2 (Figure 26) and the Gal/1B4 containing plasmid DNA template (10 ng/reaction), 2.5 units of Taq polymerase, and the remaining standard reaction components. The two internal DNA fragments are amplified using the standard procedures which include the presence of 50 p moles of each of the oligodeoxynucleotide primers, 2.5 units of Taq polymerase, and the same template DNA and reaction components described above. Following 25 cycles of amplification (as described previously) the reactions are made to contain 1 ml of H₂O, and each is placed in a Centricon 100 cartridge (Amicon, Danvers, MA), centrifuged for 30 minutes at 3500 x g, at 4° C, and the retentate is resuspended in another 1 ml of H₂O and the centrifugation is repeated. The final retentate is resuspended in 100 µl of H₂O. Each of the four reaction products is combined (1 µl of each of the retained DNA solutions), the standard components are added, 2.5 units of Taq polymerase, and 50 p moles of the PCR recombination amplifying primers (Figure 26), and the reaction is cycled 25 times. The resultant 0.8 kb DNA fragment is phenol extracted, concentrated by ethanol precipitation, and digested with Spe I and Bam H1 restriction enzymes. Following purification of this 0.8 kb DNA fragment by agarose gel electrophoresis it is cloned into the heavy chain expression vector p8958, after this latter plasmid is electrophoretically purified from its Gal/1B4 heavy chain variable region insert liberated by digestion with both Spe I and Bam H1 restriction enzymes. The fully CDR-grafted Gal-m1/1B4 heavy chain expression plasmid DNA is co-transfected (10 ug of each DNA) with the fully CDR-grafted REI/1B4 light chain expression plasmid DNA or the fully CDR-grafted Len/1B4 light chain expression plasmid DNA into 293 cells. The resultant antibodies present in the conditioned medium 48 hours later are isolated by protein A Sepharose chromatography and subjected to avidity measurements. Independent of the origin of the light chain variable region framework, the measured avidity for CD18 on the surface of activated human PMNs of the two antibodies is nearly identical. Again the role of the light chain variable region frameworks seems to be minimal. The avidity of the mutated Gal framework (mutated Gal/Rel, Figure 20) is signifi-

antly improved relative to the non-mutated Gal heavy chain framework (Gal/Rei in Figure 20) support and its avidity is nearly equivalent to that of native m1B4 (Figure 20). It is concluded that one or more of the three residues mutated contributes to the display of the CDRs (antigen binding sites), thus proper framework choice is critical for optimal humanization of recombinant antibodies. Indeed, it appears that the framework closest to the CDRs dictates the final structural arrangement of the CDRs and thus the ability to bind antigen. Additional comparisons of the heavy chain frameworks reveal major differences between those of New and Jon or Gal when the "packing" residues are examined (Figure 14). Packing residues as used herein is defined as internal or non-surface exposed residues of the structure that may be involved in Intrastrand or Interstrand forces. These packing residues are associated with the framework regions adjacent to the CDRs and are involved in the proper orientation of the CDRs for interaction with the substance that induced the antibody formation. Only 27 of 41 internal residues of New match the corresponding residues in the murine 1B4 framework. This is contrasted to the match of 38 of 41 residues by the human Gal framework. The localization of the region of greatest variation to those residues ending framework 2 may explain the differences between the Gal and Jon supported antibodies. This region of framework 2 is where these two differ and where Gal-m1 differs from Gal.

EXAMPLE 3

Enhanced Expression systems

This example shows expression systems employed to produce large quantities of recombinant CDR-grafted 1B4 antibodies as discussed in Example 2. The first expression system applicable to many mammalian cells utilizes the extrachromosomal characteristics of EBNA-1/oriP based DNA plasmids (Yates et al., Nature : 313 : 812, 1985). Such a vector, pREP3 described by Hambor et al. (Proc. Natl. Acad. Sci. USA 85 : 4010, 1988), containing the hygromycin B selection cassette and the Rous Sarcoma Virus (RSV) LTR for transcription of the gene of interest was modified as disclosed. The RSV LTR, as well as the poly A addition signal, was removed by digestion of the pREP3 plasmid DNA with Sal I and Xba I followed by agarose gel purification of the 9.02 Kb promoterless fragment. DNA from plasmid pD5mcs (see Figure 10), containing the adenovirus major late promoter, a multi-cloning site, and SV40 poly A addition signal was used as the template for the PCR amplification of those sequences beginning with the SV40 enhancer and ending with the SV40 poly A addition signal. In the process of amplification Xba and Sal I restriction enzyme sites were appended to the product ends by

their incorporation into the synthetic PCR oligodeoxynucleotide primers. The expected 1.26 Kb PCR amplified product was agarose gel purified following its digestion with Xba I and Sal I restriction enzymes and ligated into the 9.02 Kb EBNA/oriP backbone vector. The resultant plasmid (p8914) constitutes a versatile mammalian expression vector into which can be ligated either the heavy chain or light chain expression cassette contained within plasmid p8958 (see Figure 19) or p8953 (see Figure 6), respectively. The p8914 plasmid was also the template for the HIVLTR promoter version of the EBNA/oriP backbone vector. In order to switch to the HIVLTR promoter the p8914 plasmid DNA was digested with Bam H1 and Xba I. The 9.35 Kb promoterless backbone was purified by agarose gel electrophoresis. The HIVLTR promoter, from residue -117 to +80 (as found in the vector pCD23 containing this portion of the HIV-1 LTR ; (Cullen, Cell 46 : 973 [1986]) was PCR amplified from the plasmid pCD23 using oligodeoxynucleotide primers which appended to the ends of the product the Spe I and Bcl I restriction sites. Following the digestion of the resulting 0.24 Kb PCR product with these latter enzymes the fragment was agarose gel purified and ligated into the 9.35 Kb DNA promoterless DNA fragment described above. The p8962 plasmid so constructed was also the recipient of the heavy and light chain cassette (Figure 37). To accomplish this the p8962 plasmid DNA was digested within its multicloning site with Not I and Xba I so as to linearize the DNA. The 9.5 Kb linearized expression vector DNA was ligated to either the 2.5 Kb heavy chain cassette obtained by agarose gel purification of Not I and Spe I digested p8960 DNA or the 1.5 Kb light chain cassette obtained similarly following digestion of p8953 DNA with Not I and Spe I. These constructed EBNA/oriP based expression vectors ,p8969 and p8968, (Figure 38) were co-transfected into CV1P cells (monkey kidney cells ; Figge et al., Cell 52 : 713 [1988]) which constitutively express the HIV-1 TAT protein by virtue of having previously been transfected with the plasmid pMLTAT (Siekevitz et al., Science 238 : 1575 [1987]). The cell clones which arose in DMEM medium containing 10% heat inactivated new born calf serum, 200 µg/mL of G418, and 100 µg/ml of hygromycin B were picked using cloning cylinders (Fishney, In, Culture of Animal Cells, Alan R. Liss, Inc. New York, 1983) and expanded individually. Clones were screened for the secretion of recombinant antibody using the ELISA assay previously described. Multiple cell clones were expanded and their antibody secretion levels were determined to be in the range of 75 ng - 2 µg of antibody per 96 hours of medium conditioning of 6 well plate cultures. The most productive of these clones was eventually adapted to growth on microcarriers (cyledex 3 and cultisphere GL) and produced approximately 100 mg/L of recombinant antibody each 3 day harvest in serum-

free medium at a cell density of $1-2 \times 10^6$ cells per ml.

EXAMPLE 4

In Vitro Activity Of Recombinant Human Anti-CD18 Antibodies

To increase the precision of avidity determinations, the IB4 competitive binding assay of Example 2 was modified as follows. Both m1B4 (50 μ g) or h1B4 (from Example 3) were iodinated using chloramine-T, and the radiolabeled IgG purified over a Bio-Sil TSK250 (Biorad) gel filtration HPLC column that fractionates proteins in the range of 5-300 x 10³ daltons. Effluent radioactivity was monitored with a Beckman #170 in-line gamma counter (Beckman, Fullerton, CA), the total protein was detected by absorbance at 280 nm with a Kratos Spectroflow 757 detector (Kratos, Mahwah, NJ), and the column was equilibrated with 0.1 M phosphate buffer (pH 7.0). A single symmetrical peak of coincident absorbance and radioactivity tracings was routinely observed at 6 min. 30 sec. following sample injection (the retention time characteristic of IgG in this system). Specific activity of the product was usually 10 mCi/mg for m1B4 or 70mCi/mg for h1B4; 96-98% of the counts were trichloroacetic acid-precipitable in either case. SDS-PAGE and autoradiography of ¹²⁵I labeled antibody showed that 1B4 remained intact following radiolabeling. Using these radio-labeled probes, a competitive ¹²⁵I-1B4 suspension binding assay was established to determine the avidity of m1B4 or r-h-anti-CD18 (h1B4) for CD18 expressed at the leukocyte surface. Human venous blood was collected freshly into heparin (1.0 unit/ml). PMNs were purified on a Ficoll/Hypaque gradient and activated with 100 ng/ml phorbol myristate acetate in Hanks balanced salt solution containing 20 mM Hepes (pH 7.2), 0.14 units Aprotinin and 2% human serum albumin (binding buffer) for 20 min at 37°C; viability was always >95% by trypan blue exclusion following PMA activation. After washing with binding buffer, aliquots of 1×10^5 stimulated PMNs were incubated in about $2-4 \times 10^{-11}$ M ¹²⁵I-1B4 in the presence of increasing concentrations of unlabeled murine or humanized 1B4 (about 10^{-5} to 10^{-7} M) in duplicate or triplicate 300 μ l volumes for 1 h at 4°C with constant agitation. The concentrations of purified radio-iodinated 1B4 or unlabeled antibody added as a competitor were determined by U.V. absorption using an E₂₈₀ of 1.35 for m1B4, 1.25 for mutant Gal/Rel h1B4, and 1.30 for all other h1B4 constructs (determined by the formula $E = A(\text{Ecys}) + A(\text{Etryp}) + A(\text{Etyr})$ where A = the number of residues of each amino acid; Gill and von Hippel, Anal. Biochem., 182 : 319-328, 1989; the E₂₈₀ of m1B4 and Gal/Rel h1B4 were also verified by quantitative amino acid analysis and differential UV spectroscopy). After labeling, the ¹²⁵I-1B4 bound to the cells was sepa-

rated from unbound antibody by underlaying each aliquot of PMNs with 250 μ l 0.5 M sucrose and centrifugation (4,800 x g, 3 min.); the tubes were frozen on dry ice, and the tips cut off and counted with an LKB gamma counter. The quantity of PMN-bound ¹²⁵I-1B4 for each concentration of purified unlabeled competitor IgG was expressed as the mean CPM per 1×10^5 PMNs (\pm SEM). IC₅₀s for inhibition of ¹²⁵I-1B4 binding were calculated using a four parameter program ("Fitter"; Rodbard, Munson, and Delean in "Radioimmunoassay and Related Procedures in Medicine", International Atomic Energy Agency, Vienna, vol I, 469-504, 1978). The results of the binding assays are illustrated in Figures 13, 20, 28, and 29 (p values are from Student's unpaired t-test). These data indicate that : 1) the avidity of Gal/Rel h1B4 for PMN CD18 is nearly comparable to that of m1B4 (about 2-3 fold weaker); 2) the avidities of Jon/Rel and New/Rel are still weaker than that of Gal/Rel in a rank order that correlates inversely with their degree of homology relative to m1B4 frameworks; 3) the avidity of Gal/Len is nearly equivalent to the avidity of Gal/Rel; and 4) that mutant Gal/Rel and the demi-chimeric construct possess affinities apparently comparable to that of native IB4.

Inhibition of PMN attachment to human umbilical vein endothelial cell (HUVEC) monolayers.

To reach tissue sites and cause inflammatory damage, PMNs must pass out of the bloodstream. This transendothelial migration depends on interaction of PMN CD18-containing receptors with ligands on and within the human endothelium. A direct expression of this process is reflected by attachment of agonist-treated PMNs to the vascular surface. To demonstrate that Gal/Rel h1B4 is a prospective anti-inflammatory agent for use in human disease, we determined whether this construct inhibits adhesion of PMA-stimulated hPMNs to quiescent human endothelial cell monolayers. Human umbilical vein endothelial cells (HUVECs) were grown in T-75 flasks coated with Vitrogen 100 (Collagen Corp., Palo Alto, CA) diluted 1:10 with PBS and dried onto the substrate. The culture medium was MCDB 107 supplemented with 15% FCS, 90 mg/ml heparin (GIBCO), and 150 mg/ml endothelial mitogen (Biomedical Technologies, Inc.); the cells were incubated in 2.5% CO₂ and 97.5% air. Cultures (passages 4-8) were dissociated with trypsin/EDTA, and the HUVECs seeded into 96-well microtiter plates (Costar) pre-coated with a 5 μ g/ml solution of purified human plasma fibronectin in 0.1M bicarbonate (pH 8.3); these microcultures were used for the attachment assay upon reaching confluence. Human PMNs were purified from peripheral blood as described above. To measure their attachment to the HUVEC monolayers by fluorescence microscopy, PMNs were labeled with

the vital fluorescent dye 1',1'-dioctadecyl-3,3,3',3'-tetramethylindocarbocyanine (DiI) (Molecular Probes, Inc.). PMNs were incubated in a 25 mg/ml sonicated solution of DiI in binding buffer for 10 min. at 37 °C, washed, and then activated with 50-100 ng/ml PMA or PDB for 10 min. at 37 °C. (These diI-labeled PMNs were tested in the competitive 1B4 binding assay to verify that their CD18 receptors were recognized by h1B4; the IC₅₀s were within the range expected for unlabeled PMNs). PMN aliquots (in quadruplicate) were pretreated with increasing concentrations of either Gal/Rei h1B4, m1B4, or the control Mab OKM-1 (associates with the CD11b component of the CR3 receptor but does not inhibit ligand binding). Incubation was performed for 15 min. at 4 °C with constant agitation, and the cells placed into the microwells containing the HUVEC monolayers (50,000-100,000 PMNs/well). The PMNs were permitted to settle for 5 min. at 4 °C, and then incubated for 15 min at 37 °C to allow firm adhesion to occur. Unattached PMNs were removed and the cultures fixed by gentle washing with 1% formaldehyde in PBS (4 washes with an Eppendorf Plus 8 multtip pipette). The wells were filled with a solution of 5% n-propyl gallate in glycerol, and the attached PMNs counted at 195 x under rhodamine illumination with an automated Nikon Diaphot inverted fluorescent microscope fitted with an autofocus device, a customized motorized stage, and a video camera (Vidicon #8451) connected to a Model 3000 image analyzer (Image Technology Corp., Deer Park, NY) and an IBM PCXT computer. The mean number of adherent PMNs was determined for each concentration of Mab tested (± SEM), and an inhibition curve plus IC₅₀ generated with the "Fitter" program (Rodbard et al, supra.); the data were normalized. The results of these experiments are presented in Figure 30 and Figure 31. Both Gal/Rei h1B4 and m1B4 produced congruent sigmoidal inhibition curves with nearly equivalent IC₅₀s (4-8 nM) that were not significantly different by Students' unpaired t-test. The OKM-1 control IgG did not inhibit PMN attachment. Thus, Gal/Rei h1B4 inhibits adhesion of activated hPMNs to human umbilical vein endothelial cell monolayers to the same extent as native m1B4 in a quantitative homotypic *in vitro* adhesion assay, illustrating anti-inflammatory activity.

Inhibition of CTL-mediated cytotoxicity

Cytotoxic T-lymphocyte (CTL) directed cell killing is an important component of graft rejection following tissue or organ transplantation. Since attachment to and killing of target cells is a CD18-dependent intercellular adhesive event, we determined whether Gal/REI h1B4 inhibits human CTL-mediated cell lysis. Human Q-31 CTL cells were cultivated in RPMI 1640 supplemented with 10% bovine calf serum and 30 units/ml recombinant human IL-2. To induce the dif-

ferentiated state, fragments of irradiated JY human lymphoblastoid cells were added to the media for 6-7d. The JY cells were propagated as above except without IL-2, and also served as targets for the Q-31 cells. To compare the effects of m1B4 and Gal/Rei h1B4 on cell killing, Q-31 cells were incubated in media with various antibody concentrations for 30 min. at 25 °C before addition of the target cells. To quantify cytotoxicity, JY target cells were labeled with ⁵¹Cr and mixed with effector cells at various E:T ratios of 8:1 to 2.5:1 at 37 °C. After 4h, the percent of ⁵¹Cr liberated into the culture medium for each concentration of antibodies was determined (in triplicate) as an index of cell killing. Cell Killing curves that were generated simultaneously with various concentrations of m1B4 (mOKM-1 control) or Gal/Rei h1B4 (hlgG4 control) were utilized to calculate IC₅₀s (Figure 31). Both Gal/Rei h1B4 and m1B4 inhibited JY cell lysis to the same extent. In each case, the mean IC₅₀ was equal to about 2 nM 1B4, and the inhibition curves for both antibodies were superimposable. These results indicate that Gal/Rei 1B4 can prevent the rejection of transplanted tissues and organs.

Tissue and Cellular Specificity of Gal/Rei HhB4

The process of humanization might engender abnormal binding properties that could cause h1B4 to associate with and accumulate in unexpected sites in tissues, cells, and their organelles, with toxic consequences. To ascertain whether the binding properties of Gal/Rei h1B4 were altered, we compared the immunofluorescence microscopic (IF) and immunoelectron microscopic (IEM) localization of Gal/Rei h1B4 and native m1B4 in various rabbit tissues, and in human PMNs, U-937 cells, and fibroblasts.

IF Staining of Tissues and Cells

Healthy 2 kg male New Zealand white rabbits were euthanized, and approximately 1.0 x 1.0 x 0.5 cm³ tissue blocks were excised, immersed in OCT mounting medium (Miles), and frozen rapidly in liquid nitrogen-cooled Freon 22 (Dupont) at ~-150 °C. Samples were obtained from the following organs: bone marrow, cerebrum, kidney, large intestine, liver, lungs, lymph nodes, myocardium, stomach, striated muscle (leg), and spleen, and stored at -80 °C. On the day of an experiment, 5 µm frozen tissue sections were cut with a cryostat at -20 °C, placed on poly-L-lysine-coated glass slides, and air-dried at 25 °C. The sections were immediately immunostained without fixation to avoid denaturation of CD18 antigens. In order to inhibit non-specific binding, slides were washed in 0.1 M Tris-HCl buffer (pH 7.8), and incubated with the clarified supernatant of a solution of 5% non-fat dry milk (Carnation) in 0.1% BSA, 0.1% Na₂S₂O₃,

and 0.1 M phosphate buffer, pH 7.8 for 1 h at 25 °C. All subsequent staining steps were also conducted for 1 h at 25 °C with intermittent washes in 0.1 M Tris-HCl (pH 7.8). For single-labeling experiments, the sections were stained with a 20 µg/ml solution of primary antibody (m1B4, Gal/Rei h1B4, or hlgG4 control) in staining buffer [0.1% non-fat dry milk, 0.1% BSA, 0.1% NaN₃, and 0.1 M phosphate buffer (pH 7.8)]. Bound antibodies were detected indirectly with a 25 µg/ml solution of fluorescein isothiocyanate-conjugated affinity-purified goat anti-mouse IgG, or goat anti-human IgG FITC conjugate (Kirkegaard and Perry, Inc.) in staining buffer. In double-staining experiments, specimens were immunolabeled with a mixture of primary antibodies (1 µg/ml m1B4 and 1 µg/ml h1B4 in staining buffer centrifuged at 12,000xg for 15 min.), followed by a clarified mixed-antibody detection solution [25 µg/ml fluorescein isothiocyanate-conjugated affinity-purified goat anti-human IgG and 25 µg/ml rhodamine isothiocyanate-conjugated affinity-purified goat anti-mouse IgG (Kirkegaard and Perry, Inc.) in staining buffer]. Controls for the dual-labeling experiments were clarified solutions of mixed m1B4 plus hlgG4 (1 µg/ml of each antibody), or m1B4, Gal/Rei h1B4, and hlgG4 dissolved alone at 1 µg/ml IgG in staining buffer; IgGs were localized on the sections with the mixed-antibody detection solution described above. Coverslips were mounted on the slides with a solution of 5% n-propyl gallate in 90% glycerol and 10% 1.0 M Na-bicarbonate, and the sections studied with a Zeiss Photomicroscope III equipped with epifluorescence illumination and fluorescein & rhodamine interference filter combinations. Photomicrographs were taken at 16x or 40x with Zeiss neofluar oil-immersion objective lenses using Ilford HP-5 high-speed film at speeds of 1600-6300 ASA.

The IF staining patterns of Gal/Rei h1B4 and m1B4 in rabbits are summarized in Figure 32. Specific CD18-positive IF labeling for both recombinant and native 1B4 IgGs was observed in tissues known to contain leukocytes. There was no detectable difference in IF distribution or intensity observed with Gal/Rei h1B4 versus m1B4, and control tissues treated with hlgG4 or buffer were always negative. By far, sections of bone marrow presented the most intense CD18 staining with either species of 1B4; 79% of these cells exhibited cytoplasmic labeling. Leukocytes of the spleen and the lymph nodes were stained more irregularly and with lower intensity. A conspicuous population of resident leukocytes was detected in the lungs, and to a much lesser extent in kidney glomeruli. Surprisingly, no CD18 staining was seen in the microglial cells of the cerebrum or in the Kupffer cells of the liver. The other tissues were completely unstained. Titration of the primary antibody solution indicated that a 1.0 µg/ml solution of h1B4 or m1B4 was the minimum concentration of either antibody

required to obtain maximum IF staining of bone marrow sections.

Dual IF staining experiments were conducted to determine whether the antigens recognized by Gal/Rei h1B4 and m1B4 are colocalized in the same cells. Cryosections of bone marrow, spleen, or lymph node were double-labeled with mixtures of Gal/Rei h1B4 and m1B4. As illustrated in Figure 33 for bone marrow, every cell that was positively stained with m1B4 was also labeled with Gal/Rei h1B4. In the control groups, Gal/Rei h1B4 staining (detected under fluorescein optics) was specifically eliminated by substituting hlgG4 for h1B4 in the primary antibody mixture, while retaining the m1B4 labeling (visualized with rhodamine filters). With the converse control, removal of m1B4 from the mixture of primary antibodies ablated the rhodamine labeling, but had no effect on the fluorescein staining generated by Gal/Rei h1B4. These 1B4-colocalization results were therefore highly specific.

These data indicate that native and Gal/Rei humanized 1B4 were localized in the same cells (leukocytes) and exhibited identical staining specificity and intensity in various rabbit tissues. The highest levels of CD18 labeling were observed in those tissues which contain large numbers of leukocytes, with the bone marrow presenting the most intense staining. Therefore, our humanization process has not altered the specificity of 1B4 IgG detectable at the light microscopic level of resolution.

IEM Staining of Human Cell Organelles.

Double label immunoelectron microscopic experiments were conducted to compare the specificity of Gal/Rei h1B4 and m1B4 at the subcellular/supramolecular level of resolution. CD18 antigens have been localized to the specific granules of hPMNs and monocytes via IEM with 60.3 (another Mab that recognizes CD18; Singer et al., *J. Cell Biol.*, 109: 3189-3182 [1989]). Therefore, we determined whether Gal/Rei h1B4 and m1B4 were codistributed in these granules. Human PMNs were isolated from venous blood as described above and prepared for IEM via a modification of a published method (Singer et al, supra). Briefly, the PMNs were fixed with a solution of 3.5% paraformaldehyde and 0.05% glutaraldehyde in 0.1M Na-cacodylate (pH 7.2), 0.1M sucrose, and a mixture of broad spectrum protease inhibitors. Fixation was performed under microwave irradiation until the cells reached 45°C (~45 sec.), followed by quenching with excess buffer at 4°C. Cell pellets were embedded in 7% acrylamide, infiltrated with 2.3M sucrose in 0.1M phosphate (pH 7.2), frozen in liquid propane (-190°C) and cut into ultrathin (~80 nm) cryosections. The specimens were double labeled with Gal/Rei h1B4 and m1B4 using 5 nm and 10 nm protein-A colloidal gold conjugates (Janssen Life Sci

ence Products) as described, and analyzed at 29,000x with a JEOL 100CX transmission electron microscope. A summary of the immunostaining results for PMNs is shown in Figure 34. Both Gal/Rei h1B4 and m1B4 were colocalized in specific granules; negative controls showed that the colloidal gold probes were not cross-reacting nonspecifically. Further, Gal/Rei h1B4 and m1B4 were also colocalized within a population of cytoplasmic granules in U-937 cells (a human myelomonocytic line), but not in human lung fibroblasts (IMR-90). These observations strongly suggest that the binding specificity of Gal/Rei IB4 is comparable to that of m1B4 at supermolecular resolution.

EXAMPLE 5

In Vivo Activity Of Recombinant Human Anti-CD18 Antibodies

The *in vivo* potencies of murine 1B4 (m1B4) and humanized 1B4 (h1B4) (Examples 2 and 4) were compared in the rabbit by assessing their ability to inhibit dermal inflammation, manifest as PMN accumulation and plasma extravasation, elicited by intradermal administration of C5a.

The dorsal hair of female New Zealand White rabbits (2 - 2.5 kg) was shaved at least 24 hours prior to experimentation. Rabbits were anesthetized with an intramuscular injection of Ketamine HCl (80 mg) and Xylazine (5 mg). [¹²⁵I]-Bovine serum albumin (10 μ Ci) was injected into the marginal ear vein, as a marker of plasma extravasation. Groups of animals were then treated with saline, m1B4 administered intravenously at 0.07, 0.21 or 0.7 mg/kg, or h1B4 administered intravenously at 0.1, 0.3 or 1 mg/kg 15 minutes before initiation of the dermal inflammation. Thereafter, human recombinant C5a (100 pmol), or saline, in a volume of 50 μ l was injected intradermally into 4 replicate sites in the dorsum. Three hours later, a blood sample (1 ml) was taken and centrifuged (8000g; 3 min; 20°C) to prepare cell-free plasma which was aspirated and retained. Animals were then euthanized with approximately 750 μ l Socumb (Sodium Pentobarbital 389 mg/ml in 40% isopropyl alcohol), and injection sites were excised using a 6 mm biopsy punch. Radioactivity ([¹²⁵I]) present in skin samples and cell-free plasma (50 μ l) was quantified using a gamma counter. By reference to the specific radioactivity of the cell-free plasma, the extent of plasma extravasation was expressed as μ l plasma equivalents per 6 mm biopsy. The skin biopsy was then homogenized in 5 ml of 0.5% Hexadecyltrimethyl ammonium bromide (HTAB) using a polytron homogenizer. Chloroform (1 ml) was added to the sample, which was vortexed and centrifuged (1600g; 15 min.; 20°C). Four aliquots (50 μ l) of the aqueous supernatant were added to wells in a 96 well plate for

measurement of myeloperoxidase (MPO) activity, as an index of PMN content. Duplicate wells of the 96 well plate received 200 μ l buffer (KH₂PO₄ 44 mM; K₂HPO₄ 6 mM; H₂O₂ 0.0015%; pH 6.0) alone (background) and duplicate wells received buffer containing MPO substrate (3',3-Dimethoxybenzidine dihydrochloride; 360 μ g/ml). Reactions were allowed to proceed for 15 min. at room temperature, and MPO activity was measured as the change in absorbance at 450 nm measured in a plate reading spectrophotometer. By reference to a standard curve constructed using known quantities of rabbit PMN in HTAB, the extent of PMN accumulation in each skin biopsy was estimated.

The injection of C5a into the skin of rabbits pretreated with saline produced significant increases in PMN accumulation (Figure 35) and plasma extravasation (Figure 36) compared with skin sites injected with saline. In animals pretreated with either m1B4 or h1B4 there was dose-related inhibition of both PMN accumulation (Figure 35) and plasma extravasation (Figure 36). Both antibodies were of comparable potency, as indicated by the estimated ED₅₀ values for inhibition of PMN accumulation and plasma extravasation which were approximately 0.15 mg/kg for both m1B4 and h1B4.

Claims

1. A recombinant human immunoglobulin comprising a human heavy chain framework and murine complementarity determining regions, with said heavy chain framework mutated at sites near the complementarity determining regions, a human light chain framework and murine complementarity determining regions with said human immunoglobulin or immunologic fragment thereof being capable of binding to a human CD18 integrin.
2. The recombinant human immunoglobulin of claim 1 wherein the immunoglobulin has a mean IC₅₀ nearly equal to that of the murine monoclonal antibody from which the complementarity determining regions were derived.
3. A recombinant human immunoglobulin of claim 1 wherein the immunoglobulin is designated mutated Gal/Rei.
4. The recombinant human immunoglobulin of claim 1 wherein the immunoglobulin or fragment is capable of binding to cells expressing leukocyte integrins selected from the group consisting of LFA-1, Mac-1 or p150,95.
5. The recombinant human immunoglobulin or frag-

ment thereof of claim 1 wherein the antibody or fragment is capable of binding to cells expressing the CD18 integrin subunit.

6. The recombinant human immunoglobulin or fragment thereof of claim 1 wherein the antibody or fragment is capable of binding to leukocytes and preventing the leukocytes from entering an inflammatory lesion. 5
10
7. A DNA sequence coding for the recombinant human immunoglobulin of claim 1. 15
8. A vector containing the DNA sequence of claim 7. 20
9. A mammalian host transfected by the vector of claim 8 containing the DNA sequence coding for recombinant human immunoglobulin. 25
10. A process for the preparation of recombinant human immunoglobulin mutated Gal/Rei comprising culturing the transformed mammalian host of claim 15 under conditions suitable for the expression of recombinant human anti-CD18 antibody and recovering said antibody. 30
11. An inflammatory reducing or inhibiting pharmaceutical composition comprising an effective inflammatory inhibiting amount of the recombinant human immunoglobulin of claim 1 and a pharmaceutical carrier. 35
12. A recombinant mutated human heavy chain framework into which has been grafted murine complementarity determining regions with said complementarity determining regions being specific for human CD18 integrin. 40
13. The DNA sequence of claim 7 encoding mutated Gal/Rei. 45
50
55
23

MOUSE LIGHT CHAIN VARIABLE REGION

5' UPSTREAM PRIMER - FR1 OF VARIABLE REGION

5'- TCT CGGATC CGA (CT)AT (TC)GT G(AC)T (GC)AC CCA (GA)-3'

BAM HI

3' DOWNSTREAM PRIMER - KAPPA CONSTANT REGION

5'- TCT CAA GCT TTG GTG GCA AGA T(GA)G ATA CAG TTG GTG CAG C -3'

HIND III

MOUSE HEAVY CHAIN VARIABLE REGION

5' UPSTREAM PRIMER - FR1 OF VARIABLE REGION

I) 5'- TTC TGG ATC C(CG)A GGT (GCT)CA (AG)CT G(AC)A G(GC)A GTC (TA)GG -3'

BAM HI

II) 5'- TTC TGG ATC C(CG)A GGT (GCT)AA GCT GGT G(GC)A GTC (TA)GG -3'

BAM HI

3' DOWNSTREAM PRIMER - IgG2a CH1 REGION

5'- TCT CAA GCT TAC CGA TGG (GA)GC TGT TGT TTT GGC -3'

HIND III

FIG. 1

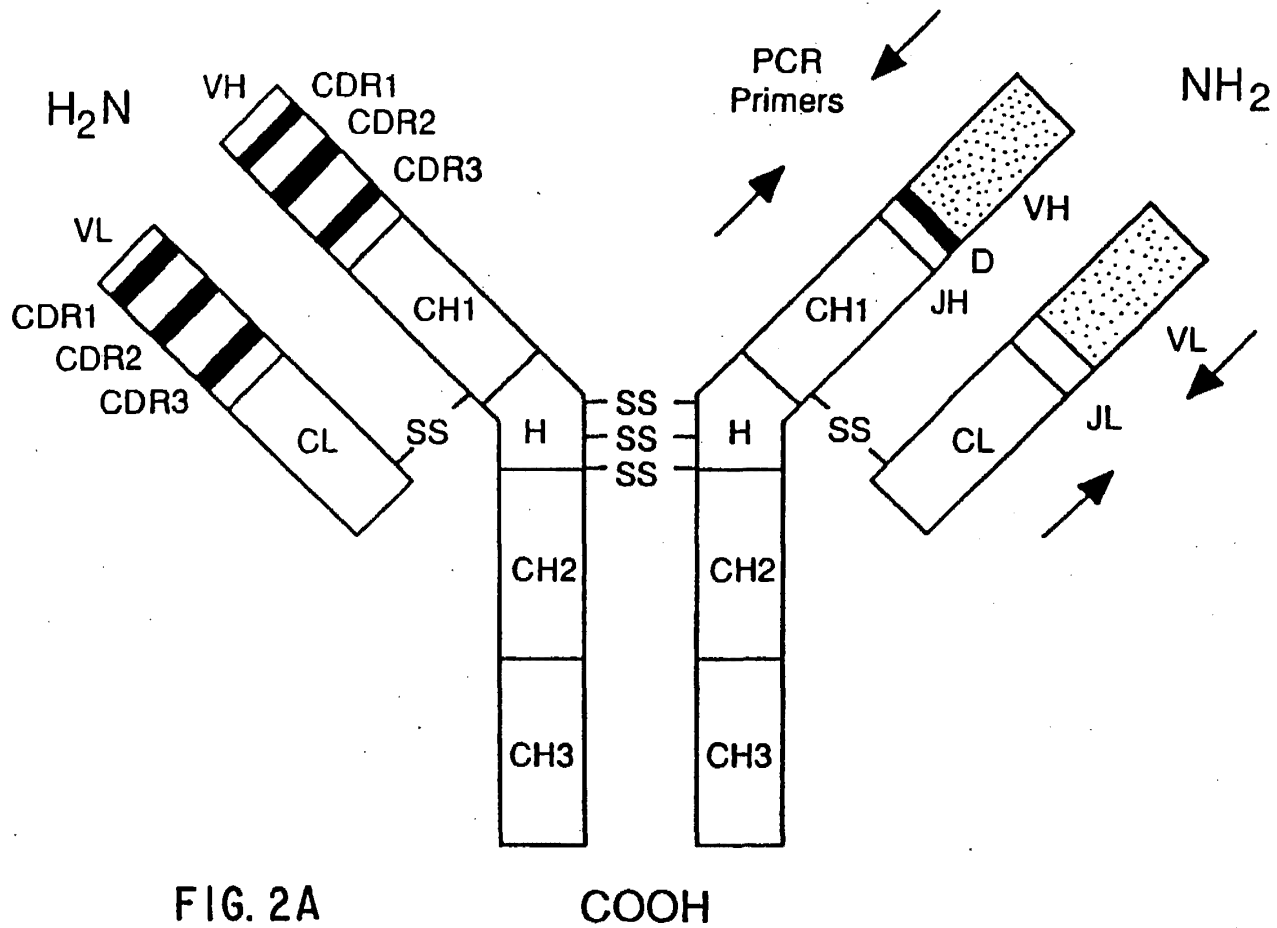

25

EP 0 438 312 A2

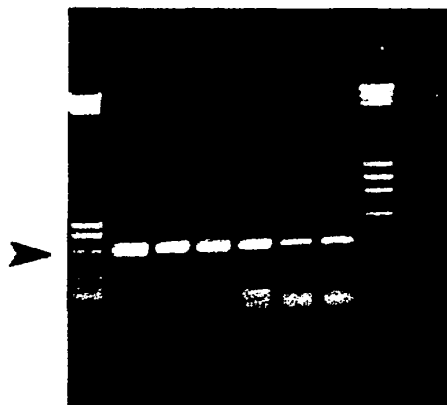

FIG. 2B

1B4 HEAVY CHAIN

Asp*Val Lys Leu Val Glu Ser Gly Gly Asp Leu Val Lys Leu Gly Gly Ser Leu
Lys Leu Ser Cys Ala Ala Ser Gly Phe Thr Phe Ser [Asp Tyr Tyr Met Ser] Trp
Val Arg Gln Thr Pro Glu Lys Arg Leu Glu Leu Val Ala [Ala Ile Asp Asn Asp
Gly Gly Ser Ile Ser Tyr Pro Asp Thr Val Lys Gly] Arg Phe Thr Ile Ser Arg
Asp Asn Ala Lys Asn Thr Leu Tyr Leu Gln Met Ser Ser Leu Arg Ser Glu Asp
Thr Ala Leu Tyr Tyr Cys Ala Arg [Gln Gly Arg Leu Arg Arg Asp Tyr Phe Asp
Tyr] Trp Gly Gln Gly Thr Thr Leu Thr Val Ser Ser Ala Lys Thr....

1B4 LIGHT CHAIN-1

Asp Ile Val Leu Thr Gln Ser Pro Ala Ser Leu Ala Val Ser Leu Gly Gln Arg Ala
Thr Ile Ser Tyr [Arg Ala Ser Lys Ser Val Ser Thr Ser Gly Tyr Ser Tyr Met
His] Trp Asn Gln Gln Lys Pro Gly Gln Pro Pro Arg Leu Leu Ile Tyr [Leu Val
Ser Asn Leu Glu Ser] Gly Val Pro Ala Arg Phe Ser Gly Ser Gly Ser Arg Thr
Asp Phe Thr Leu Asn Ile His Pro Val Glu Glu Glu Asp Ala Ala Thr Tyr Tyr
Cys [Gln His Ile Arg Glu Leu Thr] Arg Ser Glu Gly Gly Pro Ser Trp Lys ter

FIG. 3A

27

EP 0 438 312 A2

1B4 LIGHT CHAIN-2

Asp Ile Val Leu Thr Gln Ser Pro Ala Ser Leu Ala Val Ser Leu Gly Gln Arg Ala
Thr Ile Ser Cys [Arg Ala Ser Glu Ser Val Asp Ser Tyr Gly Asn Ser Phe Met
His] Trp Tyr Gln Gln Lys Pro Gly Gln Pro Pro Lys Leu Leu Ile Tyr [Arg Ala
Ser Asn Leu Glu Ser] Gly Ile Pro Ala Arg Phe Ser Gly Ser Gly Ser Arg Thr
Asp Phe Thr Leu Thr Ile Asn Pro Val Glu Ala Asp Asp Val Ala Thr Tyr Tyr
Cys [Gln Gln Ser Asn Glu Asp Pro Leu] Thr Phe Gly Ala Gly Thr Lys Leu Glu
Leu Lys Arg Ala Asp...

[CDRs] ; underline = homology to protein sequence
Asp* determined from N-terminal amino acid sequencing; PCR primer
encoded GAG for Glu

FIG. 3B

EP 0 438 312 A2

28

S1 5'- CAT TCG CTT ACC AGA TCT AAG CTT ACT AGT GAG ATC ACA GTT CTC TCT AC -3'

Bgl II Hind III Spe I

R1 5'- GCC ATA ACT ATC AAC ACT TTC ACT GGC TCT ACA GGT GAT GGT CAC TCT GTC -3'

R2 5'- GTG TTG ATA GTT ATG GCA ATT CTT TTA TGC ACT GGT ACC AGC AGA AGC CAG G -3'

R3 5'- GAT TCT AGG TTG GAT GCA CGG TAG ATC AGC AGC TTT GGA GC -3'

R4 5'- GCA TCC AAC CTA GAA TCT GGT GTG CCA AGC AGA TTC AGC -3'

R5 5'- GGA TCC TCA TTA CTT TGC TGG CAG TAG TAG GTG GCG ATG TC -3'

R6 5'- CAA AGT AAT GAG GAT CCT CTC ACG TTC GGC CAA GGG ACC AAG GTG -3'

I1 5'- GAA TGT GCC TAC TTT CTA GA G GAT CC A ACT GAG GAA GCA AAG -3'

Xba I Bam H1

PCR RECOMBINATION AMPLIFIERS

A1 5'- CAT TCG CTT ACC AGA TCT -3'

A2 5'- GAA TGT GCC TAC TTT CTA G -3'

FIG. 4

29

EP 0 438 312 A2

SHORTEN VERSION OF THE IgG4 HEAVY CHAIN CONSTANT REGION

5'- ATT TGG ATC C TC TAG A CA TCG CGG ATA GAC AAG AAC -3'

Bam H1 Xba I

5'- AAT AAT GCG GCC GC A TCG AT G AGC TCA AGT ATG TAG ACG GGG TAC G -3'

Not I Cla I Sac I

TK PROMOTER FRAGMENT

5'- TAT AGA ATT C GG TAG CCT TCA TCC CCG TGG CCC G -3'

Eco R1 Kpn I

5'- TGC GTG TTC GAA TTC GCC -3'

Eco R1

Ig H ENHANCER

5'- TTT TAG ATC T GT CGA CAG ATG GCC GAT CAG AAC CAG -3'

Bgl II Sal I

5'- TTG GTC GAC GGT ACC AAT ACA TTT TAG AAG TCG AT -3'

Sal I Kpn I

HUMAN KAPPA CONSTANT REGION

5'- TCT CGG ATC CTC TAG AAG AAT GGC TGC AAA GAG C -3'

5'- TCT CGC TAG CGG ATC CTT GCA GAG GAT GAT AGG G -3'

FIG. 7

EP 0 438 312 A2

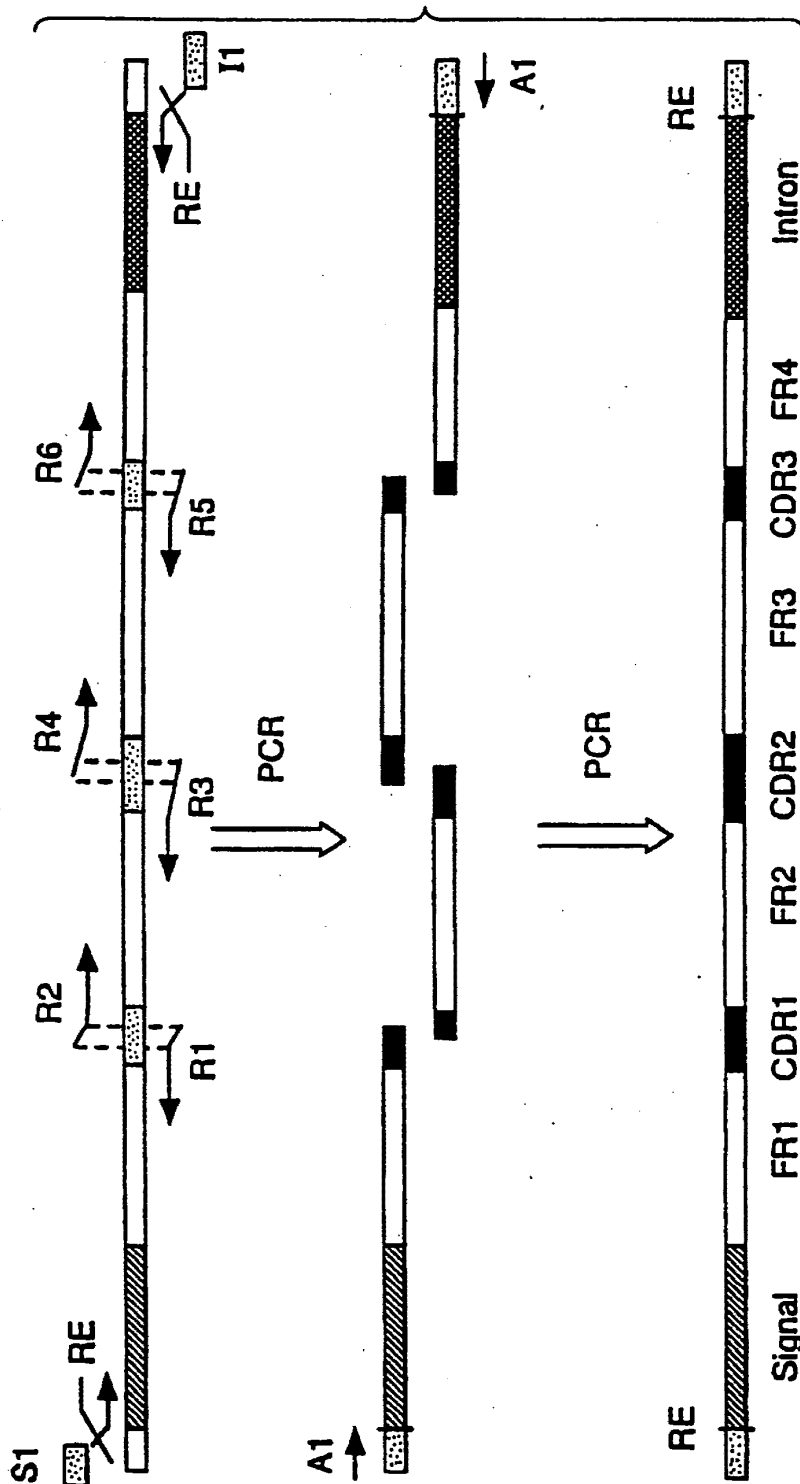
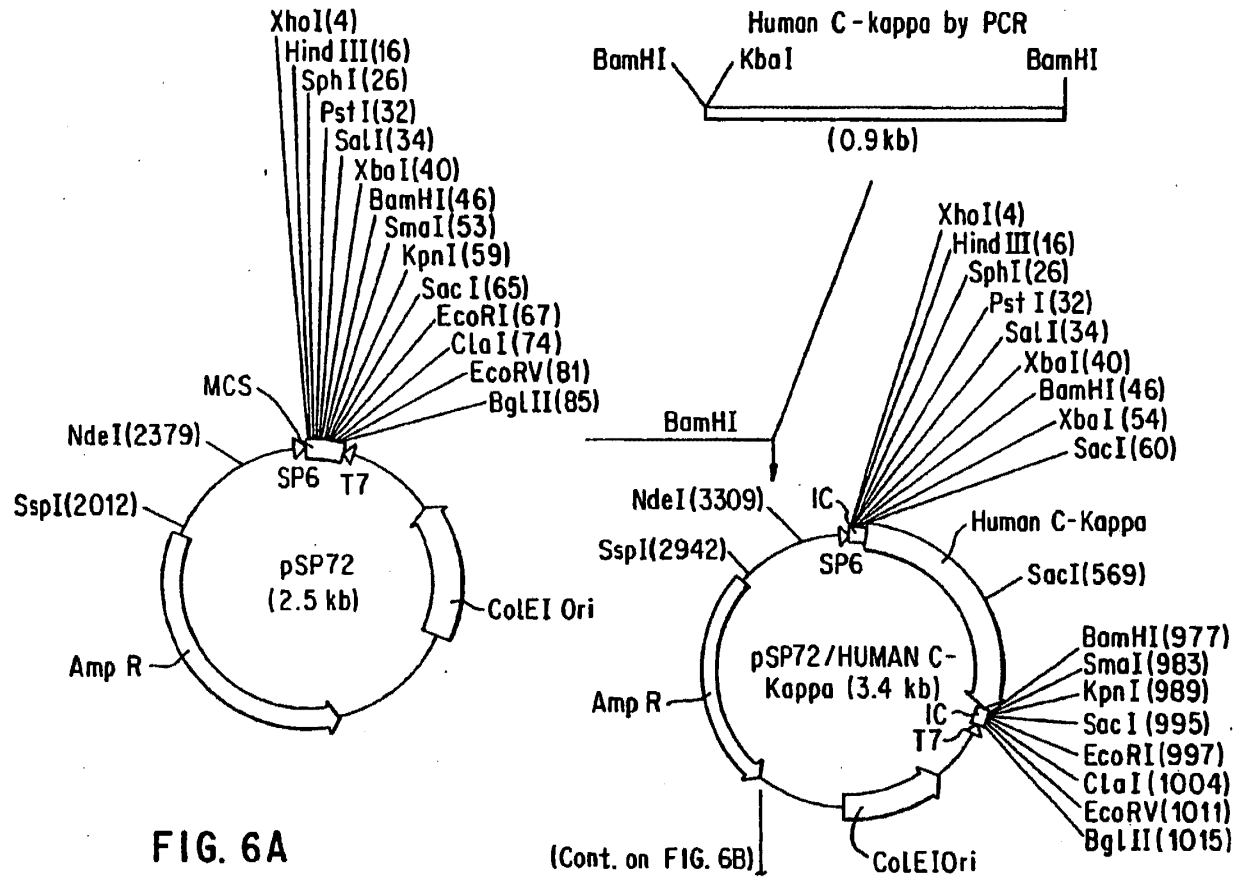
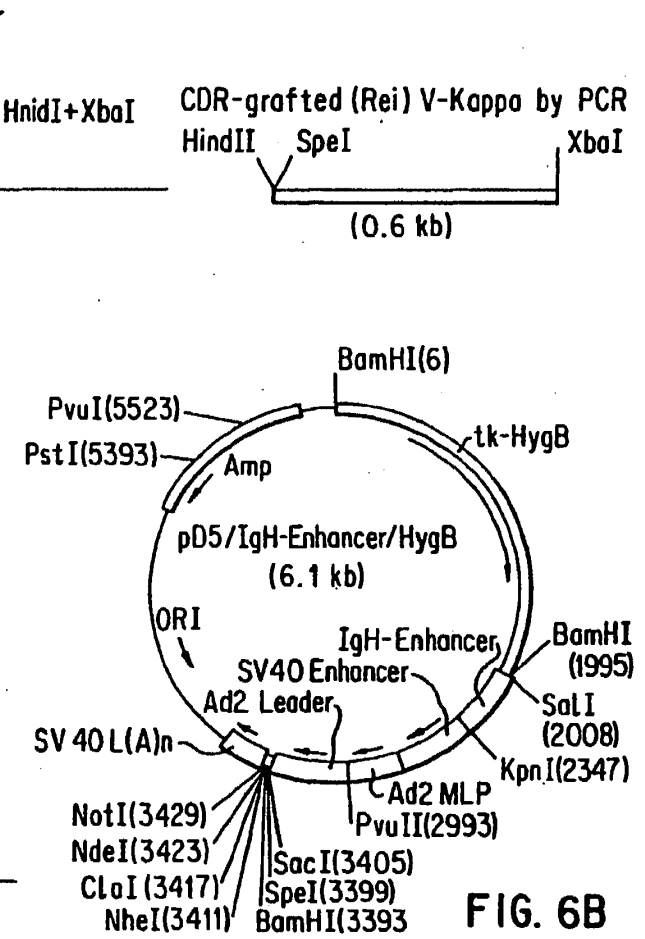
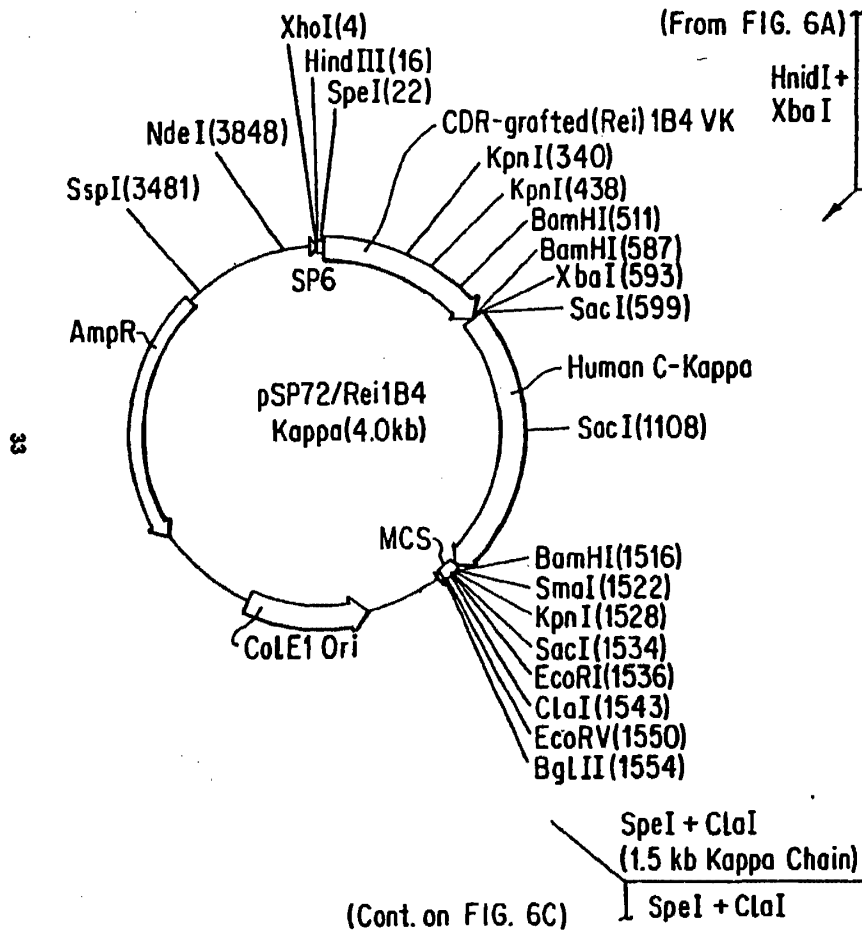

FIG. 5

32



EP 0 438 312 A2



EP 0 438 312 A2

(From FIG. 6B)

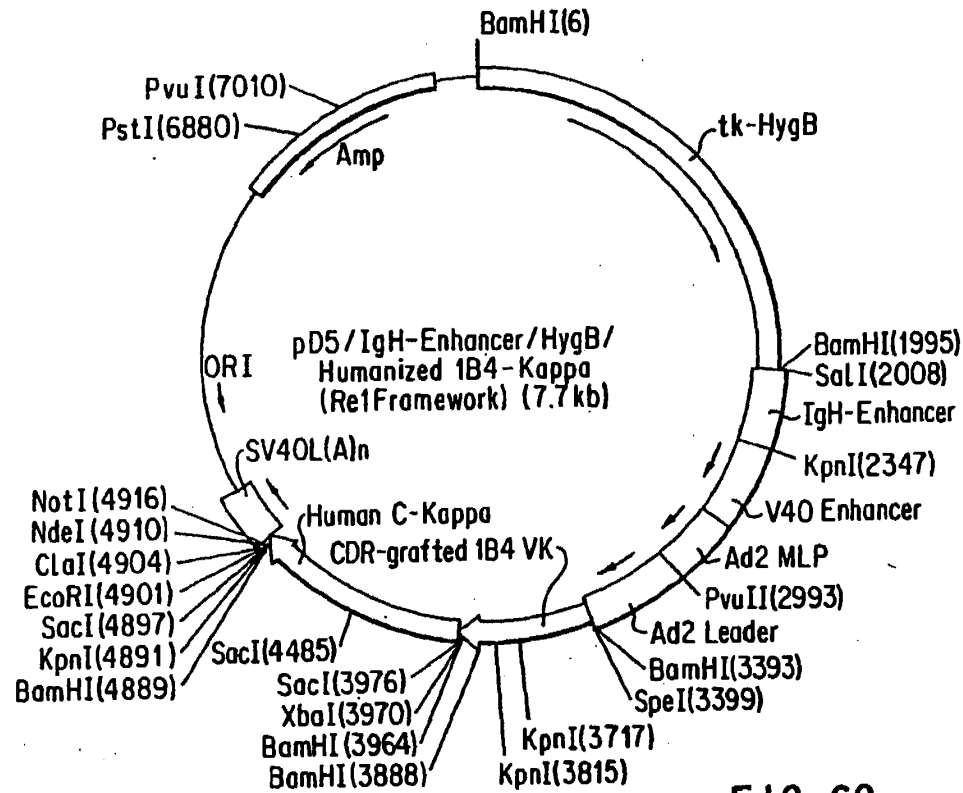
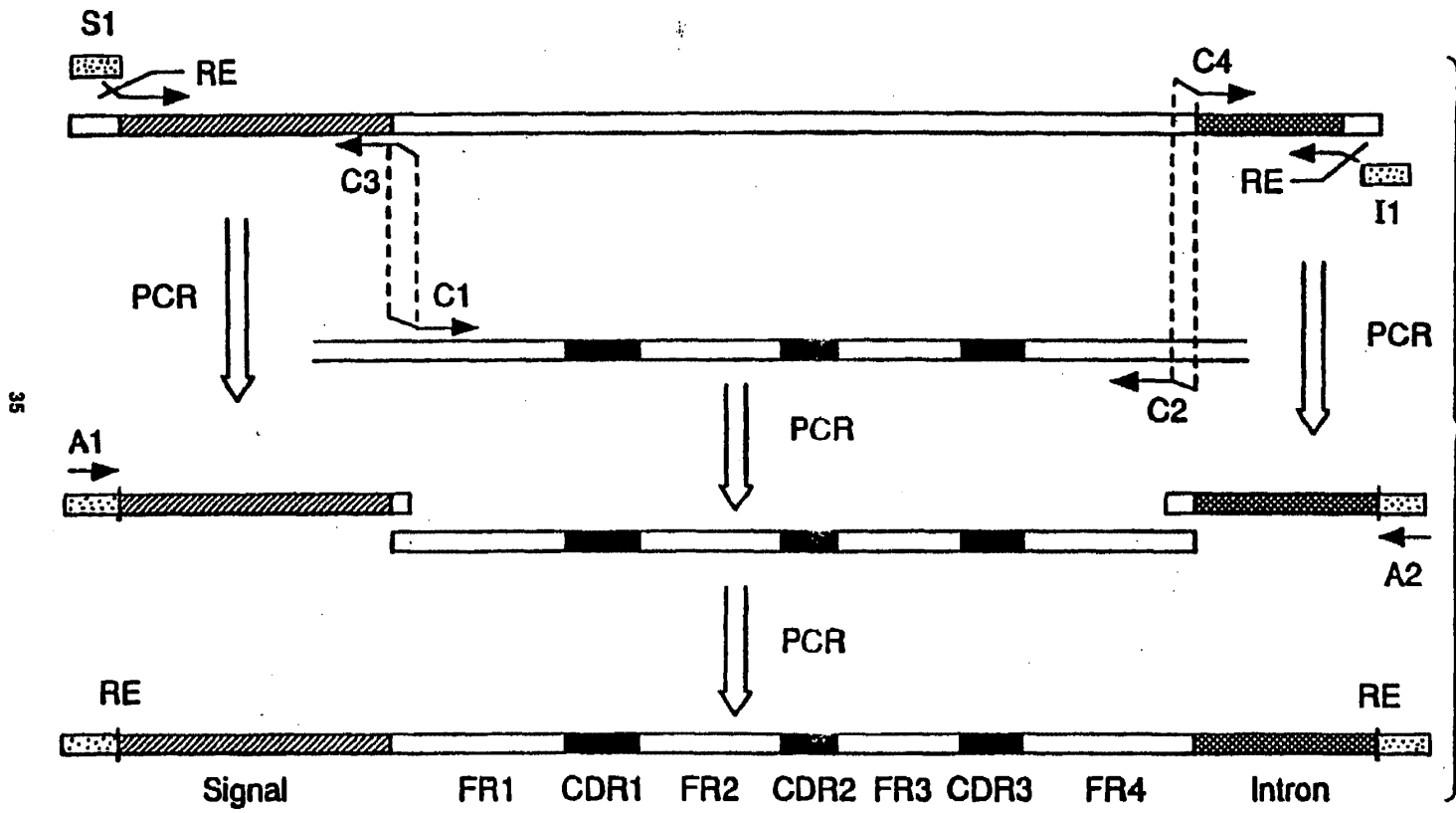

FIG. 6C

EP 0 438 312 A2

34



35

FIG. 8

EP 0 438 312 A2

#S1 5'- CAT TCG CTT ACC AGA TCT AAG CTT ACT AGT GAG ATC ACA GTT CTC TCT AC -3'

Bgl II Hind III Spe I

#C1 5'- GAT GTG AAG CTG GTG GAG TCA G -3'

#C2 5'- CTC CAC CAG CTT CAC ATC GGA GTG GAC ACC TGT GGA GAG -3'

#C3 5'- TGA GGA GAC TGT GAG AGT GGT G -3'

#C4 5'- CTC TCA CAG TCT CCT CAG GTG AGT CCT TAC AAC CTC TC -3'

#I1 5'- GAA TGT GCC TAC TTT CTA GA G GAT CC A ACT GAG GAA GCA AAG -3'

Xba I Bam HI

PCR RECOMBINATION AMPLIFIERS

#A1 5'- CAT TCG CTT ACC AGA TCT -3'

#A2 5'- GAA TGT GCC TAC TTT CTA G -3'

FIG. 9

36

EP 0 438 312 A2

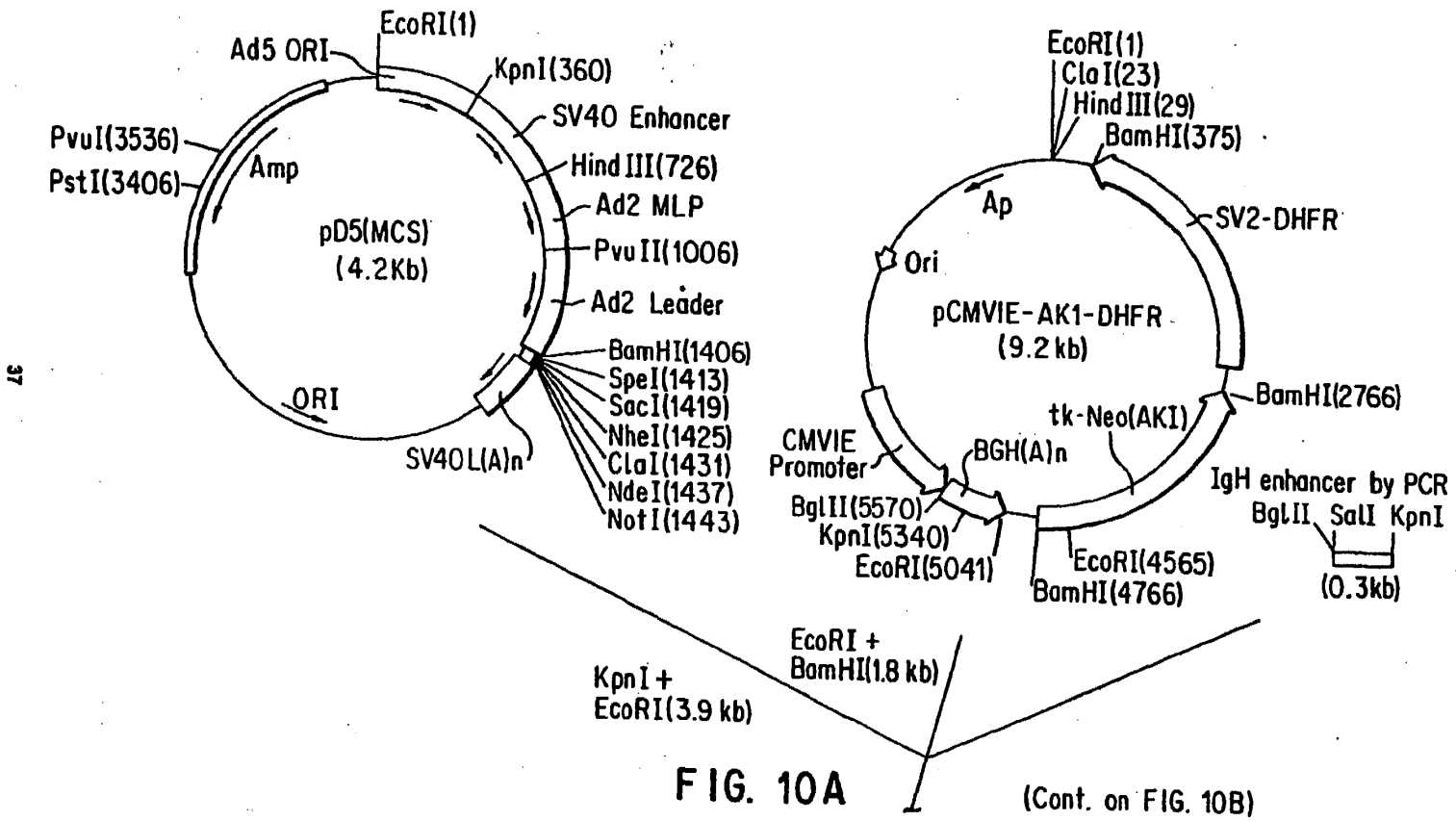

37

EP 0 438 312 A2

FIG. 10A

(Cont. on FIG. 10B)

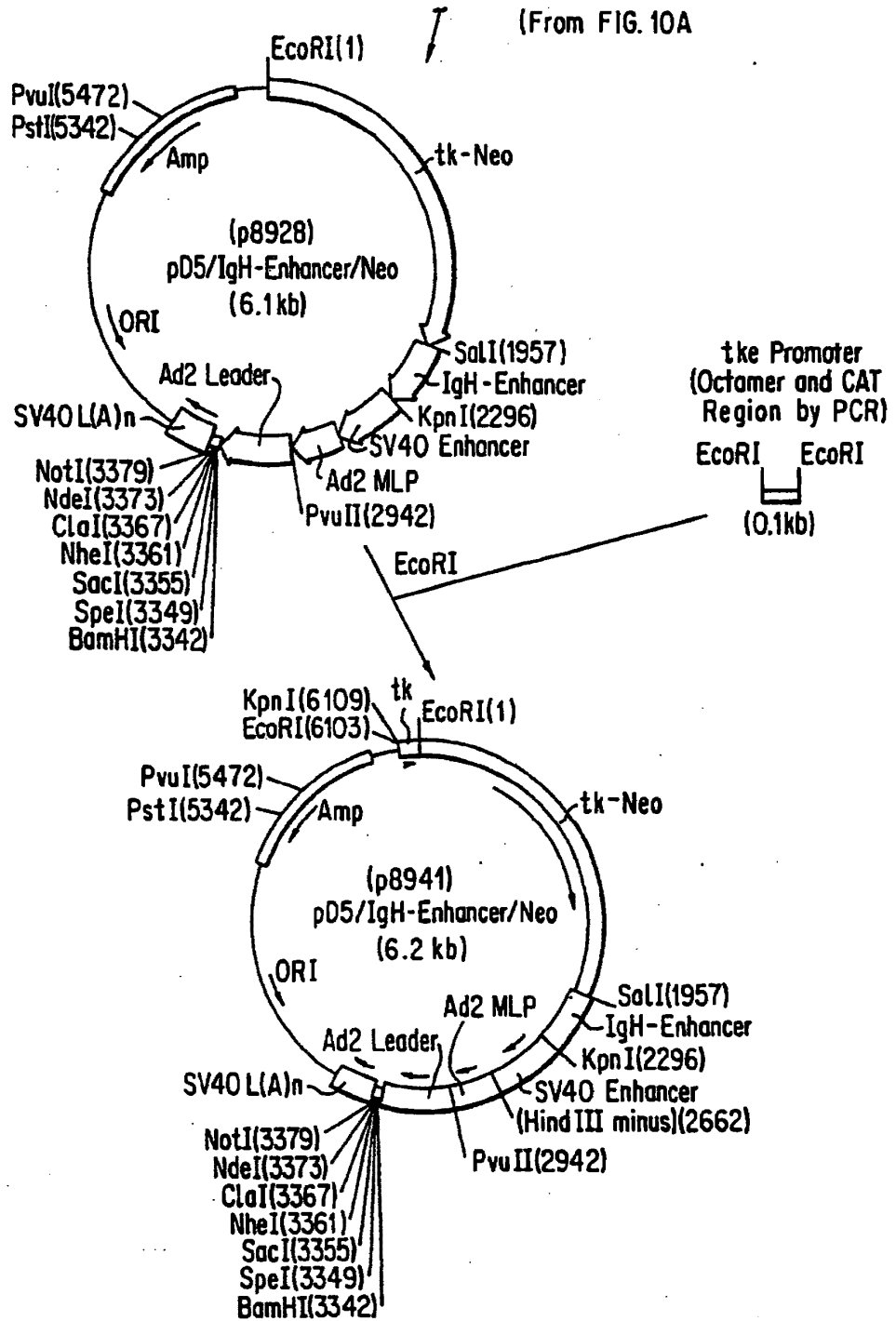
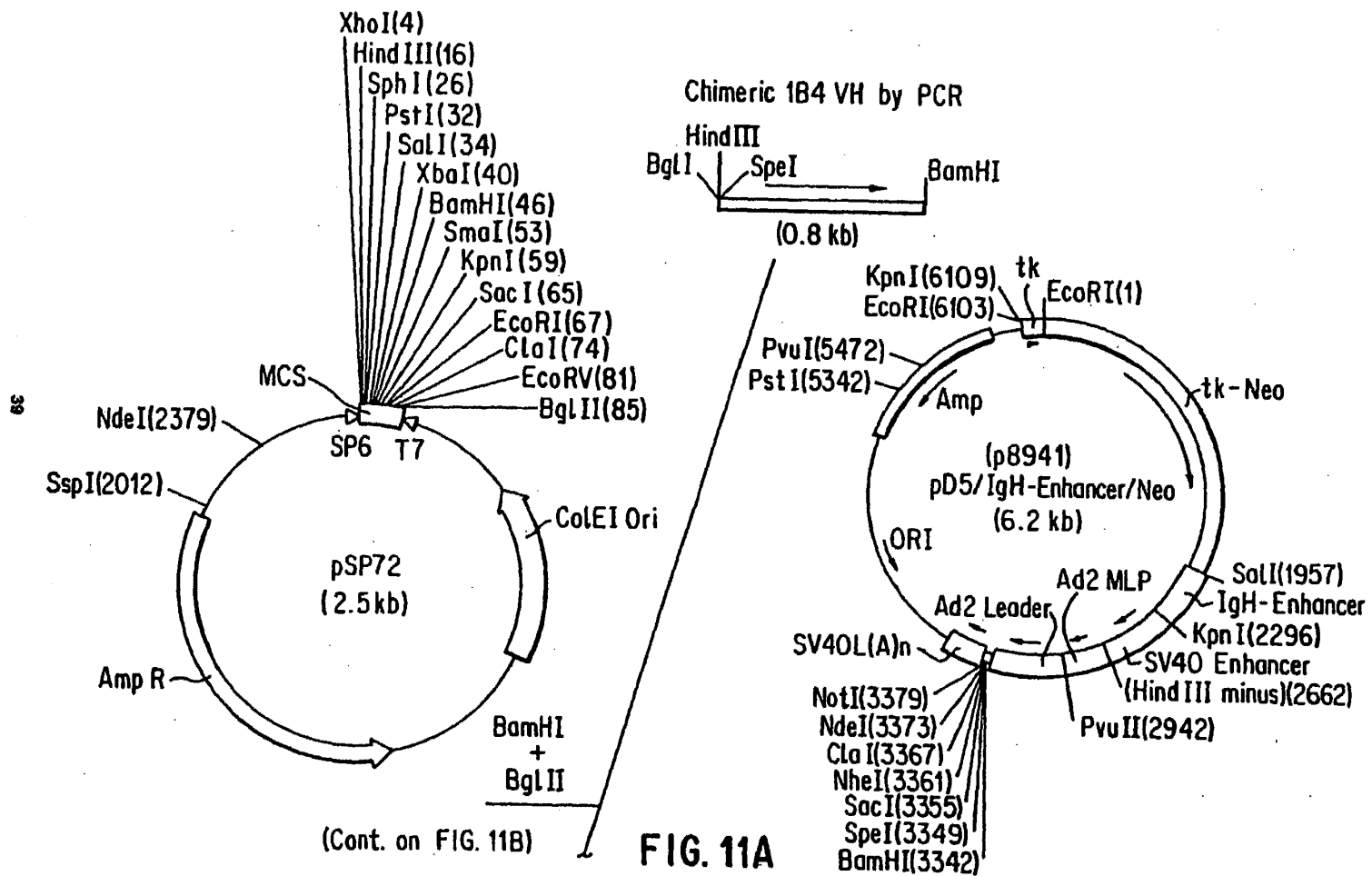
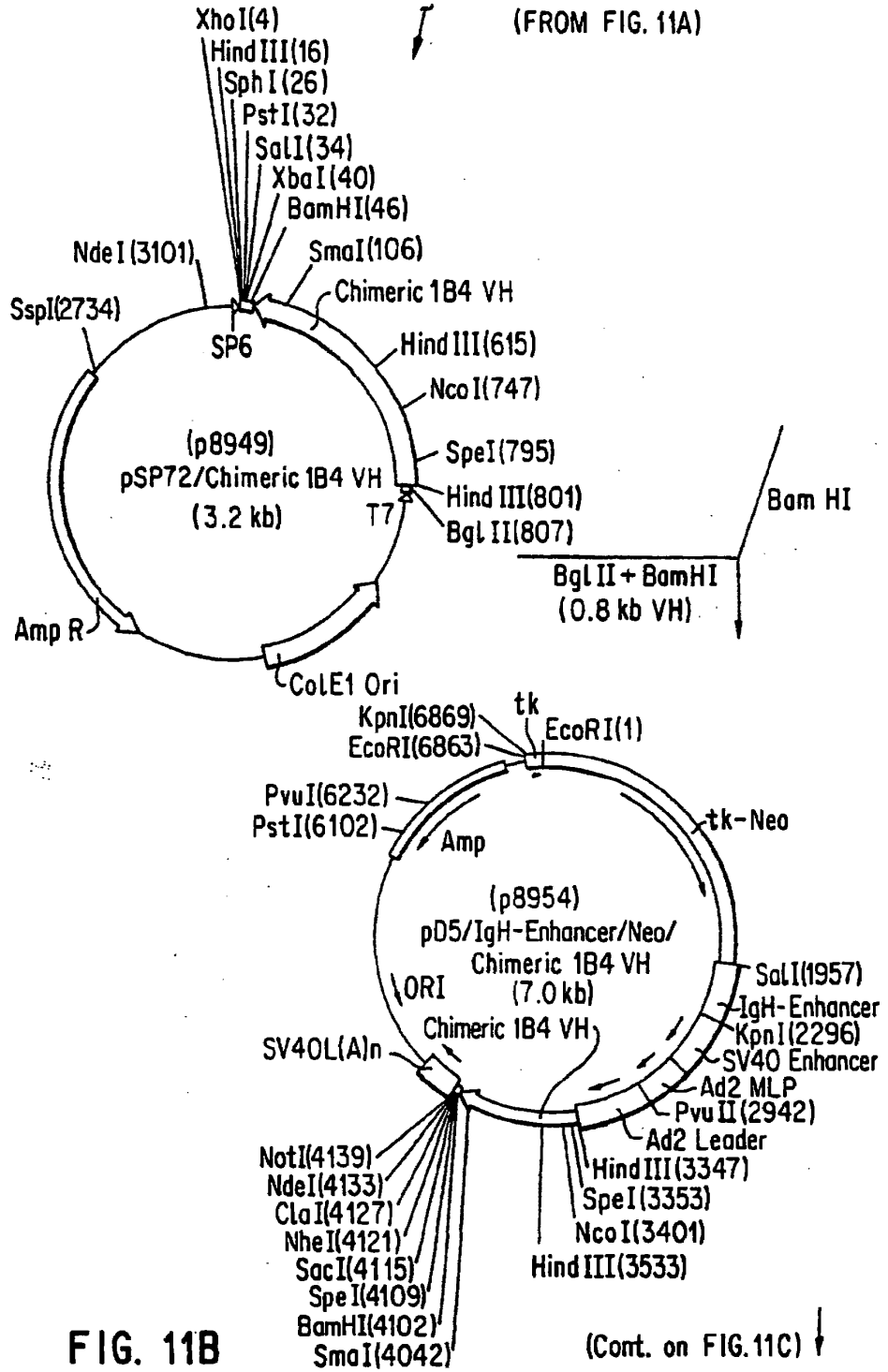

FIG. 10B



EP 0 438 312 A2



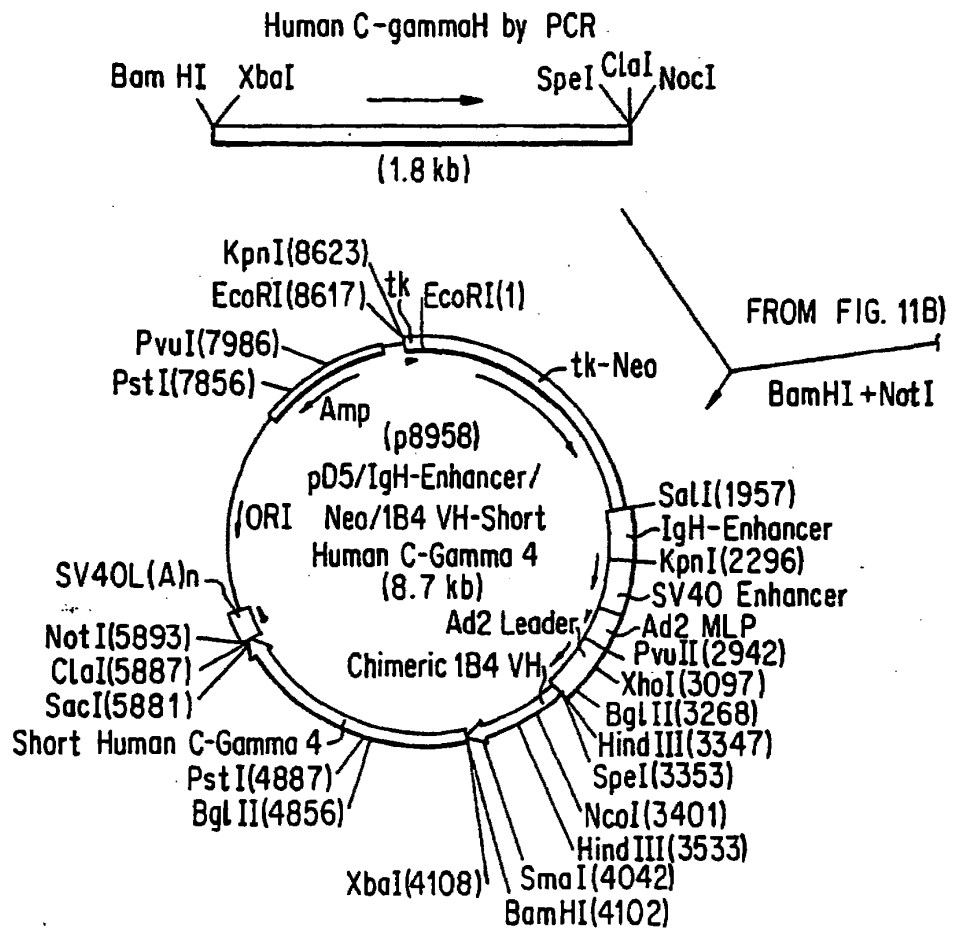

FIG. 11C

TRANSIENT EXPRESSION OF THE 1B4 CHIMERIC HEAVY CHAIN; GRAFTED RE1/1B4 LIGHT CHAIN
RECOMBINANT ANTIBODY IN CV1, COS7, AND 293 CELLS

<u>CELL LINE</u>	<u>ANTIBODY (ng/mL)</u>
CV1	50
CV1	31
COS7	71
COS7	82
293	385
293	207

FIG. 12

42

EP 0 438 312 A2

43

CPM BOUND/ 1×10^5
HUMAN PMNs

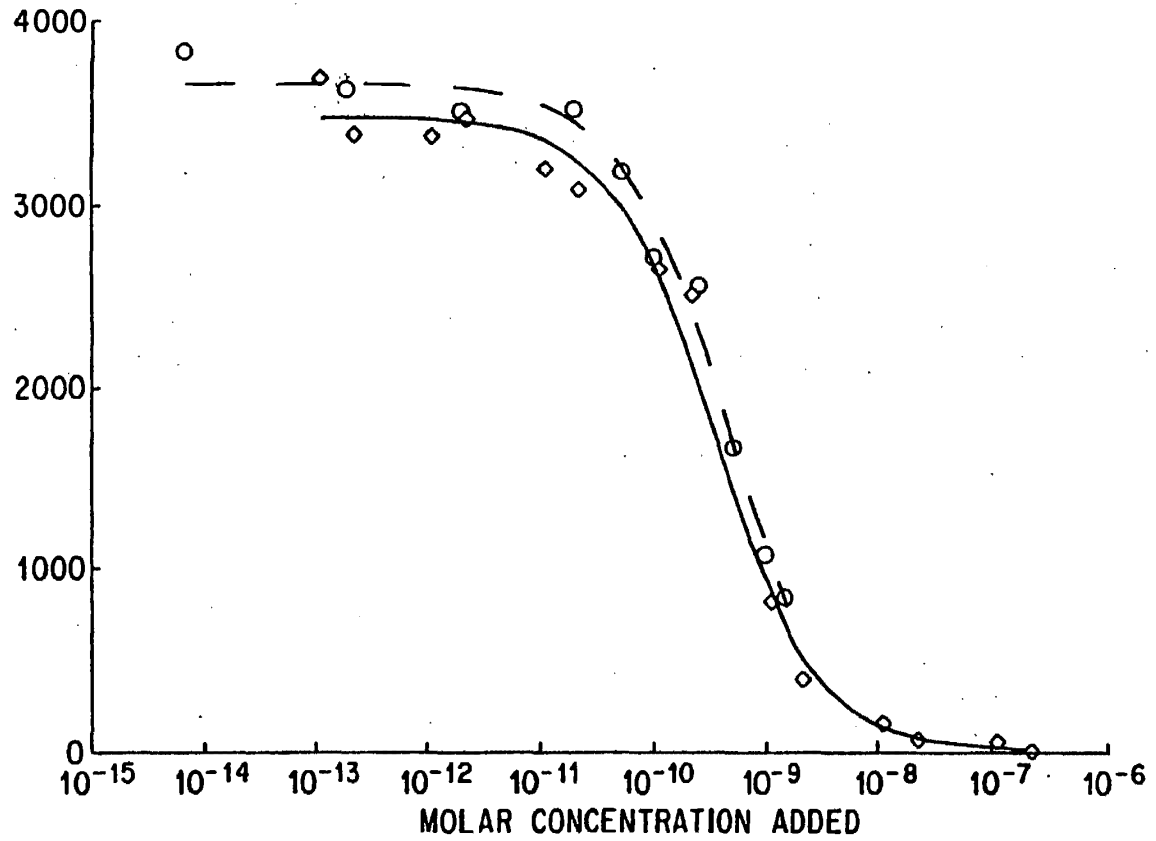

EP 0 438 312 A2

FIG. 13

HEAVY CHAIN

NEW: QVQLQESGPGLV RPSQTL SLTCTVSGFTFS [NDYYT] WVRQPP
1B4: DVKLVESGGDLVKLG GSKLSCAASGFTFS [DYYS] WVRQTP
Jon: DVQLVESGGGLVKPGGSLRLSCAASGFTFS [TAWMK] WVRQAP
Gal: EVQLVESGGDLVQPGRSLRLSCAASGFTFS [BLGNT] WVRQAP
Gal-M1: G

4
GRGLEWIG [YVFYHGTSDDTTPLRS-] RFTMLVDTSKNQFSLRL
EKRLÉLVA [AIDNDGGSISYPDTVKG] RFTISRDN AKNTLYLQM
GKGLEWVV [WRVEQVVEKAFANSVNG] RFTISRND SKNTLYLQM
GKGLEWVA [NIKZBGSZZBYVDSVKG] RFTISRDN AKNSLYLQM
L

SSVTAADTAVYYCAR [---NLIAGCIDV]WGQGS LVTVSS... 55
SSLRSED TALYYCAR [-QGRLRRDYFDY]WGQGTT LTVSS...
ISVTPEDTAVYYCAR [VPLYGBYRAFNY]WGQGT PTVSS... 78
NSLRVEDTALYYCAR [-----GWGGD-)WGQGT LVTVST... 82
L 85

EP 0 438 312 A2

FIG. 14A

LIGHT CHAIN

REI: DIQLTQSPSSLSASVGDRVITC [RASGNIHNYLA-----] WY
1B4: DIVLTQSPASLAVSLGQRATISC [RASEVDSYGN SFMH--] WY
Len: DIVMTQSPNSLAVSLGERATINC [KSSQSVLYSSNSKNYLA] WY

QKPGKAPKLLIY [YTTTLAD] GVPSRFSGSGSGTDFTTISSL
QKPGQPPKLLIY [RASNLES] GIPARFSGSGSRTDFTLTINPV
QKPGQPPKLLIY [WASTRES] GVPDRFSGSGSGTDFTTISSL

QPEDIATYYC [QHFSTPRT]	FGQGTKVVIKR...	%Id
EADDVATYYC [QSNEDPLT]	FGAGTKLELKR...	69
QAEDVAVYYC [QYYSTPYS]	FGQGTKLEIKR...	81

%Id percent identity to 1B4 FRs

FIG. 14B

EP 0 438 312 A2

"GAL"/1B4

#G1 5'- GAG GTG CAG CTG GTG GAG TCT GGG GGA GAC CTG GTC CAG CCT GGG AGG TCT CTG AGA
CTC TCC TGT GCA GCC TCT GGA TTC ACC TTC AGT GAC TAT TAC -3'
#G2 5'- ATA AGA GAT GCT ACC ACC ATC ATT ATC AAT GGC TGC AAC CCA CTC CAG CCC TTT TCC TGG
AGC CTG GCG GAC CCA AGA CAT GTA ATA GTC ACT GAA GGT -3'
#G3 5'- GGT GGT AGC ATC TCT TAT CCA GAC ACT GTG AAG GGC AGA TTC ACC ATC TCC AGA GAT AAT
GCC AAG AAC TCC CTG TAC CTG CAA ATG AAC AGC CTG AGA GTT -3'
#G4 5'- GAC CAG GGT ACC TTG GCC CCA GTA GTC AAA ATA ATC ACG TCG TAA TCT CCC CTG TCT
CGC ACA GTA ATA CAG GGC CGT GTC CTC AAC TCT CAG GCT GTT CAT -3'

48

VARIABLE REGION AMPLIFIERS

#A3 5'- GAG GTG CAG CTG GTG GAG TC -3'
#A4 5'- GAC CAG GGT ACC TTG GCC CC -3'

SIGNAL FRAGMENT

#S1 5'- CAT TCG CTT ACC AGA TCT AAG CTT ACT AGT GAG ATC ACA GTT CTC TCT AC -3'
#G5 5'- CTC CAC CAG CTG CAC CTC GGA GTG GAC ACC TGT GGA GAG -3'

FRAMEWORK 4/INTRON FRAGMENT

#G6 5'- GGC CAA GGT ACC CTG GTC ACA GTC TCC ACA GGT GAG TCC -3'
#12 5'- GAA TGT GCC TAC TTT CTA GAG GAT CCT ATA AAT CTC TG -3'

FIG. 15A

EP 0 438 312 A2

"JON"/1B4

#J1 5'- GAT GTG CAG CTG GTG GAG TCT GGG GGA GGA CTG GTC AAG CCT GGG GGG TCT CTG AGA
CTC TCC TGT GCA GCC TCT GGA TTC ACC TTC AGT GAC TAT TAC -3'
#J2 5'- ATA AGA GAT GCT ACC ACC ATC ATT ATC AAT GGC CAC AAC CCA CTC CAG CCC TTT TCC TGG
AGC CTG GCG GAC CCA AGA CAT GTA ATA GTC ACT GAA GGT -3'
#J3 5'- GGT GGT AGC ATC TCT TAT CCA GAC ACT GTG AAG GGC AGA TTC ACC ATC TCC AGA AAC GAT
TCA AAG AAC ACG CRG TAC CTG CAA ATG ATC AGC GTG ACC CCC -3'
#J4 5'- GAC AGG GGT ACC TTG GCC CCA GTA GTC AAA ATA ATC ACG TCG TAA TCT CCC CTG TCT
CGC ACA GTA ATA CAC GGC CGT GTC CTC GGG GGT CAC GCT GAT CAT -3'

VARIABLE REGION AMPLIFIERS

#A5 5'- GAT GTG CAG CTG GTG GAG TC -3'
#A6 5'- GAC AGG GGT ACC TTG GCC CC -3'

SIGNAL FRAGMENT

#S1 5'- CAT TCG CTT ACC AGA TCT AAG CTT ACT AGT GAG ATC ACA GTT CTC TCT AC -3'
#J5 5'- CTC CAC CAG CTG CAC ATC GGA GTG GAC ACC TGT GGA GAG -3'

FRAMEWORK 4/INTRON FRAGMENT

#J6 5'- GGC CAA GGT ACC CCT GTC ACA GTC TCC TCA GGT GAG TCC -3'
#I2 5'- GAA TGT GCC TAC TTT CTA GAG GAT CCT ATA AAT CTC TG -3'

PCR RECOMBINATION AMPLIFIERS USED FOR BOTH CONSTRUCTIONS

#A1 5'- CAT TCG CTT ACC AGA TCT -3'
#A2 5'- GAA TGT GCC TAC TTT CTA G -3'

FIG. 15B

EP 0 438 312 A2

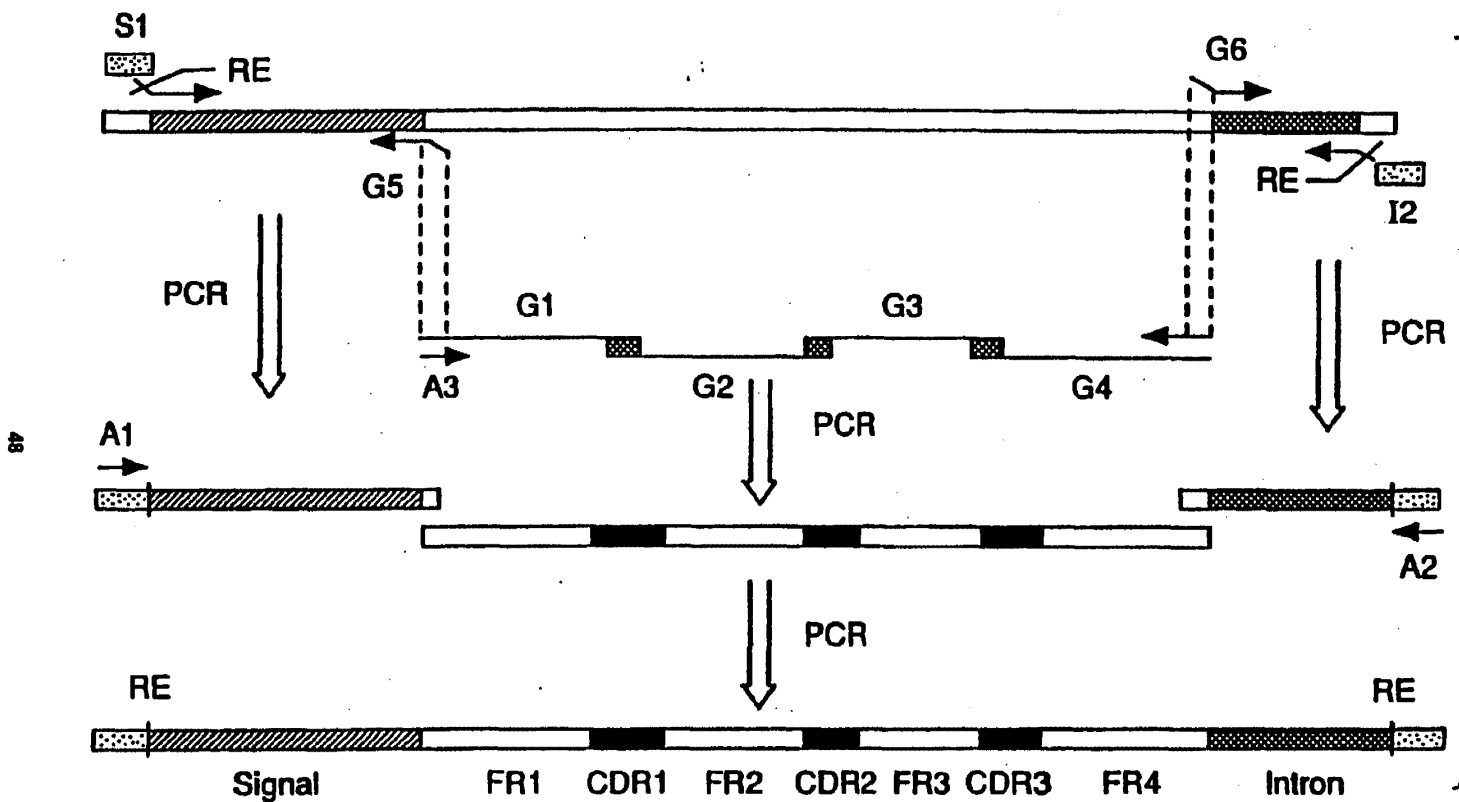

FIG. 16

EP 0 438 312 A2

								27									54
GAG	GTG	AAG	CTG	GTG	GAG	TCA	GGG	GGA	GAC	TTA	GTG	AAG	CTT	GGA	GGG	TCC	CTG
Glu	Val	Lys	Leu	Val	Glu	Ser	Gly	Gly	Asp	Leu	Val	Lys	Leu	Gly	Gly	Ser	Leu
								81									108
AAA	CTC	TCC	TGT	GCA	GCC	TCT	GGA	TTC	ACT	TTC	AGT	GAC	TAT	TAC	ATG	TCT	TGG
Lys	Leu	Ser	Cys	Ala	Ala	Ser	Gly	Phe	Thr	Phe	Ser	Asp	Tyr	Tyr	MET	Ser	Trp
								135									162
GTT	CGC	CAG	ACT	CCA	GAG	AAG	AGG	CTG	GAG	TTG	GTC	GCA	GCC	ATT	GAT	AAT	GAT
Val	Arg	Gln	Thr	Pro	Glu	Lys	Arg	Leu	Glu	Leu	Val	Ala	Ala	Ile	Asp	Asn	Asp
								189									216
GGT	GGT	AGC	ATC	TCT	TAT	CCA	GAC	ACT	GTG	AAG	GGC	CGA	TTC	ACC	ATC	TCC	AGA
Gly	Gly	Ser	Ile	Ser	Tyr	Pro	Asp	Thr	Val	Lys	Gly	Arg	Phe	Thr	Ile	Ser	Arg
								243									270
GAC	AAT	GCC	AAG	AAC	ACC	CTG	TAC	CTA	CAA	ATG	AGC	AGT	CTG	AGG	TCT	GAG	GAC
Asp	Asn	Ala	Lys	Asn	Thr	Leu	Tyr	Leu	Gln	MET	Ser	Ser	Leu	Arg	Ser	Glu	Asp
								297									324
ACA	GCC	TTG	TAT	TAC	TGT	GCT	AGA	CAG	GGG	AGA	TTA	CGA	CGT	GAT	TAT	TTT	GAC
Thr	Ala	Leu	Tyr	Tyr	Cys	Ala	Arg	Gln	Gly	Arg	Leu	Arg	Arg	Asp	Tyr	Phe	Asp
								351									
TAC	TGG	GGC	CAA	GGC	ACC	ACT	CTC	ACA	GTC	TCC	TCA	GCC	AAA	ACA	A		
Tyr	Trp	Gly	Gln	Gly	Thr	Thr	Leu	Thr	Val	Ser	Ser	Ala	Lys	Thr			

FIG. 17

EP 0 438 312 A2

50

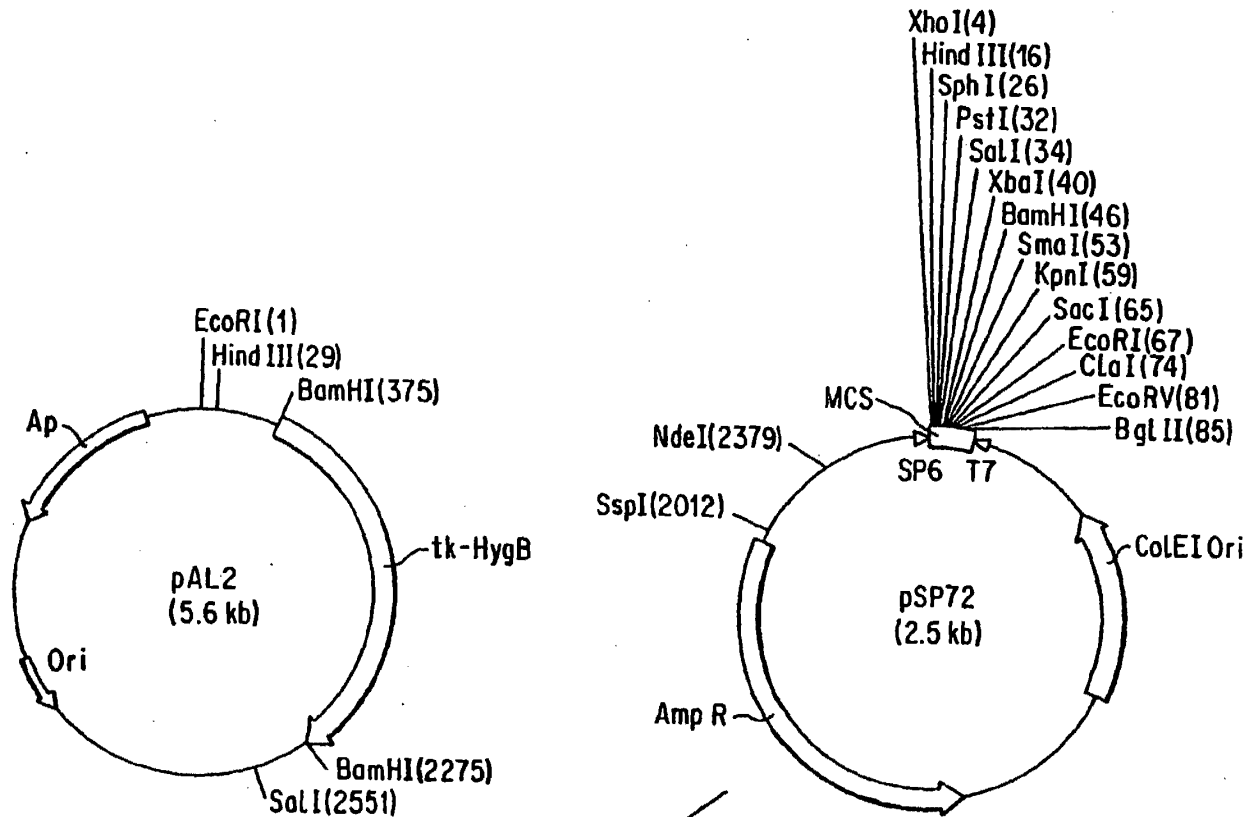
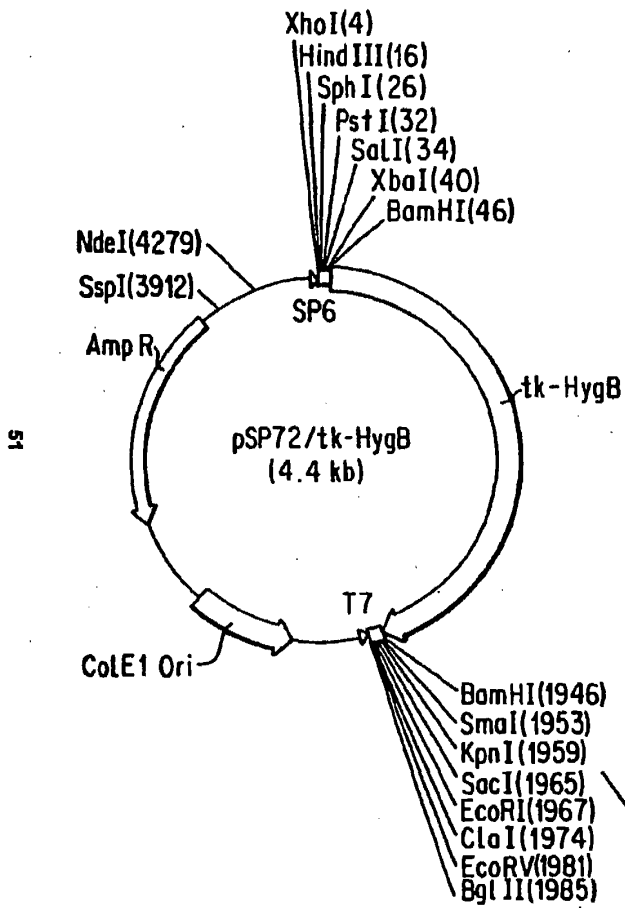

FIG. 18A

BamHI
(1.9kb tk-HygB)

BamHI (Cont. on FIG.18B)

EP 0 438 312 A2



(FROM FIG. 18A)

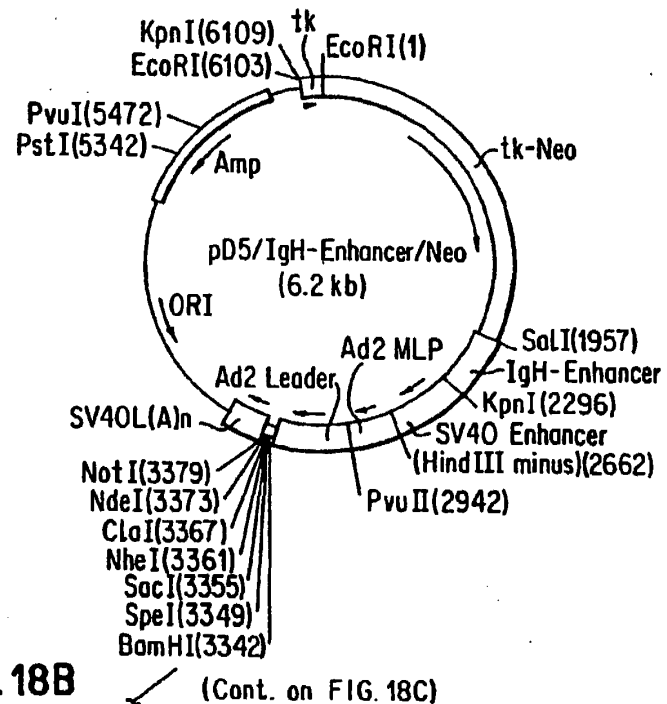

FIG. 18B

(Cont. on FIG. 18C)

EP 0 438 312 A2

(FROM FIG. 18B)

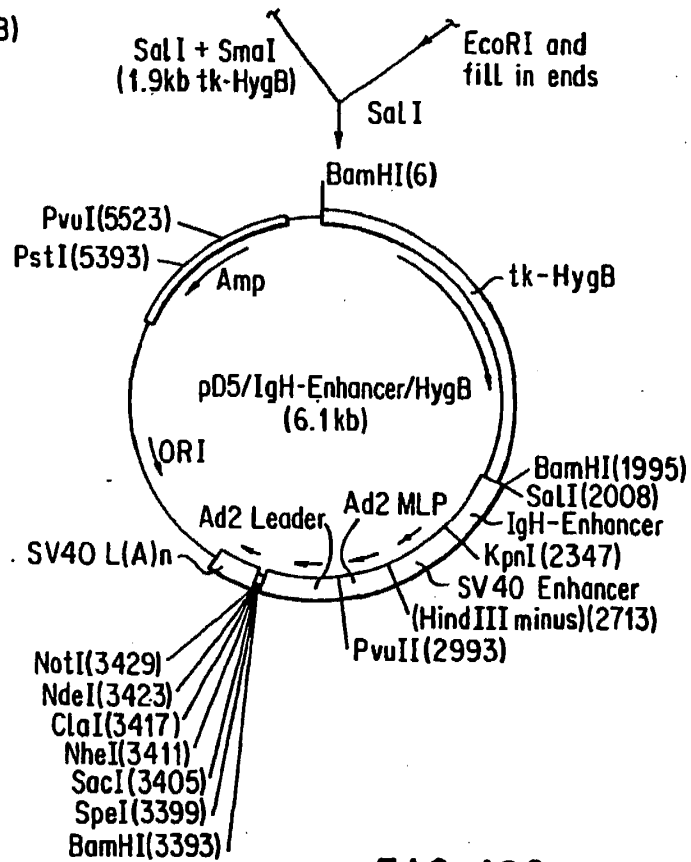
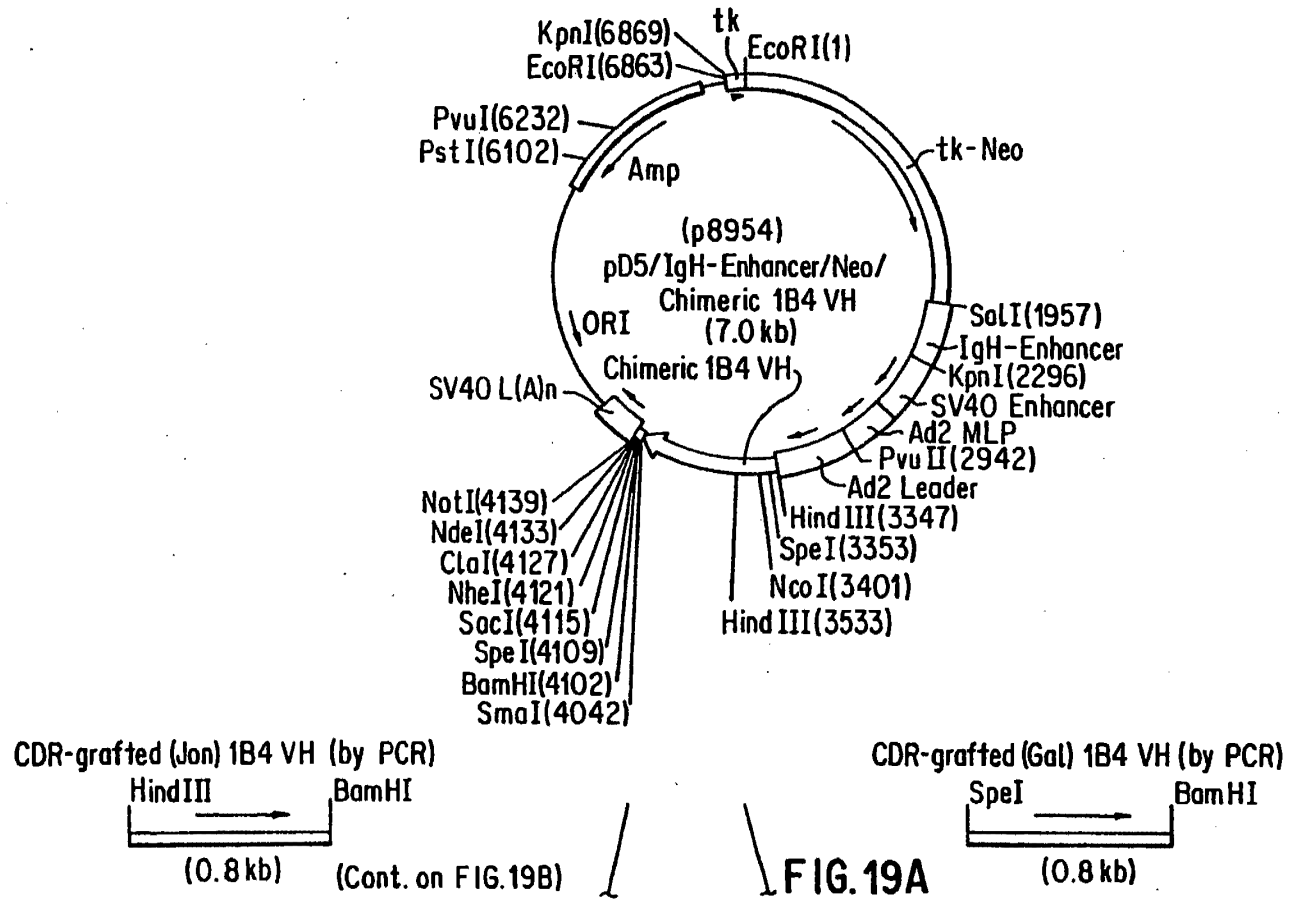

FIG. 18C

EP 0 438 312 A2



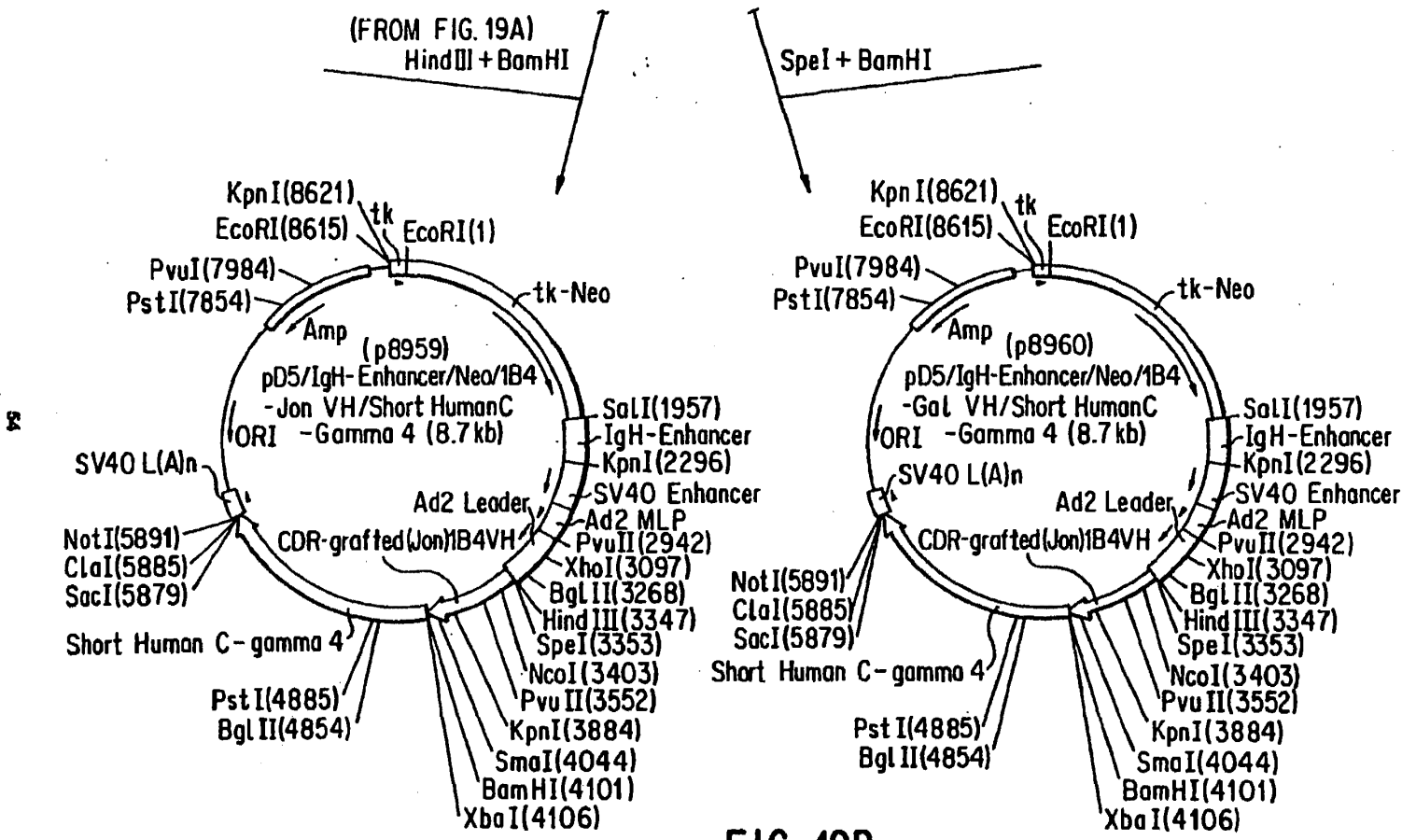

FIG. 19B

EP 0 438 312 A2

55

Summary of Competitive Binding Activities of mIB4 & hIB4 Framework Constructs				
<u>Construct</u>	<u>Mean IC₅₀ nM</u>	<u>S D</u>	<u>N</u>	<u>p (relative)</u>
mIB4	0.52	0.20	9	<0.0005(Gal*)
Gal/Rei	1.68	0.26	19	<0.0005(New)
Gal/Len	2.80	1.04	2	<0.0005(Gal*)
Jon/Rei	5.88	0.13	3	<0.0005(Gal*)
New/Rei	7.99	0.73	3	=0.008(Jon)
mut Gal/Rei	0.67	0.08	4	>0.20(mIB4)
Demichimera	0.46	0.08	3	>0.61(mIB4)
*Gal = Gal/Rei hIB4 construct				

EP 0 438 312 A2

FIG. 20

"LEN"/1B4

- # L 1 5'- GAC ATC GTG ATG ACC CAG TCT CCA AAT TCC CTG GCT GTC TCT CTT GGA
GAG AGA GCC ACC ATC AAC TGC AGA GCC AGT GAA AGT GTT GAT -3'
- # L 2 5'- ACG ATA GAT CAG GAG CTT AGG AGG CTG CCC TGG TTT CTG CTG ATA CCA GTG CAT
AAA AGA ATT GCC ATA ACT ATC AAC ACT TTC ACT GGC -3'
- # L 3 5'- AAG CTC CTG ATC TAT CGT GCA TCC AAC CTA GAA TCT GGG GTC CCA GAC AGG TTC
AGC GGC AGT GGA TCT GGG ACA GAT TTC ACT CTC ACC -3'
- # L 4 5'- CGT GAG AGG ATC CTC ATT ACT TTG CTG ACA GTA ATA AAC TGC AAC ATC TTC AGC
CTG CAG GCT GCT GAT GGT GAG AGT GAA ATC TGT -3'
- # L 5 5'- TAA TGA GGA TCC TCT CAC GTT CCG CCA AGG GAC CAA GCT GGA GAT CAA ACG TGA
GTA GAA TTT AAA CTT TGC TTC CTC AGT TAA GCT TTC TAG A -3'

VARIABLE REGION AMPLIFIERS

- # A 5 5'- GAC ATC GTG ATG ACC CAG TC -3'
- # A 6 5'- TGC CTA CTT TCT AGA AAG CTT AAC TGA GG -3'

SIGNAL FRAGMENT

- # S 2 5'- AGA TCT ACT AGT AAG CTT GAG ATC ACA GTT CTC TCT AC -3'
- # L 6 5'- CTG GGT CAT CAC GAT GTC GGA GTG GAC ACC TGT GGA GAG -3'

PCR RECOMBINATION AMPLIFIERS

- # A 7 5'- AGA TCT ACT AGT AAG CTT GAC -3'
Bgl II Spe I Hind III
- # A 8 5'- TGC CTA CTT TCT AGA AAG CTT -3'
Xba I Hind III

FIG. 21

EP 0 438 312 A2

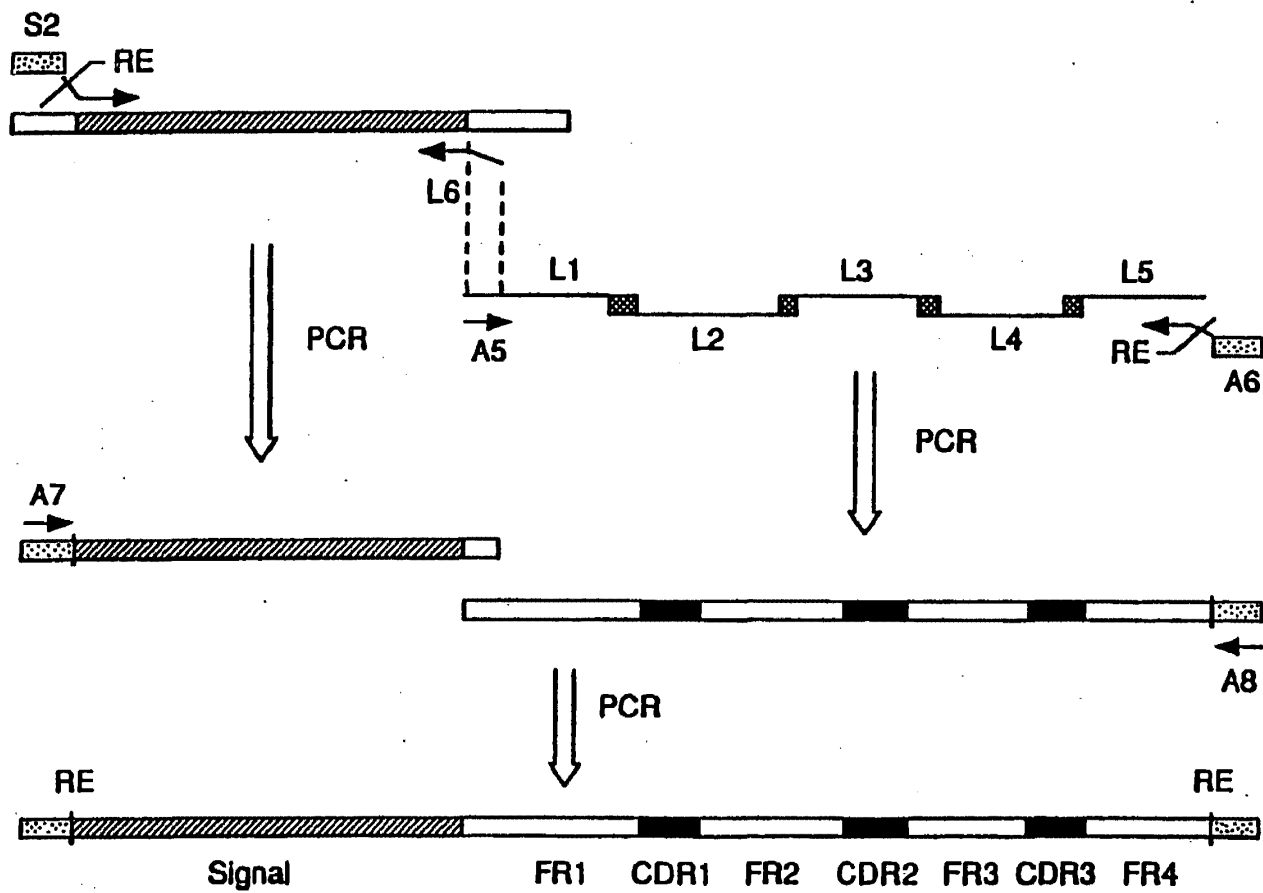

57

EP 0 438 312 A2

FIG. 22

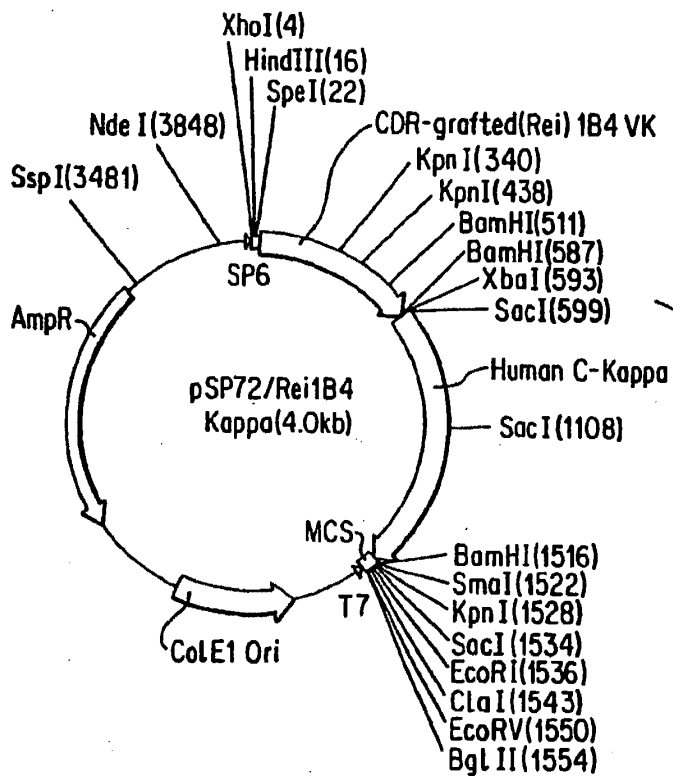
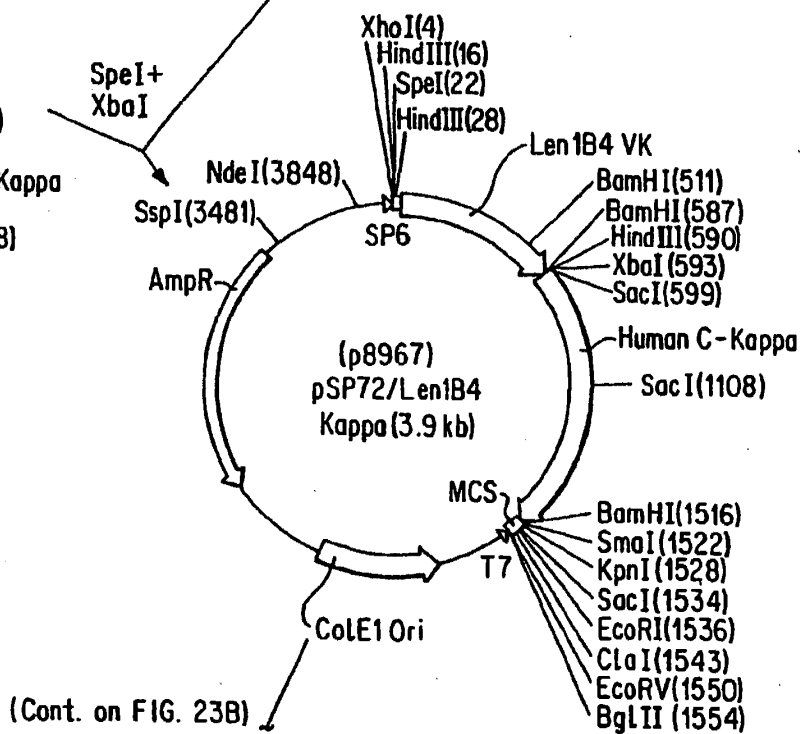
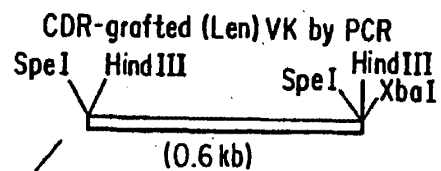

FIG. 23A



(Cont. on FIG. 23B)

58

EP 0 438 312 A2

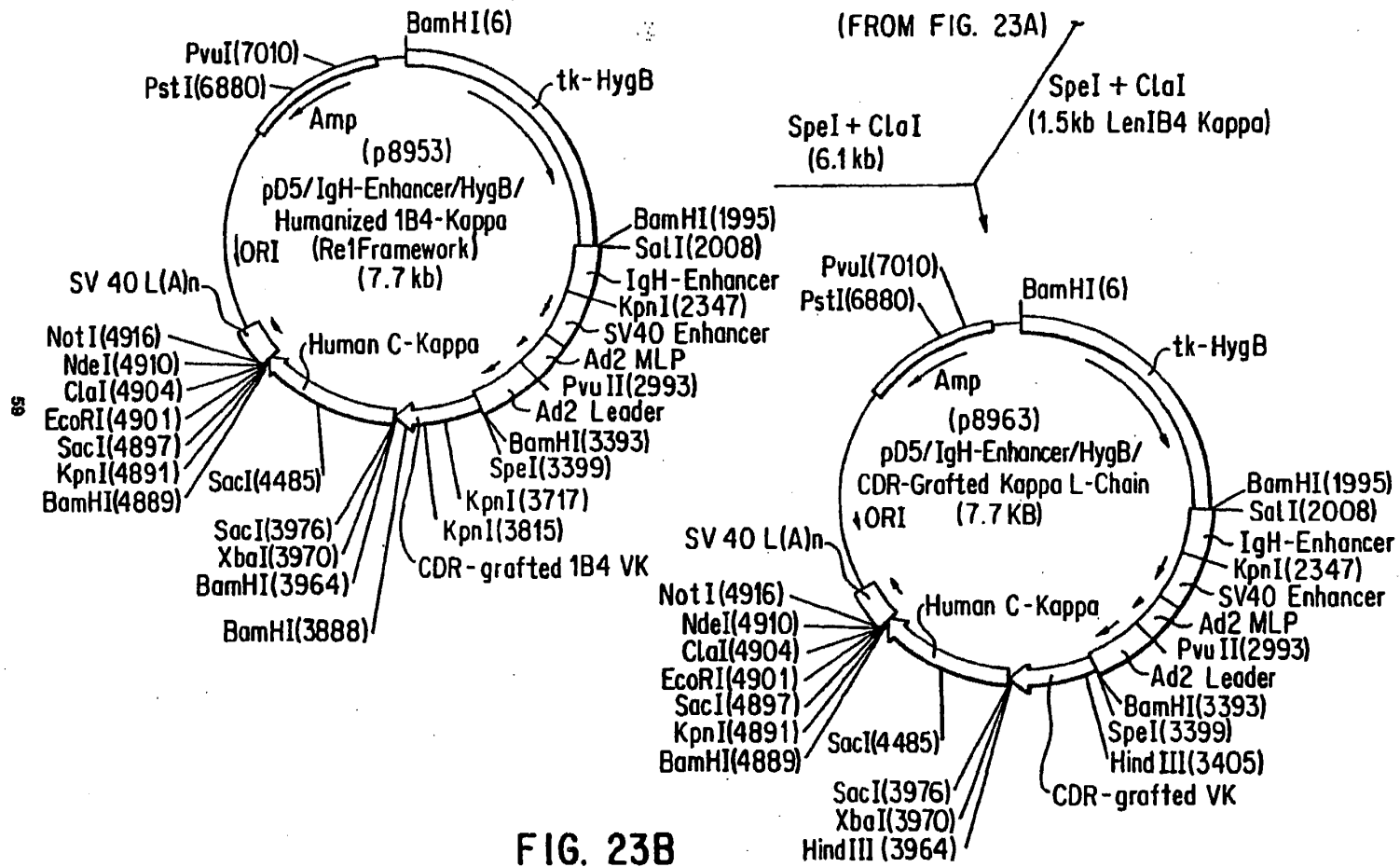

EP 0 438 312 A2

								27										54
GAC	ATT	GTG	ATG	ACC	CAG	TCT	CCT	GCT	TCC	TTA	GCT	GTA	TCT	CTG	GGG	CAG	AGG	
Asp	Ile	Val	MET	Thr	Gln	Ser	Pro	Ala	Ser	Leu	Ala	Val	Ser	Leu	Gly	Gln	Arg	
								81										108
GCC	ACC	ATC	TCA	TAC	AGG	GCC	AGC	AAA	AGT	GTC	AGT	ACA	TCT	GGC	TAT	AGT	TAT	
Ala	Thr	Ile	Ser	Tyr	Arg	Ala	Ser	Lys	Ser	Val	Ser	Thr	Ser	Gly	Tyr	Ser	Tyr	
								135										162
ATG	CAC	TGG	AAC	CAA	CAG	AAA	CCA	GGA	CAG	CCA	CCC	AGA	CTC	CTC	ATC	TAT	CTT	
MET	His	Trp	Asn	Gln	Gln	Lys	Pro	Gly	Gln	Pro	Pro	Arg	Leu	Leu	Ile	Tyr	Leu	
								189										216
GTA	TCC	AAC	CTA	GAA	TCT	GGG	GTC	CCT	GCC	AGG	TTC	AGT	GGC	AGT	GGG	TCT	AGG	
Val	Ser	Asn	Leu	Glu	Ser	Gly	Val	Pro	Ala	Arg	Phe	Ser	Gly	Ser	Gly	Ser	Arg	
								243										270
ACA	GAC	TTC	ACC	CTC	AAC	ATC	CAT	CCT	GTG	GAG	GAG	GAG	GAT	GCT	GCA	ACC	TAT	
Thr	Asp	Phe	Thr	Leu	Asn	Ile	His	Pro	Val	Glu	Glu	Glu	Asp	Ala	Ala	Thr	Tyr	
								297										324
TAC	TGT	CAG	CAC	ATT	AGG	GAG	CTT	ACA	CGT	TCG	GAG	GGG	GGA	CCA	AGC	TGG	AAA	
Tyr	Cys	Gln	His	Ile	Arg	Glu	Leu	Thr	Arg	Ser	Glu	Gly	Gly	Pro	Ser	Trp	Lys	
TAA	AAC	GGG	CT															
	Asn	Gly																

82

EP 0 438 312 A2

FIG. 24

27 54
 GAT ATT GTG CTG ACC CAG TCT CCA GCT TCT TTG GCT GTG TCT CTA GGG CAG AGG
 Asp Ile Val Leu Thr Gln Ser Pro Ala Ser Leu Ala Val Ser Leu Gly Gln Arg

81 108
 GCC ACC ATA TCC TGC AGA GCC AGT GAA AGT GTT GAT AGT TAT GGC AAT TCT TTT
 Ala Thr Ile Ser Cys Arg Ala Ser Glu Ser Val Asp Ser Tyr Gly Asn Ser Phe

135 162
 ATG CAC TGG TAC CAG CAG AAA CCA GGA CAG CCA CCC AAG CTC CTC ATC TAT CGT
 MET His Trp Tyr Gln Gln Lys Pro Gly Gln Pro Pro Lys Leu Leu Ile Tyr Arg

189 216
 GCA TCC AAC CTA GAA TCT GGG ATC CCT GCC AGG TTC AGT GGC AGT GGG TCT AGG
 Ala Ser Asn Leu Glu Ser Gly Ile Pro Ala Arg Phe Ser Gly Ser Gly Ser Arg

243 270
 ACA GAC TTC ACC CTC ACC ATT AAT CCT GTG GAG GCT GAT GAT GTT GCA ACC TAT
 Thr Asp Phe Thr Leu Thr Ile Asn Pro Val Glu Ala Asp Asp Val Ala Thr Tyr

297 324
 TAC TGT CAG CAA AGT AAT GAG GAT CCT CTC ACG TTC GGT GCT GGG ACC AAG CTG
 Tyr Cys Gln Gln Ser Asn Glu Asp Pro Leu Thr Phe Gly Ala Gly Thr Lys Leu

GAG CTG AAA CGG
 Glu Leu Lys Arg

FIG. 25

EP 0 438 312 A2

#S1 5'- CAT TCG CTT ACC AGA TCT AAG CTT ACT AGT GAG ATC AC -3'
Bgl II Hind III Spe I

#G7 5'- AGA TCT CCC CCA GAC TCA ACC AGC TG -3'

#G8 5'- TGA GTC TGG GGG AGA TCT TGT TCA GCC TGG AGG GTC TCT G -3'

#G9 5'- ATC AAT GGC TGC AAG CAG CTC CAG CCC TTT TCC -3'

#G10 5'- CTG GTT GCA GCC ATT GAT AAT -3'

#G11 5'- GGA GAC TGT CAG CAG GGT ACC TTG GCC CCA -3'

#G12 5'- ACC CTG CTG ACA GTC TCC ACA GGT GAG -3'

#I2 5'- GAA TGT GCC TAC TTT CTA GA G GAT CCT ATA AAT CTC TGG CCA TG -3'
Xba I Bam H1

PCR RECOMBINATION AMPLIFIERS

#A3 5'- CAT TCG CTT ACC AGA TCT -3'

#A4 5'- GAA TGT GCC TAC TTT CTA G -3'

FIG. 26

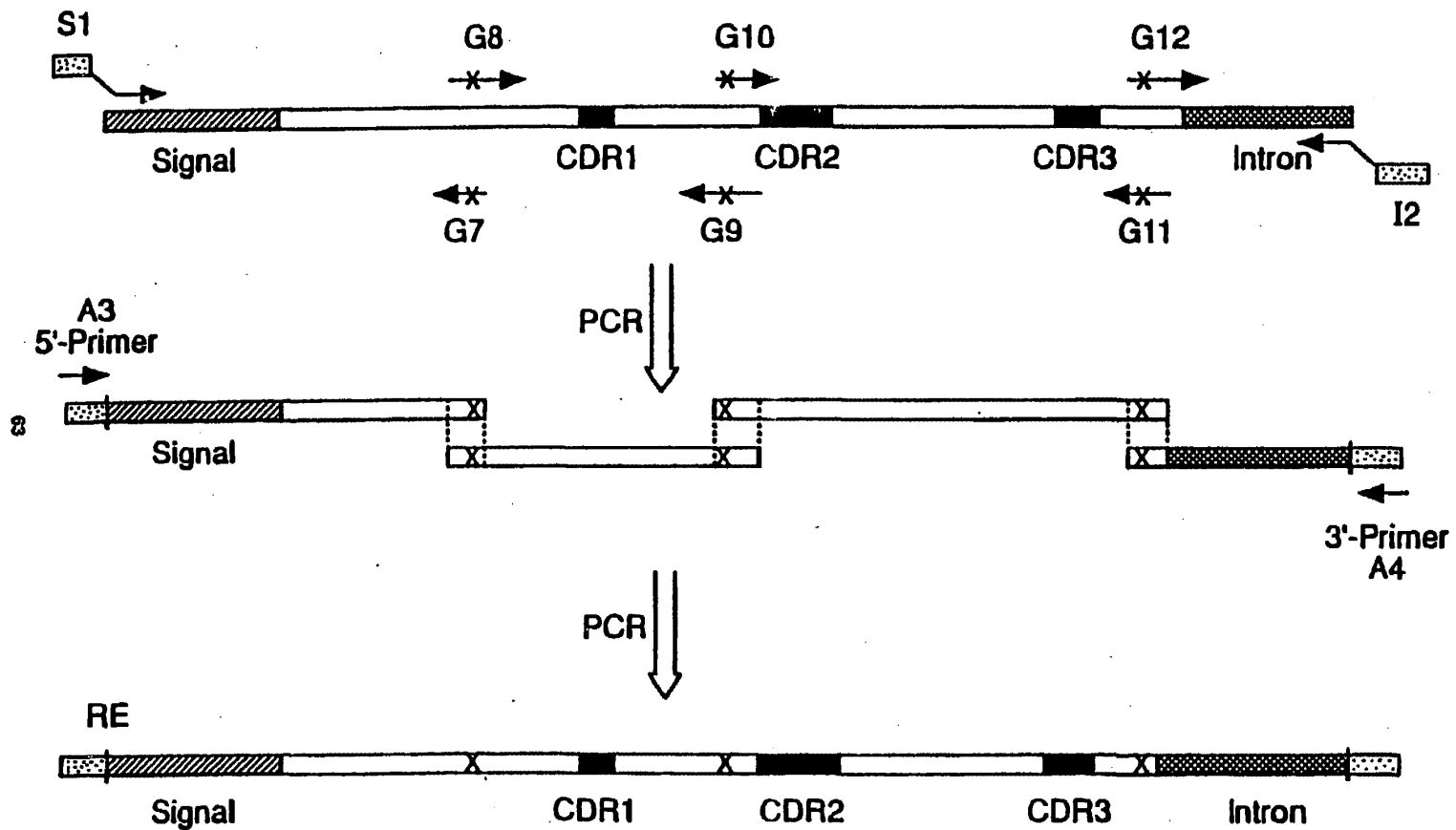
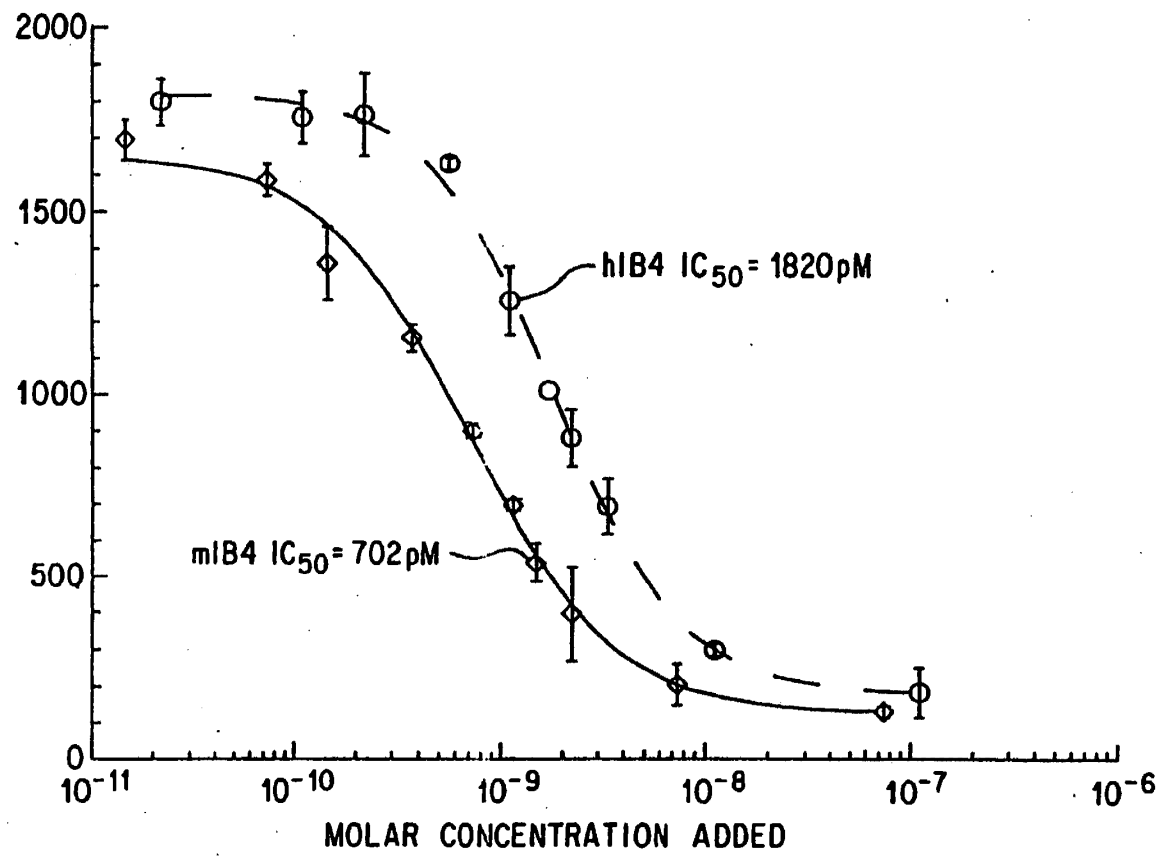

FIG. 27

EP 0 438 312 A2

24

MEAN CPM BOUND/
1 X 10⁵ PMNs (n=3)



EP 0 438 312 A2

FIG. 28

65

MEAN CPM BOUND/
 1×10^5 PMNs (n=2)

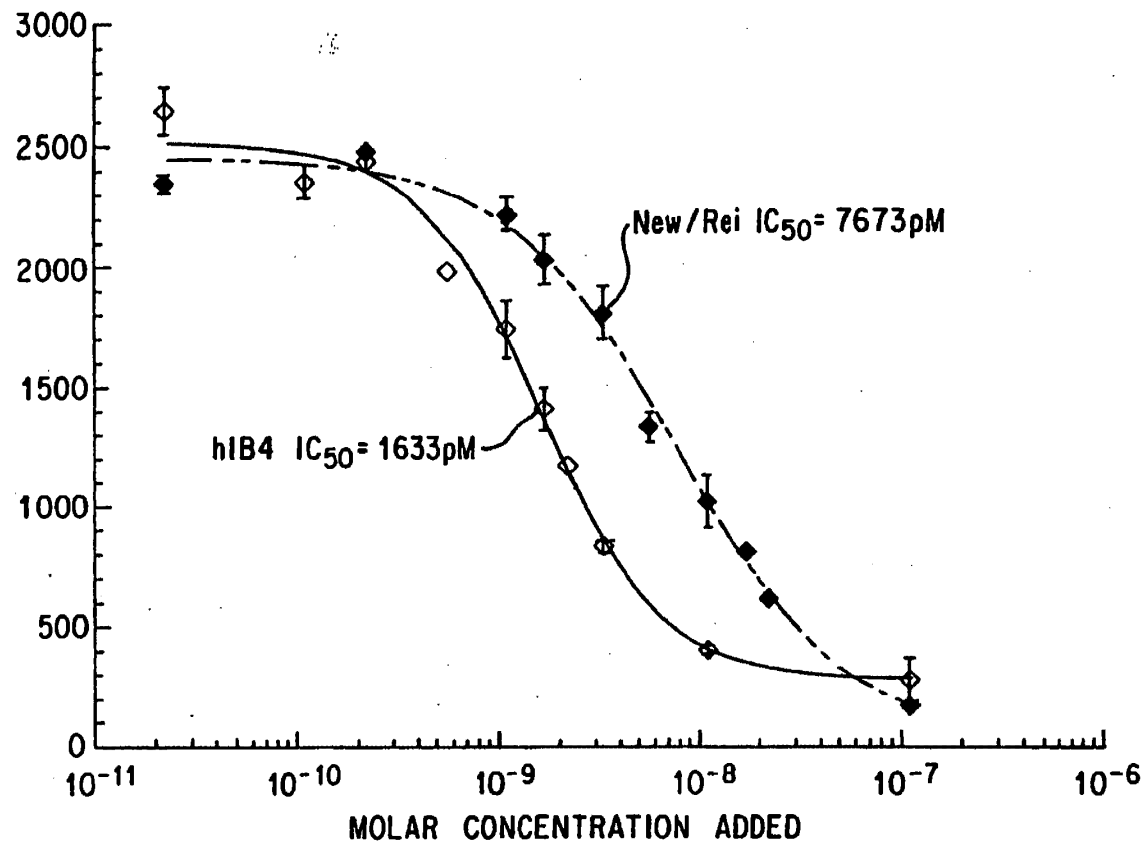

EP 0 438 312 A2

FIG. 29

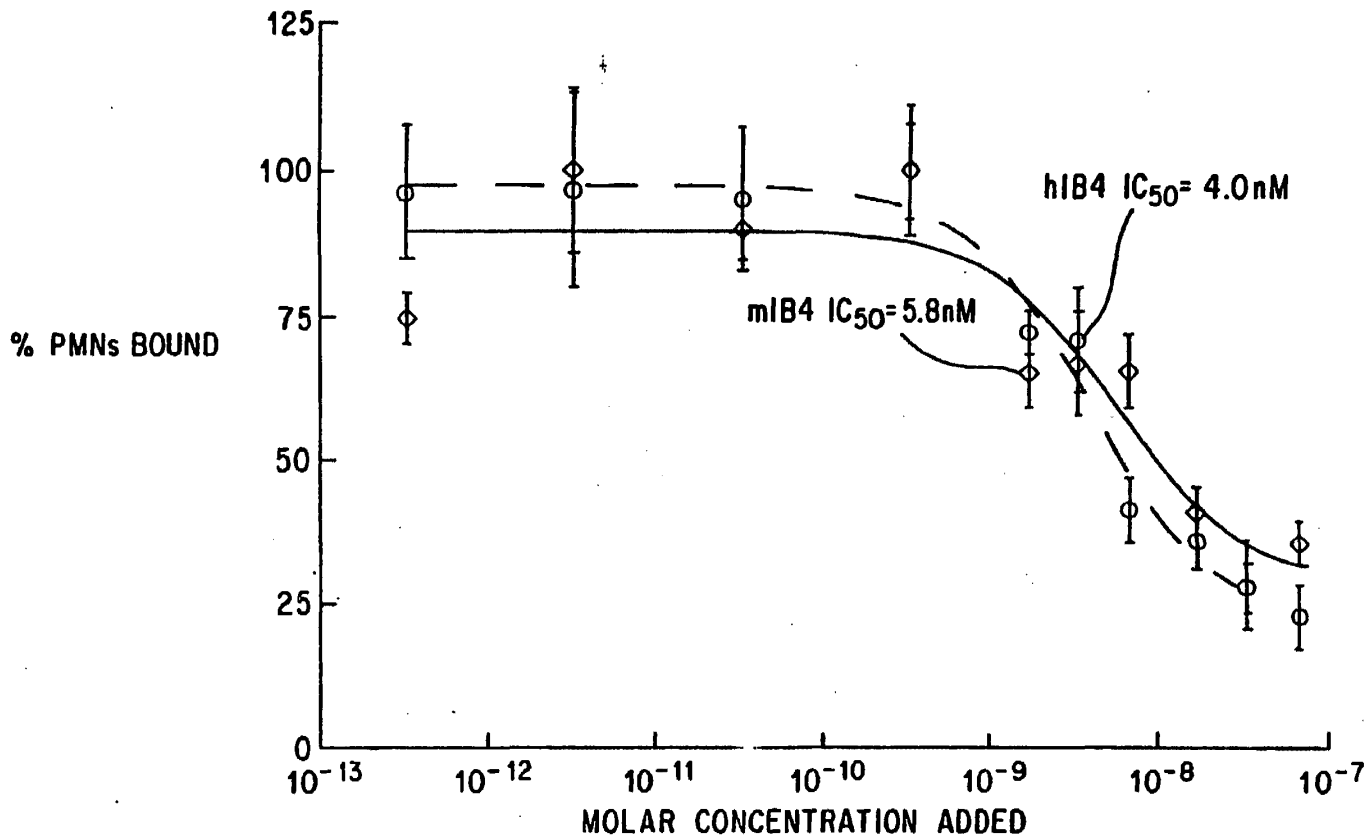

FIG. 30

87

COMPARISON OF Gal/Rel hIB4 AND mIB4 IN IN VITRO FUNCTIONAL ASSAYS					
IC50 (nM)					
	<u>hIB4</u>	<u>n</u>	<u>mIB4</u>	<u>n</u>	<u>P</u>
HUVEC	8.2	9	4.6	9	>.1
CTL	2.0	4	2.0	4	>.5

EP 0 438 312 A2

FIG. 31

IMMUNOFLUORESCENCE MICROSCOPIC LOCALIZATION OF m1B4 AND
Gal/Re1 h1B4 STAINING IN 5 μ m FROZEN SECTIONS OF RABBIT
TISSUES.*

<u>TISSUE</u>	<u>m1B4 STAINING</u>	<u>Gal/Re1 h1B4 STAINING</u>
BONE MARROW	++++	++++
CEREBRUM	0	0
KIDNEY	+ (LEUKOCYTES ONLY)	+ (LEUKOCYTES ONLY)
LARGE INTESTINE	0	0
LIVER	0	0
LUNGS	++ (LEUKOCYTES ONLY)	++ (LEUKOCYTES ONLY)
LYMPH NODES	++	++
MYOCARDIUM	0	0
STOMACH	0	0
STRIATED MUSCLE (LEG)	0	0
SPLEEN	+++	+++

*CONSECUTIVE TISSUE SECTIONS WERE STAINED INDIVIDUALLY WITH m1B4 OR h1B4.
TWO DOUBLE-BLINDED EXPERIMENTS WERE PERFORMED BY DIFFERENT INVESTIGATORS.
THE DEGREE OF LABELING WAS SCORED AS 0 (NEGATIVE), + (SPARSE), ++ (MODERATE),
+++ (INTENSE), AND ++++ (MARKEDLY INTENSE).

FIG. 32

EP 0 438 312 A2

**DOUBLE LABEL IMMUNOFLOURESCENCE MICROSCOPIC
LOCALIZATION OF Gal/Rei HUMANIZED AND MURINE
IB4 IN RABBIT BONE MARROW CELLS***

<u>Primary Antibodies Applied</u>	<u>Gal/Rei hIB4</u>	<u>mIB4</u>
Gal/Rei hIB4 + mIB4	+++	+++
hlgG4 + mIB4	0	+++
Gal/Rei hIB4 + buffer	+++	0
mIB4 + buffer	0	+++
hlgG4 + buffer	0	0

* 5 um frozen sections of rabbit bone marrow were stained with mixtures of Gal/Rei hIB4 and native murine IB4 or controls (hlgG4, buffer). +++ = moderate staining; 0 = negative.

FIG. 33

EP 0 438 312 A2

70

DOUBLE LABEL IMMUNOELECTRON MICROSCOPIC LOCALIZATION OF Gal/Rei HUMANIZED AND MURINE IB4 IN SPECIFIC GRANULES OF HUMAN PMNs*		
<u>PRIMARY ANTIBODIES APPLIED</u>	<u>RELATIVE STAINING INTENSITY</u>	
	<u>Gal/Rei hIB4</u>	<u>mIB4</u>
Gal/Rei hIB4 + mIB4	+ + + +	+ + + +
hlgG4 + mIB4	0	+ + + +
Gal/Rei hIB4 + buffer	+ + + +	0

* 80 nm ultrathin frozen sections of human PMNs were double stained with Gal/Rei hIB4 and native murine IB4 or controls (hlgG4, buffer). + + + + = Intense staining; 0 = negative.

EP 0 438 312 A2

FIG. 34

71

PMN x 10⁵ / 6 mm BIOPSY

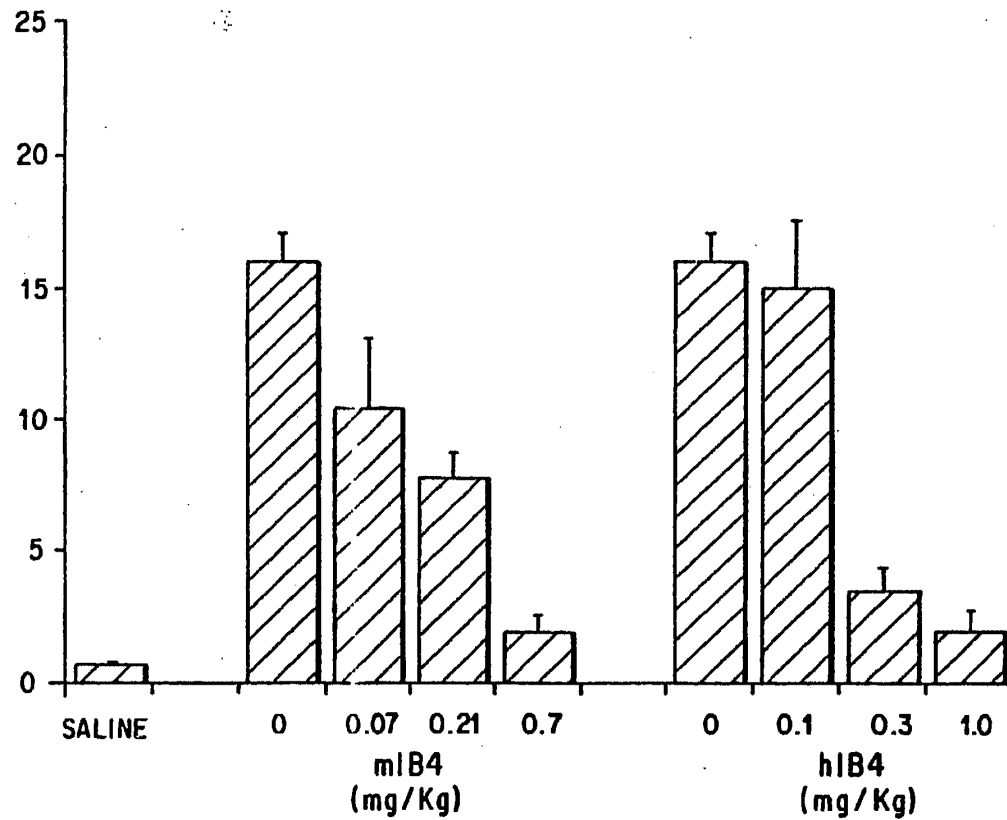

EP 0 438 312 A2

FIG. 35

72

μ l PLASMA / 6mm BIOPSY

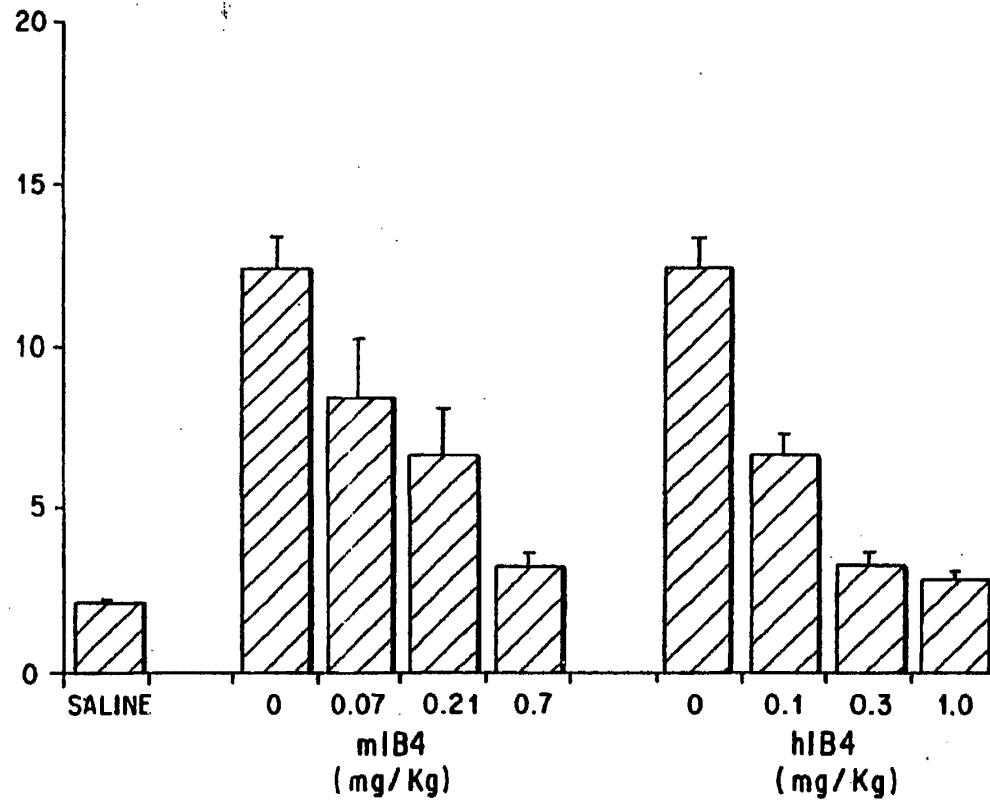

FIG. 36

EP 0 438 312 A2

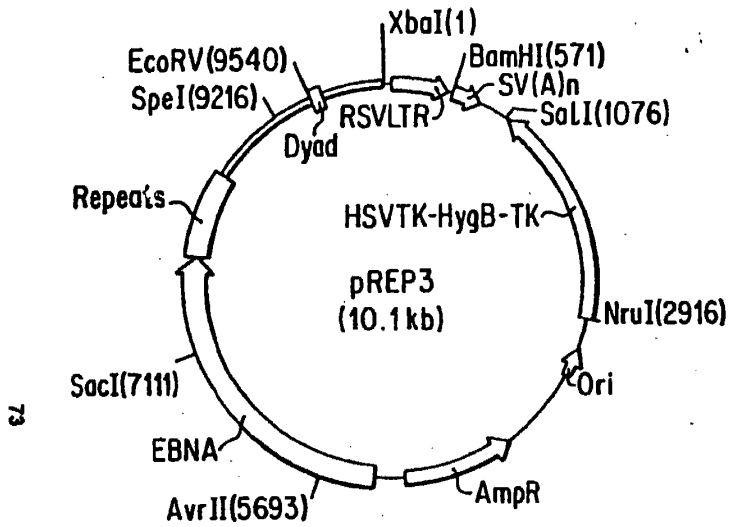
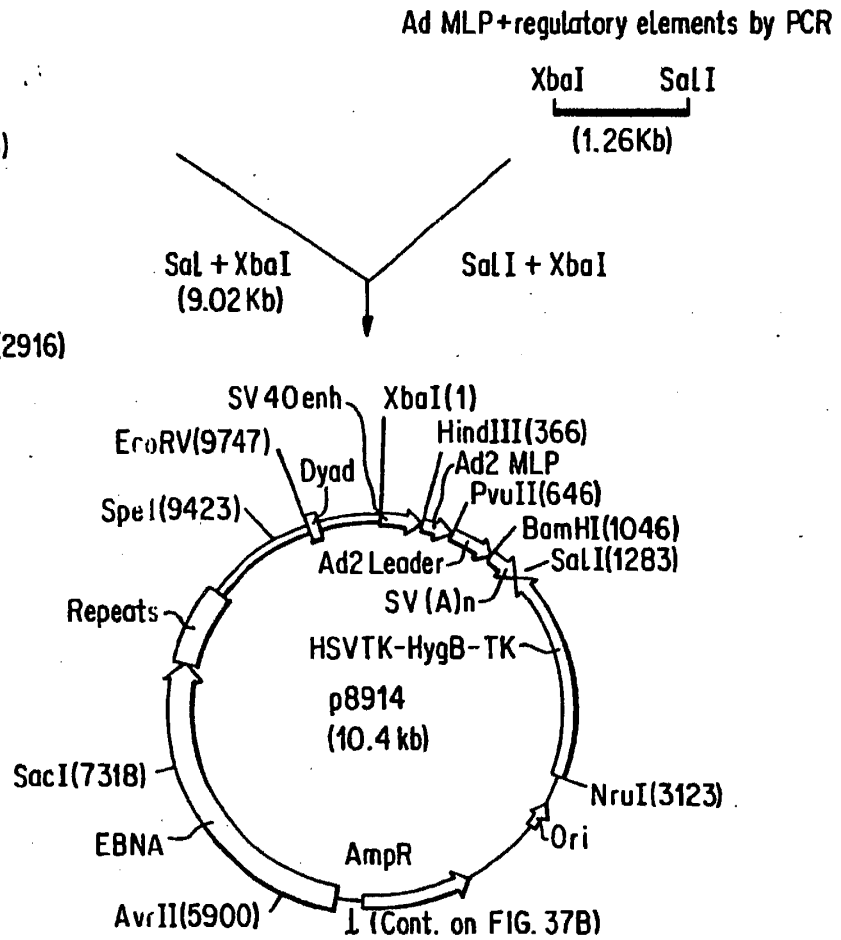
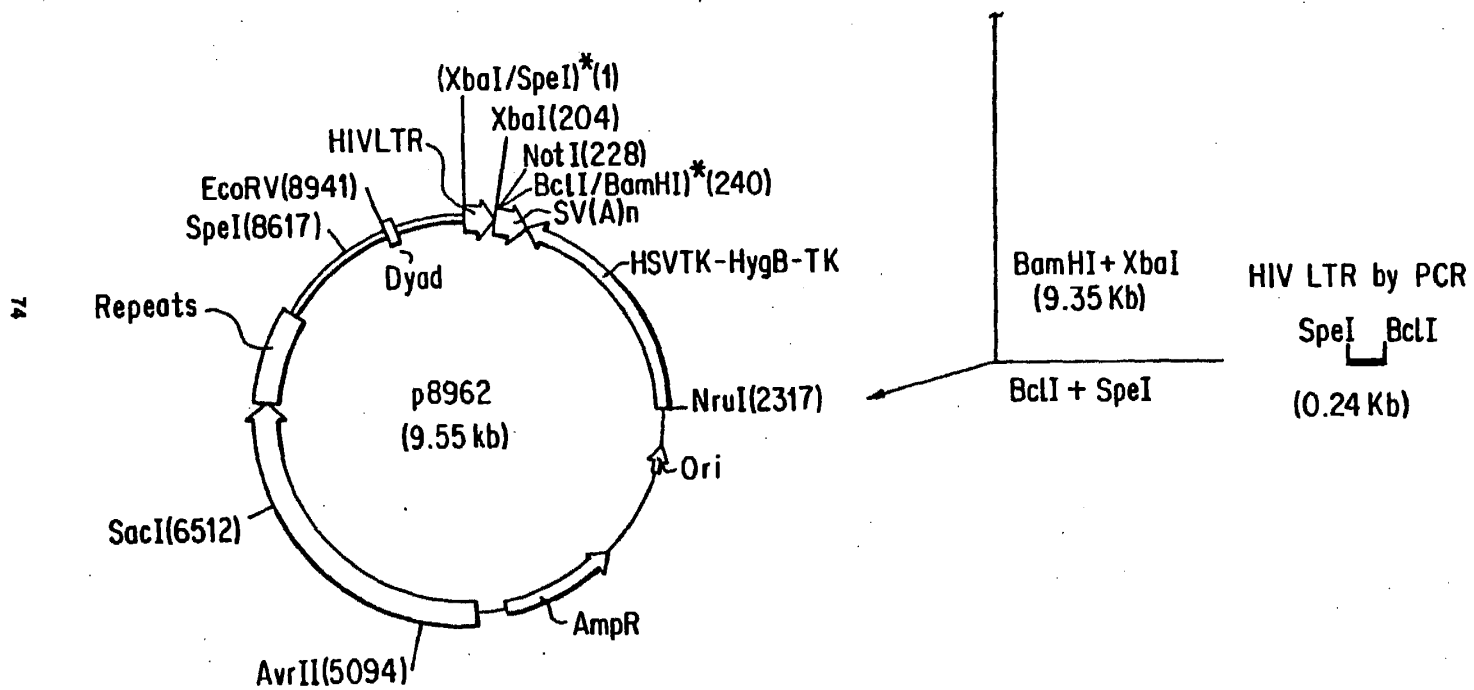

FIG. 37A



EP 0 438 312 A2

(FROM FIG. 37A)



EP 0 438 312 A2

FIG. 37B

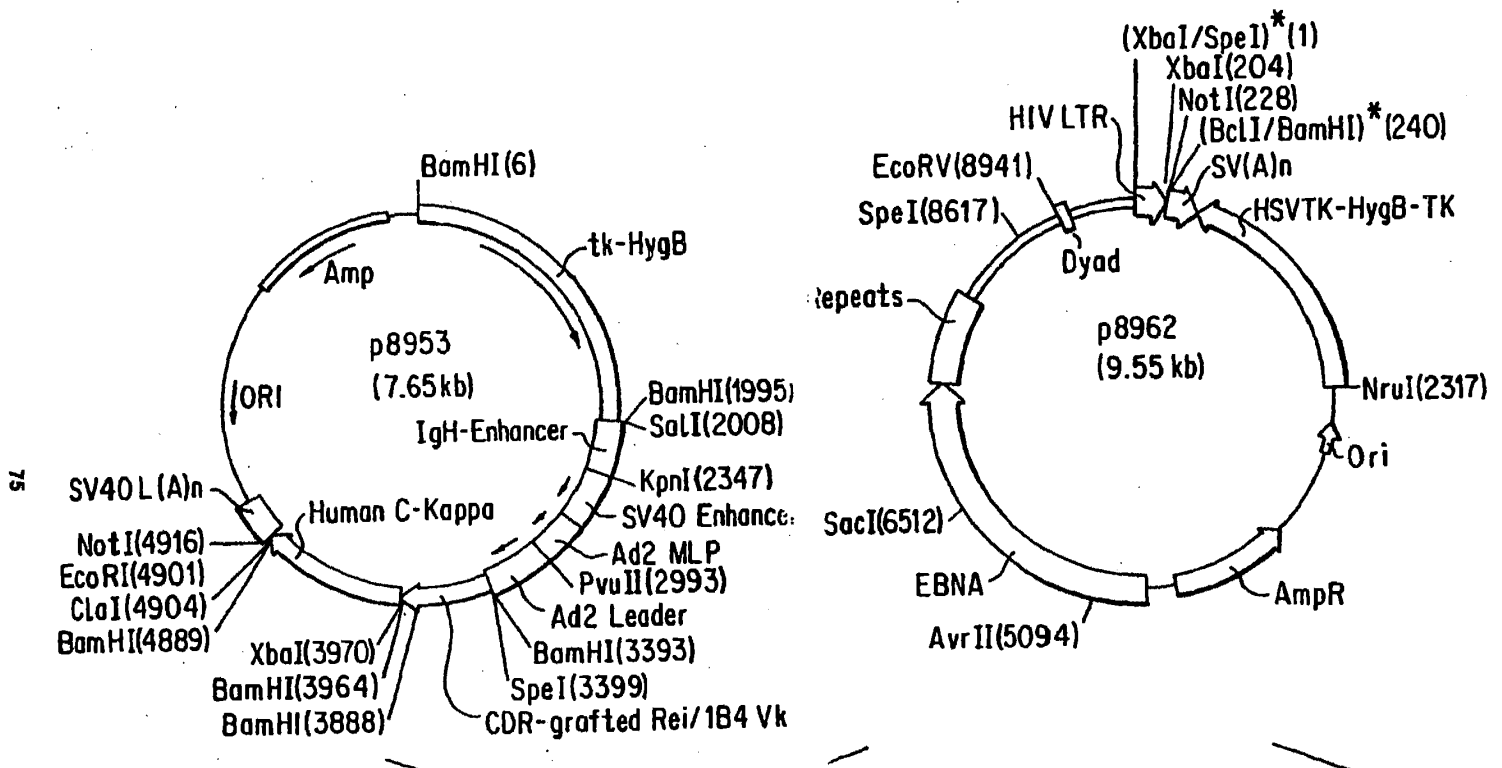

NotI+SpeI
(1.5 Kb Rei/1B4)

NotI+XbaI
(9.5 Kb)

NotI + XbaI
(9.5 Kb)
(Cont. on FIG. 38B)

(Cont. on FIG. 38C)

FIG. 38A

EP 0 438 312 A2

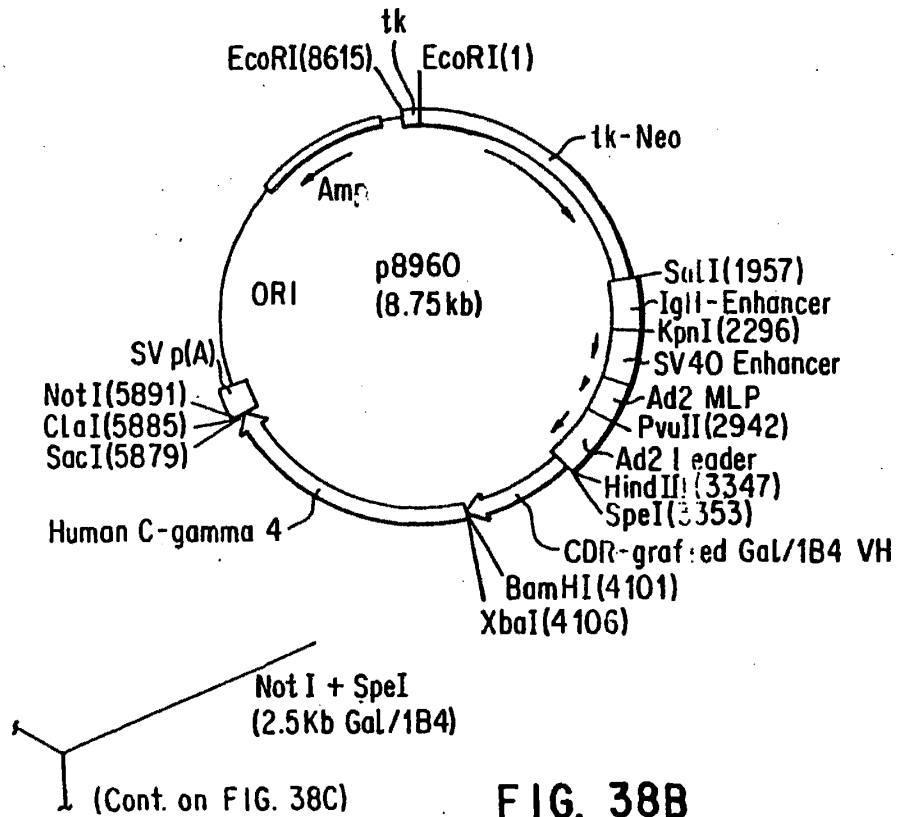

FIG. 38B

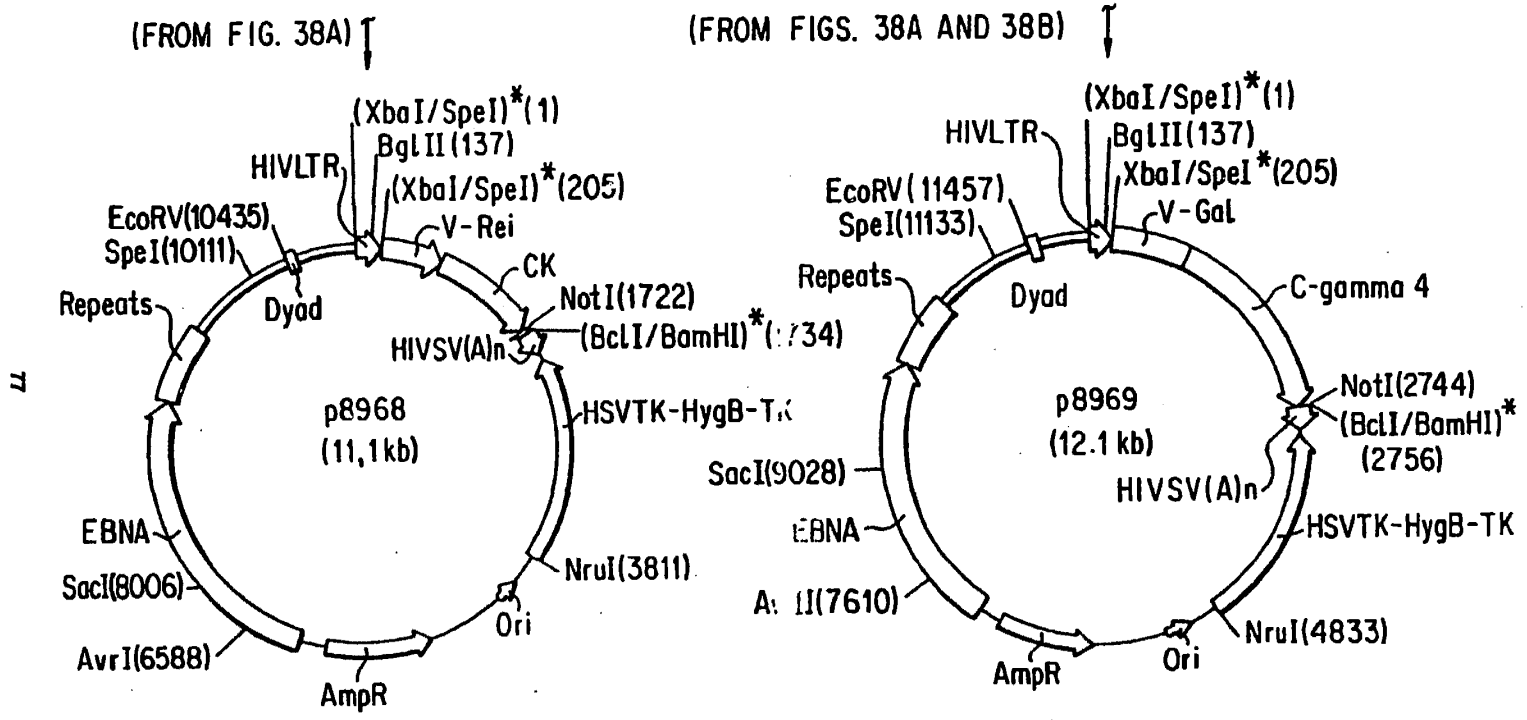

FIG. 38C



EUROPEAN PATENT APPLICATION

Application number: **91300367.9**

Int. Cl.⁵: **C12N 15/13, C12N 5/10, C12P 21/08, A61K 39/395**

Date of filing: **17.01.91**

Priority: **19.01.90 US 467692**
20.12.90 US 627421

Date of publication of application: **24.07.91 Bulletin 91/30**

Designated Contracting States: **CH DE FR GB IT LI NL**

Date of deferred publication of search report: **01.07.92 Bulletin 92/27**

Applicant: **MERCK & CO. INC.**
126, East Lincoln Avenue P.O. Box 2000
Rahway New Jersey 07065-0900 (US)

Inventor: **Law, Ming-Fan**
12344 Picrus Street
San Diego, California 92129 (US)
Inventor: **Mark, George E. III**
4 Richmond Court
Princeton Junction, NJ 08550 (US)
Inventor: **Schmidt, John A.**
19 Fairway Drive
Green Brook, NJ 08812 (US)
Inventor: **Singer, Irwin I.**
18 Lakeridge Drive
Matawan, NJ 07747 (US)

Representative: **Thompson, John Dr. et al**
Merck & Co., Inc. European Patent
Department Terlings Park Eastwick Road
Harlow, Essex CM20 2QR (GB)

Recombinant human anti-CD18 antibodies.

Recombinant immunoglobulin specifically reactive with the CD18 integrin or antigen of leukocytes and methods for the production of the immunoglobulin are disclosed. DNA constructs containing the complementarity determining regions (CDRs) of a murine antibody are recombinantly combined with the chosen frameworks of variable regions of both heavy and light chains of a human antibody. The constructs are transfected into eucaryotic host cells capable of expressing the recombinant immunoglobulin sequence.

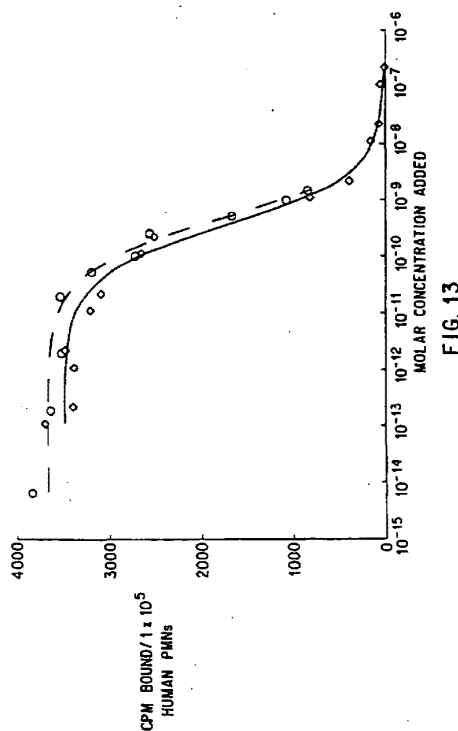

EP 0 438 312 A3

European Patent
Office

EUROPEAN SEARCH REPORT

Application Number

EP 91 30 0367
Page 1

DOCUMENTS CONSIDERED TO BE RELEVANT			
Category	Citation of document with indication, where appropriate, of relevant passages	Relevant to claim	CLASSIFICATION OF THE APPLICATION (Int. Cl.5)
Y, D	PROCEEDINGS OF THE NATIONAL ACADEMY OF SCIENCES OF USA, vol. 80, September 1983, WASHINGTON US pages 5699 - 5703; S. O. WRIGHT ET AL.: 'Identification of the C3b1 receptor of human monocytes and macrophages by using monoclonal antibodies' * page 5699, column 2, paragraph 2 * * page 5702, column 2 * ---	1-13	C12N15/13 C12N5/10 C12P21/08 A61K39/395
Y, D	PROCEEDINGS OF THE NATIONAL ACADEMY OF SCIENCES OF USA, vol. 86, no. 10, May 1989, WASHINGTON US pages 3833 - 3837; R. ORLANDINI ET AL.: 'Cloning immunoglobulin variable domains for expression by the polymerase chain reaction' * the whole document * ---	1-13	
A, D	NATURE, vol. 332, 24 March 1988, LONDON GB pages 323 - 327; L. RIECHMANN ET AL.: 'Reshaping human antibodies for therapy' * page 325, column 2 - page 326, column 1, line 40 * ---	1-13	TECHNICAL FIELDS SEARCHED (Int. Cl.5) C07K C12N C12P A61K
A	EP-A-0 314 863 (BAYLOR COLLEGE OF MEDICINE) 10 May 1989 * page 2, last paragraph * ---	11	
E	EP-A-0 440 351 (MERCK & CO. INC.) 7 August 1991 * the whole document * ---	1-13	
E	EP-A-0 438 310 (MERCK & CO. INC.) 24 July 1991 * the whole document * ---	1-13	
-/-			
The present search report has been drawn up for all claims			
Place of search THE HAGUE		Date of completion of the search 02 APRIL 1992	Examiner CUPIDO M.
CATEGORY OF CITED DOCUMENTS X : particularly relevant if taken alone Y : particularly relevant if combined with another document of the same category A : technological background O : non-written disclosure F : intermediate document T : theory or principle underlying the invention E : earlier patent document, but published on, or after the filing date D : document cited in the application I : document cited for other reasons & : member of the same patent family, corresponding document			

EPO FORM 1501 CLASS (P0001)



European Patent
Office

EUROPEAN SEARCH REPORT

Application Number

EP 91 30 0367
Page 2

DOCUMENTS CONSIDERED TO BE RELEVANT			
Category	Citation of document with indication, where appropriate, of relevant passages	Relevant to claim	CLASSIFICATION OF THE APPLICATION (Int. CL.5)
T	<p>NUCLEIC ACIDS RESEARCH. vol. 19, no. 9, 11 May 1991, EYNHAM, OXFORD GB pages 2471 - 2476; B. L. DAUGHERTY ET AL.: 'Polymerase chain reaction facilitates the cloning, CDR-grafting, and rapid expression of a murine monoclonal antibody directed against the CD18 component of leukocyte integrins' * the whole document *</p> <p style="text-align: center;">-----</p>	I-13	
			TECHNICAL FIELDS SEARCHED (Int. CL.5)
The present search report has been drawn up for all claims			
Place of search THE HAGUE		Date of completion of the search 02 APRIL 1992	Examiner CUPIDO M.
<p>CATEGORY OF CITED DOCUMENTS</p> <p>X : particularly relevant if taken alone Y : particularly relevant if combined with another document of the same category A : technological background O : non-written disclosure P : intermediate document</p>		<p>T : theory or principle underlying the invention E : earlier patent document, but published on, or after the filing date D : document cited in the application L : document cited for other reasons A : number of the same patent family, corresponding document</p>	

EPO FORM 1503 (04.92) (P0401)



Publication number : **0 440 351 A2**

EUROPEAN PATENT APPLICATION

Application number : **91300369.5**

Int. Cl.⁵ : **C12N 15/13, C12N 5/10,
C12P 21/08, A61K 39/395**

Date of filing : **17.01.91**

Priority : **19.01.90 US 467692
20.12.90 US 627422**

Date of publication of application :
07.08.91 Bulletin 91/32

Designated Contracting States :
AT BE CH DE DK ES FR GB GR IT LI LU NL SE

Applicant : **MERCK & CO. INC.
128, East Lincoln Avenue P.O. Box 2000
Rahway New Jersey 07065-0900 (US)**

Inventor : **Law, Ming-Fan
12344 Picrus Street
San Diego, California 92129 (US)**
Inventor : **Mark III, George E.
4 Richmond Court
Princeton Junction, NJ 08550 (US)**
Inventor : **Schmidt, John A.
19 Fairway Drive
Green Brook, NJ 08812 (US)**
Inventor : **Singer, Irwin I.,
18 Lakeridge Drive
Matawan, NJ 07747 (US)**

Representative : **Thompson, John Dr. et al
Merck & Co., Inc. European Patent
Department Terlings Park Eastwick Road
Harlow, Essex CM20 2QR (GB)**

Recombinant human anti-CD18 antibodies.

Recombinant immunoglobulin specifically reactive with the CD18 integrin or antigen of leukocytes and methods for the production of the immunoglobulin are disclosed. DNA constructs containing the complementarity determining regions (CDRs) of a murine antibody are recombinantly combined with the chosen frameworks of variable regions of both heavy and light chains of a human antibody. The constructs are transfected into eucaryotic host cells capable of expressing the recombinant immunoglobulin sequence.

EP 0 440 351 A2

Fig. 13

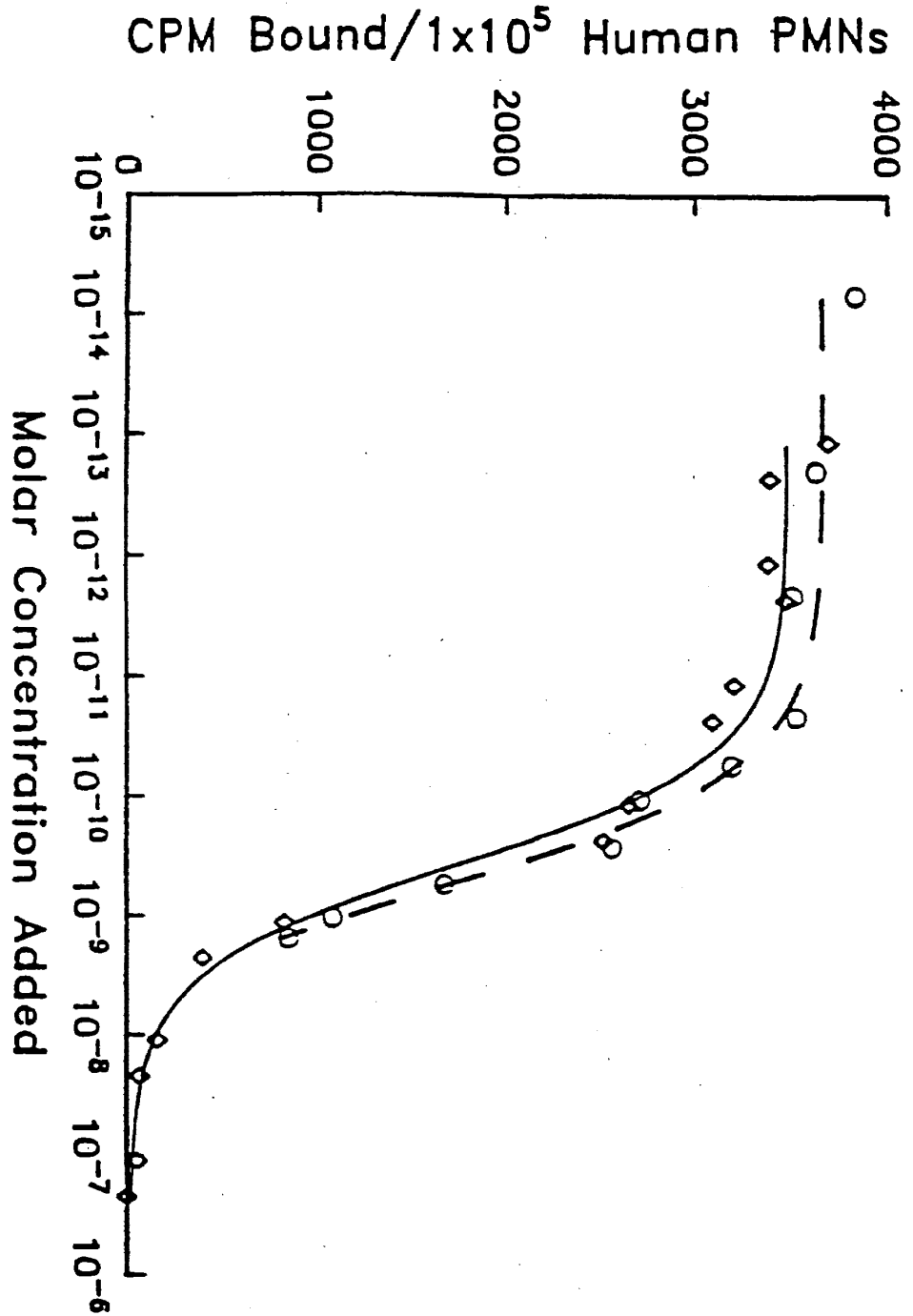

RECOMBINANT HUMAN ANTI-CD18 ANTIBODIES

BRIEF DESCRIPTION OF THE DRAWINGS

Figure 1. Primers used to isolate DNA encoding murine kappa light chain variable region and murine IgG2a heavy chain variable region using PCR.

Figure 2. Diagram of antibody structure and PCR products of murine heavy and light chain.

Figure 3. 1B4 amino acid sequence for heavy chain variable region and light chain variable regions 1 and 2 deduced from the nucleic acid sequence of the cloned cDNAs.

Figure 4. Oligodeoxynucleotides used as primers for PCR mutagenesis and amplification of the Rei light chain variable region template so as to graft the CDRs of 1B4 into the Rei light chain variable region.

Figure 5. PCR recombination strategy used in the CDR-grafting of the Rei/1B4 light chain variable region.

Figure 6. Outline of the insertion of light chain variable and constant regions into the light chain expression vector.

Figure 7. Oligodeoxynucleotides used as PCR primers to generate a shortened IgG4 heavy chain. Oligodeoxynucleotide primers used in PCR to re-engineer the thymidine kinase (TK) promoter to facilitate the expression of the neomycin resistance gene. Oligodeoxynucleotide primers used in PCR to clone the IgH enhancer sequence. Oligodeoxynucleotides used as PCR primers to generate a human kappa light chain constant region.

Figure 8. PCR recombination strategy used in the fusing of human signal and intronic sequence to the 1B4 heavy chain variable region.

Figure 9. Oligodeoxynucleotides used as primers for PCR recombination to fuse human signal and intronic sequences onto the 1B4 heavy chain variable region.

Figure 10. Outline of the construction of the neomycin selectable expression vector.

Figure 11. Outline of the insertion of the "chimaeric" 1B4 heavy chain variable region and the shortened human IgG4 heavy chain constant region into the heavy chain expression vector.

Figure 12. Levels of transient expression as determined by trapping ELISA, of the 1B4 chimaeric heavy chain : grafted Rei/1B4 light chain recombinant antibody in CV1, COS 7 and 293 cells.

Figure 13. Competitive binding assay of recombinant "chimaeric"/REI 1B4 (circles) and native murine 1B4 MAb (diamonds) for CD18 on activated human PMNs.

Figure 14. Amino acid sequence composition of the human heavy and light chain variable regions from which framework regions were used to support the murine 1B4 CDRs.

Figure 15. Oligodeoxynucleotides used in the construction of Gal/1B4 heavy chain variable region and Jon/1B4 heavy chain variable region plus those necessary to fuse the human signal and intronic sequences onto these variable regions.

Figure 16. PCR-recombination strategy used in the CDR-grafting of the Gal/1B4 heavy chain and Jon/1B4 heavy chain variable regions.

Figure 17. DNA sequence and deduced amino acid sequence determined for murine 1B4 heavy chain variable region.

Figure 18. Outline of the construction of the hygromycin selectable expression vector.

Figure 19. Outline of the insertion of the Gal/1B4 heavy chain and the Jon/1B4 heavy chain variable regions into the heavy chain expression vector containing the shortened IgG4 heavy chain constant region.

Figure 20. Summary of the competitive binding activities of murine MAb 1B4 and recombinant human anti-CD18 antibody constructs.

Figure 21. Oligodeoxynucleotides used in the construction of Len/1B4 light chain variable region plus those necessary to fuse the human signal onto the Len light chain variable region.

Figure 22. PCR-recombination strategy used in the CDR-grafting of the Len/1B4 light chain variable region.

Figure 23. Outline of the insertion of the Len/1B4 light chain variable region into an intermediate vector followed by its insertion into the light chain expression vector.

Figure 24. DNA sequence and deduced amino acid sequence determined for murine 1B4 light chain-1 variable region.

Figure 25. DNA sequence and deduced amino acid sequence determined for murine 1B4 light chain-2 variable region.

Figure 26. Oligodeoxynucleotides used in the construction of Gal-m1/1B4 (mutant) heavy chain variable region plus those necessary to fuse the human signal onto the Gal-m1 heavy chain variable region.

Figure 27. PCR-recombination strategy used in the CDR-grafting of the Gal-m1/1B4 (mutant) heavy chain variable region.

Figure 28. Competitive binding assay of native murine 1B4 (diamonds) and Gal/Rei humanized 1B4 (circles).

Figure 29. Competitive binding assay of New/Rei recombinant h1B4 (closed diamonds) and Gal/Rei recombinant h1B4 (open diamonds).

Figure 30. Effects of native murine 1B4 (diamonds) and Gal/Rei recombinant humanized 1B4 (circles) on attachment of human PMNs to human

umbilical vein endothelial cell monolayers *in vitro*.

Figure 31. Comparison of Gal/Rei h1B4 and m1B4 in *in vitro* functional assays.

Figure 32. Immunofluorescence microscopic localization of m1B4 and Gal/Rei h1B4 staining in 5 μ m frozen sections of rabbit tissues.

Figure 33. Double label immunofluorescence microscopic localization of Gal/Rei h1B4 and m1B4 in rabbit bone marrow cells.

Figure 34. Double label immunoelectron microscopic localization of Gal/Rei h1B4 and m1B4 in specific granules of human PMNs.

Figure 35. Dose-dependent inhibition by m1B4 and Gal/Rei h1B4 of C5a (100 pmol)-induced PMN accumulation in rabbit skin.

Figure 36. Dose-dependent inhibition by m1B4 and Gal/Rei h1B4 of C5a (100 pmol)-induced plasma extravasation in rabbit skin.

Figure 37. Outline of the construction of expression system p8962 capable of producing large quantities of recombinant CDR-grafted 1B4 antibodies.

Figure 38. Outline of the construction of expression systems p8968 and p8969 capable of producing large quantities of recombinant CDR-grafted 1B4 antibodies.

BACKGROUND OF THE INVENTION

Murine derived monoclonal antibodies have been utilized as diagnostic and therapeutic agents for numerous human pathologic conditions including acute inflammatory responses associated with numerous diseases. Administration of murine derived monoclonal antibodies (mMAbs) as therapeutic agents in man has been severely limited by the development of antibody within the recipient to the mouse antigens of the murine derived monoclonal antibody. In attempts to circumvent this outcome mMAbs have been restructured by recombinant DNA technology in such a way as to decrease their immunogenicity in humans. Immunoglobulins are well defined both chemically and biologically with the general structures illustrated in *Molecular Cell Biology*, Damell, Lodish, and Baltimore, Eds., Scientific American Books, Inc., W.H. Freeman, New York, NY (1986). Initially, this involved the construction of chimaeric antibodies, Morrison *et al.*, *Proc. Natl. Acad. Sci. USA* **81** : 6851-6855 (1984). Recombinant technology was employed to replace the murine heavy and light chain constant regions with corresponding human constant regions. Upon expression, such interspecies antibody chimaeras yielded molecules with the antigen binding specificities of the parent murine antibody. The following references generally describe chimaeric antibody technology : Lobuglio *et al.*, *Proc. Natl. Acad. Sci. USA* **86** : 4220-4224 (1989) ; United States Patent 4,816,567 ; PCT International Publication No. WO 87/02671,

published May 7, 1987 ; European Patent Publication No. 255,694, published February 10, 1988 ; European Patent Publication No. 274,394, published July 13, 1988 ; European Patent Publication No. 323,806, published July 12, 1989 ; PCT International Publication No. WO/89/00999, published February 9, 1989 ; European Patent Publication No. 327,000, published August 9, 1989 ; European Patent Publication No. 328,404, published August 16, 1989 ; and European Patent Publication No. 332,424, published September 13, 1989.

The immunogenicity of chimaeric antibodies can be further reduced by grafting rodent hypervariable regions into the variable region frameworks of human light and heavy chains, Jones *et al.*, *Nature* **321** : 522-525 (1986). These hypervariable regions have also been termed complementarity determining regions (CDR). The technique involves the substitution or recombinant grafting of antigen-specific murine CDR sequences for those existent within "generic" human heavy and light chain variable regions, European Patent Publication No. 239,400, published September 30, 1987. In this approach, little, if any, concern is shown for the variable region frameworks (FRs) within which the murine CDRs are placed. The instant invention illustrates that appropriate supportive structures for the CDRs are vital not only for the assembly of the functional antibody molecules but also for the production of antibody molecules with avidities which allow for the administration of therapeutic doses (about 0.1-1mg/kg).

Recent studies by Queen *et al.*, *Proc. Natl. Acad. Sci. USA* **86** : 10029-10033 (1989), have shown the CDRs from a murine anti-Tac monoclonal antibody can be grafted into a human framework. The human framework variable regions were chosen to maximize identity with the murine sequence. The authors also utilized a computer model of the mMAb to identify several amino acids which, while outside the CDRs, are close enough to interact with the CDRs or antigen. These residues were mutated to the residue found in the murine sequence. The grafted anti-Tac antibody had an affinity for the antigen which was only about 1/3 that of the murine anti-tac mMAb and maintenance of the human character of this antibody was problematic.

Leukocyte infiltration into an inflammatory site is dependent on the adhesion of the leukocytes to the endothelium prior to extravasation. The rapid binding of polymorphonuclear leukocytes (PMN) to the endothelium and diapedesis occurs within minutes after the introduction of a chemotactic stimulus in tissue, Cybulski *et al.*, *Am. J. Pathol.* **124** : 367 (1986). This rapid extravasation appears to depend on the response of the PMNs to chemoattractants and on the presence of the CD11/CD18 family of glycoproteins on the leukocyte surface. The family of glycoproteins associated with PMNs are termed leukocyte integrins

and include LFA-1 (CD11a/CD18), Mac-1 (CD11b/CD18) and p150,95 (CD11c/CD18). Each of these heterodimers has a unique alpha chain (CD11 a, b, c) and an invariant beta-2 chain (CD18). Stimulation of PMNs with various chemotactic factors causes increased expression of leukocyte integrins (CD11b/CD18) fostering strong adhesion to unstimulated endothelium *in vitro*, Harlan, *Blood* 65 : 513 (1985), and essentially all of the chemoattractant-induced adhesion is inhibited by treating the PMNs with mAbs specifically reactive with the CD11/CD18 complex, Harlan *et al.*, *Blood* 66 : 167 (1985); Zimmerman and McIntyre *J. Clin. Invest.* 81 : 531 (1988); Smith *et al.*, *J. Clin. Invest.* 82 : 1746 (1988); and Lo *et al.*, *J. Exp. Med.* 169 : 1779 (1989). Polymorphonuclear leukocytes from patients with leukocyte adhesion deficiency (LAD) fail to express CD18 and fail to bind unstimulated endothelium *in vitro*, Harlan *et al.*, *Blood* 66 : 167 (1985); Lo *et al.*, *J. Exp. Med.* 169 : 1779 (1989).

Murine hybridomas producing monoclonal antibodies reactive with the beta chain common to the Mac-1, LFA-1 and the p150,95 integrins have been described. The mAbs are designated 1B4, 60.3, TS1/18, H52 and ATCC TIB 218. The 1B4 is an IgG2a antibody and was prepared by Wright *et al.*, *Proc. Natl. Acad. Sci. USA* 80 : 5699-5703 (1983), the 60.3 is also IgG2a and was prepared by Beatty *et al.*, *J. Immunol.* 131 : 2913-2918 (1983), TS1/18 is an IgG1 antibody and was prepared by Sanchez-Madrid *et al.*, *J. Exp. Med.* 158 : 1785-1803 (1983), H52, a MAb against beta 2 (CD18) was prepared by Hildreth and Orentas, *Science* 244 : 1075-1078 (1989) and ATCC TIB 218, a IgG2a kappa prepared by Springer *et al.*, *J. Exp. Med.* 158 : 586-602 (1983). These antibodies appear to be functionally equivalent and cross-react with the beta-2 chain found on human, sheep pig, rabbit, and dog leukocytes but not with the beta-2 chain found on murine and rat leukocytes.

SUMMARY OF THE INVENTION

Recombinant immunoglobulin specifically reactive with the CD18 integrin or antigen of leukocytes and methods for the production of the immunoglobulin are disclosed. DNA constructs containing the complementarity determining regions (CDRs) of a murine antibody are recombinantly combined with the frameworks of chosen variable regions of both heavy and light chains of a human antibody. The constructs are transfected into eukaryotic host cells capable of expressing the recombinant immunoglobulin sequences.

OBJECT OF THE INVENTION

It is accordingly, an object of the present invention to provide novel DNA sequences for the com-

plementarity determining regions of murine heavy and light chain monoclonal antibody. Another object of the invention is to provide novel DNA sequences for the complementarity determining regions of murine heavy and light chain monoclonal antibody that immunologically binds to the CD18 integrin or antigen of leukocytes. A further object is to provide novel DNA sequences for recombinant animal antibody. Another object is to provide a vector containing the DNA sequence for recombinant animal antibody. Another object is to provide a mammalian host transformed with a vector containing the DNA sequence for recombinant animal antibody. It is a further object that the animal recombinant antibody be human recombinant antibody. A further objective is to provide recombinant human immunoglobulin that binds to leukocyte integrin. Another object is to provide a process for making recombinant human immunoglobulin. A further object is to provide a process for producing recombinant immunoglobulins.

DETAILED DESCRIPTION OF THE INVENTION

The present invention relates to methods and means for the construction and expression of unique recombinant derived antibody in which complementarity determining regions (CDRs) from a first animal monoclonal antibody of defined specificity are inserted into a second animal, including man, variable heavy and light chain frameworks which show a high degree of sequence similarity with the frameworks of the first animal and present the CDRs in the appropriate configuration to react with the appropriate antigen or ligand. The insertion or grafting is carried out by processes well known in the biotechnical arts, primarily recombinant DNA technology. The unique frameworks (FRs) are selected for their structural compatibility and sequence similarity with the first animal frameworks. This preselection is dependent on one or more of the following criteria : (i) sequence matching to all known human heavy chain variable (V_H) and light chain variable (V_L) framework sequences with the framework sequences of the animal monoclonal antibody from which the CDRs have been removed ; (ii) sequence matching as described in (i), but with significant attention paid to interspecies matching of the non-surface exposed amino acid residues ; (iii) tertiary and quaternary structural model of human framework sequences with CDRs in place for comparison with models of the original animal monoclonal antibody ; and (iv) screening of human genomic DNA with DNA probes corresponding to framework sequences in chosen animal monoclonal antibody. These criteria and the following procedures are used to prepare recombinant DNA sequences which incorporate the CDRs of animal mAb, both light and heavy chains, into human frameworks that can then be used to transfect mammalian cells for the

expression of recombinant human antibody with the antigen specificity of the animal monoclonal antibody.

The present invention further comprises a method for constructing and expressing the altered antibody comprising: (i) mutagenesis and assembly of variable region domains including CDRs and FRs regions; (ii) preparation of an expression vector including at least one variable region which upon transfection into cells results in the secretion of protein sufficient for avidity and specificity determinations; and (iii) co-amplification of heavy and light chain expression vectors in appropriate cell lines.

The present invention provides recombinant methods for incorporating CDRs from animal monoclonal antibodies into human immunoglobulin frameworks so that the resulting recombinant human antibody will be either weakly immunogenic or non-immunogenic when administered to humans. Preferably the recombinant immunoglobulins will be recognized as self proteins when administered for therapeutic purposes. This method of "humanization" will render the recombinant antibodies useful as therapeutic agents because they will be either weakly immunogenic or non-immunogenic when administered to humans. The invention is further contemplated to include the recombinant conversion of any animal monoclonal antibody into a recombinant human monoclonal antibody providing that a suitable framework region can be identified (as described below). It is intended that the present invention include the nucleotide and amino acid sequences of the murine CDR regions and the human framework regions either separately or combined as a light or heavy chain or an intact immunoglobulin and any conservatively modified variants thereof. The animal monoclonals may include, but are not limited to, those murine monoclonal antibodies described by Van Voorhis *et al.*, *J. Exp. Med.* **158**: 126-145 (1983) which bind to human leukocytes and the appropriate mAbs produced by hybridomas deposited in the Hybridoma Cell Bank maintained by the American Type Culture Collection (ATCC) and described in the ATCC Catalog of Cell Lines & Hybridomas, No. 6, 1988.

The CDR sequences from the animal monoclonal antibody are derived as follows. Total RNA is extracted from the murine hybridomas, for example the 1B4 myeloma cells described by Wright *et al.*, *Proc. Natl. Acad. Sci. USA* **80**: 5699-5703 (1983), the 60.3 cells described by Beatty *et al.*, *J. Immunol.* **131**: 2913-2918 (1983), the TS1/18 cells described by Sanchez-Madrid *et al.*, *J. Exp. Med.* **158**: 1785-1803 (1983), and other anti-CD18 or CD11 monoclonal antibodies and hybridomas as described in *Leukocyte Typing III*, Springer-Verlag, New York (1988), using standard methods involving cellular solubilization with guanidinium isothiocyanate (Chirgwin *et al.*, *Biochem.* **18**: 5294-5299 [1979]). The murine 1B4 mAb will be

used as the primary example of animal MAb that can be "humanized" by the unique process being disclosed. The invention is intended to include the conversion of any animal immunoglobulin to a human immunoglobulin. It is further intended that human immunoglobulin (Ig) can contain either kappa or lambda light chains or be one of any of the following heavy chain isotypes (alpha, delta, epsilon, gamma and mu). Pairs of degenerate oligodeoxynucleotide primers (Figure 1) representing sequences within framework 1 of the murine kappa light chain variable region and light chain constant domain, or those within framework 1 of the murine IgG2a heavy chain variable region and heavy chain constant CH1 domain are synthesized on an Applied Biosystem 381A DNA synthesizer, removed from the resin by treatment with concentrated NH₄OH and desalted on a NAP-5 column eluted with H₂O. Total RNA, about 2 µg, is reverse transcribed for about 30 min at about 42° C using Moloney MLV reverse transcriptase, about 200 units (BRL), and about 10 pmoles of the constant region complementary strand primers for either the heavy or light chain. The reverse transcriptase is heat inactivated, about 95° C for about 5 min, and the reactions are made to contain in about 100 µl of PCR buffer about 50 pmoles of each of the paired primers and 25 units of Taq polymerase. About 45 cycles of amplification (2', 94° C; 2', 55° C; 2' 72° C) are followed by gel purification of the anticipated 400+ base pair (bp) DNA fragments (Figure 2). Prior to subcloning those DNAs into a blunt-ended intermediate plasmid such as pSP72 (Promega) they are terminally phosphorylated using T4 polynucleotide kinase. Frozen competent *E. coli* were thawed on ice and 100 µl aliquots were distributed into wet ice chilled polypropylene tubes. DNA (1-10 ng) from the ligation mixture was dispensed with agitation into these tubes and incubated on ice was continued for 30 minutes. The *E. coli* cells were heat-shocked by incubation at 42° C for 45 seconds, then chilled for 2 minutes on ice. Room temperature S.O.C. (Hanahan, D., *J. Mol. Biol.* **166**: 557, 1983) was added and the cultures were shaken at 225 RPM at 37° C for 60 minutes. Aliquots of the cultures were spread on LB agar plates containing 100 µg/mL ampicillin and these plates were incubated overnight at 37° C to allow for colony growth. Multiple clones representing these PCR amplified sequences are grown and submitted to DNA sequence determinations using Sequenase® and T7 and SP6 specific sequencing primers. A unique DNA sequence representing a murine IgG2a heavy chain variable region is obtained, but two kappa light chain variable regions are represented within the cloned population (Figure 3). To distinguish which sequence belongs to the 1B4 mAb, the 1B4 mAb is reduced with dithiothreitol (DTT) and purified heavy and light chains are subjected to N-terminal amino acid sequencing using the Applied Biosystems 477A sequ-

encer. Tryptic and cyanogen bromide digested peptides are also sequenced.

Replacement of human variable region CDRs with those unique to mMAb 1B4 is accomplished utilizing the following unique processes. An appropriate human framework is determined utilizing the criteria discussed above. A light chain variable region framework such as the REI framework (Orlandi, et al., Proc. Natl. Acad. Sci. USA 86 : 3833-3837 [1989]; Riechmann et al., Nature 332 : 323-327 [1988]; European Patent Application, Publication No. 239,400), with its leader and 3' intronic sequences, is subcloned into the intermediate vector pGEM3Z (Promega). About eight oligodeoxynucleotide primers (Figure 4) are synthesized representing the primers necessary to generate by polymerase chain reaction (PCR) amplification four DNA fragments. Incorporated into all but the terminal oligodeoxynucleotide primers were those sequences corresponding to MAb 1B4 light chain CDRs and at least 15 bases of 5'—terminal complementarity (see Figure 5). The appropriate primer pair, about 50 pmole each, was combined with about 10⁶ ng of plasmid DNA representing the REI framework, about 2.5 units of Taq DNA polymerase and about thirty (30) cycles of PCR amplification ensued (cycle periods, as above). The products of the four reactions, purified by agarose gel electrophoresis, are combined, about 10 ng of each DNA fragment, along with terminal oligodeoxynucleotide primers (Figure 4) and Taq DNA polymerase and the combined fragments were PCR amplified (see Figure 5). Following restriction endonuclease digestion with HindIII and XbaI the amplified DNA is purified by agarose gel electrophoresis and subcloned into compatible sites of an intermediate vector pSP72 (Promega) which contains the human kappa light chain constant region (see Figure 6). Genomic DNA, about 1 µg, purified from a human B cell line (GM108A: NIGMS Human Genetic Mutant Cell Repository, Institute for Medical Research, Camden, NJ) is used as a template for PCR amplification (Figure 7) of about a 920 base pair fragment containing the splice acceptor for the kappa light chain constant domain, the exon and a portion of its 3'-untranslated region. The PCR product is purified by agarose gel electrophoresis, digested with BamHI endonuclease, and subcloned into pSP72 previously linearized with BamHI. The individual clones representing the pSP72 intermediate vector containing both the 1B4 grafted variable region derived from REI and the human kappa constant region derived by PCR amplification of human DNA are used to determine the DNA sequence of the grafted light chain variable region.

The chimaeric heavy chain portion of the recombinant antibody is derived from the murine 1B4 heavy chain variable region fused to the human constant region of a gamma 4 subtype obtained from a lambda library constructed by Flanagan and Rabbits, Nature

300 : 709-713 (1982).

The variable region of the chimaeric heavy chain is constructed from three DNA fragments representing a signal sequence, a portion of the murine heavy chain variable region, and an intronic sequence (Figure 8). Oligodeoxynucleotide primer pairs (Figure 9) are synthesized representing the primers necessary to generate by PCR amplification these three DNA fragments from about 10 ng of plasmid DNA templates obtained from M13VHPCR1 (Orlandi et al., Proc. Natl. Acad. Sci. USA 86 : 3833-3837 [1989]) or the pSP72 intermediate vector containing the IgG2a heavy chain variable region previously used to determine the murine 1B4 CDR sequence. Amplification of the signal fragment, variable region fragment and intron-containing fragment was as described above. The agarose gel purified products are combined, about 10 ng of each product, with terminal oligodeoxynucleotide primer pairs (Figure 9) and the PCR-generated *in vitro* recombined template is amplified using the standard procedures described above. Prior to subcloning into a BglII and BamHI digested intermediate vector pSP72 this recombined product is similarly digested and agarose gel purified. Individual clones are submitted to DNA sequence determination using Sequenase® and T7 and SP6 specific sequencing primers and one is chosen (p8950) for subsequent expression.

The gamma 4 heavy chain constant region is subcloned as about a 6.7 Kb HindIII fragment derived from the plasmid pAT84 (Flanagan and Rabbits, Nature 300 : 709-713 [1982]) into the Hind III site of the intermediate vector pSP72. This plasmid is then used as the template DNA from which a shortened version of the gamma 4 constant region is subcloned using PCR amplification and the primer pairs indicated in Figure 7. Eukaryotic expression vectors are constructed as described below. Expression vectors are defined herein as DNA sequences that are required for the transcription of cloned copies of genes and the translation of their mRNAs in an appropriate host. Such vectors can be used to express eukaryotic genes in a variety of hosts such as bacteria, blue-green algae, plant cells, yeast cells, insect cells and animal cells. The immunoglobulins may also be expressed in a number of virus systems. Specifically designed vectors allow the shuttling of DNA between hosts such as bacteria-yeast or bacteria-animal cells. An appropriately constructed expression vector should contain : an origin of replication for autonomous replication in host cells, selectable markers, a limited number of useful restriction enzyme sites, a potential for high copy number, and strong promoters. A promoter is defined as a DNA sequence that directs RNA polymerase to bind to DNA and initiate RNA synthesis. A strong promoter is one which causes mRNAs to be initiated at high frequency. Expression vectors may include, but are not limited to, cloning

vectors, modified cloning vectors, specifically designed plasmids or viruses. The heavy chain immunoglobulin molecule is transcribed from a plasmid carrying the neomycin (G418) resistance marker while the light chain immunoglobulin is transcribed from a plasmid carrying the hygromycin B resistance marker. With the exception of the drug resistance portion of these plasmids they are identical.

The preferred progenitor of the immunoglobulin expression vectors is the pD5 (Berkner and Sharp, Nucl. Acids Res. 13 : 841-857 [1985]) eukaryotic expression vector which contains the origin of adenovirus replication, the SV40 enhancer domain, the adenovirus major late promoter, the adenovirus 2 tripartite leader, a 5' splice donor from the adenovirus third leader and a 3' splice acceptor derived from an immunoglobulin locus, a multiple cloning site placed in the Bam H1 site subsequent to receipt of the vector, and the SV40 late polyadenylation signal (Figure 10). The origin of replication is removed by digestion with Eco R1 and KpnI and replaced by two fragments representing the neo selectable marker gene (derived from plasmid pCMVIE-AK1-DHFR as an Eco R1/Bam H1 about 1.8 Kb fragment) and the Ig heavy chain enhancer (obtained as a PCR amplified fragment using human DNA as the template, and the oligodeoxynucleotides listed in Figure 7 as the primer pair, following its digestion with Bgl II and Kpn I). The resultant expression vector is found to lack a small portion of the TK promoter responsible for the transcription of the neomycin gene. This is replaced by insertion into the EcoRI site of about a 0.14kb PCR amplified fragment derived from the CMVIE-AK1-DHFR DNA using the primer pair listed in Figure 7. The resultant heavy chain expression vector (p8941) is modified by removal of the indicated HindIII and XbaI sites using standard procedures. To convert this vector into one expressing the hygromycin B selectable marker the neomycin-resistance cassette is removed by digestion first with Eco R1 followed by DNA polymerase-directed fill in of the 5' overhang, then subsequent Sall digestion. The about 1.9 kb hygromycin B expression cassette, TK promoter and TK polyadenylation signal flanking the hygromycin B gene, (obtained as a 1.8 kb BamH1 fragment in plasmid pL690, Gritz and Davies, Gene 25 : 179-188 [1981]) is removed from the plasmid pAL-2 by Bam H1 digestion and subcloned into the BamH1 site of the intermediate vector pSP72. The hygromycin B cassette is removed from this vector by digestion with SmaI and Sall and cloned into the expression vector linearized as described above to create a blunt end and Sall end DNA fragment.

Expression of the 1B4 CDR-grafted kappa light chain is accomplished by transferring this cistron from the pSP72-based intermediate cloning vector (p8952) to the hygromycin B selectable eukaryotic expression vector (see Figure 6). An about 1.5 kb DNA fragment

resulting from the endonuclease digestion of p8952 with Spe I and Cla I is purified by agarose gel electrophoresis and ligated into the expression vector which has previously been linearized, following digestion with the same two restriction enzymes, and agarose gel purified. The heavy chain eukaryotic expression vector is constructed in two steps (see Figure 11). First, the p8950 vector containing the modified heavy chain variable region of murine 1B4 Kb fragment is digested with Bgl II and Bam H1. The agarose gel purified 0.75 kb fragment is ligated into the BamH1 site of the p8941 vector and recombinant clones containing this fragment in the proper orientation are identified. Plasmid DNA from one such clone is linearized by Bam H1 digestion and ligated with a 1.78 Kb BamH1 fragment representing a short version of the human gamma 4 constant region, derived from plasmid pAT84 by PCR amplification. Following the identification of clones containing these inserts in the appropriate orientation, plasmid DNAs (one which is referred to as p8953) are grown and purified for transfection into recipient mammalian cells. Host cells for the expression of humanized monoclonal antibodies include, but are not limited to, human cells such as 293 cells, monkey cells such as COS-7 and CV-1P, and other mammalian cells such as CHO and NS0.

Equal amounts, about 10 µg, of the plasmids encoding the chimeric IgG4 heavy chain and the 1B4 CDR-grafted kappa light chain are transfected by standard calcium phosphate precipitation procedures into human 293 cells, and the monkey cells COS-7 and CV-1P. The culture supernatants are assayed by a trapping Elisa (described below) for the secretion of human IgG4/kappa immunoglobulin. This Elisa assay is also employed for the quantitation of the amounts of a humanized 1B4 recombinant antibody expressed in conditioned mammalian cell growth medium.

Immulon—2 (Dynatech Labs.) 96—well plates are coated overnight with about a 5 µg/ml solution of mouse anti—human kappa chain constant domain monoclonal antibody (cat. #MC009, The Binding Site, Inc., San Diego, CA) in about 0.1 M NaHCO₃ buffer (pH 8.2) at about 4°C, and blocked with about 1% bovine serum (BSA) in about 0.1M NaHCO₃ for about 1h at about 25° C. After this and all subsequent steps, washing was performed with phosphate buffered saline (PBS). The wells are then inoculated with conditioned medium containing recombinant anti-CD18 antibody, or with predetermined quantities of human IgG4/kappa purified by protein A Sepharose (Pharmacia Fine Chemicals) chromatography from human IgG4 myeloma serum (cat. #BP026, The Binding Site, Inc.) All samples are diluted in PBS containing about 0.05% Tween—20. About 100 µl aliquots are incubated for about 1h at about 37°C in triplicate, and standard calibration curves are constructed using IgG4 concentrations ranging from about 10 ng/ml to

about 100 ng/ml. Bound and fully assembled human IgG4 (either native or recombinant 1B4—human IgG4 constructs) are detected with about 100 μ l aliquots of a 1:500 dilution of mouse anti-human IgG4 Fc monoclonal antibody conjugated to alkaline phosphatase (cat #05—3822, Zymed Laboratories, Inc.) in phosphate buffered saline (PBS) containing about 1% BSA. After incubation for about 1h at about 37°C and subsequent washing, the quantities of bound conjugate are detected by incubating all samples with a 1 mg/ml solution of p-nitrophenyl phosphate in 0.1 M 2,2'-amino-methyl-propanediol buffer, pH 10.3, for about 30 min at about 25°C. The adsorbance of the wells is determined with a UV Max ELISA plate reader (Molecular Devices) set at 405 nm. All supernatant fluids from the transfected cells are found to contain this immunoglobulin, though in various amounts (Figure 12). The antibody secreted by the transfected 293 cells is isolated by protein A chromatography and the concentration of recombinant human anti-CD18 antibodies determined by the trapping Elisa described above, are used to compete with the binding of radiolabeled murine 1B4 to the CD18 ligand on the surface of activated human PMNs. Affinities of various recombinant human anti-CD18 (r-h-anti-CD18) antibody constructs are determined using a competitive 125 I-1B4 soluble binding assay with stimulated human polymorphonuclear leukocytes (PMNs). Purified murine anti-CD18 monoclonal antibody (50 μ g) is iodinated using chloramine-T (Hunter and Greenwood, *Nature* 194: 495-496, 1962), and the radiolabeled antibody purified using a Bio-Sil TSK250 (Biorad) gel filtration HPLC column (which fractionates proteins in the range of 1-300 x 10³ daltons) equilibrated in 0.1 M phosphate buffer, pH 7.0. Effluent radioactivity is monitored with an in-line detector (Beckman Model 170; Beckman) and total protein measured at OD₂₈₀ with a Kratos Spectroflow 757 detector (Kratos). A single 125 I-1B4 peak composed of coincident OD₂₈₀ and radioactivity tracings characteristically elutes about 6 minutes, 30 seconds following sample injection. Specific activity of the product is generally about 10 μ Ci/ μ g protein, and 97-99% of the counts are precipitable with 10% trichloroacetic acid. The binding of this radiolabeled antibody is assessed on human PMNs purified on a discontinuous Ficoll/Hypaque gradient (English and Anderson, *J. Immunol. Methods* 5: 249-255, 1974) and activated with about 100 ng/ml phorbol myristate acetate for about 20 minutes at about 37°C (Lo et al., *J. Exp. Med.* 169: 1779-1793, 1989). To determine the avidity of antibodies for CD18 molecules on the PMN surface, about 1 x 10⁶ activated PMNs are incubated in a buffer such as Hanks balanced salt solution containing about 20 mM Hepes (pH 7.2), about 0.14 units aprotinin (Sigma Chemical Co.) and about 2% human serum albumin (binding buffer) containing about 1.3 ng 125 I-1B4 (2.8 x 10⁻¹¹M) in the presence of increas-

ing concentrations of unlabeled 1B4 antibody (about 10⁻⁷ to 10⁻¹⁵ M) in about a 300 μ l reaction volume for about 1 h at about 4°C with constant agitation. Cell bound 1B4 is separated from the unbound antibody by centrifugation through a 0.5M sucrose cushion (4,800 x g, 3 minutes); the tubes are frozen on dry ice, and the tips cut off and counted with an LKB gamma counter. The IC₅₀ of the anti-CD18 antibody for the inhibition of 125 I-1B4 antibody binding is calculated using a four parameter fit program (Rodbard et al., In, "Radioimmunoassay and Related Procedures in Medicine", International Atomic Energy Agency, Vienna, vol I, 469 - 504, 1978). The affinity of the various recombinant humanized anti-CD18 (r-h-anti-CD18) antibodies for the CD18 ligand is determined in a similar manner using murine 125 I-1B4 antibody and increasing quantities, as determined by the trapping Elisa, of unlabeled r-h-antiCD18. The results of the binding assays are shown in Figure 13 and indicate that the avidity of the chimaeric heavy chain/grafted light chain recombinant 1B4 antibody is approximately that of the murine 1B4 monoclonal antibody.

The results described above show that an antibody with human isotype may be recombinantly expressed following the transfer of the antigen binding domains from a first animal (murine) light chain framework to a second animal (human) light chain framework one fused with a human kappa constant region, when combined with a chimaeric heavy chain (murine heavy chain variable region fused to a human gamma 4 constant domain) without loss in avidity for the antigen. It can be inferred from this result that the human RE1 light chain framework region does not alter the presentation of the murine 1B4 light chain CDRs and/or the contribution of the light chain CDRs to the antibody's avidity is minimal. Many of the examples of construction of recombinant human antibodies containing complementarity regions replaced by those found within murine monoclonal antibodies have resulted in loss of avidity for the ligand or antigen. Thus, although these transmutations are possible, the successful maintenance of avidity is not assured. The procedures described below demonstrate that when strict attention is paid to the framework regions, CDR domains may be transferred to those frameworks without the loss of avidity which accompanies their transfer to the "generic" frameworks employed by Winter, European Patent Publication No. 239,400, published September 30, 1987.

To identify human framework sequences compatible with the CDRs of, say, murine 1B4, human frameworks with a high degree of sequence similarity to those of murine 1B4 were identified. Sequence similarity was measured using identical residues as well as evolutionarily conservative amino acid substitutions. Similarity searches were performed using

the murine 1B4 framework sequence from which the CDR sequences had been removed. This sequence was used to query a database of human immunoglobulin sequences that had been derived from multiple sources. Sequences with a high degree of sequence similarity were examined individually for their potential as humanizing framework sequences. Special attention must be given to those framework residues which are not located or exposed on the surface of the antibody since these residues will play a critical role in the packing of the CDR supporting scaffolding. In this way, the human homologue providing the murine CDRs with the structure most similar to their native murine framework was selected for subsequent construction of the humanized variable region (see Figure 14). It should be noted that in the present invention the heavy and light chain framework sequences chosen for grafting need not be derived from the same human antibody. That is to say, using the above mentioned criteria for choosing human frameworks the entire accumulated human nucleic acid and protein databases may be searched for the desired matching sequences. The ideal light chain framework may come from one immunoglobulin sequence while the heavy chain framework may come from another. Should human frameworks of sufficient similarity not be identifiable from compiled sequences, it is possible to isolate from human genomic DNA a group of closely related variable regions using recombinant technology. Thus, a degenerate 5' upstream oligodeoxynucleotide primer may be designed from the conserved sequences within the amino-terminus of each of the various human FR1 regions and paired with a degenerate 3' downstream oligodeoxynucleotide primer fashioned from the FR3 sequence determined from the murine monoclonal whose CDRs one wishes to transfer into a human context. These primer pairs are then used to PCR amplify from a human genomic template those DNA sequences which are flanked by the primer pair. The resulting DNAs may then be cloned and the DNA sequence derived from individual members will describe various murine-related human variable regions. The paucity of somatic mutations in framework residues and the conservation of amino acid sequence between mouse and man make this approach possible.

The construction of a complete recombinant human IgG4 antibody, whose heavy and light chain variable domains contain the CDR residues of the murine monoclonal antibody, with complete retention of the specificity and avidity of the parent murine monoclonal antibody is disclosed. The construction of the CDR-grafted light chain framework derived from the human sequence of RE1 fused with a human kappa light chain constant region is described above.

The murine variable region framework sequence, devoid of CDR sequences, is used to query a datab-

ase of complete human variable region sequences. The human sequences that are most similar to the murine framework region are then analyzed individually to determine both their sequence identity and similarity to the murine framework region. In the case of murine 1B4 these sequences include, but are not limited to, Gal and Jon, chosen because of their high degrees of both similarity and identity with the murine 1B4 heavy chain sequence. The Gal FR has been shown to be 85% similar and 79% identical to murine 1B4, while the Jon FR has been shown to be 88% similar and 75% identical to 1B4. These values are based upon the Dayhoff similarity matrix of evolutionarily conserved amino acid substitutions (R. M. Schwartz, M. O. Dayhoff, in *Atlas of Protein sequence and structure* M. O. Dayhoff, Eds. (National Biomedical Research Foundation, Washington, DC [1979]) (see Figure 14). To prepare a recombinant DNA encoding the murine heavy chain CDRs in the context of each of these frameworks the following procedures are performed.

Two sets of four long oligodeoxynucleotides are synthesized. When each set is combined, they encode the 1B4 heavy chain CDRs and the chosen human heavy chain variable region framework. The four oligodeoxynucleotides of a set, about 1 pmole of each, are combined in a PCR reaction with Taq polymerase and about 50 pmoles of each terminal amplifying oligodeoxynucleotide (Figure 15, Figure 16). By virtue of the complementary ends of the single-stranded oligodeoxynucleotides, the polymerization-denaturation-polymerization cycles of the polymerase chain reaction result in the formation, and subsequent amplification, of the combined sequences. Following about 25 cycles of amplification the combined 0.4 Kb fragment is electrophoretically purified from an agarose gel. In parallel, two DNA fragments representing amino terminal sequences encoding the signal peptide and carboxy terminal sequences encoding framework 4, splice donor, and intronic sequences are amplified using oligodeoxynucleotide primer pairs (Figure 15) and the NEWM containing plasmid DNA template M-13VHPCR1 (described above). These two fragments are agarose gel purified, as above, and about 10 ng of each is combined with about 10 ng of the amplified grafted variable region fragment, Taq polymerase, about 50 pmoles of each of the terminal primers (Figure 15) and the mixture was PCR amplified. The resultant 0.85 Kb fragment is digested with restriction enzymes Spe I and BamHI. Following agarose gel electrophoresis, the purified DNA fragment is ligated into the heavy chain expression vector, p8958 (see Figure 11), in place of the chimaeric variable region. In this way, two unique heavy chain frameworks containing the grafted murine CDRs (Jon/1B4 and Gal/1B4) are constructed. Each fully grafted heavy chain expression vector plasmid is co-transfected

with the fully grafted REI/1B4 light chain expression vector plasmid into 293 cells and the recombinant human antibody is present in conditioned medium. The Gal/1B4:REI/1B4 heterodimeric human (fully humanized) recombinant antibody is isolated by protein A chromatography. The avidity of this antibody for the CD18 ligand displayed on the surface of activated human PMNs is compared with that of the chimaeric/grafted antibody, described above, and the 1B4 murine monoclonal antibody parent. Figure 20 shows that although each hetero-dimeric antibody contains the same set of six CDRs, they do not exhibit identical avidity for the ligand. Thus, the avidity of an antibody molecule relies upon the variable region framework structure in which the CDRs are presented. The parent murine monoclonal antibody demonstrates an IC_{50} of about 0.5 nM while the Gal/Rei heterodimer has an IC_{50} of about 1.6 nM.

To determine the relative contribution of the heavy and light chain variable regions to the enhanced avidity of the Gal/REI grafted hetero-dimer, second light chain and heavy chain frameworks were constructed containing the 1B4 CDR sequences. These frameworks, termed Len and mutant Gal or Gal-M1 were chosen from the human immunoglobulin database by virtue of their high degree of similarity to the light chain FR and heavy chain FR of murine 1B4 (Figure 14). The Len FR shows a similarity of 90% and an identity of 81% when compared to murine 1B4. The resulting recombinant antibodies which specifically bind to CD18 antigen or receptor are termed recombinant human anti-CD18 antibodies (r-h-anti-CD18 Abs).

This invention further relates to a method of inhibiting the influx or migration of leukocytes capable of expressing CD18 antigen (leukocyte integrin, beta-2 subunit) on their surface into a site of inflammation or a tissue area or organ that will become inflamed following an influx of the cells. The inflammation which is the target of the method of the present invention may result from an infection with pathogenic microorganisms such as gram-positive and gram-negative bacteria, parasites and fungi. The response may also be induced by viruses and non-infectious means such as trauma or reperfusion following myocardial infarction or stroke, immune responses to foreign antigen and autoimmune responses.

The recombinant human anti-CD18 antibodies are useful in the treatment of inflammation in lung, central nervous system, kidney, joints, endocardium, pericardium, eyes, ears, skin, gastrointestinal tract and urogenital system. Disease states in which the recombinant human anti-CD18 antibodies are useful as therapeutic agents include, but are not limited to: infectious diseases where active infection exists at any body site, such as meningitis; conditions such as chronic or acute secondary inflammations caused by antigen deposition; and other conditions such as,

encephalitis; arthritis; uveitis; colitis; glomerulonephritis; dermatitis; psoriasis; and respiratory distress syndrome associated with sepsis and/or trauma. Other inflammatory diseases which may be responsive to recombinant human anti-CD18 antibody include, but are not limited to, immune disorders and conditions involving T-cell and/or macrophage attachment/recognition, such as acute and delayed hypersensitivity, graft vs. host disease; primary auto-immune conditions such as pernicious anemia; infection related auto-immune conditions such as Type I diabetes mellitus; flares during rheumatoid arthritis; diseases that involve leukocyte diapedesis, such as multiple sclerosis; antigen-antibody complex mediated diseases including certain of the secondary infection states listed above; immunosuppression; and transplant rejection. Inflammatory conditions due to toxic shock or trauma such as adult respiratory distress syndrome and reperfusion injury; and disease states due to leukocyte dyscrasias and metastasis, are included within the scope of this invention.

The present invention is also applicable to the inhibition of leukocyte-endothelial attachment for diagnostic and therapeutic purposes; such as the iatrogenic opening of the endothelium to prevent the ingress of leukocytes during the ingress of a dye or image enhancer into tissue, or to allow the selective entry of a therapeutic drug in the instance of chemotherapy; or to enhance the harvesting of leukocytes from patients.

Recombinant human anti-CD18 antibodies or an active fragment thereof can be used to treat the above mentioned diseases. An active fragment will include the $F(ab')_2$, the Fab and any other fragment that can bind to the CD18 antigen. Recombinant human anti-CD18 antibodies can be administered alone for non-infectious disease states or combined with antibiotics or other anti-infective agents for the treatment of infectious diseases for reasons discussed above. Administration will generally include the antibodies and other substance in a physiologically acceptable medium or pharmaceutical carrier. Such physiologically acceptable media or pharmaceutical carriers include, but are not limited to, physiological saline, phosphate buffered saline, phosphate buffered saline glucose, buffered saline and the like. The antibodies and any anti-infective agent will be administered by parenteral routes which include intravenous, intramuscular, subcutaneous and intraperitoneal injection or delivery.

The amount of the antibodies and the mixture in the dosage form is dependent upon the particular disease state being treated. The amount of the recombinant human anti-CD18 antibody utilized in a dosage form can range from about 1 to about 1,000 mg, with a range of from about 10 mg to about 100 mg being preferred. The antibodies can be administered daily

or less than daily as determined by the treating physician.

The following examples illustrate the present invention without, however, limiting the same thereto.

EXAMPLE 1

Preparation of a Grafted / Chimaeric Recombinant Antibody

An antibody was produced in which the variable domain of the light chain comprises the framework regions of a human light chain and the CDRs from a mouse light chain, while the variable domain of the heavy chain is derived entirely from the murine heavy chain. The light chain framework regions were derived from human myeloma protein REI (Orlandi, et al., Proc. Natl. Acad. Sci. USA 86 : 3833-3837 [1989]; Riechmann et al., Nature 332 : 323-327 [1988]; European Patent Application, Publication No. 239,400) for which the crystallographic structure has been determined. The CDR sequences from the murine monoclonal antibody 1B4 which binds to CD18 (the beta subunit of the leukocyte integrin beta-2 family which includes : LFA-1, Mac-1, and p150.95) were derived as follows. The hybridoma designated 1B4 which produces 1B4 monoclonal antibody was deposited under the Budapest Treaty at the International Depository Authority : American Type Culture Collection, 12301 Parklawn Drive, Rockville, MD, 20852. Viability was determined on June 6, 1989 and the hybridoma was designated HB 10164. Previous experiments had determined this antibody to be an IgG 2a with a kappa light chain (Wright et al., Proc. Natl. Acad. Sci. USA 80 : 5699-5703 [1983]).

Total RNA was extracted from the 1B4 myeloma cells using standard methods involving cellular solubilization with guanidinium isothiocyanate (Chirgwin et al., Biochem. 18 : 5294-5299 [1979]). Sets of degenerate oligonucleotide primers (Figure 1) representing sequences within framework 1 of the murine kappa light chain variable region and kappa light chain constant domain, or those within framework 1 of the murine IgG2a heavy chain variable region and heavy chain constant CH1 domain were synthesized by standard phosphoramidite procedures on an Applied Biosystem 381A DNA synthesizer. Removal of the oligodeoxynucleotides (oligos) from the resin was accomplished by treatment with concentrated NH₄OH followed by desalting on a NAP-5 column (Pharmacia) with H₂O elution (when the oligos were <45 bases in length), or by use of an OPC column (Applied Biosystems Inc) with 20% acetonitrile elution (when the oligos were >45 bases in length), as recommended by the manufacturers. Total RNA (2µg) was reversed transcribed for 30' at 42°C using Moloney MLV reverse transcriptase (200 units, BRL) and 10 pmoles of the constant region complementary strand

primers representing either heavy or light chain in a buffer (final volume of 20 µl) containing 50 mM Tris HCl, pH 8.3, 75 mM KCl, 3 mM MgCl₂, 10 mM DTT, and 20 units of RNAsin (Pharmacia). The reverse transcriptase was heat inactivated (95°C, 5') and the reactions were made to contain in 100 µl of PCR buffer (10 mM Tris HCl, pH 8.3, 50 mM KCl, 1.5 mM MgCl₂, 0.01% gelatin, 200 µM each dNTP), 50 pmoles of each of the paired primers, and 2.5 units of Taq polymerase (Perkin Elmer/Cetus). Polymerase chain reaction (PCR) amplification was carried out essentially as described by Saiki et al., Science 230 : 1350-1354 (1985) and others (Mullis et al., Cold Spring Harbor Symp. Quant. Biol. 51 : 263-273 [1986], Dawasaki and Wang, PCR Technology, Principles and Applications for DNA Amplification, Erlich, Ed., Stockton Press, NY, pp. 89-97 [1989], Tung et al., ibid. pp. 99-104 [1989]). Forty five cycles of amplification by a DNA Thermal Cycler (Perkin Elmer Cetus Instruments) (2', 94°C ; 2', 55°C ; 2' 72°C) were followed by gel purification of the anticipated 400+ base pair (bp) DNA fragments (Figure 2). Prior to subcloning the DNAs into a blunt-ended intermediate plasmid (pSP72, Promega) they were terminally phosphorylated using T4 polynucleotide kinase (Boehringer Mannheim). Frozen competent *E. coli* were thawed on ice and 100 µl aliquots were distributed into wet ice chilled polypropylene tubes. DNA (1-10 ng) from the ligation mixture was dispensed with agitation into these tubes and the mixture was incubated on ice for 30 minutes. The *E. coli* cells were heat-shocked by incubation at 42° C for 45 seconds, then chilled for 2 minutes on ice. Room temperature S.O.C. (Hanahan, D., J.Mol. Biol. 166 : 557 [1983]) was added and the cultures were shaken at 225 RPM at 37° C for 60 minutes. Aliquots of the cultures were spread on LB agar plates containing 100 µg/mL ampicillin and these plates were incubated overnight at 37°C to allow for colony growth.

Multiple clones representing these PCR amplified sequences were isolated from DH5 transformed *E. coli* plated on LB agar plates containing 50 µg/ml ampicillin, grown by described procedures (Maniatis et al., Molecular Cloning, A Laboratory Manual, Cold Spring Harbor Laboratory, Cold Spring Harbor, NY, 1982), plasmid DNAs were extracted from the bacteria using the DNA preparation procedures of Birnboim and Doly Nucleic Acid Res. 7 : 1515 (1979), and the double-stranded plasmid DNAs were submitted to DNA sequence determinations using Sequenase® (United States Biochemicals) and T7 and SP6 specific sequencing primers (Boehringer Mannheim) using the protocols recommended by the manufacturer. A unique DNA sequence representing a murine IgG2a heavy chain variable region was obtained, but two kappa light chain variable regions were represented within the cloned population (Figure 3). To distinguish which sequence belonged to the 1B4 MAb, the 1B4

MAB was reduced with DTT and purified light chains were subjected to N-terminal amino acid sequencing using the Applied Biosystems 477A sequencer. Although stretches of amino acid residues were identical to the mMAb 1B4 observed within the 1B4 light chain -1 sequence predicted from the cDNA, 1B4 light chain -2 (Figure 25) was deemed to be the actual sequence of the MAb 1B4 light chain. This is consistent with the determined DNA sequence of the light chain-1 molecule (Figure 24) which suggests it represents a murine kappa light chain variable region of subgroup III containing a mutation in the CDR3/FR4 region whose consequence is peptide chain termination.

Replacement of the human REI variable region CDRs with those unique to MAb 1B4 took place as follows. The REI framework (obtained as the RF form of the M13 vector M13VKPCR1, Orlandi et al., Proc. Natl. Acad. Sci. USA 86 : 3833 (1989), with its signal peptide leader and intronic sequences, was subcloned into the intermediate vector pGEM3Z (Promega), as was the NEW or NEWM heavy chain variable region framework (obtained in the form of the M13 vector M13VHPCR1, Orlandi et al., supra). Eight oligodeoxynucleotides (Figure 4) were synthesized representing the primers necessary to generate by PCR amplification four DNA fragments. Incorporated into all but the terminal oligodeoxynucleotides were those sequences corresponding to the mMAb 1B4 light chain CDRs and at least 15 bases of 5'-terminal complementarity (see Figure 5). The appropriate primer pair (50 pmole each) was combined with 10 ng of REI framework-containing plasmid DNA, 2.5 units of Taq DNA polymerase, PCR reaction components and buffer, and thirty (30) cycles of PCR amplification ensued (cycle periods, as above). The products of the four reactions, purified by agarose gel electrophoresis, were combined (10 ng of each DNA fragment) along with a terminal oligodeoxynucleotide primer pair (amplifier) (Figure 4), Taq DNA polymerase, PCR reaction components and buffer, and the subsequent recombined fragments were amplified, as described above, for thirty cycles (see Figure 5). Following restriction endonuclease digestion with HindIII and XbaI the amplified DNA was purified from an agarose gel and subcloned into these same sites of an intermediate vector pSP72 (Promega) which contained the human kappa light chain constant region, obtained as follows. DNA (1 µg) purified from a human B cell line (GM01018A; NIGMS Human Genetic Mutant Cell Repository, Institute for Medical Research, Camden, N.J. 08103) was used as a template for the oligodeoxynucleotide primers described in Figure 7 to PCR amplify a 920 base pair fragment containing the splice acceptor for the human kappa light chain constant domain, the exon and a portion of its 3'-untranslated region (PCR primer pair choice was selected based on the kappa constant region sequence des-

cribed by Hieter et al., Cell 22 : 197-207 [1980]). The PCR product was purified by agarose gel electrophoresis, digested with BamHI endonuclease, and subcloned into pSP72 (Promega) previously linearized with BamHI.

The individual clones (p8982) representing the pSP72 intermediate vector containing both the 1B4 grafted light chain variable region derived from REI and the human kappa constant region derived by PCR amplification of human DNA were used to verify the DNA sequence of the grafted light chain variable region. The chimaeric heavy chain portion of the recombinant antibody was derived from the murine 1B4 heavy chain variable region fused to the human constant region of gamma 4 subtype obtained from a lambda library constructed by Flanagan and Rabbitts, Nature 300 : 709-713 (1982).

The variable region of the chimaeric heavy chain was constructed from three DNA fragments representing a signal sequence, a portion of the murine 1B4 heavy chain variable region, and an intronic sequence (Figure 8). Oligodeoxynucleotide primer pairs (Figure 9) were synthesized representing the primers necessary to generate by PCR amplification these three DNA fragments from 10 ng of plasmid DNA template containing either the NEW heavy chain variable region (M13VHPCR1) or a pSP72 intermediate vector containing the IgG 2a heavy chain region previously used to determine the murine 1B4 CDR sequence. Amplification of the 225 bp signal fragment, 350 bp variable region fragment, and 230 bp intron-containing fragment was performed as described above. The agarose gel purified products were combined (10 ng of each product) with terminal primer pairs (Figure 9) and the PCR-generated *in vitro* recombined template was amplified using the standard procedure described above for recombining the fragments comprising the 1B4 grafted REI light chain variable region. Prior to subcloning into a BglII and BamHI digested intermediate vector (pSP72) Promega) this recombined product was similarly digested and agarose gel purified. DNA was obtained following growth of individual bacterial clones and submitted to DNA sequence determination using Sequenase® and T7 and SP6 specific sequencing primers in order to verify the sequence of the reconstructed variable region and its flanking domains.

The gamma 4 heavy chain constant region was subcloned as a 6.7 Kb HindIII fragment derived from the plasmid pAT84 (Flanagan and Rabbitts, supra) into the Hind III site of the intermediate vector pSP72 (Promega). This plasmid (p8947) was then used as the template DNA from which a shortened version of the gamma 4 constant region was obtained using the standard PCR amplification procedures described above and the primer pairs indicated in Figure 7. Eukaryotic expression vectors were constructed as described below such that the heavy chain immunog-

lobulin molecule was transcribed from a plasmid carrying the neomycin (G418) (Rothstein and Reznikoff, *Cell* **23** : 191-199 [1981]) resistance marker, while the light chain immunoglobulin was transcribed from a plasmid carrying the hygromycin B resistance marker (Gritz and Davies, *Gene* **25** : 179-188 [1983]). With the exception of the drug resistance portion of these plasmids they are identical.

The progenitor of the immunoglobulin expression vectors was the pD5 eukaryotic expression vector (Berkner and Sharp, *Nucl. Acids Res.* **13** : 841-857 [1985]) which contained the origin of adenovirus replication, the SV40 enhancer domain, the adenovirus major late promoter, the adenovirus 2 tripartite leader, a 5' splice donor from the adenovirus third leader and a 3' splice acceptor derived from an immunoglobulin locus, a multiple cloning site, and the SV40 late polyadenylation signal (Figure 10). The origin of replication was removed by digestion with Eco R1 and KpnI and replaced by two fragments representing the neo selectable marker gene (derived from plasmid pCMVIE-AK1-DHFR (Silberklang et al., *Modern Approaches to Animal Cell Technology*, Ed. Spier et al., Butterworth, U.K., [1987]) as an Eco R1/Bam H1 1.8 Kb fragment) and the Ig heavy chain enhancer (obtained as a PCR amplified fragment using standard procedures described above and human DNA as the template; the oligonucleotide primer pair is listed in Figure 7) following its digestion with Bgl II and Kpn I. The resultant expression vector was found to lack a small portion of the TK promoter responsible for the transcription of the neomycin gene. This was replaced by insertion into the EcoRI site of a 0.14 kb PCR amplified fragment derived from the CMVIE-AK1-DHFR DNA using the primer pair also listed in Figure 7. The resultant heavy chain expression vector was subsequently modified by removal of the indicated HindIII and XbaI sites. To convert this neomycin selectable vector (p8941) into one expressing the hygromycin B selectable marker (p8942) (Figure 10) the neomycin-resistance cassette was removed by digestion first with Eco R1 followed by DNA polymerase-directed fill in of the 5' overhang, then subsequent SalI digestion. The 1.9 kb hygromycin B expression cassette [TK promoter and TK polyadenylation signal flanking the hygromycin B gene obtained from Gritz and Davies, *Gene* **25** : 179-188 (1983), as the 1.9 kb BamH1 fragment in plasmid (pLG90)] was removed from the plasmid pAL-2 by Bam H1 digestion and subcloned into the BamH1 site of the intermediate vector pSP72 (Promega). The hygromycin B cassette was removed from this vector by digestion with SmaI and SalI and cloned into the expression vector linearized as described above to create a blunt end and SalI end DNA fragment.

Expression of the 1B4 CDR-grafted kappa light chain was accomplished by transferring this cistron from its position within the pSP72 intermediate vector

to the hygromycin B selectable eukaryotic expression vector (Figure 18). A 1.5 kb DNA fragment resulting from the endonuclease digestion of p8952 with SpeI and ClaI was purified by agarose gel electrophoresis and ligated into the expression vector (p8942) which had previously been linearized, by digestion with the same two restriction enzymes and agarose gel purified.

The heavy chain eukaryotic expression vector (p8958) was constructed in two steps (Figure 11). First, p8949 containing the modified heavy chain variable region of murine 1B4 was digested with Bgl II and Bam H1. The agarose gel purified 0.8 kb fragment was ligated into the BamH1 site of the p8941 vector and recombinants containing this fragment in the proper orientation were identified. One such plasmid was linearized by BamH1 digestion and ligated with the 1.8 Kb BamH1 fragment representing a short version of the human gamma 4 constant region derived from plasmid p8947 by PCR amplification as described above. Following the identification of clones containing these inserts in the appropriate orientation plasmid DNAs were grown (Maniatis et al., *supra*) and purified for transfection into recipient mammalian cells (Maniatis et al., *supra*; Birnion and Doly, *supra*).

Equal amounts (10 μ g) of the plasmids encoding the chimaeric IgG4 heavy chain and the 1B4 CDR-grafted kappa light chain were transfected by standard calcium phosphate precipitation procedures into human 293 cells, and the monkey cells COS-7 and CV-1P. The culture supernatant fluids were assayed by a trapping Elisa (described below) for the secretion of a human IgG4/kappa immunoglobulin.

An Elisa was developed for the quantitation of the amounts of a 1B4 recombinant antibody expressed in conditioned mammalian cell growth medium. Immunon-2 (Dynatech Labs.) 96-well plates are coated overnight with a 5 μ g/ml solution of mouse anti-human kappa chain constant domain monoclonal antibody (cat. #MC009, The Binding Site, Inc., San Diego, CA) in 0.1 M NaHCO₃ buffer (pH 8.2) at 4 $^{\circ}$ C, and blocked with 1% bovine serum (BSA) in 0.1 M NaHCO₃ for 1 h at 25 $^{\circ}$ C. After this and all subsequent steps, washing was performed with phosphate buffered saline (PBS). The wells are then inoculated with conditioned medium containing recombinant anti-CD18 antibody, or with predetermined quantities of human IgG4/kappa purified by protein A Sepharose (Pharmacia Fine Chemicals) chromatography from human IgG4 myeloma serum (cat. # BP026, The Binding Site, Inc.) All samples are diluted in PBS containing 0.05% Tween-20. 100 μ l aliquots are incubated for 1 h at 37 $^{\circ}$ C in triplicate, and standard calibration curves are constructed using IgG4 concentrations ranging from 10 ng/ml to 100 ng/ml. Bound and fully assembled human IgG4 (either native or recombinant 1B4-human IgG4 constructs) is detected with 100 μ l aliquots of a 1:500 dilution of mouse anti-human

IgG4 Fc monoclonal antibody conjugated to alkaline phosphatase (cat #05-3822, Zymed Laboratories, Inc.) in phosphate buffered saline (PBS) containing 1% BSA. After incubation for 1h at 37°C and subsequent washing, the quantities of bound conjugate are detected by incubating all samples with a 1 mg/ml solution of p-nitrophenyl phosphate in 0.1 M 2,2'-amino-methyl-propanediol buffer, pH 10.3, for 30 min at 25°C. The adsorbance of the wells is determined with a UV Max ELISA plate reader (Molecular Devices) set at 405 nm. All supernatant fluids from the transfected cells are found to contain this immunoglobulin, though in various amounts (Figure 12). The antibody secreted by the transfected 293 cells is concentrated by protein A chromatography and the concentrations of the recombinant human anti-CD18 antibodies determined by the trapping Elisa described above, are used to compete with the binding of radiolabeled murine 1B4 to the CD18 ligand on the surface of activated human PMNs. Affinities of various r-h-anti-CD18 antibody constructs are determined using a competitive ¹²⁵I-1B4 soluble binding assay with stimulated human polymorphonuclear leukocytes (PMNs). Purified murine anti-CD18 monoclonal antibody (50 µg) is iodinated using chloramine-T (Hunter, W.M. and Greenwood, F.C., *Nature* 194 : 495-496, 1962), and the radiolabeled antibody purified using a Bio-Sil TSK250 (Biorad, Richmond, CA) gel filtration HPLC column (which fractionates proteins in the range of 1-300 x 10³ daltons) equilibrated in 0.1 M phosphate buffer, pH 7.0. Effluent radioactivity is monitored with an in-line detector (Beckman Model 170; Beckman, Fullerton, CA) and total protein measured at OD₂₈₀ with a Kratos Spectroflow 757 detector (Kratos, Mahwah, N.J.). A single ¹²⁵I-1B4 peak composed of coincident OD₂₈₀ and radioactivity tracings characteristically elutes 6 minutes, 30 seconds following sample injection. Specific activity of the product is generally about 10 µCi/µg protein, and 97-99% of the counts are precipitable with 10% trichloroacetic acid. The binding of this radiolabeled antibody is assessed on human PMNs purified on a discontinuous Ficoll/Hypaque gradient (English and Anderson, *J. Immunol. Methods* 5 : 249-255, 1974) and activated with 100 mg/ml phorbol myristate for 20 minutes at 37°C (Lo et al., *J. Exp. Med.* 169 : 1779-1793, 1989). To determine the avidity of antibodies for CD18 molecules on the PMN surface, about 1 x 10⁵ activated PMNs are incubated in a buffer such as Hanks balanced salt solution containing 20 mM Hepes (pH 7.2), 0.14 units aprotinin (Sigma Chemical Co.) and 2% human serum albumin (binding buffer) containing 1.3 ng ¹²⁵I-1B4 (2.8 x 10⁻¹¹ M) in the presence of increasing concentrations of unlabeled 1B4 antibody (10⁻⁷ to 10⁻¹⁵ M) in a 300 µl reaction volume for 1 h at 4°C with constant agitation. Cell bound 1B4 was separated from the unbound antibody by centrifugation through a 0.5M sucrose cushion (4,800 x g, 3

minutes); the tubes are frozen on dry ice, and the tips cut off and counted with an LKB gamma counter. The IC₅₀ of the anti-CD18 antibody for the inhibition of ¹²⁵I-1B4 antibody binding is calculated using a four parameter fitter program (Rodbard, Munson, and DeLean, in "Radioimmunoassay and Related Procedures in Medicine", International Atomic Energy Agency, Vienna, vol I, 469 - 504, 1978). The affinity of the various r-h-anti-CD18 antibodies for the CD18 ligand is determined in a similar manner using murine ¹²⁵I-1B4 antibody and increasing quantities, as determined by the trapping Elisa, of unlabeled r-h-anti-CD18. The results of the binding assays are shown in Figure 13 and indicate that the avidity of the chimeric heavy chain/grafted light chain recombinant 1B4 antibody (circles) is approximately that of the murine 1B4 monoclonal antibody (diamonds).

EXAMPLE 2

Preparation of Fully Grafted Recombinant Human IgG4 Antibodies

This example shows the production of recombinant human IgG4 antibodies, whose variable domains contain the CDR residues of the murine monoclonal antibody 1B4. The construction of the CDR-grafted light chain framework derived from the human sequence of RE1 fused with a human kappa light chain constant region was described in the preceding example (Example 1).

The 1B4-specific heavy chain component of the recombinant antibody was constructed from the IgG4 heavy chain constant region, described in Example 1, fused to a pre-selected human heavy chain variable region framework sequence into which the 1B4 CDR residues were transplanted. The murine 1B4 MAb m1B4 heavy chain was first analyzed to determine the precise position of the CDR sequences. These were determined by visual comparisons with the data sets found in Kabat, Wu, Reid-Miller, Perry, and Gottesman, *Sequences of proteins of immunological interest*. (US Dept Health and Human Services, Bethesda, MD, 1987). Once the boundaries of the CDRs were determined these sequences were removed to leave the murine FRs alone. This sequence was then used to query the human immunoglobulin database which was mainly derived from release 22 of the PIR database (George et al., *Nucl. Acids Res.* 14 : 11-16 (1986)). The sequence search was performed using the Profile search system of the GCG sequence analysis package (Devereux et al., *Nuc. Acids Res.* 12 : 387-395 (1984)). The matrix used for similarity comparisons was the Dayhoff evolutionary distance matrix (R. M. Schwartz, M. O. Dayhoff, in *Atlas of Protein sequence and structure* M. O. Dayhoff, Eds. (National Biomedical Research Foundation, Washington, DC, 1979)). Additionally, the Risler

structural distance matrix (Risler *et al.*, *J. Mol. Biol.* 204 : 1019-1029 [1988]) was used to generate the murine sequence profile, and the results of searches with this query were considered with those generated using the Dayhoff matrix. Use of the profile searching system also allowed the weighting of specific residues within the murine FR that were deemed important based on various criteria. The sequences that repeatedly showed the highest levels of sequence similarity in the database queries were then analyzed using a pairwise comparison to the FRs of murine 1B4. The program Gap of the GCG package was used for this analysis, because it produces an exact measure of both the sequence similarity and identity shared between two sequences. This method was used to select the human sequences Gal and Jon, which shared a similarity of 85% and 88% and identities of 79% and 75% with murine 1B4, respectively (Figure 14). To prepare a recombinant DNA representing the 1B4 heavy chain CDRs within each of these frameworks the following procedures were performed.

Two sets of four long oligonucleotides were synthesized. When each set was combined, they encoded that portion of heavy chain corresponding to the murine 1B4 variable region present in the chimaeric heavy chain expressed in Example 1. The four oligonucleotides of each set (Figure 15, Figure 16), 1 pmole of each, were combined in a standard PCR reaction with 2.5 units of Taq polymerase and 50 pmoles of each terminal amplifying oligodeoxynucleotide (Figure 15, Figure 16). By virtue of the complementary ends of the single-stranded oligonucleotides, the polymerization-denaturation-polymerization cycles of the polymerase chain reaction result in the formation, and subsequent amplification, of the combined sequences. Following 25 cycles of amplification the combined 0.4 Kb fragment was electrophoretically purified and extracted from an agarose gel. In parallel, two DNA fragments representing amino terminal sequences encoding the signal peptide and carboxy terminal sequences encoding framework 4, splice donor, and intronic sequences were amplified using oligodeoxynucleotide primer pairs (Figure 15) and the M13VHPCR1 plasmid DNA template described in example 1. These two DNA fragments were purified by agarose gel electrophoresis, as above, and 10 ng of each was combined with 10 ng of the amplified variable region fragment, 2.5 units of Taq polymerase, 50 pmoles of terminal primers (Figure 15) and the mixture was amplified by 25 cycles of PCR. The resultant 0.8 Kb fragment was digested with restriction enzymes Spe I and BamH1 (Gal) and Hind III and Bam H1 (Jon). Following agarose gel electrophoresis, the purified DNA fragment was ligated into the heavy chain expression vector, p8958, in place of the chimaeric variable region (Figure 11). In this way, two unique heavy chain

frameworks containing grafted 1B4 CDRs (1B4/Jon and 1B4/Gal) were constructed. Each fully grafted heavy chain expression vector plasmid was co-transfected with the fully grafted 1B4/REI light chain expression vector (Example 1) plasmid into 293 cells and the antibody present in conditioned medium was isolated by protein A chromatography. The recombinant humanized 1B4 (h1B4) avidity of these two antibodies for the CD18 ligand displayed on the surface of activated human PMNs was compared with that of the chimaeric/grafted antibody described in Example 1. Figure 20 shows that although each hetero-dimeric antibody contains the same set of six CDRs, they do not exhibit identical avidity for the ligand. Thus, the biological properties of an antibody molecule (i.e., its avidity) rely significantly on the variable region framework structure which support the CDR loops.

To determine the relative contribution of the light chain variable region to the enhanced avidity of the Gal/REI grafted hetero-dimer a second light chain framework was constructed containing the 1B4 CDR sequences. The light chain framework Len was identified as a donor framework sequence based upon its selection from the database. Len was identified by using the murine 1B4 light chain framework sequence, with CDRs removed based upon visual identification of the CDRs when compared to Kabat (*supra*), to query the human immunoglobulin database. The methodology of the query was similar to that described for the heavy chain FRs. Len was shown, by Gap analysis, to be 90% similar and 81% identical to the murine 1B4 light chain FR. Len was thought to be a better choice for grafting of the light chain CDRs than REI, based on its higher levels of both similarity and identity to 1B4 as compared to REI (82% similarity and 65% identity) (see Figure 14). A set of five long oligodeoxynucleotides (Figure 21) representing the Len light chain framework with 1B4 specific CDR sequences and intronic sequences were synthesized using 2.5 units of Taq polymerase and 50 p moles of each terminal amplifying oligodeoxynucleotide primer and combined by PCR, as described above for the Jon and Gal frameworks (Figure 22). Following 25 cycles of amplification the combined 0.6 kb DNA fragment was purified by agarose gel electrophoresis. In parallel, a DNA fragment representing the amino-terminal signal peptide was amplified using a oligodeoxynucleotide primer pair (Figure 21) and the M13VHPCR1 plasmid DNA template, as described in Example 1. This fragment was also purified by agarose gel electrophoresis. These two DNA fragments are placed together, 10 ng of each, with 2.5 units of Taq polymerase, 50 p moles of terminal oligodeoxynucleotide primers (Figure 21) and the entire mixture is subjected to 25 cycles of PCR amplification. The resultant 0.8 kb DNA fragment is digested with restriction enzymes Spe I and Xba I, purified following agarose gel electrophoresis, and ligated into

the pSP72/REI 1B4 intermediate vector which is digested with the same two restriction enzymes and electrophoretically purified from its liberated REI/1B4 variable region containing DNA fragment (see Figure 23). The combined light chain variable region and kappa constant region within a sequence verified clone (p8967) is excised by digestion with restriction enzymes Spe I and Cla I and this 1.5 kb agarose gel electrophoretically purified DNA fragment is cloned into the light chain expression vector p8953, after this latter plasmid is electrophoretically purified from its REI/1B4/kappa light chain insert following digestion with both Spe I and Cla I restriction enzymes. The fully CDR-grafted Gal/1B4 heavy chain expression vector and the fully CDR-grafted Len/1B4 or REI/1B4 light chain expression vector DNAs (10 ug each) are co-transfected into 293 cells and the antibody present in conditioned medium 48 hours later is isolated by protein A Sepharose chromatography. The avidity of these two recombinant antibodies for the CD18 ligand present on the surface of activated human PMNs is determined and compared to that of the murine 1B4 MAAb (Figure 20). The differences between the two humanized 1B4 recombinant antibodies for the ligand, as measured by their IC_{50} s, revealed that a comparison of p values between Gal/Rei and Gal/Len are statistically significant by the students unpaired t-test but the standard deviations of both Mabs overlap (see Figure 20). Thus, although the Len light chain variable region framework sequences, relative to the REI light chain frameworks, show more identical residues and more similar residues when aligned to the murine 1B4 frameworks, this has little, if any, impact on the antibody/antigen interactions measured by avidity. Comparison of the presumed three dimensional structure of these two light chain variable regions (REI and Len) indicates that the alpha carbon trace of the 1B4 CDRs residing within these frameworks are superimposable, again suggesting that the both frameworks identically support the CDRs in space. Does the 1B4 heavy chain variable region play a greater role in avidity of the antibody for its ligand? To address this question, and also to investigate the role of a small number of heavy chain variable region framework sequences, modifications of the Gal/1B4 fully grafted molecule are performed.

Three residues within the heavy chain variable region of Gal/1B4 are chosen to mutate such that they become identical to their counterparts in the murine 1B4 framework (see Figure 14). To accomplish the mutation of three well separated residues simultaneously the following procedures are performed. Four oligodeoxynucleotide primer pairs (Figure 26) are synthesized which incorporate the deoxynucleotide alterations necessary to mutate the amino acid residues located in FR1, FR2, and FR4 of the Gal/1B4 DNA template. In this instance, the polymerase chain reactions needed to produce four overlapping DNA

fragments were amplified in such a way as to generate primarily single-stranded DNAs representing the outside two DNA fragments, while the inside two DNA fragments are amplified so as to produce double-stranded DNAs. This approach of combining four amplified DNAs is facilitated by the above modification and, when combined with the use of terminal amplifying oligodeoxynucleotide primers which are unique to residues found only in the outside amplified DNA fragments, remove the need to purify the PCR products between the first and second round of amplification. Thus, asymmetric PCR is used to amplify the two terminal DNA fragments. Combined into the standard PCR amplification reactions are 50 p moles of primer #S1 and 0.5 p moles of primer #G2 (Figure 26) or 50 p moles of primer #I2 and 0.5 p moles of primer #G2 (Figure 26) and the Gal/1B4 containing plasmid DNA template (10 ng/reaction), 2.5 units of Taq polymerase, and the remaining standard reaction components. The two internal DNA fragments are amplified using the standard procedures which include the presence of 50 p moles of each of the oligodeoxynucleotide primers, 2.5 units of Taq polymerase, and the same template DNA and reaction components described above. Following 25 cycles of amplification (as described previously) the reactions are made to contain 1 ml of H₂O, and each is placed in a Centricon 100 cartridge (Amicon, Danvers, MA), centrifuged for 30 minutes at 3500 x g, at 4° C, and the retentate is resuspended in another 1 ml of H₂O and the centrifugation is repeated. The final retentate is resuspended in 100 µl of H₂O. Each of the four reaction products is combined (1 µl of each of the retained DNA solutions), the standard components are added, 2.5 units of Taq polymerase, and 50 p moles of the PCR recombination amplifying primers (Figure 26), and the reaction is cycled 25 times. The resultant 0.8 kb DNA fragment is phenol extracted, concentrated by ethanol precipitation, and digested with Spe I and Bam H1 restriction enzymes. Following purification of this 0.8 kb DNA fragment by agarose gel electrophoresis it is cloned into the heavy chain expression vector p8958, after this latter plasmid is electrophoretically purified from its Gal/1B4 heavy chain variable region insert liberated by digestion with both Spe I and Bam H1 restriction enzymes. The fully CDR-grafted Gal-m1/1B4 heavy chain expression plasmid DNA is co-transfected (10 ug of each DNA) with the fully CDR-grafted REI/1B4 light chain expression plasmid DNA or the fully CDR-grafted Len/1B4 light chain expression plasmid DNA into 293 cells. The resultant antibodies present in the conditioned medium 48 hours later are isolated by protein A sepharose chromatography and subjected to avidity measurements. Independent of the origin of the light chain variable region framework, the measured avidity for CD18 on the surface of activated human PMNs of the two antibodies is nearly identical. Again

the role of the light chain variable region frameworks seems to be minimal. The avidity of the mutated Gal framework (mutated Gal/Rei, Figure 20) is significantly improved relative to the non-mutated Gal heavy chain framework (Gal/Rei in Figure 20) support and its avidity is nearly equivalent to that of native m1B4 (Figure 20). It is concluded that one or more of the three residues mutated contributes to the display of the CDRs (antigen binding sites), thus proper framework choice is critical for optimal humanization of recombinant antibodies. Indeed, it appears that the framework closest to the CDRs dictates the final structural arrangement of the CDRs and thus the ability to bind antigen. Additional comparisons of the heavy chain frameworks reveal major differences between those of New and Jon or Gal when the "packing" residues are examined (Figure 14). Packing residues as used herein is defined as internal or non-surface exposed residues of the structure that may be involved in intrastrand or interstrand forces. These packing residues are associated with the framework regions adjacent to the CDRs and are involved in the proper orientation of the CDRs for interaction with the substance that induced the antibody formation. Only 27 of 41 internal residues of New match the corresponding residues in the murine 1B4 framework. This is contrasted to the match of 38 of 41 residues by the human Gal framework. The localization of the region of greatest variation to those residues ending framework 2 may explain the differences between the Gal and Jon supported antibodies. This region of framework 2 is where these two differ and where Gal-m1 differs from Gal.

EXAMPLE 3

Enhanced Expression systems

This example shows expression systems employed to produce large quantities of recombinant CDR-grafted 1B4 antibodies as discussed in Example 2. The first expression system applicable to many mammalian cells utilizes the extrachromosomal characteristics of EBNA-1/oriP based DNA plasmids (Yates et al., Nature : 313 : 812, 1985). Such a vector, pREP3 described by Hambor et al. (Proc. Natl. Acad. Sci. USA 85 : 4010, 1988), containing the hygromycin B selection cassette and the Rous Sarcoma Virus (RSV) LTR for transcription of the gene of interest was modified as disclosed. The RSV LTR, as well as the poly A addition signal, was removed by digestion of the pREP3 plasmid DNA with Sal I and Xba I followed by agarose gel purification of the 9.02 Kb promoterless fragment. DNA from plasmid pD5mcs (see Figure 10), containing the adenovirus major late promoter, a multi-cloning site, and SV40 poly A addition signal was used as the template for the PCR amplification of those sequences beginning with the SV40 enhancer

and ending with the SV40 poly A addition signal. In the process of amplification Xba I and Sal I restriction enzyme sites were appended to the product ends by their incorporation into the synthetic PCR oligodeoxynucleotide primers. The expected 1.26 Kb PCR amplified product was agarose gel purified following its digestion with Xba I and Sal I restriction enzymes and ligated into the 9.02 Kb EBNA/oriP backbone vector. The resultant plasmid (p8914) constitutes a versatile mammalian expression vector into which can be ligated either the heavy chain or light chain expression cassette contained within plasmid p8958 (see Figure 19) or p8953 (see Figure 6), respectively. The p8914 plasmid was also the template for the HIVLTR promoter version of the EBNA/oriP backbone vector. In order to switch to the HIVLTR promoter the p8914 plasmid DNA was digested with Bam H1 and Xba 1. The 9.35 Kb promoterless backbone was purified by agarose gel electrophoresis. The HIVLTR promoter, from residue -117 to +80 (as found in the vector pCD23 containing this portion of the HIV-1 LTR ; (Cullen, Cell 46 : 973 [1986]) was PCR amplified from the plasmid pCD23 using oligodeoxynucleotide primers which appended to the ends of the product the Spe I and Bcl I restriction sites. Following the digestion of the resulting 0.24 Kb PCR product with these latter enzymes the fragment was agarose gel purified and ligated into the 9.35 Kb DNA promoterless DNA fragment described above. The p8962 plasmid so constructed was also the recipient of the heavy and light chain cassette (Figure 37). To accomplish this the p8962 plasmid DNA was digested within its multicloning site with Not I and Xba I so as to linearize the DNA. The 9.5 Kb linearized expression vector DNA was ligated to either the 2.5 Kb heavy chain cassette obtained by agarose gel purification of Not I and Spe I digested p8960 DNA or the 1.5 Kb light chain cassette obtained similarly following digestion of p8953 DNA with Not I and Spe I. These constructed EBNA/oriP based expression vectors ,p8969 and p8968, (Figure 38) were co-transfected into CV1P cells (monkey kidney cells ; Figge et al., Cell 52 : 713 [1988]) which constitutively express the HIV-1 TAT protein by virtue of having previously been transfected with the plasmid pMLTAT (Siekevitz et al., Science 238 : 1575 [1987]). The cell clones which arose in DMEM medium containing 10% heat inactivated newf born calf serum, 200 µg/mL of G418, and 100 µg/ml of hygromycin B were picked using cloning cylinders (Fishney, In, Culture of Animal Cells, Alan R. Liss, Inc. New York, 1983) and expanded individually. Clones were screened for the secretion of recombinant antibody using the ELISA assay previously described. Multiple cell clones were expanded and their antibody secretion levels were determined to be in the range of 75 ng - 2 µg of antibody per 96 wells of medium conditioning of 6 well plate cultures. The most productive of these clones was eventually adap-

ted to growth on microcarriers (cyledex 3 and cultisphere GL) and produced approximately 100 mg/L of recombinant antibody each 3 day harvest in serum-free medium at a cell density of $1-2 \times 10^6$ cells per ml.

EXAMPLE 4

In Vitro Activity Of Recombinant Human Anti-CD18 Antibodies

To increase the precision of avidity determinations, the 1B4 competitive binding assay of Example 2 was modified as follows. Both m1B4 (50 μ g) or h1B4 (from Example 3) were iodinated using chloramine-T, and the radiolabeled IgG purified over a Bio-Sil TSK250 (Biorad) gel filtration HPLC column that fractionates proteins in the range of 5-300 x 10³ daltons. Effluent radioactivity was monitored with a Beckman #170 in-line gamma counter (Beckman, Fullerton, CA), the total protein was detected by absorbance at 280 nm with a Kratos Spectroflow 757 detector (Kratos, Mahwah, NJ), and the column was equilibrated with 0.1 M phosphate buffer (pH 7.0). A single symmetrical peak of coincident absorbance and radioactivity tracings was routinely observed at 6 min. 30 sec. following sample injection (the retention time characteristic of IgG in this system). Specific activity of the product was usually 10 mCi/mg for m1B4 or 70mCi/mg for h1B4; 96-98% of the counts were trichloroacetic acid-precipitable in either case. SDS-PAGE and autoradiography of ¹²⁵I labeled antibody showed that 1B4 remained intact following radiolabeling. Using these radio-labeled probes, a competitive ¹²⁵I-1B4 suspension binding assay was established to determine the avidity of m1B4 or r-h-anti-CD18 (h1B4) for CD18 expressed at the leukocyte surface. Human venous blood was collected freshly into heparin (1.0 unit/ml). PMNs were purified on a Ficoll/Hypaque gradient and activated with 100 ng/ml phorbol myristate acetate in Hanks balanced salt solution containing 20 mM Hepes (pH 7.2), 0.14 units Aprotinin and 2% human serum albumin (binding buffer) for 20 min at 37°C; viability was always >95% by trypan blue exclusion following PMA activation. After washing with binding buffer, aliquots of 1×10^5 stimulated PMNs were incubated in about $2-4 \times 10^{-11}$ M ¹²⁵I-1B4 in the presence of increasing concentrations of unlabeled murine or humanized 1B4 (about 10^{-16} to 10^{-7} M) in duplicate or triplicate 300 ml volumes for 1 h at 4°C with constant agitation. The concentrations of purified radio-iodinated 1B4 or unlabeled antibody added as a competitor were determined by U.V. absorption using an E₂₈₀ of 1.35 for m1B4, 1.25 for mutant Gal/Rei h1B4, and 1.30 for all other h1B4 constructs [determined by the formula $E = A(E_{cys}) + A(E_{tryp}) + A(E_{tyr})$ where A = the number of residues of each amino acid; Gill and von Hippel, Anal. Biochem., 182: 319-328, 1989; the E₂₈₀ of

m1B4 and Gal/Rei h1B4 were also verified by quantitative amino acid analysis and differential UV spectroscopy]. After labeling, the ¹²⁵I-1B4 bound to the cells was separated from unbound antibody by underlaying each aliquot of PMNs with 250 μ l 0.5 M sucrose and centrifugation (4,800 x g, 3 min.); the tubes were frozen on dry ice, and the tips cut off and counted with an LKB gamma counter. The quantity of PMN-bound ¹²⁵I-1B4 for each concentration of purified unlabeled competitor IgG was expressed as the mean CPM per 1×10^5 PMNs (\pm SEM). IC₅₀s for inhibition of ¹²⁵I-1B4 binding were calculated using a four parameter program ("Fitter"; Rodbard, Munson, and Delean in "Radioimmunoassay and Related Procedures in Medicine", International Atomic Energy Agency, Vienna, vol I, 469-504, 1978). The results of the binding assays are illustrated in Figures 13, 20, 28, and 29 (p values are from Student's unpaired t-test). These data indicate that: 1) the avidity of Gal/Rei h1B4 for PMN CD18 is nearly comparable to that of m1B4 (about 2-3 fold weaker); 2) the avidities of Jon/Rei and New/Rei are still weaker than that of Gal/Rei in a rank order that correlates inversely with their degree of homology relative to m1B4 frameworks; 3) the avidity of Gal/Len is nearly equivalent to the avidity of Gal/Rei; and 4) that mutant Gal/Rei and the demi-chimeric construct possess affinities apparently comparable to that of native 1B4.

Inhibition of PMN attachment to human umbilical vein endothelial cell (HUVEC) monolayers.

To reach tissue sites and cause inflammatory damage, PMNs must pass out of the bloodstream. This transendothelial migration depends on interaction of PMN CD18-containing receptors with ligands on and within the human endothelium. A direct expression of this process is reflected by attachment of agonist-treated PMNs to the vascular surface. To demonstrate that Gal/Rei h1B4 is a prospective anti-inflammatory agent for use in human disease, we determined whether this construct inhibits adhesion of PMA-stimulated hPMNs to quiescent human endothelial cell monolayers. Human umbilical vein endothelial cells (HUVECs) were grown in T-75 flasks coated with Vitrogen 100 (Collagen Corp., Palo Alto, CA) diluted 1:10 with PBS and dried onto the substrate. The culture medium was MCDB 107 supplemented with 15% FCS, 90 mg/ml heparin (GIBCO), and 150 mg/ml endothelial mitogen (Biomedical Technologies, Inc.); the cells were incubated in 2.5% CO₂ and 97.5% air. Cultures (passages 4-8) were dissociated with trypsin/EDTA, and the HUVECs seeded into 96-well microtiter plates (Costar) pre-coated with a 5 μ g/ml solution of purified human plasma fibronectin in 0.1M bicarbonate (pH 8.3); these microcultures were used for the attachment assay upon reaching confluence. Human PMNs were

purified from peripheral blood as described above. To measure their attachment to the HUVEC monolayers by fluorescence microscopy, PMNs were labeled with the vital fluorescent dye 1',1'-dioctadecyl-3,3',3'-tetramethylindocarbocyanine (Dil) (Molecular Probes, Inc.). PMNs were incubated in a 25 mg/ml sonicated solution of Dil in binding buffer for 10 min. at 37 °C, washed, and then activated with 50-100 ng/ml PMA or PDB for 10 min. at 37 °C. (These dil-labeled PMNs were tested in the competitive 1B4 binding assay to verify that their CD18 receptors were recognized by h1B4; the IC₅₀s were within the range expected for unlabeled PMNs). PMN aliquots (in quadruplicate) were pretreated with increasing concentrations of either Gal/Rei h1B4, m1B4, or the control Mab OKM-1 (associates with the CD11b component of the CR3 receptor but does not inhibit ligand binding). Incubation was performed for 15 min. at 4 °C with constant agitation, and the cells placed into the microwells containing the HUVEC monolayers (50,000-100,000 PMNs/well). The PMNs were permitted to settle for 5 min. at 4 °C, and then incubated for 15 min at 37 °C to allow firm adhesion to occur. Unattached PMNs were removed and the cultures fixed by gentle washing with 1% formaldehyde in PBS (4 washes with an Eppendorf Plus 8 multtipipette). The wells were filled with a solution of 5% n-propyl gallate in glycerol, and the attached PMNs counted at 195 x under rhodamine illumination with an automated Nikon Diaphot inverted fluorescent microscope fitted with an autofocus device, a customized motorized stage, and a video camera (Vidicon #8451) connected to a Model 3000 image analyzer (Image Technology Corp., Deer Park, NY) and an IBM PCXT computer. The mean number of adherent PMNs was determined for each concentration of Mab tested (± SEM), and an inhibition curve plus IC₅₀ generated with the "Fitter" program (Rodbard et al, supra.); the data were normalized. The results of these experiments are presented in Figure 30 and Figure 31. Both Gal/Rei h1B4 and m1B4 produced congruent sigmoidal inhibition curves with nearly equivalent IC₅₀s (4-8 nM) that were not significantly different by Students' unpaired t-test. The OKM-1 control IgG did not inhibit PMN attachment. Thus, Gal/Rei h1B4 inhibits adhesion of activated hPMNs to human umbilical vein endothelial cell monolayers to the same extent as native m1B4 in a quantitative homotypic *in vitro* adhesion assay, illustrating anti-inflammatory activity.

Inhibition of CTL-mediated cytotoxicity

Cytotoxic T-lymphocyte (CTL) directed cell killing is an important component of graft rejection following tissue or organ transplantation. Since attachment to and killing of target cells is a CD18-dependent intercellular adhesive event, we determined whether Gal/REI h1B4 inhibits human CTL-mediated cell lysis.

Human Q-31 CTL cells were cultivated in RPMI 1640 supplemented with 10% bovine calf serum and 30 units/ml recombinant human IL-2. To induce the differentiated state, fragments of irradiated JY human lymphoblastoid cells were added to the media for 6-7d. The JY cells were propagated as above except without IL-2, and also served as targets for the Q-31 cells. To compare the effects of m1B4 and Gal/Rei h1B4 on cell killing, Q-31 cells were incubated in media with various antibody concentrations for 30 min. at 25 °C before addition of the target cells. To quantify cytotoxicity, JY target cells were labeled with ⁵¹Cr and mixed with effector cells at various E:T ratios of 8:1 to 2.5:1 at 37 °C. After 4h, the percent of ⁵¹Cr liberated into the culture medium for each concentration of antibodies was determined (in triplicate) as an index of cell killing. Cell killing curves that were generated simultaneously with various concentrations of m1B4 (mOKM-1 control) or Gal/Rei h1B4 (hlgG4 control) were utilized to calculate IC₅₀s (Figure 31). Both Gal/Rei h1B4 and m1B4 inhibited JY cell lysis to the same extent. In each case, the mean IC₅₀ was equal to about 2 nM 1B4, and the inhibition curves for both antibodies were superimposable. These results indicate that Gal/Rei 1B4 can prevent the rejection of transplanted tissues and organs.

Tissue and Cellular Specificity of Gal/Rei HhB4

The process of humanization might engender abnormal binding properties that could cause h1B4 to associate with and accumulate in unexpected sites in tissues, cells, and their organelles, with toxic consequences. To ascertain whether the binding properties of Gal/Rei h1B4 were altered, we compared the immunofluorescence microscopic (IF) and immunoelectron microscopic (IEM) localization of Gal/Rei h1B4 and native m1B4 in various rabbit tissues, and in human PMNs, U-937 cells, and fibroblasts.

IF Staining of Tissues and Cells

Healthy 2 kg male New Zealand white rabbits were euthanized, and approximately 1.0 x 1.0 x 0.5 cm³ tissue blocks were excised, immersed in OCT mounting medium (Miles), and frozen rapidly in liquid nitrogen-cooled Freon 22 (Dupont) at ~-150 °C. Samples were obtained from the following organs: bone marrow, cerebrum, kidney, large intestine, liver, lungs, lymph nodes, myocardium, stomach, striated muscle (leg), and spleen, and stored at -80°C. On the day of an experiment, 5 µm frozen tissue sections were cut with a cryostat at -20 °C, placed on poly-L-lysine-coated glass slides, and air-dried at 25 °C. The sections were immediately immunostained without fixation to avoid denaturation of CD18 antigens. In order to inhibit non-specific binding, slides were

washed in 0.1 M Tris-HCl buffer (pH 7.8), and incubated with the clarified supernatant of a solution of 5% non-fat dry milk (Camation) in 0.1% BSA, 0.1% NaN₃, and 0.1 M phosphate buffer, pH 7.8 for 1 h at 25 °C. All subsequent staining steps were also conducted for 1 h at 25 °C with intermittent washes in 0.1 M Tris-HCl (pH 7.8). For single-labeling experiments, the sections were stained with a 20 µg/ml solution of primary antibody (m1B4, Gal/Rei h1B4, or hlgG4 control) in staining buffer [0.1% non-fat dry milk, 0.1% BSA, 0.1% NaN₃, and 0.1 M phosphate buffer (pH 7.8)]. Bound antibodies were detected indirectly with a 25 µg/ml solution of fluorescein isothiocyanate-conjugated affinity-purified goat anti-mouse IgG, or goat anti-human IgG FITC conjugate (Kirkegaard and Perry, Inc.) in staining buffer. In double-staining experiments, specimens were immunolabeled with a mixture of primary antibodies (1 µg/ml m1B4 and 1 µg/ml h1B4 in staining buffer centrifuged at 12,000xg for 15 min.), followed by a clarified mixed-antibody detection solution [25 µg/ml fluorescein isothiocyanate-conjugated affinity-purified goat anti-human IgG and 25 µg/ml rhodamine isothiocyanate-conjugated affinity-purified goat anti-mouse IgG (Kirkegaard and Perry, Inc.) in staining buffer]. Controls for the dual-labeling experiments were clarified solutions of mixed m1B4 plus hlgG4 (1 µg/ml of each antibody), or m1B4, Gal/Rei h1B4, and hlgG4 dissolved alone at 1 µg/ml IgG in staining buffer; IgGs were localized on the sections with the mixed-antibody detection solution described above. Coverslips were mounted on the slides with a solution of 5% n-propyl gallate in 90% glycerol and 10% 1.0 M Na-bicarbonate, and the sections studied with a Zeiss Photomicroscope III equipped with epifluorescence illumination and fluorescein & rhodamine interference filter combinations. Photomicrographs were taken at 16x or 40x with Zeiss neofluar oil-immersion objective lenses using Ilford HP-5 high-speed film at speeds of 1600-6300 ASA.

The IF staining patterns of Gal/Rei h1B4 and m1B4 in rabbits are summarized in Figure 32. Specific CD18-positive IF labeling for both recombinant and native 1B4 IgGs was observed in tissues known to contain leukocytes. There was no detectable difference in IF distribution or intensity observed with Gal/Rei h1B4 versus m1B4, and control tissues treated with hlgG4 or buffer were always negative. By far, sections of bone marrow presented the most intense CD18 staining with either species of 1B4; 79% of these cells exhibited cytoplasmic labeling. Leukocytes of the spleen and the lymph nodes were stained more irregularly and with lower intensity. A conspicuous population of resident leukocytes was detected in the lungs, and to a much lesser extent in kidney glomeruli. Surprisingly, no CD18 staining was seen in the microglial cells of the cerebrum or in the Kupffer cells of the liver. The other tissues were completely

unstained. Titration of the primary antibody solution indicated that a 1.0 µg/ml solution of h1B4 or m1B4 was the minimum concentration of either antibody required to obtain maximum IF staining of bone marrow sections.

Dual IF staining experiments were conducted to determine whether the antigens recognized by Gal/Rei h1B4 and m1B4 are colocalized in the same cells. Cryosections of bone marrow, spleen, or lymph node were double-labeled with mixtures of Gal/Rei h1B4 and m1B4. As illustrated in Figure 33 for bone marrow, every cell that was positively stained with m1B4 was also labeled with Gal/Rei h1B4. In the control groups, Gal/Rei h1B4 staining (detected under fluorescein optics) was specifically eliminated by substituting hlgG4 for h1B4 in the primary antibody mixture, while retaining the m1B4 labeling (visualized with rhodamine filters). With the converse control, removal of m1B4 from the mixture of primary antibodies ablated the rhodamine labeling, but had no effect on the fluorescein staining generated by Gal/Rei h1B4. These 1B4-colocalization results were therefore highly specific.

These data indicate that native and Gal/Rei humanized 1B4 were localized in the same cells (leukocytes) and exhibited identical staining specificity and intensity in various rabbit tissues. The highest levels of CD18 labeling were observed in those tissues which contain large numbers of leukocytes, with the bone marrow presenting the most intense staining. Therefore, our humanization process has not altered the specificity of 1B4 IgG detectable at the light microscopic level of resolution.

IEM Staining of Human Cell Organelles.

Double label immunoelectron microscopic experiments were conducted to compare the specificity of Gal/Rei h1B4 and m1B4 at the subcellular/supramolecular level of resolution. CD18 antigens have been localized to the specific granules of hPMNs and monocytes via IEM with 60.3 (another Mab that recognizes CD18; Singer et al., *J. Cell Biol.* 109: 3169-3182 [1989]). Therefore, we determined whether Gal/Rei h1B4 and m1B4 were codistributed in these granules. Human PMNs were isolated from venous blood as described above and prepared for IEM via a modification of a published method (Singer et al, supra). Briefly, the PMNs were fixed with a solution of 3.5% paraformaldehyde and 0.05% glutaraldehyde in 0.1M Na-cacodylate (pH 7.2), 0.1M sucrose, and a mixture of broad spectrum protease inhibitors. Fixation was performed under microwave irradiation until the cells reached 45°C (~45 sec.), followed by quenching with excess buffer at 4°C. Cell pellets were embedded in 7% acrylamide, infiltrated with 2.3M sucrose in 0.1M phosphate (pH 7.2), frozen in liquid propane (-190°C) and cut into ultrathin (~80 nm)

cryosections. The specimens were double labeled with Gal/Rei h1B4 and m1B4 using 5 nm and 10 nm protein-A colloidal gold conjugates (Janssen Life Science Products) as described, and analyzed at 29,000x with a JEOL 100CX transmission electron microscope. A summary of the immunostaining results for PMNs is shown in Figure 34. Both Gal/Rei h1B4 and m1B4 were colocalized in specific granules; negative controls showed that the colloidal gold probes were not cross-reacting nonspecifically. Further, Gal/Rei h1B4 and m1B4 were also colocalized within a population of cytoplasmic granules in U-937 cells (a human myelomonocytic line), but not in human lung fibroblasts (IMR-90). These observations strongly suggest that the binding specificity of Gal/Rei h1B4 is comparable to that of m1B4 at supramolecular resolution.

EXAMPLE 5

In Vivo Activity Of Recombinant Human Anti-CD18 Antibodies

The in vivo potencies of murine 1B4 (m1B4) and humanized 1B4 (h1B4) (Examples 2 and 4) were compared in the rabbit by assessing their ability to inhibit dermal inflammation, manifest as PMN accumulation and plasma extravasation, elicited by intradermal administration of C5a.

The dorsal hair of female New Zealand White rabbits (2 - 2.5 kg) was shaved at least 24 hours prior to experimentation. Rabbits were anesthetized with an intramuscular injection of Ketamine HCl (60 mg) and Xylazine (5 mg). [¹²⁵I]-Bovine serum albumin (10 μCi) was injected into the marginal ear vein, as a marker of plasma extravasation. Groups of animals were then treated with saline, m1B4 administered intravenously at 0.07, 0.21 or 0.7 mg/kg, or h1B4 administered intravenously at 0.1, 0.3 or 1 mg/kg 15 minutes before initiation of the dermal inflammation. Thereafter, human recombinant C5a (100 pmol), or saline, in a volume of 50 μl was injected intradermally into 4 replicate sites in the dorsum. Three hours later, a blood sample (1 ml) was taken and centrifuged (8000g; 3 min; 20°C) to prepare cell-free plasma which was aspirated and retained. Animals were then euthanized with approximately 750 μl Solumb (Sodium Pentobarbital 389 mg/ml in 40% isopropyl alcohol), and injection sites were excised using a 6 mm biopsy punch. Radioactivity ([¹²⁵I]) present in skin samples and cell-free plasma (50 μl) was quantified using a gamma counter. By reference to the specific radioactivity of the cell-free plasma, the extent of plasma extravasation was expressed as μl plasma equivalents per 6 mm biopsy. The skin biopsy was then homogenized in 5 ml of 0.5% Hexadecyltrimethyl ammonium bromide (HTAB) using a polytron homogenizer. Chloroform (1 ml) was added to the

sample, which was vortexed and centrifuged (1600g; 15 min.; 20°C). Four aliquots (50 μl) of the aqueous supernatant were added to wells in a 96 well plate for measurement of myeloperoxidase (MPO) activity, as an index of PMN content. Duplicate wells of the 96 well plate received 200 μl buffer (KH₂PO₄ 44 mM; K₂HPO₄ 6 mM; H₂O₂ 0.0015%; pH 6.0) alone (background) and duplicate wells received buffer containing MPO substrate (3',3-Dimethoxybenzidine dihydrochloride; 360 μg/ml). Reactions were allowed to proceed for 15 min. at room temperature, and MPO activity was measured as the change in absorbance at 450 nm measured in a plate reading spectrophotometer. By reference to a standard curve constructed using known quantities of rabbit PMN in HTAB, the extent of PMN accumulation in each skin biopsy was estimated.

The injection of C5a into the skin of rabbits pretreated with saline produced significant increases in PMN accumulation (Figure 35) and plasma extravasation (Figure 36) compared with skin sites injected with saline. In animals pretreated with either m1B4 or h1B4 there was dose-related inhibition of both PMN accumulation (Figure 35) and plasma extravasation (Figure 36). Both antibodies were of comparable potency, as indicated by the estimated ED₅₀ values for inhibition of PMN accumulation and plasma extravasation which were approximately 0.15 mg/kg for both m1B4 and h1B4.

Claims

1. A recombinant human anti-CD18 antibody or active fragment thereof.
2. The recombinant human anti-CD18 antibody or fragment thereof of claim 1 wherein the antibody or fragment is capable of binding to cells expressing leukocyte integrins selected from the group consisting of LFA-1, Mac-1 or p150,95.
3. The recombinant human anti-CD18 antibody or fragment thereof of claim 1 wherein the antibody or fragment is capable of binding to cells expressing the CD18 integrin subunit.
4. The recombinant human anti-CD18 antibody or fragment thereof of claim 1 wherein the antibody or fragment is capable of binding to leukocytes and preventing the leukocytes from entering an inflammatory lesion.
5. A recombinant human immunoglobulin comprising a human heavy chain framework and murine complementarity determining regions, a human light chain framework and murine complementarity determining regions wherein said human

immunoglobulin is capable of binding to a human CD18 integrin.

6. A murine 1B4 light chain variable region amino acid sequence as shown in Figure 3.
7. A DNA sequence coding for the murine 1B4 light chain variable region amino acid sequence of claim 6.
8. A murine 1B4 heavy chain variable region amino acid sequence as shown in Figure 3.
9. A DNA sequence coding for the murine 1B4 light chain variable region amino acid sequence of claim 8.
10. A DNA sequence coding for the recombinant human anti-CD18 antibody of claim 1.
11. A DNA sequence coding for the recombinant human immunoglobulin of claim 5.
12. A vector containing the DNA sequence of claim 10.
13. A vector containing the DNA sequence of claim 11.
14. A mammalian host transfected by the vector of claim 12 containing the DNA sequence coding for recombinant human anti-CD18 antibody.
15. A mammalian host transfected by the vector of claim 13 containing the DNA sequence coding for recombinant human immunoglobulin.
16. A process for the preparation of recombinant human anti-CD18 comprising culturing the transformed mammalian host of claim 14 under conditions suitable for the expression of recombinant human anti-CD18 antibody and recovering said antibody.
17. A process for the preparation of recombinant human anti-CD18 comprising culturing the transformed mammalian host of claim 15 under conditions suitable for the expression of recombinant human anti-CD18 antibody and recovering said antibody.
18. An inflammatory reducing or inhibiting pharmaceutical composition comprising an effective inflammatory inhibiting amount of the recombinant human anti-CD18 antibody of claim 1 and a pharmaceutical carrier.
19. The use of the recombinant human anti-CD18

5

10

15

20

25

30

35

40

45

50

55

23

antibody of claim 17 for the manufacture of a medicament suitable for preventing or reducing inflammation.

20. The recombinant human anti-CD18 antibody of claim 1 wherein the antibody specifically reacts with leukocyte integrins LAF-1, Mac-1 and p150,95.

21. A recombinant human heavy chain framework into which has been grafted murine complementarity determining regions with said complementarity determining regions being specific for human CD18 integrin.

22. A recombinant human light chain framework into which has been grafted murine complementarity determining regions with said complementarity determining regions being specific for human CD18 integrin.

Fig. 1

Mouse Light Chain Variable Region

5' upstream primer - FR1 of variable region

5'- TCT CGG ATC CGA (CT)AT (TC)GT G(AC)T (GC)AC CCA (GA) -3'
Bam H1

3' downstream primer - kappa constant region

5'- TCT CAA GCT TTG GTG GCA AGA T(GA)G ATA CAG TTG GTG CAG C -3'
Hind III

Mouse Heavy Chain Variable Region

5' upstream primer - FR1 of variable region

i) 5'- TTC TGG ATC C(CG)A GGT (GCT)CA (AG)CT G(AC)A G(GC)A GTC (TA)GG -3'
Bam H1

ii) 5'- TTC TGG ATC C(CG)A GGT (GCT)AA GCT GGT G(GC)A GTC (TA)GG -3'
Bam H1

3' downstream primer - IgG2a CH1 region

5'- TCT CAA GCT TAC CGA TGG (GA)GC TGT TGT TTT GGC -3'
Hind III

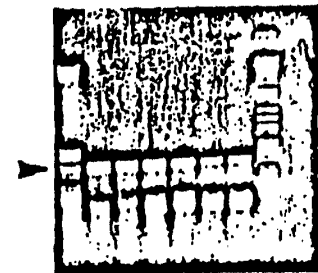
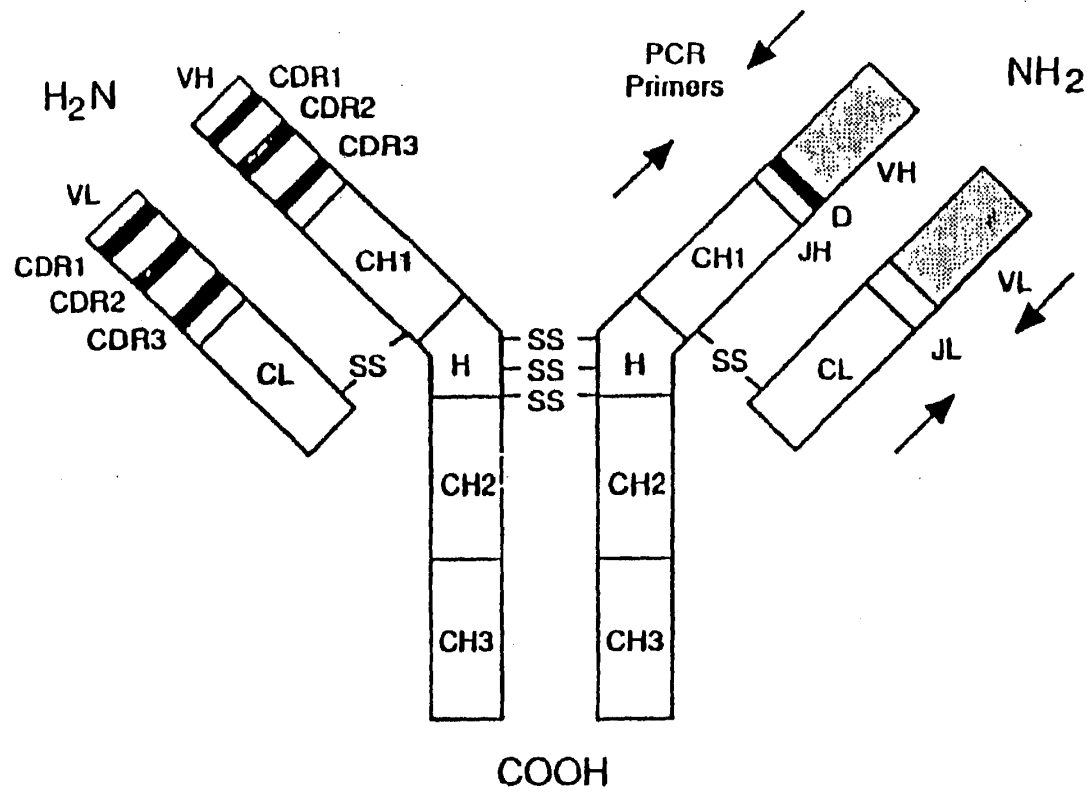

25

Fig. 2

Fig. 3

1B4 HEAVY CHAIN

Asp*Val Lys Leu Val Glu Ser Gly Gly Asp Leu Val Lys Leu Gly Gly Ser Leu
Lys Leu Ser Cys Ala Ala Ser Gly Phe Thr Phe Ser [Asp Tyr Tyr Met Ser] Trp
 Val Arg Gln Thr Pro Glu Lys Arg Leu Glu Leu Val Ala [Ala Ile Asp Asn Asp
 Gly Gly Ser Ile Ser Tyr Pro Asp Thr Val Lys Gly] Arg Phe Thr Ile Ser Arg
 Asp Asn Ala Lys Asn Thr Leu Tyr Leu Gln Met Ser Ser Leu Arg Ser Glu Asp
Thr Ala Leu Tyr Tyr Cys Ala Arg [Gln Gly Arg Leu Arg Arg Asp Tyr Phe Asp
Tyr] Trp Gly Gln Gly Thr Thr Leu Thr Val Ser Ser Ala Lys Thr...

1B4 LIGHT CHAIN-1

Asp Ile Val Leu Thr Gln Ser Pro Ala Ser Leu Ala Val Ser Leu Gly Gln Arg Ala
Thr Ile Ser Tyr [Arg Ala Ser Lys Ser Val Ser Thr Ser Glu Tyr Ser Tyr Met
His] Trp Asn Gln Gln Lys Pro Gly Gln Pro Pro Arg Leu Leu Ile Tyr [Leu Val
Ser Asn Leu Glu Ser] Gly Val Pro Ala Arg Phe Ser Gly Ser Gly Ser Arg Thr
Asp Phe Thr Leu Asn Ile His Pro Val Glu Glu Glu Asp Ala Ala Thr Tyr Tyr
Cys [Gln His Ile Arg Glu Leu Thr] Arg Ser Glu Gly Gly Pro Ser Trp Lys ter

1B4 LIGHT CHAIN-2

Asp Ile Val Leu Thr Gln Ser Pro Ala Ser Leu Ala Val Ser Leu Gly Gln Arg Ala
Thr Ile Ser Cys [Arg Ala Ser Glu Ser Val Asp Ser Tyr Glu Asn Ser Phe Met
His] Trp Tyr Gln Gln Lys Pro Gly Gln Pro Pro Lys Leu Leu Ile Tyr [Arg Ala
Ser Asn Leu Glu Ser] Gly Ile Pro Ala Arg Phe Ser Gly Ser Gly Ser Arg Thr
Asp Phe Thr Leu Thr Ile Asn Pro Val Glu Ala Asp Asp Val Ala Thr Tyr Tyr
Cys [Gln Gln Ser Asn Glu Asp Pro Leu] Thr Phe Gly Ala Gly Thr Lys Leu Glu
Leu Lys Arg Ala Asp...

[CDRs] ; underline = homology to protein sequence

Asp* determined from N-terminal amino acid sequencing; PCR primer
 encoded GAG for Glu

Fig. 4

S1 5'- CAT TCG CTT ACC AGA TCT AAG CTT ACT AGT GAG ATC ACA GTT CTC TCT AC -3'
Bgl II Hind III Spe I

R1 5'- GCC ATA ACT ATC AAC ACT TTC ACT GGC TCT ACA GGT GAT GGT CAC TCT GTC -3'

R2 5'- GTG TTG ATA GTT ATG GCA ATT CTT TTA TGC ACT GGT ACC AGC AGA AGC CAG G -3'

R3 5'- GAT TCT AGG TTG GAT GCA CCG TAG ATC AGC AGC TTT GGA GC -3'

R4 5'- GCA TCC AAC CTA GAA TCT GGT GTG CCA AGC AGA TTC AGC -3'

R5 5'- GGA TCC TCA TTA CTT TGC TGG CAG TAG TAG GTG GCG ATG TC -3'

R6 5'- CAA AGT AAT GAG GAT CCT CTC ACG TTC GGC CAA GGG ACC AAG GTG -3'

I1 5'- GAA TGT GCC TAC TTT CTA GA G GAT CC A ACT GAG GAA GCA AAG -3'
Xba I Bam H1

PCR RECOMBINATION AMPLIFIERS

A1 5'- CAT TCG CTT ACC AGA TCT -3'

A2 5'- GAA TGT GCC TAC TTT CTA G -3'

CDR-GRAFTING VIA PCR-RECOMBINATION

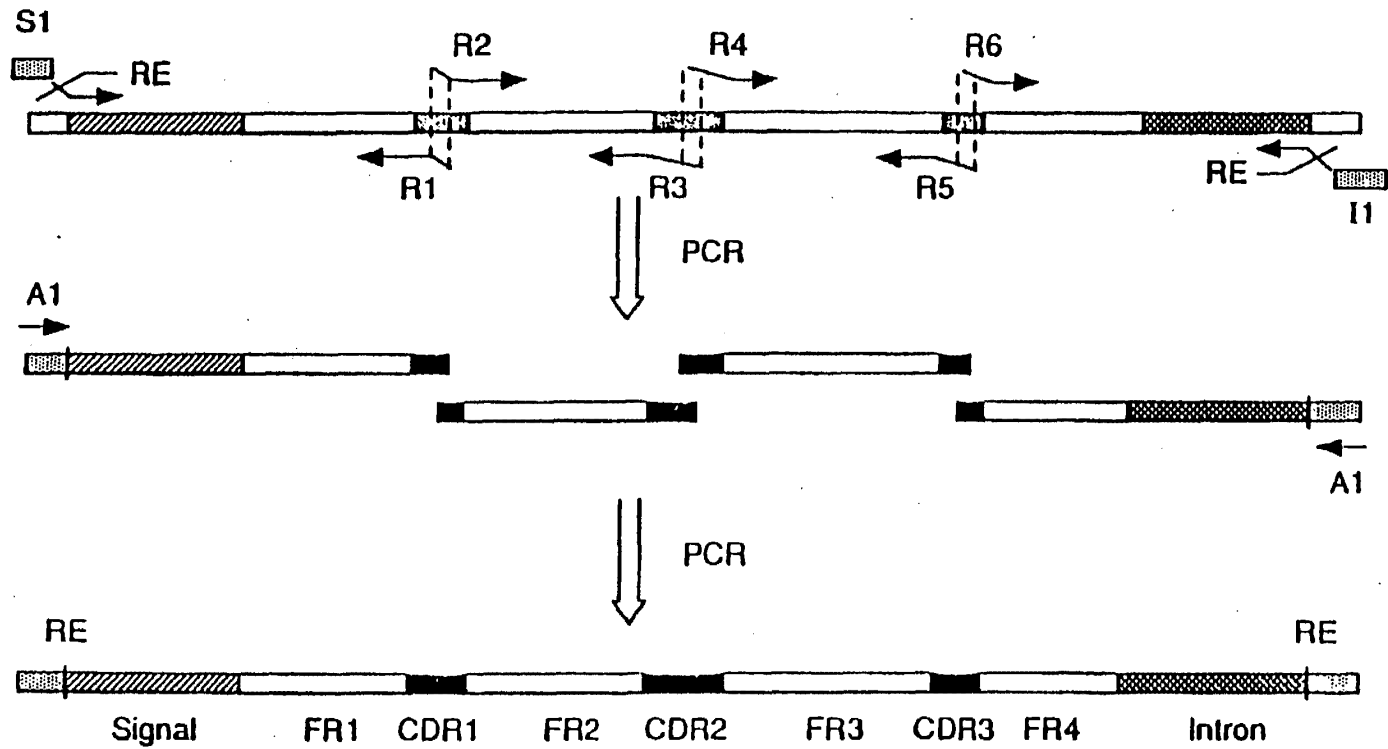

EP 0 440 351 A2

Fig. 5

28

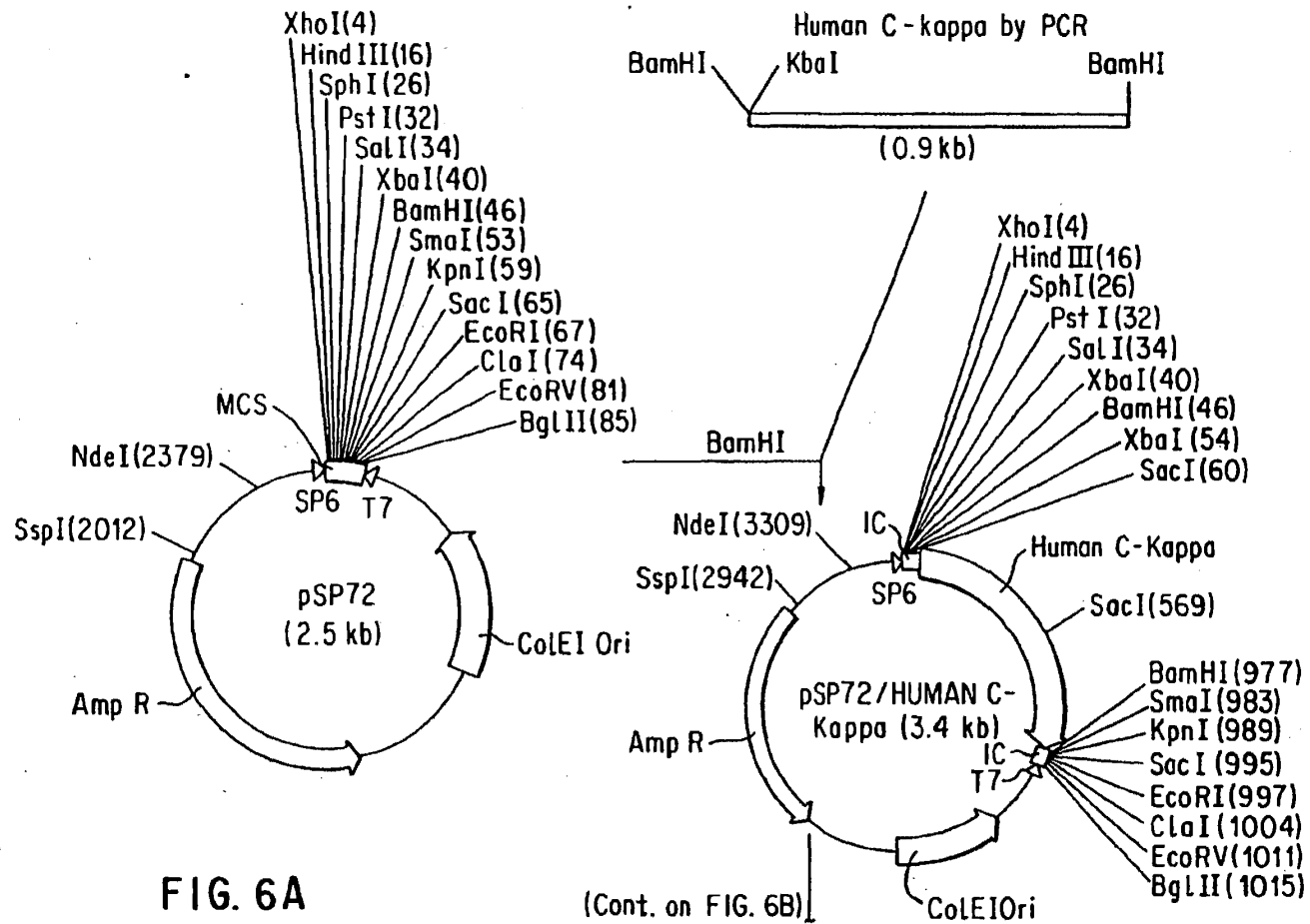

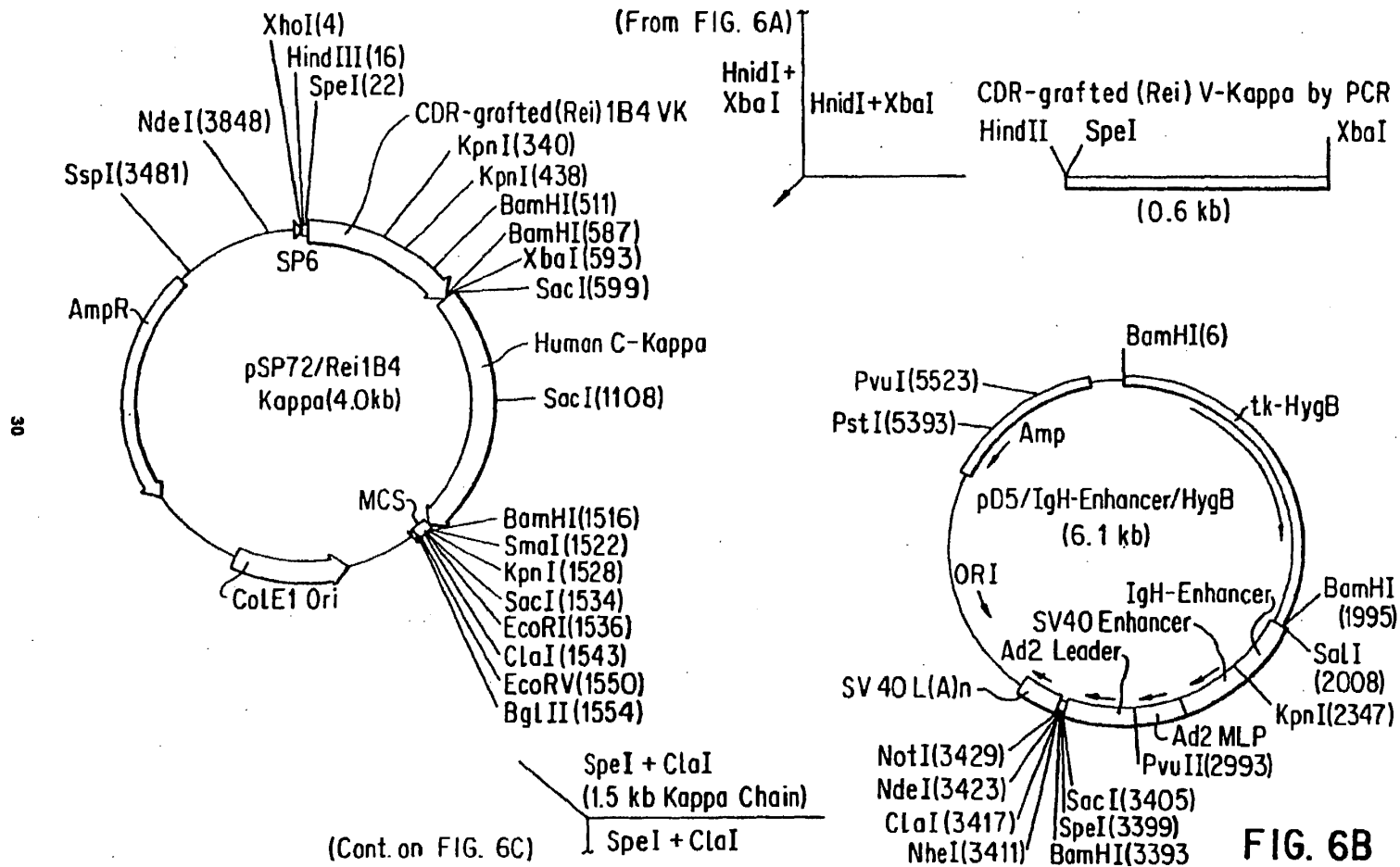

EP 0 440 351 A2

(From FIG. 6B)

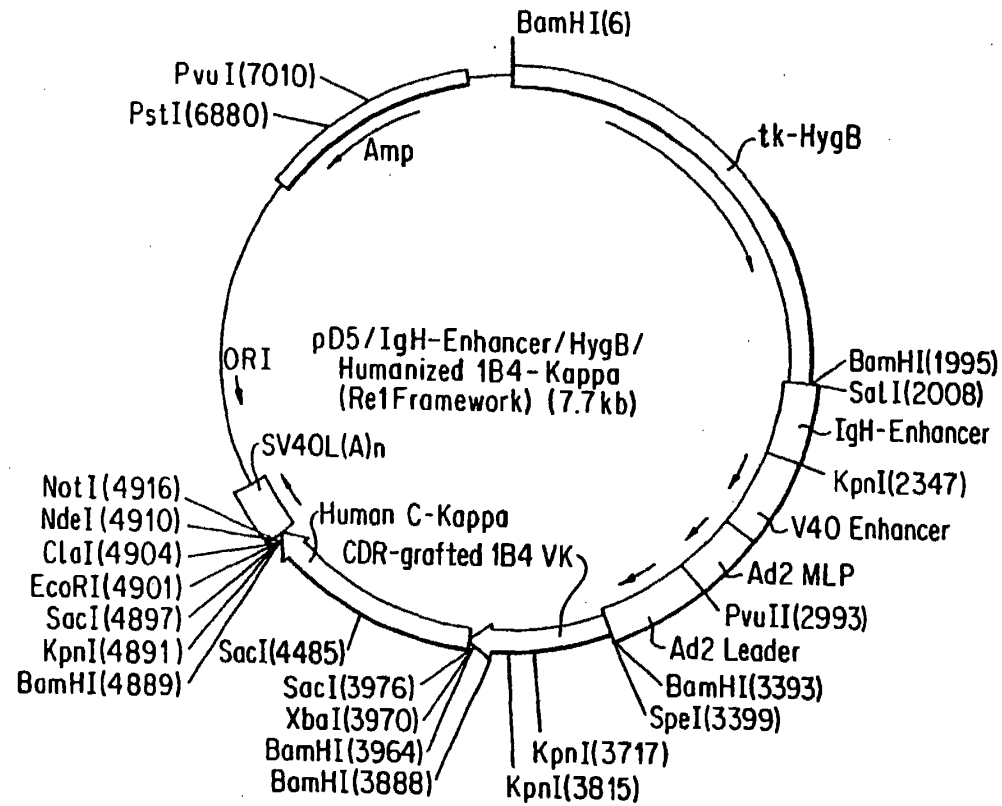

FIG. 6C

31

EP 0 440 351 A2

Fig. 7

SHORTEN VERSION OF THE IgG4 HEAVY CHAIN CONSTANT REGION

5- ATT TGG ATC C TC TAG A CA TCG CGG ATA GAC AAG AAC -3'

Bam H1 Xba I

5- AAT AAT GCG GCC GC A TCG AT G AGC TCA AGT ATG TAG ACG GGG TAC G -3'

Not I Cla I Sac I

TK PROMOTER FRAGMENT

5- TAT AGA ATT C GG TAC CCT TCA TCC CCG TGG CCC G -3'

Eco R1 Kpn I

5- TGC GTG TTC GAA TTC GCC -3'

Eco R1

Ig H ENHANCER

5- TTT TAG ATC T GT CGA CAG ATG GCC GAT CAG AAC CAG -3'

Bgl II Sal I

5- TTG GTC GAC GGT ACC AAT ACA TTT TAG AAG TCG AT -3'

Sal I Kpn I

HUMAN KAPPA CONSTANT REGION

5- TCT CGG ATC CTC TAG AAG AAT GGC TGC AAA GAG C -3'

5- TCT CGC TAG CGG ATC CTT GCA GAG GAT GAT AGG G -3'

CDR-GRAFTING VIA PCR-RECOMBINATION

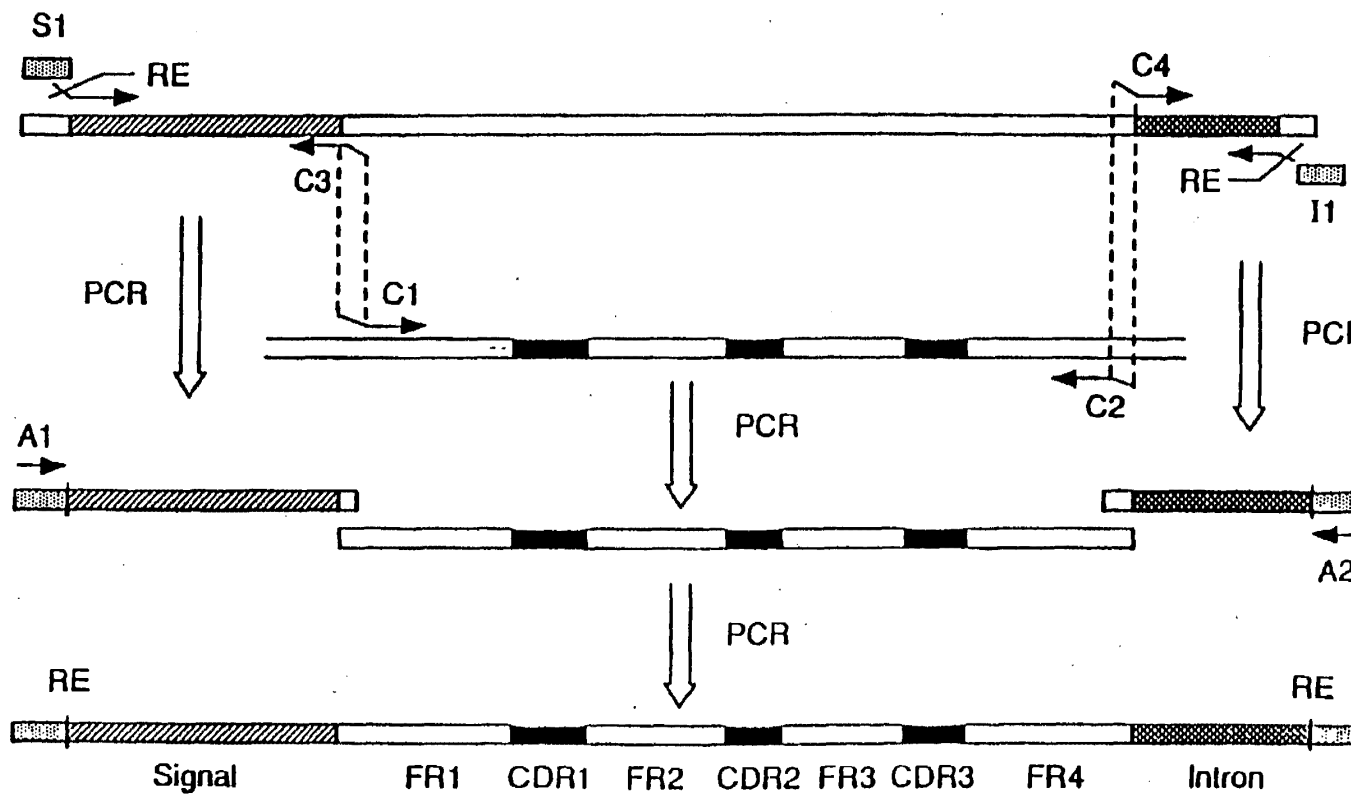

EP 0 440 351 A2

Fig. 8

Fig. 9

#S1 5'- CAT TCG CTT ACC AGA TCT AAG CTT ACT AGT GAG ATC ACA GTT CTC TCT AC -3'
Bgl II Hind III Spe I

#C1 5'- GAT GTG AAG CTG GTG GAG TCA G -3'

#C2 5'- CTC CAC CAG CTT CAC ATC GGA GTG GAC ACC TGT GGA GAG -3'

#C3 5'- IGA GGA GAC TGT GAG AGT GGT G -3'

#C4 5'- CTC TCA CAG TCT CCT CAG GTG AGT CCT TAC AAC CTC TC -3'

#I1 5'- GAA TGT GCC TAC TTT CTA GA G GAT CC A ACT GAG GAA GCA AAG -3'
Xba I Bam HI

PCR RECOMBINATION AMPLIFIERS

#A1 5'- CAT TCG CTT ACC AGA TCT -3'

#A2 5'- GAA TGT GCC TAC TTT CTA G -3'

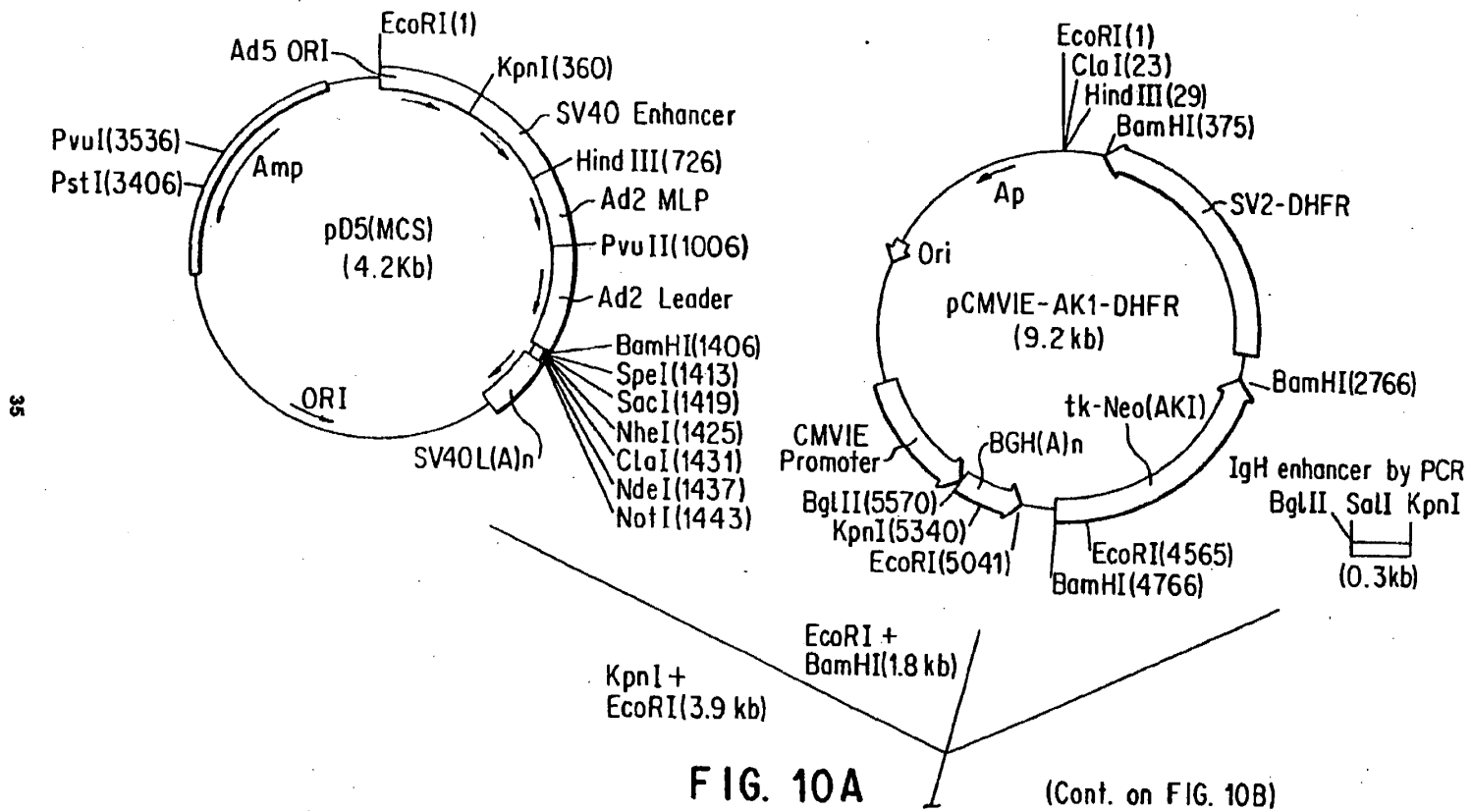

FIG. 10A

(Cont. on FIG. 10B)

EP 0 440 351 A2

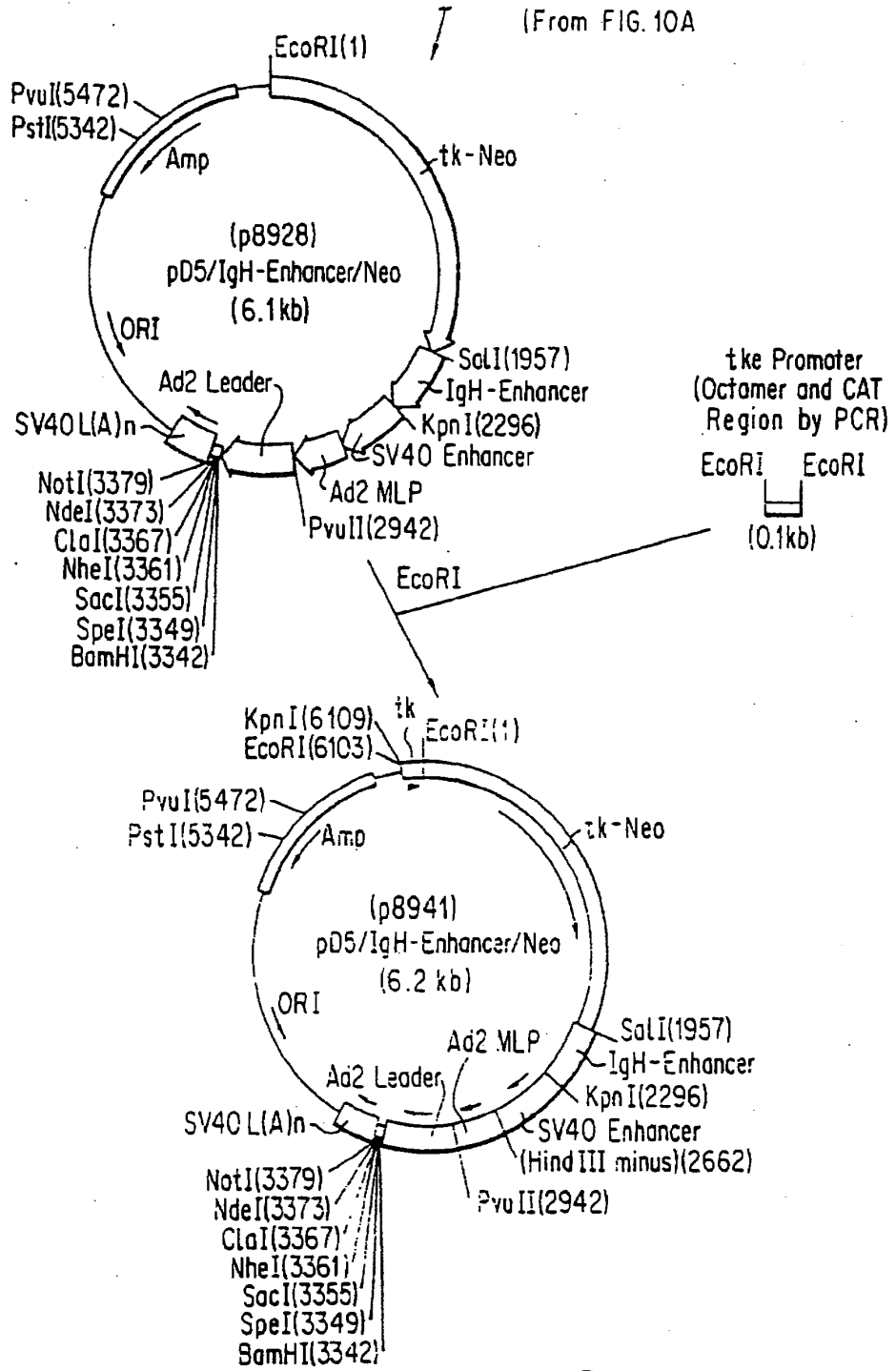
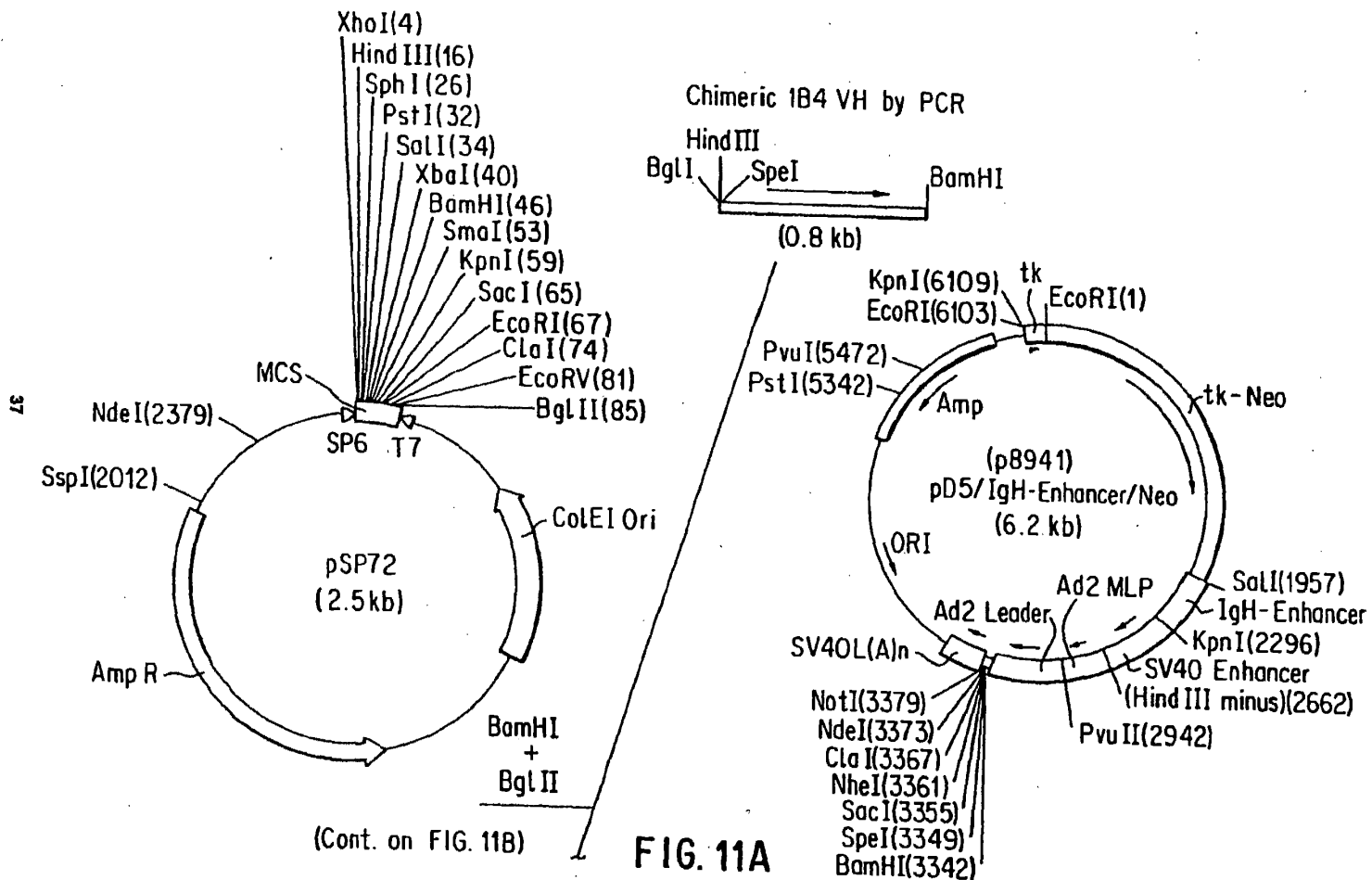
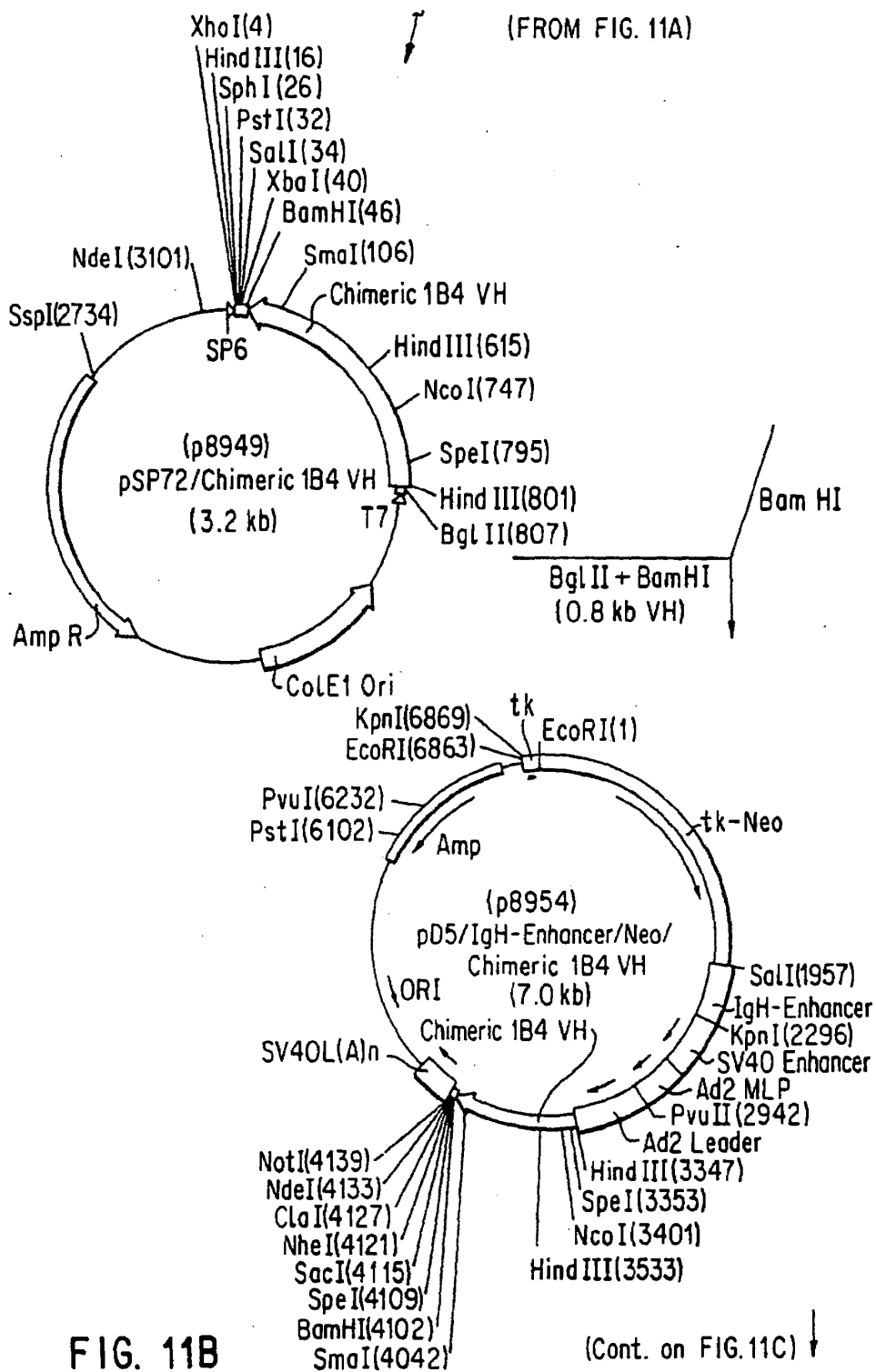

FIG. 10B



EP 0 440 351 A2



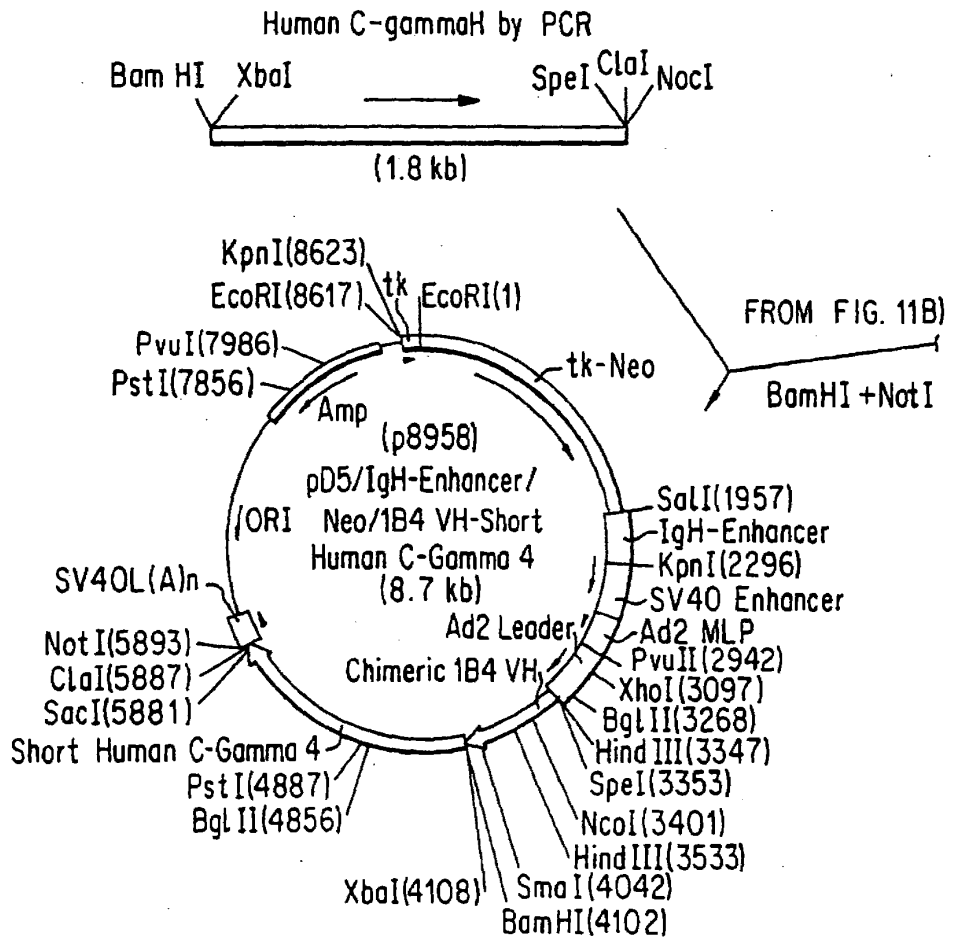

FIG. 11C

Fig. 12

TRANSIENT EXPRESSION OF THE 1B4 CHIMERIC HEAVY CHAIN : GRAFTED REV1B4 LIGHT CHAIN
RECOMBINANT ANTIBODY IN CV1, COS7, AND 293 CELLS

<u>CELL LINE</u>	<u>ANTIBODY (ng/mL)</u>
CV1	50
CV1	31
COS7	71
COS7	82
293	385
293	207

Fig. 13

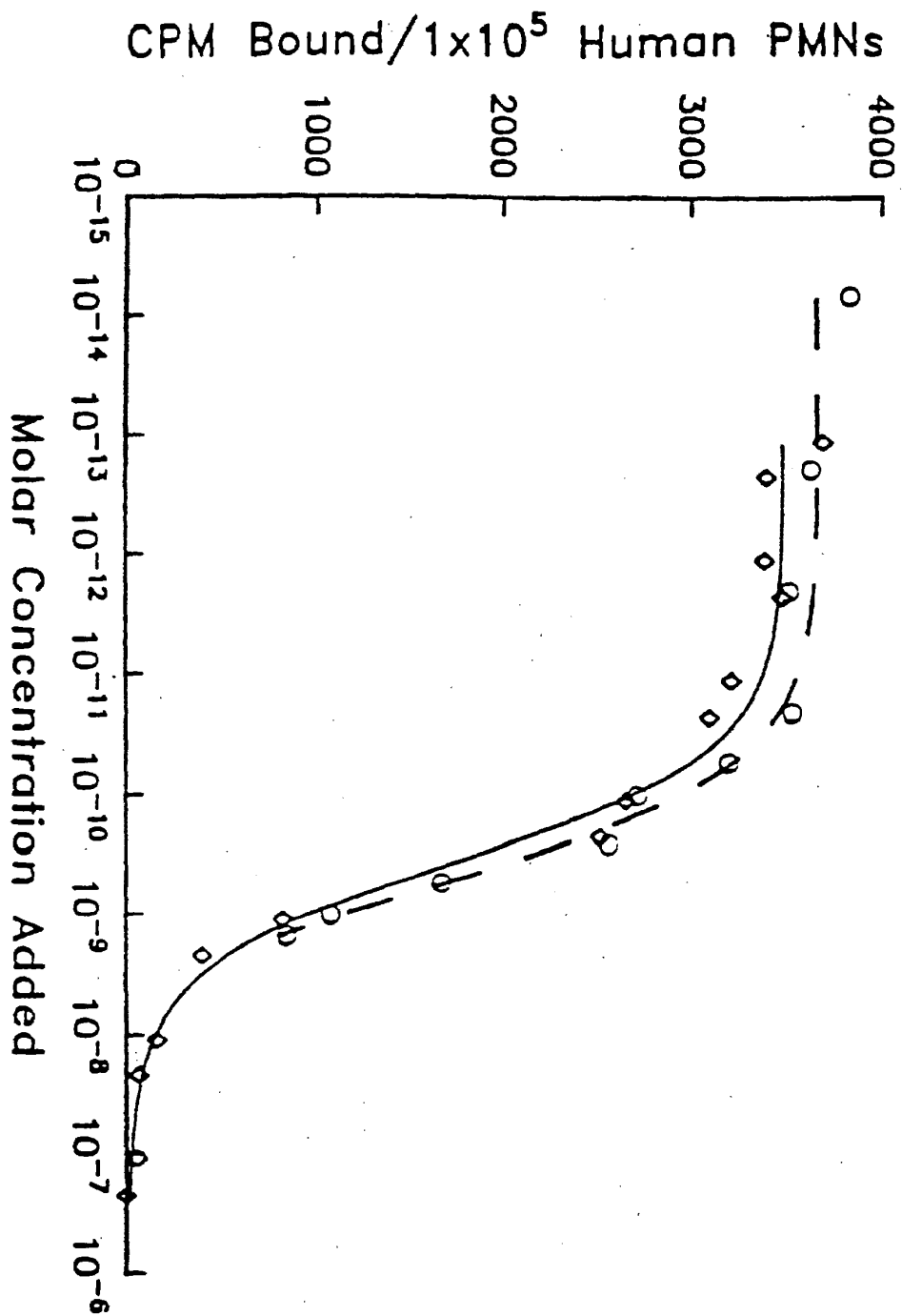

Fig. 14

TEMPLATES USED AS HEAVY AND LIGHT CHAIN VARIABLE REGION FRAMEWORKS

Heavy Chain

NEW: QVQLQESGPGLVSRPSQTLSTCTVSGFTFS [NDYYT] WVRQP
 1B4: DVKLVESGGDLVKLGSLKLSAASGFTFS [DYYS] WVRQTP
 Jon: DVQLVESGGGLVKPGGSLRLSAAASGFTFS [TAWMK] WVROAP
 Gal: EVQLVESGGDLVQPRSLRLSAAASGFTFS [BLGHT] WVROAP
 Gal-M1: G

GRGLEWIG [YVFYHGTSDDTFLRS-] RFTMLVDTSKNQFSLRL
 EKRELVVA [AIDNDGGSISYPDTVKG] RFTISRDNKNTLYLQM
 GKGLEWVV [WRVEQVVEKAFANSVNG] RFTISRNDKNTLYLQM
 GKGLEWVA [NIKZBGSZZBYVDSVKG] RFTISRDNKNSLYLQM
 L

		%id
SSVTAADTAVYYCAR	[---NLIAGCIDV]WGQGS�VTVSS...	55
SSLRS EDTALYYCAR	[-QGRLLRDYFDY]WGQGTTLTVSS...	
ISVTFEDTAVYYCAR	[VPLYGBYRAFNY]WGQGTPTVTVSS...	78
NSLRVEDTALYYCAR	[-----GWGGGD-]WGQGTLLTVST...	82
	L	85

Light Chain

REI: DIQLTQSPSSLSASVGDRTTTC [RASGNIHNYLA-----]WY
 1B4: DIVLTQSPASLAVSLGQRATISC [RASESVDSYGNSTFMH--]WY
 Len: DIVMTQSPNSLAVSLGERATINC [KSSQSVLYSSNSKNYLA]WY

QOKPGKAPKLLIY [YTTTLAD] GVPDRFSGSGSGTDFITLTISSL
 QOKPGQPPKLLIY [RASNLES] GIPARFSGSGSRTDFITLTIPLV
 QOKPGQPPKLLIY [WASTRES] GVPDRFSGSGSGTDFITLTISSL

QPEDIATYYC	[QHFWSPTPT] FGQGTKVVIKR...	%id
EADDVATYYC	[QSNEDPLT] FGAGTKLELKR...	69
QAEDVAVYYC	[QXYSTPYS] FGQGTKLEIKR...	81

%id percent identity to 1B4 FRs

Fig. 15

TABLE 8

***GAL*1B4**

#G1 5'- GAG GTG CAG CTG GTG GAG TCT GGG GGA GAC CTG GTC CAG CCT GGG AGG TCT CTG AGA
CTC TCC TGT GCA GCC TCT GGA TTC ACC TTC AGT GAC TAT TAC -3'

#G2 5'- ATA AGA GAT GCT ACC ACC ATC ATT ATC AAT GGC TGC AAC CCA CTC CAG CCC TTT TCC TGG
AGC CTG GCG GAC CCA AGA CAT GTA ATA GTC ACT GAA GGT -3'

#G3 5'- GGT GGT AGC ATC TCT TAT CCA GAC ACT GTG AAG GGC AGA TTC ACC ATC TCC AGA GAT AAT
GCC AAG AAC TCC CTG TAC CTG CAA ATG AAC AGC CTG AGA GTT -3'

#G4 5'- GAC CAG GGT ACC TTG GCC CCA GTA GTC AAA ATA ATC ACG TCG TAA TCT CCC CTG TCT
CGC ACA GTA ATA CAG GGC CGT GTC CTC AAC TCT CAG GCT GTT CAT -3'

VARIABLE REGION AMPLIFIERS

#A3 5'- GAG GTG CAG CTG GTG GAG TC -3'

#A4 5'- GAC CAG GGT ACC TTG GCC CC -3'

SIGNAL FRAGMENT

#S1 5'- CAT TCG CTT ACC AGA TCT AAG CTT ACT AGT GAG ATC ACA GTT CTC TCT AC -3'

#G5 5'- CTC CAC CAG CTG CAC CTC GGA GTG GAC ACC TGT GGA GAG -3'

FRAMEWORK 4/INTRON FRAGMENT

#G6 5'- GGC CAA GGT ACC CTG GTC ACA GTC TCC ACA GGT GAG TCC -3'

#I2 5'- GAA TGT GCC TAC TTT CTA GAG GAT CCT ATA AAT CTC TG -3'

***JON*1B4**

#J1 5'- GAT GTG CAG CTG GTG GAG TCT GGG GGA GGA CTG GTC AAG CCT GGG GGG TCT CTG AGA
CTC TCC TGT GCA GCC TCT GGA TTC ACC TTC AGT GAC TAT TAC -3'

#J2 5'- ATA AGA GAT GCT ACC ACC ATC ATT ATC AAT GGC CAC AAC CCA CTC CAG CCC TTT TCC TGG
AGC CTG GCG GAC CCA AGA CAT GTA ATA GTC ACT GAA GGT -3'

#J3 5'- GGT GGT AGC ATC TCT TAT CCA GAC ACT GTG AAG GGC AGA TTC ACC ATC TCC AGA AAC GAT
TCA AAG AAC ACG CRG TAC CTG CAA ATG ATC AGC GTG ACC CCC -3'

#J4 5'- GAC AGG GGT ACC TTG GCC CCA GTA GTC AAA ATA ATC ACG TCG TAA TCT CCC CTG TCT
CGC ACA GTA ATA CAC GGC CGT GTC CTC GGG GGT CAC GCT GAT CAT -3'

VARIABLE REGION AMPLIFIERS

#A5 5'- GAT GTG CAG CTG GTG GAG TC -3'

#A6 5'- GAC AGG GGT ACC TTG GCC CC -3'

SIGNAL FRAGMENT

#S1 5'- CAT TCG CTT ACC AGA TCT AAG CTT ACT AGT GAG ATC ACA GTT CTC TCT AC -3'

#J5 5'- CTC CAC CAG CTG CAC ATC GGA GTG GAC ACC TGT GGA GAG -3'

FRAMEWORK 4/INTRON FRAGMENT

#J6 5'- GGC CAA GGT ACC CCT GTC ACA GTC TCC TCA GGT GAG TCC -3'

#I2 5'- GAA TGT GCC TAC TTT CTA GAG GAT CCT ATA AAT CTC TG -3'

PCR RECOMBINATION AMPLIFIERS USED FOR BOTH CONSTRUCTIONS

#A1 5'- CAT TCG CTT ACC AGA TCT -3'

#A2 5'- GAA TGT GCC TAC TTT CTA G -3'

Underlined are that region of each oligo which hybridize with other oligos to create the overlapping 3' ends necessary for PCR directed recombination. Subsequent amplification of the combined oligos is mediated through the sequences in bold type.

CDR-GRAFTING VIA LONG OLIGOS AND PCR-RECOMBINATION

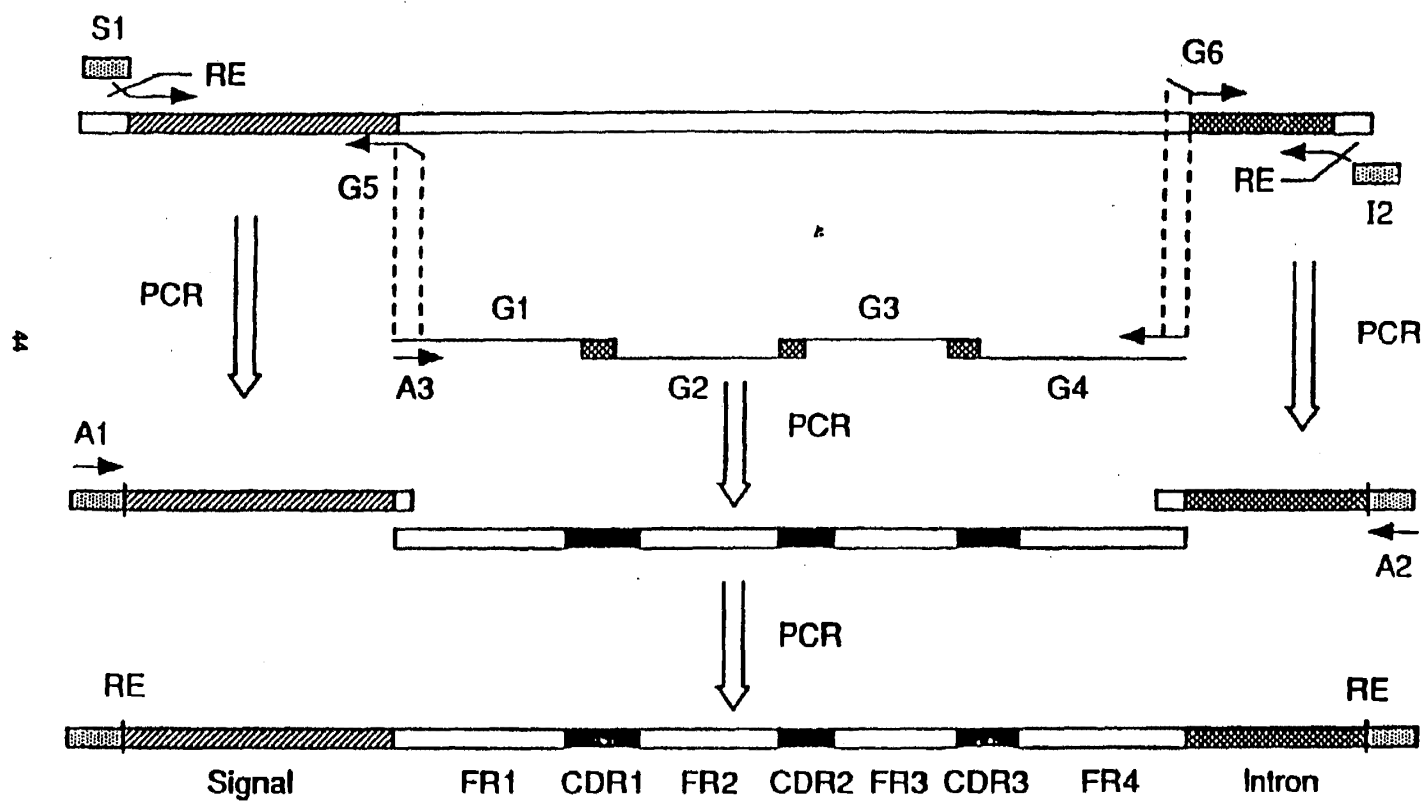
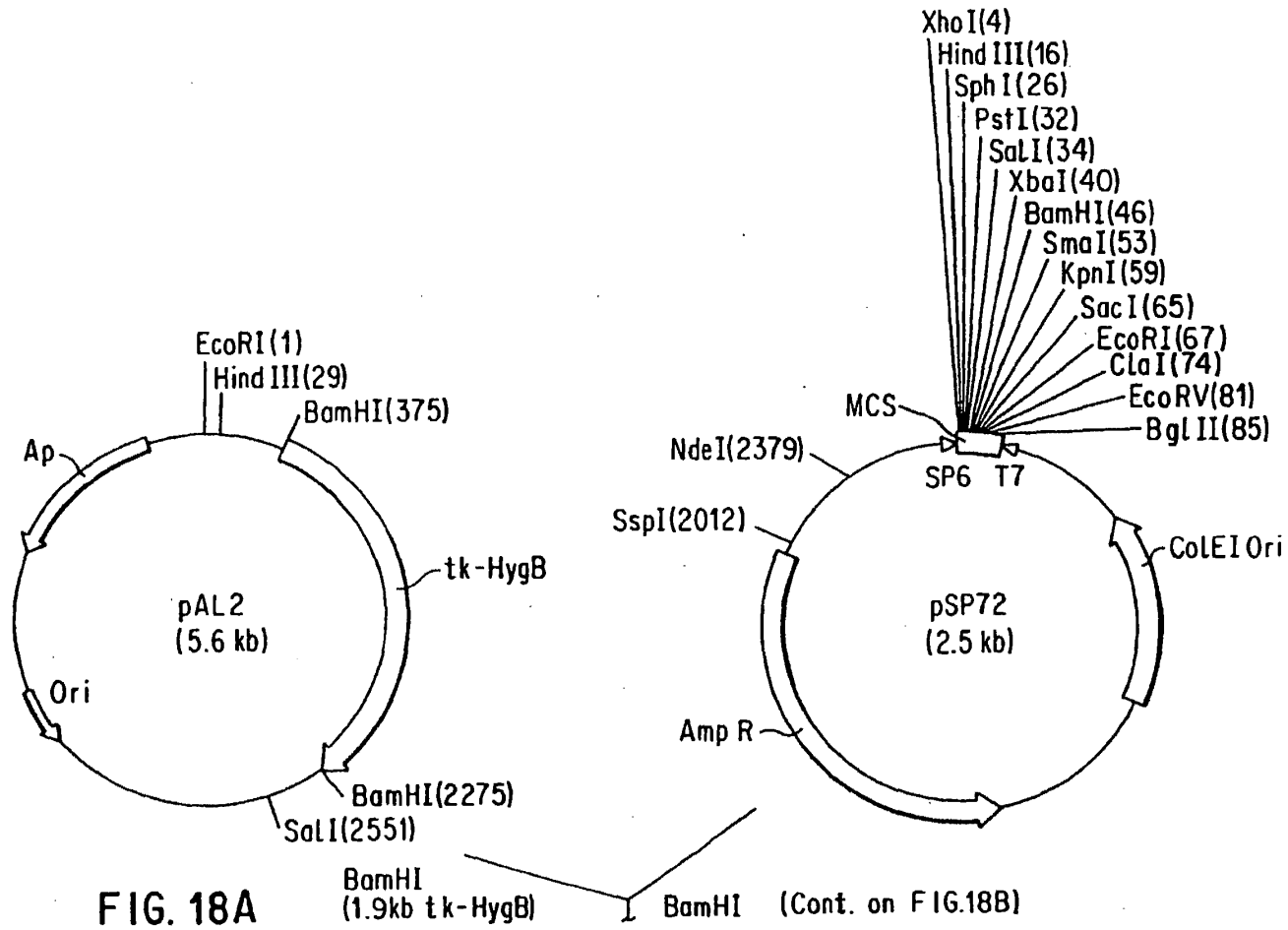

Fig. 16

EP 0 440 351 A2

Fig. 17

GAG GTG AAG CTG GTG GAG TCA GGG GGA GAC TTA GTG AAG CTT GGA GGG TCC CTG	27	54
Glu Val Lys Leu Val Glu Ser Gly Gly Asp Leu Val Lys Leu Gly Gly Ser Leu		
AAA CTC TCC TGT GCA GCC TCT GGA TTC ACT TTC AGT GAC TAT TAC ATG TCT TGG	81	108
Lys Leu Ser Cys Ala Ala Ser Gly Phe Thr Phe Ser Asp Tyr Tyr MET Ser Trp		
GTT CGC CAG ACT CCA GAG AAG AGG CTG GAG TTG GTC GCA GCC ATT GAT AAT GAT	135	162
Val Arg Gln Thr Pro Glu Lys Arg Leu Glu Leu Val Ala Ala Ile Asp Asn Asp		
GST GGT AGC ATC TCT TAT CCA GAC ACT GTG AAG GGC CGA TTC ACC ATC TCC AGA	189	216
Gly Gly Ser Ile Ser Tyr Pro Asp Thr Val Lys Gly Arg Phe Thr Ile Ser Arg		
GAC AAT GCC AAG AAC ACC CTG TAC CTA CAA ATG AGC AGT CTG AGG TCT GAG GAC	243	270
Asp Asn Ala Lys Asn Thr Leu Tyr Leu Gln MET Ser Ser Leu Arg Ser Glu Asp		
ACA GCC TTG TAT TAC TGT GCT AGA CAG GGG AGA TTA CGA CGT GAT TAT TTT GAC	297	324
Thr Ala Leu Tyr Tyr Cys Ala Arg Gln Gly Arg Leu Arg Arg Asp Tyr Phe Asp		
TAC TGG GGC CAA GGC ACC ACT CTC ACA GTC TCC TCA GCC AAA ACA A	351	
Tyr Trp Gly Gln Gly Thr Thr Leu Thr Val Ser Ser Ala Lys Thr		



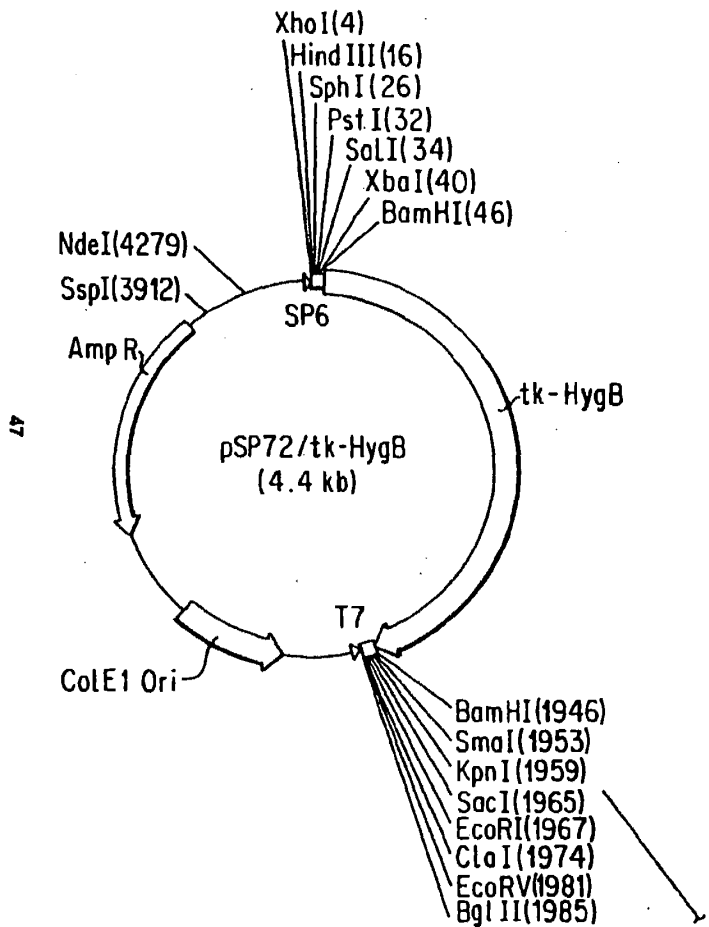

(FROM FIG. 18A)

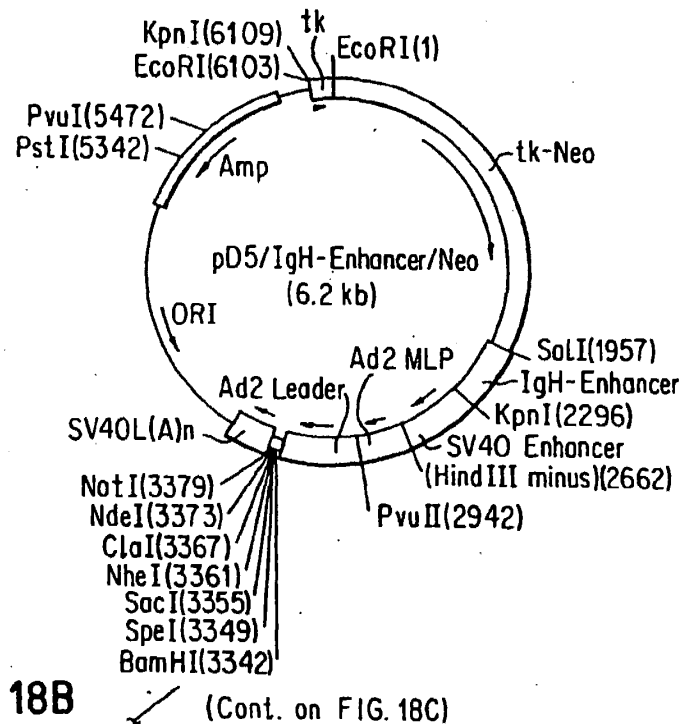

EP 0 440 351 A2

(FROM FIG. 18B)

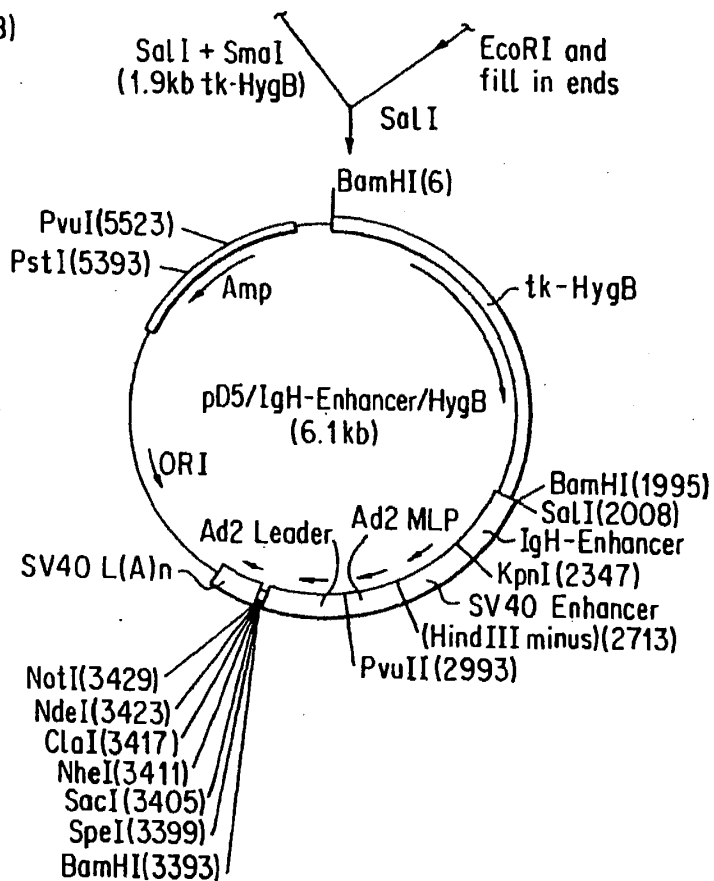
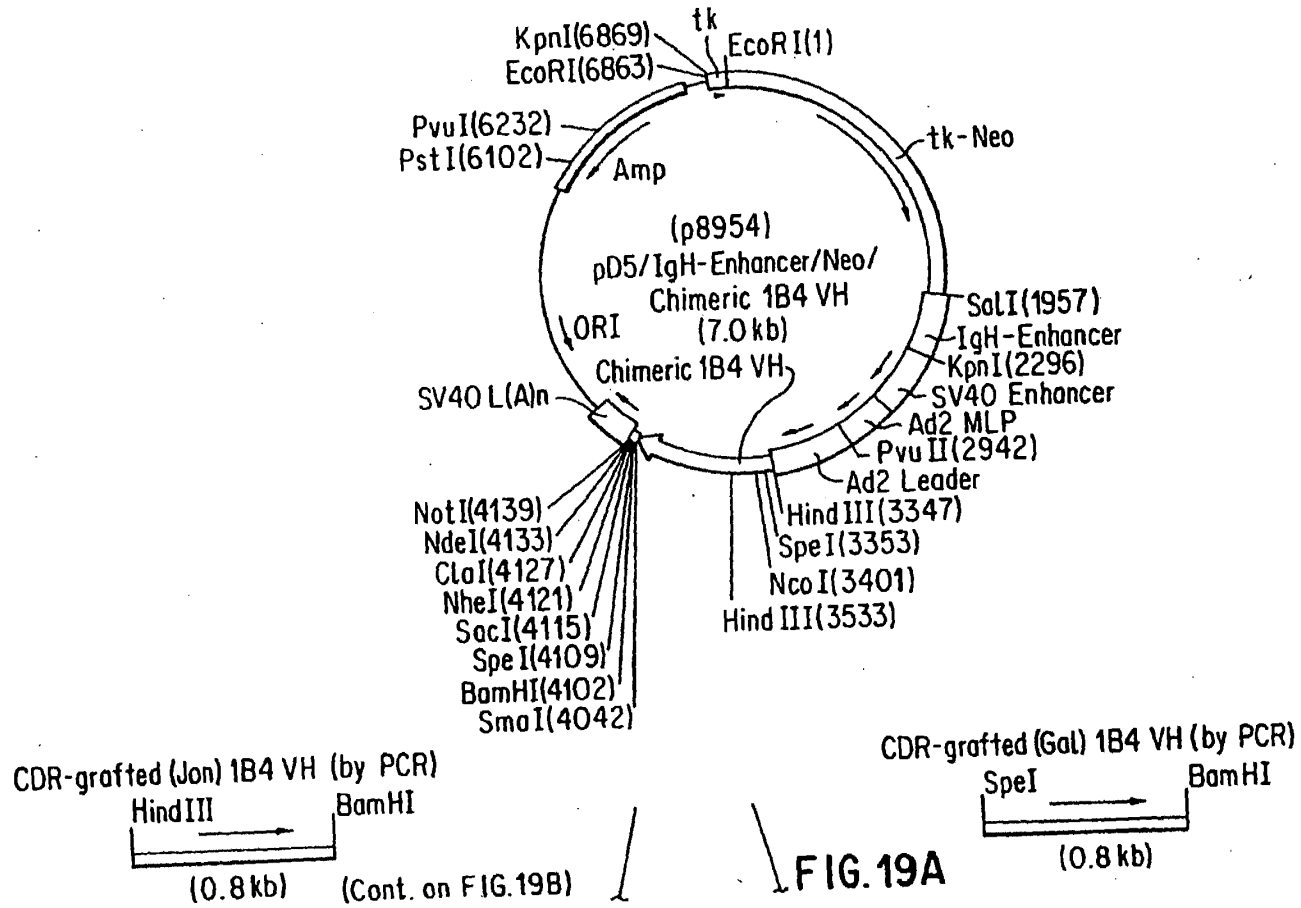

FIG. 18C

48

EP 0 440 351 A2



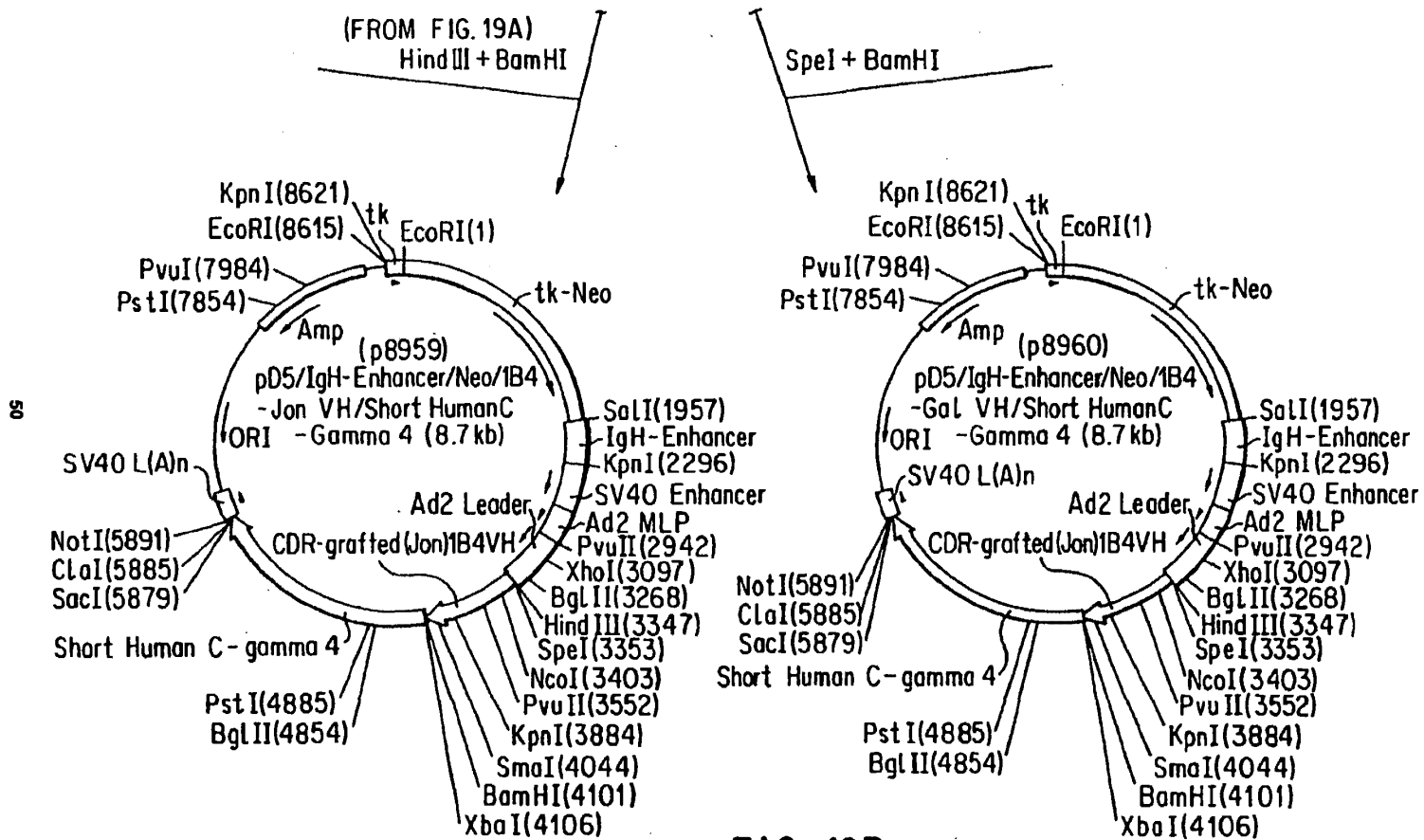

FIG. 19B

EP 0 440 351 A2

Fig. 20

**Summary of Competitive Binding Activities of mIB4 & hIB4
Framework Constructs**

<u>Construct</u>	<u>Mean IC₅₀ nM</u>	<u>S D</u>	<u>N</u>	<u>p (relative)</u>
mIB4	0.52	0.20	9	<0.0005(Gal*)
Gal/Rei	1.68	0.26	19	<0.0005(New)
Gal/Len	2.80	1.04	2	<0.0005(Gal*)
Jon/Rei	5.88	0.13	3	<0.0005(Gal*)
New/Rei	7.99	0.73	3	=0.008(Jon)
mut Gal/Rei	0.67	0.08	4	>0.20(mIB4)
Demichimera	0.46	0.08	3	>0.61(mIB4)

*Gal = Gal/Rei hIB4 construct

Fig. 21

*LEN*1B4

- # L1 5'- GAC ATC GTG ATG ACC CAG TCT CCA AAT TCC CTG GCT GTC TCT CTT GGA
GAG AGA GGC ACC ATC AAC TGC AGA CCC AGT GAA AGT GTT GAT -3'
- # L2 5'- ACG ATA GAT CAG GAG CTT AGG AGG CTG CCC TGG TTT CTG CTG ATA CCA GTG CAT
AAA AGA ATT GCC ATA ACT ATC AAC ACT TTC ACT GGC -3'
- # L3 5'- AAG CTC CTG ATC TAT CGT GCA TCC AAC CTA GAA TCT GGG GTC CCA GAC AGG TTC
AGC GGC AGT GGA TCT GGG ACA GAT TTC ACT CTC ACC -3'
- # L4 5'- CGT GAG AGG ATC CTC ATT ACT TTG CTG ACA GTA ATA AAC TGC AAC ATC TTC AGC
CTG CAG GCT GCT GAT GGT GAG AGT GAA ATC TGT -3'
- # L5 5'- TAA TGA GGA TCC TCT CAC GTT CCG CCA AGG GAC CAA GCT GGA GAT CAA ACG TGA
GTA GAA TTT AAA CTT TGC TTC CTC AGT TAA GCT TTC TAG A -3'

VARIABLE REGION AMPLIFIERS

- # A5 5'- GAC ATC GTG ATG ACC CAG TC -3'
- # A6 5'- TGC CTA CTT TCT AGA AAG CTT AAC TGA GG -3'

SIGNAL FRAGMENT

- # S2 5'- AGA TCT ACT AGT AAG CTT GAG ATC ACA GTT CTC TCT AC -3'
- # L6 5'- CTG GGT CAT CAC GAT GTC GGA GTG GAC ACC TGT GGA GAG -3'

PCR RECOMBINATION AMPLIFIERS

- # A7 5'- AGA TCT ACT AGT AAG CTT GAC -3'
Bgl II Spe I Hind III
- # A8 5'- TGC CTA CTT TCT AGA AAG CTT -3'
Xba I Hind III

Underlined are that region of each oligo (L1-L5) which hybridize with other oligos to create the overlapping 3' ends necessary for PCR directed recombination. Subsequent amplification of the combined oligos is mediated through the sequences in bold type.

CDR-GRAFTING VIA LONG OLIGOS.AND PCR-RECOMBINATION

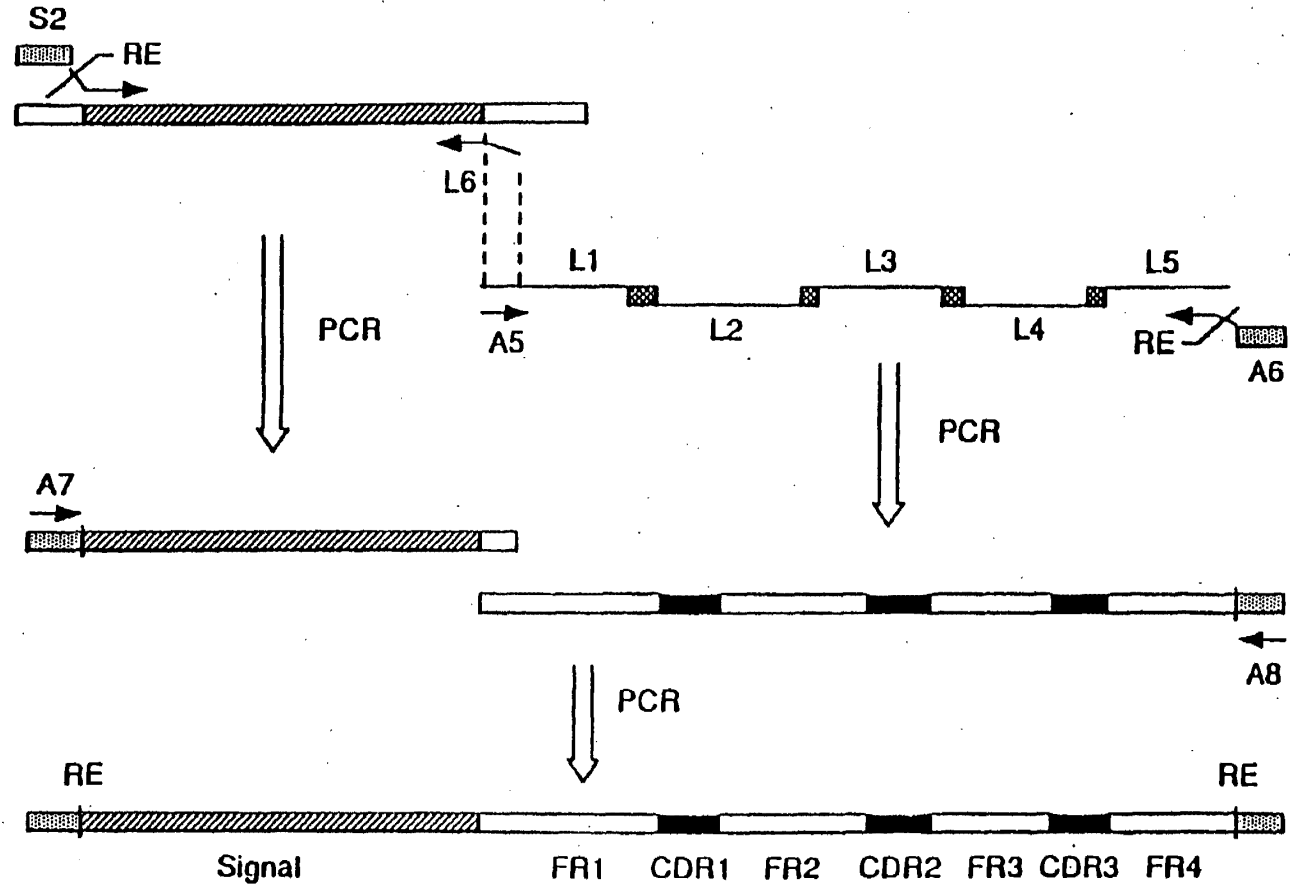

EP 0 440 351 A2

Fig. 22

3

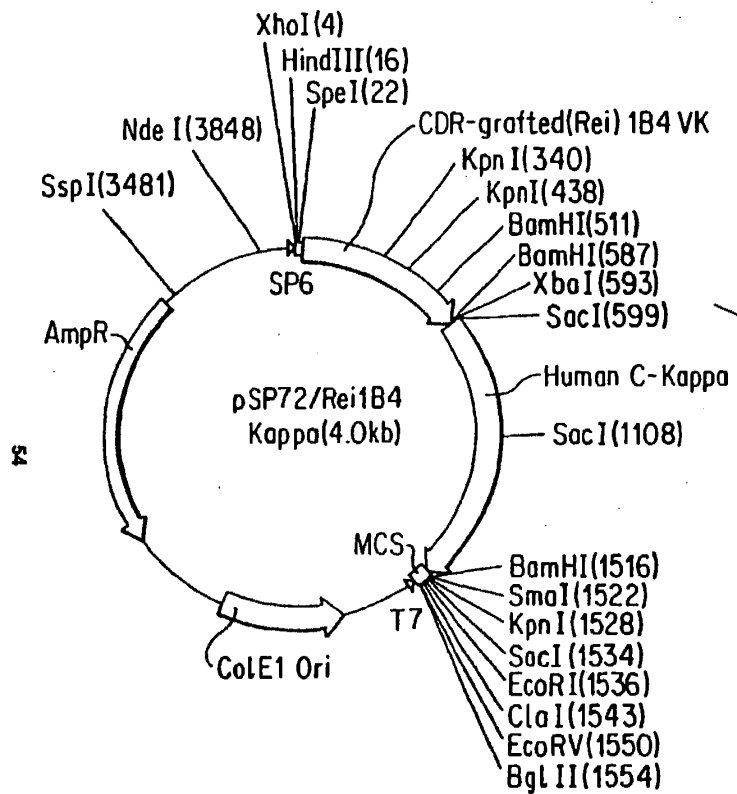
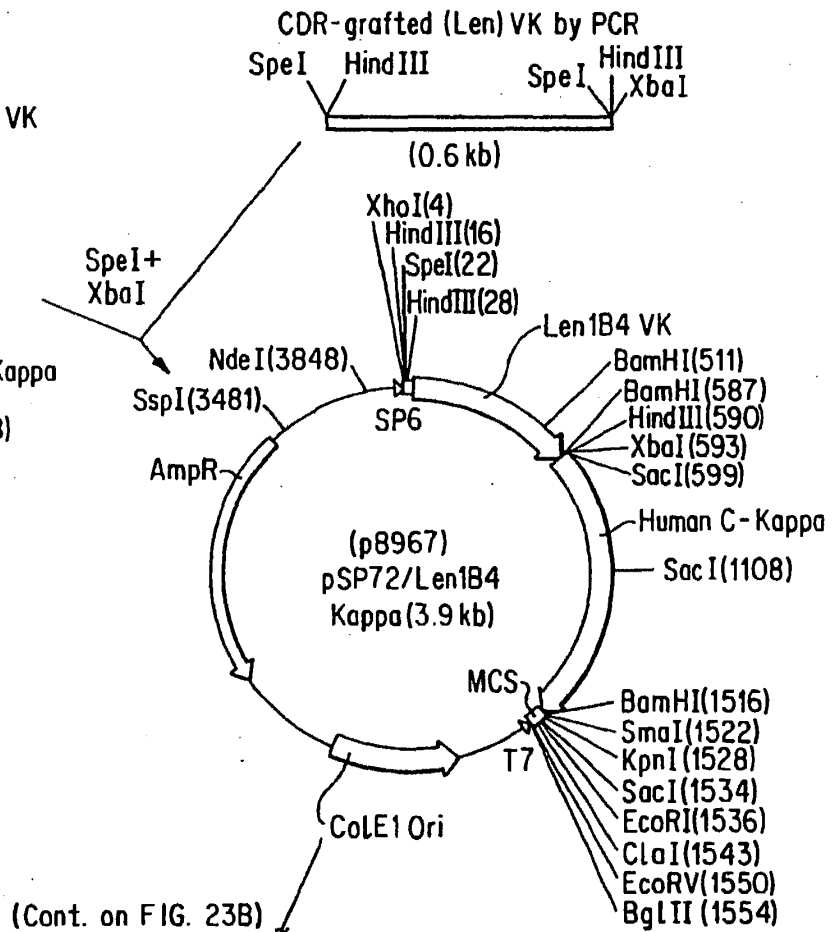

FIG. 23A



(Cont. on FIG. 23B)

EP 0 440 351 A2

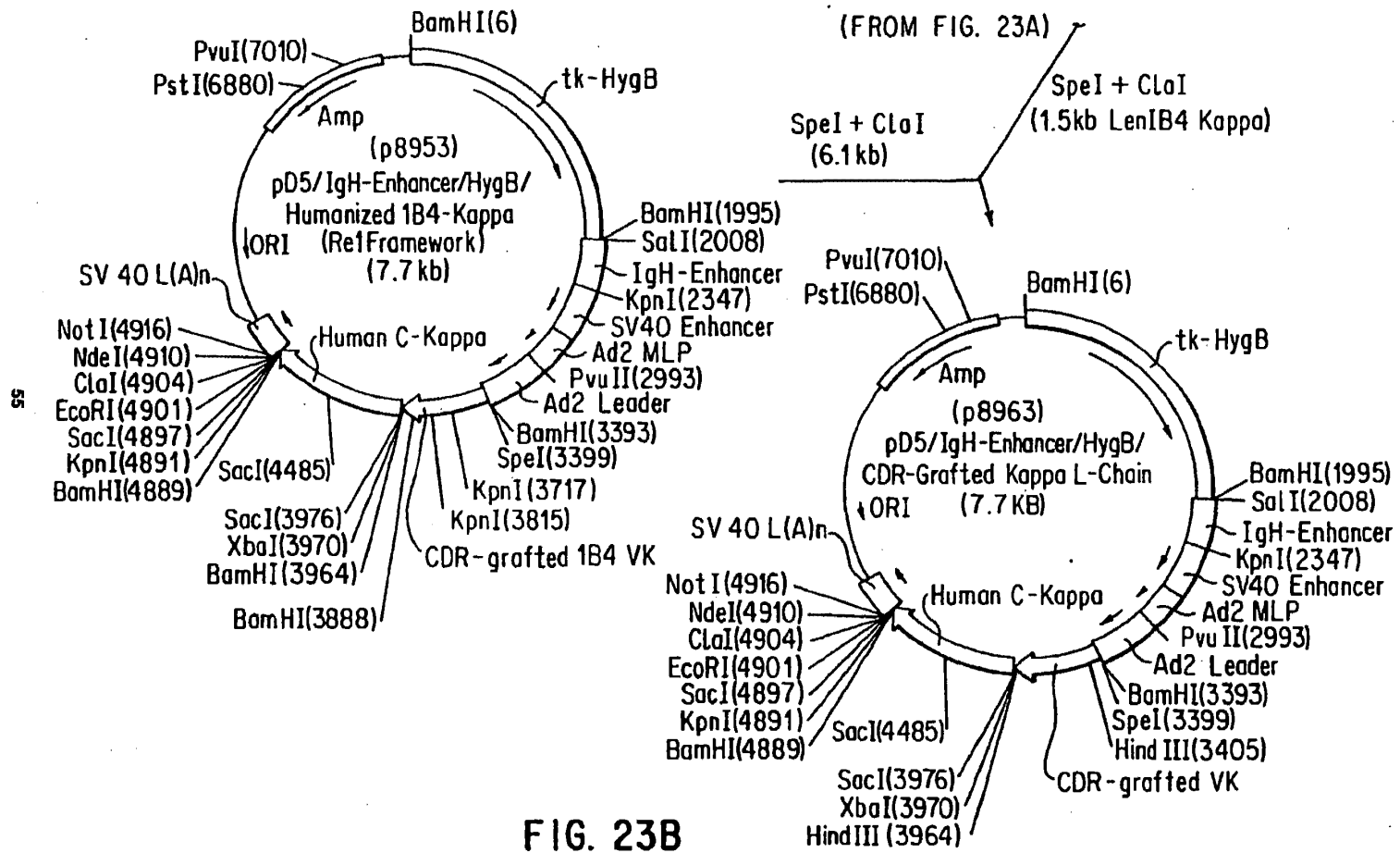

FIG. 23B

EP 0 440 351 A2

Fig. 24

27 54
 GAC ATT GTG ATG ACC CAG TCT CCT GCT TCC TTA GCT GTA TCT CTG GGG CAG AGG
 Asp Ile Val MET Thr Gln Ser Pro Ala Ser Leu Ala Val Ser Leu Gly Gln Arg

81 108
 GGC ACC ATC TCA TAC AGG GCC AGC AAA AGT GTC AGT ACA TCT GGC TAT AGT TAT
 Ala Thr Ile Ser Tyr Arg Ala Ser Lys Ser Val Ser Thr Ser Gly Tyr Ser Tyr

135 162
 ATG CAC TGG AAC CAA CAG AAA CCA GGA CAG CCA CCC AGA CTC CTC ATC TAT CTT
 MET His Trp Asn Gln Gln Lys Pro Gly Gln Pro Pro Arg Leu Leu Ile Tyr Leu

189 216
 GTA TCC AAC CTA GAA TCT GGG GTC CCT GCC AGG TTC AGT GGC AGT GGG TCT AGG
 Val Ser Asn Leu Glu Ser Gly Val Pro Ala Arg Phe Ser Gly Ser Gly Ser Arg

243 270
 ACA GAC TTC ACC CTC AAC ATC CAT CCT GTG GAG GAG GAG GAT GCT GCA ACC TAT
 Thr Asp Phe Thr Leu Asn Ile His Pro Val Glu Glu Glu Asp Ala Ala Thr Tyr

297 324
 TAC TGT CAG CAC ATT AGG GAG CTT ACA CGT TCG GAG GGG GGA CCA AGC TGG AAA
 Tyr Cys Gln His Ile Arg Glu Leu Thr Arg Ser Glu Gly Gly Pro Ser Trp Lys

TAA AAC GGG CT
 Asn Gly

Fig. 25

27 54
 GAT ATT GTG CTG ACC CAG TCT CCA GCT TCT TTG GCT GTG TCT CTA GGG CAG AGG
 Asp Ile Val Leu Thr Gln Ser Pro Ala Ser Leu Ala Val Ser Leu Gly Gln Arg

81 108
 GCC ACC ATA TCC TGC AGA GCC AGT GAA AGT GTT GAT AGT TAT GGC AAT TCT TTT
 Ala Thr Ile Ser Cys Arg Ala Ser Glu Ser Val Asp Ser Tyr Gly Asn Ser Phe

135 162
 ATG CAC TGG TAC CAG CAG AAA CCA GGA CAG CCA CCC AAG CTC CTC ATC TAT CGT
 MET His Trp Tyr Gln Gln Lys Pro Gly Gln Pro Pro Lys Leu Leu Ile Tyr Arg

189 216
 GCA TCC AAC CTA GAA TCT GGG ATC CCT GCC AGG TTC AGT GGC AGT GGG TCT AGG
 Ala Ser Asn Leu Glu Ser Gly Ile Pro Ala Arg Phe Ser Gly Ser Gly Ser Arg

243 270
 ACA GAC TTC ACC CTC ACC ATT AAT CCT GTG GAG GCT GAT GAT GTT GCA ACC TAT
 Thr Asp Phe Thr Leu Thr Ile Asn Pro Val Glu Ala Asp Asp Val Ala Thr Tyr

297 324
 TAC TGT CAG CAA AGT AAT GAG GAT CCT CTC ACG TTC GGT GCT GGG ACC AAG CTG
 Tyr Cys Gln Gln Ser Asn Glu Asp Pro Leu Thr Phe Gly Ala Gly Thr Lys Leu

GAG CTG AAA CGG
 Glu Leu Lys Arg

Fig. 26

#S1 5'- CAT TCG CTT ACC AGA TCT AAG CTT ACT AGT GAG ATC AC -3'
Bgl II Hind III Spe I

#G7 5'- AGA TCT CCC CCA GAC TCA ACC AGC TG -3'

#G8 5'- TGA GTC TGG GGG AGA TCT TGT TCA GCC TGG AGG GTC TCT G -3'

#G9 5'- ATC AAT GCC TGC AAC CAG CTC CAG CCC TTT TCC -3'

#G10 5'- CTG GTT GCA GCC ATT GAT AAT -3'

#G11 5'- GGA GAC TGT CAG CAG GGT ACC TTG GCC CCA -3'

#G12 5'- ACC CTG CTG ACA GTC TCC ACA GGT GAG -3'

#12 5'- GAA TGT GCC TAC TTT CTA GA G GAT CCT ATA AAT CTC TGG CCA TG -3'
Xba I Bam HI

PCR RECOMBINATION AMPLIFIERS

#A3 5'- CAT TCG CTT ACC AGA TCT -3'

#A4 5'- GAA TGT GCC TAC TTT CTA G -3'

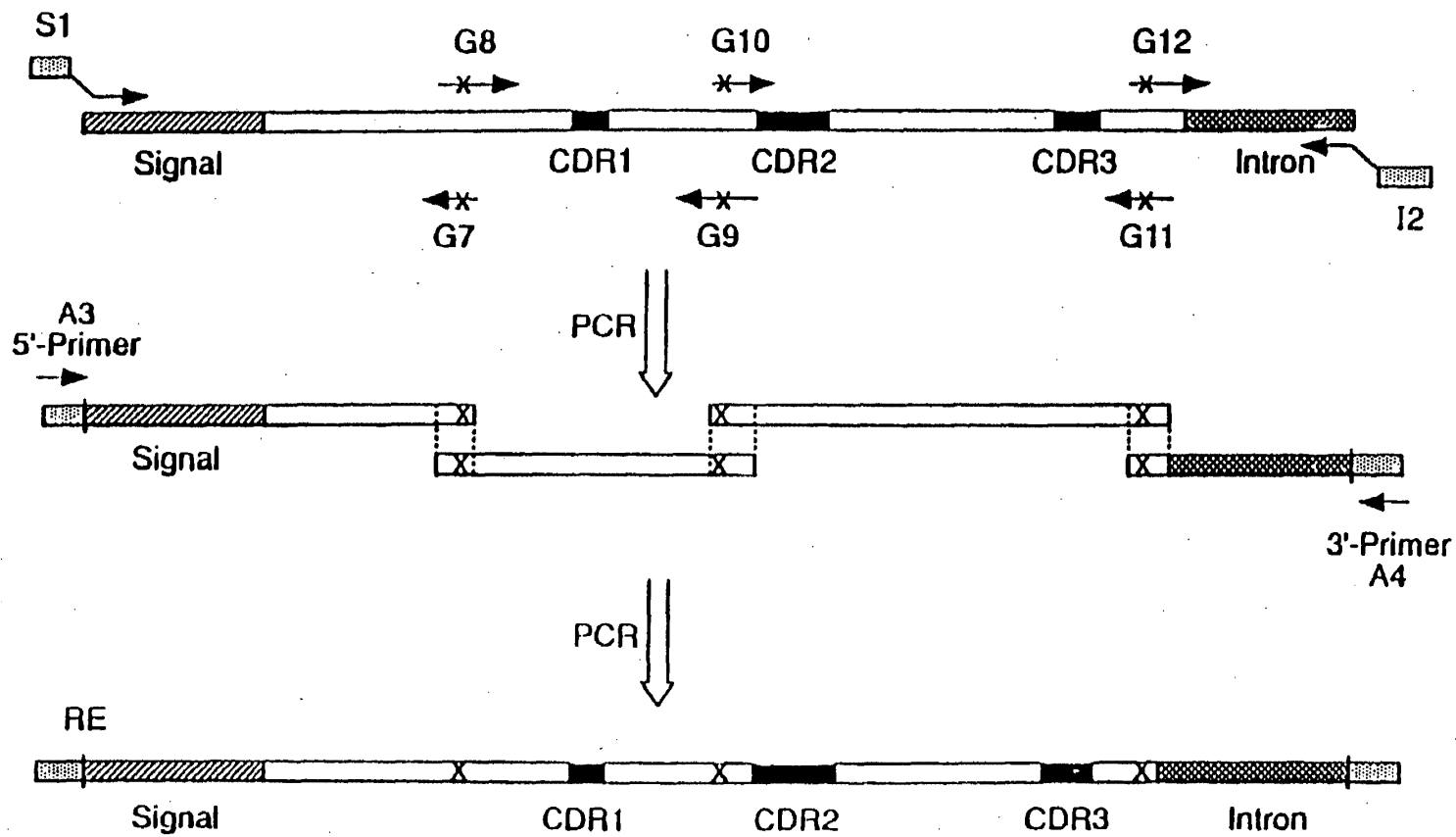

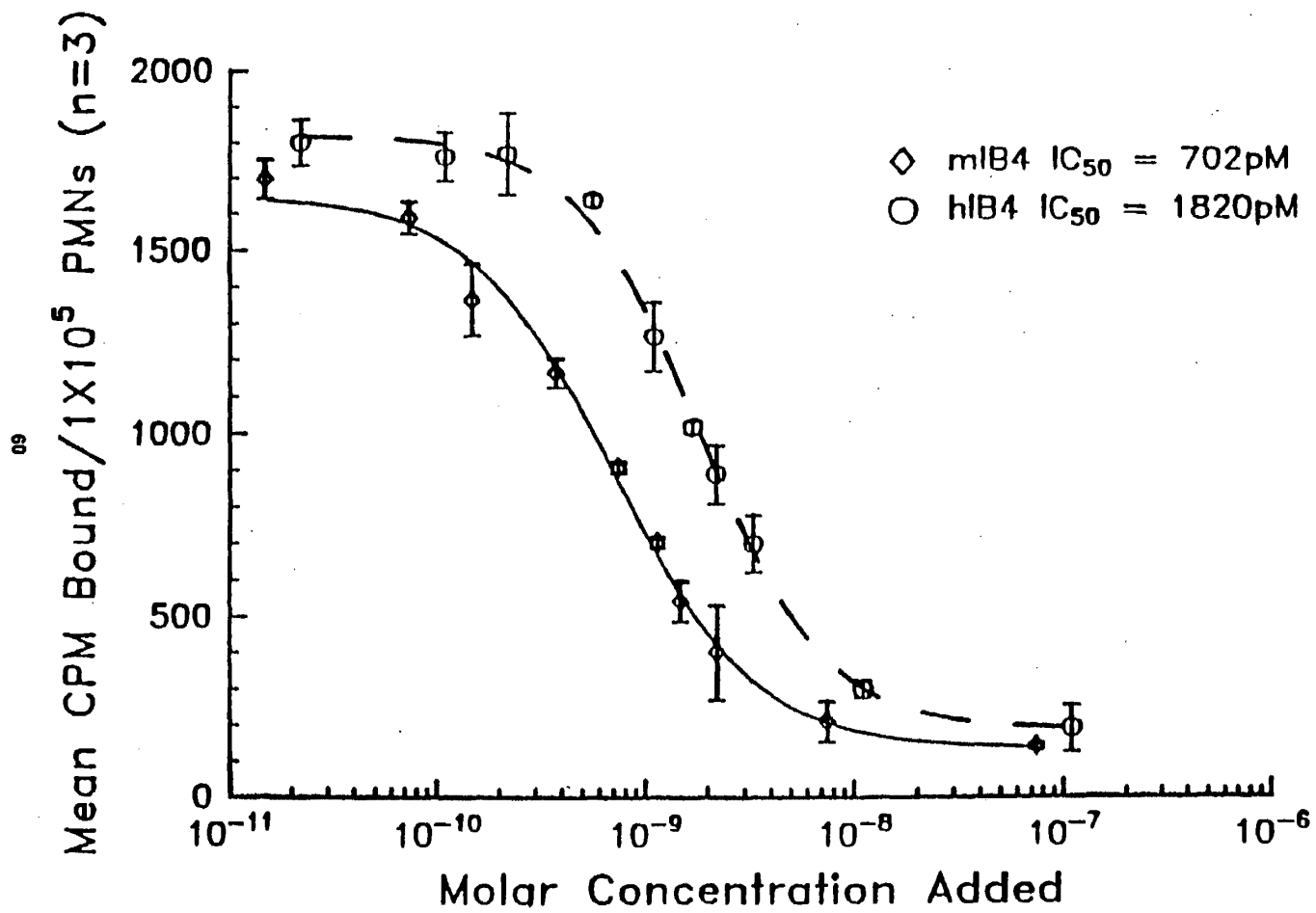

Fig. 28

EP 0 440 351 A2

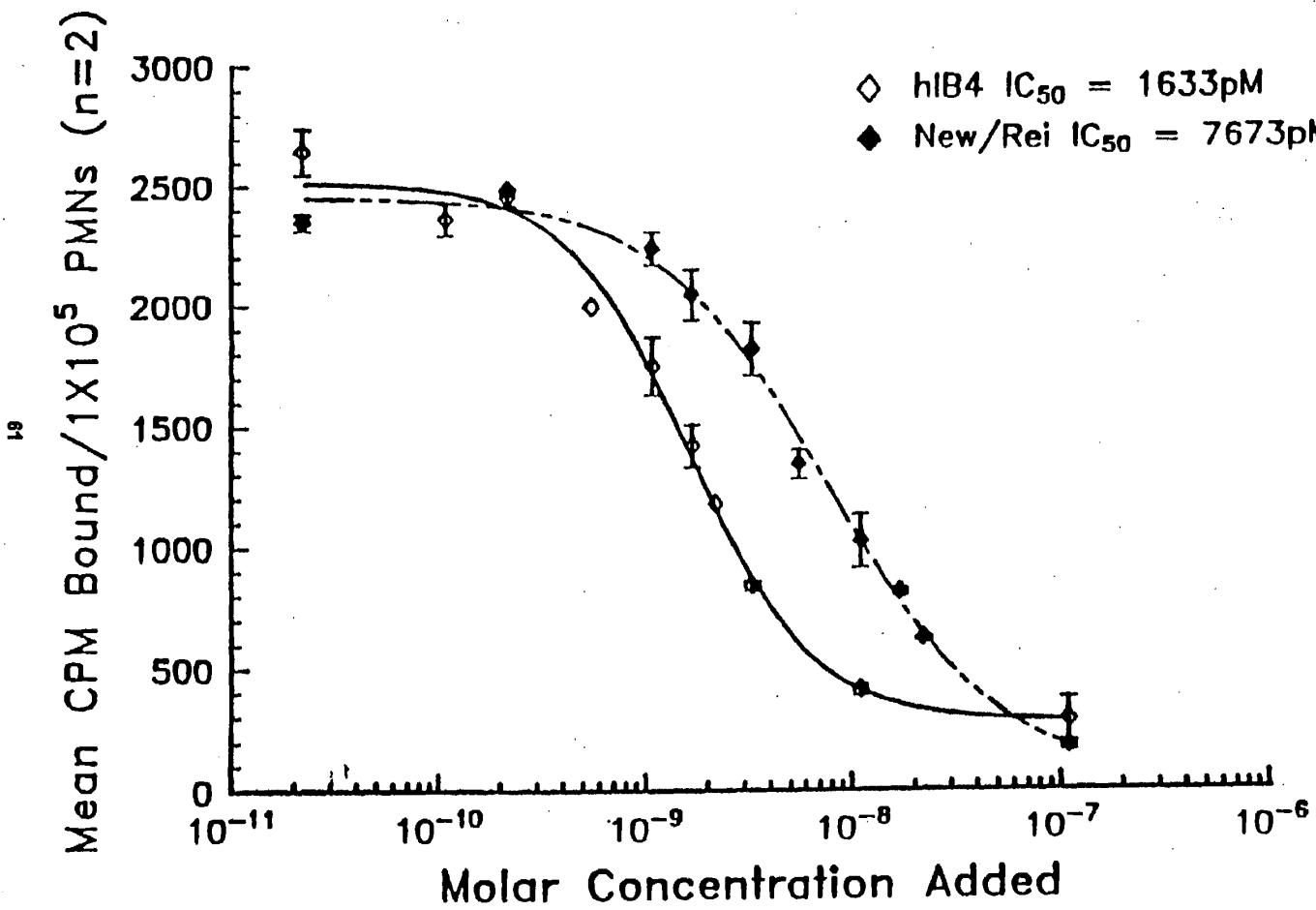

Fig. 29

EP 0 440 351 A2

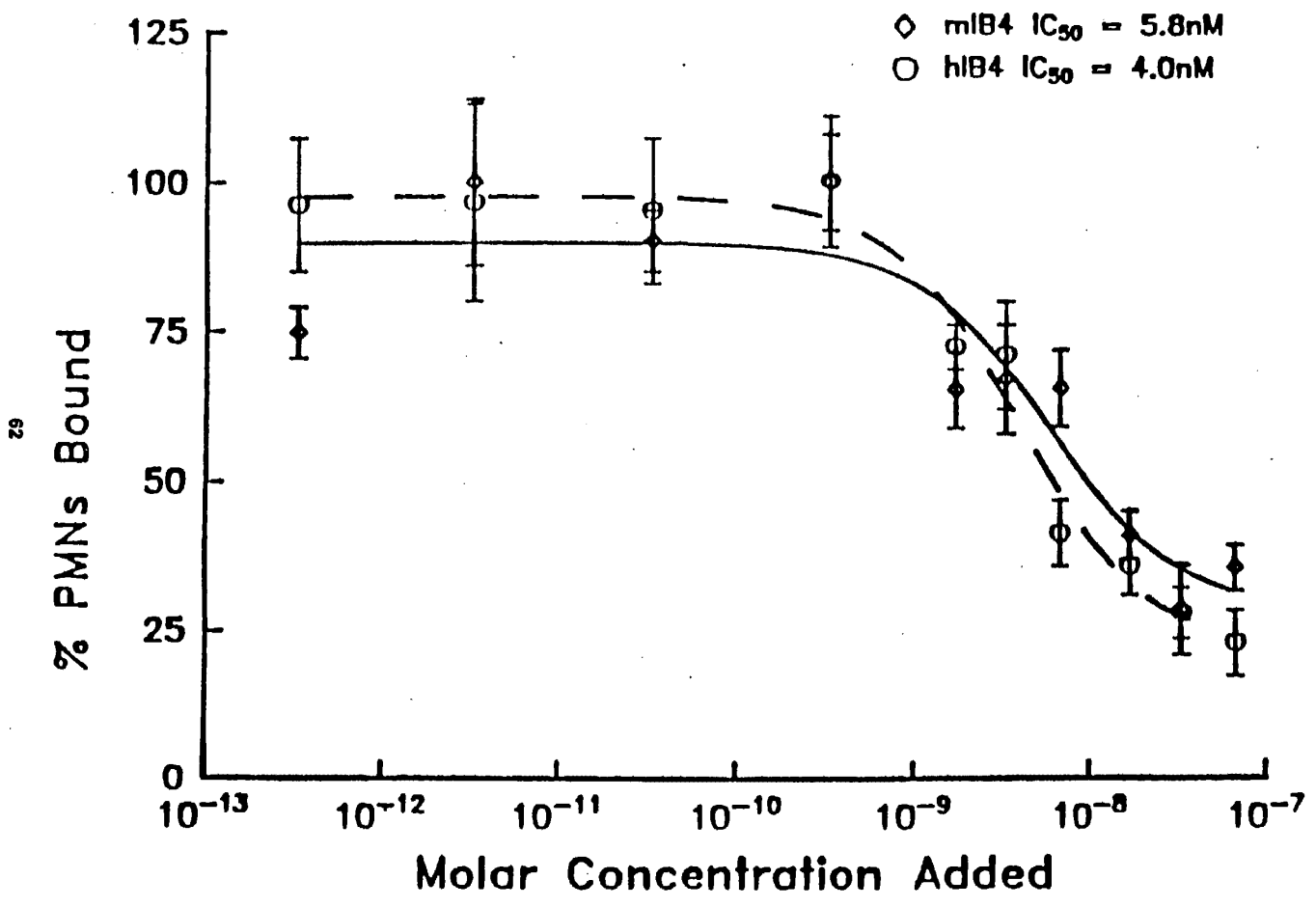

Fig. 30

EP 0 440 351 A2

Fig. 31

COMPARISON OF Gal/Rel hIB4 AND mIB4 IN
IN VITRO FUNCTIONAL ASSAYS

	IC ₅₀ (nM)				
	<u>hIB4</u>	<u>n</u>	<u>mIB4</u>	<u>n</u>	<u>P</u>
HUVEC	8.2	9	4.6	9	>.1
CTL	2.0	4	2.0	4	>.5

Immunofluorescence microscopic localization of mIB4 and Gal/Rei hIB4 staining in 5 um frozen sections of rabbit tissues.*

<u>Tissue</u>	<u>mIB4 staining</u>	<u>Gal/Rei hIB4 staining</u>
bone marrow	++++	++++
cerebrum	0	0
kidney	+ (leukocytes only)	+ (leukocytes only)
large intestine	0	0
liver	0	0
lungs	++ (leukocytes only)	++ (leukocytes only)
lymph nodes	++	++
myocardium	0	0
stomach	0	0
striated muscle (leg)	0	0
spleen	+++	+++

*Consecutive tissue sections were stained individually with mIB4 or hIB4. Two double-blinded experiments were performed by different investigators. The degree of labeling was scored as 0 (negative), + (sparse), ++ (moderate), +++ (intense), and ++++ (markedly intense).

Fig. 33

**DOUBLE LABEL IMMUNOFLOURESCENCE MICROSCOPIC
LOCALIZATION OF Gal/Rei HUMANIZED AND MURINE
IB4 IN RABBIT BONE MARROW CELLS***

<u>Primary Antibodies Applied</u>	<u>Gal/Rei hIB4</u>	<u>mIB4</u>
Gal/Rei hIB4 + mIB4	+++	+++
hlgG4 + mIB4	0	+++
Gal/Rei hIB4 + buffer	+++	0
mIB4 + buffer	0	+++
hlgG4 + buffer	0	0

* 5 um frozen sections of rabbit bone marrow were stained with mixtures of Gal/Rei hIB4 and native murine IB4 or controls (hlgG4, buffer). +++ = moderate staining; 0 = negative.

Fig. 34

**DOUBLE LABEL IMMUNOELECTRON MICROSCOPIC
LOCALIZATION OF Gal/Rei HUMANIZED AND MURINE
IB4 IN SPECIFIC GRANULES OF HUMAN PMNs***

<u>Primary Antibodies Applied</u>	<u>Relative Staining Intensity</u>	
	<u>Gal/Rei hIB4</u>	<u>mIB4</u>
Gal/Rei hIB4 + mIB4	++++	++++
hlgG4 + mIB4	0	++++
Gal/Rei hIB4 + buffer	++++	0

* 80 nm ultrathin frozen sections of human PMNs were double stained with Gal/Rei hIB4 and native murine IB4 or controls (hlgG4, buffer). + + + + = intense staining; 0 = negative.

Fig. 35

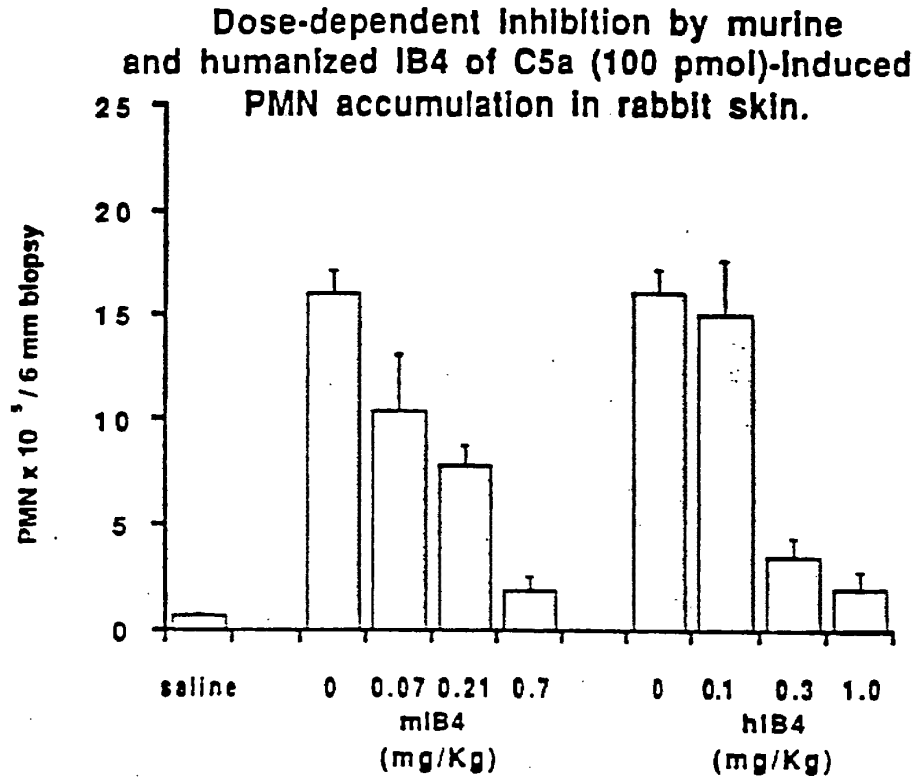
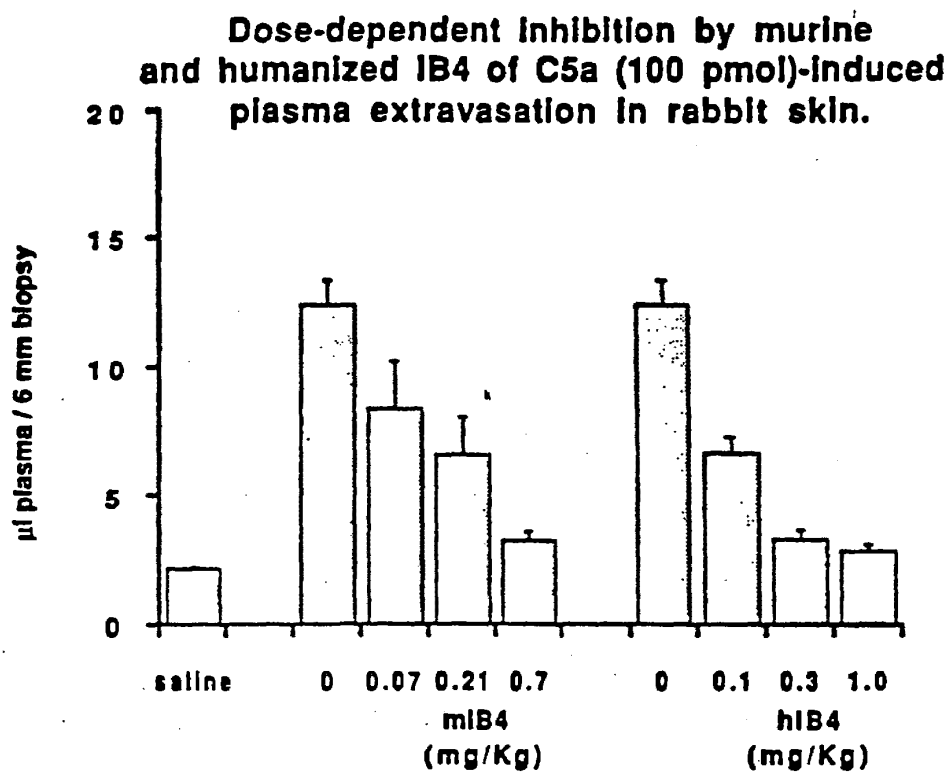

Fig. 36



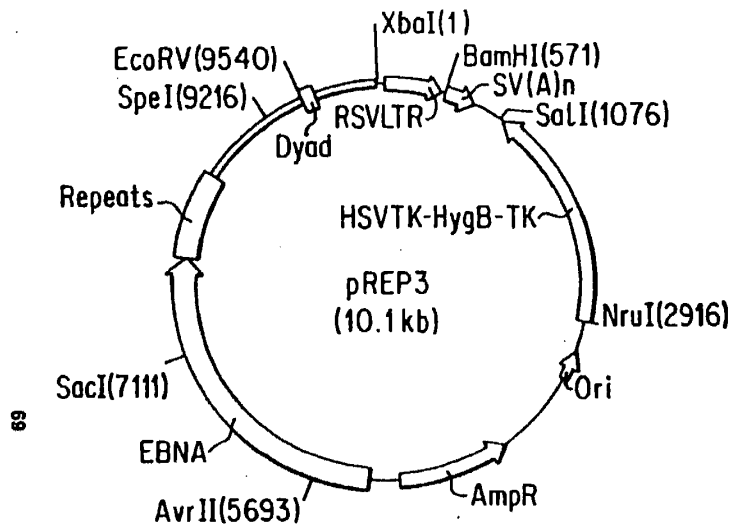
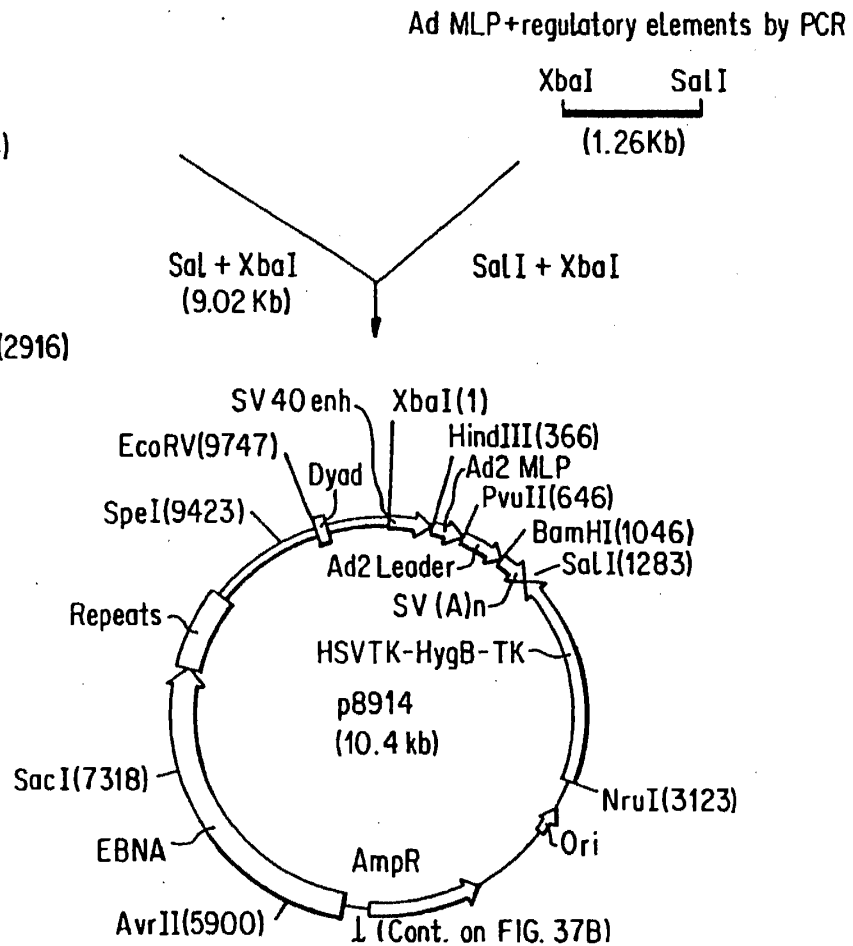
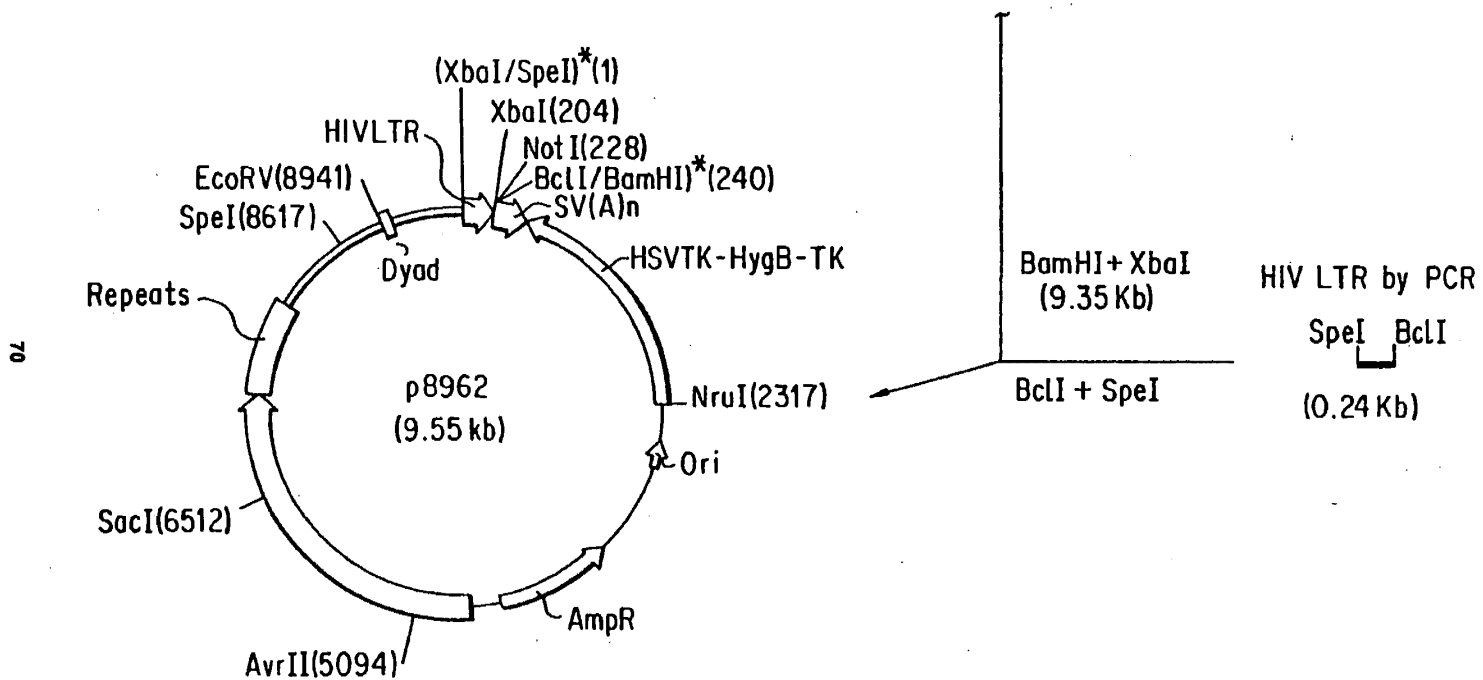

FIG. 37A



EP 0 440 351 A2

(FROM FIG. 37A)



EP 0 440 351 A2

FIG. 37B

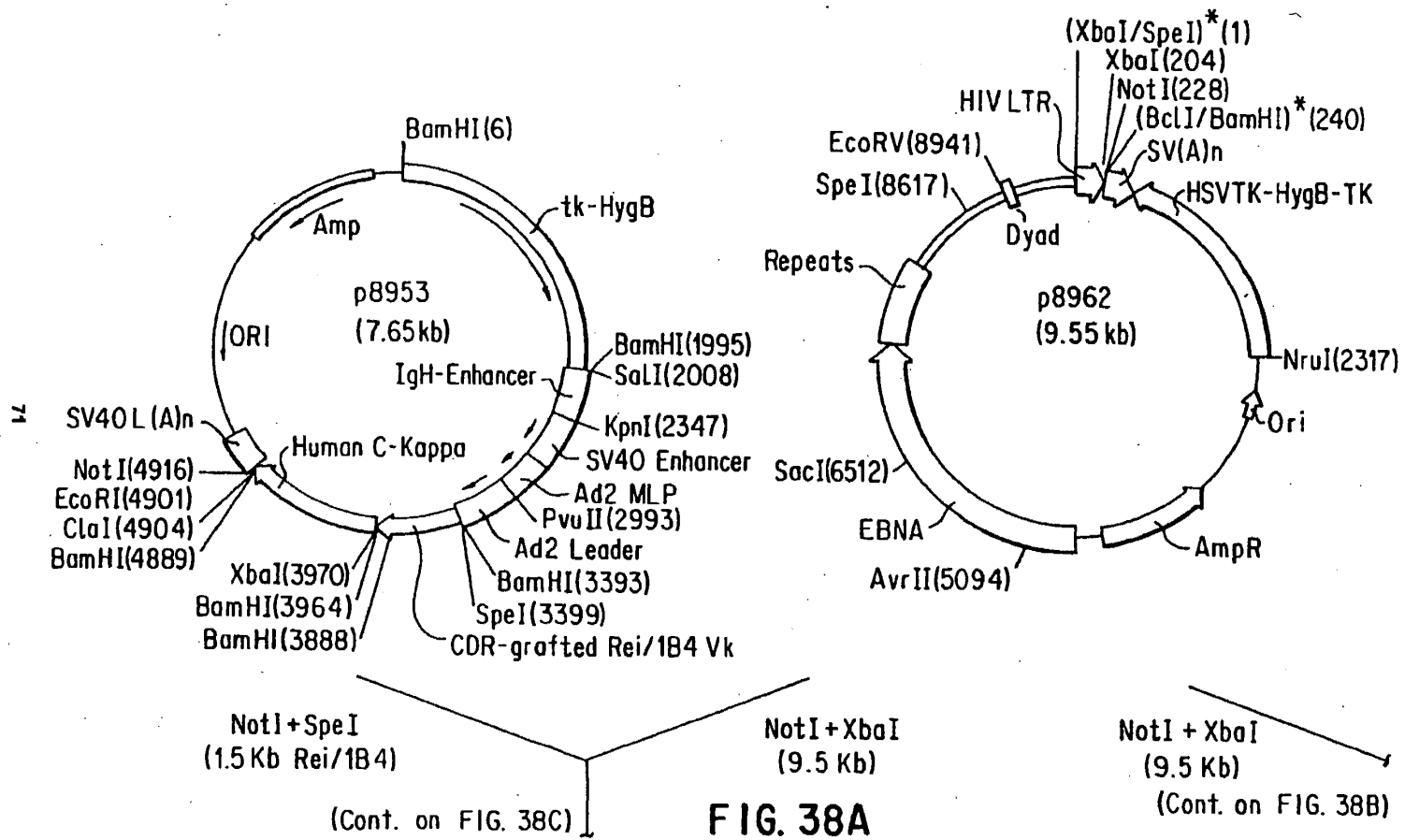

EP 0 440 351 A2

FIG. 38A

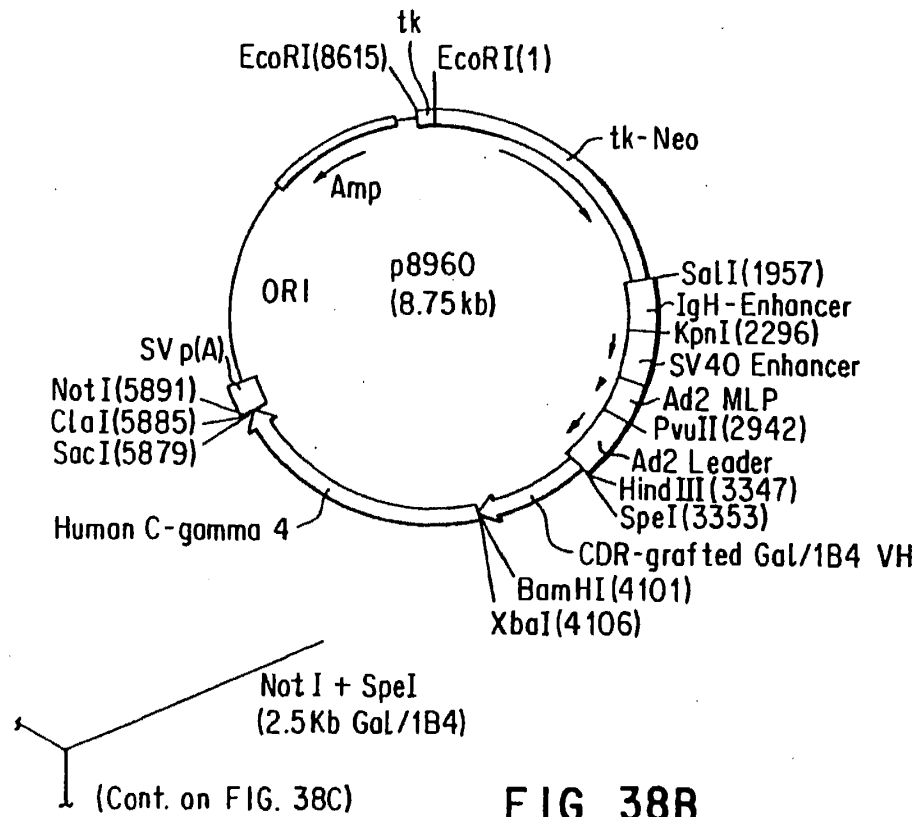

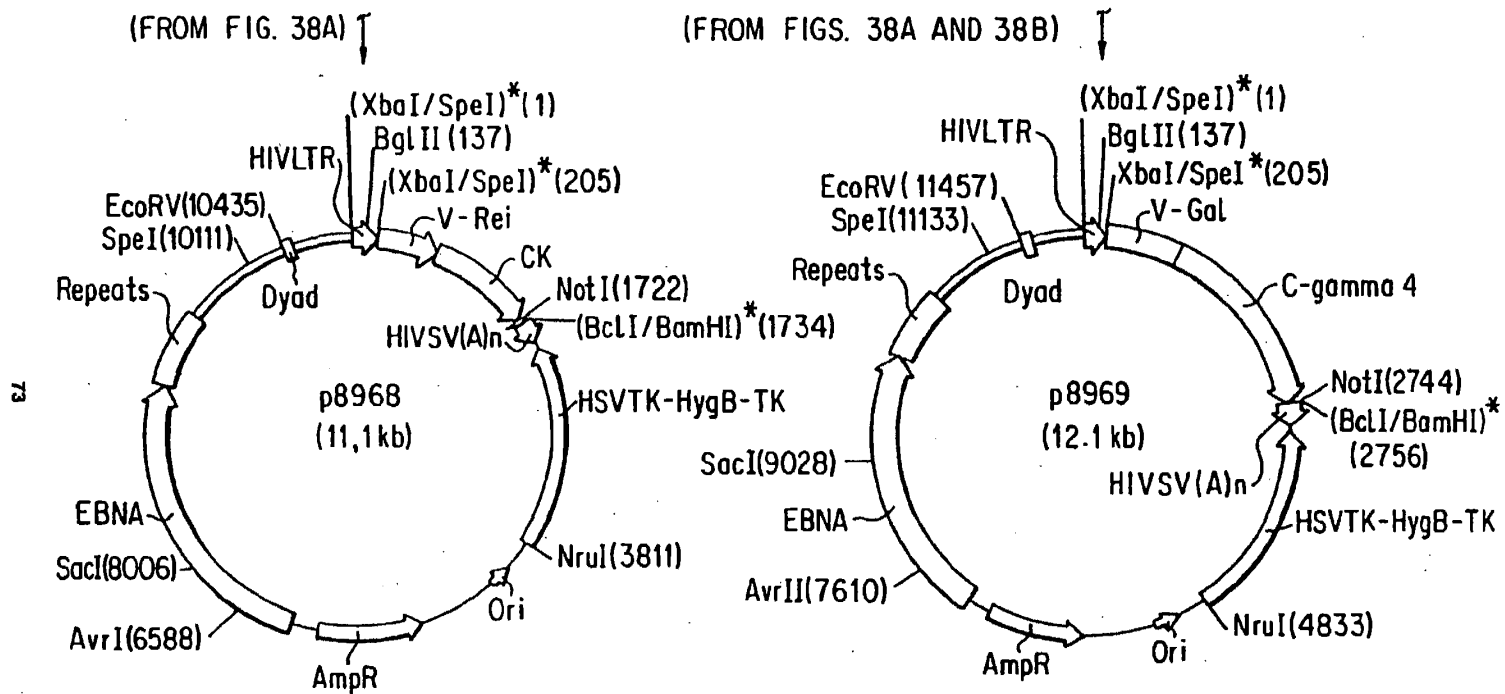

FIG. 38C

EP 0 440 351 A2



12

EUROPEAN PATENT APPLICATION

21 Application number : 91300369.5

51 Int. Cl.⁵: **C12N 15/13, C12N 5/10, C12P 21/08, A61K 39/395**

22 Date of filing : 17.01.91

30 Priority : 19.01.90 US 467692
 20.12.90 US 627422
 43 Date of publication of application :
 07.08.91 Bulletin 91/32
 64 Designated Contracting States :
AT BE CH DE DK ES FR GB GR IT LI LU NL SE
 88 Date of deferred publication of search report :
 01.07.92 Bulletin 92/27
 71 Applicant : **MERCK & CO. INC.**
 126, East Lincoln Avenue P.O. Box 2000
 Rahway New Jersey 07065-0900 (US)

72 Inventor : Law, Ming-Fan
 12344 Picrus Street
 San Diego, California 92129 (US)
 Inventor : Mark III, George E.
 4 Richmond Court
 Princeton Junction, NJ 08550 (US)
 Inventor : Schmidt, John A.
 19 Fairway Drive
 Green Brook, NJ 08812 (US)
 Inventor : Singer, Irwin I.
 18 Lakeridge Drive
 Matawan, NJ 07747 (US)
 74 Representative : Thompson, John Dr. et al
 Merck & Co., Inc. European Patent
 Department Terlings Park Eastwick Road
 Harlow, Essex CM20 2QR (GB)

54 Recombinant human anti-CD18 antibodies.

57 Recombinant immunoglobulin specifically reactive with the CD18 integrin or antigen of leukocytes and methods for the production of the immunoglobulin are disclosed. DNA constructs containing the complementarity determining regions (CDRs) of a murine antibody are recombinantly combined with the chosen frameworks of variable regions of both heavy and light chains of a human antibody. The constructs are transfected into eucaryotic host cells capable of expressing the recombinant immunoglobulin sequence.

Fig. 13

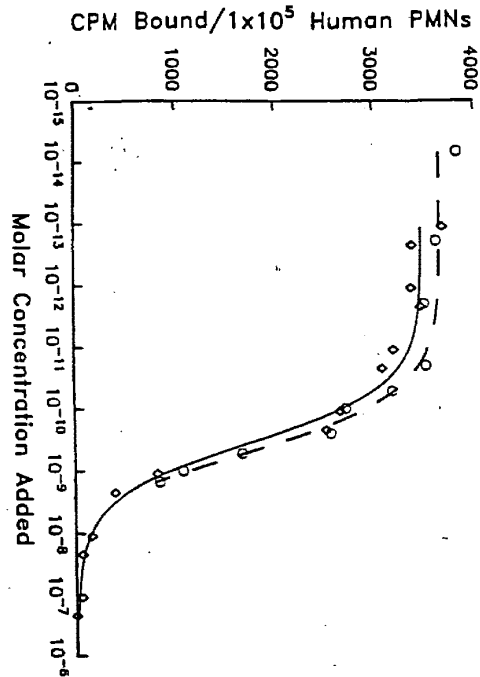

EP 0 440 351 A3

European Patent
Office

EUROPEAN SEARCH REPORT

Application Number

EP 91 30 0369
Page 1

DOCUMENTS CONSIDERED TO BE RELEVANT			
Category	Citation of document with indication, where appropriate, of relevant passages	Relevant to claim	CLASSIFICATION OF THE APPLICATION (Int. Cl.5)
Y,D	PROCEEDINGS OF THE NATIONAL ACADEMY OF SCIENCES OF USA, vol. 80, September 1983, WASHINGTON US pages 5699 - 5703; S.D. WRIGHT ET AL.: 'Identification of the C3b1 receptor of human monocytes and macrophages by using monoclonal antibodies' * page 5699, column 2, paragraph 2 * * page 5702, column 2 * ---	1-13, 18-22	C12N15/13 C12N5/10 C12P21/08 A61K39/395
Y,D	PROCEEDINGS OF THE NATIONAL ACADEMY OF SCIENCES OF USA, vol. 86, no. 10, May 1989, WASHINGTON US pages 3833 - 3837; R. ORLANDINI ET AL.: 'Cloning immunoglobulin variable domains for expression by the polymerase chain reaction' * the whole document * ---	1-13, 18-22	
A,D	NATURE, vol. 321, 29 May 1986, LONDON GB pages 522 - 525; P.T. JONES ET AL.: 'Replacing the complementary-determining regions in a human antibody with those from a mouse' * page 525, column 1 * ---	1-22	TECHNICAL FIELDS SEARCHED (Int. Cl.5) C07K C12N C12P A61K
A	EP-A-0 314 863 (BAYLOR COLLEGE OF MEDICINE) 10 May 1989 * page 2, last paragraph * ---	4	
E	EP-A-0 438 312 (MERCK & CO. INC.) 24 July 1991 * the whole document * ---	1-22	
E	EP-A-0 438 310 (MERCK & CO. INC.) 24 July 1991 * the whole document * ---	1-22	
-/--			
The present search report has been drawn up for all claims			
Place of search THE HAGUE		Date of completion of the search 01 APRIL 1992	Examiner CUPIDO M.
CATEGORY OF CITED DOCUMENTS X: particularly relevant if taken alone Y: particularly relevant if combined with another document of the same category A: technological background O: non-written disclosure P: intermediate document		T: theory or principle underlying the invention E: earlier patent document, but published on, or after the filing date D: document cited in the application L: document cited for other reasons --- A: member of the same patent family, corresponding document	

EPO FORM 150 (04/89) (P.04)



European Patent
Office

EUROPEAN SEARCH REPORT

Application Number

EP 91 30 0369
Page 2

DOCUMENTS CONSIDERED TO BE RELEVANT			
Category	Citation of document with indication, where appropriate, of relevant passages	Relevant to claim	CLASSIFICATION OF THE APPLICATION (Int. Cl.5)
T	<p>NUCLEIC ACIDS RESEARCH. vol. 19, no. 9, 11 May 1991, EYNSHAM, OXFORD GB pages 2471 - 2476; B.L. DAUGHERTY ET AL.: 'Polymerase chain reaction facilitates the cloning, CDR-grafting, and rapid expression of a murine monoclonal antibody directed against the CD18 component of leukocyte integrins' * the whole document *</p> <p style="text-align: center;">-----</p>	1-22	
			TECHNICAL FIELDS SEARCHED (Int. Cl.5)
The present search report has been drawn up for all claims			
Place of search THE HAGUE		Date of completion of the search 01 APRIL 1992	Examiner CUPIDO M.
<p>CATEGORY OF CITED DOCUMENTS</p> <p>X : particularly relevant if taken alone Y : particularly relevant if combined with another document of the same category A : technological background O : non-written disclosure P : intermediate document</p>		<p>T : theory or principle underlying the invention E : earlier patent document, but published on, or after the filing date D : document cited in the application L : document cited for other reasons</p> <p>..... & : number of the same patent family, corresponding document.</p>	

EPO FORM 1501 (04/91) (P0001)



INTERNATIONAL APPLICATION PUBLISHED UNDER THE PATENT COOPERATION TREATY (PCT)

<p>(51) International Patent Classification ⁵ : C12N 15/13, C07K 15/28 C12P 21/08, A61K 39/395 G01N 33/80</p>	<p>A1</p>	<p>(11) International Publication Number: WO 91/07492 (43) International Publication Date: 30 May 1991 (30.05.91)</p>
<p>(21) International Application Number: PCT/EP90/01964 (22) International Filing Date: 13 November 1990 (13.11.90) (30) Priority data: 8925590.5 13 November 1989 (13.11.89) GB (71) Applicant (for all designated States except US): CENTRAL BLOOD LABORATORIES AUTHORITY [GB/GB]; The Crest, Dagger Lane, Elstree, Borehamwood, Hertfordshire WD6 3AU (GB). (72) Inventor; and (75) Inventor/Applicant (for US only) : HUGHES-JONES, Nevin, Campbell [GB/GB]; 65 Orchard Road, Melbourn, Royston, Hertfordshire SG8 6BB (GB).</p>	<p>(74) Agents: HOLMES, Michael, John et al.; Frank B. Dehn & Co., Imperial House, 15-19 Kingsway, London WC2B 6UZ (GB). (81) Designated States: AT (European patent), AU, BE (European patent), CA, CH (European patent), DE (European patent), DK (European patent), ES (European patent), FR (European patent), GB (European patent), GR (European patent), IT (European patent), JP, KR, LU (European patent), NL (European patent), SE (European patent), US. Published With international search report.</p>	
<p>(54) Title: MONOCLONAL ANTIBODIES</p> <div style="text-align: center; margin: 20px 0;"> <p>The diagram illustrates the structure of a monoclonal antibody. It shows three oligonucleotide regions (OLIGO1, OLIGO2, OLIGO3) positioned above the variable domain. The variable domain is divided into three complement-determining regions (CDR1, CDR2, CDR3) and four framework regions (FR1, FR2, FR3, FR4). The CDR3 region is specifically labeled as the anti-D V_H CDNA sequence.</p> </div> <p>(57) Abstract</p> <p>The present invention provides DNA sequences encoding complementarity determining regions of variable domains of human anti-RhD antibodies and their use in the production of recombinant chimaeric antibody molecules.</p>		

FOR THE PURPOSES OF INFORMATION ONLY

Codes used to identify States party to the PCT on the front pages of pamphlets publishing international applications under the PCT.

AT	Austria	FI	Finland	ML	Mali
AU	Australia	FR	France	MN	Mongolia
BB	Barbados	GA	Gabon	MR	Mauritania
BE	Belgium	GB	United Kingdom	MW	Malawi
BF	Burkina Faso	GN	Guinea	NL	Netherlands
BG	Bulgaria	GR	Greece	NO	Norway
BJ	Benin	HU	Hungary	PL	Poland
BR	Brazil	IT	Italy	RO	Romania
CA	Canada	JP	Japan	SD	Sudan
CF	Central African Republic	KP	Democratic People's Republic of Korea	SE	Sweden
CG	Congo	KR	Republic of Korea	SN	Senegal
CH	Switzerland	LI	Liechtenstein	SU	Soviet Union
CI	Côte d'Ivoire	LK	Sri Lanka	TD	Chad
CM	Cameroon	LU	Luxembourg	TC	Togo
DE	Germany	MC	Monaco	US	United States of America
DK	Denmark	MG	Madagascar		
ES	Spain				

Monoclonal Antibodies

5 This invention relates to novel monoclonal anti-RhD antibodies prepared by recombinant DNA methods.

The Rhesus blood group system is a major antigenic constituent of the human red blood cell membrane; of this group, the RhD antigen is of particular clinical
10 importance in relation to isoimmune reactions. An Rh D- individual with anti-RhD who receives RhD+ blood is liable to suffer substantial red blood cell (RBC) destruction due to the RhD phenotype incompatibility, and thus blood of donors must routinely be classified as
15 RhD+ or RhD-. Anti RhD monoclonal antibodies (antiD Mabs) are capable of providing blood-typing reagents of high specificity and reliability.

The RhD antigen is also responsible for haemolytic disease of the newborn (HDN). This condition arises in
20 newborn RhD+ infants of RhD- mothers previously sensitised to RhD antigen as a result of IgG anti-RhD antibodies crossing the placenta during pregnancy and causing foetal red blood cell (RBC) destruction. Sensitization of the RhD- mother to RhD antigen often
25 occurs during the birth of an earlier RhD+ child due to some foetal RBCs entering the maternal circulation and being recognised as foreign by the maternal immune system. To reduce the incidence of HDN, it is routine practice in the United Kingdom and many other countries
30 to give anti-RhD antibodies to RhD- mothers immediately after the birth of an RhD+ infant so that any RhD+ RBCs which may have entered the maternal circulation are rapidly removed.

The search for the most effective anti D Mabs has
35 proved to be extremely time consuming, involving the isolation of B-lymphocytes from humans immunised against RhD, usually Rh-ve mothers who have given birth to Rh+ve

children. Such lymphocytes are subjected to EBV treatment to provide an immortalised cell-line directly or the EBV-treated cells are hybridised with suitable mouse myeloma cells to provide a hybridoma: The cell-line or hybridoma may then be used to produce the anti-D Mab in the conventional way.

However, there are significant differences between anti-D Mabs in terms of their binding affinities for red cells, their ability to recognise D-variants such as D^u and D^{vi}, and their ability to destroy target cells by phagocytosis or cell-mediated lysis. It is desirable, therefore, to have available a method of combining the favourable parameters of different anti-D Mabs or, indeed of combining the most favourable features of selected anti-D Mabs with Mabs of quite different specificities which present particular advantages, in order to produce so-called chimaeric Mabs.

The concept of building chimaeric Mabs, has been described by Jones et al (Nature 321, 522-525 (1986)) and Riechmann et al (Nature 332, 323-327 (1988)). Three dimensional studies have shown that immunoglobulins comprise essentially constant regions common to most Mabs and terminally situated variable domains associated with antigen binding.

It has been shown that the variable domains consist of two β -sheets joined by a disulphide bridge with their hydrophobic faces in contact. Sequence comparisons among heavy- and light-chain variable domains (V_H and V_L respectively) have revealed that each of these domains comprises three hypervariable domains or complementarity determining regions (CDRs) set in a framework of four relatively conserved regions, the framework regions (FRs). The CDRs are primarily responsible for the recognition of specific antigens. The structure of the β -sheet framework is similar in different antibodies, as the packing together of V_L and V_H FRs is conserved and therefore the orientation of V_L with respect to V_H is

fixed.

Genes coding for a number of Mabs are now available and the sequences coding for the variable regions V_L and V_H have been determined. It is thus possible to replace the latter sequences by DNA coding for V_L and V_H from different Mabs and indeed to construct the latter by incorporating DNA coding for chosen CDRs into DNA coding for a standard set of FRs. It is thus possible to construct genes coding for chimeric anti-D Mabs having the CDRs from anti-D Mabs possessing particularly desirable specificities or other properties and framework and constant regions derived from Mabs having other desirable properties.

It is a prerequisite of such construction that the amino acid sequences of the CDR regions of the chosen anti-D Mabs and/or the genes coding for them, should be known. The specific CDR gene sequences can then be synthesised, conveniently by chemical synthesis of the appropriate oligonucleotides, and incorporated into DNA sequences coding for a standard set of FRs and the human (or other) constant region. Of course, the FRs may be identical with those of the Mab providing the constant region or, more conveniently, they may be a standard set of FRs which can be used generally in the synthesis of chimeric Mabs.

We have produced a number of anti-D Mabs of particular interest and have determined their amino acid sequences, thus making it possible for DNA sequences corresponding to their CDRs to be synthesised and incorporated into V_H and V_L sequences as described above. These may then be combined with DNA coding for the constant region to enable novel anti-D Mabs to be synthesised which may have lower, the same or higher binding ability.

Thus, according to one aspect we provide DNA sequences comprising oligonucleotides encoding CDR1, CDR2, and CDR3 regions of V_H and V_L domains of antibodies

against the human RhD antigen, and functional equivalents thereof. In particular, we have investigated and sequenced eleven Mabs, namely a) FOG-B, b) PAG-1, c) MAD-2, d) FOG-1, e) FOM-1, f) FOM-A, g) BRAD-3, h) JAC-10, i) GAD-2, J) REG-A, K) HAM-B, whose heavy and light chain sequences are represented in figures 2-14, of the accompanying drawings, and which have both varied and particularly useful binding specificities. The figures 2 and 3 show the nucleotide and amino acid sequences of the light chain variable domains of the Mabs FOG-B and PAG-1. Corresponding sequences for the heavy chain variable domains of these two Mabs are shown in figures 4 and 5, and sequences of the heavy chain variable domains of the Mabs MAD-2, FOG-1, FOM-A, BRAD-3, JAC-10, GAD-2, REG-A and HAM-B are shown in figures 6-14.

Synthetic genes, for both heavy and light chains may be created by combining selected CDR 1, 2, and 3 regions, which may be selected from different antibody molecules having varied binding specificities.

Thus according to a further aspect, we provide DNA molecules coding for the heavy or light chain fragments of a monoclonal antibody or fragment thereof comprising CDR1, CDR2 and CDR3 encoding oligonucleotides from antibodies FOG-B, PAG-1, MAD-2, FOG-1, FOM-1, FOM-A, BRAD-3, JAC-10, GAD-2, REG-A and HAM-B as illustrated in figures 2-14.

In order to create functional genes, such oligonucleotides must be incorporated into a backbone sequence such that when expressed, functional proteins result.

Thus according to a further aspect, we provide DNA molecules comprising a gene coding for the framework regions of a human antibody light or heavy chain having inserted therein in the correct CDR region, oligonucleotides encoding CDR1, CDR2 and CDR3 regions according to the present invention.

In the synthesis of a chimeric Mab in accordance with the invention, single stranded DNA coding for the V_H region of a chosen Mab (not necessarily an anti-D Mab) is incorporated in single stranded form into a vector capable of producing single stranded DNA, such as the M13 bacteriophage. Fig. 1 shows diagrammatically the structure of a single stranded V_H DNA including framework regions FR1 to FR4 with complementarity determining regions CDR1 to CDR3 of a Mab. These steps can be accomplished by conventional techniques such as those described in Riechmann et al (Nature, 332, 323-327, (1988)).

Three oligonucleotides may then be prepared corresponding to the CDR regions of the chosen anti-D Mab variable domain, eg the V_H region of FOG-B as shown in Fig. 4, and will include several nucleotides on either side of each CDR region to permit hybridisation with the framework regions FR1 to FR4 (see figure 1). The sequences of the latter will normally be substantially homologous with those of the anti-D Mab (e.g. FOG-B) but since the oligonucleotides will normally be synthesised chemically, hybridisation may be ensured by matching the overlapping nucleotides exactly to the FRs 1 to 4. It may also be beneficial to modify the oligonucleotides to express the CDRs more efficiently in the eventual host cells.

The three oligonucleotides, shown in Fig 1 as oligo 1 to oligo 3, may then be annealed to a single stranded V_H DNA in the M13 vector and used as primers to synthesise second strand DNA containing the anti-D V_H CDR sequences. This may be achieved conventionally using a suitable polymerase. Since the antibody specificity is determined solely by the three CDR regions, the actual V_H gene chosen for the framework template is immaterial. All that is required is that there is sufficient homology of the three chosen oligonucleotides with the template. This is ensured by appropriate design of the

terminal nucleotides of the synthetic oligonucleotide primers. Thus the second strand may contain sequences from substantially any human antibody heavy chain gene, so long as the resulting expressed protein possesses the desired binding parameters.

The double stranded M13 vector may then be used to transform a suitable host microorganism e.g. a conventional E. coli and one or more clones selected which contain the required anti-D V_H specificity. The correct clone may be identified by DNA sequencing.

The corresponding V_L DNA (e.g. for FOG-B) may be prepared in the same way.

The DNA coding for the V_H and V_L regions may then be excised from the above vectors and introduced into other vectors.

According to a further aspect, we provide DNA molecules being synthetic genes for chimaeric antibody, heavy or light chains when incorporated into vectors capable of expressing such antibody chains. Preferred vectors include mammalian expression vectors, such as pSV2gpt (heavy chains) and pSV2neo (light chains) containing DNA coding for the human constant region. Such vectors are readily available from a number of laboratories, or can readily be prepared by incorporating DNA coding for human constant region into known mammalian vectors.

The expression vectors so constructed may then be co-transfected into an appropriate cell-line e.g. a non-secreting IgG myeloma, for large scale production.

Thus according to a yet further aspect, the present invention provides each of the CDR polypeptides of the Mabs FOG-B, PAG-1, MAD-2, FOG-1, FOM-1, FOM-A, BRAD-3, JAC-10, GAD-2, REG-A and HAM-B shown in Figs. 2-14 of the accompanying drawings in single stranded or double stranded form in the absence of the constant and or framework regions of said Mabs.

According to a yet further aspect, the invention

provides chimaeric antibody heavy and light chains of the variable domains comprising CDR polypeptide sequences of the present invention.

5 Knowledge of the antibody sequences according to the invention enables new chimaeric anti-D antibody molecules to be prepared, having appropriately designed binding specificities. These antibodies may be used for both therapy and diagnosis using presently known techniques.

10 According to a yet further aspect, we provide anti-RhD reagents comprising at least one antibody molecule according to the invention.

15 According to a still yet further aspect, we provide pharmaceutical compositions for use in passive immunisation to prevent haemolytic disease of the newborn comprising an antibody of the present invention together with at least one pharmacologically acceptable carrier or diluent.

20 A sterile solution of such an antibody for human injection may be formulated in any physiologically acceptable aqueous medium, for example isotonic phosphate buffered saline or serum. Alternatively, the antibody may be supplied in a freeze-dried formulation ready for reconstitution prior to use.

25

EXAMPLE(1) Construction of Chimaeric Antibody Genes

5 Three oligonucleotide primers are synthesised using
an Applied Biosystems machine according to the
manufacturer's instructions and purified on an 8 M
Urea/polyacrylamide gel (Sanger & Coulson, Febs Lett.,
87, 107-110, 1978). The primers are designed to
10 comprise in their central regions sequences
complementary to the CDR1, CDR2 and CDR3 regions of the
anti-RhD antibody PAG-1 heavy chain gene, as identified
according to the criteria described by Kabat et al.
(Sequences of Proteins of Immunological Interest, US
15 Department of Health and Social Services, 1987).

The central sequences are flanked at both their 5'
and 3' termini by sequences of 10 nucleotides which
hybridise to the termini of the corresponding framework
region sequences adjacent to the CDR sequence of the
20 heavy chain antibody gene NEWM (Poljack et al.,
Biochemistry 16, 3412-3420, 1977). The primers are then
hybridised to the derived NEWM single stranded DNA heavy
chain sequence in the M13 bacteriophage and the
complementary strand of the heavy chain variable region
25 extended using DNA polymerase (Neuberger et al., Nature
314, 268-270 (1985), Jones et al., Nature 321, 522-5
(1986)). The M13 vector also contains an appropriate
arrangement for ultimate expression, i.e. a leader
sequence, and unique HindIII and BamHI restriction
30 sites.

A similar construct is prepared from
oligonucleotide primers homologous to the CDR regions of
the PAG-1 anti-RhD antibody light chain genes, and
utilising the M13 vector in which V_L and J_L regions of
35 the antibody gene PAV1 (Sun et al., Nucleic Acids
Research 13, 4921-4934, 1985) are cloned.

(2) Expression of Antibody Polypeptides

The cloned genes for the V_H domains are excised
5 using HindIII and BamHI and cloned into pSV2gpt
(Mulligan and Berg, PNAS 78, 2072-6, 1981). The cloned
light chain genes are similarly excised and cloned into
pSV2neo (Southern and Berg, J. Molec. Appl. Genetics 1
327-381, 1981). Sequences enclosing IgG1 constant
10 regions are then inserted into the vectors (Riechmann et
al., Nature 312, 323-7, (1988). Both vectors are then
transfected by electroporation (Potter et al., PNAS 81,
7161-3, 1984) into the rat myelomacell line
YO (YB2/3.0 AG, 20) (Galfre and Milstein, Methods in
15 Enzymology 73, 1-46, 1981) for antibody production.

CLAIMS

1. A DNA sequence comprising an oligonucleotide
 encoding a CDR1, CDR2 and/or CDR3 region of a V_H or
 5 V_L domain of an antibody against the human RhD
 antigen, and functional equivalents thereof.

2. A DNA sequence as claimed in claim 1 encoding the
 CDR1 region of a V_H domain selected from:

10

AGTGGTGGTCTCTACTGGGGC;

AGTTCCTACTGGAGC;

GGTACTACTGGAGC;

GTTTACTACTGGACC;

15

GGTACTACTGGAAC;

GGTACTACTGGAGC;

AGCTATGGCATGCAC;

AGTACTGGATGCAC;

AGCTATGGCATGCAC;

20

AATTATGGCATGCAC; and

AGCTATGGCATGCAC,

optionally with extended terminal regions.

25 3. A DNA sequence as claimed in claim 1 encoding the
 CDR2 region of a V_H domain selected from:

30

AGTATATTTTATAGTGGGAGCACCTACTACAATCCCTCCCTCAAGAGC;

TATATCTATTACAGTGGGAGCACCAACTACAACCCCTCCCTCAGGAGT;

GAAATCAATCATAGTGAAGGACCAACTACAACCCGTCCCTCAAGACT;

GAAATCAATCATAGTGGAGGCGCCAACTACAATCCGTCCCTCAAGAGT;

GAAATCATTCATAGTGAAGCACCAACTACAACCCGTCCCTCAAGAGT;

GAAATCAGTCGTGGTGAAGCACCAACTACAACCCGTCCCTCAAGAGT;

CTTATATGGTATGATGGAAGTAATAAAGAATATGCAGACTTCGTGAAG

35

GGC;

CGTATTAATAGTTATGGAATTAGCACAAAGTTACGCGAACTCCGTGAAG

GGC;

GTGATATGGTATGATGGAAGTAATAAGTACTATGCAGAGTCCGTGAAG
 GGC;
 GTTATATGGTATGATGGAAGTAATAAAACTATGCAGACTCCGTGAAG
 GGC; and
 5 GTTATTTGGTATGATGGAAGTAATAAATACTATGCAGACTCCGTGAAG
 GGC,

optionally with extended terminal regions.

- 10 4. A DNA sequence as claimed in claim 1 encoding the
 CDR3 region of a V_H domain selected from:

CCAGGCTATGGCGACACCTCGGTACGGAAGAGGGTTTGGAAATATGGAC
 CTC;
 15 GTTTTGGTTTCCCGTACCATTTACAGTACTCCTATTACATGGACGTC;
 GTTTTGGTTTCCCGTACGATTTACAGTACTCCTATTACATGGACGTC;
 CTGTGGCTCGATGGACATGGGTACAAGTTTACTAC;
 GGCCGGTCCCGTTATAGTGGTTACGGCTTCTACTCCGGCATGGACGTC;
 GGCTTAGAACGTCCGATTAGGAACCAGCTGCTAAACCGTCTCGGTTAC
 20 TACATGGACGTC;
 GCCTTGGACTACATCTCCTTGGATTACGGTATGGACGTC;
 GATAGTCCCAAATGAGGGCTGGAAGTATGTTTCGCTACTACTACATG
 GACGTC;
 GGAGAGCGCATAGCAGCTCGTCTCTTGTCCGGCGGGTACGGTATGGAC
 25 GTC;
 GTCGTTAGCAGCAACCGGTACTCTCTAAGCTACTATTACTACATGGAC
 GTC;
 GAACGTACTACGATGTCTGGAGTGATCATTCTCGCCGSTATTTTGAC
 TAC; and
 30 GAAGTTACTATGGTTCGGGGAGTTAGGCGTTACTACGGTATGGACGTC,

optionally with extended terminal regions.

5. A DNA sequence as claimed in claim 1 encoding the
 35 CDR1 region of a V_L domain selected from:

TCCGGAACCAGCTCCAACATTGGGAATAATTATGTATCC;

12

GGGGGAAACAACATTGGGCGTAAAAGTGTGCAC; and
GGGGGAAACAACATTGGACGTAAAAGTGTGCAC,

optionally with extended terminal regions.

5

6. A DNA sequence as claimed in claim 1 encoding the CDR2 region of a V_L domain selected from:

GACAATAATAAGCGACCCTCA;
10 GGTGCTAGCGAGCGGCCCTCA; and
GGTGCTAGCGACCGGCCCTCA,

optionally with extended terminal regions.

15

7. A DNA sequence as claimed in claim 1 encoding the CDR3 region of a V_L domain selected from:

GCAACATGGGATAGCAGCCTGAGTGCTGTGGTG; and
20 CAGGTGTGGGATAGTAGTAGTGCTCATCC3GGGGTGGTA,

optionally with extended terminal regions.

8. A DNA sequence as claimed in any one of claims 2 to
25 7 wherein the said extended terminal regions hybridise with the terminal sequences of the framework regions of a human antibody heavy or light chain gene flanking the CDR region.

- 30 9. A DNA molecule for the synthesis of a synthetic gene coding for the heavy chain fragment of a monoclonal antibody or fragment thereof comprising a CDR1 encoding oligonucleotide as claimed in claim 2, a CDR2 encoding oligonucleotide as claim in
35 claim 3 and a CDR3 oligonucleotide as claimed in claim 4.

10. A DNA molecule for the synthesis of a synthetic gene coding for the light chain fragment of a monoclonal antibody or fragment thereof comprising a CDR1 encoding oligonucleotide as claimed in claim 5, a CDR2 encoding oligonucleotide as claimed in claim 6 and a CDR3 oligonucleotide as claimed in claim 7.
11. A DNA molecule comprising a gene coding for the framework region of a human antibody light or heavy chain having inserted therein for a heavy chain in the CDR1 position an oligonucleotide as claimed in claim 2, in the CDR2 position, an oligonucleotide as claimed in claim 3 and in the CDR3 position, an oligonucleotide as claimed in claim 4.
12. A DNA molecule comprising a gene coding for the framework region of a human antibody light or heavy chain having inserted therein for a light chain in the CDR1 position an oligonucleotide as claimed in claim 5, in the CDR2 position an oligonucleotide as claimed in claim 6 and in the CDR3 position an oligonucleotide as claimed in claim 7.
13. A DNA molecule as claimed in claim 11 or claim 12 when incorporated in a vector capable of expressing the said antibody heavy or light chain.
14. An expression vector as claimed in claim 13 which is replicable in mammalian cells.
15. A polypeptide sequence encoded by a CDR nucleotide sequence as claimed in any one of claims 2 to 7, and functional equivalents thereof.
16. A chimaeric antibody V_H or V_L chain or fragment thereof encoded by a DNA sequence as claimed

respectively in claim 11 or claim 12.

- 5 17. A chimaeric antibody molecule against the RhD antigen wherein the variable regions of the heavy and light chains comprise polypeptide sequences as claimed in claim 15.
- 10 18. An anti-RhD reagent comprising at least one antibody molecule as claimed in claim 17.
- 15 19. A pharmaceutical composition for use in passive immunisation to prevent haemolytic disease of the newborn comprising an antibody as claimed in claim 17 together with at least one pharmacologically acceptable carrier or diluent.
- 20 20. A method of Rh-typing wherein an antibody as claimed in claim 17 is employed.

FIG. 1

1/14

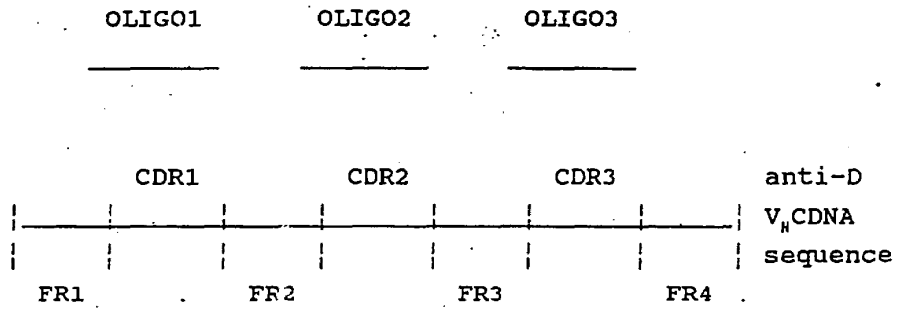

SUBSTITUTE SHEET

2/14

SUBSTITUTE SHEET

1 CAGTCTGTGTTGACGCAGCCGCCCTGAGTGTCTGLEGCCCCAGGGACAGAAAGGTCACCATC 60
 Q S V L T Q P P S V S A A P G Q K V T I

61 TCCTGCTCCGGAACCCAGCTCCAACATTGGGAATAATTATGTATCCTGGTATCAGCAAGCTC 120
 S C S G T S S N I G N N Y V S W Y Q Q L
 <-----CDR1----->

121 CCAGGAACAGCCCCAAACTCCTCATTATGACAATAATAAGCGACCCCTCAGGGATTTCCT 180
 P G T A P K L L I Y D N N K R P S G I P
 <-----CDR2----->

181 GACCGATTCTCTGGCTCCAAGTCTGGCACGTGAGCCACCCTGGGGCATCACCAGGACTCCGG 240
 D R F S G S K S G T S A T L G I T G L R

241 ACTGGGGACGAGGCCGATTATTACTGCGCAACATGGGGATAGCAGCCTGAGTGTCTGTGGTG 300
 T G D E A D Y Y C A T W D S S L S A V V
 <-----CDR3----->

301 TTCGGCGGAGGGACCAAGCTGACCGTCCTAAGT 333
 F G G G T K L T V L S

SUBSTITUTE SHEET

1 TCCTATGTGCTGACTCAGCCACCCTCGGTGTCACTGGCCCCAGGACAGACGGCCAGGATT 60
S Y V L T Q P P S V S V A P G Q T A R I

61 ACCTGTGGGGGAAACAACATTGGACGTAAAAGTGTGCACTGGTACCAGCAGAAECCAGGC 120
T C G G N N I G R K S V H W Y Q Q K P G
←-----CDR1----->

121 CAGGCCCCCTGTGCTGGTCTATGGTGTAGCGACCGGCCCTCAGGGATCCCTGAGCGA 180
Q A P V L V V Y G A S D R P S G I P E R
←-----CDR2----->

181 TTCTCTGGCTCCAACCTCTGGGAACACGGCCACCCTGACCATCAGCAGGGTCCGAGCCGGG 240
F S G S N S G N T A T L T I S R V * A A G

241 GATEAGGCCGACTATTACTGTCAAGTGTGGGATAGTAGTAGTCTCATCCGGGGGTGGTA 300
D E A D Y Y C Q V W D S S S A H P G V V
←-----CDR3----->

301 TTCEGCGGGAGGGACCAAGCTGACCGTCCTAGGT 333
F G G G T K L T V L G

WO 91/07492

PAG-1 VL SEQUENCE

3/14

PCT/EP90/01964

SUBSTITUTE SHEET

1 CAGCTGCGGCTGCAGGAGTCGGGCCAGGACTGGTGAAGCCTTCGGAGACCCTGTCCCTC 60
 O L R L D E S G P G L V K P S E T L S L

61 ACCTGCAGTGTCTCTGGTGGCTCCGTGAGCAGTGGTGGTCTCTACTGGGGCTGGGTCCGC 120
 T C S V S G G S V S S G G L Y W G W V R
 <-----CDR1----->

121 CAGCCCCAGGGAAAGGGGCTCGAATGGATTGGCAGTATATTTTATAAGTGGGAGCACCTAC 180
 O P P G K G L E W I G S I F Y S G S T Y
 <-----CDR2----->

181 TACAATCCCTCCCTCAAGAGCCGAGTCACCATATCCGTAGACACGTTGAAGAATAACTTC 240
 Y N P S L K S R V T I S V D T L K N N F
 ----->

241 TCCCTGAAGCTGAGTTCTGTGACCGCCGACACGGCTGTTTATTACTGTACGAGACCA 300
 S L K L S S V T A A D T A V Y Y C T R P
 <---

301 GGCTATGGCGACACCTCGGTACGGAAAGAGGGTTTGGAAATATGGACCTCTGGGGCCAAGGG 360
 G Y G D T S V R K R V W N M D L W G D G
 -----CDR3----->

361 ACCACGGTCACCGTCTCCTCG 381
 T T V T V S S

WO 91/07492

FOG-B VH SEQUENCE
4/14

PCT/EP90/01964

SUBSTITUTE SHEET

1 CAGGTGCAGCTGCAAGGAGTCGGGCCACGACTGGTGAAGCCTTCGGAGACCCTGTCCGTC 60
Q V Q L Q E S G P G L V K P S E T L S V

61 ACCTGCACTGTCTCTGGTGGCTCCGTCAGTAGTTCCTACTGGAGCTGGATCCGGCAGCCC 120
T C T V S G G S V S S S Y W S W I R Q P
<-----CDR1----->

121 CCAGGGAAAGGGACCGGAGTGGATTGGGTATATCTATTACAGTGGGAGCACCACACTACAAC 180
P G K G P E W I G Y I Y Y S G S T N Y N
<-----CDR2----->

181 CCCTCCCTCAGGAGTGGAGTCACCATATCAGTAGACACGTCCAAGAACCAAGTTCTCCCTG 240
P S L R S R V T I S V D T S K N Q F S L
----->

241 AAGCTGGGCTCTGTGACCGCTGGGACACGGCCGTGTATTACTGTGCGAGAGTTTTGGTT 300
K L G S V T A A D T A V Y Y C A R V L V
-----<

301 TCCCGTACGATTTACAGTACTCCTATTACATGGACGTCTGGGGCAAAGGGACCACGGTC 360
S R T I S Q Y S Y Y M D V W G K G T T V
-----CDR3----->

361 ACCGTGTCCTCA 372
T V S S

WO 91/07492

PAG-1 VH SEQUENCE

S/14

PCT/EP90/01964

SUBSTITUTE SHEET

1 -----PCR primer-----CGCAGGACTGTTGAAGCCTTCGGAGACCCTGTCCCTC 60
A G L L K P S E T L S L

61 ACCTGCGCTGTCTATGGTGGGTCCTTCAGTGGTTACTACTGGAGCTGGATCCGCCAGCCT 120
T C A V Y G G S F S G Y Y W S W I R Q P
<-----CDR1----->

121 CCAGGGAAGGGGCTGGAGTGGATTGGGGAAATCAATCATAGTGGGAGGACCAACTACAAC 180
P G K G L E W I G E I N H S G R T N Y N
<-----CDR2----->

181 CCGTCCCTCAAGACTCGAGTCACCATATCAGTAGACACGTCCAAGAACCAGTTCTCCCTG 240
P S L K T R V T I S V D T S K N Q F S L
----->

241 AAGCTGAGTTCTGTGACCGCCGCGGACACGGCTGTGTATTACTGTGCGAGACTGTGGCTC 300
K L S S V T A A D T A V Y Y C A R L W L
<----->

301 GATGGACATGGGTACAAGTTTGACTACTGGGGCCAGGGAAACCCT---PCR primer--- 360
D G H G Y K F D Y W G Q G T L
-----CDR3----->

WO 91/07492

MAD-2 VH SEQUENCE

6/14

PCT/EP90/01964

SUBSTITUTE SHEET

1 CAGGTGCATCTACAGCAGTGGGGCACAGGGCTGTTGAAGCCTTCGGAGACCCTGTCCCTC 60
 G V H L Q D W G T G L L K P S E T L S L

61 ACCTGCCTGTCCATGGTGGGTCCTTCAATGTTTACTACTGGACCTGGATCCGCCAGCCC 120
 T C A V H G G S F N V Y Y W T W I R Q P
 <-----CDR1----->

121 CCAGGAAAGGCGCTGGAGTGGATTGGGGAATCAATCATAGTGGAGGCGCCAACTACAAT 180
 P G K A L E W I G E I N H S G G A N Y N
 <-----CDR2----->

181 CCGTCCCTCAAGAGTGGAGTCAACATGTCAGCAGACACGTCCAAGAACCAGTTCTCCCTG 240
 P S L K S R V T M S A D T S K N O F S L
 ----->

241 AACTGACCTCTGTGACCGCCGCGGACACGGCTGTGTTTTATTGTGGAGAGGCCGGTCC 300
 K L T S V T A A D T A V F Y C A R G R S
 <----->

301 CGTTATAGTGGTTACGGCTTCTACTCCGGCATGGACGTCGGGGCCCAGGGACCACGGTC 360
 R Y S G Y G F Y S G M D V W G P G T T V
 -----CDR3----->

361 ACCGTCCTCTCA 372
 T V S S

WO 91/07492

FORM-1 VH SEQUENCE

8/14

PCT/EP90/01964

SUBSTITUTE SHEET

1 CAGGTGCAGCTACAGCAGTGGGGCGCAGGACTGTTGAAGCCTTCGGAGACCCTGTCCTC 60
D V Q L Q Q W G A G L L K P S E T L S L

61 ACCTGCGCTGTCTATGGTGGGTCCCTTCAGTGGTTACTACTGGAAGTGGATCCGCCAGCCC 120
T C A V Y G G S F S G Y Y W N W I R Q P
<-----CDR1----->

121 CCAGGGAAAGGGGCTGGAGTGGATTGGGGAAATCATTGATGGAAGCACCAACTACAAC 180
P G K G L E W I G E I I H S G S T N Y N
<-----CDR2----->

181 CCGTCCCTCAAGAGTCAAGTCAACCATGTCAGTAGACACGTCCAAGAACCAAGTTCTCCCTG 240
P S L K S R V T M S V D T S K N Q F S L
----->

241 AAGCTGAGCTCTGTGACCGCCGCGGACACGGCTGTGTATTACTGTGCGAGAGGCTTAGAA 300
K L S S V T A A D T A V Y Y C A R G L E
-----<

301 CGTCCGATTAGGAACCAAGCTGCTAAACCGTCTCGGTTACTACATGGACGCTCTGGGGCAAA 360
R P I R N Q L L N R L G Y Y N D V W G K
-----CDR3----->

361 GGGACCACGGTCACCGTCTCCTCA 384
G T T V T V S S

SUBSTITUTE SHEET

1 CAGGTGCAGCTACAGCAGTGGGGCGCAGGACTGTTGAAGCCTTCGGAGACCCTGTCCCTC 50
 Q V Q L Q Q W G A G L L K F S E T L S L

61 ACCTGCGCTGTCTATGGTGGGTCCCTTCAGTGGTTACTACTGGAGCTGGATCCGCCAGCCC 120
 T C A V Y G G S F S G Y Y W S W I R Q P
 <-----CDR1----->

121 CCAGGGAAAGGGGCTGGAGTGGATTGGGGAAATCAGTCGTCGTGGAAAGCACCAACTACAAC 180
 P G K G L E W I G E I S R R G S T N Y N
 <-----CDR2----->

181 CCGTCCCTCAAGAGTCGAGTCGCCATATCAGTAGACACGTCCAAGAACCCAGTTCTCCCTG 240
 P S L K S R V A I S V D T S K N Q F S L
 ----->

241 AAGGTGAGGTCTGTGACCGCCGCGGACACGGCTGTGTATTACTGTGCGAGAGCCTTGGAC 300
 K V R S V T A A D T A V Y Y C A R A L D
 ----->

301 TACATCTCCTTGGATTACGGTATGGACGCTCGGGGCCAAGGGACCACGGTCACCGTCTCC 360
 Y I S L D Y G M D V W G Q G T T V T V S
 -----CDR3----->

361 TCA 363
 S

WO 91/07492

FORM-A VH SEQUENCE

9/14

PCT/EP90/01964

SUBSTITUTE SHEET

1 -----PCR primer-----GGGAGGCGTGGTCCAGCCTGGGAGGTTCTGAGACTC 50
 G G V V D P G R F L R L

61 TCCTGTGCAGCGTCTGGATTACCTTCAGTAGCTATGGCATGCACTGGGTCCGCCAGGCT 120
 S C A A S G F T F S S Y G H H W V R D A
 <-----CDR1----->

121 CCAGGCCAAGGGGCTGGAGTGGGTGGCACTTATATGGTATGATGGAGTAATAAAGAAAT 180
 F G K G L E W V A L I W Y D G S N K E Y
 <-----CDR2----->

181 GCAGACTTCGTGAAGGGCCGATTCACCATCTCCAGAGACAATTCCAAGAATACACTGTAT 240
 A D F V K G R F T I S R D N S K N T L Y
 ----->

241 CTGCAAATGAACAGCCTGAGAGCCGAGGACACGGCTGTGTATTACTGTGCGACAGATAGT 300
 L Q M N S L R A E D T A V Y Y C A T D S
 <----->

301 CCCAAAATGAGGGCTGGAGTATGTTTCCTACTACTACATGGACGCTCTGGGGCAAAGGG 360
 P K M R A G S M F R Y Y Y H D V W G K G
 -----CDR3----->

361 ACCAC---PCR primer--- 381
 T

WO 91/07492

BRAD-3 VH SEQUENCE

no/14

PCT/EP90/01964

SUBSTITUTE SHEET

1 -----PCR primer-----GGGAGGCTTAGTCAGCCTGGGGGTCCTGAGACTC 60
G G L V Q P G G S L R L

61 TCCTGTGCA6CCTCTGGATTACCTTCA6TAGTTACTGGATGCACTGGGTCCGCCAA6CT 120
S C A A S G F T F S S Y W M H W V R Q A
<-----CDR1----->

121 CCAGGGAA6GGGGCTGGTGTGGGTCTCACGTATTAATAGTTATGGAAATTAGCACAAGTTAC 180
P G K G L V W V S R I N S Y G I S T S Y
<-----CDR2----->

181 GCGAACTCCGTGAAGGGCCGATTCACCATCTCCAGAGACAACGCCAAGAACAC6CTGTAT 240
A N S V K G R F T I S R D N A K N T L Y
----->

241 CTGCAAATGAACACTCTGAGAGCCGGAGGACACGGCTGTGTATTACTGTGCAAGAGGGAGAG 300
L Q M N T L R A E D T A V Y Y C A R G E
-----<

301 CGCATAGCAGCTCGTCTCTTGTGGGGCGGGTACGGTATGGAC6TCTGGGGCCAA6GGACC 360
R I A A R L L S G G Y G M D V W G Q G T
-----CDR3----->

361 AC---PCR primer--- 378
.....

WO 91/07492

JAC-10 VH SEQUENCE

11/14

PCT/EP90/01964

SUBSTITUTE SHEET

1 -----PCR primer-----GGGAGGCCTGGTCCAGCCTGGGAGGTCCTGAGACTC 60
G G V V Q P G R S L R L

61 TCCTGTGCAGCGTCTGGATTACCTTTAGTAGCTATGGCATGCACTGGGTCCGCCAGGCT 120
S C A A S G F T F S S Y G M H W V R Q A
<-----CDR1----->

121 CCAGGCAAGGGGCTGGAGTGGGTGGCAGTGATATGGTATGATGGAGTAATAAGTACTAT 180
P G K G L E W V A V I W Y D G S N K Y Y
-----CDR2-----

181 GCAGAGTCCGTGAAGGGCCGATTCACCATCTCCAGAGACATTCCAAGAACACGCTGTAT 240
A E S V K G R F T I S R D N S K N T L Y
----->

241 CTGCAAATGAACAGCCTGAGAGCCGAGGACACGGCTGTGTATTACTGTGCGAGAGTCGTT 300
L Q M N S L R A E D T A V Y Y C A R V V
-----<

301 AGCAGCAACCGGTACTCTCTAAGCTACTATTATTACTACATGGACGCTCTGGGGCAAAGGG 360
S S N R Y S L S Y Y Y Y Y M D V W G K G
-----CDR3----->

361 ACCAC---PCR primer--- 381
T

WO 91/07492

GAD-2 VH SEQUENCE

12/14

PCT/EP90/01964

SUBSTITUTE SHEET

1 -----PCR primer-----GGGAGGCGTGGTCCAGCCTGGGAGGTCCTGAGACTC 60
 G G V V Q P S R S L R L

61 TCCTGTGCAAGCGTCTGGATTACCTTCAATAATTATGGCATGCACTGGGTCCGCCAGGCT 120
 S C A A S G F T F N N Y G M H W V R Q A
 <-----CDR1----->

121 CCAGGCCAAGGGGCTGGAGTGGGTGGCAGTTATATGTTATCATGGAAGTAATAAAACTAT 180
 P G K G L E W V A V I W Y D G S N K N Y
 <-----CDR2----->

181 GCAGACTCCGTGAAGGGCCGATTCACCATCTCCAGAGACAATCCAAGAACACGCTGTAT 240
 A D S V K G R F T I S R D N S K N T L Y
 ----->

241 CTGCAAATGAACAGCCTGAGAGCCGAGGACACGGCTGTGTATTACTGTGCGAGAGAACGT 300
 L O M N S L R A E D T A V Y Y C A R E R
 <----->

301 ACTACGATGTCTGGAGTGATCATTCCCTCGCCGGTATTTTGACTACTGGGGCCAGGGAAACC 360
 T T M S G V I I P R R Y F D Y W G Q G T
 -----CDR3----->

361 CG---PCR primer--- 378

44/44

SUBSTITUTE SHEET

1 -----PCR primer-----GGGRGGCGTGTTCCAGCCTGGGAGGTCCCTGAGACTC 60
 G G V V O P G R S L R L

61 TCCTGTGCA6CGTCTGGATTACCTTCAGTAGCTATGGCATGCACTGGGTCCGCCAGGCT 120
 S C A A S G T I F S S Y G M H W V R O A
 <-----CDR1----->

121 CCAGGCAAGGGGCTGGAGTGGGTGGCAGTTATTTGGTATGATGGAA6TAATAAATACTAT 180
 P G K G L E W V A V I W Y D G S N K Y Y
 <-----CDR2----->

181 GCAGACTCCGTGAAGGGCCGATTCACCATCTCCAGAGACAATTCCAAGAACACGCTGTAT 240
 A D S V K G R F T I S R D N S K N T L Y
 ----->

241 CTGCAAATGAACAGCCTGAGAGCCGAGGACACGGCTGTGTATTACTGTGCGAGAGAA6TT 300
 L Q M N S L R A E D T A V Y Y C A R E V
 <----->

301 ACTATGGTTCGGGGAGTTAGGC6TTACTACGGTATGGACGTCTGGGGCCCA6GGACCAC- 360
 T M V R G V R R Y Y G M D V W G P G T .
 -----CDR3----->

361 --PCR primer--- 375

INTERNATIONAL SEARCH REPORT

International Application No. **PCT/EP 90/01964**

I. CLASSIFICATION OF SUBJECT MATTER (if several classification symbols apply, indicate all) ⁸		
According to International Patent Classification (IPC) or to both National Classification and IPC C 12 N 15/13		
IPC⁵: C 07 K 15/28, C 12 P 21/08, A 61 K 39/395, G 01 N 33/80		
II. FIELDS SEARCHED		
Minimum Documentation Searched ⁷		
Classification System	Classification Symbols	
IPC⁵	C 12 N, C 12 P, C 07 K	
Documentation Searched other than Minimum Documentation to the Extent that such Documents are Included in the Fields Searched ⁸		
III. DOCUMENTS CONSIDERED TO BE RELEVANT ⁹		
Category ⁹	Citation of Document, ¹¹ with Indication, where appropriate, of the relevant passages ¹²	Relevant to Claim No. ¹³
X	GB, A, 2189506 (CENTRAL BLOOD LABORATORIES AUTHORITY) 28 October 1987 see the whole document	15-20
Y	---	1-14
Y	EP, A, 0239400 (G.P. WINTER) 30 September 1987 see the whole document, especially page 31	1-14
A	Clinical Chemistry, volume 34, no. 9, September 1988, S.L. Morrison et al.: "Production and characterization of genetically engineered antibody molecules", pages 1668-1675 see the whole document	1-14
	---	./.
<p>⁹ Special categories of cited documents: ¹⁰</p> <p>"A" document defining the general state of the art which is not considered to be of particular relevance</p> <p>"E" earlier document but published on or after the international filing date</p> <p>"L" document which may throw doubts on priority claim(s) or which is cited to establish the publication date of another citation or other special reason (as specified)</p> <p>"O" document referring to an oral disclosure, use, exhibition or other means</p> <p>"P" document published prior to the international filing date but later than the priority date claimed</p> <p>"T" later document published after the international filing date or priority date and not in conflict with the application but cited to understand the principle or theory underlying the invention</p> <p>"X" document of particular relevance; the claimed invention cannot be considered novel or cannot be considered to involve an inventive step</p> <p>"Y" document of particular relevance; the claimed invention cannot be considered to involve an inventive step when the document is combined with one or more other such documents, such combination being obvious to a person skilled in the art.</p> <p>"A" document member of the same patent family</p>		
IV. CERTIFICATION		
Date of the Actual Completion of the International Search	Date of Mailing of this International Search Report	
5th February 1991	27 FEB 1991	
International Searching Authority	Signature of Authorized Official	
EUROPEAN PATENT OFFICE	MISS T. FAZELAAR	

Form PCT/ISA/210 (second sheet) (January 1985)

III. DOCUMENTS CONSIDERED TO BE RELEVANT (CONTINUED FROM THE SECOND SHEET)		
Category *	Citation of Document, ** with indication, where appropriate, of the relevant passages	Relevant to Claim No.
A	Bio Essays, volume 8, no. 2, February/ March 1988, M. Verhoeyen et al.: "Engineering of antibodies", pages 74-78 see the whole document -----	1-14

Form PCT/ISA 210(extra sheet) (January 1985)

**ANNEX TO THE INTERNATIONAL SEARCH REPORT
ON INTERNATIONAL PATENT APPLICATION NO.**

EP 9001964
SA 41668

This annex lists the patent family members relating to the patent documents cited in the above-mentioned international search report. The members are as contained in the European Patent Office EDP file on 22/02/91. The European Patent Office is in no way liable for these particulars which are merely given for the purpose of information.

Patent document cited in search report	Publication date	Patent family member(s)	Publication date
GB-A- 2189506	28-10-87	AU-A- 7196387	29-10-87
		BE-A- 1001517	21-11-89
		EP-A- 0251440	07-01-88
		FR-A- 2601963	29-01-88
		JP-A- 63044881	25-02-88
		LU-A- 86855	07-12-87
EP-A- 0239400	30-09-87	GB-A, B 2188638	07-10-87
		JP-A- 62296890	24-12-87

EPO FORM P007P

For more details about this annex : see Official Journal of the European Patent Office, No. 12/82

PCT

WORLD INTELLECTUAL PROPERTY ORGANIZATION
International Bureau



INTERNATIONAL APPLICATION PUBLISHED UNDER THE PATENT COOPERATION TREATY (PCT)

<p>(51) International Patent Classification ⁵ : A61K 39/395, C07K 15/28, C12N 15/13, C12P 21/08</p>	<p>A1</p>	<p>(11) International Publication Number: WO 94/12214 (43) International Publication Date: 9 June 1994 (09.06.94)</p>
<p>(21) International Application Number: PCT/US93/11611 (22) International Filing Date: 30 November 1993 (30.11.93) (30) Priority Data: 07/983,949 1 December 1992 (01.12.92) US (60) Parent Application or Grant (63) Related by Continuation US 07/983,949 (CIP) Filed on 1 December 1992 (01.12.92) (71) Applicant (for all designated States except US): PROTEIN DESIGN LABS, INC. [US/US]; 2375 Garcia Avenue, Mountain View, CA 94303 (US). (72) Inventors; and (75) Inventors/Applicants (for US only): CO, Man, Sung [GB/US]; 10230 Yoshino Place, Cupertino, CA 95014 (US). LAN- DOLFI, Nicholas, F. [US/US]; 246 Seaside Drive, Milpitas, CA 95035 (US). (74) Agents: DUNN, Tracy, J. et al.; Townsend and Townsend Khourie and Crew, One Market Plaza, 20th floor, Steuart Street Tower, San Francisco, CA 94105 (US).</p>	<p>(81) Designated States: AT, AU, BB, BG, BR, BY, CA, CH, CZ, DE, DK, ES, FI, GB, HU, JP, KP, KR, KZ, LK, LU, LV, MG, MN, MW, NL, NO, NZ, PL, PT, RO, RU, SD, SE, SK, UA, US, VN, European patent (AT, BE, CH, DE, DK, ES, FR, GB, GR, IE, IT, LU, MC, NL, PT, SE), OAPI patent (BF, BJ, CF, CG, CI, CM, GA, GN, ML, MR, NE, SN, TD, TG).</p> <p>Published With international search report.</p>	
<p>(54) Title: HUMANIZED ANTIBODIES REACTIVE WITH CD18</p> <p>(57) Abstract</p> <p>Humanized immunoglobulins specifically reactive with CD18 are prepared employing recombinant DNA technology for use in e.g., treatment of inflammatory disorders.</p>		

FOR THE PURPOSES OF INFORMATION ONLY

Codes used to identify States party to the PCT on the front pages of pamphlets publishing international applications under the PCT.

AT	Austria	GB	United Kingdom	MR	Mauritania
AU	Australia	GE	Georgia	MW	Malawi
BB	Barbados	GN	Guinea	NE	Niger
BE	Belgium	GR	Greece	NL	Netherlands
BF	Burkina Faso	HU	Hungary	NO	Norway
BG	Bulgaria	IE	Ireland	NZ	New Zealand
BJ	Benin	IT	Italy	PL	Poland
BR	Brazil	JP	Japan	PT	Portugal
BY	Belarus	KE	Kenya	RO	Romania
CA	Canada	KG	Kyrgyzstan	RU	Russian Federation
CF	Central African Republic	KP	Democratic People's Republic of Korea	SD	Sudan
CG	Congo	KR	Republic of Korea	SE	Sweden
CH	Switzerland	KZ	Kazakhstan	SI	Slovenia
CI	Côte d'Ivoire	LI	Liechtenstein	SK	Slovakia
CM	Cameroon	LK	Sri Lanka	SN	Senegal
CN	China	LU	Luxembourg	TD	Chad
CS	Czechoslovakia	LV	Latvia	TG	Togo
CZ	Czech Republic	MC	Monaco	TJ	Tajikistan
DE	Germany	MD	Republic of Moldova	TT	Trinidad and Tobago
DK	Denmark	MG	Madagascar	UA	Ukraine
ES	Spain	ML	Mali	US	United States of America
FI	Finland	MN	Mongolia	UZ	Uzbekistan
FR	France			VN	Viet Nam
GA	Gabon				

HUMANIZED ANTIBODIES REACTIVE WITH CD185 Field of the Invention

The present invention relates generally to the combination of recombinant DNA and monoclonal antibody technologies for developing novel biologics and, more particularly, for example, to the production of non-
10 immunogenic (in humans) immunoglobulins specific for the CD18 protein and their uses in vitro and in vivo.

Background of the Invention

The ability of cells to adhere to one another plays
15 a critical role in development, normal physiology, and disease processes. This ability is mediated by adhesion molecules, generally glycoproteins, expressed on cell membranes. Often, an adhesion molecule on one cell type will
20 bind to another adhesion molecule expressed on a different cell type, forming a receptor counter-receptor pair. Three very important classes of adhesion molecules are the integrins, selectins, and immunoglobulin (Ig) superfamily members (see Springer, Nature 346, 425 (1990); Osborn, Cell
25 62, 3 (1990); Hynes, Cell 69, 11 (1992), all of which are incorporated herein by reference). These molecules are especially vital to the interaction of leukocytes and platelets with themselves and with the extracellular matrix and vascular endothelium.

Integrins are heterodimeric transmembrane
30 glycoproteins consisting of an α chain (120-180 kD) and a β chain (90-110 kD), generally having short cytoplasmic domains. The α subunits all share sequence homology and motifs with each other, as do the β subunits. The three
35 known integrins containing the β subunit designated β_2 are important to the function of T cells, neutrophils and monocytes. LFA-1 ($\alpha_1\beta_2$) is widely distributed on lymphocytes, granulocytes and monocytes. Its counter-receptor is ICAM-1 (and perhaps of lesser importance, ICAM-2) an Ig family molecule which is expressed on many cells including

leukocytes and is up-regulated on vascular endothelium by cytokines such as TNF and IL-1. Blocking LFA-1 on T cells with antibodies to either the α or β subunit strongly inhibits adhesion-dependent functions such as CTL-mediated lysis of target cells. Mac-1 ($\alpha_M\beta_2$) is distributed on neutrophils and monocytes, and its counter-receptor is also ICAM-1 (and possibly ICAM-2). Among other things, Mac-1 is the type 3 complement receptor (CR3) and binds the C3bi fragment. The third β_2 integrin, P150,95 ($\alpha_X\beta_2$), is also found on neutrophils and monocytes, but seems of less importance. The α subunits of LFA-1, Mac-1 and P150,95 are also given the respective CD designations CD11a, CD11b and CD11c, while β_2 is also denoted CD18, so that LFA-1 is CD11a/CD18 and Mac-1 is CD11b/CD18.

There are three known selectins, which were previously known as LECCAMs, and are now designated L-selectin (also called LECAM-1, Mel-14 or LAM-1), E-selectin (also called ELAM-1) and P-selectin (also called GMP140 or PADGEM). They have all been sequenced at the cDNA level and share sequence homology and motifs, including a lectin-like domain. L-selectin has a dual role: it is a homing receptor on T cells for the high endothelial venules of peripheral lymph nodes, and it is an adhesion molecule on neutrophils for endothelium (Hallmann et al., Biochem. Biophys. Res. Commun. 174, 236 (1991), which is incorporated herein by reference). E-selectin and P-selectin are both induced on endothelium by cytokines, although with different kinetics. L-selectin is a counter-receptor on neutrophils for both E-selectin and P-selectin (Picker et al., Cell 66, 921 (1991), which is incorporated herein by reference), although all three selectins probably have other counter-receptors as well. In particular, E-selectin binds the carbohydrate group sialyl Lewis x (sLex) (Lowe et al., Cell 63, 475 (1990)), which is incorporated herein by reference), and while this carbohydrate is prominently presented on L-selectin (Picker et al., Cell 66, 921 (1991)), it may occur on other proteins as well. E-selectin is expressed especially in cutaneous sites of inflammation and also serves as an adhesion molecule

for skin-homing T cells that may contribute to the inflammation (Picker et al. Nature 349, 796 (1991), which is incorporated herein by reference).

5 In various assays, antibodies to CD11a, CD11b, CD18, L-selectin and E-selectin all block binding of neutrophils to activated endothelial cells to a lesser or greater degree, but the most complete inhibition is generally achieved by the combination of an antibody to CD18 and an antibody to L- or E-selectin (see e.g., Luscinikas, J. Immunol. 142, 2257 (1989), which is incorporated herein by reference). A recent but now widely accepted model accounts for these facts with a three step process of adhesion (Butcher, Cell 67, 1033 (1991), which is incorporated herein by reference). In the first step, neutrophils reversibly bind to inflamed vascular endothelium via the selectins, which bind well under conditions of flow, causing the neutrophils to literally roll along the vascular wall. The neutrophils are then activated by a variety of stimulants surrounding or released by the endothelium, including IL-8, PAF and C5a. The activated neutrophils shed L-selectin and up-regulate Mac-1. In the final step, binding of Mac-1 to ICAM-1 and perhaps other counter-receptors on the endothelial cells allows stable adhesion and extravasation through the endothelium.

25 Although important for eliminating infection, neutrophils are now believed to be a major cause of tissue damage during inflammation by binding to vascular endothelium and migrating through it into tissues (Harlan, Acta. Med. Scand. Suppl. 715, 123 (1987), which is incorporated herein by reference). The neutrophils release proteases and toxic, reactive oxygen metabolites which damage endothelium as well as other tissues. In principle, antibodies or other antagonists of the integrin and selectin adhesion molecules could abort this process, by preventing neutrophils from binding to endothelium and from extravasating into tissues. Hence such antibodies could be used to treat a great many different disease conditions of which inflammation is an important component.

For example, in animal models anti-CD18 antibodies, which bind to both LFA-1 and Mac-1, have been especially useful in reducing ischemia-reperfusion injury (see, e.g., Vedder et al., J. Clin. Invest. 81, 939 (1988); Vedder et al., Proc. Natl. Acad. Sci. USA 87, 2643 (1990); U.S. Patent No. 4,797,277). They also reduce neutrophil-mediated damage in the lung in response to various insults (Doerschuk et al., J. Immunol. 144, 2327 (1990) and Mulligan et al., J. Immunol. 148, 1847 (1992)), including gram-negative sepsis (Walsh et al., Surgery 110, 205 (1991)). In a rabbit model, anti-CD18 antibodies also protect from lethality due to meningitis (Tuomanen et al., J. Exp. Med. 170, 959 (1990)). They may also be useful in preventing or treating organ transplant rejection because they block T-cell function.

For example, injection of antibodies to L-selectin or E-selectin into rodents suppressed neutrophil accumulation within inflamed peritoneum (Jutila et al. J. Immunol. 143, 3318 (1989) and Mulligan et al., J. Clin. Invest. 88, 1396 (1991)). Intravital video microscopy was used to show that an anti-L-selectin antibody strongly inhibits rolling of leukocytes along the vascular wall endothelium of mesenteric venules exteriorized from rabbits (von Andrian et al., Proc. Natl. Acad. Sci. USA 88, 7538 (1991)). An anti-E-selectin antibody greatly reduced vascular injury induced by immune complex deposition in the skin or lungs of rats, and substantially reduced neutrophil accumulation at those sites (Mulligen et al., J. Clin. Invest. 88, 1396 (1991)). Also, in a primate model of extrinsic asthma, an anti-E-selectin antibody greatly reduced neutrophil influx into the lung and associated late-phase airway obstruction after antigen inhalation (Gundel et al., J. Clin. Invest. 88, 1407 (1991)).

The antibody NA-8 has been developed that binds to human CD18 as disclosed herein. This antibody partially or completely blocks the binding of human neutrophils to stimulated human umbilical vein endothelial cells. Because of its ability to block binding of neutrophils to endothelial cells, this antibody could be used to treat inflammatory disease conditions (see above).

Unfortunately, the use of non-human monoclonal antibodies such as NA-8 have certain drawbacks in human treatment, particularly in repeated therapeutic regimens as explained below. Mouse monoclonal antibodies, for example, have a relatively short circulating half-life, and lack other important immunoglobulin functional characteristics when used in humans.

Perhaps more importantly, non-human monoclonal antibodies contain substantial stretches of amino acid sequences that will be immunogenic when injected into a human patient. Numerous studies have shown that, after injection of a foreign antibody, the immune response elicited by a patient against an antibody can be quite strong, essentially eliminating the antibody's therapeutic utility after an initial treatment. Moreover, as increasing numbers of different mouse or other antigenic (to humans) monoclonal antibodies can be expected to be developed to treat various diseases, after the first or several treatments with any different non-human antibodies, subsequent treatments even for unrelated therapies can be ineffective or even dangerous in themselves, because of cross-reactivity.

While the production of so-called "chimeric antibodies" (e.g., mouse variable regions joined to human constant regions) has proven somewhat successful, a significant immunogenicity problem remains. In general, the production of human immunoglobulins reactive with CD18 antigen, as with many antigens, would be extremely difficult using typical human monoclonal antibody production techniques. Similarly, utilizing recombinant DNA technology to produce so-called "humanized" or "reshaped" antibodies (see, e.g., Riechmann et al., Nature 332, 323 (1988) and EPO Publication No. 0239400, which are incorporated herein by reference), provides uncertain results, in part due to unpredictable binding affinities of the resultant immunoglobulins.

Thus, there is a need for improved forms of humanized immunoglobulins specific for CD18 antigen that are substantially non-immunogenic in humans, yet easily and

economically produced in a manner suitable for therapeutic formulation and other uses. The present invention fulfills these and other needs.

5 Summary of the Invention

 The present invention provides novel compositions useful, for example, in the treatment of inflammatory human disorders, the compositions containing mouse or humanized immunoglobulins specifically capable of binding to CD18. The
10 immunoglobulins can have two pairs of light chain/heavy chain complexes, at least one chain comprising one or more mouse complementarity determining regions functionally joined to human framework region segments. For example, mouse complementarity determining regions, with or without
15 additional naturally-associated mouse amino acid residues, can be introduced into human framework regions to produce humanized immunoglobulins capable of binding to the CD18 at affinity levels stronger than about $10^7 M^{-1}$. These humanized immunoglobulins will also be capable of blocking the binding
20 of the CDR-donating mouse monoclonal antibody to CD18.

 The immunoglobulins, including binding fragments and other derivatives thereof, of the present invention may be produced readily by a variety of recombinant DNA techniques, with ultimate expression in transfected cells,
25 preferably immortalized eukaryotic cells, such as myeloma or hybridoma cells. Polynucleotides comprising a first sequence coding for humanized immunoglobulin framework regions and a second sequence set coding for the desired immunoglobulin complementarity determining regions can be produced
30 synthetically or by combining appropriate cDNA and genomic DNA segments.

 The humanized immunoglobulins may be utilized alone in substantially pure form, or together with a chemotherapeutic agent such as a non-steroidal anti-
35 inflammatory drug, a corticosteroid, or an immunosuppressant. All of these compounds will be particularly useful in treating inflammatory disorders. The humanized immunoglobulins or their complexes can be prepared in a

pharmaceutically acceptable dosage form, which will vary depending on the mode of administration.

BRIEF DESCRIPTION OF THE FIGURES

5 Fig. 1. Sequences of the cDNA and translated amino acid sequences of the light chain (A) [SEQ. ID NOS:1 and 2] and heavy chain (B) [SEQ. ID NOS:3 and 4] variable regions of the NA-8 antibody. The mature light chain begins with amino acid 21 D, and the mature heavy chain begins with amino acid
10 20 Q, preceded by the respective signal sequences.

Fig. 2. Amino acid sequences of the mature light chain (A) [SEQ. ID NO:5] and heavy chain (B, [SEQ. ID NO:6] C [SEQ. ID NO:7]) variable regions of the mouse NA-8 antibody (upper lines) and humanized NA-8 antibody (B; lower lines)
15 and humanized NA-8a antibody (C, lower lines). The three CDRs in each chain are underlined. Residues in the framework that have been replaced with mouse amino acids or typical human amino acids in the humanized antibody are double underlined.

20 Fig. 3. Nucleotide sequences of the genes encoding the light chain (A) [SEQ. ID NOS:8 and 9] and heavy chain (B) [SEQ. ID NOS:10 and 11] variable regions of the humanized NA-8 antibody, beginning and ending with the XbaI sites, and translated amino acid sequences, including signal sequences.

25 Fig. 4. Competitive binding of mouse and humanized IgG1 and IgG4 NA-8 antibodies. The target cells were THP-1 cells, a human monocytic line that expresses human CD18 (ATCC TIB 202). 2×10^5 cells were incubated with 3 ng of ^{125}I -labeled tracer mouse antibody ($2 \mu\text{Ci}/\mu\text{g}$), together with
30 increasing amounts of mouse or humanized competitor antibody as indicated in 0.2 ml of binding buffer (PBS + 2% FBS + 0.1% azide) for 1 hr at 4°C. Cells were washed and pelleted, and their bound radioactivity measured. The concentrations of bound and free tracer antibody were calculated.

35 Fig. 5. Binding of human neutrophils to IL-1 stimulated human umbilical cord endothelial cells (HUVEC). The neutrophils were first treated with irrelevant control

antibody, mouse NA-8 antibody, or humanized IgG1 NA-8 antibody, as indicated.

Definitions

5 Unless defined otherwise, all technical and scientific terms used herein have the same meaning as commonly understood by one of ordinary skill in the art to which this invention belongs. Although any methods and materials similar or equivalent to those described herein can
10 be used in the practice or testing of the present invention, the preferred methods and materials are described. For purposes of the present invention, the following terms are defined below.

15 The term "naturally-occurring" as used herein as applied to an object refers to the fact that an object can be found in nature. For example, a polypeptide or polynucleotide sequence that is present in an organism (including viruses) that can be isolated from a source in nature and which has not been intentionally modified by man
20 in the laboratory is naturally-occurring.

 As used herein, "substantially pure" means an object species is the predominant species present (i.e., on a molar basis it is more abundant than any other individual species in the composition), and preferably a substantially
25 purified fraction is a composition wherein the object species comprises at least about 50 percent (on a molar basis) of all macromolecular species present. Generally, a substantially pure composition will comprise more than about 80 to 90 percent of all macromolecular species present in the
30 composition. Most preferably, the object species is purified to essential homogeneity (contaminant species cannot be detected in the composition by conventional detection methods) wherein the composition consists essentially of a single macromolecular species.

35 As used herein, the terms "label" or "labeled" refers to incorporation of a detectable marker, e.g., by incorporation of a radiolabeled amino acid or attachment to a polypeptide of biotinyl moieties that can be detected by

marked avidin (e.g., streptavidin containing a fluorescent marker or enzymatic activity that can be detected by optical or colorimetric methods). Various methods of labeling polypeptides and glycoproteins are known in the art and may be used. Examples of labels for polypeptides include, but are not limited to, the following: radioisotopes (e.g., ³H, ¹⁴C, ³²P, ³⁵S, ¹²⁵I, ¹³¹I), fluorescent labels (e.g., FITC, rhodamine, lanthanide phosphors), enzymatic labels (e.g., horseradish peroxidase, β -galactosidase, luciferase, alkaline phosphatase), biotinyl groups, predetermined polypeptide epitopes recognized by a secondary reporter (e.g., leucine zipper pair sequences, binding sites for secondary antibodies, metal binding domains, epitope tags). In some embodiments, labels are attached by spacer arms of various lengths to reduce potential steric hindrance.

DETAILED DESCRIPTION OF THE INVENTION

Generally, the nomenclature used hereafter and the laboratory procedures in cell culture, molecular genetics, and nucleic acid chemistry and hybridization described below are those well known and commonly employed in the art. Standard techniques are used for recombinant nucleic acid methods, polynucleotide synthesis, cell culture, and transgene incorporation (e.g., electroporation, microinjection, lipofection). Generally enzymatic reactions, oligonucleotide synthesis, and purification steps are performed according to the manufacturer's specifications. The techniques and procedures are generally performed according to conventional methods in the art and various general references which are provided throughout this document. The procedures therein are believed to be well known in the art and are provided for the convenience of the reader. All the information contained therein is incorporated herein by reference.

In accordance with the present invention, mouse or humanized immunoglobulins specifically reactive with CD18 related epitopes are provided. These immunoglobulins, which

have binding affinities to CD18 under suitable binding conditions (e.g., physiological serum conditions) of at least about $10^7 M^{-1}$, and preferably $10^8 M^{-1}$ to $10^{10} M^{-1}$ or stronger, are capable of, e.g., binding to CD18-expressing cells, such as neutrophils. The humanized immunoglobulins will have a human framework and will have one or more complementarity determining regions (CDRs) from an immunoglobulin, typically a mouse immunoglobulin, specifically reactive with CD18. In a preferred embodiment, one or more of the CDRs will come from the NA-8 antibody, and the humanized immunoglobulin will be of the IgG1 or IgG4 isotype. Thus, the immunoglobulins of the present invention, which can be produced economically in large quantities, find use, for example, in the treatment of adhesion-related pathological conditions (e.g., inflammatory disorders) in human patients by a variety of techniques.

The basic antibody structural unit is known to comprise a tetramer. Each tetramer is composed of two identical pairs of polypeptide chains, each pair having one "light" (about 25kD) and one "heavy" chain (about 50-70kD). The NH_2 -terminus of each chain begins a variable region of about 100 to 110 or more amino acids primarily responsible for antigen recognition. The COOH part of each chain defines a constant region primarily responsible for effector function.

Light chains are classified as either kappa or lambda. Heavy chains are classified as gamma, mu, alpha, delta, or epsilon, and define the antibody's isotype as IgG, IgM, IgA, IgD and IgE, respectively. Within light and heavy chains, the variable and constant regions are joined by a "J" region of about 12 or more amino acids, with the heavy chain also including a "D" region of about 10 more amino acids. (See, generally, Fundamental Immunology, Paul, W., Ed., Chapter 7, pgs. 131-166, Raven Press, N.Y. (1984), which is incorporated herein by reference.)

The variable regions of each light/heavy chain pair form the antibody binding site. The chains all exhibit the same general structure of relatively conserved framework regions joined by three hypervariable regions, also called

Complementarity Determining Regions or CDRs (see, "Sequences of Proteins of Immunological Interest," Kabat, E., et al., U.S. Department of Health and Human Services, (1987); and Chothia and Lesk, J. Mol. Biol., 196, 901-917 (1987), which are incorporated herein by reference). The CDRs from the two chains of each pair are aligned by the framework regions, enabling binding to a specific epitope.

As used herein, the term "immunoglobulin" refers to a protein consisting of one or more polypeptides substantially encoded by immunoglobulin genes. The recognized immunoglobulin genes include the kappa, lambda, alpha, gamma, delta, epsilon and mu constant region genes, as well as the myriad immunoglobulin variable region genes. The immunoglobulins may exist in a variety of forms besides antibodies; including, for example, Fv, Fab, and (Fab')₂ as well as bifunctional hybrid antibodies (e.g., Lanzavecchia et al., Eur. J. Immunol. 17, 105 (1987)) and in single chains (e.g., Huston et al., Proc. Natl. Acad. Sci. U.S.A., 85, 5879-5883 (1988) and Bird et al., Science, 242, 423-426 (1988), which are incorporated herein by reference). (See, generally, Hood et al., Immunology, Benjamin, N.Y., 2nd ed. (1984), Harlow and Lane, Antibodies. A Laboratory Manual, Cold Spring Harbor Laboratory (1988) and Hunkapiller and Hood, Nature, 323, 15-16 (1986), which are incorporated herein by reference).

It is well known that native forms of "mature" immunoglobulins will vary somewhat in terms of length by deletions, substitutions, insertions or additions of one or more amino acids in the sequences. Thus, both the variable and constant regions are subject to substantial natural modification, yet are "substantially identical" and still capable of retaining their respective activities. Human constant region and rearranged variable region DNA sequences can be isolated in accordance with well known procedures from a variety of human cells, but preferably immortalized B-cells. Similar methods can be used to isolate nonhuman immunoglobulin sequences from non-human sources. Suitable source cells for the DNA sequences and host cells for

expression and secretion can be obtained from a number of sources, such as the American Type Culture Collection ("Catalogue of Cell Lines and Hybridomas," Fifth edition (1985) Rockville, Maryland, U.S.A., which is incorporated herein by reference).

In addition to these naturally-occurring forms of immunoglobulin chains, "substantially identical" modified heavy and light chains can be readily designed and manufactured utilizing various recombinant DNA techniques well known to those skilled in the art. For example, the chains can vary from the naturally-occurring sequence at the primary structure level by several amino acid substitutions, terminal and intermediate additions and deletions, and the like. Alternatively, polypeptide fragments comprising only a portion of the primary structure may be produced, which fragments possess one or more immunoglobulin activities (e.g., binding activity). In particular, it is noted that like many genes, the immunoglobulin-related genes contain separate functional regions, each having one or more distinct biological activities. In general, modifications of the genes encoding the desired epitope binding components may be readily accomplished by a variety of well-known techniques, such as site-directed mutagenesis (see, Gillman and Smith, Gene 8:81-97 (1979) and Roberts, S. et al., Nature 328:731-734 (1987), both of which are incorporated herein by reference). In preferred embodiments of the invention, the epitope binding component is encoded by immunoglobulin genes that are "chimeric" or "humanized" (see, generally, Co and Queen (1991) Nature 351:501, which is incorporated herein by reference). Generally, the humanized antibodies of the invention will comprise heavy chain variable region sequences wherein the sequence of the humanized immunoglobulin heavy chain variable region framework is more than 65% identical but less than 95% identical to the sequence of the donor immunoglobulin heavy chain variable region framework, preferably the variable region framework is less than 10% identical to the sequence of the donor immunoglobulin.

Chimeric antibodies are antibodies whose light and heavy chain genes have been constructed, typically by genetic engineering, from immunoglobulin gene segments belonging to different species. For example, the variable (V) segments of the genes from a mouse monoclonal antibody may be joined to human constant (C) segments, such as γ_1 and γ_4 . A typical therapeutic chimeric antibody is thus a hybrid protein consisting of the V or antigen-binding domain from a mouse antibody and the C or effector domain from a human antibody, although other mammalian species may be used.

As used herein, the term "framework region" refers to those portions of immunoglobulin light and heavy chain variable regions that are relatively conserved (*i.e.*, other than the CDRs) among different immunoglobulins in a single species, as defined by Kabat, et al., *op. cit.* As used herein, a "human framework region" is a framework region that is substantially identical (about 85% or more) to the framework region of a naturally occurring human antibody.

As used herein, the term "humanized immunoglobulin" refers to an immunoglobulin comprising a human framework, at least one CDR from a non-human antibody, and in which any constant region present is substantially identical to a human immunoglobulin constant region, *i.e.*, at least about 85-90%, preferably at least 95% identical. Hence, all parts of a humanized immunoglobulin, except possibly the CDRs, are substantially identical to corresponding parts of one or more native human immunoglobulin sequences. For example, a humanized immunoglobulin would not encompass a chimeric mouse variable region/human constant region antibody.

Humanized antibodies have at least three potential advantages over mouse and in some cases chimeric antibodies for use in human therapy:

- 1) because the effector portion is human, it may interact better with the other parts of the human immune system (*e.g.*, destroy the target cells more efficiently by complement-dependent

cytotoxicity (CDC) or antibody-dependent cellular cytotoxicity (ADCC)).

- 2) The human immune system should not recognize the framework or C region of the humanized antibody as foreign, and therefore the antibody response against such an injected antibody should be less than against a totally foreign mouse antibody or a partially foreign chimeric antibody.
- 3) Injected mouse antibodies have been reported to have a half-life in the human circulation much shorter than the half-life of normal antibodies (Shaw, D. et al., J. Immunol. 138, 4534-4538 (1987)). Injected humanized antibodies will presumably have a half-life more like that of naturally occurring human antibodies, allowing smaller and less frequent doses to be given.

In one aspect, the present invention is directed to recombinant DNA segments encoding the heavy and/or light chain CDRs from an immunoglobulin capable of binding to a desired epitope of CD18, such as monoclonal antibody NA-8. The DNA segments encoding these regions will typically be joined to DNA segments encoding appropriate human framework regions. Exemplary DNA sequences, which on expression code for the polypeptide chains comprising the heavy and light chain CDRs of monoclonal antibody NA-8 are included in Fig. 1. Due to codon degeneracy and non-critical amino-acid substitutions, other DNA sequences can be readily substituted for those sequences, as detailed below. For a detailed description of the design and production of humanized immunoglobulins, see, commonly assigned serial nos. 07/290,975 and 07/310,252, filed December 28, 1988 and February 13, 1989, respectively, both of which are incorporated herein by reference.

The DNA segments will typically further include an expression control DNA sequence operably linked to the humanized immunoglobulin coding sequences, including naturally-associated or heterologous promoter regions.

5 Preferably, the expression control sequences will be eukaryotic promoter systems in vectors capable of transforming or transfecting eukaryotic host cells, but control sequences for prokaryotic hosts may also be used. Once the vector has been incorporated into the appropriate
10 host, the host is maintained under conditions suitable for high level expression of the nucleotide sequences, and, as desired, the collection and purification of the light chains, heavy chains, light/heavy chain dimers or intact antibodies, binding fragments or other immunoglobulin forms may follow.

15 The nucleic acid sequences of the present invention capable of ultimately expressing the desired humanized antibodies can be formed from a variety of different polynucleotides (genomic or cDNA, RNA, synthetic oligonucleotides, etc.) and components (e.g., V, J, D, and C
20 regions), as well as by a variety of different techniques. Joining appropriate genomic and synthetic sequences is presently the most common method of production, but cDNA sequences may also be utilized (see, European Patent
25 Publication No. 0239400 and Reichmann, L. et al., Nature 332, 323-327 (1988), both of which are incorporated herein by reference).

Human constant region DNA sequences can be isolated in accordance with well known procedures from a variety of human cells, but preferably immortalized B-cells (see, Kabat
30 op. cit. and WP87/02671). The CDRs for producing the immunoglobulins of the present invention will be similarly derived from monoclonal antibodies capable of binding to CD18 and produced in any convenient mammalian source, including, mice, rats, rabbits, or other vertebrate capable of producing
35 antibodies by well known methods. Suitable source cells for the DNA sequences and host cells for immunoglobulin expression and secretion can be obtained from a number of sources, such as the American Type Culture Collection

(Catalogue of Cell Lines and Hybridomas, Fifth edition (1985) Rockville, Maryland, U.S.A., which is incorporated herein by reference). In preferred embodiments, the CDRs have sequences corresponding to the CDR sequences of NA-8, and may include degenerate nucleotide sequences encoding the corresponding CDR amino acid sequence(s) of NA-8.

In addition to the humanized immunoglobulins specifically described herein, other "substantially homologous" modified immunoglobulins can be readily designed and manufactured utilizing various recombinant DNA techniques well known to those skilled in the art. For example, the framework regions can vary from the native sequences at the primary structure level by several amino acid substitutions, terminal and intermediate additions and deletions, and the like. Moreover, a variety of different human framework regions may be used singly or in combination as a basis for the humanized immunoglobulins of the present invention. In general, modifications of the genes may be readily accomplished by a variety of well-known techniques, such as site-directed mutagenesis (see, Gillman and Smith, *Gene* 8, 81-97 (1979) and Roberts S. et al, *Nature* 328, 731-734 (1987), both of which are incorporated herein by reference).

Alternatively, polypeptide fragments comprising only a portion of the primary antibody structure may be produced, which fragments possess one or more immunoglobulin activities (e.g., binding activity). These polypeptide fragments may be produced by proteolytic cleavage of intact antibodies by methods well known in the art, or by inserting stop codons at the desired locations in the vectors pV_k and pV_{g1-dhfr} using site-directed mutagenesis, such as after CH1 to produce Fab fragments or after the hinge region to produce (Fab')₂ fragments. Single chain antibodies may be produced by joining VL and VH with a DNA linker (see Huston et al., op cit., and Bird et al., op cit.). As one example, Fv or Fab fragments may be produced in E. coli according to the methods of Buchner and Rudolph (1991) Bio/Technology 9: 157-162 and Skerra et al. (1991) Bio/Technology 9: 273-277, incorporated herein by reference). Fv and Fab may also be produced by

expression of encoding polynucleotides in eukaryotic, preferably mammalian, cells. Also because like many genes, the immunoglobulin-related genes contain separate functional regions, each having one or more distinct biological activities, the genes may be fused to functional regions from other genes (e.g., enzymes, see, commonly assigned U.S.S.N. 132,387, filed Dec. 15, 1987, which is incorporated herein by reference) to produce fusion proteins (e.g., immunotoxins) having novel properties.

Expression of the humanized immunoglobulin sequences in bacterial hosts may be used to advantage to select higher affinity humanized immunoglobulin sequences by mutagenizing the CDR regions and producing bacteriophage display libraries which may be screened for humanized immunoglobulin CDR variants which possess high affinity and/or high specificity binding to CD18. One potential advantage of such affinity sharpening is the generation of humanized immunoglobulin CDR variants which have improved binding affinity and/or reduced cross-reactivity with molecules other than CD18s. Methods for producing phage display libraries having immunoglobulin variable region sequences are provided in the art, for example see Cesareni (1992) FEBS Lett 307: 66-70; Swimmer et al. (1992) Proc. Natl. Acad. Sci. (U.S.A.) 89: 3756-60; Gram et al. (1992) Proc. Natl. Acad. Sci. (U.S.A.) 89: 3576-80; Clackson et al. (1991) Nature 352: 624-8; Scott and Smith (1990) Science 249: 386-90; Garrard et al. (1991) Bio/Techniques 9: 1373-1377, which are incorporated herein by reference. The resultant affinity sharpened CDR variant humanized immunoglobulin sequences are subsequently expressed in a suitable host for efficient expression.

As stated previously, the DNA sequences will be expressed in hosts after the sequences have been operably linked to (i.e., positioned to ensure the functioning of) an expression control sequence. These expression vectors are typically replicable in the host organisms either as episomes or as an integral part of the host chromosomal DNA. Commonly, expression vectors will contain selection markers,

e.g., tetracycline-resistance (tet^R), G418-resistance (neo^R), mycophenolic acid-resistance (gpt), or HSV-tk, to permit detection of those cells transformed with the desired DNA sequences (see, e.g., U.S. Patent 4,704,362, which is incorporated herein by reference).

E. coli is one prokaryotic host useful particularly for cloning the DNA sequences of the present invention. Other microbial hosts suitable for use include bacilli, such as Bacillus subtilis, and other enterobacteriaceae, such as Salmonella, Serratia, and various Pseudomonas species. In these prokaryotic hosts, one can also make expression vectors, which will typically contain expression control sequences compatible with the host cell (e.g., an origin of replication). In addition, any number of a variety of well-known promoters will be present, such as the lactose promoter system, a tryptophan (trp) promoter system, a beta-lactamase promoter system, or a promoter system from phage lambda. The promoters will typically control expression, optionally with an operator sequence, and have ribosome binding site sequences and the like, for initiating and completing transcription and translation.

Other microbes, such as yeast, may also be used for expression. Saccharomyces is a preferred host, with suitable vectors having expression control sequences, such as promoters, including 3-phosphoglycerate kinase or other glycolytic enzymes, and an origin of replication, termination sequences and the like as desired.

Plants and plant cell cultures may be used for expression of the humanized immunoglobulins of the invention. (Larrick and Fry (1991) Hum. Antibodies Hybridomas 2(4): 172-89; Benvenuto et al. (1991) Plant Mol. Biol. 17 (4): 865-74; Durin et al. (1990) Plant Mol. Biol. 15(2): 281-93; Hiatt et al. (1989) Nature 342: 76-8, incorporated herein by reference). Preferable plant hosts include, for example: Arabidopsis, Nicotiana tabacum, Nicotiana rustica, and Solanum tuberosum. A preferred expression cassette for expressing polynucleotide sequences encoding the humanized anti-CD18 antibodies of the invention is the plasmid pMOG18

in which the inserted polynucleotide sequence encoding the humanized immunoglobulin chain is operably linked to a CaMV 35S promoter with a duplicated enhancer; pMOG18 is used according to the method of Sijmons et al. (1990)

5 Bio/Technology 8: 217-221, incorporated herein by reference. Alternatively, a preferred embodiment for the expression of humanized immunoglobulins in plants follows the methods of Hiatt et al. (1989) op.cit., with the substitution of

10 polynucleotide sequences encoding the humanized anti-CD18 antibodies of the invention for the immunoglobulin sequences used by Hiatt et al. Agrobacterium tumifaciens T-DNA-based vectors may also be used for expressing humanized

15 immunoglobulin sequences, preferably such vectors include a marker gene encoding spectinomycin-resistance or other selectable marker.

Insect cell culture may also be used to produce the humanized immunoglobulins of the invention, typically using a baculovirus-based expression system. The humanized immunoglobulins may be produced by expressing polynucleotide

20 sequences encoding the humanized immunoglobulins according to the methods of Putlitz et al. (1990) Bio/Technology 8: 651-654, incorporated herein by reference. The method of Putlitz et al. can be followed with the modification that

25 polynucleotide sequences encoding the humanized anti-CD18 antibodies of the invention are inserted in place of the mouse monoclonal Ab 6A4 heavy chain and light chain cDNA sequences of Putlitz et al.

In addition to microorganisms and plants, mammalian tissue cell culture may also be used to express and produce

30 the polypeptides of the present invention (see, Winnacker, From Genes to Clones, VCH Publishers, N.Y., N.Y. (1987), which is incorporated herein by reference). Mammalian cells are actually preferred, because a number of suitable host

35 cell lines capable of secreting intact immunoglobulins have been developed in the art, and include the CHO cell lines, various COS cell lines, HeLa cells, preferably myeloma cell lines, etc, or transformed B-cells or hybridomas. Expression vectors for these cells can include expression control

sequences, such as an origin of replication, a promoter, an enhancer (Queen et al., Immunol. Rev. 89, 49-68 (1986), which is incorporated herein by reference), and necessary processing information sites, such as ribosome binding sites, RNA splice sites, polyadenylation sites, and transcriptional terminator sequences. Preferred expression control sequences are promoters derived from immunoglobulin genes, SV40, Adenovirus, Bovine Papilloma Virus, cytomegalovirus and the like. Generally, a selectable marker, such as a neo^R expression cassette, is included in the expression vector.

Transgenes encoding a humanized immunoglobulin of the invention may be used to generate transgenic nonhuman animals which express the desired humanized immunoglobulin, typically in a recoverable body fluid such as milk or serum. Such transgenes comprise a polynucleotide sequence encoding the humanized immunoglobulin(s) operably linked to a promoter, usually with a linked enhancer, such as a rodent immunoglobulin enhancer or a casein gene promoter/enhancer (Buhler et al. (1990) Bio/Technology 8: 140-143; Meade et al. (1990) Bio/Technology 8: 443-446, incorporated herein by reference). Transgenes may be transferred into cells and embryos according to the methods described in the art and infra for homologous recombination constructs. Preferred nonhuman animals include: mice, rats, sheep, cows, and goats; with expression in bovine milk being particularly preferred. Purification of the humanized antibodies is accomplished by art-known purification methods for immunoglobulin purification.

Homologous recombination constructs may also be used for producing cells or transgenic animals expressing the humanized immunoglobulins of the invention. Preferred promoter/enhancer combinations for operable linkage to polynucleotide sequences encoding the humanized immunoglobulins of the invention in the homologous recombination constructs include those associated with the albumin gene, β -casein gene, α -casein gene, whey protein genes, or lactalbumin gene. Most usually, a selectable marker gene expression cassette (e.g., neo^R, HSV-tk, or gpt

operably linked to a constitutive promoter such as the pgk gene promoter) is included in the homologous recombination construct for selection. The homologous targeting constructs encoding humanized immunoglobulins of the invention can be transferred into embryonic stem (ES) cells by lipofection, electroporation, or needle microinjection, or into fertilized animal embryos by pronuclear needle microinjection, or other art-accepted method. If ES cells are used for transgenesis, the resultant ES cells are usually selected by positive selection, and optionally by negative selection as well, and verified for correctly targeted recombination by PCR or Southern blotting. Correctly targeted ES cells are incorporated into blastocysts by blastocyst injection according to methods known in the art and cited herein. General principles regarding the construction of targeting constructs and selection methods are reviewed in Bradley et al. (1992) Bio/Technology 10: 534, incorporated herein by reference.

Chimeric targeted mice are derived according to Hogan, et al., Manipulating the Mouse Embryo: A Laboratory Manual, Cold Spring Harbor Laboratory (1988) and Teratocarcinomas and Embryonic Stem Cells: A Practical Approach, E.J. Robertson, ed., IRL Press, Washington, D.C., (1987) which are incorporated herein by reference. Embryonic stem cells are manipulated according to published procedures (Teratocarcinomas and Embryonic Stem Cells: A Practical Approach, E.J. Robertson, ed., IRL Press, Washington, D.C. (1987); Zijlstra et al., Nature 342:435-438 (1989); and Schwartzberg et al., Science 246:799-803 (1989), each of which is incorporated herein by reference).

Frequently, homologous targeting constructs are propagated in cloning hosts (e.g., bacteria, yeast) and may also include an origin of replication and selectable marker(s) for facile cloning.

It is frequently preferable to use a transfection technique with linearized transgenes containing only modified target gene sequence(s) and without vector sequences. The modified gene site is such that a homologous recombinant

between the exogenous targeting construct and the endogenous DNA target sequence can be identified by using carefully chosen primers and PCR or by Southern blot analysis, followed by analysis to detect if PCR products or Southern blot bands specific to the desired targeted event are present (Erlich et al., (1991) Science 252: 1643, which is incorporated herein by reference). Several studies have already used PCR to successfully identify the desired transfected cell lines (Zimmer and Gruss (1989) Nature 338: 150; Mouellic et al. (1990) Proc. Natl. Acad. Sci. (U.S.A.) 87: 4712; Shesely et al. (1991) Proc. Natl. Acad. Sci. USA 88: 4294, which are incorporated herein by reference). This approach is very effective when the number of cells receiving exogenous targeting transgene(s) is high (i.e., with electroporation or with liposomes) and the treated cell populations are allowed to expand (Capecchi, M. (1989) Science 244:1288, incorporated herein by reference).

For making transgenic non-human animals (which include homologously targeted non-human animals), embryonal stem cells (ES cells) are preferred. Murine ES cells, such as AB-1 line grown on mitotically inactive SNL76/7 cell feeder layers (McMahon and Bradley, Cell 62:1073-1085 (1990)) essentially as described (Robertson, E.J. (1987) in Teratocarcinomas and Embryonic Stem Cells: A Practical Approach. E.J. Robertson, ed. (Oxford: IRL Press), p. 71-112) may be used for homologous gene targeting. Other suitable ES lines include, but are not limited to, the E14 line (Hooper et al. (1987) Nature 326: 292-295), the D3 line (Doetschman et al. (1985) J. Embryol. Exp. Morph. 87: 27-45), and the CCE line (Robertson et al. (1986) Nature 323: 445-448). The success of generating a mouse line from ES cells bearing a specific targeted mutation depends on the pluripotency of the ES cells (i.e., their ability, once injected into a host blastocyst, to participate in embryogenesis and contribute to the germ cells of the resulting animal). The blastocysts containing the injected ES cells are allowed to develop in the uteri of pseudopregnant nonhuman females and are born as chimeric mice. The resultant transgenic mice are chimeric

for cells having the homologously integrated humanized immunoglobulin gene sequence(s) and are backcrossed and screened for the presence of the correctly targeted transgene(s) by PCR or Southern blot analysis on tail biopsy DNA of offspring so as to identify transgenic mice heterozygous for the inactivated lymphocyte transduction locus/loci. By performing the appropriate crosses, it is possible to produce, if desired, a transgenic nonhuman animal homozygous for multiple transgenes encoding a humanized immunoglobulin of the invention.

The vectors containing the DNA segments of interest (e.g., the heavy and light chain encoding sequences and expression control sequences) can be transferred into the host cell by well-known methods, which vary depending on the type of cellular host. For example, calcium chloride transfection is commonly utilized for prokaryotic cells, whereas calcium phosphate treatment, lipofection, biolistics, viral-based transduction, or electroporation may be used for other cellular hosts. Tungsten particle ballistic transgenesis is preferred for plant cells and tissues. (See, generally, Maniatis et al., Molecular Cloning: A Laboratory Manual, Cold Spring Harbor Press, (1982), which is incorporated herein by reference.)

Once expressed, the whole antibodies, their dimers, individual light and heavy chains, or other immunoglobulin forms of the present invention can be purified according to standard procedures of the art, including ammonium sulfate precipitation, affinity columns, column chromatography, gel electrophoresis and the like (see, generally, Scopes, R., Protein Purification, Springer-Verlag, N.Y. (1982), which is incorporated herein by reference). Substantially pure immunoglobulins of at least about 90 to 95% homogeneity are preferred, and 98 to 99% or more homogeneity most preferred, for pharmaceutical uses. Once purified, partially or to homogeneity as desired, the polypeptides may then be used therapeutically (including extracorporeally) or in developing and performing assay procedures, immunofluorescent stainings, and the like. (See, generally, Immunological Methods, Vols.

I and II, Lefkovits and Pernis, eds., Academic Press, New York, N.Y. (1979 and 1981)).

In a preferred embodiment, humanized immunoglobulins are produced which bind to CD18 with a binding affinity of at least $1 \times 10^7 \text{ M}^{-1}$ in standard binding conditions (e.g., phosphate-buffered saline with 2 percent fetal bovine serum at 25°C); one example of such humanized immunoglobulins is the humanized NA-8 antibody comprising the amino acid sequences shown in Fig. 2. The humanized antibodies of the invention preferably bind, in standard binding conditions, to human CD18 with an affinity of at least $1 \times 10^8 \text{ M}^{-1}$, more preferably with an affinity of at least $1 \times 10^9 \text{ M}^{-1}$, and advantageously with an affinity of at least $1 \times 10^{10} \text{ M}^{-1}$ or stronger.

The antibodies of the present invention will typically find use in the treatment of disease conditions with an inflammatory component, especially those which are mediated by neutrophils or T cells. A preferred application is the treatment of ischemia-reperfusion injury caused by myocardial infarction, cerebral ischemic event (e.g., stroke), renal infarction, brain surgery, shock, cardiac surgery (e.g., coronary artery bypass), elective angioplasty, and the like. Other preferred applications are the treatment of sepsis, adult respiratory distress syndrome, and multiple organ failure. The antibodies will find use in treating injury due to trauma, burns, frostbite or damage to the spinal cord. They will also find use in treating autoimmune diseases including by way of example and not limitation, rheumatoid arthritis, systemic lupus erythematosus, multiple sclerosis, type I diabetes and uveitis, in treating inflammatory diseases of the skin such as psoriasis, and in treating meningitis and encephalitis. Other typical applications are the prevention and treatment of organ transplant rejection, graft-versus-host disease, and neoplasia.

Any humanized immunoglobulins of the present invention may also be used in combination with other antibodies, particularly humanized antibodies reactive with

different adhesion molecules. For example, suitable antigens to which a cocktail of humanized immunoglobulins may react include CD11a, CD11b, L-selectin, E-selectin, P-selectin and ICAM-1. Other suitable antigens are lymphokines such as IL-1, IL-2 and IFN- γ , and their receptors.

The humanized antibodies can also be used as separately administered compositions given in conjunction with chemotherapeutic agents. Typically, the agents may include non-steroidal anti-inflammatory drugs and corticosteroids, but numerous additional agents (e.g., cyclosporin) well-known to those skilled in the art of medicine may also be utilized. Indeed, the humanized immunoglobulins of the present invention will typically be used in combination with drugs currently used by those skilled in the art to treat particular diseases.

A preferred pharmaceutical composition of the present invention comprises the use of the subject immunoglobulins in immunotoxins to kill CD18 expressing cells. Immunotoxins are characterized by two components and are particularly useful for killing selected cells in vitro or in vivo. One component is a cytotoxic agent which is usually fatal to a cell when attached or absorbed. The second component, known as the "delivery vehicle," provides a means for delivering the toxic agent to a particular cell type, such as cells expressing a CD18 epitope. The two components are commonly chemically bonded together by any of a variety of well-known chemical procedures. For example, when the cytotoxic agent is a protein and the second component is an intact immunoglobulin, the linkage may be by way of heterobifunctional cross-linkers, e.g., SPDP, carbodiimide, glutaraldehyde, or the like. Production of various immunotoxins is well-known with the art, and can be found, for example in "Monoclonal Antibody-Toxin Conjugates: Aiming the Magic Bullet," Thorpe et al., Monoclonal Antibodies in Clinical Medicine, Academic Press, pp. 168-190 (1982), which is incorporated herein by reference. The components may also be linked genetically (see Chaudhary et

al., Nature 339, 394 (1989), incorporated herein by reference).

A variety of cytotoxic agents are suitable for use in immunotoxins. Cytotoxic agents can include
5 radionuclides, such as Iodine-131 or other isotopes of iodine, Yttrium-90, Rhenium-188, and Bismuth-212 or other alpha emitters; a number of chemotherapeutic drugs, such as vindesine, methotrexate, adriamycin, and cisplatin; and
10 cytotoxic proteins such as ribosomal inhibiting proteins like pokeweed antiviral protein, Pseudomonas exotoxin A, ricin, diphtheria toxin, ricin A chain, etc., or an agent active at the cell surface, such as the phospholipase enzymes (e.g., phospholipase C). (See, generally, commonly assigned U.S.S.N. 07/290,968, "Chimeric Toxins," Olsnes and Phil, Pharm. There., 25, 355-381 (1982), and Monoclonal Antibodies for Cancer Detection and Therapy, eds. Baldwin and Byers, pp. 159-179, 224-266, Academic Press (1985), all of which are incorporated herein by reference.)

The delivery component of the immunotoxin will
20 include the humanized immunoglobulins of the present invention. Intact immunoglobulins or their binding fragments, such as Fab or Fv, are preferably used. Typically, the antibodies in the immunotoxins will be of the human IgM or IgG isotype, but other mammalian constant
25 regions may be utilized as desired.

For some applications, such as diagnostic uses, the humanized anti-CD-18 antibodies of the present invention will comprise a detectable label; typically the label is attached by covalent linkage or incorporation of a labeled
30 radionuclide into the glycoprotein immunoglobulin. For example and not limitation, one application of the humanized anti-CD-18 antibodies is as a research reagent and/or diagnostic reagent to detect quantitatively the presence of CD-18 on cell surfaces; frequently a labeled second antibody
35 (e.g., goat anti-human IgG) will be used to bind to the human sequence portion (e.g., the constant region and/or human variable region framework) of the humanized immunoglobulin. This approach can be used advantageously when the sample

being assayed for CD-18 expressing cells also contains other species which would interfere with a mouse primary antibody reactive with CD-18.

5 The humanized antibodies and pharmaceutical compositions thereof of this invention are particularly useful for parenteral administration, i.e., subcutaneously, intramuscularly or intravenously. The humanized antibodies of the invention may also be administered, typically for local application, by gavage or lavage, intraperitoneal
10 injection, ophthalmic ointment, topical ointment, intracranial injection (typically into a brain ventricle), intrapericardial injection, or intrabursal injection. The compositions for parenteral administration will commonly comprise a solution of the immunoglobulin or a cocktail thereof dissolved in an acceptable carrier, preferably an aqueous carrier. A variety of aqueous carriers can be used,
15 e.g., water, buffered water, phosphate buffered saline (PBS), 0.4% saline, 0.3% glycine, human albumin solution and the like. These solutions are sterile and generally free of particulate matter. These compositions may be sterilized by conventional, well-known sterilization techniques. The compositions may contain pharmaceutically acceptable auxiliary substances as required to approximate physiological conditions such as pH adjusting and buffering agents,
25 toxicity adjusting agents and the like, for example sodium acetate, sodium chloride, potassium chloride, calcium chloride, sodium lactate, etc. The concentration of antibody in these formulations can vary widely, i.e., from less than about 0.005%, usually at least about 1% to as much as 15 or
30 20% by weight and will be selected primarily based on fluid volumes, viscosities, etc., in accordance with the particular mode of administration selected.

Thus, a typical pharmaceutical composition for injection could be made up to contain 1 ml sterile buffered
35 water, and 1-10 mg of immunoglobulin. A typical composition for intravenous infusion could be made up to contain 250 ml of sterile Ringer's solution, and 150 mg of antibody. Actual methods for preparing parenterally administrable compositions

will be known or apparent to those skilled in the art and are described in more detail in, for example, Remington's Pharmaceutical Science, 15th ed., Mack Publishing Company, Easton, Pennsylvania (1980), which is incorporated herein by reference. Compositions suitable for lavage or other routes will be selected according to the particular use intended.

The antibodies of this invention can be frozen or lyophilized for storage and reconstituted in a suitable carrier prior to use. This technique has been shown to be effective with conventional immune globulins and art-known lyophilization and reconstitution techniques can be employed. It will be appreciated by those skilled in the art that lyophilization and reconstitution can lead to varying degrees of antibody activity loss (e.g., with conventional immune globulins, IgM antibodies tend to have greater activity loss than IgG antibodies) and that use levels may have to be adjusted to compensate.

The compositions containing the present humanized antibodies or a cocktail thereof can be administered for prophylactic and/or therapeutic treatments. In therapeutic applications, compositions are administered to a patient already suffering from an inflammatory disease, in an amount sufficient to cure or at least partially arrest the disease and its complications. An amount adequate to accomplish this is defined as a "therapeutically effective dose." Amounts effective for this use will depend upon the severity of the disease and the general state of the patient's own immune system, but generally range from about 1 to about 200 mg of antibody per dose, with dosages of from 5 to 100 mg per patient being more commonly used. Dosing schedules will vary with the disease state and status of the patient, and will typically range from a single bolus dosage or continuous infusion to multiple administrations per day (e.g., every 4-6 hours), or as indicated by the treating physician and the patient's condition. It must be kept in mind that the materials of this invention may generally be employed in serious disease states, that is life-threatening or potentially life-threatening situations. In such cases, in view of the

minimization of extraneous substances and the lower probability of "foreign substance" rejections which are achieved by the present humanized immunoglobulins of this invention, it is possible and may be felt desirable by the treating physician to administer substantial excesses of these antibodies.

In prophylactic applications, compositions containing the present antibodies or a cocktail thereof are administered to a patient not already suffering from a particular disease to enhance the patient's resistance. Such an amount is defined to be a "prophylactically effective dose." In this use, the precise amounts again depend upon the patient's state of health and general level of immunity, but generally range from 1 to 50 mg per dose. Preferred prophylactic uses are for the prevention of adult respiratory distress syndrome in patients already suffering from sepsis or trauma; prevention of organ transplant rejection; and prevention of reperfusion injury in patients suffering from ischemia. In seriously ill patients, dosages of about 50 to 100 mg of humanized immunoglobulin per administration are frequently used, and larger dosages may be indicated.

Single or multiple administrations of the compositions can be carried out with dose levels and pattern being selected by the treating physician. In any event, the pharmaceutical formulations should provide a quantity of the antibody(ies) of this invention sufficient to effectively treat the patient.

Humanized antibodies of the present invention can further find a wide variety of utilities in vitro. By way of example, the antibodies can be utilized for detection of CD18 antigens, for isolating specific leukocytes, or the like. For example but not for limitation, a humanized NA-8 immunoglobulin can be immobilized and contacted with blood extravasated from a patient to remove blood cells bearing CD18 antigens, and the remaining blood, depleted of CD18-bearing cells, may be reintroduced into the patient. Any residual humanized antibody present in the depleted blood reintroduced into the patient (e.g., as a consequence of

detachment from the immobilization support) would have reduced or negligible antigenicity as compared to a murine antibody.

5 For diagnostic purposes, the antibodies may either be labeled or unlabeled. Unlabeled antibodies can be used in combination with other labeled antibodies (second antibodies) that are reactive with the humanized antibody, such as antibodies specific for human immunoglobulin constant regions. Alternatively, the antibodies can be directly labeled. A
10 wide variety of labels may be employed, such as radionuclides, fluors, enzymes, enzyme substrates, enzyme co-factors, enzyme inhibitors, ligands (particularly haptens), etc. Numerous types of immunoassays are available and are well known to those skilled in the art.

15 The following examples are offered by way of illustration, not by limitation. It will be understood that although the examples pertain to the NA-8 antibody, producing humanized antibodies with high binding affinity for CD18 may also be performed using CDRs from other monoclonal antibodies
20 that bind to an epitope of CD18.

EXPERIMENTAL

Generation of anti-CD18 NA-8 antibody.

25 The mouse antibody NA-8 that binds to human CD18 was developed as follows. A mouse was subcutaneously immunized with 25×10^6 PMA-activated human neutrophils emulsified in Hunter's TiterMax™ adjuvant at two sites. The mouse was boosted 4 times by intraperitoneal injection of $20-25 \times 10^6$ PMA-activated neutrophils at intervals of 2 to 3
30 weeks. Four days following the final boost, the spleen cells were fused with myeloma cell to produce hybridomas, following methods well known in the art. Supernatants of hybridomas were then screened for the ability to inhibit neutrophil adherence to protein-coated plastic. Hybridoma supernatant
35 samples (100 μ l) were transferred to a 96 well plate. A neutrophil suspension (100 μ l of 5×10^6 cells/ml) was added to each well. Following a 5 min incubation at room temperature, 20 μ l of a 500 ng/ml stock of PMA was added to

each well. The plate was incubated for thirty minutes at 37°C to allow the neutrophils to settle to the bottom of the well. Following this incubation, the wells of the plate were washed 3 times with RPMI to remove non-adherent cells. Each well was then stained with 50 µl of 0.2% crystal violet in 10% phosphate-buffered formalin for 20 min, then washed with H₂O and allowed to air dry. Wells in which neutrophils had adhered to the plastic were deeply stained, while wells in which the hybridoma supernatant inhibited the adherence did not stain and appeared clear. NA-8 was one of the hybridomas whose supernatant inhibited adherence.

That NA-8 specifically binds to CD18 was shown in two ways. Immunoprecipitation of labelled neutrophil lysate gave the same pattern as the Known anti-CD18 antibody IB4 (Wright et al. (1983) Proc. Natl. Acad. Sci. USA 80: 5699), that is bands of the correct size for CD18 and for co-precipitated CD11b and CD11c. Therefore, the antibody reacts with the CD11/CD18 complex, and the presence of 2 alpha chains (both CD11b and CD11c) implies that reactivity is in fact with CD18. Secondly, NA-8 binds to the same cell lines among a panel of cell lines as IB4. In particular, NA-8 reacts with Hut-102B and JURKAT cells as well as normal human peripheral blood lymphocytes, which express CD18 but not CD11b.

Cloning of heavy chain and light chain cDNA.

cDNAs for the heavy chain and light chain variable domain genes of NA-8 were cloned using anchored polymerase chain reactions as described (see Co et al., J. Immunol. 148, 1149 (1992) and commonly assigned U.S.S.N. 07/634,278), using 3' primers that hybridized to the constant regions and contained HindIII sites, and 5' primers that hybridized to the dG tails and contained EcoRI sites. The PCR amplified fragments were digested with EcoRI and HindIII and cloned into the pUC18 vector for sequencing. For NA-8, at least two gamma-1 specific and two kappa specific clones were sequenced. The gamma-1 clones and the kappa clones are respectively identical in sequence. The cDNA variable domain

sequences and the deduced amino acid sequences are shown in Fig. 1.

Computer modeling of humanized antibodies.

5 In order to retain high binding affinity in the humanized antibodies, the general procedures of Queen et al. were followed (see, Queen et al., Proc. Natl. Acad. Sci. USA 86, 10029 (1989) and WO 90/07861, which are incorporated herein by reference). The more homologous a human antibody
10 is to the original murine antibody, the less likely will combining the murine CDRs with the human framework be to introduce distortions into the CDRs that could reduce affinity. Normally the heavy chain and light chain from the same human antibody are chosen to provide the framework
15 sequences, so as to reduce the possibility of incompatibility in the assembling of the two chains. Based on sequence homology search against the NBRF protein sequence database (performed with the MicroGenie Sequence Analysis Software (Beckman)), the antibody Eu was chosen to provide the
20 framework sequences for humanization of NA-8.

 The computer program ENCAD (M. Levitt, J. Mol. Biol. 168, 595 (1983), which is incorporated herein by reference) was used to construct a model of the NA-8 variable region. The model was used to determine the amino acids in
25 the NA-8 framework that were close enough to the CDRs to potentially interact with them (category 4 below). To design the humanized light and heavy chain NA-8 variable regions, at each position the amino acid was chosen to be the same as in the Eu antibody, unless that position fell in one or more of
30 four categories:

- (1) The position fell within a CDR,
- (2) The Eu amino acid was unusual for human antibodies at that position, whereas the NA-8 amino acid was typical for human
35 antibodies at that position,
- (3) The position was immediately adjacent to a CDR,

(4) The model described above suggested that the amino acid may be physically close to the antigen binding region (CDRs).

5 For positions in these categories, the amino acid from the mouse NA-8 antibody was used.

The amino acids in each category are shown in Table 1. Some amino acids may be in more than one category. The final sequences of the humanized NA-8 light and heavy chain variable domains are shown in Fig. 2, A-B compared with the murine NA-8 sequences.

TABLE 1

Category	Light Chain	Heavy Chain
15 1	24-40, 56-62, 95-103	31-35, 50-66, 99-106
2	54, 87, 112	93, 95, 98, 107-109, 111
20 3	--	30, 67, 98, 107
4	22, 54, 69, 76	27, 30, 38, 48, 67-68, 70, 74

25 In addition, the amino acid from the mouse NA-8 antibody was chosen at light chain position 49, because it was at the light-heavy chain interface.

To determine whether amino acids 67, 68, 70 and 74 in the heavy chain variable region framework of humanized NA-8 were important in maintaining binding affinity, a second humanized version of NA-8 was constructed, designated humanized NA-8a. This antibody has the same light chain as the first version (Fig. 2A), but in the heavy chain the human EU amino acids were retained at positions 67, 68, 70 and 74, rather than being replaced by the murine NA-8 amino acids. The sequence of the mature heavy chain variable region of humanized NA-8a is shown in Fig. 2C. Humanized NA-8a was produced and characterized analogously to humanized NA-8 (see below).

40 For the construction of genes for the humanized antibodies, nucleotide sequences were selected that encode the protein sequences of the humanized heavy and light chains,

including signal peptides, generally utilizing codons found in the mouse sequence. Several degenerate codons were changed to create restriction sites or to remove undesirable ones. The nucleotide sequences of the genes also included splice donor signals and an XbaI site at each end. For example, the nucleotide sequences and encoded humanized light and heavy chain variable domains of humanized NA-8 are shown in Fig. 3. Each gene was constructed from four overlapping synthetic oligonucleotides, as described (see, Co et al., J. Immunol. 148, 1149 (1992), and commonly assigned U.S.S.N. 07/634,278, which are incorporated herein by reference.) The heavy and light chain variable region genes were then respectively ligated into the XbaI sites of the pVg1-dhfr or pVκ expression vectors (see, commonly assigned U.S.S.N 07/634,278) in the appropriate orientations to produce the complete heavy and light chain genes. Reactions were carried out under conditions well-known in the art (Maniatis et al., op. cit.)

The heavy chain and light chain plasmids were transfected into Sp2/0 mouse myeloma cells by electroporation and cells were selected for gpt expression. Clones were screened by assaying human antibody production in the culture supernatant by ELISA, and antibody was purified from the best-producing clones. Humanized NA-8 IgG1 antibody was then purified by passing tissue culture supernatant over a column of staphylococcal protein A-Sepharose CL-4B (Pharmacia). The bound antibody was eluted with 0.2 M Glycine-HCl, pH3.0 and neutralized with 1 M Tris pH8.0. The buffer was exchanged into PBS by passing over a PD10 column (Pharmacia), or by dialysis. To obtain cells producing higher levels of antibody, the transfected clones may be cultured in increasing concentrations of methotrexate.

To produce a humanized NA-8 antibody of the IgG4 isotype, another vector pVg4-dhfr was first constructed. To do so, the XbaI-BamHI fragment of pVg1-dhfr containing the γ 1 constant region was replaced with an approximately 2000 bp fragment of the human γ 4 constant region gene (Ellison and Hood, Proc. Natl. Acad. Sci. USA 79: 1984 (1982)) that extended from the HindIII site preceding the C_H1 exon of the

5 γ 4 gene to 270 bp after the NsiI site following the C_H4 exon of the gene, using methods well-known to those skilled in the art, including polymerase chain reaction. The humanized NA-8 heavy chain variable region gene was then cloned into the XbaI site of pVg4-dhfr. This heavy chain plasmid was then transfected together with the above light chain plasmid into Sp2/0 cells, clones selected, and humanized NA-8 IgG4 antibody purified as described above for the IgG1 antibody. A humanized NA-8a IgG4 antibody is produced similarly.

10 Properties of humanized antibodies.

15 The affinity of the humanized NA-8 antibodies for CD18 were determined by competition with the radio-iodinated mouse NA-8 antibody (Fig. 4). The binding affinities were calculated according to the methods of Berzofsky (J.A. Berzofsky and I.J. Berkower, in Fundamental Immunology (ed. W.E. Paul), Raven Press (New York), 595 (1984), which is incorporated herein by reference). The humanized NA-8 antibodies had an affinity within about 2-fold of the mouse NA-8 antibody. A similar result will be found when the affinity for CD18 on human neutrophils is measured. The humanized NA-8a antibody was similarly determined to have approximately the same binding affinity for CD18 as humanized NA-8.

25 The ability of the mouse and humanized NA-8 antibodies to block the adhesion of human neutrophils to endothelial cells was shown as follows (Fig 5). Human umbilical cord endothelial cells (HUVEC; from Clonetics, San Diego) were grown to confluency in EGM media (Clonetics) in a 24 well plate. Four hours prior to the assay, each well was washed with RPMI, and media containing 20 ng/ml IL-1 β was added. The plates were then incubated at 37° C. Human neutrophils were isolated from buffy coats that had been cleared of erythrocytes by dextran sedimentation, and then adjusted to 10⁷ cells per ml. The neutrophils were then labelled with 200-400 μ Ci of ⁵¹Cr. Twenty minutes prior to the assay, 250 μ l of the labelled neutrophil suspension was added to a polypropylene tube containing 250 μ l of RPMI with varying

concentrations of an antibody. The assay was begun by washing the HUVEC free of IL-1 β and adding antibody-treated cells to the wells. The plate was incubated for thirty minutes at 37° C to allow the neutrophils to settle onto the activated HUVEC. Each well was washed 3 times with RPMI to remove non-adherent neutrophils. The contents of each well was lysed by the addition of 500 μ l of 1% SDS, and transferred to a vial to determine adherent cpm. The humanized NA-8a antibody similarly blocked binding of neutrophils to HUVEC.

From the foregoing, it will be appreciated that the humanized immunoglobulins of the present invention offer numerous advantages over other CD18 specific antibodies. In comparison to mouse monoclonal antibodies, the present humanized immunoglobulins can be more economically produced and contain substantially less foreign amino acid sequences. This reduced likelihood of antigenicity after injection into a human patient represents a significant therapeutic improvement.

All publications and patent applications are herein incorporated by reference to the same extent as if each individual publication or patent application was specifically and individually indicated to be incorporated by reference. Although the present invention has been described in some detail by way of illustration and example for purposes of clarity and understanding, it will be apparent that certain changes and modifications may be practiced within the scope of the appended claims.

WE CLAIM:

1. A humanized immunoglobulin having
complementarity determining regions (CDRs) corresponding to
5 CDRs from the donor immunoglobulin NA-8 and heavy and light
chain variable region frameworks corresponding to human
acceptor immunoglobulin heavy and light chain frameworks,
which humanized immunoglobulin specifically binds to human
CD18 with an affinity constant of at least $10^7 M^{-1}$, wherein the
10 sequence of the humanized immunoglobulin heavy chain variable
region framework is more than 65% identical but less than 95 %
identical to the sequence of the donor immunoglobulin heavy
chain variable region framework.
- 15 2. A humanized immunoglobulin according to claim 1
which is an antibody comprising two light chain/heavy chain
dimers.
- 20 3. A humanized immunoglobulin of claim 2, wherein
said antibody is of the IgG1 or IgG4 isotype.
- 25 4. A humanized immunoglobulin according to claim
1, which specifically binds to human CD18 with an affinity of
at least $10^8 M^{-1}$.
5. A humanized immunoglobulin according to claim
1, which is an Fab or (Fab')₂.
- 30 6. A humanized immunoglobulin according to claim
1, wherein said acceptor immunoglobulin heavy and light chain
frameworks are from the same human antibody.
- 35 7. A humanized immunoglobulin according to claim
6, wherein said human antibody is the Eu human antibody.
8. A humanized immunoglobulin having
complementarity determining regions (CDRs) corresponding to
CDRs from the donor immunoglobulin NA-8 and heavy and light

chain variable region frameworks corresponding to acceptor immunoglobulin heavy and light chain frameworks, which humanized immunoglobulin specifically binds to human CD18 with an affinity constant of at least $10^7 M^{-1}$, wherein the sequence of the acceptor immunoglobulin heavy chain variable region is among the 5 sequences in a representative collection of sequences of human immunoglobulin heavy chain variable regions most homologous to the sequence of the donor immunoglobulin heavy chain variable region.

10

9. A humanized immunoglobulin having complementarity determining regions (CDRs) corresponding to CDRs from the donor immunoglobulin NA-8 and heavy and light chain variable region frameworks corresponding to acceptor immunoglobulin heavy and light chain frameworks, which humanized immunoglobulin specifically binds to human CD18 with an affinity constant of at least $10^7 M^{-1}$, wherein said humanized immunoglobulin comprises amino acids from the donor immunoglobulin framework replacing the corresponding amino acids in the acceptor immunoglobulin heavy or light chain frameworks, said amino acids not in positions 26-30 of the heavy chain, and each of said amino acids:

15

20

(i) is adjacent to a CDR in the donor immunoglobulin sequence, or

25

(ii) contains an atom within a distance of 5 angstroms of a CDR in said humanized immunoglobulin.

10. A humanized immunoglobulin having complementarity determining regions (CDRs) corresponding to CDRs from the donor immunoglobulin NA-8 and heavy and light chain variable region frameworks corresponding to acceptor immunoglobulin heavy and light chain frameworks, which humanized immunoglobulin specifically binds to human CD18 with an affinity constant of at least $10^7 M^{-1}$, wherein said humanized immunoglobulin comprises amino acids from the donor immunoglobulin framework replacing the corresponding amino acids in the acceptor immunoglobulin heavy or light chain

30

35

frameworks, said amino acids not in positions 26-30 of the heavy chain, and each of said amino acids:

(i) is adjacent to a CDR in the donor immunoglobulin sequence, or

(ii) contains an atom within a distance of 4 angstroms of a CDR in said humanized immunoglobulin.

11. A humanized immunoglobulin according to claims 9 or 10 wherein the distance from said atom to said CDR is determined from a computer-generated model of an immunoglobulin.

12. A humanized immunoglobulin according to claims 9 or 10, which is an Fab or (Fab')₂.

13. A humanized immunoglobulin according to claim 9 which is an antibody comprising two light chain/heavy chain dimers.

14. A humanized immunoglobulin of claim 13, wherein said antibody is of the IgG1 or IgG4 isotype.

15. A humanized immunoglobulin according to claim 9, wherein said acceptor immunoglobulin heavy and light chain frameworks are both from the Eu human antibody.

16. A humanized immunoglobulin according to claims 1 or 9 which is substantially pure.

17. A humanized immunoglobulin according to claims 1 or 9 that inhibits the binding of human neutrophils to human endothelial cells.

18. A composition comprising a humanized immunoglobulin according to claims 1 or 9.

19. A recombinant immunoglobulin which specifically binds to human CD18, wherein the amino acid sequence of the

mature light chain variable region is as shown in the lower lines of Fig. 2A.

5 20. A recombinant immunoglobulin which specifically binds to human CD18, wherein the amino acid sequence of the mature heavy chain variable region is as shown in the lower lines of Fig. 2B or Fig. 2C.

10 21. A method of treating an inflammatory disease or condition, comprising administering to a human patient a therapeutically-effective dose of a humanized immunoglobulin which specifically binds to human CD18.

15 22. A method according to claim 21, wherein the inflammatory disease or condition is selected from the group consisting of: ischemia-reperfusion injury, myocardial infarction, balloon angioplasty, cardiac surgery, adult respiratory distress syndrome, cerebral ischemia, sepsis, and autoimmune disease.

20 23. A method according to claim 21, wherein the humanized immunoglobulin comprises the amino acid sequence of the mature light chain variable region as shown in the lower lines of Fig. 2A and the amino acid sequence of the mature heavy chain variable region as shown in the lower lines of Fig. 2B or Fig. 2C.

25 24. A method according to claim 21, wherein the humanized immunoglobulin binds to human CD18 with an affinity of at least $1 \times 10^7 \text{ M}^{-1}$.

30 25. A method according to claim 24, wherein at least about 10 mg of the humanized immunoglobulin is administered by a parenteral route.

35

26. The murine antibody NA-8.

27. A cell line producing an antibody of claim 26.

28. An immunoglobulin whose light or heavy chain variable region respectively comprises the CDRs shown in Fig. 2A or Fig. 2B.

5 29. An immunoglobulin according to claim 28 which is humanized.

10 30. An immunoglobulin according to claim 29 which is an antibody comprising two light chain/heavy chain dimers.

1 / 6

```

30
ATGGATTACAGGCCAGGTTCTTATGTTACTGCTGCTATGGGSTATCTGGAACCTGTGGG
M D S Q A Q V L M L L L L W V S G T C G
60

90
GACATTGTGATGTCACAGTCTCCATCCTCCCTAGCTGTGTCAGTTGGAGAGAAGGTACT
D I V M S Q S P S S L A V S V G E K V T
120

150
ATGAGCTGCAAGTCCAGTCAGAGCCTTTATATAGTAGCATTCAAAAGAATTACTTGGCC
M S C K S S Q S L L Y S S I Q K N Y L A
180

210
TGGTACCAGCAGAAACCAGGGCAGTCTCCTAAACTGCTGATTTACTGGGCATCTACTAGG
W Y Q Q K P G Q S P K L L I Y W A S T R
240

270
GAATCTGGGGTCCCTGATCGCTTCACAGGCAGTGGATCTGGGACAGATTTCACTCTCACC
E S G V P D R F T G S G S G T D F T L T
300

330
ATCAGCAGTGTGAAGGCTGAAGACCTGGCAGTTTATTACTGTCAGCAATATTATAGCTAT
I S S V K A E D L A V Y Y C Q Q Y Y S Y
360

390
CCATTCAGTTTCGGCTCGGGGACAAAGTTGGAAATAAAA
P F T F G S G T K L E I K

```

Fig. 1A

```

30
ATGGAAAGGCACTGGATCTTTCTCTTCTGTTTTTCAGTAACTGCAGGTGTCCACTCCCAG
M E R H W I F L F L F S V T A G V H S Q
60

90
GTCCAGCTTCAGCAGTCTGGGGCTGAACTGGCAAACCTGGGGCCTCAGTGAAGATGTCC
V Q L Q Q S G A E L A K P G A S V K M S
120

150
TGCAAGGCTTCTGGCTACACCTTTACTAGTTACTTGATGCACTGGGTAAAACAGAGGCCT
C K A S G Y T F T S Y L M H W V K Q R P
180

210
GGACAGGGTCTGGAATGGATTGGAAACATTAATCCTAGCACTGCTTATACCGACTACAAT
G Q G L E W I G N I N P S T A Y T D Y N
240

270
CAGAACTTTAACGACAAGGCCACATTGACTGCAGACAGATCCTCCACCACAGCCTACATG
Q N F N D K A T L T A D R S S T T A Y M
300

330
CAACTGAGCAGCCTGACATCTGAGGACTCTGCACTTACTGTGCAAGAGGGGGTGTAT
Q L S S L T S E D S A V Y Y C A R G G D
360

390
TTCCTTATGGACTACTGGGGTCAAGGAACCTCAGTCACCGTCTCCTCA
F L M D Y W G Q G T S V T V S S

```

Fig. 1B

1	D	I	V	M	S	Q	S	P	S	S	L	A	V	S	V	G	E	K	V	T
1	D	I	Q	M	T	Q	S	P	S	T	L	S	A	S	V	G	D	R	V	T
21	M	S	C	K	S	S	Q	S	L	L	Y	S	S	I	Q	K	N	Y	L	A
21	I	S	C	K	S	S	Q	S	L	L	Y	S	S	I	Q	K	N	Y	L	A
41	W	Y	Q	Q	K	P	G	Q	S	P	K	L	L	I	Y	W	A	S	T	R
41	W	Y	Q	Q	K	P	G	K	S	P	K	L	L	I	Y	W	A	S	T	R
61	E	S	G	V	P	D	R	F	T	G	S	G	S	G	T	D	F	T	L	T
61	E	S	G	V	P	S	R	F	T	G	S	G	S	G	T	D	F	T	L	T
81	I	S	S	V	K	A	E	D	L	A	V	Y	Y	C	Q	Q	Y	Y	S	Y
81	I	S	S	L	Q	P	E	D	F	A	T	Y	Y	C	Q	Q	Y	Y	S	Y
101	P	F	T	F	G	S	G	T	K	L	E	I	K							
101	P	F	T	F	G	Q	G	T	K	V	E	I	K							

Fig 2A

1	Q	V	Q	L	Q	Q	S	G	A	E	L	A	K	P	G	A	S	V	K	M
1	Q	V	Q	L	V	Q	S	G	A	E	V	K	K	P	G	S	S	V	K	V
21	S	C	K	A	S	G	Y	T	F	T	S	Y	L	M	H	W	V	K	Q	R
21	S	C	K	A	S	G	Y	T	F	T	S	Y	L	M	H	W	V	K	Q	A
41	P	G	Q	G	L	E	W	I	G	N	I	N	P	S	T	A	Y	T	D	Y
41	P	G	Q	G	L	E	W	I	G	N	I	N	P	S	T	A	Y	T	D	Y
61	N	Q	N	F	N	D	K	A	T	L	T	A	D	R	S	S	T	T	A	Y
61	N	Q	N	F	N	D	K	A	T	L	T	A	D	R	S	T	N	T	A	Y
81	M	Q	L	S	S	L	T	S	E	D	S	A	V	Y	Y	C	A	R	G	G
81	M	E	L	S	S	L	R	S	E	D	T	A	V	Y	Y	C	A	R	G	G
101	D	F	L	M	D	Y	W	G	Q	G	T	S	V	T	V	S	S			
101	D	F	L	M	D	Y	W	G	Q	G	T	L	V	T	V	S	S			

Fig. 2B

1	Q	V	Q	L	Q	Q	S	G	A	E	L	A	K	P	G	A	S	V	K	M
1	Q	V	Q	L	V	Q	S	G	A	E	V	K	K	P	G	S	S	V	K	V
21	S	C	K	A	S	G	Y	T	F	T	S	Y	L	M	H	W	V	K	Q	R
21	S	C	K	A	S	G	<u>Y</u>	T	F	<u>T</u>	<u>S</u>	<u>Y</u>	<u>L</u>	<u>M</u>	<u>H</u>	W	V	<u>K</u>	<u>Q</u>	A
41	P	G	Q	G	L	E	W	I	G	N	I	N	P	S	T	A	Y	T	D	Y
41	P	G	Q	G	L	E	W	<u>I</u>	<u>G</u>	<u>N</u>	<u>I</u>	<u>N</u>	<u>P</u>	<u>S</u>	<u>T</u>	<u>A</u>	<u>Y</u>	<u>T</u>	<u>D</u>	<u>Y</u>
61	N	Q	N	F	N	D	K	A	T	L	T	A	D	R	S	S	T	T	A	Y
61	<u>N</u>	<u>Q</u>	<u>N</u>	<u>F</u>	<u>N</u>	<u>D</u>	R	V	T	I	T	A	D	E	S	T	N	T	A	Y
81	M	Q	L	S	S	L	T	S	E	D	S	A	V	Y	Y	C	A	R	G	G
81	M	E	L	S	S	L	R	S	E	D	T	A	<u>V</u>	<u>Y</u>	<u>Y</u>	C	A	<u>R</u>	<u>G</u>	<u>G</u>
101	D	F	L	M	D	Y	W	G	Q	G	T	S	V	T	V	S	S			
101	<u>D</u>	<u>F</u>	<u>L</u>	<u>M</u>	<u>D</u>	<u>Y</u>	<u>W</u>	<u>G</u>	<u>Q</u>	<u>G</u>	<u>T</u>	L	V	T	V	S	S			

Fig. 2C

10 20 30 40 50 60
 TCTAGACCACCATGGAGAAAGACACACTCCTGCTATGGGTCCTGCTTCTCTGGGTTCCAG
 M E K D T L L L W V L L L W V P
 70 80 90 100 110 120
 GTTCCACAGGTGATATACAGATGACTCAGTCACCGTCTGAGTCTGAGTCTCAGTCGGTG
 G S T G D I Q M T Q S P S T L S A S V G
 130 140 150 160 170 180
 ATCGTGTCACTATATCATGTAAGAGCTCACAGTCACTACTATATTCTAGTATACAGAAGA
 D R V T I S C K S S Q S L L Y S S I Q K
 190 200 210 220 230 240
 ACTATCTAGCTTGGTATCAGCAGAAGCCTGGTAAGTCACCTAAGCTTCTGATCTACTGGG
 N Y L A W Y Q Q K P G K S P K L L I Y W
 250 260 270 280 290 300
 CGAGTACACGTGAGTCTGGAGTACCAAGTCGTTTCACAGGTAGTGGCTCAGGCACGGATT
 A S T R E S G V P S R F T G S G S G T D
 310 320 330 340 350 360
 TCACACTGACTATATCGTCACTGCAGCCAGAGGACTTCGCAACGTACTACTGTCAGCAGT
 F T L T I S S L Q P E D F A T Y Y C Q Q
 370 380 390 400 410 420
 ATTACTCATATCCGTTCCAGTTCGGACAGGGAAGTAAAGGTAGAGATCAAGCGTAAAGTAGA
 Y Y S Y P F T F G Q G T K V E I K
 430
 ATCCAAAGTCTAGA

Fig. 3A

10 20 30 40 50 60
 TCTAGACCACCATGGGATGGAGCTGGATCTTTCTCTTCTCCTCCTGTCAGGAAGTCTGGCG
 M G W S W I F L F L L S G T A G
 70 80 90 100 110 120
 TCCACTCTCAAGTACAGCTAGTGCACTCTGGAGCTGAGGTCAAGAAGCCTGGATCGTCAG
 V H S Q V Q L V Q S G A E V K K P G S S
 130 140 150 160 170 180
 TCAAGGTCAGCTGTAAGGCATCAGGATATACGTTTCAGTTCATACCTGATGCACTGGGTGA
 V K V S C K A S G Y T F T S Y L M H W V
 190 200 210 220 230 240
 AGCAGGCCCTGGACAGGGACTCGAGTGGATCGGTAACATAAAATCCGTCGACTGCATATA
 K Q A P G Q G L E W I G N I N P S T A Y
 250 260 270 280 290 300
 CGGACTATAATCAGAATTTCAACGATAAGGCAACTCTGACGGCTGATCGATCGACAAACA
 T D Y N Q N F N D K A T L T A D R S T N
 310 320 330 340 350 360
 CTGCGTATATGGAGCTGTCAAGCTTGGCATCAGAAGATACTGCTGTTTACTACTGCGCAC
 T A Y M E L S S L R S E D T A V Y Y C A
 370 380 390 400 410 420
 GAGGTGGAGACTTCTGATGGACTATTGGGGACAGGGTACGCTAGTAACGGTGAGCTCAG
 R G G D F L M D Y W G Q G T L V T V S S
 430
 GTAAGAATGGCCTCTAGA

Fig. 3B

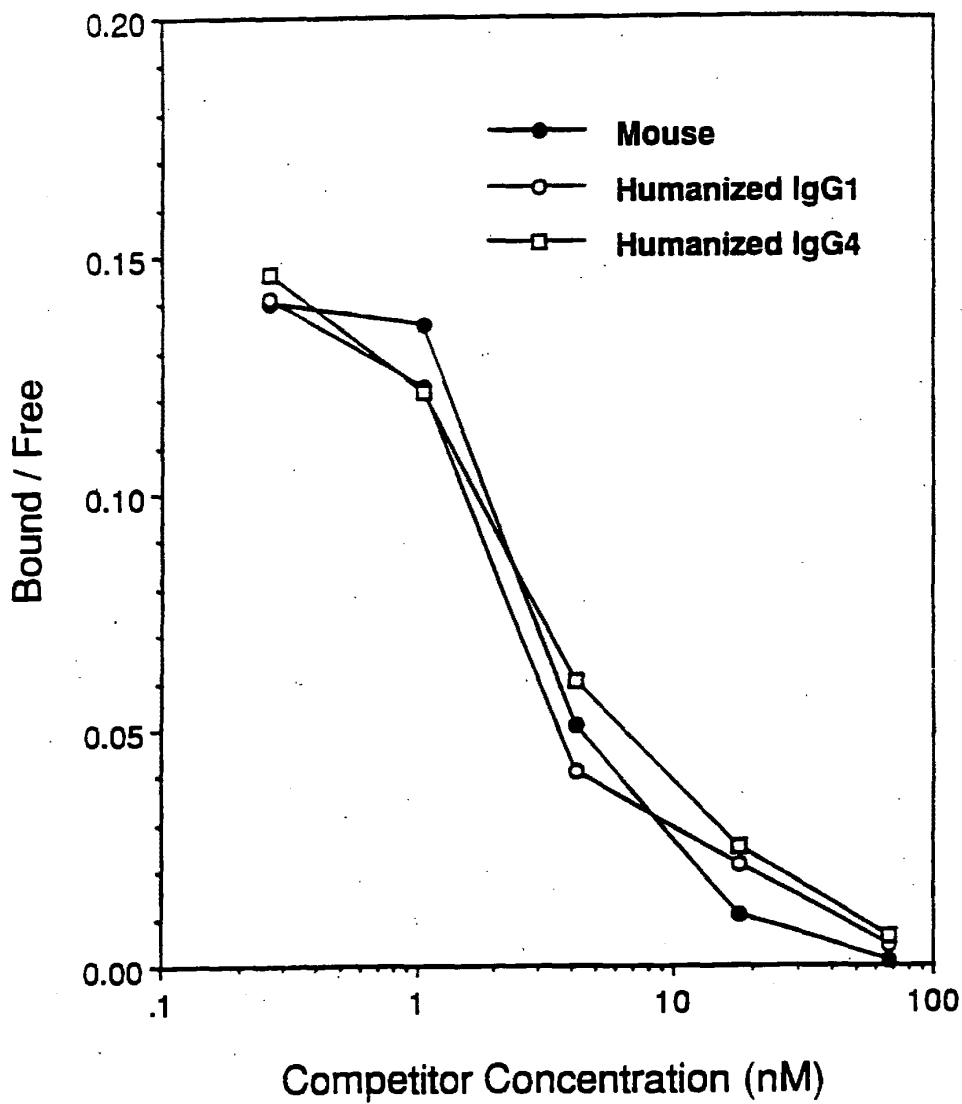

Figure 4

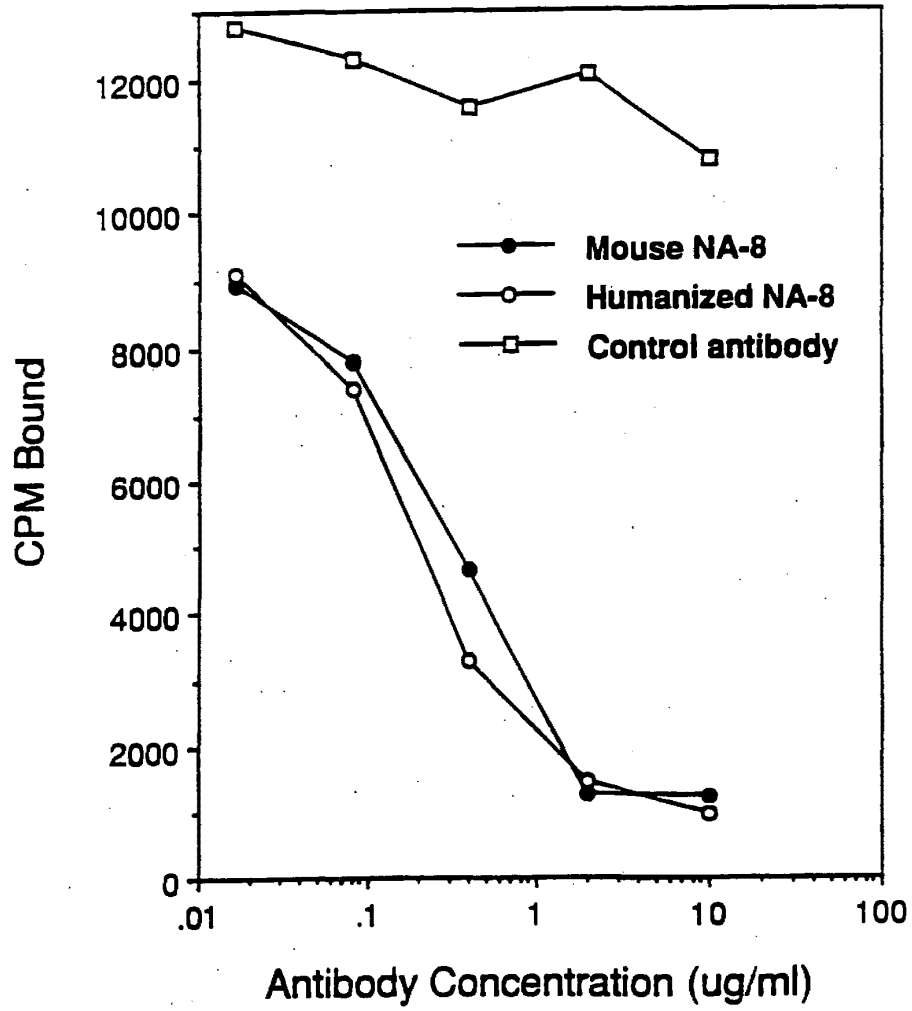

Figure 5

INTERNATIONAL SEARCH REPORT

International application No.
PCT/US93/11611

A. CLASSIFICATION OF SUBJECT MATTER IPC(5) :A61K 39/395; C07K 15/28; C12N 15/13; C12P 21/08 US CL :424/85.8; 530/387.1, 387.3, 388.1, 388.22, 388.7 According to International Patent Classification (IPC) or to both national classification and IPC		
B. FIELDS SEARCHED Minimum documentation searched (classification system followed by classification symbols) U.S. : 424/85.8; 530/387.1, 387.3, 388.1, 388.22, 388.7 Documentation searched other than minimum documentation to the extent that such documents are included in the fields searched Electronic data base consulted during the international search (name of data base and, where practicable, search terms used) APS, DIALOG, BIOSIS, EMBASE, MEDLINE, WPI search terms: CD18, humanized, chimeric, antibody, NA-8, Co, Landolfi		
C. DOCUMENTS CONSIDERED TO BE RELEVANT		
Category*	Citation of document, with indication, where appropriate, of the relevant passages	Relevant to claim No.
Y,P	TIBTECH, Volume 11, issued February 1993, W.J. Harris et al., "Therapeutic Antibodies -The Coming of Age", pages 42-45, see entire document.	1-30
Y	Immunol. Reviews, Volume 114, issued April 1990, M. Arnaout, "Leukocyte Adhesion Molecules Deficiency: Its Structural Basis, Pathophysiology and Implications for Modulating the Inflammatory Response", pages 145-179, see entire document.	1-30
<input checked="" type="checkbox"/> Further documents are listed in the continuation of Box C. <input type="checkbox"/> See patent family annex.		
* Special categories of cited documents:		
"A"	document defining the general state of the art which is not considered to be part of particular relevance	"T" later document published after the international filing date or priority date and not in conflict with the application but cited to understand the principle or theory underlying the invention
"E"	earlier document published on or after the international filing date	"X" document of particular relevance; the claimed invention cannot be considered novel or cannot be considered to involve an inventive step when the document is taken alone
"L"	document which may throw doubt on priority claim(s) or which is cited to establish the publication date of another citation or other special reason (as specified)	"Y" document of particular relevance; the claimed invention cannot be considered to involve an inventive step when the document is combined with one or more other such documents, such combination being obvious to a person skilled in the art
"O"	document referring to an oral disclosure, use, exhibition or other means	"&" document member of the same patent family
"P"	document published prior to the international filing date but later than the priority date claimed	
Date of the actual completion of the international search	Date of mailing of the international search report	
13 January 1994	FEB 17 1994	
Name and mailing address of the ISA/US Commissioner of Patents and Trademarks Box PCT Washington, D.C. 20231	Authorized officer PHILLIP GAMBEL <i>P. Kuyza</i>	
Facsimile No. NOT APPLICABLE	Telephone No. (703) 308-0196	

Form PCT/ISA/210 (second sheet)(July 1992)*

INTERNATIONAL SEARCH REPORT

International application No.
PCT/US93/11611

C (Continuation). DOCUMENTS CONSIDERED TO BE RELEVANT		
Category*	Citation of document, with indication, where appropriate, of the relevant passages	Relevant to claim No.
Y	Proc. Natl. Acad. Sci., Volume 86, issued December 1989, C. Queen et al., "A Humanized Antibody That Binds To The Interleukin 2 Receptor", pages 10029-10033, see entire document.	1-30
Y	EP,A,0,440,351 (Law et al.) 07 August 1991, see entire document	1-30
Y	US, A, 5,147,637 (Wright et al.) 15 September 1992, see entire document.	1-30
Y	Proc. Natl. Acad. Sci., Volume 80, issued September 1983, S.D. Wright et al., "Identification of the C3bi Receptor of Human Monocytes and Macrophages by Using Monoclonal Antibodies", pages 5699-5703, see entire document.	1-30
Y	Nucleic Acids Res., Volume 19, No. 9 issued 1991, B.L. Daugherty et al., "Polymerase Chain Reaction Facilitates the Cloning, CDR-Grafting, and Rapid Expression of a Murine Monoclonal Antibody Directed Against the CD18 Component of Leukocyte Integrins", pages 2471-2476, see entire document.	1-30

Form PCT/ISA/210 (continuation of second sheet)(July 1992)*



9P 1816

25
C. Jeff
10/14/96

Patent Docket P0709P

IN THE UNITED STATES PATENT AND TRADEMARK OFFICE

In re Application of Paul J. Carter et al. Serial No.: 08/146,206	Group Art Unit: 1816 Examiner: D. Adams
Filed: November 17, 1993 For: METHOD FOR MAKING HUMANIZED ANTIBODIES	<p style="text-align: center;">CERTIFICATE OF MAILING</p> <p style="text-align: center;"><small>I hereby certify that this correspondence is being deposited with the United States Postal Service with sufficient postage as first class mail in an envelope addressed to: Assistant Commissioner of Patents, Washington, D.C. 20231 on</small></p> <p style="text-align: center;">August 27, 1996</p> <p style="text-align: center;"><i>Duane Alexander Vick</i> Duane Alexander Vick</p>

PETITION AND FEE FOR THREE MONTH EXTENSION OF TIME
(37 CFR 1.136(a))

Assistant Commissioner of Patents
Washington, D.C. 20231

RECEIVED
SEP 17 1996
GROUP 1800

Sir:

Applicant petitions the Commissioner of Patents and Trademarks to extend the time for response to the Notice of Appeal dated 3/27/96 for 3 month(s) from 5/27/96 to 8/27/96. The extended time for response does not exceed the statutory period.

Please charge Deposit Account No. 07-0630 in the amount of \$ 900.00 to cover the cost of the extension. Any deficiency or overpayment should be charged or credited to this deposit account. A duplicate of this sheet is enclosed.

Respectfully submitted,
GENENTECH, INC.

Date: August 27, 1996

By: *Wendy M. Lee*
Wendy M. Lee
Reg. No. P-40,378

460 Pt. San Bruno Blvd.
So. San Francisco, CA 94080-4990
Phone: (415) 225-1994
Fax: (415) 952-9881
AG70175 09/12/96 08146206

07-0630 070 117 900.00CH

#26

FAX TRANSMISSION

GENENTECH, INC.
460 PT. SAN BRUNO BLVD.
SOUTH SAN FRANCISCO, CA 94080-4990
415-225-1994
FAX: 415-952-0881

OFFICIAL

To: Examiner Chris Eisenschenk **Date:** December 3, 1996
 Group 1816
 Tel: (703) 308-0452
 U.S. Patent and Trademark Office
 Washington, D.C. 20231

Fax #: 703-308-4242 **Pages:** 9, including this cover sheet.

From: Wendy M. Lee

Subject: U.S. Serial No. 08/146,206
 Our Docket No. P0709P1

26

CONFIDENTIALITY NOTE

The documents accompanying this facsimile transmission contain information from GENENTECH, INC. which is confidential or privileged. This information is intended only for the individual or entity named on this transmission sheet. If you are not the intended recipient, be aware that any disclosure, copying, distribution, or use of the contents of this faxed information is strictly prohibited. If you have received this facsimile in error, please notify us by telephone immediately so that we can arrange for the return of the original documents to us and the retransmission of them to the intended recipient.

COMMENTS:

PLEASE DELIVER THESE DOCUMENTS DIRECTLY TO EXAMINER EISENSCHENK.

DEC 13 1996

12/03/1996



UNITED STATES DEPARTMENT OF COMMERCE
 Patent and Trademark Office
 Address: COMMISSIONER OF PATENTS AND TRADEMARKS
 Washington, DC 20231

APPLICATION NO.	FILING DATE	FIRST NAMED INVENTOR	ATTORNEY DOCKET NO.
087146,206	11/17/93	CARTER	P 709PT.

JANET E. HASAK
 GENENTECH, INC.
 460 POINT SAN BRUNO BOULEVARD
 SOUTH SAN FRANCISCO CA 94080-4990

18M1/1223

EXAMINER NOLAN, P

ART UNIT 1816	PAPER NUMBER #27
------------------	---------------------

DATE MAILED: 12/23/96

6407213

Please find below and/or attached an Office communication concerning this application or proceeding.

Commissioner of Patents and Trademarks

Office Action Summary

Application No. 08/146,206	Applicant(s) Carter et al.
Examiner Patrick Nolan	Group Art Unit 1816



Responsive to communication(s) filed on Dec 3, 1996

This action is **FINAL**.

Since this application is in condition for allowance except for formal matters, prosecution as to the merits is closed in accordance with the practice under *Ex parte Quayle*, 1935 C.D. 11; 453 O.G. 213.

A shortened statutory period for response to this action is set to expire 3 month(s), ~~or thirty days, whichever is longer~~, from the mailing date of this communication. Failure to respond within the period for response will cause the application to become abandoned. (35 U.S.C. § 133). Extensions of time may be obtained under the provisions of 37 CFR 1.136(a).

Disposition of Claims

Claim(s) 1-12, 15, and 19-25 is/are pending in the application.

Of the above, claim(s) _____ is/are withdrawn from consideration.

Claim(s) _____ is/are allowed.

Claim(s) 1-12, 15, and 19-25 is/are rejected.

Claim(s) _____ is/are objected to.

Claims _____ are subject to restriction or election requirement.

Application Papers

See the attached Notice of Draftsperson's Patent Drawing Review, PTO-948.

The drawing(s) filed on _____ is/are objected to by the Examiner.

The proposed drawing correction, filed on _____ is approved disapproved.

The specification is objected to by the Examiner.

The oath or declaration is objected to by the Examiner.

Priority under 35 U.S.C. § 119

Acknowledgement is made of a claim for foreign priority under 35 U.S.C. § 119(a)-(d).

All Some* None of the CERTIFIED copies of the priority documents have been received.

received in Application No. (Series Code/Serial Number) _____.

received in this national stage application from the International Bureau (PCT Rule 17.2(a)).

*Certified copies not received: _____

Acknowledgement is made of a claim for domestic priority under 35 U.S.C. § 119(e).

Attachment(s)

Notice of References Cited, PTO-892

Information Disclosure Statement(s), PTO-1449, Paper No(s). 19, 24, 26

Interview Summary, PTO-413

Notice of Draftsperson's Patent Drawing Review, PTO-948

Notice of Informal Patent Application, PTO-152

--- SEE OFFICE ACTION ON THE FOLLOWING PAGES ---

Art Unit 1816

1. Claims 1-12, 15 and 19-25 are pending.

2. Claims 19-21 stand rejected under 35 U.S.C. § 112, second paragraph, as being indefinite for failing to particularly point out and distinctly claim the subject matter which applicant regards as the invention.

Claims 19-21 are substantial duplicates of claim 1. There appears to be no difference in scope between these claims, see MPEP 706.03(k).

3. The following is a quotation of 35 U.S.C. § 103 which forms the basis for all obviousness rejections set forth in this Office action:

A patent may not be obtained though the invention is not identically disclosed or described as set forth in section 102 of this title, if the differences between the subject matter sought to be patented and the prior art are such that the subject matter as a whole would have been obvious at the time the invention was made to a person having ordinary skill in the art to which said subject matter pertains. Patentability shall not be negatived by the manner in which the invention was made.

Subject matter developed by another person, which qualifies as prior art only under subsection (f) or (g) of section 102 of this title, shall not preclude patentability under this section where the subject matter and the claimed invention were, at the time the invention was made, owned by the same person or subject to an obligation of assignment to the same person.

4. This application currently names joint inventors. In considering patentability of the claims under 35 U.S.C. § 103, the examiner presumes that the subject matter of the various claims was commonly owned at the time any inventions covered therein were made absent any evidence to the contrary. Applicant is advised of the obligation under 37 C.F.R. § 1.56 to point out the inventor and invention dates of each claim that was not commonly owned at the time a later invention was made in order for the examiner to consider the applicability of potential 35 U.S.C. § 102(f) or (g) prior art under 35 U.S.C. § 103.

5. Claims 1, 2, 4-12, 15, and renumbered claims 19-22 and 24-25 stand rejected under 35 U.S.C. § 103 as being unpatentable over Winter [EP 0239400], Riechmann et al. [Nature 332:323-327 (1988)]

Art Unit 1816

and Queen et al. [Proc. Natl. Acad. Sci. 86:10029-10033 (1989)], all of record for the same reasons set forth in paper No. 18.

Briefly the claims are drawn to a method for producing humanized antibodies and humanized antibodies. Winter, teaches the production of altered, chimeric, antibodies by replacing the complementarily determining regions (CDRs), see abstract. Winter, teaches the requirements for CDR fusions, see page 6 to page 8, line 29. Particularly, page 8, lines 11-18, where Winter, teaches that "merely by replacing one or more CDRs with complementary CDRs may not always result in a functional altered antibody..... it will be well within the competence of the man skilled in the art, either by carrying out routine experimentation or by trial and error testing to obtain a functional altered antibody. Note at page 8, last full paragraph that Winter states that framework region replacement and sequence changing may be necessary to obtain a functional humanized antibody. On page 9, lines 13-16, Winter suggests that the antibodies would be of importance for use in human therapy. Winter, teaches a method of producing the antibody, see page 10, paragraph 3 to page 15, paragraph 2. Consistent with Winter, Riechmann et al. teach a method of reshaping human antibodies for therapy by CDR grafting, see whole document and Queen et al. teach the humanization of antibodies by CDR grafting, see entire document. Riechmann et al. teach altering the sequence of the antibody to restore packing or to increase binding affinity, see page 326, first column, first full paragraph. Queen et al. teach the use of computer modeling to assist in the production of humanized antibodies, specifically to predict which amino acids to change thereby effecting molecular interactions, note that of the amino acids predicted to change include those identified by applicant in claims 7 and 10. A person of ordinary skill in the art would have realized that dependent upon the framework region selected and the sequence of the CDR regions amino acid changes would need to be made and they would depend upon the precise amino acid interactions of the polypeptide. The combination of Winter, Riechmann et al. and Queen et al. teach a comprehensive method for producing humanized antibodies which include the steps outlined in applicant's claims. Therefore, it would have been prima facie obvious to a person of ordinary skill in the art at the time the invention was made to take the combined teachings of Winter, Riechmann et al. and Queen et al. to produce a method of making a humanized antibody and to have a humanized antibody for either diagnostic or therapeutic use.

Applicant's arguments filed 6/12/95 have been fully considered but they are not persuasive. Applicant argues that the claimed invention is distinct from that taught by the above combination of

Art Unit 1816

references because a consensus sequence is used and further modifications are not necessary. Applicant further argues that the combination of references do not teach a humanized antibody with reduced immunogenicity.

Regarding the consensus sequence, the combination of references teach the human framework regions having a significantly high degree of sequence homology (conservative regions). Queen et al. in particular point to Kabat as demonstrating that this was known in the art well in advance of applicant's filing date, see reference 38, cited by Queen et al. In essence there is no functional/structural distinction from what applicant has claimed and that taught by the combination of references. Ex parte C, 27 U.S.P.Q.2d 1492 (BPAI 1993). Applicants recitation of Co et al. is unclear, it was not used in the prior art rejection. Applicant then points to several other references concluding that the techniques of the prior art and the technique of the instant application are "certainly different". However, the minor differences between the prior art and the claimed invention are obvious differences. Modifications in the framework regions which affect the proximity or orientation of the V_L-V_H interface regions is the same as substituting that FR residue from the import regions that is involved in the effects set forth in paragraph (f) of claim 1. The combination of references clearly teach reduced immunogenicity associated with the humanized antibody. See e.g. Riechmann et al. page 323, column 2, lines 5-8. Applicant's comments have been fully considered and were as a whole not found persuasive.

6. Claims 1, 2, 4-12 and 15, and renumbered claims 19-22 and 24-25 stand rejected under 35 U.S.C. § 103 as being unpatentable over Winter [EP 0239400], Riechmann et al. [Nature 332:323-327 (1988)] and Queen et al. [Proc. Natl. Acad. Sci. 86:10029-10033 (1989)] in view of In re Durden 226 U.S.P.Q. 359 (Fed. Cir. 1985), all of record, for the same same reasons set forth in paper No. 18.

Briefly the claims are drawn to a method for producing humanized antibodies and humanized antibodies. As discussed above the combination of Winter, Riechmann et al. and Queen et al. teach humanized antibodies and methods for their production. Applicant's claimed invention does not appear to differ from what has previously known in the art.

Applicant cites the above comments in their response to this rejection.

Applicant's comments were fully considered as described above and

Art Unit 1816

were not found persuasive, to the extent that they apply to this rejection.

7. Claim 3 and renumbered claim 23 stand rejected under 35 U.S.C. § 103 as being unpatentable over Winter [EP 0239400], Riechmann et al. [Nature 332:323-327 (1988)] and Queen et al. [Proc. Natl. Acad. Sci. 86:10029-10033 (1989)] as applied to claims 1, 2, 4-12 and 15 and further in view of Roitt [Immunology, published 1985, by Gower Medical Publishing Ltd. (London, England) page 5.5], all of record for the same reasons set forth in paper No. 18.

Briefly the claim is drawn to a method for producing humanized antibodies having the additional steps of searching the import variable domain sequence for glycosylation sites, determining if any such glycosylation site is reasonable expected to affect the antigen binding or affinity of the antibody and if so substituting the glycosylation site into the consensus sequence. As discussed above the combination of Winter, Riechmann et al. and Queen et al. teach humanized antibodies and methods of producing humanized antibodies. The combination of Winter, Riechmann et al. and Queen et al. do not teach the importance of carbohydrate residues. However, Roitt teaches that antibodies contain carbohydrate residues in the variable region. A person of ordinary skill in the art would realize that carbohydrate residues can produce steric modifications in the folding characteristics of polypeptides. Therefore it would have been prima facie obvious to a person of ordinary skill in the art at the time the invention was made to include a step in the method taught by the combination of Winter, Riechmann et al. and Queen et al. which determines if the presence of carbohydrate residues occur in the variable region that can affect antigen binding and then include in the antibody sequence the appropriate glycosylation signal, by adding the appropriate consensus sequence. A person of ordinary skill in the art would have been motivated to add the additional step of identifying glycosylation that may affect antigen binding to ensure that the antibody produced will have the appropriate binding affinity. A person of ordinary skill in the art would have been motivated to produce such a method to produce antibodies having diagnostic or therapeutic utility.

The bulk of applicant's argument is that the references relied on in the above rejection do not render the invention obvious and Roitt adds nothing to these references to overcome the deficiency.

From the above discussion, the references used render the claimed invention obvious. Roitt fulfills the deficiency of the references

Art Unit 1816

discussed above to the extent that Roitt teaches antibodies contain carbohydrate residues in the variable region. A person of ordinary skill in the art would realize that carbohydrate residues can produce steric modifications in the folding characteristics of polypeptides.

THE FOLLOWING REJECTIONS ARE NEW GROUNDS OF REJECTIONS

Double Patenting

The non-statutory double patenting rejection, whether of the obviousness-type or non-obviousness-type, is based on a judicially created doctrine grounded in public policy (a policy reflected in the statute) so as to prevent the unjustified or improper timewise extension of the "right to exclude" granted by a patent. *In re Thorington*, 418 F.2d 528, 163 USPQ 644 (CCPA 1969); *In re Vogel*, 422 F.2d 438, 164 USPQ 619 (CCPA 1970); *In re Van Ornum*, 686 F.2d 937, 214 USPQ 761 (CCPA 1982); *In re Longi*, 759 F.2d 887, 225 USPQ 645 (Fed. Cir. 1985); and *In re Goodman*, 29 USPQ2d 2010 (Fed. Cir. 1993).

A timely filed terminal disclaimer in compliance with 37 CFR 1.321(b) and (c) may be used to overcome an actual or provisional rejection based on a non-statutory double patenting ground provided the conflicting application or patent is shown to be commonly owned with this application. See 37 CFR 1.78(d). Effective January 1, 1994, a registered attorney or agent of record may sign a terminal disclaimer. A terminal disclaimer signed by the assignee must fully comply with 37 CFR 3.73(b).

8. Claims 1-12, 15 and 19-25 are provisionally rejected under the judicially created doctrine of obviousness-type double patenting as being unpatentable over claims 1-12, 15 and 19 of copending application Serial No. 08/439,004. Although the conflicting claims are not identical, they are not patentably distinct from each other because the invention claimed in claims 1-12, 15 and 19 of copending application Serial No. 08/439,004 encompasses the invention claimed in claims 1-12, 15 and 19, of the instant application.

This is a *provisional* obviousness-type double patenting rejection because the conflicting claims have not in fact been patented.

Art Unit 1816

Claim Rejections - 35 USC § 102

The following is a quotation of the appropriate paragraphs of 35 U.S.C. § 102 that form the basis for the rejections under this section made in this Office action:

A person shall be entitled to a patent unless --

e) the invention was described in a patent granted on an application for patent by another filed in the United States before the invention thereof by the applicant for patent, or on an international application by another who has fulfilled the requirements of paragraphs (1), (2), and (4) of section 371(c) of this title before the invention thereof by the applicant for patent.

9. Claims 1-12, 15 and 19-25 are rejected under 35 U.S.C. § 102(e) as being anticipated by U.S. Patent 5,530,101 (82).

Claims 1-2 and 19-25:

The '101 patent teaches methods for the production of humanized antibodies wherein the CDR amino acid sequences from the import (i.e. donor) are exchanged for the human (i.e. acceptor) CDR amino acid sequences (abstract, in particular). The '101 patent teaches alignment of import and human framework regions and selection of substituted human framework antibody residues based on the following effects; the import framework residue non-covalently binds antigen directly (i.e. Category three, column 14, in particular), interacts with a CDR (i.e. Category three or four, column 14-15, in particular), or participates in the V_L - V_H interface (i.e. Category 3,4 or 5, column 14-15, in particular).

The '101 patent teaches that if a residues is exposed on the surface of the domain (i.e. interacts with CDR) and doesn't have one of the effects of step f in claim 1, then to leave the human residue intact (column 13-14, in particular). The term "consensus" has been interpreted to include the aligning of murine import framework residues to human acceptor framework residues, in addition to the aligning of all human framework residues and compiling a single "consensus" human framework to be used as a template in every humanized antibody. Since "consensus" has limitless interpretations as vaguely defined in the specification, the prior art reads on the claimed invention.

Claims 3 and 4:

The additional step of determining whether or not a substituted residue is glycosylated is determined by the residue makeup of the import peptide, a fact well known in the art prior to

Art Unit 1816

the invention and therefore lends no patentable import to the invention.

Claim 5:

The '101 patent teaches retaining those residues that are highly conserved (i.e. not rare) in the human framework region (Category 2 and 5, Column 14-16, in particular).

Claims 6-8:

The '101 patent teaches which human and import residues are likely to be selected for substitution. In addition the '101 patent teaches corresponding import for human substitution at specific sites (Column 15, in particular).

Claim 9:

The '101 patent teaches a method employing a consensus human variable domain based on human variable domains and additionally variable domains from species other than human (Column 13, in particular).

Claims 10-12:

The '101 patent teaches a humanized antibody variable domain having a non-human CDR incorporated into a human antibody variable domain, wherein the improvement comprises the substitution of only specific corresponding human and import amino acid residues (column 15, in particular).

Claim 15:

The '101 patent teaches a method for engineering a humanized antibody comprising introducing residues from an import antibody variable domain into an amino acid sequence representing a consensus of mammalian antibody variable domain sequences (column 12-13, in particular).

The prior art teachings anticipate the claimed invention.

10. The references crossed out in the form PTO-1449 filed on 12/3/96 are the duplicates of the references stated in the formn PTO-1449 filed 8/30/96.

11. The lengthy specification has not been checked to the extent necessary to determine the presence of all possible minor errors. Applicants cooperation is requested in correcting any errors of which applicant may become aware of in the specification.

12. Any inquiry concerning this communication or earlier communications from the examiner should be directed to Patrick

Serial No. 08/146,206

9

Art Unit 1816

Nolan whose telephone number is (703) 305-1987. The examiner can normally be reached on Monday through Friday from 8:30 am to 4:30 pm.

13. If attempts to reach the examiner are unsuccessful, the examiner's supervisor, Christina Chan, can be reached at (703) 305-3973. The FAX number for our group, 1816, is (703) 305-7939. Any inquiry of a general nature relating to the status of this application or proceeding should be directed to the Group receptionist, whose telephone number is (703) 308-0196.

Patrick J. Nolan, Ph.D.
December 19, 1996

CHRISTINA Y. CHAN
SUPERVISORY PATENT EXAMINER
GROUP 1800

duplicate of DS received on 08/30/96

Received 12/3/96

Sheet 1 of 1

FORM PTO-1449	U.S. Dept. of Commerce Patent and Trademark Office	Atty Docket No. U070901	Serial No. 08/146,206
LIST OF DISCLOSURES CITED BY APPLICANT (Use several sheets if necessary)		Applicant Carter et al.	
		Filing Date 17 Nov 1993	Group 2000 1816

U.S. PATENT DOCUMENTS

Examiner Initials	Document Number	Date	Name	Class	Subclass	Filing Date
PW	81 5,225,539 8-6-93	06.09.93	Winter, G.	G07K	15/28	25-10-91 10-25-91
PW	82 5,530,101 6-25-96	25.06.96	Queen et al.	A61K	34/395	19-12-90 2-19-90

FOREIGN PATENT DOCUMENTS

Examiner Initials	Document Number	Date	Country	Class	Subclass	Translation Yes	No
PW	83 85058/91 2-30-92	30.03.92	AUSTRALIA	G07K	15/12		
	84 328,404 A1 8-16-89	16.08.89	KPO	A61K	39/395		
	85 451,216 B1 1-24-96	24.01.96	KPO	C12P	21/08		
	86 WO 91/09966 7-11-91	11.07.91	PCT	C12P	21/08		
	87 WO 91/09968 7-11-91	11.07.91	PCT	C12P	21/08		
PW	88 WO 92/11010 7-7-92	07.09.92	PCT	A61K	35/14		

OTHER DISCLOSURES (Including Author, Title, Date, Pertinent Pages, etc.)

PW	89	Carter et al., "High level escherichia coli expression and production of a bivalent humanized antibody fragment" <i>Bio/Technology</i> 10:163-167 (1992)
	90	Foote et al., "Antibody Framework Residues Affecting the Conformation of the Hypervariable Loops" <i>J. Mol. Biol.</i> 224:487-499 (1992)
	91	Foote, J., "Humanized Antibodies" <i>Nova acta Leopoldina</i> 51(269):103-110 (1989)
	92	Kabat et al., "Sequences of Proteins of Immunological Interest", Bethesda, MD: National Institute of Health pp. 14-32 (1981)
	93	Kettleborough et al., "Humanization of a Mouse Monoclonal Antibody by CDR-grafting: The Importance of Framework Residues on Loop Conformation" <i>Protein Engineering</i> 4(1):73-78 (1991)
	94	Maeda et al., "Construction of Reshaped Human Antibodies with HIV-neutralizing Activity" <i>Hum. Anticab. Hybridomas</i> 2:124-134 (July 1991)
	95	Riechmann et al., "Expression of an antibody Fv Fragment in Myeloma Cells" <i>J. Mol. Biol.</i> 201:825-828 (1988)
	96	Houghton et al., "A Humanized Monovalent CD3 Antibody which can Activate Homologous Complement" <i>European Journal of Immunology</i> 21:2747-2754 (1991)
	97	Shearman et al., "Construction, Expression and Characterization of Humanized Antibodies Directed Against the Human α/β T Cell Receptor" <i>J. Immunol.</i> 147(12):4366-4373 (December 15, 1991)
PW	98	Tempest et al., "Reshaping a Human Monoclonal Antibody to Inhibit Human Respiratory Syncytial Virus Infection In Vivo" <i>Bio/Technology</i> 9:266-271 (March 1991)

Examiner <i>Patricia H. W. Z.</i>	Date Considered 12/16/96
--------------------------------------	-----------------------------

*Examiner: Initial if reference considered, whether or not citation is in conformance with MPEP 609; draw line through citation if not in conformance and not considered. Include copy of this form with next communication to applicant.



Patent Docket P0709P1 #29

IN THE UNITED STATES PATENT AND TRADEMARK OFFICE

In re Application of Paul J. Carter et al. Serial No.: 08/146,206 Filed: November 17, 1993 For: METHOD FOR MAKING HUMANIZED ANTIBODIES	Group Art Unit: 1816 Examiner: P. Nolan
--	--

RECEIVED
JUL 20 1997
GROUP 1800

CERTIFICATE OF MAILING
I hereby certify that this correspondence is being deposited with the United States Postal Service with sufficient postage as first class mail in an envelope addressed to: Assistant Commissioner of Patents, Washington, D.C. 20231 on
June 23, 1997
Sandra K. T. Sullivan
Sandra K. T. Sullivan

AMENDMENT TRANSMITTAL

Assistant Commissioner of Patents
Washington, D.C. 20231

Sir:

Transmitted herewith is an amendment in the above-identified application.
The fee has been calculated as shown below.

	Claims Remaining After Amendment		Highest No. Previously Paid For	Present Extra	Rate	Additional Fees
Total	31	-	24	7	x 22 =	\$154.00
Independent	7	-	10	0	x 80 =	\$0.00
___ First Presentation of Multiple Dependent Claims					+ 260 =	
Total Fee Calculation						\$154.00

X

X

No additional fee is required.
The Commissioner is hereby authorized to charge Deposit Account No. 07-0630 in the amount of \$154.00. **A duplicate copy of this transmittal is enclosed.**
Petition for Extension of Time is enclosed.

The Commissioner is hereby authorized to charge any additional fees required under 37 CFR 1.16 and 1.17, or credit overpayment to Deposit Account No. 07-0630. **A duplicate copy of this sheet is enclosed.**

Respectfully submitted,
GENENTECH, INC.

Date: June 23, 1997

By: Janet E. Hasak
Janet Hasak
Reg. No. 28,616
(for Wendy M. Lee
Reg. No. 40,378)

460 Pt. San Bruno Blvd.
So. San Francisco, CA 94080-4990
Phone: (415) 225-1994
Fax: (415) 952-9881

Revised (10/13/95)

1816



Patent Docket P0709P1

IN THE UNITED STATES PATENT AND TRADEMARK OFFICE

<p>In re Application of Paul J. Carter et al. Serial No.: 08/146,206 Filed: November 17, 1993 For: METHOD FOR MAKING HUMANIZED ANTIBODIES</p>	<p>Group Art Unit: 1816 Examiner: P. Nolan</p>
<p style="text-align: right;">RECEIVED JUL 20 1997 GROUP 1816</p> <p style="text-align: center;">CERTIFICATE OF MAILING I hereby certify that this correspondence is being deposited with the United States Postal Service with sufficient postage as first class mail in an envelope addressed to: Assistant Commissioner of Patents, Washington, D.C. 20231 on June 23, 1997 <i>Sandra K. T. Sullivan</i> Sandra K. T. Sullivan</p>	

PETITION AND FEE FOR THREE MONTH EXTENSION OF TIME
(37 CFR 1.136(a))

Assistant Commissioner of Patents
Washington, D.C. 20231

Sir:

Applicant petitions the Commissioner of Patents and Trademarks to extend the time for response to the OFFICIAL ACTION dated 23 December 1996 for three month(s) from 23 March 1997 to 23 June 1997. The extended time for response does not exceed the statutory period.

Please charge Deposit Account No. 07-0630 in the amount of \$930.00 to cover the cost of the extension. Any deficiency or overpayment should be charged or credited to this deposit account. A duplicate of this sheet is enclosed.

Respectfully submitted,
GENENTECH, INC.

Date: June 23, 1997

By: *Janet E. Hasak*
Janet Hasak
Reg. No. 28,616
(for Wendy M. Lee
Reg. No. 40,378)

460 Pt. San Bruno Blvd.
So. San Francisco, CA 94080-4990
Phone: (415) 225-1994
Fax: (415) 952-9881

08146206
07/25/1997 KCDP/EP 00000101 DMB:070630
01 FC:103 154.00 CH

Revised (10/17/86)

D

1816
#29/E
C Sullivan
8/1/97

Patent Docket P0709P1



IN THE UNITED STATES PATENT AND TRADEMARK OFFICE

In re Application of Paul J. Carter et al. Serial No.: 08/146,206	Group Art Unit: 1816 Examiner: P. Nolan
Filed: 17 November 1993 For: METHOD FOR MAKING HUMANIZED ANTIBODIES	CERTIFICATE OF MAILING I hereby certify that this correspondence is being deposited with the United States Postal Service with sufficient postage as first class mail in an envelope addressed to Assistant Commissioner of Patents, Washington, D.C. 20231 on June 23, 1997 <i>Sandra K. T. Sullivan</i> Sandra K. T. Sullivan

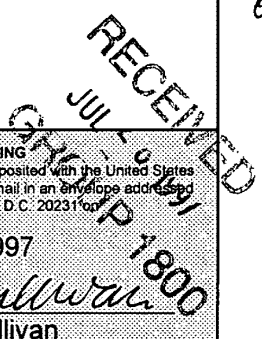

TP
7/31/97

AMENDMENT UNDER 37 C.F.R. §1.111

Assistant Commissioner of Patents
Washington, D.C. 20231

Sir:

In response to the Office Action dated December 23, 1996, the period for response having been extended as a result of the enclosed Petition for a three-month Extension of Time and requisite fee, Applicants respectfully request reconsideration of the above-identified application in view of the following amendments and remarks.

IN THE CLAIMS:

1. (Twice Amended) A method for making a humanized antibody comprising amino acid sequences of a non-human, import antibody and a human antibody, comprising the steps of:
 - (a) obtaining the amino acid sequences of at least a portion of an import heavy chain variable domain and of a consensus human variable domain of a human heavy chain immunoglobulin subgroup;
 - (b) identifying Complementarity Determining Region (CDR) amino acid sequences in the import variable domain and the consensus human variable domain;
 - (c) substituting an import CDR amino acid sequence for the corresponding consensus human CDR amino acid sequence;

E1

25/1997 KCOOPER 00000102 DAI=070600 08146206
FC:117 930.00 CH

- E1
- (d) aligning the amino acid sequences of a Framework Region (FR) of the import variable domain and a corresponding FR of the consensus human variable domain;
 - (e) identifying import FR residues in the aligned FR sequences that are non-homologous to the corresponding consensus FR residues;
 - (f) determining if the non-homologous import FR residue is expected to have at least one of the following effects:
 - (1) non-covalently binds antigen directly; [1]
 - (2) interacts with a CDR; or
 - (3) participates in the $V_L - V_H$ interface by affecting the proximity or orientation of the V_L and V_H regions with respect to one another; and
 - (g) for any non-homologous import FR residue which is expected to have at least one of these effects, substituting that residue for the corresponding amino acid residue in the consensus FR.

6. (Twice Amended) The method of claim 1, wherein the corresponding consensus FR residues substituted in step (g) are selected from the group consisting of 4L, [35L,] 36L, 38L, 43L, 44L, 46L, 58L, 62L, [64L,] 65L, 66L, 67L, 68L, 69L, 70L, [71L,] 73L, 85L, 87L, 98L, 2H, 4H, 24H, 36H, 37H, 39H, 43H, 45H, 49H, 68H, 69H, 70H, 73H, 74H, 75H, 76H, [and] 78H and 92H.

E2

7. (Twice Amended) A method comprising providing at least a portion of an import, non-human heavy chain variable domain amino acid sequence having a Complementarity Determining Region (CDR) and a Framework Region (FR), obtaining the amino acid sequence of at least a portion of a consensus human variable domain of a human heavy chain immunoglobulin subgroup having a CDR and a FR, substituting the non-human CDR for the human CDR in the consensus human variable domain, and substituting a non-human amino acid residue for the consensus amino acid residue at at least one of the following sites:

4L, [35L,] 36L, 38L, 43L, 44L, 46L, 58L, 62L, [64L,] 65L, 66L, 67L, 68L, 69L, 70L, [71L,] 73L, 85L, 87L, 98L, 2H, 4H, 24H, 36H, 37H, 39H, 43H, 45H, 49H, 69H, 68H, 70H, 73H, 74H, 75H, 76H, [and] 78H or 92H.

Please cancel claim 9, without prejudice.

10. (Twice Amended) A humanized antibody variable domain having a non-human Complementarity Determining Region (CDR) incorporated into a [consensus] human antibody variable domain, wherein an [human] amino acid residue has been substituted [by a non-] for the human amino acid residue at a site selected from the group consisting of:
4L, [35L,] 36L, 38L, 43L, 44L, 46L, 58L, 62L, [64L,] 65L, 66L, 67L, 68L, 69L, 70L, [71L,] 73L, 85L, 87L, 98L, 2H, 4H, 24H, 36H, 37H, 39H, 43H, 45H, 49H, 68H, 69H, 70H, 73H, 74H, 75H, 76H, [and] 78H and 92H.

15. (Twice Amended) A method for engineering a humanized antibody comprising introducing amino acid residues from a non-human, import heavy chain variable domain into a consensus human variable domain of a human heavy chain immunoglobulin subgroup.

Please cancel claims 19-21, without prejudice.

22. (Amended) A humanized antibody comprising a consensus human variable domain of a human heavy chain immunoglobulin subgroup wherein the amino acid residues forming the Complementarity Determining Regions (CDRs) thereof comprise non-human import antibody amino acid residues.

In claim 25, line 1, please replace "about 7" with --about 5--.

Please add the following claims:

--26. The humanized antibody of claim 22 wherein the human heavy chain immunoglobulin subgroup is V_H subgroup III.

27. The humanized antibody of claim 26 wherein the consensus human variable domain comprises the amino acid sequence of SEQ ID NO:4.

28. The humanized antibody of claim 22 further comprising a consensus human light chain variable domain comprising the amino acid sequence of SEQ ID NO:3 wherein the amino acid residues forming the CDRs of the light chain variable domain comprise non-human import antibody amino acid residues.
29. The humanized antibody of claim 23 wherein the FR residue noncovalently binds antigen directly.
30. The humanized antibody of claim 23 wherein the FR residue interacts with a CDR.
31. The humanized antibody of claim 23 wherein the FR residue comprises a glycosylation site which affects the antigen binding or affinity of the antibody.
32. The humanized antibody of claim 23 wherein the FR residue participates in the V_L - V_H interface by affecting the proximity or orientation of the V_L and V_H regions with respect to one another.
33. The humanized antibody of claim 22 which comprises one or more CDR residues from the consensus human variable domain.
34. The humanized antibody of claim 22 which binds antigen more tightly than the non-human antibody.
35. The humanized antibody of claim 22 which mediates antigen dependent cellular cytotoxicity (ADCC) to a greater extent than the non-human antibody.
36. The humanized antibody of claim 35 which is an IgG.
37. The humanized antibody of claim 36 which has an IgG γ 1 constant region, wherein residue 359 of the constant region is D and residue 361 of the constant region is L.

EV

H

38. A method for making a humanized antibody comprising amino acid sequences of a non-human antibody and of a human antibody, comprising the steps of aligning the amino acid sequence of a Framework Region (FR) of the non-human antibody and the corresponding amino acid sequence of a FR of the human antibody, identifying non-human antibody residue(s) in the aligned FR sequences that are non-homologous to the corresponding human antibody residue(s); and if any such non-homologous residue(s) is/are exposed on the surface of the variable domain, providing the corresponding human antibody residue(s) in the humanized antibody.--

REMARKS

Amendments

Claims 1, 7, 15 and 22 have been revised herein to refer to a consensus human variable domain of a "human heavy chain immunoglobulin subgroup," as supported, for example, on page 15, lines 18-25 and page 64, line 33 through to page 65, line 2 of the specification. Basis for heavy chain variable domain in **claims 1, 7 and 15** is found on at least page 11, line 9 of the specification. **Claims 6, 7 and 10** have been amended to include FR substitutions as in the claims as originally filed. **Claim 10** has been amended to have wording as in the claim as originally filed, and basis for the revision to **claim 25** is found, for example, in Table 3 in Example 1.

Claims 26-38 have been added herein and find basis at least as follows: **claims 26 and 27** (page 15, lines 18-25 and page 64, line 33 through to page 65, line 2); **claim 28** (page 15, lines 18-21); **claims 29-32** (part f of claim 1 and originally filed, now canceled claim 3); **claim 33** (page 27, lines 1-8; page 27 lines 8-9 and page 65, lines 5-9); **claim 34** (page 68, lines 25-27 and Table 3 on page 65 with respect to Kd values for the murine antibody and two humanized variants huMAb4D5-6 and huMAb4D5-8); **claim 35** (page 69, lines 32-34 and Table 4 on page 74); **claim 36** (page 11, lines 11-14); **claim 37** (page 65, line 29 through to page 66, line 1); and **claim 38** (claims 1 and 10, and originally filed, now canceled claim 2).

In that the amendments do not introduce new matter, their entry is respectfully requested.

Section 112, second paragraph

Claims 19-21 are rejected under 35 USC §112, second paragraph, as substantial duplicates of claim 1. In the interest of expediting examination, and without acquiescing in the rejection, claims 19-21 have been canceled, thus rendering this rejection moot.

§103

Claims 1, 2, 4-12, 15 and renumbered claims 19-22 and 24-25 stand rejected under 35 USC §103 as unpatentable over EP239,400A2 (Winter patent application); Riechmann *et al.* *Nature* **332**:323-327 (1988); and Queen *et al.* *PNAS, USA* **86**:10029-10033 (1989). The Examiner states that Applicants' arguments filed 6/12/95 are not considered to be persuasive. Concerning the consensus sequence, the Examiner alleges that "the combination of references teach [the] human framework regions having a significantly high degree of sequence homology (conservative regions)" and states that Queen *et al.* point to Kabat as demonstrating that this was known in the art. The Examiner urges that "In essence there is no functional/structural distinction from what applicant has claimed and that taught by the combination of references." The Examiner contends that modifications in the framework regions which affect the proximity or orientation of the V_L-V_H interface regions are the same as substituting that FR residue from the import regions that is involved in the effects set forth in paragraph (f) of claim 1. According to the Examiner, the references, *e.g.*, Riechmann *et al.*, teach reduced immunogenicity associated with the humanized antibody.

Applicants respectfully traverse this rejection as it may apply to the claims as amended herein.

With respect to the cited references, Applicants point out that the Winter patent application fails to disclose or suggest the use of a consensus human variable domain in antibody humanization. On the contrary, the heavy chain framework region of the humanized B1-8 antibody of Example 1 and of the humanized anti-lysozyme antibody D1.3 of Example 2 was derived from the human myeloma heavy chain NEWM (see page 17, lines 1-2 and lines 9-10 on page 26), which was chosen because the crystallographic structure thereof was known (see page 17, lines 2-3). The light chains of the B1-8 and D1.3 antibodies were never humanized in EP 239,400 A2.

Furthermore, only the CDRs were transferred in the Examples of this patent application; none of the non-human FR residues were incorporated into the engineered molecule.

Using the same strategy as disclosed in the Winter patent application, Riechmann and his colleagues made a humanized heavy chain variable domain which had the framework regions of human NEWM alternating with the CDRs of the rat CAMPATH-1 antibody. Thus, the same heavy chain framework region as disclosed in the Winter patent application was used once again, in view of the availability of a crystallographic structure for it (see page 325, second to last paragraph of Riechmann *et al.*). In this respect, Riechmann *et al.* fails to disclose or suggest the use of a "consensus human variable domain of a human heavy chain immunoglobulin subgroup" (e.g., human heavy chain immunoglobulin V_H subgroup III (claim 26) having the amino acid sequence of SEQ ID NO:4 (claim 27), for example) for providing the framework region of the heavy chain variable domain of the humanized antibody. For humanization of the light chain of the rat CAMPATH-1 antibody, Riechmann *et al.* states that a framework sequence based on the human REI light chain variable domain (for which a crystallographic structure was available) was used (see, Figure 1 legend and page 325, second column). Applicants have now learnt that the humanized light chain gene of the CAMPATH-1 antibody in Riechmann *et al.* was converted from an anti-lysozyme construct (see page 108 of Foote, J., *Nova acta Leopoldina* NF **61(269)**:103-110 (1989), of record). Foote's anti-lysozyme construct was prepared by combining CDR sequences from the kappa light chain of the anti-lysozyme antibody with consensus human kappa frameworks (see page 106, third paragraph of Foote, *supra*).

Queen *et al.* teaches that human framework regions used in humanization must be chosen to maximize homology with the murine antibody in order to avoid introducing "distortions into the CDRs" (see page 10031, column 2, paragraph 2). Using their "best-fit" approach, Queen *et al.* used the heavy and light chain variable regions of the human Eu antibody to form the framework of their humanized anti-Tac antibody. There is no mention of a consensus human variable domain for providing the framework region of the humanized antibody. In fact, Queen *et al.* taught away from the instantly claimed invention, in that they proposed that the framework region sequence of the humanized antibody be derived from a single human antibody amino acid sequence which was as homologous as possible to the non-human sequence to be humanized.