

FIG. 7 (contd.)

170	T F P A V L Q S S G L Y S L S S V V T V	189
600	ACCTTCCCGGCTGTCCTACAGTCCTCAGGACTCTACTCCCTCAGCAGCGTGGTGACCGTG	659
190	P S S S L G T Q T Y I C N V N H K P S N	209
660	CCCTCCAGCAGCTTGGGCACCCAGACCTACATCTGCAACGTGAATCACAAGCCCAGCAAC	719
210	T K V D K K V E P K S C D K T H T C P P	229
720	ACCAAGGTGGACAAGAAAGTTGAGCCCAAATCTTGTGACAAACTCACACATGCCACCG	779
230	C P A P E L L G G P S V F L F P P K P K	249
780	TGCCCAGCACCTGAACTCCTGGGGGGACCGTCAGTCTTCCTCTTCCCCCAAACCCAAG	839
250	D T L M I S R T P E V T C V V V D V S H	269
840	GACACCCTCATGATCTCCCGGACCCCTGAGGTCACATGCGTGGTGGTGGACGTGAGCCAC	899

SUBSTITUTE SHEET

21/33

FIG. 7 (contd.)

270	E D P E V K F N W Y V D G V E V H N A K	289
900	GAAGACCCTGAGGTCAAGTTCAACTGGTACGTGGACGGCGTGGAGGTGCATAATGCCAAG	959
290	T K P R E E Q Y N S T Y R V V S V L T V	309
960	ACAAAGCCGCGGGAGGAGCAGTACAACAGCACGTACCGTGTGGTCAGCGTCCTCACCGTC	1019
310	L H Q D W L N G K E Y K C K V S N K A L	329
1020	CTGCACCAGGACTGGCTGAATGGCAAGGAGTACAAGTGCAAGGTCTCCAACAAAGCCCTC	1079
330	P A P I E K T I S K A K G Q P R E P Q V	349
1080	CCAGCCCCATCGAGAAAACCATCTCAAAGCCAAAGGGCAGCCCCGAGAACCACAGGTG	1139
350	Y T L P P S R D E L T K N Q V S L T C L	369
1140	TACACCCTGCCCCATCCCGGGATGAGCTGACCAAGAACCAGGTCAGCCTGACCTGCCTG	1199

SUBSTITUTE SHEET

22/33

FIG. 7 (contd.)

SUBSTITUTE SHEET

370	V K G F Y P S D I A V E W E S N G Q P E	389
1200	GTCAAAGGCTTCTATCCCAGCGACATCGCCGTGGAGTGGGAGAGCAATGGGCAGCCGGAG	1259
390	N N Y K T T P P V L D S D G S F F L Y S	409
1260	AACAAC TACAAGACCACGCCTCCCGTGCTGGACTCCGACGGCTCCTTCTTCCTCTACAGC	1319
410	K L T V D K S R W Q Q G N V F S C S V M	429
1320	AAGCTCACCGTGGACAAGAGCAGGTGGCAGCAGGGGAACGTCTTCTCATGCTCCGTGATG	1379
430	H E A L H N H Y T Q K S L S L S P G K Trm	448
1380	CATGAGGCTCTGCACAACCACTACACGCAGAAGAGCCTCTCCCTGTCTCCGGGTAAATGA	1439
	<i>Hind</i> III	
1440	GTGCGACGGCCCAAGCTT	1458

23/33

FIG. 8

SUBSTITUTE SHEET

1		Q V Q L V E S G G G V V Q	13
		CDR 1	
14	P G R S L R L S C S S S G F I F S	<u>S Y A</u>	33
		CDR 2	
34	<u>M Y</u> W V R Q A P G K G L E W V A	<u>I I W D</u>	53
54	<u>D G S D Q H Y A D S V K G</u> R F T I S R D		73
74	N S K N T L F L Q M D S L R P E D T G V		93
		CDR 3	
94	Y F C A R <u>D G G H G F C S S A S C F G P</u>		113
114	<u>D Y</u> W G Q G T P V T V S S		126

24/33

FIG. 9

*Hind*III

SUBSTITUTE SHEET

1 AAGCTTATGAATATGCAAATCCTCTGAATCTACATGGTAAATATAGGTTTGTCTATAACC 59

60 ACAAACAGAAAAACATGAGATCACAGTTCTCTCTACAGTTACTCAGCACACAGGACCTCA 119

-19 M G W S C I I L F L V A T A T -5

120 CCATGGGATGGAGCTGTATCATCCTCTTCTTGGTAGCAACAGCTACAGGTAAGGGGCTCA 179

180 CAGTAGCAGGCTTGAGGTCTGGACATATATATGGGTGACAATGACATCCACTTTGCCTTT 239

-4 G V H S Q V Q L V E S G G G V V Q 13

240 CTCTCCACAGGTGTCCACTCCCAGGTCCAAGTGGTGGAGTCTGGTGGAGGCGTGGTGCAG 299

14 P G R S L R L S C S S S G F I F S N Y G 33

300 CCTGGAAGGTCCCTGAGACTCTCCTGTTCTCCTCTGGATTCATCTTCAGTAACTATGGC 359

34 M A W V R Q A P G K G L E W V A T I S H 53

360 ATGGCCTGGGTCCGCCAGGCTCCAGGCAAGGGGCTGGAGTGGGTCCGCAACCATTAGTCAT 419

25/33

FIG. 9 (contd.)

54 D G S D T Y F R D S V K G R F T I S R D 73
 420 GATGGTAGTGACACTTACTTTTCGAGACTCCGTGAAGGGCCGATTCACTATCTCCAGAGAT 479

74 N S K N T L F L Q M D S L R P E D T G V 93
 480 AATAGCAAAAACACCCTATTCCTGCAAATGGACAGTCTGAGGCCCGAGGACACGGGCGTG 539

CDR 3

94 Y F C A R Q G T I A G I R H W G Q G T P 113
 540 TATTTCTGTGCAAGACAAGGGACTATAGCAGGTATACGTCACTGGGGCCAAGGGACCCCC 599

114 V T V S S 118
 600 GTCACCGTCTCCTCAGGTGAGTCCTTACAACCTCTCTCTTCTATTTCAGCTTAAATAGATT 659

660 TTACTGCATTTGTTGGGGGGAAATGTGTGTATCTGAATTCAGGTCATGAAGGACTAGG 719

720 GACACCTTGGGAGTCAGAAAGGGTCATTGGGAGCCCGGGCTGATGCAGACAGACATCCTC 779

*Ban*HI

780 AGCTCCCAGACTTCATGGCCAGAGATTTATAGGGATCC 817

SUBSTITUTE SHEET

26/33

WO 92/05274

PCT/GB91/01578

FIG. 10

SUBSTITUTE SHEET

-19 *Hind*III M G W S C I I L F -11
 1 AAGCTTTACAGTTACTCAGCACACAGGACCTCACCATGGGATGGAGCTGTATCATCCTCT 60

-10 L V A T A T -5
 61 TCTTGGTAGCAACAGCTACAGGTAAGGGGCTCACAGTAGCAGGCTTGAGGTCTGGACATA 120

-4 G V H S Q V 2
 121 TATATGGGTGACAATGACATCCACTTTGCCTTTCTCTCCACAGGTGTCCACTCCCAGGTC 180

3 Q L V E S G G G V V Q P G R S L R L S C 22
 181 CAACTGGTGGAGTCTGGTGGAGGCGTGGTGCAGCCTGGAAGGTCCCTGAGACTCTCCTGT 240

CDR 1
 23 S S S G F I F S N Y G M A W V R Q A P G 42
 241 TCCTCCTCTGGATTCATCTTCAGTAACTATGGCATGGCCTGGGTCCGCCAGGCTCCAGGC 300

CDR 2
 43 K G L E W V A T I S H D G S D T Y F R D 62
 301 AAGGGGCTGGAGTGGGTCCGAACCATTAGTCATGATGGTAGTGACACTTACTTTCGAGAC 360

27/33

FIG. 10 (contd.)

63	<u>S V K G</u> R F T I S R D N S K N T L F L Q	82
361	TCCGTGAAGGGCCGATTCACTATCTCCAGAGATAATAGCAAAAACACCCTATTCCTGCAA	420
		CDR 3
83	M D S L R P E D T G V Y F C A R <u>Q G T I</u>	102
421	ATGGACAGTCTGAGGCCCGAGGACACGGGCGTGTATTTCTGTGCAAGACAAGGGACTATA	480
103	<u>A G I R H</u> W G Q G T P V T V S S	122
481	GCAGGTATACGTCACTGGGGCCAAGGGACCCCCGTCACCGTCTCCTCAGGTGAGTCCTTA	540
541	CAACCTCTCTTCTATTTCAGCTTAAATAGATTTTACTGCATTTGTTGGGGGGGAAATGT	600
601	GTGTATCTGAATTTTCAGGTCATGAAGGACTAGGGACACCTTGGGAGTCAGAAAGGGTCAT	660
661	TGGGAGCCCGGGCTGATGCAGACAGACATCCTCAGCTCCCAGACTTCATGGCCAGAGATT	720
	<i>Bam</i> HI	
721	TATAGGGATCC	731

SUBSTITUTE SHEET

28/33

PCT/GB91/01578

FIG. 11

*Hind*III

1 AAGCTTATGAATATGCAAATCCTCTGAATCTACATGGTAAATATAGTTTGTCTATACC 59

60 ACAAACAGAAAACATGAGATCACAGTTCTCTCTACAGTTACTCAGCACACAGGACCTCA 119

-19 M G W S C I I L F L V A T A T -5

120 CCATGGGATGGAGCTGTATCATCCTCTTCTTGGTAGCAACAGCTACAGGTAAGGGGCTCA 179

180 CAGTAGCAGGCTTGAGGTCTGGACATATATATGGGTGACAATGACATCCACTTTGCCTTT 239

-4 G V H S Q V Q L V E S G G G V V Q 13

240 CTCTCCACAGGTGTCCACTCCCAGGTCCAAGTGGTGGAGTCTGGTGGAGGCGTGGTGCAG 299

14 P G R S L R L S C S S S G F I F S N Y G 33

300 CCTGGAAGGTCCCTGAGACTCTCCTGTTCTCCTCTGGATTCATCTTCAGTAACTATGGC 359

34 M A W V R Q A P G K G L E W V A T I S H 53

360 ATGGCCTGGGTCCGCCAGGCTCCAGGCAAGGGGCTGGAGTGGGTGCAACCATTAGTCAT 419

SUBSTITUTE SHEET

FIG.11 (contd.)

54	<u>D G S D T Y F R D S V K G</u> R F T I S R D	73
420	GATGGTAGTGACACTTACTTTTCGAGACTCCGTGAAGGGCCGATTCACTATCTCCAGAGAT	479
74	N S K N T L F L Q M D S L R P E D T G V	93
480	AATAGCAAAAACACCCTATTCCTGCAAATGGACAGTCTGAGGCCCGAGGACACGGGCGTG	539
	CDR 3	
94	Y F C A R <u>Q G T I A G I R H</u> W G Q G T T	113
540	TATTTCTGTGCAAGACAAGGGACTATAGCAGGTATACGTCACTGGGGCCAAGGGACCACG	599
114	V T V S S	118
600	GTCACCGTCTCCTCAGGTGAGTCCTTACAACCTCTCTCTTCTATTCAGCTTAAATAGATT	659
660	TTACTGCATTTGTTGGGGGGGAAATGTGTGTATCTGAATTCAGGTCATGAAGGACTAGG	719
720	GACACCTGGGAGTCAGAAAGGGTCATTGGGAGCCCGGGCTGATGCAGACAGACATCCTC	779
	<i>Ban</i> HI	
780	AGCTCCCAGACTTCATGGCCAGAGATTTATAGGGATCC	817

SUBSTITUTE SHEET

30/33

SUBSTITUTE SHEET

FIG. 12

-19 *Hind*III M G W S C I I L F -11

1 AAGCTTTACAGTTACTCAGCACACAGGACCTCACCATGGGATGGAGCTGTATCATCCTCT 60

-10 L V A T A T -5

61 TCTTGGTAGCAACAGCTACAGGTAAGGGGCTCACAGTAGCAGGCTTGAGGTCTGGACATA 120

-4 G V H S Q V 2

121 TATATGGGTGACAATGACATCCACTTTGCCTTTCTCTCCACAGGTGTCCACTCCCAGGTC 180

3 Q L V E S G G G V V Q P G R S L R L S C 22

181 CAACTGGTGGAGTCTGGTGGAGGCGTGGTGCAGCCTGGAAGGTCCCTGAGACTCTCCTGT 240

CDR 1

23 S S S G F I F S N Y G M A W V R Q A P G 42

241 TCCTCCTCTGGATTCATCTTCAGTAACTATGGCATGGCCTGGGTCCGCCAGGCTCCAGGC 300

CDR 2

43 K G L E W V A T I S H D G S D T Y F R D 62

301 AAGGGGCTGGAGTGGGTCCGAACCATTAGTCATGATGGTAGTGACACTTACTTTCGAGAC 360

63 S V K G R F T I S R D N S K N T L F L Q 82

361 TCCGTGAAGGGCCGATTCACTATCTCCAGAGATAATAGCAAAAACACCCTATTCTGCAA 420

WO 92/05274

31/33

PCT/GB91/01578

FIG. 12 (contd.)

CDR 3

SUBSTITUTE SHEET

83	M D S L R P E D T G V Y F C A R	<u>Q G T I</u>	102
421	ATGGACAGTCTGAGGCCCGAGGACACGGGCGTGTATTTCTGTGCAAGACAAGGGACTATA		480
103	<u>A G I R H</u>	W G Q G T T V T V S S	122
481	GCAGGTATACGTCACTGGGGCCAAGGGACCACGGTCACCGTCTCCTCAGGTGAGTCCTTA		540
541	CAACCTCTCTTCTATTTCAGCTTAAATAGATTTTACTGCATTTGTTGGGGGGAAATGT		600
601	GTGTATCTGAATTTTCAGGTCATGAAGGACTAGGGACACCTTGGGAGTCAGAAAGGGTCAT		660
661	TGGGAGCCCGGGCTGATGCAGACAGACATCCTCAGCTCCCAGACTTCATGGCCAGAGATT		720
	<i>Ban</i> HI		
721	TATAGGGATCC		731

32/33

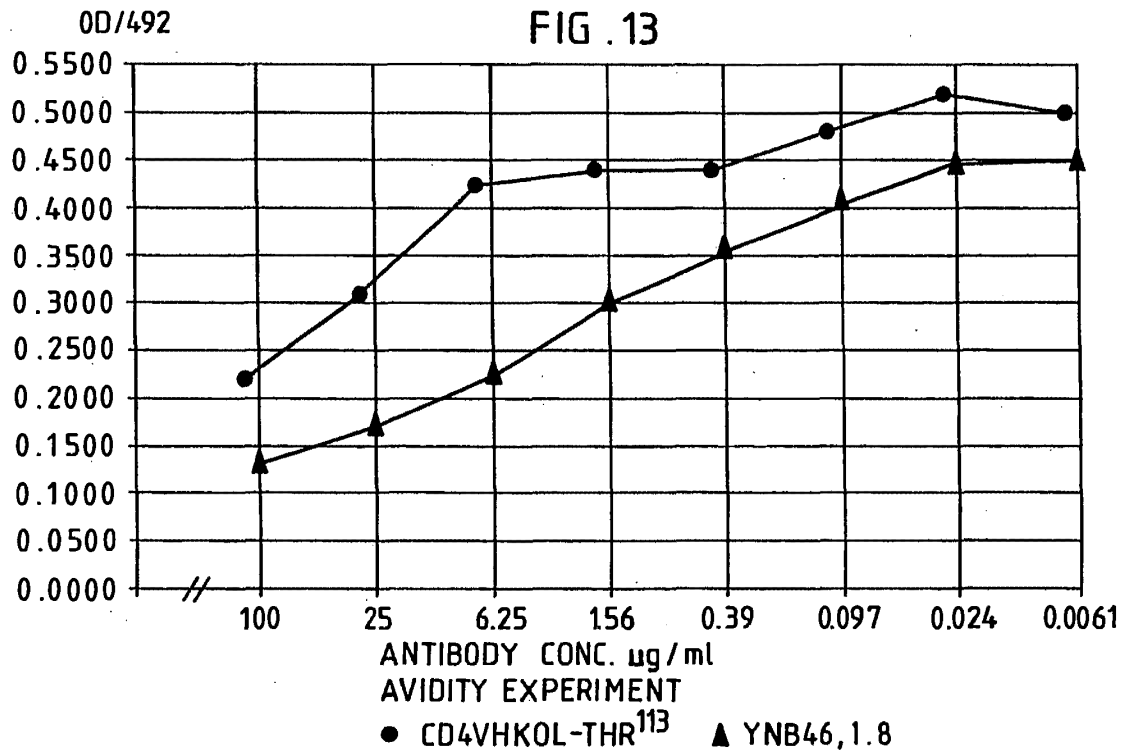

INTERNATIONAL SEARCH REPORT

International Application No PCT/GB 91/01578

I. CLASSIFICATION OF SUBJECT MATTER (if several classification symbols apply, indicate all) ⁶		
According to International Patent Classification (IPC) or to both National Classification and IPC		
IPC5: C 12 P 21/08, C 12 N 15/13, A 61 K 39/395		
II. FIELDS SEARCHED		
Minimum Documentation Searched ⁷		
Classification System	Classification Symbols	
IPC5	C 12 P; C 12 N; A 61 K	
Documentation Searched other than Minimum Documentation to the Extent that such Documents are Included in Fields Searched ⁸		
III. DOCUMENTS CONSIDERED TO BE RELEVANT⁹		
Category *	Citation of Document, ¹¹ with indication, where appropriate, of the relevant passages ¹²	Relevant to Claim No. ¹³
X	WO, A1, 9007861 (PROTEIN DESIGN LABS, INC.) 26 July 1990, see page 5; page 10, line 25 - page 14; page 28 - page 30	1-5
Y	--	1-9
X	Proc. Natl. Acad. Sci., vol. 86, December 1989, Cary Queen et al.: "A humanized antibody that binds to the interleukin 2 receptor", see pages 10029-10033, page 10031 right column-page 10033	1-5
Y	--	1-9
Y	Nature, vol. 341, October 1989, E. Sally Ward et al.: "Binding activities of a repertoire of single immunoglobulin variable domains secreted from Escherichia coli", see page 544 - page 546	1-9
	--	
<p>^a Special categories of cited documents: ¹⁰</p> <p>^A document defining the general state of the art which is not considered to be of particular relevance</p> <p>^E earlier document but published on or after the international filing date</p> <p>^L document which may throw doubts on priority claim(s) or which is cited to establish the publication date of another citation or other special reason (as specified)</p> <p>^O document referring to an oral disclosure, use, exhibition or other means</p> <p>^P document published prior to the international filing date but later than the priority date claimed</p> <p>^T later document published after the international filing date or priority date and not in conflict with the application but cited to understand the principle or theory underlying the invention</p> <p>^X document of particular relevance, the claimed invention cannot be considered novel or cannot be considered to involve an inventive step</p> <p>^Y document of particular relevance, the claimed invention cannot be considered to involve an inventive step when the document is combined with one or more other such documents, such combination being obvious to a person skilled in the art.</p> <p>^{&} document member of the same patent family</p>		
IV. CERTIFICATION		
Date of the Actual Completion of the International Search	Date of Mailing of this International Search Report	
16th December 1991	08 JAN 1992	
International Searching Authority	Signature of Authorized Officer	
EUROPEAN PATENT OFFICE	MISS T. TAZELAAR	

Form PCT/ISA/210 (second sheet) (January 1985)

III. DOCUMENTS CONSIDERED TO BE RELEVANT (CONTINUED FROM THE SECOND SHEET)		
Category *	Citation of Document, with indication, where appropriate, of the relevant passages	Relevant to Claim No
Y	Nature, vol. 332, March 1988, L Riechmann et al.: "Reshaping human antibodies for therapy", see page 323 - page 327 page 526 right column --	1-9
X	EP, A1, 0328404 (MEDICAL RESEARCH COUNCIL) 16 August 1989, see page 4; page 9, line 30; page 11, line 5 --	1-5
X	EP, A2, 0365209 (BECTON DICKINSON AND COMPANY) 25 April 1990, see in particular col. 3, lines 27-49 and columns 5-8 --	1-5
A	Proc.Natl.Acad.Sci., vol. 87, June 1990, J Sharon: "Structural correlates of high antibody affinity: Three engineered amino acid substitutions can increase the affinity of an anti-p-azophenylarsonate antibody 200-fold", see page 4814 - page 4817 --	1
A	Science, vol. 239, March 1988, M Verhoeyen et al.: "Reshaping Human Antibodies: Grafting an Antilysozyme Activity", see page 1534 - page 1536 --	1-9
A	Nature, vol. 321, May 1986, P T Jones et al.: "Replacing the complementarity-determining regions in a human antibody with those from a mouse", see page 522 - page 525 page 525, left column --	1
A	Nature, vol. 328, August 1987, S. Roberts et al.: "Generation of an antibody with enhanced affinity and specificity for its antigen by protein engineering", see page 731 - page 734 --	1

Form PCT/ISA/210 (extra sheet) (January 1985)

III. DOCUMENTS CONSIDERED TO BE RELEVANT (CONTINUED FROM THE SECOND SHEET)		
Category *	Citation of Document, with indication, where appropriate, of the relevant passages	Relevagt to Claim No
P,X	WO, A1, 9109966 (ORTHO PHARMACEUTICAL CORPORATION) 11 July 1991, see the whole document ---	1-5
P,X	WO, A1, 9107492 (CENTRAL BLOOD LABORATORIES AUTHORITY) 30 May 1991, see page 3 ---	1
P,X	EP, A1, 0403156 (GENZYME CORPORATION) 19 December 1990, see example 12 ---	1-5
P,X	WO, A1, 9109967 (CELLTECH LIMITED) 11 July 1991, see the whole document -- -----	1-9

**ANNEX TO THE INTERNATIONAL SEARCH REPORT
ON INTERNATIONAL PATENT APPLICATION NO.PCT/GB 91/01578**

SA 51310

This annex lists the patent family members relating to the patent documents cited in the above-mentioned international search report. The members are as contained in the European Patent Office EDP file on 31/10/91. The European Patent office is in no way liable for these particulars which are merely given for the purpose of information.

Patent document cited in search report	Publication date	Patent family member(s)	Publication date
WO-A1- 9007861	26/07/90	AU-D- 5153290	13/08/90
		CA-A- 2006865	28/06/90
		EP-A- 0451216	16/10/91
EP-A1- 0328404	16/08/89	AU-D- 3062689	06/09/89
		GB-A- 2216126	04/10/89
		WO-A- 89/07452	24/08/89
EP-A2- 0365209	25/04/90	JP-A- 2238883	21/09/90
WO-A1- 9109966	11/07/91	WO-A- 91/09967	11/07/91
		WO-A- 91/09968	11/07/91
WO-A1- 9107492	30/05/91	AU-D- 6721490	13/06/91
EP-A1- 0403156	19/12/90	CA-A- 2018248	07/12/90
WO-A1- 9109967	11/07/91	WO-A- 91/09966	11/07/91
		WO-A- 91/09968	11/07/91

For more details about this annex : see Official Journal of the European patent Office, No. 12/82

EPO FORM P0478



INTERNATIONAL APPLICATION PUBLISHED UNDER THE PATENT COOPERATION TREATY (PCT)

<p>(51) International Patent Classification⁵ : C12N 15/13, C07K 13/00 C12N 15/62, C12P 21/08 A61K 39/395, 49/00</p>	A1	<p>(11) International Publication Number: WO 92/15683 (43) International Publication Date: 17 September 1992 (17.09.92)</p>
<p>(21) International Application Number: PCT/EP92/00480 (22) International Filing Date: 4 March 1992 (04.03.92) (30) Priority data: 91103389.2 6 March 1991 (06.03.91) EP (34) Countries for which the regional or international application was filed: AT et al. (71) Applicant (for all designated States except US): MERCK PA- TENT GESELLSCHAFT MIT BESCHRÄNKTER HAFTUNG[DE/DE]; Frankfurter Str. 250, D-6100 Darmstadt (DE). (72) Inventors; and (75) Inventors/Applicants (for US only) : BENDIG, Mary, M. [US/GB]; 64 Solent Road, West Hamstead, London NW6 1TX (GB). KETTLEBOROUGH, Catherine, A. [GB/GB]; 28 Milton St., Watford, Herts, WD2 5W (GB). SALDANHA, José [GB/GB]; 22 Lincoln Way, Enfield, Middlesex EN1 1TE (GB).</p>	<p>(81) Designated States: AT (European patent), AU, BE (Euro- pean patent), CA, CH (European patent), CS, DE (Eu- ropean patent), DK (European patent), ES (European patent), FR (European patent), GB (European patent), GR (European patent), HU, IT (European patent), JP, KR, LU (European patent), MC (European patent), NL (European patent), SE (European patent), US. Published <i>With international search report.</i></p>	
<p>(54) Title: HUMANIZED AND CHIMERIC MONOCLONAL ANTIBODIES</p>		
<p>(57) Abstract</p> <p>The invention relates to new humanized monoclonal antibody comprising an artificial modified consensus sequence at least of the FRs of the heavy chain variable region of a human immunoglobulin. The invention relates, furthermore, to corresponding humanized and chimeric monoclonal antibodies which are binding to epitopes of the Epidermal Growth Factor wherein the responsible hypervariable regions have the following amino acid sequence: <i>light chain</i>: CDR-1: -Ser-Ala-Ser-Ser-Val-Thr-Tyr-Met-Tyr-; CDR-2: -Asp-Thr-Ser-Asn-Leu-Ala-Ser-; CDR-3: -Gln-Gln-Trp-Ser-Ser-His-Ile-Phe-Thr-; <i>heavy chain</i>: CDR-1: -Ser-His-Trp-Met-His-; CDR-2: -Glu-Phe-Asn-Pro-Ser-Asn-Gly-Arg-Thr-Asn-Glu-Lys-Phe-Lys-Ser-; CDR-3: -Arg-Asp-Tyr-Asp-Tyr-Asp-Gly-Arg-Tyr-Phe-Asp-Tyr-. The antibodies can be used for therapeutical and diagnostic purposes.</p>		

FOR THE PURPOSES OF INFORMATION ONLY

Codes used to identify States party to the PCT on the front pages of pamphlets publishing international applications under the PCT.

AT	Austria	FI	Finland	MI	Mali
AU	Australia	FR	France	MN	Mongolia
BB	Barbados	GA	Gabon	MR	Mauritania
BE	Belgium	GB	United Kingdom	MW	Malawi
BF	Burkina Faso	GN	Guinea	NL	Netherlands
BG	Bulgaria	GR	Greece	NO	Norway
BJ	Benin	HU	Hungary	PL	Poland
BR	Brazil	IE	Ireland	RO	Romania
CA	Canada	IT	Italy	RU	Russian Federation
CF	Central African Republic	JP	Japan	SD	Sudan
CG	Congo	KP	Democratic People's Republic of Korea	SE	Sweden
CH	Switzerland	KR	Republic of Korea	SN	Senegal
CI	Côte d'Ivoire	LK	Sri Lanka	SU	Soviet Union
CM	Cameroon	LJ	Liechtenstein	TD	Chad
CS	Czechoslovakia	LU	Luxembourg	TG	Togo
DE	Germany	MC	Monaco	US	United States of America
DK	Denmark	MG	Madagascar		
ES	Spain				

Humanized and Chimeric Monoclonal Antibodies

5

TECHNICAL FIELD OF THE INVENTION

10 The invention relates to new humanized monoclonal antibodies comprising an artificial modified consensus sequence at least of the FRs in the variable region of the heavy chain of human immunoglobulins.

15 The invention relates, furthermore, to humanized and chimeric monoclonal antibodies which are binding to epitopes of the Epidermal Growth Factor. The invention discloses the amino acid sequences of the responding antigen-binding site for this receptor.

20 The invention relates to pharmaceutical compositions comprising the said antibodies for the purposes of treating tumors like melanoma, glioma or carcinoma. The said antibodies can be used also for diagnostic applications regarding locating and assessing the said tumors in vitro or in vivo.

25

The specification relates to several technical terms which are here defined as follows:

30

"Humanized" antibodies mean antibodies comprising FRs of the variable regions and constant regions of amino acids located in the light and heavy chain which derive from human sources whereas the hypervariable regions derive from non-human sources.

"Chimeric" antibodies mean antibodies comprising variable and hypervariable regions which derive from non-human sources whereas the constant regions derive from human origin.

"FRs" mean the framework regions of an antibody and are found within the variable regions. In these regions a certain alteration of amino acids occurs.

"CDRs" mean the complementarity determining or "hypervariable" regions of an antibody and are found within the variable regions. These regions represent the specific antigen-binding site and show an immense exchange of amino acids. CDRs are primarily responsible for the binding affinity of the antigen.

"Consensus sequence" means a non-naturally occurring amino acid sequence as light or heavy chain variable regions and is used as substitute for the originally present non-human heavy or light chain variable regions. The consensus sequences is synthetic and therefore an artificial sequence of the most common amino acids of a distinct class or subclass or subgroup of heavy or light chains of human immunoglobulins.

"EGF" and "EGFR" mean the Epidermal Growth Factor and its receptor.

"V_L" regions mean light chain variable regions.

"V_H" regions mean heavy chain variable regions.

5 BACKGROUND OF THE INVENTION

10 The murine monoclonal antibody 425 (Mab 425) was raised against the human A431 carcinoma cell line and found to bind to a polypeptide epitope on the external domain of the human epidermal growth factor receptor (EGFR). It was found to inhibit the binding of epidermal growth factor (EGF) at both low and high affinity EGFR sites (Murthy et al., 1987), Enhanced expression of EGFR is found to occur on malignant tissue from a variety of sources thus making Mab 425 a possible agent for the diagnosis and therapeutic treatment of human tumors. Indeed, Mab 425 was found to mediate tumor cytotoxicity in vitro and to suppress tumor cell growth of epidermoid and colorectal carcinoma-derived cell lines in vitro (Rodeck et al., 1987). Radiolabelled Mab 425 has also been shown to bind to xenografts of human malignant gliomas in mice (Takahashi et al., 1987).

25 EGF is a polypeptide hormone which is mitogenic for epidermal and epithelial cells. When EGF interacts with sensitive cells, it binds to membrane receptors; the receptor EGF complexes cluster and then are internalized in endocytotic vesicles. This is responsible for the phenomenon of "down-regulation". EGF binding induces a tyrosine kinase activity of the receptor molecule and induces synthesis of DNA.

30

The EGF-receptor is a transmembrane glycoprotein of about 170,000 Daltons (Cohen, 1982). It is the gene product of the c-erb-B proto-oncogene (Downward et al., Nature, Vol. 307, pp. 521-527, 1984). The receptor exists in two kinetic forms:
5 so-called low affinity and high-affinity receptors.

The A431 carcinoma cell line expresses abundant EGF-receptors on its cell surfaces, and thus has been used in many studies to generate anti-EGF-receptor antibodies. However, the recep-
10 tors on A431 differ from those of other cell types in the carbohydrate moieties attached to the polypeptide. Thus many antibodies raised against A431 membranes are directed against carbohydrates which are not common to all forms of the recep-
tor molecule (e.g. Schreiber, 1983).

15 Other monoclonal antibodies are reactive with the protein moiety of EGF-receptors. These antibodies display a variety of properties upon binding to EGF-receptors, presumably dependent on the particular portion of the receptor molecule
20 bound, and the isotype of the antibody. Some antibodies mimic some of the effects of EGF (agonists) and some inhibit the effects (antagonists).

Expression of EGF-receptors has been implicated in the pro-
25 gression of tumor growth. The gene for the receptors has been found to be the cellular analogue of the avian viral oncogene v-erb-B (Ulrich, 1984). In addition an association has been detected between late stages of melanoma development and extra copies of the chromosome carrying the receptor gene
30 (Koprowski et al., Somatic Cell and Molecular Genetics, Vol. 11, pp. 297-302, 1985).

Because of EGF-receptors are expressed on a wide variety of solid tumors they provide a suitable target for anti-tumor therapy. However, there is a need in the art for a suitable anti-receptor antibody. Many of the known antibodies have
5 properties which would be deleterious if used as anti-tumor agents. For example, antibodies which mimic the effects of EGF could stimulate the progression of the tumor rather than arresting it. Other antibodies which only bind to high or low affinity receptors could be less than optimally effective
10 because EGF could still exert its effect through the unbound receptors. Still other antibodies convert low affinity receptors to high affinity receptors, which could exacerbate tumor growth rather than inhibiting it. Thus there is a need in the art for an anti-EGF-receptor antibody which would be suitable
15 for anti-tumor therapy.

Although murine MAbs have been used for therapeutic treatment in humans, they have elicited an immune response (Giorgi et al., 1983; Jaffers et al., 1986). To overcome this problem,
20 several groups have tried to "humanize" murine antibodies. This can involve one of two approaches. Firstly, the murine constant region domains for both the light and heavy chain can be replaced with human constant regions. Such "chimeric" murine-human antibodies have been successfully constructed
25 from several murine antibodies directed against human tumor-associated antigens (Sun et al., 1987; Whittle et al., 1987; Liu et al., 1987; Gillies and Wesolowski, 1990). This approach totally conserves the antigen-binding site of the murine antibody, and hence the antigen affinity, while conferring the human isotype and effector functions. In the
30 second approach only the complementarity determining regions

(CDRs) from the mouse variable regions are grafted together with human framework regions (FRs) of both the light and heavy chain variable domains (V_L and V_H). It is reasoned that this technique will transfer the critical and major portion of the antigen-binding site to the human antibody (Jones et al., 1986).

CDR grafting has been carried out for several rodent monoclonals (Jones et al., 1986; Reichmann et al., 1988; Verhoeyen et al.; 1988; Queen et al.; 1989; Co et al., 1991; Gorman et al., 1991; Maeda et al., 1991; Temptest et al., 1991). All retained their capacity to bind antigen, although the affinity was usually diminished. In most cases it was deemed necessary to alter certain amino acids in the human framework residues (FRs). Both chimeric and CDR grafted antibodies have proved superior to the mouse antibodies in the clinic (Hale et al., 1988; LoBuglio et al., 1989; Mathieson et al., 1990). However, a general teaching of which amino acids have to be changed, is not known and not completely predictable in any case.

EP 088 994 proposes the construction of recombinant DNA vectors comprising of a DNA sequence which codes for a variable domain of a light or a heavy chain of an immunoglobulin specific for a predetermined ligand. The application does not contemplate variations in the sequence of the variable domain.

EP 102 634 describes the cloning and expression in bacterial host organisms of genes coding for the whole or a part of human IgG heavy chain polypeptide, but does not contemplate variations in the sequence of the polypeptide.

5 EP 239 400 proposes that humanized antibodies can be obtained by replacing the antigen-binding site (hypervariable regions) of any human antibody by an antigen-binding site of a non-human, for example of a mouse or a rat antibody by genetech-
nological methods.

10 Thus, following this teaching, human or humanized antibodies can be manufactured having specific antigen-binding sites which were not available up to now in antibodies originating from humans.

15 Chimeric antibodies can be obtained by replacing not only the CDRs but the whole variable regions of the light and heavy chains. Chimeric antibodies, however, can still be immuno-
genic. Chimeric antibodies are, however, very useful for diagnostic purposes and optimizing humanized antibodies.

20 It could be shown that the affinity of the antigen-binding sites can be influenced by selective exchange of some single amino acids within the variable regions which are not directly part of the CDRs (Reichmann et al., 1988).

25 As consequence in the worst case, the binding affinity of the antigen can be completely lost if one works according to the teaching of the EP 239 400. This fact could be demonstrated by the inventors of the instant invention, who failed in constructing a correspondingly humanized antibody which was directed to epitopes of the EGF-receptor.

30 Therefore, it must be considered that the success of such a humanization depends on the constitution and conformation of the used variable regions and their interactions with the

corresponding antigen-binding site. Thus, it is not completely predictable whether or which modifications within the variable domains of the antibody are necessary in order to obtain or to improve the binding of the antigen to the antibody.

SUMMARY OF THE INVENTION

Thus, the invention has the object of providing a humanized monoclonal antibody which is, in particular, directed to the EGF-receptor, comprising an antigen-binding site of non-human sources and the FRs of the variable regions and constant regions of human origins, which are, if necessary, modified in a way that the specificity of the binding site can be conserved or restored.

In particular, the invention has the object of characterizing the hypervariable regions of the antigen-binding site of an antibody against the EGF-receptor and providing these CDRs within a humanized monoclonal antibody defined as above.

This antibody and its chimeric variant can play an important role as a therapeutic or diagnostic agent in order to combat tumors, as melanoma, glioma or carcinoma.

It has been found, that effective and specific humanized monoclonal antibodies can be easily obtained by using a consensus sequence of at least the heavy chain variable regions of human immunoglobulins. In particular, all those consensus sequences are suitable which have a good (at least 60-70 %, particularly 65-70 %) identity compared with the variable regions of the original non-human antibodies.

Furthermore, it has been found, that these consensus sequences have to be modified only to a low extent whereas sometimes much more modifications have to be undertaken using variable regions of naturally occurring human antibodies.

5 Often no or only a few modifications in the amino acid sequence are necessary according to the invention in order to receive a good specific antigen binding. Thus, only a few amino acids must be replaced in getting a perfect binding of the EGF-receptor to the preferred humanized antibody according to the invention, whereas no binding can be obtained here
10 according to the teaching of the EP 239 400. The modifications which are necessary according to the invention can be indicated with 0 to 10 %, or preferably, 1 to 5 % related to the exchange of amino acids.

15

A humanized monoclonal antibody according to the invention has the following advantage: a consensus sequence which is a sequence according to the most common occurrence of amino acid on a distinct position of a chain of human immunoglobulin of a defined class or subclass or subgroup, can be synthesized as a whole or as a part without problems. There is
20 no dependence on the detailed knowledge or availability of certain individual antibodies or antibody fragments. That means that a wide range of individually and naturally occurring antibody fragments can be covered by providing a very
25 restricted number of consensus sequences which are cloned into corresponding expression vectors. A consensus sequence may be favorable with respect to the immunogenicity in comparison with individual natural sequences which are known to
30 be sometimes epitopes for other antibodies (for example anti-idiotypic antibodies).

Although only one preferred embodiment was made, a general principal teaching is disclosed according to the instant invention. It is not a mere accident with respect to the large number of possible sequences and combinations of sequences in the variable and hypervariable domains that the described teaching regarding the consensus sequence succeeded in constructing a humanized antibody directed to the EGF-receptor.

Furthermore, it has been found, that the heavy chains of the variable domains provide a greater contribution to the antigen-binding site than the corresponding light chains. Therefore, it is not necessary to modify in the same manner the light chain of a humanized antibody having a consensus sequence. This is an interesting aspect because it is known that the light chains in some known natural antibodies play the more important role than the corresponding heavy chains (see Williams et al., 1990).

Finally and above all, the invention provides for the first time the characterization, cloning and amplification by means of genetic engineering the antigen-binding site of a murine antibody against the EGF-receptor (Mab 425). Corresponding oligonucleotides could be synthesized which code for that antigen-binding site and for the whole variable domain of a humanized and chimeric monoclonal antibody. The invention provides, moreover, correspondingly effective expression vectors which can be used for the transformation of suitable eukaryotic cells.

30

Thus, the invention relates to a humanized monoclonal antibody comprising antigen binding sites (CDRs) of non-human origin, and the FRs of variable regions and constant regions of light and heavy chains of human origin, characterized in that at least the FRs of the variable regions of the heavy chain comprise a modified consensus sequence of different variable regions of a distinct class or subgroup of a human immunoglobulin.

10 In particular, the invention relates to a humanized monoclonal antibody, wherein the FRs of the consensus sequence has a homology of at least 70 % compared with the amino acid sequence of the FRs of the variable region of the non-human antibody from which the antigen-binding sites originate.

15 In particular, the invention relates to a humanized monoclonal antibody, having the following properties:

- (a) binds to human EGF-receptors;
- 20 (b) inhibits binding of EGF to EGF-receptor;
- (c) inhibits the EGF-dependent tyrosine kinase activity of EGF-receptor;
- (d) inhibits the growth of EGF-sensitive cells.

25 In particular, the invention relates to a humanized monoclonal antibody, wherein the hypervariable regions of the antigen-binding sites comprise the following amino acid sequences:

30

light chain

CDR-1 -Ser-Ala-Ser-Ser-Ser-Val-Thr-Tyr-Met-Tyr-
 CDR-2 -Asp-Thr-Ser-Asn-Leu-Ala-Ser-
 5 CDR-3 -Gln-Gln-Trp-Ser-Ser-His-Ile-Phe-Thr-

heavy chain

CDR-1 -Ser-His-Trp-Met-His-
 10 CDR-2 -Glu-Phe-Asn-Pro-Ser-Asn-Gly-Arg-Thr-Asn-Tyr-Asn-Glu-
 Lys-Phe-Lys-Ser-
 CDR-3 -Arg-Asp-Tyr-Asp-Tyr-Asp-Gly-Arg-Tyr-Phe-Asp-Tyr-

In particular, the invention relates to a humanized mono-
 15 clonal antibody, wherein the FRs of the variable regions
 which are not related to the antigen-binding sites comprise
 the following amino acid sequence:

light chain

20 FR-1 -Asp-Ile-Gln-Met-Thr-Gln-Ser-Pro-Ser-Ser-Leu-Ser-Ala-
 Ser-Val-Gly-Asp-Arg-Val-Thr-Ile-Thr-Cys-
 FR-2 -Trp-Tyr-Gln-Gln-Lys-Pro-Gly-Lys-Ala-Pro-Lys-Leu-Leu-
 Ile-Tyr-
 25 FR-3 -Gly-Val-Pro-Ser-Arg-Phe-Ser-Gly-Ser-Gly-Ser-Gly-Thr-
 Asp-Tyr (Phe, Trp, His) -Thr-Phe-Thr-Ile-Ser-Ser-Leu-Gln-
 Pro-Glu-Asp-Ile-Ala-Thr-Tyr-Tyr-Cys-
 FR-4 -Phe-Gly-Gln-Gly-Thr-Lys-Val-Glu-Ile-Lys-

30

heavy chain

FR-1 -Gln-Val-Gln-Leu-Val-Gln-Ser-Gly-Ala-Glu-Val-Lys-Lys-
Pro-Gly-Ala-Ser-Val-Lys-Val-Ser-Cys-Lys-Ala-Ser-Gly-
5 Tyr-Thr-Phe-Thr (Ser) -
FR-2 -Trp-Val-Arg (His) -Gln-Ala (Lys, His) -Pro (Val) -Gly-Gln-
Gly-Leu-Glu-Trp-Ile (Val, Leu) -Gly-
FR-3 -Lys (Arg, His) -Ala (Val, Pro-Gly) -Thr-Met-Thr-
Val (Ala, Pro, Gly) -Asp-Thr-Ser-Thr-Asn-Thr-Ala-Tyr-Met-
10 Glu (Asn) -Leu-Ser-Ser-Leu-Arg-Ser-Glu-Asp-Thr-Ala-Val-
Tyr-Tyr-Cys-Ala-Ser-
FR-4 -Trp-Gly-Gln-Gly-Thr-Leu-Val-Thr-Val-Ser-Ser-,

15 and wherein the amino acids listed in the brackets are alter-
natives.

In particular, the invention relates to a humanized mono-
clonal antibody, wherein the constant regions of the heavy
chain comprise the amino acid sequence of a gamma-1 chain,
20 and the constant regions of the light chain comprise the
amino acid sequence of a kappa chain of a human immunoglobu-
lin.

In particular, the invention relates to a humanized mono-
25 clonal antibody, comprising a derivate of an amino acid
sequence modified by amino acid deletion, substitution,
addition or inversion within the variable and constant
regions wherein the biological function of specific binding
to the antigen is preserved.

30

Furthermore, the invention relates to an expression vector, suitable for transformation of host cells, characterized in that it comprises a DNA sequence coding for the variable and/or constant regions of the light and/or heavy chains of a humanized antibody.

Furthermore, the invention relates to humanized or chimeric monoclonal antibody, comprising hypervariable regions (CDRs) of antigen-binding sites of murine origin and the FRs of the variable regions of human or murine origin and constant regions of light and heavy chains of human origin, characterized in that the hypervariable regions comprise the following amino acid sequences,

light chain

CDR-1 -Ser-Ala-Ser-Ser-Ser-Val-Thr-Tyr-Met-Tyr-

CDR-2 -Asp-Thr-Ser-Asn-Leu-Ala-Ser-

CDR-3 -Gln-Gln-Trp-Ser-Ser-His-Ile-Phe-Thr-

heavy chain

CDR-1 -Ser-His-Trp-Met-His-

CDR-2 -Glu-Phe-Asn-Pro-Ser-Asn-Gly-Arg-Thr-Asn-Tyr-Asn-Glu-Lys-Phe-Lys-Ser-

CDR-3 -Arg-Asp-Tyr-Asp-Tyr-Asp-Gly-Arg-Tyr-Phe-Asp-Tyr-,

and wherein the constant regions of the heavy chain comprise the amino acid sequence of a gamma-1 chain, and the constant regions of the light chain comprise the amino acid sequence of a kappa chain of a human immunoglobulin.

In particular, the invention relates to a humanized monoclonal antibody according to claim 12, wherein the FRs of the variable regions which are not related to the antigen-binding sites, are of human origin and comprise the following amino acid sequence,

5

light chain

FR-1 -Asp-Ile-Gln-Met-Thr-Gln-Ser-Pro-Ser-Ser-Leu-Ser-Ala-
 10 Ser-Val-Gly-Asp-Arg-Val-Thr-Ile-Thr-Cys-
 FR-2 -Trp-Tyr-Gln-Gln-Lys-Pro-Gly-Lys-Ala-Pro-Lys-Leu-Leu-
 Ile-Tyr-
 FR-3 Gly-Val-Pro-Ser-Arg-Phe-Ser-Gly-Ser-Gly-Ser-Gly-Thr-
 Asp-Tyr (Phe, Trp, His) -Thr-Phe-Thr-Ile-Ser-Ser-Leu-Gln-
 15 Pro-Glu-Asp-Ile-Ala-Thr-Tyr-Tyr-Cys-
 FR-4 -Phe-Gly-Gln-Gly-Thr-Lys-Val-Glu-Ile-Lys-

heavy chain

FR-1 -Gln-Val-Gln-Leu-Val-Gln-Ser-Gly-Ala-Glu-Val-Lys-Lys-
 20 Pro-Gly-Ala-Ser-Val-Lys-Val-Ser-Cys-Lys-Ala-Ser-Gly-
 Tyr-Thr-Phe-Thr (Ser) -
 FR-2 -Trp-Val-Arg (His) -Gln-Ala (Lys, His) -Pro (Val) -Gly-Gln-
 Gly-Leu-Glu-Trp-Ile (Val, Leu) -Gly-
 25 FR-3 -Lys (Arg, His) -Ala (Val, Pro, Gly) -Thr-Met-Thr-
 Val (Ala, Pro, Gly) -Asp-Thr-Ser-Thr-Asn-Thr-Ala-Tyr-Met-
 Glu (Asn) -Leu-Ser-Ser-Leu-Arg-Ser-Glu-Asp-Thr-Ala-Val-
 Tyr-Tyr-Cys-Ala-Ser-
 FR-4 -Trp-Gly-Gln-Gly-Thr-Leu-Val-Thr-Val-Ser-Ser-

30

In particular, the invention relates to a chimeric monoclonal antibody according to Claim 12, wherein the FRs of the variable regions which are not related to the antigen-binding site, are of murine origin and comprise the following amino acid sequences:

5

light chain

FR-1 -Gln-Ile-Val-Leu-Thr-Gln-Ser-Pro-Ala-Ile-Met-Ser-Ala-
 10 Ser-Pro-Gly-Glu-Lys-Val-Thr-Met-Thr-Cys-
 FR-2 -Trp-Tyr-Gln-Gln-Lys-Pro-Gly-Ser-Ser-Pro-Arg-Leu-Leu-
 Ile-Tyr-
 FR-3 -Gly-Val-Pro-Val-Arg-Phe-Ser-Gly-Ser-Gly-Ser-Gly-Thr-
 Ser-Tyr-Ser-Leu-Thr-Ile-Ser-Arg-Met-Glu-Ala-Glu-Asp-
 15 Ala-Ala-Thr-Tyr-Tyr-Cys-
 FR-4 -Phe-Gly-Ser-Gly-Thr-Lys-Leu-Glu-Ile-Lys-

heavy chain

20 FR-1 -Gln-Val-Gln-Leu-Gln-Gln-Pro-Gly-Ala-Glu-Leu-Val-Lys-
 Pro-Gly-Ala-Ser-Val-Lys-Leu-Ser-Cys-Lys-Ala-Ser-Gly-
 Tyr-Thr-Phe-Thr-
 FR-2 -Trp-Val-Lys-Gln-Arg-Ala-Gly-Gln-Gly-Leu-Glu-Trp-Ile-
 Gly-
 25 FR-3 -Lys-Ala-Thr-Leu-Thr-Val-Asp-Lys-Ser-Ser-Ser-Thr-Ala-
 Tyr-Met-Gln-Leu-Ser-Ser-Leu-Thr-Ser-Glu-Asp-Ser-Ala-
 Val-Tyr-Tyr-Cys-Ala-Ser-
 FR-4 -Trp-Gly-Gln-Gly-Thr-Thr-Leu-Thr-Val-Ser-Ser-

30

Moreover, the invention relates to an expression vector, suitable for transformation of host cells, characterized in that it comprises DNA sequences coding for the variable and/or constant regions of the light and/or heavy chains of a humanized or chimeric monoclonal antibody.

Furthermore, the invention relates to a process for the preparation of a humanized monoclonal antibody, comprising hypervariable regions (CDRs) of antigen-binding sites of non-human origin, and FRs of variable regions and constant regions of the light and heavy chains of human origin by cultivating transformed host cells in a culture medium and purification and isolation the expressed antibody proteins, characterized in

(a) synthesizing or partially synthesizing or isolating an oligonucleotide sequence which codes for an amino acid consensus sequence of different variable regions (FR-1 to FR-4) of a heavy chain of a class or a subgroup of a human immunoglobulin, wherein the used consensus sequence has a homology of at least 70 % compared with the amino acid sequence of the FRs of the variable regions of the non-human antibody from which the antigen-binding sites originate, and wherein the consensus sequence is modified by alterations of maximum 10 % of the amino acids in order to preserve the binding capability of the antigen to the hypervariable regions;

(b) synthesizing or partially synthesizing or isolating an oligonucleotide sequence which codes for an amino acid consensus sequence under the conditions given in (a) of

different variable regions (FR-1 to FR-4) of a light chain of a class or a subgroup of a human immunoglobulin, or, alternatively, which codes for a corresponding natural occurring amino acid sequence;

5

(c) in each case synthesizing or partially synthesizing or isolating an oligonucleotide sequence which codes for the amino acid sequence of the hypervariable regions (CDRs) of the light and heavy chain corresponding to the hypervariable regions of the basic non-human antibody;

10

(d) in each case synthesizing or partially synthesizing or isolating an oligonucleotide sequence which codes for the amino acid sequence of the constant regions of the light and heavy chain of a human immunoglobulin;

15

(e) constructing one or several expression vectors comprising in each case at least a promoter, a replication origin and the coding DNA sequences according to (a) to (d), wherein the DNA sequences coding for the light and heavy chains can be present together in one or, alternatively, in two or more different vectors,

20

and finally,

25

(f) transforming the host cells with one or more of the expression vectors according to (e).

30

In particular, the invention relates to a process, wherein DNA sequences are used coding for the following amino acid sequences which represent the hypervariable regions (CDRs):

light chain

CDR-1 -Ser-Ala-Ser-Ser-Ser-Val-Thr-Tyr-Met-Tyr-
 CDR-2 -Asp-Thr-Ser-Asn-Leu-Ala-Ser-
 5 CDR-3 -Gln-Gln-Trp-Ser-Ser-His-Ile-Phe-Thr-

heavy chain

CDR-1 -Ser-His-Trp-Met-His-
 10 CDR-2 -Glu-Phe-Asn-Pro-Ser-Asn-Gly-Arg-Thr-Asn-Tyr-Asn-Glu-
 Lys-Phe-Lys-Ser-
 CDR-3 -Arg-Asp-Tyr-Asp-Tyr-Asp-Gly-Arg-Tyr-Phe-Asp-Tyr-

In particular, the invention relates to a process, wherein
 15 DNA sequences are used coding for the following amino acid
 sequences which represent the FRs of the variable regions :

light chain

20 FR-1 -Asp-Ile-Gln-Met-Thr-Gln-Ser-Pro-Ser-Ser-Leu-Ser-Ala-
 Ser-Val-Gly-Asp-Arg-Val-Thr-Ile-Thr-Cys-
 FR-2 -Trp-Tyr-Gln-Gln-Lys-Pro-Gly-Lys-Ala-Pro-Lys-Leu-Leu-
 Ile-Tyr-
 FR-3 -Gly-Val-Pro-Ser-Arg-Phe-Ser-Gly-Ser-Gly-Ser-Gly-Thr-
 25 Asp-Tyr (Phe, Trp, His) -Thr-Phe-Thr-Ile-Ser-Ser-Leu-Gln-
 Pro-Glu-Asp-Ile-Ala-Thr-Tyr-Tyr-Cys-
 FR-4 -Phe-Gly-Gln-Gly-Thr-Lys-Val-Glu-Ile-Lys-

30

heavy chain

FR-1 -Gln-Val-Gln-Leu-Val-Gln-Ser-Gly-Ala-Glu-Val-Lys-Lys-
 Pro-Gly-Ala-Ser-Val-Lys-Val-Ser-Cys-Lys-Ala-Ser-Gly-
 5 Tyr-Thr-Phe-Thr (Ser)-
 FR-2 -Trp-Val-Arg (His) -Gln-Ala (Lys, His) -Pro (Val) -Gly-Gln-
 Gly-Leu-Glu-Trp-Ile (Val, Leu) -Gly-
 FR-3 -Lys (Arg, His) -Ala (Val, Pro, Gly) -Thr-Met-Thr-
 Val (Ala, Pro, Gly) -Asp-Thr-Ser-Thr-Asn-Thr-Ala-Tyr-Met-
 10 Glu (Asn) -Leu-Ser-Ser-Leu-Arg-Ser-Glu-Asp-Thr-Ala-Val-
 Tyr-Tyr-Cys-Ala-Ser-
 FR-4 -Trp-Gly-Gln-Gly-Thr-Leu-Val-Thr-Val-Ser-Ser

Moreover, the invention relates to a process for the prepara-
 15 tion of a chimeric monoclonal antibody having the biological
 function of binding to epitopes of the EGF-receptor, compris-
 ing hypervariable regions (CDRs) of antigen-binding sites and
 FRs of variable regions of murine origin and FRs of
 variable regions of murine origin and constant regions of the
 20 light and heavy chains of human origin by cultivating trans-
 formed host cells in a culture medium and purification and
 isolation the expressed antibody proteins, characterized in
 that the host cells are transformed with expression vectors
 according to one of the expression vectors.

25 Furthermore, the invention relates to a pharmaceutical compo-
 sition comprising a humanized or chimeric monoclonal anti-
 body.

30 Furthermore, the invention relates to the use of humanized or
 chimeric antibody for the manufacture of a medicament
 directed to tumors.

Finally, the invention relates to the use of humanized or chimeric antibody for diagnostic locating and assessing tumor growth.

5 To sum up, the invention relates to a monoclonal antibody comprising a consensus sequence of variable regions of a heavy chain of a class or a subgroup of human immunoglobulins.

10 The entire disclosures of all applications, patents and publications, if any, cited above and below, and of corresponding European Patent application 91 103 389.2, filed March 6, 1991, are hereby incorporated by reference.

15 Microorganisms and plasmids used in the invention:

(a) prVL425 (= HCMV-RV_b425-k), deposited on February 1, 1991, according to the Budapest Treaty at the Deutsche Sammlung von Mikroorganismen (DSM) under the accession No.
20 DMS 6340. The expression vector contains the sequences of the hypervariable regions (CDRs) of the murine antibody 425 and the FRs of the variable region and the constant (kappa) region of the light chain of the humanized antibody. R is standing for "reshaped".

25 (b) prVH425 (= HCMV-RV_{Hg}425-γ), deposited on February 1, 1991, according to the Budapest Treaty at the Deutsche Sammlung von Mikroorganismen (DSM) under the accession No.
30 DSM 6339. The expression vector contains the sequences of the hypervariable regions (CDRs) of the murine antibody

425 and the FRs of variable region and constant (gamma-1) region of the heavy chain of the humanized antibody. R is standing for "reshaped".

5 (c) **pCVL425 (= HCMV-CV_L425-k)**, deposited on February 1, 1991, according to the Budapest Treaty at the Deutsche Sammlung von Mikroorganismen (DSM) under the accession No. DSM 6338. The expression vector contains the sequences of the FRs and hypervariable regions (CDRs) of the light
10 chain variable region of the murine antibody 425 and the constant (kappa) region of the light chain of human immunoglobulin. C is standing for chimeric.

15 (d) **pCVH425 (= HCMV-CV_H425-γ)**, deposited on February 1, 1991, according to the Budapest Treaty at the Deutsche Sammlung von Mikroorganismen (DSM) under the accession No. DSM 6337. The expression vector contains the sequences of the FRs and hypervariable regions (CDRs) of the light
20 chain variable region of the murine antibody 425 and the constant region of the light chain of the human gamma-1 immunoglobulin. C is standing for chimeric.

25 (e) **Hybridoma cell line 425**, deposited on January 26, 1988, according to Budapest Treaty at the American Type Culture Collection (ATCC) under the accession No. HB 9629. The cell line produces the murine antibody 425 which is directed to the EGF-receptor.

30

Other biological materials:

5 Other microorganisms, cell lines, plasmids, promoters, resistance markers, replication origins or other fragments of
vectors which are mentioned in the application are commercially or otherwise generally available. Provided that no
10 other hints in the application are given, they are used only as examples and are not essential according to the invention and can be replaced by other suitable tools and biological materials, respectively.

Bacterial hosts are preferably used for the amplification of the corresponding DNA sequences. Examples for these host are:
15 E. coli or Bacillus.

Eukaryotic cells like COS (CV1 origin SV40) or CHO (Chinese hamster ovary) cells or yeasts, for example, are preferred in order to produce the humanized and chimeric antibodies according to the invention. COS and CHO cells are preferred.
20

General methods for manufacturing:

The techniques which are essential according to the invention are described in detail in the specification.
25

Other techniques which are not described in detail correspond to known standard methods which are well known to a person skilled in the art or are described more in detail in the cited references and patent applications and in standard
30 literature.

Brief descriptions of the Figures

- 5 **Fig. 1** Schematic representations of the vectors used for the expression of chimeric and reshaped human antibodies. Restriction sites used in the construction of the expression plasmids are marked. The variable region coding sequences are represented by the dark boxes, constant regions by the light boxes, the HCMV promoter and enhancer by the hatched boxes, and the nucleotide fragment from the plasmid pSVneo by the speckled boxes. The directions of transcription are represented by arrows.
- 10
- 15 **Fig. 2** The nucleotide and amino acid sequences of the V_H425 (A), and V_L425 (B) cDNA as cloned into pUC18. The amino acids contributing to the leader are underlined and CDRs are indicated by brackets. The splice sites between the variable regions and constant regions are also shown. The front and back PCR-primers and their annealing sites, used in the construction of the genes coding for the chimeric antibodies, are shown.
- 20
- 25 **Fig. 3** The nucleotide and amino acid sequences of the synthesized gene fragment coding for reshaped human V_Ha425. The leader sequence is underlined and residues contributing to the CDRs are bracketed.
- 30 **Fig. 4** Comparison of the amino acid sequences of mouse and reshaped human 425 variable regions. Panel A shows the sequences of mouse V_L (V_L425) and reshaped human V_LS (RV_La425 and RV_Lb425). Panel B shows the sequences

of mouse V_H (V_H425) and reshaped human V_H s ($RV_{Ha}425$,
 $RV_{Hb}425$, $RV_{Hc}425$, $RV_{Hd}425$, $RV_{He}425$, $RV_{Hf}425$, $RV_{Hg}425$,
 $RV_{Hh}425$, and $RV_{Hi}425$). The FRs and CDRs are indicated.
Amino acids are numbered according to Kabat et al.,
1987.

5

Fig. 5 Molecular model of the mouse MAb 425 variable regions.

10

Fig. 6 Detection of binding to EGFR by ELISA. Antigen-binding activity was assayed in dilutions of transfected COS cell supernatants and plotted as optical density at 450 nm against concentration of IgG (quantitated by ELISA, see Materials and Methods). All versions of reshaped human V_H regions were cotransfected with $RV_{La}425$ and are represented as follows: $RV_{Ha}425$ Δ , $RV_{Hb}425$ \diamond , $RV_{Hc}425$ Δ , $RV_{Hd}425$ \otimes , $RV_{He}425$ \square , $RV_{Hf}425$ \boxtimes , $RV_{Hg}425$ \square , $RV_{Hh}425$ \circ , $RV_{Hi}425$ \ominus , $RV_{Hb}425$ co-transfected with $RV_{Lb}425$ is represented as \blacklozenge . A co-transfection of the chimeric $VL425$ and $VH425$ are represented as \bullet .

15

20

25

Fig. 7 Competition for binding to antigen. Panel A shows competition between labelled mouse 425 antibody and (1) unlabelled mouse 425 antibody (+) and (2) chimeric 425 antibody (\bullet) produced by COS cells after co-transfection with HCMV- CV_L425 -kappa and HCMV- C_H425 -gamma-1. Panel B shows competition between labelled mouse 425 antibody and (1) unlabelled mouse 425 antibody (+) and (2) the reshaped human 425 antibodies

30

produced by COS cells after co-transfection with HCMV-RV_La425-kappa and HCMV-RV_Hi425-gamma-1 (○), and with HCMV-RV_La425-kappa and HCMV-RV_Hg425-gamma-1 (□). In each case, the horizontal axis represents the concentration of inhibitor (ng/ml). The vertical axis represents percentage of inhibition of binding.

5

Fig. 8 An examination of the effects of different reshaped human V_L regions on antigen-binding. Panel A shows antigen-binding by reshaped human antibodies produced in COS cells transfected with HCMV-CV_L425-kappa and HCMV-CV_H425-gamma-1 (●), HCMV-RV_La425-kappa and HCMV-RV_Hg425-gamma-1 (□), HCMV-RV_Lb425-kappa and HCMV-RV_Hg425-gamma-1 (■), HCMV-RV_La425-kappa and HCMV-RV_Hc425-gamma-1 (Δ), and HCMV-RV_Lb425-kappa and HCMV-RV_Hc425-gamma-1 (▲). Panel B shows competition for binding to antigen between labelled mouse 425 antibody and (1) unlabelled mouse 425 antibody (+) and (2) reshaped human 425 antibodies produced in COS cells co-transfected with HCMV-V_La425-kappa and HCMV-V_Hg425-gamma-1 (□) and with HCMV-V_Lb425-kappa and HCMV-V_Hg425-gamma-1 (■). In panel A, the vertical axis represents the optical density at 450 nm (OD₄₅₀) and the horizontal axis represents the concentration of IgG (ng/ml). In panel B, the horizontal axis represents the concentration of inhibitor (ng/ml) and the vertical axis represents percentage of inhibition of binding.

10

15

20

25

30

5 **Fig. 9** Panel A: Analysis of reshaped (lanes 1, 2), chimeric (lane 3) and murine (lane 4) MAb 425 by SDS-PAGE under non-reducing conditions (a) and under reducing conditions (b). Reshaped (lanes 7, 8), chimeric (lane 9) and murine (lane 10). Lanes 5, 6, 11, and 12 are MW markers.

Panel B: Purification by gel filtration of reshaped MAb 425 on Superose 12. Peak 2 represents IgG.

10

Fig. 10 Competitive binding of murine, chimeric and reshaped MAb 425 to EGF-receptor (EGFR). The vertical axis represents the ratio bound (Mab) to total (Mab) in % (% bound/total). The horizontal axis represents the concentration of antibody (mol/l [log]).

15

∇ means MAb 425 murine
○ means MAb 425 chimeric
●, ▼ mean MAb 425 reshaped

20

Fig. 11 Competition of EGF and antibodies to EGF-receptor. The vertical axis represents % bound/total (Mab). The horizontal axis represents the concentration of antibody (mol/l [log]).

25

○ means MAb 425 murine
Δ, ∇, □ mean MAb 425 reshaped

30

DETAILED DESCRIPTION

Cloning and sequencing of variable region genes of MAb 425:

5 From the cDNA synthesis and cloning using the kappa chain primer, 300-400 colonies are preferably picked for screening. From the cDNA synthesis and cloning using the gamma-2a primer, 200-300 colonies are preferably for screening. After screening by hybridization using the two respective cloning
10 primers, 20-30 light chain colonies and 10-20 heavy chain colonies give strong signals. Plasmid DNA is isolated from these colonies and analyzed by usual and commercially available restriction enzyme digests to determine the size of the cDNA inserts. Clones that appear to have inserts 400-500 bp
15 or 500-600 bp for V_L and V_H cloning, respectively, are selected as candidates for sequencing. Three V_L clones and three V_H clones are sequenced on both strands using M13 universal and reverse sequencing primers. Of the three possible V_L clones sequenced, one codes for a complete variable
20 region and the others appears to code for unrelated peptides. Two of the V_H clones code for identical V_H regions while the other appears to code for the V_H region with the intron between the leader sequence and FR-1 still present. Apart
25 from the intron, the third V_H clone contains coding sequence identical to that of the first two clones. To verify the sequence of the V_L region, three more cDNA clones containing inserts of the appropriate size are sequenced. Two of these give sequences in agreement with the first V_L clone. The third
30 is an unrelated DNA sequence. In the clones sequenced, not

all of the original primer sequence are present. The extent of the deletions varies from clone to clone. These deletions, which probably occur during cDNA synthesis and cloning, may decrease the efficiency of the colony screening.

5

The V_L and V_H genes for MAb 425 are shown in Figure 2. The amino acid sequence of the 425 V_L and V_H regions, are compared to other mouse variable regions in the Kabat data base (Kabat et al., 1987). The V_L region can be classified into the mouse kappa chain variable region subgroup IV or VI. Within the FRs, the 425 V_L region has an approximately 86 % identity to the consensus sequence for mouse kappa subgroup IV and an approximately 89 % identity to subgroup VI. The 425 V_L region appear to use the JK4 segment. Examination of the VH region shows an approximately 98 % identity to the FRs of the consensus sequence for mouse heavy chain subgroup II (B).

10

15

20

The right choice of a suitable class or subgroup of human immunoglobulin is dependent on the extent of the identity to the originally present chain in the non-human antibody. The identity of the deduced consensus sequence according to the present invention should be greater than 65 to 70 % compared with the sequence of the original non-human chain.

25

30

The consensus sequences of the heavy chains are preferred especially, however, the consensus sequence of human heavy chain subgroup I. However, for other antibodies, the consensus sequences of other human heavy chains are suitable. The preferred consensus sequences are modified. The possible exchange of amino acids is 0 to 10 % according to the invention, preferably 5 to 10 %.

Construction and expression of chimeric 425 antibody:

Before the cDNAs coding for the VL and VH regions can be used in the construction of chimeric 425 antibody, it is necessary to introduce several modifications at the 5'- and 3' ends. These include introducing appropriate restriction enzyme sites so that the variable region coding sequences can be conveniently subcloned into the HCMV expression vectors. It is necessary to re-create donor splice sites in the 3'-flanking regions so that the variable regions are spliced correctly and efficiently to the constant regions. The 5'-flanking regions are also modified to include a sequence that would create efficient initiation sites for translation by eukaryotic ribosomes (Kozak, 1987). These modifications are introduced using PCR primers. The used primers are indicated in Table 1.

Table 1 Oligonucleotides used for cDNA cloning, construction of chimerics, and mutagenesis. Underlined sections denote bases that anneal to the human framework.

<u>Number</u>	<u>Sequence</u>	<u>Description</u>
1.	5'-GTAGGATCCTGGATGGTGGGAAGATG-3'	Light chain primer for cDNA synthesis.
2.	5'-GTAGGATCCAGTGGATAGACCGATG-3'	Heavy chain primer for cDNA synthesis.
3.	5'-CTCCAAGCTTGACCTCACCATGG-3'	Chimeric V _H front primer.

<u>Number</u>	<u>Sequence</u>	<u>Description</u>
	4. 5'-TTGGATCCACTCACCTGAGGAGACTGTGA-3'	Chimeric V _H back primer.
5	5. 5'-AGAAAGCTTCCACCATGGATTTTCAAGTG-3'	Chimeric V _L front primer.
	6. 5'-GTAGATCTACTCACGTTTTATTCCAAC-3'	Chimeric V _L back primer.
10	7. 5'- <u>ACCATCACCTGTAGTGCCAGCTCAAGTGTAACTTACATGTATTGGTACCAGCAG</u> -3'	Reshaped V _L CDR-1 primer.
	8. 5'- <u>CTGCTGATCTACGACACATCCAACCTGGCTTCTGGTGTGCCAAGC</u> -3'	Reshaped V _L CDR-2 primer.
15	9. 5'- <u>ACCTACTACTGCCAGCAGTGGAGTAGTCA-CATATTCACGTTGGCCAA</u> -3'	Reshaped V _L CDR-3 primer.
	*	
	10. 5'-AGCGGTACCGACTACACCTTCACCATC-3'	Primer to introduce F71Y into RV _L .
	* *	
20	11. 5'-ATACCTTCACATCCCCTG-3'	Primer to introduce S30T into RV _H .
	* *	
25	12. 5'-CGAGTGGATTGGCGAGT-3'	Primer to introduce V48I into RV _H .
30		

<u>Number</u>	<u>Sequence</u>	<u>Description</u>
13.	5'-TTTAAGAGCAAGGCTACCATGACCGTGGA- CACCTCT-3'	Primer to intro- duce R66K, V67A, L71V into RV _H .
14.	5'-CATGACCGTGGACACCTCT-3'	Primer to intro- duce L71V into RV _H .

For each variable region cDNA two primers are preferably designed. In the front primers, 15 bases at the 3'-end of the primer are used to hybridize the primer to the template DNA while the 5'-end of the primer contains a HindIII site and the "Kozak" sequence. The back primers have a similar design with 15 bases at the 3'-end used to hybridize the primer to the template DNA and the 5'-end of the primer contains a BamHI site and a donor splice site. In the case of the light chain back primer, a BglII site is used instead of BamHI site because the cDNA coding for the V_L contains an internal BamHI site (Figure 2). The PCR reaction is preferably carried out as described in the examples.

The PCR-modified V_L region DNA is cloned into the HindIII-BamHI sites of the HCMV light chain expression vector as a HindIII-BglII fragment. This vector already contains the human genomic kappa constant region with the necessary splice acceptor site and poly(A⁺) sites. The entire PCR-modified V_L fragment is sequenced using two primers that anneal to sites flanking the cloning site in the expression vector. Sequencing confirms that no errors have been incorporated during the

PCR step. The PCR-modified V_H DNA is cloned into the HCMV heavy chain expression vector as a HindIII-BamHI fragment and also sequenced to confirm the absence of PCR errors. A BamHI fragment containing the human genomic gamma-1 constant region is inserted into the HCMV-CV_H vector on the 3'-side of the V_H region. This fragment contains the necessary acceptor splice site for the V-C splice to occur in vivo and the naturally occurring poly(A⁺) site.

The expression vectors containing the chimeric 425 V_L and V_H regions are co-transfected into appropriate eukaryotic cells, preferably COS cells. After approximately 72 h of transient expression, the cell culture medium is assayed by ELISA for human IgG production and for binding to EGFR protein. Amounts of human IgG detected in the media vary from 100-400 ng/ml. The chimeric antibody produced binds well to EGFR protein in a standard antigen-binding ELISA thus confirming that the correct mouse variable regions has been cloned and sequenced.

Initial design, construction and expression or reshaped human 425 light and heavy chains:

In designing a reshaped human 425 antibody, most emphasis is placed on the V_H region since this domain is often the most important in antigen-binding (Amit et al., 1986; Verhoeyen et al., 1988). To select the human FRs on which to graft the mouse CDRs, the FRs of mouse MAb 425 V_H region are compared with the FRs from the consensus sequences for all subgroups

30

of human V_H regions (Kabat et al., 1987). This comparison shows that the FRs of mouse MAb 425 V_H are most like the FRs of human V_H subgroup I showing an approximately 73 % identity within the FRs and an approximately 65 % identity over the entire V_H regions.

A further comparison of the mouse 425 V_H region with other mouse V_H regions from the same Kabat subgroups is carried out to identify any FR residues which are characteristic of MAb 425 and may, therefore, be involved in antigen binding. The residue at position 94 of the mouse MAb 425 V_H region is a serine while in other V_H regions from mouse subgroup II (B), and also from human subgroup I, residue 94 is an arginine (Kabat et al., 1987). This amino acid substitution is an unusual one and, since position 94 is adjacent to CDR-3, it is at a surprisingly important position. For these reasons, the reshaped human 425 V_H region is preferably designed based on the CDRs of mouse MAb 425 and FRs derived from the consensus sequence for human subgroup I FRs (as defined by Kabat et al., 1987). Position 94 in FR-3 is made a serine as found in mouse MAb 425. At positions in the consensus sequence for human subgroup I FRs where no single amino acid are listed, the most commonly occurring amino acid at that position is selected. If there is no preferred amino acid at a particular position in the human consensus sequence, the amino acid that is found at that position in the sequence of mouse MAb 425 V_H is selected. The resulting amino acid sequence comprises the first version (versions "a") of reshaped human 425 V_H (Figure 3). All subsequent versions of reshaped human 425 V_H are modifications of this first version.

A 454 bp DNA fragment coding for the reshaped human 425 V_H region, as described above, is designed and synthesized (see examples and Figure 3). In addition to DNA sequences coding for the amino acids of reshaped human 425 V_H region, this DNA
5 fragment also contains sequences coding for a human leader sequence. The human leader sequence can be taken for example from antibody HG3 CL (Rechavi et al., 1983), a member of human V_H subgroup I (Kabat et al., 1987). The synthetic DNA
10 fragment also contains eukaryotic translation signals at the 5'-end (Kozak, 1987), a donor splice site at the 3'-end (Breathnach et al., 1978), and HindIII and BamHI sites at the 5'- and 3'-ends, respectively, for subcloning into the HCMV expression vector.

15 A similar procedure is carried out for the design of the reshaped human 425 V_L region. The FRs of mouse MAb 425 V_L region are compared with the consensus sequences for all the subgroups of human V_L regions (Kabat et al., 1987). Within the
20 FRs, an approximately 71 % identity is found between mouse 425 V_L and human kappa V_L subgroup III, and an approximately 70 % identity with human kappa V_L subgroup I. DNA coding for human FRs of human kappa V_L subgroup I is already available from the reshaped human D1.3 V_L region (EP 239 400, Winter)
25 and reshaped human CAMPATH-1 (Reichmann et al., 1988). The design of the reshaped human V_L regions in these two human antibodies is based on the structurally-solved human immunoglobulin REI protein (Epp et al., 1975). For these reasons, the human V_L FRs from reshaped human D1.3 and CAMPATH-1H are
30 also used in reshaped human 425 V_L. A comparison of the FRs of mouse 425 V_L region with FRs of other mouse antibodies from

similar subgroups reveal no significant differences in amino acid residues at functionally important positions. No changes in the human FRs are necessary therefore. The amino acid sequence of the reshaped human 425 V_L region version "a" is
5 shown in Figure 4.

To construct the reshaped human 425 V_L region, three oligonucleotides are designed that contain internal DNA sequences coding for the three CDRs of mouse 425 V_L region and also
10 contain 12 bases at the 5'- and 3'-ends designed to hybridize to the DNA sequences coding for the human FRs in reshaped human D1.3 V_L region (see oligonucleotides 7-9 in Table I). CDR-grafting is carried as described in the examples. After
15 DNA sequencing of putative positive clones from the screening, the overall yield of the triple mutant is 5-15 %, preferably 9-10 %. A reshaped human 425 V_L region containing no PCR errors is cloned as a HindIII-BamHI fragment into the light chain expression vector to create the plasmid HCMV-
20 RV_La425-kappa (Figure 1).

The two expression vectors bearing the reshaped human 425 V_L and V_H regions are now co-transfected into appropriate cells (see above) to look for transient expression of a functional
25 reshaped human 425 antibody. After approximately 72 h, the cell supernatants are harvested and assayed by ELISA for human IgG. Human IgG can be detected at levels ranging from 100-500 ng/ml, however, in the ELISA assay for antigen binding, binding to EGFR is surprisingly undetectable. When the
30 cells are co-transfected with HCMV-RV_La425-kappa/HCMV-CV_H425-

gamma-1, human IgG is produced and it binds to EGFR. However, when cells are co-transfected with HCMV-CV_L425-kappa/HCMV-RV_Ha425-gamma-1, human IgG is produced but it does not bind to EGFR at detectable levels. From these unexpected results, it is clear that further inventive modifications in the FRs of reshaped human 425 V_H are necessary in order to get a functional antigen-binding site.

Modifications in the FRs of reshaped human 425 V_H region:

Further changes in the FRs of reshaped human 425 V_H region are made based on a molecular model of the mouse 425 variable region domains. The CDR loops of the reshaped human V_H region are examined to see how they fit into the canonical structures described by Chothia et al., 1989. As a result of this analysis, certain changes in the FRs are made. Other changes in the FRs are made based on a functional reshaped human anti-Tac antibody that was also designed based on human FRs from subgroup I (Queen et al., 1989). Surprisingly, the V_H region of mouse anti-Tac antibody is approximately 79 % identical to the V_H region of mouse 425 antibody. Now, according to the invention, a molecular model of the mouse 425 variable regions is made (Figure 5). The model is based on the structure of HyHEL-5, a structurally-solved antibody whose variable regions exhibit a high degree of homology to those of mouse 425 antibody. As a result of the above analysis, amino acid residues at positions 30, 48, 67, 68 and 71

30

in the reshaped human 425 V_H region are changed to be identical to the amino acids occurring at those positions in mouse 425 V_H region. To dissect the individual effects of these changes, a variety of combinations of these changes are constructed and tested according to the invention.

In total, 8 new versions of the reshaped human 425 V_H region are constructed (see Figure 4). From the versions generated by the methods described in detail in the examples, other versions are made by recombining small DNA fragments from previous versions. Once all the desired versions are assembled preferably in pUC18, the reshaped human 425 V_H regions are transferred as HindIII-BamHI fragments into the HCMV-V_H expression vector thus generating versions "b" to "i" of plasmid HCMV-RV_H425-gamma-1 (Figure 4).

Modifications in the FRs of reshaped human 425 V_L region:

Although the corresponding cells co-transfected with vectors expressing the reshaped human 425 light chain, version "a", and chimeric 425 heavy chain do produce an antibody that bound to EGFR, the antibody with the reshaped human 425 light chain does not appear to bind as well as chimeric 425 antibody. Examination of the V_L regions of mouse 425 and reshaped human 425 version "a" reveal that residue 71, which is part of the canonical structure for CDR-1 (L1), is not retained in version "a" (Chothia et al., 1989). The PCR-mutagenesis

30

method (Kamman et al., 1989) is preferably used to introduce a Phe to Tyr change at this position. The HindIII-BamHI fragment generated from this mutagenesis is introduced into the HCMV-V_L expression vector to generate HCMV-RV_Lb425-kappa
5 (Figure 4).

Analysis of the new versions of reshaped human 425 V_H region:

The expression vectors containing reshaped human V_H versions
10 "a" to "i" are co-transfected into the above characterized cells with the expression vector containing reshaped human V_L region version "a". After about 3 days, the cell supernatants are analyzed by ELISA for human IgG production. Levels of
15 production vary between 50-500 ng/ml. The samples are then analyzed by ELISA for human IgG capable fo binding to EGFR. The different versions of reshaped human V_H regions result in a wide variety of levels of antigen binding (Figure 6). In
20 this ELISA assay for antigen binding, the various reshaped human 425 antibodies can be directly compared with chimeric 425 antibody, but no to mouse 425 antibody. This is because the antibody used to detect binding to antigen is an anti-human IgG antibody. The nine versions of reshaped human V_H
25 region can be grouped according to their ability to bind to EGFR. Reshaped human V_H region version "g" and "i" provide the highest levels of binding, followed by version "c", "f", and "h", and then followed by version "b". In some experiments, version "e" gives low, but detectable, levels of binding. Versions "a" and "d" never give detectable levels of binding.
30

A competition binding assay is used to directly compare the reshaped human 425 antibodies containing versions "g" and "i" of V_H , and the chimeric 425 antibody, to mouse 425 antibody (Figure 7). Since the antibodies in the cell supernatants are not purified and are, therefore, quantitated by ELISA, the results from the competition-binding assay are regarded as giving relative levels of binding rather than an accurate quantitation of affinity. Competition binding assays with samples from four experiments in, for example, COS cells provide consistent results with respect to relative levels of binding to antigen. Chimeric 425 antibody compete well with the labelled mouse 425 antibody and give a percent inhibition of binding just slightly less than that obtained when unlabelled mouse 425 antibody is competed with labelled mouse 425 antibody (Figure 7, Panel A). Reshaped human antibody with V_{L_a} and V_{H_g} is better than that with V_{L_a} and V_{H_i} region (Figure 7, Panel B). Comparison of the plateau points of the binding curves indicates that the reshaped human antibody with V_{H_g} competes with labelled mouse 425 antibody 60-80 % as well as the unlabelled mouse 425 antibody does in the same assay. When the results using samples from four independent experiments in, for example, COS or CHO cells were averaged, reshaped human antibody containing V_{L_a} and V_{H_g} give a binding that is 60-80 % that of mouse 425 antibody.

Based on these results, it is possible to comment on the relative contributions of individual residues in the FRs make to antigen binding. The most significant single change in this study is the L71V change. Without this change, surprisingly, no binding to antigen is detectable (compare versions

"a" and "b" of V_H). The R67K and V68A changes are, surprisingly, also important for binding (compare versions "b" and "c", and versions "i" and "h" of V_H). While introduction of V48KI change alone, and V48I and S30T together, fail to produce significant antigen binding, changes at these positions do enhance antigen binding. The S30T change, surprisingly seems to have a greater effect than the V48I change (compare versions "g" and "i", and versions "f" and "i" of V_H).

Analysis of the new version of reshaped human 425 V_L region:

The expression vector containing the RV_{Lb425} was co-transfected into appropriate preferably eukaryotic cells with the expression vector containing reshaped human V_H region versions "b", "c" or "g". Cell supernatants are harvested and assayed for human IgG production and then for human IgG capable of binding to EGFR (Figure 8, Panel A). These results show that version "b" of reshaped human 425 V_L region increases the binding to antigen. A competition binding assay is then carried out to compare reshaped human 425 antibodies with V_{La} plus V_{Hg} and V_{Lb} plus V_{Hg} to mouse 425 antibody. Reshaped human MAb 425 with version "b" of the V_L region has a greater avidity for antigen. Thus, a F71Y change in the V_L increases antigen binding. The reshaped human MAb 425 with V_{Lb} and V_{Hg} has an avidity for antigen 60-80 % of that of the murine MAb 425.

From other experiments, using a reshaped human antibody containing V_L b plus V_H g (Examples 10, 11) it can be seen, that the binding potency to EGFR is similar for chimeric, reshaped and murine antibodies.

5

The invention demonstrates that relatively conservative changes in the FR residues can strongly influence antigen-binding.

10

The molecular model of mouse 425 variable regions clearly shows this residue at position 30 in V_H to be on the surface of the molecule, in the vicinity of CDR-1. In fact, H1, as defined by Chothia and Lesk, 1987, extends from residues 26 to 32, thus encompassing the residue at position 30. When the

15

residue at position 30 is changed from Ser to Thr in the CAMPATH-1H antibody, it has no effect on antigen binding. When position 30 is changed from Ser to Thr in reshaped human V_H 425, binding to antigen is improved. It appears that the amino acid at position 30 does play a role in antigen binding in this particular antibody-antigen interaction. Since the S30T change only improves antigen binding slightly and since the change is not essential for antigen binding, the Thr at position 30 has only a weak interaction with the antigen.

20

25

The residue change at position 71 in V_H strongly influences antigen binding. This is surprising since the two residues tested at this position, Val and Leu, only differ by one methyl group. H2 of mouse 425 antibody is a member of H2, group 2 canonical structures as defined by Chothia et al.,

30

1989. HyHEL-5 has an H2 with an amino acid sequence similar to that of the H2 of mouse 425 antibody. In HyHEL-5, a Pro at

position 52A in CDR-2 packs into a cavity created by the small amino acid (Ala) at position 71 in the FRs. In the model of the mouse 425 variable regions, there is a similar interaction between Pro-52A and Val-71. Although in mouse 425 V_H the Pro at position 52A is able to pack into the cavity created by Val at position 71, replacement of Val-71 with a Leu causes molecular clashing that could alter the conformation of the CDR-2 loop. For this reason, the V71L change in reshaped human VH425 re-creates the CDR-2-FR interaction as it occurs in mouse 425 V_H. This, surprisingly, greatly improves the antigen-binding properties of the reshaped human 425 antibodies (compare reshaped human antibodies with versions "a" and "b" of V_H in Figure 6).

The change at position 71 in V_L probably affects CDR conformation because residue 71 is a member of the proposed canonical structure for L1 (CDR-1) (Chothia et al., 1989). Residue 29 in CDR-1 is a buried residue and has a contact with residue 71 in the FRs. In mouse 425 antibody, residue 71 in V_L is Tyr. In the human FRs used for constructing the reshaped human V_Ls, it is a Phe. It appears that the hydroxyl group found in Tyr, but not in Phe, has a role in maintaining the correct conformation of CDR-1.

From the molecular model of the mouse 425 variable regions, it appears that Lys-66 forms a salt bridge with Asp-86. Introduction of larger Arg residue at position 66 would disrupt the structure. Ala-67 may interact with CDR-2 and simultaneously changing residues 66 and 67 to Arg and Val, as in V_Ha425, could have an adverse steric effect on CDR-2. The

residue at position 48 is known to be buried (Chothia and Lesk, 1987), and the model confirms this. Changing residue 48 from an Ile, as found in mouse 425 antibody, to a Val, as found in human V_H regions of subgroup I, could affect antigen binding by generally disrupting the structure. The amino acid at position 48 is also close to CDR-2 and may have a subtle steric effect on the CDR-2 loop.

From the competition binding studies, the best reshaped human V_L and V_H regions are V_Lb and V_Hg. V_Hg has all 5 of the FR changes discussed above plus the change at position 94 that is included in the first version of reshaped human 425 V_H region. The FRs in version "b" of reshaped human 425 V_L region are 70 % identical to those in mouse 425 V_L region. The FRs in version "g" of reshaped human 425 V_H region are 80 % identical to those in mouse.

Therapeutic and diagnostic use of the antibodies:

The antibodies according to the invention can be administered to human patients for therapy or diagnosis according to known procedures. Typically the antibody, or antibody fragments, will be injected parenterally, preferably intraperitoneally. However, the monoclonal antibodies of the invention can also be administered intravenously.

Determination of appropriate titers of antibody to administer is well within the skill of the art. Generally, the dosage ranges for the administration of the monoclonal antibodies of the invention are those large enough to produce the desired tumor suppressing effect. The dosage should not be so large

as to cause adverse side effects, such as unwanted cross reactions, anaphylactic reactions, and the like. Generally, the dosage will vary with the age, condition, sex and extent of the disease in the patient and can be determined by one of
5 skill in the art. The dosage can be adjusted by the individual physician in the event of any counter indications, immune tolerance or similar conditions. Dosage can vary from 0.1 mg/kg to 70 mg/kg, preferably 0.1 mg/kg to 500 mg/kg/dose, in one or more doses administrations daily,
10 for one or several days.

Preparations for parenteral administration includes sterile aqueous or non-aqueous solutions, suspensions, and emulsions. Examples of non-aqueous solvents are propylene glycol, poly-
15 ethylene glycol, vegetable oils such as olive oil, and injectable organic esters such as ethyl oleate. Aqueous carriers include water, alcoholic/aqueous solutions, emulsions or suspensions, including saline and buffered media. Parenteral vehicles include sodium chloride solution, Ring-
20 er's dextrose, dextrose and sodium chloride, lactated Ringer's or fixed oils. Intravenous vehicles include fluid and nutrient replenishers, electrolyte replenishers, such as those based on Ringer's dextrose, and the like. Preservatives and other additives may also be present such as for example,
25 antimicrobials, antioxidants, chelating agents, and inert gases and the like.

The antibodies can be conjugated to a toxin such as ricin subunit A, diphtheria toxin, or toxic enzyme. Alternatively it
30 can be radiolabelled according to known methods in the art. However, the antibody of the present invention display excellent cytotoxicity, in the absence of toxin, in the presence of effector cells, i.e. human monocytes.

.Solid tumors which can be detected and treated using the present methods include melanoma, glioma and carcinoma. Cancer cells which do not highly express EGFR-receptors can be induced to do so using lymphokine preparations. Also
5 lymphokine preparations may cause a more homogenous expression of EGF-receptors among cells of a tumor, leading to more effective therapy.

Lymphokine preparations suitable for administration include
10 interferon-gamma, tumor necrosis factor, and combinations thereof. These can be administered intravenously, Suitable dosages of lymphokine are 10,000 to 1,000,000 units/patient.

For diagnostic purposes the antibody can be conjugated to a
15 radio-opaque dye or can be radiolabelled. A preferred labeling method is the Iodogen method (Fraker et al., 1978). Preferably the antibody will be administered as F(ab')₂ fragments for diagnostic purposes. This provides superior results so that background subtraction is unnecessary.
20 Fragments can be prepared by known methods (e.g., Herlyn et al., 1983). Generally pepsin digestion is performed at acid pH and the fragments are separated from undigested IgG and heavy chain fragments by Protein A-Sepharose™ chromatography.

25 The reshaped human 425 antibodies according to the invention are less likely than either mouse or chimeric 425 antibodies to raise an immune response in humans. The avidity of the best version of reshaped human 425 antibody equals that of mouse or chimeric 425 antibody in the best embodiments of the
30 invention. Binding studies show that the potency to compete with EGF for binding to EGFR under optimized

conditions is the same for chimeric, reshaped and murine antibodies. Moreover, the reshaped human 425 antibodies are more efficacious, when used therapeutically in humans, than either the mouse or chimeric 425 antibodies. Due to the great
5 reduction in immunogenicity, the reshaped human 425 antibody has a longer half-life in humans and is the least likely to raise any adverse immune response in the human patient.

The results of the defined MAb 425 show that humanized monoclonal antibodies having an artificial consensus sequence do
10 not effect a remarkable minimum response. Further advantages are described above in the paragraph: Summary of the Invention.

15 Therefore, the value of the new antibodies of the invention for therapeutic and diagnostic purposes is extraordinarily high.

References cited in the specification:

- 20 Amit et al. (1986), Science 233, 747
Aviv et al. (1972), Proc. Nat. Acad. Sci. USA 69, 1408
Bernstein et al. (1977), J. Mol. Bio. 112, 525
Breathnach et al. (1978), Proc. Natl. Acad. Sci USA 75, 4853
25 Brooks et al. (1983), J. Comp. Chem 4, 187
Brüggemann et al. (1987), J. Exp. Med. 166, 1351
Carter et al. (1985), Oligonucleotide Sitedirected Mutagenesis in M 13, an Experimental Approach Manual, Anglian Biotechnology Ltd. Colchester
30 Chirgwin et al. (1979), Biochemistry 18, 5294
Chothia et al. (1987), J. Mol. Biol. 196, 901

- Chothia et al. (1989), Nature 342, 877
- Co et al. (1991), Proc. Natl. Acad. Sci. USA 88, 2869
- Cohen (1982), J. Biol. Chem. 258, 1523
- Downward et al. (1984), Nature 307, 521
- 5 Epp et al. (1975), Biochemistry 14, 4943
- Epp et al. (1983), Eur. J. Biochem. 133, 51
- Fraker et al. (1978), Biochem. Biophys. Res. Commun. 80, 849
- Gillis et al. (1990), Hum. Antibod. Hybridomas 1, 47
- Giorgi et al. (1983), Transplant. Proc. 15, 639
- 10 Gorman et al. (1991), Proc. Natl. Acad. Sci. USA 88, 4181
- Gubler et al. (1983), Gene 25, 263
- Hale et al. (1988), Lancet, ii, 1394
- Herlyn et al. (1983), Cancer Res. 43, 2731
- Hoggenboom et al. (1990), J. Immunol. 144, 3211
- 15 Jaffers et al. (1986), Transplantation 41, 572
- Jones et al. (1986), Nature 321, 14
- Kaariten et al. (1983), J. Immunol. 130, 937
- Kabat et al. (1987), Sequences of Proteins of Immunological Interest. US Dept. Health and Human Services, US Government Printing Offices
- 20 Kammann et al. (1989), Nucleic Acids Res. 17, 5404
- Koprowski et al. (1985), Somatic Cell and Mol. Genetics 11, 297
- Kozak (1987), J. Mol. Bio. 196, 947
- 25 Levy et al. (1987), Gene 54, 167
- Liu et al. (1987), Proc. Natl. Acad. Sci. USA 84, 3439
- LoBuglio et al. (1989), Proc. Natl. Acad. Sci. USA 86, 4220
- Maeda et al. (1991), Hum. Antibod. Hybridomas 2, 124
- Martin (1990), D. Phil. thesis, Oxford University
- 30 Martin et al. (1989), Proc. Natl. Acad. Sci. USA 86, 9268
- Mathieson et al. (1990), N. Eng. J. Med. 323, 250
- Murthy et al. (1987), Arch. Biochem. Biophys. 252, 549
- Nakamaye et al. (1986), Nucleic Res. 14, 9679

- Padlan et al. (1989), Proc. Natl. Acad. Sci. USA 86, 5938
Panka et al. (1988), Proc. Natl. Acad. Sci. USA 85, 3080
Queen et al. (1989), Proc. Natl. Acad. Sci. USA 86, 10029
Rabbitts et al. (1984), Curr. Top. Microbiol. Immunol. 113,
5 166
Rechavi et al. (1983), Proc. Natl. Acad. Sci. USA 80, 855
Reichmann et al. (1988), Nature 322, 21
Rodeck et al. (1987), Cancer Res. 47, 3692
Sayers et al. (1988), Nucleic Acid Res. 16, 791
10 Schreiber (1983), J. Biol. Chem. 258, 846
Sheriff et al. (1987), Proc. Natl. Acad. Sci. USA 84, 8075
Show et al. (1986), Proteins 1, 267
Suh et al. (1986), Proteins 1, 74
Sun et al. (1987), Proc. Natl. Acad. Sci. USA 84, 214
15 Sutcliffe (1988), Ph. D. thesis, London University
Takahashi et al. (1987), Cancer Res. 47, 3847
Takahashi et al. (1982), Cell 29, 671
Taylor et al. (1985a), Nucleic Acids Res. 13, 8749
Taylor et al. (1985b), Nucleic Acids Res. 13, 8764
20 Tempest et al. (1991), Biol. Technology 9, 266
Ulrich et al. (1984), Nature 309, 418
Verhoeyen et al. (1988), Science 239, 18
Verhoeyen et al. (1991), In Epenetos, A.A. (ed.), Monoclonal
Antibodies: Applications in Clinical Oncology, Chapman and
25 Hall, London, pp. 37
Ward et al. (1989), Nature 341, 544
Whittle et al. (1987), Protein Eng. 1, 499
Williams et al. (1990), Tibtech 8, 256

30

Example 1Molecular cloning sequencing:

5 Total RNA was isolated from cell line W425-15 (ACCT HB 9629)
which produces MAb 425. Approximately 9.6×10^7 cells were
used to produce total RNA using the guanidinium-CsCl method
(Chirgwin et al., 1979). Supernatants from the cells used for
total RNA isolation were assayed by ELISA to ensure that the
10 cells were producing the correct MAb in high amounts. Poly(A⁺)
RNA was prepared (Aviv and Leder, 1972). Double-stranded cDNA
was synthesized essentially according to the methods of
Gubler and Hoffman (1983) except that primers homologous to
the 5'-regions of the mouse kappa and gamma-2a immunoglobulin
15 constant regions were used to prime first-strand synthesis
(Levy et al., 1987). The design of the light chain primer was
a 26-mer (oligonucleotide 1, Table I) which was designed
based on published data (Levy et al., 1987; Kaariten et al.,
1983). The design of the heavy chain primer was a 25-mer
20 (oligonucleotide 2, Table I) and designed based on published
data (Kaariten et al., 1983; Kabat et al., 1987). Primers
were designed and synthesized on an Applied Biosystems 380B
DNA Synthesizer and purified on urea-acrylamide gels. After
second-strand synthesis, the blunt-ended cDNAs were cloned
25 into SmaI-digested pUC18 (commercially available) and trans-
formed into competent E. coli cells, e.g. DH5-alpha (commer-
cially available). Colonies were gridded onto agar plates and
screened by hybridization using ³²P-labelled first-strand
synthesis primers (Carter et al., 1985). Sequencing of dou-
30 ble-stranded plasmid DNA was carried out using Sequenase
(United States Biochemical Corporation).

Example 2Construction of chimeric genes:

5 For each variable region, a front 5' and back 3' polymerase
chain reaction (PCR) primer was synthesized (oligonucleotides
3-6, Table I). PCR reactions were set up using 1 ng of pUC18
plasmid DNA containing the cloned cDNA, front and back PCR
primers at a final concentration of 1 μ M each, 200 μ M of each
10 dNTP, 10 mM Tris-HCl (pH 8.3), 50 mM KCl, 1.5 mM MgCl, and
0.01 % gelatin (w/v). Amplitaq DNA polymerase (Perkin Elmer
Cetus) was added at 2.5 units per assay. After an initial
melt at 94 °C for 1.5 min, 25 cycles of amplification were
performed at 94 °C for 1 min, 45 °C for 1 min, and 72 °C for
15 3 min. A final extension step at 72 °C was carried out for
10 min. PCR reactions were phenol/chloroform extracted twice
and ethanol precipitated before digesting with HindIII and
BamHI. The PCR fragment coding for the V_L or V_H region was
then cloned into an expression vector. This vector contains
20 the HCMV (human cytomegalovirus) enhancer and promoter, the
bacterial neo gene, and the SV40 origin of replication. A
2.0 Kb BamHI fragment of genomic DNA coding for the human
gamma-1 constant region (Takahashi et al., 1982) was inserted
in the correct orientation downstream of the V_H region frag-
25 ment (see HCMV-CV_H425-gamma-1 in Figure 1). This vector was
later adapted by removing the BamHI site at the 3'-end of the
constant region fragment thus allowing variable regions to be
directly inserted into the heavy chain expression vector as
HindIII-BamHI fragments (Maeda et al., 1991). The fragment
30 coding for the V_L region was inserted into a similar HCMV

expression vector in this case containing a BamHI fragment of genomic DNA, approximately 2.6 Kb in size, coding for the human kappa constant region and containing a splice acceptor site and a poly(A⁺) (Rabbitts et al., 1984) (see HCMV-CV₁-425-kappa in Figure 1).

Example 3

Molecular modelling of MAb 425 V_L and V_H:

A molecular model of the variable regions of murine MAb 425 was built on the solved structure of the highly homologous anti-lysozyme antibody, HyHEL-5 (Sheriff et al., 1987). The variable regions of MAb 425 and HyHEL-5 have about 90 % homology.

The model was built on a Silicon Graphics Iris 4D workstation running UNIX and using the molecular modeling package "QUANTA" (Polygen Corp.). Identical residues in the framework were retained; non-identical residues were substituted using the maximum overlap (Snow and Amzel, 1986) incorporated into QUANTA's protein modeling facility. The main chain conformation of the three N-terminal residues in the heavy chain were substituted from a homologous antibody structure (HyHEL-10 (Padlan et al., 1989)) since their temperature factors were abnormally high (greater than the mean plus three standard deviations from the backbone temperature factors) and since they influence the packing of V_H CDR-3 (H3) (Martin, 1990).

5 The CDR-1 (L1) and CDR-2 (L2) sequences of the V_L region and
the CDR-1 (H1) and CDR-2 (H2) sequences of the V_H region from
Mab 425 corresponded to canonical forms postulated by Chothia
et al. (1989). The main chain torsion angles of these loops
10 were kept as in HyHEL-5. The CDR-3 (L3) sequence of the V_L
region and the CDR-3 (H3) of the V_H region from Mab 425 did
not correspond to canonical structures and, therefore, were
modeled in a different way. The computer program of Martin et
al. (1989) was used to extract loops from the Brookhaven
15 Databank (Bernstein et al., 1977). The loops were then sorted
based on sequence similarity, energy, and structure-determin-
ing residues (Sutcliffe, 1988). The top-ranked loops were
inspected on the graphics and the best selected by eye. H3
was modeled on bovine glutathione peroxidase (Epp et al.,
1983) in the region of residues 92-103. L3 was modelled on
the murine IgA (J539) Fab fragment (Suh et al., 1986) in the
region of residues 88-96 of the light chain.

20 The model was subjected to steepest descents and conjugate
gradients energy minimization using the CHARm potential
(Brooks et al., 1983) as implemented in QUANTA in order to
relieve unfavorable atomic contacts and to optimize Van der
25 Waals and electrostatic interactions.

30

Example 4Construction of humanized antibody genes:

5 The construction of the first version of the reshaped human
425 light chain was carried out using a CDR-grafting approach
similar to that described by Reichmann et al. (1988) and
Verhoeyen et al. (1988). Single-stranded template DNA was
prepared from a M13mp18 vector (commercially available)
10 containing a HindIII-BamHI fragment coding for the human
anti-lysozyme V_L region (EP 239 400, G. Winter). The FRs of
this light chain are derived from the crystallographically-
solved protein REI. Three oligonucleotides were designed
which consisted of DNA sequences coding for each of the mouse
15 MAb 425 light chain CDRs flanked on each end by 12 bases of
DNA complementary to the DNA sequences coding for the adja-
cent FRs of human REI (oligonucleotides 7-9 in Table I).
Oligonucleotides were synthesized and purified as before. All
three oligonucleotides were phosphorylated and used simulta-
20 neously in an oligonucleotide-directed in vitro mutagenesis
system based on the methods of Eckstein and coworkers (Taylor
et al., 1985; Nakamaye and Eckstein, 1986; and Sayers et al.,
1988). The manufacturer's instructions were followed through
the exonuclease III digestion step. The reaction was then
25 phenol/chloroform extracted, ethanol precipitated, and resus-
pended in 100 µl of TE. A volume of 10 µl was used as tem-
plate DNA in a 100 µl PCR amplification reaction containing
M13 universal primer and reverse sequencing primer to a final
concentration of 0.2 µM each. Buffer and thermocycling condi-
30 tions were as described in Example 2 with the exception of
using a 55 °C annealing temperature. The PCR reaction was
phenol/chloroform extracted twice and ethanol precipitated

before digestion with HindIII and BamHI and subcloning into pUC18. Putative positive clones were identified by hybridization to ³²P-labelled mutagenic primers (Carter et al., 1987). Clones were confirmed as positive by sequencing. A V_L region
5 containing all three grafted CDRs was cloned as a HindIII-BamHI fragment into the V_L expression vector to create the plasmid HCMV-RV_La425-kappa.

Version "b" of the reshaped V_L was constructed using the PCR
10 mutagenesis method of Kammann et al. (1989), with minor modifications. The template DNA was the RV_La subcloned into pUC18. The first PCR reaction was set up in a total volume of 50 µl and contained 1 ng template, M13 reverse sequencing
15 primer and primer 10 (Table I) at a final concentrations of 1 µM, 200 µM dNTPs, 10 mM Tris-HCl (pH 8.3), 50 mM KCl, 1.5 mM MgCl₂, and 0.01 % (w/v) gelatin. Amplitaq DNA polymerase was added at a concentration of 1 unit per assay. The reaction was set up in triplicate. After melting at 94 °C for 1.5 min,
20 the reactions were cycled at 1 min 94 °C, 1 min 37 °C, and 2 min 72 °C for 40 cycles, followed by an extension at 72 °C for 10 min. The reactions were pooled, phenol/chloroform extracted and ethanol precipitated before isolating the PCR product from a TAE agarose gel. A tenth of the first PCR
25 reaction was then used as one of the primers in the second PCR reaction. The second reaction was as the first except the first reaction product and 20 pmol of M13 universal primer were used. Cycling was as described by Kammann et al. (1989). The HindIII-BamHI fragment was cloned into pUC18 and
30 sequenced. A DNA fragment bearing the desired change was subcloned into the V_L expression plasmid to create plasmid HCMV-RV_Lb425-kappa.

The first version of the reshaped human V_H region of 425 was chemically synthesized. A DNA sequence was designed coding for the required amino acid sequence and containing the necessary flanking DNA sequences (see above). Codon usage was optimized for mammalian cells with useful restriction enzyme sites engineered into the DNA sequences coding for FRs. The 454 bp was synthesized and subcloned into pUC18 as an EcoRI-HindIII fragment. A HindIII-BamHI fragment coding for the reshaped humanized 425 heavy chain was then transferred into the V_H expression vector, to produce the plasmid HCMV-RV_Ha-425-gamma-1.

Eight other versions of the reshaped humanized heavy chains were constructed by a variety of methods. The HindIII-BamHI fragment coding for the version "a" of the heavy chain was transferred to M13mp18 and single-stranded DNA prepared. Using oligonucleotides 11-13 (Table I), PCR-adapted M13 mutagenesis, as described above, was used to generate DNA coding for reshaped human 425 V_H regions versions "d", "e", "f" and "g" in pUC18. These versions were subcloned into the heavy chain expression vector as HindIII-BamHI fragments to create plasmids HCMV-RV_Hd425-gamma-1, HCMV-RV_He425-gamma-1, HCMV-RV_Hf425-gamma-1, and HCMV-RV_Hg425-gamma-1.

Reshaped human 425 V_H regions versions "b" and "c" were generated using the PCR mutagenesis method of Kammann et al. (1989) as described above. The template DNA was reshaped human 425 V_H region version "a" subcloned into pUC18, and the mutagenic primer used in the first PCR reaction was either

primer 13 or 14 (Table I). After mutagenesis and sequencing, sequences bearing the desired changes were subcloned into the heavy chain expression plasmid to create plasmids. HCMV-RV_Hb425-gamma-1 and HCMV-RV_Hc425-gamma-1.

5

Reshaped heavy chain versions "h" and "i" were constructed from the pUC-based clones of existing versions. A 0.2 Kb HindIII-XhoI fragment from version "e" was ligated to a 2.8 Kb XhoI-HindIII fragment from either version "b" or "c" producing the new versions "h" and "i", respectively. The HindIII-BamHI fragments coding for these versions were subcloned into the heavy chain expression vector to produce the HCMV-RV_Hh425-gamma-1 and HCMV-RV_Hi425-gamma-1.

10

Example 5

Transfection of DNA into COS cells:

COS cells were electroporated with 10 µg each of the expression vectors bearing the genes coding for the heavy and light chains. Briefly, 10 µg of each plasmid was added to a 0.8 ml aliquot of a 1 x 10⁷ cells/ml suspension of COS cells in PBS. A Bio-Rad™ Gene Pulser was used to deliver a pulse of 1900 V, with a capacitance of 25 µF. The cells were left to recover at room temperature for 10 min before plating into 8 ml DMEM containing 10 % fetal calf serum. After 72 h incubation, the media was collected, centrifuged to remove cellular debris, and stored under sterile conditions at 4 °C for short periods, or at -20 °C for longer periods, prior to analysis by ELISA.

25
30

Example 6

The transfection of DNA into CHO cells was done according to Example 5.

5

Example 7

Quantification of IgG production and detection of antigen binding:

10

Human IgG present in COS cell supernatants was detected by ELISA: In the ELISA assay for human IgG, 96-well plates were coated with goat anti-human IgG (whole molecule) and human IgG in the samples that bound to the plates was detected using alkaline phosphatase-conjugated goat anti-human IgG (gamma-chain specific). Purchasable purified human IgG was used as a standard. Binding to the antigen recognized by MAb 425 was determined in a second ELISA. Plates were coated with an EGFR protein preparation (obtainable, for example, according to Rodeck et al., 1980) and antibodies binding to EGFR were detected using either an anti-human IgG (gamma-chain specific) peroxidase conjugate (for chimeric and reshaped human antibodies) or an anti-mouse IgG (whole molecule) peroxidase conjugate (for the mouse MAb 425 antibody) (both conjugates supplied by Sigma). Purified murine MAb 425 was used as a standard.

15

20

25

30

Example 8Competition binding assay:

5 Murine MAb 425 was biotinylated using a correspondingly
purchasable kit. ELISA plates were coated with an optimal
dilution of the EGFR protein. Dilutions of the COS cell
supernatants, in a volume of 50 μ l, were mixed with 50 μ l of
the biotinylated murine MAb 425 (estimated by ELISA to be
10 1.75 μ g/ml). Each COS cell supernatant was tested in dupli-
cate. Plates were incubated at room temperature, overnight.
Bound biotinylated murine MAb 425 was detected by the addi-
tion of a purchasable streptavidin horseradish peroxidase
complex. A control with no competitor present allowed a value
15 of percentage of inhibition or blocking to be calculated for
each COS cell supernatant as follows:

$$100 - [(OD_{450} \text{ of sample} / OD_{450} \text{ of control}) \times 100]$$

20 Example 9

Different probes of murine, reshaped and chimeric MAb 425
were analyzed by SDS-Polyacrylamide-Gelspaceelectrophoresis
(SDS-PAGE) according to Laemmli et al. 2.5 μ g of each sample
25 were applied to each well under non-reducing as well as under
reducing conditions. Protein was visualized by Coomassie
staining. Fig. 9 (A) shows that the samples have similar
purity.

30 MW range of the antibodies: 180,000 - 200,000.

Example 10

Reshaped MAb 425 was purified by gelspacefiltration on Superose 12™ (Pharmacia Corp. Sweden) according to standard methods. The antibody was eluted with PBS (pH 7.4, 0.8 M NaCl) (0.1 M). A single peak (at 5 min) can be obtained (Fig. 9 (B)).

Example 11

Biotin-labelled MAb 425 was used to compete with unlabelled MAb 425 or derivates for binding to EGFR. Biotin-labelling occurred according to standard methods. EGFR was solubilized from A431 membranes by standard methods. A431 cells were commercially purchased. Detection was done after incubation with POD-conjugated streptavidin and substrate. From this data inhibition curves were constructed (Fig. 10). The curves show that the binding of the various antibodies are comparable.

Example 12

Different probes of purified murine, chimeric and reshaped MAbs 425 were tested for their potency to compete with EGF regarding their binding to EGFR. The test was performed by competing ¹²⁵I-labelled EGF (Amersham Corp., GB) and various antibodies for binding to EGF-receptor positive membranes (A431). The test system is based on SPA technology (Amersham). The competition curves of the murine and the reshaped antibodies (3 probes) are nearly identical (Fig. 11).

b1

5

Patent Claims

- 10 1. Humanized monoclonal antibody comprising antigen binding sites (CDRs) of non-human origin, and the FRs of variable region and constant regions of light and heavy chains of human origin, characterized in that at least the FRs of the variable region of the heavy chain comprise a modified consensus sequence of different variable regions of
- 15 a distinct class or subgroup of a human immunoglobulin.
2. Humanized monoclonal antibody according to Claim 1, wherein the FRs of the consensus sequence has a homology of at least 70 % compared with the amino acid sequence of
- 20 the FRs of the variable regions of the non-human antibody from which the antigen binding sites originate.
3. Humanized monoclonal antibody according to Claim 1 or 2, having the following properties:
- 25 (a) binds to human EGF-receptors;
- (b) inhibits binding of EGF to EGF-receptor;
- (c) inhibits the EGF-dependent tyrosine kinase activity of EGF-receptor;
- 30 (d) inhibits the growth of EGF-sensitive cells.

4. Humanized monoclonal antibody according to Claim 3, wherein the hypervariable regions of the antigen binding sites comprise the following amino acid sequences:

5 **light chain**

CDR-1 -Ser-Ala-Ser-Ser-Ser-Val-Thr-Tyr-Met-Tyr-

CDR-2 -Asp-Thr-Ser-Asn-Leu-Ala-Ser-

CDR-3 -Gln-Gln-Trp-Ser-Ser-His-Ile-Phe-Thr-

10

heavy chain

CDR-1 -Ser-His-Trp-Met-His-

CDR-2 -Glu-Phe-Asn-Pro-Ser-Asn-Gly-Arg-Thr-Asn-Tyr-Asn-

15 Glu-Lys-Phe-Lys-Ser-

CDR-3 -Arg-Asp-Tyr-Asp-Tyr-Asp-Gly-Arg-Tyr-Phe-Asp-Tyr-

5. Humanized monoclonal antibody according to Claim 4, wherein the FRs of the variable region which is not related to the antigen binding sites comprise the following amino acid sequence:

20

light chain

25 FR-1 -Asp-Ile-Gln-Met-Thr-Gln-Ser-Pro-Ser-Ser-Leu-Ser-
 Ala-Ser-Val-Gly-Asp-Arg-Val-Thr-Ile-Thr-Cys-

FR-2 -Trp-Tyr-Gln-Gln-Lys-Pro-Gly-Lys-Ala-Pro-Lys-Leu-
 Leu-Ile-Tyr-

30

63

FR-3 -Gly-Val-Pro-Ser-Arg-Phe-Ser-Gly-Ser-Gly-Ser-Gly-
 Thr-Asp-Tyr (Phe, Trp, His) -Thr-Phe-Thr-Ile-Ser-Ser-
 Leu-Gln-Pro-Glu-Asp-Ile-Ala-Thr-Tyr-Tyr-Cys-
 FR-4 -Phe-Gly-Gln-Gly-Thr-Lys-Val-Glu-Ile-Lys-

5

heavy chain

FR-1 -Gln-Val-Gln-Leu-Val-Gln-Ser-Gly-Ala-Glu-Val-Lys-
 Lys-Pro-Gly-Ala-Ser-Val-Lys-Val-Ser-Cys-Lys-Ala-
 Ser-Gly-Tyr-Thr-Phe-Thr (Ser) -
 10 FR-2 -Trp-Val-Arg (His) -Gln-Ala (Lys, His) -Pro (Val) -Gly-
 Gln-Gly-Leu-Glu-Trp-Ile (Val, Leu) -Gly-
 FR-3 -Lys (Arg, His) -Ala (Val-Pro-Gly) -Thr-Met-Thr-
 Val (Ala, Pro, Gly) -Asp-Thr-Ser-Thr-Asn-Thr-Ala-Tyr-
 15 Met-Glu (Asn) -Leu-Ser-Ser-Leu-Arg-Ser-Glu-Asp-Thr-
 Ala-Val-Tyr-Tyr-Cys-Ala-Ser-
 FR-4 -Trp-Gly-Gln-Gly-Thr-Leu-Val-Thr-Val-Ser-Ser-,

and wherein the amino acids listed in the brackets are
 20 alternatives.

6. Humanized monoclonal antibody according to Claim 4 or 5,
 wherein the constant regions of the heavy chain comprise
 the amino acid sequence of a gamma-1 chain, and the
 25 constant regions of the light chain comprise the amino
 acid sequence of a kappa chain of a human immunoglobulin.
7. Humanized monoclonal antibody according to one of the
 Claims 3 to 6, comprising a derivate of an amino acid
 30 sequence modified by amino acid deletion, substitution,
 addition or inversion within the variable and constant
 regions wherein the biological function of specific
 binding to the antigen is preserved.

64

- 5 8. Expression vector, suitable for transformation of host cells, characterized in that it comprises a DNA sequence coding for the variable and/or constant regions of the light and/or heavy chains of a humanized antibody according to Claims 1 to 7.
- 10 9. Expression vector according to Claim 8, wherein the DNA sequences are coding for an antibody protein according to one of the antibodies of Claims 3 to 7.
- 15 10. Expression vector having the designation pRVL425, deposited at DSM under Accession No. DSM 6340.
- 15 11. Expression vector having the designation pRVH425, deposited at DSM under Accession No. DSM 6339.
- 20 12. Humanized or chimeric monoclonal antibody, comprising hypervariable regions (CDRs) of antigen binding sites of murine origin and the FRs of variable regions of human or murine origin and constant regions of light and heavy chains of human origin, characterized in that the hypervariable regions comprise the following amino acid sequences,
- 25 **light chain**
- CDR-1 -Ser-Ala-Ser-Ser-Ser-Val-Thr-Tyr-Met-Tyr-
CDR-2 -Asp-Thr-Ser-Asn-Leu-Ala-Ser-
CDR-3 -Gln-Gln-Trp-Ser-Ser-His-Ile-Phe-Thr-

30

65

heavy chain

CDR-1 -Ser-His-Trp-Met-His-
 CDR-2 -Glu-Phe-Asn-Pro-Ser-Asn-Gly-Arg-Thr-Asn-Tyr-Asn-
 5 Glu-Lys-Phe-Lys-Ser-
 CDR-3 -Arg-Asp-Tyr-Asp-Tyr-Asp-Gly-Arg-Tyr-Phe-Asp-
 Tyr-,

and wherein the constant regions of the heavy chain
 10 comprise the amino acid sequence of a gamma-1 chain, and
 the constant regions of the light chain comprise the
 amino acid sequence of a kappa chain of a human immuno-
 globulin.

15 13. Humanized monoclonal antibody according to Claim 12,
 wherein the FRs of the variable region which is not
 related to the antigen binding sites, are of human origin
 and comprise the following amino acid sequence,

20 **light chain**

FR-1 -Asp-Ile-Gln-Met-Thr-Gln-Ser-Pro-Ser-Ser-Leu-Ser-
 Ala-Ser-Val-Gly-Asp-Arg-Val-Thr-Ile-Thr-Cys-
 FR-2 -Trp-Tyr-Gln-Gln-Lys-Pro-Gly-Lys-Ala-Pro-Lys-Leu-
 25 Leu-Ile-Tyr-
 FR-3 Gly-Val-Pro-Ser-Arg-Phe-Ser-Gly-Ser-Gly-Ser-Gly-
 Thr-Asp-Tyr (Phe, Trp, His) -Thr-Phe-Thr-Ile-Ser-Ser-
 Leu-Gln-Pro-Glu-Asp-Ile-Ala-Thr-Tyr-Tyr-Cys-
 FR-4 -Phe-Gly-Gln-Gly-Thr-Lys-Val-Glu-Ile-Lys-

30

66

heavy chain

FR-1 -Gln-Val-Gln-Leu-Val-Gln-Ser-Gly-Ala-Glu-Val-Lys-
 Lys-Pro-Gly-Ala-Ser-Val-Lys-Val-Ser-Cys-Lys-Ala-
 5 Ser-Gly-Tyr-Thr-Phe-Thr (Ser) -

FR-2 -Trp-Val-Arg (His) -Gln-Ala (Lys, His) -Pro (Val) -Gly-
 Gln-Gly-Leu-Glu-Trp- Ile (Val , Leu) -Gly-

FR-3 -Lys (Arg, His) -Ala (Val, Pro, Gly) -Thr-Met-Thr-
 Val (Ala, Pro, Gly) -Asp-Thr-Ser-Thr-Asn-Thr-Ala-Tyr-
 10 Met-Glu (Asn) -Leu-Ser-Ser-Leu-Arg-Ser-Glu-Asp-Thr-
 Ala-Val-Tyr-Tyr-Cys-Ala-Ser-

FR-4 -Trp-Gly-Gln-Gly-Thr-Leu-Val-Thr-Val-Ser-Ser-

14. Chimeric monoclonal antibody according to Claim 12,
 15 wherein the FRs of the variable region which is not
 related to the antigen binding site, are of murine origin
 and comprise the following amino acid sequences:

light chain

20 FR-1 -Gln-Ile-Val-Leu-Thr-Gln-Ser-Pro-Ala-Ile-Met-Ser-
 Ala-Ser-Pro-Gly-Glu-Lys-Val-Thr-Met-Thr-Cys-

FR-2 -Trp-Tyr-Gln-Gln-Lys-Pro-Gly-Ser-Ser-Pro-Arg-Leu-
 Leu-Ile-Tyr-

25 FR-3 -Gly-Val-Pro-Val-Arg-Phe-Ser-Gly-Ser-Gly-Ser-Gly-
 Thr-Ser-Tyr-Ser-Leu-Thr-Ile-Ser-Arg-Met-Glu-Ala-
 Glu-Asp-Ala-Ala-Thr-Tyr-Tyr-Cys-

FR-4 -Phe-Gly-Ser-Gly-Thr-Lys-Leu-Glu-Ile-Lys-

30

67

heavy chain

- FR-1 -Gln-Val-Gln-Leu-Gln-Gln-Pro-Gly-Ala-Glu-Leu-Val-
Lys-Pro-Gly-Ala-Ser-Val-Lys-Leu-Ser-Cys-Lys-Ala-
5 Ser-Gly-Tyr-Thr-Phe-Thr-
- FR-2 -Trp-Val-Lys-Gln-Arg-Ala-Gly-Gln-Gly-Leu-Glu-Trp-
Ile-Gly-
- FR-3 -Lys-Ala-Thr-Leu-Thr-Val-Asp-Lys-Ser-Ser-Ser-Thr-
Ala-Tyr-Met-Gln-Leu-Ser-Ser-Leu-Thr-Ser-Glu-Asp-
10 Ser-Ala-Val-Tyr-Tyr-Cys-Ala-Ser-
- FR-4 -Trp-Gly-Gln-Gly-Thr-Thr-Leu-Thr-Val-Ser-Ser-

- 15 15. Expression vector, suitable for transformation of host cells, characterized in that it comprises DNA sequences coding for the variable and constant regions of the light and/or heavy chains of a humanized monoclonal antibody according to Claim 12 or 13, or of a chimeric monoclonal antibody according to Claim 12 or 14.
- 20 16. Expression vector having the designation pCVL425, deposited at DSM under Accession No. DSM 6338.
- 25 17. Expression vector having the designation pCVH425, deposited at DSM under Accession No. DSM 6337.
- 30 18. Process for the preparation of a humanized monoclonal antibody, comprising hypervariable regions (CDRs) of antigen binding sites of non-human origin, and FRs of the variable regions and constant regions of the light and heavy chains of human origin by cultivating transformed host cells in a culture medium and purification and isolation the expressed antibody proteins, characterized in

- 5 (a) synthesizing or partially synthesizing or isolating
an oligonucleotide sequence which codes for an amino
acid consensus sequence of different FRs of the vari-
able regions (FR-1 to FR-4) of a heavy chain of a
class or a subgroup of a human immunoglobulin,
wherein the used consensus sequence has a homology of
at least 70 % compared with the amino acid sequence
of the FRs of the variable regions of the non-human
antibody from which the antigen binding sites origi-
10 nate, and wherein the consensus sequence is modified
by alterations of maximum 10 % of the amino acids in
order to preserve the binding capability of the anti-
gen to the hypervariable regions;
- 15 (b) synthesizing or partially synthesizing or isolating
an oligonucleotide sequence which codes for an amino
acid consensus sequence under the conditions given in
(a) of different FRs of the variable regions (FR-1 to
FR-4) of a light chain of a class or a subgroup of a
20 human immunoglobulin, or, alternatively, which codes
for a corresponding natural occurring amino acid
sequence;
- 25 (c) in each case synthesizing or partially synthesizing
or isolating an oligonucleotide sequence which codes
for the amino acid sequence of the hypervariable
regions (CDRs) of the light and heavy chain corre-
sponding to the hypervariable regions of the basic
non-human antibody;
- 30

5 (d) in each case synthesizing or partially synthesizing or isolating an oligonucleotide sequence which codes for the amino acid sequence of the constant regions of the light and heavy chain of a human immunoglobulin;

10 (e) constructing one or several expression vectors comprising in each case at least a promoter, a replication origin and the coding DNA sequences according to (a) to (d), wherein the DNA sequences coding for the light and heavy chains can be present together in one or, alternatively, in two or more different vectors,

15 and finally,

(f) transforming the host cells with one or more of the expression vectors according to (e).

20 19. Process according to Claim 18, wherein DNA sequences are used coding for the following amino acid sequences which represent the hypervariable regions (CDRs):

light chain

25 CDR-1 -Ser-Ala-Ser-Ser-Ser-Val-Thr-Tyr-Met-Tyr-
CDR-2 -Asp-Thr-Ser-Asn-Leu-Ala-Ser-
CDR-3 -Gln-Gln-Trp-Ser-Ser-His-Ile-Phe-Thr-

30

70

heavy chain

CDR-1 -Ser-His-Trp-Met-His-

CDR-2 -Glu-Phe-Asn-Pro-Ser-Asn-Gly-Arg-Thr-Asn-Tyr-Asn-
5 Glu-Lys-Phe-Lys-Ser-

CDR-3 -Arg-Asp-Tyr-Asp-Tyr-Asp-Gly-Arg-Tyr-Phe-Asp-Tyr-

20. Process according to Claim 18 or 19, wherein DNA
sequences are used coding for the following amino acid
10 sequences which represent the FRs of the variable
regions:

light chain15 FR-1 -Asp-Ile-Gln-Met-Thr-Gln-Ser-Pro-Ser-Ser-Leu-Ser-
Ala-Ser-Val-Gly-Asp-Arg-Val-Thr-Ile-Thr-Cys-FR-2 -Trp-Tyr-Gln-Gln-Lys-Pro-Gly-Lys-Ala-Pro-Lys-Leu-
Leu-Ile-Tyr-FR-3 -Gly-Val-Pro-Ser-Arg-Phe-Ser-Gly-Ser-Gly-Ser-Gly-
20 Thr-Asp-Tyr (Phe, Trp, His) -Thr-Phe-Thr-Ile-Ser-Ser-
Leu-Gln-Pro-Glu-Asp-Ile-Ala-Thr-Tyr-Tyr-Cys-

FR-4 -Phe-Gly-Gln-Gly-Thr-Lys-Val-Glu-Ile-Lys-

heavy chain25 FR-1 -Gln-Val-Gln-Leu-Val-Gln-Ser-Gly-Ala-Glu-Val-Lys-
Lys-Pro-Gly-Ala-Ser-Val-Lys-Val-Ser-Cys-Lys-Ala-
Ser-Gly-Tyr-Thr-Phe-Thr (Ser) -FR-2 -Trp-Val-Arg- (His) -Gln-Ala (Lys, His) -Pro (Val) -Gly-
30 Gln-Gly-Leu-Glu-Trp-Ile (Val, Leu) -Gly-

71

FR-3 -Lys (Arg, His) -Ala (Val, Pro, Gly) -Thr-Met-Thr-
 Val (Ala, Pro, Gly) -Asp-Thr-Ser-Thr-Asn-Thr-Ala-Tyr-
 Met-Glu (Asn) -Leu-Ser-Ser-Leu-Arg-Ser-Glu-Asp-Thr-
 Ala-Val-Tyr-Tyr-Cys-Ala-Ser-

5 FR-4 -Trp-Gly-Gln-Gly-Thr-Leu-Val-Thr-Val-Ser-Ser

21. Process for the preparation of a chimeric monoclonal antibody having the biological function of binding to epitopes of the EGF-receptor, comprising hypervariable regions (CDRs) of antigen binding sites and FRs of the variable regions of murine origin and FRs of the variable regions of murine origin and constant regions of the light and heavy chains of human origin by cultivating transformed host cells in a culture medium and purification and isolation the expressed antibody proteins, characterized in that the host cells are transformed with expression vectors according to one of the expression vectors of Claims 15 to 17.
22. Pharmaceutical composition comprising a humanized monoclonal antibody according to one of the antibodies of Claims 1 to 7 or 12 to 13.
23. Pharmaceutical composition comprising a chimeric monoclonal antibody according to one of the antibodies of Claim 12 or 14.
24. Use of humanized or chimeric antibody according to one of the antibodies of Claims 3 to 7 or 12 to 14 for the manufacture of a drug directed to tumors.

72

25. Use of humanized or chimeric antibody according to one of the antibodies of Claims 3 to 7 or 12 to 14 for diagnostic locating and assessing tumor growth.

5 26. Purified humanized and chimeric monoclonal antibody which derives from murine MAb 425.

10

15

20

25

30

FIG. 1

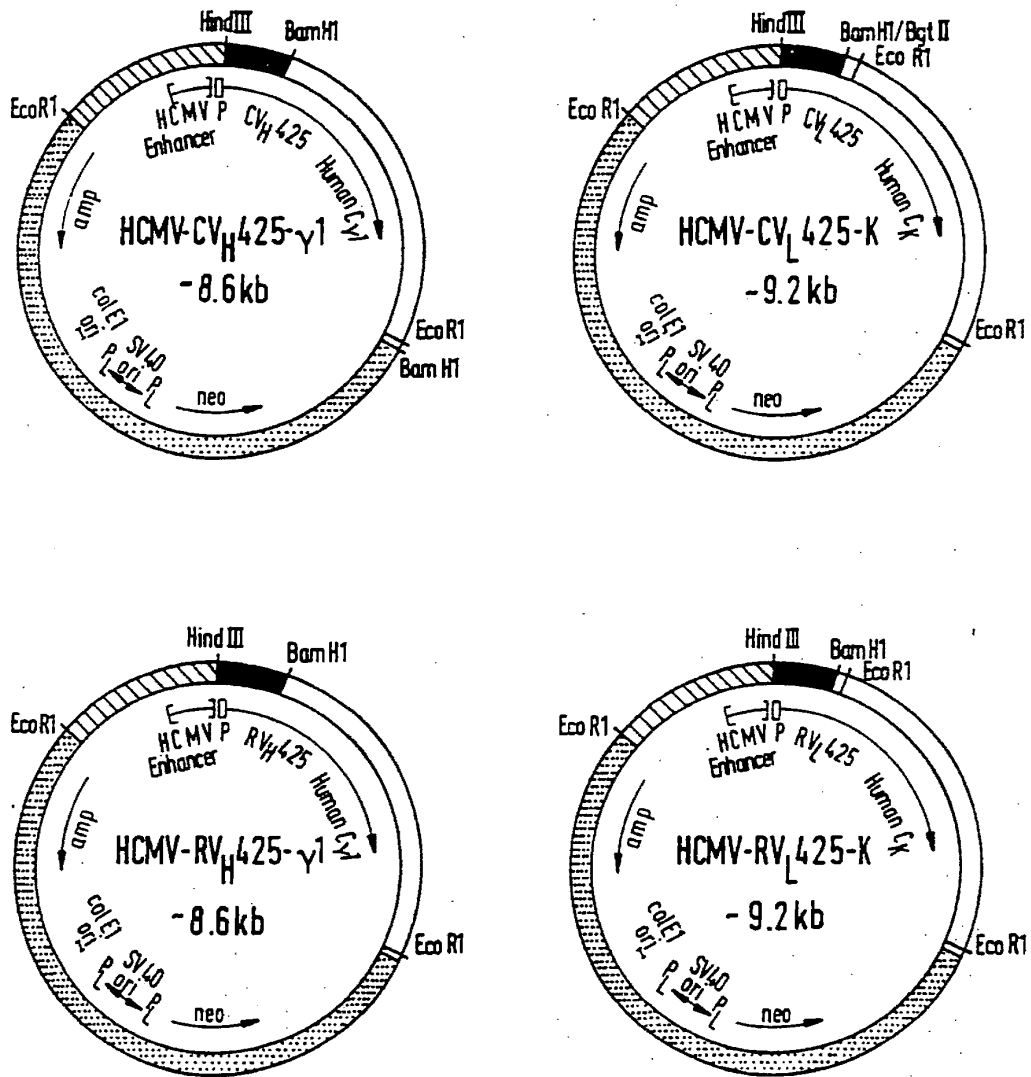

SUBSTITUTE SHEET

2/12
FIG. 2

Panel A:

5'-----CGAGCTCGG-CTGAGCACACAGGACCTCACCATG GGT TGG AGC TAT 45
 pUC18----->-3'-GACTCGTGTGTCCTGGAGTGGTACCCA-----5'
 5'-CTCCAAGCTTGACCTCACCATGG-3'
 HindIII Met Gly Trp Ser Tyr

ATC ATC CTC TTT TTG GTA GCA ACA GCT ACA GAT GTC CAC TCC CAG 90
 Ile Ile Leu Phe Leu Val Ala Thr Ala Thr Asp Val His Ser Gln
 GTC CAG CTG CAA CAA CCT GGG GCT GAA CTG GTG AAG CCT GGG GCT 135
 Val Gln Leu Gln Gln Pro Gly Ala Glu Leu Val Lys Pro Gly Ala
 TCA GTG AAG TTG TCC TGC AAG GCT TCC GGC TAC ACC TTC ACC AGC 180
 Ser Val Lys Leu Ser Cys Lys Ala Ser Gly Tyr Thr Phe Thr(Ser
 CAC TGG ATG CAC TGG GTG AAG CAG AGG GCT GGA CAA GGC CTT GAG 225
 His Trp Met His)Trp Val Lys Gln Arg Ala Gly Gln Leu Glu
 TGG ATC GGA GAG TTT AAT CCC AGC AAC GGC CGT ACT AAC TAC AAT 270
 Trp Ile Gly(Glu Phe Asn Pro Ser Asn Gly Arg Thr Asn Tyr Asn
 GAG AAA TTC AAG AGC AAG GCC ACA CTG ACT GTA GAC AAA TCC TCC 315
 Glu Lys Phe Lys Ser)Lys Ala Thr Leu Thr Val Asp Lys Ser Ser
 AGC ACA GCC TAC ATG CAA CTC AGC AGC CTG ACA TCT GAG GAC TCT 360
 Ser Thr Ala Tyr Met Gln Leu Ser Ser Leu Thr Ser Glu Asp Ser
 GCG GTC TAT TAC TGT GCC AGT CGG GAC TAT GAT TAC GAC GGA CGG 405
 Ala Val Tyr Tyr Cys Ala Ser(Arg Asp Tyr Asp Tyr Asp Gly Arg

3'-AG TGT CAG AGG AGT
 TAC TTT GAC TAC TGG GGC CAA GGC ACC ACT CTC ACA GTC TCC TCA 450
 Tyr Phe Asp Tyr)Trp Gly Gln Gly Thr Thr Leu Thr Val Ser Ser
 BanHI
 CCACTCACCTAGGTT-5' <----- pUC15
 GCCAAAACAACACCCCATCGGTCTATCCACTGGAT-TCCTCTAGAGTCGACC---3' 501

Panel B:

--- pUC18 ----->
 5'-----TTCGAGCTCGGTACCC-ACAAAATG GAT TTT CAA GTG CAG ATT TTC 45
 3'-----AAGCTCGAGCCATGGG-TGTTTTAC CTA AAA GTT CAC GTC--5'
 5'-AGAAAGCTT-CCACCATG GAT TTT CAA GTG-3'
 HindIII Met Asp Phe Gln Val Gln Ile Phe

AGC TTC CTG CTA ATC AGT GCC TCA GTC ATA CTG TCC AGA GGA CAA 90
 Ser Phe Leu Leu Ile Ser Ala Ser Val Ile Leu Ser Arg Gly Gln
 ATT GTT CTC ACC CAG TCT CCA GCA ATC ATG TCT GCA TCT CCA GGG 135
 Ile Val Leu Thr Gln Ser Pro Ala Ile Met Ser Ala Ser Pro Gly
 GAG AAG GTC ACT ATG ACC TGC AGT GCC AGC TCA AGT GTA ACT TAC 180
 Glu Lys Val Thr Met Thr Cys(Ser Ala Ser Ser Ser Val Thr Tyr
 ATG TAT TGG TAC CAG CAG AAG CCA GGA TCC TCC CCC AGA CTC CTG 225
 Met Tyr)Trp Tyr Gln Gln Lys Pro Gly Ser Ser Pro Arg Leu Leu
 ATT TAT GAC ACA TCC AAC CTG GCT TCT GGA GTC CCT GTT CGT TTC 270
 Ile Tyr(Asp Thr Ser Asn Leu Ala Ser)Gly Val Pro Val Arg Phe
 AGT GGC AGT GGG TCT GGG ACC TCT TAC TCT CTC ACA ATC AGC CGA 315
 Ser Gly Ser Gly Ser Gly Thr Ser Tyr Ser Leu Thr Ile Ser Arg
 ATG GAG GCT GAA GAT GCT GCC ACT TAT TAC TGC CAG CAG TGG AGT 360
 Met Glu Ala Glu Asp Ala Ala Thr Tyr Tyr Cys(Gln Gln Trp Ser

3'-C AAC CTT TAT TTT
 AGT CAC ATA TTC ACG TTC GGC TCG GGG ACA AAG TTG GAA ATA AAA 405
 Ser His Ile Phe Thr)Phe Gly Ser Gly Thr Lys Leu Glu Ile Lys
 GCACTCATCTAGATG-5' BglII <--- pUC15
 CCGGCTGATGCTGCACCAACTGTATGGATCTTCCCACCATCCAGGATCC-GGGGATCC-3' 462

SUBSTITUTE SHEET

4/12

FIG. 4 - 1

Panel A:

V _L 425	Gln-Ile-Val-Leu-Thr-Gln-Ser-Pro-Ala-Ile-	
RV _L a425	Asp-Ile-Gln-Met-Thr-Gln-Ser-Pro-Ser-Ser-	
RV _L b425	-----	
V _L 425	Met-Ser-Ala-Ser-Pro-Gly-Glu-Lys-Val-Thr-	<u>FR-1</u>
RV _L a425	Leu-Ser-Ala-Ser-Val-Gly-Asp-Arg-Val-Thr-	
RV _L b425	-----	
V _L 425	Met-Thr-Cys	
RV _L a425	Ile-Thr-Cys	
RV _L b425	-----	
V _L 425	Ser-Ala-Ser-Ser-Ser-Val-Thr-Tyr-Met-Tyr	
RV _L a425	Ser-Ala-Ser-Ser-Ser-Val-Thr-Tyr-Met-Tyr	<u>CDR-1</u>
RV _L b425	-----	
V _L 425	Trp-Tyr-Gln-Gln-Lys-Pro-Gly-Ser-Ser-Pro-	
RV _L a425	Trp-Tyr-Gln-Gln-Lys-Pro-Gly-Lys-Ala-Pro-	
RV _L b425	-----	<u>FR-2</u>
V _L 425	Arg-Leu-Leu-Ile-Tyr	
RV _L a425	Lys-Leu-Leu-Ile-Tyr	
RV _L b425	-----	
V _L 425	Asp-Thr-Ser-Asn-Leu-Ala-Ser	
RV _L a425	Asp-Thr-Ser-Asn-Leu-Ala-Ser	<u>CDR-2</u>
RV _L b425	-----	
V _L 425	Gly-Val-Pro-Val-Arg-Phe-Ser-Gly-Ser-Gly-	
RV _L a425	Gly-Val-Pro-Ser-Arg-Phe-Ser-Gly-Ser-Gly-	
RV _L b425	-----	
V _L 425	Ser-Gly-Thr-Ser-Tyr-Ser-Leu-Thr-Ile-Ser-	<u>FR-3</u>
RV _L a425	Ser-Gly-Thr-Asp-Phe-Thr-Phe-Thr-Ile-Ser-	
RV _L b425	-----Tyr-----	
V _L 425	Arg-Met-Glu-Ala-Glu-Asp-Ala-Ala-Thr-Tyr-Tyr-Cys	
RV _L a425	Ser-Leu-Gln-Pro-Glu-Asp-Ile-Ala-Thr-Tyr-Tyr-Cys	
RV _L b425	-----	
V _L 425	Gln-Gln-Trp-Ser-Ser-His-Ile-Phe-Thr	
RV _L a425	Gln-Gln-Trp-Ser-Ser-His-Ile-Phe-Thr	<u>CDR-3</u>
RV _L b425	-----	
V _L 425	Phe-Gly-Ser-Gly-Thr-Lys-Leu-Glu-Ile-Lys	
RV _L a425	Phe-Gly-Gln-Gly-Thr-Lys-Val-Glu-Ile-Lys	<u>FR-4</u>
RV _L b425	-----	

SUBSTITUTE SHEET

5/12

FIG. 4-2

Panel B:

V _H 425	Gln-Val-Gln-Leu-Gln-Gln-Pro-Gly-Ala-Glu	
RV _H a-d, f425	Gln-Val-Gln-Leu-Val-Gln-Ser-Gly-Ala-Glu	
RV _H e, g-i425	-----	
V _H 425	Leu-Val-Lys-Pro-Gly-Ala-Ser-Val-Lys-Leu	<u>FR-1</u>
RV _H a-d, f425	Val-Lys-Lys-Pro-Gly-Ala-Ser-Val-Lys-Val	
RV _H e, g-i425	-----	
V _H 425	Ser-Cys-Lys-Ala-Ser-Gly-Tyr-Thr-Phe-Thr	
RV _H a-d, f425	Ser-Cys-Lys-Ala-Ser-Gly-Tyr-Thr-Phe-Ser	
RV _H e, g-i425	-----Thr	
V _H 425	Ser-His-Trp-Met-His	<u>CDR-1</u>
RV _H a-i425	Ser-His-Trp-Met-His	
V _H 425	Trp-Val-Lys-Gln-Arg-Ala-Gly-Gln-Gly-Leu	
RV _H a-c, h, i425	Trp-Val-Arg-Gln-Ala-Pro-Gly-Gln-Gly-Leu	
RV _H d-g425	-----	
V _H 425	Glu-Trp-Ile-Gly	<u>FR-2</u>
RV _H a-c, h, i425	Glu-Trp-Val-Gly	
RV _H d-g425	-----Ile----	
V _H 425	Glu-Phe-Asn-Pro-Ser-Asn-Gly-Arg-Thr-Asn	
RV _H a-i425	Glu-Phe-Asn-Pro-Ser-Asn-Gly-Arg-Thr-Asn	
V _H 425	Tyr-Asn-Glu-Lys-Phe-Lys-Ser	<u>CDR-2</u>
RV _H a-i425	Tyr-Asn-Glu-Lys-Phe-Lys-Ser	
V _H 425	Lys-Ala-Thr-Leu-Thr-Val-Asp-Lys-Ser-Ser	
RV _H a, d, e425	Arg-Val-Thr-Met-Thr-Leu-Asp-Thr-Ser-Thr	
RV _H b, h425	-----Val-----	
RV _H c, f, g, i425	Lys-Ala-----Val-----	
V _H 425	Ser-Thr-Ala-Tyr-Met-Gln-Leu-Ser-Ser-Leu	
RV _H a, d, e425	Asn-Thr-Ala-Tyr-Met-Glu-Leu-Ser-Ser-Leu	<u>FR-3</u>
RV _H a, d, e425	-----	
RV _H c, f, g, i425	-----	
V _H 425	Thr-Ser-Glu-Asp-Ser-Ala-Val-Tyr-Tyr-Cys-Ala-Ser	
RV _H a, d, e425	Arg-Ser-Glu-Asp-Thr-Ala-Val-Tyr-Tyr-Cys-Ala-Ser	
RV _H a, d, e425	-----	
RV _H c, f, g, i425	-----	
V _H 425	Arg-Asp-Tyr-Asp-Tyr-Asp-Gly-Arg-Tyr-Phe-Asp-Tyr	<u>CDR-3</u>
RV _H a-i425	Arg-Asp-Tyr-Asp-Tyr-Asp-Gly-Arg-Tyr-Phe-Asp-Tyr	
V _H 425	Trp-Gly-Gln-Gly-Thr-Thr-Leu-Thr-Val-Ser-Ser	<u>FR-4</u>
RV _H a-i425	Trp-Gly-Gln-Gly-Thr-Leu-Val-Thr-Val-Ser-Ser	

SUBSTITUTE SHEET

6/12

FIG. 5

A

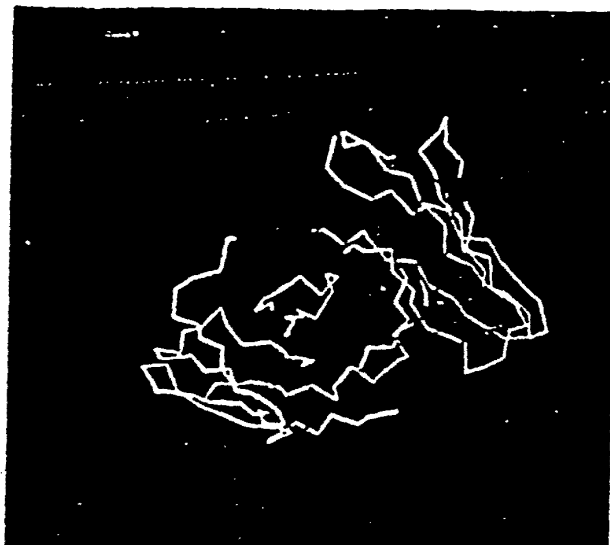

B

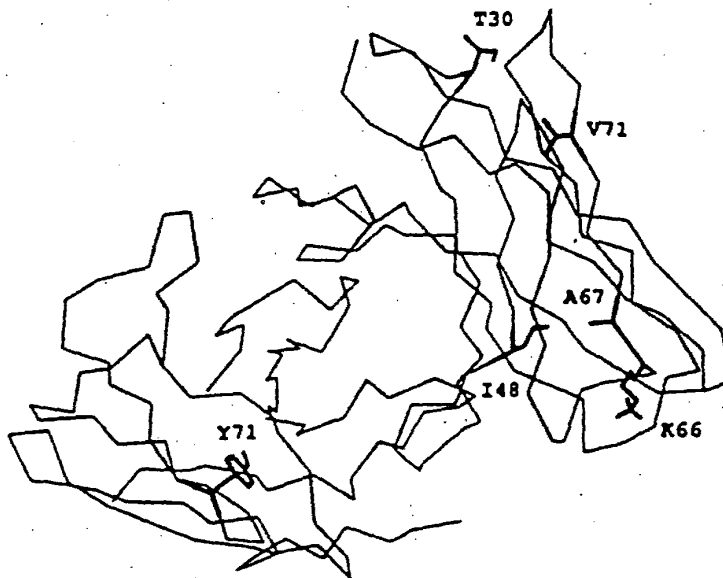

SUBSTITUTE SHEET

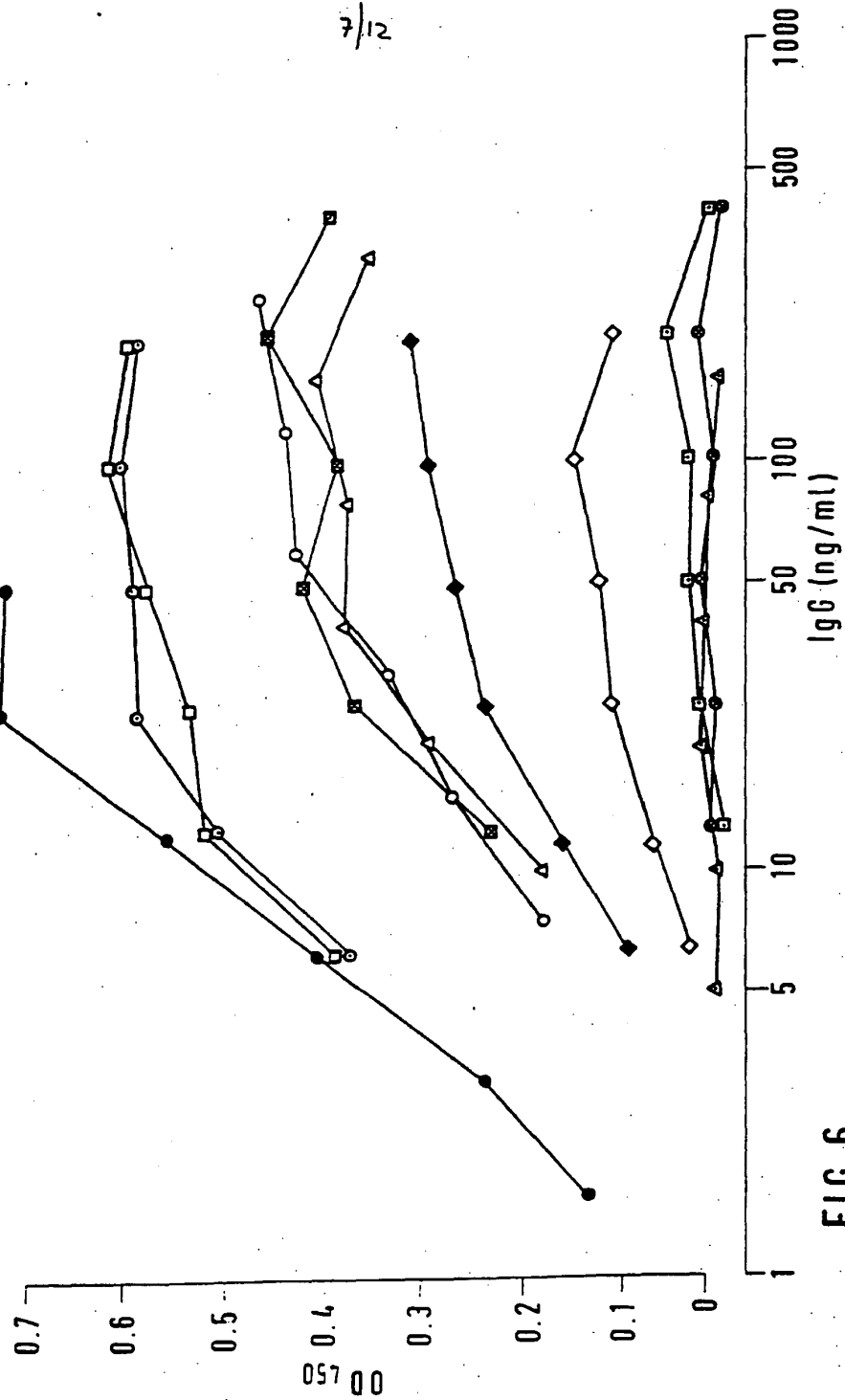
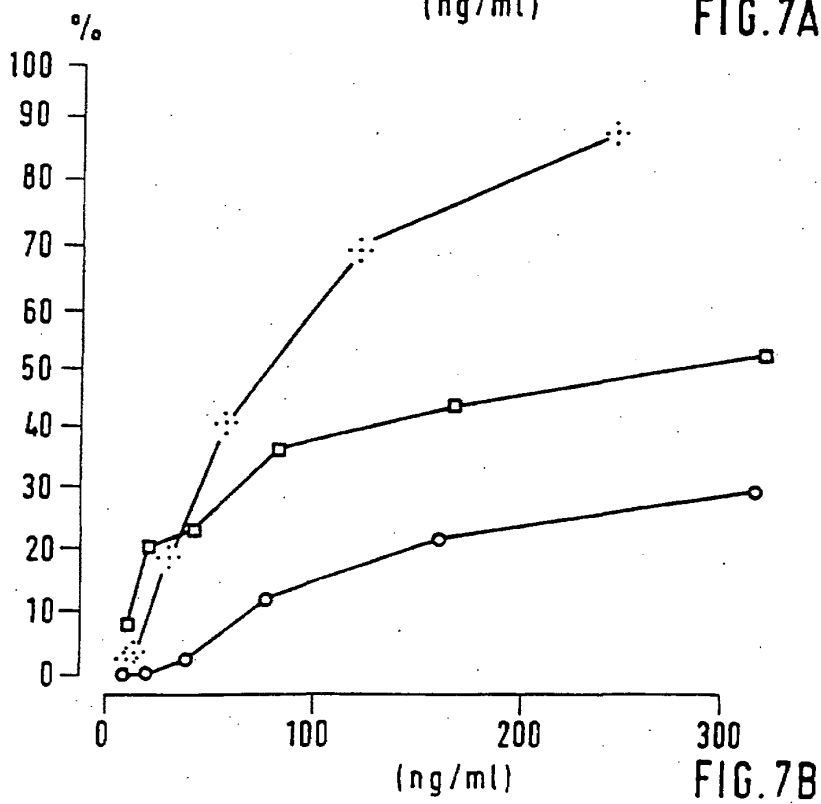
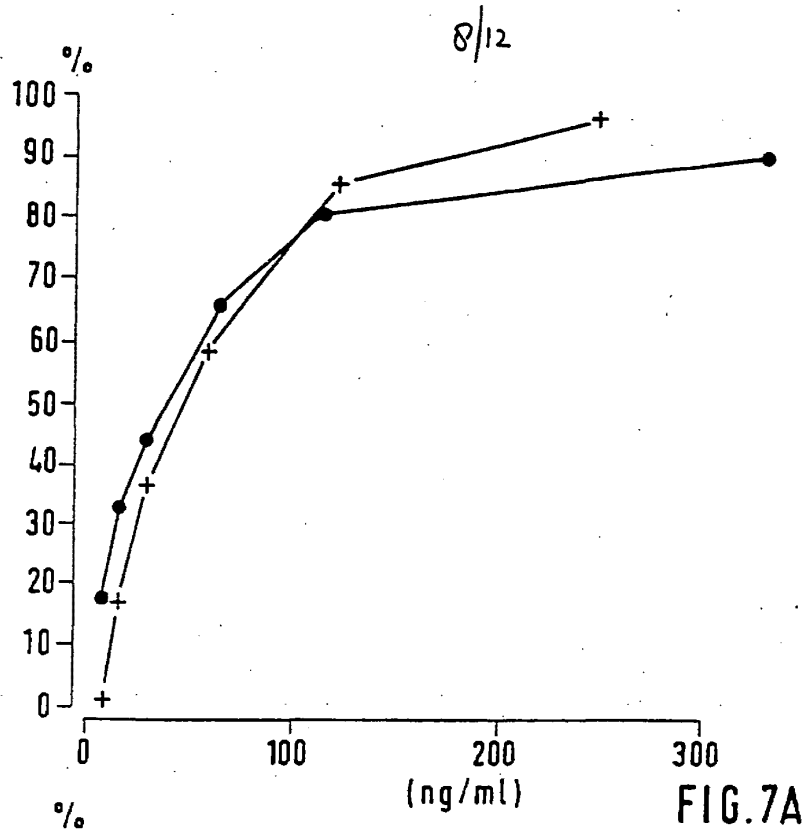

FIG. 6

SUBSTITUTE SHEET



SUBSTITUTE SHEET

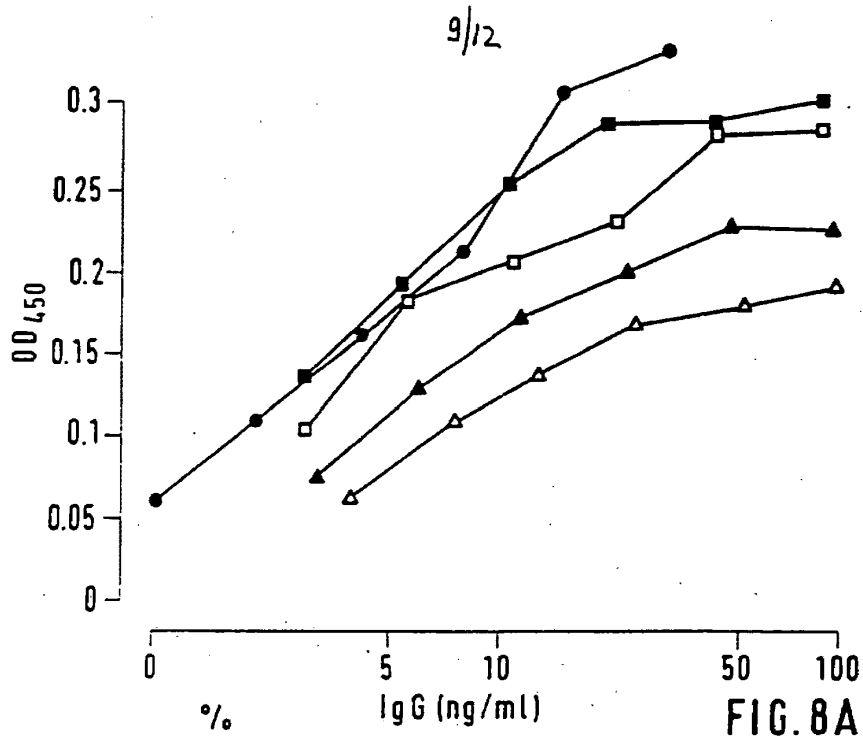

FIG. 8A

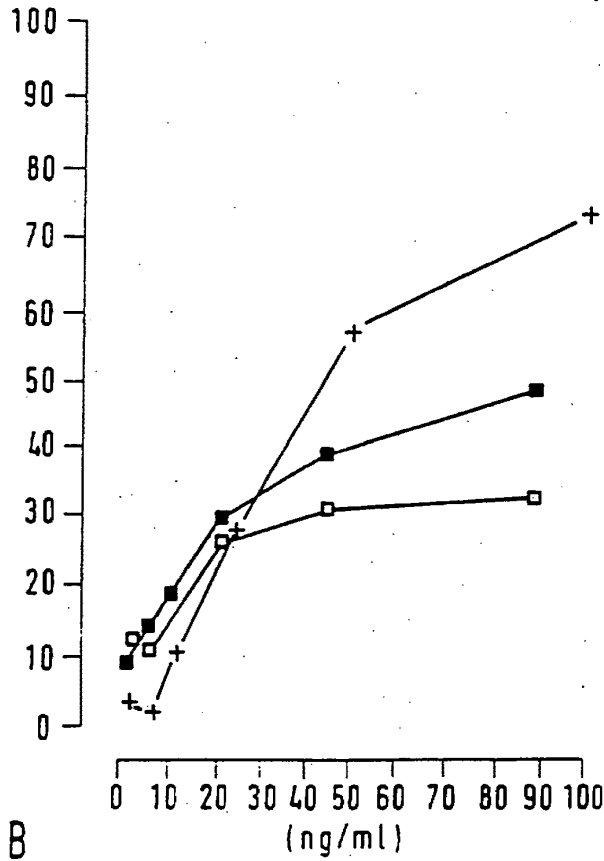

FIG. 8B

SUBSTITUTE SHEET

10/12

FIG. 9A

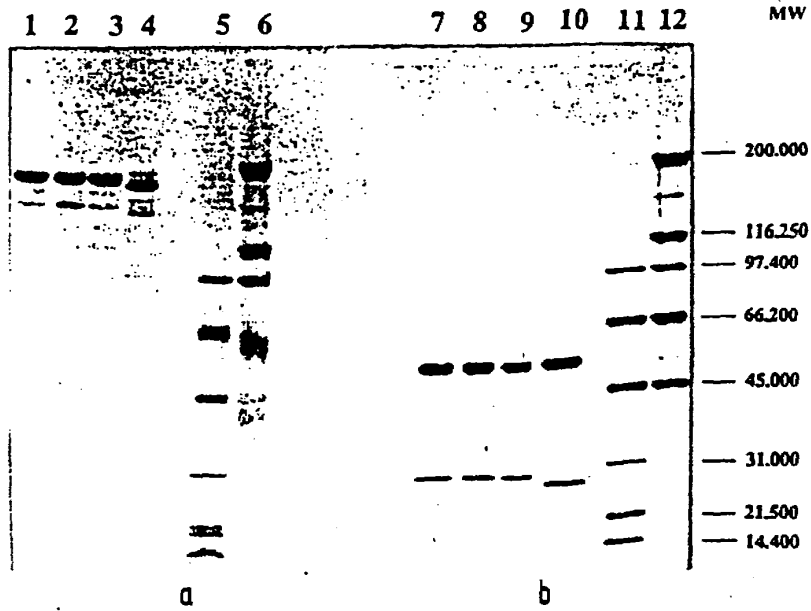
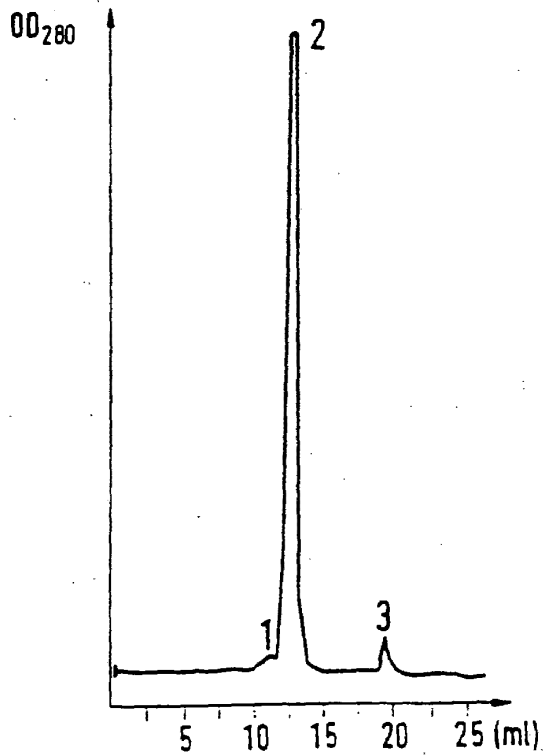

FIG. 9B



SUBSTITUTE SHEET

FIG. 10

11/12

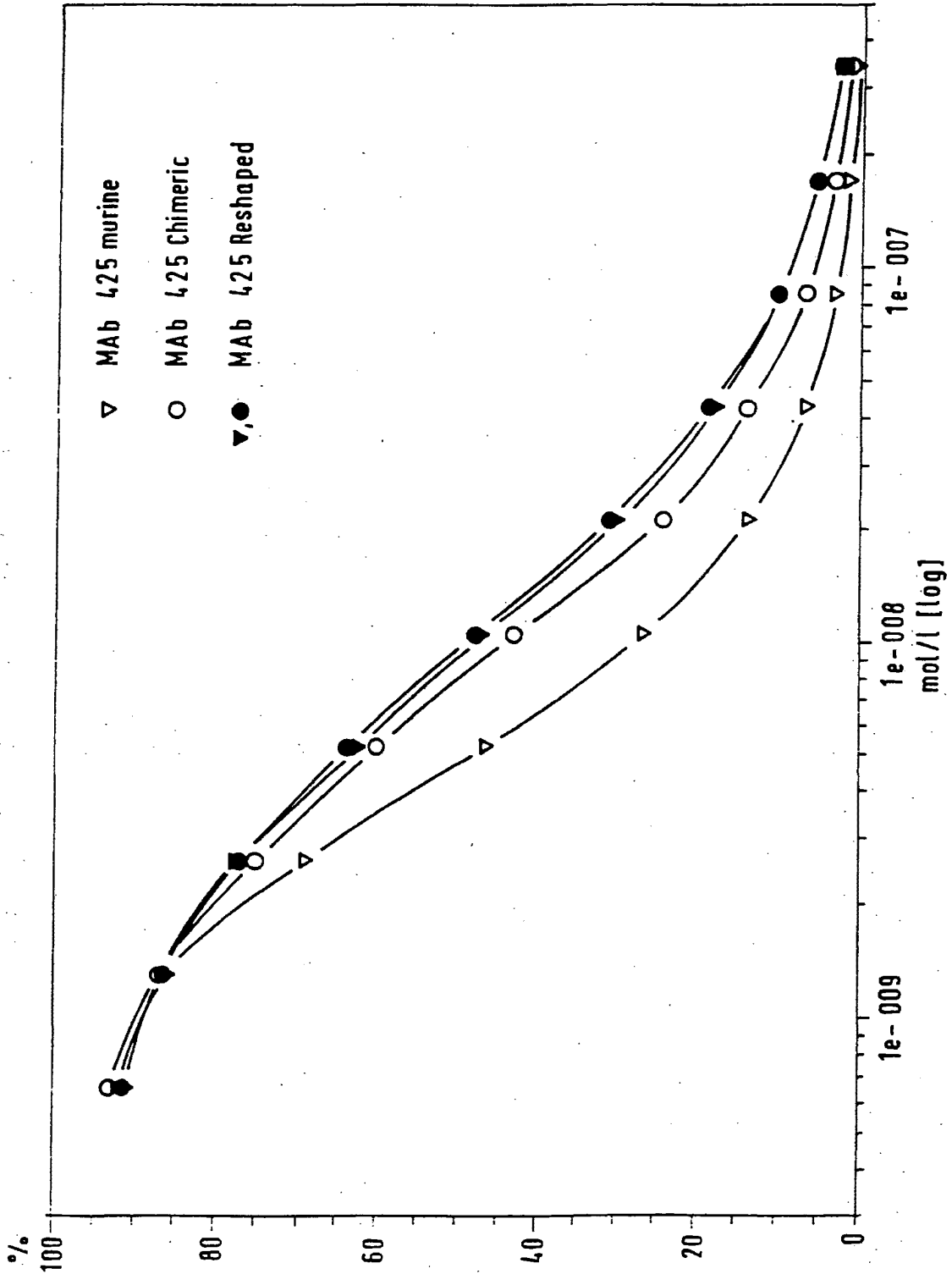

SUBSTITUTE SHEET

FIG. 11

12/12

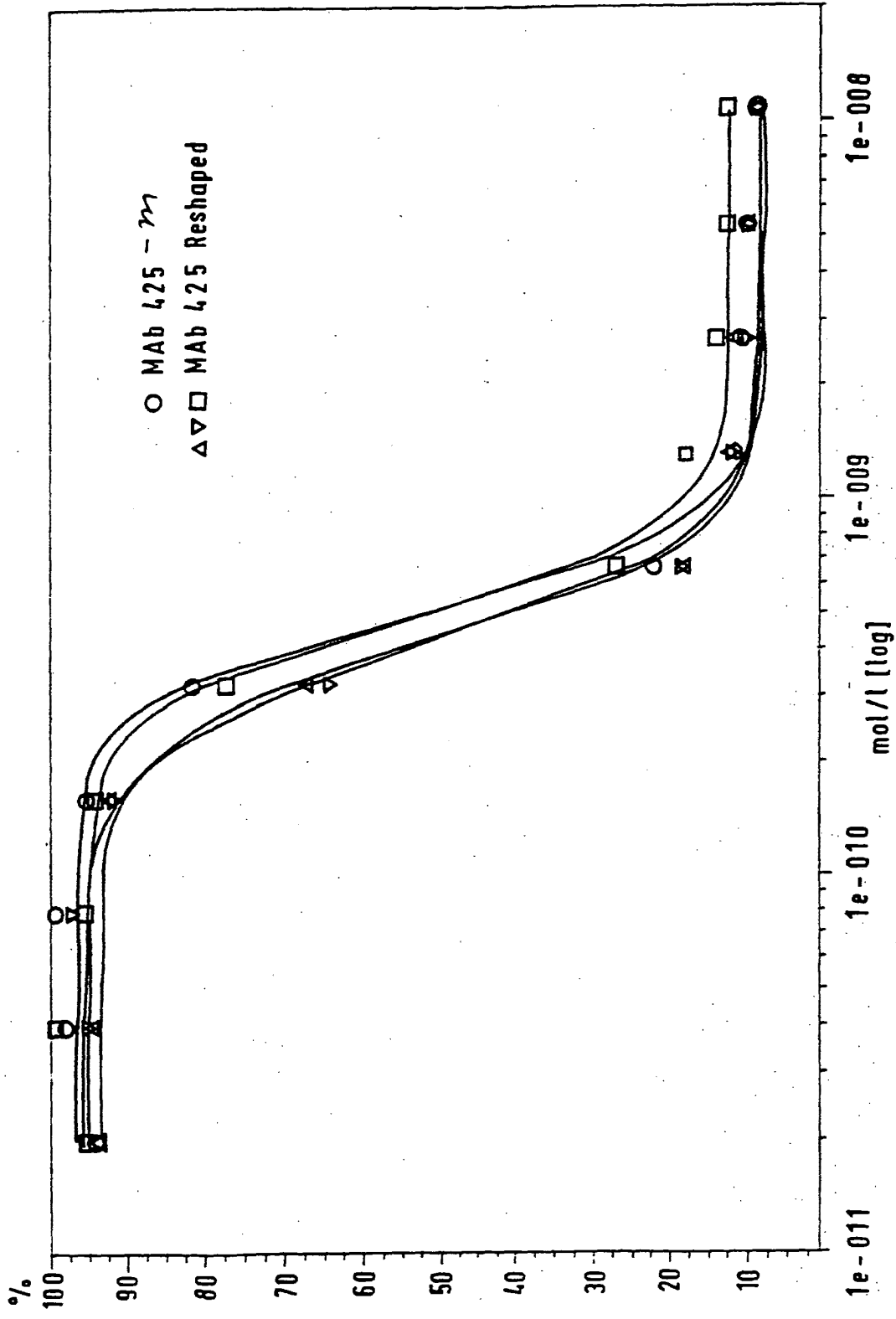

SUBSTITUTE SHEET

INTERNATIONAL SEARCH REPORT

International Application No **PCT/EP 92/00480**

I. CLASSIFICATION OF SUBJECT MATTER (If several classification symbols apply, indicate all) ⁶		
According to International Patent Classification (IPC) or to both National Classification and IPC		
Int.C1.5 C 12 P 21/08	C 12 N 15/13 A 61 K 39/395	C 07 K 13/00 A 61 K 49/00
C 12 N 15/62		
II. FIELDS SEARCHED		
Minimum Documentation Searched ⁷		
Classification System	Classification Symbols	
Int.C1.5	C 07 K	
Documentation Searched other than Minimum Documentation to the Extent that such Documents are Included in the Fields Searched ⁸		
III. DOCUMENTS CONSIDERED TO BE RELEVANT⁹		
Category ¹⁰	Citation of Document, ¹¹ with indication, where appropriate, of the relevant passages ¹²	Relevant to Claim No. ¹³
X	Journal of Molecular Biology, vol. 215, no. 1, 5 September 1990, A. TRAMONTANO et al.: "Framework residues 71 is a major determinant of the position and conformation of the second hypervariable region in the VH domains of immunoglobulins", pages 175-182, see paragraph 7: "Conclusion"	1-3
Y	---	4-25
Y	Arch. Biochem. Biophys., vol. 252, no. 2, 1 February 1987, U. MURTHY et al.: "Binding of an antagonistic monoclonal antibody to an intact and fragmented EGF-receptor polypeptide", pages 549-560, see the whole document (cited in the application) ---	4-25
-/-		
<p>¹⁰ Special categories of cited documents:</p> <p>"A" document defining the general state of the art which is not considered to be of particular relevance</p> <p>"E" earlier document but published on or after the international filing date</p> <p>"L" documents which may throw doubts on priority claim(s) or which is cited to establish the publication date of another citation or other special reason (as specified)</p> <p>"O" document referring to an oral disclosure, use, exhibition or other means</p> <p>"P" document published prior to the international filing date but later than the priority date claimed</p> <p>"T" later document published after the international filing date or priority date and not in conflict with the application but cited to understand the principle or theory underlying the invention</p> <p>"X" document of particular relevance; the claimed invention cannot be considered novel or cannot be considered to involve an inventive step</p> <p>"Y" document of particular relevance; the claimed invention cannot be considered to involve an inventive step when the document is combined with one or more other such documents, such combination being obvious to a person skilled in the art.</p> <p>"A" document member of the same patent family</p>		
IV. CERTIFICATION		
Date of the Actual Completion of the International Search	Date of Mailing of this International Search Report	
03-06-1992	30.06.92	
International Searching Authority	Signature of Authorized Officer	
EUROPEAN PATENT OFFICE	Nicole De Ble	

Form PCT/ISA/230 (continued sheet) (January 1985)

III. DOCUMENTS CONSIDERED TO BE RELEVANT (CONTINUED FROM THE SECOND SHEET)		
Category	Citation of Document, with indication, where appropriate, of the relevant passages	Relevant to Claim No.
X	Science, vol. 239, 25 March 1988, M. VERHOEYEN et al.: "Reshaping human antibodies: grafting an antilysozyme activity", pages 1534-1536, see the whole document, especially figures 1c,2 (cited in the application)	1-3
Y	---	4-25
Y	J. Cell. Biochem., vol. 44, no. 2, October 1990, U. RODECK et al.: "Monoclonal antibody 425 inhibits growth stimulation of carcinoma cells by exogenous EGF and tumor-derived EGF/TGF-alpha", pages 69-79	4-25
X	---	1-3
X	Proc. Natl. Acad. Sci. USA, vol. 86, December 1989, C. QUEEN et al.: "A humanized antibody that binds to the interleukin 2 receptor", pages 10029-10033, see the whole document (cited in the application)	1-3
Y	---	4-25
P,X	Protein Eng., vol. 4, no. 7, October 1991, C.A. KETTLEBOROUGH et al.: "Humanization of a mouse monoclonal antibody by CDR-grafting: the importance of framework residues on loop conformation", see the whole document	1-25
A	---	1-25
A	Nature, vol. 342, 21/28 December 1989, C. CHOTHIA et al.: "Conformations of immunoglobulin hypervariable regions", pages 877-883 (cited in the application)	1-25
A	---	
A	Cancer Res., vol. 47, no. 10, 15 May 1987, A. BASU et al.: "Presence of tumor-associated antigens in epidermal growth factor receptors from different human carcinomas", pages 2531-2536	

FURTHER INFORMATION CONTINUED FROM THE SECOND SHEET

V. OBSERVATION WHERE CERTAIN CLAIMS WERE FOUND UNSEARCHABLE ¹

This International search report has not been established in respect of certain claims under Article 17(2)(a) for the following reasons:

1. Claim numbers _____ because they relate to subject matter not required to be searched by this Authority, namely:

Although claim 25 is directed to diagnostic methods practised on the human body (Rule 39.1(IV) PCT) the search has been carried out and based on the alleged effects of the compound/composition.
2. Claim numbers _____ because they relate to parts of the International application that do not comply with the prescribed requirements to such an extent that no meaningful International search can be carried out, specifically:
3. Claim numbers _____ because they are dependent claims and are not drafted in accordance with the second and third sentences of PCT Rule 6.4(a).

VI. OBSERVATIONS WHERE UNITY OF INVENTION IS LACKING ²

This International Searching Authority found multiple inventions in this International application as follows:

1. As all required additional search fees were timely paid by the applicant, this International search report covers all searchable claims of the International application
2. As only some of the required additional search fees were timely paid by the applicant, this International search report covers only those claims of the International application for which fees were paid, specifically claims: _____
3. No required additional search fees were timely paid by the applicant. Consequently, this International search report is restricted to the invention first mentioned in the claims; it is covered by claim numbers: _____
4. As all searchable claims could be searched without effort justifying an additional fee, the International Searching Authority did not invite payment of any additional fee.

Remark on Protest

- The additional search fees were accompanied by applicant's protest.
 No protest accompanied the payment of additional search fees.



INTERNATIONAL APPLICATION PUBLISHED UNDER THE PATENT COOPERATION TREATY (PCT)

(51) International Patent Classification ⁵ : C07K 15/28, C12P 21/08 C12N 5/10, 15/13, A61K 39/395	A1	(11) International Publication Number: WO 92/16562 (43) International Publication Date: 1 October 1992 (01.10.92)
(21) International Application Number: PCT/GB92/00445 (22) International Filing Date: 12 March 1992 (12.03.92) (30) Priority data: 9105245.6 12 March 1991 (12.03.91) GB (71) Applicant (for all designated States except US): LYNXVALE LIMITED [GB/GB]; The Old Schools, Cambridge CB2 ITS (GB). (72) Inventor; and (75) Inventor/Applicant (for US only) : CLARK, Michael, Ronald [GB/GB]; 108 York Street, Cambridge CB1 2PY (GB). (74) Agent: MEWBURN ELLIS; 2 Cursitor Street, London EC4A 1BQ (GB).	(81) Designated States: AT (European patent), BE (European patent), CA, CH (European patent), DE (European patent), DK (European patent), ES (European patent), FR (European patent), GB (European patent), GR (European patent), IT (European patent), JP, LU (European patent), MC (European patent), NL (European patent), SE (European patent), US. Published <i>With international search report.</i>	
(54) Title: HUMANISED ANTIBODIES HAVING MODIFIED ALLOTYPIC DETERMINANTS (57) Abstract <p>The invention relates to molecules which have an amino acid sequence derivable from part or all of the constant region of an immunoglobulin heavy chain. The constant regions are of a particular isotype and have one or more allotypic determinants. The amino acid sequence is substantially homologous to the amino acid sequence of the constant region. However, it has been altered so that it is without at least one of said allotypic determinants by making its sequence the site for an allotypic determinant identical to the amino acid sequence from the corresponding position in another equivalent immunoglobulin constant region of a different isotype. The invention provides synthetic immunoglobulins with reduced allotypic differences as compared to a given wild-type immunoglobulin.</p>		

FOR THE PURPOSES OF INFORMATION ONLY

Codes used to identify States party to the PCT on the front pages of pamphlets publishing international applications under the PCT.

AT	Austria	ES	Spain	MG	Madagascar
AU	Australia	FI	Finland	ML	Mali
BB	Barbados	FR	France	MN	Mongolia
BE	Belgium	GA	Gabon	MR	Mauritania
BF	Burkina Faso	GB	United Kingdom	MW	Malawi
BG	Bulgaria	GN	Guinea	NL	Netherlands
BJ	Benin	GR	Greece	NO	Norway
BR	Brazil	HU	Hungary	PL	Poland
CA	Canada	IT	Italy	RO	Romania
CF	Central African Republic	JP	Japan	SD	Sudan
CG	Congo	KP	Democratic People's Republic of Korea	SE	Sweden
CH	Switzerland	KR	Republic of Korea	SN	Senegal
CI	Côte d'Ivoire	LI	Liechtenstein	SU ⁺	Soviet Union
CM	Cameroon	LK	Sri Lanka	TD	Chad
CS	Czechoslovakia	LU	Luxembourg	TG	Togo
DE*	Germany	MC	Monaco	US	United States of America
DK	Denmark				

+ Any designation of "SU" has effect in the Russian Federation. It is not yet known whether any such designation has effect in other States of the former Soviet Union.

Humanised antibodies having modified allotypic determinants

The present invention relates to binding molecules. In particular, it relates to recombinantly produced
5 antibodies.

Owing to their high specificity for a given antigen, antibodies and particularly monoclonal antibodies (Kohler, G. and Milstein C., 1975 Nature 256:495) represented a significant technical break-through with
10 important consequences scientifically, commercially and therapeutically.

Monoclonal antibodies are made by establishing an immortal cell line which is derived from a single immunoglobulin producing cell secreting one form of a
15 biologically functional antibody molecule with a particular specificity.

Owing to their specificity, the therapeutic applications of monoclonal antibodies hold great promise for the treatment of a wide range of diseases (Clinical
20 Applications of Monoclonal Antibodies, edited by E. S. Lennox. British Medical Bulletin 1984, publishers Churchill Livingstone). Antibodies are generally raised in animals, particularly rodents, and therefore the immunoglobulins produced bear characteristic features
25 specific to that species. The repeated administration of these foreign rodent proteins for therapeutic purposes to

human patients can lead to harmful hypersensitivity reactions. In the main therefore, these rodent-derived monoclonal antibodies have limited therapeutic use. A further problem with these rodent derived antibodies, is that they are relatively ineffective at the depletion of cells in vivo, although the rat IgG2b antibody CAMPATH-1G is an exception to this rule.

Thus, there is a need for therapeutic antibodies which have characteristic features specific to human proteins. Unfortunately, immortal human antibody-producing cell lines are very difficult to establish and they give low yields of antibody (approximately 1 µg/ml). In contrast, equivalent rodent cell lines yield high amounts of antibody (approximately 100 µg/ml). Furthermore, where one wants to produce a human antibody with a particular specificity it is not practically or ethically feasible to immunise humans with an immunogen bearing the epitope of interest.

In part, this problem has been overcome in recent years by using the techniques of recombinant DNA technology to 'humanise' non-human antibodies. Structurally, the simplest antibody (IgG) comprises four polypeptide chains, two heavy (H) chains and two light (L) chains inter-connected by disulphide bonds (see figure 1). The light chains are of two types, either kappa or lambda. Each of the H and L chains has a region

of low sequence variability, the constant region (C) giving rise to allotypes and a region of high sequence variability, the variable region (V) giving rise to idiotypes. The antibody has a tail region (the Fc region) which comprises the C regions of the two H chains. The antibody also has two arms (the Fab region) each of which has a V_L and a V_H region associated with each other. It is this pair of V regions (V_L and V_H) that differ from one antibody to another, and which together are responsible for recognising the antigen. In even more detail, each V region is made up from three complementarity determining regions (CDR) separated by four framework regions (FR). The CDRs are the most variable part of the variable regions, and they perform the critical antigen binding function. The CDR regions are derived from many potential germ line sequences via a complex process involving recombination, mutation and selection. It has been shown that the function of binding antigens can be performed by fragments of a whole antibody. Binding fragments are the Fv fragment which comprises the V_L and V_H of a single heavy chain variable domain (V_H).

In creating "humanised" immunoglobulins, the Fc tail of a non-human antibody is exchanged for that of a human antibody. For a more complete humanisation, the FRs of the non-human antibody are exchanged for human FRs. This

process is carried out at the DNA level using recombinant techniques. However, these humanised immunoglobulins do not solve all the problems, because an immune response may still be mounted against the treatment antibody even
5 when a patient is treated with a human antibody, as it may show certain sequence differences in the V (ie idiotypic differences) and C (ie allotypic differences) regions when compared with the patients own equivalent antibodies. This is a particular problem where the
10 patient's immune system has already seen, and therefore been primed against, antibodies having these sequence differences (eg a patient may have received a prior blood transfusion which contained allotypically different immunoglobulins). A model system of injecting "mouseised
15 human antibodies" into mice indicated that the allotype matching could critically affect the anti-idiotypic response (Bruggemann M., Winter G., Waldmann H., Neuberger M.S., (1989) J. Exp. Med. 170, 2153-2157).

The present applicants have realised that one way
20 around this problem is to eliminate the allotypic variation from the constant region.

There are a range of different immunoglobulins IgG, IgM, IgA, IgD, IgE, known as isotypes, of which IgG is most commonly used therapeutically. It exists as
25 isotypic sub-classes IgG1, IgG2, IgG3 and IgG4.

There are 24 recognised allotypes of human

5

immunoglobulin distributed between the different isotypes
as follows:

5 IgG1 x 4
IgG2 x 1
IgG3 x 13
IgA2 x 2
IgE x 1
Kappa x 3

10 The allotypes represent alternative amino acid
substitutions found at discrete sites in the protein
sequence. These different allotypic determinants are
found in different combinations within given allelic
forms of genes, but not all possible combinations which
theoretically might exist are in practice observed.

15 For example, the four different allotypes of IgG1
can be seen (ie distinguished) by the immune system.
These are G1m 1, 2, 3 and 17. Alternatively,
combinations thereof, such as G1m (1, 17), can also be
distinguished. The four different single allotypes are
20 depicted in figure 2.

Antisera can be raised in other non-human species
which can see the alternative isoallotypes provided that
the antibody is purified away from the other human
isotypes. Such isoallotypes for which such an antisera
25 exists have been called non-allotypes and given the
designation for example, nG1m(1) which is the isoallotype

of G1m(1). Thus, although a human isoallotype should not be immunogenic in humans, it can still potentially be recognized in a different species.

Of the above mentioned different allotypes of IgG1,
5 three common allelic forms of human IgG1 occur with different frequencies within different racial groups, namely G1m (3), G1m (1, 17), and G1m (1, 2, 17) based upon their reactivities with human antisera directed against the determinants G1m 1, 2, 3 and 17. At some
10 point in the future, it is likely that a patient with an existing anti-allotype response to one or more of these determinants will need treatment with a humanised antibody. The obvious solution and one which has been proposed in a letter to the Journal Nature (Mage, R.G.,
15 Nature (1988) 333, 807-808), is to make all the different allelic forms of an antibody and to allotype match each patient for therapy. The present applicants have realised that commercially this is not a good proposal because of increased production costs and the need to
20 process several reagents in parallel through the regulatory requirements. Additionally, each patient would have to be tested for the response to different allotypes.

Thus, the present applicants propose eliminating the
25 allotypes altogether from each therapeutic antibody. The sequence of the human allotype of IgG1 G1m (1, 2, 17) is

shown aligned with sequences for the other human IgG, isotype sub-classes in figure 4 (a, b, c and d). It can be seen that the four isotypes are extremely homologous for the domains CH1, CH2 and CH3, and that the major isotypic differences are in the hinge region which varies in both, length and sequence between isotypes. The allotypic residues of IgG1 G1m (1, 2, 17) have been marked in figure 4. However, for the purposes of clarity the sequences around the allotypic sites G1m (1) (2) and (17) are shown below for each isotype.

Site (1)

	<u>355</u>	<u>356</u>	<u>357</u>	<u>358</u>	
	Arg	Asp or Glu	Glu	Leu or Met	IgG1
	Arg	Glu	Glu	Met	IgG2
15	Arg	Glu	Glu	Met	IgG3
	Gln	Glu	Glu	Met	IgG4

Thus, at site (1), IgG1 may exist as several allotypes depending on whether aspartic acid or glutamic acid at position 356, or leucine or methionine at position 358 are present.

Site 2

	<u>430</u>	<u>431</u>	<u>432</u>	
	Glu	Gly or Ala	Leu	IgG1
	Glu	Ala	Leu	IgG2
25	Glu	Ala	Leu	IgG3
	Glu	Ala	Leu	IgG4

Thus, at site (2), IgG1 may exist as either of two allotypes depending on whether glycine or alanine is present at position 431.

Site (17)/(3)

5 Sites (3) and (17) are alternative substitutions at the same site.

	<u>213</u>	<u>214</u>	<u>215</u>	
	Lys	Lys or Arg	Val	IgG1
	Lys	Thr	Val	IgG2
10	Lys	Arg	Val	IgG3
	Lys	Arg	Val	IgG4

Thus, at site (17)/(3), IgG1 may exist as either of two allotypes depending on whether lysine or arginine is present. The allotypes (17) and (3) cannot co-exist as
 15 they represent alternative substitutions at the same position.

The alternative alleles of G1m (1) and (2) do not provoke a human allotype response because of the homology of these alleles with the other IgG sub-classes in this
 20 region. These alleles are therefore called isoallotypes because they are only recognisable by xenoantisera (antisera from a different species) and only when the isotype is purified away from the other sub-classes.

Therefore, the present applicants propose the
 25 creation of a new IgG1 allele by site-directed mutagenesis of the gene, for example, an existing

CAMPATH-1H monoclonal antibody gene described below, so that the new allele consists entirely of isoallotypic determinants. The preparation of IgG1 mutants according to the teaching provided by the present applicants is shown schematically in figure 3.

For G1m (1) and G1m (2), the changes comprise simple substitution by the alternative isoallotypic residues. However, in the case of G1m (17) the conversion of lysine to arginine would in some cases merely change the allotype to an allotype that is recognised by certain individuals as a G1m (3) allotype despite the fact that this residue is homologous with IgG3 and IgG4. This apparent contradiction is thought to be because this arginine is seen in a tertiary epitope in the context of the other IgG1 specific residues in close proximity in the CH1 domain or hinge region. This indicates that in addition to changing lysine, other residues in CH1 or the hinge will need to be changed in order to create a new isoallotype.

Although the above and ensuing description is specifically directed to IgG1 and in particular, the CAMPATH-1H monoclonal antibody, the same approach can be used to create isoallotypes of the other human isotypes such as IgG2, IgG3 and kappa.

Thus, the present invention provides a first binding molecule derivable from a second binding molecule;

which second binding molecule is an immunoglobulin, or a derivative, structural or functional analogue thereof, a member of a family of homologous molecules, and has one or more sites which are structurally
5 distinctive from equivalent sites in the other family members;

wherein said first binding molecule is more closely homologous to the other family members than to said second binding molecule, at at least one of said one or
10 more sites.

The first binding molecule may also be an immunoglobulin or a derivative, structural or functional analogue thereof. The one or more sites which are structurally distinctive from the equivalent sites in the
15 other family members may be in the constant region giving rise to an allotypic difference. The first binding molecule may comprise entirely isoallotypic determinants.

The second binding molecule may be selected from the group consisting of IgG1, IgG2, IgG3, IgA2, IgE, kappa
20 light chains or derivatives, structural or functional analogues thereof. Where the second binding molecule is IgG1, the allotypic differences may be present at one or more of sites (1) (2) (3) or (17) as described herein. Where the second binding molecule is IgG2, the allotypic
25 difference may be present at site (23). Where the second binding molecule is IgG3, the allotypic differences may

be present at one or more of the sites (11) (5) (13) (14) (10) (6) (24) (21) (15) (16) (26) or (27). Where the second binding molecule is IgA2, the allotypic differences may be present at one or more of the sites (1) and (2). Where the second binding molecule is kappa light chain, the allotypic differences may be present at one or more of the sites (1) (2) or (3). The sites referred to above are well documented in the literature (see e.g. Eur. J. Immunol. 1976.6:599-601. Review of the notation for the allotypic and related marks of human immunoglobulins).

The present invention also provides pharmaceutical preparations comprising a first binding molecule as defined above or described herein together with one or more excipients. The pharmaceutical preparation may comprise a cocktail of said first binding molecules.

Also provided by the present invention are methods for making a first binding molecule as defined above or described herein.

These methods comprise the steps of: a) identifying in said second binding molecule, one or more sites which are structurally distinctive from the equivalent sites in the other family members; b) making said first binding molecule whereby it is more closely homologous to the other family members than to said second binding molecule at at least one of said one or more sites.

The first binding molecule may be made by providing a gene sequence encoding the second binding molecule and altering those parts of the gene sequence encoding said one or more sites. The gene sequence may be altered by
5 site directed mutagenesis using oligonucleotide primers. The altered gene sequence may be incorporated into a cloning vector or expression vector. The expression vector may be used to transform a cell. The cell may be induced to express the altered gene sequence.

10 The present invention therefore provides cloning vectors and expression vectors incorporating the altered gene sequence. Also provided are cells transformed by expression vectors defined above. Also provided are cell cultures and products of cell cultures containing the
15 first binding molecules. Also provided are recombinantly produced said first binding molecules.

Thus the present invention provides a molecule which comprises an amino acid sequence derivable from part or all of the constant region of an immunoglobulin heavy
20 chain which constant regions are of a particular isotype and have one or more allotypic determinants

wherein said amino acid sequence is substantially homologous to the amino acid sequence of said constant region, but has been altered so that it is without at
25 least one of said allotypic determinants, by making the amino acid residues at the site of an allotypic

determinant identical to the amino acid residues from the corresponding position in another equivalent immunoglobulin constant region of a different isotype.

The molecule may comprise an amino acid sequence
5 derivable from part or all of a human immunoglobulin constant region.

The molecule may also comprise one or more polypeptides together with said amino acid sequence.

The polypeptide may comprise a functional biological
10 domain. The domain may be such that it mediates any biological function. The functional biological domain may comprise a binding domain. The binding domain will have an ability to interact with another polypeptide. The interaction may be non-specific or specific.

15 The polypeptide, biological domain, binding domain and immunoglobulin-like binding domain may derive from the same source or a different source to the constant region.

The constant region may be from an immunoglobulin of
20 the isotype IgG. The isotype subclass may be IgG1 and the molecule may no longer have one or more of the allotypic determinants 1,2,3 and 17. The isotype subclass may be IgG2 and the molecule may no longer have the allotypic determinant 23. The isotype subclass may
25 be IgG3 and the molecule may no longer have one or more of the allotypic determinants 11,5,13,14,10,6,24,21,15,

16,26 and 27.

The constant region may be from an immunoglobulin of the isotype IgA2 and the molecule may no longer have either or both of the allotypic determinants 1 and 2.

5 The present invention also provides a pharmaceutical preparation which comprises a molecule as defined.

The present invention also provides a reagent which comprises a molecule as defined.

10 The present invention also provides a nucleotide sequence encoding a molecule as defined.

The present invention also provides cloning and expression vectors comprising a nucleotide sequence as delivered above.

15 The present invention also provides host cells comprising a cloning or expression vector as defined above.

The present invention also provides a method of preparing a molecule as defined above which comprises the steps of:

- 20 (a) identifying a constant region of an immunoglobulin heavy chain;
- (b) comparing the identified constant region with constant regions from immunoglobulin heavy chains of the same isotype to locate allotypic determinants in the
- 25 identified constant region;
- (c) obtaining the coding sequence for the identified

constant region having allotypic determinants;

(d) altering the coding sequence so that it codes for a molecule without at least one of said allotypic determinants and by making the amino acid residues at the site for an allotypic determinant identical to the amino acid residues from the corresponding position in an equivalent immunoglobulin constant region of an isotype different to that of said identified constant region;

(e) using said altered coding sequence in an expression system to produce a said molecule.

The present invention also provides a method of treating a patient which comprises administering a pharmaceutical preparation as defined above.

Of course, there are a number of different strategies which could be used in order to make the molecules with fewer allotypic determinants.

Genes encoding therapeutically useful antibodies are generally available in one of several different forms. They may be available as a cloned variable region DNA sequence with restriction sites at each end, suitable for recloning along with a chosen cloned constant region DNA sequence into a suitable expression vector. This is the strategy described herein for the constructs TF57-19, MTF121 and MTF123. Alternatively, they may be available as complete immunoglobulin DNA sequences including the V and C regions together, e.g. a cDNA clone of a complete

humanised or human antibody.

Whatever the form in which the cloned immunoglobulin gene is obtained, the next step is to predict the amino acid sequence of the constant region
5 from the DNA sequence. The DNA sequence can be obtained using a variety of strategies familiar to molecular biologists. The predicted amino acid sequence would then be checked for the amino acids known to vary as allotypes. Any isoallotypes present within the sequence
10 can be left unaltered. Any allotypes present can be mutated.

The next step, is to decide what amino acid sequence to mutate the allotype to, in order to imitate an isoallotype. This is done by lining up the sequence with
15 the corresponding region of the other immunoglobulin isotypes. For all known allotypes, it has been found that one or more of the other isotypes have invariant sequences for the homologous region. One of these sequences can then be chosen to form the basis for the
20 changes to be made in the allotype in question. Having predicted the new amino acid sequence for the constant region, it is necessary to alter the existing DNA clone or to create a new DNA clone which will encode this sequence. Again there are several strategies available
25 to molecular biologists in order to achieve this. In the case of the example CAMPATH-1H constructs described

herein, the gamma-1 constant region was cloned in an M13TG131 single stranded phage vector. Mutagenic oligonucleotides were synthesised which were largely homologous to the single strand, but which contained base changes necessary to alter the codons for the critical amino acids. The mutagenesis was carried out using a commercial kit from Amersham International, High Wycombe, Bucks. Alternatively it would be possible to synthesise a complete artificial gene which encodes the predicted sequence.

Once mutated or newly synthesised, the gene is ready for expression. There are many different expression vectors available. Some of these are more suitable for expression in restricted cell types. Again it is within the standard technical expertise of one skilled in this field to choose and adapt expression vectors for this purpose. In the case of the CAMPATH-1H constructs described herein, modifications of the pSVgpt and pSVneo vectors have been used. These vectors have convenient cloning sites for the immunoglobulin variable and constant region, encoding DNA fragments adjacent to suitable promoter and enhancer sequences to allow expression in lymphoid cells. The vector allows the easy independent replacement of variable or constant region encoding DNA fragments. Thus, any suitable variable region can be subcloned into the vector, to give rise to

a new specificity, or the variable region can be kept and the constant region changed to give rise to a new isotype or allotype. Alternative vector systems are readily available.

5 Having removed allotypes from heavy chain constant regions by mutating them all to isoallotypes, it may still be desirable to consider the light chain effect in stimulating an immune response.

10 The most common kappa light chain allotype is Km(3) in the general population. Therefore it may be sufficient to utilise this common kappa light chain allotype, as relatively few members of the population would see it as foreign.

15 Alternatively there are no lambda light chain allotypes. Therefore they could be used in combination with the de-allotyped molecules derivable from heavy chain constant regions.

20 Where one utilises the kappa light chain, the allotype Km(1,2) could first be mutated to the allotype Km(1). The light chain allotype Km(1) is often only weakly recognized in combination with certain heavy chain classes and subclasses, and so may not cause a major problem in therapeutic use.

25 In order that the present invention is more fully understood embodiments will now be described in more detail, by way of example only, and not by way of

limitation. Reference will be made (and has already been made in the text above) to the following figures in which:

5 figure 1 illustrates the structure of an IgG antibody;

figure 2 shows the allotypes for the IgG1 antibody CAMPATH-1H;

figure 3 shows schematically the preparation of IgG1 mutants;

10 figure 4 shows the IgG1 G1m (1,2,17) allotype sequence aligned to single allotypic examples of IgG2, 3 and 4 (none of these other subclasses have allotypic residues which cover the same residues as for the IgG1 allotypes);

15 figure 5 shows the M13TG131 cloning vector containing the human gamma-1 constant region, showing cloning sites and modified polylinker;

figure 6 shows the original Hu4vH HuG1 pSVgpt expression vector and its modified version;

20 figure 7 shows the result of an ELISA assay testing different dilutions of the antibodies of mutants 1, 2 and wild type CAMPATH-1H for IgG1 specificity;

figure 8 shows the result of an autologous complement mediated lysis test using human peripheral
25 blood lymphocytes; and

figure 9 illustrates an antibody-dependent cell-

mediated cytotoxicity assay (ADCC) using CD3 activated interleukin-2 expanded human blastocytes cell effectors (E) and targets (T).

The starting antibody used for site-directed
5 mutagenesis was CAMPATH-1H, a monoclonal antibody with a kappa light chain containing the human constant region sequence for IgG1 which carries the G1m (1, 17) allelic determinants. The whole IgG1 encoding region exists as approximately 2.3 kb HindIII-SphI restriction fragment
10 cloned in an M13 vector. The M13TG131 cloning vector containing the human gamma-1 constant region showing cloning sites and modified polylinker is shown in figure 5.

The IgG1 encoding region is entered in the EMBL
15 Sequence Database under the code number HS1GCC4. The accession number is AC J00228 (the printout from the database is provided herein as Appendix 1). This sequence is for the G1m (1, 17) allotype. It covers 2009 bases from the 5' HindIII site (A)AGCTT including all of
20 the coding region. It does not however, include some of the 3' non-coding region up to the SphI site. The sequence provided by the EMBL Database is that of the upper strand of DNA. The CH1 domain starts at nucleotide 210 and ends at nucleotide 503. The mutagenic
25 oligonucleotides M01 and M04 hybridise to nucleotides 486 to 510. The hinge region starts at nucleotide 892 and

ends at nucleotide 936. The CH2 domain starts at nucleotide 1481 and ends at nucleotide 1803. The mutagenic oligonucleotide MO2 hybridises to nucleotides 1515 to 1543. The essential signal for the poly A tail
5 is provided by nucleotides 1902 to 1908.

In M13TG131, the IgG1 coding region exists as a 2260 nucleotide fragment, of which the final 251 nucleotides are non-coding and therefore, inessential. Therefore, an embodiment of the invention could be carried out using
10 the sequence information provided by the EMBL Sequence Database. It should be noted however, that the SphI restriction site referred to above, is present in the 3' end inessential non-coding region. Therefore, if the sequence data as provided by the EMBL database were being
15 used, alternative restriction sites would have to be utilised.

Using site-directed mutagenesis, (carried out using protocols and reagents as supplied in kit form, Amersham code RPN. 1523, Amersham International Plc, Amersham, UK)
20 the sequence corresponding to the G1m (1) allele was converted to the corresponding sequence found in the other sub-classes for IgG (Asp Glu Leu to Glu Glu Met at positions 356-358 in the CH3 domain).

The mutagenic oligonucleotides used were:

- 25 a) MO1 (to convert G1m (17) to G1m (3))
5' CTC TCA CCA ACT CTC TTG TCC ACC T 3';

- b) MO2 (to convert G1m (1) to its isoallotype nG1m (1))
5' GGT TCT TGG TCA TCT CCT CCC GGG ATG GG 3'; and
- c) MO4 (to eliminate G1m(3) by changing Lys to Thr in
the CH1 region)

5 5' CTC TCA CCA ACA GTC TTG TCC ACC T 3'.

The oligonucleotides were synthesised and then purified using an automated synthesizer and oligo purification columns supplied by Applied Biosystems (Applied Biosystems, 850 Lincoln Drive, Foster City, California, 10 94404 USA) following the manufacturers recommended protocols. Mutations were checked by Sanger Dideoxy sequencing (Sanger, F.S., Nicklen, S., and Coulson, A.R., (1977) Proc. Natl. Acad. Sci., USA, 74, 5463) using standard protocols and kits. As this newly formed 15 allotype sequence is found in all humans, there should be no immunological response to this alternative form of G1m (1). Additionally and similarly, the lysine residue responsible for the G1m (17) allotypic determinant was converted to an arginine residue corresponding to the G1m 20 allele (Lys 214-Arg; mutant 1).

The gene for this new constant region of mutant 1 carrying these three changes has been sequenced, incorporated into an expression vector containing the CAMPATH-1H V-region and expressed together with the 25 CAMPATH-1H light chain which had been introduced by co-transfection.

A further mutant has been made by replacing the critical arginine residue associated with G1m (3) of mutant 1 with a threonine residue, to produce a heavy chain which is the equivalent of IgG2 and which should fail to react with both anti-G1m (17) and anti-G1m (3) antisera (mutant 2).

Mutant 2 has also been sequenced, re-cloned in an expression vector containing the CAMPATH-1H light chain.

The supernatants of growing cultures containing either of the two mutants were subsequently assayed for the expression of a human IgG1 kappa product.

The mutations were introduced with the oligonucleotides listed above. The modified Hu4vHG1pSVgpt vector shown in figure 6 was used to simplify the subcloning of all the new mutants into the expression vector, owing to the possibility of use of two different "sticky ends" Bam HI and NotI. The expression vectors and V_H region sequences and expression, along with the light chains, in YO rat plasmacytoma cells are all as described in Riechmann L., Clark, M.R. Waldman H., Winter G. (1988) Nature 332, 323-327.

From the positive cultures, the producers of the largest amount of the IgG1 product were selected to obtain purified antibody for biological assays to determine their allotypes and biological effector functions.

Example 1

An Enzyme-linked Immuno Sorbent Assay (ELISA) was performed to verify that an IgG1 type antibody was produced by the mutants. This was tested with microtiter
5 plates coated with anti-CAMPATH-idiotypic antibody (YID 13.9). Wild type CAMPATH-1H antibody served as control. The bound antibody was detected with biotin-labelled anti-human kappa reagents or anti-human IgG reagent (monoclonals NH3/41 and NH3/130 respectively although
10 other suitable reagents are commonly available) and subsequent development with streptavidin horseradish peroxidase. Figure 7 illustrates the results obtained for:

TF 57-19 ("wild type" CAMPATH-1H antibody, 0)
15 MTF 121 (mutant 1, Δ)
MTF 123 (mutant 2, \square)

and the wild type CAMPATH-1H (∇) in a known amount as standard. The concentrations had been estimated, and the starting dilutions adjusted to 50 μ g/ml in PBS/10 mg/ml
20 BSA. The starting dilution was used to prepare 8 two-fold dilutions.

The slope of the graph shows clearly that the CAMPATH-idiotypic antibodies recognises mutants 1 and 2 to an extent equivalent to that of the wild type CAMPATH-1H,
25 and that all three antibodies tested are present in similar concentrations as the standard.

Example 2

The mutants' capability of autologous complement mediated lysis of human peripheral blood lymphocytes was tested.

5 Human peripheral blood mononuclear cells from a healthy donor were isolated from 60 ml defibrinated blood on a Lymphoprep* gradient (Nyeggard & Co., AS, Oslo, Norway). The cell pellet was washed in IMDM (Iscove's Modification of Dulbecco's Medium, Flow Laboratories, 10 Scotland), and the cells were labelled with ⁵¹Cr. The starting dilution of antibodies used in the test was 50 µg/ml in PBS, 10 µg/ml BSA (dilution 1). Dilution 1 was further diluted 8 times two-fold to a final dilution of 1/128. Wild type antibody diluted in the same manner was 15 used as a control.

The result is illustrated in figure 8. As can be seen, both antibody mutants show a very similar result in lysing the blood mononuclear cells as the wild type. The efficiency of the mutants is almost identical.

20 Example 3

Experiments were conducted to investigate whether or not, the mutant antibodies were capable of antibody-dependent cell-mediated cytotoxicity (ADCC) using CD3 activated interleukin-2 expanded human blastocytes as 25 effectors (E) and targets (T). Cells were generated and used as both effectors and targets essentially as

described in Riechmann L., Clark M.R., Waldmann H., Winter G., 1988, Nature 322, 323-327.

Preparation of Target Cells (T)

5 ml of blastocytes (3×10^6 cells) were labelled with ^{51}Cr for 1 h. After 1 h the cells were washed and transferred in 6 equal aliquots in 100 μl IMDM 1% BSA, to 6 x 10 ml tubes containing 100 μl of the antibodies of mutants 1 and 2, and the control. The tubes were incubated for 1.5 h at room temperature. The cells were then washed with 10 ml IMDM 1% BSA and resuspended in 1.5 ml IMDM 1% BSA.

Preparation of Effector Cells (E)

Unlabelled blastocytes (2×10^6) were diluted 100:1 and 30:1 in IMDM 1% BSA medium. The ratios 100:1 and 30:1 refer to the final absolute ratios of effectors to ^{51}Cr labelled targets in the assay. Assays were performed in microtitre plates with a total volume of 200 μl per assay well. Thus 100 μl of targets at a concentration of 2×10^4 were put in each well ie 2×10^3 total cells. For E:T of 100:1, 100 μl of effectors at 2×10^6 were plated per well ie 2×10^5 . For E:T of 30:1 100 μl of effectors at 6×10^5 were put into each well ie 6×10^4 total cells.

The efficiency percentage of specific ^{51}Cr release was calculated as follows:

% specific ^{51}Cr release =

(test release cpm - spontaneous (cpm) x 100

(total cpm - spontaneous cpm)

cpm = radioactive counts per minute as measured on a counter.

5 The result is shown in figure 9. The figure shows that all of the antibodies tested released chromium. Wild type TF 57-19 and mutant 2 (MTF 123) released at about equal levels, whereas mutant 1 (MTF 121) shows a slightly higher release.

10 These results clearly show that the mutants have biological activity comparable to the wild type CAMPATH-1H antibody.

Example 4

15 The antibodies were tested in an assay specific for their Glm (3) allotypes reactivity using a monoclonal reagent from Oxoid (WHO/IVISS recognised agent, Study Code No HP 6027). These tests were performed in replicates of two.

20 Microtiter plates were coated with the anti-CAMPATH idiotype YID 13.9.4 antibody captive, and divided into three arrays of 4 x 4 wells. Into each of the three arrays, 4 x 5 fold dilutions of the antibody TF 57-19, MTF 121 and MTF 123 (50 µg/ml) in PBS 1% BSA and a control solution of PBS/BSA each were added.

25 After an incubation of 45 minutes at room temperature, the antibody solution was removed, and

(i) to the first array was added a 1:500 dilution of biotin-labelled anti-G1m (3);

(ii) to the second array was added a 1:100 dilution of biotin-labelled antibody (NH3/41) specific
5 for the kappa light chain; and

(iii) to the third array was added a 1:1000 dilution of biotin-labelled antibody (NH3/130) specific for human IgG1.

The microtiter plate was developed with streptavidin
10 horseradish peroxidase.

The result is illustrated in Table 1. The numbers in the results represent the optical density (O.D) as measured in an ELISA plate reader multiplied by 100 ie 12 represents an O.D of 0.12 and 70 an O.D of 0.70.

15 The result clearly shows, that samples 1-3 all react with the antibodies specific for IgG1 (see also Example 1 above) and the kappa light chains. The control is negative. However, in the assay for G1m (3) specificity, only MTF 121 (mutant 1) shows reactivity, whereas the
20 wild type TF 57-19, MTF 123 (mutant 2) and the PBS/BSA control did not show any response.

This result illustrates clearly that the elimination of sites recognised in the allotype response by site-directed mutagenesis of these sites can overcome the
25 problems of allotypic immuno-reactions. Although the examples refer to the mutagenesis of IgG1 only, it will

be clear to the person skilled in the art that other immunoglobulin isotypes can be similarly modified.

Example 5

The antibodies were tested in a conventional
5 allotyping experiment using inhibition of red cell agglutination. The experiment was carried out using reagents supplied by the Central Laboratory of the Netherlands Red Cross, Blood Transfusion Service (PO Box 9190, 1006 AD Amsterdam, Netherlands).

10 Human blood group O Rhesus D red cells were washed and then aliquots separately labelled as described below with one of the following three relevant anti-RhD human sera having antibodies of known allotype.

- (1) anti-D G1m(az) = G1m (1,17)
- 15 (2) anti-D G1m(x) = G1m (2)
- (3) anti-D G1m(f) = G1m (3)

Coating of Red Cells with Anti-Rh Antibodies

One volume of packed washed red blood cells were incubated with 4 volumes anti-Rh serum and 4 volumes
20 (phosphate) buffered saline (PBS) at 37°C during 60 minutes. Every 15 minutes the cells were mixed by shaking.

After incubation the coated cells were washed four times with PBS and stored at 4°C in preservation fluid
25 (although coated red blood cells can be stored at 4°C in PBS for one week).

These coated red blood cells were then agglutinated with four antisera to the IgG1 allotypes as follows using the recommended dilution for each antiserum.

- 5 (1) anti-Glm(z) = anti-Glm(17) 1 in 30 dilution
 (2) anti-Glm(a) = anti-Glm(1) 1 in 30 dilution
 (3) anti-Glm(x) = anti-Glm(2) 1 in 20 dilution
 (4) anti-Glm(f) = anti-Glm(3) 1 in 30 dilution

The wild-type CAMPATH-1H TF57-19 or the different CAMPATH-1H constructs (MTF 121, MTF 123) with the altered
 10 gamma-1 constant regions were then tested for their abilities to inhibit the agglutination of the red cells by the above antisera. The inhibiting antibodies were tried at concentrations of 0.5mg/ml, 0.25mg/ml and
 15 0.125mg/ml in phosphate buffered saline containing 5% foetal bovine serum. Control sera containing IgG1 of allotype Glm(zax) or Glm(f) [Glm(1,2,17) or Glm(3)] were also included in the experiment and were used at dilutions of 1 in 10,20 and 40. Where it occurred the
 20 inhibition was most easily seen for the CAMPATH-1H antibodies at the 0.5mg/ml concentration and it was much weaker for 0.25mg/ml and no inhibition was seen at 0.125mg/ml. The control sera inhibited at all three dilutions tested. The results for the highest concentration are shown below.

25

Allotype	CAMPATH-1H constructs	Control sera
----------	-----------------------	--------------

31

	TF57-19	MTF121	MTF123	Glm(1,2,17)	Glm(3)
Glm(1)	+	-	-	+	-
Glm(2)	-	-	-	+	-
Glm(3)	-	+	-	-	+
5 Glm(17)	+	-	-	+	-

The results are therefore consistent with the original wild type CAMPATH-1H antibody TF57-19 having allotype Glm(1,17). The new mutant MTF121 type as
 10 allotype Glm(3) whilst the mutant MTF123 fails to allotype for any of the IgG1 allotype markers Glm(1,2,3,17) i.e. it appears not to have an IgG1 allotype.

The skilled man will be able to use the binding
 15 molecules hereby provided to make pharmaceuticals according to standard techniques. Similarly the pharmaceuticals can be used in accordance with standard practices.

SUBSTITUTE SHEET

Table 1

Type Specific Antibody	anti Glm(3)				anti kappa (NH3/41)				anti IgG 1 (NH3/130)			
	10	2	0.4	0.08	10	2	0.4	0.08	10	2	0.4	0.08
1) TF 57-19 (Wildtype)	12/10	13/12	13/12	13/11	52/59	52/53	45/47	27/30	61/66	65/66	54/53	28/23
2) MTF 121 (Mutant 1)	80/75	69/69	64/65	53/44	59/53	54/52	48/41	28/20	71/68	71/69	55/52	26/23
3) MTF 123 (Mutant 2)	17/16	15/17	16/16	16/17	56/58	55/60	50/55	36/36	67/73	66/70	57/63	31/35
4) PBS/BSA	15/16	15/16	15/18	15/19	15/16	17/17	18/18	15/18	15/17	15/16	15/15	15/16

32

WO 92/16562

PCT/GB92/00445

APPENDIX 1 - Sheet (a)

HSIGCC4 2009 bases
Human ig germline g-e-a region a: gamma-1 constant region

ID HSIGCC4 standard; DNA; PRI; 2009 BP.

AC J00228;

DT 23-APR-1990 (reference update)

DT 18-JUL-1985 (incorporated)

DE Human ig germline g-e-a region a: gamma-1 constant
DE region

KW constant region; gamma-immunoglobulin; germ line;
KW hinge exon; immunoglobulin; immunoglobulin heavy
KW chain.

OS Homo sapiens (human)

OC Eukaryota; Metazoa; Chordata; Vertebrata; Tetrapoda;

OC Mammalia; Eutheria; Primates.

RN [1] (bases 1-2009)

RA Ellison J.W., Berson B.J., Hood L.E.;

RT "The nucleotide sequence of a human immunoglobulin

RT c-gamma-1 gene";

RL Nucleic Acids Res. 10:4071-4079(1982).

RN [2] (bases 469-1070, 1465-1821)

RA Takahashi N., Ueda S., Obata M., Nikaido T.,

RA Nakai S., Honjo T.;

RT "Structure of human immunoglobulin gamma genes:

RT Implications for evolution of a gene family";

RL Cell 29:671-679(1982).

CC [1] and [2] report that nucleotide divergence among
CC the four gamma genes is much greater in the hinge
CC regions than anywhere else. [2] also reports the
CC hinge regions of gamma-2, gamma-3, gamma-4, a gamma
CC pseudogene, and the 5' flanking, ch2, and ch3
CC domains of the gamma genes.

CC this entry is part of a multigene region (region a)
CC containing the gamma-3, gamma-1, pseudo-epsilon, and
CC alpha-1 genes. see segment 1 for more comments.

Key Location/Qualifiers

FT CDS 210..503
FT /note="Ig gamma-1 heavy chain

APPENDIX 1 - cont. Sheet (b)

FT		c-region chl domain (aa at 212)"
FT	conflict	563..563
FT		/citation=([1],[2])
FT		/note="T in [1]; c in [2]"
FT	conflict	593..593
FT		/citation=([1],[2])
FT		/note="C in [1]; t in [2]"
FT	conflict	614..614
FT		/citation=([1],[2])
FT		/note="G in [1]; a in [2]"
FT	conflict	633..633
FT		/citation=([1],[2])
FT		/note="G in [1]; gg in [2]"
FT	conflict	643..643
FT		/citation=([1],[2])
FT		/note="G in [1]; a in [2]"
FT	conflict	654..654
FT		/citation=([1],[2])
FT		/note="G in [1]; a in [2]"
FT	conflict	684..684
FT		/citation=([1],[2])
FT		/note="C in [1]; cc in [2]"
FT	conflict	692..692
FT		/citation=([1],[2])
FT		/note="G in [1]; a in [2]"
FT	conflict	765..766
FT		/citation=([1],[2])
FT		/note="Aa in [1]; a in [2]"
FT	CDS	892..936
FT		/note="Ig gamma-1 heavy chain
FT		c-region hinge"
FT	CDS	1055..1384
FT		/note="Ig gamma-1 heavy chain
FT		c-region ch2 domain"
FT	conflict	1475..1475
FT		/citation=([1],[2])
FT		/note="C in [1]; cc in [2]"
FT	CDS	1481..1803
FT		/note="Ig gamma-1 heavy chain
FT		c-region ch3 domain"
FT	conflict	1578..1578
FT		/citation=([1],[2])
FT		/note="T in [1]; c in [2]"
SQ	Sequence	2009 BP; 418 A; 698 C; 566 G; 327 T; 0
SQ	Other;	

APPENDIX 1 - cont. Sheet (c)

	10	20	30	40	50	60
1	AGCTTTCTGG	GGCAGGCCAG	GCCTGACCTT	GGCTTTGGGG	CAGGGAGGGG	GCTAAGGTGA
61	GGCAGGTGGC	GCCAGCAGGT	GCACACCCAA	TGCCCATGAG	CCCAGACACT	GGACGCTGAA
121	CCTCGCGGAC	AGTTAAGAAC	CCAGGGGGCCT	CTGCGCCTGG	GCCCAGCTCT	GTCCCACACC
181	GCGGTACAT	GGCACCACCT	CTCTTGACAG	CTCCACCAAG	GGCCCATCGG	TCTTCCCCCT
241	GGCACCTCC	TCCAAGAGCA	CCTCTGGGGG	CACAGCGGCC	CTGGGCTGCC	TGGTCAAGGA
	310	320	330	340	350	360
301	CTACTTCCCC	GAACCGGTGA	CGGTGTCGTG	GAACTCAGGC	GCCCTGACCA	GCGGCCTGCA
361	CACCTTCCCG	GCTGTCTTAC	AGTCCTCAGG	ACTCTACTCC	CTCAGCAGCG	TGGTGACCGT
421	GCCCTCCAGC	AGCTTGGGCA	CCCAGACCTA	CATCTGCAAC	GTGAATCACA	AGCCCAGCAA
481	CACCAAGGTG	GACAAGAAAG	TGGGTGAGAG	GCCAGCACAG	GGAGGGAGGG	TGTCTGCTGG
541	AAGCAGGCTC	AGCGCTCCTG	CCTGGACGCA	TCCCGGCTAT	GCAGCCCCAG	TCCAGGGCAG
	610	620	630	640	650	660
601	CAAGGCAGGC	CCCGTCTGCC	TCTTCACCCG	GAGCCTCTGC	CCGCCCCACT	CATGCTCAGG
661	GAGAGGGTCT	TCTGGCTTTT	TCCCAGGCTC	TGGGCAGGCA	CAGGCTAGGT	GCCCCTAACC
721	CAGGCCCTGC	ACACAAAGGG	GCAGGTGCTG	GGCTCAGACC	TGCCAAGAGC	CATATCCGGG
781	AGGACCTTGC	CCCTGACCTA	AGCCCACCCC	AAAGGCCAAA	CTCTCCACTC	CCTCAGCTCG
841	GACACCTTCT	CTCCTCCCAG	ATTCCAGTAA	CTCCCAATCT	TCTCTCTGCA	GAGCCCAAAT
	910	920	930	940	950	960
901	CTTGTGACAA	AACTCACACA	TGCCCACCGT	GCCCAGGTAA	GCCAGCCCAG	GCCTCGCCCT
961	CCAGCTCAAG	GCGGGACAGG	TGCCCTAGAG	TAGCCTGCAT	CCAGGGACAG	GCCCCAGCCG
1021	GGTGTGACAA	CGTCCACCTC	CATCTCTTCC	TCAGCACCTG	AACTCCTGGG	GGGACCGTCA
1081	GTCTTCTCT	TCCCCC AAA	ACCCAAGGAC	ACCCTCATGA	TCTCCCGGAC	CCCTGAGGTC
1141	ACATGCGTGG	TGGTGGACGT	GAGCCACGAA	GACCCTGAGG	TCAAGTTCAA	CTGGTACGTG

WO 92/16562

35

PCT/GB92/00445

APPENDIX 1 - cont. Sheet (d)

	1210	1220	1230	1240	1250	1260
1201	GACGGCGTGG	AGGTGCATAA	TGCCAAGACA	AAGCCGCGGG	AGGAGCAGTA	CAACAGCACG
1261	TACCGGGTGG	TCAGCGTCCT	CACCGTCCTG	CACCAGGACT	GGCTGAATGG	CAAGGAGTAC
1321	AAGTGCAAGG	TCTCCAACAA	AGCCCTCCCA	GCCCCATCG	AGAAAACCAT	CTCCAAAGCC
1381	AAAGGTGGGA	CCCCTGGGGT	GCGAGGGCCA	CATGGACAGA	GGCCGGCTCG	GCCCACCCTC
1441	TGCCCTGAGA	GTGACCGCTG	TACCAACCTC	TGTCCTACAG	GGCAGCCCCG	AGAACCACAG
	1510	1520	1530	1540	1550	1560
1501	GTGTACACCC	TGCCCCCATC	CCGGGATGAG	CTGACCAAGA	ACCAGGTCAG	CCTGACCTGC
1561	CTGGTCAAAG	GCTTCTATCC	CAGCGACATC	GCCGTGGAGT	GGGAGAGCAA	TGGGCAGCCG
1621	GAGAACAAC	ACAAGACCAC	GCCTCCCGTG	CTGGACTCCG	ACGGCTCCTT	CTTCCTCTAC
1681	AGCAAGCTCA	CCGTGGACAA	GAGCAGGTGG	CAGCAGGGGA	ACGTCTTCTC	ATGCTCCGTG
1741	ATGCATGAGG	CTCTGCACAA	CCACTACACG	CAGAAGAGCC	TCTCCCTGTC	TCCGGGTA
	1810	1820	1830	1840	1850	1860
1801	TGAGTGCGAC	GGCCGGCAAG	CCCCGCTCCC	CGGGCTCTCG	CGGTCCGACG	AGGATGCTTG
1861	GCACGTACCC	CCTGTACATA	CTTCCCGGGG	GCCCAGCATG	GAAATAAAGC	ACCCAGCGCT
1921	GCCCTGGGCC	CCTGCGAGAC	TGTGATGGTT	CTTTCCACGG	GTCAGGCCGA	GTCTGAGGCC
1981	TGAGTGGCAT	GAGGGAGGCA	GAGCGGGTC			

SUBSTITUTE SHEET

WO 92/16562

36

PCT/GB92/00445

CLAIMS

1. A molecule which comprises an amino acid sequence derivable from part or all of the constant region of an immunoglobulin heavy chain which constant regions are of a particular isotype and have one or more allotypic determinants

5
10
15 wherein said amino acid sequence is substantially homologous to the amino acid sequence of said constant region, but has been altered so that it is without at least one of said allotypic determinants, by making the amino acid residues at the site of an allotypic determinant identical to the amino acid residues from the corresponding position in another equivalent immunoglobulin constant region of a different isotype.

2. A molecule according to claim 1 which comprises an amino acid sequence derivable from part or all of a human immunoglobulin constant region.

20
3. A molecule according to claim 1 or claim 2 which comprises one or more polypeptides together with said amino acid sequence.

25
4. A molecule according to claim 3 wherein the polypeptide comprises a functional biological domain.

SUBSTITUTE SHEET

5. A molecule according to claim 4 wherein the functional biological domain comprises a binding domain.
- 5 6. A molecule according to claim 5 wherein the binding domain is an immunoglobulin-like binding domain.
7. A molecule according to claim 6 in which said immunoglobulin-like binding domain and said amino acid
10 sequence are derivable from the same or different sources.
8. A molecule according to any one of claims 1 to 7 wherein the constant region is from an immunoglobulin of
15 the isotype IgG.
9. A molecule according to claim 8 wherein the isotype subclass is IgG1 and the molecule no longer has one or more of the allotypic determinants 1,2,3 and 17.
20
10. A molecule according to claim 8 wherein the isotype subclass is IgG2 and the molecule no longer has the allotypic determinant 23.
- 25 11. A molecule according to claim 8 wherein the isotype subclass is IgG3 and the molecule no longer has one or

SUBSTITUTE SHEET

more of the allotypic determinants 11,5,13,14,10,6,24,21,
15,16,26 and 27.

5 12. A molecule according to any one of claims 1 to 7
wherein the constant region is from an immunoglobulin of
the isotype IgA2 and the molecule no longer has either or
both of the allotypic determinants 1 and 2.

10 13. A pharmaceutical preparation which comprises a
molecule according to any one of claims 1 to 12.

14. A reagent which comprises a molecule according to
any one of claims 1 to 12.

15 15. A nucleotide sequence encoding a molecule according
to any one of claims 1 to 12.

20 16. A cloning or expression vector comprising a
nucleotide sequence according to claim 15.

17. A host cell comprising a cloning or expression
vector according to claim 16.

25 18. A method of preparing a molecule according to any
one of claims 1 to 12 which comprises the steps of:

(a) identifying a constant region of an immunoglobulin

SUBSTITUTE SHEET

heavy chain;

(b) comparing the identified constant region with constant regions from immunoglobulin heavy chains of the same isotype to locate allotypic determinants in the identified constant region;

(c) obtaining the coding sequence for the identified constant region having allotypic determinants;

(d) altering the coding sequence so that it codes for a molecule without at least one of said allotypic determinants and by making the amino acid residues at the site for an allotypic determinant identical to the amino acid residues from the corresponding position in an equivalent immunoglobulin constant region of an isotype different to that of said identified constant region;

(e) using said altered coding sequence in an expression system to produce a said molecule.

19. A method of treating a patient which comprises administering a pharmaceutical preparation according to claim 13.

SUBSTITUTE SHEET

1/11

Fig. 1.

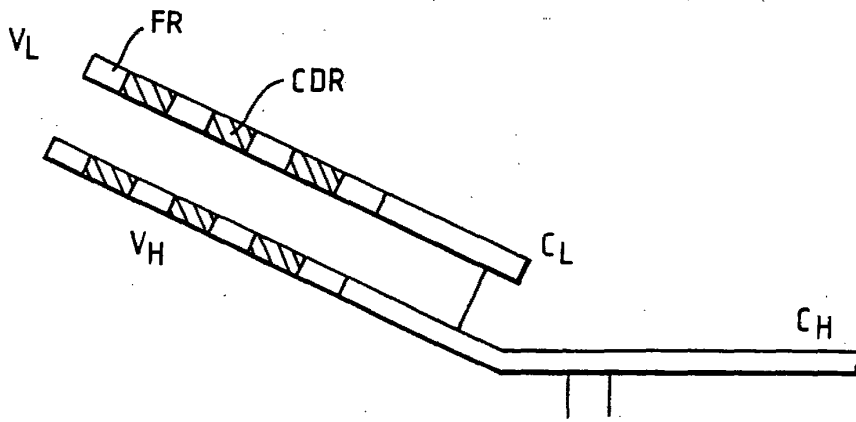
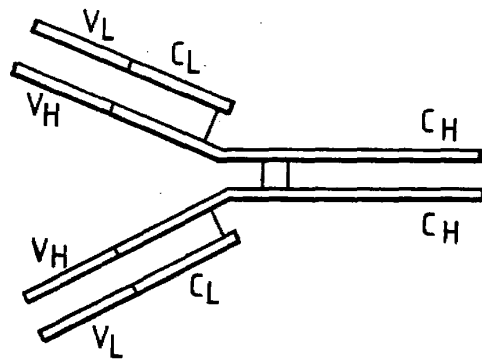
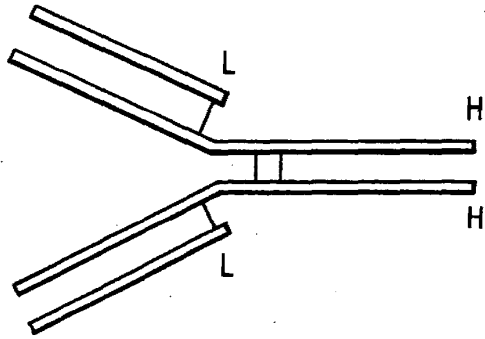

SUBSTITUTE SHEET

Fig. 2.

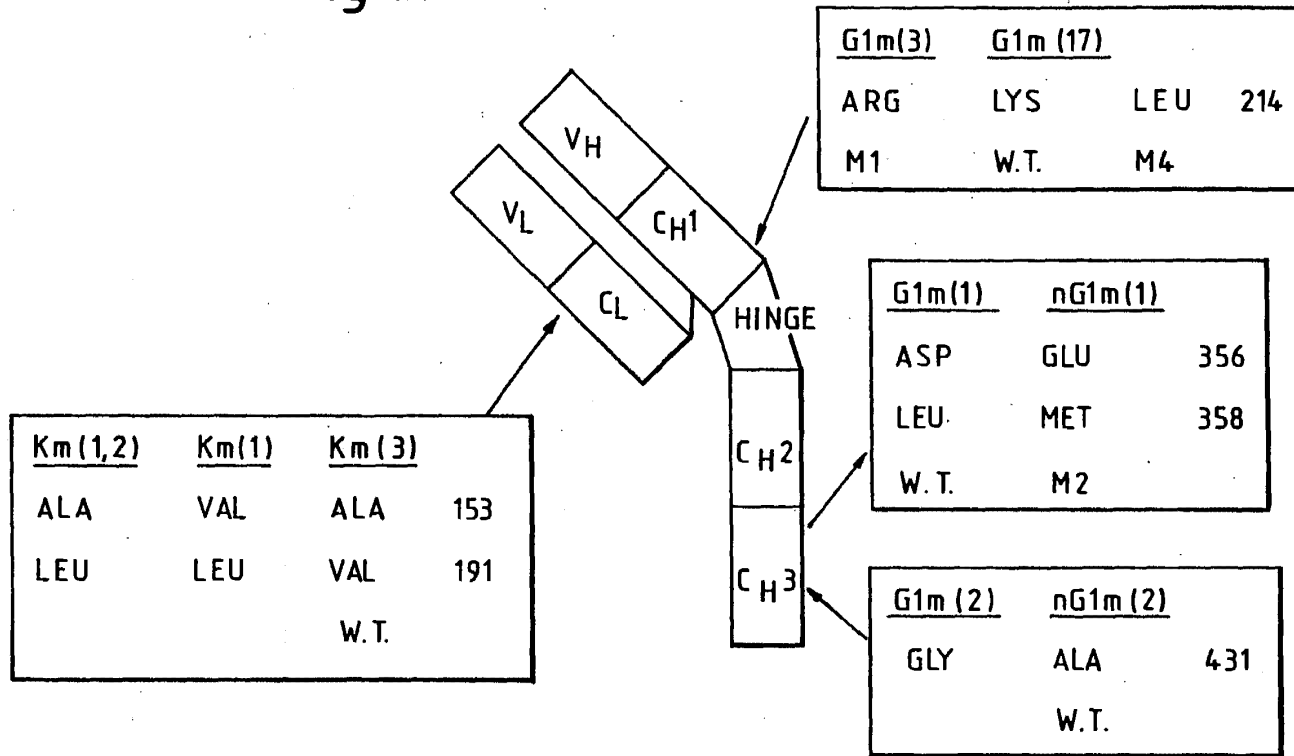

2/11

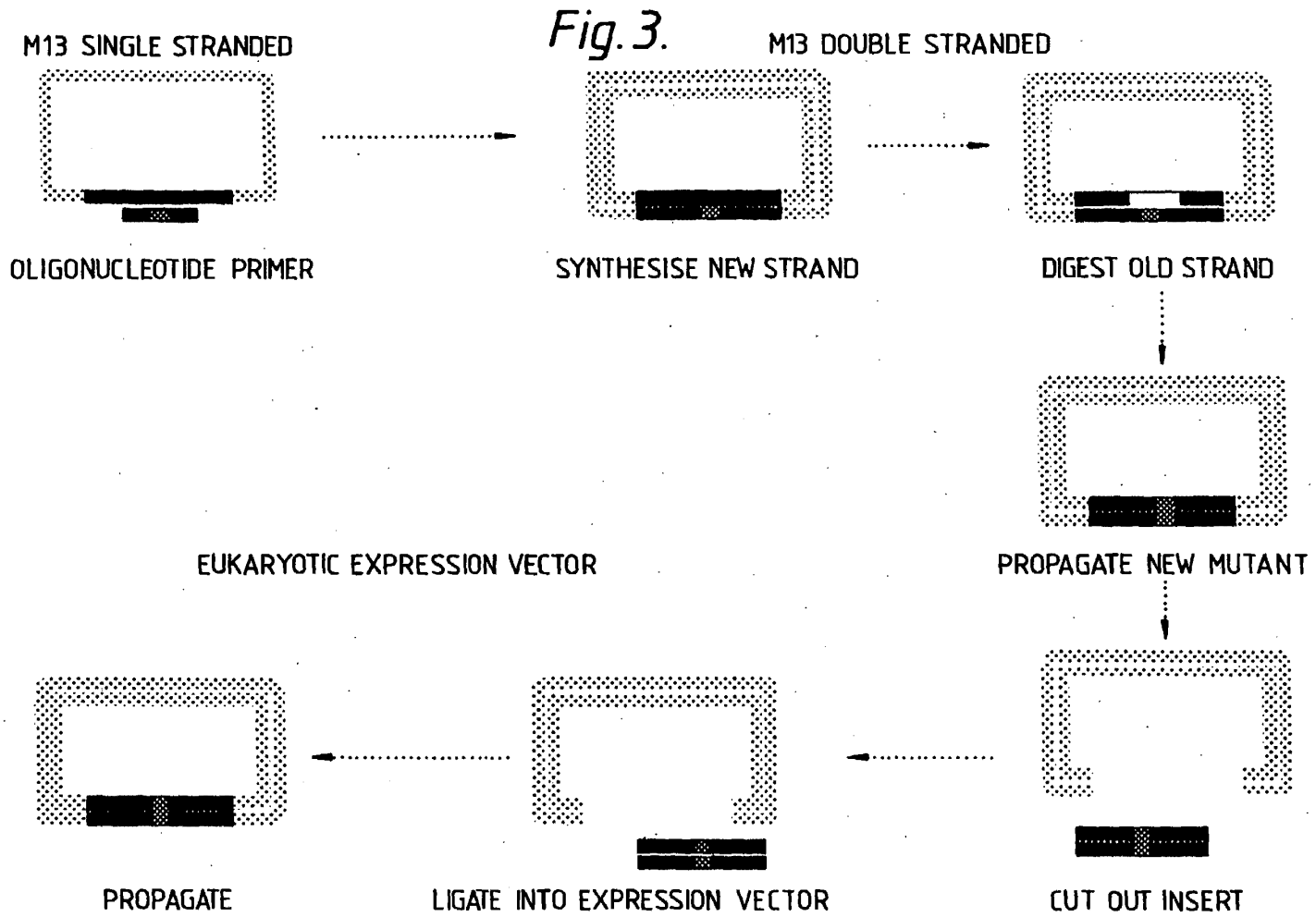

4/11

Fig. 4 a.

Human immunoglobulin sequences CH1 region

Ala	Ser	Thr	Lys	Gly	Pro	Ser	Val	Phe	Pro	Leu	Ala	Pro	Ser	Ser	Lys	Ser	Thr	Ser	Gly	IgG1
-	-	-	-	-	-	-	-	-	-	-	-	-	-	-	Arg	-	-	-	Glx	IgG2
-	-	-	-	-	-	-	-	-	-	-	-	-	-	Cys	-	Arg	-	-	-	IgG3
-	-	-	-	-	-	-	-	-	-	-	-	-	-	Cys	-	Arg	-	-	Glu	IgG4
Gly	Thr	Ala	Ala	Leu	Gly	Cys	Leu	Val	Lys	Asp	Tyr	Phe	Pro	Glu	Pro	Val	Thr	Val	Ser	IgG1
Ser	-	-	-	-	-	-	-	-	-	-	-	-	-	-	-	-	-	-	-	IgG2
-	-	-	-	-	-	-	-	-	-	-	-	-	-	-	-	-	-	-	-	IgG3
Ser	-	-	-	-	-	-	-	-	-	-	-	-	-	-	-	-	-	-	-	IgG4
Trp	Asn	Ser	Gly	Ala	Leu	Thr	Ser	Gly	Val	His	Thr	Phe	Pro	Ala	Val	Leu	Gln	Ser	Ser	IgG1
-	-	-	-	-	-	-	-	-	-	-	-	-	-	-	-	-	-	-	-	IgG2
-	-	-	-	-	-	-	-	-	-	-	-	-	-	-	-	-	-	-	-	IgG3
-	-	-	-	-	-	-	-	-	-	-	-	-	-	-	-	-	-	-	-	IgG4
Gly	Leu	Tyr	Ser	Leu	Ser	Ser	Val	Val	Thr	Val	Pro	Ser	Ser	Ser	Leu	Gly	Thr	Gln	Thr	IgG1
-	-	-	-	-	-	-	-	-	-	-	-	-	-	-	Asn	Phe	-	-	-	IgG2
-	-	-	-	-	-	-	-	-	-	-	-	-	-	-	-	-	-	-	-	IgG3
-	-	-	-	-	-	-	-	-	-	-	-	-	-	-	-	-	-	Lys	-	IgG4
														Gln(17)						
Tyr	Ile	Cys	Asn	Val	Asn	His	Lys	Pro	Ser	Asn	Thr	Lys	Val	Asp	Lys	Lys	Val	IgG1		
-	Thr	-	-	Asp	-	-	-	-	-	-	-	-	-	-	-	Thr	-	IgG2		
-	Thr	-	-	-	-	-	-	-	-	-	-	-	-	-	-	Arg	-	IgG3		
-	Thr	-	-	Asp	-	-	-	-	-	-	-	-	-	-	-	Arg	-	IgG4		

SUBSTITUTE SHEET

5/11

Fig. 4b.

Human immunoglobulin sequences hinge region

GluProLys	SerCysAspLysThrHisThrCysProPro	IgG1
GlxArgLys	CysCys Val Glx CysProPro	IgG2
GluLeuLysThrProLeuGlyAspThrThrHisThrCysProArgCysProGlu		IgG3
GluSerLysTyrGly	ProProCysProPro	IgG4
		IgG1
		IgG2
ProLysSerCysAspThrProProProCysProArgCysProGluProLysSer		IgG3
		IgG4
		IgG1
		IgG2
CysAspThrProProProCysProArgCysProGluProLysSerCysAspThr		IgG3
		IgG4
	CysPro	IgG1
	CysPro	IgG2
ProProProCysProArgCysPro		IgG3
	CysPro	IgG4

SUBSTITUTE SHEET

6/11

Fig. 4c.

Human immunoglobulin sequences CH2 region

AlaProGluLeuLeuGlyGly	IgG1
- - ProValAla - -	IgG2
- - - - -	IgG3
- - - Phe - - -	IgG4
ProSerValPheLeuPheProProLysProLysAspThrLeuMetIleSerArgThrPro	IgG1
- - - - -	IgG2
- - - - -	IgG3
- - - - -	IgG4
GluValThrCysValValValAspValSerHisGluAspProGluValLysPheAsnTrp	IgG1
- - - - - Gln - - -	IgG2
- - - - - Gln - Lys -	IgG3
- - - - - Gln - - - - Gln - - -	IgG4
TyrValAspGlyValGluValHisAsnAlaLysThrLysProArgGluGluGlnTyrAsn	IgG1
- - - - - Phe -	IgG2
- - - - -	IgG3
- - - - - Phe -	IgG4
SerThrTyrArgValValSerValLeuThrValLeuHisGlnAspTrpLeuAsnGlyLys	IgG1
- - Phe - - - - Val - - - -	IgG2
- - Phe - - - -	IgG3
- - - - -	IgG4
GluTyrLysCysLysValSerAsnLysAlaLeuProAlaProIleGluLysThrIleSer	IgG1
- - - - - Gly - - - -	IgG2
- - - - -	IgG3
- - - - - Gly - SerSer - - - -	IgG4
LysAlaLys	IgG1
- Thr -	IgG2
- Thr -	IgG3
- - -	IgG4

7/11

Fig. 4d.

Human immunoglobulin sequences CH3 region

	C1m(1)	
GlyClnProArgGluProClnValTyrThrLeuProProSerArgAspGlu	IgG1	
- - - - - - - - - - - - - - - Glu -	IgG2	
- - - - - - - - - - - - - - - Glu -	IgG3	
- - - - - - - - - - - - ClnGlu -	IgG4	
C1m(1)		
LeuThrLysAsnClnValSerLeuThrCysLeuValLysGlyPheTyrProSerAspIle	IgG1	
Met -	IgG2	
Met -	IgG3	
Met -	IgG4	
AlaValGluTrpGluSerAsnGlyClnProGluAsnAsnTyrLysThrThrProProVal	IgG1	
- Met	IgG2	
- - - - - Ser - - - - - - - - - - - Asn - - - - - Met	IgG3	
- -	IgG4	
LeuAspSerAspGlySerPhePheLeuTyrSerLysLeuThrValAspLysSerArgTrp	IgG1	
- -	IgG2	
- -	IgG3	
- - - - - - - - - - - - - - - Arg - - - - - - - - - -	IgG4	
	C1m(2)	
ClnClnGlyAsnValPheSerCysSerValMetHisGluGlyLeuHisAsnHisTyrThr	IgG1	
- Ala - - - - -	IgG2	
- - - - - Ile - - - - - - - - - - - - - - - Ala - - - - - ArgPhe -	IgG3	
- Ala - - - - - - - - -	IgG4	
ClnLysSerLeuSerLeuSerProGlyLys	IgG1	
- -	IgG2	
- -	IgG3	
- - - - - - - - - - - Leu - - - - -	IgG4	

Fig. 5.

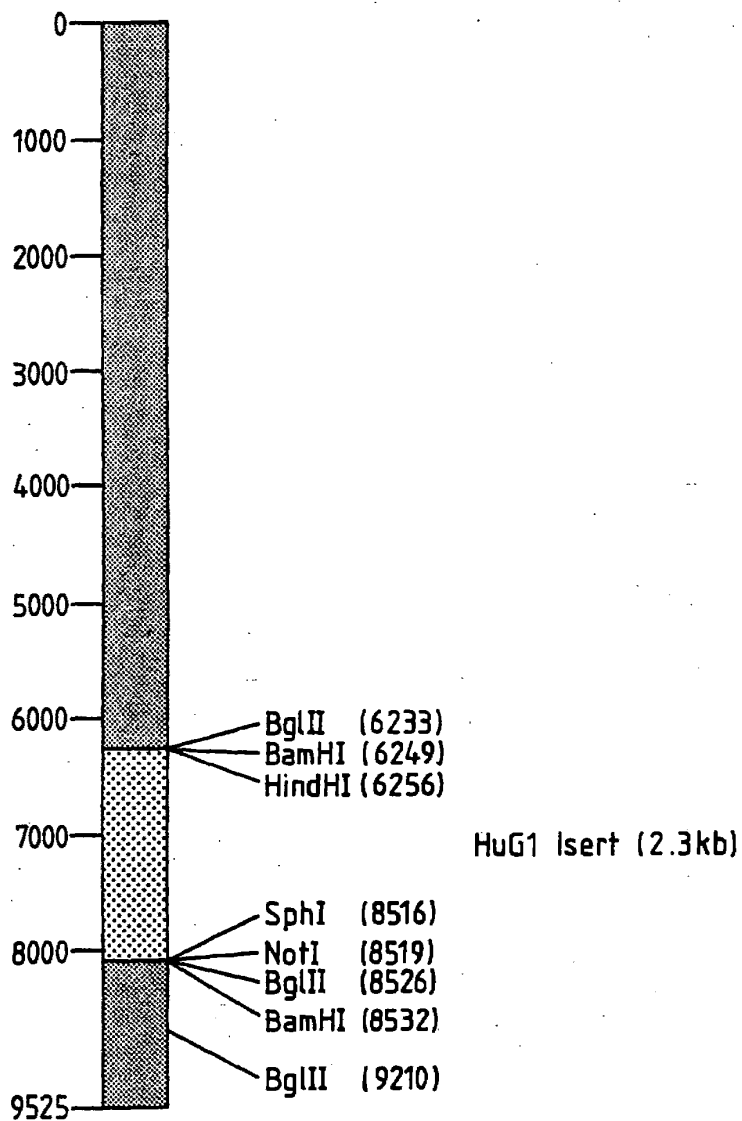

SUBSTITUTE SHEET

Fig. 6.

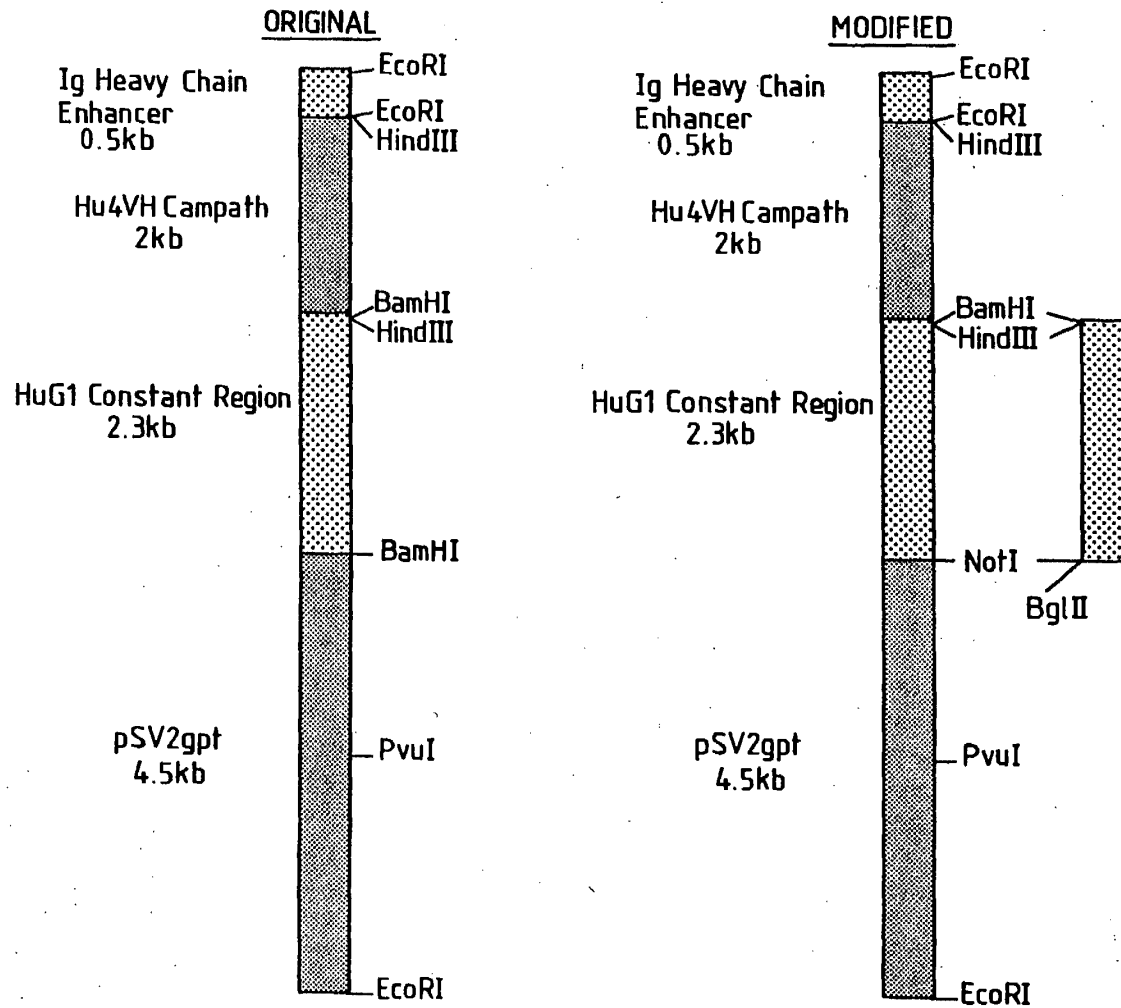

9/11

10/11

Fig. 7.

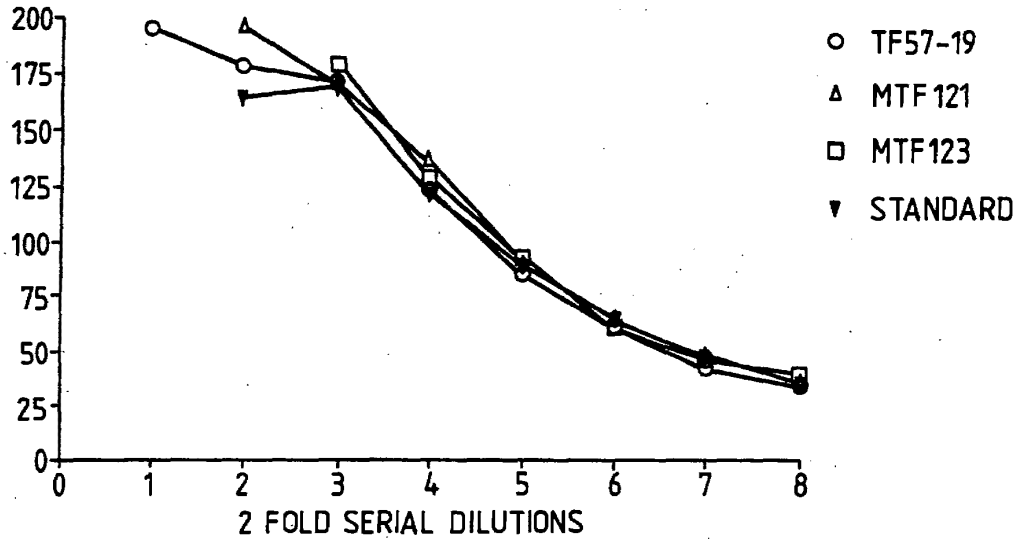
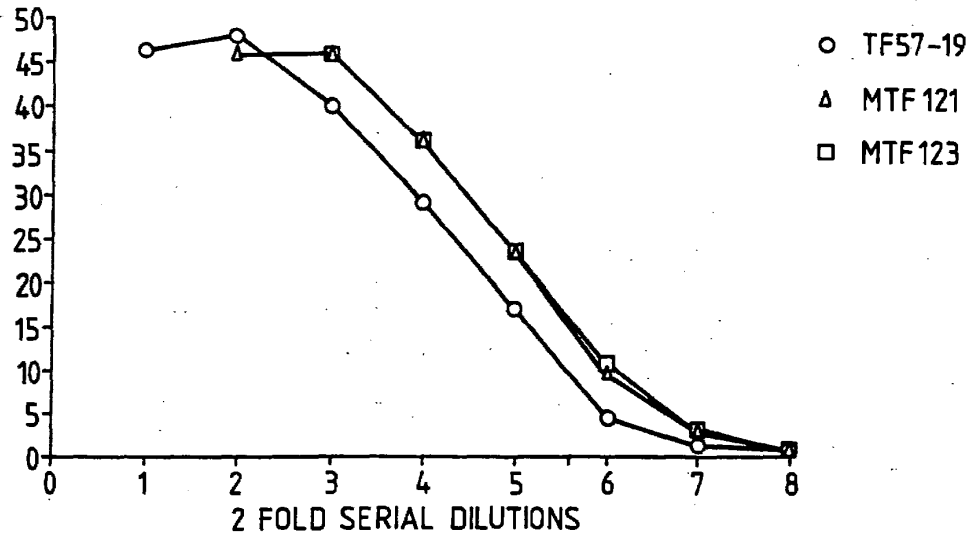
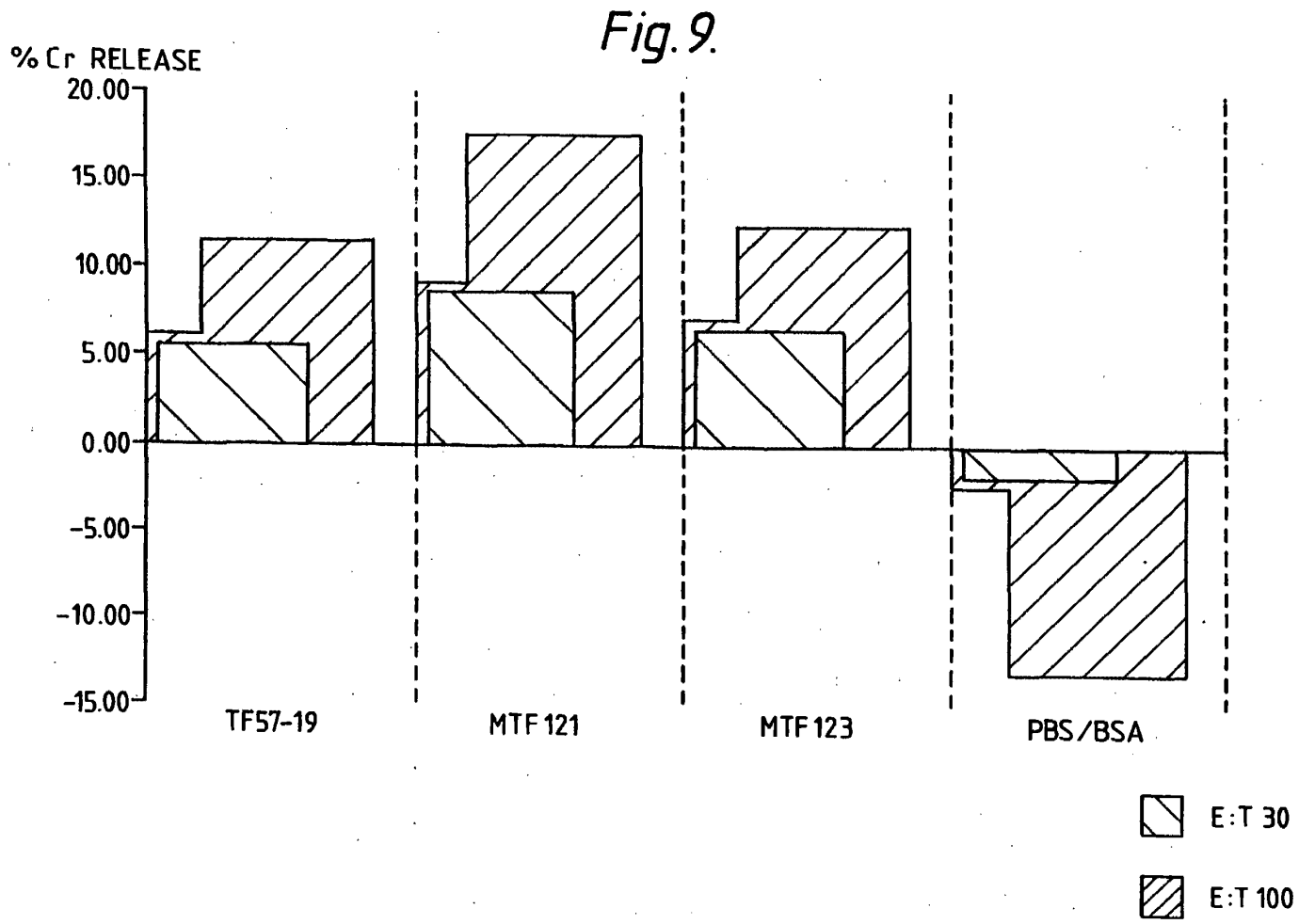

Fig. 8.



SUBSTITUTE SHEET

SUBSTITUTE SHEET



11/11

WO 92/16562

PCT/GB92/0045

INTERNATIONAL SEARCH REPORT

International Application No **PCT/GB 92/00445**

I. CLASSIFICATION OF SUBJECT MATTER (if several classification symbols apply, indicate all) ⁶		
According to International Patent Classification (IPC) or to both National Classification and IPC		
Int. Cl. 5 C 12 N 15/13	C 07 K 15/28 A 61 K 39/395	C 12 P 21/08 C 12 N 5/10
II. FIELDS SEARCHED		
Minimum Documentation Searched ⁷		
Classification System	Classification Symbols	
Int. Cl. 5	C 07 K	
Documentation Searched other than Minimum Documentation to the Extent that such Documents are Included in the Fields Searched ⁸		
III. DOCUMENTS CONSIDERED TO BE RELEVANT⁹		
Category ⁹	Citation of Document, ¹¹ with indication, where appropriate, of the relevant passages ¹²	Relevant to Claim No. ¹³
X	The Journal of Immunology, vol. 143, no. 11, 1 December 1989, (Baltimore, MD, US), G. HEINRICH et al.: "Characterization of a human T cell-specific antibody (CD7) with human constant and mouse variable regions", pages 3589-3597, see the whole document, especially front page abstract; page 3591, left-hand column: "Cloning of human IgG1 genes"; page 3591, right-hand column, lines 9-13; page 3592, right-hand column, lines 13-19; page 3593, line 34 - page 3594, line 4	1-19
A	---	
	NATURE, vol. 333, 30 June 1988, (London, GB), R.G. MAGE: "Designing antibodies for human therapies", pages 807-808, see the article (cited in the application)	1-19

	-/-	
<p>⁹ Special categories of cited documents: ¹⁰</p> <p>"A" document defining the general state of the art which is not considered to be of particular relevance</p> <p>"E" earlier document but published on or after the international filing date</p> <p>"L" document which may throw doubts on priority claim(s) or which is cited to establish the publication date of another citation or other special reason (as specified)</p> <p>"O" document referring to an oral disclosure, use, exhibition or other means</p> <p>"P" document published prior to the international filing date but later than the priority date claimed</p> <p>"T" later document published after the international filing date or priority date and not in conflict with the application but cited to understand the principle or theory underlying the invention</p> <p>"X" document of particular relevance; the claimed invention cannot be considered novel or cannot be considered to involve an inventive step</p> <p>"Y" document of particular relevance; the claimed invention cannot be considered to involve an inventive step when the document is combined with one or more other such documents, such combination being obvious to a person skilled in the art.</p> <p>"&" document member of the same patent family</p>		
IV. CERTIFICATION		
Date of the Actual Completion of the International Search	Date of Mailing of this International Search Report	
04-06-1992	30. 06. 92	
International Searching Authority	Signature of Authorized Officer	
EUROPEAN PATENT OFFICE	Nicole De Bie	

Form PCT/ISA/210 (second sheet) (January 1985)

III. DOCUMENTS CONSIDERED TO BE RELEVANT (CONTINUED FROM THE SECOND SHEET)		
Category °	Citation of Document, with indication, where appropriate, of the relevant passages	Relevant to Claim No.
A	EP, A, 0328404 (MEDICAL RESEARCH COUNCIL) 16 August 1989, see the whole document -----	1-19
A	W.E. PAUL, M.D.: "Fundamental Immunology", 1984, Raven Press, New York, US; chapter 9: J.B. FLEICHMAN et al.: "Immunoglobulins: Allotypes and Idotypes", see the whole document -----	1-19

FURTHER INFORMATION CONTINUED FROM THE SECOND SHEET

V. OBSERVATION WHERE CERTAIN CLAIMS WERE FOUND UNSEARCHABLE ¹

This International search report has not been established in respect of certain claims under Article 17(2)(a) for the following reasons:

1. Claim numbers _____ because they relate to subject matter not required to be searched by this Authority, namely:
Although claim 19 is directed to a method of the human body the search has been carried out and based on the alleged effects of the composition.
2. Claim numbers _____ because they relate to parts of the International application that do not comply with the prescribed requirements to such an extent that no meaningful International search can be carried out, specifically:
3. Claim numbers _____ because they are dependent claims and are not drafted in accordance with the second and third sentences of PCT Rule 6.4(a).

VI. OBSERVATIONS WHERE UNITY OF INVENTION IS LACKING ²

This International Searching Authority found multiple inventions in this International application as follows:

1. As all required additional search fees were timely paid by the applicant, this International search report covers all searchable claims of the International application.
2. As only some of the required additional search fees were timely paid by the applicant, this International search report covers only those claims of the International application for which fees were paid, specifically claims: _____
3. No required additional search fees were timely paid by the applicant. Consequently, this International search report is restricted to the invention first mentioned in the claims; it is covered by claim numbers: _____
4. As all searchable claims could be searched without effort justifying an additional fee, the International Searching Authority did not invite payment of any additional fee.

Remark on Protest

- The additional search fees were accompanied by applicant's protest.
 No protest accompanied the payment of additional search fees.

**ANNEX TO THE INTERNATIONAL SEARCH REPORT
ON INTERNATIONAL PATENT APPLICATION NO.**

GB 9200445-
SA 57491

This annex lists the patent family members relating to the patent documents cited in the above-mentioned international search report. The members are as contained in the European Patent Office EDP file on 23/06/92. The European Patent Office is in no way liable for these particulars which are merely given for the purpose of information.

Patent document cited in search report	Publication date	Patent family member(s)	Publication date
EP-A- 0328404	16-08-89	AU-A- 3062689 WO-A- 8907452 GB-A- 2216126	06-09-89 24-08-89 04-10-89

EPO FORM P009

For more details about this annex : see Official Journal of the European Patent Office, No. 12/82



UNITED STATES DEPARTMENT OF COMMERCE
Patent and Trademark Office

Address: COMMISSIONER OF PATENTS AND TRADEMARKS
Washington, D.C. 20231

SERIAL NUMBER	FILING DATE	FIRST NAMED INVENTOR	ATTORNEY DOCKET NO.
---------------	-------------	----------------------	---------------------

EXAMINER

ART UNIT PAPER NUMBER

DATE MAILED: 10/27/95 ¹⁸

This is a communication from the examiner in charge of your application.
COMMISSIONER OF PATENTS AND TRADEMARKS

This application has been examined Responsive to communication filed on _____ This action is made final.

A shortened statutory period for response to this action is set to expire 3 month(s), 0 days from the date of this letter.
Failure to respond within the period for response will cause the application to become abandoned. 35 U.S.C. 133

Part I THE FOLLOWING ATTACHMENT(S) ARE PART OF THIS ACTION:

- | | |
|---|---|
| 1. <input type="checkbox"/> Notice of References Cited by Examiner, PTO-892. | 2. <input type="checkbox"/> Notice of Draftsman's Patent Drawing Review, PTO-948. |
| 3. <input checked="" type="checkbox"/> Notice of Art Cited by Applicant, PTO-1449. | 4. <input type="checkbox"/> Notice of Informal Patent Application, PTO-152. |
| 5. <input type="checkbox"/> Information on How to Effect Drawing Changes, PTO-1474. | 6. <input type="checkbox"/> _____ |

Part II SUMMARY OF ACTION

1. Claims 1-12, 15 & 19-25 are pending in the application.
Of the above, claims _____ are withdrawn from consideration.
2. Claims 13, 14 & 16-18 have been cancelled.
3. Claims _____ are allowed.
4. Claims 1-12, 15 & 19-25 are rejected.
5. Claims _____ are objected to.
6. Claims _____ are subject to restriction or election requirement.
7. This application has been filed with informal drawings under 37 C.F.R. 1.85 which are acceptable for examination purposes.
8. Formal drawings are required in response to this Office action.
9. The corrected or substitute drawings have been received on _____. Under 37 C.F.R. 1.84 these drawings are acceptable; not acceptable (see explanation or Notice of Draftsman's Patent Drawing Review, PTO-948).
10. The proposed additional or substitute sheet(s) of drawings, filed on _____, has (have) been approved by the examiner; disapproved by the examiner (see explanation).
11. The proposed drawing correction, filed _____, has been approved; disapproved (see explanation).
12. Acknowledgement is made of the claim for priority under 35 U.S.C. 119. The certified copy has been received not been received been filed in parent application, serial no. _____; filed on _____.
13. Since this application appears to be in condition for allowance except for formal matters, prosecution as to the merits is closed in accordance with the practice under Ex parte Quayle, 1935 C.D. 11; 453 O.G. 213.
14. Other

EXAMINER'S ACTION

PTOL-326 (Rev. 2/93)

Art Unit 1816

15. Claims 16-18 have been cancelled.

16. Claims 13-16 have been cancelled.

5 17. Applicant attempted to amend a previously non-existent claim, Claim 19. This amendment was not entered into the record. Newly added claims 20-25 were renumbered 19-25.

10 18. The dependency of the renumbered claims has been changed as follows:

- (a) renumbered claim 23, depends from renumbered claim 22;
- (b) renumbered claim 24, depends from renumbered claim 23;
- (c) renumbered claim 25, depends from renumbered claim 24.

15 19. Claims 19-25 (renumbered) have been added.

20. Claims 1-12, 15 and 19-25 are currently under consideration.

20 21. The amendments to page 65 were not entered. The comments referring to these corrections at page 6 of the response are unclear with regard to these amendments. The cited phrases at the page and lines do not exist.

25 22. This application has been filed with informal drawings which are acceptable for examination purposes only. Formal drawings will be required when the application is allowed. Applicant's request to hold this requirement in abeyance until the application is allowed is acknowledged.

30 23. Claims 19-21 are rejected under 35 U.S.C. § 112, second paragraph, as being indefinite for failing to particularly point out and distinctly claim the subject matter which applicant regards as the invention. Claims 19-21 are substantial duplicates of claim 1. There appears to be no difference in scope between these claims, see MPEP 706.03(k).

35 24. The following is a quotation of 35 U.S.C. § 103 which forms the basis for all obviousness rejections set forth in this Office action:

40 A patent may not be obtained though the invention is not identically disclosed or described as set forth in section 102 of this title, if the differences between the subject matter sought to be patented and the prior art are such that
45 the subject matter as a whole would have been obvious at the time the invention was made to a person having ordinary skill in the art to which said subject matter pertains. Patentability shall not be negated by the manner in which the invention was made.

Art Unit 1816

5 Subject matter developed by another person, which qualifies as prior art only under subsection (f) or (g) of section 102 of this title, shall not preclude patentability under this section where the subject matter and the claimed invention were, at the time the invention was made, owned by the same person or subject to an obligation of assignment to the same person.

10 25. This application currently names joint inventors. In considering patentability of the claims under 35 U.S.C. § 103, the examiner presumes that the subject matter of the various claims was commonly owned at the time any inventions covered therein were made absent any evidence to the contrary. Applicant is advised of the obligation under 37 C.F.R. § 1.56 to point out the inventor and invention dates of each claim that was not
15 commonly owned at the time a later invention was made in order for the examiner to consider the applicability of potential 35 U.S.C. § 102(f) or (g) prior art under 35 U.S.C. § 103.

20 26. Claims 1, 2, 4-12, 15, and renumbered claims 19-22 and 24-25 are rejected under 35 U.S.C. § 103 as being unpatentable over Winter [EP 0239400], Riechmann et al. [Nature 332:323-327 (1988)] and Queen et al. [Proc. Natl. Acad. Sci. 86:10029-10033 (1989)]. Briefly the claims are drawn to a method for producing humanized
25 antibodies and humanized antibodies. Winter, teaches the production of altered, chimeric, antibodies by replacing the complementarily determining regions (CDRs), see abstract. Winter, teaches the requirements for CDR fusions, see page 6 to page 8, line 29. Particularly, page 8, lines 11-18, where
30 Winter, teaches that "merely by replacing one or more CDRs with complementary CDRs may not always result in a functional altered antibody..... it will be well within the competence of the man skilled in the art, either by carrying out routine experimentation or by trial and error testing to obtain a functional altered antibody. Note at page 8, last full paragraph
35 that Winter states that framework region replacement and sequence changing may be necessary to obtain a functional humanized antibody. On page 9, lines 13-16, Winter suggests that the antibodies would be of importance for use in human therapy. Winter, teaches a method of producing the antibody, see page 10, paragraph 3 to page 15, paragraph 2. Consistent with Winter, Riechmann et al. teach a method of reshaping human antibodies for therapy by CDR grafting, see whole document and Queen et al. teach the humanization of antibodies by CDR grafting, see entire
40 document. Riechmann et al. teach altering the sequence of the antibody to restore packing or to increase binding affinity, see page 326, first column, first full paragraph. Queen et al. teach the use of computer modeling to assist in the production of humanized antibodies, specifically to predict which amino acids to change thereby effecting molecular interactions, note that of
45

Art Unit 1816

the amino acids predicted to change include those identified by applicant in claims 7 and 10. A person of ordinary skill in the art would have realized that dependent upon the framework region selected and the sequence of the CDR regions amino acid changes would need to be made and they would depend upon the precise amino acid interactions of the polypeptide. The combination of Winter, Riechmann et al. and Queen et al. teach a comprehensive method for producing humanized antibodies which include the steps outlined in applicant's claims. Therefore, it would have been prima facie obvious to a person of ordinary skill in the art at the time the invention was made to take the combined teachings of Winter, Riechmann et al. and Queen et al. to produce a method of making a humanized antibody and to have a humanized antibody for either diagnostic or therapeutic use.

Applicant argues that the claimed invention is distinct from that taught by the above combination of references because a consensus sequence is used and further modifications are not necessary. Applicant further argues that the combination of references do not teach a humanized antibody with reduced immunogenicity.

Regarding the consensus sequence, the combination of references teach the human framework regions having a significantly high degree of sequence homology (conservative regions). Queen et al. in particular point to Kabat as demonstrating that this was known in the art well in advance of applicant's filing date, see reference 38, cited by Queen et al. In essence there is no functional/structural distinction from what applicant has claimed and that taught by the combination of references. Ex parte C, 27 U.S.P.Q.2d 1492 (BPAI 1993). Applicants recitation of Co et al. is unclear, it was not used in the prior art rejection. Applicant then points to several other references concluding that the techniques of the prior art and the technique of the instant application are "certainly different". However, the minor differences between the prior art and the claimed invention are obvious differences. Modifications in the framework regions which affect the proximity or orientation of the V_L-V_H interface regions is the same as substituting that FR residue from the import regions that is involved in the effects set forth in paragraph (f) of claim 1. The combination of references clearly teach reduced immunogenicity associated with the humanized antibody. See e.g. Riechmann et al. page 323, column 2, lines 5-8. Applicant's comments have been fully considered and were as a whole not found persuasive.

27. Claims 1, 2, 4-12 and 15, and renumbered claims 19-22 and 24-25 are rejected under 35 U.S.C. § 103 as being unpatentable over Winter [EP 0239400], Riechmann et al. [Nature 332:323-327 (1988)] and Queen et al. [Proc. Natl. Acad. Sci. 86:10029-10033

Art Unit 1816

(1989)] in view of In re Durden 226 U.S.P.Q. 359 (Fed. Cir. 1985). Briefly the claims are drawn to a method for producing humanized antibodies and humanized antibodies. As discussed above the combination of Winter, Riechmann et al. and Queen et al. teach humanized antibodies and methods for their production. Applicant's claimed invention does not appear to differ from what has previously known in the art.

Applicant cites the above comments in their response to this rejection.

Applicant's comments were fully considered as described above and were not found persuasive, to the extent that they apply to this rejection.

28. Claim 3 and renumbered claim 23 are rejected under 35 U.S.C. § 103 as being unpatentable over Winter [EP 0239400], Riechmann et al. [Nature 332:323-327 (1988)] and Queen et al. [Proc. Natl. Acad. Sci. 86:10029-10033 (1989)] as applied to claims 1, 2, 4-12 and 15 and further in view of Roitt [Immunology, published 1985, by Gower Medical Publishing Ltd. (London, England) page 5.5]. Briefly the claim is drawn to a method for producing humanized antibodies having the additional steps of searching the import variable domain sequence for glycosylation sites, determining if any such glycosylation site is reasonable expected to affect the antigen binding or affinity of the antibody and if so substituting the glycosylation site into the consensus sequence. As discussed above the combination of Winter, Riechmann et al. and Queen et al. teach humanized antibodies and methods of producing humanized antibodies. The combination of Winter, Riechmann et al. and Queen et al. do not teach the importance of carbohydrate residues. However, Roitt teaches that antibodies contain carbohydrate residues in the variable region. A person of ordinary skill in the art would realize that carbohydrate residues can produce steric modifications in the folding characteristics of polypeptides. Therefore it would have been prima facia obvious to a person of ordinary skill in the art at the time the invention was made to include a step in the method taught by the combination of Winter, Riechmann et al. and Queen et al. which determines if the presence of carbohydrate residues occur in the variable region that can affect antigen binding and then include in the antibody sequence the appropriate glycosylation signal, by adding the appropriate consensus sequence. A person of ordinary skill in the art would have been motivated to add the additional step of identifying glycosylation that may affect antigen binding to ensure that the antibody produced will have the appropriate binding affinity. A person of ordinary skill in the art would have been motivated to produce such a method to produce antibodies having diagnostic or therapeutic utility.

Art Unit 1816

The bulk of applicant's argument is that the references relied on in the above rejection do not render the invention obvious and Roitt adds nothing to these references to overcome the deficiency.

5

From the above discussion, the references used render the claimed invention obvious. Roitt fulfills the deficiency of the references discussed above to the extent that Roitt teaches antibodies contain carbohydrate residues in the variable region. A person of ordinary skill in the art would realize that carbohydrate residues can produce steric modifications in the folding characteristics of polypeptides.

10

29. Applicant's deposit account has been charged for the information disclosure statements. References 2, 6, 55-57 and 73 were lined through since they were previously made of record in this application. All other references cited on applicant's 1449 form were not received by the Office and therefore were not considered.

20

30. No claim allowed.

31. Applicant's amendment necessitated the new grounds of rejection. Accordingly, **THIS ACTION IS MADE FINAL**. See M.P.E.P. § 706.07(a). Applicant is reminded of the extension of time policy as set forth in 37 C.F.R. § 1.136(a).

25

A SHORTENED STATUTORY PERIOD FOR RESPONSE TO THIS FINAL ACTION IS SET TO EXPIRE THREE MONTHS FROM THE DATE OF THIS ACTION. IN THE EVENT A FIRST RESPONSE IS FILED WITHIN TWO MONTHS OF THE MAILING DATE OF THIS FINAL ACTION AND THE ADVISORY ACTION IS NOT MAILED UNTIL AFTER THE END OF THE THREE-MONTH SHORTENED STATUTORY PERIOD, THEN THE SHORTENED STATUTORY PERIOD WILL EXPIRE ON THE DATE THE ADVISORY ACTION IS MAILED, AND ANY EXTENSION FEE PURSUANT TO 37 C.F.R. § 1.136(a) WILL BE CALCULATED FROM THE MAILING DATE OF THE ADVISORY ACTION. IN NO EVENT WILL THE STATUTORY PERIOD FOR RESPONSE EXPIRE LATER THAN SIX MONTHS FROM THE DATE OF THIS FINAL ACTION.

30

35

32. Papers related to this application may be submitted to Group 180 by facsimile transmission. Papers should be faxed to Group 180 via the PTO Fax Center located in Crystal Mall 1. The faxing of such papers must conform with the notice published in the Official Gazette, 1096 OG 30 (November 15, 1989). The CM1 Fax Center telephone number is (703) 308-4227.

40

45

33. Any inquiry concerning this communication or earlier communications from the examiner should be directed to Donald E. Adams whose telephone number is (703) 308-0570. The examiner can normally be reached Monday through Thursday from 7:30 to 6:00. A

50

Serial No. 08/146,206

7

Art Unit 1816

5 message may be left on the examiners voice mail service. If
attempts to reach the examiner by telephone are unsuccessful, the
examiner's supervisor, Ms. Margaret Moskowitz Parr can be reached
at (703) 308-2554. The fax phone number for Group 1806 is (703)
305-7401. Any inquiry of a general nature or relating to the
status of this application should be directed to the Group 180
receptionist whose telephone number is (703) 308-0196.

10 October 25, 1995

Donald E. Adams
Donald E. Adams, Ph.D.
Primary Examiner
Group 1800

2/28/96
1801
12-26-95

#20
C. J. [unclear]
3/7/96

Patent Docket P0709P1

IN THE UNITED STATES PATENT AND TRADEMARK OFFICE

<p>In re Application of Carter et al. Serial No.: 08/146,206 Filed: November 17, 1993 For: METHOD FOR MAKING HUMANIZED ANTIBODIES</p>	<p>Group Art Unit: 1816 Examiner: D. Adams</p> <p>1851 1801</p>
<p>CERTIFICATE OF HAND DELIVERY I hereby certify that this correspondence is being delivered to Examiner D. Adams of the United States Patents and Trademarks, Washington, D.C. 20231 on December 8, 1995 Signature: [Signature] Printed Name:</p>	

ASSOCIATE POWER OF ATTORNEY (37 CFR 1.34)

Honorable Commissioner of Patents
and Trademarks
Washington, D.C. 20231

RECEIVED
RECEIVED

DEC 08 1995

GROUP 1800

Sir:

Please recognize as Associate Attorney in this case:

Wendy M. Lee*

Please direct all communications relative to said pending patent application to the following address:

Genentech, Inc.
460 Point San Bruno Boulevard
South San Francisco, CA 94080
Telephone: (415) 225-1994

*A copy of a document pursuant to 37 C.F.R. § 10.9(b) is attached as proof of the authorization of the undersigned to prosecute the above-mentioned application. The original of this document is on file in the Office of Enrollment and Discipline.

Respectfully submitted,
GENENTECH, INC.

Date: December 7, 1995

By: Janet E. Hasak [Signature]
Janet E. Hasak
Reg. No. 28,616

460 Pt. San Bruno Blvd.
So. San Francisco, CA 94080-4990
Phone: (415) 225-1896
Fax: (415) 952-9881



UNITED STATES DEPARTMENT OF COMMERCE
Patent and Trademark Office
ASSISTANT SECRETARY AND COMMISSIONER
OF PATENTS AND TRADEMARKS
Washington, D.C. 20231

LIMITED RECOGNITION UNDER 37 CFR § 10.9(b)

Wendy M. Lee is hereby given limited recognition under 37 CFR § 10.9(b) as an employee of Genentech, Inc., to prepare and prosecute patent applications and to represent patent applicants wherein Genentech, Inc., is the assignee of record of the entire interest. This limited recognition shall expire on the date appearing below, or when whichever of the following events first occurs prior to July 15, 1996: (i) Wendy M. Lee ceases to lawfully reside in the United States, (ii) Wendy M. Lee's employment with Genentech, Inc., ceases or is terminated, or (iii) Wendy M. Lee ceases to remain or reside in the United States on a H-1B visa.

This document constitutes proof of such recognition. The original of this document is on file in the Office of Enrollment and Discipline of the U.S. Patent and Trademark Office.

Expires: July 15, 1996

Karen L. Bovard, Director
Office of Enrollment and Discipline

#19
Time Plurkett
Patent Docket P0709P1
12/26/95

IN THE UNITED STATES PATENT AND TRADEMARK OFFICE

In re Application of Carter et al. Serial No.: 08/146,206 Filed: November 17, 1993 For: METHOD FOR MAKING HUMANIZED ANTIBODIES	Group Art Unit: 1816 Examiner: D. Adams CERTIFICATE OF HAND DELIVERY I hereby certify that this correspondence is being delivered to Examiner D. Adams, examining group 1816, of the United States Patents and Trademarks, Washington, D.C. 20231 on December ____, 1995 Signature _____ Printed Name: _____
--	---

TRANSMITTAL LETTER

Honorable Commissioner of Patents
and Trademarks
Washington, D.C. 20231

MAILED

DEC 26 1995

GROUP 1800

Sir:

Applicants submit herewith, courtesy copies of the previously filed Information Disclosure Statement, PTO-1449 with 78 references and a copy of the date stamped postcard indicating receipt of these documents and references by the United States Patent and Trademark Office on April 17, 1995.

In view of the outstanding FINAL office action, Applicants provide these references by hand delivery to expedite their consideration by the Examiner. While the fee for filing these documents has already been paid, should there be any additional fees associated with the deposit of these documents with the Examiner, the Commissioner is hereby authorized to charge deposit account 07-0630 for said fees.

A copy of a document pursuant to 37 C.F.R. § 10.9(b) is attached as proof of the authorization of the undersigned to prosecute the above-mentioned application. The original of this document is on file in the Office of Enrollment and Discipline.

Respectfully submitted,
GENENTECH INC.

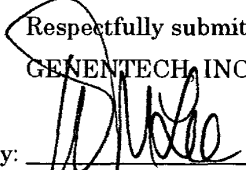
By: 
Wendy M. Lee

Date: December 7, 1995

460 Pt. San Bruno Blvd.
So. San Francisco, CA 94080-4990
Phone: (415) 225-1994
Fax: (415) 952-9881

In re Application of: **Carter and Presta**
Serial No. **08/11,206**
Filed on **17 November 1993**
Mailed on **13 April 1995**

Docket No. **P0709P1**
By: **W. M. Lee**
Reg. *J.T.*

The following has been received in the U.S. Patent Office on the date stamped:

Amendment/Response
 Extension of Time Request
 Communication/Transmittal Declaration/
 Notice of Appeal
 Issue Fee Transmittal Form
 Information Disclosure Statement
 Form 1449 with 78 References
 Certificate of Mailing
 Express Mail No. _____

U.S. Patent Application
 Rule 60 _____ Rule 62
 Declaration/
 Power of Attorney
 Assignment
 Drawings: _____ Sheets
 Informal _____ Formal
 Sequence Listing & Diskette
 PCT Patent Application

Other Limited Recognition Under 37 CFR 10.9(b)

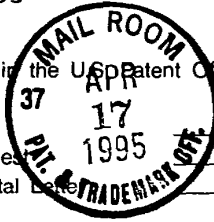

IN THE UNITED STATES PATENT AND TRADEMARK OFFICE

19
Dis

In re Application of)
)
 Carter and Presta)
)
 Serial No. 08/146,206)
)
 Filed: 17 November 1993)
)
 For: METHOD OF MAKING HUMANIZED)
 ANTIBODIES)

Group Art Unit: 1806
 Examiner: ADAMS, D.

CERTIFICATE OF MAILING	
I hereby certify that this correspondence is being deposited with the United States Postal Service as first class mail in an envelope addressed to: Commissioner of Patents and Trademarks, Washington, D.C. 20231 on	
13 April 1995	
(Date of Deposit)	
Aida A. Miclat	
Name of Depositing Party	
<i>Aida A. Miclat</i>	
Signature of Depositing Party	
13 April 1995	
Date of Signature	

MAILED

INFORMATION DISCLOSURE STATEMENT

DEC 26 1995

Honorable Commissioner of Patents
 and Trademarks
 Washington, D.C. 20231

GROUP 1806

Sir:

Applicants submit herewith patents, publications or other information (attached hereto and listed on the attached Form PTO-1449) of which they are aware, which they believe may be material to the examination of this application and in respect of which there may be a duty to disclose in accordance with 37 CFR §1.56.

This Information Disclosure Statement:

- (a) accompanies the new patent application submitted herewith. 37 CFR §1.97(a).
- (b) is filed within three months after the filing date of the application or within three months after the date of entry of the national stage of a PCT application as set forth in 37 CFR §1.491.
- (c) as far as is known to the undersigned, is filed before the mailing date of a first Office action on the merits.
- (d) is filed after the first Office Action and more than three months after the application's filing date or PCT national stage date of entry filing but, as far as is known to the undersigned, prior to the mailing date of either a final rejection or a notice of allowance, whichever occurs first, and is accompanied by either the fee (\$210) set forth in 37 CFR §1.17(p) or a certification as specified in 37 CFR §1.97(e), as checked below. Should any fee be due, the U.S. Patent and Trademark Office is hereby authorized to charge Deposit Account No. 07-0630 in the amount of \$210.00 to cover the cost of this Information Disclosure Statement. Any deficiency or overpayment should be charged or credited to this deposit account. A duplicate of this sheet is enclosed.

- (e) is filed after the mailing date of either a final rejection or a notice of allowance, whichever occurred first, and is accompanied by the fee (\$130) set forth in 37 CFR §1.17(i)(1) and a certification as specified in 37 CFR §1.97(e), as checked below. This document is to be considered as a petition requesting consideration of the information disclosure statement.

[If either of boxes (d) or (e) is checked above, the following "certification" under 37 CFR §1.97(e) may need to be completed.] The undersigned certifies that:

- Each item of information contained in the information disclosure statement was cited in a communication mailed from a foreign patent office in a counterpart foreign application not more than three months prior to the filing of this information disclosure statement.
- No item of information contained in this information disclosure statement was cited in a communication mailed from a foreign patent office in a counterpart foreign application or, to the knowledge of the undersigned after making reasonable inquiry, was known to any individual designated in 37 CFR §1.56(c) more than three months prior to the filing of this information disclosure statement.

A list of the patent(s) or publication(s) is set forth on the attached Form PTO-1449 (Modified).

A copy of the items on PTO-1449 is supplied herewith:

each none only those listed below:

Those patent(s) or publication(s) which are marked with an asterisk (*) in the attached PTO-1449 form are not supplied because they were previously cited by or submitted to the Office in a prior application Serial No. , filed and relied upon in this application for an earlier filing date under 35 USC §120.

A concise explanation of relevance of the items listed on PTO-1449 is:

- not given
- given for each listed item:
- given for only non-English language listed item(s) [Required]
- in the form of an English language copy of a Search Report from a foreign patent office, issued in a counterpart application, which refers to the relevant portions of the references.

The Examiner is reminded that a "concise explanation of the relevance" of the submitted prior art "may be nothing more than identification of the particular figure or paragraph of the patent or publication which has some relation to the claimed invention," MPEP §609.

While the information and references disclosed in this Information Disclosure Statement may be "material" pursuant to 37 CFR §1.56, it is not intended to constitute an admission that any patent, publication or other information referred to therein is "prior art" for this invention unless specifically designated as such.

In accordance with 37 CFR §1.97(b), the filing of this Information Disclosure Statement shall not be construed to mean that a search has been made or that no other material information as defined in 37 CFR §1.56(a) exists. It is submitted that the Information Disclosure Statement is in compliance with 37 CFR §1.98 and MPEP §609 and the Examiner is respectfully requested to consider the listed references.

A copy of a document pursuant to 37 C.F.R. § 10.9(b) is attached as proof of the authorization of the undersigned to prosecute the above-mentioned application. The original of this document is on file in the Office of Enrollment and Discipline.

Respectfully submitted,
GENENTECH, INC.

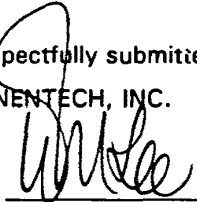
By: 
Wendy M. Lee

Date: April 13, 1995

460 Pt. San Bruno Blvd.
So. San Francisco, CA 94080-4990
Phone: (415) 225-1994
Fax: (415) 952-9881



AU9185058

(12) PATENT ABRIDGMENT (11) Document No. AU-B-85058/91
(19) AUSTRALIA PATENT OFFICE (10) Acceptance No. 654827

(54) Title
NOVEL ANTIBODIES FOR TREATMENT AND PREVENTION OF INFECTION IN ANIMALS AND MAN

International Patent Classification(s)
(51)^s C07K 015/12 A61K 039/42 C07K 007/06 C07K 007/08
C12N 015/13 C12P 021/08

(21) Application No. : 85058/91 (22) Application Date : 11.09.91

(87) PCT Publication Number : WO92/04381

(30) Priority Data

(31) Number (32) Date (33) Country
90:981: 11.09.90 GB UNITED KINGDOM

(43) Publication Date : 30.03.92

(44) Publication Date of Accepted Application : 24.11.94

(71) Applicant(s)
SCOTGEN LIMITED

(72) Inventor(s)
WILLIAM J. HARRIS; PHILIP R. TEMPEST; GERALDINE TAYLOR

(74) Attorney or Agent
DAVIES COLLISON CAVE, 1 Little Collins Street, MELBOURNE VIC 3000

(57) Claim

1. An altered antibody in which at least parts of the complementarity determining regions (CDRs) in the light and/or heavy variable domains of an acceptor monoclonal antibody have been replaced by analogous parts of CDRs from one or more donor monoclonal antibodies, and in which there ~~may or may not have~~ ^{has} been minimal alteration of the acceptor monoclonal antibody light and/or heavy variable domain framework region in order to retain donor monoclonal antibody binding specificity, wherein such donor antibodies have specificity for a particular microorganism.

2. The antibody of Claim 1 wherein the microorganism is human respiratory syncytial virus (RSV).

10. The altered antibody of Claim 1 which is a Fab fragment or a (Fab')₂ fragment.

OPI DATE 30/03/92 APPLN. NO 85058 / 91

F A0JP DATE 14/05/92 PCT NUMBER PCT/GR91/01554

INTERNATIONAL APPLICATION PUBLISHED UNDER THE PATENT COOPERATION TREATY (PCT)

<p>(51) International Patent Classification⁵ : C07K 15/28, C12P 21/08 A61K 39/42, C12N 15/09, 5/10</p>	<p>AI</p>	<p>(11) International Publication Number: WO 92/04381 (43) International Publication Date: 19 March 1992 (19.03.92)</p>
<p>(21) International Application Number: PCT/GB91/01554 (22) International Filing Date: 11 September 1991 (11.09.91) (30) Priority data: 9019812.8 11 September 1990 (11.09.90) GB (71) Applicant (for all designated States except US): SCOTGEN LIMITED [GB/GB]; Queen's House, 2 Holly Road, Twickenham, Middlesex TW1 4EG (GB). (72) Inventors; and (75) Inventors/Applicants (for US only): HARRIS, William, J. [GB/GB]; 3 Caesar Avenue, Carnoustie, Angus DD7 6DR (GB). TEMPEST, Philip, R. [GB/GB]; 63 Brighton Place, Aberdeen AB1 6RT (GB). TAYLOR, Geraldine [GB/GB]; Robinsgrove, Wallingford Road, Compton, Berkshire RG16 0PT (GB).</p>	<p>(74) Agent: VALENTINE, Jill, Barbara; SmithKline Beecham, Great Burgh, Yew Tree Bottom Road, Epsom, Surrey KT18 5XQ (GB). (81) Designated States: AT (European patent), AU, BE (European patent), CA, CH (European patent), DE (European patent), DK (European patent), ES (European patent), FR (European patent), GB (European patent), GR (European patent), IT (European patent), JP, KR, LU (European patent), NL (European patent), SE (European patent), US. Published <i>With international search report. Before the expiration of the time limit for amending the claims and to be republished in the event of the receipt of amendments.</i></p> <p style="font-size: 2em; text-align: center;">654827</p>	
<p>(54) Title: NOVEL ANTIBODIES FOR TREATMENT AND PREVENTION OF INFECTION IN ANIMALS AND MAN</p>		
<p>(57) Abstract</p> <p>Altered antibodies in which at least parts of the complementary determining regions (CDRs) in the light and/or heavy variable domains of an acceptor monoclonal antibody have been replaced by analogous parts of CDRs from one or more donor monoclonal antibodies, and in which there has been minimal alteration of the acceptor monoclonal antibody light and/or heavy variable domain framework region in order to retain donor monoclonal antibody binding specificity, wherein such donor antibodies have specificity for microorganisms, in particular specificity for respiratory syncytial virus (RSV); a process for preparing such altered antibodies; a pharmaceutical composition comprising a therapeutic, non-toxic amount of such altered antibodies and a pharmaceutically acceptable carrier or diluent; a method of prophylactically or therapeutically treating a microorganism-induced disease state in a human or animal in need thereof which comprises administering an effective amount of such altered antibodies to such human or animal; a specific epitope of the F protein of RSV; monoclonal antibodies directed against such epitope; Fab fragments of such monoclonal antibodies; a pharmaceutical composition comprising a therapeutic, non-toxic amount of such monoclonal antibodies or Fab fragments and a pharmaceutically acceptable carrier or diluent; and a method of prophylactically or therapeutically treating RSV infection in a human or animal in need thereof which comprises administering an effective amount of such monoclonal antibodies or Fab fragments to such human or animal.</p>		

NOVEL ANTIBODIES FOR TREATMENT AND PREVENTION OF
INFECTION IN ANIMALS AND MAN

5

BACKGROUND OF THE INVENTION

There has long been a need for effective agents for prevention and treatment
of infection in animals and man. Typical methods comprise administration
10 of chemical agents which inhibit the growth of microorganisms allowing the
immune system to eradicate the infectious agent. Whilst natural and
synthetic chemicals have been particularly effective as treatments for
bacterial infection, the emergence of resistant strains has proved frequent
and problematic. For viral infections, chemical agents have had limited
15 effect and the severity of disease is usually correlated with immune system
status.

For many years, the effectiveness of serum from immune individuals on
prevention and treatment of infectious disease has been known. However, it
20 is well known that the antibodies within human immune sera which are
responsible for effective treatment, i.e., the neutralising antibody
component, are only a very small fraction of the total sera antibody.
Furthermore, the use of immune sera has been limited by low neutralising
antibody levels, by the scarcity of immune donors, by the cost of treatment
25 and more recently by the risk of adventitious spread of disease through
microorganisms in donor sera.

The development of monoclonal antibody technology provided the means for
development and production of pure murine monoclonal antibodies in large
30 quantities from cell lines devoid of pathogenic microorganisms. With this
technique it was possible to provide monoclonal antibodies which interacted
with pathogenic organisms, some of which monoclonal antibodies could
prevent the growth of the target microorganisms in infected mice.
Unfortunately, it is not possible to predict from in vitro studies which
35 antibodies will be most effective at in vivo killing of microorganisms. Many

- 2 -

monoclonal antibodies with high binding affinity for their target in an in vitro setting are not effective in vivo. In fact, in some cases where antibodies are effective at preventing growth of the microorganisms under laboratory conditions, they prove ineffective in the in vivo environment.

5

The impact and limitations of murine monoclonal antibodies for treatment of infectious disease is illustrated by the case of respiratory syncytial virus (RSV) infection. RSV is the major cause of lower respiratory tract infection in infants in the first year of life and a significant cause of respiratory disease in young cattle. In man, most attempts to vaccinate against RSV infection have failed, and treatment of RSV infection with chemical drugs such as ribavirin is only partially effective. Murine monoclonal antibodies specific for RSV have been shown to be effective in prevention and treatment of RSV in mice. However, the use of murine monoclonal antibodies for treatment and prevention of RSV in non-murine species is potentially limited by the immune response of these species to the "foreign" murine antibody, i.e., immune responses in humans against murine antibodies have been shown to both immunoglobulin constant and variable regions (human anti-mouse antibodies). Therefore, non-immunogenic variants of monoclonal antibodies where the immunoglobulin constant and variable regions contain amino acid sequences recognised as "self" by the RSV infected recipient are needed for effective prevention and treatment of RSV infection.

10

15

20

25

30

35

Recombinant DNA technology has provided the ability to alter antibodies in order to substitute specific immunoglobulin (Ig) regions from one species with regions from another. Patent Cooperation Treaty Patent Application No. PCT/GB85/00392 (Neuberger et al and Celltech Limited) describes a process whereby the complementary heavy and light chain variable domain of an Ig molecule from one species may be combined with the complementary heavy and light chain Ig constant domains from another species. This process may be used, for example, to alter murine monoclonal antibodies directed against a specific human disease. Such alteration is effected by substitution of the murine antibody constant region domains with human IgG constant region domains to create a "chimeric" antibody to

be potentially used for treatment of such human disease. However, such chimeric antibodies will still potentially elicit an immune response in humans against the murine (i.e., "foreign") variable regions.

5 British Patent Application Publication Number GB2188638A (Winter) describes a process whereby antibodies are altered by substitution of their complementarity determining regions (CDRs) from one species with those from another. This process may be used, for example, to substitute the CDRs from human heavy and light chain Ig variable region domains with
10 alternative CDRs from murine variable region domains. These altered Ig variable regions may subsequently be combined with human Ig constant regions to create antibodies which are totally human in composition except for the substituted murine CDRs. Such murine CDR-substituted antibodies are likely to elicit a considerably reduced immune response in
15 humans compared to chimeric antibodies because they contain considerably less murine components. However, as stated in British Patent Application Publication Number GB2188638A, merely replacing one or more CDRs with complementary CDRs from another species which are specific for a desired disease may not always result in an altered antibody which retains the
20 antigen binding capacity of complementary CDRs. The British Patent Application proposes that by "routine experimentation or by trial and error", a functional altered antibody with antigen binding capacity may be obtained. However, no description of the nature of the routine experimentation or the trial and error process needed to obtain the desired
25 antibody is provided, and there is a suggestion that successive replacements of CDRs from different sources should be attempted.

Examination of the three-dimensional structures of several IgGs has led to the conclusion that the Ig variable regions of heavy and light chains each
30 comprise three looped structures (which include the CDRs) supported on a sheet-like structure termed the variable region framework. The predominant definition of what comprises a CDR and what comprises a framework is based upon amino acid sequences of a number of Igs.

In three dimensional configuration, the aforementioned loop structures and CDRs between a mouse and human antibody do not correspond exactly although there is considerable overlap. Therefore it appears that, in some cases, the transfer of antigen binding specificity by replacement of CDRs
5 may require the additional replacement of residues adjacent to the defined CDRs. For example, it has been hypothesized that, in certain cases, variable region framework amino acid residues may be important in antigen binding through direct interaction with CDRs (See, Amit et al., *Science*, 233 (1986) pp 747-753; Queen et al., *Proc. Natl. Acad. Sci.* 86 (1989) pp10029-
10 10033; and Protein Design Labs, Patent Cooperation Treaty Patent Application Publication Number WO9007861, published July 26, 1990). In the Queen et al. reference, the authors selected human variable regions for murine CDR-replacement on the basis of maximum homology to the murine variable region comprising the CDRs used for the replacement. In addition,
15 on the basis of computer modelling, the Queen et al. authors utilized a human framework for CDR replacement which included several murine framework amino acids thought to interact with the murine CDRs. The resultant altered antibody, whilst retaining antigen binding capacity, contained additional murine framework amino acids. Such additional
20 murine framework amino acids might contribute to an enhanced immune response to the altered antibody in humans.

In addition, previous studies (see, e.g., Riechmann, et al., *Nature*, 332 (1988), p323-327) have demonstrated that the use of reshaping can be used
25 to transfer *in vitro* high affinity binding from mouse to human antibodies, but it has not previously been shown that it is possible to provide the combination of properties required for preservation of effective prevention of growth of human respiratory syncytial virus (RSV) *in vivo*.

30 Therefore, there is a need for altered antibodies with minimal immunogenicity for the prevention and treatment of infectious disease. In addition, there is a need for a defined process to produce such altered antibodies without radical alteration of variable region frameworks and the associated effect on immunogenicity. The present invention provides
35 altered antibodies for prevention and treatment of infectious disease and a

process for their production by introducing only critical variable region framework modifications.

5 RSV, which is in the genus Pneumovirus of the *Paramyxoviridae* family, is a major cause of lower respiratory tract infections in young children. Primary infection gives an incomplete immunity, and reinfection is frequently observed during childhood. The role of immune mechanisms in the human disease have not been clarified. Previous attempts to develop effective vaccines with attenuated or
10 killed RSV have met with failure, i.e., not only were the children unprotected, but subsequent infections with RSV sometimes resulted in more severe diseases than in non-immunized controls. RSV infection is also a major cause of respiratory infection in young cattle.

15 Recently, certain immunological and molecular information has been obtained regarding the antigenic and functional properties of RSV proteins. The RSV fusion protein (F) and the RSV attachment protein (G) have been identified as the major viral antigens, and
20 their genes have been cloned and sequenced. Two antigenically distinct subgroups of human RSV, designated A and B, have been described. The antigenic differences between A and B subgroups reside mainly on the RSV G protein. In contrast, the RSV F protein has a high degree of genetic and antigenic homology between the
25 two subgroups, and various strains within these subgroups.

Monoclonal antibodies (mAbs) directed against both envelope glycoproteins (F and G) of RSV have been demonstrated to neutralize the virus. (See, Walsh & Hruska, *J. Virology*, 47, 171-177
30 (1983); and Walsh et al., *J. Gen. Virology*, 65, 761-767 (1984)). However, *in vitro* and *in vivo* studies with mAbs or with vaccinia virus recombinants expressing F protein indicated that this protein is the most important antigen in inducing cross-protective immunity. (See, Johnson et al., *J. Virology*, 61, 3163-3166 (1987);
35 Olmsted et al., *Proc. Nat. Acad. Sci. USA*, 7462-7466 (1986); Wertz

- 6 -

et al., *J. Virology*, **61**, 293-310 (1987); and Walsh et al., *Infection and Immunity*, **43**, 756-758 (1984)). Several authors have identified different antigenic sites in the F protein and have shown that at least three of these antigenic sites are involved in neutralization.

5 Two or three neutralizing epitopes have been located on the F protein in different ways. Using escape mutant viruses, Lopez et al., *J. Virology*, **64**, 927-930 (1990) have shown that two amino acid residues (i.e., 262-Asn and 268-Asn) of the F₁ subunit of the F protein are essential for the integrity of a particular neutralizing

10 epitope. Another highly conserved neutralizing epitope has been mapped with synthetic peptides to residues 221-Ile to 232-Glu of the F₁ subunit of the F protein by Trudel et al., *J. General Virology*, **68**, 2273-2280 (1987). Finally, a recent analysis by the Pepsan procedure identified an epitope at positions 483-Phe to 488-Phe of

15 the F₁ subunit of the F protein, which epitope could correspond to another neutralizing epitope. (See, Scopes et al., *J. General Virology*, **71**, 53-59 (1990)).

There is a need for the development of new therapies for the treatment and

20 prevention of RSV infection. A neutralizing and protective epitope of an RSV viral antigen could prove useful in the generation of monoclonal antibodies useful for the prophylaxis and/or treatment of RSV infection. The present invention provides such a novel epitope on the RSV F protein which is recognised by a neutralizing and protective antibody *in vivo*.

25

BRIEF DESCRIPTION OF THE FIGURES

Figure 1 shows the DNA sequence and corresponding amino acid sequence of the RSV19 heavy chain variable region (VH). The CDR sequences are

30 boxed. The first eight and last eleven amino acids, as underlined, correspond to sequences of the oligonucleotide primers used.

Figure 2 shows the DNA sequence and corresponding amino acid sequence of the RSV19 light chain variable region (VK). The CDR sequences are

- 7 -

boxed. The first eight and last six amino acids, as underlined, correspond to sequences of the oligonucleotide primers used.

5 Figure 3 shows the basic plasmid pHuRSV19VH comprising a human Ig heavy chain variable region framework and CDRs derived from mouse RSV19.

10 Figure 4 shows the basic plasmid pHuRSV19VK comprising a human Ig light chain variable region framework and CDRs derived from mouse RSV19.

15 Figure 5 shows the derived Ig variable region amino acid sequences encoded by RSV19VH, RSV19VK, pHuRSVVH and pHuRSV19VK, and derivations of pHuRSV19VH.

Figure 6 shows an ELISA analysis of the binding of HuRSV19VH/VK antibody and its derivative, HuRSV19VHFNS/VK, to RSV antigen.

20 Figure 6A shows that there is little if any difference between the ability of the RSV19 and HuRSV19VHFNS/HuRSV19VK antibodies to bind to intact, non-denatured RS virus.

25 Figure 7 shows that mAb RSV19 binds to two synthetic peptides consisting of, respectively, amino acid residues 417-432 and 422-438 of the F protein.

SUMMARY OF THE INVENTION

30 The present invention relates to altered antibodies in which at least parts of the complementarity determining regions (CDRs) in the light and/or heavy variable domains of an acceptor monoclonal antibody have been replaced by analogous parts of CDRs from one or more donor monoclonal antibodies, and in which there ~~may or may not have~~^{has} been minimal alteration of the acceptor monoclonal antibody light and/or heavy variable domain
35 framework region in order to retain donor monoclonal antibody binding

specificity, wherein such donor antibodies have specificity for microorganisms, in particular specificity for respiratory syncytial virus (RSV). The present invention also relates to a process for preparing such altered antibodies; a pharmaceutical composition comprising a therapeutic, 5 non-toxic amount of such altered antibodies and a pharmaceutically acceptable carrier or diluent; and a method of prophylactically or therapeutically treating a microorganism-induced disease state in a human or animal in need thereof which comprises administering an effective amount of such altered antibodies to such human or animal. Preferably the 10 altered antibodies of the invention will be produced by recombinant DNA technology. The altered antibody of the present invention may comprise a complete antibody molecule (having full length heavy and light chains) or any fragment thereof, such as the Fab or (Fab')₂ fragment, a light chain or heavy chain dimer, or any minimal recombinant fragment thereof such as 15 an Fv or a SCA (single-chain antibody) or any other molecule with the same specificity as the altered antibody of the invention. Alternatively, the altered antibody of the invention may have attached to it an effector or reporter molecule. For instance, the altered antibody of the invention may have a macrocycle, for chelating a heavy metal atom, or a toxin, such as 20 ricin, attached to it by a covalent bridging structure. Alternatively the procedure of recombinant DNA technology may be used to produce an altered antibody of the invention in which the Fc fragment or CH3 domain of a complete antibody molecule has been replaced by an enzyme or toxin molecule. The remainder of the altered antibody may be derived from any 25 suitable human immunoglobulin. However, it need not comprise only protein sequences from the human immunoglobulin. For instance a gene may be constructed in which a DNA sequence encoding part of a human immunoglobulin chain is fused to a DNA sequence encoding the amino acid sequence of a polypeptide effector or reporter molecule.

30 Another aspect of this invention is the discovery of a specific epitope of the F (fusion) protein of RSV which has been demonstrated to be a target for monoclonal antibodies which both protect and cure mice of infection by RSV. In addition, it has also been demonstrated that Fab fragments of such 35 monoclonal antibodies protect mice from *in vivo* infection. Thus, the present

invention also relates to such specific epitope of the F protein of RSV; monoclonal antibodies directed against such epitope; and Fab fragments of such monoclonal antibodies. In addition, this invention relates to a pharmaceutical composition comprising a therapeutic, non-toxic amount of such monoclonal antibodies or Fab fragments and a pharmaceutically acceptable carrier or diluent; and a method of prophylactically or therapeutically treating RSV infection in a human or animal in need thereof which comprises administering an effective amount of such monoclonal antibodies or Fab fragments to such human or animal.

The present invention provides altered antibodies with specificity for microorganisms, and the DNA coding for such antibodies. These antibodies comprise Ig constant regions and variable regions from one source, and one or more CDRs from a different source.

In addition, amino acid substitutions in the variable region frameworks are described which are critical for antigen binding affinity. The invention also provides vectors producing the altered antibodies in mammalian cell hosts.

The present invention particularly applies to the provision of altered antibodies with the combination of properties required for the prevention and treatment of infections in animals and man. For example, non-human antibodies with specificity for micro organisms may be altered to produce "humanised" antibodies which elicit a minimal immune response in humans. In particular, the invention provides "humanised" antibodies with specificity for RSV which are shown to be effective in an animal model for RSV infection in humans and to recognise a large variety of human clinical isolates of RSV.

The present invention also provides a method for effecting minimal modifications to the amino acids of variable region frameworks in order to retain the antigen binding capacity of CDRs from a different source. The method involves stepwise alteration and testing of individual amino acids in the variable region framework potentially critical for antigen binding

- 10 -

affinity. The method avoids major introduction of framework amino acids from the same source as CDRs.

DETAILED DESCRIPTION OF THE INVENTION

5

As used herein, the term "humanized antibody" refers to a molecule having its complementarity determining regions (and, perhaps, minimal portions of its light and/or heavy variable domain framework region) derived from an immunoglobulin from a non-human species, the remaining immunoglobulin-derived parts of the molecule being derived from a human immunoglobulin.

10

The present invention relates to altered antibodies in which at least parts of the complementarity determining regions (CDRs) in the light and/or heavy variable domains of an acceptor monoclonal antibody have been replaced by analogous parts of CDRs from one or more donor monoclonal antibodies, and in which there may or may not have been minimal alteration of the acceptor monoclonal antibody light and/or heavy variable domain framework region in order to retain donor monoclonal antibody binding specificity, wherein such donor antibodies have specificity for microorganisms, in particular specificity for respiratory syncytial virus (RSV). The present invention also relates to a process for preparing such altered antibodies; a pharmaceutical composition comprising a therapeutic, non-toxic amount of such altered antibodies and a pharmaceutically acceptable carrier or diluent; and a method of prophylactically or therapeutically treating a microorganism-induced disease state in a human or animal in need thereof which comprises administering an effective amount of such altered antibodies to such human or animal.

15

20

25

The altered antibodies of the invention may be produced by the following process:

30

(a) producing, by conventional techniques, in an expression vector an operon having a DNA sequence which encodes an antibody heavy or light chain wherein at least the CDRs (and those minimal portions of the acceptor monoclonal antibody light and/or heavy variable domain framework region

35

- 11 -

required in order to retain donor monoclonal antibody binding specificity) of the variable domain are derived from a non-human immunoglobulin, such as that produced by RSV19, and the remaining immunoglobulin-derived parts of the antibody chain are derived from a human immunoglobulin, thereby producing the vector of the invention;

(b) producing, by conventional techniques, in an expression vector an operon having a DNA sequence which encodes a complementary antibody light or heavy chain wherein at least the CDRs (and those minimal portions of the acceptor monoclonal antibody light and/or heavy variable domain framework region required in order to retain donor monoclonal antibody binding specificity) of the variable domain are derived from a non-human immunoglobulin, such as that produced by RSV19, and the remaining immunoglobulin-derived parts of the antibody chain are derived from a human immunoglobulin, thereby producing another vector of the invention;

(c) transfecting a host cell by conventional techniques with the or each vector to create the transfected host cell of the invention;

(d) culturing the transfected cell by conventional techniques to produce the altered antibody of the invention.

The host cell may be transfected with two vectors of the invention, the first vector containing an operon encoding a light chain-derived polypeptide and the second vector containing an operon encoding a heavy chain-derived polypeptide. Preferably the vectors are identical except in so far as the coding sequences and selectable markers are concerned so to ensure as far as possible that each polypeptide chain is equally expressed. Alternatively, a single vector of the invention may be used, the vector including the sequence encoding both light chain- and heavy chain-derived polypeptides. The DNA in the coding sequences for the light and heavy chains may comprise cDNA or genomic DNA or both.

- 12 -

The host cell used to express the altered antibody of the invention is preferably a eukaryotic cell, most preferably a mammalian cell, such as a CHO cell or a myeloid cell.

5 The general methods by which the vectors of the invention may be constructed, transfection methods required to produce the host cell of the invention, and culture methods necessary to produce the altered antibody of the invention from such host cell are all conventional techniques. Likewise, once produced, the altered antibodies of the invention may be purified
10 according to standard procedures of the art, including ammonium sulfate precipitation, affinity columns, column chromatography, gel electrophoresis and the like.

An example of the altered antibody of the invention are humanised
15 antibodies derived from the murine monoclonal antibody RSV19 such as HuRSV19VH/VK and HuRSV19VHFNS/HuRSV19VK which are described in the Examples. Such antibodies are useful in treating, therapeutically or prophylactically, a human against human RSV infection. Therefore, this invention also relates to a method of treating, therapeutically or
20 prophylactically, human RSV infection in a human in need thereof which comprises administering an effective, human RSV infection treating dose such altered antibodies to such human.

The altered antibodies of this invention may also be used in conjunction
25 with other antibodies, particularly human monoclonal antibodies reactive with other markers (epitopes) responsible for the disease against which the altered antibody of the invention is directed.

The altered antibodies of this invention may also be used as separately
30 administered compositions given in conjunction with chemotherapeutic or immunosuppressive agents. The appropriate combination of agents to utilized can readily be determined by one of skill in the art using conventional techniques. As an example of one such combination, the altered antibody of the invention known as HuRSV19VHFNS/HuRSV19VK

may be given in conjunction with the antiviral agent ribavirin in order to facilitate the treatment of RSV infection in a human.

5 One pharmaceutical composition of the present invention comprises the use of the antibodies of the subject invention in immunotoxins, i.e., molecules which are characterized by two components and are particularly useful for killing selected cells in vitro or in vivo. One component is a cytotoxic agent which is usually fatal to a cell when attached or absorbed. The second component, known as the "delivery vehicle" provides a means for delivering
10 the toxic agent to a particular cell type, such as cells comprising a carcinoma. The two components are commonly chemically bonded together by any of a variety of well-known chemical procedures. For example, when the cytotoxic agent is a protein and the second component is an intact immunoglobulin, the linkage may be by way of heterobifunctional cross-
15 linkers, e.g., carbodiimide, glutaraldehyde, and the like. Production of various immunotoxins is well-known in the art.

A variety of cytotoxic agents are suitable for use in immunotoxins, and may include, among others, radionuclides, chemotherapeutic drugs such as
20 methotrexate, and cytotoxic proteins such as ribosomal inhibiting proteins (e.g., ricin).

The delivery component of the immunotoxin will include the human-like immunoglobulins of the present invention. Intact immunoglobulins or their
25 binding fragments, such as Fab, are preferably used. Typically, the antibodies in the immunotoxins will be of the human IgM or IgG isotype, but other mammalian constant regions may be utilized if desired.

The altered antibodies and pharmaceutical compositions of the invention are particularly useful for parenteral administration, i.e., subcutaneously,
30 intramuscularly or intravenously. The compositions for parenteral administration will commonly comprise a solution of the altered antibody of the invention or a cocktail thereof dissolved in an acceptable carrier, preferably an aqueous carrier. A variety of aqueous carriers may be
35 employed, e.g., water, buffered water, 0.4% saline, 0.3% glycine, and the

like. These solutions are sterile and generally free of particulate matter. These solutions may be sterilized by conventional, well known sterilization techniques. The compositions may contain pharmaceutically acceptable auxiliary substances as required to approximate physiological conditions
5 such as pH adjusting and buffering agents, etc. The concentration of the the altered antibody of the invention in such pharmaceutical formulation can vary widely, i.e., from less than about 0.5%, usually at or at least about 1% to as much as 15 or 20% by weight and will be selected primarily based on fluid volumes, viscosities, etc., according to the particular mode of
10 administration selected.

Thus, a pharmaceutical composition of the invention for intramuscular injection could be prepared to contain 1 mL sterile buffered water, and 50 mg of an altered antibody of the invention. Similarly, a pharmaceutical
15 composition of the invention for intravenous infusion could be made up to contain 250 ml of sterile Ringer's solution, and 150 mg of an altered antibody of the invention. Actual methods for preparing parenterally administrable compositions are well known or will be apparent to those skilled in the art and are described in more detail in, for example,
20 Remington's Pharmaceutical Science, 15th ed., Mack Publishing Company, Easton, Pennsylvania.

The altered antibodies of the invention can be lyophilized for storage and reconstituted in a suitable carrier prior to use. This technique has been
25 shown to be effective with conventional immune globulins and art-known lyophilization and reconstitution techniques can be employed.

Depending on the intended result, the pharmaceutical composition of the invention can be administered for prophylactic and/or therapeutic
30 treatments. In therapeutic application, compositions are administered to a patient already suffering from a disease, in an amount sufficient to cure or at least partially arrest the disease and its complications. In prophylactic applications, compositions containing the present antibodies or a cocktail thereof are administered to a patient not already in a disease state to
35 enhance the patient's resistance.

- 15 -

Single or multiple administrations of the pharmaceutical compositions can be carried out with dose levels and pattern being selected by the treating physician. In any event, the pharmaceutical composition of the invention
5 should provide a quantity of the altered antibodies of the invention sufficient to effectively treat the patient.

It should also be noted that the altered antibodies of this invention may be used for the design and synthesis of either peptide or non-peptide
10 compounds (mimetics) which would be useful in the same therapy as the antibody. See, e.g., Saragovi et al., *Science*, 253, 792-795 (1991).

Another aspect of this invention is the discovery of a specific epitope of the F (fusion) protein of RSV which has been demonstrated to be a target for
15 monoclonal antibodies which both protect and cure mice of infection by RSV. In addition, it has also been demonstrated that Fab fragments of such monoclonal antibodies protect mice from *in vivo* infection. Thus, the present invention also relates to such specific epitope of the F protein of RSV; monoclonal antibodies directed against such epitope; and Fab fragments of
20 such monoclonal antibodies. In addition, this invention relates to a pharmaceutical composition comprising a therapeutic, non-toxic amount of such monoclonal antibodies or Fab fragments and a pharmaceutically acceptable carrier or diluent; and a method of prophylactically or therapeutically treating RSV infection in a human or animal in need thereof
25 which comprises administering an effective amount of such monoclonal antibodies or Fab fragments to such human or animal.

The present invention provides altered antibodies with specificity for microorganisms, and the DNA coding for such antibodies. These antibodies
30 comprise Ig constant regions and variable regions from one source, and one or more CDRs from a difference source.

In addition, amino acid substitutions in the variable region frameworks are described which are critical for antigen binding affinity. The invention also
35 provides vectors producing the altered antibodies in mammalian cell hosts.

- 16 -

The present invention particularly applies to the provision of altered antibodies with the combination of properties required for the prevention and treatment of infections in animals and man. For example, non-human antibodies with specificity for micro organisms may be altered to produce "humanised" antibodies which elicit a minimal immune response in humans. In particular, the invention provides "humanised" antibodies with specificity for RSV which are shown to be effective in an animal model for RSV infection in humans and to recognise a large variety of human clinical isolates of RSV.

The present invention also provides a method for effecting minimal modifications to the amino acids of variable region frameworks in order to retain the antigen binding capacity of CDRs from a different source. The method involves stepwise alteration and testing of individual amino acids in the variable region framework potentially critical for antigen binding affinity. The method avoids major introduction of framework amino acids from the same source as CDRs.

The following examples are offered by way of illustration, not by limitation.

EXAMPLES

In the following examples all necessary restriction enzymes, plasmids, and other reagents and materials were obtained from commercial sources unless otherwise indicated.

In the following examples, unless otherwise indicated, all general cloning, ligation and other recombinant DNA methodology was performed as described in "Molecular Cloning, A Laboratory Manual (1982) eds T. Maniatis et. al., published by Cold Spring Harbor Laboratory, Cold Spring Harbor, New York (hereinafter referred to as "Maniatis et al.").

35

- 17 -

In the following examples, the following abbreviations may be employed:

dCTP	deoxycytidine triphosphate
dATP	deoxyadenosine triphosphate
dGTP	deoxyguanosine triphosphate
5 dTTP	deoxythymidine triphosphate
DTT	dithiothreitol
C	cytosine
A	adenine
T	thymine
10 G	guanine
DMEM	Dulbecco's modified Eagle's medium
PBST	Phosphate buffered saline containing 0.02% Tween 20 (pH 7.5)

15 ALTERED ANTIBODIES

Examples 1-3 describe the preparation of the altered antibodies of the invention.

EXAMPLE 1-PRODUCTION OF ALTERED ANTIBODIES SPECIFIC FOR RSV

The source of the donor CDRs utilized to prepare these altered antibodies
20 was a murine monoclonal antibody, RSV19, specific for the fusion (F)
protein of RSV. The RSV19 hybridoma cell line was obtained from Dr.
Geraldine Taylor, Institute for Animal Health, Compton Laboratory,
Compton, Near Newbury, Berks, RG16 0NN, England. Methodology for the
isolation of hybridoma cell lines secreting monoclonal antibodies specific for
25 RSV is described by Taylor et al., *Immunology*, 52 (1984) p137-142.

Cytoplasmic RNA was prepared by the method of Favaloro et. al., (1980)

Methods in Enzymology, Vol. 65, p.718-749, from the RSV19 hybridoma cell
line, and cDNA was synthesized using Ig variable region primers as follows:

30 for the Ig heavy chain variable (VH) region, the primer
VH1FOR (5'TGAGGAGACGGTGACCGTGGTCCCTTGGCCCCAG3')
was used, and
for the Ig light chain variable region (VK), the primer
VK1FOR (5'GTTAGATCTCCAGCTTGGTCCC3')
35 was used.

- 18 -

cDNA synthesis reactions consisted of 20mg RNA, 0.4mM VH1FOR or VK1FOR, 250mM each of dATP, dCTP, dGTP and dTTP, 50mM Tris-HCl pH 7.5, 75mM KCl, 10mM DTT, 3mM MgCl₂ and 27 units RNase inhibitor (Pharmacia, Milton Keynes, United Kingdom) in a total volume of 50ml. Samples were heated at 70°C for 10 minutes (min) and slowly cooled to 42°C over a period of 30 min. Then, 100m MMLV reverse transcriptase (Life Technologies, Paisley, United Kingdom) was added and incubation at 42°C continued for 1 hour.

10

VH and VK cDNAs were then amplified using the polymerase chain reaction (PCR) as described by Saiki, et al., *Science*, 239 (1988), p487-491. For such PCR, the primers used were:

15

VH1FOR;

VK1FOR;

VH1BACK (5'AGGTSMARCTGCAGSAGTCWGG3'); and

VK1BACK (5'GACATTCAGCTGACCCAGTCTCCA3'),

where M = C or A, S = C or G, and W = A or T .

20

Primers VH1FOR, VK1FOR, VH1BACK and VK1BACK, and their use for PCR-amplification of mouse Ig DNA, is described by Orlandi et al., *Proc. Nat. Acad. Sci. USA*, 86, 3833-3937 (1989).

25

For PCR amplification of VH, DNA/primer mixtures consisted of 5ml RNA/cDNA hybrid, and 0.5mM VH1FOR and VH1BACK primers. For PCR amplifications of VK, DNA/primer mixtures consisted of 5ml RNA/cDNA hybrid, and 0.5mM VH1FOR and VK1BACK primers. To these mixtures was added 200 mM each of dATP, dCTP, dGTP and dTTP, 10mM Tris-HCl pH 8.3, 50mM KCl, 1.5mM MgCl₂, 0.01% (w/v) gelatin, 0.01% (v/v) Tween 20, 0.01% (v/v) Nonidet P40 and 2 units Taq DNA polymerase (United States Biochemicals-Cleveland, Ohio, USA). Samples were subjected to 25 thermal cycles of PCR at 94°C, 1 min; 60°C, 1 min; 72°C, 2 min; ending with 5 min at 72°C. For cloning and sequencing, amplified VH DNA was purified on a low melting point agarose gel and by Elutip-d column chromatography (Schleicher and Schuell-Dussel, Germany) and cloned into phage M13

35

- 19 -

(Pharmacia-Milton Keynes, United Kingdom). The general cloning and ligation methodology was as described in "Molecular Cloning, A Laboratory Manual (1982) eds T. Maniatis et. al., published by Cold Spring Harbor Laboratory, Cold Spring Harbor, New York (hereinafter referred to as "Maniatis et al."). VH DNA was either directly ligated into the SmaI site of M13 mp18/19 (Pharmacia-Milton Keynes, UK) or, following digestion with PstI, into the PstI site of M13tg131 (Amersham International-Little Chalfont, UK). Amplified VK was similarly gel purified and cloned by the following alternatives:

- 10 PvuII digest into M13mp19 (SmaI site)
- PvuII and BglII digest into M13mp18/19 (SmaI - BamHI site)
- PvuII and BglII digest into M13tg131 (EcoRV - BglII site)
- BglII digest into M13tg131 (SmaI - BglII site)

- 15 The resultant collections of overlapping clones were sequenced by the dideoxy method (Sanger, et al., *Proc. Nat. Acad. Sci. USA* 74 (1977) p5463-5467) using Sequenase (United States Biochemicals-Cleveland, Ohio, USA).

20 From the sequence of RSV19 VH and VK domains, as shown in Figure 1 and 2 respectively, the CDR sequences were elucidated in accordance with the methodology of Kabat et al., in *Sequences of Proteins of Immunological Interest* (US Dept of Health and Human Services, US Government Printing Office, (1987)) utilizing computer assisted alignment with other VH and VK sequences.

- 25 Transfer of the murine RSV19 CDRs to human frameworks was achieved by site directed mutagenesis. The primers used were:

VHCDR1 5'CTGTCTCACCCAGTGCATATAGTAGTCGCTGAAGGTGAA
GCCAGACACGGT3'

- 30 VHCDR2 5'CATTGTCACCTCTGCCCTGGAAGTTCGGGGCATATGGAA
CATCATCATTCTCAGGATCAATCCA3'

35

- 20 -

VHCDR3 5' CCCTGGCCCCAGTGGTCAAAGTCACTCCGCCATCTT
GCACAATA3'

VKCDR1 5' CTGCTGGTACCATTCTAAATAGGTGTTTCCATCAGTATGT
ACAAGGGTCTGACTAGATCTACAGGTGATGGTCA3'

5 VKCDR2 5' GCTTGGCACACCAGAAAATCGGTTGGAAACTCTGTAG
ATCAGCAG3'

VKCDR3 5' CCCTGGCCGAACGTCCGAGGAAGATGTGAACCTTGAA
AGCAGTAGTAGGT3'

10 The DNA templates for mutagenesis comprised human framework regions
derived from the crystallographically solved proteins, NEW (described by
Saul, et al., *J. Biol. Chem.* **53** (1978), p585-597) with a substitution of
amino acid 27 from serine to phenylalanine (See, Riechmann et al., *loc. cit.*)
and REI (described by Epp et al, *Eur J. Biochem.* **45** (1974), p513-524) for
15 VH and VK domains, respectively. M13 based templates comprising human
frameworks with irrelevant CDRs were prepared as described by
Riechmann et al., *Nature*, **332** (1988).

Oligonucleotide site directed mutagenesis of the human VH and VK genes
20 was based on the method of Nakamaye et al., *Nucl. Acids Res.* **14** (1986)
p9679-9698.

To 5mg of VH or VK single-stranded DNA in M13 was added a two-fold
molar excess of each of the three VH or VK phosphorylated oligonucleotides
25 encoding the three mouse CDR (complementarity determining region)
sequences. Primers were annealed to the template by heating to 70°C and
slowly cooled to 37°C. To the annealed DNA was added 6u Klenow
fragment (Life Technologies, Paisley, UK); 6u T4 DNA ligase (Life
Technologies, Paisley, UK); 0.5mM of each of the following nucleoside
30 triphosphates (dATP, dGTP, dTTP and 2'-deoxycytidine 5'-0-(1-
thiotriphosphate) (thiodCTP); 60mM Tris-HCl (pH 8.0); 6mM MgCl₂; 5mM
DTT (Sigma, Poole, UK); and 10mM ATP in a reaction volume of 50ml. This
mixture was incubated at 16°C for 15 hours (h). The DNA was then ethanol
precipitated and digested with 5 units NciI (Life Technologies, Paisley, UK)
35 which nicks the parental strand but leaves the newly synthesised strand

- 21 -

containing thiodCTP intact. The parental strand was then removed by digesting for 30 min with 100 units exonuclease III (Pharmacia, Milton Keynes, United Kingdom) in 50 ml of 60mM Tris-HCl (pH 8.0), 0.66mM MgCl₂, and 1mM DTT. The DNA was then repaired through addition of 3
5 units of DNA polymerase I (Life Technologies, Paisley, UK), 2 units T4 DNA ligase in 50 ml of 60mM Tris-HCl (pH 8.0), 6mM MgCl₂, 5mM DTT, 10mM ATP and 0.5mM each of dATP, dCTP, dGTP and dTTP. The DNA was transformed into competent *E. coli* TG1 cells (Amersham International, Little Chalfont, UK) by the method of Maniatis et al. Single-stranded DNA
10 was prepared from individual plaques and sequenced by the method of Messing (1983) *Methods in Enzymology*, 101, p. 20-78. If only single or double mutants were obtained, then these were subjected to further rounds of mutagenesis (utilizing the methodology described above) by using the appropriate oligonucleotides until the triple CDR mutants were obtained.

15 The CDR replaced VH and VK genes were cloned in expression vectors (by the method of Maniatis et al.) to yield the plasmids shown in Figures 3 and 4 respectively, and such plasmids were termed pHuRSV19VH and pHuRSV19VK. For pHuRSV19VH, the
20 CDR replaced VH gene together with the Ig heavy chain promoter (Figures 3 and 4), appropriate splice sites and signal peptide sequences (Figures 3 and 4) were excised from M13 by digestion with HindIII and BamHI, and cloned into an expression vector containing the murine Ig heavy chain enhancer (Figures 3 and 4),
25 the SV40 promoter (Figures 3 and 4), the gpt gene for selection in mammalian cells (Figures 3 and 4) and genes for replication and selection in *E. coli* (Figures 3 and 4). A human IgG1 constant region was then added as a BamHI fragment (Figures 3 and 4). The construction of the pHuRSV19VK plasmid was essentially the
30 same except that the gpt gene was replaced by the hygromycin resistance gene (Figures 3 and 4) and a human kappa chain constant region was added (Figures 3 and 4).

35 10mg of pHuRSV19VH and 20mg of pHuRSV19VK were digested with PvuI utilizing conventional techniques. The DNAs were mixed

- 22 -

together, ethanol precipitated and dissolved in 25ml water. Approximately 10^7 YB2/0 cells (from the American Type Culture Collection, Rockville, Maryland, USA) were grown to semi-confluency, harvested by centrifugation and resuspended in 0.5ml DMEM (Gibco, Paisley, UK) together with the digested DNA in a cuvette. After 5 min on ice, the cells were given a single pulse of 170V at 960uF (Gene-Pulser, Bio-Rad-Richmond, California, USA) and left in ice for a further 20 min. The cells were then put into 20 ml DMEM plus 10% foetal calf serum and allowed to recover for 48h. After this time, the cells were distributed into a 24-well plate and selective medium applied (DMEM, 10% foetal calf serum, 0.8mg/ml mycophenolic acid, and 250mg/ml xanthine). After 3-4 days, the medium and dead cells were removed and replaced with fresh selective medium. Transfected clones were visible with the naked eye 10-12 days later.

The presence of human antibody in the medium of wells containing transfected clones was measured by conventional ELISA techniques. Micro-titre plates were coated overnight at 4°C with goat anti-human IgG (gamma chain specific) antibodies (Sera-Lab Ltd., Crawley Down, UK) at 1 mg per well. After washing with PBST (phosphate buffered saline containing 0.02% Tween 20x (pH7.5)), 100ml of culture medium from the wells containing transfectants was added to each microtitre well for 1h at 37°C. The wells were then emptied, washed with PBST and either peroxidase-conjugated goat anti-human IgG or peroxidase-conjugated goat anti-human kappa constant region antibodies (both obtained from Sera-Lab Ltd., Crawley Down, UK) were added at 100 ng per well. Plates were then incubated at 37°C for 1h. The wells were then emptied and washed with PBST. 340 mg/ml o-phenylenediamine in 50mM sodium citrate, 50mM sodium phosphate (pH 5.0) and 0.003% (v/v) H_2O_2 were added at 200ml per well. Reactions were stopped after 1 to 5 min by the addition of 12.5% sulphuric acid at 50 ml per well. The absorbance at 492 nm was then measured spectrophotometrically.

The humanised antibody HuRSV19VH/VK, secreted from transfected cell lines cotransfected with pHuRSVVH and pHuRSVVK, was purified on Protein-A agarose columns (Boehringer Mannheim, Lewes, UK) and tested for binding to RSV virus in an ELISA assay. Antigen consisted of calf kidney (CK) cells infected with RSV (A2 strain of RSV obtained from a child in Australia and described by Lewis et al., *Med. J. Australia*, 48, 932-933 (1961)) and treated with 0.5% (v/v) NP40 detergent to yield a cell lysate. A control cell lysate was similarly prepared using uninfected CK cells. Microtitre plate wells were coated with either infected or control cell lysate. Antigen coated plates were blocked with PBST for 1 hour at 37°C, washed with PBST, and thereafter humanised antibody was applied (i.e., HuRSV19VH/VK). After 1 hour at 37°C, the wells were emptied, washed with PBST and 200 ng goat anti-human IgG antibodies (Sera Lab-Ltd., Crawley Down, UK) added per well. After 1 hour at 37°C, the wells were emptied, washed with PBST and 200ml of a 1:1000 dilution of horseradish peroxidase conjugated rabbit anti-goat IgG antibodies (Sigma-Poole, UK) were added. After 1 hour at 37°C, the wells were emptied and washed with PBST. To each well was added 200ml substrate buffer (340mg/ml o-phenylenediamine in 50mM sodium citrate, 50mM sodium phosphate (pH 5.0) and 0.003% (v/v) H₂O₂). Reactions were stopped by the addition of 50ml 12.5% sulphuric acid. The absorbance at 492 nm was then measured. Antibody HuRSVVH/VK bound to RSV although with an affinity less than the murine RSV19 antibody.

EXAMPLE 2-PRODUCTION OF HIGH AFFINITY ANTIBODIES SPECIFIC FOR RSV BY A METHOD DESIGNED TO ACHIEVE MINIMAL VARIABLE REGION FRAMEWORK MODIFICATIONS GIVING RISE TO HIGH AFFINITY BINDING

The method of this invention involves the following order of steps of alteration and testing:

1. Individual framework amino acid residues which are known to be critical for interaction with CDRs are compared in the primary antibody and the altered CDR-replacement antibody. For example, heavy chain amino acid residue 94 (Kabat numbering- see
5 Kabat et al., cited above) is compared in the primary (donor) and altered antibodies. An arginine residue at this position is thought to interact with the invariant heavy chain CDR aspartic acid residue at position 101.

10 If amino acid 94 comprises arginine in the framework of the primary antibody but not in the framework of the altered antibody, then an alternative heavy chain gene comprising arginine 94 in the altered antibody is produced. In the reverse situation whereby the
15 altered antibody framework comprises an arginine residue at position 94 but the primary antibody does not, then an alternative heavy chain gene comprising the original amino acid at position 94 is produced. Prior to any further analysis, alternative plasmids produced on this basis are tested for production of high affinity
20 altered antibodies.

2. Framework amino acids within 4 residues of the CDRs as defined according to Kabat (see Kabat et al., cited above) are compared in the primary antibody and altered CDR-replacement
25 antibody. Where differences are present, then for each region (e.g., upstream of VHCDR1) the specific amino acids of that region are substituted for those in the corresponding region of the altered antibody to provide a small number of altered genes. Alternative plasmids produced on this basis are then tested for production of
30 high affinity antibodies.

3. Framework residues in the primary and altered CDR-replacement antibodies are compared and residues with major differences in charge, size or hydrophobicity are highlighted.
35 Alternative plasmids are produced on this basis with the individual

- 25 -

highlighted amino acids represented by the corresponding amino acids of the primary antibody and such alternative plasmids are tested for production of high affinity antibodies.

5 The method is exemplified by the production of a high affinity altered antibody derivative of HuRSV_{VH}/VK (See, Example 1) specific for RSV. Comparison of VH gene sequences between RSV_{19VH} and pHuRSV_{19VH} (See, Figure 5) indicates that 3 out of 4 amino acid differences occur between amino acids 27 to 30 and
10 between amino acids 91 to 94. Thus, pHuRSV_{19VHNIK} and pHuRSV_{19VHFNS} were produced with framework amino acids 27 to 30 and 91 to 94 in the former, and amino acids 91 and 94 in the latter, represented as in the primary RSV_{19VH}. Using oligonucleotide site directed mutagenesis as described in Example
15 1, the following oligonucleotides were used for mutagenesis of the HuRSV_{19VH} gene in M13:

pHuRSV_{19VHNIK} - 5'ATATAGTAGTCTTTAATGTTGAAGCCAGACA3'

19 pHuRSV_{19VHFNS} - 5'CTCCCCATGAATTACAGAAATAGACCG3'
20

Humanised HuRSV_{19VHFNS}/HuRSV_{19VK} antibody was tested in an ELISA assay as detailed in Example 1 for analysis of binding to RSV antigen prepared from detergent-extracted, virus-infected
25 cells. Figure 6 shows that the substitution of VH residues 91 to 94 in HuRSV_{19VH}/VK with VH residues from mouse RSV_{19VH} partially restored antigen binding levels. Additional analysis of HuFNS binding properties was performed using an ELISA assay in which intact Type A RS virus (Long strain) was used as the
30 antigen. The data from such additional analysis (as shown in Figure 6A) show that there is little if any difference between the ability of the RSV₁₉ and HuRSV_{19VHFNS}/HuRSV_{19VK} antibodies to bind to intact, non-denatured RS virus. This additional analysis also showed detectable binding of HuRSV_{19VH}/VK to intact virus,
35 although of a much lower magnitude than was seen with either

- 26 -

RSV19 or HuRSV19VHFNS/HuRSV19VK. Thus, the data from this additional analysis suggests that the affinity for the native antigen was restored in the HuRSV19VHFNS/HuRSV19VK mAb.

5 Specificity of HuRSV19VHFNS/HuRSV19VK for RSV F protein was shown by conventional Western blot analysis using a truncated soluble F protein construct expressed in CHO cells.

EXAMPLE 3-SPECIFICITY AND BIOLOGICAL ACTIVITY OF AN ALTERED ANTIBODY SPECIFIC FOR RSV.

10

In order to ascertain the potential clinical usefulness of a humanised antibody specific for RSV, an immunofluorescence analysis of binding to 24 RSV clinical isolates was undertaken. The isolates were obtained from children during the winter of 1983-84
15 by the Bristol Public Health Laboratory (Bristol, England) and represented both of the major subgroups of RSV. 13 isolates were serotyped as subgroup A and 11 isolates as subgroup B. HeLa or MA104 cells infected with RSV isolates were grown in tissue culture. When the cells showed evidence of cytopathic effect, 20 ml of 0.02% (w/v) disodium EDTA (ethylenediaminetetra-acetic acid) (BDH Chemicals Ltd., Poole, UK) in PBS and 3ml of 0.25% (w/v) trypsin in PBS were added and the cell suspension spotted into wells of PTFE-coated slides (polytetrafluoroethylene coated slides) (Hendley, Essex, UK). After 3 hours at 37°C, the slides were dried
25 and fixed in 80% acetone. Cells were overlaid with monoclonal antibody (i.e., either humanised antibody, HuRSV19VHFNS/HuRSV19VK, or the murine antibody RSV19) for 1 hour at room temperature. After extensive washing, either fluorescein-conjugated rabbit anti-mouse IgG (Nordic Laboratories-Tilburg, The Netherlands) or fluorescein-conjugated goat anti-human IgG1 (Southern Biotechnology, Birmingham, Alabama, USA) was added, and the incubation was repeated. After further washing, cells were mounted in glycerol and examined under UV
30 light.

- 27 -

Table I shows the results of comparative immunofluorescence for the humanised antibody, HuRSV19VHFNS/HuRSV19VK, and the murine antibody RSV19. This data indicates that 100% of clinical isolates are recognised by both the humanised and murine antibodies. Such data demonstrates that the humanised antibody has the potential for recognition of most clinical isolates comprising both of the major RSV subgroups.

TABLE I

Binding of Humanised Anti-RSV to Clinical IsolatesExtent of Fluorescence*

<u>Isolate Number</u>	<u>HuRSV19VHFNS/HuRSV19VK</u>	<u>Murine RSV19</u>
<u>Subgroup A</u>		
V818	++++	++++
V795	++++	++++
V00401	++	++
V00214	+	++
V00764	++	+++
V743	++	+++
V316	++	++
V369	++++	++++
V1249	+++	+++
V04692	+++	+++
V1248	+	-
V01232	++	--
V729	+	--
<u>Subgroup B</u>		
V00634	+	++
V4715	++	+++
V00463	+	++
V4712	++	++
V00165	++	--
V00422	++	--
V837	+++	+++
V00900	++	++
4677	+++	+++
4424	++	++
V01231	+	+

*+, ++, +++ and ++++ refer to relative numbers of fluorescing cells observed and represent the proportion of cells infected

The humanised antibody, HuRSV19VHFNS/HuRSV19VK, was next tested for biological activity *in vitro* in a fusion inhibition assay. A suspension of MA104 cells was infected with RSV at an m.o.i. (multiplicity of infection) of 0.01 PFU (plaque forming units) per cell. After 1 hour at 37°C, 2ml of cells at 10^5 /ml were distributed to glass coverslips in tubes. After a further 24 hours at 37°C, the culture medium was replaced by medium containing dilutions of humanised antibody, HuRSV19VHFNS/HuRSV19VK. 24 hours later, coverslip cultures were fixed in methanol for 10 minutes and stained with May Grunwald stain (BDH Chemicals Ltd., Poole, UK). Table II shows the effect of increasing concentrations of HuRSV19VHFNS/HuRSV19VK in inhibiting the frequency of giant cells. The data represented in the following Table II demonstrates the biological activity of the humanised antibody

HuRSV19VHFNS/HuRSV19VK in inhibiting Type A RSV induced cell fusion. It should be noted that additional studies showed that the fusion inhibition titres for RSV19 versus HuRSV19VHFNS/HuRSV19VK were comparable, providing additional evidence that affinity for the native viral antigen was fully restored in HuRSV19VHFNS/HuRSV19VK. The humanized antibody HuRSV19VHFNS/HuRSV19VK has also been shown, (using methodology analogous to that utilized above for showing inhibition of Type A RSV induced cell fusion), to exhibit a dose dependent inhibition of Type B RSV (strain 8/60) induced giant cell fusion.

TABLE II

Inhibition of RSV Induced Cell Fusion by Humanised Anti-RSV

Concentration of HuRSV19VHFNS/HuRSV19VK (ug/ml)	Number of Giant Cells*	Average number of Nucleii
100	44	4.5
50	71	4.0
25	40	3.8
12.5	67	
6.3	89	
3.1	87	
1.6	164	
0.8	201	
0.4	292	
0.2	219	
0	239,259	14,13.5
0 (no virus)	10	

* Scored as the number of cells with 2 or more nucleii in 20 fields with a 25x objective microscope lens

- The humanised antibody, HuRSV19VHFNS/HuRSV19VK was next tested for biological activity *in vivo* in an RSV-mouse infection model. BALB/c mice (obtained from Charles Rivers: specific pathogen free category 4 standard) were challenged intranasally with 10^4 PFU of the A2 strain of human RSV (as described by Taylor et al., *Infection and Immunity*, 43 (1984) p649-655). Groups of mice were administered with 25mg of humanised antibody either one day prior to virus infection or 4 days following infection.
- 5
- 10 Administration of antibody was either by the intranasal (i.n.) or intraperitoneal (i.p.) routes. 5 days after RSV infection, mice were sacrificed and lungs were assayed for RSV PFU (see, Taylor et al., *Infection and Immunity*, 43 (1984) p649-655). The data in the following Table III shows that HuRSV19VHFNS/HuRSV19VK at a
- 15 single dose of 25mg per mouse is extremely effective in prevention and treatment of RSV infection.

TABLE III

Prevention and Treatment of RSV Infection in Mice by Humanised Anti-RSV

<u>Antibody Treatment</u>		
<u>Day*</u>	<u>Route*</u>	<u>log₁₀ PFU per gram of lung</u>
-1	i.p.	<1.7
		<1.7
		<1.7
		<1.7
		<1.7
-1	i.n.	<1.7
		<1.7
		<1.7
		<1.7
		<1.7
+4	i.p.	<1.7
		<1.7
		1.7
		<1.7
+4	i.n.	<1.7
		1.7
		<1.7
		1.7
		<1.7
No antibody		4.47
		4.32
		4.64
		4.61
		4.55

* -1 refers to administration of HuRSV19VHFNS/HuRSV19VK antibody 1 day prior to RSV infection, +4 refers to administration of antibody 4 days post infection

+ i.p. - intraperitoneal, i.n. - intranasal

- virus PFU is expressed as the virus titre from dilutions of 10% (v/v) lung homogenates (see Taylor et al., loc. cit.) adjusted to PFU per gram of lung. <1.7 log₁₀ PFU per gram means that no virus was detected in the starting dilution of lung homogenate 10%.

HuRSV19VHFNS/HuRSV19VK was also shown to be active *in vivo* when administered prophylactically to mice challenged with Type B RSV (strain 8/60) using methodology similar to that described above. In addition, the humanized antibody HuRSV19VH/VK was also shown to be active *in vivo* when administered prophylactically to mice challenged with Type B RSV (strain 8/60) using methodology similar to that described above.

This invention also relates to a method of preventing human RSV infection in a human in need thereof which comprises administering to such human an effective, human RSV infection inhibiting dose of an altered antibody of this invention for which RSV19 or RSV20 was the donor monoclonal antibody.

This invention also relates to a method of therapeutically treating human RSV infection in a human in need thereof which comprises administering to such human an effective, human RSV infection therapeutic dose of an altered antibody of this invention for which RSV19 or RSV20 was the donor monoclonal antibody.

To effectively prevent RSV infection in a human, one dose of approximately 1 mg/kg to approximately 20 mg/kg of an altered antibody of this invention for which RSV19 or RSV20 was the donor monoclonal antibody, such as HuRSV19VH/VK or

HuRSV19VHFNS/HuRSV19VK should be administered parenterally, preferably i.v. (intravenously) or i.m. (intramuscularly); or one dose of approximately 200 ug/kg to approximately 2 mg/kg of such antibody should be administered i.n. (intranasally). Preferably, such dose should be repeated every six

(6) weeks starting at the beginning of the RSV season (~~October=~~ ~~November~~) until the end of the RSV season (~~March-April~~).

Alternatively, at the beginning of the RSV season, one dose of approximately 5 mg/kg to approximately 100 mg/kg of an altered antibody of this invention for which RSV19 or RSV20 was the donor monoclonal antibody, such as HuRSV19VH/VK or



HuRSV19VHFNS/HuRSV19VK, should be administered i.v. or i.m. or one dose of approximately 0.5 mg/kg to approximately 10 mg/kg of such antibody should be administered i.n.

To effectively therapeutically treat RSV infection in a human, one
5 dose of approximately 2 mg/kg to approximately 20 mg/kg of an altered antibody of this invention for which RSV19 or RSV20 was the donor monoclonal antibody, such as HuRSV19VH/VK or HuRSV19VHFNS/HuRSV19VK should be administered parenterally., preferably i.v. or i.m.; or approximately 200 ug/kg to
10 approximately 2 mg/kg of such antibody should be administered i.n. Such dose may, if necessary, be repeated at appropriate time intervals until the RSV infection has been eradicated.

The altered antibodies of the invention may also be administered by
15 inhalation. By "inhalation" is meant intranasal and oral inhalation administration. Appropriate dosage forms for such administration, such as an aerosol formulation or a metered dose inhaler, may be prepared by conventional techniques. For example, to prepare a composition for administration by inhalation, for an aerosol
20 container with a capacity of 15-20 ml: Mix 10 mg of an altered antibody of this invention with 0.2-0.2% of a lubricating agent, such as polysorbate 85 or oleic acid, and disperse such mixture in a propellant, such as freon, preferably in a combination of (1,2
25 dichlorotetrafluoroethane) and difluorochloromethane and put into an appropriate aerosol container adapted for either intranasal or oral inhalation administration. As a further example, for a composition for administration by inhalation, for an aerosol container with a capacity of 15-20 ml: Dissolve 10 mg of an altered
30 antibody of this invention in ethanol (6-8 ml), add 0.1-0.2% of a lubricating agent, such as polysorbate 85 or oleic acid; and disperse such in a propellant, such as freon, preferably a combination of (1,2 dichlorotetrafluoroethane) and difluorochloromethane, and put into an appropriate aerosol container adapted for either intranasal or oral inhalation administration.

35

- 35 -

The preferred daily dosage amount to be employed of an altered antibody of the invention to prophylactically or therapeutically treat RSV infection in a human in need thereof to be administered by inhalation is from about 0.1 mg to about 10 mg/kg per day).

5

Natural RSV infections have been reported in cattle, goats, sheep and chimpanzees. Thus, for example, utilizing the methodology described above, an appropriate mouse antibody could be "bovinized", and appropriate framework region residue alterations could be effected, if necessary, to restore specific binding affinity. Once the appropriate mouse antibody has been created, one of skill in the art, using conventional dosage determination techniques, can readily determine the appropriate dose levels and regimens required to effectively treat, prophylactically or therapeutically, bovine RSV infection.

10

15

Examples 1-3 show that altered antibodies for prevention and treatment of infection can be produced with variable region frameworks potentially recognised as "self" by recipients of the altered antibody. Minor modifications to the variable region frameworks can be implemented to effect large increases in antigen binding without appreciable increased immunogenicity for the recipient. Such altered antibodies can effectively prevent and eradicate infection.

20

25

Thus the present invention provides an altered antibody in which complementarity determining regions (CDRs) in the heavy or light chain variable domains have been replaced by analogous parts of CDRs from a different source resulting in antibodies possessing the combination of properties required for effective prevention and treatment of infectious disease in animals or man. Suitably, the entire CDRs have been replaced. Preferably, the variable domains in both heavy and light chains have been altered by CDR replacement. Typically, the CDRs from a mouse antibody are grafted onto the framework regions of a human antibody. The

30

35

altered antibody preferably has the structure of a natural antibody or a fragment thereof.

A preferred antibody is one directed against respiratory syncytial virus (RSV), preferably one specific for the fusion (F) protein of RSV. A particularly preferred antibody of this kind has the following N-terminal variable domain amino acid sequences (see the Amino Acid Shorthand Table immediately following) in its heavy and light chains:

10

heavy:

QVQLQESGPGGLVLRPSQTL~~SL~~TCTVSGFT
~~ES~~(or ~~NIK~~)DYMHWVRQPPGRGLEWIGWIDPEN
 DDVQYAPKFGGRVTMLVDTSKNQFSLRLSSVTAAD
 15 TAVYCAR(or ~~ECNS~~)WGSDFDHWGQGTTVTVSS

light:

DIQLTQSPSSLSASVGDRVTITCRSSQTLVHTDGNTY
 LEWYQQKPGAPKLLIYRVS~~NR~~FSGVPSRFSGSGSGT
 20 DFTFTISSLQPEDIATYYCQSHLPRTFGQGTKVEIK

Table Amino Acid Shorthand

25	Amino Acid	Three-letter abbreviation	One-letter symbol
	Alanine	Ala	A
	Arginine	Arg	R
30	Asparagine	Asn	N
	Aspartic acid	Asp	D
35	Cysteine	Cys	C
	Glutamine	Gln	Q
	Glutamic acid	Glu	E

- 37 -

	Glutamic acid	Glu	E
	Glycine	Gly	G
5	Histidine	His	H
	Isoleucine	Ile	I
10	Leucine	Leu	L
	Lysine	Lys	K
	Methionine	Met	M
15	Phenylalanine	Phe	F
	Proline	Pro	P
20	Serine	Ser	S
	Threonine	Thr	T
	Tryptophan	Trp	W
25	Tyrosine	Tyr	Y
	Valine	Val	V

30 It will be understood by those skilled in the art that such an altered antibody may be further altered by changes in variable domain amino acids without necessarily affecting the specificity of the antibody for the fusion (F) protein of RSV, and it is anticipated that even as many as 25% of heavy and light chain amino acids may be

35 substituted by other amino acids either in the variable domain frameworks or CDRs or both. Such altered antibodies can be effective in prevention and treatment of respiratory syncytial virus (RSV) infection in animals and man.

40 The invention also includes a recombinant plasmid containing the coding sequence of the altered antibody of the invention, and a

- 38 -

mammalian cell-line transfected with a recombinant plasmid containing the coding sequence of the altered antibodies hereof. Such a vector is prepared by conventional techniques and suitably comprises DNA sequences encoding immunoglobulin domains including variable region frameworks and CDRs derived from a different source and a suitable promoter operationally linked to the DNA sequences which encode the altered antibody. Such a vector is transfected into a transfected mammalian cell via conventional techniques.

10

The invention further comprises a method for effecting minimal modifications within the variable region frameworks of an altered antibody necessary to produce an altered antibody with increased binding affinity comprising the following steps:

15

(a) analysis of framework amino acids known to be critical for interaction with CDRs, and production and testing of altered antibodies where single framework amino acids have been substituted by the corresponding amino acids from the same source as the CDRs;

20

(b) analysis of framework amino acids adjacent to CDRs, and production and testing of altered antibodies where one or more of the amino acids within 4 residues of CDRs have been substituted by the corresponding amino acids from the same source of the CDRs;

25

(c) analysis of framework residues within the altered antibody, and production and testing of altered antibodies where single amino acids have been substituted by the corresponding amino acids with major differences in charge, size or hydrophobicity from the same source of CDRs.

30

The following Examples relate to the novel RSV F protein epitope of the invention.

35

SPECIFIC RSV F PROTEIN EPITOPE

The following examples demonstrate that two monoclonals which protect and cure mice of *in vivo* infection by RSV recognize a linear epitope within the F protein of RSV (which linear epitope may be part of a conformational epitope) and which contains amino acid residues 417 to 438 of the F protein coding sequence including an essential arginine residue at position 429, or any immunoprotective portion thereof, such as, but not limited to amino acid residues 417-432 of the F protein coding sequence, and amino acid residues 422-438 of the F protein coding sequence. This novel epitope (which may be referred to herein as "epitope 417-438") is a suitable target for screening for other neutralizing epitopes, for protective and therapeutic agents against RSV, and in particular, for monoclonal antibodies against this epitope. Knowledge of this epitope enables one of skill in the art to define synthetic peptides which would be suitable as vaccines against RSV. Epitope 417-438 is also useful for generating monoclonal antibodies which will be useful in the treatment, therapeutic and/or prophylactic, of human RSV infection in humans.

The present invention also applies to the use of Fab fragments derived from monoclonal antibodies directed against such novel epitope as protective and therapeutic agents against *in vivo* infection by viruses, and particularly relates to the protection against RSV.

The invention also includes a recombinant plasmid containing the coding sequence of a monoclonal antibody generated against the 417-438 epitope, and a mammalian cell-line transfected with a recombinant plasmid containing such coding sequence. Such a vector is prepared by conventional techniques and suitably comprises DNA sequences encoding immunoglobulin domains including variable region frameworks and CDRs and a suitable promoter operationally linked to the DNA sequences which encode

the antibody. Such a vector is transfected into a mammalian cell via conventional techniques.

EXAMPLE 4

- 5 This example shows the production of murine monoclonal antibodies against the F protein of RSV which protect and cure mice of infection.
- 10 Murine monoclonal antibodies (mAbs) 19 and 20 were produced as follows. BALB/c mice (obtained from Charles Rivers-specific pathogen free) were inoculated intranasally (i.n.) on two occasions, 3 weeks apart, with 1×10^4 PFU of the A2 strain of human (H) RSV (described by Lewis et al., 1961, *Med. J. Australia*, 48, 932-933).
- 15 After an interval of 4 months, the mice were inoculated intraperitoneally (i.p.) with 2×10^7 PFU of the 127 strain of bovine (B) RSV (isolated at Institute for Animal Health, Compton, Near Newbury, Berks, England). Three days after inoculation, the immune splenocytes were fused with NS-1 myeloma cells (see,
- 20 Williams et al., 1977, *Cell*, 12, 663). The resulting hybridomas were screened for antibody to RSV by radioimmunoassay and immunofluorescence as described previously (Taylor et al., 1984, *Immunology*, 52, 137-142), cloned twice on soft agar (as described by Kohler et al., "Immunologic Methods", pp397-402, ed. I.
- 25 Lefkowitz & B. Perris, Academic Press), and the resulting cloned cells were inoculated into BALB/c mice to produce ascitic fluid as described previously (see, Taylor et al., 1984, *Immunology*, 52, 137-142).
- 30 The specificity of the mAbs for viral polypeptides was determined by radioimmune precipitation of (35 S)-methionine or (3 H)-glucosamine labelled RSV-infected cell lysates as described previously (see, Kennedy, et al., 1988, *J. Gen Virol*, 69, 3023-2032) and by immunoblotting (see, Taketa et al., 1985, *Electrophoresis*, 6,
- 35 492-497). The antigens used in immunoblotting were either Hep-2

- 41 -

cells (obtained from the American Type Culture Collection, Rockville, Maryland, USA) infected with the A2 strain of HRSV or primary calf kidney (CK) cells (produced at the Institute for Animal Health, Compton) infected with the 127 strain of BRSV. Uninfected
5 Hep-2 or CK cells were used as control antigens.

The immunoglobulin isotype of the mAbs was determined by immunodiffusion using a radial immunodiffusion kit (Serotec, Kidlington, Oxfordshire, UK).

- 10

The properties of mAbs 19 and 20 are shown in the following Table A.

Table A Properties of mAb 19 and mAb 20

mAb	Protein specificity			Ig class	ELISA titre ¹			% SFA ²	Complement lysis ³	Neut. titre ⁴	Fusion inhibition	Mouse protection ⁵
	RIIP ⁶	Western blot			A2	8/60	BRS					
		Native	Reduced									
19	F	140K, 70K	46K	G2a	7.2	7.4	6.7	88	1.7	3.4	+	>3.8
20	F	140K, 70K	46K	G2a	>6.0	8.6	7.5	69	76	4.3	+	>3.8

¹Antibody titre, using HRSV strain A2 (subtype A), HRSV strain 8/60 (subtype B) and BRSV strain 127 as antigens in ELISA, expressed as log₁₀ titre.

²SFA = percent of HRSV strain A2 infected cells showing surface fluorescence.

³Percent specific chromium release from virus infected cells (bovine nasal mucosa cells persistently infected with BRSV) by 1/100 dilution of mAb and rabbit complement.

⁴50% plaque reduction titre expressed as log₁₀.

⁵Reduction in peak titre of RSV, strain A2 in lungs of mice given 100 μl of mAb intra peritoneally one day before intranasal challenge, expressed as log₁₀ pfu.

- 43 -

Immune precipitation of radiolabelled RSV (by the method of Brunda et al, (1977) J. Immunol. 119, 193-198) indicated that mAbs 19 and 20 recognized the fusion (F) glycoprotein. This was confirmed by a Western blot of non-reduced and reduced lysates of cells infected with RSV. The blots were probed with HRP-conjugated goat anti-mouse IgG (Kpl, Gaithersburg, Maryland, USA). mAbs 19 and 20 recognized the 140k F protein dimer and the 70K monomer present in the native F protein antigen and the 46K F1 fragment in antigen denatured by boiling in 2-mercaptoethanol. Both mAb 19 and 20 were identified as IgG2a, and their ELISA titres against the A2 and 8/60 strains of HRSV were similar to the ELISA titres against the 127 strain of BRSV, indicating that the epitopes recognized by these mAbs were conserved amongst strains of human and bovine RSV. Both mAb 19 and 20 neutralized RSV infectivity and inhibited the formation of multinucleated giant cells in MA104 cells infected with RSV. In contrast to mAb 19, mAb 20 lysed RSV-infected cells in the presence of rabbit complement. The failure of mAb 19 to lyse RSV-infected cells was not due to failure to bind to the surface of virus-infected cells since mAb 19 stained 88% of such cells. The failure of mAb 19 and complement to lyse virus-infected cells indicates that antibody and complement-mediated lysis is not important in the *in vivo* protection mediated by this antibody. The ability of mAbs 19 and 20 to protect against RSV infection was assessed by challenging mice *in.* with approximately 10^4 PFU of RSV 24 h after *i.p.* inoculation of mAbs 19 and 20. The lungs of untreated mice killed 5 days after challenge contained $5.5 \log_{10}$ PFU of RSV/g tissue whereas virus was not detected in the lungs of mice given either mAb 19 or 20.

EXAMPLE 5

This example describes methods of isolating mutants of RSV which are resistant to inhibition by mAbs 19 and 20 generated in Example 4.

Mutant RS viruses refractory to neutralization by mAbs 19 and 20 were produced using a plaque reduction technique with the A2 strain of HRSV as follows. Confluent monolayers of CK cells, in a tissue culture flask, were infected with the A2 strain of HRSV at a MOI of 0.1. Starting 24 hours after infection and continuing for 3 to 5 days, the culture medium was replaced daily with fresh medium containing 10% mAb. Virus was harvested when a cytopathic effect was observed. Virus prepared in this way was mixed with an equal volume of either undiluted mAb 19 or 20, or medium alone for 1 hour at room temperature and inoculated onto CK monolayers in 35mm multi-well plates (Nunc, Kamstrup, Riskilde, Denmark). After 1 hour incubation at 37°C, the plates were overlaid with medium containing 0.25% agarose and 10% mAb or medium alone. Cultures were incubated at 37°C in 5% CO₂ in air for 7 days before adding the vital stain, 0.3% 3-(4,5-Dimethylthiazolyl-2)-2,5-diphenyltetrazolium bromide in 0.15M NaCl, to the overlay to visualize virus plaques.

Putative mutant viruses were removed in agar plugs from plates which contained single plaques, diluted in medium, mixed with an equal volume of mAbs 19 or 20 and inoculated onto CK monolayers in 35 mm multi-well plates as before. Putative mutant viruses were plaque picked again and inoculated into tubes containing coverslips of calf testes cells. After 4 to 6 days incubation, the coverslips were removed and stained with mAb 19 and 20 and FITC-labelled rabbit anti-mouse Ig (Nordic Labs, Tilburg, The Netherlands). As a positive control, coverslips were stained with polyclonal bovine antiserum to RSV (produced at Institute for Animal Health-Compton from a gnotobiotic calf hyperimmunised with RSV), and FITC-labelled rabbit anti-bovine Ig (obtained from Nordic Immunology, Tilburg, The Netherlands). RS viruses that failed to react by immunofluorescence to mAb 19 or 20 were classed as mutant viruses and were used to infect monolayers of Hep-2 cells to produce antigen for ELISA. Thus, 3 to 4 days after RSV infection,

- 45 -

cells were scraped into the medium, spun at 400 g for 5 mins, resuspended in distilled water, and treated with 0.5% (v/v) NP40 detergent to yield a cell lysate. A control cell lysate was made in a similar way using uninfected Hep-2 cells. The binding of a panel of

5 mAbs to the F protein of RSV to the mutant viruses was examined by ELISA. Microtitre plate wells were coated with 50 ul of either infected or control cell lysate overnight at 37°C, incubated with blocking buffer consisting of 5% normal pig serum in PBS and 0.05% Tween 20 for 1 h at room temperature and washed 5x with

10 PBS/TWEEN. Serial dilutions (three times) of the mAbs were added to the wells and the plates were incubated for 1 hour. After washing 5 times with PBS/Tween, HRP-conjugated goat anti-mouse IgG (Kpl, Gaithersburg, Maryland, USA), diluted 1:2000, was added to each well. After a final washing, bound conjugate was

15 detected using the substrate 3,3',5,5'-tetramethylbenzidine (TMB), (obtained from ICN Immunobiologicals, Illinois). Mutant viruses, selected for resistance to mAb 19, failed to react in ELISA with both mAbs 19 and 20. Similarly, mutant viruses selected for resistance to mAb 20 failed to react with mAbs 19 and 20. All other mAbs

20 tested reacted with the mutants to the same extent as to parent HRSV, strain A2. These results are illustrated in the following Table B.

TABLE B

Table B Binding of anti-F mAbs to antibody escape mutants of RSV.

mAb	Parent A2	Mutants selected with indicated mAb					
		19			20		
		C4848f	C4909/1	C4902/6	C4902Wa	C42902Wb	C4902Wc
1	+	+	+	+	+	+	+
2	+	+	+	+	÷	÷	÷
5	+	+	+	÷	+	+	+
11	+	+	+	+	÷	÷	÷
13	÷	+	+	÷	÷	÷	÷
14	+	÷	+	+	÷	÷	÷
16	+	÷	+	÷	÷	÷	÷
17	+	+	+	÷	÷	÷	÷
18	+	+	+	+	÷	÷	÷
19	+	-	-	-	-	-	-
20	÷	-	-	-	-	-	-
21	+	+	+	+	÷	÷	÷
B1	+	+	+	÷	÷	+	÷
B2	+	+	+	+	+	+	÷
B3	+	+	+	+	+	+	÷
B4	+	+	+	÷	+	+	÷
B5	+	+	+	÷	+	+	÷
B6	+	+	+	+	+	+	÷
B7	+	+	+	+	+	+	÷
B8	+	+	+	+	+	+	÷
B9	+	+	+	+	+	+	÷
B10	+	+	+	+	+	+	÷
7C2	+	+	+	+	+	+	÷
47F	+	+	+	+	+	+	÷

EXAMPLE 6

This example describes the identification of an amino acid sequence within the F protein which binds protective monoclonal antibodies and demonstrates that arginine 429 is essential for binding protective mAbs to this amino acid sequence.

Poly(A)⁺ RNAs, isolated from cells infected with either the A2 strain of HRSV or each of the mutants described in Example 5, were used to sequence the F protein mRNA. These sequences were determined by the dideoxy method (cited above) using 5'-³²P-labelled oligonucleotide primers, synthesized according to the previously reported F-protein sequence of the Long strain of RSV (see, Lopez, et al., 1988, *Virus Res.* 10, 249-262), followed by a chase with terminal deoxynucleotide transferase (see, DeBorde, et al., 1986, *Anal Biochem.* 157, 275-282). Three mutants were selected with mAb 19 and three were selected with mAb 20. All such mutants showed a single transversion (C to G) at nucleotide 1298 compared with the parent A₂ strain. This nucleotide substitution changes the amino acid residue at position 429 of the F protein from arginine to serine. Since mAbs 19 reacted in Western blot with the F₁ subunit, it is likely that the antibody-binding site is determined by a linear sequence of contiguous amino acids in which residue 429 of the F₁ subunit plays an essential role.

Synthetic peptides corresponding to amino acids residues 417-432, 422-438, 417-438 and 421-450 of the F protein were examined for their ability to react with mAbs 19 and 20 in ELISA. mAbs 19 and 20 reacted with peptides 417-432 (F417), 417-438 and with 422-438 (F422) but not with peptide 431-450. The binding of mAb 19 to peptides 417-432 and 422-438 (2ug/well) either coated onto microtitre plate wells overnight at 37°C ("dry") or coated onto the wells for 1h at room temperature ("wet") is shown in Figure 7. It should be noted that mAb 20 gave essentially the same results.

35

Example 7

- 5 This example shows that Fab fragments derived from mAbs 19 and 20 can protect and treat mice infected by RSV.

mAbs 19 and 20 were purified from ascitic fluid using Protein A Sepharose (Pharmacia, Milton Keynes, United Kingdom).

- 10 Approximately 10 mg of purified mAb 19 and 20 were incubated with 0.5 ml of immobilized papain (Pierce-Oud-Beijerland, The Netherlands) for 5 h and overnight respectively at 37°C with constant mixing. The resulting Fab fragments were recovered on an immobilized Protein A column (Pierce). The purified IgG and
15 the papain cleaved fragments were analyzed by SDS-PAGE under reducing conditions. The purified IgG showed bands at 53,000d and 23,000d, corresponding to Ig heavy and light chains. The Protein A fractions containing Fab fragments showed bands at approximately 25,000d and the fraction containing the Fc
20 fragments showed 3 distinct bands corresponding to the heavy and light chains of the undigested IgG and also the Fc fragment at approximately 28,000d. The purified IgG and the papain cleaved fragments were evaluated for anti-RSV activity by ELISA with HRSV strain A2 infected and uninfected Hep-2 cells as antigen, and
25 HRP-goat anti-mouse Fab (Sigma Chemical Co., St. Louis, Mi, USA) and HRP-goat anti-mouse Fc (ICN ImmunoBiologicals, Illinois). The ELISA showed that the Fab fragments of mAbs 19 and 20 were not contaminated with undigested Ig. These data are illustrated in the following Table C.

(12)

EUROPEAN PATENT APPLICATION

(21) Application number: **89301291.4**

(81) Int. Cl. 4: **A 61 K 39/395**
C 12 N 15/00

(22) Date of filing: **10.02.89**

(30) Priority: **12.02.88 GB 8803228**
25.02.88 GB 8804464

(43) Date of publication of application:
16.08.89 Bulletin 89/33

(84) Designated Contracting States:
AT BE CH DE ES FR GB GR IT LI LU NL SE

(71) Applicant: **MEDICAL RESEARCH COUNCIL**
20 Park Crescent
London W1N 4AL (GB)

Waldmann, Herman
11 Gurney Way
Cambridge (GB)

Clark, Michael Ronald
108 York Street
Cambridge CB1 2PY (GB)

(72) Inventor: **Clark, Michael Ronald**
108 York Street
Cambridge, CB1 2PY (GB)

Riechmann, Lutz
7064 Vista del Mar Avenue
La Jolla California 92037 (US)

Waldmann, Herman
11 Gurney Way
Cambridge (GB)

Winter, Gregory Paul
64 Cavendish Avenue
Cambridge (GB)

(74) Representative: **Morton, Colin David et al**
Keith W Nash & Co. Pearl Assurance House 90-92 Regent
Street
Cambridge CB2 1DP (GB)

Claims for the following Contracting States: ES + GR.

(54) **Improvements relating to antibodies.**

(57) An antibody is produced, which will bind effectively with the antigen Campath-1, and which has at least one complementarity determining region of rat origin, as identified in Figure 2, which may be combined with a range of different foreign variable domain framework regions as desired, including framework regions of human origin.

EP 0 328 404 A1

Description**Improvements in or relating to antibodies**Field of the invention

5 This invention relates to antibodies.

Background to the invention

10 Antibodies, or immunoglobulins, comprise two heavy chains linked together by disulphide bonds and two light chains, each light chain being linked to a respective heavy chain by disulphide bonds. The general structure of an antibody of class IgG (i.e. an immunoglobulin (Ig) of class gamma (G)) is shown schematically in Figure 1 of the accompanying drawings.

15 Each heavy chain has at one end a variable domain followed by a number of constant domains. Each light chain has a variable domain at one end and a constant domain at its other end, the light chain variable domain being aligned with the variable domain of the heavy chain and the light chain constant domain being aligned with the first constant domain of the heavy chain. The constant domains in the light and heavy chains are not involved directly in binding the antibody to antigen.

20 The variable domains of each pair of light and heavy chains form the antigen binding site. The domains on the light and heavy chains have the same general structure and each domain comprises four framework regions, whose sequences are relatively conserved, connected by three complementarity determining regions (CDRs) (see reference 11). The four framework regions largely adopt a beta-sheet conformation and the CDRs form loops connecting, and in some cases forming part of, the beta-sheet structure.

The CDRs are held in close proximity by the framework regions and, with the CDRs from the other domain, contribute to the formation of the antigen binding site.

Summary of the invention

25 According to one aspect of the present invention there is provided an antibody having at least one CDR which is foreign with respect to the constant region of the antibody, said at least one foreign CDR being selected from CDRs substantially as identified in Figure 2, namely residues 31 to 35, 50 to 65 and 95 to 102 of the heavy chain and residues 24 to 34, 50 to 56 and 89 to 97 of the light chain, the antibody being capable of binding effectively to the antigen Campath-1.

30 The term "foreign" is used in relation to the CDR(s) and constant region to mean of different origin.

In Figure 2 and elsewhere in the specification amino acid residues are identified by the conventionally used one letter symbols, as follows:

35	Amino Acid	One-letter symbol
	Alanine	A
	Arginine	R
	Asparagine	N
40	Aspartic acid	D
	Asparagine or aspartic acid	B
	Cysteine	C
	Glutamine	Q
45	Glutamic acid	E
	Glutamine or glutamic acid	Z
	Glycine	G
50	Histidine	H
	Isoleucine	I
	Leucine	L
	Lysine	K
	Methionine	M
55	Phenylalanine	F
	Proline	P
	Serine	S
	Threonine	T
60	Tryptophan	W
	Tyrosine	Y
	Valine	V

In this specification, effective antibody-antigen binding is used to mean that antibody effects 50% binding to antigen at antibody concentrations of less than or equal to 70 ug/ml, preferably at concentrations of less than or equal to 7 ug/ml. Binding affinity may be tested by assay procedures such as are described in the Example herein, eg using Campath-1 antigen obtained from a glycolipid extract from human spleen. (ug = microgram)

Thus, a standard procedure for the extraction of glycolipids can be applied to the extraction of the Campath-1 antigen from human spleens. This standard extraction procedure involves the treatment of 1 volume of homogenised human spleen tissue with 3 volumes of water, 11 volumes of methanol and 5.4 volumes of chloroform. After mixing precipitated material is discarded and a further 3.5 volumes of water are added, followed by further mixing. The mixture is then allowed to separate into two phases, the lower chloroform-containing phase is discarded and the upper aqueous phase is concentrated to provide a crude extract of the Campath-1 antigen, which can if desired be purified further by affinity chromatography, for example using the YTH66.9 antibody referred to hereinafter.

The antibody of the present invention desirably has a light chain with at least one CDR selected from CDRs substantially as identified in Figure 2 and a heavy chain with at least one CDR selected from CDRs substantially as identified in Figure 2.

As a further possibility, the antibody of the present invention preferably has three heavy chain CDRs substantially as identified in Figure 2, or three light chain CDRs substantially as identified in Figure 2. More preferably, the antibody has all six heavy and light chain CDRs substantially as identified in Figure 2.

Hence, in a preferred aspect the present invention provides an antibody having heavy and light chain CDRs which are foreign with respect to the constant region of the antibody, said CDRs being substantially as identified in Figure 2, namely residues 31 to 35, 50 to 65 and 95 to 102 of the heavy chain and residues 24 to 34, 50 to 56 and 89 to 97 of the light chain, the antibody being capable of binding effectively to the antigen Campath-1.

The CDRs identified in Figure 2 are of rat origin and may be combined with a range of different variable domain framework regions, as desired, including, eg, framework regions of rat or human origin.

In a further aspect the present invention provides an antibody having heavy and light chain variable domains as identified in the lower lines of sequence information in Figure 2, namely residues 1 to 113 of the heavy chain and residues 1 to 108 of the light chain, the CDRs and constant region of the antibody being foreign with respect to one another, the antibody being capable of binding effectively to the antigen Campath-1.

Such an antibody comprises CDRs and framework regions of rat origin.

The invention also provides an antibody having heavy and light chain variable domains as identified in the upper lines of sequence information in Figure 2, namely residues 1 to 113 of the heavy chain and residues 1 to 108 of the light chain, and that will bind effectively to the antigen Campath-1.

Such an antibody comprises CDRs of rat origin in framework regions of human origin.

Such an antibody may be modified by having a phenylalanine group at residue 27 of the heavy chain in place of serine, and possibly also by having a threonine group at residue 30 of the heavy chain in place of serine. A Ser(27) to Phe mutation is found to increase antibody-antigen binding significantly. However, the mutation of Ser (30) to Thr (in the human framework with the Ser (27) to Phe mutation) has little effect on binding affinity. This illustrates that point mutations in the antibody may have a major effect or little effect on the affinity of the antibody for the antigen. Although the two changes Ser (27) to Phe and Ser (30) to Thr are located within the framework region as defined in reference 11, they lie within the hypervariable loop H1 as defined in reference 18. It is accordingly believed that some changes in the CDRs may similarly be made without necessarily having an adverse effect on antibody-antigen affinity. References to CDRs substantially as identified in Figure 2 are accordingly intended to include within their scope not only CDRs identical to those identified in Figure 2 but also variants of such CDRs, subject to the requirement of the antibody binding effectively to Campath-1.

The antibody is preferably in biologically pure form, desirably being at least 95% (by wt) free of other biological materials.

The remainder of the antibody, namely the heavy and light chain constant domains and possibly also variable domain framework regions and one or more CDRs, can be based on antibodies of various different types as desired including, eg, rat and human antibodies of different classes. Thus, the constant domains can be selected to have desired effector functions appropriate to the intended use of the antibody. For example, for therapeutic purposes, human IgG1 and rat IgG2b are currently favoured isotypes. Further, of the human IgG isotypes, IgG1 and IgG3 appear to be the most effective for complement and cell mediated lysis, and therefore for killing tumour cells. For other purposes other isotypes may be favoured, eg, rat IgM, IgG1, IgG2a, IgG2c, human IgG2, IgG4 etc. For human therapy it is particularly desirable to use human isotypes, to minimise antioglobulin responses during therapy.

The Campath-1 antigen is strongly expressed on virtually all human lymphocytes and monocytes, but is absent from other blood cells including the hemopoietic stem cells, the antigen being described by Hale et al in Blood, 1983, 62, 873-882 (reference 6). That paper describes the antibody YTH66.9 which is specific for the Campath-1 antigen, this antibody being available from Serotec of 22 Bankside, Station Approach, Kidlington, Oxford, England, under the designation YTH 66.9 HL. A further series of antibodies to Campath-1 have been produced, including rat monoclonal antibodies of IgM, IgG2a, and IgG2c isotypes (reference 7) and more recently IgG1 and IgG2b isotypes have been isolated as class switch variants from the IgG2a secreting cell line YTH 34.5HL (reference 8). All of these antibodies with the exception of the rat IgG2c isotype are able to efficiently lyse human lymphocytes with human complement.

In addition, the IgG2b antibody YTH 34.5HL-G2b, but not the other isotypes, is effective in antibody dependent cell mediated cytotoxicity (ADCC) with human effector cells (reference 8). These rat monoclonal antibodies have found important application in the context of immunosuppression, for control of graft-versus-host disease in bone marrow transplantation (reference 6); the management of organ rejection (reference 9); the prevention of marrow rejection and in the treatment of various lymphoid malignancies (reference 10). For in-vivo use, the IgG2b antibody YTH 34.5HL-G2b seems to be the most effective at depleting lymphocytes, but the use of any of the antibodies in this group is limited by the antiglobulin response which can occur within two weeks of the initiation of treatment (reference 10).

Antibodies in accordance with the invention, particularly those based on human isotypes, thus have good therapeutic potential. In particular, the availability of a reshaped human antibody with specificity for the Campath-1 antigen should permit a full analysis of the in vivo potency and immunogenicity of an anti-lymphocyte antibody with wide therapeutic potential. Such reshaped antibodies have been used in the treatment of patients with non-Hodgkin lymphoma, as well as in the treatment of some cases of autoimmune disease. Further trials with organ graft patients, particularly kidney graft patients, are proposed. Even if anti-idiotypic responses are eventually observed, considerable therapeutic benefit could be derived by an extended course of treatment. In addition an antiglobulin response restricted to idiotype should be circumvented by using a series of antibodies with different idiotype (reference 20). In principle, the Idiotype of the reshaped Campath-1 could be changed by altering the hypervariable regions or the framework regions: evidence from a reshaped antibody specific for the hapten nitrophenyl acetate suggests that the recognition by anti-idiotypic antisera and anti-idiotypic monoclonal antibodies is influenced by residues in the framework region (reference 5). Thus recycling the hypervariable regions on different human framework regions should change the idiotype, although ultimately it could focus the response directly onto the binding site for Campath-1 antigen. Although such focussing would be undesirable for Campath-1 antibodies, it could be an advantage for the development of anti-idiotypic vaccines.

In further aspect, the invention thus provides a method of treating patients, particularly humans, with cancers, particularly lymphomas, or for immunosuppression purposes, comprising administering antibodies in accordance with the invention.

Antibodies in accordance with the present invention may be formulated for administration to patients by mixing antibody purified in conventional manner with a physiologically acceptable diluent or carrier, possibly in admixture with other therapeutic agents such as other antibodies. In one example, purified antibody was reconstituted in a commercially available human plasma protein solution (minus gamma globulin). The formulation was administered by intravenous infusion at the rate of 5 mg antibody per day for at least 10 days.

Antibodies in accordance with the invention can be produced in various different ways, as will be described in greater detail in the Examples following.

Heavy and light chain variable domains are conveniently produced separately and assembled with the remainder of an antibody of desired origin, eg desired human isotype.

Genes encoding the variable domains of an antibody of desired structure may be produced, and attached to genes encoding the constant domains of an antibody of desired isotype. Genes encoding variable domains can be derived from hybridoma cDNA or from the chromosome. Genes encoding the variable domains are also conveniently constructed by gene synthesis techniques or by site directed mutagenesis using long synthetic oligonucleotides. Expression is conveniently effected by transforming a cell line, eg an immortalised mammalian cell line such as a myeloma cell line, with expression vectors including DNA coding for the variable domains and for the remainder of the antibody and culturing the transformed cell line to produce the desired antibody.

In another aspect the invention provides a process for the preparation of an antibody having at least one CDR (complementarity determining region) which is foreign with respect of the constant region of the antibody, said at least one foreign CDR being selected from CDRs substantially as identified in Figure 2, that is amino acid residues 31 to 35, 50 to 65 and 95 to 102 of the heavy chain as shown in Figure 2a, and amino acid residues 24 to 34, 50 to 56 and 89 to 97 of the light chain as shown in Figure 2b, the antibody being capable of binding effectively to the antigen Campath-1, which process comprises culturing a cell capable of expressing the antibody in order to effect expression thereof.

It will be appreciated that the antibody may be used in a form which retains the CDRs but lacks other parts of the whole molecule not essential to its binding efficacy, in particular a $F(ab')_2$ fragment, and the word antibody is used herein to include such materials.

The invention will be further described, by way of illustration, in the following Examples which refer to the accompanying drawings, in which:

Figure 1 is a schematic diagram illustrating the structure of an IgG molecule:

Figure 2 illustrates nucleic acid and amino acid sequences of the variable domains of antibodies in accordance with the invention, with Figure 2a representing the heavy chain and Figure 2b representing the light chain. The upper line of the Figure gives sequence information for reshaped antibody, with the lower line giving sequence information for rat YTH 34.5HL antibody;

Figure 3 illustrates the sequence of the HuVLLYS^o gene and derived amino acid sequence;

Figure 4 illustrates the sequence of the HuVLLYS gene and derived amino acid sequence;

Figure 5 illustrates a strategy for producing a reshaped human antibody having rat CDRs;

Figure 6 illustrate loop Phe 27 to Tyr 35 in the heavy chain variable domain of the human myeloma

protein KOL;

Figure 7 illustrates the results of complement lysis and ADCC for various antibodies;

Figure 8 illustrates the results of complement lysis and ADCC of various further antibodies;

Figure 9 shows the effect of CAMPATH-1H on blood counts in a patient (patient 1), with solid triangles showing results for lymphocytes and empty triangles results for neutrophils;

Figure 10 shows the cytology of bone marrow cells from two (patients 1 and 2) patients treated with CAMPATH-1H:

A = patient 1 trephine before treatment with CAMPATH-1H

B = patient 1 trephine on day 43 (ie 16 days after treatment)

C = patient 2 aspirate before treatment with CAMPATH-1H

D = patient 2 aspirate on day 78 (ie 35 days after treatment);

Figure 11 shows computed tomography scans from patients 1 and 2, showing affected spleens and lymphonode:

A = patient 1 before treatment with CAMPATH-1H

B = patient 1 on day 57

C = patient 2 before treatment with CAMPATH-H (retrocrural node arrowed)

D = patient 2 on day 51; and

Figure 12 shows the effect of CAMPATH-H on blood counts in patient 2, with solid triangles showing results for lymphocytes and empty triangles results for neutrophils.

Example 1

The sequences of the heavy and light chain variable domains of rat IgG2a Campath-1 antibody YTH 34.5HL were determined by cloning the cDNA (Figure 2), and the hypervariable regions were identified according to Kabat (see reference 11). Sequence information is given in the lower lines of Figure 2, with the CDRs identified in boxes.

In the heavy chain variable domain there is an unusual feature in the framework region. In most known heavy chain sequences Pro(41) and Leu(45) are highly conserved: Pro(41) helps turn a loop distant from the antigen binding site and Leu(45) is in the beta bulge which forms part of the conserved packing between heavy and light chain variable domains (reference 12). In YTH 34.5HL these residues are replaced by Ala(41) and Pro(45), and presumably this could have some effect on the packing of the heavy and light chain variable domains.

Working at the level of the gene and using three large mutagenic oligonucleotides for each variable domain, in a single step the hypervariable regions of YTH 34.5HL were mounted on human heavy or light chain framework regions taken from the crystallographically solved proteins NEW for the heavy chain (reference 13) and from a protein based closely on the human myeloma protein REI for the light chain (reference 14). The NEW light chain was not used because there is a deletion at the beginning of the third framework region of the NEW light chain. The resulting reshaped heavy chain variable domain HuVHCAMP is based on the HuVHNP gene (references 1, 5) with the framework regions of human NEW alternating with the hypervariable regions of rat YTH 34.5HL. There are discrepancies involving the first framework region and the first hypervariable loop of the NEW heavy chain between the published sequence used here and the sequence deposited in the Brookhaven data base (in parentheses): Ser27 (to Thr), Thr28 (to Ser) and Ser30 (to Asp). Neither version is definitive and the discrepancies do not affect present considerations. The reshaped light chain variable domain HuVLCAMP is a similar construct, except with essentially the framework regions of the human myeloma protein REI, with the C-terminal and the 3' non-coding sequence taken from a human J_K-region sequence (reference 22). Sequence information for the variable domain of the reshaped antibody is given in the upper lines in Figure 2. The sequences of oligonucleotide primers are given and their locations on the genes are also marked in Figure 2.

Considering the above in further detail, mRNA was purified (reference 23) from the hybridoma clone YTH 34.5HL (gamma 2a, k^b), and first strand cDNA made by priming with oligonucleotides complementary to the 5' end of the CH1 (oligonucleotide I) and the C_κ exons (oligonucleotide II). cDNA was cloned and sequenced as described in references 24 and 25.

For expression of the rat heavy chain variable domain RaVHCAMP, two restriction sites (XbaI and Sall) were introduced at each end of the cDNA clone in M13 using mutagenic oligonucleotides III and V respectively, and the XbaI-Sall fragment excised. Simultaneously, the corresponding sites were introduced into the M13-HuVHNP gene using oligonucleotides IV and VI, and the region between the sites exchanged. The sequence at the junctions was corrected with oligonucleotides VII and VIII, and an internal BamHI site removed using the oligonucleotide IX, to create the M13-RaVHCAMP gene. The encoded sequence of the mature domain is thus identical to that of YTH 34.5HL.

The reshaped heavy chain variable domain (HuVHCAMP) was constructed in an M13 vector by priming with three long oligonucleotides simultaneously on the single strand containing the M13-HuVHNP gene (references 1, 5). The mutagenesis techniques used were similar to those described in reference 33, using the host 71-18 mutL and without imposing strand selection. Each oligonucleotide (X, XI and XII) was designed to replace each of the hypervariable regions with the corresponding region from the heavy chain of the YTH 34.5HL antibody.

Colony blots were probed initially with the oligonucleotide X and hybridisation positives were sequenced: the overall yield of the triple mutant was 5%. Ser27 to Phe and Ser27 to Phe, Ser30 to Thr mutants (to be described below) of M13mp8-HuVHCAMP were made with the mixed oligonucleotide XIII.

The reshaped light chain variable domain (HuVLCAMP) was constructed in an M13 vector from a gene with framework regions based on human REI. As above, three long oligonucleotides (XIV, XV, and XVI) were used to introduce the hypervariable regions of the YTH 34.5HL light chain.

5 Construction of the humanised light chain variable domain is described in greater detail in the following seven paragraphs.

(1) The "humanised" light chain variable domain (HuVLCAMP) was constructed in three stages, utilising a "humanised" light chain variable domain (HuVLLYS) which had been constructed for other purposes.

(a) The first stage involved the gene synthesis of a "humanised" light chain variable domain gene (HuVLLYS^o). The HuVLLYS^o gene incorporates human framework regions identical to the most common residue in each position in the Kabat alignment of the human kappa subgroup I, except for residues 97-108, which were identical to those in the human J1 fragment described in reference 34. The sequences of the framework regions are very similar to the crystallographically solved light chain structure REI. The CDRs in HuVLLYS^os were identical to those in the mouse antilysozyme antibody (D1.3) light chain (unpublished). A 30 bp sequence, identical to the sequence following the genomic J1 segment, was introduced to the 3' side of residue 108. BamH1 and EcoRI restriction sites were introduced at the 3' end of the synthetic gene, and a PstI site at the 5' end. The gene synthesis of HuVLLYS^o is described in paragraphs (2) to (5) below, and the sequence of the gene and the derived amino acid sequence is given in Figure 3.

(b) The second stage involved the introduction of the HuVLLYS^o gene in place of the heavy chain variable domain in the vector M13-MOVHNP and this is described in paragraphs 6 and 7 below. Thus the light chain variable domain utilises the promoter and signal sequence of a heavy chain variable domain: at the 3' end of the gene the sequence is derived from the human light chain J1 segment as described in paragraph (1a). The sequence of the HuVLLYS gene and the derived amino acid sequence is given in Figure 4.

(c) The third stage involved the conversion of HuVLLYS to a "humanised" light chain variable domain with the CDRs of Campath-1 specificity.

2. For the synthesis of the HuVLLYS^o gene, three blocks of oligonucleotides (PK1-5, KK1-5 and KE1-8 in the table in paragraph 3 below) were cloned separately into M13 vectors, and sequenced. Each cloned block was excised and ligated together into M13mp19 to create the HuVLLYS^o gene.

3. Oligonucleotides listed below were produced on an Applied Biosystems 380B synthesizer. Each oligonucleotide was size-purified, 10 nmol being subjected to electrophoresis on a 20 x 40 cm 12% polyacrylamide, 7M urea gel, eluted from the gel by dialysis against water, and lyophilized. For gene synthesis or mutagenesis, a 50 pmol aliquot of each purified oligonucleotide was phosphorylated in a 20 ul reaction mixture with 50mM Tris-Cl (pH 8.0), 10mM MgCl₂, 5mM dithiothreitol, 1 mM ATP, and 5 units of polynucleotide kinase, incubated at 37° for 30 minutes. When used as hybridization probes, gel-purified oligonucleotides were phosphorylated in a similar fashion, except on a 15 pmol scale with an excess of ³²P labeled ATP.

40

45

50

55

60

65

EP 0 328 404 A1

sequence (5'-3')

GACATCCAGATGACCCAGAGCCCAAGCAGCCTGAGCGCCAGCGTGGGT	5
GACAGAGTGACCATCACCTGTAGAGCCAGCGGTAACATCCACAACCTAC	
CTGGCTTGGTAC	
CAAGCCAGGTAGTTGTGGATGTTACCGCTGGCTCTACAGGTGAT	10
GGTCACTCTGTCACCCACGCTGGCGCTCAGGCT	
GCTTGGGCTCTGGGTCATCTGGATGCTGCA	15
CAGCAGAAGCCAGGTAAGGCTCCAAAGCTGCTGATCTACTACACCACC	
A	
CCCTGGCTGACGGTGTGCCAAGCAGATTCAGCGGTAGCGGTAGCGGTA	20
C	
CGCTACCGCTACCGCTGAATCTGCT	
TGGCACACCGTCAGCCAGGGTGGTGGTGTAGTAGATCAGC	25
AGCTTTGGAGCCTTACCTGGCTTCTGCTGGTAC	
CGACTTCACCTTACCATCAGCAGCCTCCAGCCAGAGGACATCGCCAC	30
CTACTACTGCC	
AGCACTTCTGGAGCACCCCAAGGACGTTCCGGCCAAGGGACCAAGGTGG	35
A	
AATCAAACGTGAGTAGAATTTAAACTTTGCTTCCCTCAGTTGGATCCTA	
G	
KE4 AATTCTAGGATCCAAC TGAGGAAGCAAAGTTTAAA	40
KE5 TTCTACTCACGTTTGATTTCCACCTTGGTCCCTT	
KE6 GGCCGAACGTCC TTGGGGTGCTCCAGAAGTGCTGGCAGTAGTAG	45
KE7 GTGGCGATGTCCCTG GCTGGAGGCT	
KE8 GCTGATGGTGAAGGTGAAGTCGGTAC	
PK0 TCATCTGGATGTCCGGAGTGGACACCT	50
	55
	60

4. The construction of individual blocks is described for the PK1-5 block, but KK1-5 and KE1-8 blocks were cloned as KpnI-KpnI and KpnI-EcoRI fragments respectively in a similar way. 4ul portions of each oligonucleotide PK1, PK2, PK3, PK4 and PK5, kinased as in paragraph 3, were combined and annealed at 80°C for 5 minutes, 67°C for 30 minutes, and allowed to cool to room temperature over the span of 30 minutes, 0.1ul 65

of this annealing mix was ligated with 20 ng of PstI/KpnI digested M13-mp19, in 10ul 50mM Tris-Cl (pH7.5), 10mM MgCl₂, 10mM dithiothreitol, 1 mM ATP, 120 units T4 DNA ligase (Biolabs), and incubated 12 hours at 15°C. The ligation mix was used to transfect competent E. coli strain BMH 71-18, plated with BCIG and IPTG, and a clone containing the complete PstI-KpnI insert was identified.

5 5. The three cloned blocks were excised from 10ug double-stranded replicative form of the three M13 vectors, by digestion with PstI/KpnI (block PK1-5), KpnI (block KKI-5) and KpnI/EcoRI (block KE1-8). The inserts were separated from the vector by electrophoresis on a 20 x 20 cm 12% polyacrylamide gel, eluted from the gel slices with 0.5 M NH₄OAc, 10 mM Mg (OAc)₂, 0.1 mM EDTA, 0.1% SDS, and purified by phenol extraction and ethanol precipitation. All three fragments were ligated to PstI/EcoRI cut M13- mp19. 200 white
10 plaques were transferred by toothpick to a fresh 2xTY plate, and grown as a grid of infected colonies. The plate was blotted with nitrocellulose filters, which were then treated with 0.5 M NaOH, followed by 1M Tris-Cl (pH7.5), and baked 1 hr at 80°C under vacuum. The filters were washed at 67°C in 3x Denhardt's solution, 2xSSC, 0.07% SDS, followed by 6xSSC at room temperature. Filters were then probed with the radiolabeled oligonucleotides KK3 or KK4 in 3ml of 6xSSC at 37°. Following hybridization with both oligonucleotides, positive
15 colonies were picked for DNA sequencing. A phage clone containing correctly assembled blocks was designated M13-HuVLLYS°.

6. To introduce the HuVLLYS° gene in place of the heavy chain variable domain in the vector M13-MOVHNP (described in reference 5) as MV_{NP} with HindIII site at the 3' end of the reading frame), double-stranded replicative form DNA of phages M13-HuVLLYS° and M13-MOVHNP were prepared and digested with PstI and BamHI. The insert of M13-HuVLLYS° was isolated on a polyacrylamide gel, and the vector portion of M13-MOVHNP was isolated on an agarose gel. The purified fragments were ligated and transfected into E. coli strain BMH71-18, and the resulting plaques probed with oligonucleotide KK3 to identify the insert. The clone was designated M13-HuVLLYS°.

7. In the M13-HuVLLYS° gene, to join the signal sequence of MOVHNP correctly to the 5' end of the HuVLLYS° gene (at the PstI site), single stranded DNA was prepared and altered by oligonucleotide directed mutagenesis with the primer PKO- see paragraph (3) for sequence. The mutant clone was designated M13-HuVLLYS°.

The reshaped human heavy and light chain variable domains were then assembled with constant domains in three stages as illustrated in Figure 5. In Figure 5 sequences of rat origin are marked in black, and those of human origin in white. The recombinant heavy and light chains are also marked using a systematic nomenclature.

The illustrated procedure permits a step-wise check on the reshaping of the heavy chain variable domain (stage 1), the selection of the human isotype (stage 2), and the reshaping of the light chain variable domain and assembly of human antibody (stage 3). The vector constructions were genomic, with the variable domains excised from the M13 vectors and cloned as HindIII-BamHI fragments and the constant domains as BamHI-BamHI fragments in either pSVgpt (heavy chain) (reference 15) or pSVneo (light chain) (reference 16) vectors. The heavy chain enhancer was included to the 5' side of the variable domain, and expression of both light and heavy chains was driven from heavy chain promoter and the heavy chain signal sequence.

The human gamma 1 (reference 26), gamma 2 (reference 27), gamma 3 (reference 28), gamma 4 (reference 21) and K (reference 22) constant domains, and the rat gamma 2b (reference 29) constant domains were introduced as BamHI-BamHI fragments. The following plasmids were constructed and transfected into lymphoid cell lines by electroporation (reference 30). In stage 1, the pSVgpt vectors HuVHCAMP-RalgG2B, and also two mutants for reasons to be explained below, HuVHCAMP(Ser27 to Phe)-RalgG2B, HuVHCAMP(Ser27 to Phe, Ser30 to Thr)-RalgG2B were introduced into the heavy chain loss variant of YTH34.5HL. In stage 2, the pSVgpt vectors RaVHCAMP-RalgG2B, RaVHCAMP-HulgG1, RaVHCAMP-HulgG2, RaVHCAMP-HulgG3, RaVHCAMP-HulgG4 were transfected as described above. In stage 3, the pSVgpt vector Hu(Ser27-Phe, Ser30-Thr)VHCAMP-HulgG1 was cotransfected with the pSV-neo vector HuVLCAMP-HulgK into the rat myeloma cell line Y0 (Y B2/3.0 Ag 20) (ref. 17). In each of the three stages, clones resistant to mycophenolic acid were selected and screened for antibody production by ELISA assays. Clones secreting antibody were subcloned by limiting dilution (for Y0) or the soft agar method (for the loss variant) and assayed again before 1 litre growth in roller bottles.

Heavy chain variable domain

In stage 1, the reshaped heavy chain variable domain (HuVHCAMP) was attached to constant domains of the rat isotype IgG2b and transfected into a heavy chain loss variant of the YTH34.5 hybridoma. The loss variant carries two light chains, one derived from the Y3 fusion partner (reference 17). The cloned rat heavy chain variable domain (RaVHCAMP) was also expressed as above.

Antibodies were harvested at stationary phase and concentrated by precipitation with ammonium sulphate, followed by ion exchange chromatography on a Pharmacia MonoQ column. The yields of antibody were measured by an ELISA assay directed against the rat IgG2b isotype, and each adjusted to the same concentration (reference 21).

The HuVHCAMP and RaVHCAMP antibodies - all of the rat IgG2b isotype - were compared in a direct binding assay to the Campath-1 antigen (obtained from a glycolipid extract from human spleen), and also in complement lysis of human lymphocytes. For measuring the binding to antigen, the partially purified Campath-1 antigen was coated onto microtitre wells. Bound antibody was detected via a biotin labelled anti-rat

IgG2b monoclonal antibody (reference 21), developed with a streptavidin-peroxidase conjugate (Amersham plc). Complement lysis of human lymphocytes with human serum as the complement source was as described in reference 7. For both binding and complement assays, the titres for the antibodies were determined by fitting the data to a sigmoid curve by a least squares iterative procedure (reference 7), and the concentration of antibody giving 50% maximal binding or lysis was noted.

The results are given in Table 1.

Table 1

Reshaping the heavy chain variable domain

heavy chain variable domain	Concentration of antibody in ug/ml at 50% binding or lysis	
	antigen binding	complement lysis
RaVHCAMP	0.7	2.1
HuVHCAMP	27.3	(*)
HuVHCAMP (Ser27 to Phe)	1.8	16.3
HuVHCAMP (Ser27 to Phe,Ser30 to Thr)	2.0	17.6

(*) Complement lysis with the HuVHCAMP variable domain was too weak for the estimation of lysis titre.

Compared with the original rat antibody, or the engineered equivalent, the antibody with the reshaped heavy chain domain HuVHCAMP bound poorly to the Campath-1 antigen and was weakly lytic. This suggested an error in the design of the reshaped domain.

There are several assumptions underlying the transfer of hypervariable loops from one antibody to another, and in particular that the antigen binds mainly to the hypervariable regions. These are defined as regions of sequence (reference 11) or structural (reference 18) hypervariability, and the locations of hypervariable regions are similar by either criterion, except for the first hypervariable loop of the heavy chain. By sequence the first hypervariable loop extends from residues 31 to 35 (reference 11) and by structure from residues 26 to 32 (reference 18). Residues 29 and 30 form part of the surface loop, and residue 27 which is phenylalanine or tyrosine in most sequences including YTH34.5HL, helps pack against residues 32 and 34.

By way of illustration, see Figure 6 which illustrates loop Phe27 to Tyr35 in the heavy chain variable domain of the human myeloma protein KOL which is crystallographically solved (reference 31). The backbone of the hypervariable region according to Kabat (reference 11) is highlighted, and a 200% van der Waal surface is thrown around Phe27 to show the interactions with Tyr32 and Met34 of the Kabat hypervariable region. In the rat YTH34.5HL heavy chain, these three side chains are conserved, but in HuVHCAMP, Phe27 is replaced by Ser: this is because, unlike most human heavy chains, in NEW the phenylalanine is replaced by serine, which would be unable to pack in the same way as phenylalanine. To restore the packing of the loop, a Ser(27) to Phe mutation was made in HuVHCAMP, and also a double mutation Ser(27) to Phe, Ser(30) to Thr (as mentioned above).

The two mutants showed a significant increase in binding to CAMPATH-1 antigen and lysed human lymphocytes with human complement. See the results given in Table 1. Thus the affinity of the reshaped antibody could be restored by altering the packing between the hypervariable regions and the framework by a single Ser(27) to Phe mutation. This suggests that alterations in the "Kabat" framework region can enhance the affinity of the antibody, and extends previous work in which an engineered change in the hypervariable region yielded an antibody with increased affinity (reference 19).

Heavy chain constant domains

In stage 2 (Figure 5), the rat heavy chain variable domain was attached to constant domains of the human isotypes IgG1, 2, 3, and 4, and transfected into the heavy chain loss variant of the YTH34.5 hybridoma.

Antibody was harvested from cells in stationary phase, concentrated by precipitation with ammonium sulphate and desalted into phosphate buffered saline (PBS). Antibodies bound to the Campath-1 antigen coated on microtitre plates, were assayed in ELISA directed against the rat k light chain (reference 21), and adjusted to the same concentration. The antibodies were assayed in complement lysis (as described above) and ADCC with activated human peripheral blood mononuclear cells (references 21, 32). Briefly, 5×10^4 human peripheral blood cells were labelled with ^{51}Cr and incubated for 30 minutes at room temperature with different concentrations of antibody. Excess antibody was removed and a 20 fold excess of activated cells added as

effectors. After 4 hours at 37°C death was estimated by ⁵¹Cr release.

The results are shown in Figure 7, in which the results for rat heavy chain variable domain attached to different human isotypes are represented as follows:

- 5 IgG1 empty squares
- IgG2 empty circles
- IgG3 solid squares
- IgG4 empty triangles

10

Results of lysis with the antibody YTH34.5HL are represented by solid circles.

In complement lysis (Figure 7a), the human IgG1 isotype proved similar to the YTH34.5HL-G2b, with the human IgG3 isotype less effective. The human IgG2 isotype was only weakly lytic and the IgG4 isotype non-lytic. In ADCC (Figure 7b) the human IgG1 was more lytic than the YTH34.5HL-G2b antibody. The decrease in lysis at higher concentration of the rat IgG2b and the human IgG1 antibody is due to an excess of antibody, which causes the lysis of effector cells. The human IgG3 antibody was weakly lytic, and the IgG2 and IgG4 isotypes were non-lytic.

15

The human IgG1 isotype was therefore suitable for a reshaped antibody for therapeutic use. Other recent work also suggests the IgG1 isotype as favoured for therapeutic application. When the effector functions of human isotypes were compared using a set of chimaeric antibodies with an anti-hapten variable domain, the IgG1 isotype appeared superior to the IgG3 in both complement and cell mediated lysis (reference 4). Furthermore, of two mouse chimaeric antibodies directed against cell surface antigens as tumour cell markers, with human IgG1 or IgG3 isotypes, only the IgG1 isotype mediated complement lysis (references 2, 3).

25

Light chain

In stage 3 (Figure 5), the reshaped heavy chain was completed, by attaching the reshaped HuVHCAMP (Ser27 to Phe, Ser30 to Thr) domain to the human IgG1 isotype. The reshaped light chain domain HuVHCAMP was attached to the human Ck domain. The two vectors were cotransfected into the non-secreting rat Y0 myeloma line.

30

Antibody HuVHCAMP (Ser27 to Phe, Thr30 to Ser)-HuIgG1, HuVLCAMP-HuIgK was purified from supernatants of cells in stationary phase by affinity chromatography on protein A Sepharose. The antibody was at least 95% (by wt) pure. The yield (about 10mg/l) was measured spectrophotometrically. Complement and ADCC assays were performed as described in connection with Figure 7.

35

The results are shown in Figure 8, in which the results are reshaped human antibodies are represented by squares and those for rat YTH34.5HL antibodies are represented by solid circles.

The purified antibody proved almost identical to the YTH34.5HL-G2b antibody in complement lysis (Figure 8a). In cell mediated lysis the reshaped human antibody was more reactive than the rat antibody (Figure 8b). Similar results to the ones in Figure 8b were obtained with three different donors of target and effector cells (data not shown). Furthermore the antibody was as effective as YTH34.5HL-G2b in killing leukaemic cells from three patients with B Cell lymphocytic leukaemia by complement mediated lysis with human serum.

40

The rat antibody and fully humanised antibody were compared in a direct binding assay to Campath-1 antigen. Antibody concentrations were determined as described in Figures 7 and 8. The amount of rat antibody bound to partially purified Campath-1 antigen was determined as described in connection with Table 1. The amount of human antibody bound was determined by an ELISA assay using a biotinylated sheep anti-human IgG antibody (Amersham).

45

Table 2

Reshaping the heavy and light chain variable domains simultaneously

50

antibody	Concentration of antibody in ug/ml at 50% binding antigen binding
RaVHCAMP Ra1GG2B	
RaVHCAMP RaKappa	1.01
HuVHCAMP (Ser27 to Phe, Ser30 to Thr)	
Hu1GG1	
HuVLCAMP HuKappa	1.11

55

60

65

Thus by transplanting the hypervariable regions from a rodent to a human antibody of the IgG1 subtype, the

antibody can be reshaped for therapeutic application.

The strategy illustrated in Figure 5 is stepwise assembly to allow any problems to be detected at each stage (reshaping of heavy chain variable domain, selection of constant domain and reshaping of light chain variable domain). It is quite possible to build the reshaped antibody in a single step assembly, i.e. constructing the two reshaped variable domains, attaching to appropriate constant domains and cotransfecting into e.g. YO.

5

Example 2

Patients and Methods

Antibody HuVHCAMP (Ser 27 to Phe, Thr 30 to Ser) - HuIgG1, HuVLCAMP - HuIgK, hereinafter referred to as CAMPATH-1H, was prepared as described in Example 1. The CAMPATH-1H antibodies were obtained from culture supernatant of cells growing in a hollow fibre bioreactor ('Acusyst - Jr', Endotronics) and purified by affinity chromatography on protein-A-'sepharose'. They were dissolved in phosphate-buffered saline, sterile filtered, and tested for pyrogen and sterility. Patients were prehydrated over night and antibody, diluted in 500 ml saline, was infused over 2-4 hours.

10

15

Campath-1 expression on tumour cells was measured by flow cytometry and complement-mediated lysis (references 6, 35). Serum concentrations of CAMPATH-1H were measured by immunofluorescence with normal lymphocytes. Southern blot analysis with an immunoglobulin J_H probe was used to detect residual tumour cells in DNA extracted from mononuclear fractions of bone marrow. Antigliobulin responses were sought by two techniques. The first was a solid-phase enzyme-linked assay using microtitre plates coated with CAMPATH-1H. After incubation with patients' serum samples, the assay was developed with biotin-labelled CAMPATH-1H followed by streptavidin-peroxidase. A mixture of monoclonal mouse antibodies against human IgG was used as a positive control and 500 ng/ml of this mixture would be detected. In the second assay, patients serum samples were mixed with red cells coupled with CAMPATH-1H (reference 10). Agglutination by 5 ng/ml of the control mixture would be detected. Immunoglobulin allotypes were determined by means of standard reagents and techniques from the Central Laboratory of the Netherlands Red Cross Blood Transfusion Service.

20

25

RESULTS

30

Patient 1

A 69-year-old woman presented in 1983, and grade 1, stage IVA non-Hodgkin lymphoma in leukaemic phase was diagnosed. Between 1983 and 1988 the patient received various types of treatment, including chemotherapy and radiotherapy and rat antibody to Campath-1. She was then given treatment with CAMPATH-1H.

35

The starting dose was 1 mg daily and, since it was well tolerated, the dose was increased to a maximum of 20 mg/day, though the usual was 4 mg/day owing to the small amount available. In all the patient received 126 mg over 30 days. The response was prompt; in 6 days night sweats had abated, by day 10 there was pronounced reduction in splenomegaly and recovery of blood neutrophils, and by day 18 lymphoma cells were cleared from the blood (Figure 9).

40

On day 28 a bone marrow aspirate and trephine were hypocellular but showed active myelopoiesis and erythropoiesis and no lymphoid cells (Figure 10B). No CAMPATH-1 positive cells could be detected by flow cytometry. DNA from the mononuclear marrow cells was germline when probed with an immunoglobulin J_H probe under conditions where clonal rearrangements could be detected in 0.2% of cells. Thus, it is concluded that lymphoma cells were cleared from the marrow. The spleen volume was reduced about eight-fold (Figures 11A, B), although it was still slightly larger than normal.

45

Other than fever occurring about 1 hour after the end of antibody infusions there were no adverse effects of antibody treatment until the 5th week, when severe rigors occurred after each infusion. No antiglobulin response could be detected and the rate of clearance of antibody from the serum was unchanged. For the next 3 weeks the patient continued to experience occasional fever and rigors. She was given oral cotrimoxazole because of her lymphopenia, but no infective cause of these symptoms could be found.

50

In the next 4 months lymphocytes, which appeared morphologically normal, slowly reappeared in the blood (up to $0.2 \times 10^9/l$). They did not show the characteristic rearranged immunoglobulin fragments, and both CD3-positive and CD19-positive cells were present (see Table 3). Serum immunoglobulin levels, which had been very low since presentation, have risen towards normal (Table 3). A marrow aspirate and trephine taken 50 days after the end of treatment were again hypocellular but had no lymphomatous infiltration. This marrow sample contained 4% CAMPATH-1-positive cells and showed some oligoclonal rearrangements of immunoglobulin genes. However, by day 100, lymphoma cells were again detected in the blood and the spleen size had started to increase. A second course of 12 days' therapy with CAMPATH-1H was completed with similar therapeutic benefit to the first and no adverse effects. Since the main reservoir of disease in the patient appeared to be the spleen, splenectomy was carried out at the end of this second course of treatment. At that time no tumour cells could be detected in blood or marrow. The patient is now well 37 days after the splenectomy. The lymphocyte count is low but she has normal neutrophil, platelet, and red-cell counts.

55

60

65

Patient 2

A 67-year old man presented in April 1988 with splenic pain; there was 12 cm splenomegaly, and computed tomography scan of thorax and abdomen revealed retrocrural and para-aortic lymphadenopathy, the largest node measuring 3 cm in diameter (Figure 11C). A blood count revealed 36.6×10^9 lymphocytes/ml, the majority being lymphoplasmacytoid cells which expressed surface IgG-kappa and were characterised by large cytoplasmic periodic-acid-Schiff-positive vacuoles which could be intensely stained by anti-IgG. A marrow aspirate contained 72% lymphomatous cells (Figure 10C). DNA from blood mononuclear cells showed biallelic rearrangement of immunoglobulin J_H genes but was germline with various T-cell receptor and oncogene probes. The lymphoma cells expressed the CAMPATH-1 antigen in amounts comparable with normal lymphocytes but were more resistant to complement-mediated lysis. Stage IVA grade I lymphoplasmacytoid non-Hodgkin lymphoma was diagnosed.

The patient was offered CAMPATH-1H as primary therapy and received a total of 85 mg over 43 days. This resulted in clearance of the lymphoma cells and normal lymphocytes from blood (Figure 12) and marrow (Figure 10D), resolution of splenomegaly, and improvement in the lymphadenopathy. A computed tomography scan taken 8 days after the end of antibody treatment was normal (Figure 11D). A bone marrow aspirate taken at the same time showed active haemopoiesis but no lymphoma cells, and no CAMPATH-1-positive cells could be detected by flow cytometry. DNA from the mononuclear fraction of this marrow showed only germline configuration when probed with the immunoglobulin J_H probe. By day 78 morphologically normal blood lymphocytes began to reappear and none of the vacuolated cells could be seen. The patient remains well and off therapy.

Some toxic effects of CAMPATH-1H were observed. The first dose was stopped after 3 mg had been given because of hypotension, possibly caused by tumour lysis. This problem was subsequently avoided by giving smaller doses at a slower rate and when lymphoma cells had been cleared from the blood, the dose was increased to a maximum of 8 mg over 4 h without any effect on blood pressure. Nevertheless, all doses induced fever (up to 38.5°C), and malaise for up to 36 h, but these were not severe enough to stop antibody treatment which, after the first week, was given on an outpatient basis. Treatment was stopped after 43 days because of the development of an urticarial rash after two successive antibody infusions.

Half-life of CAMPATH 1-H

The concentration of CAMPATH-1H was measured in serum samples taken before and after antibody infusions and at other times throughout treatment. In theory, a dose of 4-6 mg corresponds to about 1 ug/ml in the plasma. In fact free antibody could not be detected until day 4-6, about 5-20% after 24 hours.

Lack of Antiglobulin Response

The allotype of CAMPATH-1H is G1m(1,2,17),Km(3). Patient 1 was G1m(1,3,17),Km(3) and patient 2 was G1m(3),Km(3), so both could theoretically have made an anti-allotype response as well as a response to the hypervariable regions. However, we failed to detect any antiglobulin to CAMPATH-1H either by the solid-phase enzyme-linked assay or by the more sensitive haemagglutination assay. In addition, the rate of clearance of CAMPATH-1H did not change and free antibody could be detected for up to 8 days after the last dose had been given. It is possible that the reactions experienced at the end of the course of treatment could have been provoked by contaminating non-human proteins in the antibody preparation.

Discussion

The remissions achieved in these two patients show that it is possible to clear large numbers of tumour cells with small amounts of an unmodified monoclonal antibody. The effects in the first patient were far superior to the results of the previous chemotherapy and radiotherapy. The selective lysis of lymphoma cells with recovery of normal haemopoiesis during the course of treatment was an important advantage, which allowed treatment to be given largely on an outpatient basis. It is believed the choice of antibody-specificity and isotype is important; indeed, it may be why these tests had more success than previous efforts with other monoclonal antibodies. (References 36-38.) The CAMPATH-1 antigen seems to be a good target because it is widely distributed and abundant, and does not suffer from antigenic modulation. (References 6,35.)

EP 0 328 404 A1

TABLE 3 - PATIENT CHARACTERISTICS BEFORE AND AFTER TREATMENT WITH CAMPATH-1H

		Case 1		Case 2	
Diagnosis		Stage IVB grade I NHL in leukaemic phase		Stage IVA grade I lymphoplasmacytoid NHL	
		before	after	before	after
Spleen size	ml	4460	590	2600	440
Lymphadenopathy		nil	nil	retrocrural paraortic	nil
Bone marrow					
lymphoma cell	%	99	0	72	0
Southern blot analysis					
Ig J _H fragment		R/R	G/G	R/R	G/G
Peripheral blood					
haemoglobin	g/dl	8.7	10.6	11.2	12.0
reticulocytes	x10 ⁹ /l	31	135	nd	nd
platelets	x10 ⁹ /l	37	50	110	453
lymphocytes	x10 ⁹ /l	60	0	37	0
neutrophils	x10 ⁹ /l	0	2.0	4.6	7.3

EP 0 328 404 A1

	monocytes	x10 ⁹ /l	0	0.04	1.5	0.5
5	Lymphocyte phenotype					
	CD19	%	97	46	93	< 5
10	CD3	%	0	32	8	80
	CAMPATH-1M	%	96	nd	95	nd
15	CAMPATH-1H	%	98	nd	97	nd
	Serum immunoglobulins					
20	IgM	g/l	<0.3	1.2	<0.3	0.7
	IgA	g/l	<0.5	<0.5	<0.5	0.5
25	IgG	g/l	5.8	8.2	3.2	4.7
	Bence-Jones		nil	nil	++	nil
30						

35 The post-therapy values refer to measurements made shortly after the end of antibody therapy, except for lymphocyte phenotyping and serum Ig, which were assessed 6 weeks later. Lymphocyte phenotypes were measured by immunofluorescence and APAAP techniques. Spleen and lymph node dimensions were measured by serial CT scanning (Fig11).

45 nd = not done

50

55 References

1. Neuberger, M.S., Williams, G.T., Mitchell, E.B., Jouhal, S.S., Flanagan, J.G. & Rabbits, T.H. Nature 314,268-270 (1985).
2. Liu, A.Y., Robinson, R.R., Hellstrom, K.E., Murray, E.D. Jr., Cheng, C.P. & Hellstrom, I. Proc.natl.Acad.Sci USA 84,3439-3443 (1987).
3. Shaw, D.R., Khazaell, M.B., Sun, L.K., Ghraeyeb, J., Daddona, P.E., McKinney, S. & Lopuglio, A.F. J. Immunol. 138,4534-4538 (1987).
4. Bruggemann, M., Williams, G.T., Bindon, C., Clark, M.R., Walker, M.R., Jefferis, R., Waldmann, H. & Neuberger, M.S. J.Exp.Med. 166, 1351-1361 (1987).
5. Jones, P.T., Dear, P.H., Foote, J., Neuberger, M.S. & Winter, G. Nature 321,522-525 (1986).
6. Hale, G., Bright, S., Chumbley, G., Hoang, T., Metcalf, D., Munro, A.J. & Waldmann, H. Blood

65

- 62,873-882 (1983).
7. Hale, G., Hoang, T., Prospero, T., Watts, S.M. & Waldmann, H. *Mol.Biol.Med.* 1,305-319 (1983).
 8. Hale, G., Cobbold, S.P., Waldmann, H., Easter, G., Matejtschuk, P. & Coombs, R.R.A. *J. Immunol.Meth.* 103,59-67 (1987).
 9. Hale, G., Waldmann, H., Friend, P. & Calne, R. *Transplantation* 42,308-311 (1986). 5
 10. Hale, G., Swirsky, D.M., Hayhoe, F.G.J. & Waldmann, H. *Mol.Biol.Med.* 1,321-334 (1983).
 11. Kabat, E.A., Wu, T.T., Reid-Miller, M., Perry, H.M. & Gottesman, K.S. in *Sequences of Proteins of Immunological Interest* (US Dept. of Health and Human Services, 1987).
 12. Chothia, C., Novotny, J., Brucoleri, R. & Karplus, M. *J. Mol.Biol.* 186,651-663 (1985).
 13. Saul, F.A., Amzel, M. & Poljak, R.J. *J.Biol.Chem.* 253,585-597 (1978). 10
 14. EPP, O., Colman, P., Fehilhammer, H., Bode, W., Schiffer, M. & Huber, R. *Eur.J.Biochem.* 45,513-524 (1974).
 15. Mulligan, R.C. & Berg, P. *Proc.natl.Acad.Sci USA* 78,2072-2076 (1981).
 16. Southern, P.J. & Berg, P.J. *Mol.Appl.Genetics* 1,327-341 (1981).
 17. Galfre, G. & Milstein, C. *Meth.Enzymol.* 73,1-46 (1981). 15
 18. Chothia, C. & Lesk, A. *J.Mol.Biol.* 196,901-917 (1987).
 19. Roberts, S., Cheetham, J.C. & Rees, A.R. *Nature* 328,731-734 (1987).
 20. Jonker, M. & den Brok, J.H.A.M. *Eur.J. Immunol.* 17, 1547-1552 (1987).
 21. Clark, M. & Waldmann, H. *J.N.C.I.* 79, 1393-1398 (1987).
 22. Hieter, P.A., Max, E.E., Seidmann, J.G., Maizel, J.V.Jr & Leder, P. *Cell* 22,197-207 (1980). 20
 23. Kaartinen, M., Griffiths, G.M., Hamlyn, P.H., Markham, A.F., Karjalainen, K., Pelkonen J.L.T., Makela, O. & Milstein, C. *J. Immunol.* 130,320-324 (1983).
 24. Gubler, U. & Hoffmann, B.J. *Gene* 25,263-269 (1983).
 25. Sanger, F., Nicklen, S.A. & Coulson, A.R. *Proc.natl.Acad.Sci USA* 74,5463-5467 (1977).
 26. Takahashi, N., Ueda, N.S., Obata, M., Nikaide, T. & Honjo, T. *Cell* 29,671-679 (1982). 25
 27. Flanagan, J.G. & Rabbits, T.H. *Nature* 300,709-713 (1982).
 28. Huck, S., Fort, P., Crawford, D.H., Lefranc, M.-P. & Lefranc, G. *Nucl.Acids Res.* 14,1779-1789 (1986).
 29. Bruggemann, M., Free, J., Diamond, A., Howard, J., Cobbold, S. & Waldmann, H. *Proc.natl.Acad.Sci. USA* 83,6075-6079 (1986).
 30. Potter, H., Weir, L. & Leder, P. *Proc.natl.Acad.Sci. USA* 81,7161-7163 (1984). 30
 31. Marquardt, M., Deisenhofer, J., Huber, R. & Palm, W. *J.Mol.Biol.* 141,368-391 (1980).
 32. Hale, G., Clark, M. & Waldmann, H. *J. Immunol.* 134,3056-3061 (1985).
 33. Carter, P., Bedouelle, H. & Winter, G. *Nucleic Acids Res.* 13,4431-4443 (1985).
 34. Heiter, P., Maizel, J & Leder, P. *J. Biol. Chem.* 257, 1516-1522 (1982).
 35. Hale, G., Swirsky, D., Waldman, H., & Chan, L.C., *Br. J. Haematol.* 60, 41-48, (1985). 35
 36. Ritz, J., Schlossman, S.F., *Blood*, 59, 1-11 (1982).
 37. Levy, R., Miller R.A., *Annu. Rev. Med.*, 34, 107-116 (1983).
 38. Stevenson, G.T., Glennie, M.J., *Cancer Surv.* 4, 213-44, (1985).

Claims

1. An antibody having at least one CDR (complementarity determining region) which is foreign with respect to the constant region of the antibody, said at least one foreign CDR being selected from CDRs substantially as identified in Figure 2, that is amino acid residues 31 to 35, 50 to 65 and 95 to 102 of the heavy chain as shown in Figure 2a, and amino acid residues 24 to 34, 50 to 56 and 89 to 97 of the light chain as shown in Figure 2b, the antibody being capable of binding effectively to the antigen Campath-1. 45
2. An antibody as claimed in claim 1, having a heavy chain with at least one CDR selected from CDRs substantially as identified in Figure 2a and a light chain with at least one CDR selected from CDRs substantially as identified in Figure 2b. 50
3. An antibody as claimed in claim 1, having a heavy chain with three CDRs substantially as identified in Figure 2a or a light chain with three CDRs substantially as identified in Figure 2b.
4. An antibody having heavy and light chain CDRs which are foreign with respect to the constant region of the antibody, said CDRs being substantially as identified in Figure 2, that is residues 31 to 35, 50 to 65 and 95 to 102 of the heavy chain as shown in Figure 2a and residues 24 to 34, 50 to 56 and 89 to 97 of the light chain as shown in Figure 2b, the antibody being capable of binding effectively to the antigen Campath-1. 55
5. An antibody as claimed in any one of claims 1 to 4, wherein the CDRs are combined with variable domain framework regions of human origin.
6. An antibody having heavy and light chain variable domains as identified in the lower lines of sequence information in Figure 2, that is residues 1 to 113 of the heavy chain and residues 1 to 108 of the light chain, the CDRs and constant region of the antibody being foreign with respect to one another, the antibody being capable of binding effectively to the antigen Campath-1. 60
7. An antibody having heavy and light chain variable domains as identified in the upper lines of sequence information in Figure 2, namely residues 1 to 113 of the heavy chain and residues 1 to 108 of the 65

light chain, and that will bind effectively to the antigen Campath-1.

8. An antibody as claimed in claim 7, wherein the phenylalanine at residue 27 in the heavy chain is replaced by serine.

5 9. An antibody as claimed in claim 7 or 8, wherein the threonine at residue 30 in the heavy chain is replaced by serine.

10. An antibody as claimed in any one of the preceding claims, wherein the heavy and light chain constant domains are of human IgG1 class.

10 11. An antibody composition, for administration to patients, comprising an antibody as claimed in any one of the preceding claims in substantially biologically pure form, together with a physiologically acceptable diluent or carrier.

Claims for the following Contracting States ES,GR

15 1. A process for the preparation of an antibody having at least one CDR (complementarity determining region) which is foreign with respect to the constant region of the antibody, said at least one foreign CDR being selected from CDRs substantially as identified in Figure 2, that is amino acid residues 31 to 35, 50 to 65 and 95 to 102 of the heavy chain as shown in Figure 2a, and amino acid residues 24 to 34, 50 to 56 and 89 to 97 of the light chain as shown in Figure 2b, the antibody being capable of binding effectively to the antigen Campath-1, which process comprises culturing a cell capable of expressing the antibody in order to effect expression thereof.

2. A process as claimed in claim 1, for preparing an antibody having a heavy chain with at least one CDR selected from CDRs substantially as identified in Figure 2a and a light chain with at least one CDR selected from CDRs substantially as identified in Figure 2b.

25 3. A process as claimed in claim 1, for preparing an antibody having a heavy chain with three CDRs substantially as identified in Figure 2a or a light chain with three CDRs substantially as identified in Figure 2b.

30 4. A process for the preparation of an antibody having heavy and light chain CDRs which are foreign with respect to the constant region of the antibody, said CDRs being substantially as identified in Figure 2, that is residues 31 to 35, 50 to 65 and 95 to 102 of the heavy chain as shown in Figure 2a and residues 24 to 34, 50 to 56 and 89 to 97 of the light chain as shown in Figure 2b, the antibody being capable of binding effectively to the antigen Campath-1, which process comprises culturing a cell capable of expressing the antibody in order to effect expression thereof.

5. A process as claimed in any one of claims 1 to 4, for preparing an antibody wherein the CDRs are combined with variable domain framework regions of human origin.

35 6. A process for the preparation of an antibody having heavy and light chain variable domains as identified in the lower lines of sequence information in Figure 2, that is residues 1 to 113 of the heavy chain and residues 1 to 108 of the light chain, the CDRs and constant region of the antibody being foreign with respect to one another, the antibody being capable of binding effectively to the antigen Campath-1, which process comprises culturing a cell capable of expressing the antibody in order to effect expression thereof.

40 7. A process for the preparation of an antibody having heavy and light chain variable domains as identified in the upper lines of sequence information in Figure 2, namely residues 1 to 113 of the heavy chain and residues 1 to 108 of the light chain, and that will bind effectively to the antigen Campath-1, which process comprises culturing a cell capable of expressing the antibody in order to effect expression thereof.

45 8. A process as claimed in claim 7, for preparing an antibody wherein the phenylalanine at residue 27 in the heavy chain is replaced by serine.

9. A process as claimed in claim 7 or 8, for preparing an antibody wherein the threonine at residue 30 in the heavy chain is replaced by serine.

50 10. A process as claimed in any one of the preceding claims, for preparing an antibody wherein the heavy and light chain constant domains are of human IgG1 class.

55 11. A process for the preparation of an antibody composition, for administration to patients, comprising mixing an antibody prepared by the process as claimed in any one of the preceding claims in substantially biologically pure form with a physiologically acceptable diluent or carrier.

55

60

65

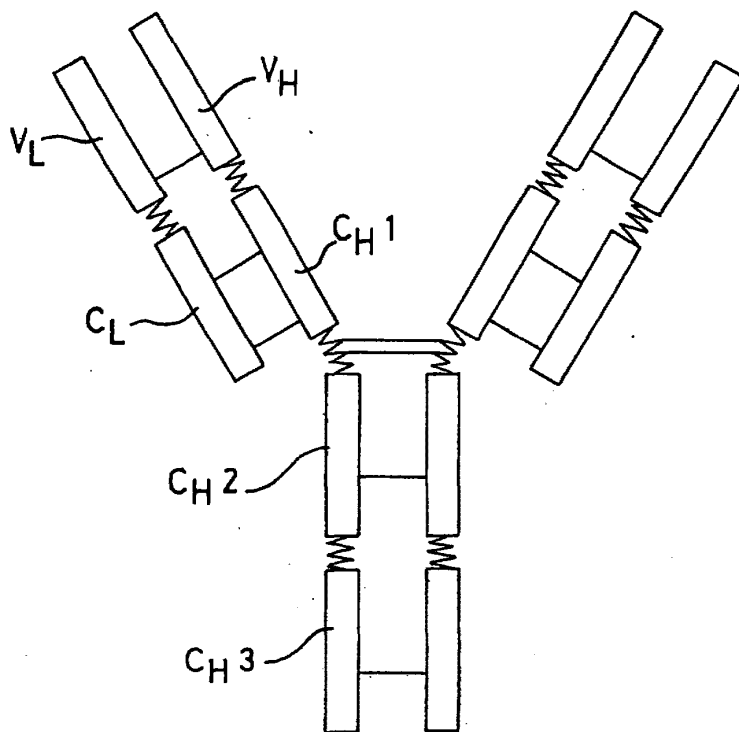

- ▭ = DOMAINS
- ∩ = INTER-DOMAIN SECTIONS
- = DISULPHIDE BOND
- V = VARIABLE
- C = CONSTANT
- L = LIGHT CHAIN
- H = HEAVY CHAIN

Fig.1

HindIII
 5'... ATGCAATCCTCTGAATCTACATGGTAAATATAGGTTTGTCTATACC
 RNA starts RNA starts
 ACAAACAGAAAACATGAGATCACAGTTCTCTACAGTTACTGAGCACACAGGACCTCA +60
 signal Splice
 (M G W S C I I L F L U A T A T)
 CCATGGGATGGAGCTGTATCATCCTCTTCTTGGTAGCAACAGCTACAGGTAAGGGGCTCA +120
 ATGAAGTTGTGGCTGAACTGGATTTTCTTTTAAACACTTTTAAAT
 (M K L W L N W I F L L T L L N)
 CAGTAGCAGGCTTGAGGCTGGACATATATATGGGTGACATGACATCCACTTTGCCTTT +180
 Splice oligos III, IV, VII
 signal 1 5 10
 (G U H S) Q U Q L Q E S G P G L U R
 CTCTCCACAGGTGCTCCACTCCCAGGTCCAACTGCAGGAGCGGTCCAGGCTTGTGAGA +240
 GGTATCCAGTGTGAGGTGAACTGTTGGARTCTGGAGGAGGCTTGGTACAG
 (G I Q C) E V K L L E S G G G L U O
 oligo XIII oligo X
 15 20 25 30 CDR 1
 P S Q T L S L T C T U S G S* T F S* (D F Y)
 CCTAGCCAGACCCCTGAGCCTGACCTGCACCGTGTCTGGCAGCACCTTCAGCGATTTCTAC +300
 CCGGGGGGTTCTATGAGACTCTCCTGTGCAGGTTCTGGATTACCTTCACTGATTTCTAC
 P G G S M R L S C A G S G F T F T (D F Y)
 35 oligo IX 40 45 50 52 a
 (M N) W U R Q P P G R G L E W I G (F I R D)
 ATGAACTGGGTGAGACAGCCACCTGGACGAGGTCTTGAGTGGATTGGATTTATTAGAGAC +360
 ATGAACTGGGTGAGACAGCCACCTGGACGAGGTCTTGAGTGGATTGGATTTATTAGAGAC
 (M N) W I R Q P A G K A P E W L G (F I R D)
 oligo XI
 b c 53 55 CDR 2 60 65 70
 (K A K G Y T T E Y N P S U K G) R U T M L
 AAGCTAAGGTTACACAACAGAGTACAATCCATCTGTGAGGGGAGGTGACAAATGCTG +420
 AAGCTAAGGTTACACAACAGAGTACAATCCATCTGTGAGGGGCGGTTACCAATCTCC
 (K A K G Y T T E Y N P S U K G) R F T I S
 75 80 82 a b c 83 85
 U D T S K N Q F S L R L S S U T A A D T
 GTAGACACAGCAAGAACAGTTCAGCCTGAGACTCAGCAGCGTGACAGCCGCCGACACC +480
 AGAGATAATACCCAAACATGCTCTATCTTCAATGAACACCCTAAGAGCTGAGGACACT
 R D N T Q N M L Y L Q M N T L R A E D T
 oligo XII
 90 CDR 3 100 a b 101 105
 A U Y Y C A R (E G H T A A P F D Y) W G Q
 GCGGTCTATTATTGTGCAAGAGAGGGCCACACTGCTGCTCCTTTTGTATTACTGGGGTCAA +540
 GCCACTTACTACTGTGCAAGAGAGGGCCACACTGCTGCTCCTTTTGTATTACTGGGGCCAA
 A T Y Y C A R (E G H T A A P F D Y) W G Q
 oligos V, VI, VII
 110 113 Splice
 G S L U T U S S
 GGCAGCCTCGTCACAGTCTCCTCAGGT..... BamHI
 GGAGTCATGGTCACAGTCTCCTCA3' +600
 G U H V T U S S

Oligonucleotides: I: 5'-GGC CAG TGG ATA GAC-3', III: 5'-CAG TTT CAT CTA
 GAA CTG GAT A-3', IV: 5'-GCA GTT GGG TCT AGA AGT GGA CAC C-3',
 V: 5'-TCA GCT GAG TCG ACT GTG AC-3', VI: 5'-TCA CCT GAG TCG ACT GTG
 AC-3', VII: 5'-AGT TTC ACC TCG GAG TGG ACA CCT-3', VIII: 5'-TCA CCT GAG
 GAG ACT GTG AC-3', IX: 5'-GGC TGG CGA ATC CAG TT-3', X: 5'-CTG TCT CAC
 CCA GTT CAT GTA GAA ATC GCT GAA GGT GCT-3', XI: 5'-CAT TGT CAC TCT
 CCC CTT CAC AGA TGG ATT GTA CTC TGT TGT GTA ACC TTT AGC TTT GTC
 TCT AAT AAA TCC AAT CCA CTC-3', XII: 5'-GCC TTG ACC CCA GTA ATC AAA
 AGG AGC AGC AGT GTG GCC CTC TCT TGC ACA ATA-3', XIII: 5'-AGA AAT
 CCG/C TGA AGG TGA AGC CAG ACA C-3'.

Fig.
2a

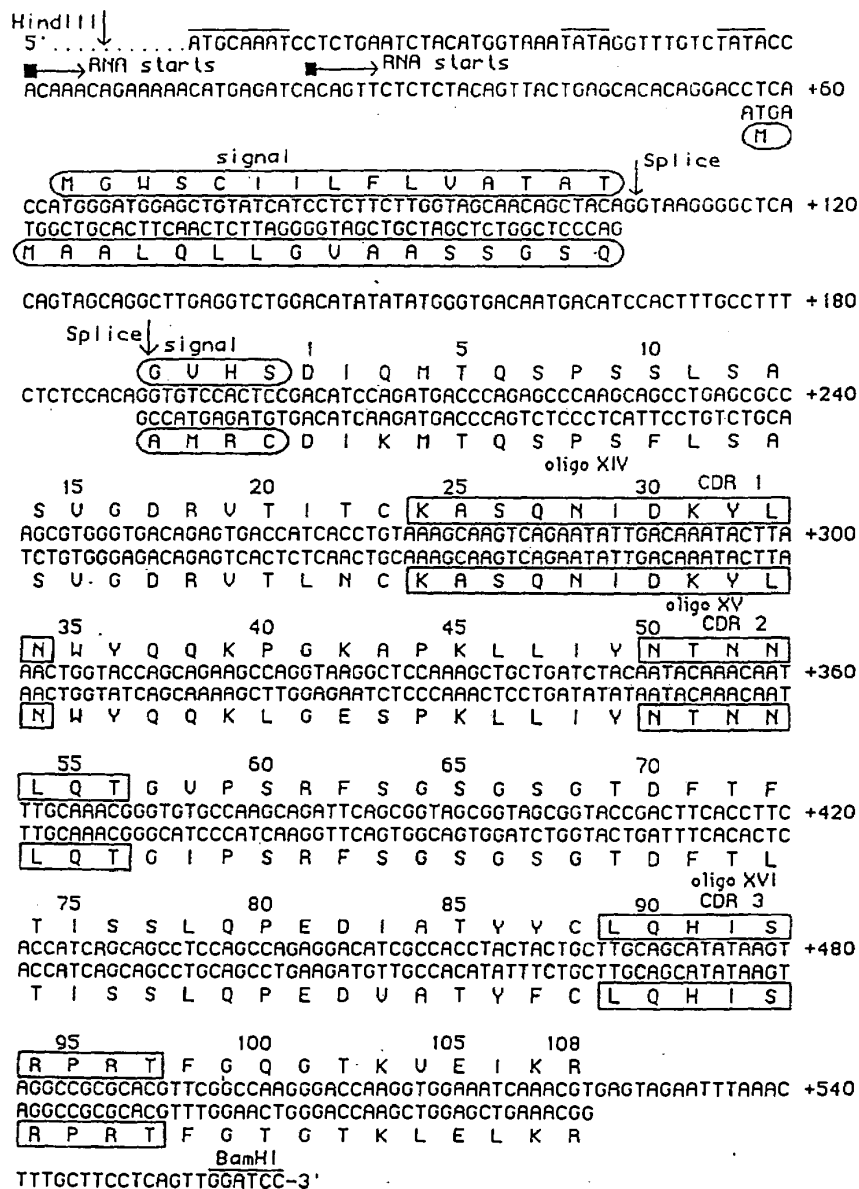

Oligonucleotides: II: 5'-TGC AGC ATC AGC C-3', XIV: 5'-CTG CTG GTA CCA
 GTT TAA GTA TTT GTC AAT ATT CTG ACT TGC TTT ACA GGT GAT GGT-3',
 XV: 5'-GCT TGG CAC ACC CGT TTG CAA ATT GTT TGT ATT GTA GAT CAG
 CAG-3', XVI: 5'-CCC TTG GCC GAA CGT GCG CGG CCT ACT TAT ATG CTG CAA
 GCA GTA GTA GGT-3'.

Fig. 2b

Sequence of the synthetic gene HUVLLYSO

D I Q M T Q S P S S L S A S V G D R V
 CTGCA GACATCCAGATGACCCAGAGCCCAAGCAGCCTGAGCGCCAGCGTGGSTGACAGAG
 GACGT CTGTAGGTCTACTGGGTCTCGGGTTCGTGGACTCGCGSTCGCACCCACTGTCTC
 10 20 30 40 50 60

T I T C R A S G N I H N Y L A W Y Q Q K
 TGACCATCACCTGTAGAGCCAGCGGTAACATCCACAACCTACCTGGCTTGGTACCAGCAGA
 ACTGGTAGTGGACATCTCGGTGCGCATTGTAGGTGTTGATGGACCGAACCATGGTCGTCT
 70 80 90 100 110 120

P G K A P K L L I Y Y T T T L A D G V P
 AGCCAGGTAAGGCTCCAAAGCTGCTGATCTACTACACCACCACCCTGGCTGACGGTGTGC
 TCGGTCCATTCCGAGGTTTCGACGACTAGATGATGTGGTGGTGGGACCGACTGCCACAGG
 130 140 150 160 170 180

S R F S G S G S G T D F T F T I S S L Q
 CAAGCAGATTCAGCGGTAGCGGTAGCGGTACCGACTTCACCTTCACCATCAGCAGCCTCC
 GTTCGTCTAAGTCGCCATCGCCATCGCCATGGCTGAAGTGGAAAGTGGTAGTCGTGGGAGG
 190 200 210 220 230 240

P E D I A T Y Y C Q H F W S T P R T F G
 AGCCAGAGGACATCGCCACCTACTACTGCCAGCACTTCTGGAGCACCCCAAGGACGTTCCG
 TCGGTCTCCGTAGCGGTGGATGATGACGGTCGTGAAGACCTCGTGGGGTTCTGCAAGC
 250 260 270 280 290 300

Q G T K V E I K R
 GCCAAGGGACCAAGGTGGAAATCAAACGTGAGTAGAATTTAACTTTGCTTCTCAGTTG
 CGGTTCCCTGGTCCACCTTTAGTTTGCACCTCATCTTAAATTTGAAACBAAGGAGTCAAC
 310 320 330 340 350 360

GATCCTAGAATC
 CTAGGATCTTAAG
 370

Fig. 3

ATGCAAATCCTCTGAAT

CTACATGGTAAATATAGGTTTGTCTATAACCACAAACAGAAAACATGAGATCACAGTTCT

M G W S C I I L F
 CTCTACAGTTACTGAGCACACAGGACCTCACCATGGGATGGAGCTGTATCATCCTCTTCT

L V A T A T
 TGGTAGCAACAGCTACAGGTAAGGGGCTCACAGTAGCAGGCTTGAGGTCTGGACATATAT

G V H S D I Q
 ATGGGTGACAAATGACATCCACTTTGCCTTTTCTCTCCACAGGTGTCCACTCCGACATCCAG

5 10 15 20
 M T Q S P S S L S A S V G D R V T I T C
 ATGACCCAGAGCCCAAGCAGCCTGAGCGCCAGCGTGGGTGACAGAGTGACCATCACCTGT

25 30 35 40
 R A S G N I H N Y L A W Y Q Q K P G K A
 AGAGCCAGCGGTAAACATCCACAACACTACCTGGCTTGGTACCAGCAGAAGCCAGGTAAGGCT

45 50 55 60
 P K L L I Y Y T T T L A D G V P S R F S
 CCAAAGCTGCTGATCTACTACACCACCACCCTGGCTGACGGTGTGCCAAGCAGATTACG

65 70 75 80
 G S G S G T D F T F T I S S L Q P E D I
 GGTAGCGGTAGCGGTACCGACTTCAOCTTCACCATCAGCAGCCTCCAGCCAGAGGACATC

85 90 95 100
 A T Y Y C Q H F W S T P R T F G Q G T K
 GCCACCTACTACTGCCAGCACTTCTGGAGCACCCCAAGGACGTTCCGCCAAGGGACCAAG

105 108
 V E I K R
 GTGGAAATCAAACGTGAGTAGAATTTAACTTTGCTTCTCAGTTGGATCCTAGAATTC

Fig. 4

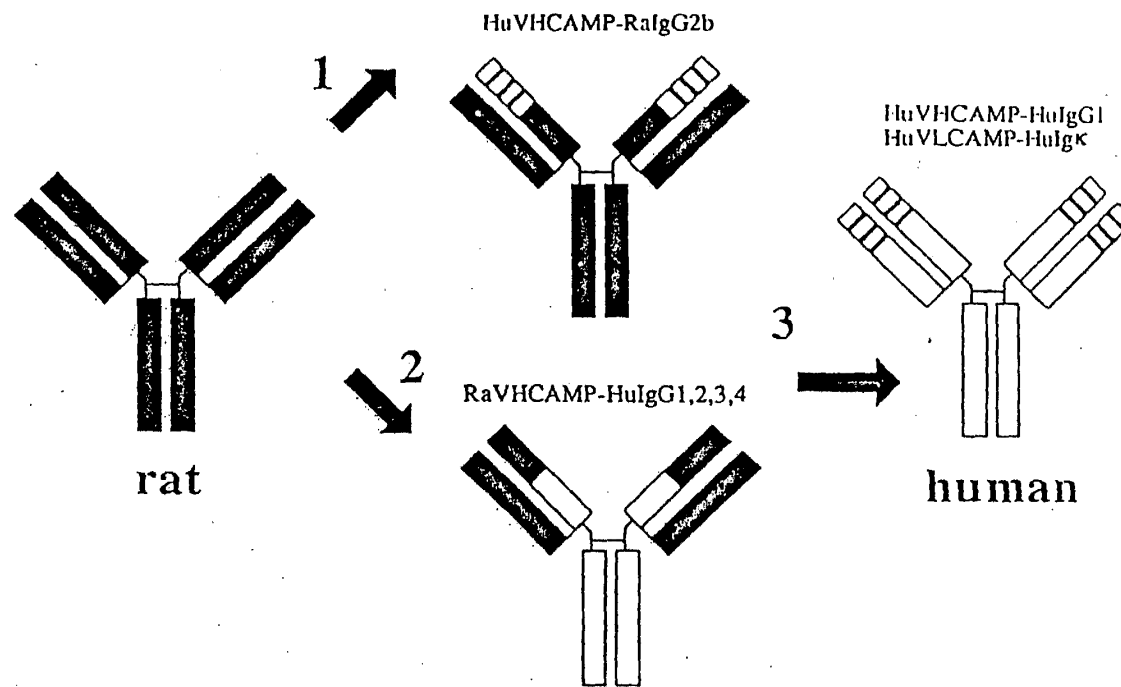

Fig. 5

EP 0 328 404 A1

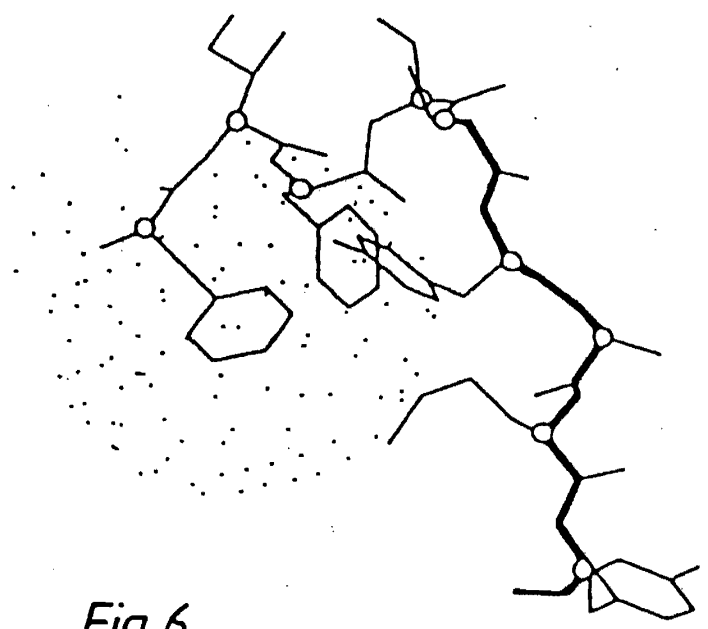
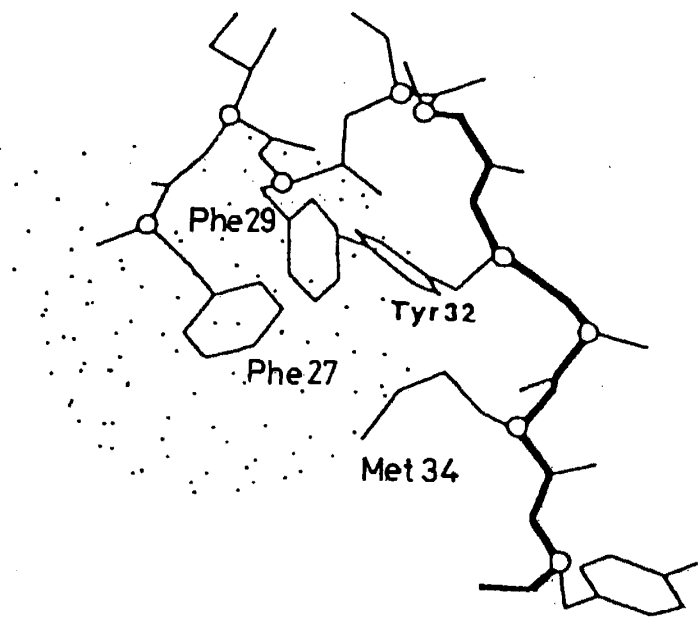
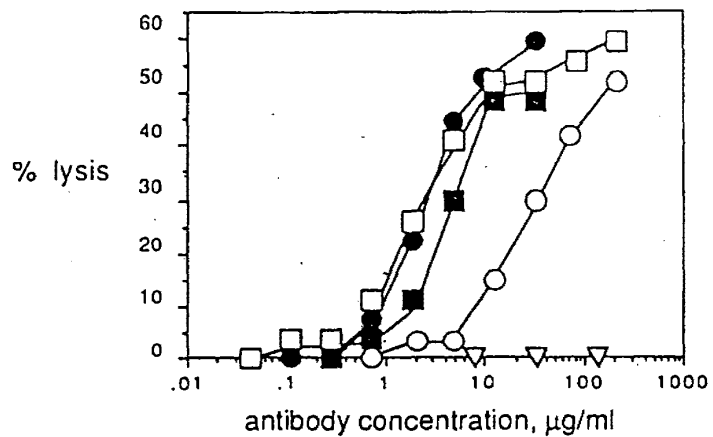
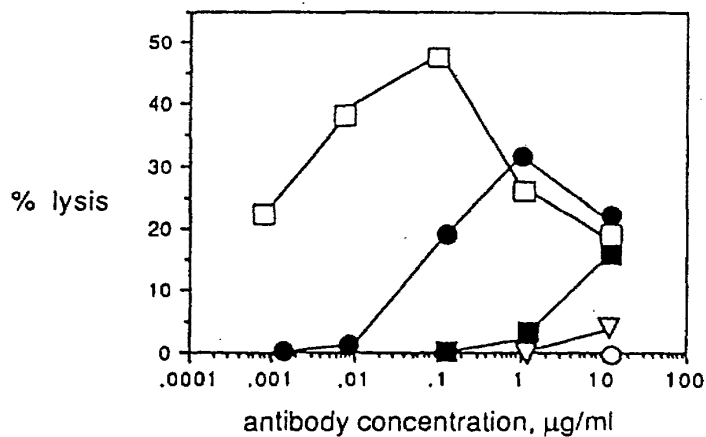

Fig.6

EP 0 328 404 A1



a.)



b.)

Fig. 7

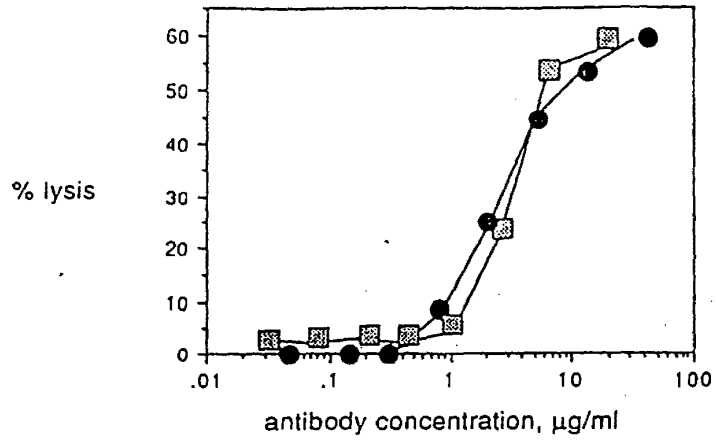

a.)

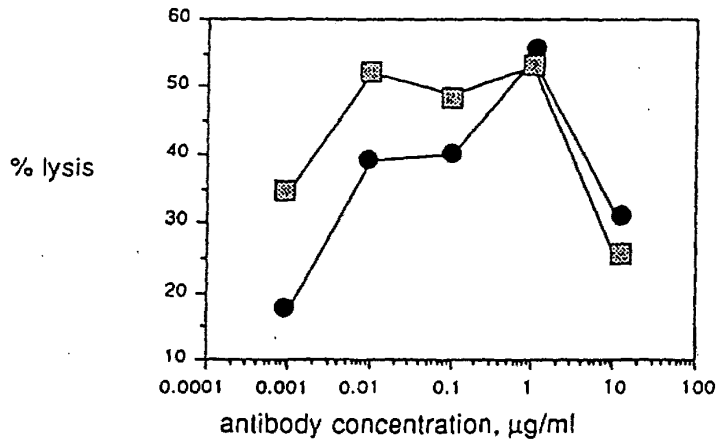

b.)

Fig. 8

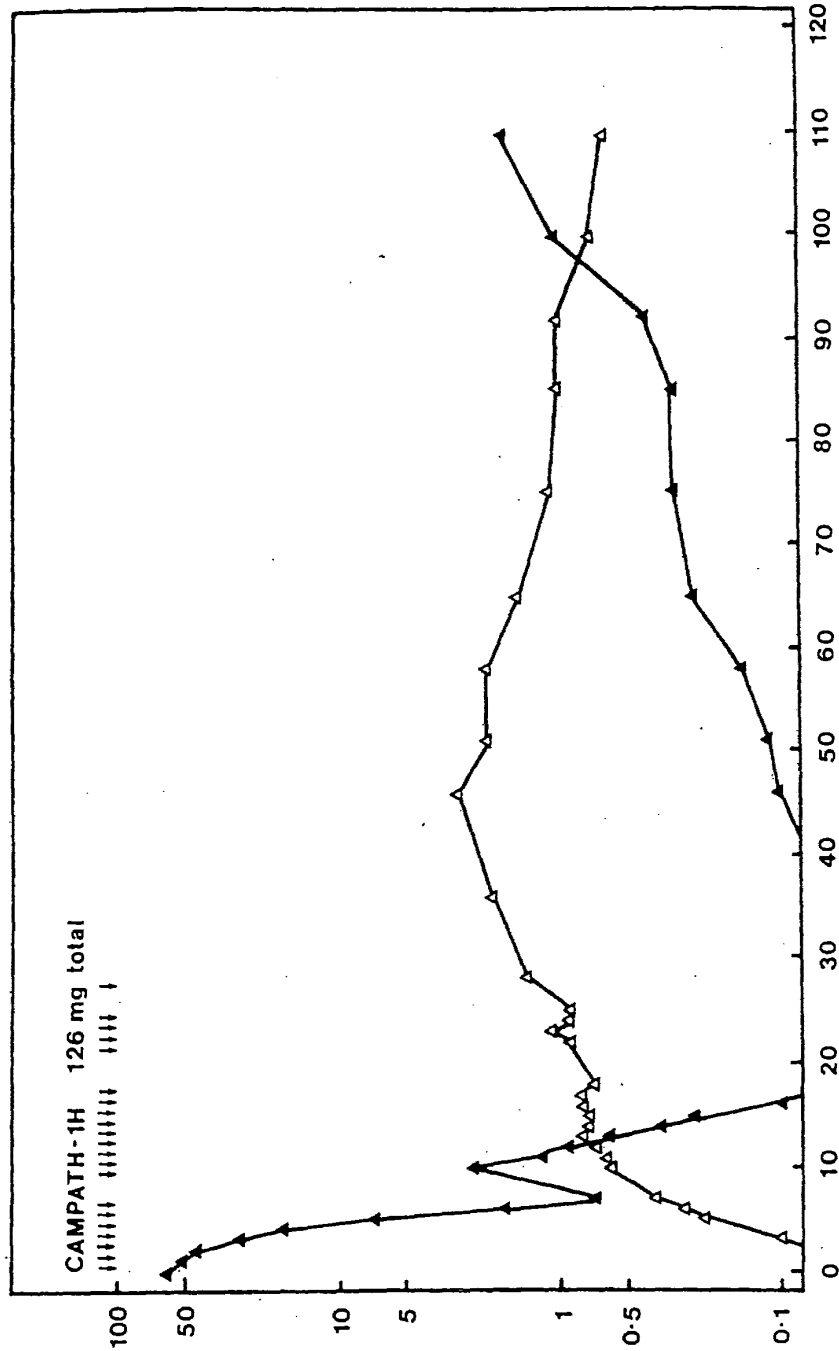

Fig. 9

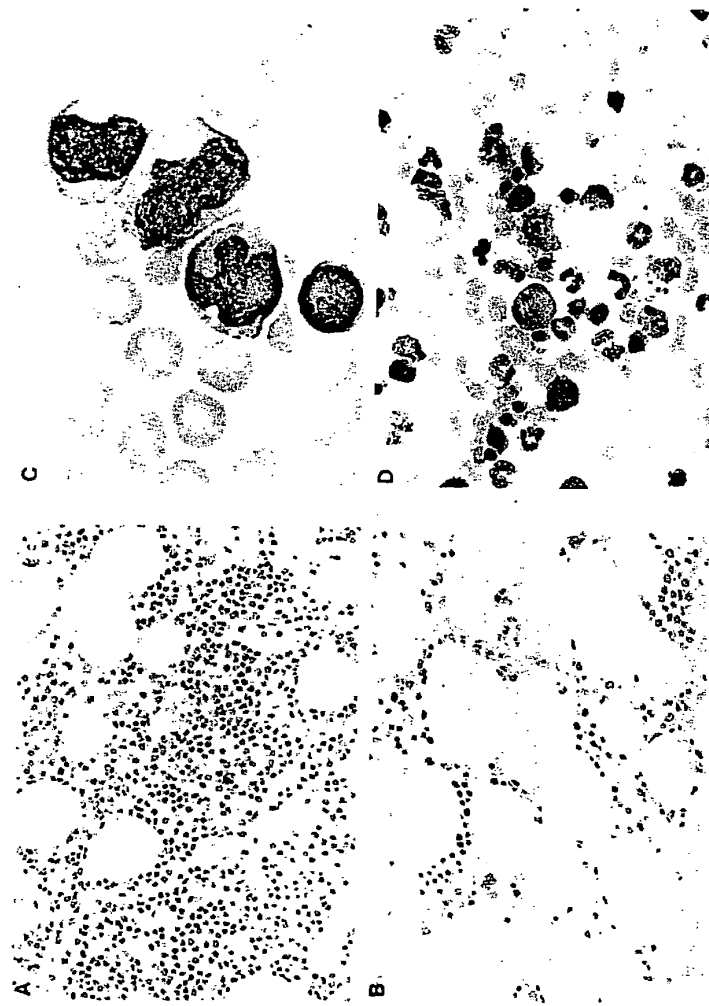

Fig. 10

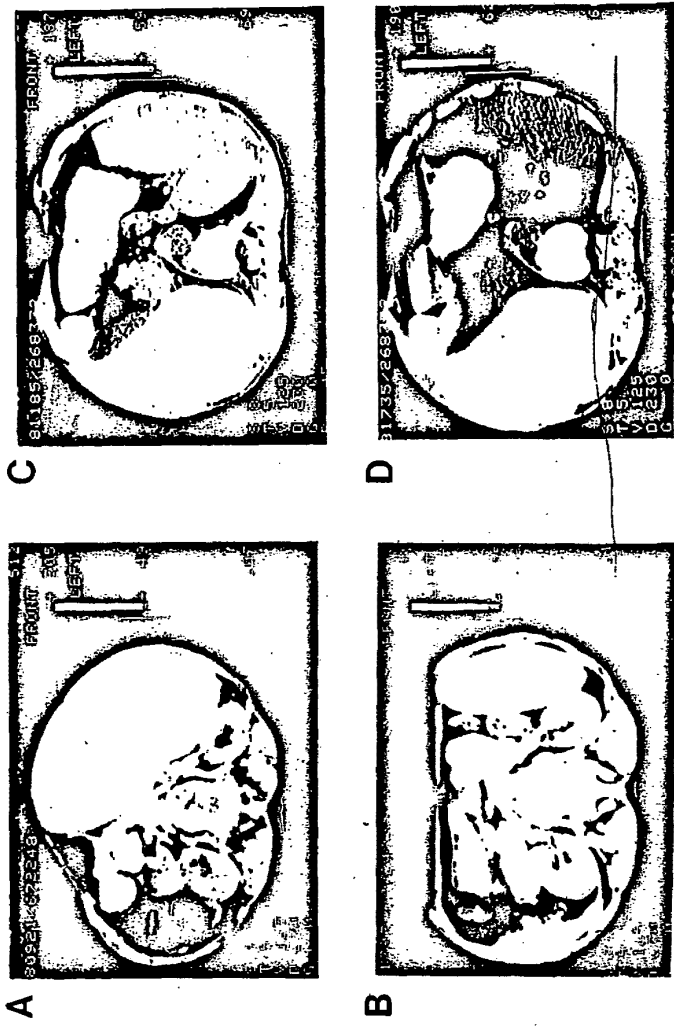

Fig.11

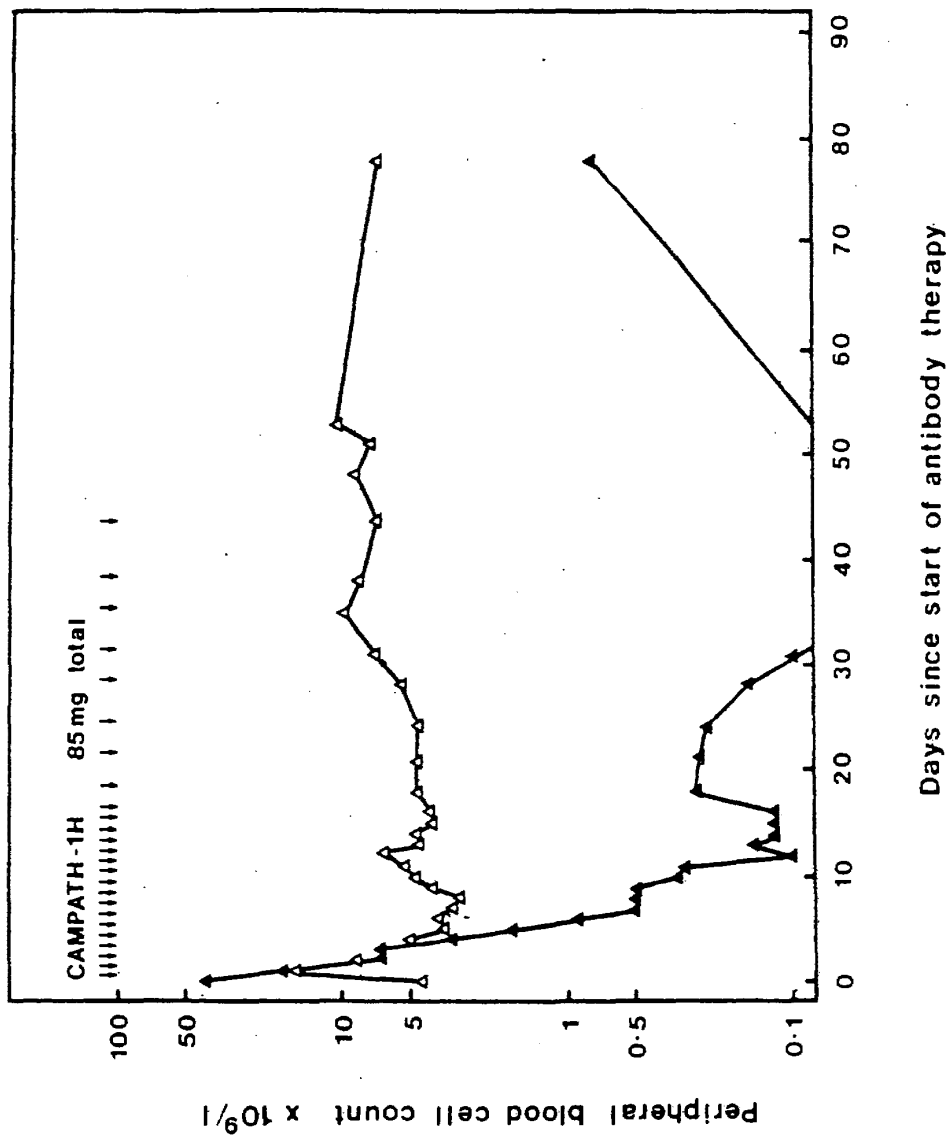

Fig.12



DOCUMENTS CONSIDERED TO BE RELEVANT					
Category	Citation of document with indication, where appropriate, of relevant passages	Relevant to claim	CLASSIFICATION OF THE APPLICATION (Int. Cl.4)		
X	EP-A-0 239 400 (G.P. WINTER) * Whole document, especially page 30, last paragraph * ---	1-11	A 61 K 39/395 C 12 N 15/00		
Y,D	JOURNAL OF IMMUNOLOGICAL METHODS, vol. 103, 1987, pages 59-67, Elsevier Science Publishers B.V. (Biomedical Division); G. HALE et al.: "Isolation of low-frequency class-switch variants from rat hybrid myelomas" * Whole article * ---	1-11			
Y,D	NATURE, vol. 321, 29th May 1986, pages 522-525; P.T. JONES et al.: "Replacing the complementarity-determining regions in a human antibody with those from a mouse" * Whole article * ---	1-11			
X,P	NATURE, vol. 332, 24th March 1988, pages 323-327; L. RIECHMANN et al.: "Reshaping human antibodies for therapy" * Whole article * -----	1-11	TECHNICAL FIELDS SEARCHED (Int. Cl.4) C 12 N C 12 P		
The present search report has been drawn up for all claims					
Place of search THE HAGUE		Date of completion of the search 11-05-1989	Examiner CUPIDO M.		
<p style="text-align: center;">CATEGORY OF CITED DOCUMENTS</p> <table style="width: 100%; border: none;"> <tr> <td style="width: 50%; border: none; vertical-align: top;"> <p>X : particularly relevant if taken alone Y : particularly relevant if combined with another document of the same category A : technological background O : non-written disclosure P : intermediate document</p> </td> <td style="width: 50%; border: none; vertical-align: top;"> <p>T : theory or principle underlying the invention E : earlier patent document, but published on, or after the filing date D : document cited in the application L : document cited for other reasons & : member of the same patent family, corresponding document</p> </td> </tr> </table>				<p>X : particularly relevant if taken alone Y : particularly relevant if combined with another document of the same category A : technological background O : non-written disclosure P : intermediate document</p>	<p>T : theory or principle underlying the invention E : earlier patent document, but published on, or after the filing date D : document cited in the application L : document cited for other reasons & : member of the same patent family, corresponding document</p>
<p>X : particularly relevant if taken alone Y : particularly relevant if combined with another document of the same category A : technological background O : non-written disclosure P : intermediate document</p>	<p>T : theory or principle underlying the invention E : earlier patent document, but published on, or after the filing date D : document cited in the application L : document cited for other reasons & : member of the same patent family, corresponding document</p>				

EPO FORM 1503 (03-82) (P0401)



(12) **EUROPEAN PATENT SPECIFICATION**

- (45) Date of publication and mention of the grant of the patent: **24.01.1996 Bulletin 1996/04**
- (21) Application number: **90903576.8**
- (22) Date of filing: **28.12.1989**
- (51) Int Cl.⁶: **C12P 21/08, A61K 39/395, C12N 15/13**
- (86) International application number: **PCT/US89/05857**
- (87) International publication number: **WO 90/07861 (26.07.1990 Gazette 1990/17)**

(54) **HUMANIZED IMMUNOGLOBULINS AND THEIR PRODUCTION AND USE**
HUMANISIERTE IMMUNGLOBULINE, DEREN HERSTELLUNG UND VERWENDUNG
IMMUNOGLOBULINES HUMANISES, LEURS PRODUCTION ET UTILIZATION

<p>(84) Designated Contracting States: AT BE CH DE ES FR GB IT LI LU NL SE</p> <p>(30) Priority: 28.12.1988 US 290975 13.02.1989 US 310252</p> <p>(43) Date of publication of application: 16.10.1991 Bulletin 1991/42</p> <p>(60) Divisional application: 95105609.2</p> <p>(73) Proprietor: PROTEIN DESIGN LABS, INC. Mountain View, CA 94043 (US)</p> <p>(72) Inventors: • QUEEN, Cary L. Los Altos, CA 94022 (US) • SELICK, Harold Edwin Belmont, CA 94002 (US)</p> <p>(74) Representative: Bizley, Richard Edward et al Epping, Essex CM16 5DQ (GB)</p>	<p>(56) References cited:</p> <table><tr><td>EP-A- 0 239 400</td><td>WO-A-89/01783</td></tr><tr><td>WO-A-89/09622</td><td>GB-A- 2 188 941</td></tr><tr><td>US-A- 4 816 567</td><td></td></tr></table> <ul style="list-style-type: none">• PROCEEDINGS OF THE NATL. ACADEMY OF SCIENCES USA, vol. 86, December 1989, Washington, DC (US); C. QUEEN et al., pp. 10029-10033/• SCIENCE, vol. 238, 20 November 1987; VITETTA et al., pp. 1098-1104/• SCIENCE, vol. 229, 20 September 1985; MORRISON, pp. 1202-1207/• SCIENCE, vol. 232, 09 May 1986; WALDMANN, pp. 727-732/• JOURNAL OF IMMUNOLOGY, vol. 126, no. 4, 04 April 1981; UCHIYAMA/• SCIENCE, vol. 239, 25 March 1988; VERHOEYEN et al., pp. 1534-1536/• NATURE, vol. 321, 29 May 1986; JONES et al., pp. 522-525/• NATURE, vol. 332, 24 March 1988; RIECHMANN et al., pp. 323-326/ <p>Remarks: The file contains technical information submitted after the application was filed and not included in this specification</p>	EP-A- 0 239 400	WO-A-89/01783	WO-A-89/09622	GB-A- 2 188 941	US-A- 4 816 567	
EP-A- 0 239 400	WO-A-89/01783						
WO-A-89/09622	GB-A- 2 188 941						
US-A- 4 816 567							

EP 0 451 216 B1

Note: Within nine months from the publication of the mention of the grant of the European patent, any person may give notice to the European Patent Office of opposition to the European patent granted. Notice of opposition shall be filed in a written reasoned statement. It shall not be deemed to have been filed until the opposition fee has been paid. (Art. 99(1) European Patent Convention).

DescriptionField of the Invention

5 The present invention relates generally to the combination of recombinant DNA and monoclonal antibody technologies for developing novel therapeutic agents and, more particularly, to the production of non-immunogenic antibodies and their uses.

Background of the Invention

10

In mammals, the immune response is mediated by two types of cells that interact specifically with foreign material, i.e., antigens. One of these cell types, B-cells, are responsible for the production of antibodies. The second cell class, T-cells, include a wide variety of cellular subsets controlling the in vivo function of both B-cells and a wide variety of other hematopoietic cells, including T-cells.

15

One way in which T-cells exert this control is through the production of a lymphokine known as interleukin-2 (IL-2), originally named T-cell growth factor. IL-2's prime function appears to be the stimulation and maintenance of T-cells. Indeed, some immunologists believe that IL-2 may be at the center of the entire immune response (see, Farrar, J., et al., Immunol. Rev. 63:129-166 (1982)).

20

To exert its biological effects, IL-2 interacts with a specific high-affinity membrane receptor (Greene, W., et al., Progress in Hematology XIV, Brown, Ed., Grune and Statton, New York (1986), at pgs. 283 ff). The human IL-2 receptor is a complex multichain glycoprotein, with one chain, known as the Tac peptide, being about 55kD in size (see, Leonard, W., et al., J. Biol. Chem. 260:1872 (1985), which is incorporated herein by reference). A gene encoding this protein has been isolated, and predicts a 272 amino acid peptide, including a 21 amino acid signal peptide (see, Leonard, W., et al., Nature 311: 626 (1984)). The 219 NH₂-terminal amino acids of the p55 Tac protein apparently comprise an extracellular domain (see, Leonard, W., et al., Science, 230:633-639 (1985)).

25

Much of the elucidation of the human IL-2 receptor's structure and function is due to the development of specifically reactive monoclonal antibodies. In particular, one mouse monoclonal antibody, known as anti-Tac (Uchiyama, et al., J. Immunol. 126:1393 (1981)) has shown that IL-2 receptors can be detected on T-cells, but also on cells of the monocyte-macrophage family, Kupffer cells of the liver, Langerhans' cells of the skin and, of course, activated T-cells. Importantly, resting T-cells, B-cells or circulating macrophages typically do not display the IL-2 receptor (Herrmann, et al., J. Exp. Med. 162:1111 (1985)).

30

The anti-Tac monoclonal antibody has also been used to define lymphocyte functions that require IL-2 interaction, and has been shown to inhibit various T-cell functions, including the generation of cytotoxic and suppressor T lymphocytes in cell culture. Also, based on studies with anti-Tac and other antibodies, a variety of disorders are now associated with improper IL-2 receptor expression by T-cells, in particular adult T-cell leukemia.

35

More recently, the IL-2 receptor has been shown to be an ideal target for novel therapeutic approaches to T-cell mediated diseases. It has been proposed that IL-2 receptor specific antibodies, such as the anti-Tac monoclonal antibody, can be used either alone or as an immunoconjugate (e.g., with Ricin A, isotopes and the like) to effectively remove cells bearing the IL-2 receptor. These agents can, for example, theoretically eliminate IL-2 receptor-expressing leukemic cells, certain B-cells, or activated T-cells involved in a disease state, yet allow the retention of mature normal T-cells and their precursors to ensure the capability of mounting a normal T-cell immune response as needed. In general, most other T-cell specific agents can destroy essentially all peripheral T-cells, which limits the agents' therapeutic efficacy. Overall, the use of appropriate monoclonal antibodies specific for the IL-2 receptor may have therapeutic utility in autoimmune diseases, organ transplantation and any unwanted response by activated T-cells. Indeed, clinical trials have been initiated using, e.g., anti-Tac antibodies (see, generally, Waldman, T., et al., Cancer Res. 45:625 (1985) and Waldman, T., Science 232:727-732 (1986)).

45

Unfortunately, the use of the anti-Tac and other non-human monoclonal antibodies have certain drawbacks, particularly in repeated therapeutic regimens as explained below. Mouse monoclonal antibodies, for example, do not fix human complement well, and lack other important immunoglobulin functional characteristics when used in humans.

50

Perhaps more importantly, anti-Tac and other non-human monoclonal antibodies contain substantial stretches of amino acid sequences that will be immunogenic when injected into a human patient. Numerous studies have shown that, after injection of a foreign antibody, the immune response elicited by a patient against an antibody can be quite strong, essentially eliminating the antibody's therapeutic utility after an initial treatment. Moreover, as increasing numbers of different mouse or other antigenic (to humans) monoclonal antibodies can be expected to be developed to treat various diseases, after the first and second treatments with any different non-human antibodies, subsequent treatments even for unrelated therapies can be ineffective or even dangerous in themselves.

55

While the production of so-called "chimeric antibodies" (e.g., mouse variable regions joined to human constant regions) (see, for example, W089/09622) has proven somewhat successful, a significant immunogenicity problem re-

mains. In general, the production of human immunoglobulins reactive with the human IL-2 receptor, as with many human antigens, has been extremely difficult using typical human monoclonal antibody production techniques. Similarly, past attempts utilizing recombinant DNA technology to produce so-called "humanized" antibodies (see e.g. EPO Publication No. 0239400), provides uncertain results, in part due to unpredictable binding affinities.

5 Thus, there is a need for improved forms of human-like immunoglobulins, such as those specific for the human IL-2 receptor, that are substantially non-immunogenic in humans, yet easily and economically produced in a manner suitable for therapeutic formulation and other uses. The present invention fulfills these and other needs. The hypervariable regions (also called Complementarity Determining Regions, abbreviated to "CDRs") of immunoglobulins were originally defined by Kabat et al., ("Sequences of Proteins of Immunological Interest" Kabat, E., et al., U.S. Department of Health and Human Services, (1983)) based on extent of sequence variability, to consist of residues 24-34 (L1), 50-56 (L2) and 89-97 (L3) in the light chain variable domain (V_L) and 31-35 (H1), 50-65 (H2) and 95-102 (H3) in the heavy chain variable domain (V_H), using Kabat's standard numbering system for antibody amino acids. The CDRs are believed to contact the target antigen of an antibody and to be primarily responsible for binding. More recently Chothia et al (Chothia and Lesk, J. Mol. Biol., 196:901- 917 (1987)) have given an alternate definition of the hypervariable regions or CDRs as consisting of residues 26-32 (L1), 50-52 (L2), 91-96 (L3) in V_L and residues 26-32 (H1), 53- 55 (H2), 96-101 (H3) in V_H . The Chothia definition is based on the residues that constitute the loops in the 3-dimensional structures of antibodies. It is particularly important to note that for each of the six CDRs the Chothia CDR is actually a subset of (i.e. smaller than) the Kabat CDR, with the single exception of H1 (the first heavy chain CDR), where the Chothia CDR contains amino acids 26-30 that are not in the Kabat CDR.

10
15
20 Riechmann et al ("Reshaping human antibodies for therapy", Nature, Vol 332, pp 323-326, (March 1989)) describe work in which precisely the Kabat CDRs were transferred to a pre-determined human framework (NEW again for the heavy chain and REI for the light chain). However, they found that an antibody containing the humanized heavy chain lost most of its binding affinity and ability to lyse target cells. They therefore made a new humanized antibody containing the Kabat CDRs from the mouse antibody and two amino acid changes in Chothia CDR H1, but no other mouse amino acids.

Summary of the Invention

25
30 The invention provides the use of at least one amino acid substitution outside of complementarity determining regions (CDR's) as defined by Kabat et al ("Sequences of Proteins of Immunological Interest", Kabat, E., et al., US Department of Health and Human Services, (1983)) together with Chothia et al (Chothia and Lesk, J. Mol. Biol., 196:901-917 (1987)) in the production of a humanized immunoglobulin, wherein said at least one amino acid substitution is from the non-CDR variable region of a non-human donor immunoglobulin, and in which humanized immunoglobulin the variable region amino acid sequence other than the CDR's comprises at least 70 amino acid residues identical to an acceptor human immunoglobulin variable region amino acid sequence, and the CDR's are from the variable region of said non-human donor immunoglobulin.

35
40 In another aspect, the invention provides a method of producing a humanized immunoglobulin chain having a framework region from a human acceptor immunoglobulin and complementarity determining regions (CDR's) from a donor immunoglobulin capable of binding to an antigen, said method comprising the steps of substituting at least one non-CDR framework amino acid of the acceptor immunoglobulin with a corresponding amino acid from the donor immunoglobulin at a position in the immunoglobulins where:

45 (a) the amino acid in the human framework region of the acceptor immunoglobulin is rare for said position and the corresponding amino acid in the donor immunoglobulin is common for said position in human immunoglobulin sequences; or

(b) the amino acid is immediately adjacent to one of the CDR's; or

50 (c) the amino acid is predicted to have a side chain atom capable of interacting with the antigen or with the CDR's of the humanized immunoglobulin.

55 The present invention provides novel compositions useful, for example, in the treatment of T-cell mediated human disorders, the compositions containing human-like immunoglobulins specifically capable of blocking the binding of human IL-2 to its receptor and/or capable of binding to the p55 Tac protein on human IL-2 receptors. The immunoglobulins can have two pairs of light chain/heavy chain complexes, typically at least one pair having chains comprising mouse complementarity determining regions functionally joined to human framework region segments. For example, mouse complementarity determining regions, with or without additional naturally-associated mouse amino acid residues, can be used to produce human-like antibodies capable of binding to the human IL-2 receptor at affinity levels stronger than

about 10^9 M⁻¹.

The immunoglobulins, including binding fragments and other derivatives thereof, of the present invention may be produced readily by a variety of recombinant DNA techniques, with ultimate expression in transfected cells, preferably immortalized eukaryotic cells, such as myeloma or hybridoma cells. Polynucleotides comprising a first sequence coding for human-like immunoglobulin framework regions and a second sequence set coding for the desired immunoglobulin complementarity determining regions can be produced synthetically or by combining appropriate cDNA and genomic DNA segments.

The human-like immunoglobulins may be utilized alone in substantially pure form, or complexed with a cytotoxic agent, such as a radionuclide, a ribosomal inhibiting protein or a cytotoxic agent active at cell surfaces. All of these compounds will be particularly useful in treating T-cell mediated disorders. The human-like immunoglobulins or their complexes can be prepared in a pharmaceutically accepted dosage form, which will vary depending on the mode of administration.

Methods for designing human-like immunoglobulin chains having one or more complementarity determining regions (CDR's) from a donor immunoglobulin and a framework region from a human immunoglobulin, may involve first comparing the framework or variable region amino acid sequence of the donor immunoglobulin to corresponding sequences in a collection of human immunoglobulin chains, and selecting as the human immunoglobulin one of the more homologous sequences from the collection. The human immunoglobulin, or acceptor immunoglobulin, sequence is typically selected from a collection of at least 10 to 20 immunoglobulin chain sequences, and usually will have the highest homology to the donor immunoglobulin sequence of any sequence in the collection. The human immunoglobulin framework sequence will typically have about 65 to 70% homology or more to the donor immunoglobulin framework sequences. The donor immunoglobulin may be either a heavy chain or light chain (or both), and the human collection will contain the same kind of chain. A humanized light and heavy chain can be used to form a complete humanized immunoglobulin or antibody, having two light/heavy chain pairs, with or without partial or full-length human constant regions and other proteins.

The humanized immunoglobulin chain will typically comprise at least about 3 amino acids from the donor immunoglobulin in addition to the CDR's, usually at least one of which is immediately adjacent to a CDR in the donor immunoglobulin. The heavy and light chains may each be designed by using any one or all three of the position criteria.

When combined into an intact antibody, the humanized light and heavy chains of the present invention will be substantially non-immunogenic in humans and retain substantially the same affinity as the donor immunoglobulin to the antigen (such as a protein or other compound containing an epitope). These affinity levels can vary from about 10^8 M⁻¹ or higher, and may be within about 4 fold of the donor immunoglobulin's original affinity to the antigen.

BRIEF DESCRIPTION OF THE FIGURES

Figure 1. Comparison of sequences of anti-Tac heavy chain (upper lines) and Eu heavy chain (lower lines). The 1-letter code for amino acids is used. The first amino acid on each line is numbered at the left. Identical amino acids in the two sequences are connected by lines. The 3 CDRs are underlined. Other amino acid positions for which the anti-Tac amino acid rather than the Eu amino acid was used in the humanized anti-Tac heavy chain are denoted by an *.

Figure 2. Comparison of sequences of anti-Tac light chain (upper lines) and Ed light chain (lower lines). The single-letter code for amino acids is used. The first amino acid on each line is numbered at the left. Identical amino acids in the two sequences are connected by lines. The 3 CDRs are underlined. Other amino acid positions for which the anti-Tac amino acid rather than the Eu amino acid was used in the humanized anti-Tac heavy chain are denoted by an *.

Figure 3. Nucleotide sequence of the gene for the humanized anti-Tac heavy chain variable region gene. The translated amino acid sequence for the part of the gene encoding protein is shown underneath the nucleotide sequence. The nucleotides TCTAGA at the beginning and end of the gene are Xba I sites. The mature heavy chain sequence begins with amino acid #20 Q.

Figure 4. Nucleotide sequence of the gene for the humanized anti-Tac light chain variable region gene. The translated amino acid sequence for the part of the gene encoding protein is shown underneath the nucleotide sequence. The nucleotides TCTAGA at the beginning and end of the gene are Xba I sites. The mature light chain sequence begins with amino acid #21 D.

Figure 5. A. Sequences of the four oligonucleotides used to synthesize the humanized anti-Tac heavy chain gene, printed 5' to 3'. B. Relative positions of the oligonucleotides. The arrows point in the 3' direction for each oligonucleotide.

Figure 6. (A) Sequences of the four oligonucleotides used to synthesize the humanized anti-Tac light chain gene printed 5' to 3'. (B) Relative positions of the oligonucleotides. The arrows point in the 3' direction for each oligonucleotide. The position of a Hind III site in the overlap of JFD2 and JFD3 is shown.

Figure 7. Schematic diagram of the plasmid pHuGTAC1 used to express the humanized anti-Tac heavy chain. Relevant restriction sites are shown, and coding regions of the heavy chain are displayed as boxes. The direction of transcription from the immunoglobulin (Ig) promoter is shown by an arrow. E_H = heavy chain enhancer, Hyg = hygromycin

resistance gene.

Figure 8. Schematic diagram of the plasmid pHuLTAC used to express the humanized anti-Tac light chain. Relevant restriction sites are shown, and coding regions of the light chain are displayed as boxes. The direction of transcription from the Ig promoter is shown by an arrow.

5 Figure 9. Fluorocytometry of HUT-102 and Jurkat cells stained with anti-Tac antibody or humanized anti-Tac antibody followed respectively by fluorescein-conjugated goat anti-mouse Ig antibody or goat anti-human Ig antibody, as labeled. In each panel, the dotted curve shows the results when the first antibody was omitted, and the solid curve the results when first and second (conjugated) antibodies were included as described.

10 Figure 10. (A) Fluorocytometry of HUT-102 cells stained with 0-40 ng of anti-Tac, as indicated, then with biotinylated anti-Tac, and then with phycoerythrin-conjugated avidin. (B) Fluorocytometry of HUT-102 cells stained with the indicated antibody, then with biotinylated anti-Tac, and then with phycoerythrin-conjugated avidin.

DETAILED DESCRIPTION OF THE INVENTION

15 In accordance with one embodiment of the present invention, human-like immunoglobulins specifically reactive with desired epitopes, such as those on the IL-2 receptor on human T-cells, are provided. These immunoglobulins, which have binding affinities of at least about 10^8 m^{-1} , and preferably 10^9 M^{-1} to 10^{10} M^{-1} or stronger, are capable of, e.g., blocking the binding of IL-2 to human IL-2 receptors. The human-like immunoglobulins will have a human-like framework and can have complimentary determining regions (CDR's) from an immunoglobulin, typically a mouse immunoglobulin, specifically reactive with an epitope on p55 Tac protein. The immunoglobulins of the present invention, which can be produced economically in large quantities, find use, for example, in the treatment of T-cell mediated disorders in human patients by a variety of techniques.

The basic antibody structural unit is known to comprise a tetramer. Each tetramer is composed of two identical pairs of polypeptide chains, each pair having one "light" (about 25kD) and one "heavy" chain (about 50-70kD). The NH_2 -terminus of each chain begins a variable region of about 100 to 110 or more amino acids primarily responsible for antigen recognition. The COOH terminus of each chain defines a constant region primarily responsible for effector function.

Light chains are classified as either kappa or lambda. Heavy chains are classified (and subclassified) as gamma, mu, alpha, delta, or epsilon, and define the antibody's isotype as IgG, IgM, IgA, IgD and IgE, respectively. Within light and heavy chains, the variable and constant regions are joined by a "J" region of about 12 or more amino acids, with the heavy chain also including a "D" region of about 12 more amino acids. (See, generally, Fundamental Immunology, Paul, W., Ed., Chapter 7, pgs. 131- 166, Raven Press, N.Y. (1984)).

The variable regions of each light/heavy chain pair form the antibody binding site. The chains all exhibit the same general structure of relatively conserved framework regions joined by three hypervariable regions, also called CDR's (see, "Sequences of Proteins of Immunological Interest," Kabat, E., et al., U.S. Department of Health and Human Services, (1983); and Chothia and Lesk, J. Mol. Biol., 196:901-917 (1987)). The CDR's from the two chains of each pair are aligned by the framework regions, enabling binding to a specific epitope.

As used herein, the term "immunoglobulin" refers to a protein consisting of one or more polypeptides substantially encoded by immunoglobulin genes. The recognized immunoglobulin genes include the kappa, lambda, alpha, gamma, delta, epsilon and mu constant region genes, as well as the myriad immunoglobulin variable region genes. The immunoglobulins may exist in a variety of forms besides antibodies; including, for example, Fv, Fab, and F(ab)₂, as well as in single chains (e.g., Huston, et al., Proc. Nat. Acad. Sci. U.S.A., 85:5879-5883 (1988) and Bird, et al., Science, 242:423-426 (1988)). (See, generally, Hood, et al., "Immunology", Benjamin, N.Y., 2nd ed. (1984), and Hunkapiller and Hood, Nature, 323:15-16 (1986)).

Chimeric antibodies are antibodies whose light and heavy chain genes have been constructed, typically by genetic engineering, from immunoglobulin gene segments belonging to different species. For example, the variable (V) segments of the genes from a mouse monoclonal antibody may be joined to human constant (C) segments, such as γ_1 and γ_3 . A typical therapeutic chimeric antibody is thus a hybrid protein consisting of the V or antigen-binding domain from a mouse antibody and the C or effector domain from a human antibody (e.g., A.T.C.C. Accession No. CRL 9688 secretes an anti-Tac chimeric antibody), although other mammalian species may be used.

As used herein, the term "framework region" refers to those portions of immunoglobulin light and heavy chain variable regions that are relatively conserved (i.e., other than the CDR's) among different immunoglobulins in a single species, as defined by Kabat, et al., op. cit. As used herein, a "human-like framework region" is a framework region that in each existing chain comprise at least about 70 or more amino acid residues, typically 75 to 85 or more residues, identical to those in a human immunoglobulin.

As used herein, the term "human-like immunoglobulin" refers to an immunoglobulin comprising a human-like framework and in which any constant region present is substantially homologous to a human immunoglobulin constant region, i.e., at least about 85-90%, preferably about 95% identical. Hence, all parts of a human-like immunoglobulin, except possibly the CDR's, are substantially homologous to corresponding parts of one or more native human immunoglobulin

sequences. For example, a human-like immunoglobulin would not encompass a chimeric mouse variable region/human constant region antibody.

In accordance with another general aspect of the present invention, also included are criteria by which a limited number of amino acids in the framework of a human-like or humanized immunoglobulin chain are chosen to be the same as the amino acids at those positions in the donor Ig rather than in the acceptor Ig, in order to increase the affinity of an antibody comprising the humanized immunoglobulin chain.

This aspect of the present invention is based in part on the model that two contributing causes of the loss of affinity in prior means of producing humanized antibodies (using as examples mouse antibodies as the source of CDR's) are:

(1) When the mouse CDR's are combined with the human framework, the amino acids in the framework close to the CDR's become human instead of mouse. Without intending to be bound by theory, we believe that these changed amino acids may slightly distort the CDR's, because they create different electrostatic or hydrophobic forces than in the donor mouse antibody, and the distorted CDR's may not make as effective contacts with the antigen as the CDR's did in the donor antibody;

(2) Also, amino acids in the original mouse antibody that are close to, but not part of, the CDR's (i.e., still part of the framework), may make contacts with the antigen that contribute to affinity. These amino acids are lost when the antibody is humanized, because all framework amino acids are made human.

To avoid these problems, and to produce humanized antibodies that have a very strong affinity for a desired antigen, the present invention uses the following four criteria for designing humanized immunoglobulins. These criteria may be used singly, or when necessary in combination, to achieve the desired affinity or other characteristics.

Criterion I: As acceptor, use a framework from a particular human immunoglobulin that is unusually homologous to the donor immunoglobulin to be humanized, or use a consensus framework from many human antibodies. For example, comparison of the sequence of a mouse heavy (or light) chain variable region against human heavy (or light) variable regions in a data bank (for example, the National Biomedical Research Foundation Protein Identification Resource) shows that the extent of homology to different human regions varies greatly, typically from about 40% to about 60-70%. By choosing as the acceptor immunoglobulin one of the human heavy (respectively light) chain variable regions that is most homologous to the heavy (respectively light) chain variable region of the donor immunoglobulin, fewer amino acids will be changed in going from the donor immunoglobulin to the humanized immunoglobulin. Hence, and again without intending to be bound by theory, it is believed that there is a smaller chance of changing an amino acid near the CDR's that distorts their conformation. Moreover, the precise overall shape of a humanized antibody comprising the humanized immunoglobulin chain may more closely resemble the shape of the donor antibody, also reducing the chance of distorting the CDR's.

Typically, one of the 3-5 most homologous heavy chain variable region sequences in a representative collection of at least about 10 to 20' distinct human heavy chains will be chosen as acceptor to provide the heavy chain framework, and similarly for the light chain. Preferably, one of the 1-3 most homologous variable regions will be used. The selected acceptor immunoglobulin chain will most preferably have at least about 65% homology in the framework region to the donor immunoglobulin.

Regardless of how the acceptor immunoglobulin is chosen, higher affinity may be achieved by selecting a small number of amino acids in the framework of the humanized immunoglobulin chain to be the same as the amino acids at those positions in the donor rather than in the acceptor. The following criteria define what amino acids may be so selected. Preferably, at most of all amino acid positions satisfying one of these criteria, the donor amino acid will in fact be selected.

Criterion II: If an amino acid in the framework of the human acceptor immunoglobulin is unusual (i.e., "rare", which as used herein indicates an amino acid occurring at that position in no more than about 10% of human heavy (respectively light) chain V region sequences in a representative data bank), and if the donor amino acid at that position is typical for human sequences (i.e., "common", which as used herein indicates an amino acid occurring in at least about 25% of sequences in a representative data bank), then the donor amino acid rather than the acceptor may be selected. This criterion helps ensure that an atypical amino acid in the human framework does not disrupt the antibody structure. Moreover, by replacing an unusual amino acid with an amino acid from the donor antibody that happens to be typical for human antibodies, the humanized antibody may be made less immunogenic.

Criterion III: In the positions immediately adjacent to the 3 CDR's in the humanized immunoglobulin chain, the donor amino acid rather than acceptor amino acid may be selected. These amino acids are particularly likely to interact with the amino acids in the CDR's and, if chosen from the acceptor, distort the donor CDR's and reduce affinity. Moreover, the adjacent amino acids may interact directly with the antigen (Amit *et al.*, *Science*, 233, 747-753 (1986)) and selecting these amino acids from the donor may be desirable to keep all the antigen contacts that provide affinity in the original antibody.

Criterion IV: A 3-dimensional model, typically of the original donor antibody, shows that certain amino acids outside of the CDR's are close to the CDR's and have a good probability of interacting with amino acids in the CDR's by hydrogen

bonding, Van der Waals forces, hydrophobic interactions, etc. At those amino acid positions, the donor amino acid rather than the acceptor immunoglobulin amino acid may be selected. Amino acids according to this criterion will generally have a side chain atom within about 3 angstrom units of some site in the CDR's and must contain atoms that could interact with the CDR atoms according to established chemical forces, such as those listed above. Computer programs to create models of proteins such as-antibodies are generally available and well known to those skilled in the art (see, 5 Loew *et al.*, *Int. J. Quant. Chem., Quant. Biol. Symp.*, 15:55-66 (1988); Bruccoleri *et al.*, *Nature*, 335, 564-568 (1988); Chothia *et al.*, *Science*, 233:755-758 (1986)). These do not form part of the invention. Indeed, because all antibodies have similar structures, the known antibody structures, which are available from the Brookhaven Protein Data Bank, can be used if necessary as rough models of other antibodies. Commercially available computer programs can be used 10 to display these models on a computer monitor, to calculate the distance between atoms, and to estimate the likelihood of different amino acids interacting (see, Ferrin *et al.*, *J. Mol. Graphics*, 6:13-27 (1988)).

Humanized or human-like antibodies generally have at least three potential advantages over mouse or in some cases chimeric antibodies for use in human therapy:

- 1) Because the effector portion is human, it may interact better with the other parts of the human immune system (e.g., destroy the target cells more efficiently by complement-dependent cytotoxicity (CDC) or antibody-dependent cellular cytotoxicity (ADCC)).
- 2) The human immune system should not recognize the framework or constant region of the humanized antibody as foreign, and therefore the antibody response against such an injected antibody should be less than against a 20 totally foreign mouse antibody or a partially foreign dimeric antibody.
- 3) Injected mouse antibodies have been reported to have a half-life in the human circulation much shorter than the half-life of normal antibodies (D. Shaw *et al.*, *J. Immunol.*, 138:4534-4538 (1987)). Injected humanized antibodies will presumably have a half-life more similar to naturally occurring human antibodies, allowing smaller and less frequent doses to be given.

The present invention is specifically directed to improved humanized immunoglobulins (e.g., capable of binding the human IL-2 receptor) with respect to those described in EPA publication no. 0239400. That application, the disclosure of which is excluded from coverage herein, describes, for certain immunoglobulins substituting CDR's regions in the light or heavy chain variable domains of an acceptor antibody with analogous parts of CDR's (typically solvent accessible) 30 from an antibody of different specificity. Also, that application discusses, for certain immunoglobulins, the possibility of only transferring residues that are (solvent) accessible from the antigen binding site, which residues apparently may include certain framework regions (specifically, residues known to be involved in antigen binding as described in Amit *et al.*, *Science* 233: 747-753 (1986) or perhaps residues essential for inter-chain interactions - but for the selection of which insufficient guidance is provided in that application). Thus, for example, a preferred embodiment of the present invention entails substituting entire CDR's and framework amino acids immediately adjacent one (or preferably each) 35 of the CDR's. In general, any framework residue that also makes contact with the CDR's to, e.g., maintain their conformation (and usually their antigen binding specificity) are specifically included within preferred embodiments of the present invention as described in detail, *supra*.

In one aspect, the present invention is directed to recombinant DNA segments encoding the heavy and/or light chain CDR's (typically with other amino acid residues as described above) from an immunoglobulin capable of binding to a desired epitope, such as on the human IL-2 receptor (e.g., the anti-Tac monoclonal antibody). The DNA segments encoding these regions will typically be joined to DNA segments encoding appropriate human-like framework regions. For example, the preferred DNA sequences, which on expression code for the polypeptide chains comprising the anti-Tac heavy and light chain hypervariable regions (with human-like framework regions), are shown in Figures 3 and 4, 45 respectively. Due to codon degeneracy and non-critical amino-acid substitutions, other DNA sequences can be readily substituted for those sequences, as detailed below.

The DNA segments will typically further include an expression control DNA sequence operably linked to the human-like antibody coding sequences, including naturally-associated or heterologous promoter regions. Preferably, the expression control sequences will be eukaryotic promoter systems in vectors capable of transforming or transfecting 50 eukaryotic host cells, but control sequences for prokaryotic hosts may also be used. Once the vector has been incorporated into the appropriate host, the host is maintained under conditions suitable for high level expression of the nucleotide sequences, and, as desired, the collection and purification of the light chains, heavy chains, light/heavy chain dimers or intact antibodies, binding fragments or other immunoglobulin forms may follow.

Human constant region DNA sequences can be isolated in accordance with well known procedures from a variety 55 of human cells, but preferably immortalized B-cells (see, Kabat *op. cit.* and WP87/02671). For example, the human kappa immunoglobulin constant and J region genes and sequences are described in Heiter *et al.*, *Cell* 22:197-207 (1980) and the nucleotide sequence of a human immunoglobulin C_{γ1} gene is described in Ellison *et al.*, *Nucl. Acid. Res.* 10:4071 (1982). The CDR's for producing the immunoglobulins of the present invention will be similarly derived from

monoclonal antibodies capable of binding to the desired antigen (e.g., the human IL-2 receptor) and produced in any convenient mammalian source, including, mice, rats, rabbits, or other vertebrate capable of producing antibodies by well known methods. Suitable source cells for the DNA sequences and host cells for immunoglobulin expression and secretion can be obtained from a number of sources, such as the American Type Culture Collection ("Catalogue of Cell Lines and Hybridomas," Fifth edition (1985) Rockville, Maryland, U.S.A.).

In addition to the human-like immunoglobulins specifically described herein, other "substantially homologous" modified immunoglobulins can be readily designed and manufactured utilizing various recombinant DNA techniques well known to those skilled in the art. For example, for the IL-2 receptor immunoglobulins the framework regions can vary from the sequences in Figures 3 and 4 at the primary structure level by several amino acid substitutions, terminal and intermediate additions and deletions, and the like. Moreover, a variety of different human framework regions may be used singly or in combination as a basis for the human-like immunoglobulins of the present invention. In general, modifications of the genes may be readily accomplished by a variety of well-known techniques, such as site-directed mutagenesis (see, Gillman and Smith, Gen 8:81-97 (1979) and Roberts, S. et al, Nature 328:731-734 (1987)). Alternatively, polypeptide fragments comprising only a portion of the primary antibody structure may be produced, which fragments possess one or more immunoglobulin activities (e.g., complement fixation activity). Also because like many genes, the immunoglobulin-related genes contain separate functional regions, each having one or more distinct biological activities, the genes may be fused to functional regions from other genes (e.g., enzymes) to produce fusion proteins (e.g., immunotoxins) having novel properties.

The nucleic acid sequences of the present invention capable of ultimately expressing the desired human-like antibodies can be formed from a variety of different polynucleotides (genomic or cDNA, RNA, synthetic oligonucleotides, etc.) and components (e.g., V, J, D, and C regions), as well as by a variety of different techniques. Joining appropriate genomic sequences is presently the most common method of production, but cDNA sequences may also be utilized (see, European Patent Publication No. 0239400 and Reichmann, L., et al., Nature 332:323-327 (1988)).

As stated previously, the DNA sequences will be expressed in hosts after the sequence have been operably linked to (i.e., positioned to ensure the functioning of) an expression control sequence. These expression vectors are typically replicable in the host organisms either as episomes or as an integral part of the host chromosomal DNA. Commonly, expression vectors will contain selection markers, e.g., tetracycline or neomycin, to permit detection of those cells transformed with the desired DNA sequences (see, e.g., U.S. Patent 4,704,362).

E. coli is one prokaryotic host useful particularly for cloning the DNA sequences of the present invention. Other microbial hosts suitable for use include bacilli, such as Bacillus subtilis, and other enterobacteriaceae, such as Salmonella, Serratia, and various Pseudomonas species. In these prokaryotic hosts, one can also make expression vectors, which will typically contain expression control sequences compatible with the host cell (e.g., an origin of replication). In addition, any number of a variety of well-known promoters will be present, such as the lactose promoter system, a tryptophan (trp) promoter system, a beta-lactamase promoter system, or a promoter system from phage lambda. The promoters will typically control expression, optionally with an operator sequence, and have ribosome binding site sequences and the like, for initiating and completing transcription and translation.

Other microbes, such as yeast, may also be used for expression. Saccharomyces is a preferred host, with suitable vectors having expression control sequences, such as promoters, including 3-phosphoglycerate kinase or other glycolytic enzymes, and an origin of replication, termination sequences and the like as desired.

In addition to microorganisms, mammalian tissue cell culture may also be used to express and produce the polypeptides of the present invention (see, Winnacker, "From Genes to Clones," VCH Publishers, N.Y., N.Y. (1987)). Eukaryotic cells are actually preferred, because a number of suitable host cell lines capable of secreting intact immunoglobulins have been developed in the art, and include the CHO cell lines, various COS cell lines, HeLa cells, myeloma cell lines, etc, but preferably transformed B-cells or hybridomas. Expression vectors for these cells can include expression control sequences, such as an origin of replication, a promoter, an enhancer (Queen, C., et al., Immunol. Rev. 89:49-68 (1986)), and necessary processing information sites, such as ribosome binding sites, RNA splice sites, polyadenylation sites, and transcriptional terminator sequences. Preferred expression control sequences are promoters derived from SV40 with enhancer (see, Mulligan and Berg, Science 209:1422-1427 (1980), an immunoglobulin gene, Adenovirus, Bovine Papilloma Virus, and the like.

The vectors containing the DNA segments of interest (e.g., the heavy and light chain encoding sequences and expression control sequences) can be transferred into the host cell by well-known methods, which vary depending on the type of cellular host. For example, calcium chloride transfection is commonly utilized for prokaryotic cells, whereas calcium phosphate treatment or electroporation may be used for other cellular hosts. (See, generally, Maniatis, et al., Molecular Cloning: A Laboratory Manual, Cold Spring Harbor Press, (1982)).

Once expressed, the whole antibodies, their dimers, individual light and heavy chains, or other immunoglobulin forms of the present invention can be purified according to standard procedures of the art, including ammonium sulfate precipitation, affinity columns, column chromatography, gel electrophoresis and the like (see, generally, Scopes, R., Protein Purification, Springer-Verlag, N.Y. (1982)). Substantially pure immunoglobulins of at least about 90 to 95%

homogeneity are preferred, and 98 to 99% or more homogeneity most preferred, for pharmaceutical uses. Once purified, partially or to homogeneity as desired, the polypeptides may then be used therapeutically (including extracorporeally) or in developing and performing assay procedures, immunofluorescent stainings, and the like. (See, generally, Immunological Methods, Vols. I and II, Lefkovits and Pernis, eds., Academic Press, New York, N.Y. (1979 and 1981)).

5 The IL-2 receptor specific antibodies exemplified in the present invention will typically, find use individually in treating a T-cell mediated disease state. Generally, where the cell linked to a disease has been identified as IL-2 receptor bearing, then the human-like antibodies capable of blocking the binding of IL-2 to the human IL-2 receptor are suitable. For example, typical disease states suitable for treatment include graft versus host disease and transplant rejection in patients undergoing an organ transplant, such as heart, lungs, kidneys, liver, etc. Other diseases include autoimmune diseases, such as Type I diabetes, multiple sclerosis, rheumatoid arthritis, systemic lupus erythematosus, and myasthenia gravis.

The human-like antibodies of the present invention may also be used in combination with other antibodies, particularly human monoclonal antibodies reactive with other markers on cells responsible for the disease. For example, suitable T-cell markers can include those grouped into the so-called "Clusters of Differentiation," as named by the First International Leukocyte Differentiation Workshop, Leukocyte Typing, Bernard, et al., Eds., Springer-Verlag, N.Y. (1984).

15 The antibodies can also be used as separately administered compositions given in conjunction with chemotherapeutic or immunosuppressive agents. Typically, the agents will include cyclosporin A or a purine analog (e.g., methotrexate, 6-mercaptopurine, or the like), but numerous additional agents (e.g., cyclophosphamide, prednisone, etc.) well-known to those skilled in the art may also be utilized.

20 A preferred pharmaceutical composition of the present invention comprises the use of the subject antibodies in immunotoxins. Immunotoxins are characterized by two components and are particularly useful for killing selected cells in vitro or in vivo. One component is a cytotoxic agent which is usually fatal to a cell when attached or absorbed. The second component, known as the "delivery vehicle," provides a means for delivering the toxic agent to a particular cell type, such as cells comprising a carcinoma. The two components are commonly chemically bonded together by any of a variety of well-known chemical procedures. For example, when the cytotoxic agent is a protein and the second component is an intact immunoglobulin, the linkage may be by way of heterobifunctional cross-linkers, e.g., SPDP, carbodiimide, glutaraldehyde, or the like. Production of various immunotoxins is well-known with the art, and can be found, for example in "Monoclonal Antibody-Toxin Conjugates: Aiming the Magic Bullet," Thorpe et al, Monoclonal Antibodies in Clinical Medicine, Academic Press, pp. 168-190 (1982).

30 A variety of cytotoxic agents are suitable for use in immunotoxins. Cytotoxic agents can include radionuclides, such as Iodine-131, Yttrium-90, Rhenium-188, and Bismuth-212; a number of chemotherapeutic drugs, such as vindesine, methotrexate, adriamycin, and cisplatin; and cytotoxic proteins such as ribosomal inhibiting proteins like pokeweed antiviral protein, Pseudomonas exotoxin A, ricin, diphtheria toxin, ricin A chain, etc., or an agent active at the cell surface, such as the phospholipase enzymes (e.g., phospholipase, (See, generally, "Chimeric Toxins," Olsnes and Phil, Pharmac. Ther., 25:355-381 (1982), and "Monoclonal Antibodies for Cancer Detection and Therapy," eds. Baldwin and Byers, pp. 159-179, 224-266, Academic Press (1985)).

The delivery component of the immunotoxin will include the human-like immunoglobulins of the present invention. Intact immunoglobulins or their binding fragments, such as Fab, are preferably used. Typically, the antibodies in the immunotoxins will be of the human IgM or IgG isotype, but other mammalian constant regions may be utilized as desired.

40 The human-like antibodies and pharmaceutical compositions thereof of this invention are particularly useful for parenteral administration, i.e., subcutaneously, intramuscularly or intravenously. The compositions for parenteral administration will commonly comprise a solution of the antibody or a cocktail thereof dissolved in an acceptable carrier, preferably an aqueous carrier. A variety of aqueous carriers can be used, e.g., water, buffered water, 0.4% saline, 0.3% glycine and the like. These solutions are sterile and generally free of particulate matter. These compositions may be sterilized by conventional, well known sterilization techniques. The compositions may contain pharmaceutically acceptable auxiliary substances as required to approximate physiological conditions such as pH adjusting and buffering agents, toxicity adjusting agents and the like, for example sodium acetate, sodium chloride, potassium chloride, calcium chloride, sodium lactate, etc. The concentration of antibody in these formulations can vary widely, i.e., from less than about 0.5%, usually at or at least about 1% to as much as 15 or 20% by weight and will be selected primarily based on fluid volumes, viscosities, etc., in accordance with the particular mode of administration selected.

50 Thus, a typical pharmaceutical composition for intramuscular injection could be made up to contain 1 ml sterile buffered water, and 50 mg of antibody. A typical composition for intravenous infusion could be made up to contain 250 ml of sterile Ringer's solution, and 150 mg of antibody. Actual methods for preparing parenterally administrable compositions will be known or apparent to those skilled in the art and are described in more detail in, for example, Remington's Pharmaceutical Science, 15th ed., Mack Publishing Company, Easton, Pennsylvania (1980).

55 The antibodies of this invention can be lyophilized for storage and reconstituted in suitable carrier prior to use. This technique has been shown to be effective with conventional immune globulins and art-known lyophilization and reconstitution techniques can be employed. It will be appreciated by those skilled in the art that lyophilization and reconstitution

can lead to varying degrees of antibody activity loss (e.g., with conventional immune globulins, IgM antibodies tend to have greater activity loss than IgG antibodies) and that use levels may have to be adjusted to compensate.

The compositions containing the present human-like antibodies or a cocktail thereof can administered for prophylactic and/or therapeutic treatments. In therapeutic application, compositions are administered to a patient already suffering from a disease, in an amount sufficient to cure or at least partially arrest the disease and its complications. An amount adequate to accomplish this is defined as a "therapeutically effective dose." Amounts effective for this use will depend upon the severity of the infection and the general state of the patient's own immune system, but generally range from about 1 to about 200 mg of antibody per dose, with dosages of from 5 to 25 mg per patient being more commonly used. It must be kept in mind that the materials of this invention may generally be employed in serious disease states, that is life-threatening or potentially life-threatening situations. In such cases, in view of the minimization of extraneous substances and the lower probability of "foreign substance" rejections which are achieved by the present human-like antibodies of this invention, it is possible and may be felt desirable by the treating physician to administer substantial excesses of these antibodies.

In prophylactic applications, compositions containing the present antibodies or a cocktail thereof are administered to a patient not already in a disease state to enhance the patient's resistance. Such an amount is defined to be a "prophylactically effective dose." In this use, the precise amounts again depend upon the patient's state of health and general level of immunity, but generally range from 0.1 to 25 mg per dose, especially 0.5 to 2.5 mg per patient. A preferred prophylactic use is for the prevention of kidney transplant rejection.

Single or multiple administrations of the compositions can be carried out with dose levels and pattern being selected by the treating physician. In any event, the pharmaceutical formulations should provide a quantity of the antibody(ies) of this invention sufficient to effectively treat the patient.

Human-like antibodies of the present invention can further find a wide variety of utilities *in vitro*. By way of example, the exemplary antibodies can be utilized for T-cell typing, for isolating specific IL-2 receptor bearing cells or fragments of the receptor, for vaccine preparation, or the like.

For diagnostic purposes, the antibodies may either be labeled or unlabeled. Unlabeled antibodies can be used in combination with other labeled antibodies (second antibodies) that are reactive with the human-like antibody, such as antibodies specific for human immunoglobulin constant regions. Alternatively, the antibodies can be directly labeled. A wide variety of labels may be employed, such as radionuclides, fluoros, enzymes, enzyme substrates, enzyme cofactors, enzyme inhibitors, ligands (particularly haptens), etc. Numerous types of immunoassays are available and are well known to those skilled in the art.

Kits can also be supplied for use with the subject antibodies in the protection against or detection of a cellular activity or for the presence of a selected antigen. Thus, the subject antibody composition of the present invention may be provided, usually in a lyophilized form in a container, either alone or in conjunction with additional antibodies specific for the desired cell type. The antibodies, which may be conjugated to a label or toxin, or unconjugated, are included in the kits with buffers, such as Tris, phosphate, carbonate, etc., stabilizers, biocides, inert proteins, e.g., serum albumin, or the like, and a set of instructions for use. Generally, these materials will be present in less than about 5% wt. based on the amount of active antibody, and usually present in total amount of at least about 0.001% wt. based again on the antibody concentration. Frequently, it will be desirable to include an inert extender or excipient to dilute the active ingredients, where the excipient may be present in from about 1 to 99% wt. of the total composition. Where a second antibody capable of binding to the chimeric antibody is employed in an assay, this will usually be present in a separate vial. The second antibody is typically conjugated to a label and formulated in an analogous manner with the antibody formulations described above.

The following examples are offered by way of illustration, not by limitation.

EXPERIMENTAL

Design of genes for human-like light and heavy chains

The sequence of the human antibody Eu (Sequences of Proteins of Immunological Interest, Kabat, E., et al., U.S. Dept. of Health and Human Services, 1983) was used to provide the framework of the humanized antibody, because the amino acid sequence of the heavy chain of anti-Tac is more homologous to the heavy chain of this antibody than to any other heavy chain sequence in the National Biomedical Foundation Protein Identification Resource.

To select the sequence of the humanized heavy chain, the anti-Tac heavy chain sequence was aligned with the sequence of the Eu heavy chain (Figure 1). At each position, the Eu amino acid was selected for the humanized sequence, unless that position fell in any one of the following categories, in which case the anti-Tac amino acid was selected.

(1) The position fell within a complementarity determining region (CDR), as defined by Kabat, et al., op. cit. (amino acids 31-35, 50-66, 99-106);

EP 0 451 216 B1

(2) The Eu amino acid was unusual for human heavy chains at that position, whereas the anti-Tac amino acid was typical for human heavy chains at that position (amino acids 27, 93, 95, 98, 107-109, 111) ;

(3) The position was immediately adjacent to a CDR in the amino acid sequence of the anti-Tac heavy chain (amino acids 30 and 67).

5 (4) 3-dimensional modeling of the anti-Tac antibody suggested that the amino acid was physically close to the antigen binding region (amino acids 48 and 68).

Some amino acids fell in more than one of these categories but are only listed in one.

10 To select the sequence of the humanized light chain, the anti-Tac light chain sequence was aligned with the sequence of the Eu light chain (Figure 2). The Eu amino acid was selected at each position, unless the position again fell into one of the categories (1) - (4), (with light chain replacing heavy chain in the category definitions):

(1) CDRs (amino acids 24-34, 50-56, 89-97).

(2) Anti-Tac amino acid more typical than Eu (amino acids 48 and 63).

15 (3) Adjacent to CDRs (no amino acids; Eu and anti-Tac were already the same at all these positions).

(4) Possible 3-dimensional proximity to binding region (amino acid 60).

The actual nucleotide sequence of the heavy (Figure 3) and light chain (Figure 4) genes were selected as follows:

20 (1) the nucleotide sequences code for the amino acid sequences chosen as described above.

(2) 5' of these coding sequences, the nucleotide sequences code for a leader (signal) sequence, namely the leader of the light chain of the antibody MOPC 63 and the leader of the heavy chain of the antibody PCH 108A (Kabat et al., *op. cit.*). These leader sequences were chosen as typical of antibodies.

25 (3) 3' of the coding sequences, the nucleotide sequences are the sequences that follow the mouse light chain J5 segment and the mouse heavy chain J2 segment, which are part of the anti-Tac sequences. These sequences are included because they contain splice donor signals:

(4) At each end of the sequence is an Xba I site to allow cutting at the Xba I sites and cloning into the Xba I site of a vector.

30 Construction of humanized light and heavy chain genes

To synthesize the heavy chain, four oligonucleotides HES12, HES13, HES14, HES15 (Figure 5A) were synthesized using an Applied Biosystems 380B DNA synthesizer. Two of the oligonucleotides are part of each strand of the heavy chain, and each oligonucleotide overlaps the next one by about 20 nucleotides to allow annealing (Figure 5B). Together, 35 the oligonucleotides cover the entire humanized heavy chain (Figure 3) with a few extra nucleotides at each end to allow cutting at the Xba I sites. The oligonucleotides were purified from polyacrylamide gels.

Each oligonucleotide was phosphorylated using ATP and T4 polynucleotide kinase by standard procedures (*see, Maniatis, op. cit.*). To anneal the phosphorylated oligonucleotides, they were suspended together in 40 µl of TA (33 mM Tris acetate, pH 7.9, 66 mM potassium acetate, 10 mM magnesium acetate) at a concentration of about 3.75 µM each, 40 heated to 95 deg for 4 min. and cooled slowly to 4 °C. To synthesize the complete gene from the oligonucleotides by synthesizing the opposite strand of each oligonucleotide (Figure 5B), the following components were added in a final volume of 100µl:

45	10 µl	annealed oligonucleotides
	0.16 mM each	deoxyribonucleotide
	0.5 mM	ATP
	0.5 mM	DTT
	100 µg/ml	BSA
50	3.5 µg/ml	T4 g43 protein (DNA polymerase)
	25 µg/ml	T4 g44/62 protein (polymerase accessory protein)
	25 µg/ml	45 protein (polymerase accessory protein)

55 The mixture was incubated at 37 °C for 30 min. Then 10 U of T4 DNA ligase was added and incubation at 37 °C resumed for 30 min. The polymerase and ligase were inactivated by incubation of the reaction at 70 °C for 15 min. To digest the gene with Xba I, to the reaction was added 50 µl of 2x TA containing BSA at 200 µg/ml and DTT at 1 mM, 43 µl of water, and 50 U of Xba I in 5 µl. The reaction was incubated for 3 hr at 37 °C, and run on a gel. The 431 bp Xba I fragment was purified from a gel and cloned into the Xba I site of the plasmid pUC19 by standard methods. Four plasmids

isolates were purified and sequenced using the dideoxy method. One of these had the correct sequence (Figure 3).

To synthesize the light chain, four oligonucleotides JFD1, JFD2, JFD3, JFD4 (Figure 6A) were synthesized. Two of the oligonucleotides are part of each strand of the light chain, and each oligonucleotide overlaps the next one by about 20 nucleotides to allow annealing (Figure 6B). Together, the oligonucleotides cover the entire humanized light chain (Figure 4) with a few extra nucleotides at each end to allow cutting at the Xba I sites. The oligonucleotides were purified from polyacrylamide gels.

The light chain gene was synthesized from these oligonucleotides in two parts. 0.5 µg each of JFD1 and JFD2 were combined in 20 µl sequenase buffer (40 mM Tris-HCl, pH 7.5, 20 mM magnesium chloride, 50 mM sodium chloride), heated at 70 °C for 3 min and allowed to cool slowly to 23 deg in order for the oligonucleotides to anneal. JFD3 and JFD4 were treated in the same way. Each reaction was made 10 mM in DTT and 0.5 mM in each deoxyribonucleotide and 6.5 U of sequenase (US Biochemicals) was added, in a final volume of 24 µl, and incubated for 1 hr at 37 °C to synthesize the opposite strands of the oligonucleotides. Xba I and Hind III were added to each reaction to digest the DNA (there is a Hind III site in the region where JFD2 and JFD3 overlap and therefore in each of the synthesized DNAs; Figure 6B). The reactions were run on polyacrylamide gels, and the Xba I - Hind III fragments were purified and cloned into pUC18 by standard methods. Several plasmid isolates for each fragment were sequenced by the dideoxy method, and correct ones chosen.

Construction of plasmids to express humanized light and heavy chains

The heavy chain Xba I fragment was isolated from the pUC19 plasmid in which it had been inserted and then inserted into the Xba I site of the vector pVγ1 in the correct orientation by standard methods, to produce the plasmid pHuGTAC1 (Figure 7). This plasmid will express high levels of a complete heavy chain when transfected into an appropriate host cell.

The two light chain Xba I - Hind III fragments were isolated from the pUC18 plasmids in which they had been inserted. The vector plasmid pVκ1 was cut with Xba I, dephosphorylated and ligated with the two fragments by standard methods. The desired reaction product has the circular form: vector - Xba I - fragment 1 - Hind III - fragment 2 - Xba I - vector. Several plasmid isolates were analyzed by restriction mapping and sequencing, and one with this form chosen. This plasmid, pHuLTAC (Figure 8), therefore contains the complete humanized light chain (Figure 4) and will express high levels of the light chain when transfected into an appropriate host cell.

Synthesis and affinity of humanized antibody

The plasmids pHuGTAC1 and pHuLTAC were transfected into mouse Sp2/0 cells, and cells that integrated the plasmids were selected on the basis of resistance to mycophenolic acid and/or hygromycin B conferred by the gpt and hyg genes on the plasmids (Figures 7,8) by standard methods. To verify that these cells secreted antibody that binds to the IL-2 receptor, supernatant from the cells was incubated with HUT-102 cells that are known to express the IL-2 receptor. After washing, the cells were incubated with fluorescein-conjugated goat anti-human antibody, washed, and analyzed for fluorescence on a FACSCAN cytofluorometer. The results (Figure 9A), clearly show that the humanized antibody binds to these cells, but not to Jurkat T-cells that do not express the IL-2 receptor (Figure 9D). As controls, the original mouse anti-Tac antibody was also used to stain these cells (Figure 9B,C), giving similar results.

For further experiments, cells producing the humanized antibody were injected into mice, and the resultant ascites collected. Humanized antibody was purified to substantial homogeneity from the ascites by passage through an affinity column of goat anti-human immunoglobulin antibody, prepared on an Affigel-10 support (Bio-Rad Laboratories, Inc., Richmond, CA) according to standard techniques. To determine the affinity of the humanized antibody relative to the original anti-Tac antibody, a competitive binding experiment was performed. About 5×10^5 HUT-102 cells were incubated with known quantities (10 - 40 ng) of the anti-Tac antibody and the humanized anti-Tac antibody for 10 min at 4 °C. Then 100 ng of biotinylated anti-Tac was added to the cells and incubated for 30 min at 4 °C. This quantity of anti-Tac had previously been determined to be sufficient to saturate the binding sites on the cells, but not to be in large excess. Then the cells were washed twice with 2 ml of phosphate buffered saline (PBS) containing 0.1% sodium azide. The cells were then incubated for 30 min at 4 °C with 250 ng of phycoerythrin-conjugated avidin, which bound to the biotinylated anti-Tac already bound to the cells. The cells were washed again as above, fixed in PBS containing 1% paraformaldehyde, and analyzed for fluorescence on a FACSCAN cytofluorometer.

Use of increasing amounts (10 - 40 ng) of the anti-Tac antibody as competitor in the first step decreased the amount of biotinylated anti-Tac that could bind to the cells in the second step, and therefore the amount of phycoerythrin-conjugated avidin that bound in the last step, thus decreasing fluorescence (Figure 10A). Equivalent amounts (20 ng) of anti-Tac, and humanized anti-Tac used as competitor decreased the fluorescence to approximately the same degree (Figure 10B). This shows that these antibodies have approximately the same affinity (within 3 to 4 fold), because if one had much greater affinity, it would have more effectively competed with the biotinylated anti-Tac, thus decreasing fluorescence more.

Biological properties of the humanized antibody

For optimal use in treatment of human disease, the humanized antibody should be able to destroy T-cells in the body that express the IL-2 receptor. One mechanism by which antibodies may destroy target cells is antibody-dependent cell-mediated cytotoxicity, abbreviated ADCC (Fundamental Immunology, Paul, W., Ed., Raven Press, New York (1984), at pg. 681), in which the antibody forms a bridge between the target cell and an effector cell such as a macrophage that can lyse the target. To determine whether the humanized antibody and the original mouse anti-Tac antibody can mediate ADCC, a chromium release assay was performed by standard methods. Specifically, human leukemia HUT-102 cells, which express the IL-2 receptor, were incubated with ⁵¹Cr to allow them to absorb this radionuclide. The HUT-102 cells were then incubated with an excess of either anti-Tac or humanized anti-Tac antibody. The HUT-102 cells were next incubated for 4 hrs with either a 30:1 or 100:1 ratio of effector cells, which were normal purified human peripheral blood mononuclear cells that had been activated by incubation for about 20 hrs with human recombinant IL-2. Release of ⁵¹Cr, which indicated lysis of the target HUT-102 cells, was measured and the background subtracted (Table 1). The results show that at either ratio of effector cells, anti-Tac did not lyse a significant number of the target cells (less than 5%), while the humanized antibody did (more than 20%). Hence, the humanized antibody is likely to be more efficacious than the original mouse antibody in treating T-cell leukemia or other T-cell mediated diseases.

TABLE 1

Percent ⁵¹ Cr release after ADCC		
Effector: Target ratio		
	30:1	100:1
Antibody		
Anti-Tac	4%	< 1%
Humanized anti-Tac	24%	23%

From the foregoing, it will be appreciated that the human-like immunoglobulins of the present invention offer numerous advantages of other antibodies. For example, in comparison to anti-Tac mouse monoclonal antibodies, the present human-like IL-2 receptor immunoglobulins can be more economically produced and contain substantially less foreign amino acid sequences. This reduced likelihood of antigenicity after injection into a human patient represents a significant therapeutic improvement for immunoglobulins designed in accordance with the above criteria.

Claims

1. The use of at least one amino acid substitution outside of complementarity determining regions (CDR's) as defined by Kabat et al ("Sequences of Proteins of Immunological Interest", Kabat, E., et al., US Department of Health and Human Services, (1983)) together with Chothia et al (Chothia and Lesk, J. Mol. Biol., 196:901-917 (1987)) in the production of a humanized immunoglobulin, wherein said amino acid substitution is from the non-CDR variable region of a non-human donor immunoglobulin, and in which humanized immunoglobulin the variable region amino acid sequence other than the CDR's comprises at least 70 amino acid residues identical to an acceptor human immunoglobulin variable region amino acid sequence, and the CDR's are from the variable region of said non-human donor immunoglobulin.
2. A use according to claim 1, wherein said humanized immunoglobulin is specifically reactive with p55 Tac protein, is capable of inhibiting binding of human interleukin-2 (IL-2) to a human IL-2 receptor, or is capable of binding to a human IL-2 receptor.
3. A use according to claim 2, wherein said humanized immunoglobulin exhibits a binding affinity to a human IL-2 receptor of about 10⁸ M⁻¹ or stronger.
4. A use according to claim 2 or claim 3, wherein the mature light and heavy variable region protein sequences of said humanized immunoglobulin are homologous to the mature protein sequences in Figures 3 and 4.
5. A use according to any one of claims 1 to 4, wherein said humanized immunoglobulin is an IgG₁ immunoglobulin isotype.

EP 0 451 216 B1

6. A use according to any one of claims 1 to 5, wherein said substitution is immediately adjacent a CDR.
7. A method of producing a humanized immunoglobulin chain having a framework region from a human acceptor immunoglobulin and complementarity determining regions (CDR's) from a donor immunoglobulin capable of binding to an antigen, said method comprising substituting at least one non-CDR framework amino acid of the acceptor immunoglobulin with a corresponding amino acid from the donor immunoglobulin at a position in the immunoglobulins where:
- (a) the amino acid in the human framework region of the acceptor immunoglobulin is rare for said position and the corresponding amino acid in the donor immunoglobulin is common for said position in human immunoglobulin sequences; or
- (b) the amino acid is immediately adjacent to one of the CDR's; or
- (c) the amino acid is predicted to have a side chain atom capable of interacting with the antigen or with the CDR's of the humanized immunoglobulin.
8. A method according to claim 7, wherein there are at least three of said non-CDR framework amino acids substituted by amino acids from the donor immunoglobulin chosen by criteria (a), (b) or (c).
9. A method according to claim 8, wherein at least one of the amino acids substituted from the donor is immediately adjacent to a CDR.
10. A method according to any one of claims 7 to 9, wherein the mature light and heavy variable region protein sequences of said humanized immunoglobulin are homologous to the mature protein sequences in Figures 3 and 4.
11. A humanized immunoglobulin chain obtainable by a use according to any one of claims 1 to 6.
12. A humanized immunoglobulin chain obtainable by a method according to any one of claims 7 to 10.
13. A humanized immunoglobulin in which the heavy and light chains are chains according to claim 11 or claim 12.
14. A polynucleotide comprising a first sequence coding for a human-like immunoglobulin non-CDR framework region and a second sequence coding for one or more CDR's, wherein upon expression said polynucleotide encodes an immunoglobulin chain of claim 11 or claim 12.
15. Polynucleotides according to claim 14 which upon expression encode the chains constituting an immunoglobulin of claim 13.
16. A cell line transfected with a polynucleotide or polynucleotides of claim 14 or claim 15.
17. A process for the preparation of a humanized immunoglobulin as defined in claim 13, which process comprises cultivating a cell line as defined in claim 16 and isolating the humanized immunoglobulin from the cell culture medium.
18. The use of an immunoglobulin of claim 13 or a binding fragment thereof in the manufacture of a medicament.
19. A use according to claim 18 in which the medicament is suitable for treating T-cell mediated disorders in a human patient.
20. A pharmaceutical preparation which contains a humanized immunoglobulin according to claim 13 formulated in a pharmaceutically acceptable form.
21. A pharmaceutical preparation according to claim 20 and for the treatment of T-cell mediated disorders.

55

Patentansprüche

1. Die Verwendung von mindestens einer Aminosäure-Substitution außerhalb der die Komplementarität bestimmen-

EP 0 451 216 B1

- den Regionen (CDR's), wie bei Kabat et al. ("Sequences of Proteins of Immunological Interest", Kabat, E., et al., US Department of Health and Human Services, (1983)) zusammen mit Chothia et al (Chothia and Lesk, J. Mol. Biol., 196:901-917 (1987)) definiert, für die Herstellung von einem humanisiertem Immunglobulin, in dem die Aminosäure-Substitution von der nicht-CDR-variablen Region von einem nicht menschlichen Donor-Immunglobulin ist, und in dem die Aminosäuresequenz der variablen Region des humanisierten Immunglobulins anders als die CDR's mindestens 70 Aminosäurereste identisch zu einer Aminosäuresequenz der variablen Region von einem menschlichen Akzeptor-Immunglobulin umfassen, und in dem die CDR's von der variablen Region von dem nicht menschlichen Donor-Immunglobulin sind.
- 5
- 10 2. Verwendung nach Anspruch 1, wobei das humanisierte Immunglobulin spezifisch reaktiv für p55 TAC-Protein ist, fähig ist, die Bindung von menschlichem Interleukin-2 (IL-2) zu einem menschlichem IL-2-Rezeptor zu verhindern, oder zur Bindung zu einem menschlichen IL-2-Rezeptor fähig ist.
- 15 3. Verwendung nach Anspruch 2, wobei das humanisierte Immunglobulin eine Bindungsaffinität zu einem menschlichen IL-2-Rezeptor von etwa 10^9 M⁻¹ oder mehr zeigt.
4. Verwendung nach Anspruch 2 oder 3, wobei die Proteinsequenzen der leichten und schweren variablen Region von dem humanisierten Immunglobulin homolog zu der Sequenz des reifen Proteins in Figur 3 und 4 sind.
- 20 5. Verwendung nach einem der Ansprüche 1 - 4, wobei das humanisierte Immunglobulin ein IgG₁ Immunglobulin-Iso-
typ ist.
6. Verwendung nach einem der Ansprüche 1 - 5, wobei die Substitution unmittelbar an eine CDR angrenzt.
- 25 7. Ein Verfahren zur Herstellung einer humanisierten Immunglobulinkette mit einer Rahmenregion von einem menschlichen Akzeptor-Immunglobulin und mit die Komplementarität bestimmenden Regionen (CDR's) von einem Donor-Immunglobulin, die fähig sind, an ein Antigen zu binden, wobei das Verfahren die Substitution von mindestens einer nicht-CDR-Rahmen-Aminosäure des Akzeptor-Immunglobulins durch eine korrespondierende Aminosäure von dem Donor-Immunglobulin an einer Position in den Immunglobulinen umfaßt, wobei:
- 30 (a) die Aminosäure in der menschlichen Rahmenregion des Akzeptor-Immunglobulins selten für diese Position ist und die korrespondierende Aminosäure in dem Donor-Immunglobulin häufig für diese Position in menschlichen Immunglobulinsequenzen ist, oder
- 35 (b) die Aminosäure unmittelbar benachbart zu einer der CDR's ist oder
- (c) die Aminosäure ein Seitenkettenatom hat, das fähig ist, mit dem Antigen oder mit den CDR's des humanisierten Immunglobulins zu interagieren.
- 40 8. Ein Verfahren nach Anspruch 7, in dem mindestens drei der nicht CDR-Rahmen-Aminosäuren substituiert sind durch Aminosäuren des Donor-Immunglobulins, ausgewählt nach den Kriterien (a), (b) oder (c).
9. Ein Verfahren nach Anspruch 8, wobei mindestens eine der durch den Donor substituierten Aminosäuren unmittelbar an eine CDR angrenzt.
- 45 10. Ein Verfahren nach einem der Ansprüche 7 - 9, wobei die Proteinsequenzen der reifen leichten und schweren variablen Region dieses humanisierten Immunglobulins homolog sind zu den Sequenzen des reifen Proteins in Figur 3 und 4.
- 50 11. Eine humanisierte Immunglobulinkette, erhältlich bei einer Verwendung nach einem der Ansprüche 1 - 6.
12. Eine humanisierte Immunglobulinkette, erhältlich bei einem Verfahren nach einem der Ansprüche 7 - 10.
13. Ein humanisiertes Immunglobulin, in dem die schweren und leichten Ketten Ketten nach Anspruch 11 oder 12 sind.
- 55 14. Ein Polynucleotid umfassend eine erste Sequenz kodierend für eine nicht- CDR-Rahmenregion eines menschenähnlichen Immunglobulins und eine zweite Sequenz kodierend für eine oder mehrere CDR's, wobei das Polynucleotid eine Immunglobulinkette nach Anspruch 11 oder 12 kodiert.

EP 0 451 216 B1

15. Polynucleotide nach Anspruch 14, die die Ketten kodieren, die ein Immunglobulin nach Anspruch 13 bilden.
16. Eine Zelllinie transferiert mit einem Polynucleotid oder Polynucleotiden nach Anspruch 14 oder Anspruch 15.
- 5 17. Ein Verfahren zur Herstellung von einem humanisiertem Immunglobulin nach Anspruch 13, wobei das Verfahren die Kultivierung einer Zelllinie nach Anspruch 16 und die Isolierung des humanisierten Immunglobulins aus dem Zellkulturmedium umfaßt.
- 10 18. Die Verwendung eines Immunglobulins des Anspruchs 13 oder eines Bindungsfragments davon für die Herstellung eines Medikaments.
19. Die Verwendung nach Anspruch 18, wobei das Medikament für die Behandlung von T-Zellen-bedingter Störungen bei einem Menschen geeignet ist.
- 15 20. Eine pharmazeutische Zubereitung, die ein humanisiertes Immunglobulin nach Anspruch 13, zubereitet in einer pharmazeutisch akzeptablen Form, enthält.
21. Eine pharmazeutische Zubereitung nach Anspruch 20 für die Behandlung von T-Zellen-bedingter Störungen.

20

Revendications

1. Utilisation d'au moins une substitution d'acide aminé hors des régions hypervariables, également dénommées régions "CDR" (Complementary Determining Regions) selon la définition de Kabat et al ("Sequences of proteins of Immunological Interest", Kabat, E., et al., US Department of Health and Human Services, (1983)) ainsi que Chothia et al (Chothia and Lesk, J. MOL. Biol., 196: 901-917 (1987)) pour la production d'une immunoglobuline humanisée, où ladite substitution d'acide aminé provient de la région variable non-CDR d'une immunoglobuline donneur non-humaine et où dans ladite immunoglobuline humanisée, la séquence en acides aminés de la région variable autre que les régions CDR comprend au moins 70 résidus d'acides aminés identiques à la séquence en acides aminés de la région variable d'une immunoglobuline humaine accepteur, et les CDR proviennent de la région variable de ladite immunoglobuline donneur non-humaine.
- 25 2. Utilisation selon la revendication 1 où ladite immunoglobuline humanisée réagit spécifiquement avec la protéine p55 Tac, est capable d'inhiber la liaison de l'interleukine-2 humaine (IL-2) à un récepteur IL-2 humain, ou est capable de se lier à un récepteur humain pour l'IL-2.
- 35 3. Utilisation selon la revendication 2 où ladite immunoglobuline humanisée possède une affinité de liaison pour un récepteur de l'IL-2 humain d'environ 10^8 M^{-1} ou plus.
- 40 4. Utilisation selon la revendication 2 ou 3 où les séquences protéiques matures de la région variable légère et lourde de ladite immunoglobuline humanisée sont homologues aux séquences protéiques matures des figures 3 et 4.
- 45 5. Utilisation selon l'une quelconque des revendications 1 à 4 où ladite immunoglobuline humanisée est une immunoglobuline d'isotype IgG₁.
6. Utilisation selon l'une quelconque des revendications 1 à 5 où ladite substitution est immédiatement adjacente à une CDR.
- 50 7. Méthode de production d'une chaîne d'immunoglobuline humanisée ayant une région charpente provenant d'une immunoglobuline accepteur humaine et des régions hypervariables (CDR) provenant d'une immunoglobuline donneur capable de se fixer sur un antigène, ladite méthode comprenant la substitution d'au moins un acide aminé charpente non CDR de l'immunoglobuline accepteur par un acide aminé correspondant provenant de l'immunoglobuline donneur à une position dans les immunoglobulines où:
- 55 (a) l'acide aminé dans la région charpente humaine de l'immunoglobuline accepteur et rare pour cette position et l'acide aminé correspondant dans l'immunoglobuline donneur et commun pour ladite position dans les séquences d'immunoglobuline humaines; ou
- (b) l'acide aminé est immédiatement adjacent à l'une des CDR; ou

EP 0 451 216 B1

(c) l'acide aminé est supposé avoir un atome sur une chaîne latérale capable d'interagir avec l'antigène ou avec les CDR de l'immunoglobuline humanisée.

- 5
8. Méthode selon la revendication 7 où il y a au moins trois des dix acides aminés de la région charpente non-CDR qui sont substitués par des acides aminés provenant de l'immunoglobuline donneur choisie en fonction des critères (a), (b) ou (c).
- 10
9. Méthode selon la revendication 8 où au moins l'un des acides aminés substitués provenant du donneur est immédiatement adjacent à un CDR.
- 10
10. Méthode selon l'une quelconque des revendications 7 à 9 où les séquences protéiques matures des régions variables légère et lourde de ladite immunoglobuline humanisée sont homologues aux séquences protéiques matures des figures 3 et 4.
- 15
11. Chaîne d'immunoglobuline humanisée qui peut être obtenue par une utilisation selon l'une quelconque des revendications 1 à 6.
- 20
12. Chaîne d'immunoglobuline humanisée qui peut être obtenue par une méthode selon l'une quelconque des revendications 7 à 10.
- 20
13. Immunoglobuline humanisée dans laquelle les chaînes lourdes et légères sont des chaînes selon les revendications 11 ou 12.
- 25
14. Polynucléotide comprenant une première séquence codant pour une région charpente non-CDR d'une immunoglobuline semblable à une région humaine ("human-like") et une seconde séquence codant pour une ou plusieurs CDR où lors de son expression ledit polynucléotide code une chaîne d'immunoglobuline selon la revendication 11 ou la revendication 12.
- 30
15. Polynucléotides selon la revendication 14 qui lors de leur expression codent les chaînes constituant une immunoglobuline selon la revendication 13.
- 35
16. Lignée cellulaire transfectée avec un polynucléotide ou des polynucléotides selon la revendication 14 ou 15.
- 35
17. Procédé pour la préparation d'une immunoglobuline humanisée tel que défini dans la revendication 13 comprenant la culture d'une lignée cellulaire telle que définie dans la revendication 16 et l'isolement de l'immunoglobuline humanisée du milieu de culture cellulaire.
- 40
18. Utilisation d'une immunoglobuline selon la revendication 13 ou d'un fragment de liaison de celle-ci pour la fabrication d'un médicament.
- 40
19. Utilisation selon la revendication 18 où le médicament est adapté au traitement des désordres médiés par des cellules T chez un patient humain.
- 45
20. Préparation pharmaceutique qui contient une immunoglobuline humanisée selon la revendication 13 formulée sous une forme pharmaceutiquement acceptable.
- 50
21. Préparation pharmaceutique selon la revendication 20 et pour le traitement des désordres médiés par des cellules T.
- 55

1	Q	V	Q	L	Q	Q	S	G	A	E	L	A	K	P	G	A	S	V	K	M
1	Q	V	Q	L	V	Q	S	G	A	E	V	K	K	P	G	S	S	V	K	V
21	S	C	K	A	S	G	Y	T	F	T	S	Y	R	M	H	W	V	K	Q	R
21	S	C	K	A	S	G	G	T	F	S	R	S	A	I	I	W	V	R	Q	A
							*			*										
41	P	G	Q	G	L	E	W	I	G	Y	I	N	P	S	T	G	Y	T	E	Y
41	P	G	Q	G	L	E	W	M	G	G	I	V	P	M	F	G	P	P	N	Y
							*													
61	N	Q	K	F	K	D	K	A	T	L	T	A	D	K	S	S	S	T	A	Y
61	A	Q	K	F	Q	G	R	V	T	I	T	A	D	E	S	T	N	T	A	Y
							*	*												
81	M	Q	L	S	S	L	T	F	E	D	S	A	V	Y	Y	C	A	R	G	
81	M	E	L	S	S	L	R	S	E	D	T	A	F	Y	F	C	A	G	G	Y
												*		*			*			
100	G	G	V	F	D	Y	W	G	Q	G	T	T	L	T	V	S	S			
101	G	I	Y	S	P	E	E	Y	N	G	G	L	V	T	V	S	S			
							*	*	*		*									

FIG. 1.

1	Q	I	V	L	T	Q	S	P	A	I	M	S	A	S	P	G	E	K	V	T
1	D	I	Q	M	T	Q	S	P	S	T	L	S	A	S	V	G	D	R	V	T
21	I	T	C	S	A	S	S	S	I		S	Y	M	H	W	F	Q	Q	K	P
21	I	T	C	R	A	S	Q	S	I	N	T	W	L	A	W	Y	Q	Q	K	P
40	G	T	S	P	K	L	W	I	Y	T	T	S	N	L	A	S	G	V	P	A
41	G	K	A	P	K	L	L	M	Y	K	A	S	S	L	E	S	G	V	P	S
							*													*
60	R	F	S	G	S	G	S	G	T	S	Y	S	L	T	I	S	R	M	E	A
61	R	F	I	G	S	G	S	G	T	E	F	T	L	T	I	S	S	L	Q	P
			*																	
80	E	D	A	A	T	Y	Y	C	H	Q	R	S	T	Y	P	L	T	F	G	S
81	D	D	F	A	T	Y	Y	C	Q	Q	Y	N	S	D	S	K	M	F	G	Q
100	G	T	K	L	E	L	K													
101	G	T	K	V	E	V	K													

FIG. 2.

10 20 30 40 50 60
 TCTAGATGGGATGGAGCTGGATCTTTCTCTTCCTCCTGTCAGGTACCGCGGGCGTGCCT
 M G W S W I F L F L L S G T A G Y H

70 80 90 100 110 120
 CTCAGGTCCAGCTTGCCAGTCTGGGGCTGAAGTCAAGAAACCTGGCTCGAGCGTGAAGG
 S Q V Q L V Q S G A E V K K P G S S V K

130 140 150 160 170 180
 TCTCCTGCAAGGCTTCTGGCTACACCTTTACTAGCTACAGGATGCACTGGGTAAGGCAGG
 V S C K A S G Y T F T S Y R M H W V R Q

190 200 210 220 230 240
 CCCCTGGACAGGGTCTGGAATGGATTGGATATATTAATCCGTCCACTGGGTATACTGAAT
 A P G Q G L E W I G Y I N P S T G Y T E

250 260 270 280 290 300
 ACAATCAGAAGTTCAAGGACAAGGCAACAATTACTGCAGACGAATCCACCAATACAGCCT
 Y N Q K F K D K A T I T A D E S T N T A

310 320 330 340 350 360
 ACATGGAAGTGGAGCAGCCTGAGATCTGAGGACACCGCAGTCTATTACTGTGCAAGAGGGG
 Y M E L S S L R S E D T A V Y Y C A R G

370 380 390 400 410 420
 GGGGGTCTTTGACTACTGGGGCCAAGGAACCCTGGTCACAGTCTCCTCAGGTGAGTCCT
 G G V F D Y W G Q G T L V T V S S

430
 TAAAACCTCTAGA

FIG. 3.

10 20 30 40 50 60
 TCTAGATGGAGACCGATACCGTCCTGCTATGGGTCCTCCTGCTATGGGTCCCAGGATCAA
 M E T D T L L L W V L L L W V P G S

70 80 90 100 110 120
 CCGGAGATATTCAGATGACCCAGTCTCCATCTACCCTCTCTGCTAGCGTCGGGGATAGGG
 T G D I Q M T Q S P S T L S A S V G D R

130 140 150 160 170 180
 TCAGCATAACGTGCTCTGCCAGCTCAAGTATAAGTTACATGCACTGGTACCAGCAGAAGC
 V T I T C S A S S S I S Y M H W Y Q Q K

190 200 210 220 230 240
 CAGGCAAAGCTCCCAAGCTTCTAATTTATACCACATCCAACCTGGCTTCTGGAGTCCCTG
 P G K A P K L L I Y T T S N L A S G V P

250 260 270 280 290 300
 CTGGCTTCAGTGGCAGTGGATCTGGGACCGAGTTCACCCCTCACAATCAGCTCTCTGCAGC
 A R F S G S G S G T E F T L T I S S L Q

310 320 330 340 350 360
 CAGATGATTTGCCACTTATTACTGCCATCAAAGGAGTACTTACCCACTCACGTTGGGTC
 P D D F A T Y Y C H Q R S T Y P L T F G

370 380 390 400
 AGGGGACCAAGGTGGAGGTCAAACGTAAGTACACTTTTCTAGA
 Q G T K V E V K

FIG. 4.

A

HES12 AGCTTCAGATGGGATGGAGCTGGATCTTTCTCTTCCTCCTGTCAGGTACC6CGGGCGTG
 CACTCAGGTCAGCTTGTCCAAGTCTGGGGCTGAA GTC AAGAAACC TGGCTC GAG CGTC
 AAGGTC

HES13 CCCAGTCGACGGATTAATATATCCAATCCATTCCAGAC CCTGTCCAGGGG CCTGCCTTAC
 CCAGTGCATCCTGTAGCTAGTAAAGGTGTAGCCAGAAG CCTTG CAGGAGACCTT CACGCT
 CGAGCCAGG

HES14 TATATTAATCCGTGGA CTGGGTATACTGAATACAATCAGAAG TTC AAGGA CAAGGCAA CA
 ATTACTGCAGACGAATCCACCAATACAG CCTACATGGAAC TGAGCAG CCTGAGATCTGAG
 GACA

HES15 ATATCGTCTAGAGGTTTTAAGGACTCAGCTGAGGAGACTGTGACCAGGGTTCCTTGGCCC
 CAGTAGTCAAAGACCCCCCTCTTGCACAGTAATAGACTGCGGTGT CCTCAGATCTC
 AGGCTGCT

EP 0 451 216 B1

B

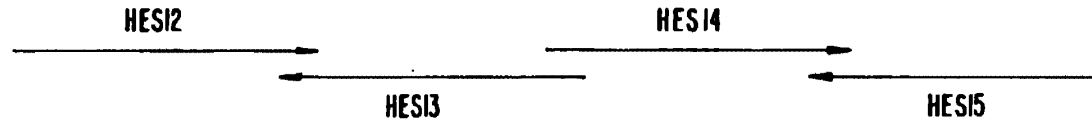

FIG. 5.

A

JFD1 CAAATCTAGATGGAGACCGA TACCCTCCTGCTATGGG TCCTCCTGCTATGGG TCCAGGA
TCAACCGGAGATATT CAGATGACCCA GCTCCATCTACCCTCTCTGCTAGCG TCGGGGAT

JFD2 ATAAATTAGAAGCTTGGGAGCTTTGCCTGGCTTCTGCTGGTACCAGTGCATGTAAC TTAT
ACTTGAGCTGGCAGAGCA GGTATG6TGACCCTATCCCCGACGCTAGCAGAGAG

JFD3 GCTCCCAAGCTTCTAATTTATACCACATCCAACCTGGCTTCTGGAGTCCCTGCTGGCTTC
AGTGGCAGTGGATCTGGGACCGAGTTCAACCCTCACAATCAGCTCTCTGCAGCCAGATGAT
TTC

JFD4 TATACTAGAAAAGTGACTTACGTTTGACCTCCACCTTGGTCCCCTGACCGAACGTGAG
TGGGTAAGTACTCCTTTGATGGCAGTAATAAGTGGCGAAATCATCTGGCTGCAGAGAGCT
CA

B

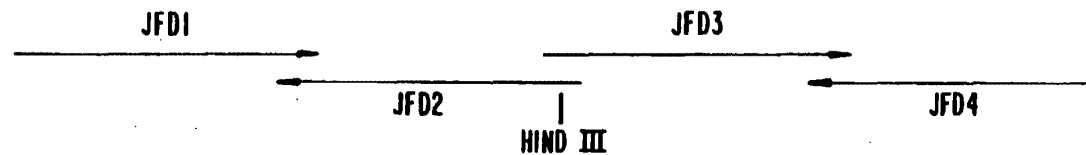

FIG._6.

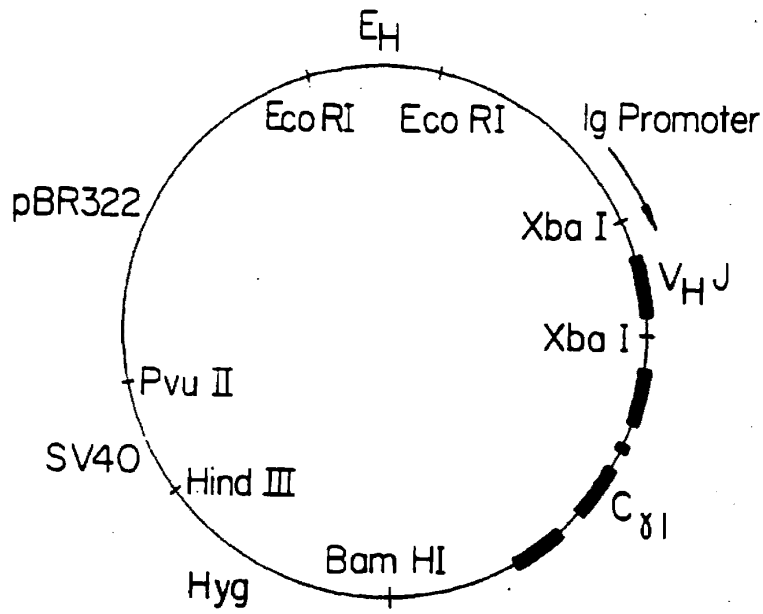

FIG. 7.

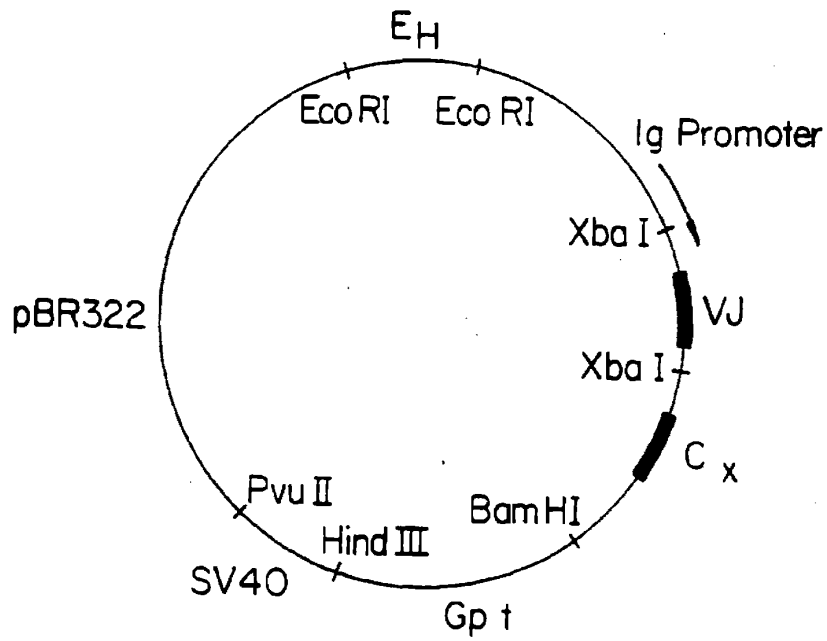

FIG. 8.

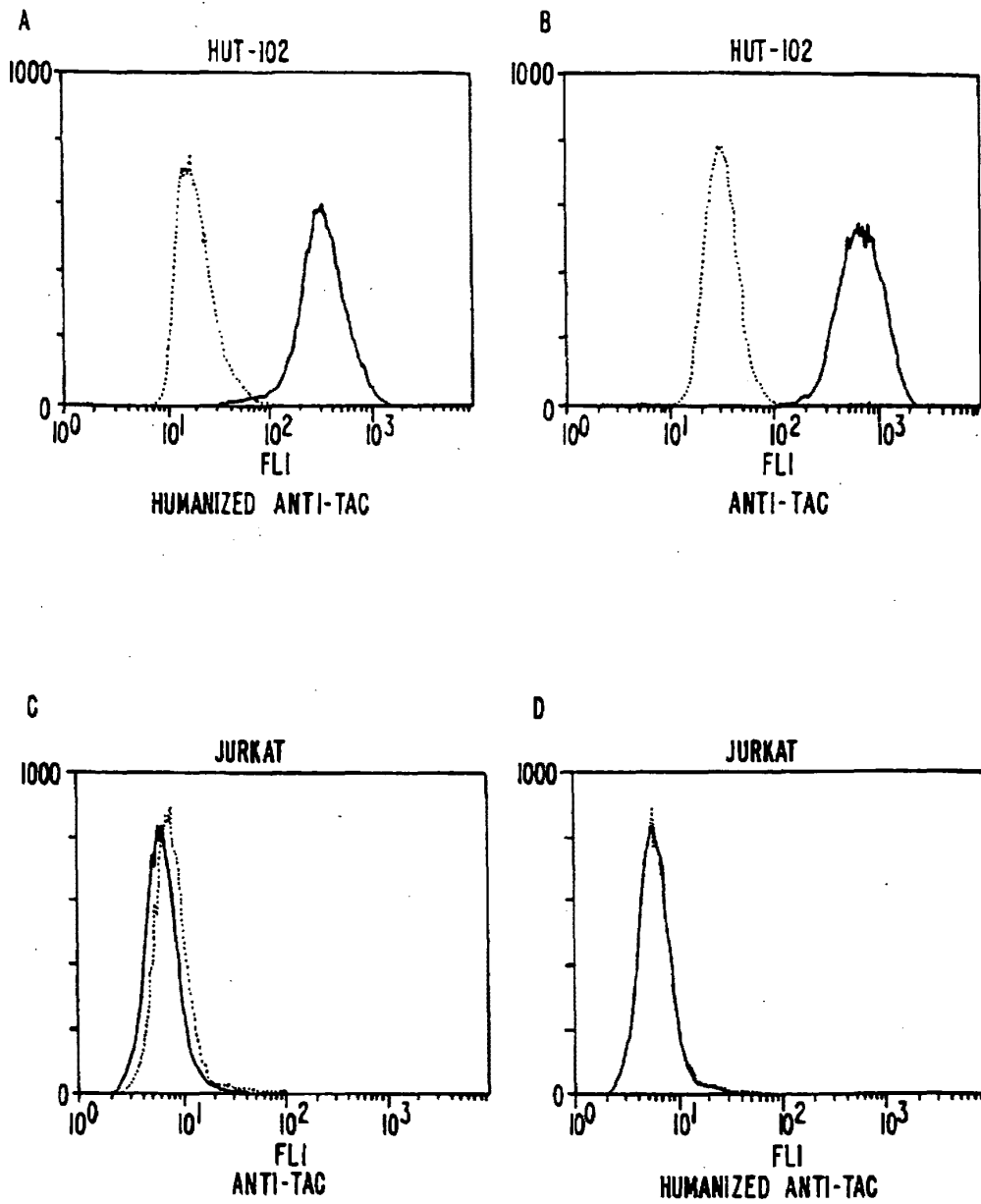

FIG. 9.

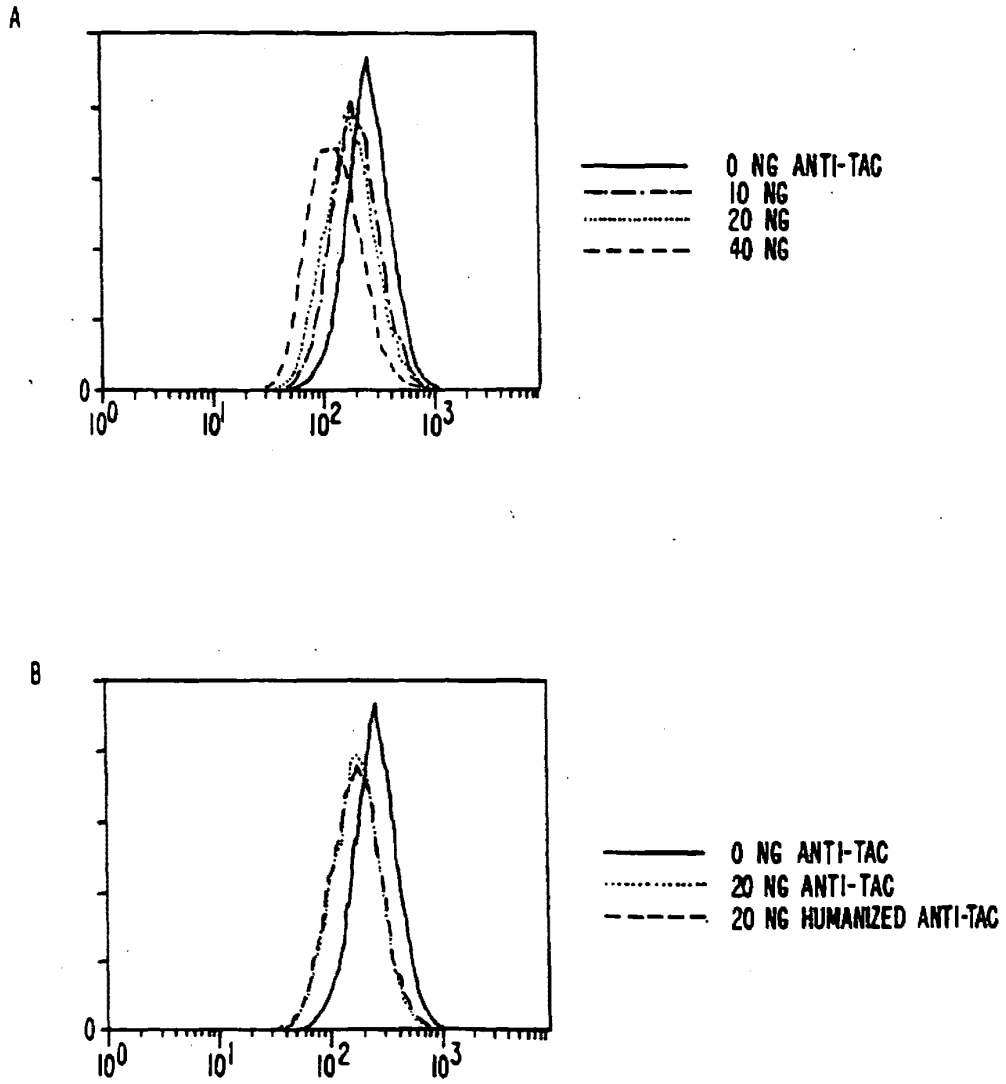

FIG. 10.



INTERNATIONAL APPLICATION PUBLISHED UNDER THE PATENT COOPERATION TREATY (PCT)

<p>(51) International Patent Classification ⁵ : C12P 21/08, C12N 15/13 A61K 39/395, C07K 15/06 C12N 5/10, 15/62</p>	A1	<p>(11) International Publication Number: WO 91/09966 (43) International Publication Date: 11 July 1991 (11.07.91)</p>
<p>(21) International Application Number: PCT/GB90/02015 (22) International Filing Date: 21 December 1990 (21.12.90) (30) Priority data: 8928874.0 21 December 1989 (21.12.89) GB (71) Applicant (for all designated States except US): ORTHO PHARMACEUTICAL CORPORATION [US/US]; US Route # 202, Raritan, NJ 08869 (US). (72) Inventors; and (75) Inventors/Applicants (for US only): JOLLIFFE, Linda, Kay [US/US]; 301 Tall Oak Lane, Somerville, NJ 08876 (US). ZIVIN, Robert, Allan [US/US]; 6 Glenbrook Court, Lawrenceville, NJ 08648 (US). PULITO, Virginia, Lee [US/US]; 37 Winding Way, Flemington, NJ 08822 (US). ADAIR, John, Robert [GB/GB]; 23 George Road, Stokenchurch, High Wycombe, Buckinghamshire HP14 3RN (GB). ATHWAL, Diljeet, Singh [GB/GB]; Flat 35, Knollys House, Tavistock Square, London WC1 (GB).</p>	<p>(74) Agent: MERCER, Christopher, Paul; Carpmals & Ransford, 43 Bloomsbury Square, London WC1A 2RA (GB). (81) Designated States: AT, AT (European patent), AU, BB, BE (European patent), BF (OAPI patent), BG, BJ (OAPI patent), BR, CA, CF (OAPI patent), CG (OAPI patent), CH, CH (European patent), CM (OAPI patent), DE, DE (European patent), DK, DK (European patent), ES, ES (European patent), FI, FR (European patent), GA (OAPI patent), GB, GB (European patent), GR, GR (European patent), HU, IT (European patent), JP, KP, KR, LK, LU, LU (European patent), MC, MG, ML (OAPI patent), MR (OAPI patent), MW, NL, NL (European patent), NO, RO, SD, SE, SE (European patent), SN (OAPI patent), SU, TD (OAPI patent), TG (OAPI patent), US. Published <i>With international search report. Before the expiration of the time limit for amending the claims and to be republished in the event of the receipt of amendments.</i></p>	
<p>(54) Title: CD4 SPECIFIC RECOMBINANT ANTIBODY</p>		
<p>(57) Abstract</p> <p>There are disclosed: a CDR-grafted antibody having at least one chain wherein the framework regions are predominantly derived from a first antibody (acceptor) and at least one CDR is derived from a second antibody (donor), the CDR-grafted antibody being capable of binding to the CD4 antigen; processes for its production; nucleotide sequences for use in its production; compositions containing it; and its use in therapy.</p>		

FOR THE PURPOSES OF INFORMATION ONLY

Codes used to identify States party to the PCT on the front pages of pamphlets publishing international applications under the PCT.

AT	Austria	ES	Spain	MG	Madagascar
AU	Australia	FI	Finland	ML	Mali
BB	Barbados	FR	France	MN	Mongolia
BE	Belgium	GA	Gabon	MR	Mauritania
BF	Burkina Faso	GB	United Kingdom	MW	Malawi
BG	Bulgaria	GN	Guinea	NL	Netherlands
BJ	Benin	GR	Greece	NO	Norway
BR	Brazil	HU	Hungary	PL	Poland
CA	Canada	IT	Italy	RO	Romania
CF	Central African Republic	JP	Japan	SD	Sudan
CG	Congo	KP	Democratic People's Republic of Korea	SE	Sweden
CH	Switzerland	KR	Republic of Korea	SN	Senegal
CI	Côte d'Ivoire	LI	Liechtenstein	SU	Soviet Union
CM	Cameroon	LK	Sri Lanka	TD	Chad
CS	Czechoslovakia	LU	Luxembourg	TC	Togo
DE	Germany	LV	Monaco	US	United States of America
DK	Denmark				

CD4 SPECIFIC RECOMBINANT ANTIBODY

The present invention relates to CDR-grafted antibody molecules, to processes for their production using recombinant DNA technology and to their therapeutic uses.

In the present application, various prior art references are cited. These are referred to by a number given in square brackets []. The references are listed in numerical order at the end of the description.

In the present application, "Ig" is used to describe natural immunoglobulins. Natural immunoglobulins have been known for many years and comprise a generally Y-shaped molecule having an antigen-binding site towards the end of each upper arm. The remainder of the structure, and particularly the stem of the Y, mediates the effector functions associated with Igs. Various fragments of Igs, such as the Fab, (Fab')₂, Fv and Fc fragments, which can be derived by enzymatic cleavage, are also known.

Natural Igs comprise two heavy chains and two light chains, the N-terminal ends of each pair of heavy and light chains being associated and forming the antigen binding sites. The C-terminal ends of the heavy chains associate to form the Fc portion.

The residue designations for Ig light and heavy chains given in the present description and claims are in accordance with the numbering scheme developed by Kabat [1] and [2]. Thus, the residue designations do not always correspond directly with the linear numbering of the amino acid residues. The actual linear amino acid sequence may contain fewer or additional amino acid residues than in the strict Kabat numbering, thus showing that there have been insertions or deletions. These insertions or

deletions may be present anywhere within the chains. The correct numbering of residues may be determined for a given Ig by alignment at regions of homology of the sequence of the Ig with a "standard" Kabat numbered sequence.

It was determined from a study of the amino acid sequences of a large number of Igs that the variable domains, which are located at the N-terminal ends of the chains, of both the heavy and the light chains contained three regions in which the amino acid sequence was hypervariable. These hypervariable regions are flanked on each side by regions which varied substantially less in sequence [1] and [2]. It was conjectured that the hypervariable regions are involved in antigen binding.

More recently, structural studies using X-ray crystallography and molecular modelling have defined three regions in the variable domains of each of the heavy and light chains which appear to be involved in antigen binding [47]. These three regions are generally referred to as the complementarity determining regions (CDRs). The CDRs are brought together by the remaining regions of the variable domains to form at least part of the antigen binding site. These remaining regions are generally referred to as the framework regions.

It will be appreciated that some workers in the art, and in particular Kabat [1] and [2], have referred to the hypervariable regions as being CDRs. For the sake of clarity, in this specification the term hypervariable region is used only to describe antigen binding regions determined by sequence analysis and the term CDR is used to describe antigen binding regions determined by structural analysis.

SUBSTITUTE SHEET

A comparison of the hypervariable regions, as determined by sequence analysis, and the CDRs, as determined by structural studies, shows that there is some, but not complete, correspondence between these regions.

5

In the present application, the term "antibody" is used to describe Igs or any fragments thereof, light chain or heavy chain monomers or dimers, and single chain antibodies, such as a single chain Fvs in which the heavy and light chain variable domains are joined by a peptide linker, whether natural or produced by recombinant DNA technology or otherwise, provided that the antibody includes at least one antigen binding site. The remainder of the antibody need not comprise only Ig-derived protein sequences. For instance, a gene may be constructed in which a DNA sequence encoding part of a human Ig chain is fused to a DNA sequence encoding the amino acid sequence of a polypeptide effector or reporter molecule. Thus, "antibody" encompasses hybrid antibodies (see below).

10
15
20

The abbreviation "MAb" is used to indicate a monoclonal antibody as produced by a hybridoma or derivative cell line.

25 The term "recombinant antibody" is used to describe an antibody produced by a process involving the use of recombinant DNA technology.

30 The term "chimeric antibody" is used to describe an antibody in which the variable domains as a whole are derived from an antibody from a first mammalian species and have been fused onto at least one constant domain from an antibody from a different mammalian species.

35 The term "hybrid antibody" is used to describe a protein comprising at least the antigen binding portion of an Ig attached by peptide linkage to at least part of another

protein. It will be appreciated that certain skilled workers may also use the word "chimeric" to describe such constructs, but in the present specification such constructs are referred to as hybrid antibodies and the term chimeric antibodies is used in the sense defined above.

The term "CDR-grafted antibody" is used to describe an antibody having at least one, and preferably two or three, of its CDRs in one or both of the variable domains derived from an antibody from a first species, the remaining Ig-derived parts of the antibody being derived from one or more different antibodies. The variable domains may be made by use of recombinant DNA technology or by peptide synthesis.

"Expression vector" includes vectors which are capable of expressing DNA sequences contained therein, i.e. the coding sequences are operably linked to other sequences capable of effecting their expression. A useful, but not always necessary (i.e. insect cells), element of an effective expression vector is a marker encoding sequence, i.e. a sequence encoding a vector sequence which results in a phenotypic property (e.g. neomycin resistance, methionine sulfoximine resistance or tryptophan prototrophy) of the cells containing the protein which permits those cells to be readily identified. In sum, "expression vector" is given a functional definition and any DNA sequence which is capable of effecting expression of a specified contained DNA code is included in this term as it is applied to the specified sequence. As at present, such vectors are frequently in the form of plasmids. Thus "plasmid" and "expression vector" are often used interchangeably. However, the invention is intended to include such other forms of expression vectors which serve equivalent functions and which may, from time

SUBSTITUTE SHEET

to time, become known in the art, including retroviruses, *in vitro* systems [48] and the like.

As stated previously, the DNA sequences will be expressed
5 in host cells after the sequences have been operably
linked to (i.e. positioned to ensure the functioning of)
an expression control sequence. These expression vectors
are typically replicable in the host organisms either as
10 episomes or as an integral part of the host chromosomal
DNA.

"Recombinant host cells" refers to cells which have been
transformed with vectors constructed using recombinant DNA
techniques. By virtue of this transformation, the host
15 cell is able to produce the desired product in useful
quantities, rather than in lesser amounts, or more
commonly, in less than detectable amounts, as one would
expect to be produced by the untransformed host. The
antibody of the present invention may be produced by a
20 recombinant host cell in quantities useful to carry out
additional experimentation or in commercial quantities
such as about a kilogram or more.

In descriptions of processes for isolation of antibodies
25 from recombinant hosts, the terms "cell" and "cell
culture" are used interchangeably to denote the source of
antibody unless it is clearly specified otherwise. In
other words, recovery of antibody from the "cells" may
mean either from spun down whole cells, or from the cell
30 culture containing both the medium and the suspended
cells, or, additionally, as is possible in the case of
myeloma cell lines, from ascites culture.

Natural Igs have been used in assay, diagnosis and, to a
35 more limited extent, therapy. However, such uses,
especially in therapy, have been hindered by the
polyclonal nature of natural Igs. A significant step

towards the realization of the potential of Igs as therapeutic agents was the discovery of techniques for the preparation of MABs of defined specificity. MABs are generally produced by fusions of rodent spleen cells with
5 rodent myeloma cells, and thus are essentially rodent proteins. However, there are very few reports of the successful production of human MABs.

A series of MABs having specificities for antigens on T
10 lymphocytes and subsets of T lymphocytes is described in EP-A-0 017 381, EP-A-0 018 794, EP-A-0 019 195, EP-A-0 025 722, EP-A-0 030 450, EP-A-0 030 814 and EP-A-0 033 578.

15 Since most available MABs are entirely of rodent origin, they are naturally antigenic in humans and thus can give rise to an undesirable immune response, such as one response termed the Human Anti-Mouse Antibody (HAMA) response. Therefore, the use of rodent MABs as
20 therapeutic agents in humans is inherently limited by the fact that the human subject may mount an immunological response to the MAB and will either remove it entirely or at least reduce its effectiveness. Thus, in practice, MABs of rodent origin are not generally recommended for
25 use in patients for more than one or a few treatments, as a HAMA response may develop, rendering the MAB ineffective as well as giving rise to undesirable side reactions.

Proposals have therefore been made to render non-human
30 MABs less antigenic in humans. Such techniques can be generically termed "humanization" techniques. These techniques generally involve the use of recombinant DNA technology to manipulate DNA sequences encoding the polypeptide chains of the antibody molecule.

35

In recent years advances in molecular biology based on

SUBSTITUTE SHEET

production of a wide range of heterologous polypeptides by transformation of host cells with heterologous DNA sequences which code for the production of the desired products.

5

EP-A-0 088 994 (Schering Corporation) proposes the construction of recombinant DNA vectors comprising a ds DNA sequence which codes for the variable domain of a light or a heavy chain of an Ig specific for a predetermined ligand. The ds DNA sequence is provided with initiation and termination codons at its 5'- and 3'-termini respectively but lacks any nucleotides coding for amino acids superfluous to the variable domain. The ds DNA sequence is used to transform bacterial cells. The application does not contemplate variations in the sequence of the variable domain.

20

EP-A-0 102 634 (Takeda Chemical Industries Limited) describes the cloning and expression in bacterial host organisms of genes coding for the whole or a part of a human IgE heavy chain polypeptide, but does not contemplate variations in the sequence of the polypeptide.

25

EP-A-0 125 023 (Genentech Inc.) proposes the use of recombinant DNA techniques in bacterial cells to produce Igs which are analagous to those normally found in vertebrate systems and to take advantage of the gene modification techniques proposed therein to construct chimeric antibodies or other modified forms of antibody.

30

It is believed that the proposals set out in the above Genentech application did not lead to the expression of any significant quantities of Ig polypeptide chains, nor to the production of Ig activity, nor to the secretion and assembly of the chains into the desired chimeric antibodies.

35

The recent emergence of techniques allowing the stable introduction of Ig gene DNA into mammalian cells [3] to [5] has opened up the possibility of using *in vitro* mutagenesis and DNA transfection to construct recombinant antibodies possessing novel properties.

However, it is known that the function of an antibody molecule is dependent on its three dimensional structure, which in turn is dependent on its primary amino acid sequence. Thus, changing the amino acid sequence of an antibody may adversely affect its activity. Moreover, a change in the DNA sequence coding for the antibody may affect the ability of the cell containing the DNA sequence to express, secrete or assemble the antibody.

It is therefore not at all clear that it will be possible to produce functional altered antibodies by recombinant DNA techniques. However, colleagues of the present inventors have devised a process whereby hybrid antibodies in which both parts of the protein are functional can be secreted. This process is disclosed in International Patent Application No. PCT/GB85/00392. However, the above PCT application only shows the production of hybrid antibodies in which complete variable domains are coded for by the first part of the DNA sequence. It does not show hybrid antibodies in which the sequence of the variable domain has been altered.

EP-A-0 239 400 describes a process in which the CDRs of a mouse MAb have been grafted onto the framework regions of the variable domains of a human Ig by site directed mutagenesis using long oligonucleotides. The inventors allude to the possibility of altering the natural amino acid sequence of the framework regions as well.

The earliest work on altering MAbs by CDR-grafting was carried out on MAbs recognizing synthetic antigens, such

as the NP or NIP antigens. However, examples in which a mouse MAb recognizing lysozyme and a rat MAb recognizing an antigen on human T-cells respectively were humanized by CDR-grafting have been described [6] and [7].

5

Reference [7] shows that transfer of the CDRs alone (as defined in that paper) was not sufficient to provide satisfactory antigen binding activity in the CDR-grafted product. Reference [7] shows that it was necessary to convert a serine residue at position 27 of the human sequence to the corresponding rat phenylalanine residue to obtain a CDR-grafted product having satisfactory antigen binding activity. This residue at position 27 of the heavy chain is within the structural loop adjacent to CDR1. A further construct which additionally contained a human serine to rat tyrosine change at position 30 of the heavy chain did not have a significantly altered binding activity over the CDR-grafted antibody with the serine to phenylalanine change at position 27 alone. These results indicate that, for CDR-grafted antibodies which recognize more complex antigens, changes to residues of the human sequence outside the CDR regions, in particular in the loop adjacent to CDR1, may be necessary to obtain effective antigen binding activity.

25

Techniques have also recently been described for altering an anti-TAC monoclonal antibody by CDR-grafting. Human framework regions were chosen to maximize homology with the anti-TAC antibody sequence, while several additional amino acids outside the CDRs were retained. The anti-TAC antibody so altered has an affinity for the p55 chain of human interleukin-2 of about one third that of murine anti-TAC [8].

30

PCT/US89/05857 also describes CDR-grafted antibodies which are specific for the p55 TAC protein of the IL-2 receptor. It is therein stated that the CDR-grafted antibody may

35

SUBSTITUTE SHEET

require that 3 or more amino acid residues from the donor Ig in addition to the CDRs, usually at least one of which is immediately adjacent to a CDR in the donor Ig, be changed to correspond to that of the donor antibody in order to obtain antigen binding activity.

It is therefore readily apparent that it is not a simple matter to produce a CDR-grafted antibody. It is often not sufficient merely to graft the CDRs from a donor Ig onto the framework regions from an acceptor Ig. It may also be necessary to alter residues in the framework regions of the acceptor antibody in order to obtain binding activity. However, it is not possible to predict, on the basis of the available prior art, which, if any, framework residues will need to be altered.

EP-A-0 018 794 describes a murine MAb which recognises an antigen characteristic of human helper T cells. A particular example of such an MAb is described in the application and is designated OKT4. The antigen it recognises is generally referred to as the CD4 antigen. The MAb is commercially available from Ortho Diagnostic Systems Inc. of Raritan, New Jersey, USA. Also available from the same supplier is a murine MAb known as OKT4A. This recognises a different epitope on the CD4 antigen from the one recognised by OKT4.

Transplantation experiments in primates have indicated that both OKT4 and OKT4A can extend graft survival and may be useful as an immunomodulator in humans. Experience from the treatment of renal transplant patients with the murine MAb OKT3 has shown that sometimes a population of patients develops neutralizing antibodies to OKT3. This immune response precludes repeat administration. To diminish the anticipated immune response to murine anti-CD4 MAbs, it would be desirable to produce a CDR-grafted

SUBSTITUTE SHEET

version of OKT4A having murine CDRs and human framework and other Ig derived regions.

5 However, as described above, the simple approach to constructing a CDR-grafted antibody does not always result in an antibody which effectively binds the antigen. The exact residues which comprise the CDRs are difficult to define and do not necessarily correspond to all the residues in the hypervariable regions. There may also be
10 critical framework residues which are important in positioning the CDRs for interaction with antigen or which are involved in interactions between the heavy and light chains. It may be necessary to alter certain framework residues so that they correspond to the murine residues at
15 these positions, rendering the CDR-grafted antibody less "human" in character.

20 Despite the problems which are inherent in attempting to produce a specific CDR-grafted antibody, in a preferred embodiment the present inventors have succeeded in producing a CDR-grafted antibody based on human framework regions and having an antigen binding site which recognises the CD4 antigen. In certain particularly preferred embodiment, the CDR-grafted antibody has an
25 affinity for the CD4 antigen similar to that of the murine MAb OKT4A.

30 Therefore, according to the present invention, there is provided a CDR-grafted antibody having at least one chain wherein the framework regions are predominantly derived from a first antibody (acceptor) and at least one CDR is derived from a second antibody (donor), the CDR-grafted antibody being capable of binding to the CD4 antigen.

35 Preferably, the CDR-grafted chain has two and, most preferably, all three CDRs derived from the donor antibody.

Advantageously, in the CDR-grafted chain, the or each CDR comprises a composite CDR comprising all the residues from the CDR and all the residues in the corresponding hypervariable region of the donor antibody.

5

Preferably, at least one residue in the framework regions of the CDR-grafted chain has been altered so that it corresponds to the equivalent residue in the antibody.

10

Preferably, the framework regions of the CDR-grafted chain are derived from a human antibody.

15

Advantageously, the framework regions of the CDR-grafted chain are derived from a human Ig heavy chain. For such heavy chains, it is preferred that residue 35 in the heavy chain framework regions be altered so that it corresponds to the equivalent residue in the donor antibody.

20

Advantageously, for such heavy chains, at least one composite CDR comprising residues 26 to 35, 50 to 65 or 95 to 102 respectively is grafted onto the human framework. It will be appreciated in this case that residue 35 will already correspond to the equivalent residue in the donor antibody.

25

Preferably, residues 23, 24 and 49 in such heavy chains correspond to the equivalent residues in the antibody. It is more preferred that residues 6, 23, 24, 48 and 49 in such heavy chains correspond to the donor antibody in equivalent residue positions. If desired, residues 71, 73 and 79 can also so correspond.

30

To further optimise affinity, any one or any combination of residues 57, 58, 60, 88 and 91 may correspond to the equivalent residue in the donor antibody.

35

The heavy chain is preferably derived from the human KOL heavy chain. However, it may also be derived from the human NEWM or EU heavy chain.

5 Alternatively, the framework regions of the CDR-grafted chain may be derived from a human kappa or lambda light chain. For such a light chain, advantageously at least one composite CDR comprising residues 24 to 34, 50 to 56
10 or 89 to 97 respectively is grafted onto the human framework. Preferably, residue 49 also corresponds to the equivalent residue in the donor antibody.

To further optimise affinity, it is preferable to ensure that residues 49 and 89 correspond to the equivalent
15 residues in the donor antibody. It may also be desirable to select equivalent donor residues that form salt bridges.

The light chain is preferably derived from the human REI
20 light chain. However, it may also be derived from the human EU light chain.

Preferably, the CDR-grafted antibody of the present invention comprises a light chain and a heavy chain, one
25 or, preferably, both of which have been CDR-grafted in accordance with the principles set out above for the individual light and heavy chains.

In the preferred case, it is advantageous that all three
30 CDRs on the heavy chain are altered and that minimal alteration is made to the light chain. It may be possible to alter none, one or two of the light chain CDRs and still retain binding affinity at a reasonable level.

35 It will be appreciated that in some cases, for both heavy and light chains, the donor and acceptor residues may be

identical at a particular position and thus no change of acceptor framework residue will be required.

5 It will also be appreciated that in order to retain as far as possible the human nature of the CDR-grafted antibody, as few residue changes as possible should be made. It is envisaged that in many cases, it will not be necessary to change more than the CDRs and a small number of framework residues. Only in exceptional cases will it be necessary
10 to change a larger number of framework residues.

Preferably, the CDR-grafted antibody is a complete Ig, for example of isotype IgG₁ or IgG₄.

15 If desired, one or more residues in the constant domains of the Ig may be altered in order to alter the effector functions of the constant domains.

20 Preferably, the CDR-grafted antibody has an affinity for the CD4 antigen of between about $10^5 \cdot M^{-1}$ to about $10^{12} \cdot M^{-1}$, more preferably at least $10^8 \cdot M^{-1}$, and most preferably the affinity is similar to that of MAb OKT4 or OKT4A.

25 Advantageously, the or each CDR is derived from a mammalian antibody and preferably is derived from a murine MAb.

30 Advantageously, the CDR-grafted antibody of the present invention is produced by use of recombinant DNA technology.

35 According to a second aspect of the present invention, there is provided a method for producing a CDR-grafted antibody according to the first aspect of the present invention, which method comprises:
providing a first DNA sequence, encoding a first antibody chain in which the framework regions are predominantly

SUBSTITUTE SHEET

derived from a first antibody (acceptor) and at least one CDR is derived from a second antibody (acceptor), under the control of suitable upstream and downstream elements; transforming a host cell with the first DNA sequence; and
5 culturing the transformed host cell so that a CDR-grafted antibody according to the first aspect of the invention is produced.

Preferably, the method further comprises:
10 providing a second DNA sequence, encoding a second antibody chain complementary to the first chain, under the control of suitable upstream and downstream elements; and transforming the host cell with both the first and second DNA sequences.

15 Advantageously, the second DNA sequence encodes a second antibody chain in which the framework regions are predominantly derived from a first antibody (acceptor) and at least one CDR is derived from the second antibody
20 (donor).

The first and second DNA sequences may be present on the same vector. In this case, the sequences may be under the control of the same or different upstream and/or
25 downstream elements.

Alternatively, the first and second DNA sequences may be present on different vectors.

30 According to a third aspect of the present invention, there is provided a nucleotide sequence which encodes an antibody chain in which the framework regions are predominantly derived from a first antibody (acceptor) and at least one CDR is derived from a second antibody
35 (donor), the antibody chain being capable of forming a CDR-grafted antibody according to the first aspect of the present invention.

It is envisaged that the CDR-grafted antibodies of the present invention will be of particular use in therapy, in particular in treating graft rejections or in treating helper T cell disorders.

5

The CDR-grafted antibodies of the present invention may be produced by a variety of techniques, with expression in transfected cells, such as yeast, insect, CHO or myeloma cells, being preferred. Most preferably, the host cell is a CHO host cell.

10

To design a CDR-grafted antibody, it is first necessary to ascertain the variable domain sequence of an antibody having the desired binding properties. Suitable source cells for such DNA sequences include avian, mammalian or other vertebrate sources such as chickens, mice, rats and rabbits, and preferably mice. The variable domain sequences (V_H and V_L) may be determined from heavy and light chain cDNA, synthesized from the respective mRNA by techniques generally known to the art. The hypervariable regions may then be determined using the Kabat method [2]. The CDRs may be determined by structural analysis using X-ray crystallography or molecular modelling techniques. A composite CDR may then be defined as containing all the residues in one CDR and all the residues in the corresponding hypervariable region. These composite CDRs along with certain select residues from the framework region are preferably transferred as the "antigen binding sites", while the remainder of the antibody, such as the heavy and light chain constant domains and remaining framework regions, may be based on human antibodies of different classes. Constant domains may be selected to have desired effector functions appropriate to the intended use of the antibody so constructed. For example, human IgG isotypes, IgG₁ and IgG₂, are effective for complement fixation and cell mediated lysis. For other

15

20

25

30

35

SUBSTITUTE SHEET

purposes other isotypes, such as IgG₂ and IgG₄, or other classes, such as IgM and IgE, may be more suitable.

5 For human therapy, it is particularly desirable to use human isotypes, to minimize antiglobulin responses during therapy. Human constant domain DNA sequences, preferably in conjunction with their variable domain framework bases can be prepared in accordance with well-known procedures. An example of this is CAMPATH 1H available from Burroughs
10 Wellcome Ltd.

In accordance with preferred embodiments of the present invention, certain CDR-grafted antibodies are provided which contain select alterations to the human-like
15 framework region (in other words, outside of the CDRs of the variable domains), resulting in a CDR-grafted antibody with satisfactory binding affinity. Such binding affinity is preferably from about $10^5.M^{-1}$ to about $10^{12}.M^{-1}$ and is more preferably at least about $10^8.M^{-1}$. Most preferably
20 the binding affinity is about equal to that of murine MAB OKT4A.

In constructing the CDR-grafted antibodies of the present invention, the V_H and/or V_L gene segments may be altered by
25 mutagenesis. One skilled in the art will also understand that various other nucleotides coding for amino acid residues or sequences contained in the Fc portion or other areas of the antibody may be altered in like manner (see, for example, PCT/US89/00297).

30 Exemplary techniques include the addition, deletion or nonconservative substitution of a limited number of various nucleotides or the conservative substitution of many nucleotides, provided that the proper reading frame
35 is maintained.

Substitutions, deletions, insertions or any subcombination may be used to arrive at a final construct. Since there are 64 possible codon sequences but only twenty known amino acids, the genetic code is degenerate in the sense that different codons may yield the same amino acid. However, the code is precise for each amino acid. Thus there is at least one codon for each amino acid, i.e. each codon yields a single amino acid and no other. It will be apparent that during translation, the proper reading frame must be maintained in order to obtain the proper amino acid sequence in the polypeptide ultimately produced.

Techniques for additions, deletions or substitutions at predetermined amino acid sites having a known sequence are well known. Exemplary techniques include oligonucleotide-mediated site-directed mutagenesis and the polymerase chain reaction.

Oligonucleotide site-directed mutagenesis in essence involves hybridizing an oligonucleotide coding for a desired mutation with a single strand of DNA containing the region to be mutated and using the single strand as a template for extension of the oligonucleotide to produce a strand containing the mutation. This technique, in various forms, is described in references [9] to [12].

Polymerase chain reaction (PCR) in essence involves exponentially amplifying DNA *in vitro* using sequence specific oligonucleotides. The oligonucleotides can incorporate sequence alterations if desired. The polymerase chain reaction technique is described in reference [13]. Examples of mutagenesis using PCR are described in references [14] to [17].

The nucleotide sequences of the present invention, capable of ultimately expressing the desired CDR-grafted antibodies, can be formed from a variety of different

SUBSTITUTE SHEET

polynucleotides (genomic DNA, cDNA, RNA or synthetic oligonucleotides). At present, it is preferred that the polynucleotide sequence comprises a fusion of cDNA and genomic DNA. The polynucleotide sequence may encode
5 various Ig components (e.g. V, J, D, and C domains). They may be constructed by a variety of different techniques. Joining appropriate genomic and cDNA sequences is presently the most common method of production, but cDNA sequences may also be utilized (see EP-A-0 239 400 and
10 [7]).

Certain suitable expression vectors and host cells are described in US-A-4 816 567.

15 The vectors and methods disclosed herein are suitable for use in host cells over a wide range of prokaryotic and eukaryotic organisms.

In general, of course, prokaryotes are preferred for
20 cloning of DNA sequences for constructing the vectors useful in the invention. For example, *E. coli* DH5 α is particularly useful. This example is, of course, intended to be illustrative rather than limiting.

25 Prokaryotes may also be used for expression. The aforementioned *E. Coli* strains, *bacilli* such as *Bacillus subtilus*, and other enterobacteriaceae, such as *Salmonella typhimurium* or *Serratia marcesans*, and various *Pseudomonas* species may be used.

30 In general, plasmid vectors containing replicon and control sequences which are derived from species compatible with the host cell are used in connection with these hosts. The vector ordinarily carries a replication
35 site as well as marking sequences which are capable of providing phenotypic selection in transformed cells. For example, *E. Coli* is typically transformed using one of the

SUBSTITUTE SHEET

many derivatives of pBR322, a plasmid derived from an *E. Coli* species [18]. pBR322 contains genes for ampicillin and tetracycline resistance and thus provides easy means for identifying transformed cells. The pBR322 plasmid, its descendents or other microbial plasmids may also contain, or be modified to contain, promoters which can be used by the microbial organism for the expression of recombinant proteins. Those promoters commonly used in recombinant DNA construction include lactose promoter systems [19] to [21] and tryptophan (*trp*) promoter systems [22] and EP-A-0 036 776. While these are the most commonly used, other microbial promoters have been discovered and utilized, and details concerning their nucleotide sequences have been published, enabling a skilled worker to ligate them functionally into plasmid vectors [23].

In addition to prokaryotes, eukaryotic microbes, such as yeast cultures, may also be used. *Saccharomyces cerevisiae*, or common baker's yeast, is the most commonly used among eukaryotic microorganisms, although a number of other strains are commonly available. For expression in *Saccharomyces*, the plasmid YRp7, for example, [24] to [26] is commonly used. This plasmid already contains the *trp1* gene which provides a selection marker for a mutant strain of yeast lacking the ability to grow in tryptophan, for example ATCC No. 44076 or PEP4-1 [27]. The presence of the *trp1* lesion as a characteristic of the yeast host cell genome then provides an effective environment for detecting transformation by growth in the absence of tryptophan.

Suitable promoting sequences in yeast vectors include the promoters for 3-phosphoglycerate kinase [28] or other glycolytic enzymes, such as enolase, glyceraldehyde-3-phosphate dehydrogenase, hexokinase, pyruvate decarboxylase, phosphofructokinase,

SUBSTITUTE SHEET

glucose-6-phosphate isomerase, 3-phosphoglycerate mutase, pyruvate kinase, triosephosphate isomerase, phosphoglucose isomerase and glucokinase [29] and [30]. In constructing suitable expression plasmids, the termination sequences
5 associated with these genes are also ligated into the expression vector 3' of the sequence desired to be expressed to provide polyadenylation of the mRNA and termination. Other promoters, which have the additional advantage of transcription controlled by growth conditions
10 are the promoter regions for alcohol dehydrogenase 2, isocytochrome C, acid phosphatase, degradative enzymes associated with nitrogen metabolism and the aforementioned glyceraldehyde-3-phosphate dehydrogenase, an enzyme responsible for maltose and galactose utilization [30].
15 Any plasmid vector containing a yeast compatible promoter, origin of replication and termination sequences is suitable.

In addition to microorganisms, cultures of cells derived
20 from multicellular organisms may also be used as hosts. In principle, any such cell culture is workable, whether from a vertebrate or an invertebrate organism. However, to date, interest has been greatest in vertebrate cells, and propagation of vertebrate cells in culture (tissue
25 culture) has become a routine procedure in recent years [31]. Examples of such useful host cell lines are VERO, HeLa, Chinese hamster ovary (CHO), W138, BHK, COS-7, MDCK and myeloma cell lines. Expression vectors for such cells may include (if necessary) an appropriate origin of
30 replication, as well as a promoter located in front of the gene to be expressed, along with any necessary ribosome binding sites, RNA splice sites, polyadenylation sites and transcriptional terminator sequences.

35 For use in mammalian cells, the control functions on the expression vectors are often provided by viral material. For example, commonly used promoters are derived from

human Cytomegalovirus (HCMV), Polyoma virus, Adenovirus 2 and, most frequently, Simian Virus 40 (SV40). The early and late promoters of SV40 virus are particularly useful because both are obtained easily from the virus as a
5 fragment which also contains the SV40 viral origin of replication [32]. Further, it is also possible, and often desirable, to utilize promoter or control sequences normally associated with the desired gene sequence, provided such control sequences are compatible with the
10 host cell system.

An origin of replication may be provided either by construction of the vector to include an exogenous origin, such as may be derived from SV40 or other viral (e.g.
15 Polyoma virus, Adeno virus, VSV or BPV) source, or may be provided by the host cell chromosomal replication mechanism. If the vector is integrated into the host cell chromosome, the latter is often sufficient.

20 The vectors containing the DNA segments of interest (e.g. the heavy and light chain encoding sequences and expression control sequences) can be transferred into the host cell by well-known methods, which vary depending on the type of cellular host. For example, calcium chloride
25 transfection is commonly utilized for prokaryotic cells, whereas calcium phosphate treatment, lipofection or electroporation may be used for other cellular hosts [33].

30 Once expressed, the CDR-grafted antibodies of the present invention can be purified according to standard procedures of the art, including ammonium sulfate precipitation, affinity columns, column chromatography and gel
35 electrophoresis [34]. Binding affinities of the constructs so expressed may be ascertained by techniques known to the art, as more fully exemplified in the example section of this specification.

Substantially pure CDR-grafted antibodies of at least 90 to 95% homogeneity are preferred, and 98 to 99% or more homogeneity is most preferred for pharmaceutical uses. Once purified, partially or to homogeneity as desired, the CDR-grafted antibodies may then be used diagnostically or therapeutically (including extracorporeally) or in developing and performing assay procedures, immunofluorescent stainings and the like [35].

10 The CDR-grafted antibodies of the present invention will typically find use in treating T-cell mediated disorders. For example, typical disease states suitable for treatment include graft versus host disease and transplant rejection in patients undergoing an organ, such as heart, lung, kidney or liver, transplant. Other diseases include 15 autoimmune diseases, such as Type I diabetes, multiple sclerosis, rheumatoid arthritis, systemic lupus erythematosus and myasthenia gravis.

20 T cells are clonal expansions from single cells expressing only one T cell antigen receptor capable of recognizing a peptide bound to a specific HLA molecule on specialized antigen presenting cells, such as a macrophages, and on other tissues. The activation of these T cells can be 25 blocked by antibodies recognizing the T cell receptor complex or the peptide-HLA complex. OKT3 recognizes the CD3 molecule which is comprised of several subunits physically complexed with the T cell receptor. Several other molecules on the T cell, including the CD4 and CD8 30 molecules, are also involved in T cell activation by binding to the HLA molecules at sites that are distinct from the T cell receptor binding site.

CD4 is found on the subpopulation of T cells with T cell 35 receptors that recognize HLA class II molecules. Therefore, one approach to immunosuppression involves the use of monoclonal antibodies, such as OKT4 or OKT4A that

are immunosuppressive because they inhibit the interaction of the CD4 molecule with the HLA class II molecule. Antibody binding to CD4 can result in immunosuppression by a number of mechanisms including the inhibition of a normal activation signal, the triggering of a down regulation signal pathway, or modulating this receptor from the cell surface. It could also induce a subpopulation of T cells capable of suppressing other alloreactive or autoreactive subpopulations. Anti-CD4 antibodies may also act by inducing complement or antibody-dependent T cell lysis or by removal of the T cells from the blood stream or site of inflammation. Therefore the Fc-receptor binding characteristics of each antibody may be important to their function. Alternative strategies include the use of anti-CD4 antibodies that have been radiolabeled or coupled to toxins.

These immunosuppressive properties of these anti-CD4 antibodies provide a therapeutic use in the suppression of activated T lymphocytes that mediate the diseases associated with transplanation and autoimmunity. The CD4 molecule is also the receptor for the gp120 subunit of the HIV virus. Since OKT4A inhibits the binding of gp120 to CD4, this antibody or fragments thereof may block viral infection.

The CD4 molecule is normally involved in providing a co-stimulatory signal to the T cell as a result of its binding to the HLA class II molecule. Therefore it is also possible that anti-CD4 antibodies can provide a co-stimulatory function in combination with other signal inducing reagents. This therapeutic strategy may be useful in the treatment of immunocompromised patients.

The CDR-grafted antibodies of the present invention may also be used in combination with other antibodies, particularly MABs reactive with other markers on human

cells responsible for the diseases. For example, suitable T-cell markers can include those grouped into the so-called "Clusters of Differentiation," as named by the First International Leukocyte Differentiation Workshop [36].

Generally, the present CDR-grafted antibodies will be utilized in purified form together with pharmacologically appropriate carriers. Typically, these carriers include aqueous or alcoholic/aqueous solutions, emulsions or suspensions, including saline and buffered media. Parenteral vehicles include sodium chloride solution, Ringer's dextrose, dextrose and sodium chloride and lactated Ringer's. Suitable physiologically acceptable adjuvants, if necessary to keep the complex in suspension, may be chosen from thickeners such as carboxymethylcellulose, polyvinylpyrrolidone, gelatin and alginates.

Intravenous vehicles include fluid and nutrient replenishers and electrolyte replenishers, such as those based on Ringer's dextrose. Preservatives and other additives, such as antimicrobials, antioxidants, chelating agents and inert gases, can also be present [37].

The CDR-grafted antibodies of the present invention may be used as separately administered compositions or in conjunction with other agents. These can include various immunotherapeutic drugs, such as cyclosporine, methotrexate, adriamycin or cisplatinum, and immunotoxins. Pharmaceutical compositions can include "cocktails" of various cytotoxic or other agents in conjunction with the CDR-grafted antibodies of the present invention, or even combinations of CDR-grafted antibodies according to the present invention and CDR-grafted antibodies having different specificities.

The route of administration of pharmaceutical compositions according to the invention may be any of those commonly known to those of ordinary skill in the art. For therapy, including without limitation immunotherapy, the CDR-grafted antibodies of the invention can be administered to any patient in accordance with standard techniques. The administration can be by any appropriate mode, including parenterally, intravenously, intramuscularly, intraperitoneally, or also, appropriately, by direct infusion with a catheter. The dosage and frequency of administration will depend on the age, sex and condition of the patient, concurrent administration of other drugs, counter indications and other parameters to be taken into account by the clinician.

The CDR-grafted antibodies of this invention can be lyophilized for storage and reconstituted in a suitable carrier prior to use. This technique has been shown to be effective with conventional immunoglobulins and art-known lyophilization and reconstitution techniques can be employed. It will be appreciated by those skilled in the art that lyophilization and reconstitution can lead to varying degrees of antibody activity loss (e.g. with conventional immunoglobulins, IgM antibodies tend to have greater activity loss than IgG antibodies) and that use levels may have to be adjusted to compensate.

The compositions containing the present CDR-grafted antibodies or a cocktail thereof can be administered for prophylactic and/or therapeutic treatments. In certain therapeutic applications, an adequate amount to accomplish at least partial inhibition or killing of a population of selected cells is defined as a "therapeutically-effective dose". Amounts needed to achieve this dosage will depend upon the severity of the disease and the general state of the patient's own immune system, but generally range from 0.005 to 5.0 mg of CDR-grafted antibody per kilogram of

SUBSTITUTE SHEET

body weight, with doses of 0.05 to 2.0 mg/kg/dose being more commonly used. For prophylactic applications, compositions containing the present CDR-grafted antibody or cocktails thereof may also be administered in similar or slightly lower dosages.

A composition containing a CDR-grafted antibody according to the present invention may be utilized in prophylactic and therapeutic settings to aid in the alteration, inactivation, killing or removal of a select T cell target population in a mammal.

In another embodiment, the constructs described herein may be used extracorporeally or *in vitro* selectively to kill, deplete or otherwise effectively remove the target cell population from a heterogenous collection of cells. Blood from the mammal may be combined extracorporeally with the CDR-grafted antibodies whereby the undesired cells are killed or otherwise removed from the blood for return to the mammal in accordance with standard techniques.

In addition to the therapeutic uses, the CDR-grafted antibodies will find use in diagnostic assays. The CDR-grafted antibodies may be labelled in accordance with techniques known to the art. The CDR-grafted antibodies are also suitable for other *in vivo* purposes. For example, the CDR-grafted antibodies can be used for selective cell treatment of peripheral blood cells where it is desired to eliminate only target T lymphocytes or similarly in cell culture to eliminate unwanted T lymphocytes.

The present invention is now described, by way of example only, with reference to the accompanying drawings, in which:

Figure 1 depicts the nucleotide sequence of the OKT4A heavy chain variable domain;

5 Figure 2 depicts the nucleotide sequence of the OKT4A light chain variable domain;

Figure 3 depicts the OKT4A heavy chain variable domain amino acid sequence in which the CDRs are underlined;

10 Figure 4 depicts the OKT4A light chain variable domain amino acid sequence in which the CDRs are underlined;

15 Figure 5 depicts the alignment of KOL with the OKT4A CDR-grafted heavy chain amino acid sequence in which the CDRs are underlined, human sequences are in upper case and murine sequences are in lower case;

20 Figure 6 depicts the alignment of REI with the OKT4A CDR-grafted light chain amino acid sequence in which the CDRs are underlined, human sequences are in upper case and murine sequences are in lower case;

25 Figure 7 depicts the DNA sequence and amino acid translation of a CDR-grafted heavy chain;

Figure 8 depicts the DNA sequence and amino acid translation of a CDR-grafted light chain;

30 Figure 9 depicts the construction of a CDR-grafted OKT4A heavy chain expression vector;

35 Figure 10 depicts binding and blocking assays of CDR-grafted OKT4A light chain constructs in combination with a chimeric OKT4A heavy chain;

- Figure 11 depicts binding and blocking assays of the OKT4A heavy chain constructs, HCDR1, HCDR2 and HCDR3, in combination with OKT4A light chain;
- 5 Figure 12 depicts the alignment of REI with the CDR-grafted OKT4A light chains, LCDR1 and LCDR2, and the murine OKT4A light chain amino acid sequences in which the CDRs are underlined, human sequences are in upper case and murine sequences are in lower case;
- 10 Figure 13 depicts the alignment of KOL with the CDR-grafted OKT4A heavy chains, HCDR1 through HCDR10, and the murine OKT4A heavy chain amino acid sequences in which the CDRs are underlined, human sequences are in upper case and murine sequences are in lower case;
- 15 Figure 14 depicts binding and blocking assays of the CDR-grafted heavy chain constructs, HCDR1, HCDR2 and HCDR3 in combination with the CDR-grafted light chain LCDR2;
- 20 Figure 15 depicts binding and blocking assays of the CDR-grafted heavy chain constructs HCDR4 through HCDR10 in combination with the light chain LCDR2;
- Figure 16 (A&B) depicts blocking assays of the OKT4A heavy chain constructs HCDR5, HCDR6, and HCDR10 in combination with light chain constructs LCDR2, LCDR3, LCDR2Q, LCDR3Q, and LCDR4Q, and the chimeric form of OKT4A;
- 25 Figure 17 depicts relative affinity assays of the OKT4A heavy chain constructs HCDR5 and HCDR10 in combination with light chain construct LCDR2 and the chimeric and murine forms of OKT4A using the murine and chimeric forms of OKT3 as negative controls;
- 30 Figure 18 depicts the results of studies on inhibition of MLR by various antibodies using T6 as negative control; and
- 35

Figure 19 depicts the results of studies on inhibition of proliferation by various antibodies.

Humanization of OKT4A

5

OKT4A is a murine monoclonal antibody which recognizes the CD4 antigen located primarily on helper T lymphocytes. CDR-grafted antibodies have been constructed in which the CDRs of the variable domains of both heavy and light chains were derived from the murine OKT4A sequence. The variable domain frameworks and constant domains were derived from human antibody sequences.

10

The three CDRs that lie on both heavy and light chains are composed of those residues which structural studies have shown to be involved in antigen binding. Theoretically, if the CDRs of the murine OKT4A antibody were grafted onto human frameworks to form a CDR-grafted variable domain, and this variable domain were attached to human constant domains, the resulting CDR-grafted antibody would essentially be a human antibody with the specificity of murine OKT4A to bind the human CD4 antigen. Given the highly "human" nature of this antibody, it would be expected to be far less immunogenic than murine OKT4 when administered to patients.

15

20

25

Following testing for antigen binding of a CDR-grafted OKT4A antibody in which only the CDRs were grafted onto the human framework, it was shown that this did not produce a CDR-grafted antibody having reasonable affinity for the CD4 antigen. It was therefore decided that additional residues adjacent to some of the CDRs and critical framework residues needed to be switched from the human to the corresponding murine OKT4A residues in order to generate a functional antibody.

30

35

SUBSTITUTE SHEET

Isolation of the OKT4A heavy and light chain cDNA and DNA sequence analysis of the variable domain.

To design the CDR-grafted OKT4A antibody, it was first
5 necessary to determine the sequence of the variable domain
of the murine OKT4A heavy and light chains. The sequence
was determined from heavy and light chain cDNA that had
been synthesized from the respective mRNA.

10 mRNA was prepared from OKT4A-producing hybridoma cells by
guanidinium thiocyanate extraction followed by cesium
chloride gradient purification [38]. cDNA was synthesized
and libraries were prepared and screened in Dr. J. Rosen's
laboratory at The R.W. Johnson Pharmaceutical Research
15 Institute in La Jolla, California. cDNA was synthesized
from the mRNA, EcoRI linkers were added, and it was then
ligated into the EcoRI site of the lgt10 cloning vector.
The recombinant phage was packaged into infectious
particles which were used to infect *E. Coli* C600.

20 This library was screened for OKT4A heavy chain sequences
using oligonucleotide probes Cg and FR3. Cg (the mRNA
sequencing primer from Pharmacia LKB Biotechnologies, Inc)
has the sequence

25 5' GGCCAGTGGATAGAC 3'

and binds to the murine IgG constant domain. Probe FR3
has the sequence

5' GGCCGTGTCCTCAGACCT 3'

30 and binds to the third framework region of the variable
domain of murine heavy chains. Five positive clones were
evaluated by southern transfer and hybridization to probes
Cg, FR3 and a cDNA to mouse IgG2a CH3. A single clone
with a 1600 bp EcoRI insert which hybridized to all three
probes was selected.

35

The library was screened for the OKT4A light chain sequence using an oligonucleotide probe Ck (the mRNA sequencing primer from Pharmacia) with a sequence of

5' GGCTCCAGGTTGCTGATGCTGAAGG 3'

5 and which binds to the mouse kappa constant domain. Six positive clones were further assessed by southern transfer and hybridization to oligonucleotide probes T4AK, whose sequence is

5' GGCTCCAGGTTGCTGATGCTGAAGG 3'

10 and which binds to mouse kappa chain framework region 3, and Ck. A single clone which contained a 900 bp EcoRI insert and hybridized to both probes was chosen.

The 1600 bp heavy chain cDNA was subcloned into the EcoRI sites of the pBluescript plasmid vector (Stratagene Cloning Systems) and the M13mp8 sequencing vector (Pharmacia LKB Biotechnologies, Inc). The 900 bp light chain cDNA was subcloned into the EcoRI sites of the plasmid vector pUC8 (Pharmacia LKB Biotechnologies, Inc) and the M13mp19 sequencing vector.

25 The dideoxy-nucleotide chain termination method of DNA sequence analysis [39] was used to determine sequence of both single-stranded (M13) and double-stranded (plasmid) templates. The sequence of the 5' untranslated regions, signal sequences, variable domains and a portion of the constant domains were determined for both heavy and light chain cDNA. The DNA sequence for heavy and light chains is illustrated in Figures 1 and 2. The amino acid translation of the heavy chain variable domain sequence is presented in Figure 3. A translation of the light chain variable domain is presented in Figure 4.

35 It is to be noted that the nucleotide sequence given for the light chain has an A residue at position 163, towards the beginning of the CDR1 coding sequence (see Figure 2).

SUBSTITUTE SHEET

Translation of this sequence gives a glutamine residue at position 27 in the light chain (see Figure 4).

5 When the sequencing of the OKT4 light chain was originally carried out, nucleotide residue 163 was thought to be a C residue, giving a proline residue at position 27 in the light chain. The first CDR-grafted antibodies produced by the present inventors were constructed on the assumption that light chain residue 27 was a proline residue. This
10 can be seen from Figures 6, 8 and 12.

Design of the CDR-grafted OKT4A Antibody

15 To design the CDR-grafted OKT4A antibody, it was necessary to determine which residues of murine OKT4A comprise the CDRs of the light and heavy chains. Examination of antibody X-ray crystal structures shows the antigen binding surface to be located on a series of three loops extending from the b-barrel framework of the variable
20 domain. These loops can thus be used to define the CDRs. Since the crystal structure of murine OKT4A is not available, the structure of a similar murine antibody of known crystal structure was used to define the residues of the loops.

25 Three regions of hypervariability amid the less variable framework sequences are found on both light and heavy chains [2]. In most cases these hypervariable regions correspond to, but may extend beyond, the CDRs. It was
30 decided that a combination of those murine OKT4A residues in the CDRs and those in the hypervariable regions would comprise composite CDRs to be grafted onto the human antibody framework. The amino acid sequences of the murine OKT4A heavy and light chains are presented in
35 Figures 3 and 4, with the selected composite CDRs underlined.

The human antibody framework sequence for the heavy chain is that of the human antibody KOL. KOL was chosen because its X-ray crystallographic structure had been determined to a high degree of resolution. This should allow for accurate molecular modelling of the antibody. For the same reason, the framework sequence of the human light chain dimer, REI, was used for the light chain frameworks. The amino acid sequences of KOL and REI are shown in Figures 5 and 6 in comparison to those of the CDR-grafted OKT4A heavy (HCDR1) and light (LCDR1) chain variable domains.

The CDR-grafted heavy chain was designed to have a human IgG4 constant portion. The IgG4 subclass was selected based on experience with the murine anti-CD3 monoclonal antibody, OKT3, which is used to treat renal graft rejection. OKT3 has a murine IgG2a isotype and does not fix complement in humans. The human IgG4 isotype also does not fix complement. The CDR-grafted OKT4A light chain was constructed with the human kappa constant domain.

Construction of the CDR-grafted OKT4A genes

Heavy and light chain CDR-grafted variable domains were constructed by the ligation of synthetic double-stranded DNA oligomers, similar to the method employed in [40]. The 5' end of the variable domains contain signal sequences of the light and heavy chains of the murine monoclonal antibody B72.3 [41]. The signal sequence directs secretion of the antibody from mammalian cells. A Kozak sequence [42] immediately precedes the AUG start codon to enhance translation. The variable domains were then ligated to DNA coding for the human constant domains to create the CDR-grafted heavy and light chain genes.

CDR-Grafted OKT4A Heavy Chain Construction

SUBSTITUTE SHEET

Eight complementary pairs of oligomers, approximately 30 bp in length were designed to have overlapping ends and to span the variable domain from a XhoI site located in framework 2 to a HindIII site at the beginning of the first constant domain. These eight oligomer pairs were synthesized, ligated together in a step-wise manner and then ligated to the HindIII 5' end of the human IgG4 constant domain DNA. The IgG4 DNA was provided by Celltech, Ltd (Slough, U. K.) as genomic DNA. It is a 2153bp insert in an M13 phage DNA vector with a 5' EcoRI and a 3' BamHI restriction site. The CH1, hinge, CH2 and CH3 domains are surrounded by four introns. The gene was modified by Celltech to have a C to A change at the penultimate base of the CH1 exon to create a new HindIII site for CDR-grafted gene construction purposes.

The 5' end of the variable domain was constructed by ligating two complementary pairs of synthetic oligomers, each approximately 90bp in length. This fragment, which had a 5' EcoRI end and a 3' XhoI end was ligated to the XhoI end of the fragment described above to yield the complete CDR-grafted heavy chain gene. This gene is 2364bp in length and has a 5' EcoRI end and a 3' BamHI end. The DNA sequence with amino acid translation of the gene is shown in Figure 7. The regions of interest, defined by nucleotide number are:

	1 - 14	EcoRI site and Kozak sequence
	15 - 71	signal sequence
	72 - 146	framework 1
	147 - 176	CDR1
5	177 - 218	framework 2
	219 - 254	CDR2
	255 - 362	framework 3
	363 - 392	CDR3
	393 - 431	framework 4
10	432 - 727	CH1 domain
	728 - 1117	intron
	118 - 1153	hinge domain
	1154 - 1271	intron
	1272 - 1599	CH2 domain
15	1600 - 1698	intron
	1699 - 2016	CH3 domain
	2017 - 2366	3' untranslated region

20 CDR-grafted light chain gene construction

Twelve complementary pairs of synthetic oligomers with overlapping ends were ligated simultaneously to assemble the CDR-grafted light chain variable domain. This

25 fragment had a 5' EcoRI end and a 3' NarI end. This was ligated to the 5' NarI end of the human kappa constant domain DNA. Human kappa constant cDNA was modified by Celltech to include a NarI restriction site in the third and fourth codons. The resulting CDR-grafted light chain

30 gene was 754bp in length and had EcoRI ends. The DNA sequence with amino acid translation is shown in Figure 8. The regions of interest defined by nucleotide number are:

SUBSTITUTE SHEET

	1 - 8	EcoRI site and Kozak sequence
	9 - 68	signal sequence
	69 - 143	framework 1
	144 - 164	CDR1
5	165 - 215	framework 2
	216 - 236	CDR2
	237 - 338	framework 3
	339 - 356	CDR3
	357 - 404	framework 4
10	405 - 710	kappa constant domain
	711 - 754	untranslated

Expression of the CDR-grafted OKT4A antibody

15 Construction of the Heavy Chain Expression Vector

A CDR-grafted heavy chain expression vector was constructed by inserting the heavy chain gene into the expression plasmid pEe6HCMVBgl2 and the adding the GS
 20 fragment, which is composed of the SV40 origin and glutamine synthetase minigene. These steps are diagrammed in Figure 9. pEe6HCMVBgl2 and the GS fragment were provided by Celltech, Ltd.

25 pEe6HCMV was digested at the EcoRI and BclI sites. The pEe6HCMVBgl2 DNA had been demethylated by passaging it through the DAM⁻ *E. Coli* strain GM242, which lacks the deoxyadenosine methylase. BclI will only restrict DNA
 30 which does not contain N⁶-methylated deoxyadenosine at the enzyme's recognition site. The overhang resulting from the BclI restriction is compatible with the BamHI overhang. The EcoRI/BamHI CDR-grafted heavy chain gene (HCDR1) was then ligated to the EcoRI/BclI ends of pEe6HCMVBgl2 to produce pEe6HCDR1.

35

A 5500 bp BamHI fragment containing the glutamine synthetase minigene and the SV40 origin of replication and

SUBSTITUTE SHEET

early and late promoters was inserted into the BamHI site of pEe6HCDR1 to produce pEe6HCDR1gs. The correct orientation of the GS fragment was verified by restriction analysis. pEe6HCDR1gs was prepared for mammalian cell
5 transfection by the alkaline lysis method and cesium chloride gradient purification [43].

pEe6HCDR1gs is capable of expressing the CDR-grafted OKT4A heavy chain in COS and CHO cells. The HCMV promoter lies
10 5' to the heavy chain gene and directs its transcription. The SV40 polyadenylation signal sequence, which lies 3' to the gene, acts as a transcriptional terminator. For transient expression in COS cells, the SV40 origin of replication is present in the GS 5500 bp fragment. The GS
15 minigene is present as a selectable marker for use following CHO cell transfections. Expression of the glutamine synthetase minigene is driven by the SV40 late promoter. The GS fragment is oriented such that the SV40
20 late promoter drives transcription in the same direction as the HCMV promoter.

Several post-transcriptional events occur to produce the CDR-grafted heavy chain. Within the nucleus, the three
25 intervening sequences of the IgG4 constant portion are removed and the exons are spliced together to create a mature mRNA. Following translation, the 19 amino acid signal sequence is removed in the rough endoplasmic reticulum (ER). A single carbohydrate is added to the CH2 domain of each chain in the ER and the Golgi apparatus.
30 Each chain also contains four intrachain disulfide bonds. When a light chain peptide is provided by a cotransfected light chain expression vector, a mature antibody is assembled by the binding together, via disulfide bonds, of two heavy and two light chains.

SUBSTITUTE SHEET

Construction of the CDR-grafted OKT4A light chain expression vector:

5 The CDR-grafted OKT4A light chain expression vector was constructed by inserting the CDR-grafted light chain gene into the expression vector pEe6HCMVBgl2 and then adding the SV40 origin and glutamine synthetase minigene-containing GS fragment. The light chain expression vector was constructed by essentially the same process that was used for the heavy chain expression vector as illustrated in Figure 9. The light chain gene was ligated into the EcoRI site of pEe6HCMVBgl2 to produce pEe6LCDR1. The correct orientation of the light chain gene was verified by restriction analysis. The 5500 bp GS fragment was inserted into the BamHI site to produce pEe6LCDR1gs. The correct orientation of the GS fragment was verified by restriction analysis. pEe6LCDR1gs prepared for mammalian cell transfection by the alkaline lysis method [43] and by cesium chloride gradient purification.

20 As with the CDR-grafted heavy chain gene, the transcription of the CDR-grafted light chain gene in pEe6LCDRgs is driven by the HCMV promoter and transcriptional termination is signalled by the SV40 polyadenylation signal sequence. The SV40 origin of replication contained in the GS fragment allows for autonomous replication of this construct in COS cells. The glutamine synthetase minigene in the GS fragment provides a mechanism for selection and amplification in CHO cells.

30 Post-transcriptional processing of the CDR-grafted light chain mRNA is not required prior to translation because no introns are present in the gene. Following translation, the leader sequence is removed in the rough ER. Two intrachain disulfide bonds are formed. Assembly of a mature antibody was discussed in the previous section.

Transient expression of CDR-grafted OKT4A in COS-1 cells

The transient expression of the CDR-grafted genes in COS-1 cells provides a rapid and convenient system to test CDR-grafted OKT4A antibody expression and function. COS-1 cells constitutively express the SV40 large T antigen which supports the transient replication of episomes carrying the SV40 origin of replication [44]. The CDR-grafted gene expression vectors pEe6HCDR1gs and pEe6LCDR1gs contain the SV40 origin of replication as a portion of the GS fragment. Upon transfection into COS-1 cells, the expression vectors are replicated in the nucleus to a high copy number, resulting in relatively high expression levels.

COS-1 cells were obtained from the American Type Culture Collection (CRL 1650) and cultured in Dulbecco's Modified Eagle Medium (DMEM from GIBCO) with 10% fetal calf serum. The CDR-grafted gene expression vectors were transfected into COS cells using the DEAE-dextran method followed by DMSO shock [45]. Briefly, 0.2 ml of 1 mg/ml DEAE-dextran in buffer is added to 15 mg vector DNA in 0.8 ml DMEM/Tris. This was added to $1 - 1.5 \times 10^6$ cells in a 60 mm tissue culture plate and incubated for approximately 6 hours. The DEAE-dextran/DNA complex is removed and 10% DMSO in buffer is added to the plate for 2 minutes. This is removed, the cells are washed once with DMEM and then incubated with DMEM containing 10% fetal calf serum for 3-4 days. At that time supernatant from the wells is harvested and examined for antibody levels and ability to bind CD4 positive lymphocytes.

Antibody levels were determined by ELISA. Wells were coated with a goat anti-human Fc specific antibody. Various dilutions of the COS cell supernatant containing secreted antibody were added, incubated for one hour at room temperature in a humidity chamber and washed. A

SUBSTITUTE SHEET

horse radish peroxidase-linked goat anti-human kappa chain antibody was added, incubated for one hour at room temperature and washed. Substrate for the horse radish peroxidase was added for detection. The CDR-grafted OKT4A
5 levels following co-transfection of pEe6HCDR1gs and pEe6LCDR1gs range from 200 to 1200 ng/ml of COS cell supernatant.

Antigen Binding Studies

10

CDR-grafted OKT4A produced by COS cells was tested for its ability to bind to human peripheral blood lymphocytes (PBLs) or the CD4-positive HPBALL (human peripheral blood acute lymphocytic leukemia) cell line. It was also tested
15 for its ability to block the binding of murine OKT4A to these cells. Binding was measured by the following procedure. PBLs were isolated from serum or HPBALL cells were harvested from tissue culture. Cells were incubated at 4°C for 1 hour with various dilutions of test antibody,
20 positive control antibody or negative control antibody. The cells were washed once and incubated at 4°C for 1 hour with an FITC-labeled goat anti-human IgG (Fc-specific, mouse absorbed). The cells were washed twice and analyzed by cytofluorography. chimeric OKT4A (described below) was
25 used as a positive control. FITC-labeled murine OKT4A was used as a positive control for direct binding. Cells incubated with mock-transfected COS cell supernatant, followed by the FITC-labeled goat anti-human IgG, provided the negative control.

30

To test the ability of CDR-grafted OKT4A to block murine OKT4A binding, the PBLs or HPBALL cells were incubated at 4°C for 1 hour with various dilutions of test antibody or control antibody. A fixed saturating amount of FITC-OKT4A
35 was added. The samples were incubated for 1 hour at 4°C, washed twice and analyzed by cytofluorography. Positive controls were FITC-labeled OKT4A to determine maximum

SUBSTITUTE SHEET

binding and unlabeled murine OKT4A as a reference standard for blocking. Negative controls were unstained cells with or without mock-transfected cell supernatant.

5 The ability of the CDR-grafted OKT4A light chain to bind
CD4 positive cells and block the binding of murine OKT4A
was initially tested in combination with a chimeric OKT4A
heavy chain. The chimeric OKT4A heavy chain is composed
10 of the murine OKT4AA variable domain and the human IgG4
constant portion. The chimeric heavy chain gene is
expressed in the same expression vector used for the CDR-
grafted genes. The CDR-grafted light chain expression
vector and the chimeric heavy chain expression vector were
15 co-transfected into COS cells. The full chimeric OKT4
antibody (chimeric light chain and chimeric heavy chain)
was found to be fully capable of binding to CD4 positive
cells and blocking the binding of murine OKT4 to these
cells.

20 As Figure 10 illustrates, the CDR-grafted OKT4A light
chain, LCDR1, in combination with the chimeric OKT4A heavy
chain was unable to bind CD4 positive cells or block the
binding of murine OKT4A to these cells.

25 Figure 11 shows the binding and blocking studies done with
the CDR-grafted OKT4A heavy chain, HCDR1, combined with
the chimeric OKT4A light chain. The chimeric OKT4A light
chain is composed of a murine OKT4A variable domain and a
human kappa constant domain. It is also expressed in the
30 same expression vector as is used for the CDR-grafted
antibodies. COS cells were co-transfected with the CDR-
grafted heavy chain expression vector and the chimeric
light chain expression vector.

35 The CDR-grafted OKT4A heavy chain, HCDR1, in combination
with the chimeric OKT4A light chain was also unable to

SUBSTITUTE SHEET

bind CD4 positive cells or block the binding of murine OKT4A to these cells.

Modification of the CDR-Grafted Antibody

5

The binding and blocking data clearly demonstrated that the initially designed CDR-grafted OKT4A antibody was not capable of recognizing the CD4 antigen. Further modification of the antibody was necessary. Either the
10 murine OKT4A CDRs needed to be further expanded or critical framework residues involved in the positioning of CDRs, domain packing or light and heavy chain interactions needed to be changed from human to mouse.

15 Molecular modelling was used to identify the residues which appeared most critical for successful antigen interaction. Modelling was done at Celltech, Ltd with HYDRA software on a SiliconGraphics instrument.

20 Modification of the CDR-Grafted Light Chain

The crystal structure of OKT4A has not been determined, so a molecular model of OKT4A itself could not be used in the analysis. To analyze residues of the CDR-grafted light
25 chain, a molecular model of the human REI light chain was superimposed with a mouse MOPC 603 Fab fragment. The MOPC 603 light chain is similar in amino acid sequence to OKT4A. Also studies were done where the human REI light chain and the human KOL heavy chain were docked.

30 Decisions were made to extend CDR1 by converting residues 33 and 34 from the human leu and asp to the murine OKT4A ile and ala. The human REI residue glu38 was found to be involved in heavy chain and light chain packing. Changing this to the murine OKT4A his38 may be beneficial.

35 Residue 49 at the amino terminal edge of CDR2 directly impacts CDR2 and also makes contact with CDR3 of the heavy chain. Residue 89 near the amino terminal end of CDR3

interacts with phe98 in CDR3 of the light chain and also contacts CDR3 of the heavy chain. The REI tyr49 and gln89 were changed to the murine OKT4A his49 and leu89.

5 The new CDR-grafted OKT4A light chain gene that was generated by the above changes was designated LCDR2. A comparison of the amino acid sequence of the variable domains of the human REI, LCDR1, LCDR2, and the assumed murine OKT4A light chain is shown in Figure 12. The
10 changes were effected by altering codons by site-directed mutagenesis [46]. The bluescript phagemid vector from Stratagene Cloning Systems was used to generate single-stranded template for mutagenesis. The expression vector pEe6LCDR2gs was constructed in the same manner as for
15 LCDR1. COS cells were co-transfected with pEe6LCDR2gs and the chimeric heavy chain expression vector.

The results of binding and blocking studies are shown in Figure 10. The LCDR2 version of the CDR-grafted OKT4A
20 light chain, in combination with the chimeric OKT4A heavy chain, is capable of binding to CD4 positive cells and of blocking the binding of murine OKT4A. These data show that LCDR2 is a functional CDR-grafted OKT4A light chain.

25 Modification of the CDR-grafted heavy chain

For modelling studies of the heavy chain the molecular model of the human antibody KOL was used. All residue changes were made by site-directed mutagenesis to change
30 codons. A decision was made to change glu57 and his58 of KOL to thr57 and tyr58 of murine OKT4A. This revised CDR-grafted heavy chain was designated HCDR2. In addition to changes at residues 57 and 58, residue 24 lies near CDR1 and may be involved in positioning CDR1. Also residues 88
35 and 91 are involved in heavy chain variable domain packing and the interface between the heavy and light chains. These three additional residue changes from KOL to murine

SUBSTITUTE SHEET

OKT4A were incorporated into the heavy chain version HCDR3. An amino acid sequence comparison of the variable domains of KOL, HCDR1, HCDR2, HCDR3, murine OKT4A heavy chain, and versions to be described below is illustrated in Figure 13.

Expression vectors pEe6HCDR2gs and pEe6HCDR3gs were co-transfected into COS cells with either the chimeric OKT4A light chain expression vector or pEe6LCDR2gs. Binding and blocking data are presented in Figures 11 and 14. Neither HCDR2 nor HCDR3 was able to effectively interact with antigen when combined with a chimeric or CDR-grafted OKT4A light chain.

Further modifications to the CDR-grafted heavy chain were explored. A decision to change KOL tyr35 to murine OKT4A ser35 was made. Molecular modelling demonstrated that residue 42 was involved in positioning CDR2. Residue 44 is involved in light chain contacts. It may be beneficial to change the KOL gly42 and gly44 to murine OKT4A glu42 and arg44. KOL ala60 was changed to the murine OKT4A pro60. These changes were introduced in various combinations, while retaining the changes made at residues 24, 57, 58, 88, and 91 in the previous versions. These latter versions were denoted HCDR4, HCDR5, HCDR6, HCDR7, HCDR8. The residue changes in each are described in Figure 13. The same expression vector was used as with the other constructions. COS cells were co-transfected with the new heavy chain expression vectors and pEe6LCDR2gs.

The results of binding and blocking studies, in combination with LCDR2 (Figure 15), show positive interactions with the CD4 antigen in all of these versions except HCDR8. Apparently the conversion of tyr35 to the murine ser35 is a critical change. The change to the 1.2

murine residue at position 60 appears to enhance antigen interaction (compare HCDR6 vs HCDR4) while the change at position 44 appears to be slightly inhibitory (HCDR5 vs HCDR4, and HCDR7 vs HCDR6).

5

To determine if changes at residues 35 and 60 would be sufficient for antigen binding, HCDR9 (murine residues at positions 24, 35, 57, 58, 88, 91) and HCDR10 (murine residues at positions 24, 35, 57, 58, 60, 88, 91) were generated by site-directed mutagenesis. The same expression vector system was used for these versions of the CDR-grafted heavy chain. They were co-transfected into COS cells with pEe6LCDR2gs.

10

15

The results of binding and blocking experiments is illustrated in Figure 15 along with the prior versions of the CDR-grafted heavy chain. Clearly the changes made at residues 42 and 44 in previous versions were not necessary, contrary to the criteria set forth in PCT/US89/05857. The change at residue 60, present in HCDR10, but not in HCDR9, is beneficial.

20

25

A summary of the CDR-grafted OKT4A heavy chains and their activities in the binding and blocking assays is shown in Table 1. The most active CDR-grafted OKT4A antibody which contains the fewest murine residues is the combination of HCDR10 and LCDR2.

TABLE 1

5

CDR-Grafted OKT4A Heavy Chains and Their Activities

CDR-grafted <u>HC</u>	New Residue <u>Change*</u>	Total Murine <u>Residues**</u>	<u>Binding</u> <u>Activity</u>	<u>Blocking</u> <u>Activity</u>
HCDR1	none	none	-	-
HCDR2	57,58	57,58	-	-
HCDR3	24,88,91	24,57,58,88,91	-	-
HCDR4	35,42	24,35,42,57,58,88,91	++	++
5 HCDR5	35,42,44	24,35,42,44,57,58,88,91	++	++
HCDR6	35,42,60	24,35,42,57,58,60,88,91	++	+++
HCDR7	35,42,44,60	24,35,42,44,57,58,60,88,91	++	++
HCDR8	42,44,60	24,42,44,57,58,60,88,91	+	-
HCDR9	35	24,35,57,58,88,91	++	++
0 HCDR10	35,60	24,35,57,58,60,88,91	++	+++

*Residues are denoted by their Kabat position number [2].

** Murine residues refer only to those in framework regions, not CDRs.

Alternative Light Chain Constructs

As is stated above, the present light chain constructs were produced on the assumption that at position 27 in the OKT4A light chain, there was a proline residue. Once it was appreciated that position 27 should be a glutamine residue, three new light chain constructs were produced and expressed. These were labelled LCDR2Q, LCDR3Q and LCDR4Q are identical to LCDR2, LCDR3 and LCDR4 respectively except that at position 27 there is a glutamine (Q) instead of a proline (P) residue. It has been shown that these light chains retained full activity. The data showing this is presented in Figure 16.

It is to be noted that proline is significantly different from all other amino acids in that it has a planar structure. It is therefore commonly found at sites in peptide sequences where a change in orientation of the chain occurs. It is therefore likely that the structure of the light chain CDR1 having proline at residue 27 will be significantly different from that of the light chain CDR1 having glutamine at residue 27. Despite this, it has been demonstrated that the two light chains are equivalent from a functional standpoint. This supports the view expressed herein that it is not necessary to change all 6 CDRs in an antibody in order to produce a functional CDR-grafted antibody.

Alternative Modifications of the CDR-Grafted Light and Heavy Chains

Residue changes made in later versions of the CDR-grafted light and heavy chains were done based upon molecular modelling of REI, KOL and a related mouse antibody, MOPC 603, rather than of the CDR-grafted antibodies themselves. Some of the alterations may be unnecessary for binding, especially at lower binding affinities. We have

SUBSTITUTE SHEET

constructed several CDR-grafted light and heavy chain genes in which some of the framework residues previously switched to mouse residues have been changed back to the human. Generally those residues not directly involved in lengthening CDRs or positioning CDRs are being changed back to the human residues in various combinations. Table 2 lists these light and heavy chain genes with the residue numbers that revert from the murine to human. Site-directed mutagenesis was used to construct these genes. They will be expressed in COS cells and their ability to recognize CD4 will be tested in the binding and blocking assays. The most desirable CDR-grafted antibody is the one with the fewest murine residues that is capable of recognizing CD4 with an affinity similar to that of murine OKT4A.

TABLE 2

MODIFICATIONS TO THE CDR-GRAFTED LIGHT AND HEAVY CHAINS

<u>Construct</u>	<u>Residue Change*</u>	<u>Total murine residues**</u>
Light chain:		
LCDR3	38	33,34,49,89
LCDR4	49	33,34,38,89
LCDR5	89	33,34,38,49
LCDR6	38,49,89	33,34
Heavy chain:		
HCDR11	88,91	24,35,47,58,60
HCDR12	24,88,91	35,57,58,60

*Residues are denoted by their Kabat position number [2]. Noted residues will be changed from murine sequence to human sequence.

** Murine residues refer to residues in frameworks, not CDRs.

SUBSTITUTE SHEET

Determination of Relative Binding Affinity

The relative binding affinities of CDR-grafted anti-CD4 monoclonal antibodies were determined by competition binding [8] using the HPB-ALL human T cell line as a source of CD4 antigen and fluorescein-conjugated murine OKT4A (F1-OKT4A) of known binding affinity as a tracer antibody. The binding affinity of F1-OKT4A tracer antibody was determined by a direct binding assay in which increasing amount of F1-OKT4A were incubated with HPB-ALL (5×10^5) in PBS with 5% fetal calf serum for 60 min at 40°C. Cells were washed, and the fluorescence intensity was determined on a FACScan flow cytometer calibrated with quantitative microbead stands (Flow Cytometry Standards, Research Triangle Park, NC). Fluorescence intensity per antibody molecule (F/P ratio) was determined by using microbeads which have a predetermined number of mouse IgG antibody binding sites (Simply Cellular Beads, Flow Cytometry Standards). F/P equals the fluorescence intensity of beads saturated with F1-OKT4A divided by the number of binding sites per beads. The amount of bound and free F1-OKT4A was calculated from the mean fluorescence intensity per cell, and the ratio of bound/free was plotted against the number of moles of antibody bound. A linear fit was used to determine the affinity of binding (absolute value of the slope).

For competitive binding, increasing amounts of competitor antibody were added to a sub-saturating dose of F1-OKT4A and incubated with 5×10^5 HPB-ALL in 200 μ l of PBS with 5% fetal calf serum for 60 min at 4°C. The fluorescence intensities of the cells were measured on a FACScan flow cytometer calibrated with quantitative microbead standards. The concentrations of bound and free F1-OKT4A were calculated. The affinities of competing antibodies were calculated from the equation $[X] - [OKT4A] = (1/K_x) - (1/K_a)$, where K_a is the affinity of murine OKT4A, K_x is

SUBSTITUTE SHEET

the affinity of competitor X [] is the concentration of competitor antibody at which bound/free binding is R/2, and R is the maximal bound/free binding.

5 Affinity Results

The relative affinity constants of the humanized antibodies (Fig. 17, Table 3) were determined, and LCDR2 combined with HCDR10 retained 68% of the activity of the parent. LCDR2/HCDR5 (Table 1) retained only 13% of the murine antibody affinity. These results are in agreement with those obtained in blocking assays (Fig. 16a&b). Comparison of HCDR5 with HCDR7 (Fig. 15) suggests that residue 60, while not critical for activity, is beneficial when converted to that in the donor sequence. In the same figure, the deleterious effect of the donor residue at position 44 can also be seen (HCDR4 vs. HCDR5).

20 TABLE 3

Relative Affinity Constants of the CDR-grafted Antibodies

Antibody Constructs	Log conc. competitor (pM) at 50% inhibition	Affinity Constant (Kx)
25 Murine OKT4A	2.4	3×10^9
Chimeric OKT4A	2.9	1.1×10^9
LCDR2/HCDR10	2.6	2.1×10^9
LCDR2/HCDR5	3.4	0.4×10^9
30 Chimeric OKT3		No inhibition
Murine OKT3		No inhibition

Functional Studies

35 It is believed that the CD4 antigen, which is recognised by OKT4A and its chimeric and CDR-grafted equivalents, is involved in the interactions which give rise to the

biological functions of T lymphocytes carrying the CD4 antigen. In particular, it is believed that the CD4 antigen is involved in the mixed lymphocyte reaction (MLR) and in the proliferation of peripheral blood mononuclear cells (PBMC). In order to show that the CDR-grafted antibodies of the present invention are likely to have the same biological activity as murine OKT4A, the following functional studies were carried out.

10 Inhibition of MLR

Human PBMC were isolated by density gradient centrifugation with Ficoll and resuspended in complete DMEM containing 1% foetal calf serum (FCS). 2×10^5 responder PBMC and 1×10^5 irradiated (2 Mrad) allogeneic PBMC were added to each well of a 96 well tissue culture plate, followed by serial dilutions of a purified anti-CD4 antibody. Cells were cultured for 6 days, pulsed with ^3H thymidine for 24 hours and harvested. ^3H -thymidine incorporation was measured by liquid scintillation.

As a negative control, irradiated responder cells were used in place of the irradiated allogeneic PBMC and no antibody was added. As a positive control, the experiment was carried out without the addition of antibody. In the experiment, the antibodies used were murine OKT4A, chimeric OKT4A and the F(ab')_2 fragment of murine OKT4A.

The results of the experiment are shown in Figure 18. Both the chimeric OKT4A and the murine OKT4A showed similar inhibition of MLR.

Inhibition of Proliferation

35 OKT3 (20 ng/ml), a murine MAb which recognises the CD3 antigen on T lymphocytes, was immobilised on polystyrene 96 well tissue culture plates for 4 hours at 20°C. The

plates were washed three times with phosphate buffered saline (PBS) and 1×10^5 PMBC were added to each well. Thereafter, serial dilutions of an anti-CD4 antibody were added. Cells were cultured for 72 hours, pulsed with ^3H -
5 thymidine for 24 hours and harvested. ^3H -thymidine incorporation was measured by liquid scintillation.

As a negative control, proliferation was measured in the absence of both the OKT3 and anti-CD4 antibodies. As a
10 positive control proliferation was measured in the presence of OKT3 alone. In this experiment, the antibodies used were murine OKT4A, chimeric OKT4A and the $\text{F}(\text{ab}')_2$ fragment of murine OKT4A.

15 The results are given in Figure 19, which shows that chimeric OKT4A has substantially the same ability to inhibit proliferation as does murine OKT4A.

The above functional studies show that chimeric OKT4A has
20 equivalent biological properties to murine OKT4A. Since the CDR-grafted anti-CD4 antibodies have substantially the same affinity for the CD4 antigen as the chimeric OKT4A antibody and since the chimeric OKT4A antibody has the same constant domains as the CDR-grafted OKT4A antibodies,
25 it can be expected that the CDR-grafted OKT4A antibodies will have the same biological functions as murine OKT4A and will thus be of use in therapy.

SUMMARY

30 A number of different CDR-grafted OKT4A antibodies have been generated. Essentially, DNA encoding the CDRs of the murine OKT4A heavy and light chains has been grafted onto the frameworks of the human heavy chain KOL and light
35 chain REI antibody genes. These variable domains are ligated to the DNA encoding human kappa light chain and IgG4 heavy chain constant portion. The resulting CDR-

grafted genes are expressed in COS-1 cells. Antibody
secreted into the tissue culture media is collected,
quantified by ELISA, and tested for its ability to bind to
CD4 positive cells and to block the binding of murine
5 OKT4A.

The initially designed CDR-grafted antibody was unable to
interact with CD4. A number of modifications were made to
the light chain where critical human framework residues in
10 the REI sequence, identified by molecular modelling, were
changed to the murine OKT4A residues. This new version of
the light chain, LCDR2, was able to recognize the CD4
antigen. Similarly, a number of heavy chain human
framework residues were changed to murine in various
15 combinations to generate HCDR2 through HCDR10. Several of
these heavy chains, in combination with LCDR2, competed
well with the murine OKT4A antibody for CD4. Presently
the CDR-grafted OKT4A of choice is the combination of
LCDR2Q and HCDR10. Further versions of the light and
20 heavy chains are currently being generated where framework
residues that were previously switched to the murine
residues are being changed back to human. These more
humanized CDR-grafted antibodies will be tested for their
ability to recognize CD4.

SUBSTITUTE SHEET

REFERENCES

- [1] Kabat et al., in Sequences of Proteins of Immunological Interest, US Department of Health and Human Services, 1987.
- 5 [2] Wu and Kabat, J. Exp. Med., 132, 211, 1970.
- [3] Oi et al., PNAS-USA, 80, 825, 1983.
- [4] Neuberger, EMBO J., 2, 1373, 1983.
- [5] Ochi et al., PNAS-USA, 80, 6351, 1983.
- [6] Verhoeyen et al., Science, 239, 1534, 1988.
- 10 [7] Reichmann et al., Nature, 332, 323, 1988.
- [8] Queen et al., PNAS-USA, 86, 10029, 1989.
- [9] Zoller and Smith, Nuc. Acids Res., 10, 6487, 1982.
- [10] Norris et al., Nuc. Acids Res., 11, 5103, 1983.
- 15 [11] Zoller and Smith, DNA, 3, 479, 1984.
- [12] Kramer et al., Nuc. Acids Res., 10, 6475, 1982.
- [13] Mullis and Faloona, Meth. Enz., 155, 335, 1987.
- [14] Higuchi et al., Nuc. Acids Res., 16, 7351, 1988.
- [15] Ho et al., Gene, 77, 51, 1989.
- 20 [16] Ho et al., in Engineering Hybridisation Restriction Genes without the Use of Restriction Enzymes: Gene Splicing by Overlap Extension.
- [17] Horton et al., Gene, 77, 61, 1989.
- [18] Bolivar et al., Gene, 2, 95, 1977.
- 25 [19] Chang et al., Nature, 275, 615, 1978.
- [20] Itakura et al., Science, 198, 1056, 1978.
- [21] Goedell et al., Nature, 281, 544, 1979.
- [22] Goedell et al., Nuc. Acids Res., 8, 4057, 1980.
- [23] Siebenlist et al., Cell, 20, 269, 1980.
- 30 [24] Stinchcomb et al., Nature, 282, 39, 1979.
- [25] Kingsman et al., Gene, 7, 141, 1979.
- [26] Tschemper et al., Gene, 19, 157, 1980.
- [27] Jones, Genetics, 85, 12, 1977.
- [28] Hitzeman et al., J. Biol. Chem., 255, 2073, 1980.
- 35 [29] Hess et al., J. Adv. Enzyme Reg., 7, 149, 1968.
- [30] Holland et al., Biochemistry, 17, 4900, 1978.

SUBSTITUTE SHEET

- [31] Kruse and Patterson, in *Tissue Culture*, Academic Press, 1973.
- [32] Fiers et al., *Nature*, 273, 113, 1978.
- [33] Maniatis et al., in *Molecular Cloning: A Laboratory Manual*, 2nd Edition, Cold Spring Harbor Press, 1990.
- [34] Scopes, in *Protein Purification*, Springer Verlag, NY, 1982.
- [35] Lefkovite and Pernis, in *Immunological Methods*, Volumes I and II, Academic Press, NY, 1979 and 1981.
- [36] Bernhard et al., in *Leukocyte Typing*, Springer Verlag, NY, 1984.
- [37] Mack, in *Remington's Pharmaceutical Sciences*, 16th Edition, 1982.
- [38] Chirgwin et al., *Biochemistry*, 18, 5294, 1979.
- [39] Sanger et al., *PNAS-USA*, 74, 5463, 1977.
- [40] Jones et al., *Nature*, 321, 522, 1986.
- [41] Whittle et al., *Protein Engineering*, 1, 499, 1987.
- [42] Kozak et al., *J. Mol. Biol.*, 196, 947, 1987.
- [43] Birnboim and Doly, *Nuc. Acids Res.*, 14, 1513, 1979.
- [44] Gluzman, *Cell*, 23, 175, 1981.
- [45] Lopata et al., *Nuc. Acids Res.*, 14, 5707, 1984.
- [46] Kunkel, *PNAS-USA*, 82, 488, 1985.
- [47] Chotia and Lesk, *J. Mol. Biol.*, 96, 4, 901, 1987.
- [48] Baranov et al., *Gene*, 84, 2, 463, 1989.

SUBSTITUTE SHEET

CLAIMS

1. A CDR-grafted antibody having at least one chain wherein the framework regions are predominantly derived from a first antibody (acceptor) and at least one CDR is derived from a second antibody (donor), the CDR-grafted antibody being capable of binding to the CD4 antigen.
2. The CDR-grafted antibody of claim 1, in which the CDR-grafted chain has two CDRs derived from the donor antibody.
3. The CDR-grafted antibody of claim 1 or claim 2, in which the CDR-grafted chain has three CDRs derived from the donor antibody.
4. The CDR-grafted antibody of any one of claims 1 to 3, wherein, in the CDR-grafted chain, the or each CDR comprises a composite CDR comprising all the residues from the CDR and all the residues in the corresponding hypervariable region of the donor antibody.
5. The CDR-grafted antibody of any one of claims 1 to 4, wherein at least one residue in the framework regions of the CDR-grafted chain has been altered so that it corresponds to the equivalent residue in the antibody.
6. The CDR-grafted antibody of any one of claims 1 to 5, wherein the framework regions of the CDR-grafted chain are derived from a human antibody.
7. The CDR-grafted antibody of any one of claims 1 to 6, wherein the framework regions of the CDR-grafted chain are derived from a human Ig heavy chain.
8. The CDR-grafted antibody of claim 7, wherein residue 35 in the heavy chain framework regions has been altered

so that it corresponds to the equivalent residue in the donor antibody.

- 5 9. The CDR-grafted antibody of claim 7 or claim 8, wherein at least one composite CDR comprising residues 26 to 35, 50 to 65 or 95 to 102 respectively is grafted onto the human framework.
- 10 10. The CDR-grafted antibody of any one of claims 7 to 9, wherein residues 23, 24 and 49 in the heavy chain are altered to correspond to the equivalent residues in the donor antibody.
- 15 11. The CDR-grafted antibody of claim 10, wherein residues 6, 23, 24, 48 and 49 correspond to the equivalent residue in the donor antibody.
- 20 12. The CDR-grafted antibody of any one of claims 7 to 11, wherein residues 71, 73 and 79 correspond to the equivalent residues in the donor antibody.
- 25 13. The CDR-grafted antibody of any one of claims 7 to 12, wherein in the heavy chain any one or any combination of residues 57, 58, 60, 88 and 91 correspond to the equivalent residues in the donor antibody.
- 30 14. The CDR-grafted antibody of any one of claims 7 to 13, wherein the heavy chain is derived from the human KOL heavy chain.
- 35 15. The CDR-grafted antibody of any one of claims 1 to 6, wherein the framework regions in the CDR-grafted chain are derived from a human Ig light chain.
16. The CDR-grafted antibody of claim 15, wherein in the light chain, at least one composite CDR comprising

residues 24 to 34, 50 to 56 or 89 to 97 respectively is grafted onto the human framework.

5 17. The CDR-grafted antibody of claim 15 or claim 16, wherein residue 49 in the light chain corresponds to the equivalent residues in the donor antibody.

10 18. The CDR-grafted antibody of any one of claims 15 to 17, wherein, in the light chains, residues 49 and 89 correspond to the equivalent residues in the donor antibody.

15 19. The CDR-grafted antibody of any one of claims 15 to 18, wherein the light chain is derived from the human REI light chain.

20 20. The CDR-grafted antibody of any one of claims 1 to 19, which comprises a light chain and a heavy chain, one of which has been CDR-grafted in accordance with the principles set out in any one of claims 2 to 19.

25 21. The CDR-grafted antibody of claim 20, wherein the CDR-grafted chain is the heavy chain and all three CDRs in the heavy chain have been altered.

30 22. The CDR-grafted antibody of any one of claims 1 to 20, which comprises a light chain and a heavy chain, both of which have been CDR-grafted in accordance with the principles set out in any one of claims 2 to 19.

35 23. The CDR-grafted antibody of claim 22, wherein all three CDRs in the heavy chain have been altered and only one or two of the CDRs in the light chain have been altered.

24. The CDR-grafted antibody any one of claims 1 to 23, which has an affinity for the CD4 antigen of from $10^5.M^{-1}$ to $10^{12}.M^{-1}$.
- 5 25. The CDR-grafted antibody of claim 24, which has an affinity for the CD4 antigen of at least about $10^8.M^{-1}$.
26. The CDR-grafted antibody of claim 24 or claim 25, which has an affinity for the CD4 antigen similar to that
10 of OKT4A.
27. The CDR-grafted antibody of any one of claims 1 to 26, wherein the or each CDR or composite CDR is derived from a mammalian antibody.
- 15 28. The CDR-grafted antibody of claim 27, wherein the or each CDR or composite CDR is derived from a murine MAb.
29. The CDR-grafted antibody of any one of claims 1 to
20 28, which is a complete Ig.
30. The CDR-grafted antibody of claim 29, which is of isotype IgG₄.
- 25 31. The CDR-grafted antibody of claim 29 or claim 30, wherein one or more residues in the constant domains of the Ig has been altered in order to alter the effector functions of the constant domains.
- 30 32. The CDR-grafted antibody of any one of claims 1 to 231 which is produced by use of recombinant DNA technology.
- 35 33. A method for producing a CDR-grafted antibody according to any one of claims 1 to 32, which method comprises:

5 providing a first DNA sequence, encoding a first antibody chain in which the framework regions are predominantly derived from a first antibody (acceptor) and at least one CDR is derived from a second antibody (donor), under the control of suitable upstream and downstream elements; transforming a host cell with the first DNA sequence; and culturing the transformed host cell so that a CDR-grafted antibody according to any one of claims 1 to 32 is produced.

10

34. The method of claim 33, which further comprises: providing a second DNA sequence, encoding a second antibody chain complementary to the first chain, under the control of suitable upstream and downstream elements; and transforming the host cell with both the first and second DNA sequences.

15

35. The method of claim 34, wherein the second DNA sequence encodes a second antibody chain in which the framework regions are predominantly derived from a first antibody and at least one CDR is derived from the second antibody.

20

36. The method of claim 34 or claim 35, wherein the first and second DNA sequences are present on the same vector.

25

37. The method of claim 36, wherein the sequences are under the control of the same upstream and/or downstream elements.

30

38. The method of claim 36, wherein the sequences are under the control of different upstream and/or downstream elements.

35

39. The method of claim 34 or claim 35, wherein the first and second DNA sequences are present on different vectors.

40. The method of any one of claims 33 to 39, wherein the host cell is a CHO cell.

5 41. A nucleotide sequence which encodes an antibody chain in which the framework regions are predominantly derived from a first antibody (acceptor) and at least one CDR is derived from a second antibody (donor), the antibody chain being capable of forming a CDR-grafted antibody according to any one of claims 1 to 32.

10

42. A CDR-grafted antibody according to any one of claims 1 to 32, for use in therapy, in particular in treating graft rejections or in treating helper T cell disorders.

15

43. A pharmaceutical composition comprising a CDR-grafted antibody according to any one of claims 1 to 32 in combination with a pharmaceutically acceptable excipient.

20

44. A method for treating a graft rejection or a helper T cell disorder which comprises administering to a patient in need of such treatment an effective amount of a CDR-grafted antibody according to any one of claims 1 to 32 or a composition according to claim 43.

25

FIG. 1

1/28

The nucleotide sequence of the variable region of the OKT4A heavy chain.

```

1  AATCCCTGG AATCGATTCC CAGTTCCTCA CATTGAGTCA GCACTGAACA
51  CGGACCCCTC ACC
      <START translation<
      ATGAACT CCGGGCTCAG CCTGATTTTC CTGTCCCTTG
101  TTTTAAAAGG TGTCCAATGT
      <START frwk1<
      GAAGTGATTC TGGTGGAGTC TGGGGGAGCC
151  TTAGTGGAGC CTGGAGGGTC CCTGAAACTC TCCTGTTTCAG CCTCT
      <START cdr1<
      GGATT
201  CACTTTCAGT AACTAT
      <START frwk2<
      GCCA TGTCTTGGGT TCGTCAGACT CCGGAGAAGA
251  GGCTGGAGTG GGTCGCA
      <START cdr2<
      GCC ATTAGTGATC ATAGTACTAA C
      <START frwk3<
      ACCTACTAT
301  CCAGACAGTG TGAAGGGGCG ATTCACTATC TCCAGAGACA ATGCCAAGAA
351  CACCCTGTAC CTACAAATGA ACAGTCTGAG GTCTGAGGAC ACGGCCATTT
401  ATTACTGTGA AAGA
      <START cdr3<
      AAGTAC GGTGGTGACT ACGACCCCTT T
      <START frwk4<
      GACTATTGG
451  GGCCAAGGCA CCACTCTCAC AGTCTCCTCA
      <START CONSTANT<
      GCCAAAACAA CAGCCCCATC
501  GGTCTATCCA CTGGCCCCTG TGTGTGGAGA TACAACTGGC TCCTCGGTGA
551  CTCTAGGATG C

```

SUBSTITUTE SHEET

2/28

FIG. 2

The nucleotide sequence of the variable region of the OKT4A light chain.

```

1  GAATTCCGTT GTAGAA
    <START translation<
    ATGA GACCGTCTAT TCAGTTCCTG GGGCTCTTGT
51  TGTTCTGGCT TCATGGT
    <START poorly sequenced region<
    GxC TSAkGTGTgt AkGAYMTCYA GATGUhwrCA
101  GTCTChAkbc
    <START FRWK1<
    TCACTGTCTG CATCTCTGGG AGGCAAAGTC ACCATCGCTT
151  GCAAGGCA
    <START cdr1<
    AG CCAAGACATT AACAACTAT
    <START FRWK2<
    A TAGCTTGGA CCAACACAAG
201  CCTGGAAAAG GTCCTAGGCT ACTCATT CAT
    <START cdr2<
    TACACATCTA CATTACAACC
251  A
    <START FRWK3<
    GGCATCCCA TCAAGGTTCA GTGGAAGTGG ATCTGGGAGA GATTATTTCCT
301  TCAGCATCAG CAACCTGGAG CCTGAAGATA TTGCAACTTA TTATTGTCTA
351  CAG
    <START cdr3<
    TATGATA ATCTTCTGTT C
    <START FRWK4<
    ACGTTCGGA GGGGGGACCA AACTGGAAAT
401  AAA
    <START constant region<
    CGGGCT GATGCTGCAC CAACTGTATC CATCTTCCCA CCABSAGTGA
451  GCAGTTAACA TCTGGAGG

```

SUBSTITUTE SHEET

FIG. 3

THE MURINE OKT4A HEAVY CHAIN PEPTIDE SEQUENCE (VARIABLE REGION)

		20		35ab
MU OKT4A	EVILVESGGA	IVEPGGSLKL	SCSASGFTFS	NYAMS--WVR
		52abc		65
MU OKT4A	QTPEKRLEWV	AAISD--HST	NTYYPDSVKG	RFTISRDNAK
		82abc	95	100c
MU OKT4A	NTLYLQMNSL	RSEDTAIYYC	AR-KYGGD-Y	DPE-----D
		113		
MU OKT4A	YWGQGTTLTV	SS		

3/28

SUBSTITUTE SHEET

FIG. 4

THE MURINE OKT4A LIGHT CHAIN PEPTIDE SEQUENCE (VARIABLE REGION)

		20		40		60
MU OKT4A	DIQMTQSPSS	LSASLGGKVT	IACKASQDIN	NYIAWYQHKP	GKGPRLLIYH	TSTLQPGIPS
		80		100		
MU OKT4A	RFSGSGSGRD	YSFSISNLEP	EDIATYYCIQ	YNDLELTTFFGG	GTKLEIKR	

ALIGNMENT OF KOL WITH OKT4A CDR-GRAFTED HEAVY CHAIN PEPTIDE SEQUENCE (VARIABLE REGION)

FIG. 5

		20		35ab
KOL	QVQLVESGGG	VVQPGRSLRL	SCSSSGFIFS	SYAMY--WVR
HCDR1	QVQLVESGGG	VVQPGRSLRL	SCSSSG <u>Ft</u> FS	nYAMY--WVR
		52abc		65
KOL	QAPGKGLEWV	<u>AI</u> IWD--DGS	<u>DQ</u> HYADSVKG	RFTISRDNK
HCDR1	QAPGKGLEWV	<u>AaIs</u> D-- <u>hst</u>	<u>nQ</u> HYADSVKG	RFTISRDNK
		82abc	95	100c
KOL	NTLFLQMDSL	RPEDTGVYFC	<u>AR--DGGHGF</u>	CSSASCFGPD
HCDR1	NTLFLQMDSL	RPEDTGVYFC	<u>AR-kyGGd-Y</u>	<u>dpf-----D</u>
		113		
KOL	YWGQGPVTV	SS		
HCDR1	YWGQGPVTV	SS		

WO 91/09966

4/28

SUBSTITUTE SHEET

ALIGNMENT OF REI WITH OKT4A CDR-GRAFTED LIGHT CHAIN PEPTIDE SEQUENCE (VARIABLE REGION)

FIG. 6

		20		40	60
REI	DIQMTQSPSS	LSASVGDRVT	ITCOASODII	KYLNWYQQT	GKAPKLLIYE
LCDR1	DIQMTQSPSS	LSASVGDRVT	ITCKASpDIn	nYLNWYQQT	GKAPKLLIy
				<u>tstLQpGVPS</u>	
		80		100	
REI	RFSGSGSGTD	YTFTISSLQP	EDIATYYCQQ	<u>YOSLPYTFGQ</u>	GTKLQITR
LCDR1	RFSGSGSGTD	YTFTISSLQP	EDIATYYCQQ	<u>YdnLlF</u> TFGQ	GTKLQITR

PCT/GB90/02015

FIG. 7(i)

The DNA SEQUENCE and PROTEIN TRANSLATION of the CDR-GRAFTED HEAVY CHAIN

```

      10      20      30      40      50
AATTC GCCGC CACC ATG GAA TGG AGC TGG GTC TTT CTC TTC TTC CTG TCA GTA
TTAAG CGGCG GTGG TAC CTT ACC TCG ACC CAG AAA GAG AAG AAG GAC AGT CAT
      Met Glu Trp Ser Trp Val Phe Leu Phe Phe Leu Ser Val>
      a a TRANSLATION OF HCDR1-IGG4.SEQ a a >

      60      70      80      90      100
ACT ACA GGT GTC CAC TCC CAG GTT CAG CTG GTG GAG TCT GGA GGA GGA GTC
TGA TGT CCA CAG GTG AGG GTC CAA GTC GAC CAC CTC AGA CCT CCT CCT CAG
Thr Thr Gly Val His Ser Gln Val Gln Leu Val Glu Ser Gly Gly Gly Val>
a a a a TRANSLATION OF HCDR1-IGG4.SEQ a a a a >

      110      120      130      140      150
GTC CAG CCT GGA AGG TCC CTG AGA CTG TCT TGT TCT TCT TCT GGA TTC ACT
CAG GTC GGA CCT TCC AGG GAC TCT GAC AGA ACA AGA AGA AGA CCT AAG TGA
Val Gln Pro Gly Arg Ser Leu Arg Leu Ser Cys Ser Ser Ser Gly phe Thr>
a a a a TRANSLATION OF HCDR1-IGG4.SEQ a a a a >

      160      170      180      190      200
TTC AGT AAC TAT GCT ATG TAC TGG GTC AGA CAG GCT CCT GGA AAG GGA CTC
AAG TCA TTG ATA CGA TAC ATG ACC CAG TCT GTC CGA CGA CCT TTC CCT GAG
Phe Ser Asn Tyr Ala Met Tyr Trp Val Arg Gln Ala Pro Gly Lys Gly Leu>
a a a a TRANSLATION OF HCDR1-IGG4.SEQ a a a a >

      210      220      230      240      250
GAG TGG GTC GCT GCC ATT AGT GAT CAT AGT ACT AAC CAG CAC TAC GCT GAC
CTC ACC CAG CGA CGG TAA TCA CTA GTA TCA TGA TTG GTC GTG ATG CGA CTG
Glu Trp Val Ala Ala Ile Ser Asp His Ser Thr Asn Gln His Tyr Ala Asp>
a a a a TRANSLATION OF HCDR1-IGG4.SEQ a a a a >

      260      270      280      290      300
TCT GTC AAG GGA AGA TTC ACA ATT TCT AGA GAC AAC TCT AAG AAT ACA CTG
AGA CAG TTC CCT TCT AAG TGT TAA AGA TCT CTG TTG AGA TTC TTA TGT GAC
Ser Val Lys Gly Arg Phe Thr Ile Ser Arg Asp Asn Ser Lys Asn Thr Leu>
a a a a TRANSLATION OF HCDR1-IGG4. SEQ a a a a >

```

SUBSTITUTE SHEET

WO 91/09966

5/28

PCT/GB90/02015

SUBSTITUTE SHEET

310 320 330 340 350
TTC CTG CAG ATG GAC TCA CTC AGA CCT GAG GAC ACA GGA GTC TAC TTC TGT
AAG GAC GTC TAC CTG AGT GAG TCT GGA CTC CTG TGT CCT CAG ATG AAG ACA
Phe Leu Gln Met Asp Ser Leu Arg Pro Glu Asp Thr Gly Val Tyr Phe Cys>
a a a a TRANSLATION OF HCDR1-IGG4.SEQ a a a a >

360 370 380 390 400 410
GCT AGA AAG TAC GGT GGT GAC TAC GAC CCC TTT GAC TAC TGG GGC CAA GGT
CGA TCT TTC ATG CCA CCA CTG ATG CTG GGG AAA CTG ATG ACC CCG GTT CCA
Ala Arg Lys Tyr Gly Gly Asp Tyr Asp Pro Phe Asp Tyr Trp Gly Gln Gly>
a a a a TRANSLATION OF HCDR1-IGG4.SEQ a a a a >

>SEQED (include) of: ja91.ins check: 5694 from: 1 to: 2153

420 430 440 450 460
ACC CCG GTC ACC GTG AGC TCA GCT TCC ACC AAG GGC CCA TCC GTC TTC CCC
TGG GGC CAG TGG CAC TCG AGT CGA AGG TGG TTC CCG GGT AGG CAG AAG GGG
Thr Pro Val Thr Val Ser Ser Ala Ser Thr Lys Gly Pro Ser Val Phe Pro>
a a a a TRANSLATION OF HCDR1-IGG4.SEQ a a a a >

470 480 490 500 510
CTG GCG CCC TGC TCC AGG AGC ACC TCC GAG AGC ACA GCC GCC CTG GGC TGC
GAC CGC GGG ACG AGG TCC TCG TGG AGG CTC TCG TGT CGG CGG GAC CCG ACG
Leu Ala Pro Cys Ser Arg Ser Thr Ser Glu Ser Thr Ala Ala Leu Gly Cys>
a a a a TRANSLATION OF HCDR1-IGG4.SEQ a a a a >

520 530 540 550 560
CTG GTC AAG GAC TAC TTC CCC GAA CCG GTG ACG GTG TCG TGG AAC TCA GGC
GAC CAG TTC CTG ATG AAG GGG CTT GGC CAC TGC CAC AGC ACC TTG AGT CCG
Leu Val Lys Asp Tyr Phe Pro Glu Pro Val Thr Val Ser Trp Asn Ser Gly>
a a a a TRANSLATION OF HCDR1-IGG4.SEQ a a a a >

570 580 590 600 610
GCC CTG ACC AGC GGC GTG CAC ACC TTC CCG GCT GTC CTA CAG TCC TCA GGA
CGG GAC TGG TCG CCG CAC GTG TGG AAG GGC CGA CAG GAT GTC AGG AGT CCT
Ala Leu Thr Ser Gly Val His Thr Phe Pro Ala Val Leu Gln Ser Ser Gly>
a a a a TRANSLATION OF HCDR1-IGG4.SEQ a a a a >

FIG. 7(ii)

6/28

WO 91/09966

PCT/GB90/02015

SUBSTITUTE SHEET

620 630 640 650 660
CTC TAC TCC CTC AGC AGC GTG GTG ACC GTG CCC TCC AGC AGC TTG GGC ACG
GAG ATG AGG GAG TCG TCG CAC CAC TGG CAC GGG AGG TCG TCG AAC CCG TGC
Leu Tyr Ser Leu Ser Ser Val Val Thr Val Pro Ser Ser Ser Leu Gly Thr>
a a a a TRANSLATION OF HCDR1-IGG4.SEQ a a a a >

670 680 690 700 710
AAG ACC TAC ACC TGC AAC GTA GAT CAC AAG CCC AGC AAC ACC AAG GTG GAC
TTC TGG ATG TGG ACG TTG CAT CTA GTG TTC GGG TCG TTG TGG TTC CAC CTG
Lys Thr Tyr Thr Cys Asn Val Asp His Lys Pro Ser Asn Thr Lys Val Asp>
a a a a TRANSLATION OF HCDR1-IGG4.SEQ a a a a >

720 730 740 750 760 770
AAG AGA GTT GG TGA GAGGC CAGCA CAGGG AGGGA GGGTG TCTGC TGGAA GCCAG
TTC TCT CAA CC ACT CTCCG GTCGT GTCCC TCCCT CCCAC AGACG ACCTT CCGTC
Lys Arg Val Gly>
a a a >

780 790 800 810 820
GCTCA GCCCT CCTGC CTGGA CGCAC CCCGG CTGTG CAGCC CCAGC CCAGG GCAGC
CGAGT CGGGA GGACG GACCT GCGTG GGGCC GACAC GTCCG GGTCC GGTCC CGTCG

830 840 850 860 870 880
AAGGC ATGCC CCATC TGTCT CCTCA CCCGG AGGCC TCTGA CCACC CCACT CATGC
TTCCG TACGG GGTAG ACAGA GGAGT GGGCC TCCGG AGACT GGTGG GGTGA GTACG

890 900 910 920 930
TCAGG GAGAG GGTCT TCTGG ATTTT TCCAC CAGGC TCCCG GCACC ACAGG CTGGA
AGTCC CTCTC CCAGA AGACC TAAAA AGGTG GTCCG AGGGC CGTGG TGTCC GACCT

940 950 960 970 980 990
TGCCC CTACC CCAGG CCCTG CGCAT ACAGG GCAGG TGCTG CGCTC AGACC TGCCA
ACGGG GATGG GGTCC GGGAC GCGTA TGTCC CGTCC ACGAC GCGAG TCTGG ACGGT

FIG. 7 (iii)

7/28

WO 91/09966

PCT/GB90/02015

SUBSTITUTE SHEET

```

      1000      1010      1020      1030      1040
AGAGC CATAT CCGGG AGGAC CCTGC CCCTG ACCTA AGCCC ACCCC AAAGG CCAAA
TCTCG GTATA GGCCC TCTG GAGCG GGGAC TGGAT TCGGG TGGGG TTTCC GGTTT

      1050      1060      1070      1080      1090      1100
CTCTC CACTC CCTCA GCTCA GACAC CTTCT CTCCT CCCAG ATCTG AGTAA CTCCC
GAGAG GTGAG GGAGT CGAGT CTGTG GAAGA GAGGA GGGTC TAGAC TCATT GAGGG

      1110      1120      1130      1140      1150
AATCT TCTCT CTGCA GA G TCC AAA TAT GGT CCC CCA TGC CCA TCA TGC CCA GG
TTAGA AGAGA GACGT CT C AGG TTT ATA CCA GGG GGT ACG GGT AGT ACG GGT CC
      Ser Lys Tyr Gly Pro Pro Cys Pro Ser Cys Pro Gly>
      b b TRANSLATION OF HCDR1-IGG4.SEQ b b >

      1160      1170      1180      1190      1200      1210
TA AGCCA ACCCA GGCCT CGCCC TCCAG CTCAA GCGGG GACAG GTGCC CTAGA GTAGC
AT TCGGT TGGGT CCGGA GCGGG AGGTC GAGTT CCGCC CTGTC CACGG GATCT CATCG

      1220      1230      1240      1250      1260
CTGCA TCCAG GGACA GGCCC CAGCC GGGTG CTGAC GCATC CACCT CCATC TCTTC
GACGT AGGTC CCTGT CCGGG GTCGG CCCAC GACTG CGTAG GTGGA GSTAG AGAAG

      1270      1280      1290      1300      1310
CTCAG C A CCT GAG TTC CTG GGG GGA CCA TCA GTC TTC CTG TTC CCC CCA AAA
GAGTC G T GGA CTC AAG GAC CCC CCT GGT AGT CAG AAG GAC AAG GGG GGT TTT
      Pro Glu Phe Leu Gly Gly Pro Ser Val Phe Leu Phe Pro Pro Lys>
      c c c c TRANSLATION OF HCDR1-IGG4.SEQ c c c c >

1320      1330      1340      1350      1360
CCC AAG GAC ACT CTC ATG ATC TCC CGG ACC CCT GAG GTC ACG TGC GTG GTG
GGG TTC CTG TGA GAG TAC TAG AGG GCC TGG GGA CTC CAG TGC ACG CAC CAC
Pro Lys Asp Thr Leu Met Ile Ser Arg Thr Pro Glu Val Thr Cys Val Val>
c c c c TRANSLATION OF HCDR1-IGG4.SEQ c c c c >

```

FIG. 7(iv)

8/28

WO 91/09966

PCT/GB90/02015

FIG. 7(v)

9/28

SUBSTITUTE SHEET

1370 1380 1390 1400 1410
 GTG GAC GTG AGC CAG GAA GAC CCC GAG GTC CAG TTC AAC TGG TAC GTG GAT
 CAC CTG CAC TCG GTC CTT CTG GGG CTC CAG GTC AAG TTG ACC ATG CAC CTA
 Val Asp Val Ser Gln Glu Asp Pro Glu Val Gln Phe Asn Trp Tyr Val Asp>
 c c c c TRANSLATION OF HCDR1-IGG4.SEQ c c c c >

1420 1430 1440 1450 1460 1470
 GGC GTG GAG GTG CAT AAT GCC AAG ACA AAG CCG CGG GAG GAG CAG TTC AAC
 CCG CAC CTC CAC GTA TTA CGG TTC TGT TTC GGC GCC CGT CTC GTC AAG TTG
 Gly Val Glu Val His Asn Ala Lys Thr Lys Pro Arg Glu Glu Gln Phe Asn>
 c c c c TRANSLATION OF HCDR1-IGG4.SEQ c c c c >

1480 1490 1500 1510 1520
 AGC ACG TAC CGT GTG GTC AGC GTC CTC ACC GTC CTG CAC CAG GAC TGG CTG
 TCG TGC ATG GCA CAC CAG TCG CAG GAG TGG CAG GAC GTG GTC CTG ACC GAC
 Ser Thr Tyr Arg Val Val Ser Val Leu Thr Val Leu His Gln Asp Trp Leu>
 c c c c TRANSLATION OF HCDR1-IGG4.SEQ c c c c >

1530 1540 1550 1560 1570
 ACC GGC AAG GAG TAC AAG TGC AAG GTC TCC AAC AAA GGC CTC CCG TCC TCC
 TTG CCG TTC CTC ATG TTC ACG TTC CAG AGG TTG TTT CCG GAG GGC AGG AGG
 Asn Gly Lys Glu Tyr Lys Cys Lys Val Ser Asn Lys Gly Leu Pro Ser Ser>
 c c c c TRANSLATION OF HCDR1-IGG4.SEQ c c c c >

1580 1590 1600 1610 1620
 ATC GAG AAA ACC ATC TCC AAA GCC AAA G GTGGG ACCCA CGGGA TGCGA GGGCC
 TAG CTC TTT TGG TAG AGG TTT CGG TTT C CACCC TGGGT GCCCC ACGCT CCCGG
 Ile Glu Lys Thr Ile Ser Lys Ala Lys>
 TRANSLATION OF HCDR1-IGG4.SE >

1630 1640 1650 1660 1670 1680
 ACACG GACAG AGGCC AGCTC GGCCC ACCCT CTGCC CTGGG AGTGA CCGCT GTGCC
 TGTGC CTGTC TCCGG TCGAG CCGGG TGGGA GACGG GACCC TCACT GGCGA CACGG

SUBSTITUTE SHEET

1690 1700 1710 1720 1730
AACCT CTGTC CCTAC AGG GCA GCC CCG AGA GCC ACA GGT GTA CAC CCT GCC CCC
TTGGA GACAG GGATG TCC CGT CGG GGC TCT CGG TGT CCA CAT GTG GGA CGG GGG
Ala Ala Pro Arg Ala Thr Gly Val His Pro Ala Pro>
d TRANSLATION OF HCDR1-IGG4.SEQ d d >

1740 1750 1760 1770 1780
ATC CCA GGA GGA GAT GAC CAA GAA CCA GGT CAG CCT GAC CTG CCT GGT CAA
TAG GGT CCT CCT CTA CTG GTT CTT GGT CCA GTC GGA CTG GAC GGA CCA GTT
Ile Pro Gly Gly Asp Asp Gln Glu Pro Gly Gln Pro Asp Leu Pro Gly Gln>
d d d d TRANSLATION OF HCDR1-IGG4.SEQ d d d d >

1790 1800 1810 1820 1830
AGG CTT CTA CCC CAG CGA CAT CGC CGT GGA GTG GGA GAG CAA TGG GCA GCC
TCC GAA GAT GGG GTC GCT GTA GCG GCA CCT CAC CCT CTC GTT ACC CGT CGG
Arg Leu Leu Pro Gln Arg His Arg Arg Gly Val Gly Glu Gln Trp Ala Ala>
d d d d TRANSLATION OF HCDR1-IGG4.SEQ d d d d >

1840 1850 1860 1870 1880
GGA GAA CAA CTA CAA GAC CAC GCC TCC CGT GCT GGA CTC CGA CGG CTC CTT
CCT CTT GTT GAT GTT CTG GTG CGG AGG GCA CGA CCT GAG GCT GCC GAG GAA
Gly Glu Gln Leu Gln Asp His Ala Ser Arg Ala Gly Leu Arg Arg Leu Leu>
d d d d TRANSLATION OF HCDR1-IGG4.SEQ d d d d >

1890 1900 1910 1920 1930
CTT CCT CTA CAG CAG GCT AAC CGT GGA CAA GAG CAG GTG GCA GGA GGG GAA
GAA GGA GAT GTC GTC CGA TTG GCA CCT GTT CTC GTC CAC CGT CCT CCC CCT
Leu Pro Leu Gln Gln Ala Asn Arg Gly Gln Glu Gln Val Ala Gly Gly Glu>
d d d d TRANSLATION OF HCDR1-IGG4.SEQ d d d d >

1940 1950 1960 1970 1980
TGT CTT CTC ATG CTC CGT GAT GCA TGA GGC TCT GCA CAA CCA CTA CAC ACA
ACA GAA GAG TAC GAG GCA CTA CGT ACT CCG AGA CGT GTT GGT GAT GTG TGT
Cys Leu Leu Met Leu Arg Asp Ala End Gly Ser Ala Gln Pro Leu His Thr>
d d d d TRANSLATION OF HCDR1-IGG4.SEQ d d d d >

FIG. 7(vi)

10/28

WO 91/09966

PCT/GB90/02015

11/28

FIG. 7(vii)

1990 2000 2010 2020 2030 2040
 GAA GAG CCT CTC CCT GTC TCT GGG TAA ATGA GTGCC AGGGC CGGCA AGCCC CCGCT
 CTT CTC GGA GAG GGA CAG AGA CCC ATT TACT CACGG TCCCG GCCGT TCGGG GCGCA
 Glu Glu Pro Leu Pro Val Ser Gly End>
 TRANSLATION OF HCDR1-IGG4.SE >

2050 2060 2070 2080 2090 2100
 CCCC GGCTC TCGGG GTCGC GCGAG GATGC TTGGC ACGTA CCCC TCTAC ATACT
 GGGGC CCGAG AGCCC CAGCG CGCTC CTACG AACCG TGCAT GGGGC AGATG TATGA

2110 2120 2130 2140 2150
 TCCCA GGCAC CCAGC ATGGA AATAA AGCAC CCACC ACTGC CCTGG GCCCC TGTGA
 AGGGT CCGTG GGTCG TACCT TTATT TCGTG GGTGG TGACG GGACC CGGGG AACT

2160 2170 2180 2190 2200 2210
 GACTG TGATG GTTCT TTCCA CGGGT CAGGC CGAGT CTGAG GCCTG AGTGA CATGA
 CTGAC ACTAC CAAGA AAGGT GCCCA GTCCG GCTCA GACTC CGGAC TCACT GTACT

2220 2230 2240 2250 2260
 GGGAG GCAGA GCGGG TCCCA CTGTC CCCAC ACTGG CCCAG GCGTT GCAGT GTGTC
 CCCTC CGTCT CGCCC AGGGT GACAG GGGTG TGACC GGGTC CGCAA CGTCA CACAG

2270 2280 2290 2300 2310 2320
 CTGGG CCACC TAGGG TGGGG CTCAG CCAGG GGCTC CCTCG GCAGG GTGGG GCATT
 GACCC GGTGG ATCCC ACCCC GAGTC GGTCC CCGAG GGAGC CGTCC CACCC CGTAA

2330 2340 2350 2360
 TGCCA GCGTG GCCCT CCCTC CAGCA GCAGG ACTCT AGAGG ATCC
 ACGGT CGCAC CGGGA GGGAG GTCGT CGTCC TGAGA TCTCC TAGG

SUBSTITUTE SHEET

FIG. 8(i)

The DNA SEQUENCE and PROTEIN TRANSLATION of the CDR-GRAFTED LIGHT CHAIN

```

10      20      30      40      50
AATTC ACC ATG GGT GTG CCC ACT CAG GTC CTG GGG TTG CTG CTG CTG TGG CTT
TTAAG TGG TAC CCA CAC GGG TGA GTC CAG GAC CCC AAC GAC GAC GAC ACC GAA
Met Gly Val Pro Thr Gln Val Leu Gly Leu Leu Leu Leu Trp Leu>
a a a TRANSLATION OF LCDR1-SEQ a a a a >

60      70      80      90      100
ACA GAT GCC AGA TGT GAT ATC CAG ATG ACA CAG TCT CCT TCT TCT CTG TCT
TGT CTA CGG TCT ACA CTA TAG GTC TAC TGT GTC AGA GGA AGA AGA GAC AGA
Thr Asp Ala Arg Cys Asp Ile Gln Met Thr Gln Ser Pro Ser Ser Leu Ser>
a a a a a TRANSLATION OF LCDR1-SEQ a a a a a >

110     120     130     140     150
GCT TCT GTC GGA GAC AGA GTC ACA ATC ACA TGT AAG GCT AGC CCA GAC AAT
CGA AGA CAG CCT CTG TCT CAG TGT TAG TGT ACA TTC CGA TCG GGT CTG TAA
Ala Ser Val Gly Asp Arg Val Thr Ile Thr Cys Lys Ala Ser Pro Asp Ile>
a a a a a TRANSLATION OF LCDR1-SEQ a a a a a >

160     170     180     190     200
AAC AAC TAT CTG AAC TGG TAC CAG CAG ACA CCT GGA AAG GCT CCT AAG CTG
TTG TTG ATA GAC TTG ACC ATG GTC GTC TGT GGA CCT TTC CGA GGA TTC GAC
Asn Asn Tyr Leu Asn Trp Tyr Gln Gln Thr Pro Gly Lys Ala Pro Lys Leu>
a a a a a TRANSLATION OF LCDR1-SEQ a a a a a >

210     220     230     240     250
CTG ATC TAC TAC ACA TCT ACA TTA CAA CCA GGA GTC CCT TCT AGA TTC TCT
GAC TAG ATG AGT TGT AGA TGT AAT GTT GGT CCT CAG GGA AGA TCT AAG AGA
Leu Ile Tyr Tyr Thr Ser Thr Leu Gln Pro Gly Val Pro Ser Arg Phe Ser>
a a a a a TRANSLATION OF LCDR1-SEQ a a a a a >

260     270     280     290     300
GGT TCT GGC TCT GGA ACA GAG TAC ACA TTC ACA ATC TCT TCT CTC CAA CCT
CCA AGA CCG AGA CCT TGT CTG ATG TGT AAG TGT TAG AGA AGA GAG GTT GGA
Gly Ser Gly Ser Gly Thr Asp Tyr Thr Phe Thr Ile Ser Ser Leu Gln Pro>
a a a a a TRANSLATION OF LCDR1-SEQ a a a a a >

```

SUBSTITUTE SHEET

12/28

WO 91/09966

PCT/GB90/02015

FIG. 8(ii)

310 320 330 340 350
 GAG GAC ATC GCT ACA TAC TAC TGC CAA CAG TAT GAT AAT CTT CTG TTC ACA
 CTC CTG TAG CGA TGT ATG ATG ACG GTT GTC ATA CTA TTA GAA GAC AAG TGT
 Glu Asp Ile Ala Thr Tyr Tyr Cys Gln Gln Tyr Asp Asn Leu Leu Phe Thr>
 a a a a a TRANSLATION OF LCDR1-SEQ a a a a a >

>SEQED (include) of: [molbio.data]hckapnar.seq check: 1483 from: 1 to: 397

360 370 380 390 400 410
 TTC GGA CAG GGA ACA AAG CTG CAG ATC ACA AGA ACT GTG GCG GCG CCG TCT
 AAG CCT GTC CCT TGT TTC GAC GTC TAG TGT TCT TGA CAC CGC CGC GGC AGA
 Phe Gly Gln Gly Thr Lys Leu Gln Ile Thr Arg Thr Val Ala Ala Pro Ser>
 a a a a a TRANSLATION OF LCDR1.SEQ a a a a a >

420 430 440 450 460
 GTC TTC ATC TTC CCG CCA TCT GAT GAG CAG TTG AAA TCT GGA ACT GCC TCT
 CAG AAG TAG AAG GGC GGT AGA CTA CTC GTC AAC TTT AGA CCT TGA CGG AGA
 Val Phe Ile Phe Pro Pro Ser Asp Glu Gln Leu Lys Ser Gly Thr Ala Ser>
 a a a a a TRANSLATION OF LCDR1.SEQ a a a a a >

470 480 490 500 510
 GTT GTG TGC CTG CTG AAT AAC TTC TAT CCC AGA GAG GCC AAA GTA CAG TGG
 CAA CAC ACG GAC GAC TTA TTG AAG ATA GGG TCT CTC CGG TTT CAT GTC ACC
 Val Val Cys Leu Leu Asn Asn Phe Tyr Pro Arg Glu Ala Lys Val Gln Trp>
 a a a a a TRANSLATION OF LCDR1.SEQ a a a a a >

520 530 540 550 560
 AAG GTG GAT AAC GCC CTC CAA TCG GGT AAC TCC CAG GAG AGT GTC ACA GAG
 TTC CAC CTA TTG CGG GAG GTT AGC CCA TTG AGG GTC CTC TCA CAG TGT CTC
 Lys Val Asp Asn Ala Leu Gln Ser Gly Asn Ser Gln Glu Ser Val Thr Glu>
 a a a a a TRANSLATION OF LCDR1.SEQ a a a a a >

SUBSTITUTE SHEET

13/28

FIG. 8 (iii)

570 580 590 600 610
 CAG GAC AGC AAG GAC AGC ACC TAC AGC CTC AGC AGC ACC CTG ACC CTG AGC
 GTC CTG TCG TTC CTG TCG TGG ATG TCG GAG TCG TCG TGG GAC TGC GAC TCG
 Gln Asp Ser Lys Asp Ser Thr Tyr Ser Leu Ser Ser Thr Leu Thr Leu Ser>
 a a a a a TRANSLATION OF LCDR1.SEQ a a a a a >

620 630 640 650 660
 AAA GCA GAC TAC GAG AAA CAC AAA GTC TAC GCC TGC GAA GTC ACC CAT CAG
 TTT CGT CTG ATG CTC TTT GTG TTT CAG ATG CGG ACG CTT CAG TGG GTA GTC
 Lys Ala Asp Tyr Glu Lys His Lys Val Tyr Ala Cys Glu Val Thr His Gln>
 a a a a a TRANSLATION OF LCDR1.SEQ a a a a a >

670 680 690 700 710
 GGC CTG AGC TCG CCC GTC ACA AAG AGC TTC AAC AGG GGA GAG TGT TAG AG
 CCG GAC TCG AGC GGG CAG TGT TTC TCG AAG TTG TCC CCT CTC ACA ATC TC
 Gly Leu Ser Ser Pro Val Thr Lys Ser Phe Asn Arg Gly Glu Cys End>
 a a a a a TRANSLATION OF LCDR1.SEQ a a a a >

720 730 740 750
 GGACA AGTGC CCCCA CCTGC TCCTC AGTTC CAGCC TGAT
 CCTCT TCACG GGGST GGACG AGGAG TCAAG GTCGG ACTA

SUBSTITUTE SHEET

14/28

15/28

CONSTRUCTION of the CDR-GRAFTED OKT4A HEAVY CHAIN
EXPRESSION VECTOR (Not to scale)

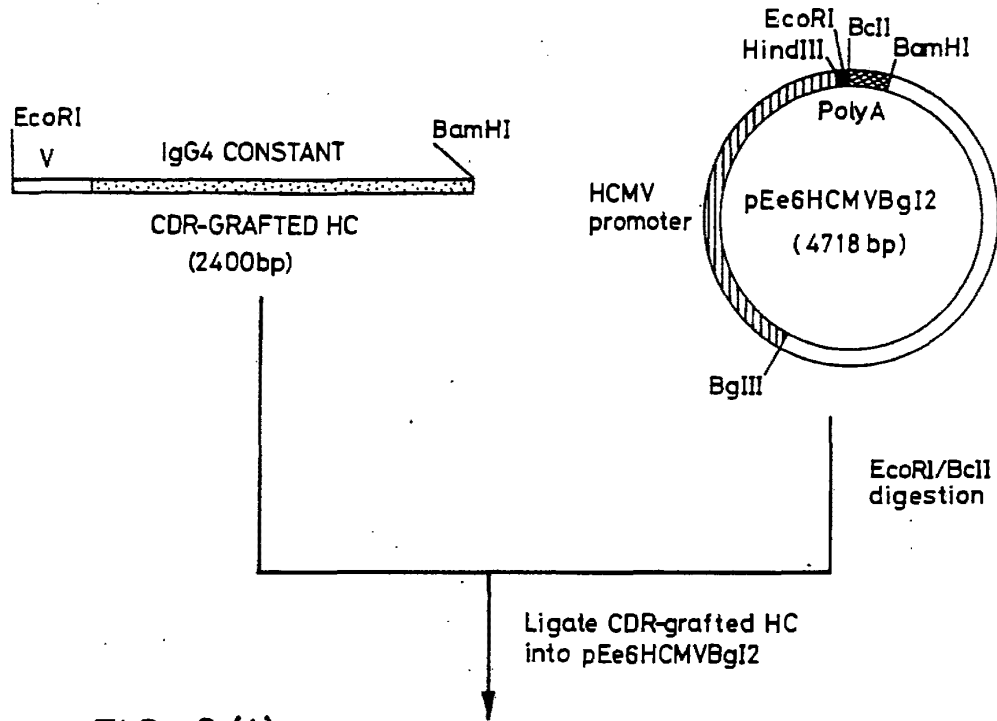
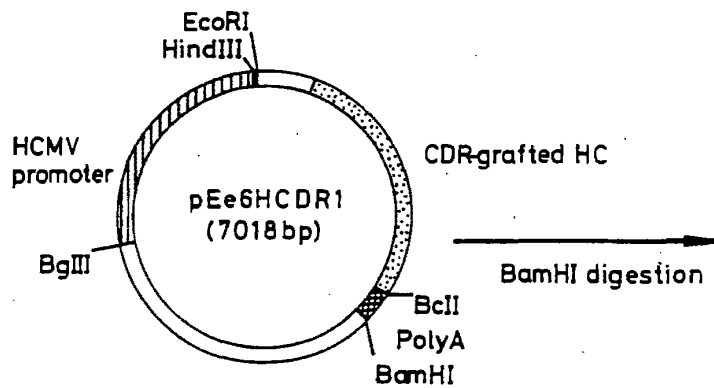

FIG. 9 (i)



SUBSTITUTE SHEET

16/28

FIG. 9 (ii)

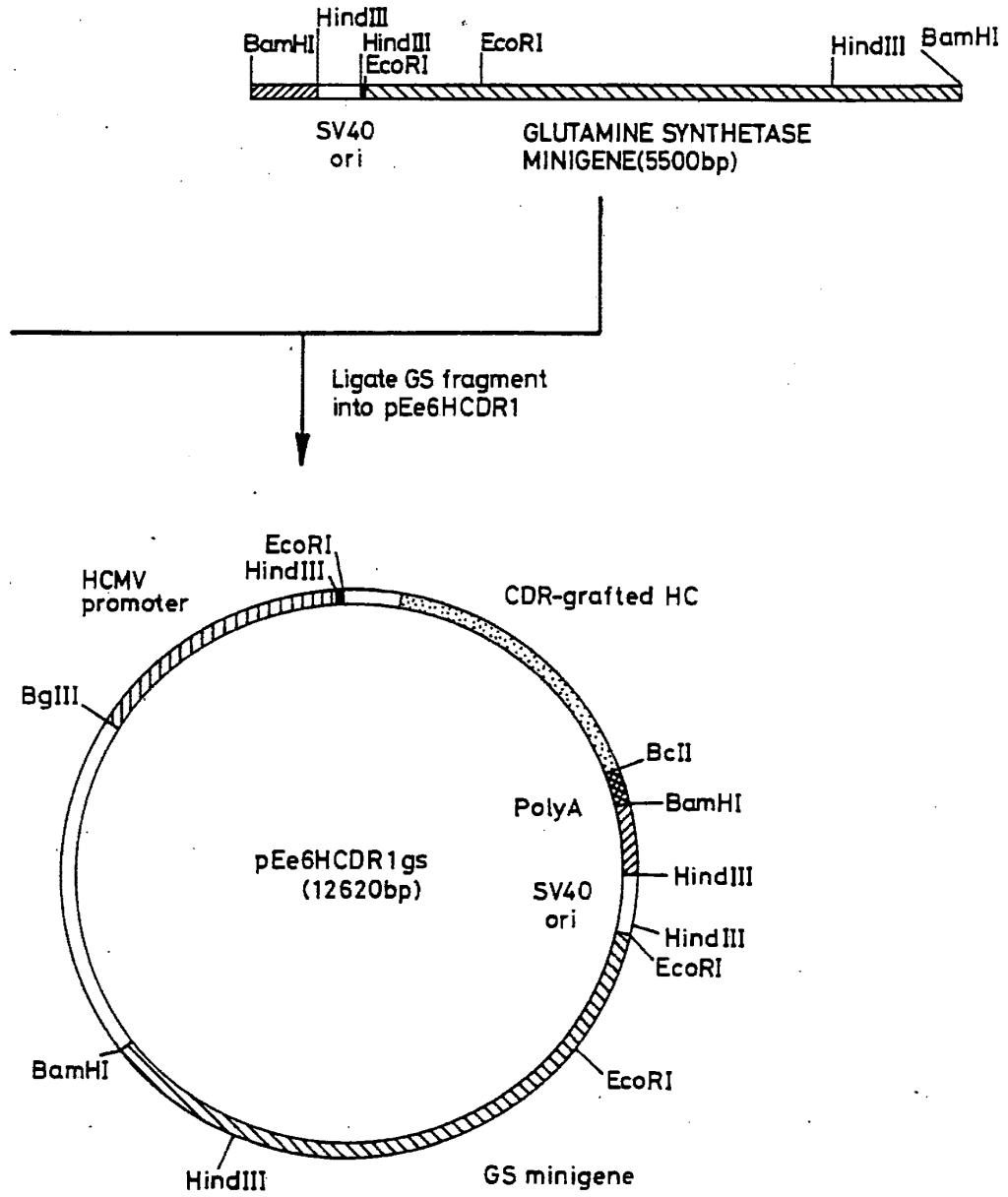

SUBSTITUTE SHEET

FIG. 10 17/28

OKT4A - GRAFTED LIGHT CHAIN CONSTRUCTS
BINDING ASSAY
(Peak Channel - PBL's)

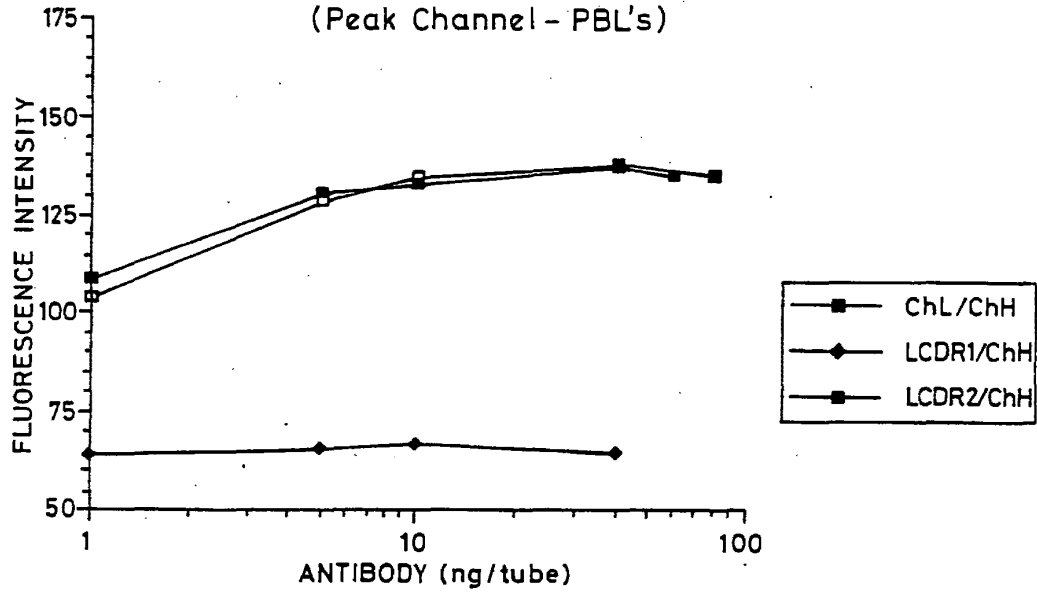

OKT4A - GRAFTED LIGHT CHAIN CONSTRUCTS
BLOCKING ASSAY
(Peak Channel - PBL's)

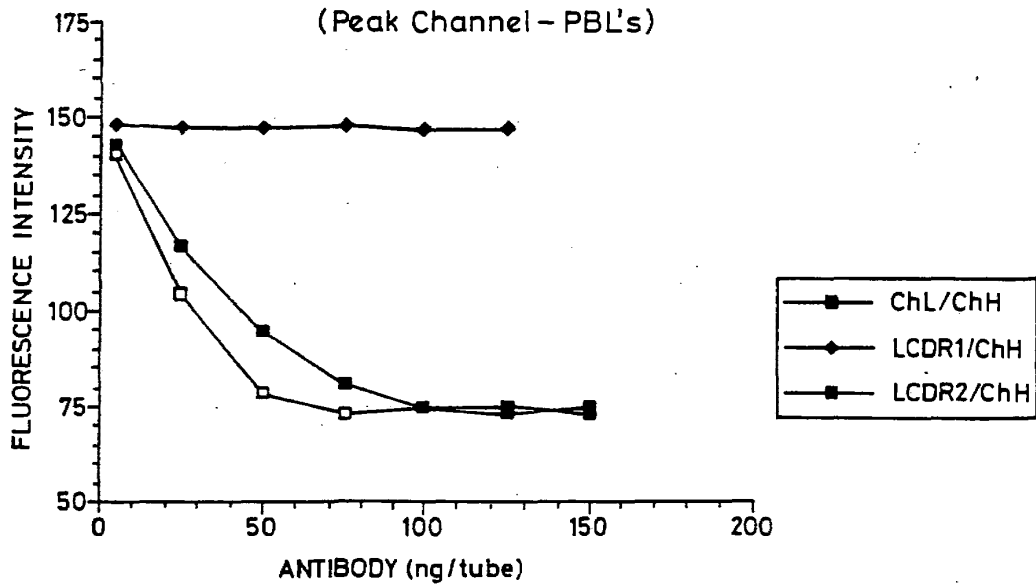

SUBSTITUTE SHEET

FIG. 11 ^{18/28}
OKT4A - GRAFTED HEAVY CHAIN CONSTRUCTS
BINDING ASSAY
(Peak Channel- PBL's)

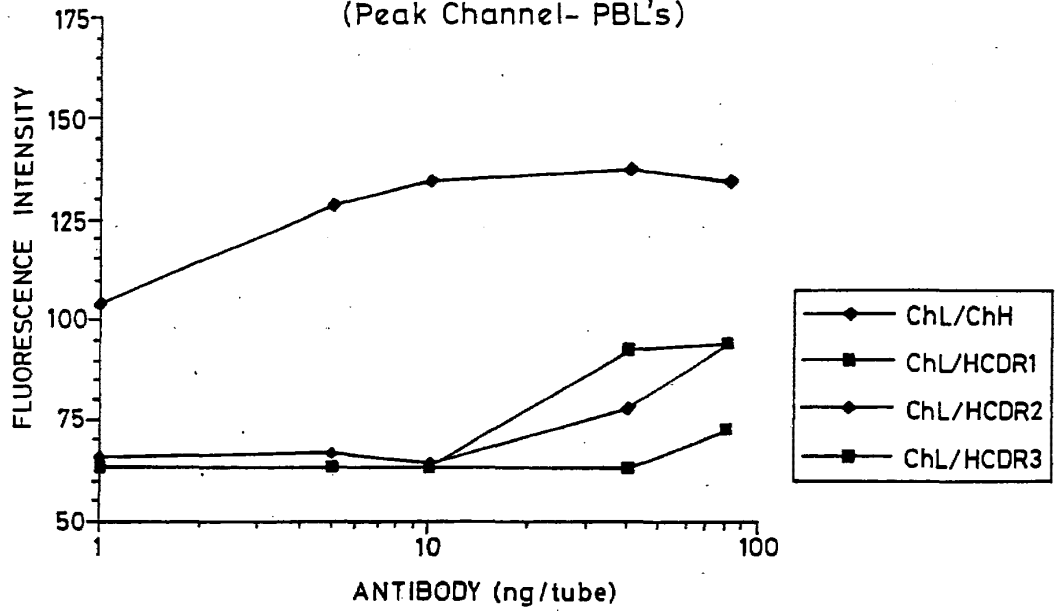

OKT4A - GRAFTED HEAVY CHAIN CONSTRUCTS
BLOCKING ASSAY
(Peak Channel - PBL's)

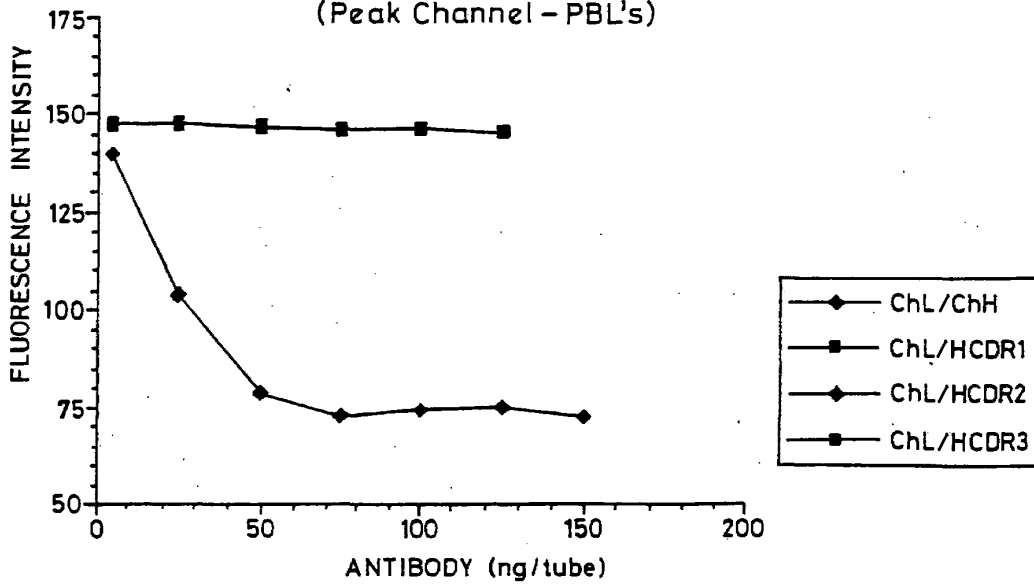

SUBSTITUTE SHEET

FIG. 12

ALIGNMENT OF REI WITH OKT4A CDR GRAFTED AND MURINE LIGHT CHAIN
PEPTIDE SEQUENCE (VARIABLE REGION)

SUBSTITUTE SHEET

	20	40	60	RESIDUE CHANGES
I	DIQMTQSPSS LSASVGDRVT ITCQASQDII KYLNWYQQTP GKAPKLLIYE ASNLOAGVPS			
DR1	DIQMTQSPSS LSASVGDRVT ITckASpDIn nYLNWYQQTP GKAPKLLIYy tStLQpGVPS			
DR2	DIQMTQSPSS LSASVGDRVT ITckASpDIn nYiaWYQhTP GKAPKLLIhy tStLQpGVPS			33, 34, 38, 49
OKT4A	DIQMTQSPSS LSASlGgkVT IaCkASpDIn nYiaWYQhkp GKgPrLLIhy tStLQpGIPS			
	80	100		
I	RFSGSGSGTD YTFTISLQP EDIATYYCQQ YQSLPYTFGQ GTKLQITR			
DR1	RFSGSGSGTD YTFTISLQP EDIATVYCQQ YdnLlftFGQ GTKLQITR			
DR2	RFSGSGSGTD YTFTISLQP EDIATYClQQ YdnLlftFGQ GTKLQITR			89
OKT4A	RFSGSGSGrD YsFsISnLeP EDIATYClQQ YdnLlftFGg GTKLeIkR			

19/28

FIG. 13(i)

ALIGNMENT OF KOL WITH OKT4A CDR GRAFTED AND MURINE
HEAVY CHAIN PEPTIDE SEQUENCE(VARIABLE REGION)

SUBSTITUTE SHEET

		20	35ab	RESIDUE CHANGES
KOL	QVQLVESGGG	VVQPGRSLRL	SCSSSGFIFS <u>SYAMY--WVR</u>	
HCDR1	QVQLVESGGG	VVQPGRSLRL	SCSSSGFtFS <u>nYAMY--WVR</u>	
HCDR2	QVQLVESGGG	VVQPGRSLRL	SCSSSGFtFS <u>nYAMY--WVR</u>	
HCDR3	QVQLVESGGG	VVQPGRSLRL	SCSaSGFtFS <u>nYAMY--WVR</u>	24
HCDR4	QVQLVESGGG	VVQPGRSLRL	SCSaSGFtFS <u>nYAMs--WVR</u>	24, 35
HCDR5	QVQLVESGGG	VVQPGRSLRL	SCSaSGFtFS <u>nYAMs--WVR</u>	24, 35
HCDR6	QVQLVESGGG	VVQPGRSLRL	SCSaSGFtFS <u>nYAMs--WVR</u>	24, 35
HCDR7	QVQLVESGGG	VVQPGRSLRL	SCSaSGFtFS <u>nYAMs--WVR</u>	24, 35
HCDR8	QVQLVESGGG	VVQPGRSLRL	SCSaSGFtFS <u>nYAMs--WVR</u>	24
HCDR9	QVQLVESGGG	VVQPGRSLRL	SCSaSGFtFS <u>nYAMs--WVR</u>	24, 35
HCDR10	QVQLVESGGG	VVQPGRSLRL	SCSaSGFtFS <u>nYAMs--WVR</u>	24, 35
MU OKT4A	eViLVESGga	lVePGgSLkL	SCSaSGFtFS <u>nYAMs--WVR</u>	24, 35

20/28

		52abc	65	
KOL	QAPGKLEWV	AIiWD--DGS	DQHYADSVKG	RFTISRDNsk
HCDR1	QAPGKLEWV	AaIsD--hst	nQHYADSVKG	RFTISRDNsk
HCDR2	QAPGKLEWV	AaIsD--hst	ntyYADSVKG	RFTISRDNsk
HCDR3	QAPGKLEWV	AaIsD--hst	ntyYADSVKG	RFTISRDNsk
HCDR4	QAPeKLEWV	AaIsD--hst	ntyYADSVKG	RFTISRDNsk
HCDR5	QAPeKrLEWV	AaIsD--hst	ntyYADSVKG	RFTISRDNsk
HCDR6	QAPeKLEWV	AaIsD--hst	ntyYpDSVKG	RFTISRDNsk
HCDR7	QAPeKrLEWV	AaIsD--hst	ntyYpDSVKG	RFTISRDNsk
HCDR8	QAPeKrLEWV	AaIsD--hst	ntyYpDSVKG	RFTISRDNsk
HCDR9	QAPGKLEWV	AaIsD--hst	ntyYADSVKG	RFTISRDNsk
HCDR10	QAPGKLEWV	AaIsD--hst	ntyYpDSVKG	RFTISRDNsk
MU OKT4A	QAPeKLEWV	AaIsD--hst	ntyYpDSVKG	RFTISRDNsk

57, 58
57, 58
42, 57, 58
42, 44, 57, 58
42, 57, 58, 60
42, 44, 57, 58, 60
42, 44, 57, 58, 60
57, 58
57, 58, 60

SUBSTITUTE SHEET

	82abc	95	100c	
KOL	NTLFLQMDSL	RPEDTGVYFC	<u>AR--DGGHGF</u>	CSSASCFGPD
HCDR1	NTLFLQMDSL	RPEDTGVYFC	<u>AR-kyGGd-y</u>	dpf-----D
HCDR2	NTLFLQMDSL	RPEDTGVYFC	<u>AR-kyGGd-y</u>	dpf-----D
HCDR3	NTLFLQMDSL	RPEDTaVYyc	<u>AR-kyGGd-y</u>	dpf-----D
HCDR4	NTLFLQMDSL	RPEDTaVYyc	<u>AR-kyGGd-y</u>	dpf-----D
HCDR5	NTLFLQMDSL	RPEDTaVYyc	<u>AR-kyGGd-y</u>	dpf-----D
HCDR6	NTLFLQMDSL	RPEDTaVYyc	<u>AR-kyGGd-y</u>	dpf-----D
HCDR7	NTLFLQMDSL	RPEDTaVYyc	<u>AR-kyGGd-y</u>	dpf-----D
HCDR8	NTLFLQMDSL	RPEDTaVYyc	<u>AR-kyGGd-y</u>	dpf-----D
HCDR9	NTLFLQMDSL	RPEDTaVYyc	<u>AR-kyGGd-y</u>	dpf-----D
HCDR10	NTLFLQMDSL	RPEDTaVYyc	<u>AR-kyGGd-y</u>	dpf-----D
MU OKT4A	NTLFLQMnSL	RPEDTaiYyc	<u>AR-kyGGd-y</u>	dpf-----D

88, 91
88, 91
88, 91
88, 91
88, 91
88, 91
88, 91
88, 91
88, 91
88, 91

21/28

	113
KOL	YWGQGTPVTV SS
HCDR1	YWGQGTPVTV SS
HCDR2	YWGQGTPVTV SS
HCDR3	YWGQGTPVTV SS
HCDR4	YWGQGTPVTV SS
HCDR5	YWGQGTPVTV SS
HCDR6	YWGQGTPVTV SS
HCDR7	YWGQGTPVTV SS
HCDR8	YWGQGTPVTV SS
HCDR9	YWGQGTPVTV SS
HCDR10	YWGQGTPVTV SS
MU OKT4A	YWGQGTt1TV SS

FIG. 13(ii)

WO 91/09966

PCT/GB90/02015

22/28

FIG. 14

OKT4A - LCDR2 VRS GRAFTED HEAVY CHAINS
BINDING ASSAY
(Peak Channel - PBL's)

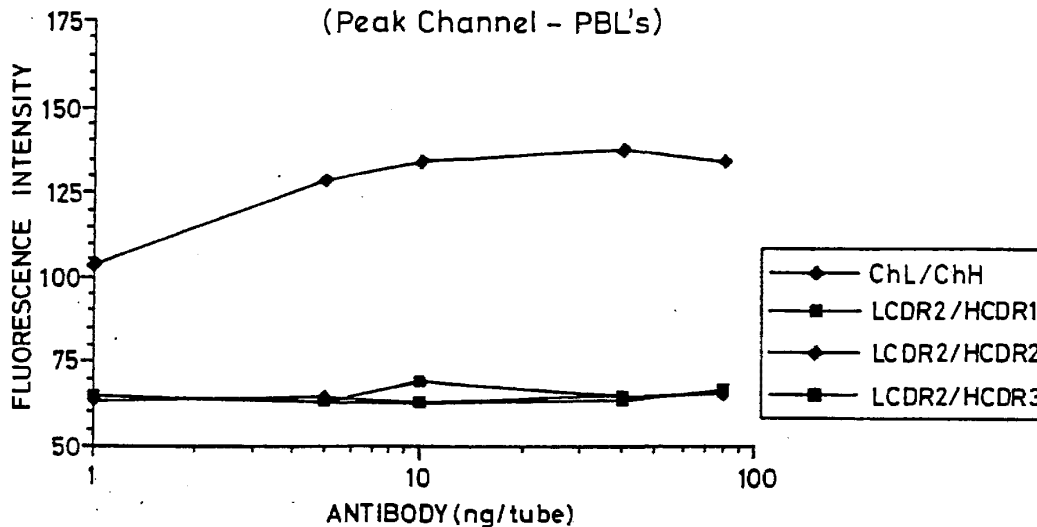

OKT4A - LCDR2 VRS GRAFTED HEAVY CHAINS
BLOCKING ASSAY
(Peak Channel - PBL's)

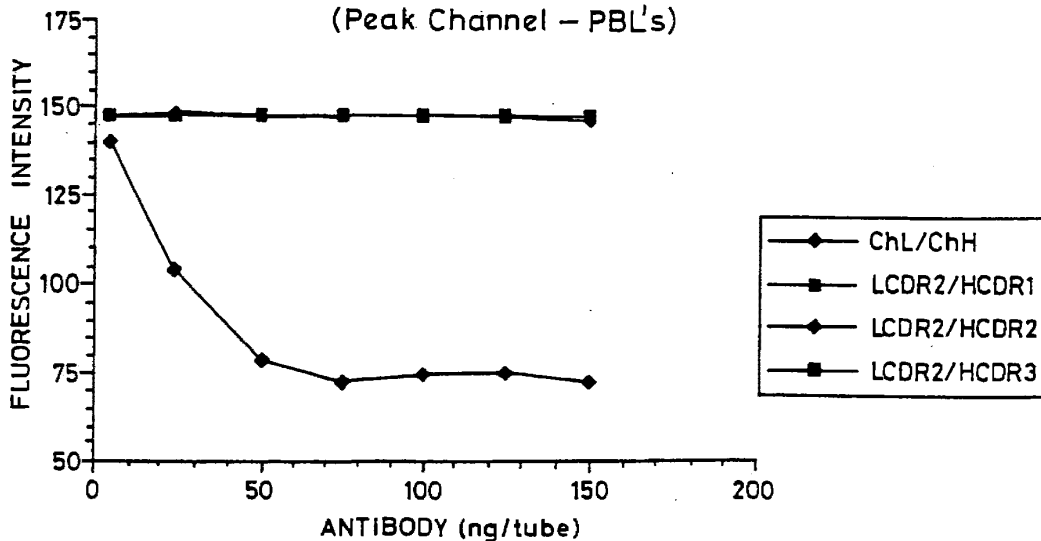

SUBSTITUTE SHEET

23/28

FIG. 15

OKT4A - GRAFTED ANTIBODIES
 BINDING ASSAY
 (Mean Channel - HPBALL's)

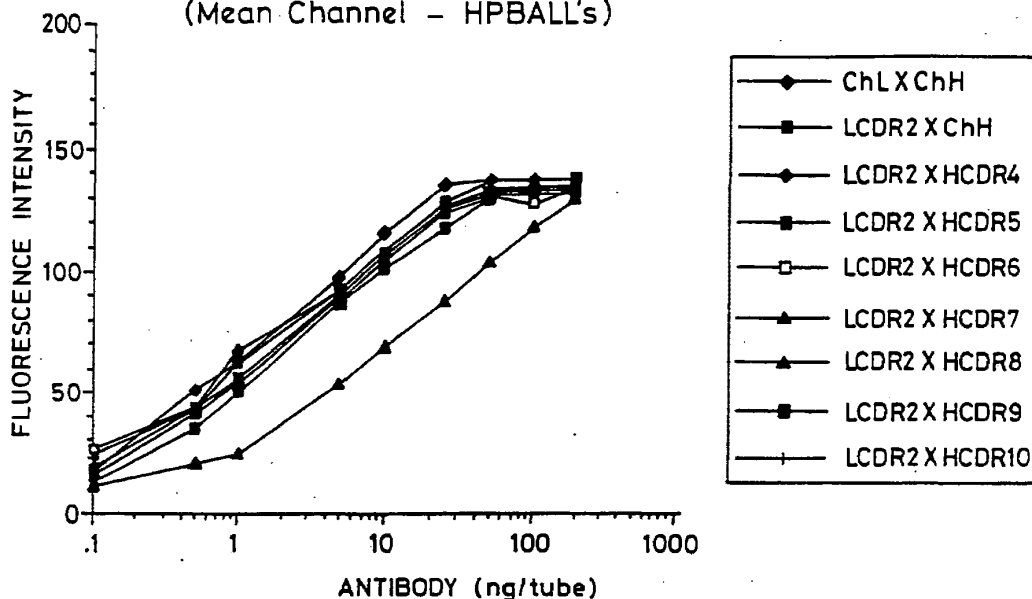

OKT4A - GRAFTED ANTIBODIES
 BLOCKING ASSAY
 (Mean Channel - HPBALL's)

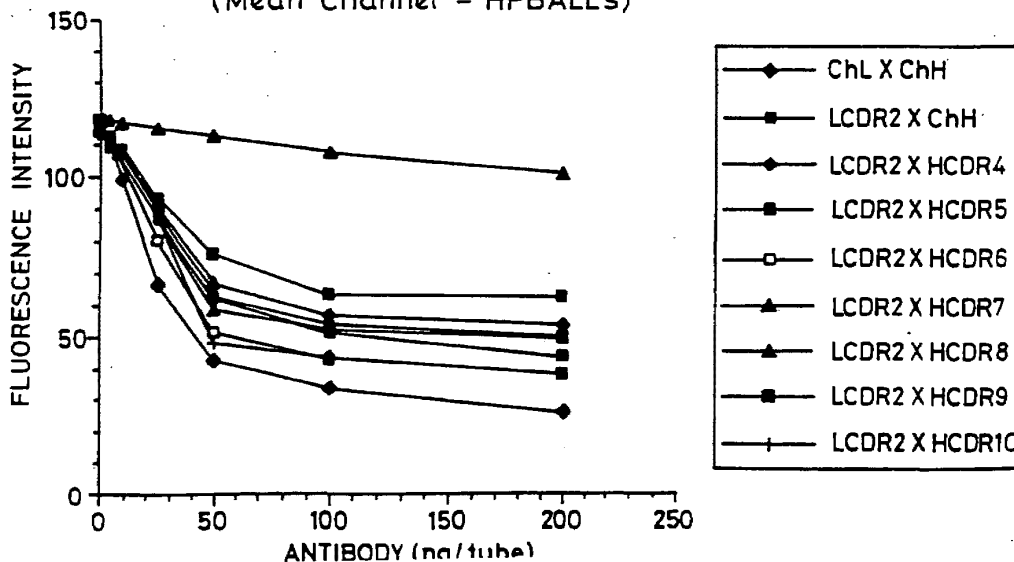

SUBSTITUTE SHEET

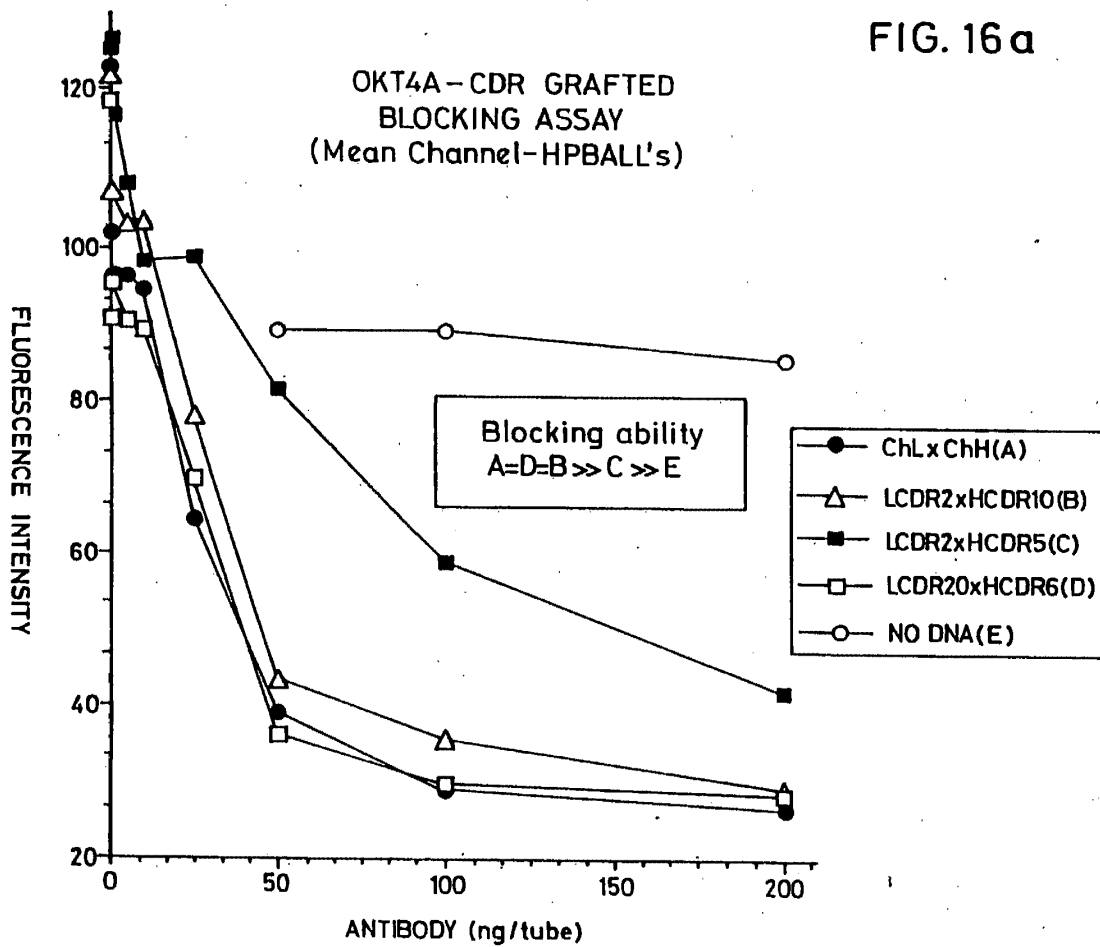
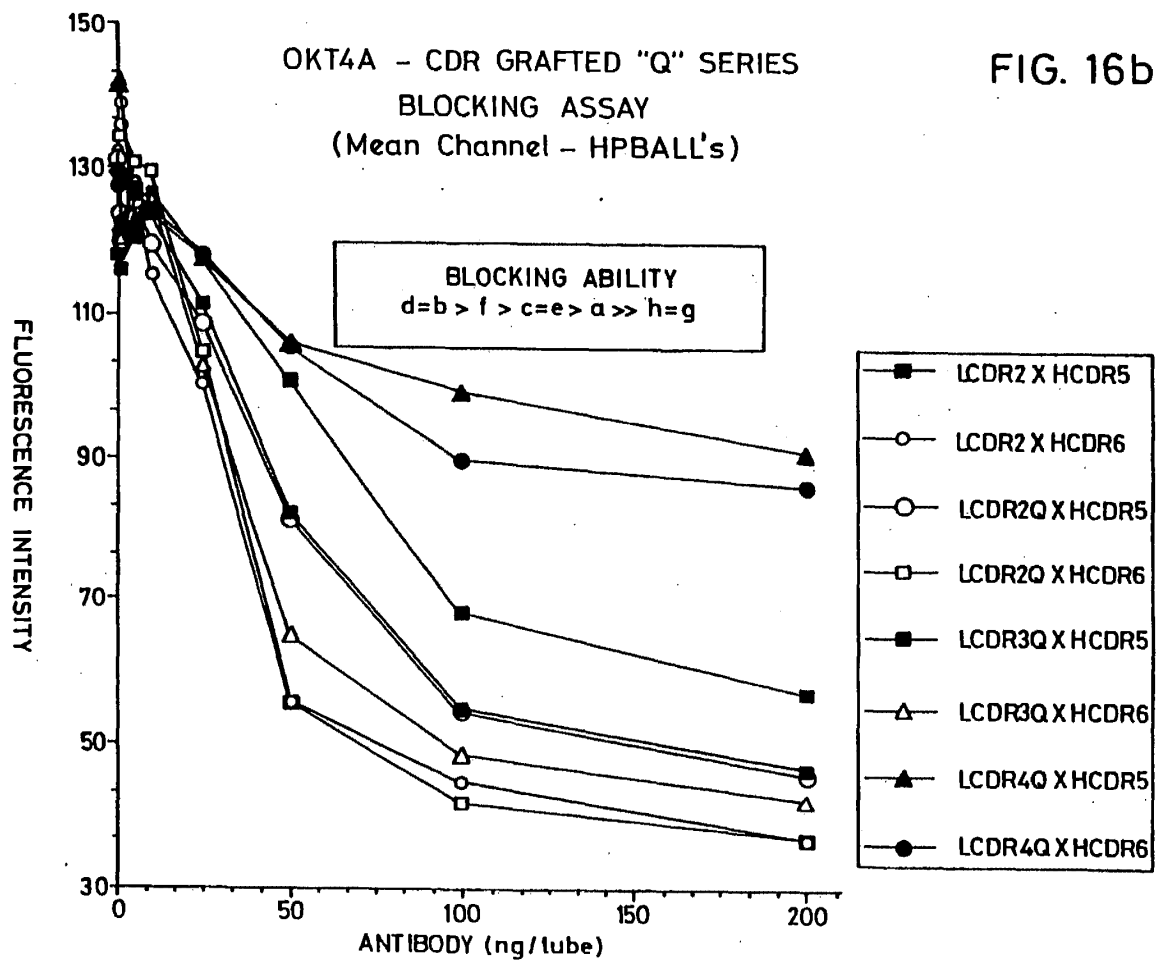

FIG. 16a

24/28

25/28

FIG. 16b



SUBSTITUTE SHEET

26/28

SUBSTITUTE SHEET

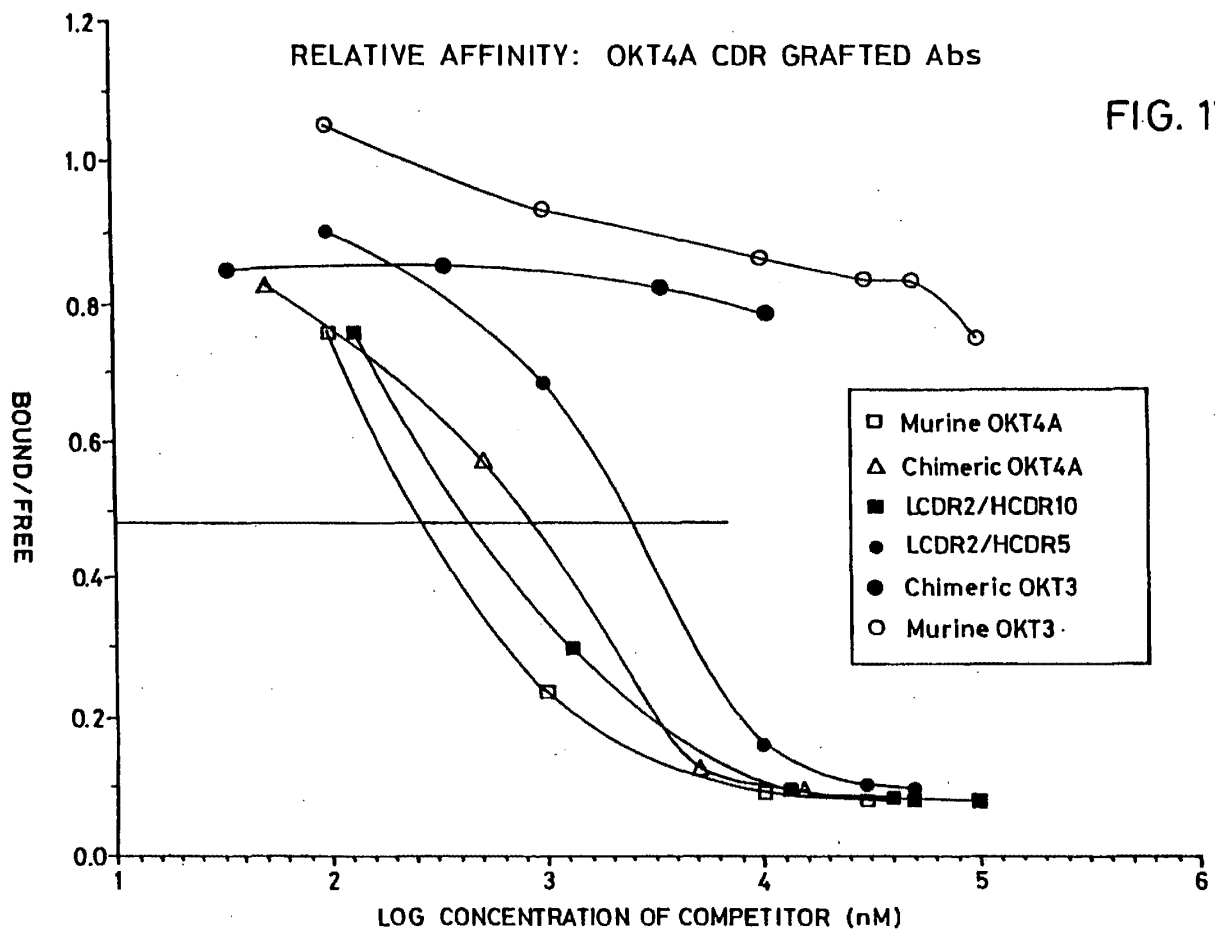

27/28

FIG. 18

MLR Block: Murine / Chimeric T4A

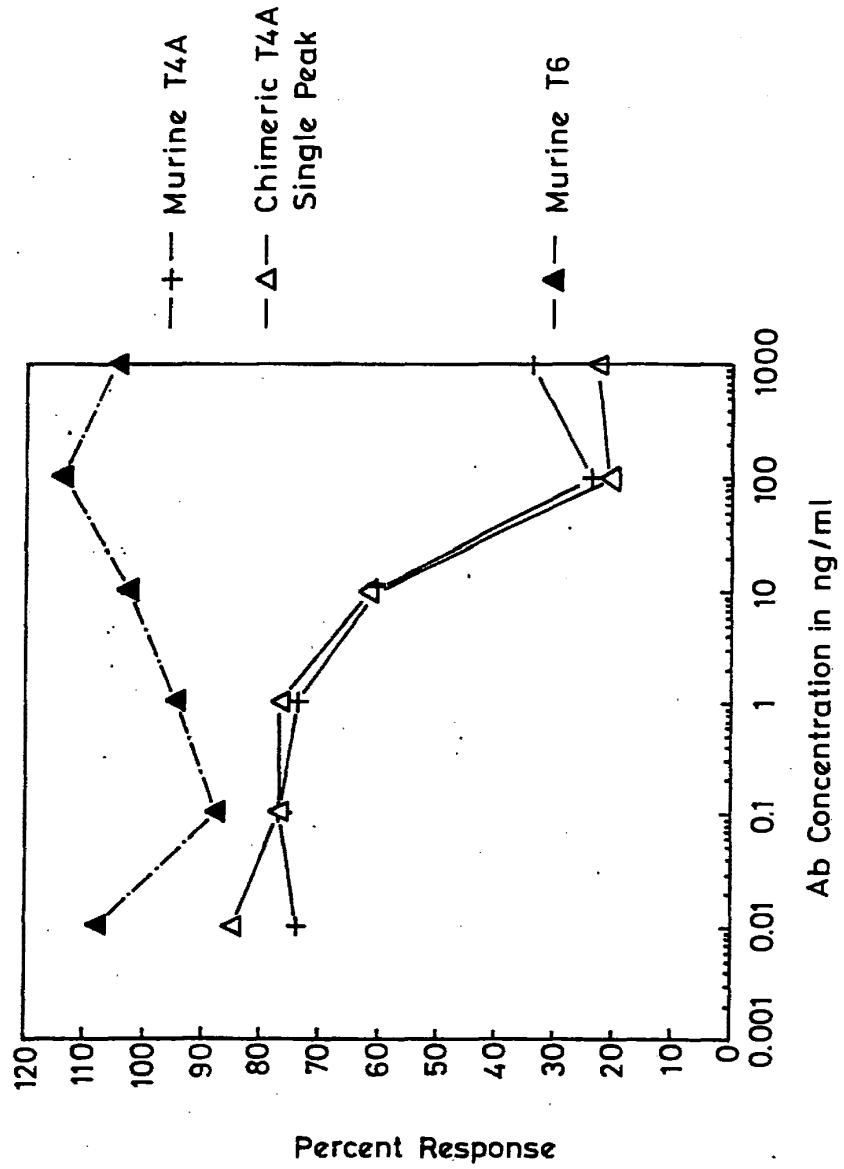

SUBSTITUTE SHEET

ANTI-CD4 Abs: INHIBITION OF
PROLIFERATION TO IMMOBILIZED OKT3

FIG. 19

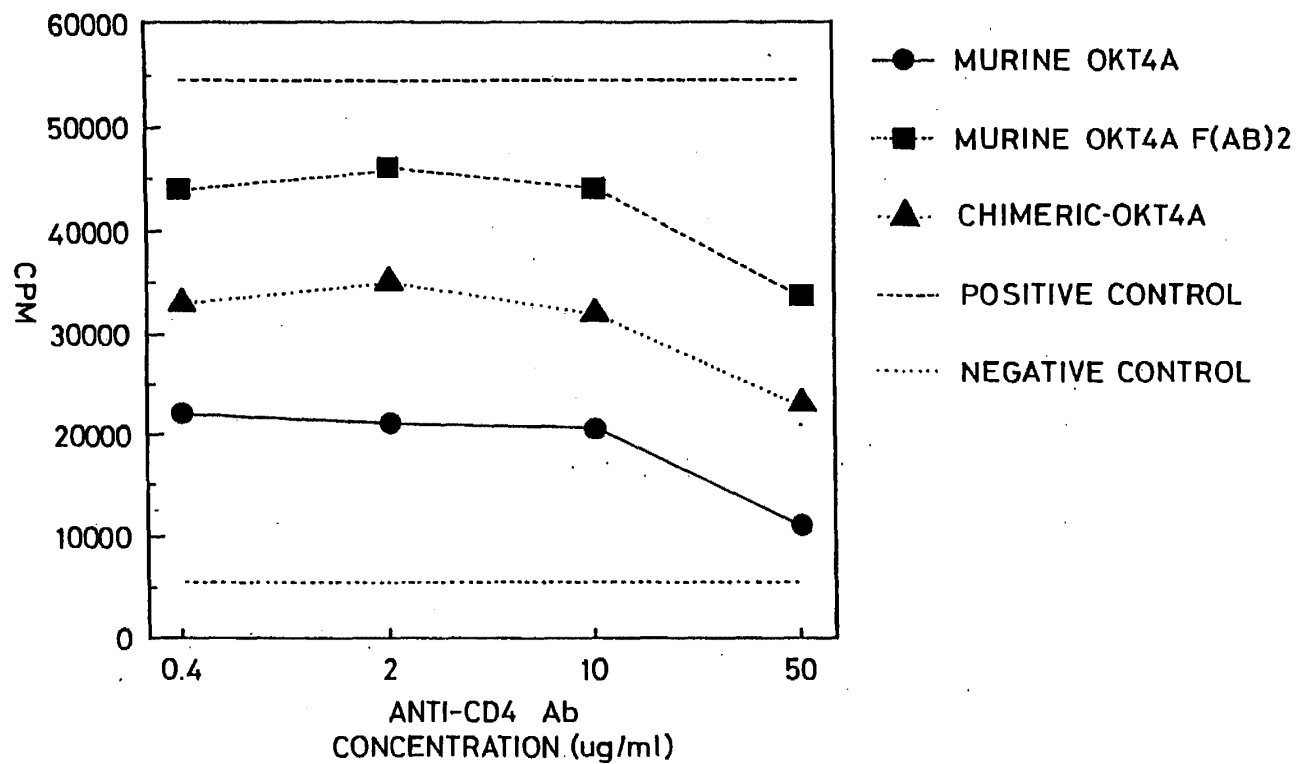

SUBSTITUTE SHEET

28/28

WO 91/09966

PCT/GB90/02015

INTERNATIONAL SEARCH REPORT

International Application No **PCT/GB 90/02015**

I. CLASSIFICATION OF SUBJECT MATTER (If several classification symbols apply, indicate all) ⁶		
According to International Patent Classification (IPC) or to both National Classification and IPC IPC5: C 12 P 21/08, C 12 N 15/13, A 61 K 39/395, C 07 K 15/06 C 12 N 5/10, 15/62		
II. FIELDS SEARCHED		
Minimum Documentation Searched ⁷		
Classification System	Classification Symbols	
IPC5	C 12 P; C 12 N; A 61 K	
Documentation Searched other than Minimum Documentation to the Extent that such Documents are Included in Fields Searched ⁸		
III. DOCUMENTS CONSIDERED TO BE RELEVANT⁹		
Category *	Citation of Document, ¹¹ with Indication, where appropriate, of the relevant passages ¹²	Relevant to Claim No. ¹³
P, X	EP, A2, 0365209 (BECTON DICKINSON AND COMPANY) 25 April 1990, see the whole document	1-3, 5-7, 14, 15, 20-22, 27-30, 32, 33- 43
Y	Proc. Natl. Acad. Sci. USA, vol. 86, December 1989, C. Queen et al.: "A humanized antibody that binds to the interleukin 2 receptor ", see page 10029- page 10033 see the whole document and in particular page 10031 right coll. - page 10032, left col. and page 10033, left col.	1-43
<p>¹⁰ Special categories of cited documents:</p> <p>"A" document defining the general state of the art which is not considered to be of particular relevance</p> <p>"E" earlier document but published on or after the international filing date</p> <p>"L" document which may throw doubts on priority claim(s) or which is cited to establish the publication date of another citation or other special reason (as specified)</p> <p>"O" document referring to an oral disclosure, use, exhibition or other means</p> <p>"P" document published prior to the international filing date but later than the priority date claimed</p> <p>"T" later document published after the international filing date or priority date and not in conflict with the application but cited to understand the principle or theory underlying the invention</p> <p>"X" document of particular relevance, the claimed invention cannot be considered novel or cannot be considered to involve an inventive step</p> <p>"Y" document of particular relevance, the claimed invention cannot be considered to involve an inventive step when the document is combined with one or more other such documents, such combination being obvious to a person skilled in the art.</p> <p>"&" document member of the same patent family</p>		
IV. CERTIFICATION		
Date of the Actual Completion of the International Search	Date of Mailing of this International Search Report	
10th April 1991	17.05.91	
International Searching Authority	Signature of Authorized Officer	
EUROPEAN PATENT OFFICE	 M. SOTELO	

Form PCT/ISA/210 (second sheet) (January 1985)

III. DOCUMENTS CONSIDERED TO BE RELEVANT (CONTINUED FROM THE SECOND SHEET)		
Category *	Citation of Document, with indication, where appropriate, of the relevant passages	Relevant to Claim No
A	Nature, vol. 332, March 1988, L. Riechmann et al.: "Reshaping human antibodies for therapy", see page 323 - page 327 see in particular page 327, right col. --	1-43
A	EP, A1, 0328404 (MEDICAL RESEARCH COUNCIL ET AL.) 16 August 1989, see pages 1-3, page 9, lines 49-54 and the claims --	1-43
Y	US, A, 4695459 (L. STEINMAN ET AL.) 22 September 1987, see the whole document --	1-43
A	Scientific American, October 1988, J.N. Weber et al.: "HIV Infection: The Cellular Picture", see page 81 - page 97 see page 84, left col., pages 85-87 --	1,43
A	Nature, vol. 337, February 1989, D.J. Capon et al.: "Designing CD4 immunoadhesins for AIDS therapy", see page 525 - page 531 see in particular page 530 -- -----	1

Form PCT/ISA/210 (extra sheet) (January 1985)

FURTHER INFORMATION CONTINUED FROM THE SECOND SHEET

V. OBSERVATIONS WHERE CERTAIN CLAIMS WERE FOUND UNSEARCHABLE ¹

This international search report has not been established in respect of certain claims under Article 17(2) (a) for the following reasons:

1. Claim numbers 44 because they relate to subject matter not required to be searched by this Authority, namely:

See PCT Rule 39.1(iv)

Method for treatment of the human or animal body by means of surgery or therapy, as well as diagnostic methods.

2. Claim numbers because they relate to parts of the international application that do not comply with the prescribed requirements to such an extent that no meaningful international search can be carried out, specifically:

3. Claim numbers because they are dependent claims and are not drafted in accordance with the second and third sentences of PCT Rule 6.4(a).

VI. OBSERVATIONS WHERE UNITY OF INVENTION IS LACKING ²

This international Searching Authority found multiple inventions in this international application as follows:

1. As all required additional search fees were timely paid by the applicant, this international search report covers all searchable claims of the international application.
2. As only some of the required additional search fees were timely paid by the applicant, this international search report covers only those claims of the international application for which fees were paid, specifically claims:
3. No required additional search fees were timely paid by the applicant. Consequently, this international search report is restricted to the invention first mentioned in the claims; it is covered by claim numbers:
4. As all searchable claims could be searched without effort justifying an additional fee, the International Searching Authority did not invite payment of any additional fee.

Remark on Protest

- The additional search fees were accompanied by applicant's protest.
- No protest accompanied the payment of additional search fees.

**ANNEX TO THE INTERNATIONAL SEARCH REPORT
ON INTERNATIONAL PATENT APPLICATION NO.PCT/GB 90/02015**

SA 43315

This annex lists the patent family members relating to the patent documents cited in the above-mentioned international search report. The members are as contained in the European Patent Office EDP file on 28/02/91. The European Patent office is in no way liable for these particulars which are merely given for the purpose of information.

Patent document cited in search report	Publication date	Patent family member(s)	Publication date
EP-A2- 0365209	25/04/90	JP-A- 2238883	21/09/90
EP-A1- 0328404	16/08/89	AU-D- 3062689	06/09/89
		GB-A- 2216126	04/10/89
		WO-A- 89/07452	24/08/89
US-A- 4695459	22/09/87	JP-A- 61161221	21/07/86

For more details about this annex : see Official Journal of the European patent Office, No. 12/82

PCT

WORLD INTELLECTUAL PROPERTY ORGANIZATION
International Bureau



INTERNATIONAL APPLICATION PUBLISHED UNDER THE PATENT COOPERATION TREATY (PCT)

<p>(51) International Patent Classification ⁵ : C12P 21/08, C12N 15/13 A61K 39/395, C07K 15/06 C12N 5/10, 15/62, A61K 49/00</p>	<p>A1</p>	<p>(11) International Publication Number: WO 91/09968 (43) International Publication Date: 11 July 1991 (11.07.91)</p>
<p>(21) International Application Number: PCT/GB90/02018 (22) International Filing Date: 21 December 1990 (21.12.90) (30) Priority data: 8928874.0 21 December 1989 (21.12.89) GB (71) Applicant (for all designated States except US): CELLTECH LIMITED [GB/GB]; 216 Bath Road, Slough, Berkshire SL1 4EN (GB). (72) Inventors; and (75) Inventors/Applicants (for US only) : JOLLIFFE, Linda, Kay [US/US]; 301 Tall Oak Lane, Somerville, NJ 08876 (US). ZIVIN, Robert, Allan [US/US]; 6 Glenbrook Court, Lawrenceville, NJ 08648 (US). ADAIR, John, Robert [GB/GB]; 23 George Road, Stokenchurch, High Wycombe, Buckinghamshire HP14 3RN (GB). ATHWAL, Diljeet, Singh [GB/GB]; Flat 35, Knollys House, Tavistock Square, London WC1 (GB).</p>	<p>(74) Agent: MERCER, Christopher, Paul; Carpmaels & Ransford, 43 Bloomsbury Square, London WC1A 2RA (GB). (81) Designated States: AT, AT (European patent), AU, BB, BE (European patent), BF (OAPI patent), BG, BJ (OAPI patent), BR, CA, CF (OAPI patent), CG (OAPI patent), CH, CH (European patent), CM (OAPI patent), DE, DE (European patent), DK, DK (European patent), ES, ES (European patent), FI, FR (European patent), GA (OAPI patent), GB, GB (European patent), GR, GR (European patent), HU, IT (European patent), JP, KP, KR, LK, LU, LU (European patent), MC, MG, ML (OAPI patent), MR (OAPI patent), MW, NL, NL (European patent), NO, RO, SD, SE, SE (European patent), SN (OAPI patent), SU, TD (OAPI patent), TG (OAPI patent), US. Published <i>With international search report. Before the expiration of the time limit for amending the claims and to be republished in the event of the receipt of amendments.</i></p>	
<p>(54) Title: CD3 SPECIFIC RECOMBINANT ANTIBODY</p>		
<p>(57) Abstract</p> <p>A recombinant antibody molecule comprises antigen binding regions derived from the heavy and/or light chain variable regions of a donor anti-CD3 antibody, e.g. OKT3, and has anti-CD3 binding specificity, preferably of affinity similar to that of OKT3. The recombinant antibody is preferably a humanised antibody and may be a chimeric or CDR-grafted antibody. A protocol is disclosed for preparing CDR-grafted humanised antibodies in which, in addition to the CDRs non-human antibody residues are preferably used at positions 23, 24, 49, 71, 73 and 78 of the heavy chain variable region and at positions 46, 48, 58 and 71 of the light chain variable region. The recombinant, especially the humanised, anti-CD3 antibodies may be used for <i>in vivo</i> therapy or diagnosis.</p>		

FOR THE PURPOSES OF INFORMATION ONLY

Codes used to identify States party to the PCT on the front pages of pamphlets publishing international applications under the PCT.

AT	Austria	ES	Spain	MG	Madagascar
AU	Australia	FI	Finland	ML	Mali
BB	Barbados	FR	France	MN	Mongolia
BE	Belgium	GA	Gabon	MR	Mauritania
BF	Burkina Faso	GB	United Kingdom	MW	Malawi
BG	Bulgaria	GN	Guinea	NL	Netherlands
BJ	Benin	GR	Greece	NO	Norway
BR	Brazil	HU	Hungary	PL	Poland
CA	Canada	IT	Italy	RO	Romania
CF	Central African Republic	JP	Japan	SD	Sudan
CG	Congo	KP	Democratic People's Republic of Korea	SE	Sweden
CH	Switzerland	KR	Republic of Korea	SN	Senegal
CI	Côte d'Ivoire	LI	Liechtenstein	SU	Soviet Union
CM	Cameroon	LK	Sri Lanka	TD	Chad
CS	Czechoslovakia	LU	Luxembourg	TG	Togo
DE	Germany	MC	Monaco	US	United States of America
DK	Denmark				

CD3 specific recombinant antibody

Field of the Invention

The present invention relates to a recombinant antibody molecule (RAM), and especially a humanised antibody molecule (HAM), having specificity for an antigen present in the T-cell receptor-CD3 complex of most T-cells, to a process for its production using recombinant DNA technology and to its therapeutic use.

In the present application, the term "recombinant antibody molecule" (RAM) is used to describe an antibody produced by an process involving the use of recombinant DNA technology, including any analogues of natural immunoglobulins or their fragments. The term "humanised antibody molecule" (HAM) is used to describe a molecule having an antigen binding site derived from an immunoglobulin from a non-human species, remaining immunoglobulin-derived parts of the molecule being derived from a human immunoglobulin. The antigen binding site may comprise either complete variable domains fused onto constant domains or one or more complementarity determining regions grafted onto appropriate framework regions in the variable domains. The abbreviation "MAb" is used to indicate a monoclonal antibody.

In the description, reference is made to a number of publications by number. The publications are listed in numerical order at the end of the description.

Background of the Invention

Natural immunoglobulins have been known for many years, as have the various fragments thereof, such as the Fab, (Fab')₂ and Fc fragments, which can be derived by enzymatic cleavage. Natural immunoglobulins comprise a generally Y-shaped molecule having an antigen-binding site towards the end of each upper arm. The remainder of the

- 2 -

structure, and particularly the stem of the Y, mediates the effector functions associated with immunoglobulins.

Natural immunoglobulins have been used in assay, diagnosis and, to a more limited extent, therapy. However, such uses, especially in therapy, have been hindered by the polyclonal nature of natural immunoglobulins. A significant step towards the realisation of the potential of immunoglobulins as therapeutic agents was the discovery of techniques for the preparation of monoclonal antibodies of defined specificity (ref. 1). However, most MAb are produced by fusions of rodent spleen cells with rodent myeloma cells. They are therefore essentially rodent proteins. There are very few reports of the production of human MAbs.

Since most available MAbs are of rodent origin, they are naturally antigenic in humans and thus can give rise to an undesirable immune response termed the HAMA (Human Anti-Mouse Antibody) response. Therefore, the use of rodent MAbs as therapeutic agents in humans is inherently limited by the fact that the human subject will mount an immunological response to the MAb and will either remove it entirely or at least reduce its effectiveness. Thus, in practice, MAbs of rodent origin may not be used in patients for more than one or a few treatments as a HAMA response soon develops rendering the MAb ineffective as well as giving rise to undesirable reactions.

Proposals have therefore been made for making non-human MAbs less antigenic in humans. Such techniques can be generically termed "humanisation" techniques. These techniques generally involve the use of recombinant DNA technology to manipulate DNA sequences encoding the polypeptide chains of the antibody molecule.

- 3 -

Early methods for humanising MAbS involved production of chimeric antibodies in which an antigen binding site comprising the complete variable domains of one antibody is linked to constant domains derived from another antibody. Methods for carrying out such chimerisation procedures are described in EP0120694 (Celltech Limited), EP0125023 (Genentech Inc. and City of Hope), EP-A-0 171496 (Res. Dev. Corp. Japan), EP-A-0 173 494 (Stanford University), and WO 86/01533 (Celltech Limited). This latter Celltech application (WO 86/01533) discloses a process for preparing an antibody molecule having the variable domains from a mouse MAb and the constant domains from a human immunoglobulin. Such humanised chimeric antibodies, however, still contain a significant proportion of non-human amino acid sequence, i.e. the complete non-human variable domains, and thus may still elicit some HAMA response, particularly if administered over a prolonged period [Begent al al Br. J.Cancer, 62: 487 (1990)].

WO 86/01533 also describes the production of an antibody molecule comprising the variable domains of a mouse MAb, the CH1 and CL domains of a human immunoglobulin, and a non-immunoglobulin-derived protein in place of the Fc portion of the human immunoglobulin.

In an alternative approach, described in EP-A-0239400 (Winter), the complementarity determining regions (CDRs) of a mouse MAb have been grafted onto the framework regions of the variable domains of a human immunoglobulin by site directed mutagenesis using long oligonucleotides. There are 3 CDRs (CDR1, CDR2 and CDR3) in each of the heavy and light chain variable regions. Such CDR-grafted humanised antibodies are much less likely to give rise to a HAMA response than humanised chimeric antibodies in view

- 4 -

of the much lower proportion of non-human amino acid sequence which they contain.

The earliest work on humanising MAb's by CDR-grafting was carried out on MAb's recognising synthetic antigens, such as the NP or NIP antigens. However, examples in which a mouse MAb recognising lysozyme and a rat MAb recognising an antigen on human T-cells respectively were humanised by CDR-grafting are shown by Verhoeyen et al (ref. 2) and Riechmann et al (ref. 3). The preparation of CDR-grafted antibody to the antigen on human T cells is also described in WO 89/07452 (Medical Research Council).

In Riechmann et al it was found that transfer of the CDR regions alone (as defined by Kabat refs. 4 and 5) was not sufficient to provide satisfactory antigen binding activity in the CDR-grafted product. Riechmann et al found that it was necessary to convert a serine residue at position 27 of the human sequence to the corresponding rat phenylalanine residue to obtain a CDR-grafted product having satisfactory antigen binding activity. This residue at position 27 of the heavy chain is within the structural loop adjacent to CDR1. A further construct which additionally contained a human serine to rat tyrosine change at position 30 of the heavy chain did not have a significantly altered binding activity over the humanised antibody with the serine to phenylalanine change at position 27 alone. These results indicate that changes to residues of the human sequence outside the CDR regions, in particular in the loop adjacent to CDR1, may be necessary to obtain effective antigen binding activity for CDR-grafted antibodies which recognise more complex antigens. Even so the binding affinity of the best CDR-grafted antibodies obtained was still significantly less than the original MAb.

- 5 -

Very recently Queen et al (ref. 6) have described the preparation of a humanised antibody that binds to the interleukin 2 receptor, by combining the CDRs of a murine MAb (anti-Tac) with human immunoglobulin framework and constant regions. The human framework regions were chosen to maximise homology with the anti-Tac MAb sequence. In addition computer modelling was used to identify framework amino acid residues which were likely to interact with the CDRs or antigen, and mouse amino acids were used at these positions in the humanised antibody.

In WO 90/07861 Queen et al propose four criteria for designing humanised immunoglobulins. The first criterion is to use as the human acceptor the framework from a particular human immunoglobulin that is unusually homologous to the non-human donor immunoglobulin to be humanised, or to use a consensus framework from many human antibodies. The second criterion is to use the donor amino acid rather than the acceptor if the human acceptor residue is unusual and the donor residue is typical for human sequences at a specific residue of the framework. The third criterion is to use the donor framework amino acid residue rather than the acceptor at positions immediately adjacent to the CDRs. The fourth criterion is to use the donor amino acid residue at framework positions at which the amino acid is predicted to have a side chain atom within about 3 Å of the CDRs in a three-dimensional immunoglobulin model and to be capable of interacting with the antigen or with the CDRs of the humanised immunoglobulin. It is proposed that criteria two, three or four may be applied in addition or alternatively to criterion one, and may be applied singly or in any combination.

- 6 -

WO 90/07861 describes in detail the preparation of a single CDR-grafted humanised antibody, a humanised antibody having specificity for the p55 Tac protein of the IL-2 receptor. The combination of all four criteria, as above, were employed in designing this humanised antibody, the variable region frameworks of the human antibody Eu (refs. 4 & 5) being used as acceptor. In the resultant humanised antibody the donor CDRs were as defined by Kabat et al (refs. 4 and 5) and in addition the mouse donor residues were used in place of the human acceptor residues, at positions 27, 30, 48, 66, 67, 89, 91, 94, 103, 104, 105 and 107 in the heavy chain and at positions 48, 60 and 63 in the light chain, of the variable region frameworks. The humanised anti-Tac antibody obtained is reported to have an affinity for p55 of $3 \times 10^9 \text{ M}^{-1}$, about one-third of that of the murine MAb.

OKT3 is a mouse IgG2a/k MAb which recognises an antigen in the T-cell receptor-CD3 complex and has been approved for use in many countries throughout the world as an immunosuppressant in the treatment of acute allograft rejection [Chatenoud et al (ref. 7), and Jeffers et al (ref. 8) However, in view of the murine nature of this MAb, a significant HAMA response, with a major anti-idiotypic component, may build up on use. Clearly, it would be highly desirable to diminish or abolish this undesirable HAMA response by suitable humanisation or other recombinant DNA manipulation of this very useful antibody and thus enlarge its area of use. It would also be desirable to apply the techniques of recombinant DNA technology more generally to this useful antibody to prepare RAM products.

Moreover, we have further investigated the preparation of CDR-grafted humanised antibody molecules and have identified a hierarchy of positions within the framework

- 7 -

of the variable regions (i.e. outside both the Kabat CDRs and structural loops of the variable regions) at which the amino acid identities of the residues are important for obtaining CDR-grafted products with satisfactory binding affinity. This has enabled us to establish a protocol for obtaining satisfactory CDR-grafted products which may be applied very widely irrespective of the level of homology between the donor immunoglobulin and acceptor framework. The set of residues which we have identified as being of critical importance does not coincide with the residues identified by Queen et al (ref. 6).

Summary of the Invention

Accordingly the present invention provides an RAM comprising antigen binding regions derived from the heavy and/or light chain variable regions of a donor anti-CD3 antibody and having anti-CD3 binding specificity, and preferably having an anti-CD3 binding affinity similar to that of OKT3.

Typically the donor anti-CD3 antibody is a rodent MAb.

The RAM of the invention may comprise antigen binding regions from any suitable anti-CD3 antibody, typically a rodent anti-CD3 MAb, e.g. a mouse or rat anti-CD3 MAb. The RAM may comprise a recombinant version of whole or a major part of the amino acid sequence of such a MAb. Also the RAM may comprise only the variable region (VH and/or VL) or one or more CDRs of such a MAb. Especially the RAM may comprise amino acid sequences, whether variable region, CDR or other, derived from the specific anti-CD3 MAb (OKT3) hereinafter specifically described with reference to Figures 1 and 2.

Preferably the RAM of the present invention is a humanised antibody molecule (HAM) having specificity for CD3 and

- 8 -

having an antigen binding site wherein at least one of the complementarity determining regions (CDRs) of the variable domain, usually at least two and preferably all of the CDRs, are derived from a non-human anti-CD3 antibody, e.g. a rodent anti-CD3 MAb.

The RAM may be a chimeric antibody or a CDR-grafted antibody.

Accordingly, in preferred embodiments the invention provides an anti-CD3 CDR-grafted antibody heavy chain having a variable region domain comprising acceptor framework and donor CD3 binding regions wherein the framework comprises donor residues at at least one of positions 6, 23 and/or 24, 48 and/or 49, 71 and/or 73, 75 and/or 76 and/or 78 and 88 and/or 91.

More preferably, the heavy chain framework of the preferred embodiment comprises donor residues at positions 23, 24, 49, 71, 73 and 78 or at positions 23, 24 and 49. The residues at positions 71, 73 and 78 of the heavy chain framework are preferably either all acceptor or all donor residues.

In particularly preferred embodiments the heavy chain framework additionally comprises donor residues at one, some or all of positions 6, 37, 48 and 94. Also it is particularly preferred that residues at positions of the heavy chain framework which are commonly conserved across species, i.e. positions 2, 4, 25, 36, 39, 47, 93, 103, 104, 106 and 107, if not conserved between donor and acceptor, additionally comprise donor residues. Most preferably the heavy chain framework additionally comprises donor residues at positions 2, 4, 6, 25, 36, 37, 39, 47, 48, 93, 94, 103, 104, 106 and 107.

- 9 -

In addition the heavy chain framework optionally comprises donor residues at one, some or all of positions:

1 and 3,
72 and 76,
69 (if 48 is different between donor and acceptor),
38 and 46 (if 48 is the donor residue),
80 and 20 (if 69 is the donor residue),
67,
82 and 18 (if 67 is the donor residue),
91,
88, and
any one or more of 9, 11, 41, 87, 108, 110 and 112.

In the preferred embodiments of the present invention described above and hereinafter, reference is made to CDR-grafted antibody products comprising acceptor framework and donor antigen binding regions. It will be appreciated that the invention is widely applicable to the CDR-grafting of anti-CD3 antibodies in general. Thus, the donor and acceptor antibodies may be anti-CD3 antibodies derived from animals of the same species and even same antibody class or sub-class. More usually, however, the donor and acceptor antibodies are derived from animals of different species. Typically the donor anti-CD3 antibody is a non-human antibody, such as a rodent MAb, and the acceptor antibody is a human antibody.

In the CDR-grafted antibody products of the present invention, the donor CD3 binding region typically comprises at least one CDR from the donor antibody. Usually the donor antigen binding region comprises at least two and preferably all three CDRs of each of the heavy chain and/or light chain variable regions. The CDRs may comprise the Kabat CDRs, the structural loop CDRs or a composite of the Kabat and structural loop CDRs and any combination of any of these. Preferably, the antigen

- 10 -

binding regions of the CDR-grafted heavy chain variable domain comprise CDRs corresponding to the Kabat CDRs at CDR2 (residues 50-65) and CDR3 (residues 95-100) and a composite of the Kabat and structural loop CDRs at CDR1 (residues 26-35).

The residue designations given above and elsewhere in the present application are numbered according to the Kabat numbering (refs. 4 and 5). Thus the residue designations do not always correspond directly with the linear numbering of the amino acid residues. The actual linear amino acid sequence may contain fewer or additional amino acids than in the strict Kabat numbering corresponding to a shortening of, or insertion into, a structural component, whether framework or CDR, of the basic variable domain structure. For example, the heavy chain variable region of the anti-Tac antibody described by Queen *et al* (ref. 6) contains a single amino acid insert (residue 52a) after residue 52 of CDR2 and a three amino acid insert (residues 82a, 82b and 82c) after framework residue 82, in the Kabat numbering. The correct Kabat numbering of residues may be determined for a given antibody by alignment at regions of homology of the sequence of the antibody with a "standard" Kabat numbered sequence.

The invention also provides in a further preferred embodiment a CDR-grafted antibody light chain having a variable region domain comprising acceptor framework and donor CD3 binding regions wherein the framework comprises donor residues at at least one of positions 1 and/or 3 and 46 and/or 47. Preferably the CDR grafted light chain of this preferred embodiment comprises donor residues at positions 46 and/or 47.

The invention also provides in a yet further preferred embodiment a CDR-grafted antibody light chain having a

- 11 -

variable region domain comprising acceptor framework and donor CD3 binding regions wherein the framework comprises donor residues at at least one of positions 46, 48, 58 and 71.

More preferably in this latter embodiment, the framework comprises donor residues at all of positions 46, 48, 58 and 71.

In particularly preferred embodiments of the above preferred embodiments, the light chain framework additionally comprises donor residues at positions 36, 44, 47, 85 and 87. Similarly positions of the light chain framework which are commonly conserved across species, i.e. positions 2, 4, 6, 35, 49, 62, 64-69, 98, 99, 101 and 102, if not conserved between donor and acceptor, additionally comprise donor residues. Most preferably the light chain framework additionally comprises donor residues at positions 2, 4, 6, 35, 36, 38, 44, 47, 49, 62, 64-69, 85, 87, 98, 99, 101 and 102.

In addition the light chain framework of the above preferred embodiments optionally comprises donor residues at one, some or all of positions:

1 and 3,
63,
60 (if 60 and 54 are able to form a potential saltbridge),
70 (if 70 and 24 are able to form a potential saltbridge),
73 and 21 (if 47 is different between donor and acceptor),
37 and 45 (if 47 is different between donor and acceptor),
and
any one or more of 10, 12, 40, 80, 103 and 105.

- 12 -

Preferably, the antigen binding regions of the CDR-grafted light chain variable domain comprise CDRs corresponding to the Kabat CDRs at CDR1 (residue 24-34), CDR2 (residues 50-56) and CDR3 (residues 89-97).

The invention further provides in a fourth aspect a CDR-grafted antibody molecule comprising at least one CDR-grafted heavy chain and at least one CDR-grafted light chain as defined above.

The CDR-grafted and humanised antibody molecules and chains of the present invention may comprise: a complete antibody molecule, having full length heavy and light chains; a fragment thereof, such as a Fab, (Fab')₂ or FV fragment; a light chain or heavy chain monomer or dimer; or a single chain antibody, e.g. a single chain FV in which heavy and light chain variable regions are joined by a peptide linker; or any other CDR-grafted or humanised antibody product with anti-CD3 binding specificity. Similarly the CDR-grafted heavy and light chain variable region may be combined with other antibody domains as appropriate.

Also the CDR-grafted or humanised heavy or light chains or antibody molecules of the present invention may have attached to them an effector or reporter molecule. For instance, it may have a macrocycle, for chelating a heavy metal atom, or a toxin, such as ricin, attached to it by a covalent bridging structure. Alternatively, the procedures of recombinant DNA technology may be used to produce an immunoglobulin molecule in which the Fc fragment or CH3 domain of a complete immunoglobulin molecule has been replaced by, or has attached thereto by peptide linkage, a functional non-immunoglobulin protein, such as an enzyme or toxin molecule.

- 13 -

For CDR-grafted antibody products, any appropriate acceptor variable region framework sequences may be used having regard to class/type of the donor antibody from which the antigen binding regions are derived. Preferably, the type of acceptor framework used is of the same/similar class/type as the donor antibody. Conveniently, the framework may be chosen to maximise/optimize homology with the donor antibody sequence particularly at positions close or adjacent to the CDRs. However, a high level of homology between donor and acceptor sequences is not important for application of the present invention. The present invention identifies a hierarchy of framework residue positions at which donor residues may be important or desirable for obtaining a CDR-grafted antibody product having satisfactory binding properties. The present invention advantageously enables the preparation of CDR-grafted antibody products having binding affinities similar to, and even in some cases better than the corresponding donor antibody product, e.g. OKT3 product. Preferably, the CDR-grafted antibody products of the invention have binding affinities of at least about 10^5 M^{-1} , preferably at least about 10^8 M^{-1} and especially within the range 10^8 - 10^{12} M^{-1} . In principle, the present invention is applicable to any combination of donor and acceptor antibodies irrespective of the level of homology between their sequences. A protocol for applying the invention to any particular donor-acceptor antibody pair is given hereinafter. Examples of human frameworks which may be used are KOL, NEWM, REI, EU, LAY and POM (refs. 4 and 5); for instance KOL and NEWM for the heavy chain and REI for the light chain and EU, LAY and POM for both the heavy chain and the light chain.

Also the constant region domains of the products of the invention may be selected having regard to the proposed function of the antibody in particular the effector

- 14 -

functions which may be required. For example, the constant region domains may be human IgA, IgE, IgG or IgM domains. In particular, IgG human constant region domains may be used, especially of the IgG1 and IgG3 isotypes, when the humanised antibody molecule is intended for therapeutic uses, and antibody effector functions are required. Alternatively, IgG2 and IgG4 isotypes may be used when the humanised antibody molecule is intended for therapeutic purposes and antibody effector functions are not required, e.g. for simple blocking of the T-cell receptor-CD3 complex.

However, the remainder of the antibody molecules need not comprise only protein sequences from immunoglobulins. For instance, a gene may be constructed in which a DNA sequence encoding part of a human immunoglobulin chain is fused to a DNA sequence encoding the amino acid sequence of a polypeptide effector or reporter molecule.

Preferably the CDR-grafted heavy and light chain and antibody molecule products are produced by recombinant DNA technology.

Thus in further aspects the invention also includes DNA sequences coding for the RAMs, HAMs and CDR-grafted heavy and light chains, cloning and expression vectors containing the DNA sequences, host cells transformed with the DNA sequences and processes for producing the CDR-grafted antibody molecules comprising expressing the DNA sequences in the transformed host cells.

The general methods by which the vectors may be constructed, transfection methods and culture methods are well known per se and form no part of the invention. Such methods are shown, for instance, in references 9 and 10.

- 15 -

The DNA sequences which encode the anti-CD3 donor amino acid sequence may be obtained by methods well known in the art. For example the anti-CD3 coding sequences may be obtained by genomic cloning, or cDNA cloning from suitable hybridoma cell lines, e.g. the OKT3 cell line hereinafter specifically described. Positive clones may be screened using appropriate probes for the heavy and light chain genes in question. Also PCR cloning may be used.

DNA coding for acceptor, e.g. human acceptor, sequences may be obtained in any appropriate way. For example DNA sequences coding for preferred human acceptor frameworks such as KOL, REI, EU and NEWM, are widely available to workers in the art.

The standard techniques of molecular biology may be used to prepare DNA sequences coding for the chimeric and CDR-grafted products. Desired DNA sequences may be synthesised completely or in part using oligonucleotide synthesis techniques. Site-directed mutagenesis and polymerase chain reaction (PCR) techniques may be used as appropriate. For example oligonucleotide directed synthesis as described by Jones et al (ref. 17) may be used. Also oligonucleotide directed mutagenesis of a pre-existing variable region as, for example, described by Verhoeyen et al (ref. 2) or Riechmann et al (ref. 3) may be used. Also enzymatic filling in of gapped oligonucleotides using T4 DNA polymerase as, for example, described by Queen et al (ref. 6) may be used.

Any suitable host cell/vector system may be used for expression of the DNA sequences coding for the CDR-grafted heavy and light chains. Bacterial e.g. E. coli, and other microbial systems may be used, in particular for expression of antibody fragments such as FAb and (Fab')₂ fragments, and especially FV fragments and single chain

- 16 -

antibody fragments e.g. single chain FVs. Eucaryotic, e.g. mammalian, host cell expression systems may be used, in particular, for production of larger CDR-grafted antibody products, including complete antibody molecules. Suitable mammalian host cells include CHO cells and myeloma or hybridoma cell lines.

Thus, according to a further aspect the present invention provides a process for producing an anti-CD3 RAM which process comprises:

(a) producing in an expression vector an operon having a DNA sequence which encodes an antibody heavy chain wherein at least one CDR of the variable domain is derived from a donor anti-CD3 antibody and remaining immunoglobulin-derived parts of the antibody chain are derived from an acceptor immunoglobulin;

and/or

(b) producing in an expression vector an operon having a DNA sequence which encodes a complementary antibody light chain wherein at least one CDR of the variable domain is derived from a donor anti-CD3 antibody and the remaining immunoglobulin-derived parts of the antibody chain are derived from an acceptor immunoglobulin;

(c) transfecting a host cell with the or each vector;
and

(d) culturing the transfected cell line to produce the RAM.

The RAM may comprise only heavy or light chain-derived polypeptide, in which case only a heavy chain or light chain polypeptide coding sequence is used to transfect the host cells.

For production of RAMs comprising both heavy and light chains, the cell line may be transfected with two vectors. The first vector may contain an operon encoding a light chain-derived polypeptide and the second vector may contain an operon encoding a heavy chain-derived polypeptide. Preferably, the vectors are identical except in so far as the coding sequences and selectable markers are concerned so as to ensure as far as possible that each polypeptide chain is equally expressed. Alternatively, a single vector may be used, the vector including the sequences encoding both light chain- and heavy chain-derived polypeptides.

The DNA in the coding sequences for the light and heavy chains may comprise cDNA or genomic DNA or both. However, it is preferred that the DNA sequence encoding the heavy or light chain comprises, at least partially, genomic DNA. Most preferably, the heavy or light chain encoding sequence comprises a fusion of cDNA and genomic DNA.

The present invention also includes therapeutic and diagnostic compositions comprising the RAMs, HAMs and CDR-grafted light and heavy chains and molecules of the invention and uses of such compositions in therapy and diagnosis.

Accordingly in a further aspect the invention provides a therapeutic or diagnostic composition comprising a RAM, HAM or CDR-grafted antibody heavy or light chain or molecule according to previous aspects of the invention in combination with a pharmaceutically acceptable carrier, diluent or excipient.

Accordingly also the invention provides a method of therapy or diagnosis comprising administering an effective

- 18 -

amount of a RAM, HAM or CDR-grafted antibody heavy or light chain or molecule according to previous aspects of the invention to a human or animal subject.

The RAM, HAM and CDR-grafted products of the present invention may be used for any of the therapeutic uses for which anti CD3 antibodies, e.g. OKT3, have been used or may be used in the future. For example, the products may be used as immunosuppressants, e.g. in the treatment of acute allograft rejection.

A preferred protocol for obtaining CDR-grafted antibody heavy and light chains in accordance with the present invention is set out below together with the rationale by which we have derived this protocol. This protocol and rationale are given without prejudice to the generality of the invention as hereinbefore described and defined.

Protocol

It is first of all necessary to sequence the DNA coding for the heavy and light chain variable regions of the donor antibody, to determine their amino acid sequences. It is also necessary to choose appropriate acceptor heavy and light chain variable regions, of known amino acid sequence. The CDR-grafted chain is then designed starting from the basis of the acceptor sequence. It will be appreciated that in some cases the donor and acceptor amino acid residues may be identical at a particular position and thus no change of acceptor framework residue is required.

1. As a first step donor residues are substituted for acceptor residues in the CDRs. For this purpose the CDRs are preferably defined as follows:

- 19 -

Heavy chain - CDR1: residues 26-35
- CDR2: residues 50-65
- CDR3: residues 95-102
Light chain - CDR1: residues 24-34
- CDR2: residues 50-56
- CDR3: residues 89-97

The positions at which donor residues are to be substituted for acceptor in the framework are then chosen as follows, first of all with respect to the heavy chain and subsequently with respect to the light chain.

2. Heavy Chain

- 2.1 Choose donor residues at all of positions 23, 24, 49, 71, 73 and 78 of the heavy chain or all of positions 23, 24 and 49 (71, 73 and 78 are either all donor or all acceptor).
- 2.2 Check that the following have the same amino acid in donor and acceptor sequences, and if not preferably choose the donor: 2, 4, 6, 25, 36, 37, 39, 47, 48, 93, 94, 103, 104, 106 and 107.
- 2.3 To further optimise affinity consider choosing donor residues at one, some or any of:
- i. 1, 3
 - ii. 72, 76
 - iii. If 48 is different between donor and acceptor sequences, consider 69
 - iv. If at 48 the donor residue is chosen, consider 38 and 46
 - v. If at 69 the donor residue is chosen, consider 80 and then 20
 - vi. 67

- 20 -

- vii. If at 67 the donor residue is chosen, consider 82 and then 18
- viii. 91
- ix. 88
- x. 9, 11, 41, 87, 108, 110, 112

3. Light Chain

- 3.1 Choose donor at 46, 48, 58 and 71
- 3.2 Check that the following have the same amino acid in donor and acceptor sequences, if not preferably choose donor:
 - 2, 4, 6, 35, 38, 44, 47, 49, 62, 64-69 inclusive, 85, 87, 98, 99, 101 and 102
- 3.3 To further optimise affinity consider choosing donor residues at one, some or any of:
 - i. 1, 3
 - ii. 63
 - iii. 60, if 60 and 54 are able to form a potential saltbridge
 - iv. 70, if 70 and 24 are able to form a potential saltbridge
 - v. 73 and 21, if 47 is different between donor and acceptor
 - vi. 37 and 45, if 47 is different between donor and acceptor
 - vii. 10, 12, 40, 80, 103, 105

Rationale

In order to transfer the binding site of an antibody into a different acceptor framework, a number of factors need to be considered.

1. The extent of the CDRs

The CDRs (Complementary Determining Regions) were defined by Wu and Kabat (refs. 4 and 5) on the basis of an analysis of the variability of different regions of antibody variable regions. Three regions per domain were recognised. In the light chain the sequences are 24-34, 50-56, 89-97 (numbering according to Kabat (ref. 4), Eu Index) inclusive and in the heavy chain the sequences are 31-35, 50-65 and 95-102 inclusive.

When antibody structures became available it became apparent that these CDR regions corresponded in the main to loop regions which extended from the β barrel framework of the light and heavy variable domains. For H1 there was a discrepancy in that the loop was from 26 to 32 inclusive and for H2 the loop was 52-56 and for L2 from 50 to 53. However, with the exception of H1 the CDR regions encompassed the loop regions and extended into the β strand frameworks. In H1 residue 26 tends to be a serine and 27 a phenylalanine or tyrosine, residue 29 is a phenylalanine in most cases. Residues 28 and 30 which are surface residues exposed to solvent might be involved in antigen-binding. A prudent definition of the H1 CDR therefore would include residues 26-35 to include both the loop region and the hypervariable residues 33-35.

It is of interest to note the example of Riechmann et al (ref. 3), who used the residue 31-35 choice for CDR-H1. In order to produce efficient antigen binding residue 27 also needed to be recruited from the donor (rat) antibody.

2. Non-CDR residues which contribute to antigen binding

By examination of available X-ray structures we have identified a number of residues which may have an effect on net antigen binding and which can be demonstrated by experiment. These residues can be sub-divided into a number of groups.

2.1 Surface residues near CDR [all numbering as in Kabat et al (ref. 4)].

2.1.1. Heavy Chain - Key residues are 23, 71 and 73. Other residues which may contribute to a lesser extent are 1, 3 and 76. Finally 25 is usually conserved but the murine residue should be used if there is a difference.

2.1.2 Light Chain - Many residues close to the CDRs, e.g. 63, 65, 67 and 69 are conserved. If conserved none of the surface residues in the light chain are likely to have a major effect. However, if the murine residue at these positions is unusual, then it would be of benefit to analyse the likely contribution more closely. Other residues which may also contribute to binding are 1 and 3, and also 60 and 70 if the residues at these positions and at 54 and 24 respectively are potentially able to form a salt bridge i.e. 60 + 54; 70 + 24.

2.2 Packing residues near the CDRs.

2.2.1. Heavy Chain - Key residues are 24, 49 and 78. Other key residues would be 36 if not a tryptophan, 94 if not an arginine, 104 and 106 if not glycines and 107 if not a threonine. Residues which may make a further contribution to stable packing of the heavy chain and hence improved affinity are 2, 4, 6, 38, 46, 67 and 69. 67 packs against the CDR residue 63 and

- 23 -

this pair could be either both mouse or both human. Finally, residues which contribute to packing in this region but from a longer range are 18, 20, 80, 82 and 86. 82 packs against 67 and in turn 18 packs against 82. 80 packs against 69 and in turn 20 packs against 80. 86 forms an H bond network with 38 and 46. Many of the mouse-human differences appear minor e.g. Leu-Ile, but could have an minor impact on correct packing which could translate into altered positioning of the CDRs.

2.2.2. Light Chain - Key residues are 48, 58 and 71. Other key residues would be 6 if not glutamine, 35 if not tryptophan, 62 if not phenylalanine or tyrosine, 64, 66, 68, 99 and 101 if not glycines and 102 if not a threonine. Residues which make a further contribution are 2, 4, 37, 45 and 47. Finally residues 73 and 21 and 19 may make long distance packing contributions of a minor nature.

2.3. Residues at the variable domain interface between heavy and light chains - In both the light and heavy chains most of the non-CDR interface residues are conserved. If a conserved residue is replaced by a residue of different character, e.g. size or charge, it should be considered for retention as the murine residue.

2.3.1. Heavy Chain - Residues which need to be considered are 37 if the residue is not a valine but is of larger side chain volume or has a charge or polarity. Other residues are 39 if not a glutamine, 45 if not a leucine, 47 if not a tryptophan, 91 if not a phenylalanine or tyrosine, 93 if not an alanine and 103 if not a tryptophan. Residue 89 is also at the interface

- 24 -

but is not in a position where the side chain could be of great impact.

- 2.3.2. Light Chain - Residues which need to be considered are 36, if not a tyrosine, 38 if not a glutamine, 44 if not a proline, 46, 49 if not a tyrosine, residue 85, residue 87 if not a tyrosine and 98 if not a phenylalanine.
- 2.4. Variable-Constant region interface - The elbow angle between variable and constant regions may be affected by alterations in packing of key residues in the variable region against the constant region which may affect the position of V_L and V_H with respect to one another. Therefore it is worth noting the residues likely to be in contact with the constant region. In the heavy chain the surface residues potentially in contact with the variable region are conserved between mouse and human antibodies therefore the variable region contact residues may influence the V-C interaction. In the light chain the amino acids found at a number of the constant region contact points vary, and the V & C regions are not in such close proximity as the heavy chain. Therefore the influences of the light chain V-C interface may be minor.
- 2.4.1. Heavy Chain - Contact residues are 7, 11, 41, 87, 108, 110, 112.
- 2.4.2. Light Chain - In the light chain potentially contacting residues are 10, 12, 40, 80, 83, 103 and 105.

The above analysis coupled with our considerable practical experimental experience in the CDR-grafting of a number of different antibodies have lead us to the protocol given above.

The present invention is now described, by way of example only, with reference to the accompanying Figures 1 - 13.

Brief Description of the Figures

- Figure 1 shows DNA and amino acid sequences of the OKT3 light chain;
- Figure 2 shows DNA and amino acid sequences of the OKT3 heavy chain;
- Figure 3 shows the alignment of the OKT3 light variable region amino acid sequence with that of the light variable region of the human antibody REI;
- Figure 4 shows the alignment of the OKT3 heavy variable region amino acid sequence with that of the heavy variable region of the human antibody KOL;
- Figure 5 shows the heavy variable region amino acid sequences of OKT3, KOL and various corresponding CDR grafts;
- Figure 6 shows the light variable region amino acid sequences of OKT3, REI and various corresponding CDR grafts;
- Figure 7 shows a graph of binding assay results for various grafted OKT3 antibodies;
- Figure 8 shows a graph of blocking assay results for various grafted OKT3 antibodies;
- Figure 9 shows a similar graph of blocking assay results;
- Figure 10 shows similar graphs for both binding assay and blocking assay results;
- Figure 11 shows further similar graphs for both binding assay and blocking assay results;
- Figure 12 shows a graph of competition assay results for a minimally grafted OKT3 antibody compared with the OKT3 murine reference standard, and
- Figure 13 shows a similar graph of competition assay results comparing a fully grafted OKT3 antibody with the murine reference standard.

DETAILED DESCRIPTION OF EMBODIMENTS OF THE INVENTIONEXAMPLEMATERIAL AND METHODS1. INCOMING CELLS

Hybridoma cells producing antibody OKT3 were provided by Ortho (seedlot 4882.1) and were grown up in antibiotic free Dulbecco's Modified Eagles Medium (DMEM) supplemented with glutamine and 5% foetal calf serum, and divided to provide both an overgrown supernatant for evaluation and cells for extraction of RNA. The overgrown supernatant was shown to contain 250 ug/mL murine IgG2a/kappa antibody. The supernatant was negative for murine lambda light chain and IgG1, IgG2b, IgG3, IgA and IgM heavy chain. 20mL of supernatant was assayed to confirm that the antibody present was OKT3.

2. MOLECULAR BIOLOGY PROCEDURES

Basic molecular biology procedures were as described in Maniatis et al (ref. 9) with, in some cases, minor modifications. DNA sequencing was performed as described in Sanger et al (ref. 11) and the Amersham International Plc sequencing handbook. Site directed mutagenesis was as described in Kramer et al (ref. 12) and the Anglian Biotechnology Ltd. handbook. COS cell expression and metabolic labelling studies were as described in Whittle et al (ref. 13)

3. RESEARCH ASSAYS**3.1. ASSEMBLY ASSAYS**

Assembly assays were performed on supernatants from transfected COS cells to determine the amount of intact IgG present.

3.1.1. COS CELLS TRANSFECTED WITH MOUSE OKT3 GENES

The assembly assay for intact mouse IgG in COS cell supernatants was an ELISA with the following format:

96 well microtitre plates were coated with F(ab')₂ goat anti-mouse IgG Fc. The plates were washed in water and samples added for 1 hour at room temperature. The plates were washed and F(ab')₂ goat anti-mouse IgG F(ab')₂ (HRPO conjugated) was then added. Substrate was added to reveal the reaction. UPC10, a mouse IgG2a myeloma, was used as a standard.

3.1.2. COS AND CHO CELLS TRANSFECTED WITH CHIMERIC OR CDR-GRAFTED OKT3 GENES

The assembly assay for chimeric or CDR-grafted antibody in COS cell supernatants was an ELISA with the following format:

96 well microtitre plates were coated with F(ab')₂ goat anti-human IgG Fc. The plates were washed and samples added and incubated for 1 hour at room temperature. The plates were washed and monoclonal mouse anti-human kappa chain was added for 1 hour at room temperature.

The plates were washed and F(ab')₂ goat anti-mouse IgG Fc (HRPO conjugated) was added. Enzyme substrate was added to reveal the reaction. Chimeric B72.3 (IgG4) (ref. 13) was used as a standard. The use of a monoclonal anti-kappa chain in this assay allows grafted antibodies to be read from the chimeric standard.

3.2. ASSAY FOR ANTIGEN BINDING ACTIVITY

Material from COS cell supernatants was assayed for OKT3 antigen binding activity onto CD3 positive cells in a direct assay. The procedure was as follows:

HUT 78 cells (human T cell line, CD3 positive) were maintained in culture. Monolayers of HUT 78 cells were prepared onto 96 well ELISA plates using poly-L-lysine and glutaraldehyde.

Samples were added to the monolayers for 1 hour at room temperature.

The plates were washed gently using PBS. F(ab')₂ goat anti-human IgG Fc (HRPO conjugated) or F(ab')₂

goat anti-mouse IgG Fc (HRPO conjugated) was added as appropriate for humanised or mouse samples. Substrate was added to reveal the reaction.

The negative control for the cell-based assay was chimeric B72.3. The positive control was mouse Orthomune OKT3 or chimeric OKT3, when available. This cell-based assay was difficult to perform, and an alternative assay was developed for CDR-grafted OKT3 which was more sensitive and easier to carry out.

In this system, CDR-grafted OKT3 produced by COS cells was tested for its ability to bind to the CD3-positive HPB-ALL (human peripheral blood acute lymphocytic leukemia) cell line. It was also tested for its ability to block the binding of murine OKT3 to these cells. Binding was measured by the following procedure: HPB-ALL cells were harvested from tissue culture. Cells were incubated at 4°C for 1 hour with various dilutions of test antibody, positive control antibody, or negative control antibody. The

- 29 -

cells were washed once and incubated at 4°C for 1 hour with an FITC-labelled goat anti-human IgG (Fc-specific, mouse absorbed). The cells were washed twice and analysed by cytofluorography. Chimeric OKT3 was used as a positive control for direct binding. Cells incubated with mock-transfected COS cell supernatant, followed by the FITC-labelled goat anti-human IgG, provided the negative control.

To test the ability of CDR-grafted OKT3 to block murine OKT3 binding, the HPB-ALL cells were incubated at 4°C for 1 hour with various dilutions of test antibody or control antibody. A fixed saturating amount of FITC OKT3 was added. The samples were incubated for 1 hour at 4°C, washed twice and analysed by cytofluorography. FITC-labelled OKT3 was used as a positive control to determine maximum binding. Unlabelled murine OKT3 served as a reference standard for blocking. Negative controls were unstained cells with or without mock-transfected cell supernatant.

The ability of the CDR-grafted OKT3 light chain to bind CD3-positive cells and block the binding of murine OKT3 was initially tested in combination with the chimeric OKT3 heavy chain. The chimeric OKT3 heavy chain is composed of the murine OKT3 variable region and the human IgG4 constant region. The chimeric heavy chain gene is expressed in the same expression vector used for the CDR-grafted genes. The CDR-grafted light chain expression vector and the chimeric heavy chain expression vector were co-transfected into COS cells. The fully chimeric OKT3 antibody (chimeric light chain and chimeric heavy

- 30 -

chain) was found to be fully capable of binding to CD3 positive cells and blocking the binding of murine OKT3 to these cells.

3.3

DETERMINATION OF RELATIVE BINDING AFFINITY

The relative binding affinities of CDR-grafted anti-CD3 monoclonal antibodies were determined by competition binding (ref. 6) using the HPB-ALL human T cell line as a source of CD3 antigen, and fluorescein-conjugated murine OKT3 (Fl-OKT3) of known binding affinity as a tracer antibody.

The binding affinity of Fl-OKT3 tracer antibody was determined by a direct binding assay in which increasing amounts of Fl-OKT3 were incubated with HPB-ALL (5×10^5) in PBS with 5% foetal calf serum for 60 min. at 4°C. Cells were washed, and the fluorescence intensity was determined on a FACScan flow cytometer calibrated with quantitative microbead standards (Flow Cytometry Standards, Research Triangle Park, NC).

Fluorescence intensity per antibody molecule (F/P ratio) was determined by using microbeads which have a predetermined number of mouse IgG antibody binding sites (Simply Cellular beads, Flow Cytometry Standards). F/P equals the fluorescence intensity of beads saturated with Fl-OKT3 divided by the number of binding sites per bead. The amount of bound and free Fl-OKT3 was calculated from the mean fluorescence intensity per cell, and the ratio of bound/free was plotted against the number of moles of antibody bound. A linear fit was used to determine the affinity of binding (absolute value of the slope).

For competitive binding, increasing amounts of competitor antibody were added to a sub-saturating dose of Fl-OKT3 and incubated with

- 31 -

5×10^5 HPB-ALL in 200 μ l of PBS with 5% foetal calf serum, for 60 min at 4°C. The fluorescence intensities of the cells were measured on a FACScan flow cytometer calibrated with quantitative microbead standards. The concentrations of bound and free F1-OKT3 were calculated. The affinities of competing antibodies were calculated from the equation $[X]-[OKT3] = (1/Kx) - (1/Ka)$, where Ka is the affinity of murine OKT3, Kx is the affinity of competitor X, [] is the concentration of competitor antibody at which bound/free binding is R/2, and R is the maximal bound/free binding.

4. cDNA LIBRARY CONSTRUCTION

4.1. mRNA PREPARATION AND cDNA SYNTHESIS

OKT3 producing cells were grown as described above and 1.2×10^9 cells harvested and mRNA extracted using the guanidinium/LiCl extraction procedure. cDNA was prepared by priming from Oligo-dT to generate full length cDNA. The cDNA was methylated and EcoRI linkers added for cloning.

4.2. LIBRARY CONSTRUCTION

The cDNA library was ligated to pSP65 vector DNA which had been EcoRI cut and the 5' phosphate groups removed by calf intestinal phosphatase (EcoRI/CIP). The ligation was used to transform high transformation efficiency Escherichia coli (E.coli) HB101. A cDNA library was prepared. 3600 colonies were screened for the light chain and 10000 colonies were screened for the heavy chain.

- 32 -

5. SCREENING

E.coli colonies positive for either heavy or light chain probes were identified by oligonucleotide screening using the oligonucleotides:

5' TCCAGATGTTAACTGCTCAC for the light chain, which is complementary to a sequence in the mouse kappa constant region, and 5' CAGGGGCCAGTGGATGGATAGAC for the heavy chain which is complementary to a sequence in the mouse IgG2a constant CH1 domain region. 12 light chain and 9 heavy chain clones were identified and taken for second round screening. Positive clones from the second round of screening were grown up and DNA prepared. The sizes of the gene inserts were estimated by gel electrophoresis and inserts of a size capable of containing a full length cDNA were subcloned into M13 for DNA sequencing.

6. DNA SEQUENCING

Clones representing four size classes for both heavy and light chains were obtained in M13. DNA sequence for the 5' untranslated regions, signal sequences, variable regions and 3' untranslated regions of full length cDNAs [Figures 1(a) and 2(a)] were obtained and the corresponding amino acid sequences predicted [(Figures 1(b) and 2(b)]. In Figure 1(a) the untranslated DNA regions are shown in uppercase, and in both Figures 1 and 2 the signal sequences are underlined.

7. CONSTRUCTION OF cDNA EXPRESSION VECTORS

Celltech expression vectors are based on the plasmid pEE6hCMV (ref. 14). A polylinker for the insertion of genes to be expressed has been

- 33 -

introduced after the major immediate early promoter/enhancer of the human Cytomegalovirus (hCMV). Marker genes for selection of the plasmid in transfected eukaryotic cells can be inserted as BamH1 cassettes in the unique BamH1 site of pEE6 hCMV; for instance, the neo marker to provide pEE6 hCMV neo. It is usual practice to insert the neo and gpt markers prior to insertion of the gene of interest, whereas the GS marker is inserted last because of the presence of internal EcoR1 sites in the cassette.

The selectable markers are expressed from the SV40 late promoter which also provides an origin of replication so that the vectors can be used for expression in the COS cell transient expression system.

The mouse sequences were excised from the M13 based vectors described above as EcoR1 fragments and cloned into either pEE6-hCMV-neo for the heavy chain and into EE6-hCMV-gpt for the light chain to yield vectors pJA136 and pJA135 respectively.

8. EXPRESSION OF cDNAS IN COS CELLS

Plasmids pJA135 and pJA136 were co-transfected into COS cells and supernatant from the transient expression experiment was shown to contain assembled antibody which bound to T-cell enriched lymphocytes. Metabolic labelling experiments using ³⁵S methionine showed expression and assembly of heavy and light chains.

9. CONSTRUCTION OF CHIMERIC GENES

Construction of chimeric genes followed a previously described strategy [Whittle et al (ref. 13)]. A restriction site near the 3' end

- 34 -

of the variable domain sequence is identified and used to attach an oligonucleotide adapter coding for the remainder of the mouse variable region and a suitable restriction site for attachment to the constant region of choice.

9.1. LIGHT CHAIN GENE CONSTRUCTION

The mouse light chain cDNA sequence contains an Aval site near the 3' end of the variable region [Fig. 1(a)]. The majority of the sequence of the variable region was isolated as a 396 bp. EcoRI-Aval fragment. An oligonucleotide adapter was designed to replace the remainder of the 3' region of the variable region from the Aval site and to include the 5' residues of the human constant region up to and including a unique NarI site which had been previously engineered into the constant region.

A HindIII site was introduced to act as a marker for insertion of the linker.

The linker was ligated to the V_L fragment and the 413 bp EcoRI-NarI adapted fragment was purified from the ligation mixture.

The constant region was isolated as an NarI-BamHI fragment from an M13 clone NW361 and was ligated with the variable region DNA into an EcoRI/BamHI/Clp pSP65 treated vector in a three way reaction to yield plasmid JA143. Clones were isolated after transformation into E.coli and the linker and junction sequences were confirmed by the presence of the HindIII site and by DNA sequencing.

9.2 LIGHT CHAIN GENE CONSTRUCTION - VERSION 2

The construction of the first chimeric light chain gene produces a fusion of mouse and human amino acid sequences at the variable-constant region junction. In the case of the OKT3 light

- 36 -

9.3.2. GENE CONSTRUCTION

The heavy chain cDNA sequence showed a BanI site near the 3' end of the variable region [Fig. 2(a)].

The majority of the sequence of the variable region was isolated as a 426bp. EcoRI/C1P/BanI fragment. An oligonucleotide adapter was designated to replace the remainder of the 3' region of the variable region from the BanI site up to and including a unique HindIII site which had been previously engineered into the first two amino acids of the constant region.

The linker was ligated to the V_H fragment and the EcoRI-HindIII adapted fragment was purified from the ligation mixture.

The variable region was ligated to the constant region by cutting pJA91 (ref. ??) with EcoRI and HindIII removing the intron fragment and replacing it with the V_H to yield pJA142.

Clones were isolated after transformation into E.coli JM101 and the linker and junction sequences were confirmed by DNA sequencing. (N.B. The HindIII site is lost on cloning).

10. CONSTRUCTION OF CHIMERIC EXPRESSION VECTORS

10.1. neo AND gpt VECTORS

The chimeric light chain (version 1) was removed from pJA143 as an EcoRI fragment and cloned into EcoRI/C1P treated pEE6hCMVneo expression vector to yield pJA145. Clones with the insert in the correct orientation were identified by restriction mapping.

The chimeric light chain (version 2) was constructed as described above.

The chimeric heavy chain gene was isolated from pJA142 as a 2.5Kbp EcoRI/BamHI fragment and

- 37 -

cloned into the EcoRI/BclI/CIP treated vector fragment of a derivative of pEE6hCMVgpt to yield plasmid pJA144.

10.2. GS SEPARATE VECTORS

GS versions of pJA141 and pJA144 were constructed by replacing the neo and gpt cassettes by a BamHI/SalI/CIP treatment of the plasmids, isolation of the vector fragment and ligation to a GS-containing fragment from the plasmid pRO49 to yield the light chain vector pJA179 and the heavy chain vector pJA180.

10.3. GS SINGLE VECTOR CONSTRUCTION

Single vector constructions containing the cL (chimeric light), cH (chimeric heavy) and GS genes on one plasmid in the order cL-cH-GS, or cH-cL-GS and with transcription of the genes being head to tail e.g. cL>cH>GS were constructed. These plasmids were made by treating pJA179 or pJA180 with BamHI/CIP and ligating in a BglII/HindIII hCMV promoter cassette along with either the HindIII/BamHI fragment from pJA141 into pJA180 to give the cH-cL-GS plasmid pJA182 or the HindIII/BamHI fragment from pJA144 into pJA179 to give the cL-cH-GS plasmid pJA181.

11. EXPRESSION OF CHIMERIC GENES

11.1. EXPRESSION IN COS CELLS

The chimeric antibody plasmid pJA145 (cL) and pJA144 (cH) were co-transfected into COS cells and supernatant from the transient expression experiment was shown to contain assembled antibody which bound to the HUT 78 human T-cell line. Metabolic labelling experiments using ³⁵S methionine showed expression and assembly of heavy and light chains. However the light chain

- 38 -

mobility seen on reduced gels suggested that the potential glycosylation site was being glycosylated. Expression in COS cells in the presence of tunicamycin showed a reduction in size of the light chain to that shown for control chimeric antibodies and the OKT3 mouse light chain. Therefore JA141 was constructed and expressed. In this case the light chain did not show an aberrant mobility or a size shift in the presence or absence of tunicamycin. This second version of the chimeric light chain, when expressed in association with chimeric heavy (cH) chain, produced antibody which showed good binding to HUT 78 cells. In both cases antigen binding was equivalent to that of the mouse antibody.

11.2 EXPRESSION IN CHINESE HAMSTER OVARY (CHO) CELLS
Stable cell lines have been prepared from plasmids PJA141/pJA144 and from pJA179/pJA180, pJA181 and pJA182 by transfection into CHO cells.

12. CDR-GRAFTING

The approach taken was to try to introduce sufficient mouse residues into a human variable region framework to generate antigen binding activity comparable to the mouse and chimeric antibodies.

12.1. VARIABLE REGION ANALYSIS

From an examination of a small database of structures of antibodies and antigen-antibody complexes it is clear that only a small number of antibody residues make direct contact with antigen. Other residues may contribute to antigen binding by positioning the contact residues in favourable configurations and also by inducing a stable packing of the individual

- 39 -

variable domains and stable interaction of the light and heavy chain variable domains. The residues chosen for transfer can be identified in a number of ways:

- (a) By examination of antibody X-ray crystal structures the antigen binding surface can be predominantly located on a series of loops, three per domain, which extend from the B-barrel framework.
- (b) By analysis of antibody variable domain sequences regions of hypervariability [termed the Complementarity Determining Regions (CDRs) by Wu and Kabat (ref. 5)] can be identified. In the most but not all cases these CDRs correspond to, but extend a short way beyond, the loop regions noted above.
- (c) Residues not identified by (a) and (b) may contribute to antigen binding directly or indirectly by affecting antigen binding site topology, or by inducing a stable packing of the individual variable domains and stabilising the inter-variable domain interaction. These residues may be identified either by superimposing the sequences for a given antibody on a known structure and looking at key residues for their contribution, or by sequence alignment analysis and noting "idiosyncratic" residues followed by examination of their structural location and likely effects.

12.1.1. LIGHT CHAIN

Figure 3 shows an alignment of sequences for the human framework region RE1 and the OKT3 light variable region. The structural loops (LOOP) and CDRs (KABAT) believed to correspond to the antigen binding region are marked. Also marked are a number of other residues which may also contribute to antigen binding as described in 13.1(c). Above the sequence in Figure 3 the residue type indicates the spatial location of each residue side chain, derived by examination of resolved structures from X-ray crystallography analysis. The key to this residue type designation is as follows:

N - near to CDR (From X-ray Structures)

P - Packing

B - Buried Non-Packing

S - Surface

E - Exposed

I - Interface

* - Interface

- Packing/Part Exposed

? - Non-CDR Residues which may require to be left as Mouse sequence.

Residues underlined in Figure 3 are amino acids. RE1 was chosen as the human framework because the light chain is a kappa chain and the kappa variable regions show higher homology with the mouse sequences than a lambda light variable region, e.g. KOL (see below). RE1 was chosen in preference to another kappa light chain because the X-ray structure of the light chain has been determined so that a structural examination of individual residues could be made.

12.1.2. HEAVY CHAIN

Similarly Figure 4 shows an alignment of sequences for the human framework region KOL and the OKT3 heavy variable region. The structural loops and CDRs believed to correspond to the

- 41 -

antigen binding region are marked. Also marked are a number of other residues which may also contribute to antigen binding as described in 12.1(c). The residue type key and other indicators used in Figure 4 are the same as those used in Figure 3.

KOL was chosen as the heavy chain framework because the X-ray structure has been determined to a better resolution than, for example, NEWM and also the sequence alignment of OKT3 heavy variable region showed a slightly better homology to KOL than to NEWM.

12.2. DESIGN OF VARIABLE GENES

The variable region domains were designed with mouse variable region optimal codon usage [Grantham and Perrin (ref. 15)] and used the B72.3 signal sequences [Whittle *et al* (ref. 13)]. The sequences were designed to be attached to the constant region in the same way as for the chimeric genes described above. Some constructs contained the "Kozak consensus sequence" [Kozak (ref. 16)] directly linked to the 5' of the signal sequence in the gene. This sequence motif is believed to have a beneficial role in translation initiation in eukaryotes.

12.3. GENE CONSTRUCTION

To build the variable regions, various strategies are available. The sequence may be assembled by using oligonucleotides in a manner similar to Jones *et al* (ref. 17) or by simultaneously replacing all of the CDRs or loop regions by oligonucleotide directed site specific mutagenesis in a manner similar to Verhoeyen *et al* (ref. 2). Both strategies were used and a list of constructions is set out in Tables 1 and 2 and Figures 4 and 5. It was noted in several

- 42 -

cases that the mutagenesis approach led to deletions and rearrangements in the gene being remodelled, while the success of the assembly approach was very sensitive to the quality of the oligonucleotides.

13. CONSTRUCTION OF EXPRESSION VECTORS

Genes were isolated from M13 or SP65 based intermediate vectors and cloned into pEE6hCMVneo for the light chains and pEE6hCMVgpt for the heavy chains in a manner similar to that for the chimeric genes as described above.

TABLE 1 GDR-GRAFTED GENE CONSTRUCTS

CODE	MOUSE SEQUENCE CONTENT	METHOD OF CONSTRUCTION	KOZAK SEQUENCE - +	

LIGHT CHAIN ALL HUMAN FRAMEWORK REL				
121	26-32, 50-56, 91-96 inclusive	SDM and gene assembly	+	n.d.
121A	26-32, 50-56, 91-96 inclusive +1, 3, 46, 47	Partial gene assembly	n.d.	+
121B	26-32, 50-56, 91-96 inclusive + 46, 47	Partial gene assembly	n.d.	+
221	24-24, 50-56, 91-96 inclusive	Partial gene assembly	+	+
221A	24-34, 50-56, 91-96 inclusive +1, 3, 46, 47	Partial gene assembly	+	+
221B	24-34, 50-56, 91-96 inclusive +1, 3	Partial gene assembly	+	+
221C	24-34, 50-56, 91-96 inclusive	Partial gene assembly	+	+
HEAVY CHAIN ALL HUMAN FRAMEWORK KOL				
121	26-32, 50-56, 95-100B inclusive	Gene assembly	n.d.	+
131	26-32, 50-58, 95-100B inclusive	Gene assembly	n.d.	+
141	26-32, 50-65, 95-100B inclusive	Partial gene assembly	+	n.d.
321	26-35, 50-56, 95-100B inclusive	Partial gene assembly	+	n.d.
331	26-35, 50-58, 95-100B inclusive	Partial gene assembly	+	
		Gene assembly		+
341	26-35, 50-65, 95-100B inclusive	SDM	+	
		Partial gene assembly		+
341A	26-35, 50-65, 95-100B inclusive +6, 23, 24, 48, 49, 71, 73, 76, 78, 88, 91 (+63 = human)	Gene assembly	n.d.	+
341B	26-35, 50-65, 95-100B inclusive + 48, 49, 71, 73, 76, 78, 88, 91 (+63 + human)	Gene assembly	n.d.	+

KEY

n.d. not done
SDM Site directed mutagenesis
Gene assembly Variable region assembled entirely from oligonucleotides
Partial gene assembly Variable region assembled by combination of restriction fragments either from other genes originally created by SDM and gene assembly or by oligonucleotide assembly of part of the variable region and reconstruction with restriction fragments from other genes originally created by SDM and gene assembly

- 44 -

14. EXPRESSION OF CDR-GRAFTED GENES

14.1. PRODUCTION OF ANTIBODY CONSISTING OF GRAFTED LIGHT (gL) CHAINS WITH MOUSE HEAVY (mH) OR CHIMERIC HEAVY (cH) CHAINS

All gL chains, in association with mH or cH produced reasonable amounts of antibody.

Insertion of the Kozak consensus sequence at a position 5' to the ATG (kgL constructs) however, led to a 2-5 fold improvement in net expression. Over an extended series of experiments expression levels were raised from approximately 200ng/ml to approximately 500 ng/ml for kgL/cH or kgL/mH combinations.

When direct binding to antigen on HUT 78 cells was measured, a construct designed to include mouse sequence based on loop length (gL121) did not lead to active antibody in association with mH or cH. A construct designed to include mouse sequence based on Kabat CDRs (gL221) demonstrated some weak binding in association with mH or cH. However, when framework residues 1, 3, 46, 47 were changed from the human to the murine OKT3 equivalents based on the arguments outlined in Section 12.1 antigen binding was demonstrated when both of the new constructs, which were termed 121A and 221A were co-expressed with cH. When the effects of these residues were examined in more detail, it appears that residues 1 and 3 are not major contributing residues as the product of the gL221B gene shows little detectable binding activity in association with cH. The light chain product of gL221C, in which mouse sequences are present at 46 and 47, shows good binding activity in association with cH.

14.2 PRODUCTION OF ANTIBODY CONSISTING OF GRAFTED HEAVY (gH) CHAINS WITH MOUSE LIGHT (mL) OR CHIMERIC LIGHT (cL) CHAINS

Expression of the gH genes proved to be more difficult to achieve than for gL. First, inclusion of the Kozak sequence appeared to have no marked effect on expression of gH genes. Expression appears to be slightly improved but not to the same degree as seen for the grafted light chain.

Also, it proved difficult to demonstrate production of expected quantities of material when the loop choice (amino acid 26-32) for CDR1 is used, e.g. gH121, 131, 141 and no conclusions can be drawn about these constructs.

Moreover, co-expression of the gH341 gene with cL or mL has been variable and has tended to produce lower amounts of antibody than the cH/cL or mH/mL combinations. The alterations to gH341 to produce gH341A and gH341B lead to improved levels of expression.

This may be due either to a general increase in the fraction of mouse sequence in the variable region, or to the alteration at position 63 where the residue is returned to the human amino acid Valine (Val) from Phenylalanine (Phe) to avoid possible internal packing problems with the rest of the human framework. This arrangement also occurs in gH331 and gH321.

When gH321 or gH331 were expressed in association with cL, antibody was produced but antibody binding activity was not detected.

When the more conservative gH341 gene was used antigen binding could be detected in association with cL or mL, but the activity was only marginally above the background level.

- 46 -

When further mouse residues were substituted based on the arguments in 12.1, antigen binding could be clearly demonstrated for the antibody produced when kgH341A and kgH341B were expressed in association with cL.

14.3

PRODUCTION OF FULLY CDR-GRAFTED ANTIBODY

The kgL221A gene was co-expressed with kgH341, kgH341A or kgH341B. For the combination kgH221A/kgH341 very little material was produced in a normal COS cell expression.

For the combinations kgL221A/kgH341A or kgH221A/kgH341B amounts of antibody similar to gL/cH was produced.

In several experiments no antigen binding activity could be detected with kgH221A/gH341 or kgH221A/kgH341 combinations, although expression levels were very low.

Antigen binding was detected when kgL221A/kgH341A or kgH221A/kgH341B combinations were expressed.

In the case of the antibody produced from the kgL221A/kgH341A combination the antigen binding was very similar to that of the chimeric antibody.

An analysis of the above results is given below.

15.

DISCUSSION OF CDR-GRAFTING RESULTS

In the design of the fully humanised antibody the aim was to transfer the minimum number of mouse amino acids that would confer antigen binding onto a human antibody framework.

15.1.

LIGHT CHAIN

15.1.1.

EXTENT OF THE CDRs

For the light chain the regions defining the loops known from structural studies of other antibodies to contain the antigen contacting residues, and those hypervariable sequences

- 47 -

defined by Kabat et al (refs. 4 and 5) as Complementarity Determining Regions (CDRs) are equivalent for CDR2. For CDR1 the hypervariable region extends from residues 24-34 inclusive while the structural loop extends from 26-32 inclusive. In the case of OKT3 there is only one amino acid difference between the two options, at amino acid 24, where the mouse sequence is a serine and the human framework RE1 has glutamine. For CDR3 the loop extends from residues 91-96 inclusive while the Kabat hypervariability extends from residues 89-97 inclusive. For OKT3 amino acids 89, 90 and 97 are the same between OKT3 and RE1 (Fig. 3). When constructs based on the loop choice for CDR1 (gL121) and the Kabat choice (gL221) were made and co-expressed with mH or cH no evidence for antigen binding activity could be found for gL121, but trace activity could be detected for the gL221, suggesting that a single extra mouse residue in the grafted variable region could have some detectable effect. Both gene constructs were reasonably well expressed in the transient expression system.

15.1.2. FRAMEWORK RESIDUES

The remaining framework residues were then further examined, in particular amino acids known from X-ray analysis of other antibodies to be close to the CDRs and also those amino acids which in OKT3 showed differences from the consensus framework for the mouse subgroup (subgroup VI) to which OKT3 shows most homology. Four positions 1, 3, 46 and 47 were identified and their possible contribution was examined by substituting the mouse amino acid for the human amino acid at each position.

- 48 -

Therefore gL221A (gL221 + D1Q, Q3V, L46R, L47W, see Figure 3 and Table 1) was made, cloned in EE6hCMVneo and co-expressed with cH (pJA144). The resultant antibody was well expressed and showed good binding activity. When the related genes gL221B (gL221 + D1Q, Q3V) and gL221C (gL221 + L46R, L47W) were made and similarly tested, while both genes produced antibody when co-expressed with cH, only the gL221C/cH combination showed good antigen binding. When the gL121A (gL121 + D1Q, Q3V, L46R, L47W) gene was made and co-expressed with cH, antibody was produced which also bound to antigen.

15.2. HEAVY CHAIN

15.2.1. EXTENT OF THE CDRs

For the heavy chain the loop and hypervariability analyses agree only in CDR3. For CDR1 the loop region extends from residues 26-32 inclusive whereas the Kabat CDR extends from residues 31-35 inclusive. For CDR2 the loop region is from 50-58 inclusive while the hypervariable region covers amino acids 50-65 inclusive. Therefore humanised heavy chains were constructed using the framework from antibody KOL and with various combinations of these CDR choices, including a shorter choice for CDR2 of 50-56 inclusive as there was some uncertainty as to the definition of the end point for the CDR2 loop around residues 56 to 58. The genes were co-expressed with mL or cL initially. In the case of the gH genes with loop choices for CDR1 e.g. gH121, gH131, gH141 very little antibody was produced in the culture supernatants. As no free light chain was detected it was presumed that the antibody was being made and assembled inside the cell but that the heavy chain was aberrant in

- 49 -

some way, possibly incorrectly folded, and therefore the antibody was being degraded internally. In some experiments trace amounts of antibody could be detected in ³⁵S labelling studies.

As no net antibody was produced, analysis of these constructs was not pursued further. When, however, a combination of the loop choice and the Kabat choice for CDR1 was tested (mouse amino acids 26-35 inclusive) and in which residues 31 (Ser to Arg), 33 (Ala to Thr), and 35 (Tyr to His) were changed from the human residues to the mouse residue and compared to the first series, antibody was produced for gH321, kgH331 and kgH341 when co-expressed with cL.

Expression was generally low and could not be markedly improved by the insertion of the Kozak consensus sequence 5' to the ATG of the signal sequence of the gene, as distinct from the case of the gL genes where such insertion led to a 2-5 fold increase in net antibody production.

However, only in the case of gH341/mL or kgH341/cL could marginal antigen binding activity be demonstrated. When the kgH341 gene was co-expressed with kgL221A, the net yield of antibody was too low to give a signal above the background level in the antigen binding assay.

15.2.2. FRAMEWORK RESIDUES

As in the case of the light chain the heavy chain frameworks were re-examined. Possibly because of the lower initial homology between the mouse and human heavy variable domains compared to the light chains, more amino acid positions proved to be of interest. Two genes kgH341A and kgH341B were constructed, with 11 or 8 human residues respectively substituted by mouse residues

compared to gH341, and with the CDR2 residue 63 returned to the human amino acid potentially to improve domain packing. Both showed antigen binding when combined with cL or kgL221A, the kgH341A gene with all 11 changes appearing to be the superior choice.

15.3

INTERIM CONCLUSIONS

It has been demonstrated, therefore, for OKT3 that to transfer antigen binding ability to the humanised antibody, mouse residues outside the CDR regions defined by the Kabat hypervariability or structural loop choices are required for both the light and heavy chains. Fewer extra residues are needed for the light chain, possibly due to the higher initial homology between the mouse and human kappa variable regions.

Of the changes seven (1 and 3 from the light chain and 6, 23, 71, 73 and 76 from the heavy chain) are predicted from a knowledge of other antibody structures to be either partly exposed or on the antibody surface. It has been shown here that residues 1 and 3 in the light chain are not absolutely required to be the mouse sequence; and for the heavy chain the gH341B heavy chain in combination with the 221A light chain generated only weak binding activity. Therefore the presence of the 6 and 23 and 24 changes are important to maintain binding affinity similar to that of murine antibody. It was important, therefore, to further study the individual contribution of the other 8 mouse residues of the kgH341A gene compared to kgH341.

16.

FURTHER CDR-GRAFTING EXPERIMENTS

Additional CDR-grafted heavy chain genes were prepared substantially as described above. With

- 51 -

reference to Table 2 the further heavy chain genes were based upon the gh341 (plasmid pJA178) and gh341A (plasmid pJA185) with either mouse OKT3 or human KOL residues at 6, 23, 24, 48, 49, 63, 71, 73, 76, 78, 88 and 91, as indicated. The CDR- grafted light chain genes used in these further experiments were gL221, gL221A, gL221B and gL221C as described above.

TABLE 2

OKT3 HEAVY CHAIN CDR GRAFTS

1. gH341 and derivatives

RES NUM	6	23	24	48	49	63	71	73	76	78	88	91	
OKT3vh	<u>Q</u>	<u>K</u>	<u>A</u>	<u>I</u>	<u>G</u>	<u>F</u>	<u>T</u>	<u>K</u>	<u>S</u>	<u>A</u>	<u>A</u>	<u>Y</u>	
gH341	E	S	S	V	A	F	R	N	N	L	G	F	JA178
gH341A	<u>Q</u>	<u>K</u>	<u>A</u>	<u>I</u>	<u>G</u>	<u>V</u>	<u>T</u>	<u>K</u>	<u>S</u>	<u>A</u>	<u>A</u>	<u>Y</u>	JA185
gH341E	<u>Q</u>	<u>K</u>	<u>A</u>	<u>I</u>	<u>G</u>	<u>V</u>	<u>T</u>	<u>K</u>	<u>S</u>	<u>A</u>	<u>G</u>	<u>G</u>	JA198
gH341*	<u>Q</u>	<u>K</u>	<u>A</u>	<u>I</u>	<u>G</u>	<u>V</u>	<u>T</u>	<u>K</u>	<u>N</u>	<u>A</u>	<u>G</u>	<u>F</u>	JA207
gH341*	<u>Q</u>	<u>K</u>	<u>A</u>	<u>I</u>	<u>G</u>	<u>V</u>	<u>R</u>	<u>N</u>	<u>N</u>	<u>A</u>	<u>G</u>	<u>F</u>	JA209
gH341D	<u>Q</u>	<u>K</u>	<u>A</u>	<u>I</u>	<u>G</u>	<u>V</u>	<u>T</u>	<u>K</u>	<u>N</u>	<u>L</u>	<u>G</u>	<u>F</u>	JA197
gH341*	<u>Q</u>	<u>K</u>	<u>A</u>	<u>I</u>	<u>G</u>	<u>V</u>	<u>R</u>	<u>N</u>	<u>N</u>	<u>L</u>	<u>G</u>	<u>F</u>	JA199
gH341C	<u>Q</u>	<u>K</u>	<u>A</u>	<u>V</u>	<u>A</u>	<u>F</u>	<u>R</u>	<u>N</u>	<u>N</u>	<u>L</u>	<u>G</u>	<u>F</u>	JA184
gH341*	<u>Q</u>	<u>S</u>	<u>A</u>	<u>I</u>	<u>G</u>	<u>V</u>	<u>T</u>	<u>K</u>	<u>S</u>	<u>A</u>	<u>A</u>	<u>Y</u>	JA203
gH341*	E	S	A	I	G	V	T	K	S	A	A	Y	JA205
gH341B	E	S	S	I	G	V	T	K	S	A	A	Y	JA183
gH341*	<u>Q</u>	<u>S</u>	<u>A</u>	<u>I</u>	<u>G</u>	<u>V</u>	<u>T</u>	<u>K</u>	<u>S</u>	<u>A</u>	<u>G</u>	<u>F</u>	JA204
gH341*	E	S	A	I	G	V	T	K	S	A	G	F	JA206
gH341*	<u>Q</u>	<u>S</u>	<u>A</u>	<u>I</u>	<u>G</u>	<u>V</u>	<u>T</u>	<u>K</u>	<u>N</u>	<u>A</u>	<u>G</u>	<u>F</u>	JA208
KOL	E	S	S	V	A		R	N	N	L	G	F	

OKT3 LIGHT CHAIN CDR GRAFTS

2. gL221 and derivatives

RES NUM	1	3	46	47	
OKT3v1	<u>Q</u>	<u>V</u>	<u>R</u>	<u>W</u>	
GL221	D	Q	L	L	DA221
gL221A	<u>Q</u>	<u>V</u>	<u>R</u>	<u>W</u>	DA221A
gL221B	<u>Q</u>	<u>V</u>	L	L	DA221B
GL221C	D	Q	<u>R</u>	<u>W</u>	DA221C
REL	D	Q	L	L	

MURINE RESIDUES ARE UNDERLINED

- 53 -

The CDR-grafted heavy and light chain genes were co-expressed in COS cells either with one another in various combinations but also with the corresponding murine and chimeric heavy and light chain genes substantially as described above. The resultant antibody products were then assayed in binding and blocking assays with HPB-ALL cells as described above.

The results of the assays for various grafted heavy chains co-expressed with the gL221C light chain are given in Figures 7 and 8 (for the JA184, JA185, JA197 and JA198 constructs - see Table 2), in Figure 9 (for the JA183, JA184, JA185 and JA197 constructs) in Figure 10 (for the chimeric, JA185, JA199, JA204, JA205, JA207, JA208 and JA209 constructs) and in Figure 11 (for the JA183, JA184, JA185, JA198, JA203, JA205 and JA206 constructs).

The basic grafted product without any human to murine changes in the variable frameworks, i.e. gL221 co-expressed with gh341 (JA178), and also the "fully grafted" product, having most human to murine changes in the grafted heavy chain framework, i.e. gL221C co-expressed with gh341A (JA185), were assayed for relative binding affinity in a competition assay against murine OKT3 reference standard, using HPB-ALL cells. The assay used was as described above in section 3.3. The results obtained are given in Figure 12 for the basic grafted product and in Figure 13 for the fully grafted product. These results indicate that the basic grafted product has relatively poor binding ability as compared with the OKT3 murine reference standard; whereas the "fully grafted" product has a binding ability very similar to that of the OKT3 murine reference standard.

The binding and blocking assay results indicate the following:

- 54 -

The JA198 and JA207 constructs appear to have the best binding characteristics and similar binding abilities, both substantially the same as the chimeric and fully grafted gH341A products. This indicates that positions 88 and 91 and position 76 are not highly critical for maintaining the OKT3 binding ability; whereas at least some of positions 6, 23, 24, 48, 49, 71, 73 and 78 are more important.

This is borne out by the finding that the JA209 and JA199, although of similar binding ability to one another, are of lower binding ability than the JA198 and JA207 constructs. This indicates the importance of having mouse residues at positions 71, 73 and 78, which are either completely or partially human in the JA199 and JA209 constructs respectively.

Moreover, on comparing the results obtained for the JA205 and JA183 constructs it is seen that there is a decrease in binding going from the JA205 to the JA183 constructs. This indicates the importance of retaining a mouse residue at position 23, the only position changed between JA205 and JA183.

These and other results lead us to the conclusion that of the 11 mouse framework residues used in the gH341A (JA185) construct, it is important to retain mouse residues at all of positions 6, 23, 24, 48 and 49, and possibly for maximum affinity at positions 71, 73 and 78.

REFERENCES

1. Kohler & Milstein, *Nature*, 265, 295-497, 1975.
2. Verhoeyen et al, *Science*, 239, 1534-1536, 1988.
3. Riechmann et al, *Nature*, 332, 323-324, 1988.
4. Kabat, E.A., Wu, T.T., Reid-Miller, M., Perry, H.M., Gottesman, K.S., 1987, in *Sequences of Proteins of Immunological Interest*, US Department of Health and Human Services, NIH, USA.
5. Wu, T.T., and Kabat, E.A., 1970, *J. Exp. Med.* 132 211-250.
6. Queen et al, (1989), *Proc. Natl. Acad. Sci. USA*, 86, 10029-10033 and WO 90/07861
7. Chatenoud et al, (1986), *J. Immunol.* 137, 830-838.
8. Jeffers et al, (1986), *Transplantation*, 41, 572-578.
9. Maniatis et al, *Molecular Cloning*, Cold Spring Harbor, New York, 1982.
10. Primrose and Old, *Principles of Gene Manipulation*, Blackwell, Oxford, 1980.
11. Sanger, F., Nicklen, S., Coulson, A.R., 1977, *Proc. Natl. Acad. Sci. USA*, 74 5463
12. Kramer, W., Drutsa, V., Jansen, H.-W., Kramer, B., Plugfelder, M., Fritz, H.-J., 1984, *Nucl. Acids Res.* 12, 9441

- 56 -

13. Whittle, N., Adair, J., Lloyd, J.C., Jenkins, E., Devine, J., Schlom, J., Raubitshek, A., Colcher, D., Bodmer, M., 1987, Protein Engineering 1, 499.
14. Bebbington, C.R., Published International Patent Application WO 89/01036.
15. Granthan and Perrin 1986, Immunology Today 7, 160.
16. Kozak, M., 1987, J. Mol. Biol. 196, 947.
17. Jones, T.P., Dear, P.H., Foote, J., Neuberger, M.S., Winter, G., 1986, Nature, 321, 522

CLAIMS

1. A recombinant antibody molecule comprising antigen binding regions derived from the heavy and/or light chain variable regions of a donor anti-CD3 antibody and having an anti-CD3 binding specificity.
2. A recombinant antibody molecule according to Claim 1, having an anti-CD3 binding affinity similar to that of OKT3.
3. A recombinant antibody molecule according to Claim 1 or Claim 2 which is a chimeric antibody.
4. A recombinant antibody molecule according to Claim 1 or Claim 2 which is a CDR-grafted antibody.
5. A recombinant antibody molecule according to any of the preceding claims which is a humanised antibody molecule.
6. A CDR-grafted antibody heavy chain according to Claim 4, having a variable region domain comprising acceptor framework and donor CD3 binding regions wherein the framework comprises donor residues at at least one of positions 6, 23 and/or 24, 48 and/or 49, 71 and/or 73, 75 and/or 76 and/or 78 and 88 and/or 91.
7. A CDR-grafted heavy chain according to Claim 6 comprising donor residues at positions 23, 24, 49, 71, 73 and 78, or at positions 23, 24 and 49.
8. A CDR-grafted heavy chain according to Claim 7 comprising donor residues at positions 2, 4, 6, 25, 36, 37, 39, 47, 48, 93, 94, 103, 104, 106 and 107.

9. A CDR-grafted heavy chain according to Claim 7 or 8, comprising donor residues at one, some or all of positions:
1 and 3,
69 (if 48 is different between donor and acceptor),
38 and 46 (if 48 is the donor residue),
67,
82 and 18 (if 67 is the donor residue),
91, and
any one or more of 9, 11, 41, 87, 108, 110 and 112.
10. A CDR-grafted heavy chain according to any one of Claims 4, or 6-9 comprising donor CDRs at positions 26-35, 50-65 and 95-100.
11. A CDR-grafted antibody light chain according to Claim 4, having a variable region domain comprising acceptor framework and donor antigen binding regions wherein the framework comprises donor residues at at least one of positions 1 and/or 3 and 46 and/or 47.
12. A CDR-grafted light chain according to Claim 11 comprising donor residues at positions 46 and 47.
13. A CDR-grafted antibody light chain according to Claim 4, having a variable region domain comprising acceptor framework and donor antigen binding regions wherein the framework comprises donor residues at at least one of positions 46, 48, 58 and 71.
14. A CDR-grafted light chain according to Claim 13 comprising donor residues at positions 46, 48, 58 and 71.

- 59 -

15. A CDR-grafted light chain according to Claim 11 or 13, comprising donor residues at positions 2, 4, 6, 35, 36, 38, 44, 47, 49, 62, 64-69, 85, 87, 98, 99, 101 and 102.
16. A CDR-grafted light chain according to any one of Claims 11, 13, or 15, comprising donor residues at one, some or all of positions:
1 and 3,
63,
60 (if 60 and 54 are able to form a potential saltbridge),
70 (if 70 and 24 are able to form a potential saltbridge),
73 and 21 (if 47 is different between donor and acceptor),
37 and 45 (if 47 is different between donor and acceptor), and
any one or more of 10, 12, 40, 83, 103 and 105.
17. A CDR-grafted light chain according to any one of Claims 4 or 11-16, comprising donor CDRs at positions 24-34, 50-56 and 89-97.
18. A CDR-grafted antibody molecule comprising at least one CDR-grafted heavy chain according to any one of Claims 6-10 and at least one CDR-grafted light chain according to any one of Claims 11-17.
19. A CDR-grafted antibody heavy or light chain or molecule according to any one of Claims 6-18 comprising human acceptor residues and non-human donor residues.

20. A DNA sequence which codes for a recombinant antibody according to Claim 1, a humanised antibody according to Claim 5, a CDR-grafted heavy chain according to Claim 6 or a CDR-grafted light chain according to Claim 11 or Claim 13.
21. A cloning or expression vector containing a DNA sequence according to Claim 20.
22. A host cell transformed with a DNA sequence according to Claim 20.
23. A process for the production of an anti-CD3 CDR-grafted antibody product comprising expressing a DNA sequence according to Claim 20 in a transformed host cell.
24. A process for producing an anti-CD3 CDR-grafted antibody product comprising:
 - (a) producing in an expression vector an operon having a DNA sequence which encodes an antibody heavy chain according to Claim 6;
 - and/or
 - (b) producing in an expression vector an operon having a DNA sequence which encodes a complementary antibody light chain according to Claim 11 or Claim 13;
 - (c) transfecting a host cell with the or each vector;
 - and
 - (d) culturing the transfected cell line to produce the CDR-grafted antibody product.
25. A therapeutic or diagnostic composition comprising a recombinant antibody molecule according to Claim 1, a humanised antibody molecule according to Claim 5, a CDR-grafted antibody heavy chain according to Claim 6,

- 61 -

a CDR-grafted light chain according to Claim 11 or Claim 13, or a CDR-grafted antibody molecule according to Claim 18 in combination with a pharmaceutically acceptable carrier, diluent or excipient.

26. A method of therapy or diagnosis comprising administering an effective amount of a recombinant antibody molecule according to Claim 1, a humanised antibody molecule according to Claim 5, a CDR-grafted heavy chain according to Claim 6, or a CDR-grafted light chain according to Claim 11 or Claim 13, or a CDR-grafted antibody molecule according to Claim 18 to a human or animal subject.

1/15

1 GAATTCCCAA AGACAAAatg gattttcaag tgcagatttt cagcttcctg
 51 ctaatcagtg cctcagtcat aatatccaga ggacaaattg ttctcaccca
 101 gtctccagca atcatgtctg catctccagg ggagaaggtc accatgacct
 151 gcagtgccag ctcaagtgta agttacatga actggtacca gcagaagtca
 201 ggcacctccc ccaaaagatg gatttatgac acatccaaac tggcttctgg
 251 agtccctgct cacttcaggg gcagtgggtc tgggacctct tactctctca
 301 caatcagcgg catggaggct gaagatgctg ccacttatta ctgccagcag
 351 tggagtagta acccattcac gttcggctcg gggacaaagt tggaaataaa
 401 ccgggctgat actgcaccaa ctgtatccat cttcccacca tccagtgagc
 451 agttaacatc tggaggtgcc tcagtcgtgt gcttcttgaa caacttctac
 501 cccaaagaca tcaatgtcaa gtggaagatt gatggcagtg aacgacaaaa
 551 tggcgtcctg aacagttgga ctgatcagga cagcaaagac agcacctaca
 601 gcatgagcag caccctcacg ttgaccaagg acgagtatga acgacataac
 651 agctatacct gtgaggccac tcacaagaca tcaacttcac ccattgtcaa
 701 gagcttcaac aggaatgagt gtTAGAGACA AAGGTCCTGA GACGCCACCA
 751 CCAGCTCCCA GCTCCATCCT ATCTCCCTT CTAAGGTCTT GGAGGCTTCC
 801 CCACAAGCGC tTACCACTGT TGCGGTGCTC tAAACCTCCT CCCACCTCCT
 851 TCTCCTCCTC CTCCCTTTC TGGCTTTTA TCATGCTAAT ATTTGCAGAA
 901 AATATTCAAT AAAGTGAGTC TTTGCCTTGA AAAAAAAAAA AAA

Fig. 1(a)

1 MDFOVOIFSF LLISASVIIS RGQIVLTQSP AIMSASPGEK VTMTCSASSS
 51 VSYMNWYQQK SGTSPKRWIY DTSKLAGVVP AHFRGSGSGT SYSLITISGME
 101 AEDAATYYCQ QWSSNPFTFG SGTKLEINRA DTAPTVSIFP PSSEQLTSGG
 151 ASVVCFLNNF YPKDINVKWK IDGSRQNGV LNSWTDQDSK DSTYSMSSTL
 201 TLTKDEYERH NSYTCEATHK TSTSPIVKSF NRNEC*

Fig. 1(b)

SUBSTITUTE SHEET

2/15

1 GAATTCCCCT CTCCACAGAC ACTGAAAACCT CTGACTCAAC ATGGAAAGGC
51 ACTGGATCTT TCTACTCCTG TTGTCAGTAA CTGCAGGTGT CCACTCCCAG
101 GTCCAGCTGC AGCAGTCTGG GGCTGAACTG GCAAGACCTG GGGCCTCAGT
151 GAAGATGTCC TGCAAGGCTT CTGGCTACAC CTTTACTAGG TACACGATGC
201 ACTGGGTAAA ACAGAGGCTT GGACAGGGTC TGGAAATGGAT TGGATACATT
251 AATCCTAGCC GTGGTTATAC TAATTACAAT CAGAAGTTCA AGGACAAGGC
301 CACATTGACT ACAGACAAAT CCTCCAGCAC AGCCTACATG CAACTGAGCA
351 GCCTGACATC TGAGGACTCT GCAGTCTATT ACTGTGCAAG ATATTATGAT
401 GATCATTACT GCCTTGACTA CTGGGGCCAA GGCACCACTC TCACAGTCTC
451 CTCAGCCAAA ACAACAGCCC CATCGGTCTA TCCACTGGCC CCTGTGTGTG
501 GAGATACAAC TGGCTCCTCG GTGACTCTAG GATGCCTGGT CAAGGGTTAT
551 TTCCCTGAGC CAGTGACCTT GACCTGGAAC TCTGGATCCC TGTCCAGTGG
601 TGTGCACACC TTCCAGCTG TCCTGCAGTC TGACCTCTAC ACCCTCAGCA
651 GCTCAGTGAC TGTAACCTCG AGCACCTGGC CCAGCCAGTC CATCACCTGC
701 AATGTGGCCC ACCCGGCAAG CAGCACCAAG GTGGACAAGA AAATGAGCC
751 CAGAGGGCCC ACAATCAAGC CCTGTCTCC ATGCAAATGC CCAGCACCTA
801 ACCTCTTGGG TGGACCATCC GTCTTCATCT TCCCTCCAAA GATCAAGGAT
851 GTACTCATGA TCTCCCTGAG CCCCATAGTC ACATGTGTGG TGGTGGATGT
901 GAGCGAGGAT GACCCAGATG TCCAGATCAG CTGGTTTGTG AACAACTGG
951 AAGTACACAC AGCTCAGACA CAAACCCATA GAGAGGATTA CAACAGTACT
1001 CTCCGGGTGG TCAGTGCCCT CCCCATCCAG CACCAGGACT GGATGAGTGG
1051 CAAGGAGTTC AAATGCAAGG TCAACAACAA AGACCTCCCA GCGCCCATCG
1101 AGAGAACCAT CTCAAAACCC AAAGGGTCAG TAAGAGCTCC ACAGGTATAT
1151 GTCTTGCCCTC CACCAGAAGA AGAGATGACT AAGAAACAGG TCACTCTGAC
1201 CTGCATGGTC ACAGACTTCA TGCCTGAAGA CATTTACGTG GAGTGGACCA
1251 ACAACGGGAA AACAGAGCTA AACTACAAGA AACTGAACC AGTCCTGGAC
1301 TCTGATGGTT CTTACTTCAT GTACAGCAAG CTGAGAGTGG AAAAGAAGAA
1351 CTGGGTGGAA AGAAATAGCT ACTCCTGTTC AGTGGTCCAC GAGGGTCTGC
1401 ACAATCACCA CACGACTAAG AGCTTCTCCC GGA CTCCGGG TAAATGAGCT
1451 CAGCACCCAC AAAACTCTCA GGTCCAAAGA GACACCACA CTCATCTCCA
1501 TGCTTCCCTT GTATAAATAA AGCACCCAGC AATGCCTGGG ACCATGTA
1551 AAAAAAAAAA AAAGGAATTC

Fig. 2(a)

SUBSTITUTE SHEET

3/15

OKT 3 HEAVY CHAIN PROTEIN SEQUENCE DEDUCED FROM DNA SEQUENCE

1 MERHWIFLLL LSVTAGVHSQ VQLQQSGAEL ARPGASVKMS CKASGYTFTR
 51 YTMHWVKQRP GQGLEWIGYI NPSRGYTNYN QKFKDKATLT TDKSSSTAYM
 101 QLSSLTSEDS AVYYCARYYD DHYCLDYWGQ GTTLTVSSAK TTAPSVYPLA
 151 PVCGDTTGSS VTLGCLVKGY FPEPVTLTWN SGLSLSGVHT FPAVLQSDLY
 201 TLSSSVTVTS STWPSQSITC NVAHPASSTK VDKKIEPRGP TIKPCPPCKC
 251 PAPNLLGGPS VFIFPPKIKD VLMISLSPIV TCVVVDVSED DPDVQISWV
 301 NNVEVHTAQT QTHREDYNST LRVVSALPIQ HQDWMSGKEF KCKVMNKDLP
 351 APIERTISKP KGSVRAPQVY VLPPPEEEMT KKQVTLTCMV TDFMPEDIYV
 401 EWTNNGKTEL NYKNTEPVLD SDGSYFMYSK LRVEKKNWVE RNSYSCSVVH
 451 EGLHNHHTTK SFSRTPGK*

Fig. 2(b)

	1		23		42
	NN	N	N	N	N
RES TYPE	SBspSPESsSbSbSsSsPSPSPsPSsse*s*p*Pi [^] ISsSe				
Okt3v1	QIVLTQSPAIMSASPGEKVTMTCSASS.SVSYMNWYQOKSGT				
REI	DIQMTQSPSSLSASVGDRTITCQASQDIKYLWYQQT [^] PGK				
	? ?				
	CDR1	(LOOP)	*****		
	CDR1	(KABAT)	*****		

		56		85
	N	NN		
RES TYPE	*IsiPpIeesesssSBesePsPSBSSEsPspSPsseeS [^] PePb			
Okt3v1	SPKRWIYDTSKLAGVPAHFRGSGSGT [^] SYSLTISGMEAE [^] DAAT			
REI	APKLLIYEASNLAGVPSRFRSGSGSGT [^] DYTF [^] TISSLQ [^] PEDIAT			
	? ?? ? ?			
	***** CDR2 (LOOP/KABAT)			

		102	108
RES TYPE	PiPIPIes**iPIIsPPSPSPSS		
Okt3v1	YQCQWSSNPFTFGG [^] GTKLEINR		
REIv1	YQCQYQSLPYTFGQ [^] GTKLO [^] ITR		
	? ?		
	*****	CDR3 (LOOP)	
	*****	CRD3 (KABAT)	

Fig. 3

SUBSTITUTE SHEET

4/15

```

NN N                23 26    32 35 N39  43
RES TYPE  SESPs^SBssS^sSSsSpSpSPsPSEbSBssBePiPiessiess
Okt3h     QVQLQQSGAELARPGASVKMSCKASGYTFTRYTMHWVKORPGQ
KOL       QVQLVESGGGYVQPGRSRLRLSCSSSGFIFSSYAMYWVRQAPGK
          ?                ??
                                ***** CDR1 (LOOP)
                                ***** CDR1 (KABAT)

```

```

52a    60 65    N N N    82abc  .89
RES TYPE ILeIppp^sssssss^ps^pSSsbSpseSsSseSp^pSpSbSSS^ePb
Okt3vh   GLEWIGYINPSRGYTNTNQKFKDKATLTTDKSSSTAYMQLSSLTSEDSAV
KOL      GLEWVAIIWDDGSDQHYADSVKGRFTISRDNSKNTLFLQMDSLRPEDTGV
          ??                ? ? ? ?                ?
          ***** CDR2 (LOOP)
          ***** CDR2 (KABAT)

```

```

92 N                107    113
RES TYPE  PiPIEiSSSSiiSSsbibi*EIPIP*spSBSS
Okt3vh    YYCARYYDDHY.....CLDYWGQGTTLTVSS
KOL       YFCARDGGHGFCSSASCFGPDYWGQGTPVTVSS
          ***** CRD3 (KABAT/LOOP)

```

Fig. 4

SUBSTITUTE SHEET

5 / 15

OKT 3 HEAVY CHAIN CDR GRAFTS

1. gh341 and derivatives

	1	26	35	39	43	
Okt3vh	QVQLQQSGAELARPGASVKMSCKASGYTFTRYTMHWVKQRPQG					
gh341	QVQLVESGGGVVQPGRSLRLSCSSSGYTFTRYTMHWVRQAPGK					JA178
gh341A	QVQLVQSGGGVVQPGRSLRLSC <u>KASGYTFTRYTMHWVRQAPGK</u>					JA185
gh341E	QVQLVQSGGGVVQPGRSLRLSC <u>KASGYTFTRYTMHWVRQAPGK</u>					JA198
gh341*	QVQLVQSGGGVVQPGRSLRLSC <u>KASGYTFTRYTMHWVRQAPGK</u>					JA207
gh341*	QVQLVQSGGGVVQPGRSLRLSC <u>KASGYTFTRYTMHWVRQAPGK</u>					JA209
gh341D	QVQLVQSGGGVVQPGRSLRLSC <u>KASGYTFTRYTMHWVRQAPGK</u>					JA197
gh341*	QVQLVQSGGGVVQPGRSLRLSC <u>KASGYTFTRYTMHWVRQAPGK</u>					JA199
gh341C	QVQLVQSGGGVVQPGRSLRLSC <u>KASGYTFTRYTMHWVRQAPGK</u>					JA184
gh341*	QVQLVQSGGGVVQPGRSLRLSCS <u>ASGYTFTRYTMHWVRQAPGK</u>					JA203
gh341*	QVQLVESGGGVVQPGRSLRLSCS <u>ASGYTFTRYTMHWVRQAPGK</u>					JA205
gh341B	QVQLVESGGGVVQPGRSLRLSCSSSGYTFTRYTMHWVRQAPGK					JA183
gh341*	QVQLVQSGGGVVQPGRSLRLSCS <u>ASGYTFTRYTMHWVRQAPGK</u>					JA204
gh341*	QVQLVESGGGVVQPGRSLRLSCS <u>ASGYTFTRYTMHWVRQAPGK</u>					JA206
gh341*	QVQLVQSGGGVVQPGRSLRLSCS <u>ASGYTFTRYTMHWVRQAPGK</u>					JA208
KOL	QVQLVESGGGVVQPGRSLRLSCSSSGFIFSSYAMYWVRQAPGK					

Fig. 5(i)

SUBSTITUTE SHEET

6 / 15

	44	50	65	83
Okt3vh	GLEW	IGYINPSRGY	TNYNQKFKDKATLTTDKSSSTAYMQLSSLT	
gH341	GLEW	VAYINPSRGY	TNYNQKFKDRFTISRDN	SKNTLFLQMDSLR JA178
gH341A	GLEW	IGYINPSRGY	TNYNQVKDRFTISTDKSKSTAFLQMDSLR	JA185
gH341E	GLEW	IGYINPSRGY	TNYNQVKDRFTISTDKSKSTAFLQMDSLR	JA198
gH341*	GLEW	IGYINPSRGY	TNYNQVKDRFTISTDKSKNTAFLQMDSLR	JA207
gH341*	GLEW	IGYINPSRGY	TNYNQVKDRFTISRDN	SKNTAFLQMDSLR JA209
gH341D	GLEW	IGYINPSRGY	TNYNQVKDRFTISTDKSKNTLFLQMDSLR	JA197
gH341*	GLEW	IGYINPSRGY	TNYNQVKDRFTISRDN	SKNTLFLQMDSLR JA199
gH341C	GLEW	VAYINPSRGY	TNYNQKFKDRFTISRDN	SKNTLFLQMDSLR JA184
gH341*	GLEW	IGYINPSRGY	TNYNQVKDRFTISTDKSKSTAFLQMDSLR	JA207
gH341*	GLEW	IGYINPSRGY	TNYNQVKDRFTISTDKSKSTAFLQMDSLR	JA205
gH341B	GLEW	IGYINPSRGY	TNYNQVKDRFTISTDKSKSTAFLQMDSLR	JA183
gH341*	GLEW	IGYINPSRGY	TNYNQVKDRFTISTDKSKSTAFLQMDSLR	JA204
gH341*	GLEW	IGYINPSRGY	TNYNQVKDRFTISTDKSKSTAFLQMDSLR	JA206
gH341*	GLEW	IGYINPSRGY	TNYNQVKDRFTISTDKSKNTAFLQMDSLR	JA208
KOL	GLEW	VAI	IWDDGSDQHYADSVKGRFTISRDN	SKNTLFLQMDSLR

Fig. 5(ii)

SUBSTITUTE SHEET

	84	95	102	113	
Okt3vh	SEDSAVYYCARYYDDHY.....CLDYWGQGTTLTVSS				
gH341	PEDTGVYFCARYYDDHY.....CLDYWGQGTTLTVSS				JA178
gH341A	PEDT <u>A</u> VY <u>Y</u> CARYYDDHY.....CLDYWGQGTTLTVSS				JA185
gH341E	PEDTGVYFCARYYDDHY.....CLDYWGQGTTLTVSS				JA198
gH341*	PEDTGVYFCARYYDDHY.....CLDYWGQGTTLTVSS				JA207
gH341D	PEDTGVYFCARYYDDHY.....CLDYWGQGTTLTVSS				JA197
gH341*	PEDTGVYFCARYYDDHY.....CLDYWGQGTTLTVSS				JA209
gH341*	PEDTGVYFCARYYDDHY.....CLDYWGQGTTLTVSS				JA199
gH341C	PEDTGVYFCARYYDDHY.....CLDYWGQGTTLTVSS				JA184
gH341*	PEDT <u>A</u> VY <u>Y</u> CARYYDDHY.....CLDYWGQGTTLTVSS				JA203
gH341*	PEDT <u>A</u> VY <u>Y</u> CARYYDDHY.....CLDYWGQGTTLTVSS				JA205
gH341B	PEDT <u>A</u> VY <u>Y</u> CARYYDDHY.....CLDYWGQGTTLTVSS				JA183
gH341*	PEDTGVYFCARYYDDHY.....CLDYWGQGTTLTVSS				JA204
gH341*	PEDTGVYFCARYYDDHY.....CLDYWGQGTTLTVSS				JA206
gH341*	PEDTGVYFCARYYDDHY.....CLDYWGQGTTLTVSS				JA208
KOL	PEDTGVYFCARDGGHGFSSASCFGPDYWGQGPVTVSS				

Fig. 5 (iii)

OKT3 LIGHT CHAIN CDR GRAFTING

1. gL221 and derivatives

	1	24	34	42
Okt3v1	QIVLTQSPAIMSASPGEKVTMTCSASS.SVSYMNWYQOKSGT			
gL221	DIQMTQSPSSLSASVGDRVTTITCSASS. <u>SVSYMNWYQOTPGK</u>			
gL221A	<u>QIV</u> MTQSPSSLSASVGDRVTTITCSASS.SVSYMNWYQOTPGK			
gL221B	<u>QIV</u> MTQSPSSLSASVGDRVTTITCSASS.SVSYMNWYQOTPGK			
gL221C	DIQMTQSPSSLSASVGDRVTTITCSASS.SVSYMNWYQOTPGK			
REI	DIQMTQSPSSLSASVGDRVTTITCQASQDIKYLWYQOTPGK			
	43	50	56	85
Okt3v1	SPKRWIYDTSKLAGVPAHFRGSGSGTYSYSLTISGMEAEDAAT			
gL221	APKLLIYDTSKLAGVPSRFRSGSGSGTDYFTFTISLQPEDIA <u>T</u>			
gL221A	APKRWIYDTSKLAGVPSRFRSGSGSGTDYFTFTISLQPEDIA <u>T</u>			
gL221B	APKRWIYDTSKLAGVPSRFRSGSGSGTDYFTFTISLQPEDIA <u>T</u>			
gL221C	APKRWIYDTSKLAGVPSRFRSGSGSGTDYFTFTISLQPEDIA <u>T</u>			
REI	APKLLIYEASNLOAGVPSRFRSGSGSGTDYFTFTISLQPEDIA <u>T</u>			
	86	91	96	108
Okt3v1	YYCQWSSNPFTFGSGTKLEINR			
gL221	YYCQWSSNPFTFGQGTKLQITR			
gL221A	YYCQWSSNPFTFGQGTKLQITR			
gL221B	YYCQWSSNPFTFGQGTKLQITR			
gL221C	YYCQWSSNPFTFGQGTKLQITR			
REI	YYCQYQSLPYTFGQGTKLQITR			

CDR'S ARE UNDERLINED

FRAMEWORK RESIDUES INCLUDED IN THE GENE ARE DOUBLE UNDERLINED

Fig. 6

SUBSTITUTE SHEET

SUBSTITUTE SHEET

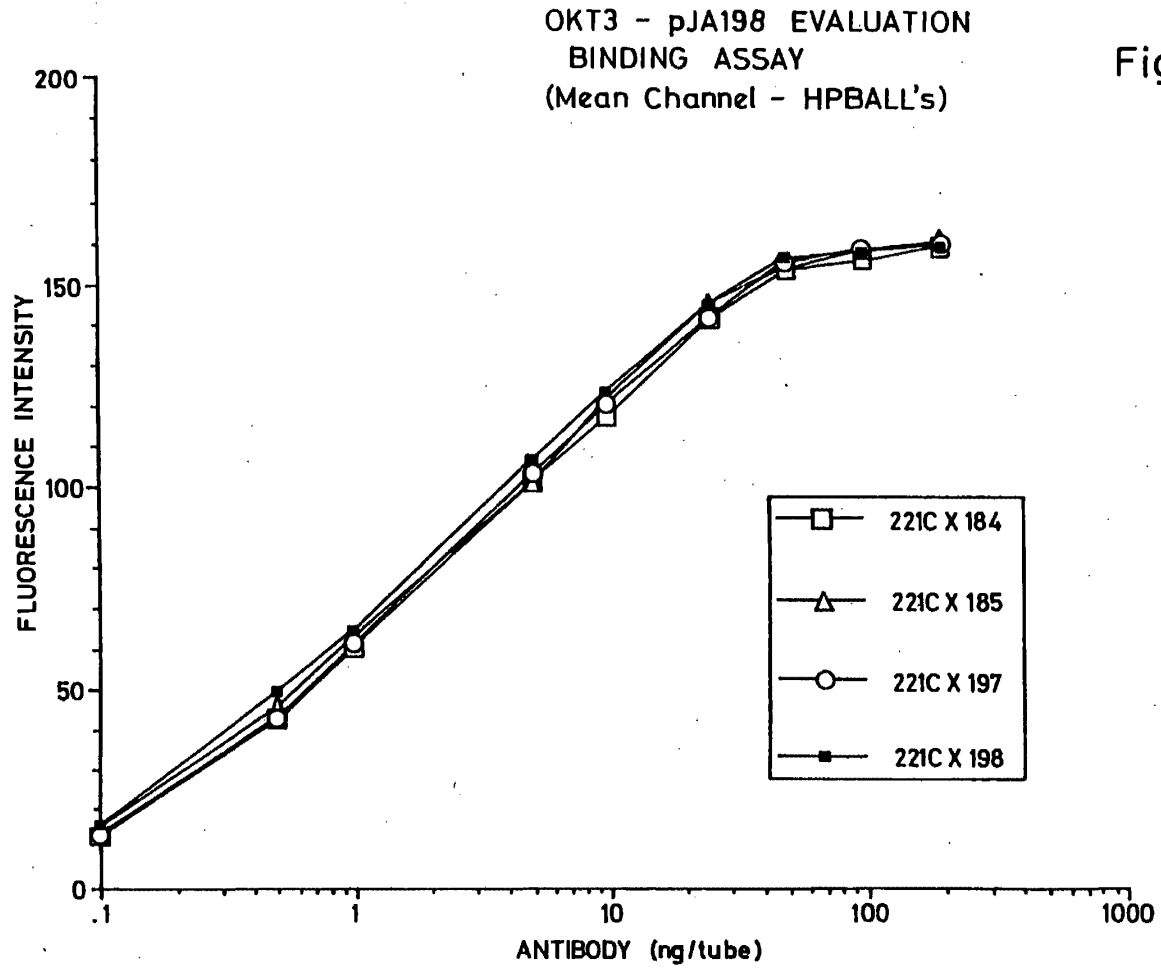

WO 91/09968

9 / 15

PCT/GB90/02018

OKT3 - pJA198 EVALUATION
BLOCKING ASSAY
(Mean Channel -HPBALL's)

Fig. 8

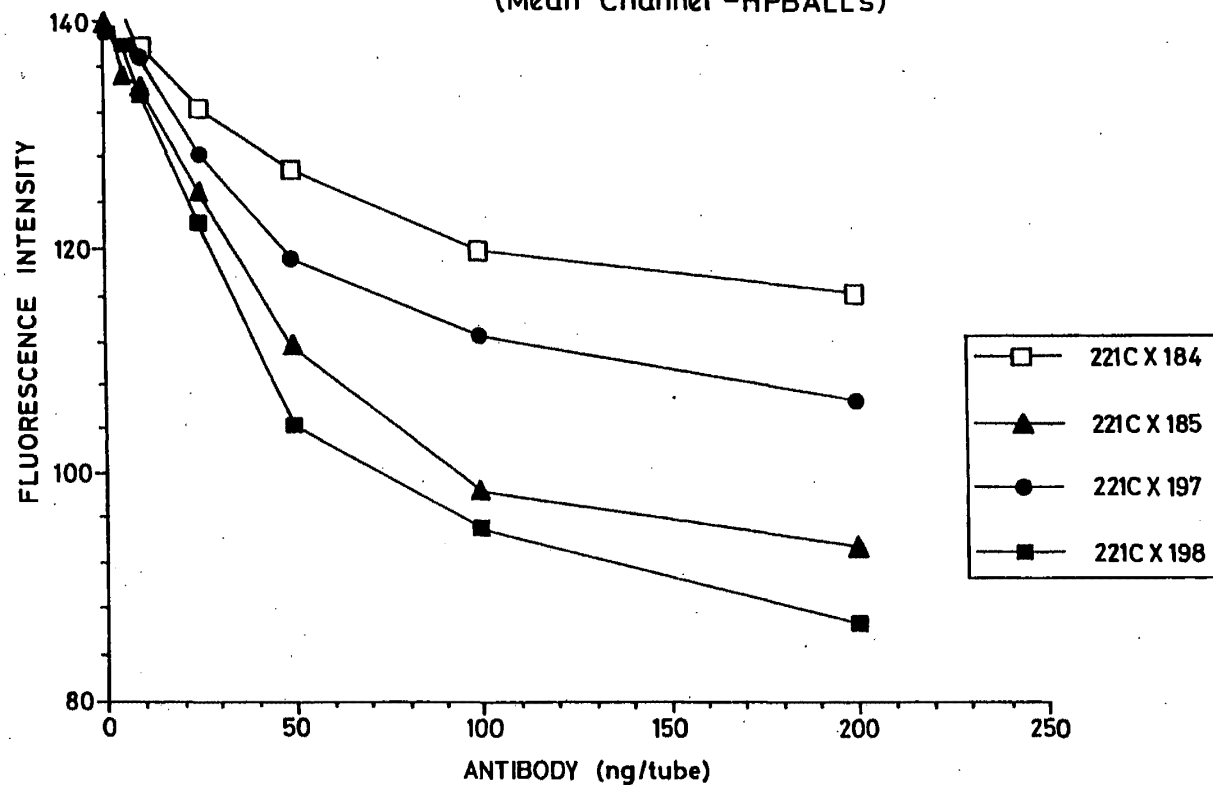

11/15

BLOCKING ASSAY
(Mean Channel - HPBALL's)

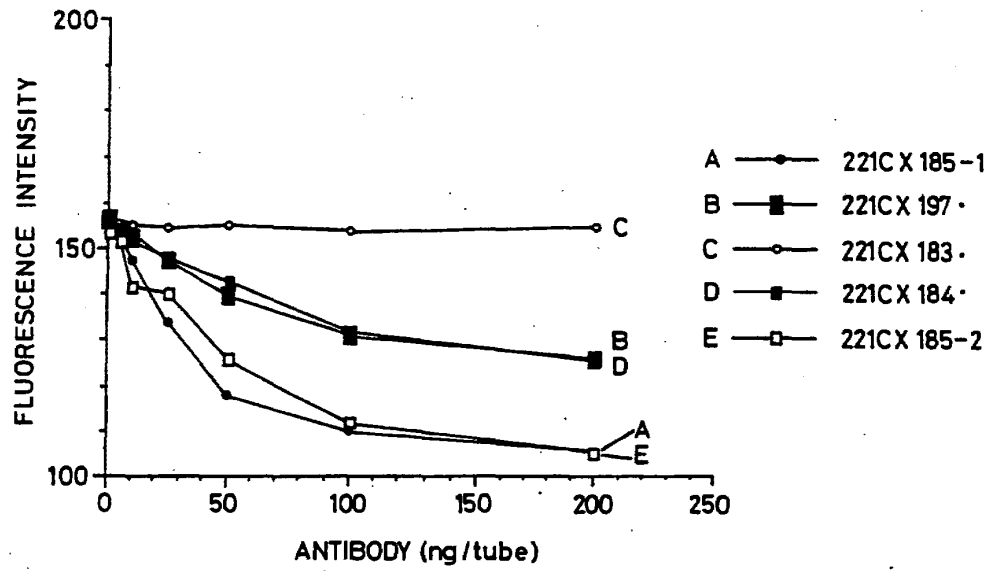

Fig.9

SUBSTITUTE SHEET

12 / 15

Fig.10

OKT3 - GRAFTED HEAVY CHAINS
BINDING ASSAY
(Mean Channel - HPBALL's)

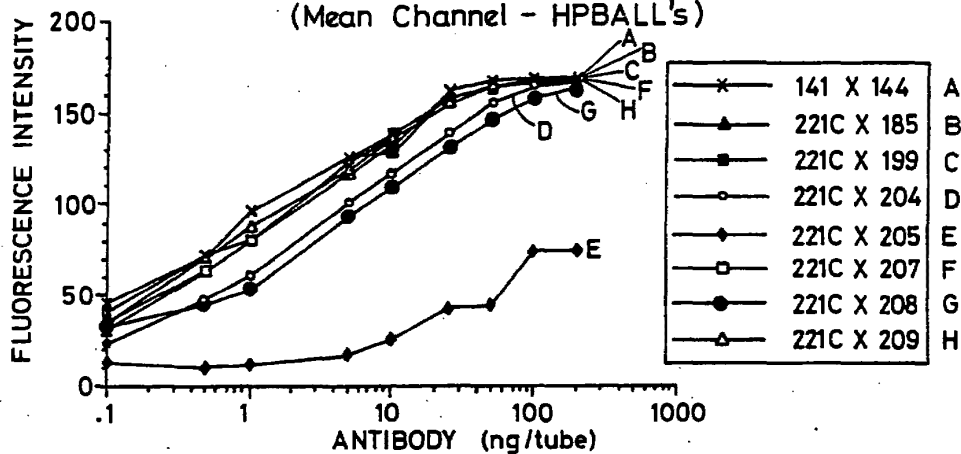

OKT3 - GRAFTED HEAVY CHAINS
BLOCKING ASSAY
(Mean Channel - HPBALL's)

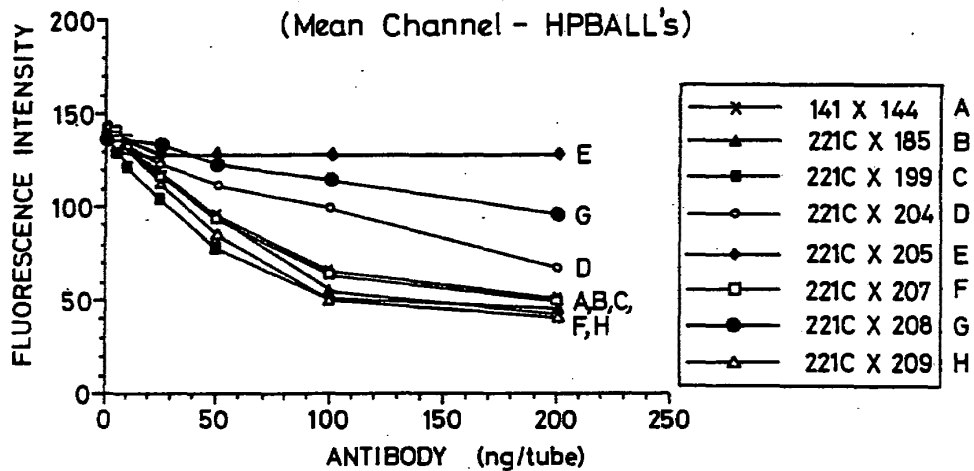

◆	(205)	---,24,48,49,71,73,76,78,88,91,
●	(208)	6,---,24,48,49,71,73,---,78,---,---
○	(204)	6,---,24,48,49,71,73,76,78,---,---
■	(199)	6,23,24,48,49,---,---,---,---,---
□	(207)	6,23,24,48,49,71,73,---,78,---,---
▲	(185)	6,23,24,48,49,71,73,76,78,88,91,
△	(209)	6,23,24,48,49,---,---,---,78,---,---
x	141 X 144	

SUBSTITUTE SHEET

Fig. 11

OKT3 - GRAFTED HEAVY CHAINS
BINDING ASSAY
(Mean Channel - HPBALL's)

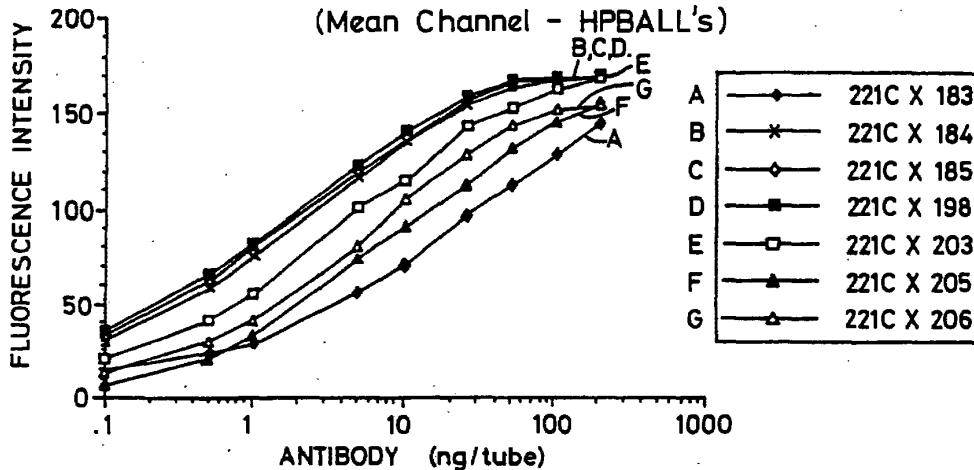

OKT3 GRAFTED HEAVY CHAINS
BLOCKING ASSAY
(Mean Channel - HPBALL's)

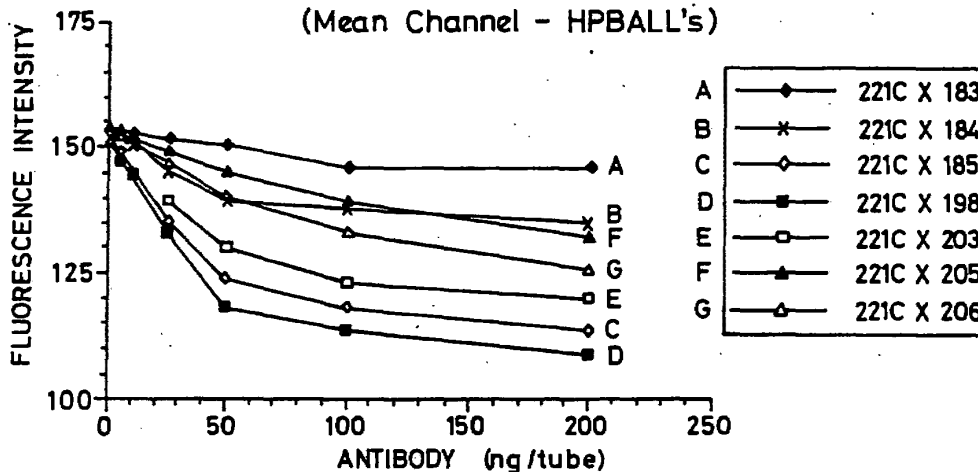

—◆—	(183)	---,48,49,71,73,76,78,88,91,
—▲—	(205)	---,24,48,49,71,73,76,78,88,91,
—×—	(184)	6,23,24,---,48,49,71,73,76,78,88,91,
—△—	(206)	---,24,48,49,71,73,76,78,88,91,
—□—	(203)	6,---,24,48,49,71,73,76,78,88,91,
—◇—	(185)	6,23,24,48,49,71,73,76,78,88,91,
—■—	(198)	6,23,24,48,49,71,73,76,78,88,91,

SUBSTITUTE SHEET

SUBSTITUTE SHEET

OKT3 Competition
Murine Ref Std vs. CDR Grafted OKT3

Fig. 12

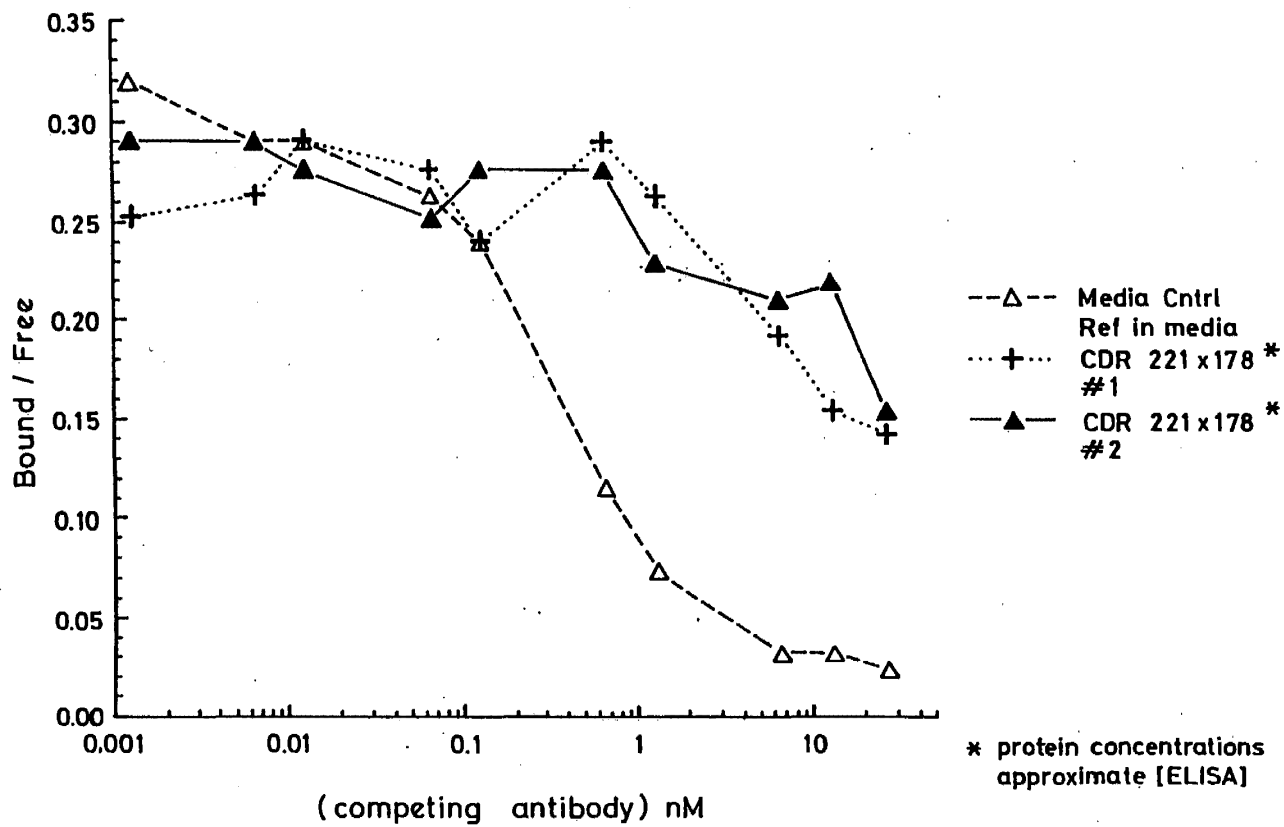

WO 91/09968

14 / 15

PCT/GB90/02018

SUBSTITUTE SHEET

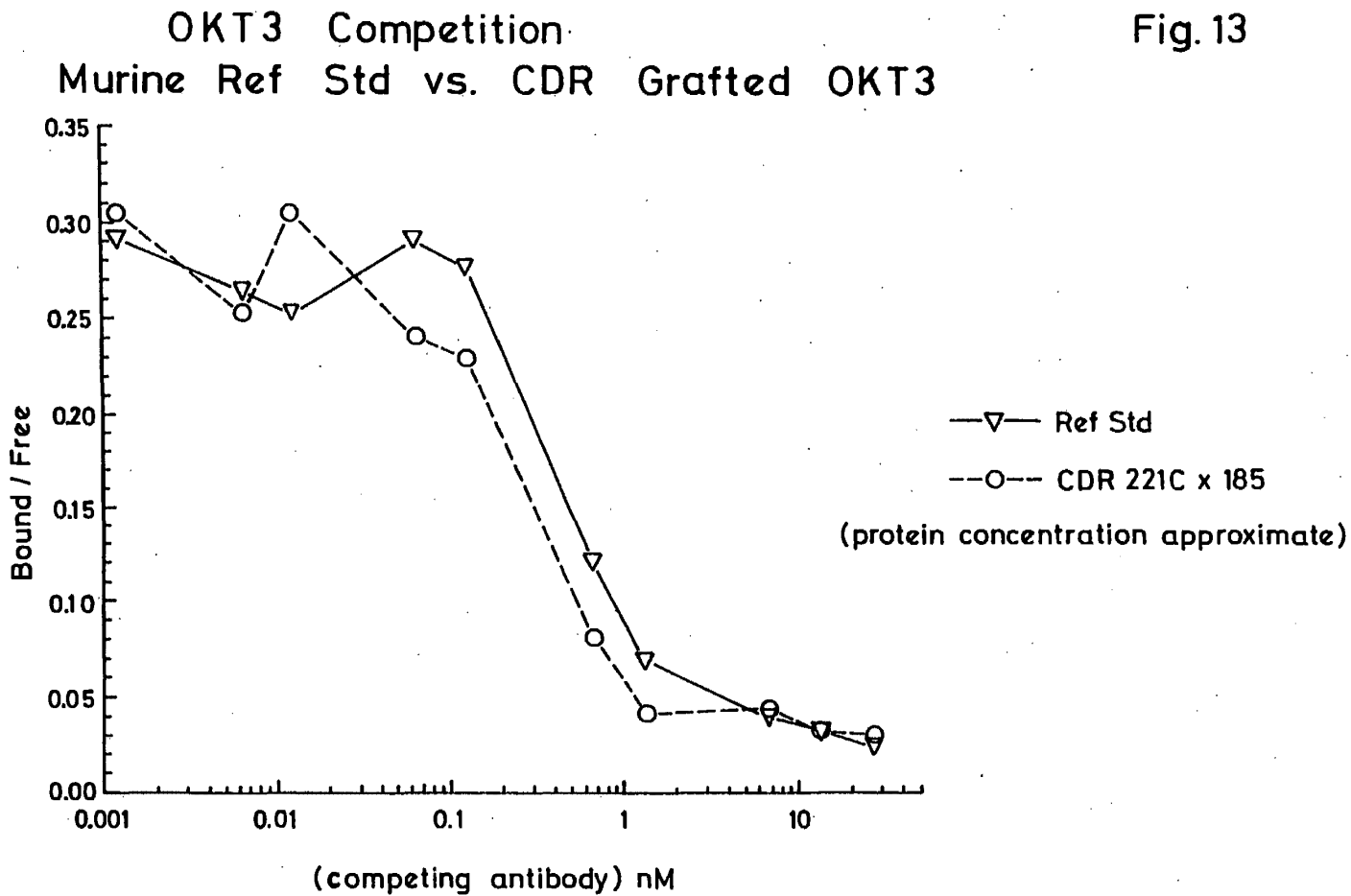

WO 91/09968

15 / 15

PCT/GB90/02018

INTERNATIONAL SEARCH REPORT

International Application No **PCT/GB 90/02018**

I. CLASSIFICATION OF SUBJECT MATTER (if several classification symbols apply, indicate all) ⁶		
According to International Patent Classification (IPC) or to both National Classification and IPC		
IPC5: C 12 P 21/08, C 12 N 15/13, A 61 K 39/395, C 07 K 15/06 C 12 N 5/10, 15/62, A 61 K 49/00		
II. FIELDS SEARCHED		
Minimum Documentation Searched ⁷		
Classification System	Classification Symbols	
IPC5	C 12 N, C 12 P, A 61 K	
Documentation Searched other than Minimum Documentation to the Extent that such Documents are Included in Fields Searched ⁸		
III. DOCUMENTS CONSIDERED TO BE RELEVANT⁹		
Category ¹⁰	Citation of Document, ¹¹ with indication, where appropriate, of the relevant passages ¹²	Relevant to Claim No. ¹³
P,X	EP, A1, 0403156 (GENZYME CORPORATION ET AL.) 19 December 1990, see page 3, lines 13-29, examples 8-12 and corresponding tables --	1-7,9, 11-14, 16,18- 25
Y	Proc. Natl. Acad. Sci. USA, vol. 86, December 1989, C. Queen et al.: "A humanized antibody that binds to the interleukin 2 receptor", see the whole document and in particular page 10031 right col. - page 10032, left col. and page 10033, left col. --	1-25
A	Nature, vol. 332, March 1988, L. Riechmann et al.: "Reshaping human antibodies for therapy ", see page 323 - page 327 see in particular page 327, right col. --	1-25
<p>* Special categories of cited documents:¹⁰</p> <p>"A" document defining the general state of the art which is not considered to be of particular relevance</p> <p>"E" earlier document but published on or after the international filing date</p> <p>"L" document which may throw doubts on priority claim(s) or which is cited to establish the publication date of another citation or other special reason (as specified)</p> <p>"O" document referring to an oral disclosure, use, exhibition or other means</p> <p>"P" document published prior to the international filing date but later than the priority date claimed</p> <p>"T" later document published after the international filing date or priority date and not in conflict with the application but cited to understand the principle or theory underlying the invention</p> <p>"X" document of particular relevance, the claimed invention cannot be considered novel or cannot be considered to involve an inventive step</p> <p>"Y" document of particular relevance, the claimed invention cannot be considered to involve an inventive step when the document is combined with one or more other such documents, such combination being obvious to a person skilled in the art.</p> <p>"&" document member of the same patent family</p>		
IV. CERTIFICATION		
Date of the Actual Completion of the International Search	Date of Mailing of this International Search Report	
10th April 1991	22 MAY 1991	
International Searching Authority	Signature of Authorized Officer	
EUROPEAN PATENT OFFICE	MISS D. S. KOWALCZYK	

Form PCT/ISA/210 (second sheet) (January 1985)

III. DOCUMENTS CONSIDERED TO BE RELEVANT (CONTINUED FROM THE SECOND SHEET)		
Category *	Citation of Document, with indication, where appropriate, of the relevant passages	Relevant to Claim No
A	EP, A1, 0328404 (MEDICAL RESEARCH COUNCIL ET AL.) 16 August 1989, see pages 1-3, page 9, lines 49-54 and the claims	1-6, 11
	--	
Y	Transplantations, vol. 41, No. 5, 1986, G.J. Jaffers et al.: "Monoclonal antibody therapy ", see page 572 - page 578 see page 572 and 577-8	1-25
	--	
A	Nature, vol. 337, January 1989, C.A. Smith et al.: "Antibodies to CD3/T-cell receptor complex induce death by apoptosis in immature T cells in thymic cultures ", see page 181 - page 184	1
	--	

FURTHER INFORMATION CONTINUED FROM THE SECOND SHEET

V. OBSERVATIONS WHERE CERTAIN CLAIMS WERE FOUND UNSEARCHABLE ¹

This international search report has not been established in respect of certain claims under Article 17(2) (a) for the following reasons:

1. Claim numbers 26 because they relate to subject matter not required to be searched by this Authority, namely:

See PCT Rule 39.1(iv)

Method for treatment of the human or animal body by means of surgery or therapy, as well as diagnostic methods.

2. Claim numbers because they relate to parts of the international application that do not comply with the prescribed requirements to such an extent that no meaningful international search can be carried out, specifically:

3. Claim numbers because they are dependent claims and are not drafted in accordance with the second and third sentences of PCT Rule 6.4(a).

VI. OBSERVATIONS WHERE UNITY OF INVENTION IS LACKING ²

This International Searching Authority found multiple inventions in this international application as follows:

1. As all required additional search fees were timely paid by the applicant, this international search report covers all searchable claims of the international application.
2. As only some of the required additional search fees were timely paid by the applicant, this international search report covers only those claims of the international application for which fees were paid, specifically claims:
3. No required additional search fees were timely paid by the applicant. Consequently, this international search report is restricted to the invention first mentioned in the claims; it is covered by claim numbers:
4. As all searchable claims could be searched without effort justifying an additional fee, the international Searching Authority did not invite payment of any additional fee.

Remark on Protest

- The additional search fees were accompanied by applicant's protest.
- No protest accompanied the payment of additional search fees.

**ANNEX TO THE INTERNATIONAL SEARCH REPORT
ON INTERNATIONAL PATENT APPLICATION NO.PCT/GB 90/02018**

SA 43131

This annex lists the patent family members relating to the patent documents cited in the above-mentioned international search report. The members are as contained in the European Patent Office EDP file on 28/02/91. The European Patent office is in no way liable for these particulars which are merely given for the purpose of information.

Patent document cited in search report	Publication date	Patent family member(s)	Publication date
EP-A1- 0403156	19/12/90	NONE	
EP-A1- 0328404	16/08/89	AU-D- 3062689	06/09/89
		GB-A- 2216126	04/10/89
		WO-A- 89/07452	24/08/89

For more details about this annex: see Official Journal of the European patent Office, No. 12/82

EPO FORM P0479



INTERNATIONAL APPLICATION PUBLISHED UNDER THE PATENT COOPERATION TREATY (PCT)

<p>(51) International Patent Classification ⁵ : A61K 35/14, 39/00, C07K 15/00</p>	<p>A1</p>	<p>(11) International Publication Number: WO 92/11018 (43) International Publication Date: 9 July 1992 (09.07.92)</p>
<p>(21) International Application Number: PCT/US91/09711 (22) International Filing Date: 19 December 1991 (19.12.91) (30) Priority data: 634,278 19 December 1990 (19.12.90) US (71) Applicant: PROTEIN DESIGN LABS, INC. [US/US]; 2375 Garcia Avenue, Mountain View, CA 94043 (US). (72) Inventors: QUEEN, Cary, L. ; 622 Benvenue Street, Los Altos, CA 94022 (US). CO, Man, Sung ; 10230 Yoshino Place, Cupertino, CA 95014 (US). SCHNEIDER, William, P. ; 484 Loreto Street, Mountain View, CA 94041 (US). LANDOLFI, Nicholas, F. ; 246 Seaside Drive, Milpitas, CA 95035 (US). COELINGH, Kathleen, L. ; 1509 Dolores Avenue, San Francisco, CA 94114 (US).</p>	<p>(74) Agent: SMITH, William, M.; Townsend and Townsend, One Market Plaza, 2000 Steuart Tower, San Francisco, CA 94105 (US). (81) Designated States: AT, AT (European patent), AU, BB, BE (European patent), BF (OAPI patent), BG, BJ (OAPI patent), BR, CA, CF (OAPI patent), CG (OAPI patent), CH, CH (European patent), CI (OAPI patent), CM (OAPI patent), CS, DE, DE (European patent), DK, DK (European patent), ES, ES (European patent), FI, FR (European patent), GA (OAPI patent), GB, GB (European patent), GN (OAPI patent), GR (European patent), HU, IT (European patent), JP, KP, KR, LK, LU, LU (European patent), MC (European patent), MG, ML (OAPI patent), MN, MR (OAPI patent), MW, NL, NL (European patent), NO, PL, RO, SD, SE, SE (European patent), SN (OAPI patent), SU*, TD (OAPI patent), TG (OAPI patent). Published <i>With international search report.</i></p>	
<p>(54) Title: IMPROVED HUMANIZED IMMUNOGLOBULINS</p> <p>(57) Abstract</p> <p>Novel humanized immunoglobulins having one or more complementarity determining regions (CDR's) and possible additional amino acids from a donor immunoglobulin and a framework region from an accepting human immunoglobulin are provided for a number of antigens.</p>		

* See back of page

+ DESIGNATIONS OF "SU"

Any designation of "SU" has effect in the Russian Federation. It is not yet known whether any such designation has effect in other States of the former Soviet Union.

FOR THE PURPOSES OF INFORMATION ONLY

Codes used to identify States party to the PCT on the front pages of pamphlets publishing international applications under the PCT.

AT	Austria	ES	Spain	MG	Madagascar
AU	Australia	FI	Finland	ML	Mali
BB	Barbados	FR	France	MN	Mongolia
BE	Belgium	GA	Gabon	MR	Mauritania
BF	Burkina Faso	GB	United Kingdom	MW	Malawi
BG	Bulgaria	GN	Guinea	NL	Netherlands
BJ	Benin	GR	Greece	NO	Norway
BR	Brazil	HU	Hungary	PL	Poland
CA	Canada	IT	Italy	RO	Romania
CF	Central African Republic	JP	Japan	SD	Sudan
CG	Congo	KP	Democratic People's Republic of Korea	SE	Sweden
CH	Switzerland			SN	Senegal
CI	Côte d'Ivoire	KR	Republic of Korea	SU*	Soviet Union
CM	Cameroon	LI	Liechtenstein	TD	Chad
CS	Czechoslovakia	LK	Sri Lanka	TC	Togo
DE	Germany	LU	Luxembourg	US	United States of America
DK	Denmark	MC	Monaco		

IMPROVED HUMANIZED IMMUNOGLOBULINS5 Field of the Invention

The present invention relates generally to the combination of recombinant DNA and monoclonal antibody technologies for developing novel therapeutic agents and, more particularly, to the production of non-immunogenic antibodies
10 having strong affinity for a predetermined antigen.

Background of the Invention

The advent of monoclonal antibody technology in the mid 1970's heralded a new age of medicine. For the first
15 time, researchers and clinicians had access to essentially unlimited quantities of uniform antibodies capable of binding to a predetermined antigenic site and having various immunological effector functions. These proteins, known as "monoclonal antibodies" were thought to hold great promise in,
20 e.g., the removal of harmful cells in vivo. Indeed, the clinical value of monoclonal antibodies seemed limitless for this use alone.

Unfortunately, the development of appropriate therapeutic products based on these proteins has been severely
25 hampered by a number of drawbacks inherent in monoclonal antibody production. For example, most monoclonal antibodies are mouse derived, and thus do not fix human complement well. They also lack other important immunoglobulin functional characteristics when used in humans.

30 Perhaps most importantly, non-human monoclonal antibodies contain substantial stretches of amino acid sequences that will be immunogenic when injected into a human patient. Numerous studies have shown that after injection of a foreign antibody, the immune response mounted by a patient
35 can be quite strong, essentially eliminating the antibody's therapeutic utility after an initial treatment. Moreover, as increasing numbers of different mouse or other antigenic (to

humans) monoclonal antibodies can be expected to be developed to treat various diseases, after one or several treatments with any non-human antibodies, subsequent treatments, even for unrelated therapies, can be ineffective or even dangerous in themselves, because of cross-reactivity.

While the production of so called "chimeric antibodies" (e.g., mouse variable regions joined to human constant regions) has proven somewhat successful, a significant immunogenicity problem remains. Moreover, efforts to immortalize human B-cells or generate human hybridomas capable of producing human immunoglobulins against a desired antigen have been generally unsuccessful, particularly with many important human antigens. Most recently, recombinant DNA technology has been utilized to produce immunoglobulins which have human framework regions combined with complementarity determining regions (CDR's) from a donor mouse or rat immunoglobulin (see, e.g., EPO Publication No. 0239400). These new proteins are called "reshaped" or "humanized" immunoglobulins and the process by which the donor immunoglobulin is converted into a human-like immunoglobulin by combining its CDR's with a human framework is called "humanization". Humanized antibodies are important because they bind to the same antigen as the original antibodies, but are less immunogenic when injected into humans.

However, a major problem with humanization procedures has been a loss of affinity for the antigen (Jones et al., Nature, 321, 522-525 (1986)), in some instances as much as 10-fold or more, especially when the antigen is a protein (Verhoeyen et al., Science, 239, 1534-1536 (1988)). Loss of any affinity is, of course, highly undesirable. At the least, it means that more of the humanized antibody will have to be injected into the patient, at higher cost and greater risk of adverse effects. Even more critically, an antibody with reduced affinity may have poorer biological functions, such as complement lysis, antibody-dependent cellular cytotoxicity, or virus neutralization. For example, the loss of affinity in the partially humanized antibody

HuVHCAMP may have caused it to lose all ability to mediate complement lysis (see, Riechmann et al., Nature, 332, 323-327 (1988); Table 1).

Thus, there is a need for humanized antibodies specifically reactive with strong affinity to predetermined antigens. These humanized immunoglobulins should remain substantially non-immunogenic in humans, yet be easily and economically produced in a manner suitable for therapeutic formulation and other uses. The present invention fulfills these and other needs.

Summary of the Invention

The present invention provides novel compositions useful, for example, in the treatment of T-cell mediated human disorders, the compositions containing human-like immunoglobulins specifically capable of inhibiting the binding of human IL-2 to its receptor and/or capable of binding to the p75 protein of human IL-2 receptors. The immunoglobulins can have two pairs of light chain/heavy chain complexes, typically at least one chain comprising mouse complementarity determining regions functionally joined to human framework region segments. For example, mouse complementarity determining regions, with or without additional naturally-associated mouse amino acid residues, can be used to produce human-like antibodies capable of binding to the p75 protein at affinity levels stronger than about $10^7 M^{-1}$. These humanized immunoglobulins will also be capable of blocking the binding of the CDR-donating mouse monoclonal antibody to p75.

The present invention also provides novel compositions useful, for example, in the treatment of HSV mediated human disorders, the compositions containing humanized immunoglobulins specifically capable of blocking the binding of HSV to its receptors and/or capable of binding to the HSV specific proteins. The immunoglobulins can have two pairs of light chain/heavy chain complexes, at least one chain comprising one or more mouse complementarity determining regions functionally joined to human framework region

segments. For example, mouse complementarity determining regions, with or without additional naturally-associated mouse amino acid residues, can be introduced into human framework regions to produce humanized immunoglobulins capable of binding to the HSV surface proteins at affinity levels stronger than about $10^7 M^{-1}$. These humanized immunoglobulins will also be capable of blocking the binding of the CDR donating mouse monoclonal antibody to HSV. These humanized immunoglobulins may be utilized alone in substantially pure form, or together with an antiviral agent, such as acyclovir or a cytotoxic agent active at viral surfaces. All of these compounds will be particularly useful in treating HSV mediated disorders.

The present invention further provides novel compositions useful, for example, in the treatment of myeloid leukemia-related human disorders, the compositions containing humanized immunoglobulins specifically capable of binding to CD33 antigen. The immunoglobulins can have two pairs of light chain/heavy chain complexes, at least one chain comprising one or more mouse complementarity determining regions functionally joined to human framework region segments. For example, mouse complementarity determining regions, with or without additional naturally-associated mouse amino acid residues, can be introduced into human framework regions to produce humanized immunoglobulins capable of binding to the CD33 antigen at affinity levels stronger than about $10^7 M^{-1}$. These humanized immunoglobulins will also be capable of blocking the binding of the CDR-donating mouse monoclonal antibody to CD33. These humanized immunoglobulins may be utilized alone in substantially pure form, or together with a chemotherapeutic agent such as cytosine arabinoside or daunorubicin active against leukemia cells, or complexed with a radionuclide such as iodine-131. All of these compounds will be particularly useful in treating leukemia and myeloid cell-mediated disorders.

The present invention also provides novel compositions useful, for example, in the treatment of CMV-

mediated human disorders, the compositions containing humanized immunoglobulins specifically capable of blocking the binding of CMV to its receptors and/or capable of binding to CMV antigens. For example, mouse complementarity determining regions, with or without additional naturally-associated mouse amino acid residues, can be introduced into human framework regions to produce humanized immunoglobulins capable of binding to CMV at affinity levels stronger than about $10^7 M^{-1}$. These humanized immunoglobulins will also be capable of blocking the binding of the CDR-donating mouse monoclonal antibody to CMV. These humanized immunoglobulins may be utilized alone in substantially pure form, or together with a chemotherapeutic agent such a acyclovir or ganciclovir active against CMV-infected cells, or complexed with a cytotoxic agent. All of these compounds will be particularly useful in treating CMV-mediated disorders.

The present invention further provides novel compositions useful, for example, in the treatment of human autoimmune disorders, the compositions containing humanized immunoglobulins specifically capable of binding to γ -IFN. For example, mouse complementarity determining regions, with or without additional naturally-associated mouse amino acid residues, can be introduced into human framework regions to produce humanized immunoglobulins capable of binding to γ -IFN at affinity levels stronger than about $10^7 M^{-1}$. These humanized immunoglobulins will also be capable of blocking the binding of the CDR-donating mouse monoclonal antibody to γ -IFN. The humanized immunoglobulins may be utilized alone in substantially pure form, or together with a chemotherapeutic agent such as a non-steroidal anti-inflammatory drug, a corticosteroid, or an immunosuppressant. All of these compounds will be particularly useful in treating autoimmune disorders.

35

BRIEF DESCRIPTION OF THE FIGURES

Figure 1. Amino acid sequences (1-letter code) of the light chain (A) and heavy chain (B) variable regions of

the mouse Fd79 antibody (upper lines), compared with the humanized antibody (lower lines), not including signal sequences. The three CDR's in each chain are underlined. Residues in the humanized antibody framework replaced with mouse amino acids or typical human amino acids are double underlined. The number of the first position on each line is given on the left.

Figure 2. Amino acid sequences (1-letter code) of the light chain (A) and heavy chain (B) variable regions of the mouse Fd138-80 antibody (upper lines), compared with the humanized antibody (lower lines), not including signal sequences. The three CDR's in each chain are underlined. Residues in the humanized antibody framework replaced with mouse amino acids or typical human amino acids are double underlined. The number of the first position on each line is given on the left.

Figure 3. Amino acid sequences (1-letter code) of the light chain (A) and heavy chain (B) variable regions of the mouse M195 antibody (upper lines), compared with the humanized antibody (lower lines), not including signal sequences. The three CDR's in each chain are underlined. Residues in the humanized antibody framework replaced with mouse amino acids or typical human amino acids are double underlined. The number of the first position on each line is given on the left.

Figure 4. Amino acid sequences (1-letter code) of the light chain (A) and heavy chain (B) variable regions of the mouse mik- β 1 antibody (upper lines), compared with the humanized antibody (lower lines), not including signal sequences. The three CDR's in each chain are underlined. Residues in the humanized antibody framework replaced with mouse amino acids or typical human amino acids are double underlined. The number of the first position on each line is given on the left.

Figure 5. Amino acid sequences (1-letter code) of the light chain (A) and heavy chain (B) variable regions of the mouse CMV5 antibody (upper lines), compared with the humanized antibody (lower lines), not including signal sequences. The three CDR's in each chain are underlined. Residues in the humanized antibody framework replaced with mouse amino acids or typical human amino acids are double underlined. The number of the first position on each line is given on the left.

Figure 6. Scheme for anchored polymerase chain reaction (PCR) cloning of the heavy and light chain variable domain cDNAs. RNA was prepared from about 10^7 hybridoma cells using the hot phenol extraction method. Briefly, cells were resuspended and vortexed in 1 ml of RNA extraction buffer (50 mM sodium acetate pH 5.2/1% SDS), extracted with 0.5 ml of phenol pH 5.2 at 65°C for 15 min, followed by another 15 min on ice. The aqueous phase was recovered and precipitated twice with ethanol. cDNA was synthesized from 10 ug of total RNA using reverse transcriptase (BRL, Bethesda, MD) and oligo-dT₁₂₋₁₈ (Pharmacia, Piscataway, New Jersey) as primers. A poly(dG) tail was attached to the 3' end of the cDNA using terminal deoxynucleotide transferase (BRL) (E.Y. Loh et al., *Science* 243, 217 (1989)), the variable domain genes (V) were amplified using AmpliTaq (Perkin Elmer-Cetus) with the primer mc045 (TAATCTAGAATCCCCCCCCCCCCCCCC) that hybridized to the poly(dG) tails and primers that hybridized to the constant region genes (C). For the light chain, the primer used was mc045 (TATAGAGCTCAAGCTTGGATGGTGGGAAGATGGATACAGTTGGTGC). For the heavy chain, the primer used was mc047 (TATAGAGCTCAAGCTTCCAGTGGATAGAC (CAT) GATGGGG (GC) TGT (TC) GTTTTGGC)

The sequence in parenthesis indicates a base degeneracy. The degeneracy was introduced so that the primer would be able to hybridize to most gamma chains. The amplified fragments were

then digested with EcoRI and HindIII and cloned into pUC18 vector for sequencing.

Figure 7. Sequences of the cDNA and translated amino acid sequences of the light chain (A) and heavy chain (B) variable regions of the antibody mik- β 1. The CDR sequences are underlined. The mature light chain protein begins with amino acid 23 Q and the mature heavy chain protein with amino acid 20 Q, preceded by the respective signal sequences.

Figure 8. Schematic diagram of the plasmids pVg1-dhfr (A) and pVk (B). The plasmid pVg1-dhfr contains the following parts: an approximately 4200 base pair BamHI-EcoRI fragment containing the amp and dhfr genes; a 630-bp fragment containing the human cytomegalovirus IE1 gene promoter and enhancer (Boshart et al., Cell 41, 521 (1985)) flanked at the 5' and 3' ends by EcoRI and XbaI linkers respectively; and a 2800 bp XbaI-BamHI fragment containing the human gamma-1 constant region gene with 215 bp of the preceding intron and the poly(A) signal. The plasmid pVk was similarly constructed, with a 1530-bp human kappa constant region gene replacing the gamma-1 gene and the gpt gene replacing the dhfr gene. The plasmids were constructed from the indicated parts using methods well-known in the art (see, Maniatis et al., Molecular Cloning: A Laboratory Manual, 2nd ed., Cold Spring Harbor Laboratory, Cold Spring Harbor, N.Y. (1989). For example, pVg1-dhfr was constructed from the plasmid pVg1 (commonly assigned U.S. patent application serial No. 07/590,274 filed September 28, 1990) by replacing the Hind III-Bgl II fragment containing the hyg gene with a 660 bp fragment containing the dhfr gene and extending to a Bgl II site (Simonsen et al., Proc. Natl. Acad. Sci. USA 80, 2495 (1983)).

35

Figure 9. Fluorocytometry of YTJB cells stained with (___) Isotype matched control antibody, (---) humanized mik- β 1 antibody, (...) chimeric mik- β 1 antibody. Cells were suspended in FACS buffer (PBS + 2% BSA + 0.1% azide) at approximately 5×10^6 /ml. 100 ul of cell suspension was transferred to a polystyrene tube and incubated with 100 ng of purified antibody on ice for 30 min. The cells were washed with FACS buffer and incubated with goat anti-human Ig antibody on ice for another 30 min. Then the cells were washed and incubated with FITC labeled rabbit anti-goat Ig antibody for 30 min. The cells were washed again and finally resuspended in PBS + 1% paraformaldehyde. Cells were analyzed on a FACSmate (Becton Dickinson).

Figure 10. Amino acid sequences of the light chain (A) and the heavy chain (B) of the humanized mik- β 1 antibody, (lower lines) and human Lay antibody (upper lines), not including signal sequences. The three CDRs in each chain are underlined. Amino acids in the framework that have been replaced with mouse amino acids or consensus human amino acids in the humanized antibody are double underlined.

Figure 11. Oligonucleotides used in the construction of the humanized mik- β 1 heavy chain (B) and light chain (A). The following pairs of oligonucleotides were mixed, extended with sequenase and cut with the indicated enzymes before ligation into the pBluescriptII ks (+) vector: wps54 and vc11 with Xba I and Sal I, vc12 and wps57 with Xba I and Sal I, vc16 and vc13 with Xba I and Kpn I, vc14 and vc15 with Xba I and Kpn I. Then the wps54-vc11 and vc12-wps57 fragments were excised with Xba I and Sal I ligated together into the Xba I site of pVg1-dhfr; and the vc16-vc13 fragments and vc14-vc15 fragments were excised with Xba I and Kpn I and ligated together into the Xba I site of pVk.

Figure 12. Competitive binding of labeled mik- β 1 tracer to YTJB cells. About 10^6 YTJB cells were incubated with

3.0 ng of radio-iodinated mouse mik- β 1 antibody (6 μ Ci/ μ g) and varying amounts of either unlabeled mouse mik- β 1 antibody (•) or humanized mik- β 1 antibody (◦) in 200 μ l of binding buffer (PBS + 10% fetal calf serum + 0.1% NaN₃ + 10 μ g/ml mouse monoclonal Ig). After incubation for 2 hr at 0°C the cells were washed twice with binding buffer without mouse Ig and collected by centrifugation. The radioactivity bound to cells was measured and expressed as the ratio of bound/free cpm.

10 Figure 13. Inhibition of IL-2 stimulated proliferation of human PHA blasts by humanized mik- β 1 + humanized anti-Tac antibodies. No antibody added (□), 2 μ g each of humanized mik- β 1 and humanized anti-Tac added (■).

15 Figure 14. Amino acid sequences of the heavy chain (A) and the light chain (B) of the murine and humanized Fd79 antibodies, and the heavy chain (C) and the light chain (D) of the murine and humanized Fd138-80 antibodies. The sequences of the murine antibody as deduced from the cDNA (upper lines) are shown aligned with the humanized antibody sequences (lower lines). The humanized Fd79 and Fd138-80 framework sequences are derived from Pom antibody and Eu antibody, respectively. Residues are numbered according to the Kabat system (E.A. Kabat et al., Sequences of Proteins of Immunological Interest 20 (National Institutes of Health, Bethesda, MD) (1987). The three CDRs in each chain are boxed. Residues in the Pom or Eu framework that have been replaced with murine sequences or 25 underlined.

30 Figure 15. Schematic diagram of the plasmids pVg1 (A) and pVk (B). The plasmid pVg1 was constructed from the following fragments; an approximately 4850 base pair BamHI-EcoRI fragment from the plasmid pSV2hph containing the amp and hyg genes; a 630-bp fragment containing the human 35 cytomegalovirus IE1 gene promoter and enhancer (Boshart et al., Cell 41, 521 (1985)) flanked at the 5' and 3' ends by EcoRI and XbaI linkers respectively; and a 2800 bp XbaI-BamHI

fragment containing the human gamma-1 constant region gene with 215 bp of the preceding intron and the poly(A) signal. The plasmid pVκ was similarly constructed, with a 1530-bp human kappa constant region gene replacing the gamma-1 gene and the gpt replacing the hyg gene.

Figure 16. Fluorocytometry of HSV-1 infected Vero cells stained with Fd79 (A) and Fd138-80 (B) antibodies. (. .) Isotype matched control antibody, (...) humanized antibody, (___) chimeric antibody. Vero cells were infected with HSV-1 (Δ 305 mutant (F strain)) at 3 pfu/cell overnight. Cells were trypsinized at 0.5 mg/ml for 1 minute, washed extensively with PBS and resuspended in FACS buffer (PBS + 2% BSA + 0.1% azide) at approximately 5×10^6 /ml. 100 ul of cell suspension was transferred to a polystyrene tube and incubated with 100 ng of purified antibody on ice for 30 min. The cells were washed with FACS buffer and incubated with FITC labeled goat anti-human antibody (Cappel) on ice for another 30 min. The cells were washed again and finally resuspended in PBS + 1% paraformaldehyde. Cells were analyzed on a FACSmate (Becton Dickinson).

Figure 17. Neutralization of HSV-1 by Fd79 (A) and Fd138-80 (B). Serial dilutions of antibodies were mixed with 100 pfu of virus and incubated at 37°C for 1 hr. The viruses were then inoculated onto 6-well plates with confluent Vero cells and adsorbed at 37°C for 1 hr. Cells were overlaid with 1% agarose in medium and incubated for 4 days. Plaques were stained with neutral red.

Figure 18. Immunostaining of infected Vero cell monolayers to examine protection of cells from viral spread in tissue culture by (A) murine or humanized Fd79, (B) murine or humanized Fd138-80. 24-well plates of confluent Vero cells were inoculated with virus at 0.1 pfu/cell and allowed to adsorb for 2 hrs. at 37°C before adding 200 ul of 10 ug/ml antibodies in medium. At the end of 4 days, culture medium

was removed and plates were dried by placing overnight in a 37°C incubator. To detect viral antigens, each well was incubated with 200 ul of anti-gB antibody at 0.5 ug/ml for 1 hr. at 37°C, washed twice and incubated with 200 ul of
5 peroxidase conjugated goat anti-mouse IgG (Cappel, 1:300 dilution) for 1 hr. at 37°C. The plates were washed and then developed with the substrate 3-amino-9-ethyl-carbazole (AEC) (Sigma, St. Louis, MO) for 15 minutes at room temperature. Reaction was stopped by rinsing with water and air dried.

10

Figure 19. Sequences of the cDNA and translated amino acid sequences of the light chain (A) and heavy chain (B) variable regions of the antibody M195. The CDR sequences
15 are underlined. The mature light chain protein begins with amino acid 21 D and the mature heavy chain protein with amino acid 20 E, preceded by the respective signal sequences.

20 Figure 20. Schematic diagram of the plasmids pVg1-dhfr (A) and pVk (B). The plasmid pVg1-dhfr contains the following parts: an approximately 4200 base pair BamHI-EcoRI fragment containing the amp and dhfr genes; a 630-bp fragment containing the human cytomegalovirus IE1 gene promoter and
25 enhancer (Boshart et al., Cell 41, 521 (1985)) flanked at the 5' and 3' ends by EcoRI and XbaI linkers respectively; and a 2800 bp XbaI-BamHI fragment containing the human gamma-1 constant region gene with 215 bp of the preceding intron and the poly(A) signal. The plasmid pVk was similarly
30 constructed, with a 1530-bp human kappa constant region gene replacing the gamma-1 gene and the gpt gene replacing the dhfr gene. The plasmids were constructed from the indicated parts using methods well-known in the art (see, Maniatis et al., Molecular Cloning: A Laboratory Manual, 2nd ed., Cold Spring
35 Harbor Laboratory, Cold Spring Harbor, N.Y. (1989) and PCT/89/01578 filed April 13, 1989. For example, pVg1-dhfr was constructed from the plasmid pVg1 by replacing the Hind III-

Bgl II fragment containing the hyg gene with a 660 bp fragment containing the dhfr gene and extending to a Bgl II site (Simonsen et al., Proc. Natl. Acad. Sci. USA 80, 2495 (1983)).

5 Figure 21. Fluorocytometry of U937 cells stained
with (.) no antibody, (...) humanized M195 antibody, (---)
chimeric M195 antibody. Cells were suspended in FACS buffer
(PBS + 2% FCS + 0.1% azide) at approximately 5×10^6 /ml. 100 ul
10 of cell suspension was transferred to a polystyrene tube and
incubated with 50 ng of purified antibody on ice for 30 min.
The cells were washed with FACS buffer and incubated with FITC
labeled goat anti-human Ig antibody on ice for another 30 min.
The cells were washed again and finally resuspended in PBS +
1% paraformaldehyde. Cells were analyzed on a FACSmate
15 (Becton Dickinson).

 Figure 22. Amino acid sequences of the light chain
(A) and the heavy chain (B) of the humanized M195 antibody
(lower lines) and human Eu antibody (upper lines); not
20 including signal sequences. The three CDR's in each chain are
underlined. Residues in the framework that have been replaced
with mouse amino acids in the humanized antibody are double
underlined.

25 Figure 23. Oligonucleotides used in the
construction of the humanized M195 heavy chain (A; mal-4) and
light chain (B; ma5-8). The following pairs of
oligonucleotides were mixed, extended with Klenow polymerase
and cut with the indicated enzymes before ligation into pUC18:
30 mal and ma2 with Xba I and Kpn I, ma3 and ma4 with Xba I and
Kpn I, ma5 and ma6 with Xba I and Hind III, ma7 and ma8 with
Xba I and Hind III. Then the mal-ma2 and ma3-ma4 fragments
were excised from pUC18 with Xba I and kpn I and ligated
together into the Xba I site of pVg1-dhfr; and the ma5-ma6 and
35 ma7-ma8 fragments were excised with Xba I and Hind III and
ligated together into the Xba I site of pVk.

Figure 24. Competitive binding of labeled M195 tracer to U937 cells. About 4×10^5 U937 cells were incubated with 4.5 ng of radio-iodinated mouse M195 antibody ($6 \mu\text{Ci}/\mu\text{g}$) and varying amounts of either unlabeled mouse M195 antibody (•) or humanized M195 antibody (◦) in 200 ul of binding buffer (PBS + 2% fetal calf serum + 0.1% sodium azide). After incubation for 2 hr at 0°C , the cells were washed twice with binding buffer and collected by centrifugation. The radioactivity bound to cells was measured and is expressed as the ratio of bound/free cpm.

Figure 25. Sequences of the cDNA and translated amino acid sequences of the light chain (A) and heavy chain (B) variable regions of the antibody CMV5. The CDR sequences are underlined. The start of the mature protein sequences are indicated by arrows, preceded by the respective signal sequences.

Figure 26. Schematic diagram of the plasmids pVg1-dhfr (A) and pVκ (B). The plasmid pVg1-dhfr contains the following parts: an approximately 4200 base pair BamHI-EcoRI fragment containing the amp and dhfr genes; a 630-bp fragment containing the human cytomegalovirus IE1 gene promoter and enhancer (Boshart et al., *Cell* 41, 521 (1985)) flanked at the 5' and 3' ends by EcoRI and XbaI linkers respectively; and a 2800 bp XbaI-BamHI fragment containing the human gamma-1 constant region gene with 215 bp of the preceding intron and the poly(A) signal. The plasmid pVκ was similarly constructed, with a 1530-bp human kappa constant region gene replacing the gamma-1 gene and the gpt gene replacing the dhfr gene. The plasmids were constructed from the indicated parts using methods well-known in the art (see, Maniatis et al., Molecular Cloning: A Laboratory Manual, 2nd ed., Cold Spring Harbor Laboratory, Cold Spring Harbor, N.Y. (1989) and commonly assigned U.S. patent application serial No. 07/181,862 filed April 15, 1988). For example, pVHP LaserJet

Series IIHPLASEII.PRSment containing the hyg gene with a 660 bp fragment containing the dhfr gene and extending to a Bgl II site (Simonsen et al., Proc. Natl. Acad. Sci. USA 80, 2495 (1983)).

5

Figure 27. Amino acid sequences of the light chain (A) and the heavy chain (B) of the humanized CMV5 antibody (lower lines) and human Wol antibody (upper lines), not including signal sequences. The three CDR's in each chain are underlined. Residues in the framework replaced with mouse amino acids or typical human amino acids in the humanized antibody are double underlined.

Figure 28. Oligonucleotides used in the construction of the humanized CMV5 light chain (A; jb16-jb19) and heavy chain (B; jb20-jb22). The following pairs of oligonucleotides were mixed, extended with Klenow polymerase and cut with the indicated enzymes before ligation into pUC18: jb16 and jb17 with Xba I and EcoR I, jb18 and jb19 with Xba I and EcoR I, jb20 and jb21 with Xba I and Kpn I, jb22 and jb23 with Xba I and Kpn I. Then the jb16-jb17 and jb18-jb19 fragments were excised with Xba I and Mlu I and ligated together into the Xba I site of pVκ; and the jb20-jb21 and jb22-jb23 fragments were excised with Xba I and Kpn I and ligated together into the Xba I site of pVg1-dhfr.

Figure 29. Competitive binding of labeled CMV5 tracer to CMV-infected cells. Increasing amounts of mouse (•) or humanized (◦) CMV5 antibody was added to CMV-infected HEL cells with tracer radio-iodinated mouse CMV5, and the amount of tracer bound to the cells was determined.

Figure 30. Sequences of the cDNA and translated amino acid sequences of the light chain (A) and heavy chain (B) variable regions of the antibody AF2. The CDR sequences are underlined. The mature light chain protein begins with

amino acid 30 N and the mature heavy chain protein with amino acid 36 Q, preceded by the respective signal sequences.

Figure 31. Schematic diagram of the plasmids pVg1-dhfr (A) and pVk (B). The plasmid pVg1-dhfr contains the following parts: an approximately 4200 base pair BamHI-EcoRI fragment containing the amp and dhfr genes; a 630-bp fragment containing the human cytomegalovirus IE1 gene promoter and enhancer (Boshart et al., Cell 41, 521 (1985)) flanked at the 5' and 3' ends by EcoRI and XbaI linkers respectively; and a 2800 bp XbaI-BamHI fragment containing the human gamma-1 constant region gene with 215 bp of the preceding intron and the poly(A) signal. The plasmid pVk was similarly constructed, with a 1530-bp human kappa constant region gene replacing the gamma-1 gene and the gpt gene replacing the dhfr gene. The plasmids were constructed from the indicated parts using methods well-known in the art (see, Maniatis et al., Molecular Cloning: A Laboratory Manual, 2nd ed., Cold Spring Harbor Laboratory, Cold Spring Harbor, N.Y. (1989) and commonly assigned U.S. patent application serial No. 07/181,862 filed April 15, 1988). For example, pVg1-dhfr was constructed from the plasmid pVg1 (commonly assigned U.S. patent application serial No. 07/590,274 filed September 28, 1990) by replacing the Hind III-Bgl II fragment containing the hyg gene with a 660 bp fragment containing the dhfr gene and extending to a Bgl II site (Simonsen et al., Proc. Natl. Acad. Sci. USA 80, 2495 (1983)).

Figure 32. Amino acid sequences of the light chain (A) and the heavy chain (B) of the humanized AF2 antibody (lower lines) and human Eu antibody (upper lines), not including signal sequences. The three CDR's in each chain are underlined. Residues in the framework that have been replaced with mouse amino acids or typical human amino acids in the humanized antibody are double underlined.

Figure 33. Oligonucleotides used in the construction of the humanized AF2 light chain (A; rh10-rh13) and heavy chain (B; rh20-23). The following pairs of oligonucleotides were mixed, extended with Klenow polymerase and cut with the indicated enzymes before ligation into pUC18: 5 rh10 and rh11 with Xba I and Hind III, rh12 and rh13 with Xba I and Hind III, rh20 and rh21 with Xba I and EcoR I, rh22 and rh23 with Xba I and EcoR I. Then the rh10-rh11 and rh12-rh13 fragments were excised with Xba I and Hind III and ligated 10 together into then Xba I site of pVκ; and the rh20-rh21 and rh22-rh23 fragments were excised with Xba I and Xho I and ligated together into the Xba I site of pVg1-dhfr.

Figure 34. Fluorescence of HS294T cells incubated 15 with γ -IFN plus varying concentrations of mouse AF2 antibody, and stained with an anti-HLA-D antibody.

DETAILED DESCRIPTION OF THE INVENTION

In accordance with the present invention, novel 20 humanized immunoglobulins capable of specifically binding to predetermined antigens with strong affinity are provided. These immunoglobulins are substantially non-immunogenic in humans but have binding affinities of at least about 10^8 M^{-1} , preferably 10^9 M^{-1} to 10^{10} M^{-1} , or stronger. The humanized 25 immunoglobulins will have a human framework and have one or more complementary determining regions (CDR's), plus a limited number of other amino acids, from a donor immunoglobulin specifically reactive with an antigen. The immunoglobulins can be produced economically in large quantities and find use, 30 for example, in the treatment of various human disorders by a variety of techniques.

In order that the invention may be more completely understood, several definitions are set forth. As used herein, the term "immunoglobulin" refers to a protein 35 consisting of one or more polypeptides substantially encoded by immunoglobulin genes. The recognized immunoglobulin genes include the kappa, lambda, alpha, gamma (IgG_1 , IgG_2 , IgG_3 ,

IgG₁), delta, epsilon and mu constant region genes, as well as the myriad immunoglobulin variable region genes. Full-length immunoglobulin "light chains" (about 25 Kd or 214 amino acids) are encoded by a variable region gene at the NH₂-terminus
5 (about 110 amino acids) and a kappa or lambda constant region gene at the COOH - terminus. Full-length immunoglobulin "heavy chains" (about 50 Kd or 446 amino acids), are similarly encoded by a variable region gene (about 116 amino acids) and one of the other aforementioned constant region genes, e.g.,
10 gamma (encoding about 330 amino acids).

One form of immunoglobulin constitutes the basic structural unit of an antibody. This form is a tetramer and consists of two identical pairs of immunoglobulin chains, each pair having one light and one heavy chain. In each pair, the
15 light and heavy chain variable regions are together responsible for binding to an antigen, and the constant regions are responsible for the antibody effector functions. In addition to antibodies, immunoglobulins may exist in a variety of other forms including, for example, Fv, Fab, and
20 (Fab')₂, as well as bifunctional hybrid antibodies (e.g., Lanzavecchia et al., Eur. J. Immunol. 17, 105 (1987)) and in single chains (e.g., Huston et al., Proc. Natl. Acad. Sci. U.S.A., 85, 5879-5883 (1988) and Bird et al., Science, 242, 423-426 (1988)). (See, generally, Hood et al., "Immunology",
25 Benjamin, N.Y., 2nd ed. (1984), and Hunkapiller and Hood, Nature, 323, 15-16 (1986)).

An immunoglobulin light or heavy chain variable region consists of a "framework" region interrupted by three hypervariable regions, also called CDR's. The extent of the
30 framework region and CDR's have been precisely defined (see, "Sequences of Proteins of Immunological Interest," E. Kabat et al., U.S. Department of Health and Human Services, (1983)). The sequences of the framework regions of different light or heavy chains are relatively conserved within a species. As
35 used herein, a "human framework region" is a framework region that is substantially identical (about 85% or more, usually 90-95% or more) to the framework region of a naturally

occurring human immunoglobulin. The framework region of an antibody, that is the combined framework regions of the constituent light and heavy chains, serves to position and align the CDR's. The CDR's are primarily responsible for
5 binding to an epitope of an antigen.

Chimeric antibodies are antibodies whose light and heavy chain genes have been constructed, typically by genetic engineering, from immunoglobulin variable and constant region genes belonging to different species. For example, the
10 variable segments of the genes from a mouse monoclonal antibody may be joined to human constant segments, such as gamma 1 and gamma 3. A typical therapeutic chimeric antibody is thus a hybrid protein composed of the variable or antigen-binding domain from a mouse antibody and the constant
15 or effector domain from a human antibody (e.g., A.T.C.C. Accession No. CRL 9688 secretes an anti-Tac chimeric antibody), although other mammalian species may be used.

As used herein, the term "humanized" immunoglobulin refers to an immunoglobulin comprising a human framework
20 region and one or more CDR's from a non-human (usually a mouse or rat) immunoglobulin. The non-human immunoglobulin providing the CDR's is called the "donor" and the human immunoglobulin providing the framework is called the "acceptor". Constant regions need not be present, but if they
25 are, they must be substantially identical to human immunoglobulin constant regions, i.e., at least about 85-90%, preferably about 95% or more identical. Hence, all parts of a humanized immunoglobulin, except possibly the CDR's, are substantially identical to corresponding parts of natural
30 human immunoglobulin sequences. A "humanized antibody" is an antibody comprising a humanized light chain and a humanized heavy chain immunoglobulin. For example, a humanized antibody would not encompass a typical chimeric antibody as defined above, e.g., because the entire variable region of a chimeric
35 antibody is non-human. One says that the donor antibody has been "humanized", by the process of "humanization", because

the resultant humanized antibody is expected to bind to the same antigen as the donor antibody that provides the CDR's.

It is understood that the humanized antibodies designed by the present method may have additional conservative amino acid substitutions which have substantially no effect on antigen binding or other immunoglobulin functions. By conservative substitutions is intended combinations such as gly, ala; val, ile, leu; asp, glu; asn, gln; ser, thr; lys, arg; and phe, tyr.

Humanized immunoglobulins, including humanized antibodies, have been constructed by means of genetic engineering. Most humanized immunoglobulins that have been previously described (Jones et al., op. cit.; Verhoeyen et al., op. cit.; Riechmann et al., op. cit.) have comprised a framework that is identical to the framework of a particular human immunoglobulin chain, the acceptor, and three CDR's from a non-human donor immunoglobulin chain. In one case (Riechmann et al., op. cit.), two additional amino acids in the framework were changed to be the same as amino acids in other human framework regions. The present invention includes criteria by which a limited number of amino acids in the framework of a humanized immunoglobulin chain are chosen to be the same as the amino acids at those positions in the donor rather than in the acceptor, in order to increase the affinity of an antibody comprising the humanized immunoglobulin chain.

The present invention is based in part on the model that two contributing causes of the loss of affinity in prior means of producing humanized antibodies (using as examples mouse antibodies as the source of CDR's) are:

(1) When the mouse CDR's are combined with the human framework, the amino acids in the framework close to the CDR's become human instead of mouse. Without intending to be bound by theory, we believe that these changed amino acids may slightly distort the CDR's, because they create different electrostatic or hydrophobic forces than in the donor mouse antibody, and the distorted CDR's may not make as effective

contacts with the antigen as the CDR's did in the donor antibody;

(2) Also, amino acids in the original mouse antibody that are close to, but not part of, the CDR's (*i.e.*, still part of the framework), may make contacts with the antigen that contribute to affinity. These amino acids are lost when the antibody is humanized, because all framework amino acids are made human.

3) Injected mouse antibodies have been reported to have a half-life in the human circulation much shorter than the half-life of normal antibodies (D. Shaw *et al.*, *J. Immunol.*, 138, 4534-4538 (1987)). Injected humanized antibodies will presumably have a half-life more similar to naturally occurring human antibodies, allowing smaller and less frequent doses to be given.

To avoid these problems, and to produce humanized antibodies that have a very strong affinity for a desired antigen, the present invention uses one or more of the following principles for designing humanized immunoglobulins. Also, the criteria may be used singly, or when necessary in combination, to achieve the desired affinity or other characteristics.

A principle is that as acceptor, a framework is used from a particular human immunoglobulin that is unusually homologous to the donor immunoglobulin to be humanized, or use a consensus framework from many human antibodies. For example, comparison of the sequence of a mouse heavy (or light) chain variable region against human heavy (or light) variable regions in a data bank (for example, the National Biomedical Research Foundation Protein Identification Resource) shows that the extent of homology to different human regions varies greatly, typically from about 40% to about 60-70%. By choosing as the acceptor immunoglobulin one of the human heavy (respectively light) chain variable regions that is most homologous to the heavy (respectively light) chain variable region of the donor immunoglobulin, fewer amino acids will be changed in going from the donor immunoglobulin to the

humanized immunoglobulin. Hence, and again without intending to be bound by theory, it is believed that there is a smaller chance of changing an amino acid near the CDR's that distorts their conformation. Moreover, the precise overall shape of a humanized antibody comprising the humanized immunoglobulin chain may more closely resemble the shape of the donor antibody, also reducing the chance of distorting the CDR's.

Typically, one of the 3-5 most homologous heavy chain variable region sequences in a representative collection of at least about 10 to 20 distinct human heavy chains will be chosen as acceptor to provide the heavy chain framework, and similarly for the light chain. Preferably, one of the 1-3 most homologous variable regions will be used. The selected acceptor immunoglobulin chain will most preferably have at least about 65% homology in the framework region to the donor immunoglobulin.

In many cases, it may be considered preferable to use light and heavy chains from the same human antibody as acceptor sequences, to be sure the humanized light and heavy chains will make favorable contacts with each other. In this case, the donor light and heavy chains will be compared only against chains from human antibodies whose complete sequence is known, *e.g.*, the Eu, Lay, Pom, Wol, Sie, Gal, Ou and WEA antibodies (Kabat et al., *op. cit.*; occasionally, the last few amino acids of a human chain are not known and must be deduced by homology to other human antibodies). The human antibody will be chosen in which the light and heavy chain variable regions sequences, taken together, are overall most homologous to the donor light and heavy chain variable region sequences. Sometimes greater weight will be given to the heavy chain sequence. The chosen human antibody will then provide both light and heavy chain acceptor sequences. In practice, it is often found that the human Eu antibody will serve this role.

Regardless of how the acceptor immunoglobulin is chosen, higher affinity may be achieved by selecting a small number of amino acids in the framework of the humanized immunoglobulin chain to be the same as the amino acids at

those positions in the donor rather than in the acceptor. A second principle is that the following categories define what amino acids may be selected from the donor. Preferably, at many or all amino acid positions in one of these categories, the donor amino acid will in fact be selected.

Category 1: The amino acid position is in a CDR is defined by Kabat et al., op. cit.

Category 2: If an amino acid in the framework of the human acceptor immunoglobulin is unusual (i.e., "rare", which as used herein indicates an amino acid occurring at that position in less than about 20% but usually less than about 10% of human heavy (respectively light) chain V region sequences in a representative data bank), and if the donor amino acid at that position is typical for human sequences (i.e., "common", which as used herein indicates an amino acid occurring in more than about 25% but usually more than about 50% of sequences in a representative data bank), then the donor amino acid rather than the acceptor may be selected. This criterion helps ensure that an atypical amino acid in the human framework does not disrupt the antibody structure. Moreover, by replacing an unusual amino acid with an amino acid from the donor antibody that happens to be typical for human antibodies, the humanized antibody may be made less immunogenic.

All human light and heavy chain variable region sequences are respectively grouped into "subgroups" of sequences that are especially homologous to each other and have the same amino acids at certain critical positions (Kabat et al., op. cit.). When deciding whether an amino acid in a human acceptor sequence is "rare" or "common" among human sequences, it will often be preferable to consider only those human sequences in the same subgroup as the acceptor sequence.

Category 3: In the positions immediately adjacent to one or more of the 3 CDR's in the primary sequence of the humanized immunoglobulin chain, the donor amino acid(s) rather than

- acceptor amino acid may be selected. These amino acids are particularly likely to interact with the amino acids in the CDR's and, if chosen from the acceptor, to distort the donor CDR's and reduce affinity. Moreover, the adjacent amino acids
- 5 may interact directly with the antigen (Amit *et al.*, *Science*, 233, 747-753 (1986)) and selecting these amino acids from the donor may be desirable to keep all the antigen contacts that provide affinity in the original antibody.
- 10 Category 4: A 3-dimensional model, typically of the original donor antibody, shows that certain amino acids outside of the CDR's are close to the CDR's and have a good probability of interacting with amino acids in the CDR's by hydrogen bonding, Van der Waals forces, hydrophobic
- 15 interactions, etc. At those amino acid positions, the donor immunoglobulin amino acid rather than the acceptor immunoglobulin amino acid may be selected. Amino acids according to this criterion will generally have a side chain atom within about 3 angstrom units of some atom in the CDR's
- 20 and must contain an atom that could interact with the CDR atoms according to established chemical forces, such as those listed above.

In the case of atoms that may form a hydrogen bond,

25 the 3 angstroms is measured between their nuclei, but for atoms that do not form a bond, the 3 angstroms is measured between their Van der Waals surfaces. Hence, in the latter case, the nuclei must be within about 6 angstroms (3 + sum of the Van der Waals radii) for the atoms to be considered

30 capable of interacting. In many cases the nuclei will be from 4 or 5 to 6Å apart. In determining whether an amino acid can interact with the CDRs, it is preferred not to consider the last 8 amino acids of heavy chain CDR 2 as part of the CDRs, because from the viewpoint of structure, these 8 amino acids

35 behave more as part of the framework.

Amino acids in the framework that are capable of interacting with amino acids in the CDR's, and which therefore

belong to Category 4, may be distinguished in another way. The solvent accessible surface area of each framework amino acid is calculated in two ways: (1) in the intact antibody, and (2) in a hypothetical molecule consisting of the antibody with its CDRs removed. A significant difference between these numbers of about 10 square angstroms or more shows that access of the framework amino acid to solvent is at least partly blocked by the CDRs, and therefore that the amino acid is making contact with the CDRs. Solvent accessible surface area of an amino acid may be calculated based on a 3-dimensional model of an antibody, using algorithms known in the art (*e.g.*, Connolly, J. Appl. Cryst. 16, 548 (1983) and Lee and Richards, J. Mol. Biol. 55, 379 (1971)). Framework amino acids may also occasionally interact with the CDR's indirectly, by affecting the conformation of another framework amino acid that in turn contacts the CDR's.

The amino acids at several positions in the framework are known to be capable of interacting with the CDRs in many antibodies (Chothia and Lesk, J. Mol. Biol. 196, 901 (1987), Chothia et al., Nature 342, 877 (1989), and Tramontano et al., J. Mol. Biol. 215, 175 (1990)), notably at positions 2, 48, 64 and 71 of the light chain and 26-30, 71 and 94 of the heavy chain (numbering according to Kabat, *op. cit.*), and therefore these amino acids will generally be in Category 4. Typically, humanized immunoglobulins, of the present invention will include donor amino acids (where different) in category 4 in addition to these. The amino acids at positions 35 in the light chain and 93 and 103 in the heavy chain are also likely to interact with the CDRs. At all these numbered positions, choice of the donor amino acid rather than the acceptor amino acid (when they differ) to be in the humanized immunoglobulin is preferred. On the other hand, certain positions that may be in Category 4 such as the first 5 amino acids of the light chain may sometimes be chosen from the acceptor immunoglobulin without loss of affinity in the humanized immunoglobulin.

Chothia and Lesk (*op. cit.*) define the CDRs differently from Kabat et al. (*op. cit.*). Notably, CDR1 is

defined as including residues 26-32. Accordingly, Riechmann et al., (op. cit.) chose these amino acids from the donor immunoglobulins.

Computer programs to create models of proteins such as antibodies are generally available and well known to those skilled in the art (see, Levy et al., Biochemistry, 28, 7168-7175 (1989); Bruccoleri et al., Nature, 335, 564-568 (1988); Chothia et al., Science, 233, 755-758 (1986)). These do not form part of the invention. Indeed, because all antibodies have similar structures, the known antibody structures, which are available from the Brookhaven Protein Data Bank, can be used if necessary as rough models of other antibodies. Commercially available computer programs can be used to display these models on a computer monitor, to calculate the distance between atoms, and to estimate the likelihood of different amino acids interacting (see, Ferrin et al., J. Mol. Graphics, 6, 13-27 (1988)).

In addition to the above categories, which describe when an amino acid in the humanized immunoglobulin may be taken from the donor, certain amino acids in the humanized immunoglobulin may be taken from neither the donor nor acceptor, if then fall in:

Category 5: If the amino acid at a given position in the donor immunoglobulin is "rare" for human sequences, and the amino acid at that position in the acceptor immunoglobulin is also "rare" for human sequences, as defined above, then the amino acid at that position in the humanized immunoglobulin may be chosen to be some amino acid "typical" of human sequences. A preferred choice is the amino acid that occurs most often at that position in the known human sequences belonging to the same subgroup as the acceptor sequence.

Humanized antibodies generally have at least three potential advantages over mouse or in some cases chimeric antibodies for use in human therapy:

1) Because the effector portion is human, it may interact better with the other parts of the human immune system (e.g., destroy the target cells more efficiently by complement-dependent cytotoxicity (CDC) or antibody-dependent cellular cytotoxicity (ADCC)).

2) The human immune system should not recognize the framework or constant region of the humanized antibody as foreign, and therefore the antibody response against such an injected antibody should be less than against a totally foreign mouse antibody or a partially foreign chimeric antibody.

In one aspect, the present invention is directed to designing humanized immunoglobulins that are produced by expressing recombinant DNA segments encoding the heavy and light chain CDR's from a donor immunoglobulin capable of binding to a desired antigen, such as the human IL-2 receptor, attached to DNA segments encoding acceptor human framework regions. Exemplary DNA sequences designed in accordance with the present invention code for the polypeptide chains comprising heavy and light chain CDR's with substantially human framework regions shown in Figs. 1 through 4. Due to codon degeneracy and non-critical amino acid substitutions, other DNA sequences can be readily substituted for those sequences, as detailed below. In general, the criteria of the present invention find applicability to designing substantially any humanized immunoglobulin.

The DNA segments will typically further include an expression control DNA sequence operably linked to the humanized immunoglobulin coding sequences, including naturally-associated or heterologous promoter regions. Preferably, the expression control sequences will be eukaryotic promoter systems in vectors capable of transforming or transfecting eukaryotic host cells, but control sequences for prokaryotic hosts may also be used. Once the vector has been incorporated into the appropriate host, the host is maintained under conditions suitable for high level expression of the nucleotide sequences, and, as desired, the collection

and purification of the humanized light chains, heavy chains, light/heavy chain dimers or intact antibodies, binding fragments or other immunoglobulin forms may follow (see, S. Beychok, Cells of Immunoglobulin Synthesis, Academic Press, 5 N.Y., (1979)).

Human constant region DNA sequences can be isolated in accordance with well known procedures from a variety of human cells, but preferably immortalized B-cells (see, Kabat op. cit. and WP87/02671). The CDR's for producing the 10 immunoglobulins of the present invention will be similarly derived from monoclonal antibodies capable of binding to the predetermined antigen, such as the human IL-2 receptor, and produced by well known methods in any convenient mammalian source including, mice, rats, rabbits, or other vertebrates, 15 capable of producing antibodies. Suitable source cells for the constant region and framework DNA sequences, and host cells for immunoglobulin expression and secretion, can be obtained from a number of sources, such as the American Type Culture Collection ("Catalogue of Cell Lines and Hybridomas," 20 sixth edition (1988) Rockville, Maryland, U.S.A.).

In addition to the humanized immunoglobulins specifically described herein, other "substantially homologous" modified immunoglobulins to the native sequences can be readily designed and manufactured utilizing various 25 recombinant DNA techniques well known to those skilled in the art. For example, the framework regions can vary specifically from the sequences in Figs. 1 through 4 at the primary structure level by several amino acid substitutions, terminal and intermediate additions and deletions, and the like. 30 Moreover, a variety of different human framework regions may be used singly or in combination as a basis for the humanized immunoglobulins of the present invention. In general, modifications of the genes may be readily accomplished by a variety of well-known techniques, such as site-directed 35 mutagenesis (see, Gillman and Smith, Gene, 8, 81-97 (1979) and S. Roberts et al., Nature, 328, 731-734 (1987)).

Substantially homologous immunoglobulin sequences are those which exhibit at least about 85% homology, usually at least about 90%, and preferably at least about 95% homology with a reference immunoglobulin protein.

5 Alternatively, polypeptide fragments comprising only a portion of the primary antibody structure may be produced, which fragments possess one or more immunoglobulin activities (e.g., complement fixation activity). These polypeptide fragments may be produced by proteolytic cleavage of intact
10 antibodies by methods well known in the art, or by inserting stop codons at the desired locations using site-directed mutagenesis, such as after CH1 to produce Fab fragments or after the hinge region to produce (Fab')₂ fragments. Single chain antibodies may be produced by joining VL and VH with a
15 DNA linker (see, Huston et al., op. cit., and Bird et al., op. cit.). Also because like many genes, the immunoglobulin-related genes contain separate functional regions, each having one or more distinct biological activities, the genes may be fused to functional regions from
20 other genes (e.g., enzymes, see, commonly assigned U.S.S.N. 132,387, filed Dec. 15, 1987) to produce fusion proteins (e.g., immunotoxins) having novel properties. The nucleic acid sequences of the present invention capable of ultimately expressing the desired humanized antibodies can be formed from
25 a variety of different polynucleotides (genomic or cDNA, RNA, synthetic oligonucleotides, etc.) and components (e.g., V, J, D, and C regions), as well as by a variety of different techniques. Joining appropriate synthetic and genomic sequences is presently the most common method of production,
30 but cDNA sequences may also be utilized (see, European Patent Publication No. 0239400 and L. Reichmann et al., Nature, 332, 323-327 (1988)).

As stated previously, the DNA sequences will be expressed in hosts after the sequences have been operably
35 linked to (i.e., positioned to ensure the functioning of) an expression control sequence. These expression vectors are typically replicable in the host organisms either as episomes

or as an integral part of the host chromosomal DNA. Commonly, expression vectors will contain selection markers, e.g., tetracycline or neomycin, to permit detection of those cells transformed with the desired DNA sequences (see, e.g., U.S. Patent 4,704,362).

E. coli is one prokaryotic host useful particularly for cloning the DNA sequences of the present invention. Other microbial hosts suitable for use include bacilli, such as Bacillus subtilis, and other enterobacteriaceae, such as Salmonella, Serratia, and various Pseudomonas species. In these prokaryotic hosts, one can also make expression vectors, which will typically contain expression control sequences compatible with the host cell (e.g., an origin of replication). In addition, any number of a variety of well-known promoters will be present, such as the lactose promoter system, a tryptophan (trp) promoter system, a beta-lactamase promoter system, or a promoter system from phage lambda. The promoters will typically control expression, optionally with an operator sequence, and have ribosome binding site sequences and the like, for initiating and completing transcription and translation.

Other microbes, such as yeast, may also be used for expression. Saccharomyces is a preferred host, with suitable vectors having expression control sequences, such as promoters, including 3-phosphoglycerate kinase or other glycolytic enzymes, and an origin of replication, termination sequences and the like as desired.

In addition to microorganisms, mammalian tissue cell culture may also be used to express and produce the polypeptides of the present invention (see, Winnacker, "From Genes to Clones," VCH Publishers, N.Y., N.Y. (1987)). Eukaryotic cells are actually preferred, because a number of suitable host cell lines capable of secreting intact immunoglobulins have been developed in the art, and include the CHO cell lines, various COS cell lines, HeLa cells, preferably myeloma cell lines, etc, and transformed B-cells or hybridomas. Expression vectors for these cells can include

expression control sequences, such as an origin of replication, a promoter, an enhancer (Queen et al., Immunol. Rev., 89, 49-68 (1986)), and necessary processing information sites, such as ribosome binding sites, RNA splice sites, polyadenylation sites, and transcriptional terminator sequences. Preferred expression control sequences are promoters derived from immunoglobulin genes, SV40, Adenovirus, cytomegalovirus, Bovine Papilloma Virus, and the like.

The vectors containing the DNA segments of interest (e.g., the heavy and light chain encoding sequences and expression control sequences) can be transferred into the host cell by well-known methods, which vary depending on the type of cellular host. For example, calcium chloride transfection is commonly utilized for prokaryotic cells, whereas calcium phosphate treatment or electroporation may be used for other cellular hosts. (See, generally, Maniatis et al., Molecular Cloning: A Laboratory Manual, Cold Spring Harbor Press, (1982).)

Once expressed, the whole antibodies, their dimers, individual light and heavy chains, or other immunoglobulin forms of the present invention, can be purified according to standard procedures of the art, including ammonium sulfate precipitation, affinity columns, column chromatography, gel electrophoresis and the like (see, generally, R. Scopes, "Protein Purification", Springer-Verlag, N.Y. (1982)). Substantially pure immunoglobulins of at least about 90 to 95% homogeneity are preferred, and 98 to 99% or more homogeneity most preferred, for pharmaceutical uses. Once purified, partially or to homogeneity as desired, the polypeptides may then be used therapeutically (including extracorporeally) or in developing and performing assay procedures, immunofluorescent stainings, and the like. (See, generally, Immunological Methods, Vols. I and II, Lefkovits and Pernis, eds., Academic Press, New York, N.Y. (1979 and 1981)).

A preferred pharmaceutical composition of the present invention comprises the use of one or more of the subject antibodies in immunotoxins. Immunotoxins are

characterized by two components and are particularly useful for killing selected cells in vitro or in vivo. One component is a cytotoxic agent which is usually fatal to a cell when attached or absorbed. The second component, known as the "delivery vehicle," provides a means for delivering the toxic agent to a particular cell type, such as cells comprising a carcinoma. The two components are commonly chemically bonded together by any of a variety of well-known chemical procedures. For example, when the cytotoxic agent is a protein and the second component is an intact immunoglobulin, the linkage may be by way of heterobifunctional cross-linkers, e.g., SPDP, carbodiimide, glutaraldehyde, or the like. Production of various immunotoxins is well-known with the art, and can be found, for example in "Monoclonal Antibody-Toxin Conjugates: Aiming the Magic Bullet," Thorpe *et al.*, Monoclonal Antibodies in Clinical Medicine, Academic Press, pp. 168-190 (1982). The components may also be linked genetically (*see*, Chaudhary *et al.*, Nature 339, 394 (1989)).

A variety of cytotoxic agents are suitable for use in immunotoxins. Cytotoxic agents can include radionuclides, such as Iodine-131 or other isotopes of iodine, Yttrium-90, Rhenium-188, and Bismuth-212 or other alpha emitters; a number of chemotherapeutic drugs, such as vindesine, methotrexate, adriamycin, and cisplatin; and cytotoxic proteins such as ribosomal inhibiting proteins like pokeweed antiviral protein, Pseudomonas exotoxin A, ricin, diphtheria toxin, ricin A chain, etc., or an agent active at the cell surface, such as the phospholipase enzymes (e.g., phospholipase C). (*See*, generally, WO90/07861, published July 26, 1990; "Chimeric Toxins," Olsnes and Phil, Pharmac. Ther., 25, 355-381 (1982); and "Monoclonal Antibodies for Cancer Detection and Therapy," eds. Baldwin and Byers, pp. 159-179, 224-266, Academic Press (1985).)

The delivery component of the immunotoxin will include the humanized immunoglobulins of the present invention. Intact immunoglobulins or their binding fragments, such as Fab, are preferably used. Typically, the antibodies

in the immunotoxins will be of the human IgM or IgG isotype, but other mammalian constant regions may be utilized as desired.

The humanized antibodies and pharmaceutical compositions thereof are particularly useful for parenteral administration, i.e., subcutaneously, intramuscularly or intravenously. The compositions for parenteral administration will commonly comprise a solution of the immunoglobulin or a cocktail thereof dissolved in an acceptable carrier, preferably an aqueous carrier. A variety of aqueous carriers can be used, e.g., water, buffered water, 0.4% saline, 0.3% glycine and the like. These solutions are sterile and generally free of particulate matter. These compositions may be sterilized by conventional, well known sterilization techniques. The compositions may contain pharmaceutically acceptable auxiliary substances as required to approximate physiological conditions such as pH adjusting and buffering agents, toxicity adjusting agents and the like, for example sodium acetate, sodium chloride, potassium chloride, calcium chloride, sodium lactate, human albumin, etc. The concentration of antibody in these formulations can vary widely, i.e., from less than about 0.5%, usually at or at least about 1% to as much as 15 or 20% by weight and will be selected primarily based on fluid volumes, viscosities, etc., in accordance with the particular mode of administration selected.

Thus, a typical pharmaceutical composition for injection could be made up to contain 1 ml sterile buffered water, and 1-10 mgs of immunoglobulin. A typical composition for intravenous infusion could be made up to contain 250 ml of sterile Ringer's solution, and 150 mg of antibody. Actual methods for preparing parenterally administrable compositions will be known or apparent to those skilled in the art and are described in more detail in, for example, Remington's Pharmaceutical Science, 15th ed., Mack Publishing Company, Easton, Pennsylvania (1980), which is incorporated herein by reference.

The antibodies of this invention can be frozen or lyophilized for storage and reconstituted in a suitable carrier prior to use. This technique has been shown to be effective with conventional immune globulins and art-known lyophilization and reconstitution techniques can be employed. It will be appreciated by those skilled in the art that lyophilization and reconstitution can lead to varying degrees of antibody activity loss (e.g., with conventional immune globulins, IgM antibodies tend to have greater activity loss than IgG antibodies) and that use levels may have to be adjusted to compensate.

The compositions containing the present humanized antibodies or a cocktail thereof can be administered for prophylactic and/or therapeutic treatments. In therapeutic application, compositions are administered to a patient in an amount sufficient to cure or at least partially arrest the disease and its complications. An amount adequate to accomplish this is defined as a "therapeutically effective dose." Amounts effective for this use will depend upon the severity of the infection and the general state of the patient's own immune system, but generally range from about 1 to about 200 mg of antibody per dose, with dosages of from 5 to 25 mg being more commonly used. It must be kept in mind that the materials of this invention may generally be employed in serious disease states, that is life-threatening or potentially life-threatening situations. In such cases, in view of the minimization of extraneous substances and the lower probability of "foreign substance" rejections which are achieved by the present humanized immunoglobulins of this invention, it is possible and may be felt desirable by the treating physician to administer substantial excesses of these antibodies.

In prophylactic applications, compositions containing the present immunoglobulins or a cocktail thereof are administered to a patient not already in a disease state to enhance the patient's resistance. Such an amount is defined to be a "prophylactically effective dose." In this

use, the precise amounts again depend upon the patient's state of health and general level of immunity, but generally range from 0.1 to 25 mg per dose.

Single or multiple administrations of the
5 compositions can be carried out with dose levels and pattern being selected by the treating physician. In any event, the pharmaceutical formulations should provide a quantity of the antibody(ies) of this invention sufficient to effectively treat the patient.

10 For diagnostic purposes, the antibodies may either be labeled or unlabeled. Unlabeled antibodies can be used in combination with other labeled antibodies (second antibodies) that are reactive with the humanized antibody, such as antibodies specific for human immunoglobulin constant regions.
15 Alternatively, the antibodies can be directly labeled. A wide variety of labels may be employed, such as radionuclides, fluors, enzymes, enzyme substrates, enzyme co-factors, enzyme inhibitors, ligands (particularly haptens), etc. Numerous types of immunoassays are available and are well known to
20 those skilled in the art.

The following examples are offered by way of illustration, not by limitation.

The production of five specific humanized antibodies are described below. The antibodies are: Fd79 and Fd138-80
25 which respectively bind to the gB and gD glycoproteins of herpes simplex virus (Metcalf et al., Intervirology 29, 39 (1988)), M195 (Tanimoto et al., Leukemia 3, 339 (1989)) which binds to the CD33 antigen, mik- β 1 (Tusdo et al., Proc. Natl. Acad. Sci. USA 86, 1982 (1989)) which binds to the p75 chain
30 of the IL-2 receptor, and CMV5 which binds to the gH glycoprotein of cytomegalovirus.

Basically, cDNAs for the heavy chain and light chain variable domain genes of each antibody were cloned using anchored polymerase chain reactions (Loh et al., Science 243,
35 219 (1989)), using 3' primers that hybridized to the constant regions and contained HindIII sites, and 5' primers that hybridized to the dG tails and contained EcoRI sites (Scheme

shown in Fig. 6). The PCR amplified fragments were digested with EcoRI and HindIII and cloned into the pUC18 vector for sequencing. For each antibody, at least two heavy chain and two kappa clones were sequenced and found to have the same
5 sequence. The deduced amino acid sequences of the mature light and heavy chain variable regions are shown in Figs. 1-5, upper lines.

In order to retain high binding affinity of the humanized antibodies, the principles and categories described
10 above were utilized when designing the antibodies. Based on high sequence homology, human antibodies were selected to provide both the acceptor light and heavy chain human frameworks for the mouse antibodies, as follows: human Pom for Fd79, human Eu for Fd138-80, human Eu for M195, human Lay
15 for mik- β 1, and human Wol for CMV5.

The computer programs ABMOD and ENCAD (Levitt, J. Mol. Biol., 168, 595 (1983) and Zilber et al., Biochemistry 29, 10032 (1990)) was used to construct a model of the
20 variable region of each mouse antibody. The model was used to determine the amino acids in each framework that were close enough to the CDR's to potentially interact with them (category 4 above). For each antibody, the positions found to fall in the categories (1) - (5) defined above are given in Table 1, numbered as in Figs. 1-5.

37

TABLE 1

Fd79 Antibody

5	<u>Category</u>	<u>Light Chain</u>	<u>Heavy Chain</u>
	1	24-38, 54-50, 93-100	31-35, 50-66, 99-111
	2	9, 45, 46, 83	82, 112
	3	53	112
10	4	53	97
	5	81	

Fd138-80 Antibody

15	<u>Category</u>	<u>Light Chain</u>	<u>Heavy Chain</u>
	1	24-34, 50-56, 89-97	31-35, 50-66, 99-110
	2	48, 63	93, 98, 111, 112,
20			113, 115
	3	--	30, 67, 98, 111
	4	36, 48, 87	27, 30, 37, 48, 67,
			68, 98

M195 Antibody

25	<u>Category</u>	<u>Light Chain</u>	<u>Heavy Chain</u>
	1	24-38, 54-60, 93-101	31-35, 50-66, 95-105
30	2	10, 52, 67, 110	93, 95, 98, 106, 107
			108, 110
	3	--	30, 67, 98, 106
35	4	40, 52, 74	27, 30, 48, 68, 98

mik- β 1 Antibody

40	<u>Category</u>	<u>Light Chain</u>	<u>Heavy Chain</u>
	1	24-33, 49-55, 88-96	31-35, 50-65, 98-108
	2	13	84, 89, 90
	3	--	30, 49
	4	70	29, 30, 72, 73
45	5	41	1

CMV5 Antibody

50	<u>Category</u>	<u>Light Chain</u>	<u>Heavy Chain</u>
	1	24-34, 50-56, 89-97	31-35, 50-66, 99-108
	2	--	69, 80
	3	49	30
55	4	49	24, 27, 28, 30, 97
	5	--	5

In designing each humanized antibody, at each position the amino acid was selected to be the same as in the human acceptor sequence, unless the position fell in categories (1) - (4), in which case the amino acid from the mouse donor sequence was used, or in category (5), in which case an amino acid typical for human sequences at that position was used.

For the construction of genes for the humanized antibodies, nucleotide sequences were selected that encode the protein sequences of the humanized heavy and light chains, including signal peptides typically from the mouse antibody chains, generally utilizing codons found in the mouse sequence. Several degenerate codons were changed to create restriction sites or to remove undesirable ones. The nucleotide sequences also included splice donor signals typical for immunoglobulin genes and an XbaI site at each end. Each gene was constructed from four overlapping synthetic oligonucleotides. For each variable domain gene, two pairs of overlapping oligonucleotides on alternating strands were synthesized that encompassed the entire coding sequences as well as the signal peptide and the splice donor signal. The oligonucleotides were synthesized on an Applied Biosystems 380B DNA synthesizer. Each oligo was about 110-140 base long with a 15-20 base overlap. Double stranded DNA fragments were synthesized with Klenow or Taq polymerase or sequenase from each pair of oligonucleotides, digested with restriction enzymes, ligated to pUC18 vector and sequenced. Two fragments with the respectively correct half-sequences were then ligated into the XbaI sites of pVg1 (heavy chains of Fd79 and Fd138-80) or pVg1-dhfr (heavy chains of M195, mik- β 1, CMV5) or pVk (all light chains) expression vectors in the appropriate orientations to produce the complete heavy and light chain genes. Reactions were carried out under conditions well-known in the art (Maniatis et al., op. cit.).

The heavy chain and light chain plasmids were transfected into Sp2/0 mouse myeloma cells by electroporation