



US006757365B1

(12) **United States Patent**
Bogard

(10) **Patent No.:** **US 6,757,365 B1**
(45) **Date of Patent:** **Jun. 29, 2004**

(54) **INSTANT MESSAGING VIA TELEPHONE INTERFACES**

(75) Inventor: **Travis A. Bogard**, San Francisco, CA (US)

(73) Assignee: **Tellme Networks, Inc.**, Mountain View, CA (US)

(*) Notice: Subject to any disclaimer, the term of this patent is extended or adjusted under 35 U.S.C. 154(b) by 213 days.

(21) Appl. No.: **09/691,606**

(22) Filed: **Oct. 16, 2000**

(51) **Int. Cl.**⁷ **H04M 1/64**

(52) **U.S. Cl.** **379/88.17; 704/270.1; 709/206**

(58) **Field of Search** 379/88.13, 88.01, 379/88.04, 88.14, 88.16, 88.22, 67.1, 265.01; 704/270.1; 709/206

(56) **References Cited**

U.S. PATENT DOCUMENTS

- 5,721,763 A * 2/1998 Joseph et al. 379/88.04
- 5,799,063 A 8/1998 Krane
- 6,301,609 B1 * 10/2001 Aravamudan et al. 709/206
- 6,324,569 B1 * 11/2001 Ogilvie et al. 709/206
- 6,377,944 B1 * 4/2002 Busey et al. 379/265.01
- 6,405,035 B1 * 6/2002 Singh 455/414
- 6,424,647 B1 * 7/2002 Ng et al. 370/352

- 6,424,945 B1 * 7/2002 Sorsa 704/270.1
- 6,430,602 B1 * 8/2002 Kay et al. 709/206
- 6,430,604 B1 * 8/2002 Ogle et al. 709/207
- 6,463,142 B1 * 10/2002 Kilp 379/88.11

OTHER PUBLICATIONS

Diament et al. Method an apparatus for telephony-enabled instant messaging Jun. 13, 2002.*

Diament et al., Method and Apparatus for Telephony-enabled Instant Messaging Jun. 13, 2002.*

Myers, Telephone Based Access to Intant Messaging, May 17, 2001.*

* cited by examiner

Primary Examiner—Fan Tsang

Assistant Examiner—Gerald Gauthier

(74) *Attorney, Agent, or Firm*—Bever, Hoffman & Harms, LLP; Jeanette S. Harms

(57) **ABSTRACT**

A method and apparatus for enabling users of a phone based speech activated system such as a voice portal to communicate with users of an Internet based instant messenger (IM) service is described. Phone based users are able to send and receive IMs. Incoming messages can cause an asynchronous notification in the user's current voice application and the user can (if they desire) switch contexts to hear the IM and respond. Sent messages may be expeditiously sent to users of the GUI as a hypertext link to a recorded audio. Other sending formats are also possible; similarly, buddy lists can be supported.

7 Claims, 5 Drawing Sheets

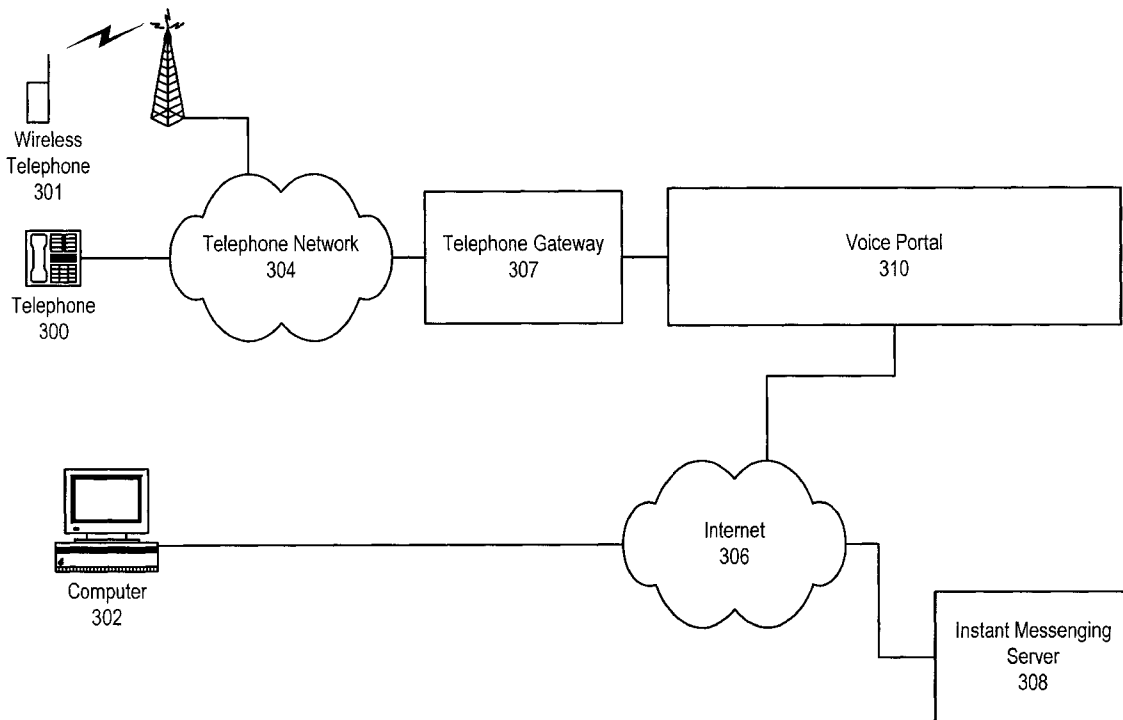

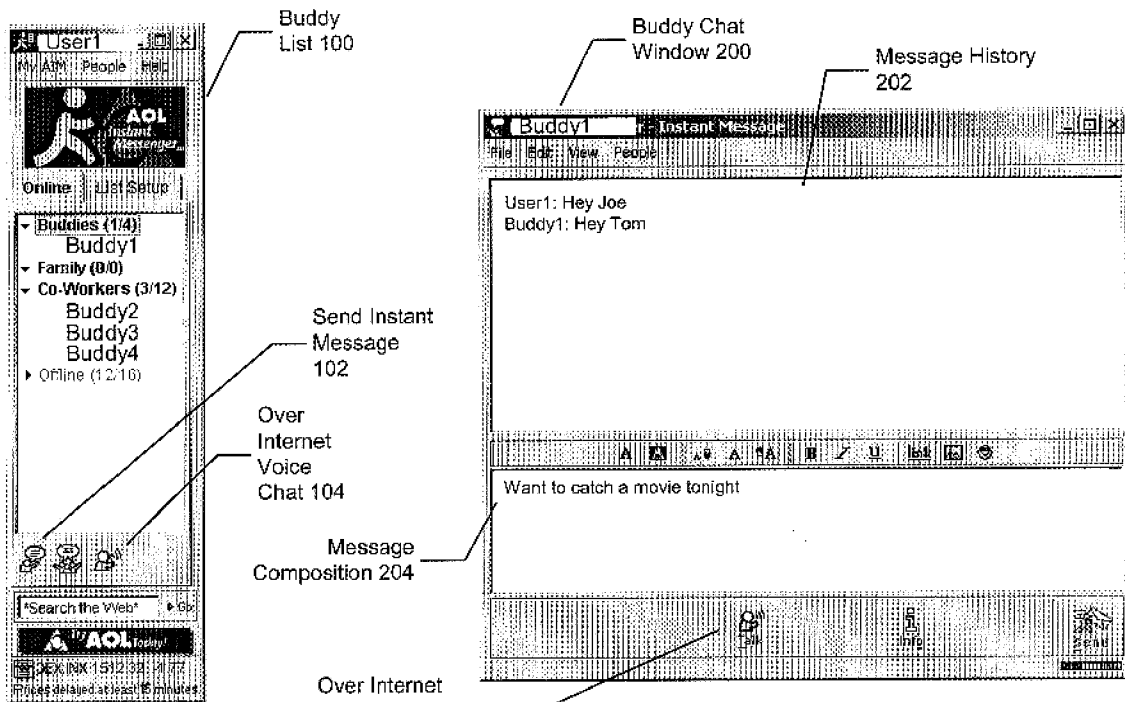
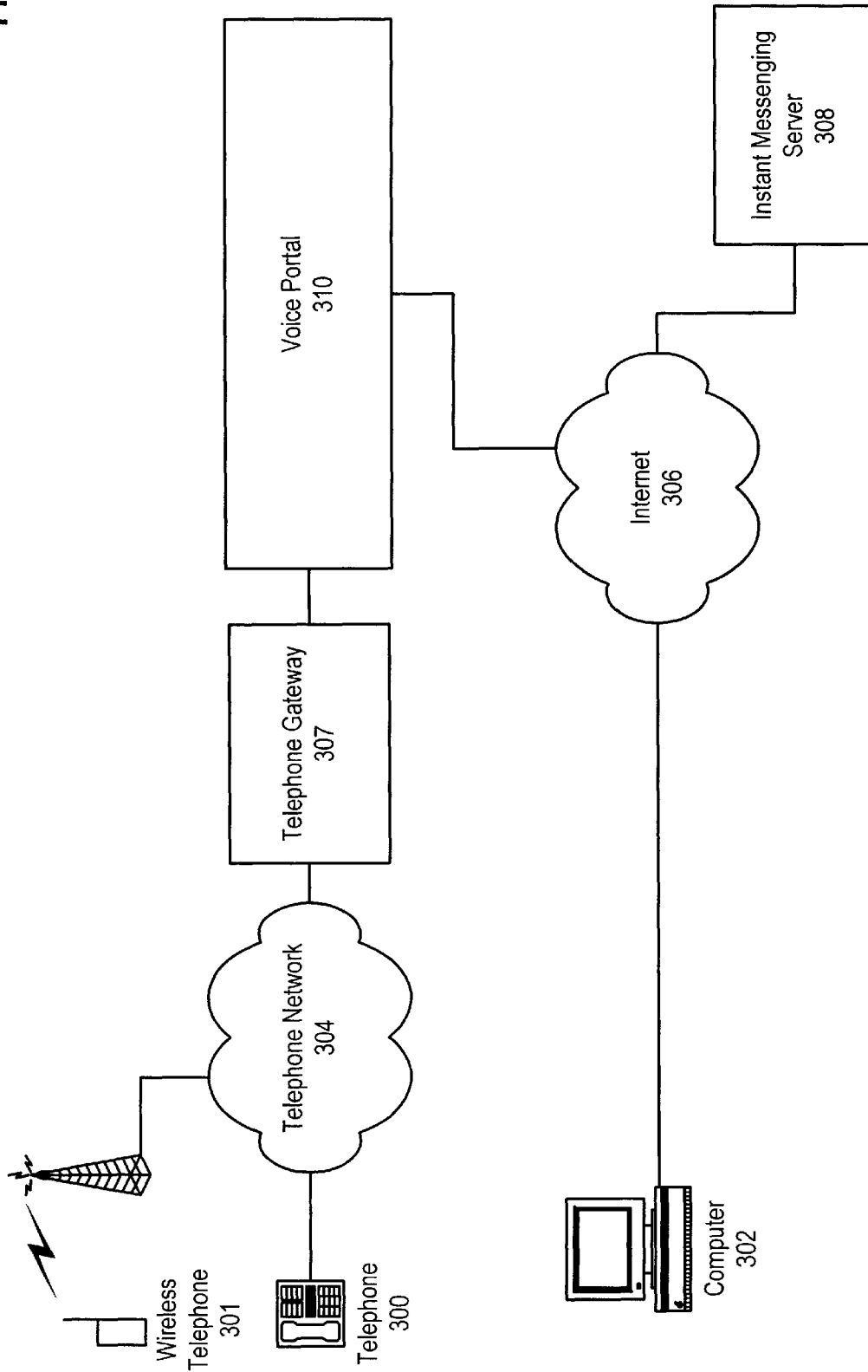

Figure 1 (Prior Art)

Figure 2 (Prior Art)

Figure 3



Initiate Messaging...

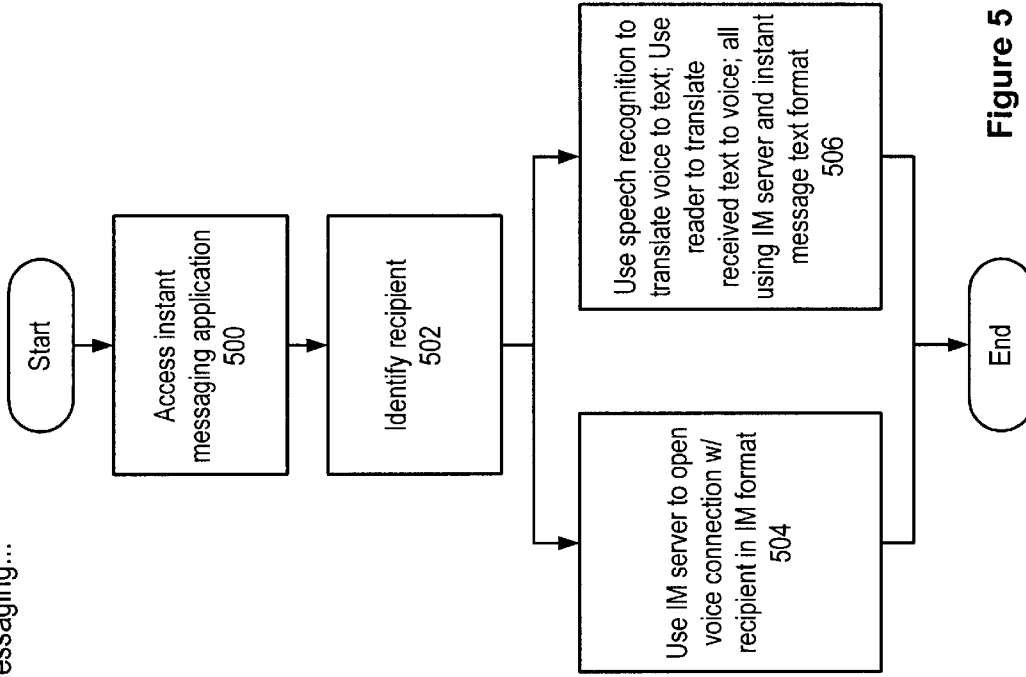

Figure 5

Is a user online?

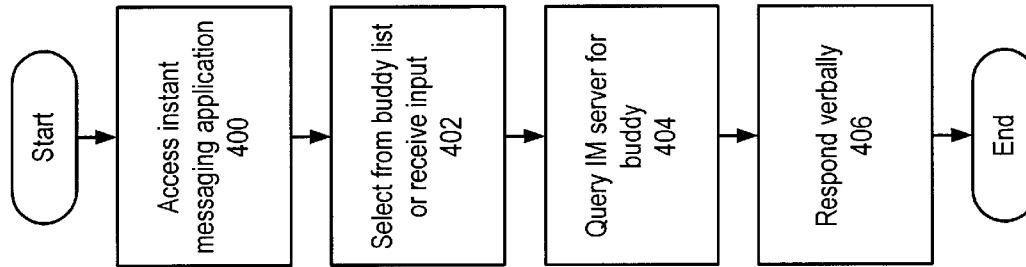

Figure 4

Retrieving Stored Messages...

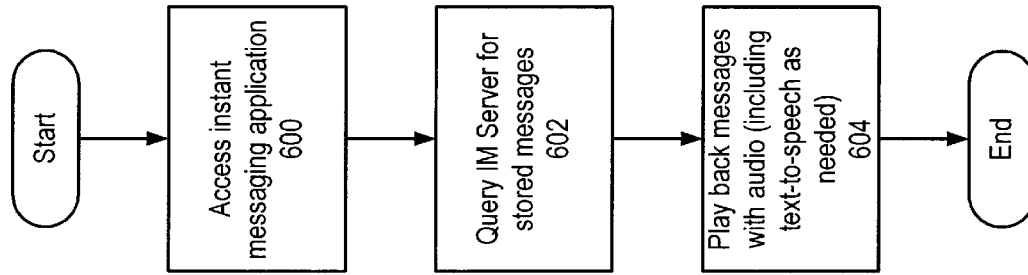

Figure 6

Query IM Server for Information, etc...

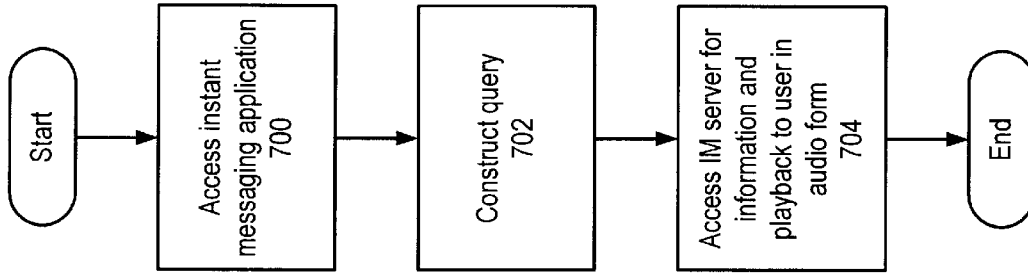

Figure 7

Explore Litigation Insights

Docket Alarm provides insights to develop a more informed litigation strategy and the peace of mind of knowing you're on top of things.

Real-Time Litigation Alerts



Keep your litigation team up-to-date with **real-time alerts** and advanced team management tools built for the enterprise, all while greatly reducing PACER spend.

Our comprehensive service means we can handle Federal, State, and Administrative courts across the country.

Advanced Docket Research



With over 230 million records, Docket Alarm's cloud-native docket research platform finds what other services can't. Coverage includes Federal, State, plus PTAB, TTAB, ITC and NLRB decisions, all in one place.

Identify arguments that have been successful in the past with full text, pinpoint searching. Link to case law cited within any court document via Fastcase.

Analytics At Your Fingertips



Learn what happened the last time a particular judge, opposing counsel or company faced cases similar to yours.

Advanced out-of-the-box PTAB and TTAB analytics are always at your fingertips.

API

Docket Alarm offers a powerful API (application programming interface) to developers that want to integrate case filings into their apps.

LAW FIRMS

Build custom dashboards for your attorneys and clients with live data direct from the court.

Automate many repetitive legal tasks like conflict checks, document management, and marketing.

FINANCIAL INSTITUTIONS

Litigation and bankruptcy checks for companies and debtors.

E-DISCOVERY AND LEGAL VENDORS

Sync your system to PACER to automate legal marketing.